

Energy Storage Technology and Cost Characterization Report

July 2019

K Mongird
V Viswanathan
P Balducci
J Alam

V Fotedar
V Koritarov
B Hadjerioua

PNNL-28866



Acknowledgments

This work was authored by the Pacific Northwest National Laboratory, operated by Battelle for the U.S. Department of Energy (DOE), under contract number DE-AC05-76RL01830; Argonne National Laboratory, operated by UChicago Argonne, LLC, under DOE Contract No. DE-AC02-06CH11357; and Oak Ridge National Laboratory, operated by UT-Battelle, LLC, under DOE Contract No. DE-AC05-00OR22725; and supported by the HydroWIRES Initiative of DOE's Water Power Technologies Office (WPTO).

We are thankful to Dr. Samuel Bockenbauer, Alejandro Moreno, and Marisol Bonnet of the U.S. Department of Energy Office of Energy Efficiency and Renewable Energy WPTO for providing guidance and input on this project. We are also grateful to Dr. Imre Gyuk, who is the Energy Storage Program Manager in the Office of Electricity Delivery and Energy Reliability at the U.S. Department of Energy, and Vince Sprenkle of Pacific Northwest National Laboratory, for reviewing this work. Finally, we would like to recognize the efforts of members of Oak Ridge National Laboratory (Patrick O'Connor and Boualem Hadjerioua) and Argonne National Laboratory (Vladimir Koritarov) for the literature they provided and their review of draft material.

HydroWIRES

The U.S. electricity system is changing rapidly with the large-scale addition of variable renewables, and the flexible capabilities of hydropower (including pumped storage hydropower) make it well-positioned to aid in integrating these variable resources while supporting grid reliability and resilience. Recognizing these challenges and opportunities, WPTO has launched a new initiative known as HydroWIRES: Water Innovation for a Resilient Electricity System. HydroWIRES is principally focused on understanding and supporting the changing role of hydropower in the evolving U.S. electricity system. Through the HydroWIRES initiative, WPTO seeks to understand and drive utilization of the full potential of hydropower resources to contribute to electricity system reliability and resilience, now and into the future.

HydroWIRES is distinguished in its close engagement with the DOE National Laboratories. Five National Laboratories—Argonne National Laboratory, Idaho National Laboratory, National Renewable Energy Laboratory, Oak Ridge National Laboratory, and Pacific Northwest National Laboratory—work as a team to provide strategic insight and develop connections across the DOE portfolio that add significant value to the HydroWIRES initiative.

HydroWIRES operates in conjunction with the Grid Modernization Initiative, which focuses on the development of new architectural concepts, tools, and technologies that measure, analyze, predict, protect, and control the grid of the future, and on enabling the institutional conditions that allow for quicker development and widespread adoption of these tools and technologies.

Energy Storage Technology and Cost Characterization Report

K Mongird¹
V Viswanathan¹
P Balducci¹
J Alam¹

V Fotedar¹
V Koritarov²
B Hadjerioua³

July 2019

¹ Pacific Northwest National Laboratory

² Argonne National Laboratory

³ Oak Ridge National Laboratory

Abstract

This report defines and evaluates cost and performance parameters of six battery energy storage technologies (BESS) (lithium-ion batteries, lead-acid batteries, redox flow batteries, sodium-sulfur batteries, sodium metal halide batteries, and zinc-hybrid cathode batteries) and four non-BESS storage technologies (pumped storage hydropower, flywheels, compressed air energy storage, and ultracapacitors). Data for combustion turbines are also presented. Cost information was procured for the most recent year for which data were available based on an extensive literature review, conversations with vendors and stakeholders, and summaries of actual costs provided from specific projects at sites across the United States. Detailed cost and performance estimates were presented for 2018 and projected out to 2025.

Executive Summary

This report was completed as part of the U.S. Department of Energy's Water Power Technologies Office-funded project entitled Valuation Guidance and Techno-Economic Studies for Pumped Storage Hydropower. The overarching project is ongoing as of the date this report was published and being performed by a multi-lab team consisting of staff from five national laboratories: the Argonne National Laboratory, Idaho National Laboratory, National Renewable Energy Laboratory, Oak Ridge National Laboratory, and the Pacific Northwest National Laboratory.

The objective of this report is to compare costs and performance parameters of different energy storage technologies. Furthermore, forecasts of cost and performance parameters across each of these technologies are made. This report compares the cost and performance of the following energy storage technologies:

- lithium-ion (Li-ion) batteries
- lead-acid batteries
- redox flow batteries
- sodium-sulfur batteries
- sodium metal halide batteries
- zinc-hybrid cathode batteries
- pumped storage hydropower (PSH)
- flywheels
- compressed air energy storage (CAES)
- ultracapacitors.

Cost and performance data were obtained from literature, conversations with vendors, and responses from vendors to questionnaires distributed by the research team. Battery operations and maintenance (O&M) costs were obtained from a relatively smaller number of sources and kept constant across all chemistries. For flywheels, ultracapacitors, CAES, and PSH, values were obtained from vendors.

Key assumptions used to govern the analysis are as follows:

- Capital costs for all battery systems are presented for battery capital and management systems (expressed in terms of \$/kWh), balance of plant (BOP) (\$/kW), power conversion systems (PCS) (\$/kW), and construction and commissioning (C&C) (\$/kWh).
- PCS costs are estimated to be the same across all battery technologies except Li-ion. For Li-ion batteries, the cost is assumed to be 90 percent of other technologies due to its higher DC voltage range. A 25 percent decrease in cost over present-day Li-ion PCS costs is assigned to year 2025 due to the benefits of standardization and scalability resulting from increased production volumes. It is assumed that by 2025 all other battery technologies will catch up in terms of increasing the DC operating voltage range. Reasoning behind this assumption is based on factors being addressed across the technologies. For example, flow batteries have been efficiently addressing shunt current-related issues to increase DC string voltage. Similarly, sodium-based high temperature systems, with their higher unit cell voltage compared to flow battery cells, are well placed to scale up to higher DC voltage levels in the coming years. The lower 2025 PCS cost is assigned uniformly to all battery chemistries.
- O&M costs (fixed and variable) were kept constant across all battery storage technologies.
- Outliers were removed from cost ranges provided by the literature and the remaining reported values were adjusted for inflation. From the adjusted range, a single value estimate was established. When

establishing a single point estimate for each technology, additional weight was given to values reported for systems with energy to power (E/P) ratios closer to the baseline values used in this report. Both the adjusted ranges and the resulting point estimates for 2018 and 2025 are provided in Table ES.1 and Table ES.2. Ranges and values collected from the literature and industry experts are detailed in each individual technology section.

- Suitable multiples were used to forecast 2025 prices from 2018 prices; the multiples ranged from 0.65 for Li-ion battery systems to 0.85 for lead-acid battery systems. Forecast procedures are described in the main body of this report.
- C&C or engineering, procurement, and construction (EPC) costs can be estimated using the footprint or total volume and weight of the battery energy storage system (BESS). For this report, volume was used as a proxy for these metrics.
- For BOP and C&C costs, a 5 percent reduction was assumed from 2018 values due to lower planning, design, and permitting costs achieved through learning with more installations.
- An energy to power E/P ratio of 4 hours was used for all battery technologies.
- An E/P ratio of 16 hours was used for PSH and CAES technologies.
- For flywheels and ultracapacitors, the largest E/P ratio observed to date is 0.25 hours for flywheels and 45 seconds or 0.0125 hours for ultracapacitors.^{1,2} These were the values used in the analysis.

Key findings include:

- Today, for a BESS with an E/P ratio of 4.0, Li-ion batteries offer the best option in terms of cost, performance, calendar and cycle life, and technological maturity.
- PSH and CAES, at \$165/kWh and \$105/kWh, respectively, give the lowest cost in \$/kWh if an E/P ratio of 16 is used inclusive of BOP and C&C costs. PSH is a more mature technology with higher rates of round-trip efficiency.
- While the zinc-hybrid cathode technology offers great promise in terms of cost and life, its technology readiness level (TRL) and manufacturing readiness level (MRL) are both low at this stage.
- Redox flow batteries appear to be well positioned, and rapid improvements are expected in overall cost, performance, life, TRL, and MRL. While the RTE for these batteries is low, there is room for improvement with stack optimization and better flow battery management algorithms.
- While lead-acid batteries are low cost with high TRLs and MRLs, their cycle life is limited, leading to a usable life of less than 3 years assuming one cycle per day.
- Sodium metal halide and sodium sulfur have similar cost and life characteristics, and metal halide technology has a higher RTE. While the planar design for the sodium metal halide technology is expected to reduce cost, as is the substitution of sodium with nickel, uncertainty associated with these innovations led the research team to not build them into the 2025 forecast.
- For PSH, CAES, flywheels, and ultracapacitors, 2025 capital costs were assumed to be the same as those estimated for 2018. These are more mature technologies; hence this study assumed the 2025 costs to be unchanged. Further, while technology innovation has potential to further reduce costs,

¹ Aquino T, M Roling, C Baker, and L Rowland, 2017a. *Battery Energy Storage Technology Assessment*. November 29, 2017. Prepared for the Platte River Power authority by HDR, Omaha, Nebraska.

² Maxwell. 2018a. "Ultracapacitor Overview." Accessed on July 20, 2018 at <http://www.maxwell.com/products/ultracapacitors>.

PSH and CAES involve long-range development timelines and, therefore, a substantial reduction in costs is unlikely to be experienced in a relatively short number of years.

Major findings from this analysis are presented in Table ES.1 and Table ES.2. Values presented are for 2018, with 2025 predictions presented in brackets as available. For the non-BESS table, blank cells are present due to a lack of information for specific cost elements. Total values for these technologies are, however, provided. For batteries, total \$/kWh project cost is determined by the sum of capital cost, PCS, BOP, and C&C where values measured in \$/kW are converted to \$/kWh by multiplying by four (given the assumed E/P ratio of four) prior to summation. Total \$/kW project cost is determined by dividing the total \$/kWh cost by four following the same assumption. The metrics \$/kWh and \$/kW refer to the total energy and power capacities of the technologies, respectively.

Table ES.1. Summary of compiled 2018 findings and 2025 predictions for cost and parameter ranges by technology type – BESS.^(a)

Parameter	Sodium-Sulfur Battery		Li-Ion Battery		Lead Acid		Sodium Metal Halide		Zinc-Hybrid Cathode		Redox Flow Battery	
	2018	2025	2018	2025	2018	2025	2018	2025	2018	2025	2018	2025
Capital Cost – Energy Capacity (\$/kWh)	400-1,000 661	(300-675) (465)	223-323 271	(156-203) (189)	120-291 260	(102-247) (220)	520-1,000 700	(364-630) (482)	265-265 265	(179-199) (192)	435-952 555	(326-643) (393)
Power Conversion System (PCS) (\$/kW)	230-470 350	(184-329) (211)	230-470 288	(184-329) (211)	230-470 350	(184-329) (211)	230-470 350	(184-329) (211)	230-470 350	(184-329) (211)	230-470 350	(184-329) (211)
Balance of Plant (BOP) (\$/kW)	80-120 100	(75-115) (95)	80-120 100	(75-115) (95)	80-120 100	(75-115) (95)	80-120 100	(75-115) (95)	80-120 100	(75-115) (95)	80-120 100	(75-115) (95)
Construction and Commissioning (\$/kWh)	121-145 133	(115-138) (127)	92-110 101	(87-105) (96)	160-192 176	(152-182) (167)	105-126 115	(100-119) (110)	157-188 173	(149-179) (164)	173-207 190	(164-197) (180)
Total Project Cost (\$/kW)	2,394-5,170 3,626	(1,919-3,696) (2,674)	1,570-2,322 1,876	(1,231-1,676) (1,446)	1,430-2,522 2,194	(1,275-2,160) (1,854)	2,810-5,094 3,710	(2,115-3,440) (2,674)	1,998-2,402 2,202	(1,571-1,956) (1,730)	2,742-5,226 3,430	(2,219-3,804) (2,598)
Total Project Cost (\$/kWh)	599-1,293 907	(480-924) (669)	393-581 469	(308-419) (362)	358-631 549	(319-540) (464)	703-1,274 928	(529-860) (669)	500-601 551	(393-489) (433)	686-1,307 858	(555-951) (650)
O&M Fixed (\$/kW-yr)	10	(8)	10	(8)	10	(8)	10	(8)	10	(8)	10	(8)
O&M Variable (cents/kWh)	0.03		0.03		0.03		0.03		0.03		0.03	
System Round-Trip Efficiency (RTE)	0.75		0.86		0.72		0.83		0.72		0.675	(0.7)
Annual RTE Degradation Factor	0.34%		0.50%		5.40%		0.35%		1.50%		0.40%	
Response Time (limited by PCS)	1 sec		1 sec		1 sec		1 sec		1 sec		1 sec	
Cycles at 80% Depth of Discharge	4,000		3,500		900		3,500		3,500		10,000	
Life (Years)	13.5		10		2.6	(3)	12.5		10		15	
MRL	9	(10)	9	(10)	9	(10)	7	(9)	6	(8)	8	(9)
TRL	8	(9)	8	(9)	8	(9)	6	(8)	5	(7)	7	(8)

iii

(a) An E/P ratio of 4 hours was used for battery technologies when calculating total costs.
MRL = manufacturing readiness level; O&M = operations and maintenance; TRL = technology readiness level.

Table ES.2. Summary of compiled 2018 findings and 2025 predictions for cost and parameter ranges by technology type – non-BESS.

Parameter	Pumped Storage Hydropower ^(a)	Combustion Turbine	CAES ^(a)	Flywheel ^(b)	Ultracapacitor ^(c)
Capital Cost – Energy Capacity (\$/kW)	1,700-3,200 2,638	678-1,193 940	1,050-2,544 1,669	600-2,400 2,400	240-400 400
Power Conversion System (PCS) (\$/kW)	Included in Capital Cost	N/A	N/A	Included in Capital Cost	350 (211)
Balance of Plant (BOP) (\$/kW)					100 (95)
Construction and Commissioning (\$/kW)				480 ^(d)	80 ^(d)
Total Project Cost (\$/kW)	1,700-3,200 2,638^(d)	678-1,193 940	1,050-2,544 1,669	1,080-2,880 2,880	930 (835)
Total Project Cost (\$/kWh)	106-200 165		94-229 105	4,320-11,520 11,520	74,480 (66,640)
O&M Fixed (\$/kW-year)	15.9	13.0	16.7	5.6	1
O&M Variable (cents/kWh)	0.00025	1.05	0.21	0.03	0.03
System Round-Trip Efficiency (RTE)	0.80	0.328	0.52	0.86	0.92
Annual RTE Degradation Factor				0.14%	0.14%
Response Time	FS AS Ternary	From cold start: 10 min Spin ramp rate: 8.33%/min Quick start ramp rate: 22.2%/min	3-10 min	0.25 sec	0.016 sec
	Spinning-in-air to full load generation	5-70 s 60 s 20-40 s			
	Shutdown to full generation	75-120 s 90 s 65-90 s			
	Spinning-in-air to full load	50-80 s 70 s 25-30 s			
	Shutdown to full load	160-360 s 230 s 80-85 s			
	Full load to full generation	90-220 s 280 s 25-60 s			
	Full generation to full load	240-500 s 470 s 25-45 s ^(g)			
Cycles at 80% Depth of Discharge	15,000	Not Relevant	10,000	200,000	1 million
Life (Years)	>25	20	25	>20	16
MRL	9 (10)	10	8 (9)	8 (9)	9
TRL	8 (9)	9	7 (8)	7(8)	8
(a) E/P = 16 h			(d) 20 percent of capital cost		
(b) E/P = 0.25 h			AS = adjustable speed; FS = fixed speed.		
(c) E/P = 0.0125 h					

Acronyms and Abbreviations

AC	alternating current
Ah	ampere-hour
BESS	battery energy storage system
BMS	battery management system
BNEF	Bloomberg New Energy Finance New Energy Outlook
BOP	balance of plant
Btu	British thermal unit
BTM	behind-the-meter
C&C	construction and commissioning
CAES	compressed air energy storage
CAGR	compound annual growth rate
CAPEX	capital expenditure
CHP	combined heat and power
CONE	cost of new entry
CPUC	California Public Utility Commission
CT	combustion turbine
DC	direct current
DoD	depth of discharge and Department of Defense
DOE	U.S. Department of Energy
E&M	electrical and mechanical
E/P	energy-to-power (ratio)
E3	Energy and Environmental Economics
EIA	Energy Information Association
EPA	U.S. Environmental Protection Agency
EPC	engineering, procurement, and construction
EPRI	Electric Power Research Institute
ESS	energy storage system
EV	electric vehicle
FERC	Federal Energy Regulatory Commission
FS	fixed speed
G&A	general & administrative
GLIDES	Ground Level Integrated Distributed Energy Storage
GW	gigawatt(s)
h	hour(s)
HRSG	heat-recovery steam generator
HVAC	heating, ventilation, and air-conditioning
ICC	installed capacity cost
IRP	integrated resource planning

kVA	kilovolt-ampere(s)
kW	kilowatt
kWh	kilowatt-hour
LFP	lithium iron phosphate
Li	lithium
LTO	lithium titanate oxide
LTSA	long-term service agreement
MRL	manufacturing readiness level
MW	megawatt
MWh	megawatt-hour
NA	not applicable
NHA	National Hydropower Association
NMC	nickel manganese cobalt oxide
NPV	net present value
NREL	National Renewable Energy Laboratory
O&M	operations and maintenance
OCV	open circuit voltage
OE	Office of Electricity
OEM	original equipment manufacturer
OPEX	operating expenditure
ORNL	Oak Ridge National Laboratory
PCS	power conversion system
PG&E	Pacific Gas & Electric
PNNL	Pacific Northwest National Laboratory
PSH	pumped storage hydropower
PV	photovoltaics and present value
R&D	research and development
RTE	round-trip efficiency
s	second(s)
SENA	Shell Energy North America
SOC	State of Charge
TRL	technology readiness level
UET	UniEnergy Technology
V	volt(s)
VLA	vented lead-acid
VRLA	valve-regulated lead-acid
WECC	Western Electricity Coordinating Council
yr	year(s)

Contents

Acknowledgments.....	ii
Abstract.....	iv
Executive Summary.....	v
Acronyms and Abbreviations	xi
1.0 Introduction	1.1
2.0 Worldwide Energy Storage Deployments by Technology	2.1
2.1 Examples of Energy Storage Deployments.....	2.2
3.0 Technology Cost and Performance Metrics	3.1
3.1.1 Capital Cost (\$/kWh or \$/kW)	3.1
3.1.2 Power Conversion System (\$/kW).....	3.1
3.1.3 Balance of Plant (\$/kW).....	3.3
3.1.4 Construction and Commissioning (\$/kWh).....	3.4
3.1.5 Fixed Operations and Maintenance (\$/kW-yr).....	3.5
3.1.6 Variable Operations and Maintenance (\$/kWh-yr)	3.5
3.1.7 Round-Trip Efficiency	3.5
3.1.8 Response Time	3.6
3.1.9 Cycle Life.....	3.6
3.1.10 Calendar Life.....	3.6
3.1.11 Manufacturing Readiness Level.....	3.7
3.1.12 Technology Readiness Level.....	3.7
3.2 Definitions of Technologies Presented.....	3.8
4.0 Technology Cost and Performance Characterization	4.1
4.1 Assumptions.....	4.1
4.2 Results.....	4.3
4.2.1 Degradation-Related Reduction of RTE	4.8
4.3 Technology-Specific Findings	4.9
4.3.1 Combustion Turbine.....	4.9
4.3.2 Li-Ion Batteries	4.11
4.3.3 Lead-Acid Batteries.....	4.16
4.3.4 Redox Flow Batteries.....	4.18
4.3.5 Sodium-Sulfur Batteries.....	4.21
4.3.6 Sodium Metal Halide Batteries	4.22
4.3.7 Zinc-Hybrid Cathode Batteries	4.24
4.3.8 Pumped Storage Hydropower	4.25
4.3.9 Flywheels	4.37
4.3.10 Compressed Air Energy Storage	4.40

4.3.11 Ultracapacitors	4.45
5.0 Annualized Costs of Technologies	5.1
5.1 Approach	5.1
5.2 Findings and Comparative Analysis	5.2
6.0 Conclusions	6.1
7.0 References	7.1
Appendix A – Questionnaire Supplied to Various Storage Vendors	A.1
Appendix B – PCS, BOP, C&C, and O&M Costs for Various Technologies	B.1
Appendix C – Calculations for RTE Degradation of Battery Storage Technologies.....	C.1
Appendix D – Annualized Cost Values	D.1

Figures

2.1	Proportion of megawatts of internationally deployed pumped storage hydro in comparison to other technologies	2.2
2.2	Breakdown of energy storage deployed internationally by technology type and excluding pumped storage hydro	2.2
2.3	Map of U.S. large-scale battery storage installations by region as of 2017	2.3
2.4	Federal energy regulatory commission map of PSH projects that have received licenses as of October 2018.....	2.4
4.1	Cost of electromechanical equipment for hydro plants.....	4.29
4.2	Capital cost breakdown for a pumped storage hydro plant	4.30
4.3	Initial capital cost estimates for greenfield PSH development for a) 6-hour, b) 8-hour, and c) 10-hour storage times	4.32
4.4	Capital cost by E/P ratio for flywheel technology	4.38
4.5	Schematic of the Siemens SXT-800 CAES	4.41
5.1	Example input values for annualized cost calculation for a sodium-sulfur battery	5.2
5.2	Annualized \$/kWh-yr cost of battery storage technologies by cost component	5.3
5.3	Annualized \$/kWh-yr cost of battery storage technologies vs. pumped storage hydro by cost component.....	5.3
5.4	Annualized \$/kW cost of non-battery technologies	5.4
5.5	Annualized \$/kW cost of all technologies.....	5.4
5.6	Annualized \$/kWh cost of all technologies.....	5.5

Tables

ES.1	Summary of compiled 2018 findings and 2025 predictions for cost and parameter ranges by technology type – BESS.....	viii
ES.2	Summary of compiled 2018 findings and 2025 predictions for cost and parameter ranges by technology type – non-BESS	ix
2.1	Worldwide deployment by technology type, 2018	2.1
3.1	System voltages by technology	3.2
3.2	Calculated PCS cost (\$/kW), 2018 and 2025	3.3
3.3	System volume by technology	3.4
3.4	C&C cost by technology (\$/kWh), 2018 and 2025	3.5
3.5	Manufacturing readiness level descriptions	3.7
3.6	Technology readiness level descriptions.....	3.7
3.7	Technology definitions and descriptive characteristics.....	3.8
4.1	Energy-to-power ratios of technology types	4.1
4.2	Ratio of year 2018 to 2025 costs.....	4.3

4.3	Summary of compiled 2018 findings and 2025 predictions for cost and parameter ranges by technology type – BESS.....	4.4
4.4	Summary of compiled 2018 findings and 2025 predictions for cost and parameter by technology type – non-BESS	4.5
4.5	Estimated decrease in RTE per year for each technology.....	4.9
4.6	Capital cost estimates of CT technology.....	4.10
4.7	Fixed and variable O&M costs for CT systems	4.11
4.8	Capital cost of Li-ion battery systems.....	4.13
4.9	Total average Li-ion project cost estimates by manufacturer	4.13
4.10	EV battery costs in the 2016-2018 time frame.....	4.14
4.11	Total EV pack cost for various EVs in 2018.....	4.14
4.12	Fixed and variable O&M costs of Li-ion battery systems.....	4.15
4.13	Cycles, life years, and round-trip efficiency of Li-ion battery systems	4.15
4.14	Capital cost of lead-acid battery systems	4.17
4.15	Cycles, lifespan, and round-trip efficiency of lead-acid batteries.....	4.18
4.16	Capital costs for redox flow batteries.....	4.19
4.17	Cycles, life years, and round-trip efficiency of redox flow batteries	4.20
4.18	Capital costs of sodium-sulfur battery systems.....	4.21
4.19	Cycles, life years, and round-trip efficiency of sodium-sulfur batteries	4.22
4.20	Cycles, life years, and round-trip efficiency of sodium metal halide batteries	4.24
4.21	Zinc-hybrid cathode battery cost by energy-to-power ratio.....	4.24
4.22	Estimated cost increase (%) for variable-speed PSH over fixed-speed PSH	4.27
4.23	Line item cost breakdown for a 16 H PSH plant.....	4.29
4.24	Capital costs of pumped storage hydro systems.....	4.30
4.25	Fixed O&M costs of pumped storage hydro	4.34
4.26	Cycles, life years, and round-trip efficiency of pumped storage hydro	4.34
4.27	Ramping ability of pumped storage hydro plants	4.35
4.28	Ramping ability of pumped storage hydro plants by technology type.....	4.36
4.29	Capital costs of flywheel systems	4.38
4.30	Capital cost for various E/P ratios for flywheel technology	4.39
4.31	Cycles, life years, and round-trip efficiency of flywheels	4.39
4.32	Capital costs of CAES systems	4.42
4.33	CAES capital cost breakdown by component	4.42
4.34	CAES plant costs in \$/kW and \$/kWh for various E/P ratios or durations.....	4.43
4.35	Cycles, life years, and round-trip efficiency of CAES.....	4.44
5.1	Pro forma assumptions.....	5.1

1.0 Introduction

This report was completed as part of the U.S. Department of Energy's (DOE's) Water Power Technologies Office-funded project entitled Valuation Guidance and Techno-Economic Studies for Pumped Storage Hydropower. As of the date this report was published, this work is ongoing and being carried out by a team comprised of staff from five national laboratories—Argonne National Laboratory, Idaho National Laboratory, National Renewable Energy Laboratory, Oak Ridge National Laboratory (ORNL), and Pacific Northwest National Laboratory (PNNL).

The objectives of this report are to define and compare energy storage technology costs and to evaluate these technologies across a variety of performance parameters. Furthermore, forecasts of cost and performance parameters across each of these technologies are made. Cost and performance characteristics are presented for the following energy storage technologies:

- lithium-ion (Li-ion) batteries
- lead-acid batteries
- redox flow batteries
- sodium-sulfur batteries
- sodium metal halide batteries
- zinc-hybrid cathode batteries
- pumped storage hydropower (PSH)
- flywheels
- compressed air energy storage (CAES)
- ultracapacitors.

Cost information was procured for the most recent year for which data are available. Escalation rates are used where appropriate for technologies that have experienced cost growth and have not been used for technologies such as Li-ion batteries that have decreased in cost over the last 10 years. The base year used is 2018 and projections for 2025 are provided. All costs are presented in 2018 dollars, unless otherwise noted.

The literature collected and analyzed to compile the technology comparisons within this report consists of a wide range of documents. These sources included academic papers, web articles and databases, conversations with vendors and stakeholders, and summaries of actual costs provided from specific projects at sites across the United States. For PSH and other competing technologies, input was solicited from various storage vendors through a questionnaire detailing key parameters with regard to their technology. Feedback collected from these vendors was then compiled and summarized. The input questionnaires that were used to collect current technology characteristics and specifications are included in Appendix A.

2.0 Worldwide Energy Storage Deployments by Technology

As of 2018, nearly 173 GW of energy storage had been deployed across the world. Table 2.1 outlines the current total installed capacity in megawatts by technology type worldwide up to 2018. Information was gathered from the DOE Storage Database (DOE 2018a) and compiled by technology type. Note that some of the records from the database are unverified and therefore the numbers below should be considered approximate.

Table 2.1. Worldwide deployment by technology type, 2018.

Technology	MW Deployed
Sodium sulfur	189
Lithium-ion	1,629
Lead acid	75
Sodium metal halide	19
Flow battery	72
PSH	169,557
CAES	407
Flywheels	931
Electrochemical capacitor	49
Total	172,928

PSH, being primarily a grid-scale storage technology, has the largest amount of deployed megawatts at nearly 170,000 MW (98 percent of worldwide energy storage deployed). PSH is followed by Li-ion, which has the largest quantity deployed of all the electrochemical technologies at just over 1.6 gigawatts (GW). Zinc-hybrid cathodes are not included in the list due to lack of data in the database.

Figure 2.1 depicts the overwhelming quantity of PSH (98 percent) with regard to total megawatts deployed internationally. Figure 2.2 shows the same information but with PSH removed in order to show the breakdown of all other technologies within the remaining 2 percent of capacity deployed internationally. Within that subset, Li-ion storage composes roughly half of the energy storage deployed internationally.

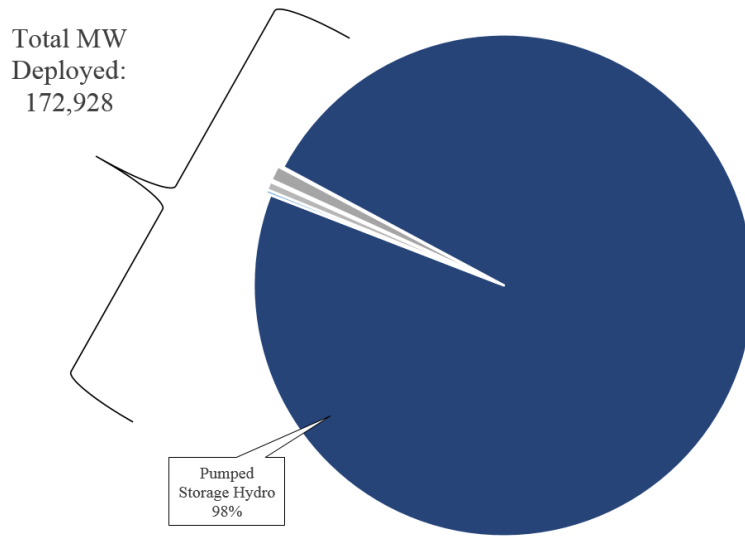

Figure 2.1. Proportion of megawatts of internationally deployed pumped storage hydro in comparison to other technologies.

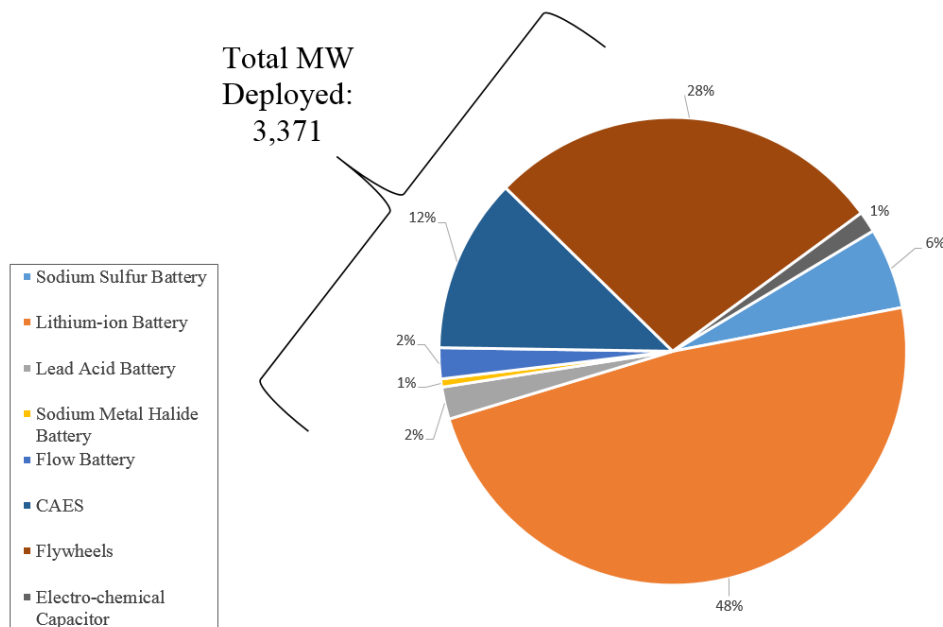

Figure 2.2. Breakdown of energy storage deployed internationally by technology type and excluding pumped storage hydro.

2.1 Examples of Energy Storage Deployments

This section briefly describes energy storage system (ESS) projects currently deployed. While storage procurements started off on a kilowatt or megawatt basis, recent installations suggest increasing E/P ratios, which may drive research and development (R&D) toward storage systems that have high specific energies and energy densities (Ailworth 2018). In terms of engineering, procurement, and construction costs (EPC) costs, as more large ESSs are installed, the planning and design costs could decrease with experience.

Following the California Public Utility Commission’s (CPUC’s) direction to solicit bids for renewable energy resources to replace three fossil-fuel plants (Ailworth 2018), Pacific Gas & Electric (PG&E), the utility that covers a large portion of Northern California, requested approval of four high-power energy storage projects in a filing with the CPUC (PG&E 2018):

- Vistra Moss Landing Energy Storage with Dynergy Marketing and Trade, LLC as the counterparty: a 20-year project using 300 MW, 4-hour, Li-ion batteries with a connection point at the transmission level
- Hummingbird Energy Storage with Hummingbird Energy Storage, LLC as the counterparty: a 15-year project using 75 MW, 4-hour Li-ion batteries with a connection point at the transmission level
- mNOC AERS Energy Storage with Micronoc, Inc. as the counterparty: a 10-year project using behind-the-meter 10 MW, 4-hour Li-ion batteries
- Moss Landing Energy Storage with Tesla, Inc. as the counterparty: a 20-year project using 183 MW, 4-hour Li-ion batteries with a connection point at the transmission level.

Additional high-power and -energy battery energy storage system (BESS) installations, including installations outside the United States, are listed below (Ailworth 2018):

- NextEra Energy is integrating a 30 MW battery with a 100 MW solar array
- Fluence Energy LLC is building a 100 MW BESS system in Long Beach, California, to power 60,000 homes for 4 hours
- A 100 MW/129 MWh Tesla BESS in the Hornsdale Power Reserve in Jamestown, Australia, is the world’s largest operating BESS as of July 2, 2018.

Note that the installations planned by PG&E have E/P ratios greater than the Tesla BESS at Hornsdale, a possible indication of the trend toward higher E/P BESSs. Figure 2.3, a map of large-scale BESS installations in the United States as of 2017, shows the areas in which investments are generally being made (EIA 2018).

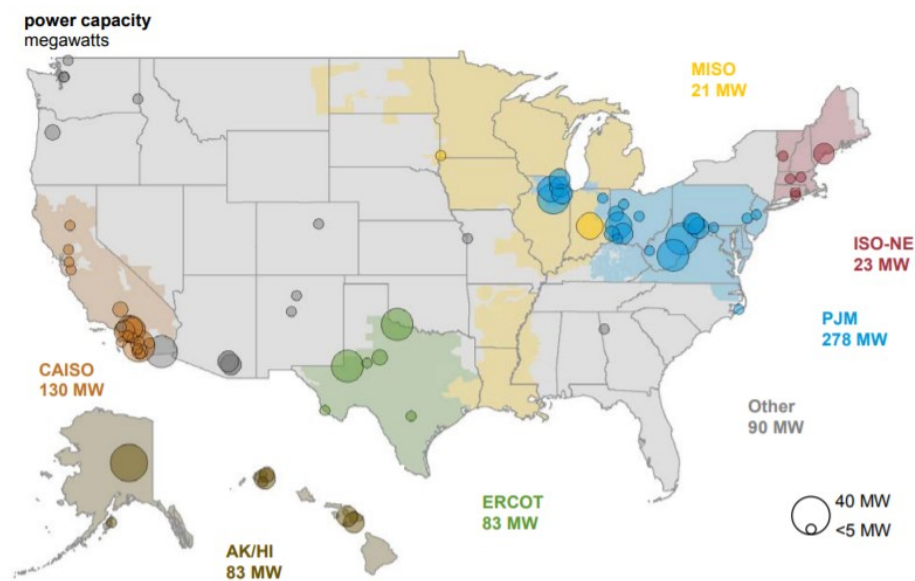
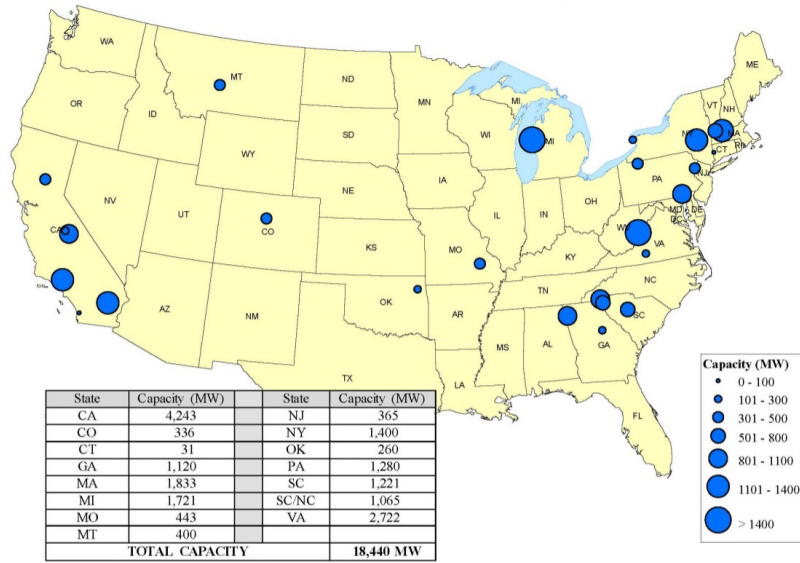

Figure 2.3. Map of U.S. large-scale battery storage installations by region as of 2017.

An example of a non-battery project over 100 MW power capacity is NextEra’s Eagle Mountain PSH project, which will provide 1,300 MW to Southern California. The license to construct the PSH unit was issued in June 2014 (Eagle Crest 2018). Adding onto this, a map of PSH projects that have received licenses as of October 2018 is shown in Figure 2.4 (FERC 2018a).



Source: FERC Staff, October 1, 2018

Figure 2.4. Federal energy regulatory commission map of PSH projects that have received licenses as of October 2018.

3.0 Technology Cost and Performance Metrics

Reported metrics used in this report include those related to capital costs and the costs of PCS, BOP, C&C, fixed and variable operations and maintenance (O&M). Performance metrics include RTE, response time, cycle life, calendar life, MRL, and TRL, as described in the following sections.

3.1.1 Capital Cost (\$/kWh or \$/kW)

Capital cost, as defined here, covers different components that vary by technology type. For batteries and capacitors, capital costs pertain to the procurement of the direct current (DC) energy storage unit and do not include PCS, BOP, or C&C costs. Capital costs for electrochemical storage devices are typically expressed in dollars per kilowatt hour (\$/kWh), while those for flywheels, PSH, CAES, and combustion turbines (CTs) are expressed in dollars per kilowatt (\$/kW). This report remains consistent with the literature for these technologies. While ultracapacitors are electrochemical devices, their total cost can be represented as either \$/kW or \$/kWh based on the application. We chose to express the technology in terms of \$/kW for this report.

For electrochemical storage units, the capital cost reported within this report includes electrodes, electrolytes, and separators. For PSH, it includes waterways, reservoirs, pumps, and electrical generators. For CAES, it includes caverns, compressors, and generators. For electrochemical systems, it should be noted that BOP, which was not available for every technology, was compiled and averaged from the limited consensus found in the literature and applied to all battery energy storage systems (BESSs). For CAES and PSH, total project costs, including installation cost, was typically available in the literature reviewed. While some project capital costs were broken down by component across technology types in the literature, CT costs were reported as a single value.

Lahiri (2017) estimated the cost range for the DC-side modules and BMS for battery systems to be in the range of \$325–\$700/kWh, keeping the values broad to accommodate technology differences. Currently, li-ion battery systems have the lowest capital costs, reaching as low as \$200/kWh (Kamath 2016) due to experience and supply chain development in support of the consumer electronics and automotive markets. Other less mature electrochemical systems, such as sodium-sulfur, have a higher capital cost. Aquino et al. (2017a) provided a range of values for a 4 MW/16 MWh sodium-sulfur system with the low end being \$500/kWh to \$1,000/kWh for just the battery cost. For flywheels, the capital cost also includes PCS costs with a variation of results found across the literature and from vendors between \$600–\$2,000/kW (Aquino et al. 2017a; Goodwin 2018). PSH, CAES, and combustion turbines, on the other hand, typically include all their costs within the total reported capital costs.

3.1.2 Power Conversion System (\$/kW)

This component of BESSs includes the cost for the inverter and packaging, as well as container and inverter controls. The PCS cost is expected to decrease as system voltages increase (Vartanian and Hellested 2018; Minear 2018b), because higher current for the same power rating leads to higher cost. Li-ion system voltages have been trending up, with voltage ranges increasing from 750–1,000 V DC to 1,000–1,500 V DC (Vartanian and Hellested 2018). Additional cost decreases are anticipated once silicon carbide (SiC) technology matures, though this is more applicable to small-scale (<100 kW) inverters.

For large-scale storage at 200 MW, it was anticipated that the PCS costs could decrease to \$140/kVA¹ (Vartanian and Hellested 2018; DOE 2018b). It is not clear what this translates to in terms of \$/kVA for the one to two orders of magnitude lower power levels investigated in this report for BESS.

In addition to voltage-related costs, which fall under the system design bucket, PCS standardization and manufacturing scale are further expected to drive down costs (Minear 2018b). For the Li-ion technology, the cost is assumed to be 90 percent of other technologies due to its higher DC voltage range. However, by 2025, it is assumed that all other battery technologies will have caught up in terms of increasing the DC operating voltage range. A 25 percent decrease in cost over present-day Li-ion PCS cost is assigned to year 2025 because of the benefits of standardization and scalability due to increased volume production. The lower 2025 cost is assigned uniformly to PCS for all battery chemistries. This assumption is supported by developments such as flow batteries efficiently addressing shunt current related issues to increase DC string voltage. Similarly, sodium-based high temperature systems, with their higher unit cell voltage than flow battery cells, are well placed to scale up to higher DC voltage levels in the coming years.

While new technologies such as SiC may mature by 2025, they may not yet benefit from large-volume production. SiC-based inverters are making headway in the electric vehicle (EV) space, charging infrastructure, photovoltaics (PV), power supplies, motor drives, and uninterruptible power supplies (Slovick 2018). This technology is expected to have a compound annual growth rate (CAGR) of 108 percent in the 2017–2023 time frame (Slovick 2018). Wafer supply limitations have been a bottleneck and are expected to be overcome through investments by the lead SiC wafer suppliers. This technology and its impact on cost has not been considered in this report due to lack of sufficient information.

Table 3.1 provides the system voltages for various BESSs.

Table 3.1. System voltages by technology.

Technology	Nominal DC Voltage (V)	Reference
Li-ion	860	Vendor specifications ^(a)
Li-ion	1,221	Samsung (2018)
Sodium metal halide	640	Same value assumed as Sodium Sulfur
Sodium sulfur	640 (5 modules, each module 64 V or 128 V)	Kishinevsky (2005)
Zinc-hybrid cathode	768	EoS (2018a) ^(b)
Lead acid	756 ^(c)	May et al. (2018)

(a) Vendor requests that details of this information be kept confidential

(b) EoS Aurora 1000 I 4000

(c) For several projects, the DC voltage was not clearly specified. The number of cells in each parallel string was stated; however, it was not explicitly stated these cells were in series. For example, 1,032 cells in a string at Chino corresponds to 2,064 V DC, which is too high.

A summary of PCS costs across various battery chemistries is provided in Appendix B. The PCS cost ranged from \$130/kW to \$890/kW. The Electric Power Research Institute (EPRI) proposed \$200/kW for small systems and estimated a 50 percent reduction for large-scale systems (Minear 2018a). PCS is common across all battery technologies (and ultracapacitors) and will affect all of them similarly. Requests for detailed cost information were sent to multiple vendors, and no response was obtained.

¹ We have used kW for AC and DC power in this report. For AC power, the proper term is kVA, where VA is volt-amperes

Based on the above table, the PCS costs were obtained by multiplying the consensus literature PCS cost of \$350/kW by the normalized voltage raised to a power of -0.4 as shown in Table 3.2. Because the nominal DC voltage for Li-ion chemistry is about 63 percent higher than other technologies, the normalized voltage for other technologies is set to 1 based on a nominal DC voltage of 750 V, while Li-ion chemistry normalized voltage is set at 1221/750 or 1.63. For the year 2025, it is assumed that this difference in nominal DC voltage will no longer persist.

Table 3.2. Calculated PCS cost (\$/kW), 2018 and 2025.

Technology	Nominal DC Voltage	Normalized Voltage	(Normalized Voltage)^{-0.4}	PCS Cost \$/kW (Year 2018)	PCS Cost \$/kW (Year 2025)
Li-ion	1221	1.63	0.82	288	211
Sodium metal halide	750	1	1	350	211
Sodium sulfur	750	1	1	350	211
Zinc-hybrid cathode	750	1	1	350	211
Lead acid	750	1	1	350	211

3.1.3 Balance of Plant (\$/kW)

The balance of the energy storage system (ESS), known as the BOP, typically includes components such as site wiring, interconnecting transformers, and other additional ancillary equipment and is measured on a \$/kW basis (DNV GL 2016). The literature has information about PCS, BOP, and C&C cost, but the individual component costs are not well documented (Aquino et al. 2017a; Lahiri 2017; Schoenung 2011). Zakeri and Syri (2015) provided PCS and BOP costs for various BESS chemistries, but the numbers were grouped together, so separate costs could not be obtained. Hayward & Graham (2017) provided BOP costs in \$/kWh, with the cost being \$508/kWh for year 2018 and \$441/kWh for year 2025 in 2017 Australian dollars. At that high of a cost, the research team believes the estimated cost could include some costs that we would deem to be C&C costs. Clean Energy Grid (2014) provides a wide range of BOP cost, expressed in \$/kWh (\$120–\$600/kWh).

The BOP costs are mainly assigned to electrical wiring and connections. Unit cell voltage plays a role to the extent that for the same ampere-hour (Ah) capacity, the cell count decreases with increasing voltage, with lower numbers of cell-to-cell interconnections needed. However, most battery systems have basic repeating units or modules, which consist of multiple cells. The module cost is already captured in the DC system cost. Hence, in terms of module interconnections for large systems, the number of modules in the system determine the inter-module connection costs. The series-parallel design within the battery system determines the maximum current between adjacent modules, thus determining the current conductor specifications for a specific material (width, thickness, and length).

Even for high cell voltage chemistries such as Li-ion, some vendors choose cells with small Ah capacity to improve reliability and safety. For example, Evanexx (2017) states that Tesla uses 18650 cells, which are 18 mm in diameter and 65 mm in height while newer EVs will have cells with 21 mm diameters and 70 mm heights. It is not clear whether these cells will also be used in ESSs. Hence, the unit cell voltage is not a reliable predictor of the cell count in the BESS.

The table in Appendix B summarizes BOP costs for various technologies. Due to the aforementioned considerations, the BOP across all battery chemistries has been set at \$100/kW, a consensus number from

the literature. Because no significant technological improvements are anticipated, a nominal 5 percent decrease in BOP costs is assigned for the year 2025 to account for efficiencies associated with scale.

3.1.4 Construction and Commissioning (\$/kWh)

C&C costs, also referred to as EPC costs, consist of site design costs, costs related to equipment procurement/transportation, and the costs of labor/parts for installation (DNV GL 2016). Damato (2017) reported costs for grid integration, sales tax, fees, and general and administrative (G&A) expenses, from which C&C costs can be estimated by backing out an assumed cost for BOP from other work. The table in Appendix B summarizes BOP and C&C costs for various technologies. The cost decreases are not expected to be as great for C&C because these costs are more mature than those more directly tied to each technology. For grid integration, the cost is mainly a function of system footprint and weight (with discrete steps in costs), degree of factory assembly vs. onsite assembly (the total cost may be the same regardless of where the assembly occurs), and architecture in terms of open racks vs. containerized systems (Minear 2018a). Potential new costs are introduced if the storage system is installed at the transmission level (Minear 2018a), which is in line with our findings for PSH (Manwaring 2018a).

For this report, C&C cost was addressed strictly using the system footprint or using the total volume and weight of the BESS. Volume has been used as a proxy for all these metrics. Footprint in and of itself does not capture the system volume and weight. While volume does not accurately reflect the BESS weight, it is a better proxy for weight than footprint. For future work, it is recommended that a weighted combination of system footprint, volume, and weight per unit energy be used. For this work, the normalized volume per watt-hour is used as a metric.

The consensus C&C costs from the literature were increased by 15 percent for the technology with the smallest energy density or largest liters per watt-hour (L/Wh). This value was multiplied by the normalized volume per watt-hour raised to a power of 0.33 to yield a Li-ion C&C cost of \$100/kWh, slightly higher than the \$80/kWh estimated by McLaren et al. (2016). A 5% drop was assumed for year 2025 because while gains have been made in recent years, the estimated C&C cost at \$100/kWh is on the low-end of current estimates with little scope for further cost decrease due to “learning”. Additionally, any benefits going further along the learning curve are expected to be partially balanced by higher material and labor costs with increased penetration of storage. Table 3.3 provides system volume, while Table 3.4 provides the C&C cost.

Table 3.3. System volume by technology.

Battery Chemistry	Wh/L	Reference	Notes
Redox flow battery	12.5	UET (2018)	
Li-ion BESS	80	Research Interfaces (2018)	
Li-ion BESS	90-130 ^(a)	Research Interfaces (2018)	
Na-S	40	Gotschall & Eguchi (2009)	
Sodium halide	65	LCE Energy (2011)	Large-scale system Wh/L assumed to be 60% of the 9.6 kWh module
Lead acid Chino system	16	Rodrigues (1990)	Large-scale system Wh/L assumed to be 60% of the 30-kWh module
Zinc-hybrid cathode	17	EoS (2018b)	

(a) Use 100 Wh/L for Li-ion BESS.

Table 3.4. C&C cost by technology (\$/kWh), 2018 and 2025.

Chemistry	L/Wh Normalized	(L/Wh normalized) ^{0.33}	C&C Cost \$/kWh, Year 2018	C&C Cost \$/kWh, Year 2025
Li-ion	0.12	0.53	101	96
Sodium halide	0.19	0.61	115	110
Na-S	0.31	0.70	133	127
Lead acid	0.78	0.93	176	167
Zinc-hybrid cathode	0.73	0.91	173	164
Redox flow battery	1	1	190	180

3.1.5 Fixed Operations and Maintenance (\$/kW-yr)

Fixed O&M includes all costs necessary to keep the storage system operational throughout the duration of its economic life that do not fluctuate based on energy usage. This value is normalized with respect to the rated power of the storage system and is expressed as \$/kW-yr. Appendix B summarizes O&M costs for various technologies. It is clear that available O&M costs for all battery chemistries were in the range of \$6–\$20/kW-yr, with most in the \$6–14/kW-yr range (Aquino et al. 2017a and DNV GL 2016). A fixed O&M cost of \$10/kW-yr was used for all battery chemistries.

3.1.6 Variable Operations and Maintenance (\$/kWh-yr)

Variable O&M includes all costs necessary to operate the storage system throughout the duration of its economic life and is normalized with respect to the annual discharge energy throughput. For this reason, this value is expressed as cents/kWh. Variable O&M costs account for wear and tear of the system during operation. Few resources in the literature provided a concrete variable O&M value (Black & Veatch 2012; Aquino et al. 2017a). Those that did assumed it to be approximately 0.3 cents/kWh-year (see table in Appendix B). This report uses this number for variable O&M for other battery technologies. Note that cycle and calendar life for each system, when accounted for properly, provide the correct variable costs as the storage system ages, while incorporation of RTE accounts for variable costs related to discharge and the subsequent recharge. Hence, the variable cost of 0.03 cents/kWh, as it appears in the literature, is assumed to be a catch-all for energy throughput-related costs that are not accounted for by cycle/calendar life and RTE.

3.1.7 Round-Trip Efficiency

RTE is the ratio of net energy that is discharged to the grid (after removing auxiliary load consumption) to the net energy used to charge the battery (after including the auxiliary load consumption) (DOE 2011b). Losses for BESSs can be grouped into the following categories:

- Loss of Ah capacity. While Ah loss can be high over the course of the battery life, it is negligible for each cycle. In flow batteries, cross-over-related losses accumulate over several cycles but are negligible for each cycle.
- Internal resistance-related losses reduce discharge voltage while increasing charge voltage.
- Auxiliary loads such as heating, ventilation, and air-conditioning (HVAC), battery management systems (BMSs), PCS controls, and pumps (for flow batteries).

While there is no single RTE value for each technology, this work lists DC-DC RTE for each technology, and used 0.96 RTE for PCS to compute the overall system RTE for each technology (Newbery 2016). For most cases, the DC-DC RTE was used in our alternating current (AC)-AC RTE estimates. For some cases, where system RTE was available based on our work on grid-scale battery testing and analysis, these values were also used in our RTE analysis.

RTEs for non-BESS technologies are described in the respective sections when appropriate. In general, RTE is simply the ratio of net energy discharged to the net energy charged, with the system being brought back to the initial state.

3.1.8 Response Time

Ramp rate is the time (typically in seconds or minutes) that a system takes to change its output level from rest to rated power; faster ramp rates or lower response times are more valuable. Response time, for the most part, is determined by the inverter selection for the application and the overall system design. If response time is critical to operation of a system, the owner of the project can select a PCS or DC stack design that can respond at the desired rate. For flow batteries, for example, if the DC stack design is such that it can ramp up to the rated power within one second, it would then be the inverter that determined the response time.

Based on an extensive literature review and testing of Li-ion and flow battery systems conducted by the research team, the response times for the DC battery and ultracapacitor ESSs contained in this report were assumed to be less than one second. However, extensive tests conducted by the research team have shown that inverter response times can range from as little as less than 1 second to approximately 13 seconds to reach rated power. Therefore, we assume that the response times for the ultracapacitor and the BESSs contained in this analysis would be 1 second, subject to PCS limitations that could extend the response time out by an additional 1-13 seconds. Flywheel response time provided by vendors was determined to be 250 milliseconds from the information gathered. Lastly, for other technologies, such as PSH and CAES, the time to go from shutdown to full power can be as high as 2–10 minutes.

3.1.9 Cycle Life

The cycle life for conventional batteries is a function of its depth of discharge (DoD), but the life for a redox flow battery does not depend on DoD. For PSH and CAES, degradation depends on the number of mode changes. Flywheels and ultracapacitors have cycle lives >200,000, because chemical degradation is not an issue.¹ The cycle life of batteries was compiled at 80 percent DoD.

3.1.10 Calendar Life

Calendar life for batteries is highly dependent on the operating conditions. For batteries and ultracapacitors operating at ambient temperatures, the life decreases with an increase in operating and/or ambient temperature. Calendar life is defined strictly as the maximum life of the system when it is not being operated, because when it is being cycled, depending on the degradation rate of calendar vs. cycle life, one of them determines the overall life of the system. The calendar life used in this work uses data gathered from literature and from vendors.

¹ See Sections 4.2.9 and 4.2.11 for specific values and references.

3.1.11 Manufacturing Readiness Level

MRL is a measure used for assessing how mature the manufacturing of a product for a technology is and it ranges from a scale of 1 (basic manufacturing issues identified) through 10 (high rate production using efficient production practices demonstrated). According to the *U.S. Department of Defense Manufacturing Readiness Levels Deskbook* (DOD 2017), the values represent a “non-linear ordinal scale that identifies what maturity should be as a function of where a program is in the acquisition life cycle.” Table 3.5, reproduced from the Deskbook, provides an overview of each of the manufacturing scales at which the technologies in this report are measured.

Table 3.5. Manufacturing readiness level descriptions.

Manufacturing Readiness Level	Description
MRL 1	Basic manufacturing implications identified
MRL 2	Manufacturing concepts identified
MRL 3	Manufacturing proof of concept developed
MRL 4	Capability to produce the technology in a laboratory environment
MRL 5	Capability to produce prototype components in a production relevant environment
MRL 6	Capability to produce a prototype system or subsystem in a production relevant environment
MRL 7	Capability to produce systems, subsystems, or components in a production representative environment
MRL 8	Pilot line capability demonstrated; ready to begin low rate initial production
MRL 9	Low rate production demonstrated; capability in place to begin full rate production
MRL 10	Full rate production demonstrated and lean production practices in place

3.1.12 Technology Readiness Level

TRL is a measure used for assessing the phase of development of a technology. TRL indicates how mature the technology is and ranges from a scale of 1 (basic principle observed) through 9 (total system used successfully in project operations). Table 3.6, reproduced from the *U.S. Department of Energy (DOE) Technology Readiness Assessment Guide* (DOE 2011a), shows an overview of each of the scales that the technologies in this report are graded on. All of the technologies included in this report are TRL 5 or higher. Combustion turbines offer the highest TRL at 9, followed by several technologies at TRL 8.

Table 3.6. Technology readiness level descriptions.

Technology Readiness Level	Description
TRL 1	Basic principles observed and reported
TRL 2	Technology concept and/or application formulated
TRL 3	Analytical and experimental critical function and/or characteristic proof of concept
TRL 4	Component and/or system validation in laboratory environment
TRL 5	Laboratory scale, similar system validation in relevant environment
TRL 6	Engineering/pilot scale; similar (prototypical) system validation in relevant environment
TRL 7	Full scale; similar (prototypical) system demonstrated in relevant environment
TRL 8	Actual system completed and qualified through test and demonstration.
TRL 9	Actual system operated over the full range of expected mission conditions.

3.2 Definitions of Technologies Presented

An overview of each of the energy storage technologies included and compared in this report is provided in Table 3.7 (EASE 2016; ESA 2018; EoS 2017; GE Power 2018). The characteristics that define the technology’s performance, such as ramp time, RTE, and parameters described in the previous section, as well as estimates for unit energy and power costs, are included later in Section 4.0 for each technology.

Table 3.7. Technology definitions and descriptive characteristics.

Type	Technology	Description	Typical Power Range	Typical Energy Range
Electrochemical Energy Storage	Sodium-sulfur battery	A molten-salt battery made up of sodium (Na) and sulfur (S) that operates at high temperature ranges and is primarily suitable for >4-hour duration applications.	Several kW to few MW	100 kWh or higher
	Li-ion battery	A battery based on charge and discharge reactions from a lithiated metal oxide cathode and a graphite anode. This battery technology is used in a wide variety of applications.	1 kW to 100 MW	<200 MWh
	Lead-acid battery	A battery made up of lead dioxide (PbO ₂) for the positive electrode and a spongy lead (Pb) negative electrode. Vented and valve-regulated batteries make up two subtypes of this technology.	Up to a few MW	<10 MWh
	Sodium metal halide battery	A molten battery made up of nickel (Ni), sodium chloride (NaCl), and sodium (Na) which is kept at a temperature between 270°C and 350°C. Batteries using other materials are being developed to decrease cost and operation temperature.	Several MW	4 kWh – several MWh
	Zinc-hybrid cathode battery	A high-energy density battery storage technology that uses inexpensive and widely available materials. Zinc-hybrid cathode batteries use non-flammable, near-neutral pH aqueous electrolytes that are non-dendritic and do not absorb CO ₂ .	250 kW subsystem repeat unit up to 2 MW	1 MWh subsystem repeat unit up to 8 MWh
	Redox flow battery	A battery in which energy storage in the electrolyte tanks is separated from power generation in stacks. The stacks consist of positive and negative electrode compartments divided by a separator or an ion exchange membrane through which ions pass to complete the electrochemical reactions. Scalability due to modularity, ability to change energy and power independently, and long cycle and calendar life are attractive features of this technology.	Several kW – 30 MW	100 kW to 120 MWh

Type	Technology	Description	Typical Power Range	Typical Energy Range
Mechanical Energy Storage	Compressed air energy storage	This energy storage system is based on using electricity to compress air and store it in underground caverns. The air is released when needed and passed through a turbine to generate electricity.	Up to 500 MW	1 GWh to 20 GWh
	Flywheels	A storage system that relies on kinetic energy from rotor spinning through a “nearly frictionless enclosure” that can provide short-term power through inertia.	Up to 20 MW	Up to 5 MWh
	Pumped storage hydro	A technology that stores energy by pumping water from a lower to a higher reservoir and then releasing it back through the connection, passing through a turbine(s), which generates electricity. This technology is typically used for grid-scale storage.	Up to 3,600 MW	Up to 40 GWh
Electrical Energy Storage	Ultracapacitor	Ultracapacitors store energy at the double layer of each electrode separated by a dielectric and can discharge energy instantaneously. Due to lack of chemical reaction, the cycle life is orders of magnitude higher than battery cycle life.	250 kW to 2 MW	2.5 kWh to 20 kWh
Non-storage Generation	Combustion turbine	A gas turbine converts fuel such as natural gas to mechanical energy, which drives a generator to produce electricity.	10 kW – 100 MW	Not applicable

4.0 Technology Cost and Performance Characterization

This section presents details concerning any assumptions governing the cost and performance characterizations presented throughout this report. Details are presented on a technology-by-technology basis.

4.1 Assumptions

The following assumptions were made when determining the estimates for the cost and performance of each type of technology in the analysis:

- For each technology, unit energy and power costs were obtained from literature and/or vendors. Battery costs were available from vendors, supplemented by literature, in terms of \$/kWh, while ultracapacitor costs provided by vendors were in both \$/kW and \$/kWh. Flywheel, PSH, and CAES costs were provided by vendors, supplemented by literature, in terms of \$/kW. Appropriate sources are noted within each technology subsection for values collected.
- For the Li-ion technology, the PCS cost is assumed to be 82 percent of other technologies due to its higher DC voltage range. However, by 2025, it is assumed that all other battery technologies will have caught up in terms of increasing the DC operating voltage range due to shown improvements and other factors. For example, flow batteries have been efficiently addressing shunt current-related issues in order to increase DC string voltage. Similarly, sodium-based high temperature systems, with their higher unit cell voltage compared to flow battery cells, are well placed to scale up to higher DC voltage levels in the coming years. A 25 percent decrease in cost over present-day Li-ion PCS cost is assigned to year 2025 due to the benefits of standardization and scalability resulting from increased volume production. This percentage is estimated based on the expected growth in installed storage (MW) in the U.S. for 2025 and applying a learning curve model used to forecast price based on cumulative production (Kelly-Detwiler 2017; Alberth 2008). This lower value is applied to all battery technologies. The summary of PCS, BOP, and C&C costs for various technologies is provided in Appendix B.
- For flywheels, installation costs ranged from 5 to 25 percent of the system cost, while 20 percent of system cost was used in this work to estimate flywheel system installation costs (Helix Power 2018; Goodwin 2018). The same fraction was used for ultracapacitors.
- The typical power and energy for each technology used in this report are given in Table 4.1, along with their E/P ratios. For calculation purposes, the E/P ratios were used to convert all \$/kW values to \$/kWh values. It is assumed that the rated energy in the BESS technical specifications is provided at the specified rated power. Vendors will occasionally oversize the DC battery so that the measured energy is greater than the rated energy. Sometimes, the rated energy is available at a fraction of rated power. In some instances, the same BESS could have different combinations of rated power and corresponding rated energy (UET 2018).

Table 4.1. Energy-to-power ratios of technology types.

Technology	MW	MWh	E/P
Battery	1	4	4
Ultracapacitor	1	0.0125	0.0125
CAES	250	4,000	16
Flywheel	20	5	0.25
PSH	2,000	32,000	16

- For all battery technologies, the same fixed and variable O&M costs were used. While Li-ion may have more costs associated with safety and BMSs, the larger size of other battery technologies can result in higher O&M costs, and their relatively safe operational characteristics work toward lowering O&M costs.
- The cycle life reported for each technology corresponds to a DoD of 80 percent. Cycle life, where provided in the literature, is listed in each technology's subsection. When cycle life was provided without a DoD, a DoD of 80 percent was assumed.
- Performance parameters for PSH, flywheels, sodium metal halide batteries, zinc-hybrid cathode batteries, and ultracapacitors were compiled based on communication with various vendors and the reviewed literature. Specific sources are noted within the technology subsections.
- Outliers were removed from cost ranges provided by the literature and the remaining reported values were adjusted for inflation. From the adjusted range, a single value estimate was established. When establishing a single point estimate for each technology, additional weight was given to values reported for systems with energy to power (E/P) ratios closer to the baseline values used in this report. Both the adjusted ranges and the resulting point estimates for 2018 and 2025 are provided in Table 4.3 and Table 4.4. Ranges and values collected from the literature and industry experts are provided in each individual technology section.
- Predictions regarding cost estimates for the year 2025 were obtained using performance improvement forecasts, which allow developers to extract more energy per unit mass, and economies of scale. The numbers used by DNV GL (2016) are shown in Table 4.2. The drop in Li-ion price was estimated to be 67 percent and in zinc air to be 60 percent, while sodium-sulfur and redox flow batteries dropped by 9 percent and 18 percent, respectively. The ratio used in this report is shown in the last column. A 35 percent drop in Li-ion prices was estimated. It was assumed that economies of scale would be balanced by an increase in demand for nickel, cobalt, and lithium. For the vanadium redox battery, it was assumed that the drop would be 29 percent, greater than the 18 percent estimated by DNV GL. As demand increases, electrode and membrane costs within the stack are expected to decrease (Viswanathan 2014; Crawford 2015). Improvement in performance is expected to increase the power density, allowing for use of fewer stacks to provide the same power, thereby further decreasing cost. For energy intensive applications, for the same power density, a larger DoD (or State of Charge [SOC] range) can be expected for redox flow battery systems, thereby dropping the unit energy costs. While a 60 percent drop in a zinc air system was estimated by the vendor, our work is a bit more conservative, and estimates a 28 percent drop from the already low cost of the zinc-hybrid cathode (or zinc air) battery system. For the sodium-sulfur system, so far deployments have been mainly in Japan. With some of the safety issues resolved, if the deployment of this technology increases globally, a 24 percent drop in cost is anticipated in this work for this technology. Sodium metal halide batteries have not gained significant traction in the energy storage space and are deployed mainly in bus fleets. Hence, there is more room for cost reduction; a reduction of 30 percent has been used in this work. The 30 percent reduction has been applied to the average low cost and high cost for sodium metal halide based on information gathered from the literature and vendor. Lead-acid batteries are a mature technology, especially in the context of Starting, Lighting Ignition batteries used in automobiles. Hence, a 15 percent cost reduction is assumed as this technology gains penetration in the energy storage space.

Table 4.2. Ratio of year 2018 to 2025 costs. (Source: DNV GL 2016)

	2018 \$/kWh	2025 \$/kWh	Year 2025/Year 2018 Cost	Ratio Used in this Report
Li-ion nickel manganese cobalt oxide	300	100	0.33	0.65
Sodium sulfur	900	815	0.91	0.76
Vanadium redox battery	520	425	0.82	0.71
Zinc air	250	100	0.40	0.72
Sodium metal halide				0.69
Lead acid				0.85
PCS (\$/kW)	400	350	0.88	0.73

Note that table values were incorporated into an economic valuation model to determine annualized costs estimated on either a unit energy or unit power level for each technology. Adjustments to 2018 U.S. dollars (USD) were made using consumer price index data from the Bureau of Labor Statistics for the Producer Price Index-Industry Data for Electric Power Generation, Transmission and Distribution Sector (BLS 2018).

4.2 Results

Figure 4.3 and Table 4.4 provide a summary of the cost and performance characteristics of the technologies compiled in this report. Primary estimates represent 2018 values; numbers in brackets represent 2025 forecast values. In Figure 4.3, total project costs are estimated for a hypothetical 1 MW/4 MWh BESS. To determine the total project costs for the Li-ion battery technology, for example, we take the product of the capital and C&C costs and its energy capacity (4,000*\$372). We then add that value to the product of the PCS and BoP costs and the unit's power capacity (1,000*\$388). Those calculations yield a total project cost of \$1.9 million for a 1 MW/4MWh Li-ion BESS, which would translate into costs of \$1,876 per kW or \$469/kWh. The batteries are listed separately, because they require a PCS. All the other technologies do not have a separate PCS, except ultracapacitors. While ultracapacitors also require a PCS, they have been listed with flywheels, because both technologies have low specific energies. Total \$/kWh project cost is determined by the sum of capital cost, PCS, BOP, and C&C where values measured in \$/kW are converted to \$/kWh by multiplying by four (given the assumed E/P ratio of four) prior to summation. Total \$/kW project cost is determined by dividing the total \$/kWh cost by four following the same assumption.

Table 4.3. Summary of compiled 2018 findings and 2025 predictions for cost and parameter ranges by technology type – BESS.^(a)

Parameter	Sodium-Sulfur Battery		Li-Ion Battery		Lead Acid		Sodium Metal Halide		Zinc-Hybrid Cathode		Redox Flow Battery	
	2018	2025	2018	2025	2018	2025	2018	2025	2018	2025	2018	2025
Capital Cost – Energy Capacity (\$/kWh)	400-1,000 661	(300-675) (465)	223-323 271	(156-203) (189)	120-291 260	(102-247) (220)	520-1,000 700	(364-630) (482)	265-265 265	(179-199) (192)	435-952 555	(326-643) (393)
Power Conversion System (PCS) (\$/kW)	230-470 350	(184-329) (211)	230-470 288	(184-329) (211)	230-470 350	(184-329) (211)	230-470 350	(184-329) (211)	230-470 350	(184-329) (211)	230-470 350	(184-329) (211)
Balance of Plant (BOP) (\$/kW)	80-120 100	(75-115) (95)	80-120 100	(75-115) (95)	80-120 100	(75-115) (95)	80-120 100	(75-115) (95)	80-120 100	(75-115) (95)	80-120 100	(75-115) (95)
Construction and Commissioning (\$/kWh)	121-145 133	(115-138) (127)	92-110 101	(87-105) (96)	160-192 176	(152-182) (167)	105-126 115	(100-119) (110)	157-188 173	(149-179) (164)	173-207 190	(164-197) (180)
Total Project Cost (\$/kW)	2,394-5,170 3,626	(1,919-3,696) (2,674)	1,570-2,322 1,876	(1,231-1,676) (1,446)	1,430-2,522 2,194	(1,275-2,160) (1,854)	2,810-5,094 3,710	(2,115-3,440) (2,674)	1,998-2,402 2,202	(1,571-1,956) (1,730)	2,742-5,226 3,430	(2,219-3,804) (2,598)
Total Project Cost (\$/kWh)	599-1,293 907	(480-924) (669)	393-581 469	(308-419) (362)	358-631 549	(319-540) (464)	703-1,274 928	(529-860) (669)	500-601 551	(393-489) (433)	686-1,307 858	(555-951) (650)
O&M Fixed (\$/kW-yr)	10	(8)	10	(8)	10	(8)	10	(8)	10	(8)	10	(8)
O&M Variable (cents/kWh)	0.03		0.03		0.03		0.03		0.03		0.03	
System Round-Trip Efficiency (RTE)	0.75		0.86		0.72		0.83		0.72		0.675	(0.7)
Annual RTE	0.34%		0.50%		5.40%		0.35%		1.50%		0.40%	
Degradation Factor	1 sec		1 sec		1 sec		1 sec		1 sec		1 sec	
Response Time (limited by PCS)	4,000		3,500		900		3,500		3,500		10,000	
Cycles at 80% Depth of Discharge	13.5		10		2.6	(3)	12.5		10		15	
Life (Years)	9	(10)	9	(10)	9	(10)	7	(9)	6	(8)	8	(9)
MRL	8	(9)	8	(9)	8	(9)	6	(8)	5	(7)	7	(8)
TRL												

(a) An E/P ratio of 4 hours was used for battery technologies when calculating total costs.
MRL = manufacturing readiness level; O&M = operations and maintenance; TRL = technology readiness level.

4.4

Table 4.4. Summary of compiled 2018 findings and 2025 predictions for cost and parameter by technology type – non-BESS.

Parameter	Pumped Storage Hydropower ^(a)	Combustion Turbine	CAES ^(a)	Flywheel ^(b)	Ultracapacitor ^(c)
Capital Cost – Energy Capacity (\$/kW)	1,700-3,200 2,638	678-1,193 940	1,050-2,544 1,669	600-2,400 2,400	240-400 400
Power Conversion System (PCS) (\$/kW)	Included in Capital Cost	N/A	N/A	Included in Capital Cost	350 (211)
Balance of Plant (BOP) (\$/kW)					100 (95)
Construction and Commissioning (\$/kW)				480 ^(d)	80 ^(d)
Total Project Cost (\$/kW)	1,700-3,200 2,638^(d)	678-1,193 940	1,050-2,544 1,669	1,080-2,880 2,880	930 (835)
Total Project Cost (\$/kWh)	106-200 165		94-229 105	4,320-11,520 11,520	74,480 (66,640)
O&M Fixed (\$/kW-year)	15.9	13.0	16.7	5.6	1
O&M Variable (cents/kWh)	0.00025	1.05	0.21	0.03	0.03
System Round-Trip Efficiency (RTE)	0.80	0.328	0.52	0.86	0.92
Annual RTE Degradation Factor				0.14%	0.14%
Response Time	FS AS Ternary	From cold start: 10 min Spin ramp rate: 8.33%/min Quick start ramp rate: 22.2%/min	3-10 min	0.25 sec	0.016 sec
	Spinning-in-air to full load generation	5-70 s 60 s 20-40 s			
	Shutdown to full generation	75-120 s 90 s 65-90 s			
	Spinning-in-air to full load	50-80 s 70 s 25-30 s			
	Shutdown to full load	160-360 s 230 s 80-85 s			
	Full load to full generation	90-220 s 280 s 25-60 s			
	Full generation to full load	240-500 s 470 s 25-45 s ^(g)			
Cycles at 80% Depth of Discharge	15,000	Not Relevant	10,000	200,000	1 million
Life (Years)	>25	20	25	>20	16
MRL	9 (10)	10	8 (9)	8 (9)	9
TRL	8 (9)	9	7 (8)	7(8)	8
(a) E/P = 16 h	(d) 20 percent of capital cost				
(b) E/P = 0.25 h	AS = adjustable speed; FS = fixed speed.				
(c) E/P = 0.0125 h					

4.5

For Li-ion batteries, nickel manganese cobalt oxide (NMC) systems had the lowest cost, followed by lithium iron phosphate (LFP), and lithium titanate oxide (LTO) systems had a 50–100 percent higher cost, with the cost difference mainly attributable to differences in operating potential. For NMC systems, the cost range was \$325–\$520/kWh. Total project costs varied from \$722–\$1,383/kWh; some of these variations could be due to chemistry, some due to C&C costs, and others due to project size. Lead-acid batteries had a much tighter cost range in most of the reviewed literature. This was expected because the lead-acid battery is a mature technology.

Lead-acid hybrid systems, such as the one produced by the manufacturer Ultrabattery, were not considered in this work because of their lower specific energy leading to higher unit energy costs for their 4-hour application. For vanadium redox flow batteries, with two exceptions the cost was in a tight range of \$357–\$584/kWh. Adjustments were made to the PNNL work to account for lower DoD and for BMS, DC controls, and container costs, and the costs were in line with the average cost from the literature. For sodium sulfur, the cost was in a wide range of \$319–\$1,000/kWh. Vendor information was not solicited, so the research team relied on data presented in the literature base. For sodium nickel halide, the cost range was \$500–\$1,000/kWh, and vendor information came in at \$586/kWh. Due to lack of sufficient installations, the cost was assumed to be \$700/kWh with a 30 percent anticipated drop by 2025. Zinc-hybrid cathode technology was estimated to be \$265/kWh based on vendor input.

PSH systems had a wide cost range of \$1,500/kW–\$5,100/kW. The lower component of this range originates from the projected cost for a PSH project at Eagle Mountain in Southern California. Conversations with lead developers and with the National Hydropower Association (NHA) Pumped Storage Development Council helped narrow down the cost range to \$2,000–\$3,500/kW across all power capacities. The range provided by NHA was for U.S. systems that have been installed or planned and includes both fixed-speed and variable-speed PSH, but it does not include ternary (Manwaring 2018b). The difference was found to be primarily based on the following:

- Equipment selection (fixed, variable-speed, or some hybrid approach) – the cost difference for fixed vs. variable-speed units is approximately 25%, which is primarily driven by the need for more power electronic equipment.¹ It was noted that the powerhouse caverns need to be slightly larger to accommodate this equipment.
- Project size/capacity.
- Availability of existing infrastructure (transmission, dams, reservoirs, etc.). The information comes from a global database of existing and new projects and are consistent with the cost estimates being provided to U.S. project developers. Outlier projects certainly will have lower development costs or higher development cost (per kW) based on the factors described above (Manwaring 2018c).

While all PSH projects in the United States are built with fixed-speed units, one or two projects have been modified to adjustable speed. The different equipment size requirements for adjustable-speed units makes this challenging to fit inside the underground cavern for the powerhouse. Most new U.S. projects under development are using variable-speed units (>60 to 70 percent), while <5 percent have ternary units. No equipment orders were placed for a new U.S. project since the last project brought online in 2012. For new projects globally, the split is close to a 50-50 split, with a very small percentage for ternary systems. At the lower end of the cost, the Eagle Mountain PSH with two existing mine pits for upper and lower reservoirs has estimated project costs of \$1,300–1,500/kW. At the high end, the 5 MW Pearl Hill Hydro Battery Project developed by Shell Energy has an estimated cost range of \$2,500–\$3,500/kW (Manwaring 2018d).

¹ Note this is not 25% of the project costs, just the equipment costs.

The cost breakdowns for various options were obtained, and a relationship was developed for unit energy costs for the upper reservoir using similar information for CAES, which is described in greater detail in Section 4.3.10.

Based on vendor input, a relationship was found for cavern cost in \$/kWh, such that cost for any power and energy combination could be estimated for the technology. The cavern for 10-hour storage for CAES was 19 percent of the total cost, while cavern cost for 15-hour storage was estimated at 6 percent of the system cost.

PSH reservoir costs can vary based on topography. Conversations with a vendor revealed that concrete dams require a wall thickness equal to the height of the dam, for example. Some reservoirs are built using steel structures, while others are naturally occurring (Dham 2018). The relationship between reservoir size and capital cost is evaluated in Section 4.3.8.

For flywheel costs, the research team relied on two vendors and published information from a third vendor. A range of \$1,050–\$2,400/kW was obtained, and the main difference was attributed to varying E/P ratios.

Ultracapacitor costs were in the range of \$160/kW from a vendor for a 1 MW system (energy content not disclosed), and \$240/kW and \$401/kW from another vendor for a 1 MW, 7.43 kWh system and 12.39 kWh system, respectively.

Combustion turbine costs were estimated to be in the \$651–\$1,193/kW range, with larger systems having lower unit power cost. This range was generated from sources including the U.S. Environmental Protection Agency (EPA) Combined Heat and Power (CHP) catalog (Darrow et. al. 2014), the DOE Gas Turbine Factsheet (DOE 2016a), the U.S. Energy Information Administration (EIA 2016), as well as other relevant literature described in more detail in Section 4.3.1.

Comparing various storage technologies with different E/P ratios can lead to misleading results. We have developed a framework for conducting this comparison across a range of E/P ratios for PSH, CAES, and ultracapacitors. For conventional battery storage technologies, increasing E/P ratios can happen by multiple methods:

- material discovery and development to improve specific energy,
- using thicker electrodes,¹ or
- a combination of the above.

If the material has the same cost per unit mass, the \$/kWh for the DC battery will drop. Using thicker electrodes will reduce passive components within the cell, thereby reducing DC system cost. However, beyond a certain thickness, electrode use decreases, thus providing no additional benefits. For the most part, ion transport is expected to dominate; hence, electrode architecture optimization is key. By tailoring the pore size distribution across the electrode thickness, transport-related limitations can be mitigated (Li 2017).

A combination of the above approaches can lead to improvement in specific energy. Note that as the E/P ratio increases, the specific power is not the limiting factor. The limiting factor for specific energy is simply the ability to fully use the electrode thickness, which is enabled by suitable electrode architecture design.

¹ To allow thicker electrodes, ion and electron transport-related issues need to be addressed.

The benefits of these R&D-related improvements are captured in the projected cost reduction for the year 2025. This analysis has been conservative—further reductions are possible if R&D improvements are substantial.

While on a \$/kWh basis, PSH and CAES are the most cost-effective, battery energy storage technologies serve a useful purpose by offering flexibility in terms of targeted deployment across the distribution system. Pathways to lower the \$/kWh of the battery technologies have been described.

4.2.1 Degradation-Related Reduction of RTE

The degradation of batteries results in Ah capacity loss (Zhang and White 2008) and an increase in the battery cell internal resistance (Ning et al. 2006). The DC-DC RTE is affected simply by the ratio of

$$V_d * Ah_d / (V_c * Ah_c)$$

where

- V_d = average discharge voltage,
- Ah_d = Ah capacity during discharge,
- V_c = average charge voltage, and
- Ah_c = charge capacity.

For most batteries, the coulombic efficiency, defined as the ratio of Ah_d/Ah_c is >0.999 , and can be assumed to be nearly equal to 1. That is, while the batteries do lose Ah capacity over time, it can be assumed that for each cycle, the charge and discharge capacity are equal to each other. Hence, the RTE depends only on the average discharge and charge voltage.

For any battery cell, the operating voltage is simply the open circuit voltage (OCV) + $I * R_i$, where I is the current in amperes, and is negative for discharge and positive for charge. Appendix C shows detailed calculations for RTE degradation which assume that each battery type has an increase in internal resistance of 50 percent over its useful life.

The voltage of the ultracapacitor decreases linearly with discharge time after a drop-in voltage associated with its internal resistance, and a corresponding increase in voltage during charge. The RTE for ultracapacitors is estimated in a way similar to estimating RTE for batteries (Kulsangcharoen et al. 2010). When the ultracapacitor is cycled between its maximum voltage and half the maximum voltage, 75 percent of its energy content can be withdrawn (Tecate Group 2018). For non-aqueous systems, the nominal voltage rating is 2.70 volts (V) (Mouser 2018), hence the voltage range of operation is 2.70 V to 1.35 V, which corresponds to an average voltage range of 2.02 V.

Flywheels have extremely low degradation; some claim “zero degradation over time” (Amber Kinetics 2018). The degradation rate of RTE for flywheels was assumed to be the same as that for ultracapacitors—both of them at a low value of 0.14 percent per year. For all practical purposes, their degradation rates can be considered negligible.

The RTE for a pumped hydro system can be approximated by the product of pumping efficiency and generating efficiency, excluding losses due to evaporation (Homer Energy 2018). However, there was no methodology available to estimate the precise degradation of pumping and generating efficiency over time.

Three losses overall are typically accounted for in PSH plants: electrical, mechanical, and hydraulic. When looking at mechanical and hydraulic losses, the degradation of PSH plants can be accelerated by factors such as trash rack fouling—when debris clog at the hydropower intake location (Nøvik et al. 2014,

Dham 2018), or cavitation—the scenario in which a cavity is generated in a pump due to a partial pressure drop of flowing liquid (Klimes 2017). While hydraulic losses from water flow through the tunnels remain unchanged, the performance of machinery itself may decrease over time through deterioration of machine parts, which may require more water to produce the same power—higher flow rate leads to more hydraulic losses. Transformer and turbine/generator losses may increase over time as well. Despite these factors, refurbishments are expected to recover performance (Dham 2018). For example, changing out the transformer oil brings it back to working condition. Typically, PSH plants are evaluated every 5 years for refurbishment of equipment, which corrects the degradation factors described.

Some of the degradation factors described in the previous paragraph also apply to other technologies. Cavitation can also occur through liquefaction within supercritical CAES units that involve liquid air (Wang et al. 2017). Deterioration of transformers and turbines for CAES and CTs can be addressed in a similar manner to the procedure described for PSH.

Batteries were found to have more methods and data for calculating RTE degradation within the literature. Table 4.5 shows the RTE loss per year for each battery chemistry. Appendix C provides more detailed calculations.

Table 4.5. Estimated decrease in RTE per year for each technology.

Chemistry	Final RTE/ Initial RTE	Calendar Life (years)	RTE Loss per Year
Li-ion loss	0.959	10	0.50%
Sodium sulfur	0.956	13.5	0.34%
Lead acid	0.898	3	5.40%
Zinc-hybrid	0.878	10	1.50%
Redox flow battery	0.847	15	0.40%
Sodium metal halide	0.956	12.5	0.35%
Ultracapacitor	0.979	16	0.14%
Flywheel	NA	> 20	0.14%

4.3 Technology-Specific Findings

The following sections present specific findings for each of the energy storage technologies.

4.3.1 Combustion Turbine

Among conventional power generation technologies, CTs offer a high degree of operational flexibility in terms of start/stop time and ramping speed, and therefore are often used as the next best alternative to more flexible resources (e.g., ESSs). With the advancement of manufacturing technology and market demand, CT units are now offered in a wide range of sizes starting from tens of kilowatts for CHP applications to hundreds of megawatts for stationary power generation. This enables using a right-sized solution to the requirement and thereby optimizes capital investment. Right sizing is also important for reducing the part-load operation of a given CT unit because its thermal efficiency declines significantly in part-load operation and impacts fuel cost. The availability of dual fuel (gaseous and liquid) CT technologies provides flexibility in the choice of fuel and hence provides more options for project location. The remainder of this section provides information about capital cost, O&M cost, and other parameters of CT technology.

4.3.1.1 Capital Cost

The basic components of an operational CT unit are the turbine itself, gearbox, electrical generator, air inlet system including filter assembly, exhaust gas system including the duct and silencer, and start-up system. Depending on the fuel and emission compliance requirements, additional costs may be incurred for fuel compression systems and emission control systems that are not included in the basic package cost.

The EPA CHP catalog (Darrow et al. 2014) studied the capital costs of five CT systems for a CHP application with net capacities ranging from 3.3 MW to 44.5 MW. Excluding the heat-recovery steam generator (HRSG), the costs of the systems studied ranged from \$1,176 to \$3,060/kW. The DOE Gas Turbine Factsheet (DOE 2016a) studied six CHP units of net capacities ranging from 3.3 MW to 40.5 MW, with cost estimates ranging from \$1,276 to \$3,320/kW. Based on the EPA CHP catalog estimate, HRSG costs 6–7 percent of the total cost. Using the mean value (6.5 percent), CT facility costs can be estimated to be \$1,193–\$3,107/kW. An EIA report (2016) studied a 100 MW conventional CT facility with two units at a cost of \$1,101/kW and a 237 MW CT unit at a cost of \$678/kW. From this, it appears that economy of scale plays a significant role in these capital cost estimates. A Brattle report (Newell et al. 2018) studied the cost of new entry (CONE) of CT units in five U.S. regions with cost estimates in the range of \$903–\$1,012/kW. A capital cost review performed by Energy and Environmental Economics (E3) for the Western Electricity Coordinating Council (WECC) found a range of costs (\$834–\$1,045/kW) in different integrated resource planning (IRP) studies relevant to the WECC region and recommended a capital cost of \$825/kW for WECC studies (Olson et al. 2014). Capital cost estimates found in various technology reports are presented in Table 4.6. A capital cost of \$940/kW was used in this report.

Table 4.6. Capital cost estimates of CT technology.

Capital Cost (\$/kW)	Notes	Source
1,176	44.5 MW net capacity unit	Darrow et al. (2014)
825	Recommended value based on review of IRP documents	Olson et al. (2014)
1,193	40.5 MW net capacity unit	DOE (2016)
1,101	100 MW facility, 2 units	EIA (2016)
678	237 MW single unit	EIA (2016)
903-1,012	CONE study in five U.S. regions	Newell et al. (2018)
651	Cost and performance projection for a 211 MW gas turbine power plant	Black & Veatch (2012)

4.3.1.2 Fixed and Variable Operations and Maintenance Costs and Performance Metrics

Major components of a CT facility’s fixed O&M costs are fixed components of inspection and maintenance costs at intervals recommended by the original equipment manufacturer (OEM). More often these services are provided by the OEM or by their affiliated third-party service providers against a long-term service agreement (LTSA). Costs of day-to-day operation manpower, G&A costs, permit fees, property taxes, and insurance are also included in fixed O&M costs. The EIA study (EIA 2016) reported a fixed O&M cost of \$17.50/kW-yr for the 100 MW, 2 CT unit facility and \$6.8/kW-yr for the 237 MW single CT unit facility. The Brattle study (Newell et al. 2018) registered a range of \$13.7–\$25.6/kW-yr for fixed O&M costs for the five U.S. regions studied. The E3 study (Olson et al. 2014) reported a range of

\$4–\$12/kW-yr but recommended a value of \$9/kW-yr for fixed O&M cost. These values are summarized in Table 4.7. A fixed O&M cost of \$13.0/kW-yr was used in this report.

Table 4.7. Fixed and variable O&M costs for CT systems.

Fixed O&M (\$/kW-yr)	Variable O&M (\$/kWh)	Notes	Source
9		Recommended value based on review of IRP documents	Olson et al. (2014)
17.50	0.0035	100 MW facility, 2 units	EIA (2016)
6.8	0.0107	237 MW single unit	EIA (2016)
13.7-25.6	0.00425-0.00429	CONE study in 5 U.S. regions	Newell et al. (2018)
5.26	0.03	Cost and performance projection for a 211 MW gas turbine power plant	Black & Veatch (2012)

Variable O&M cost components include consumables for day-to-day O&M, including inspections and overhauls. The EIA study (EIA 2016) reported a variable O&M cost of \$0.0035/kWh for the 100 MW, 2 CT unit facility and \$0.0107/kWh for the 237 MW, single CT unit facility. The Brattle study (Newell et al. 2018) reported a range of \$0.00425–\$0.00429/kWh of variable O&M costs for the five U.S. regions studied. O&M variable costs were assumed to be \$0.0105/kWh in this report.

The efficiency of CT units is typically expressed using heat rate (Btu/kWh). The EPA published a CHP technology catalog (Darrow et al. 2014) in which technical performance and costs of CT units with various sizes were studied. Heat rates were found to vary from 9,488 to 14,247 Btu/kWh (23.96–35.97 percent in terms of efficiency) for units with net capacities of 3.3 MW to 44.5 MW. For example, the heat rate for a 211 MW CT plant was 10,390 Btu/kWh (Black & Veatch 2012), corresponding to an RTE of 32.8 percent using a conversion factor of 3,412 Btu/kWh (RapidTables 2018). An RTE of 30 percent was used in the report. Its spin ramp rate was 8.33 percent per minute, while the quick start ramp rate was 22.2 percent per minute, and it takes 10 minutes to reach rated power from cold start.

4.3.1.3 Technology and Manufacturing Readiness Levels

CT technology is one of the proven power generation technologies that have been in field application for decades. As of 2016, 28 percent of total installed natural gas-fired power generation capacity in the United States (449 GW) was based only on CT technology and 53 percent was based on combined cycle technology (EIA 2017). With such wide-scale commercial deployment, this technology has had the opportunity to be tested to the highest level of TRL and MRL criteria. Therefore, a TRL of 9 and MRL of 10 are assigned to CT technology. Note that research activities are ongoing to improve CT efficiency through different performance development schemes, so those new components under trial will have lower TRLs. For instance, Siemens Energy is trying to improve the rotor component performance of gas turbines for which a TRL of 6 has been reported (NETL 2013).

4.3.2 Li-Ion Batteries

More than 500 MW of stationary Li-ion batteries were deployed worldwide by the year 2015, which increased to 1,629 MW by 2018. Given their commercialization start in the early 1990s, Li-ion batteries are prevalent across a variety of industries due to their high specific energy, power, and performance. Due to the increased demand from the electric automobile industry and the consumer electronics market, the

price of this chemistry is expected to reduce further (EASE 2016). For this reason, it is a typical choice for large installments such as Tesla's 100 MW, 129 MWh grid-scale battery installation in South Australia (Spector 2017a) or FlexGen's 10 MW, 42 MWh battery installation in West Texas (Spector 2017b). There have also been successful deployments and demonstrations of Li-ion systems built for grid support of distributed renewables up to several megawatts (EASE 2016; Ailworth 2018; PG&E 2018).

According to Bloomberg New Energy Finance New Energy Outlook (BNEF 2018), over 1,200 GW of additional Li-ion battery capacity is expected to be added by the year 2050. BNEF further predicts that nearly half of that capacity will be located behind-the-meter (BTM). Investments that are made over the next few years are expected to take place in Asia and Europe predominantly with a combined total cost of \$544 billion (BNEF 2018).

4.3.2.1 Capital Cost

The primary components of a Li-ion battery include modules composed of an assembly of cells, which comprise electrodes, electrolyte, and separators. The battery system as a whole is built of a multitude of modules as well as a BMS and a PCS. Between 2010 and 2017, battery prices decreased by 80 percent, reaching approximately \$200/kWh, and it is predicted the price will reach approximately \$96/kWh within the next 8 years (EASE 2016).

Lahiri (2017) estimated the cost range for the DC-Side Modules and BMS to be in the range of \$325–\$700/kWh, keeping the values broad to accommodate technology differences. Aquino et al. (2017) placed the value in a tighter range at \$340–\$450/kWh for a 4 MW/16 MWh Li-ion NMC system and a fully installed cost estimate of between \$9.1 million and \$12.8 million. They also provide price estimates for LFP and LTO systems at \$340–\$590/kWh and \$500–\$850/kWh, respectively.

Table 4.8 summarizes capital cost estimates from the literature. Curry (2017) and Watanabe (2017) provided estimates that were lower than those cited previously. However, the estimate provided by Curry (2017) was the cost for only the battery cells and pack. Morris (2018) provides the lowest estimate at \$209/kWh for an EV battery pack. EPRI (2017) estimated an installed cost of \$335–\$530/kWh, which includes the PCS, grid integration and equipment, tax, fees, and G&A costs. For a representative 4-hour case, the DC battery cost was 60 percent of total installed cost. Using this multiple, the DC battery cost was estimated. The results are presented in Table 4.8.

Many of the sources located for estimating costs provided costs as total project averages rather than broken down to estimate the costs of different components of the batteries. A list of these costs, all sourced from DNV GL (2017), is provided separately in Table 4.9. The average installed cost was \$932/kWh, significantly higher than the EPRI estimates. The difference between installed costs and DC battery cost for the EPRI work was \$915/kW for a 4-hour Li-ion system, while our work uses \$1,110/kW for the sum of BOP, C&C, and PCS costs. This difference amounts to only \$49/kWh, not large enough to explain the difference between the average installed cost reported by DNG VL and ours and EPRI's work. One explanation is that the systems listed in Table 4.8 were small, and hence did not experience savings through economies of scale. For this work, costs for LTO were not considered.

Table 4.8. Capital cost of Li-ion battery systems.

Battery Capital Cost (\$/kWh)	Notes	Source
\$325-\$700	Includes DC-Side Modules and BMS	Lahiri (2017)
\$325-\$450	NMC system	DNV GL (2016)
\$350-\$525	LFP system	DNV GL (2016)
\$500-\$850	LTO system	DNV GL (2016)
\$340-\$450	NMC system	Aquino et al. (2017a)
\$340-\$590	LFP system	Aquino et al. (2017a)
\$500-\$850	LTO system	Aquino et al. (2017a)
\$273	Includes cell and pack cost only	Curry (2017)
\$285		Watanabe (2017)
\$540		Wright (2014)
\$400		Greenspon (2017)
\$573		Manuel (2014)
\$300	Balance of system was \$570/kW or \$143/kWh	DiOrio et al. (2015)
\$409-\$662		DNV GL (2017)
\$180-\$520	2015 cost NMC	Kamath (2016)
\$180-\$520	2015 cost NCA	Kamath (2016)
\$300-\$450	2015 LFP	Kamath (2016)
\$430-\$1,000	2015 LTO	Kamath (2016)
\$209-\$343	Calculated from installed costs of \$335–\$530/kWh by subtracting PCS, grid integration and equipment, tax, fees, and G&A costs	Damato (2017)

Table 4.9. Total average Li-ion project cost estimates by manufacturer.

Average Project Cost (\$/kWh)	Battery Provider
\$785	Adara Power
\$1,009	Energport Inc
\$1,383	Green Charge Networks
\$722	Greensmith
\$736	LG Chem
\$1,068	Lockheed Martin
\$842	PowerSecure
\$938	Princeton Power
\$857	Sharp
\$979	Tesla
\$932	Average \$/kWh

Because Li-ion battery costs have dropped significantly over the last 10 years, the high-end values have not been used in our estimation of DC battery system cost. Costs earlier than year 2016 were not considered. Costs for years 2016 and 2017 were multiplied by 0.95 and 0.95² respectively, assuming a 5 percent decrease in cost per year. While 5 percent appears low, this approach is appropriate because only the low end of the cost range observed in the literature was considered. These storage DC battery packs averaged \$296/kWh.

Data on Li-ion EV battery pack cost were obtained and are listed in Table 4.10 and Table 4.11.

Table 4.10. EV battery costs in the 2016-2018 time frame.

Cost (\$/kWh)	Component	Year	Notes	Source
\$250-300	EV pack	2018	EV	Evertiq (2018)
\$200	Pack	2018	EV	Posawatz (2018)
\$209	Pack	2017	EV	Chediak (2017)
\$236	Pack	2017 (16% annual decline)	EV industry-wide average	Eckert (2018)
\$190	Pack	2018	EV Tesla	Safari (2018)
\$250	Pack	2016	EV	
\$227	Pack	2016	EV	Lambert (2017)
\$200-250	Pack	2016	EV	Lacey (2016)

Table 4.11. Total EV pack cost for various EVs in 2018.

Total EV Pack Cost \$	\$/kWh	EV Pack E/P	Vehicle Type	Source
\$4,500	\$253	55 kW / 17.6 kWh	Smart	
\$6,000	\$250	80 kW / 24 kWh	Nissan Visia	Safari
\$6,000	\$200	80 kW / 30 kWh	Nissan Acenta	(2018)
\$5,900	\$268	65 kW / 22 kWh	Renault Zoe	

EV pack costs were multiplied by a factor of 1.1 to reflect an estimated 10 percent increase in cost for containerization of the packs used in storage applications. This assumption is based on an analysis of costs broken down by their individual components, such as labor, material, and overhead (OS 2018; ECPC 2018). Only costs for years 2016–2018 were considered, and the 2016 and 2017 costs were multiplied by 0.95 and 0.95², respectively. EV packs with the three lowest costs were removed from the analysis. The average of the adjusted EV pack costs was \$256/kWh. The weighted average of the storage and adjusted EV battery cost was \$271/kWh. Using the PCS, BOP, and C&C costs, the Li-ion battery system cost for 2018 was estimated to be \$469/kWh.

4.3.2.2 Fixed and Variable Operations and Maintenance Costs

Li-ion systems have a typical usable life of approximately 10 years and require major maintenance on the battery system usually every 5 to 8 years to remain operational (Balducci et al. 2017). Aquino et al. (2017) estimate the fixed O&M cost to be in the range of \$6–\$14/kW-yr for their 4 MW/16 MWh NMC system and the variable cost to be \$0.0003/kWh for a system of the same size. Lahiri (2017) provides a similarly close estimate—\$6–\$12/kW-yr—with major maintenance costing in the range of \$150–\$400/kW. A fixed O&M cost of \$10/kW-yr and variable O&M cost of \$0.0003/kWh have been used in this study for all battery technologies, with a reduction of fixed O&M costs to \$8/kW-yr by 2025.

Table 4.12 provides information about the fixed and variable O&M costs of Li-ion battery systems.

Table 4.12. Fixed and variable O&M costs of Li-ion battery systems.

Fixed O&M Cost (\$/kW)	Variable O&M Cost (\$/kWh)	Notes	Source
\$6-\$12	\$0.0003	Excludes major maintenance cost	Lahiri (2017)
\$6-\$14	\$0.0003	Excludes major maintenance cost	Aquino et al. (2017)
\$10			Manuel (2014)
\$20			DiOrio et al. (2015)
£10			Newbery (2016)

4.3.2.3 Cycles, Lifespan, and Efficiency

While Li-ion technology is considered the most mature of battery storage technologies, improvements will continue to be made that will increase the calendar life, energy density, and number of cycles the Li-ion technology systems are capable of providing. Table 4.13 shows estimations for different efficiency and life parameters across a range of cited studies. On average, most of the literature places the life years in the range of 10–20 years; more of the literature estimates life years on the lower end and indicates the need for major maintenance and battery replacement to keep the system operational. A range of cycle estimates was provided throughout the literature; Greenspoon (2017) provided the lowest estimated range at 400–1,200 cycles and DiOrio et al. (2015) placed the capability at 5,475 cycles when a 70 percent DoD is assumed. With respect to RTE, estimates as low of 77 percent and as high as 98 percent were reported. PNNL testing of grid-scale batteries yielded an AC-AC RTE of 83–87 percent over 1.5 years of testing, while RTE for a battery >5 years old was 81 percent. While each of these are different chemistries, this is an example of the deterioration of RTE over time. A system RTE of 86 percent was used in this work. A cycle life of 3,500 at 80 percent DoD and calendar life of 10 years were also assumed. A PCS RTE of 96 percent was assumed for all technologies.

Table 4.13 provides information about the cycles, life years, and RTE of Li-ion battery systems.

Table 4.13. Cycles, life years, and round-trip efficiency of Li-ion battery systems.

Cycles	Life Years	DC-DC Round-Trip Efficiency	Notes	Source
2,500	15			May et al. (2018)
3,500	10	77-85%		Aquino et al. (2017)
	10	83%		Manuel (2014)
400-1,200		80-90%		Greenspoon (2017)
	9	89%	Based on an AC-AC RTE of 85% and 0.96 factor	Newbery (2016)
5,475 at 70% DoD		92%		DiOrio et al. (2015)
2,000-10,000	15-20	90-98%	Not including auxiliary loads	EASE (2016)
		87-91%	Three different battery chemistries AC-AC RTE of 83-87%	Grid-scale testing of batteries by PNNL at various utilities funded by Washington Clean Energy Funds/DOE-OE

4.3.2.4 Technology and Manufacturing Readiness Levels

The commercialization of Li-ion batteries began in the early 1990s through a wide variety of applications and sizes. With the scale of deployment reaching the level it has, the technology has been tested thoroughly across deployments of all scales up to the higher levels of both the TRL and MRL scales. For this reason, Li-ion batteries receive a TRL of 8 and an MRL of 9. It is predicted that by 2025, those numbers will rise to 9 and 10, respectively.

4.3.3 Lead-Acid Batteries

Lead-acid batteries are used across a wide variety of applications but are not typically found in small, portable systems. Lead-acid batteries are of two main types of design: flooded (vented lead-acid [VLA]) and valve-regulated lead-acid (VRLA). The technology typically has a power range of up to a few megawatts and an energy range of up to 10 MWh. A benefit of the VRLA technology option is its lack of maintenance requirements compared to the VLA counterpart. Overall, the technology offers efficient performance at a relatively low cost and its adoption is expected to become more widespread over the coming years (EASE 2016).

A manufacturer of a VLA battery, Ultrabattery, listed the following as advantages to the lead-acid system:

- high cumulative energy throughput
- high cycle life in a partial SOC cycling regime at various rates
- good charge acceptance leading to faster recharge
- uniform cell-to-cell behavior.

Ultrabattery compares the VLA system to the maintenance-free VRLA system by claiming it has a considerably more energy throughput at only a 5 percent DoD. Furthermore, they state that tests using a “Micro-HEV duty cycle” give 80 percent higher throughput than the Li-ion technology. Currently, there is a 3 MW Ultrabattery system connected to the PJM interconnection in Pennsylvania that comprises four strings of cells. The ESS is used to provide frequency regulation to the grid (Mina 2014).

Information gathered from Enersys, an additional battery manufacturer, indicated that while lead-acid batteries may not be the best technology for applications such as frequency regulation, which have highly volatile signals, they are a cost-effective solution for applications such as load following and time shifting. Furthermore, lead-acid batteries have a 99% recyclability rate, which offers another incentive over competing technologies (Vechy 2018).

4.3.3.1 Capital Cost

Both of the subtypes of lead-acid batteries consist of a grid plate for the positive electrodes and either copper or lead grids for the negative electrodes. The battery cells can be interconnected to form large battery systems. Just as with the Li-ion battery, the lead-acid system also requires a PCS as one of the components necessary for operation.

Reviewing the available literature about this technology revealed a range of costs for capital. Aquino et al. (2017b) estimated the battery cost to be in the \$200–\$500/kWh range; the PCS and system controls cost was estimated to be approximately \$150–\$350/kWh and electric BOP cost to be between \$80 and \$120/kWh. The same report predicted that C&C costs for the system would be between \$150–\$180/kWh. In comparison, PowerTech Systems (2015) provided a cost estimate of only \$183/kWh for a 100-kWh system, of which only 50 kWh was considered usable. Anuphappharadorn et al. (2014) and May et al.

(2018) provided estimates similar to PowerTech Systems (2015) at \$120/kWh and \$150/kWh, respectively. Kamath (2015) provided an estimate on the lower end of the cost range at \$400/kWh. Capital cost of \$260/kWh was assumed for this work.

Table 4.14 lists capital cost estimates and their sources for the lead-acid technology.

Table 4.14. Capital cost of lead-acid battery systems.

Battery Capital Cost (\$/kWh)	Notes	Source
\$200-500	\$150-\$350/kW for PCS	Aquino et al. (2017b)
\$183 ^(a)	100 kWh installed, 50 kWh usable.	Power Tech Systems (2015)
\$120		Anuphjappharadorn et al. (2014)
\$400-\$700		Kamath (2015)
\$160-\$240	\$400-\$600/kWh installed. Remove PCS, BOP, and C&C costs.	May et al. (2018)
€100-200	For up to 10 MWh	EASE (2016)
\$240	12 V, >150 Ah module	Quote received from a vendor

(a) \$183 obtained from converting 150 euros to U.S. dollars at a 1.11 \$/euro ratio.

4.3.3.2 Fixed and Variable Operations and Maintenance Costs

A benefit of the VRLA technology is the lack of maintenance requirements; however, Aquino et al. (2017a) estimate the fixed O&M cost for an advanced lead-acid battery combined with an asymmetric supercapacitor to be in the range of \$7–\$15/kW-yr with variable cost at an estimated \$0.0003/kWh. Note that fixed and variable O&M were kept the same for all battery technologies, as described in the Li-ion O&M section.

4.3.3.3 Cycles, Lifespan, and Efficiency

Lead-acid systems have a shorter economic life than Li-ion batteries. Lead-acid batteries are primarily used for resource adequacy or capacity applications due to their short cycle life and their limited degradation rate. It is believed that higher use of the system might cause it to have a higher degradation rate than other battery systems, such as Li-ion battery systems (Aquino et al. 2017a). Table 4.15 shows the battery parameter data that were collected for this technology.

The cycle life at 80 percent DoD of lead-acid batteries is in the 600 to 1,250 range, and the higher values reported in Table 4.15 have less reliability. Assuming 350 cycles per year, this leads to a life in the range of 1.4 to 3.6 years. While lead-acid batteries can have longer life when subjected to lower DoD or for float applications, for this report, a life of 2.6 years has been assigned. While spirally wound lead-acid cells have greater RTE due to lower internal resistance, due to higher cost, this work assumes an energy-dense cell design and an associated lower RTE. Hence, a DC-DC RTE of 75 percent is assumed.

Table 4.15 shows the cycles, life years, and RTE of lead-acid systems. Note that the values observed by May et al. (2018) are outliers in comparison to what is seen elsewhere in the literature and have been left out of the values used to derive the resulting values presented in this report. Nevertheless, they have been included in the table below. A system RTE of 72 percent was used in this work, while cycle life was assumed to be 900 cycles. At a rate of 350 cycles per year, this translated to 2.6 years of battery life.

Thus, while lead-acid systems are lower in initial capital cost relative to all the battery technologies considered in this report, their full life-cycle costs are comparable to Li-ion battery systems.

Table 4.15. Cycles, lifespan, and round-trip efficiency of lead-acid batteries.

Cycles	Life Years	Round-Trip Efficiency	Source
500 (at 50% DoD)	5.2		Power Tech Systems (2015)
	1.5-2	75%	Anuphjappharadorn et al. (2014)
600 (at 80% DoD)			DiOrio et al. (2015)
1,250 (at 80% DoD)			BAES (2011)
2,000	15	79-84%	May et al. (2018)
600			C&D Technologies, Inc. (2012)
1200	20	95	C&D Technologies, Inc. (2015)

4.3.3.4 Technology and Manufacturing Readiness Levels

Traditional lead-acid technology is one of the more mature electrochemical systems available; however, numerous changes made to create improvements over the years have led to more advanced but less mature systems. Typically, the lead-acid system has low cost over other systems, but also - lower calendar and cycle lives especially at high DoD in comparison to the prevalent Li-ion technology, as well as a low energy density, which makes it less competitive as a product. However, due to the long timespan over which research and upgrades have been made, it is assigned TRL and MRL levels of 8 and 9, respectively, the same as those of the Li-ion technology.

4.3.4 Redox Flow Batteries

Redox flow batteries offer a very different type of system than the other battery systems described in this report. The flow battery is composed of two tanks of electrolyte solutions, one for the cathode and the other for the anode. Electrolyte is then passed by a membrane to store and generate energy. The technology is still in the early phases of commercialization compared to more mature battery systems such as Li-ion and lead-acid; however, redox flow batteries offer advantages over competitive systems such as long lifecycles, low temperature ranges for operation, and easy scalability.

Vanadium redox flow batteries are primarily commercialized by a few companies: the U.S.-based UniEnergy Technology (UET) and Vionx Energy, the German-based Gildemeister, and Sumitomo Electric from Japan. To compete with Li-ion, these manufacturers have begun moving toward off-the-shelf systems as opposed to custom ones. UET also offers a warranty up to 25 years, with the rate escalating in year 21 (Aquino et al. 2017a).

4.3.4.1 Capital Cost

The capital component of a flow battery includes the electrolyte solution, membrane, and the hydraulic pumps necessary to push the solution from one tank to the other. The battery system can be composed of different design variants that can be stacked together to build systems that have larger capacities.

RedT Energy Storage (2018) and Uhrig et al. (2016) both state that the costs of a vanadium redox flow battery system are approximately \$490/kWh or \$400/kWh, respectively. Aquino et al. (2017a) estimated

the price at a higher value of between \$730/kWh and \$1,200/kWh when including PCS cost and a \$131/kWh performance guarantee. Removing these costs led to a range of \$542–\$952/kWh. Zinc-bromide flow battery systems were not considered in this analysis due to lack of available information and stability related to zinc plating with associated dendrite growth. Volterion (Seipp 2018) estimated 800 euros/kW for their stack modules inclusive of control units. Our internal work indicates for a 4-hour system, the stacks are 35 percent of the DC system cost. Hence the system cost is estimated to be \$676/kWh after converting euros to USD and using the E/P ratio of four. Near-term stack costs were estimated to be 500 euros/kW, translating to \$488/kWh assuming stacks cost 30% of DC system. Stack costs were estimated to be 250 euros/kW, which corresponds to \$293/kWh assuming stack costs are only 25 percent of DC system cost.

An average cost of \$555/kWh was used for year 2018, with a 30 percent reduction to \$393/kWh anticipated for 2025.

Table 4.16 shows the capital costs of a selection of literature.

Table 4.16. Capital costs for redox flow batteries.

Battery Capital Cost (\$/kWh)	Notes	Source
\$490	5 kW, 20 kWh	RedT Energy Storage (2018)
\$444	400 Euros	Uhrig et al. (2016)
\$463		Noack et al. (2016)
\$730-\$1,200	Includes PCS cost and \$131/kWh performance guarantee	Aquino et al. (2017a)
\$542-952	After removing PCS and performance guarantee costs	Aquino et al. (2017b)
\$500-\$700		DNV GL (2016)
\$468		Selmon & Wynne (2017)
\$435-584	PNNL calculations – increased energy cost by 10% to account for lower DoD than the 80% DoD used for the calculations. Increased cost by 15% to account for container, DC controls, BMS.	Viswanathan et al. (2014), Crawford et al. (2015)
\$357-552	\$570-\$910 for installed cost. Removed PCS, grid integration and equipment tax, fees, and G&A costs.	Damato (2017)
\$676	Volterion stack costs including control units was 800 Euros/kW. Conversion to US dollars and using stack costs as 35% of DC system cost.	Seipp (2018)
\$488	Volterion mid-term stack costs – mid-term was not specified, it may be assumed to be 2021.	Seipp (2018)
\$293	Based on stack cost of \$250/kW, a 69% reduction due to R&D.	Seipp (2018)

4.3.4.2 Fixed and Variable Operations and Maintenance Costs

Aquino et al. (2017a) estimates that the fixed O&M for a vanadium redox flow battery system is somewhere between \$7–\$16/kW-yr and that the variable O&M cost is the same as other systems at \$0.0003/kWh. Due to lack of information and reliability for O&M costs, the same O&M costs were used across all battery technologies as mentioned previously. The O&M costs are at least as high as other battery technologies due to the “growing pains” associated with a newly emerged technology.

4.3.4.3 Cycles, Lifespan, and Efficiency

Redox flow systems typically have a longer lifespan than other electrochemical battery systems due to their lack of sensitivity to temperatures and the fact that charge transfer reactions occur as redox reactions in solution, with the solid electrodes simply providing a path for electron transport, thus avoiding the stress experienced by conventional battery electrodes during cycling. Aquino et al. (2017a) estimate the life to be 15 years with an RTE of 65–78 percent for the vanadium redox flow battery. EASE (2016), on the other hand, places the ranges capable for a generic flow battery slightly higher at a usable life of 10–20 years and an RTE of 70–75 percent when battery system auxiliary load is included in the DC-DC calculation. Uhrig et al. (2016) were similar in their estimation with an RTE estimate of 70.5 percent for the vanadium redox flow. Testing of UET flow batteries by PNNL has shown an all-inclusive RTE of 65 percent at the 4 h rate. An AC-AC RTE of 67.5 percent has been assigned to this system.

For flow batteries, there is an optimal spot for operation that changes with stack design and E/P ratio. While stack performance improves at lower power levels, the nearly fixed overhead due to pumping operation results in varying RTE as a function of SOC, stack design, and E/P ratio.

Vanadium redox flow batteries have a cycle life of >10,000 cycles and an anticipated life of >15 years (May et al. 2018; Greenspon 2017). EASE (2016) states that they expect redox flow batteries to be capable of providing >12,000 cycles at an unknown depth of discharge. Aquino et al. (2017a) provide much more conservative estimates at 5,000 and 3,000 cycles for vanadium and zinc-bromide, respectively. While the electrolyte is non-degradable when used properly, the stack may need replacement as time goes on.

For this work, a cycle life of 10,000 cycles at 80 percent DoD, a calendar life of 15 years, and a system RTE of 67.5 percent were assumed for 2018, and the system RTE is expected to increase to 70 percent by 2025.

Table 4.17 shows cycle, lifespan, and RTE from the literature for redox flow batteries.

Table 4.17. Cycles, life years, and round-trip efficiency of redox flow batteries.

Cycles	Life Years	RTE	Source
5,000	14	65-78%	Aquino et al. (2017)
10,000	15	70%	May et al. (2018)
>12,000	10-20	70-75%	EASE (2016)
		70.5%	Uhrig et al. (2016)
>10,000	20-30	75-80%	Greenspon (2017)
10,000	15	70%	May et al. (2018)

4.3.4.4 Technology and Manufacturing Readiness Levels

In recent years, redox flow batteries have gained high prominence due to their flexible characteristics and long cycle lives (Herman 2003; Rastler 2010). They were originally developed in the 1970s and recent innovations and improvements have been made to further address components that could increase the RTE to make the systems more competitive than Li-ion systems given their current high cost (Herman 2003; Rastler 2010). Redox flow batteries have been assigned a TRL of 7 and an MRL of 8 after a review of the literature and the state of commercialization.

4.3.5 Sodium-Sulfur Batteries

Sodium-sulfur batteries are mature electrochemical energy storage devices with high-energy densities. According to Aquino et al. (2017a), they are primarily provided by a single Japanese-based vendor—NGK Insulators—which, to date, has installed 450 MW of the technology worldwide. The NGK battery typically consists of a set of twenty 50 kW and 100 kWh modules for one battery, allowing for systems that reach into several megawatts. It is a well-demonstrated technology and the largest installation to date is a 34 MW/245 MWh system located in Aomari, Japan, which was installed for wind stabilization. To maintain the molten state of the battery, the system is typically kept at temperatures between 300°C and 350°C. Due to these high operating temperatures and the associated safety requirements, this technology is typically suitable for non-mobile applications (EASE 2016).

4.3.5.1 Capital Cost

The basic components of a sodium-sulfur battery unit include a system built from a large combination of modules, a control system, and a PCS. A variety of literature was consulted to estimate the current capital cost. For this system, the estimated cost appears to be approximately \$750/kWh when results were averaged across the collected literature. Aquino et al. (2017a) provided a range of capital cost values for a 4 MW/16 MWh system with the low end being \$500/kWh to \$1,000/kWh for just the battery cost. PCS and power control system costs were estimated to be between \$580/kW and \$870/kW. Kamath (2016) estimated the battery system cost range to be slightly lower between \$400–\$1,000/kWh, while DNV GL (2016) estimated it to be higher at \$800/kWh–\$1,000/kWh. The PCS cost was in the \$580–\$870/kW range (DNV GL 2016), while the costs for Li-ion was twice as low.

For this work, a PCS cost range of \$230–\$470/kW was used for 2018, because there is no compelling reason to assume PCS costs will not reach a balance across all DC battery technologies. Viswanathan et al. (2013) reported a cost of \$415/kWh for a 7-hour system. Since limited information is available since then, this value is also used as a data point, with a 10 percent increase accounting for the lower E/P ratio (or higher rate of discharge). An average cost of \$661/kWh was determined for 2018 sodium-sulfur costs, with a 2025 cost of \$465/kWh assuming a decrease of 30 percent.

Table 4.18 provides capital cost estimates for sodium-sulfur batteries from the literature.

Table 4.18. Capital costs of sodium-sulfur battery systems.

Battery Capital Cost (\$/kWh)	Notes	Source
\$500-\$1,000	4MW/16 MWh	Aquino et al. (2017a)
\$400-\$1,000		Kamath (2016)
\$800-\$1,000		DNV GL (2016)
\$500		Crowe (2011)
\$319		Liu et al. (2014)
\$455		Viswanathan et al. (2013)

4.3.5.2 Fixed and Variable Operations and Maintenance Costs

A limited number of sources provided estimates for the O&M costs for a sodium-sulfur battery system. Among those that were found include an estimate by Aquino et al. (2017a) of \$7–15/kW-year for fixed O&M and no estimate was provided for variable. DNV GL (2016) estimated that the fixed cost range was narrower to be between \$7–\$12/kW-year.

4.3.5.3 Cycles, Lifespan, and Efficiency

DNV GL (2016) and Aquino et al. (2017a) both estimated the lifespan of a sodium-sulfur system to be 15 years, putting it at a longer usable life than Li-ion but shorter than redox flow. EASE (2016) similarly estimated the lifespan to be under the range of 15 years. The estimates for cycle life were all in the same approximate range of 4,000 to 4,500 cycles except for EASE (2016), which gave a range of 2,000 to 5,000 cycles. The Na-S battery was assumed to have a cycle life of 4,000 cycles at 80 percent DoD.

Regarding RTE, the ranges found in the literature were tighter than for other technologies with DNV GL (2016) providing 77 percent, Aquino et al. (2017a) giving a range of 77–83 percent, and EASE (2016) providing a range of 75–85 percent. Assuming a DC-DC RTE of 80 percent, this corresponds to an RTE of 77 percent on an AC-AC basis. Further, adjusting for 4-hour discharge as opposed to 7-hour discharge, we have assigned an AC-AC RTE of 0.75 for the NaS system to account for higher electrochemical losses at a higher rate. While the DC response time is on the order of several milliseconds for most batteries, the AC response time was set to 1, determined by PCS response time.

Table 4.19 shows cycle, lifespan, and RTE from the literature for NaS batteries.

Table 4.19. Cycles, life years, and round-trip efficiency of sodium-sulfur batteries.

Cycles	Life Years	Round-Trip Efficiency	Source
	15	77%	DNV GL (2016)
4,500	15	77-83%	Aquino et al. (2017a)
4,000	10	77%	May et al. (2018)
2,000-5,000	15	75-85%	EASE (2016)

4.3.5.4 Technology and Manufacturing Readiness Levels

Sodium-sulfur batteries have been manufactured in Japan since the early 1990s. Since then the technology has been demonstrated at over 190 sites with over 350 MW of capacity installed. Besides Japan, in 2010 there was 9 MW worth of sodium-sulfur capacity installed just within the United States to be used for peak shaving, wind capacity firming, and other applications (EASE 2016). Due to the multiple decades of development for this technology, the TRL and MRL levels can be estimated at 8 and 9, respectively, with estimates for 2025 rising to 9 and 10.

4.3.6 Sodium Metal Halide Batteries

Sodium metal halide batteries, also known as sodium-nickel-chloride or zebra batteries, have primarily been introduced into the electrical storage market for EV usage. The battery sizes themselves have a smaller range than some of the other electrochemical storage systems; the former fall in the capacity range of between a few kWh to a few MWh and have a high level of scalability and flexibility. Compared

to other batteries such as sodium-sulfur that run at high temperatures, the sodium metal halide battery has a lower temperature range between 270° and 350°C; however, the system still requires independent heaters to maintain the molten state necessary for operation (Karina et al. 2013). Overall, the technology has a high performance and durability level with low sensitivity to ambient temperature that makes it an attractive energy storage option. Due to their flexibility, sodium metal halide batteries are capable of being used across a large variety of applications, including EVs and public transportation, residential and commercial buildings, renewable generation smoothing, and others (EASE 2016).

4.3.6.1 Capital Cost

The sodium metal halide system consists of a positive electrode made of nickel and sodium chloride and a sodium anode. These components are separated by a ceramic wall. The battery systems are composed of modules that are assembled together to scale the battery up to the desired capacity value. Like other electrochemical systems, the sodium metal halide battery also requires a PCS.

EASE (2016) estimates the cost of this system to be approximately \$550–\$750/kWh for a typical system that is several megawatts. May et al. (2018) estimated the range for the average project cost to be somewhere between \$750–\$1,000/kWh. Mirardi (2018) provided a cost estimate for their BESS SPRING164 570 kW, 1.2 MWh dc system of 500 euros/kWh, which converted at the rate of \$1.1676/euro (as of July 12, 2018) amounts to \$584/kWh. For this work, \$700/kWh was used for 2018 capital cost, with an anticipated 31 percent drop to \$482/kWh by 2025. PNNL has developed planar cells that are expected to drive cost down to \$150/kWh, while use of Fe instead of Ni is expected to drive cost down further to \$100/kWh (Li 2018). The TRL for the PNNL technology is considered to be at 5, hence it has not been included. However, if the manufacturability of this planar design can be demonstrated, the sodium metal halide battery could be a leading candidate for storage.

4.3.6.2 Fixed and Variable Operations and Maintenance Costs

No estimates were found for this technology in the literature.

4.3.6.3 Cycles, Lifespan, and Efficiency

A variety of estimates were provided for RTE for this type of battery technology. EASE (2016) estimates it to be somewhere between 80–95 percent and both Li (2018) and Benato et al. (2015) follow similarly with 92 percent and 90 percent, respectively. Miraldi (2018) reported an RTE of 79 percent at rated power and 88 percent at rated energy. Because this report focuses on a 4-hour application, and discharge at rated power corresponds to 2 hours, it is appropriate to use 88 percent as the relevant number. May et al. (2018) estimate the value to be lower at 75 percent. This work uses a DC-DC RTE of 86.5 percent and an associated AC-AC RTE of 83 percent.

Regarding cycles, most of the literature reviewed estimated the value to be somewhere in the 3,500 to 4,500 cycle range; Solarquotes (2018) provided the lower estimate and EASE (2016) provided the higher. A cycle life of 3,500 cycles was assumed. The life of this system ranged from 10 years (Li 2018; May 2018) to 15 years (Benato 2015; Miraldi 2018). A life of 12.5 years was assumed for this work.

Table 4.20 provides cycles, life years, and RTE for sodium metal halide batteries found in the literature.

Table 4.20. Cycles, life years, and round-trip efficiency of sodium metal halide batteries.

Cycles	Life Years	Round-Trip Efficiency	Source
4,500	15	88%	Miraldi (2018)
4,500	<15	80-95%	EASE (2016)
4,500	15	89%	Benato et al. (2015)
4,000	10	75%	May et al. (2018)
		92%	Li (2018)
3,500			Solarquotes (2018)

4.3.6.4 Technology and Manufacturing Readiness Levels

Sodium metal halide batteries have only been in use since 1999. Since then they have primarily been manufactured in Europe and the United States with projects taking place in other continents as well. There is still a substantial amount of potential for development of the technology given the short amount of time it has been manufactured compared to other systems. The TRL for this technology is slightly lower than other electrochemical counterparts at TRL 6 and is expected to rise to TRL 8 by 2025. This technology is considered to be MRL 7 and have the potential to rise to MRL 9 by 2025.

4.3.7 Zinc-Hybrid Cathode Batteries

The zinc-hybrid cathode battery, named “Znyth” battery by its developing and commercializing entity EoS (EoS 2017), is a high-energy density storage technology that uses inexpensive and widely available materials, and therefore could be supplied at a low cost. It uses non-flammable, near-neutral pH aqueous electrolyte, which is non-dendritic and does not absorb carbon dioxide (CO₂), eliminating carbonate clogging issue. There are a number of manufacturers exploring this technology, including Urban Electric Power (Zn-MnO₂), ZAF Systems, ZincFive (Zn-Ni), and NantEnergy (Zinc-Air). Limited information on these systems was available regarding cost or performance; however, information on the EoS system was most complete and served as the primarily source of information for this technology.

4.3.7.1 Capital Cost

According to the EoS website cost calculator, the DC battery system is priced at \$263/kWh as of 2018 for a 1 MW/4 MWh system, including the batteries mounted and wired, the energy stack outdoor-rated enclosure, BMS, and a one-year warranty. It does not include PCS, C&C, or shipping estimates. The calculator also estimates cost for various multiples of the 250 kW/1,000 kWh units as shown in Table 4.21. Up to 750 kW/3,000 kWh, the capital cost was projected to be \$263/kWh, followed by a drop to \$212/kWh at 1,000 kW and higher.

Table 4.21. Zinc-hybrid cathode battery cost by energy-to-power ratio.

	250	500	750	1,000	2,000
kW	250	500	750	1,000	2,000
kWh	1,000	2,000	3,000	4,000	8,000
\$/kWh	250	250	250	200	200
Baseplate \$/kWh	13	13	13	12	12
Total \$/kWh	263	263	263	212	212
Total cost \$	263,000	526,000	789,000	848,000	1,696,000

Correspondence with EoS (Yang 2018) provided the following information regarding a 500 kW/2 MWh zinc-hybrid cathode system:

- \$225/kWh for the energy stack that includes batteries, racking, container, and building
- \$40/kWh for the DC control box.

A cost of \$265/kWh was used for 2018 in this analysis.

In subsequent communication, the 2022 cost was projected to be \$160/kWh. For this work, the researchers have used \$192/kWh for 2025, a drop of 24 percent.

4.3.7.2 Fixed and Variable Operations and Maintenance Costs

Regarding variable O&M, discussions with Yang (2018) gave a cost of \$2/kWh for the year 2022. For this work, the research team have aligned O&M costs with other battery technologies.

4.3.7.3 Cycles, Lifespan, and Efficiency

EoS claims an RTE of more than 75 percent at 100 percent DoD. It is projected to endure 5,000 cycles at 100% DoD, or a 15-year calendar life. The DC-DC RTE projections for 2022 was stated to be 75 percent from Yang (2018), while the DC response time was a few milliseconds to rated power. For this work, the AC-AC RTE was assumed to be 72 percent, while AC response time was assumed to be 1 second.

4.3.7.4 Technology and Manufacturing Readiness Levels

Thus far, EoS-manufactured Znyth batteries have been installed at only two sites, both in 2017. Based on the number of installations and length of operating experience, a TRL value of five and MRL value of six are assigned to this technology.

4.3.8 Pumped Storage Hydropower

PSH units are resources that are sought for their ability to provide bulk power and ancillary services to the grid at a low \$/kW rate. PSH is a well-established technology that has existed over a century. With that noted, the technology continues to evolve, as highlighted in this section. PSH offers quick synchronization, short response time, and the versatility to serve as both a load and a generator. Despite these benefits, however, deployments of the technology have stalled in the United States and some other markets in recent years due to large total capital costs requiring funding of hundreds of millions of dollars, the uncertainty of future market demand conditions, and environmental considerations that arise from the nature of the technology (Balducci et al. 2018). Despite these challenges, PSH plants are well suited to support variable renewable generation. For example, Helms Pump Storage Hydro uses off-river water storage to generate electricity when the demand is higher and pumps when there is lower energy demand (Yeung 2008). Until 2013, pumping energy consumption took place mostly during night hours. In recent years, however, pumping during daytime hours has expanded significantly and in 2016 and 2017 surpassed night-time pumping. Energy stored during daytime hours is now used to meet significant ramping requirements caused by a sharp increase in net load that occurs when production from solar units falls as the sun begins to set (DOE 2017a).

PSH is very efficient in ensuring renewable energy supply is smoothed out over periods of peak energy demand. Solar and wind energy require availability of certain climatic conditions to ensure uninterrupted

supply, which is not always present (ESMAP 2015). PSH can store the electricity generated by these resources and supply it when there is peak load energy demand, thus providing balancing services (Rehman et al. 2015).

Despite the lack of recent deployments, PSH provides more than 97 percent of all installed capacity of energy storage (DOE 2018a). Internationally, PSH capacity is expected to increase 26 GW between 2018 and 2023 (IEA 2019). PSH can be used to reduce or eliminate wind curtailment in areas with significant wind power and low amounts of grid-scale storage. There was a 147 percent increase in renewable curtailment in California in spring 2017 from a year earlier. The California Independent System Operator expects this trend to continue unless there is significant grid-scale storage to address it (CAISO 2017). The 2016 Hydropower Vision Report states that PSH may not be fully valued in the wholesale electricity and ancillary services markets, thus slowing down project deployment (DOE 2016b). The report also states that there is growth potential of 16.2 GW by 2030, and another 19.3 GW by 2050 under favorable market conditions, to increase deployments from the present 21.6 GW (2016) to 56 GW by 2050 (DOE 2016b). Hence, state and federal regulatory and market policy changes are essential for enhancing the viability of new PSH projects, especially in regions where renewable penetration lacks grid-scale storage.

PSH plants generally fall within three categories of technology: fixed, variable, and ternary. Fixed speed (also referred to as single-speed) involves a PSH plant that is only capable of pumping water in “blocks” of power that are non-adjustable. Variable-speed PSH units, on the other hand, were introduced to incorporate the technological capability of adjusting the rate at which water is pumped in order to provide regulation services—a use case that is unattainable with fixed speed (NHA 2017). Ternary technology consists of a PSH unit that allows for higher flexibility and improved efficiency by incorporating a separate turbine and pump on a single shaft along with the generator (Koritarov et al. 2013). Recent years have brought new approaches to the technology. Some examples include the following:

- Obermeyer Hydro Accessories, Inc. is working towards the installation of a submersible permanent magnet motor generator with reversible pump turbines (DOE 2017b).
- The National Renewable Energy Laboratory (NREL) will incorporate advanced control equipment to their ternary pumped storage unit to improve renewable integration methods. This project is working towards the development of a proof of concept (DOE 2017b).
- ORNL is working towards the development of the Ground Level Integrated Diverse Energy Storage (GLIDES) project. It is a modular system that combines compressed air technology with pumped storage (DOE 2019).

Per the U.S. Hydropower Market Report 2017 Update (DOE 2017a), by the end of 2016 there were 38 PSH projects in some stage of development, 32 of which were in the process of completing feasibility studies. Once a preliminary permit application is approved, developers have the ability to retain first rights to submitting a license application. While it is not necessary for a preliminary permit to be submitted prior to a license application, most projects go through this phase to establish the right to a license for the project prior to other applicants and possibly to engage the Federal Energy Regulatory Commission (FERC) from the onset of the project (FERC 2018b).

The following describes a selection of notable PSH plants, both in development and in operation:

- The Helms Plant, in operation in the PG&E area since 1984, takes eight minutes to go from stopped to operational mode, and is not able to use excess generation capacity to pump water in reservoirs due to transmission constraints. Hence, it is important to address this issue to use PSH plants effectively. The project uses off-river water storage to generate electricity when the demand is higher and pumps when there is lower energy demand (Yeung 2008).

- The Castaic plant in the Los Angeles area, in operation since 1978, was subject to “significant repairs and refurbishing” from 2004 to 2013, which appears to indicate that for the first 26 years of operation the O&M costs were minimal (Doughty et al. 2016).
- The Eagle Mountain PSH project is expected to be online by 2025, with an expected storage duration of 12 to 18 hours at 1,300 MW (DOE 2017b).
- Other new developments include the one in Southern California, which consists of an 8-hour PSH unit being planned at the San Vicente Reservoir in San Diego. The pump house is expected to have four 125 MW reversible pump-turbines (Nikolewski 2017).

Retrofitting of older plants to improve performance includes major upgrades such as expansion of the powerhouse and hydraulic redesign (Henry et al. 2013; Cavazzizi 2014; Valavi & Nysveen 2018). There are plans to convert fixed speed to adjustable-speed or variable-speed PSH; however, doing so results in a 20 to 30 percent increase in cost for the electrical and mechanical equipment, along with potential increases in powerhouse volume and evaluation of civil structure to accommodate larger and heavier machinery (Manwaring 2018d). Such upgrades need to be considered on a case-by-case basis for their economic feasibility. An overall project cost increase of 7 to 15 percent is estimated for adjustable-speed PSH over fixed speed, and the electromechanical equipment cost is estimated to be 60 to 100 percent higher (DOE 2015; Botterud et al. 2014). An estimate based on the various categories for cost increase is presented in Table 4.22.

Table 4.22. Estimated cost increase (%) for variable-speed PSH over fixed-speed PSH.

Item	Estimated Increase for Variable Speed
Turbine upgrade (means pump + turbine)	30%
Motor-generator upgrade	60 to 100%
Electrical redesign (assign to electrical and mechanical hardware)	30%
Powerhouse civil	30%
Hydraulic redesign (assign to tunnels civil)	20%

When looking at the performance of different units, the RTE for PSH can be approximated by the product of pumping and generating efficiency, excluding losses due to evaporation (Homer Energy 2018). The RTE varies from 60 percent for older systems to 80 percent for newer designs. The same reference described some PSH projects as part of the November 2015 Joint Workshop with the California Energy Commission and CPUC (DOE 2017b).

The RTE of 80 percent noted in this report is all-inclusive. The cycle efficiency is a function of DoD, head loss, friction loss in the conveyor tunnel, turbine efficiency, generator efficiency, and pump efficiency. A ramp rate of 20 to 35 MW/s is possible per unit. For some projects, one tunnel feeds two units, thus reducing ramp rate by a factor of two. Typically, the equipment vendors, such as General Electric Company or VOITH, provide their input to tunnel design and construction to ensure their power components can provide the necessary power (GE 2018).

4.3.8.1 Capital Cost

The capital components of a conventional PSH facility include two water reservoirs, a waterway to connect them, and a power station that includes a pump and turbine. Given the typically large footprint of the system, because PSH is capable of providing grid-scale levels of energy, the cost of an average project is typically higher than other ESSs given the construction, commissioning, and potential environmental

reviews. Aquino et al. (2017a) estimated the cost to be \$1,500–\$4,700/kW for a single-speed unit, further estimating that an adjustable-speed unit would come with a 10–20 percent higher cost. Most PSH projects were developed in the 1970s and 1980s and, according to a U.S. Bureau of Reclamation report on the Mt. Elbert Pumped Storage Power Plant, they cost around \$2,020/kW. ORNL estimated two values for the technology, the first between \$1,800 and \$3,200/kW for an adjustable-speed PSH unit and the second estimate of \$2,230/kW from a Black & Veatch report (Shan and O'Connor 2018).

Cost is typically expressed in \$/kW for PSH plants. However, sometimes it is expressed in \$/kWh. In both cases, the total cost is divided by the power or energy to get \$/kW or \$/kWh, respectively. While there is currently insufficient data to do this, it would be useful to separate out the power component cost and the energy component costs such that the total plant cost can be estimated for any E/P ratio. As described later in this section, the cost breakdown among various categories can be difficult because cost is determined by site-specific conditions. For example, the geography/terrain determines the type of reservoir to be built, which directly affects reservoir cost. Tunnel excavation cost also depends on the terrain. For a 10-hour, 300 to 1,000 MW plant, the 2017 costs were estimated to be within the wide range of \$1,700–\$5,100/kW (Damato and Minear 2016).

When evaluating capital cost on a \$/kWh basis, Kamath (2016) placed the value at \$70–\$230/kWh for an average project cost, while May et al. (2018) had a higher range of \$250–\$350/kWh.

A discussion with McMillan Jacobs Associates indicated that for a \$700/kW transmission upgrade, land costs and civil engineering costs of \$460/kW need to be added to target PSH costs. Excluding these costs, for a project to be economical, the target cost was proposed to be in the \$1,500–\$2,000/kW range. There were some locations with a projected cost of \$3,000/kW for a 50 MW system, and some with a projected cost of \$2,000/kW. Based on a conversation with HDR, our calculations indicate that the land cost is only \$6/kW, assuming \$250,000 per acre (Miller 2018). However, some plants have to purchase two orders of magnitude higher acreage than required for the project, depending on the length of the transmission line being serviced. This work assumes land required does not include the additional acreage and overall these costs are not considered, because they are site-specific.

Project costs for most sites are not broken down into various components. While the Black & Veatch (2012) report provides a breakdown for various categories for a specific case—500 MW, E/P of 10, and lower reservoir being a natural lake or river (hence no additional cost)—such information is typically not provided. In this report, the electrical and mechanical costs for the powerhouse were stated to be \$835/kW.

Per International Renewable Energy Agency (IRENA 2012), the \$/kW for electrical and mechanical equipment decreases with increasing power and is estimated to be \$570/kW for a 4 MW system, \$485/kW for a 48 MW system, and \$245/kW for a 500 MW system. There appears to be an inflection point at ~ 50 MW. From 4.3 MW to 48 MW, the \$/kW decreased by 15%, while from 48 MW to 500 MW, the drop is 50%. This is shown in Figure 4.1 (IRENA 2012). The unit power cost for the electrical and mechanical equipment in this report is ~30 percent of the \$835/kW, thus highlighting the challenge associated with arriving at a single cost number for each category. While several projects have been planned with associated cost estimates, cost data for various components are not available.

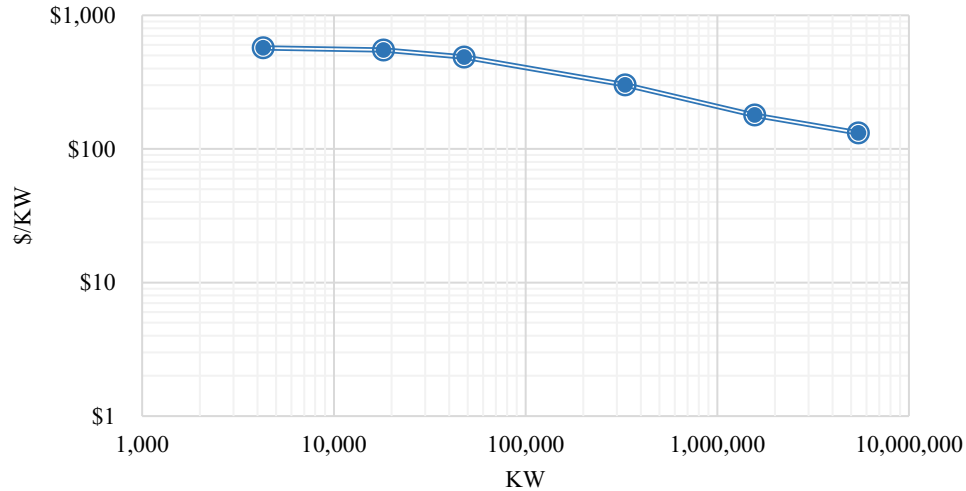

Figure 4.1. Cost of electromechanical equipment for hydro plants.

Steffen (2012) listed the investment cost for 11 announced PSH projects in Germany, which consisted of “land acquisition, civil works and the hydraulic steel structure” and the “mechanical and electrical machines,” with the latter estimated to be 20 to 30 percent of total cost. The cost decreased linearly with increasing PSH power capacity. The cost for a 500 MW system was estimated to be \$1,840/kW, with the electrical and mechanical equipment, at 25 percent, corresponding to \$460/kW. However, once the two projects with existing reservoirs and one project with high leverage were removed, there was no correlation between the project cost per kilowatt-hour and the capacity of the project. That is, site-specific conditions affected costs more than the MW capacity of the PSH plant. This is an example of the complexity of trying to break out the PSH cost among various components, because site-specific conditions may dominate costs (Manwaring 2018d).

Existing plants have a high energy-to-power ratio of 30 hours (h), but 12–16 h plants are in development and some are reaching as low as 8 h in duration. Based on this, 16 h was selected as the duration for this report, which covers the higher end of the E/P ratio for plants that are coming up. From available data, the PSH cost was determined to be \$2,638/kW for a 16-hour plant (Manwaring 2018b).

Table 4.23 shows the breakdown for the various line items, including estimated cost for the lower reservoir set equal to that for the upper reservoir (Manwaring 2018a). The powerhouse electrical and mechanical (E&M) equipment cost is \$825/kW, while the powerhouse excavation (civil engineering) cost is \$80/kW. Depending on the terrain, the costs for tunnels, upper reservoir, and lower reservoir can vary. This list does not include transmission upgrade costs, which can be as high as \$700/kW (Manwaring 2018a).

Table 4.23. Line item cost breakdown for a 16 H PSH plant.

Item	\$/kW
Total Cost \$/kW	2,640
Owner's cost	370
EPC	390
Tunnels	135
Powerhouse excavation	80
Powerhouse	835
Upper reservoir	420
Estimated lower reservoir	420

In terms of percentage cost breakdown for PSH units, the cost component breakdown for a 10-hour PSH plant provided in Black & Veatch (2012) costing \$2,230/kW is as follows:

- Owner’s cost: \$370/kW (17%)
- EPC: \$390/kW (17%)
- Powerhouse: \$835/kW (37%)
- Tunnels: \$135/kW (6%)
- Powerhouse excavation: \$80/kW (4%)
- Upper reservoir: \$420/kW (19%)

Figure 4.2 shows the breakdown in cost of the PSH units described above (Black & Veatch 2012).

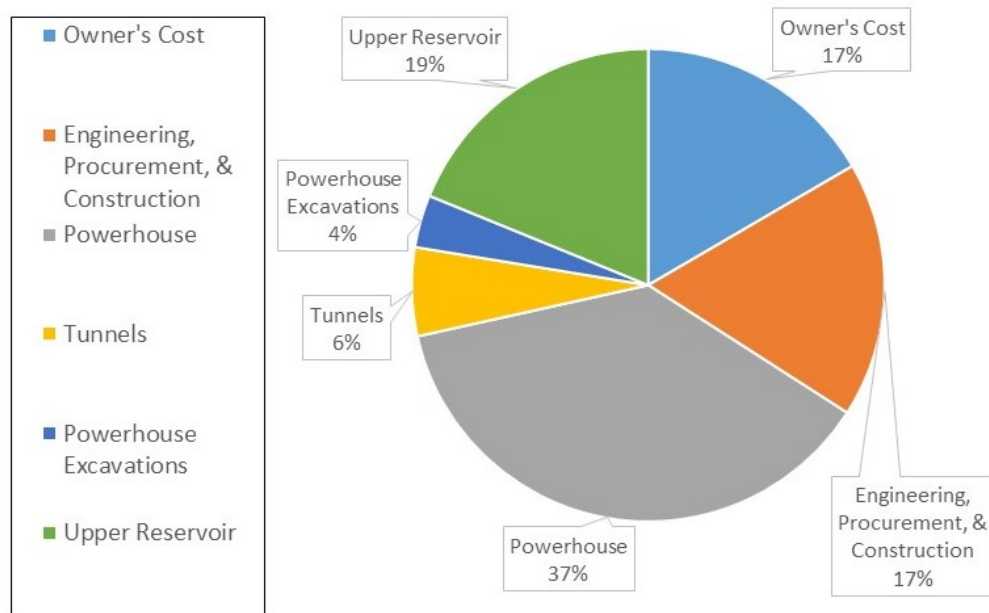

Figure 4.2. Capital cost breakdown for a pumped storage hydro plant.

Table 4.24 shows different total \$/kW capital costs from collected literature for PSH technology.

Table 4.24. Capital costs of pumped storage hydro systems.

Capital Cost (\$/kW)	Notes	Source
\$1,500-\$4,700		Aquino et al. (2017b)
\$70-\$230/kWh		Kamath (2016)
\$2,020	\$762/kW in 1985 converted to 2018 dollars using 3% escalation rate	United States Bureau of Reclamation (2018)
\$250-\$350/kWh		May et al. (2018)
\$1,500-\$2,000	Target cost for project to be economical. Excludes transmission upgrade cost of \$700/kW and civil and infrastructure cost of \$460/kW	Manwaring (2018a)
\$3,000	For 50 MW system	Manwaring (2018a)
\$1,300	Projected cost for Eagle Mountain PSH in Southern California	Manwaring (2018a)

Capital Cost (\$/kW)	Notes	Source
\$1,800-\$3,200	Adjustable-speed PSH	Shan & O'Connor (2018)
\$2,230		Black & Veatch (2012)
\$1,500-\$5,100		EPRI 2017

To estimate the initial capital cost (ICC) to develop a greenfield PSH facility, prior research conducted by ORNL and documented in Witt et al. (2016) was leveraged. Witt et al. (2016) documents the development of a scalable, comprehensive cost modeling tool capable of simulating the ICC for a variety of modular PSH projects and deployment scenarios. Based on a few input site characteristics (storage volume, storage time, design head, and optional variables), the tool provides a reference design, categorical project cost estimates, and ICC estimates. The research considered various test case scenarios, including one in which construction of new upper and lower reservoirs is required and no existing infrastructure is available. In this report, a similar approach is used to estimate ICC.

In general, the default tool settings as documented in Witt et al. (2016) were used in the present study. A few key additional assumptions made include RTE, a penstock length-to-head ratio, and the use of a Pelton turbine with standard pump arrangement. In addition, the escalation techniques used in the original tool were extended out to 2018 using the same cost indexes. Thus, all ICC estimates provided herein are in current year of 2018.

To consider a wide range of utility-scale greenfield PSH development, ICC estimates were calculated across different head (300 to 1,500 ft) and installed capacity (100 to 1,500 MW) ranges for 6-, 8-, and 10-hour design storage times. The cost per kW increase with higher E/P ratios though the cost per kWh decline across the same range. When measured on a cost per kWh basis, PSH compares favorably with other energy storage methods. Importantly, some of the design and cost methods used in the tool may not be intended for application at the high-head and high-capacity scales considered in the present study; however, the general patterns found are deemed reasonable.

The ICC estimates are provided as shown on a cost per-kilowatt (\$/kW) basis. As shown in the plots, \$/kW is lower for high-head development, which reflects the fact that for a project of the same installed capacity and same storage time, smaller reservoir storage capacity and smaller, less-expensive electromechanical equipment is required as head increases. The general trend is consistent with a major finding in Witt et al. (2016) that PSH projects tend towards greater economic viability when developed at a high head greater than 500 ft. For head above 1,000 ft, \$/kW is roughly the same.

The plots also reveal economies of scale associated with PSH development (i.e., \$/kW decreases as installed capacity increases). This effect is relatively muted for capacities above about 500 MW, as \$/kW values generally show little change. At smaller scale (e.g., 100 MW and lower), the \$/kW becomes much higher.

A final trend noticeable among the plots in Figure 4.3 is the tendency for \$/kW to increase for larger storage times. This trend is attributed to the fact that for a project of the same installed capacity and same head, larger reservoir storage capacity is required. Additional revenue-related considerations may influence a decision to design for larger reservoir capacity.

In general, for a 6-hour storage time, the estimated ICC of a high-head (700+ ft), large-capacity (500+ MW) project is \$2,200 to \$2,500/kW. For a project with similar head and installed capacity, the estimated ICC increases to \$2,400 to \$2,800/kW for an 8-hour storage time and \$2,600 to \$3,100/kW for a 10-hour storage time.

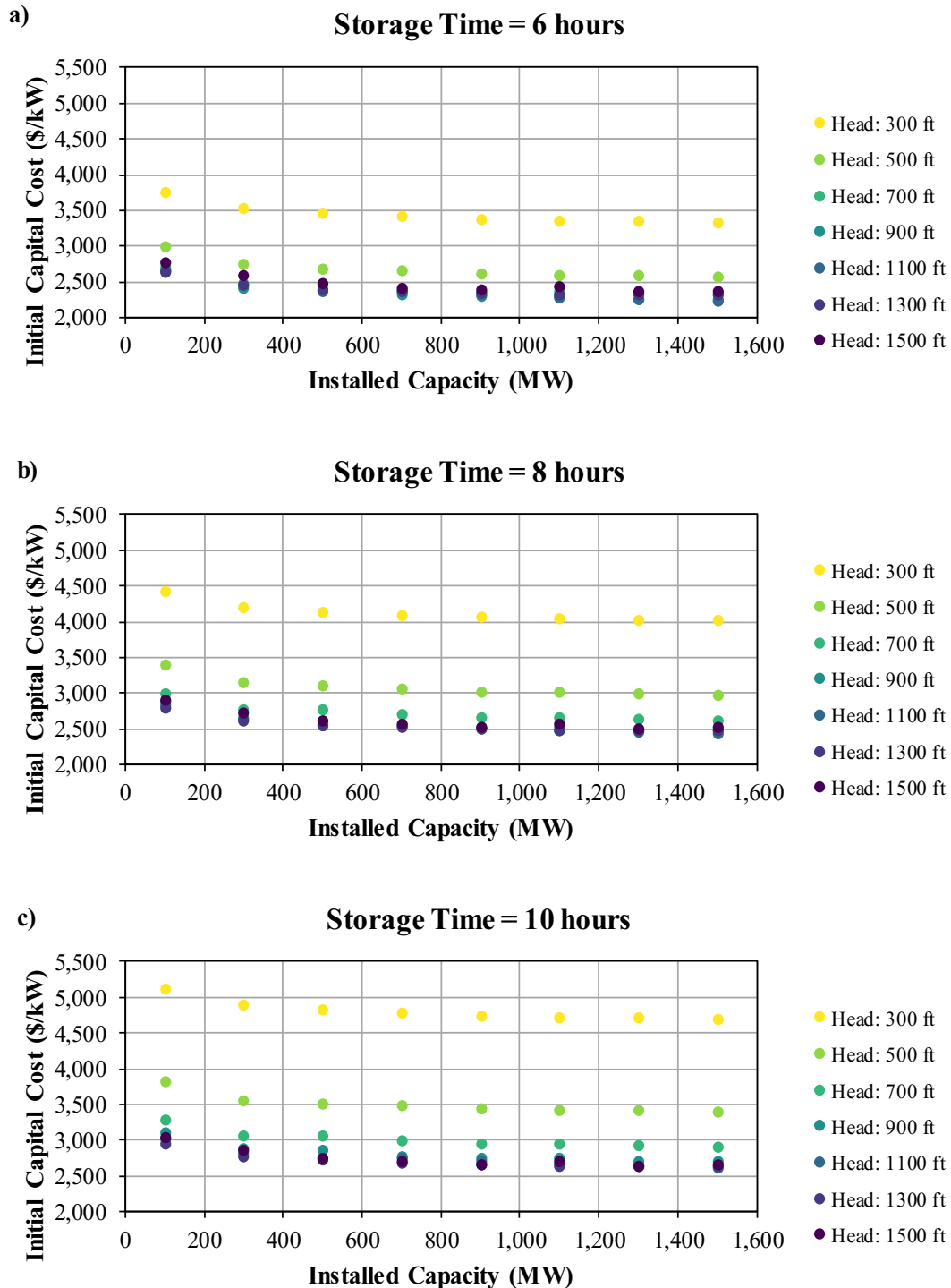

Figure 4.3. Initial capital cost estimates for greenfield PSH development for a) 6-hour, b) 8-hour, and c) 10-hour storage times.

Capital cost and the potential for the reduction of this cost have been discussed in previous literature without consensus. Some studies point to increasing costs in the next 20- to 40-year time period and some indicate a decline in costs. The International Renewable Energy Agency (IRENA 2012) stated that since a significant amount of research has been undertaken with respect to hydropower, hydropower is unlikely

to exhibit a downward sloping supply curve in the medium term. This is primarily because all the lower cost opportunities and potential have been exploited and the increase in supply of hydropower will be accompanied at higher cost (IEA 2008; IRENA 2012).

However, since then, additional research has been undertaken in the sphere and ORNL can be credited with the development of Ground Level Integrated Distributed Energy Storage or GLIDES. GLIDES stores air in high-pressure vessels as compressed air and is stated to be a low-cost energy generation technology with higher RTE. Hydraulic pumps are used to drive water into these vessels, leading to a higher air compression (Witt et al. 2015).

Other significant improvements in PSH are reversible pump-turbines with improved efficiencies, adjustable-speed pump-turbines, improved equipment controls (static frequency converters, generator insulation systems), and improved underground tunneling methods. These have higher capital costs but may lead to greater life-cycle cost reduction. According to MWH (2009), an increase of up to 5% in pumping efficiency has been caused by improvement in the pumping/turbine technology during the 25 years preceding the publication of the report (NHA 2017; MWH 2009).

As another example, Shell Energy North America (SENA) is developing a small, modular PSH plant with a 5 MW, 30 MWh capacity. The cost of the plant is estimated to be \$22.3 million or \$4,400 kW (\$743/kWh). SENA has estimated a two-year project development cycle consisting of licensing activities in Year 1 and capital costs in Year 2. Licensing costs for the first system are estimated to be \$3 million, with costs reduced to \$1 million for all subsequent plants. The capital cost for the system, excluding the floating membrane that makes up the lower reservoir, is estimated to be \$18.7 million (SENA 2017). The conceptual floating membrane system is being developed and the estimated costs are about \$600,000 with uncertainty at +100 percent/-50 percent (Hadjerioua and DeNeale 2018). Annual O&M costs are estimated to be \$408,993 in Year 1 (Balducci et al. 2018).

Outside of the SENA project, the literature has had a variety of estimates of how costs may decrease or increase over time for PSH. The IRENA (2012) for example, states that they expect lower cost opportunities have already been exploited. Similarly, Barbour et al. (2016) state that because costs are biased toward civil engineering requirements that fluctuate on a project-by-project basis, there are limits to the overall cost reduction that can be gained through the supply chain.

4.3.8.2 Fixed & Variable Operations and Maintenance Costs

Regarding fixed O&M costs, Aquino et al. (2017a) estimated the range to be between \$6.20–\$43.30/kW-yr. ORNL averaged the O&M costs for 11 PSH plants in the 2014–2016 period and found the O&M costs ranged from \$20/kW-yr at 200 MW to \$5/kW-yr at 2,800 MW (Shan and O'Connor 2018). The Black & Veatch (2012) report shows an O&M cost of \$30.8/kW-yr. The numbers indicated in Table 4.25 are averaged (excluding the highest value of 43.3) to arrive at an O&M cost of \$15.9/kW-yr. The fixed costs include labor, insurance, and taxes.

The variable costs are a function of the number of starts and stops. The variable costs include rehabilitation or repairs to welding joints, circuit breakers, and runners. ORNL estimated unit start cost in the \$300–\$1,000 range. Assuming the plant is sized at 100 MWh, and goes through 20 cycles in a year, this amounts to the 0.000094 to 0.0003 cents/kWh range. Considering the very low value, PSH variable costs have been set to 0 in this report.

Table 4.25 shows a compilation of the fixed O&M costs found in the literature O&M cost for hydropower projects have also been estimated to be 1% of the construction and equipment procurement costs (MWH 2009).

Table 4.25. Fixed O&M costs of pumped storage hydro.

Fixed O&M (\$/kW-yr)	Notes	Source
\$6.2-43.3		Aquino et al. (2017b)
\$17.6	2007 costs	United States Bureau of Reclamation
\$5-20	Fixed decreases from 20\$/kW-yr at 200 MW to 7.5 \$/kW-yr at 2,000 MW to \$5/kW-yr at 2,800 MW	Uriá-Martínez et al. (2018); Shan & O'Connor (2018)
\$30.8	500 MW plant	Black & Veatch 2012

4.3.8.3 Cycles, Lifespan, Response Time, and Efficiency

May et al. (2018) estimate that a PSH unit is capable of lasting up to 50 years with an RTE of 80 percent and up to 20,000 cycles. ORNL (Shan and O'Connor 2018 and Aquino et al. 2017b) estimate the usable life to be closer to 20 years, and an RTE range of 82 percent and 70–87 percent, respectively. An RTE of 80 percent has been used in this report. Life time is assumed to be >25 years, and 15,000 cycles are assumed.

Table 4.26 lists PSH cycles, life years, and RTE.

Table 4.26. Cycles, life years, and round-trip efficiency of pumped storage hydro.

Cycles	Life Years	Round-Trip Efficiency (%)	Source
	20	82	Aquino et al. (2017b)
20,000	50	80	May et al. (2018)
	>20	70-87	Shan and O'Connor (2018)

Typical ramp rates for PSH systems are 25 to 50 MW/s (Manwaring 2018a). The ramp rate is a function of tunnel design to move water, so for a 4-unit plant, the ramp rate is 200 MW/s. While most of the time there is one tunnel per unit, sometimes one tunnel serves two units, thus decreasing ramp rates to 12 to 25 MW/s per unit. The time for various mode changes depends on whether the PSH is ternary or not. For ternary PSH, mode changes are quicker. Table 4.27 shows the time in seconds for various mode changes. For fixed-speed (FS) units, pumping is done at fixed load consumption, hence ramp rate is not applicable for the pumping mode. For generation, FS units take 5 to 15 seconds to reach rated power from online status. Hence, the ramp rate is 7 to 20 percent of rated power per second.

When ramp rate is defined as the time from spinning to rated power, for the pumping mode, the duration is 25 to 80 seconds. Ternary systems, having the fastest ramp rate of 4 percent rated power per second, take 25 seconds for this, while fixed-speed systems take 80 seconds. Using the same definition for ramp rate during generation, again, the ternary systems achieve this in 20 seconds, while FS systems achieve this in 5 to 15 seconds or 7 to 20 percent of rated power/s (Shan & O'Connor 2018) and 70 seconds or 1.4 percent rated power/s (Fisher 2012).

Table 4.27 provides the ramping ability for a PSH plant (Shan and O'Connor 2018; GE 2018).

Table 4.27. Ramping ability of pumped storage hydro plants.

Status	Shan and O'Connor (2018)	General Electric (2018)
Shutdown to online (generating mode)	60-90 seconds	220 seconds
Online generating to shutdown		220 seconds
Online to full-load generating	5-15 seconds	60 seconds
Shutdown to full generation		120 seconds
Spinning-in-air to full-load generating	5-15 seconds	
Online to full load		80 seconds
Shutdown to normal pumping	6 minutes	300 seconds
Spinning-in-air to normal pumping	60 seconds	
Full load to online		60 seconds
Full generation to shutdown		250 seconds
Full pumping to shutdown		150 seconds
Full load to full generation		220 seconds
Full generation to full load		500 seconds

Table 4.27 has been regenerated below (as Table 4.28), with additional information provided for FS, advanced FS, adjustable-speed (AS), and ternary PSH with two different turbine types. While it would be preferable to provide ramp rates for each of these types to allow differentiation among them, there is not enough information to provide ranges for each mode change and category of PSH.

Table 4.28. Ramping ability of pumped storage hydro plants by technology type.

	Fixed Speed		Advanced Fixed Speed	Extra Fast Fixed Speed	Adjustable Speed	Ternary with Horizontal Francis Turbine	Ternary with Horizontal Pelton Turbine
Source:	Shan and O'Connor (2018)	General Electric (2018)	Fisher (2012)	Fisher (2012)	Fisher (2012)	Fisher (2012)	Fisher (2012)
Shutdown to online (generating mode)	60-90						
Online to full generation	5-15						
Spinning-in-air to full-load generating	5-15	60	70	20	60	40	20
Shutdown to full generation		120	90	75	90	90	65
Full generating to spinning-in-air		80					
Full generation to shutdown		150					
Shutdown to spinning-in-air		220					
Spinning-in-air to shutdown		220					
Shutdown to full load pumping	360	300	340	160	230	85	80
Spinning-in-air to full load pumping	60	80	70	50	70	30	25
Full load pumping to spinning-in-air		60					
Full pumping to shutdown		150					
Full load to full generation		220	190	90	280	60	25
Full generation to full load		500	420	240	470	45	25

4.3.8.4 Technology and Manufacturing Readiness Levels

PSH is considered to be the most mature energy storage technology; a majority of the projects operational today originate from the 1970s and 1980s and the concept originated long before that time. More than 170 GW of the technology are installed internationally and are operational (EASE 2016). Different design variants are still being developed to improve parameters such as efficiency and response time, and other developments are investigating ways to reduce environmental impacts and the costs associated with avoiding them. These developments might include ideas such as closed-loop solutions that avoid impacting natural waterways. Given the long range of time across which PSH has been developed and installed, it is considered to have a TRL of 8 and an MRL of 9. These values are expected to rise to TRL 9 and MRL 10 by 2025.

4.3.9 Flywheels

Flywheels are an electromechanical energy storage technology that has a short duration of only a handful of minutes, which makes them suitable for applications that only require a short time of use or that are used as backup power that can bridge between the grid and larger backup sources. Their structure consists of rotating cylinders connected to a motor that stores kinetic energy. The conversion of electric to kinetic energy is achieved through the use of a variable-frequency motor or drive. Energy is stored by using the motor to accelerate the flywheel to higher velocities. The motor of the flywheel works to accelerate the unit to a higher velocity in order to store energy. Subsequently, it is able to draw electrical energy by slowing the unit down (Aquino et al. 2017a). Given the short duration associated with the technology, although the storage system is fairly mature, it is typically not seen in utility applications. The manufacturers of the product in the United States include Beacon Power and Helix Power. The latter is currently working on a development with DOE around absorption of energy from the regenerative braking and acceleration support to train cars in New York (Helix Power 2016). Flywheel systems can also be suitable for rapid power fluctuations on an industrial-level and for renewable smoothing.

A large benefit that flywheels are able to offer as a technology is their long lifecycles and their fast response times. Associated with these is also a typically large RTE value. They require low maintenance over the course of their lifetimes and are capable of running for a large number of cycles without the associated side effects that you would see with electrochemical storage.

4.3.9.1 Capital Cost

As previously described, flywheels consist of a rotating cylinder connected to a motor that relies on kinetic energy. For bulk levels of the resource, the footprint can be large and rival that of PSH, which comparatively has a much longer duration. Flywheels that are installed as a source of uninterruptible power supply have a much smaller comparable footprint. Aquino et al. (2017a) place the capital cost of a 20 MW, 15-minute Beacon Power flywheel plant at an estimated \$50 million, resulting in a cost estimate of \$2,400/kW. Aquino et al. (2017) further state that Piller, an additional flywheel manufacturer, estimates the price to be closer to \$600/kW for a 2.7 MW unit. Information gathered from Kinetic Traction, a flywheel manufacturer, placed the cost at a similarly low level at \$600/kW for a 333 kW, 1.5 kWh system, not including installation costs (Goodwin 2018). However, the E/P ratio was only 0.27 minutes. Helix Power has a 1 MW, 0.0074 MWh system that is estimated to cost \$1 million or \$1,000/kW, with an additional \$50,000 or \$50/kW for installation.

Table 4.29 shows the capital costs found in the literature for flywheel systems.

Table 4.29. Capital costs of flywheel systems.

Capital Cost (\$/kW)	Notes	Source
\$2,400	20 MW/5 MWh Beacon Power flywheel plant	Aquino et al. (2017a)
\$600	333 kW, 1.5 kWh system excluding installation	Goodwin (2018)
\$1,050	1 MW, 0.0074 MWh system including installation	Helix Power (2018)

One way to estimate the unit energy cost is to determine the average of the \$/kWh cost from the above table, with \$/kWh calculated from the \$/kW and E/P ratio for the Beacon, Kinetic Traction, and Helix Power systems. Doing so resulted in \$61,533/kWh at an average E/P ratio of 0.093 hours, corresponding to \$5,733/kW. The flaw in this method is the overweighting of the high \$/kWh value at a low E/P ratio. A better approach is to use the same power capacity for each system at 1,000 kW to determine individual system cost. Using the E/P ratio for each system, the total power and energy for all three systems are calculated along with total cost. The total cost divided by total energy is the average \$/kWh, while the total cost divided by the total power is the average \$/kW. The results are \$1,333/kW and \$14,309/kWh. The E/P ratio for this “total system” is 0.093 hours, the same as the average E/P arrived at earlier. However, this time, the overweighting of the high \$/kWh value at low E/P ratio is not present.

A better approach is to plot the \$/kW vs. E/P ratio to get the \$/kW value at any required E/P ratio. Extrapolation of the straight-line fit provides the \$/kW at E/P ratio > 0.25. The \$/kW at E/P ratio of 0.093 was \$1,312, corresponding to a \$/kWh of \$14,573. This is shown in Figure 4.4

Table 4.30 provides the capital cost in \$/kW for various E/P ratios and the associated \$/kWh cost. For example, at an E/P ratio of 1, the \$/kW and \$/kWh is \$7,566, while at an E/P ratio of 4, the numbers are \$28,186/kW and \$7,047/kWh, respectively. Because Beacon Power’s 20 MW, 5 MWh flywheels have been operating for >3 years, this work will assume an E/P ratio of 0.25, with an associated \$/kW cost of \$2,400/kW for the flywheel system.

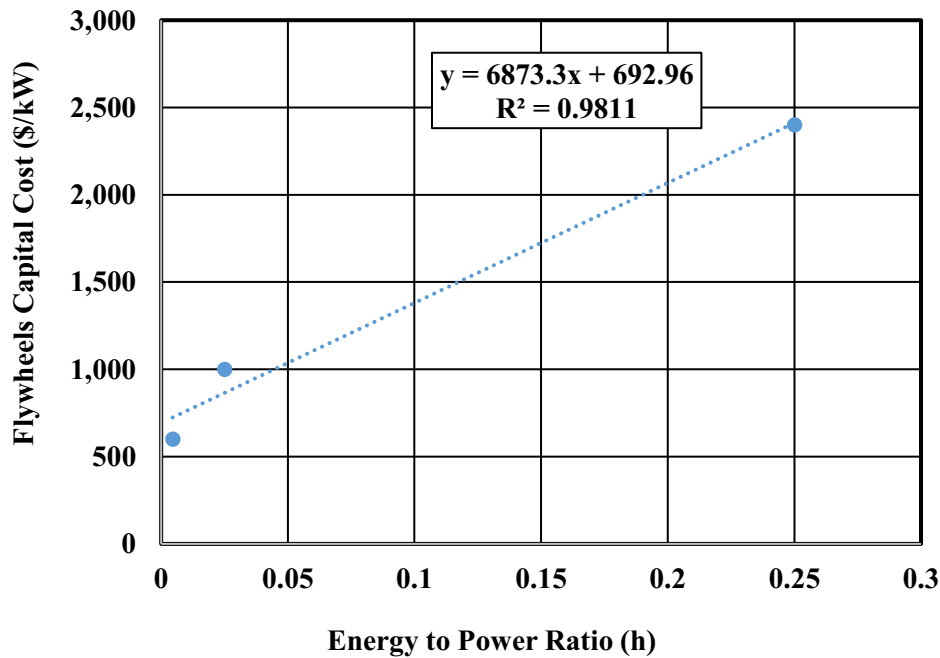

Figure 4.4. Capital cost by E/P ratio for flywheel technology.

Table 4.30. Capital cost for various E/P ratios for flywheel technology.

Vendor	kW	kWh	\$/kW	Cost \$	\$/kWh	E/P (h)	\$/kW from Fit	\$/kWh Calculated
Beacon	1,000	250	2,400	2,400,000	9,600	0.25	2,411	9,645
Helix	1,000	25	1,000	1,000,000	40,000	0.025	865	34,592
Kinetic	999	4.5	600	599,400	133,200	0.004505	724	160,710
						1	7,566	7,566
						2	14,440	7,220
						3	21,313	7,104
						4	28,186	7,047

4.3.9.2 Fixed and Variable Operations and Maintenance Costs

Only a small number of sources provided O&M information regarding this technology category. Among them were Aquino et al. (2017) and Manuel (2014), who estimated fixed O&M to be \$5.56/kW-yr and \$5.80/kW-yr, respectively. Manuel (2014) also provided a variable O&M estimate around \$0.30/MWh. Helix Power estimates the maintenance costs to be minimal, while Kinetic Traction estimates <\$5/kW-yr (< \$1500 per year for a 333-kW system) (Lazarewicz 2018).

4.3.9.3 Cycles, Lifespan, and Efficiency

Flywheels as an energy storage technology are sought after due to their long lifecycles and high RTE levels. Active Power (2017) estimates the RTE at a value as high as 98 percent. Aquino et al. (2017a) give a range that is lower—between 70–80 percent. Manuel (2014) for a 30 MW system estimates the RTE to be 81 percent. Helix Power estimates a DC-DC RTE of 88 percent, while an 85 percent RTE was reported for the Stornetic Durastor 1000 system (Stornetic 2018).

The duration of these systems range from 1–30 minutes. Regarding usable life, given that the system is a mechanical storage technology, the expected lifetime is capable of being twice as long as some electrochemical counterparts. All literature obtained for this report estimated the usable life of a flywheel system to be approximately 20 years (Lazarewicz 2018; Stornetic 2018; Helix Power 2018; Goodwin 2018).

Another attractive quality of the technology is the number of cycles it is capable of completing. Helix Power estimates that this value can be as high as 4 million, while Aquino et al. (2017b) estimate 175,000–200,000 cycles. The system is estimated to ramp to 100 percent of rated power in 250 milliseconds (Helix Power 2018) and 5 milliseconds (Goodwin 2018).

Table 4.31 lists flywheel cycles, life years, and RTE.

Table 4.31. Cycles, life years, and round-trip efficiency of flywheels.

Cycles	Life Years	Round-Trip Efficiency	Source
Unlimited	20	70-80%	Aquino et al. (2017a)
100,000	20	81%	Manuel (2014)
	20	98%	Active Power (2017)
<4 million	20	85-90%	Helix Power (2018)
	20	86%	Goodwin (2018)
		85%	Stornetic (2018)
175,000-200,000			Aquino et al. (2017b)

4.3.9.4 Technology and Manufacturing Readiness Levels

The products discussed by the vendors mentioned above are primarily for high-speed flywheels, which have seen only a limited number of installations (Aquino et al. 2017a). Given the newness and development of this technology, its maturity levels are not as high as some of the other energy storage counterparts discussed in this report. This is especially true considering the limited number of applications for which flywheels are ideally suited compared to other technologies, which can limit the amount of investment in this category. For these reasons, the current TRL for this technology is considered to be seven and the MRL is expected to be 8. Both of these values are expected to increase by one level by 2025.

4.3.10 Compressed Air Energy Storage

CAES consists of filling a cavern with compressed air during the hours when energy prices are low and then releasing the air at peak hours, and delivering it to combustion turbines, which use the natural gas for power generation (Hydrodynamics 2018).

Projects of note include one being developed Burbank Water and Power. The project will result in a 300 MW plant called the Pathfinder CAES in Utah that would utilize underground salt domes. A second phase of the project would add 1,200 MW of capacity. When completed, the project as described would have a total of 1,500 MW/25,000 MWh for an E/P ratio of slightly over 16. PG&E has also shown interest in investing in CAES through funding provided by the American Recovery and Reinvestment Act. Analysis was begun regarding the development a project in a depleted natural gas reservoir in San Joaquin County. With U.S. natural gas production having increased significantly over the last 5 years, more such reservoirs are expected to be available in the near future for CAES development (Doughty 2016).

Regarding established CAES plants, the McIntosh, Alabama, power plant has been operating for 27 years. The 110 MW plant has a rate of 400-pound mass/s, while the 55 MW corresponds to 197-pound mass/s (Siemens 2017). The project has a salt dome capacity of 18.9 MM ft³, and a pressure range of 650–1,100 psia. Dresser-Rand/Siemens has provided technical and field service support since 1991. Calculations show that at 110 MW generation, the cavern capacity corresponds to 31 hours or 3.37 GWh, while at 55 MW compression, it takes 62 hours to fill the cavern from 650 pounds per square inch absolute (psia).

According to Siemens AG (2017), the equipment consists of

- a 110 MW CAES train
- two W501F gas turbines
- two V84.2 gas turbines
- A T300 plant-wide control system
- fuel gas booster compressors
- an RG3 brushless excitation system
- a D3000 vibration monitoring package for all units
- a D4 static excitation systems and start-up frequency converters for V84.2s.

Dresser-Rand, which supplies rotating equipment for CAES, is now part of Siemens. Their current generation power train is the SXT-800, which is shown in Figure 4.5. According to conversations with Dresser-Rand representatives, “the GV and DATUM nomenclature in Figure 2.2 is [the] tradename for the compressors while the GV is their integrally geared compressor and the DATUM is their centrifugal compressor” (Baillie 2018a).

SXT-800 CAES Cycle Schematic

SIEMENS
Ingenuity for Life

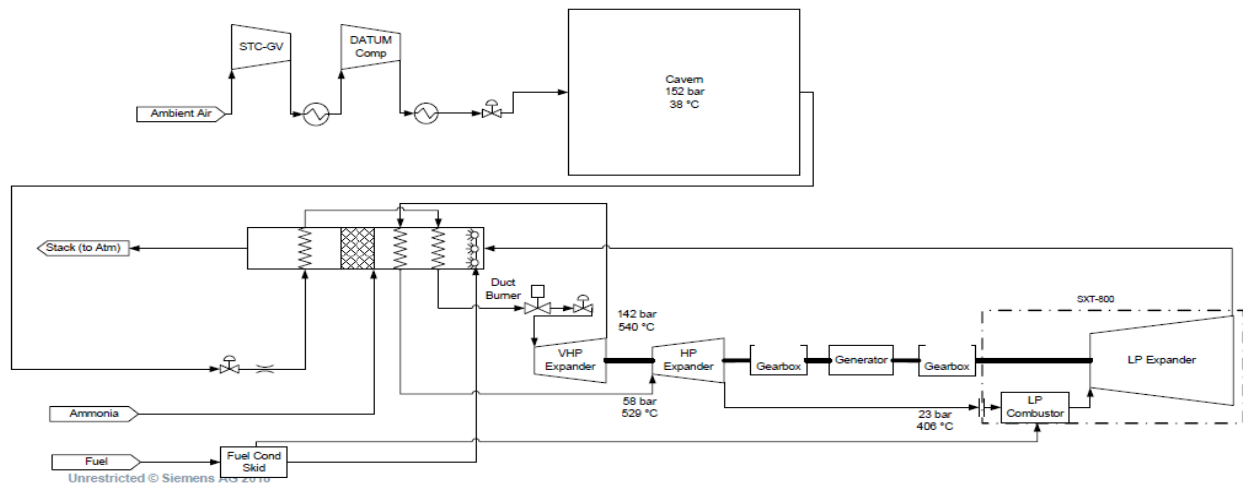

Figure 4.5. Schematic of the Siemens SXT-800 CAES.

The following information was obtained from a Siemens representative and describes the components of the SXT-800 system:

- The expander train consists of two power block module sizes:
 - 135 MW design output with inlet pressure of 1190 psia (82 bars)
 - 160 MW design output with inlet pressure of 2175 psia (150 bars).
- The quoted ramp rate is 20 percent of rated power per minute. The duration from “warm/turning” gear to full generation is 10 minutes and Siemens claims it also has a 90 percent turndown with a relatively flat heat rate.
- The compressor train MW sizing is adjustable to meet the application needs. It has a 30 percent turndown with a relatively flat heat rate. It ramps at 30 percent of rated power per minute. It takes 4 minutes to go from offline to full load, with a polytropic efficiency of 87 percent.
- The expanded train for SGT-800 has a single-shaft industrial gas turbine. It was introduced in 1999 with the power rating at 43 MW. The current models can handle 57 MW with a “simple cycle efficiency” of 40.1 percent. More than 300 units are installed worldwide for various applications; cumulatively they have over 4 million equivalent operating hours. It has dual fuel dry low emissions combustion system capabilities with <20 parts per million by volume dry basis (ppmvd) NO_x content.

The SGT-800 is used not just in CAES, but in other applications, as the document from Siemens implies. It has a large installed base with combustion hardware and high-temperature turbine hardware. Economies of scale are possible due to the high production volume. Other advantages include:

- elimination of the water injection system using a combustion system referred to by Siemens as “Dry Low Emissions type” that does not require water to achieve low emissions (<25 ppm NO_x and CO);
- emissions can further be cleaned down to single digit parts per million with a catalyst exhaust system;
- high-volume production of equipment.
- 25% reduction in air consumption with comparable heat rate;
- smaller air piping for same power output, lower costs in the plant and wellbore;

- improvement in expander system performance due to “state-of-the-art turbine inlet temperature”;
- lower air consumption, which leads to lower piping cost and cavern wellbore and greater energy per unit volume of cavern; and
- experienced personnel to install, commission, and maintain the SGT-800.

Additional information from Siemens was provided on their SGT-800 system, including CAPEX and cavern design details and diagrams of their compression train.

4.3.10.1 Capital Cost

The capital cost of CAES plants includes equipment, construction, installation, engineering, and other costs necessary to build the grid-level storage system. The 110 MW McIntosh project, commissioned in 1991, cost \$65 million or \$590/kW (\$1,310/kW in 2018 dollars) (Dugan 2013). The estimated cost for the Iowa Storage Park, a 270 MW project that was terminated due to site limitations, came to \$1,481/kW (Aquino et al. 2017a). Aquino et al. (2017a) offer a range for the plant cost of between \$1,600 and \$2,300/kW for a 300 to 500 MW diabatic system, not including storage cavern cost. The system would also include 12 to 48 hours of solution-mined storage capacity. They expect that an adiabatic system will likely come at a higher cost given the additional equipment necessary to store the heat from compression, but the values cannot be projected given the low maturity level of the technology. Siemens estimates the cost for a 150 MW/48-hour CAES system using the SXT-800 powertrain at a capital cost of between \$1,050 and \$1,400/kW or \$22–\$29/kWh. For our work, an E/P ratio of 16 was assumed for this technology, and this corresponds to \$66–\$88/kWh. The capital cost for a 16-hour plant was estimated to be \$1,669/kW using all the available data.

Table 4.32 lists the capital costs of CAES systems.

Table 4.32. Capital costs of CAES systems.

Capital Cost (\$/kW)	Notes	Source
\$1,105	\$590/kW in 1991 U.S. dollars	Siemens (2017)
\$1,481		Aquino et al. (2017b)
\$1,600-2,300	Includes 12 to 48 hours of solution-mined storage capacity	Aquino et al. (2017a)
\$1,050-\$1,400		Bailie (2018b); Siemens (2018a)
\$1,047	900\$/kW in 2010 U.S. dollars	Black & Veatch (2012)

Table 4.33 provides the cost breakdown for a CAES system (Black & Veatch 2012).

Table 4.33. CAES capital cost breakdown by component.

Item	Cost (\$/kW)	Percent (%)
Turbine	270	30
Compressor	130	14
Balance of Plant	50	6
Cavern	50	6
EPC	30	3
Owner’s cost	360	40

The breakdown for the \$1,050–\$1,400/kW estimate provided by Siemens is as follows:

- **Power Island:** \$550–\$650/kW or 49 percent (these are in line with the Black & Veatch costs for turbine and compressor).
- **Balance of Plant/Engineering, Procurement and Construction:** \$450–\$550/kW (41 percent). These costs depend on location, labor rates, building/site permitting, transmission interconnection, natural gas pipeline, etc. (Bailie 2018b). In this context, the BOP costs appear to be power related, and included BOP, EPC, and owners cost as listed by Black & Veatch (2012), which add up to 49 percent of total costs.
- **Cavern cost:** \$50–\$200/kW. This corresponds to 5 to 14 percent of total system costs when we divide the low cavern cost by the low system cost of \$1,050/kW (50/1050) and the high cavern cost by the high system cost of \$1,400/kW (200/1,400), respectively. For an E/P ratio of 16, this translates to \$3–\$12.5/kWh. The cost varies with reservoir type—salt, aquifer, or hard rock mine, new or existing. The cost is also related to the level of solution mining required (Bailie 2018b).

The cavern costs, which were listed as \$50–\$200/kW, were converted to \$/kWh (Bailie 2018b). For 48 hours of storage, these costs were \$3.5/kWh, and for 24 hours of storage, the costs were estimated to be \$4.50/kWh. Using linear fitting, energy-related costs in \$/kWh can be assumed to be $-0.0417*(E/P) + 5.5$. The cavern cost for a 16-hour plant was estimated to be \$5.08/kWh using this relationship. From the Black & Veatch (2012) report, the cavern cost for a 15-hour plant was 6 percent of system cost. Using cavern cost as 6 percent for a 16-hour plant, the cost for the rest of the plant was estimated to be $0.94*\$1,667/kW$, or \$1,567/kW. Keeping this constant across various E/P ratios, Table 4.34 lists costs that were estimated for CAES plants with various E/P ratios.

Table 4.34. CAES plant costs in \$/kW and \$/kWh for various E/P ratios or durations.

E/P (h)	10	16	20	30	40
\$/kW	1,567	1,567	1,567	1,567	1,567
\$/kWh for cavern	5.1	4.8	4.7	4.2	3.8
Total cost \$/kW	1,618	1,644	1,660	1,694	1,720
\$/kWh	162	103	83	56	43

Clearly, because cavern costs are not dominant, the unit power cost for the CAES plant increases slightly from an E/P ratio of 10 to an E/P ratio of 40, while the unit energy cost decreases from \$162/kWh to \$43/kWh. Hence, CAES appears to be a very good candidate, especially as E/P ratios increase. The low RTE of 52 percent is also a significant consideration.

4.3.10.2 Fixed & Variable Operations and Maintenance Costs

Aquino et al. (2017a) estimate that for a 100 MW CAES plant, fixed O&M costs will be approximately \$19/kW-yr for either a diabatic or adiabatic system. They believe that variable O&M costs that do not include fuel-related costs for a plant of the same size to be around \$2.3/MWh-yr in 2017 dollars. For the Iowa Stored Energy Park, fixed O&M cost was estimated to be in a range similar to that of the Aquino et al. (2017a) value at \$18.7/kW-yr and the variable O&M estimate at \$2.28/MWh-yr. Black & Veatch (2012) estimated a fixed O&M cost of \$11.6/kW-yr and variable O&M cost of \$0.00155/kWh based on 2010 USD. This translates to \$14.7kW-yr and \$0.00196/kWh, respectively. The average of these values was used for this work: \$16.7/kW-yr for O&M fixed, and \$0.00212/kWh for O&M variable.

4.3.10.3 Cycles, Lifespan, and Efficiency

May et al. (2018) estimate that a CAES system has a usable life of 25 years and is capable of providing 10,000 cycles at an RTE of 65 percent. Siemens, Aquino et al. (2017a), and EASE (2016) all state that a usable life of >30 years is possible and that an RTE is higher at >70% for adiabatic systems. For diabatic systems, Aquino et al. (2017a) and EASE (2016) both place the RTE at approximately 50 percent due to the need to reheat the cavern; however EASE (2016) believes that diabatic systems still have a usable life greater than 30 years. The lower RTE of the diabatic system is in line with Gyuk (2012), which estimates 54 percent. The remainder of the literature consulted places the RTE range at higher values than this—Bailie (2018b) stated 73 percent and Li et al. (2016) 67.12 percent.

In communication with Dresser Rand (Bailie 2018b), the RTE was calculated by dividing the electrical output by the sum of electrical input to the compressor and the amount of energy that could have been generated by the natural gas fuel, assuming a 49 percent efficiency for conversion of natural gas to electricity. Based on this formula, the RTE was estimated to be 74.6 percent. Note that their system includes heat capture in the compression cycle. It should further be noted that if the actual lower heating value of the natural gas fuel was used in the denominator, the RTE would be 51.9 percent. The latter appears to be a fair way to account for fuel usage, because in combustion turbines, the fuel lower heating value is used to estimate efficiency. Hence, an RTE of 52 percent was used in this work for CAES.

The response time and ramp rate are given as follows (Siemens 2018a):

- 10 minutes from cold start to full generation
- 5 minutes from online to full power
- 3.33 minutes from full speed no load to full load
- 4 minutes from offline to full load.

Table 4.35 lists the CAES cycles, life years, and RTE.

Table 4.35. Cycles, life years, and round-trip efficiency of CAES.

Cycles	Life Years	Round-Trip Efficiency	Notes	Source
10,000	25	65%		May et al. (2018)
		50%	Diabatic system	Aquino et al. (2017a)
	>30	>70%	Adiabatic system	EASE (2016)
	>30	>70%	Adiabatic system	Aquino et al. (2017a)
		54%		Gyuk (2012)
		73%		Dresser Rand (2018)
		67.12%		Li et al. (2016)
		69%	RTE based on heat rate of 4,910 Btu/kWh for CAES	Black & Veatch (2012)

4.3.10.4 Technology and Manufacturing Readiness Levels

Only two projects have been implemented in the U.S. and internationally, and additional projects are under development. As with PSH, CAES faces environmental restrictions when constructing the caverns that will store the compressed air. Barriers for implementation have limited the development of projects despite the fact that the compressors and gas turbines used are considered to be a mature technology

(Aquino et al. 2017a). For this reason, CAES systems are considered to have a TRL of 7 and an MRL of 8, meaning that the system has been implemented but it is not as developed or mature as other technologies. By 2025, CAES is expected to be TRL 8 and MRL 9.

4.3.11 Ultracapacitors

Ultracapacitors are typically paired with battery systems to provide and absorb pulse power, and they have extremely fast ramp rates. The charge is stored in the double layer on the electrode, and hence can be released instantaneously when needed. According to Maxwell, a developer and manufacturer of ultracapacitors, when ultracapacitors are used in a hybrid battery system they are capable of performing PV smoothing, peak shaving, time shifting of energy, and load following (Maxwell 2018a). The capacitor used was rated at 277 kW/8 kWh and was paired with a 50 kW/300 kWh aqueous battery for solar integration at Duke Energy's Rankin Substation. The capital expenditure (CAPEX) and operating expenditure (OPEX) savings over the battery-only option were estimated to be 10–15 percent and 30 percent, respectively.

An 800-kW system was used to absorb braking energy and provide propulsion in the Southeastern Pennsylvania Transportation System (SEPTA) for an average of 90 minutes per day, with each braking event lasting 15-20 seconds (Maxwell 2018a). The remaining time was spent providing frequency regulation to the grid operator (PJM). The power consumption savings were estimated to be 10–20 percent of the 400 MW used for propulsion, while the frequency regulation provided an annual revenue of \$200,000. A 3 MW, 17.2 kWh system is used at the Yangshan deep water port near Shanghai to mitigate a 10- to 15-second voltage sag during crane operation (Maxwell 2018b). This resulted in a 38 percent reduction in peak demand. The E/P ratio for this system is 20 seconds. The system design assumption was 1 million cycles for 8,000 hours of operation for 10 years. A quick check shows that this corresponds to 6,000–9,000 seconds for a 10–15 seconds per sag, and assuming a charge time equal to the discharge time (Maxwell 2018b).

Ultracapacitors typically have a long usable life while being relatively low cost in terms of maintenance. Maxwell ultracapacitors have been used across a variety of applications including brake energy recovery in the Southeastern Pennsylvania Transportation Authority Light Rail System, mitigation of voltage sags in Shanghai, and solar firming for the California Energy Commission (Maxwell 2018b).

4.3.11.1 Capital Cost

Capacitors can consist of multiple cells/modules to scale to the desired capacity range of a project in a way similar to electrochemical systems such as lithium. Ioxus energy provided details about their 250 kW DC capacitor and stated that the entire system cost is \$40,000, corresponding to \$160/kW (Colton 2018). Given the low specific energy and energy density of ultracapacitors, they are not competitive on a \$/kWh basis with battery technologies. However, on the \$/kW power level, they are more competitive due to their high specific power and power density. Maxwell provided a cost of \$241,000 for a 1,000 kW/7.43 kWh system, while a 1,000 kW/12.39 kWh system cost \$401,000 (Garcia 2018). This corresponds to \$32,565/kWh for the 7.43 kWh system and \$32,365/kWh for the 12.39 kWh system, with the \$/kW increasing from \$241/kW to \$401/kW for fixed rated power as the energy increases from 7.43 kWh to 12.39 kWh. While the energy content of the Ioxus system was not disclosed, their \$160/kW is on the same order of magnitude as the Maxwell capacitor costs. Clearly, because the power rating of the system is kept constant at 1,000 kW, the cost scales with energy, and the unit energy decreases very slightly as energy increases.

For individual cells and modules, the ratio of energy density to power density was 0.001 hours or 3.6 seconds (Maxwell 2018b). Maxwell proposed a 60-second duration as a potential use case for its capacitors. The cost estimates provided were for systems with durations of 27 and 45 seconds. This work assumes an E/P ratio of 0.0124. The capital cost is \$401/kW or \$32,365/kWh at an E/P ratio of 0.0124. Note that assuming a maximum of 4.5 Wh/kg, for 45-second storage, the maximum power density is 360 W/kg. Since ultracapacitors have a specific power of ~2,000 W/kg, they have to be used at less than rated power for durations >8 s, where 8 s is simply the ratio of 4 Wh/kg to 2,000 W/kg. In other words, the \$/actual usable power for large durations will be higher, while the \$/kWh is expected to be stable at around \$32,500/kWh.

4.3.11.2 Fixed & Variable Operations and Maintenance Costs

Capacitors, unlike other energy storage devices, require very little maintenance to keep their operational abilities over the entire duration of their usable life. For this reason their O&M costs are considered to be so small to the point of being negligible. A nominal fixed O&M cost of \$1/kW-yr, an order of magnitude lower than battery storage O&M costs, was assigned to ultracapacitors, with variable costs the same as batteries of \$0.0003/kWh.

4.3.11.3 Cycles, Lifespan, and Efficiency

An attractive quality that capacitors are able to offer compared to longer-duration storage units is their long usable life. Capacitors are typically quoted as having a lifespan of at least 20 years with some reaching as long as 40 years (Atmaja 2015), which is only rivaled by some PSH plants. Atmaja (2015) compares three different types of capacitors (Electric Double Layer Capacitor, Pseudo-Capacitor, and Hybrid Capacitors) and states that all three are capable of a 40-year usable life and of achieving a 95 percent or higher RTE. Sahay & Dwivedi (2009) place the usable life of supercapacitors at 25–30 years, the RTE at 95 percent, and state that their power density is 10x greater than that of batteries. Maxwell estimates that their ultracapacitors have a slightly shorter DC life of only 10–15 years, but they are capable of running for 1,000,000 duty cycles. Additional details, specific to their 1,000 kW/7.43 kWh and 1,000 kW/12.39 kWh systems, state that their systems have a response time under 16 milliseconds or >60 MW/second and have a DC-DC RTE of 96 percent. The Ioxus system has a calendar life of 20 years, can sustain 1,000,000 cycles, and has a DC-DC RTE of 98 percent. For this work, the capacitors are assigned 1,000,000 cycles, a 16-year calendar life, and an AC-AC RTE of 94 percent.

4.3.11.4 Technology and Manufacturing Readiness Levels

Capacitors have been implemented across a wide range of projects like those described previously with regard to Maxwell, demonstrating their effectiveness and maturity as a technology. For this reason they are believed to have a TRL of 8 and an MRL of 9. These values are expected to be the same by the year 2025.

5.0 Annualized Costs of Technologies

While the individual technology cost and performance parameters outlined in Section 2.0 provide a fundamental basis for evaluating the state of each technology individually and the predicted path forward regarding maturity and capability, to be able to fairly and objectively compare technologies, these results must be annualized. By conducting a pro forma analysis of each of the technologies that incorporates financing each storage project with applicable taxes and insurance over its usable life, a framework is provided for comparison.

5.1 Approach

To achieve a comparable annualized cost, technology-specific findings for capital cost, BOP, PCS, C&C, fixed O&M, and variable O&M were run through a pro forma that incorporates assumptions surrounding the required costs of financing a project over the duration of its expected life. This total long-run revenue requirement is then evaluated as an annualized payment in 2018 USD based on an assumed weighted cost of capital for discounting.

The assumptions used in this analysis are provided in Table 5.1.

Table 5.1. Pro forma assumptions.

Parameter	Value
Discount rate/weighted cost of capital	7.6%
Annual O&M escalation rate	2.5%
Insurance rate	0.479%
Property tax rate	0.56%
Federal and state income tax rate	24.873%
Annual energy output	1,772,690 kWh

The assumptions listed in Table 5.1 were adapted from a battery storage project located in the Pacific Northwest. It is believed that these are adequately representative of a typical storage system within the United States.

Figure 5.1 shows an example input for an energy storage technology using the parameters described in Section 4.0. These values are for the 2018 calculation for a sodium-sulfur battery with a usable life of 14 years.

Energy Storage Chemistry	
Sodium Sulfur	

Energy Storage Scale	
1,000 kW	
4,000 kWh	

Non-Financial Parameters	
Book Life	14 years
Property Tax	0.56%
FedStateIT Rate	24.873%
Annual Energy Output (kWh)	1,772,690

Financial Parameters	
Capital Cost (\$/kWh)	\$661
C&C (\$/kWh)	\$133
BOP (\$/kW)	\$100
PCS (\$/kW)	\$350
Fixed O&M (\$/kW-year)	\$10
Variable O&M (\$/kWh-year)	\$0.0003

Figure 5.1. Example input values for annualized cost calculation for a sodium-sulfur battery.

Using these inputs, the total net present value (NPV) of the total cumulative cost for the 1 MW/4 MWh storage system after tax, insurance, and other factors described is calculated to be just over \$4 million, of which nearly 71 percent is CAPEX-based. This cost is broken out into annualized payments of \$484,500 based on the discount rate described previously. From here, based on the system size, we can conclude that sodium-sulfur has an annualized cost of \$121/kWh-yr that we can compare against other technologies.

5.2 Findings and Comparative Analysis

By conducting the annualization calculation described in the previous section we are able to compare technologies laterally to get a better understanding of cost components and the economics of each system. All annualized costs that were calculated from this process can be found in the tables presented in Appendix D. Figure 5.2 shows the annualized \$/kWh-yr for each of the battery energy storage technologies based on their usable life. Given the nature of these storage assets, an energy capacity-based cost comparison is used as opposed to a power-based one. The results show that the Li-ion battery has the lowest total annualized \$/kWh cost at approximately \$74/kWh of any of the battery energy storage technologies. This is followed by zinc-hybrid cathode technology at \$91/kWh-yr. The red diamonds that are overlaid across the other results provide a forecasted cost for each technology for the year 2025 on a \$/kWh-yr basis. Pumped storage, when additionally compared on an energy basis, offered a very low cost of \$19/kWh-yr using 2018 values if compared to the battery storage technologies, as shown in Figure 5.3.

Figure 5.4 shows the results of the remaining non-battery technologies, which have been annualized on a \$/kW power basis as opposed to a \$/kWh energy basis. Of the technologies included, ultracapacitors are the only technology that requires a PCS as part of its CAPEX cost. Despite this, ultracapacitors offer the lowest annualized \$/kW cost of the technologies included. Compared to the other non-battery storage systems, PSH shows the highest cost on a \$/kW-yr basis of \$308/kW-yr.

Figure 5.5 shows the comparison if all technologies are evaluated on a \$/kW-yr basis. Looking at the results from this perspective shows that battery technologies are less economical when a storage technology is being selected for a large power capability rather than energy. With that noted, Li-ion technology and the zinc-hybrid cathode are only slightly higher in cost than flywheels on an annualized \$/kW basis. Figure 5.6 has been provided to show how non-battery technologies that are of low cost on a \$/kW basis are of substantially higher cost when evaluated on a \$/kWh basis. Note that Figure 5.6 is shown under a log-scale and, therefore, ultracapacitors are approximately one hundred times as costly at over \$14,000/kWh-yr than battery storage technologies when observed under this scenario. Flywheels are also of high cost at approximately \$3,000/kWh-yr.

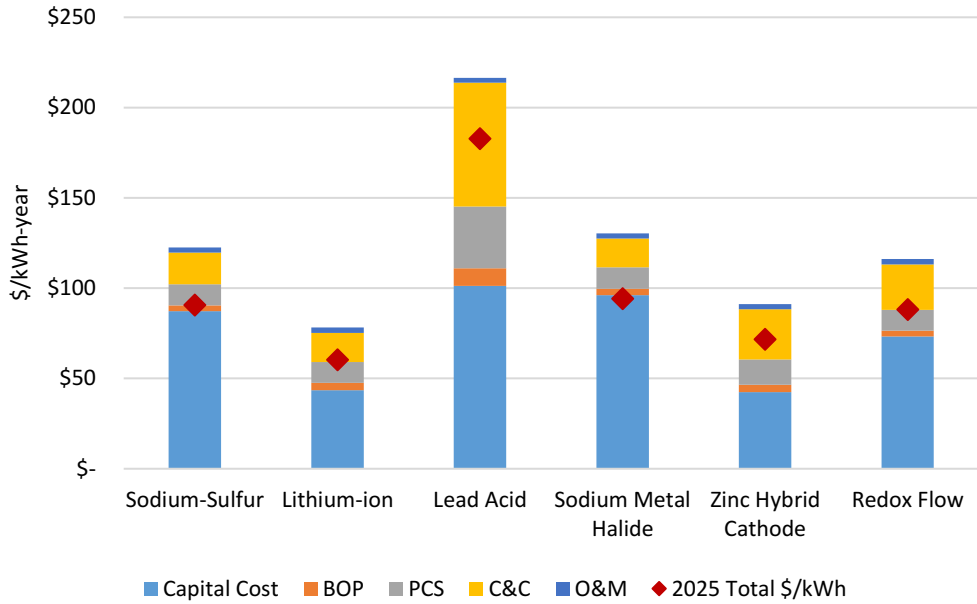

Figure 5.2. Annualized \$/kWh-yr cost of battery storage technologies by cost component.

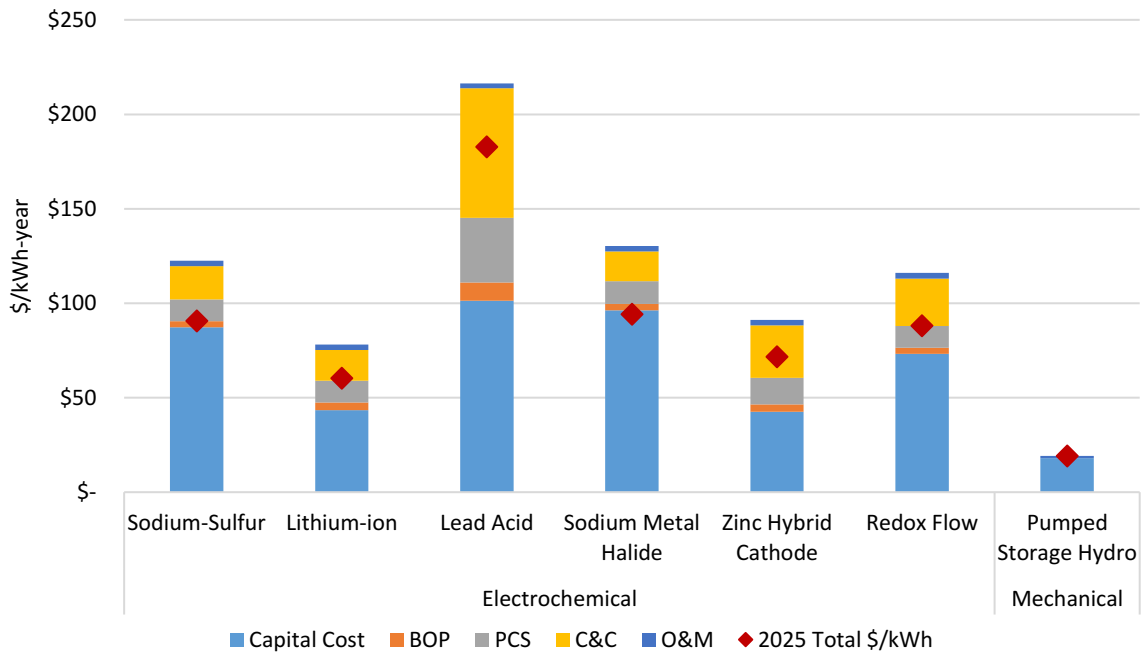

Figure 5.3. Annualized \$/kWh-yr cost of battery storage technologies vs. pumped storage hydro by cost component.

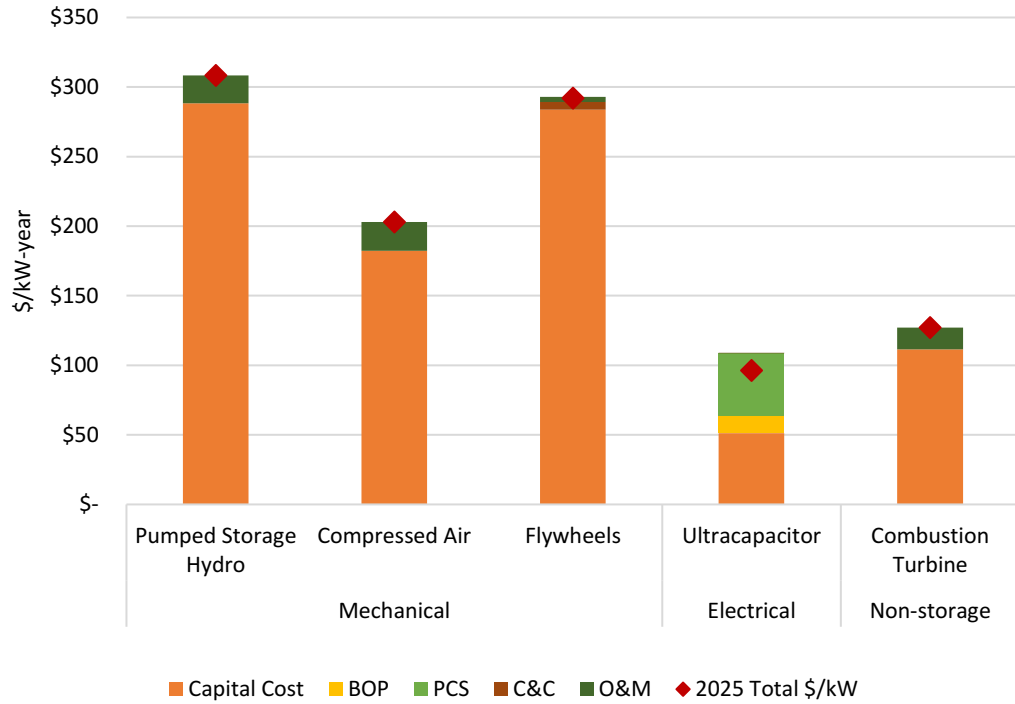

Figure 5.4. Annualized \$/kW cost of non-battery technologies.

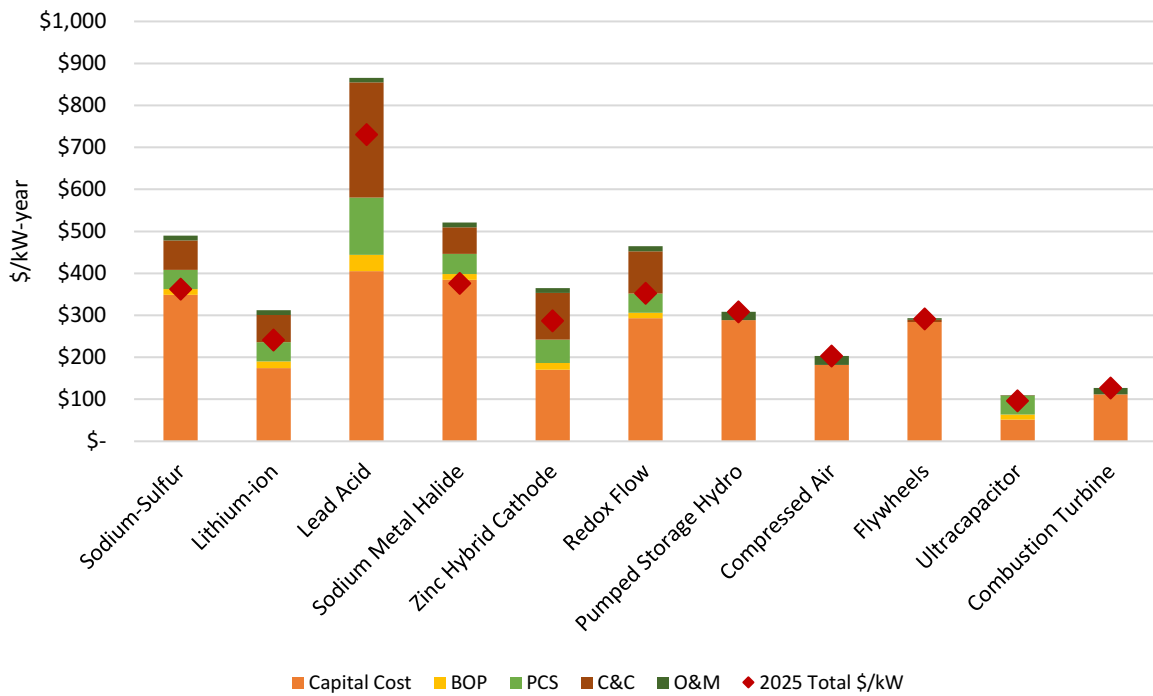

Figure 5.5. Annualized \$/kW cost of all technologies.

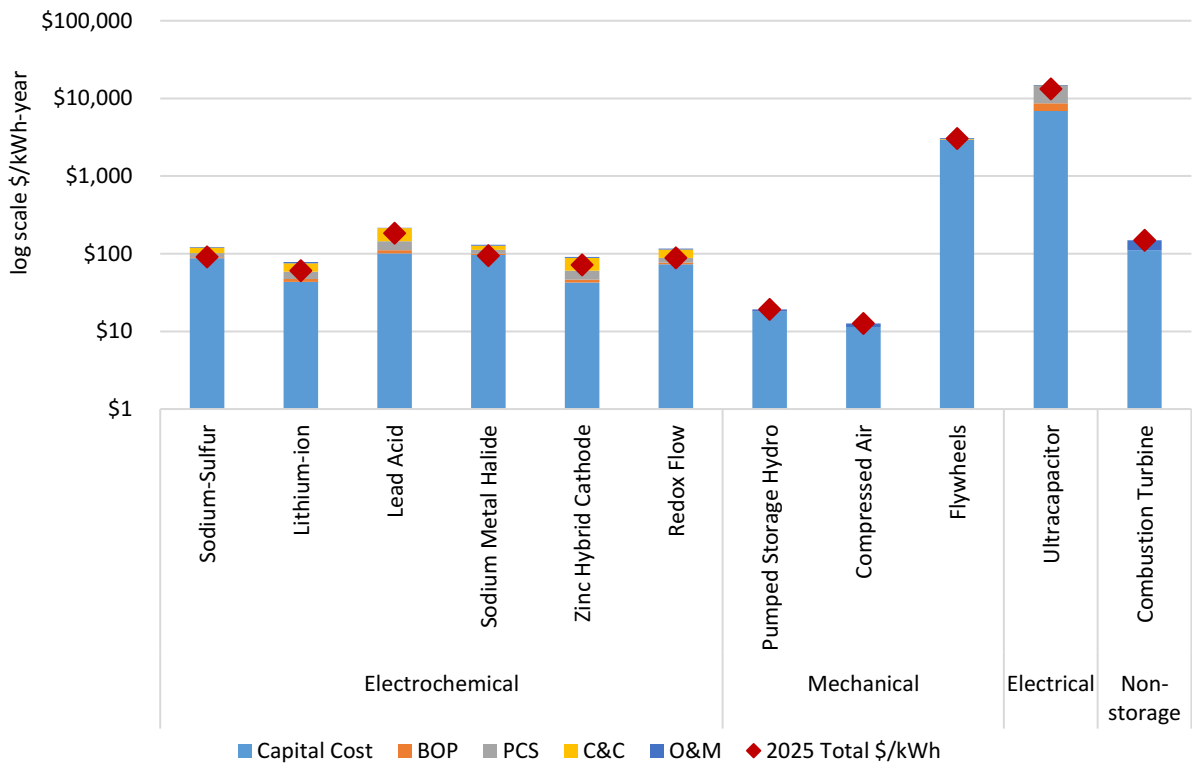

Figure 5.6. Annualized \$/kWh cost of all technologies.

6.0 Conclusions

This report compared the cost and performance of energy storage technologies—Li-ion batteries, high-temperature batteries, flow batteries, PSH, supercapacitors, flywheels, and CAES.

The literature collected and analyzed to compile the technology comparisons in this report included academic papers, web articles and databases, conversations with vendors and stakeholders, and summaries of actual costs provided from specific projects implemented for a specific technology. For PSH and other competing technologies, input was solicited from various storage vendors through a questionnaire detailing key parameters with regards to their technology. Feedback collected from these vendors was then summarized and compiled. These numbers were compared with combustion turbines, for which detailed information was available in the literature for cost, O&M, and performance metrics.

The key findings from the analysis conducted for this report are as follows:

- For a 4-hour BESS, Li-ion batteries offer the best option today in terms of cost, performance, calendar and cycle life, and technology maturity.
- For longer-term storage, PSH and CAES give the lowest cost in \$/kWh if an E/P ratio of 16 is used at \$165/kWh and \$104/kWh, respectively, inclusive of BOP and C&C costs, while their cost is \$660/kWh and \$417/kWh, respectively at an E/P ratio of 4.¹ Hence, even at the low E/P ratio of 4, they are competitive with battery storage technologies. Note that the PSH and CAES costs at an E/P ratio of 4 are expected to be lower than stated, because they are calculated by dividing total costs by the energy content—total costs will decrease as reservoir or cavern size decreases. When compared to CAES, PSH is a more mature technology with higher rates of round-trip efficiency.
- While zinc-hybrid cathode technology offers great promise in terms of cost and life, its TRL and MRL are low due to insufficient data and installations.
- Redox flow batteries, which have several installations, appear to be well positioned, coming in second in terms of overall cost, performance, life, TRL, and MRL. While their RTE is low, there is room for improvement with stack optimization and better flow battery management algorithms.
- While lead-acid batteries have a high TRL and MRL, their cycle life is limited, leading to a life of less than 3 years assuming one cycle per day.
- Sodium metal halide and sodium sulfur have similar cost and life characteristics, and the metal halide technology has a higher RTE. While planar design for sodium metal halide technology is expected to reduce cost, and substitution of sodium with nickel is expected to further reduce costs, neither of these factors were considered in this work for 2025 forecasts.
- In the year 2025, next to the zinc-hybrid cathode system, the Li-ion battery technology is still the most cost-effective battery technology. It remains to be seen whether the zinc-hybrid cathode system (or other cost-effective technologies such as Zn-MnO₂) reach a high TRL level by the year 2025.
- For PSH, CAES, flywheels, and ultracapacitors, the 2025 numbers were assumed to be the same as 2018 numbers. This assumption is based upon the fact that while there are efforts ongoing to reduce costs for these assets, any changes within the next few years are not expected to lead to significant cost reductions due to their maturity. On a 16-hour basis, PSH and CAES are more cost-effective compared to battery storage technologies in year 2025, while on a 4 hour basis batteries are competitive.

¹ Cost for Li-ion technology including BOP and C&C is \$469/kWh

- On an annualized basis, Li-ion has the lowest total annualized \$/kWh value of any of the battery energy storage technologies at \$74/kWh, and ultracapacitors offer the lowest annualized \$/kW value of the technologies included.

An attempt was made to determine the cost breakdown among the various categories for PSH and CAES. While the cost for these technologies is typically reported in \$/kW, the breakdown among EPC, BOP, power trains, and caverns from literature for CAES was compared with the numbers provided by a vendor and was found to align nicely. Based on vendor input, a relationship was found for cavern cost in \$/kWh, such that cost for a CAES system of any power and energy combination could be estimated. A relationship between reservoir size and cost for PSH was developed using an ORNL tool documented in Witt et al. (2016). This work enabled cost estimations for PSH and CAES for various E/P ratios, as opposed to using one number in \$/kW for these systems regardless of E/P ratios.

Comparing various storage technologies with different E/P ratios can lead to misleading results. A framework has been developed to compare costs across a range of E/P ratios for PSH, CAES, and redox flow batteries. For conventional battery storage technologies, E/P ratios can be increased by three methods:

- material discovery and development to improve specific energy
- use of a thicker electrode – to allow thicker electrodes, ion and electron transport-related issues need to be addressed
- a combination of the above.

If the material has the same cost per unit mass, the \$/kWh for the DC battery would drop. Using thicker electrodes will reduce passive components within the cell, thereby reducing DC system cost. However, beyond a certain thickness, the electrode utilization decreases, thus providing no additional benefits. For the most part, ion transport is expected to dominate; hence electrode architecture optimization is key. By tailoring the pore size distribution across the electrode thickness, transport-related limitations can be mitigated (Li 2017).

A combination of the above approaches can lead to improvement in specific energy. Note that as the E/P ratio increases, the specific power is not the limiting factor. The limiting factor for specific energy is simply the ability to fully use the electrode thickness, which is enabled by suitable electrode architecture design. The benefits of these R&D-related improvements were captured in the projected cost reduction for the year 2025 in this report. This analysis has been conservative—further reductions are possible if R&D improvements are substantial.

Overall, on a \$/kWh basis, PSH and CAES are the most cost-effective energy storage technologies evaluated within this report. Energy storage technologies serve a useful purpose by offering flexibility in terms of targeted deployment across the distribution system. Pathways to lower the \$/kWh of the battery technologies have been defined.

7.0 References

- Ailworth, E. 2018. "Power Firm Seeks Giant Battery." *The Wall Street Journal*. July 2, 2018, p. B4.
- Alberth, S. 2008. "Forecast technology costs via the experience curve – Myth or magic?" *Technology Forecasting & Social Change* 75(2008):952-983.
- Amber Kinetics. 2018. "Technology – Frequently Asked Questions." Accessed on September 5, 2018 at <http://amberkinetics.com/technology/faqs/>.
- Anuphapparadorn S, S Sukcha, C Sirisamphanwong, and N Ketjoy. 2014. "Comparison the Economic Analysis of the Battery between Lithium-ion and Lead-acid in PV Stand-alone Application." *Energy Procedia* 56 (2014):352-358, <https://doi.org/10.1016/j.egypro.2014.07.167>.
- Aquino T, C Zuelch, and C Koss. 2017b. *Energy Storage Technology Assessment*. HDR Report No. 10060535-0ZP-C1001, November 6, 2017. Prepared for the Public Service Company of New Mexico by HDR. Omaha, Nebraska.
- Aquino T, M Roling, C Baker, and L Rowland. 2017a. *Battery Energy Storage Technology Assessment*. November 29, 2017. Prepared for the Platte River Power authority by HDR/Omaha, Nebraska.
- Atmaja TD. 2015. "Energy Storage System Using Battery and Ultracapacitor on Mobile Charging Station for Electric Vehicle." *Energy Procedia* 68(2015):429-437.
- BAE. 2011. "Technical Specifications for Vented Lead-Acid Batteries (VLA)." BAE Secura PVS solar, March 2011, Tracking number 480522. Berlin, Germany.
- Bailie R. 2018a. Correspondence from Siemens. E-mail to Vilayanur Viswanathan, received July 31, 2018.
- Bailie R. 2018b. Correspondence from Siemens. E-mail to Viswanathan August 3, 2018.
- Balducci P, K Mongird, D Wu, Y Yuan, A Somani, J Alam, and J Steenkamp. 2018. *Shell Energy North America Hydro Battery System: Market Assessment 1*. PNNL-27162. Pacific Northwest National Laboratory. Richland, Washington.
- Balducci P, V Viswanathan, D Wu, M Weimar, K Mongird, J Alam, A Crawford, A Somani, and K Whitener. 2017. *The Salem Smart Power Center: An Assessment of Battery Performance and Economic Potential*. PNNL-26858, Pacific Northwest National Laboratory, Richland, Washington.
- Barbour E, IA Wilson, J Radcliffe, Y Ding, and L Yongliang. 2016. "A review of Pumped Hydro Energy Storage development in significant international electricity markets." *Renewable and Sustainable Energy Reviews*, 61. Pp. 421-432. ISSN 1364-0321. <https://doi.org/10.1015.j.rser.2016.04.019>.
- Benato R, N Cosciani, G Crugnola, S Dambone Sessa, G Lodi, C Parmeggiani, and M Todeschini. 2015. "Sodium nickel chloride battery technology for large-scale stationary storage in the high voltage network." *Journal of Power Sources* 293(2015):127-136.
- Black & Veatch. 2012. *Cost and Performance Data for Power Generation Technologies*. Prepared for the National Renewable Energy Laboratory. February 2012. Overland Park, Kansas.

BLS (U.S. Bureau of Labor Statistics). 2018. “Producer Price Index-Industry Data for Electric Power Generation, Transmission and Distribution.” Accessed on July 11, 2018 at <https://beta.bls.gov/dataViewer/view/timeseries/PCU2211--2211-->, 2018.<https://beta.bls.gov/dataViewer/view/timeseries/PCU2211--2211-->, Washington D.C.

BNEF (Bloomberg New Energy Finance). 2018. “New Energy Outlook.” Accessed on August 1, 2018 at <https://about.bnef.com/new-energy-outlook/#toc-download>.

Botterud A, T Levin, and V Koritarov. 2014. *Pumped Storage Hydropower: Benefits for Grid Reliability and Integration of Variable Renewable Energy*. ANL/DIS-14/10, August 2014. Argonne National Laboratory, Lemont, Illinois.

C&D Technologies, Inc. 2012. “Deep Cycle Series: Valve Regulated Lead Acid Battery Designed for Cycling Applications.” 12-1061. Redford, Michigan.

C&D Technologies, Inc. 2015. “Liberty AES: The Liberty AES 50 Series Cycle and PSoC Service Battery.” 12-1129.

CAISO (California Independent System Operator). 2017. “Impacts of renewable energy on grid operations.” Accessed on December 13, 2018 at <https://www.caiso.com/documents/curtailmentfastfacts.pdf>.

Cavazzini G. 2014. “Technological Developments for Pumped-Hydro Energy Storage.” European Energy Research Alliance, May 2014. Brussels, Belgium.

Chediak M. 2018. “Electric Car Batteries Drop Closer to a Cost Tipping Point.” December 5, 2017. Accessed August 6, 2018 at <https://www.industryweek.com/energy/electric-car-batteries-drop-closer-cost-tipping-point>.

Clean Energy Grid. 2014. “Americans for a Clean Energy Grid, Grid-Scale Energy Storage.” Accessed on October 03, 2018 at <https://cleanenergygrid.org/wp-content/uploads/2014/08/Grid-Scale-Storage.pdf>.

Colton J. 2018. Email response to questionnaire sent to Kendall Mongird by Jeffrey Colton of Ioxus. July 11, 2018.

Crawford A, V Viswanathan, D Stephenson, W Wang, E Thomsen, D Reed, B Li, P Balducci, M Kintner-Meyer, and V Sprenkle. 2015. “Comparative analysis for various redox flow batteries chemistries using a cost performance model.” *Journal of Power Sources* 293(2015):388-399, <https://doi.org/10.1016/j.jpowsour.2015.05.066>.

Crowe, R. 2011. “Energy Storage Industry Grows to Integrate Wind, Solar.” *Renewable Energy World*. August 17, 2011. Accessed on July 15, 2018 at <https://www.renewableenergyworld.com/articles/2011/08/energy-storage-industry-grows-to-integrate-wind-solar.html>.

Curry C. 2017. “Lithium-Ion Battery Costs and Market.” Bloomberg New Energy Finance. July 5. Accessed on July 11, 2018 at <https://data.bloomberglp.com/bnef/sites/14/2017/07/BNEF-Lithium-ion-battery-costs-and-market.pdf>.

Damato G and E Minear. 2016. *Energy Storage Cost Summary for Utility Planning: Executive Summary*. Report 3002008877, November 2016. Electric Power Research Institute, Palo Alto, California.

- Damato, G. 2017. *Energy Storage Cost Analysis: Executive Summary of 2017 Methods and Results*. Report 3002012046, December 20, 2017. Electric Power Research Institute, Palo Alto, California.
- Darrow K, R Tidball, J Wang, and A Hampson. 2014. *Catalog of CHP Technologies*. <http://www.fpuc.com/FPUCwordpress/wp-content/uploads/CHP-Ebook.pdf>
- Dham R. 2018. Telephone conversation of Rajesh Dham with Vilayanur Viswanathan of PNNL. December 3, 2018.
- DiOrio N, A Dobos, and S Janzou. 2015. *Economic Analysis Case Studies of Battery Energy Storage with SAM*. NREL/TP-6A20-64987, November 2015. National Renewable Energy Laboratory, Golden, Colorado.
- DNV GL. 2016. *Battery Energy Storage Study for the 2017 IRP*. 128197#-P-01-A, August 22, 2016. Chalfont, Pennsylvania.
- DNV GL. 2017. "California SGIP." Presentation. April 04, 2017.
- DOD (U.S. Department of Defense). 2017. *U.S. Department of Defense Manufacturing Readiness Levels Deskbook*. Washington, D.C. (May).
- DOE (U.S. Department of Energy). 2011a. *U.S. Department of Energy Technology Readiness Assessment Guide*. DOE G 413.3-4A, Washington, D.C. (September 2011).
- DOE (U.S. Department of Energy). 2011b. "Discussion of Data for Smart Grid Metrics and Benefits: Storage System Performance Supplement." Accessed on December 14th, 2018 at https://www.smartgrid.gov/files/energy_storage_system_performance_supplement.pdf.
- DOE (U.S. Department of Energy). 2015. *Pumped Storage and Potential Hydropower from Conduits*. Report to Congress, Washington, D.C. (February).
- DOE (U.S. Department of Energy). 2016a. *Combined Heat and Power Technology Fact Sheet Series: Gas Turbines*. July 2016. Accessed on July 3, 2018 at <https://www.energy.gov/sites/prod/files/2016/09/f33/CHP-Gas%20Turbine.pdf>.
- DOE (U.S. Department of Energy). 2016b. *Hydropower Vision Report*. Washington, D.C.
- DOE (U.S. Department of Energy). 2017a. *Hydropower Vision Report 2017 Update*. Oak Ridge National Laboratory. April 2016, Washington, D.C. (October 26, 2016).
- DOE (U.S. Department of Energy). 2017b. Energy Department Awards up to \$9.8 Million for Next-Generation Hydropower Technologies. Washington, D.C. (January 18, 2017).
- DOE (U.S. Department of Energy). 2018a. DOE Global Energy Storage Database. Accessed at <https://www.energystorageexchange.org/> on September 14, 2018.
- DOE (U.S. Department of Energy). 2018b. U.S. Department of Energy Office of Electricity ES Power Electronics Workshop.
- DOE (U.S. Department of Energy). 2019. *GLIDES PSH System*. HydroWise. Oak Ridge National Laboratory, Oak Ridge, Tennessee.

Doughty C, L Kelly, and J Mathias. 2016. "Bulk Energy Storage in California." California Energy Commission (CEC). Accessed July 26, 2018 at <http://www.energy.ca.gov/2016publications/CEC-200-2016-006/CEC-200-2016-006.pdf>.

Dugan K. 2013. "Huntsman Corp. breaks ground on \$64 million McIntosh expansion." Alabama Business. Accessed on December 14 at https://www.al.com/business/index.ssf/2013/05/huntsman_corp_breaks_ground_on.html.

Eagle Crest. 2018. "Eagle Mountain Pumped Storage Project." Accessed on November 30, 2018 at <http://www.eaglecrestenergy.com/project-description.html>.

EASE (European Association for Energy Storage). 2016. "Energy Storage Technologies." Accessed July 20 at <http://ease-storage.eu/energy-storage/technologies/>.

Eckert M. 2018. "Analysis Shows Continued Industry-Wide Decline in Electric Vehicle Battery Costs." February 21, 2018. Accessed August 6, 2018 at <https://mackinstitute.wharton.upenn.edu/2018/electric-vehicle-battery-costs-decline/>.

EIA (U.S. Energy Information Administration). 2016. "Capital Cost Estimates for Utility Scale Electricity Generating Plants." November 2016. Washington, D.C. Accessed on July 3, 2018 at https://www.eia.gov/analysis/studies/powerplants/capitalcost/pdf/capcost_assumption.pdf.

EIA (U.S. Energy Information Administration). 2017. "Natural Gas Generators Make up the Largest Share of Overall U.S. Generation Capacity." *Today in Energy*. U.S. Department on Energy, Washington, D.C. (April).

EIA (U.S. Energy Information Administration). 2018. "U.S. Battery Storage Market Trends." U.S. Department of Energy, Washington, D.C. (May).

Electric Car Parts Company (ECPC). "1MWH Energy Storage Banks in 40ft Containers...\$759,650 each, Plus Freight." Accessed on January 15, 2019 at <https://www.electriccarpartscompany.com/1MWH-Energy-Storage-Banks-in-40ft-Containers>.

EoS. 2017. "EOS Aurora: Grid-Scale Energy Storage." Accessed at <https://eosenergystorage.com/products-technology/>.

EoS. 2018a. "Eos Aurora 1000 |4000." Eos Product Description.

EoS. 2018b. "Eos, Eos Aurora® 250 l 1000 System Specification Zynth® Technology" (undated).

ESA (Energy Storage Alliance). 2018. "Energy Storage Technologies." Accessed July 11, 2018 at <http://energystorage.org/energy-storage/energy-storage-technologies>.

ESMAP. 2015. "Mexico's Power Sector Transition: Pumped Storage Hydropower to Facilitate Renewable Energy Integration." Accessed on December 10, 2018 at <https://www.esmap.org/node/56012>.

Evannex. 2017. "Tesla 2170 Battery Cells: Greater Power at Comparable Cost." *InsideEVs*. March 01, 2017. Accessed on October 04, 2018 at <https://insideevs.com/tesla-2170-battery-cells-greater-power-comparable-cost/>.

Evertiq. 2018. “Power battery prices decrease as global e-car market expands.” July 9, 2018. Accessed August 7, 2018 at <https://evertiq.com/news/44460>.

FERC (Federal Energy Regulatory Commission). 2018a. “Licensed Pumped Storage Projects Map.” Accessed on November 29, 2018 at <https://www.ferc.gov/industries/hydropower/gen-info/licensing/pump-storage/licensed-projects.pdf?csrt=5475631551797350163>.

FERC (Federal Energy Regulatory Commission). 2018b. “Hydropower General Information – Licensing.” Accessed on December 14 at <https://www.ferc.gov/industries/hydropower/gen-info/licensing.asp>.

Fisher R, J Koutnik, L Meier, V Loose, K Engels, and T Beyer. 2012. *A Comparison of Advanced Pumped Storage Equipment Drivers in the US and Europe*. Conference: Hydrovision. 10.13140/2.1.1082.4967.

Garcia, A. 2018. Correspondence from Andrew Garcia of Maxwell Technologies. E-mail from A. Garcia to Vilayanur Viswanathan of PNNL, received June 18, 2018.

GE Power. 2018. “What is a Gas Turbine and how does it work?” Accessed August 4, 2018 at <https://www.ge.com/power/resources/knowledge-base/what-is-a-gas-turbine>

General Electric (GE). 2018. “Hydro Storage.” *General Electric*. February 2018.

Goodwin, A. 2018. Correspondence from Andrew Goodwin of Kinetic Traction Email to Kendall Mongird, received July 9, 2018.

Gotschall H and T Eguchi. 2009. “NGK's Sodium Sulfur (NAS) Battery, The Vendor's Perspective on Barriers & Issues Encountered in U.S. Deployment.” *NGK Insulators*. Presented to the California Energy Commission, April 2, 2009.

Greenspon A. 2017. “The Energy Storage Landscape: Feasibility of Alternatives to Lithium Based Batteries.” *Harvard Energy Journal Club*. April 24, 2017.

Gyuk I. 2012. “Buffering the Grid with Compressed Air Energy Storage.” CAES Webinar, January 20, 2012.

Hadjerioua B and S DeNeale. 2018. *Preliminary Design Specification and Cost Estimate for a Prototype Floating Membrane Reservoir System*. Oak Ridge National Laboratory, Oak Ridge, Tennessee, April 2018.

Hayward JA and PW Graham. 2017. “Electricity generation technology cost projections: 2017-2050.” CSIRO (Commonwealth Scientific and Industrial Research Organisation), Canberra, Australia.

Helix Power. 2016. “Regenerative Braking Using Flywheels.” NY-BEST Energy Storage Technology Conference, Syracuse, New York. October 20, 2016.

Henry J, F Maurer, J Frommi, and T Sautereau. 2013. “Converting to Variable Speed at a Pumped-Storage Plant.” *Hydroworld*. September 01, 2013. Accessed on December 4, 2018 at <https://www.hydroworld.com/articles/print/volume-21/issue-5/articles/pumped-storage/converting-to-variable-speed-at-a-pumped-storage-plant.html> Accessed December 4, 2018.

Herman D. 2003. *Comparison of Storage Technologies for Distributed Resource Applications*. 1007301, Electric Power Research Institute, Palo Alto, California.

Homer Energy. 2018. “Pumped Hydro.” Accessed on September 5, 2018 at https://www.homerenergy.com/products/pro/docs/3.11/pumped_hydro.html.

Hydrodynamics. 2018. “Compressed Air Energy Storage.” *The Hydrodynamics Group*. Accessed on August 3 at <http://www.hydrodynamics-group.com/geological-consulting/compressed-air-energy-storage/overview/>.

Ibañez F, JM Echeverria, J Vadillo, F Martín, and L Fontán. 2011. “Battery Response Analyzer using a high current DC-DC converter as an electronic load.” *Renewable Energy & Power Quality Journal (RE&PQJ)* 1(9):May 2011, ISSN: 2172-038X.

IEA. 2019. “Is Pumped Storage Hydropower Capacity Forecast to Expand More Quickly than Stationary Battery Storage?” *Renewables 2018*. March 4, 2019.

International Energy Agency (IEA). 2008. “World Energy Outlook.” Paris, France. ISBN-13: 978 92 64 04560-6.

IRENA (International Renewable Energy Agency). 2012a. “Renewable Energy Technologies: Cost Analysis Series (Hydropower).” Working Paper, Volume 1: Power Sector Issue 3/5.

IRENA (International Renewable Energy Agency). 2012b. Volume 1: Power Sector, Issue 3/5, Renewable Energy Technologies: Cost Analysis, (June 2012).

Kamath H. 2016. *Batteries and Energy Storage: Looking Past the Hype*. Presentation to Tucson Electric Power. IRP Workshop on Energy Storage. Electric Power Research Institute, Palo Alto, California (November 2).

Karina H, A Michel, and R Teofilo. 2013. “High temperature sodium batteries: Status, challenges and future trends.” *Energy Environmental Science* 10.1039/c3EE24086J.

Kelly-Detwiler P. 2017. “Getting the U.S. to 35 GW of Energy Storage by 2025.” *Forbes*. Accessed on January 16, 2019 at <https://www.forbes.com/sites/peterdetwiler/2017/11/06/getting-the-u-s-to-35-gw-of-energy-storage-by-2025/#412bcafe1e44>.

Kishinevsky Y. 2005. “Long Island Bus Sodium Sulfur (NaS) Battery Storage Project.” Electrical Energy Storage Applications and Technologies (EESAT) Conference. San Francisco, California. October 17, 2005.

Klimes M. 2017. “Understanding and Avoiding Pump Cavitation.” Flow Control Network. May 2. Accessed on November 30, 2018 at <https://www.flowcontrolnetwork.com/understanding-avoiding-pump-cavitation/>.

Koritarov V, L Guzowski, J Feltes, Y Kazachkov, B Gong, B Trouille, and P Donalek. 2013. *Modeling Ternary Pumped Storage Units*. ANL/DIS-13/07, Argonne National Laboratory, Lemont, Illinois.

Kulsangcharoen P, C Klumpner, M Rashed, and G Asher. 2010. “A New Duty Cycle Based Efficiency Estimation Method for a Supercapacitor Stack under Constant Power Operation.” *IET Conference Publications*. 10.1049/cp.2010.0117.

Lacey S. 2016. “Stem CTO: Lithium-Ion Battery Prices Fell 70% in the Last 18 Months.” June 28, 2016. Accessed August 6, 2018 at <https://www.greentechmedia.com/articles/read/stem-cto-weve-seen-battery-prices-fall-70-in-the-last-18-months#gs.UwTIT0g>

Lahiri S. 2017. “Assessing CAPEX for Storage Projects.” DNV GL, Oakland, California. February 23, 2017.

Lambert F. 2017. “Electric Vehicle Battery Cost Dropped 80% in 6 Years down to \$227/kWH – Tesla Claims to be Below \$190/kWH”. January 30, 2017. Accessed on August 6, 2018 at <https://electrek.co/2017/01/30/electric-vehicle-battery-cost-dropped-80-6-years-227kwh-tesla-190kwh/>.

Lazarewicz M. 2018. Correspondence from Matthew Lazarewicz of Helix Power. E-mail to Vilayanur Viswanathan, received June 11, 2018.

LCE Energy. 2011. “SONICK FIAMM, 48TL200 Technical Data.” Accessed October 4, 2018 at http://www.lcenergy.com.au/pdfs/Fiamm_SoNick_Battery_Type_48TL200_Data_Sheet.pdf.

Li G. 2018. Correspondence from Guosheng Li of PNNL. Email to Vilayanur Viswanathan, received July 10, 2018.

Li J, Z Du, R Ruther, AN Jin, L David, K Hays, M Wood, N Phillip, Y Sheng, C Mao, S Kalnaus, C Daniel, and D Wood. 2017. “Toward low-cost, high-energy density, and High-Power Density Lithium-Ion Batteries. *Journal Materials* 69(9):1484-1496. doi: 0.1007/s11837-017-2404-9 (2015).

Liu G, D Wang, and K Dai. 2014. *A Storage Revolution: A Low Temperature Sodium Sulfur Battery*. University of California Berkeley – Haas School of Business. Cleantech to Market. January 10, 2014. Accessed on July 27, 2018 at <https://ei.haas.berkeley.edu/education/c2m/docs/Sulfur%20and%20Sodium%20Metal%20Battery.pdf>.

Manuel W. 2014. “Energy Storage Study 2014.” California Energy Commission Report, Turlock Irrigation District. September 17, 2014. California. Accessible at https://www.energy.ca.gov/assessments/ab2514_reports/Turlock_Irrigation_District/2014-10-28_Turlock_Irrigation_District_Energy_Storage_Study.pdf.

Manwaring M. 2018a. Correspondence from Michael Manwaring of the National Hydropower Association Pumped Storage Development Council. E-mail to Vilayanur Viswanathan, received July 12, 2018.

Manwaring M. 2018b. Telephone conversation between Michael Manwaring of the National Hydropower Association Pumped Storage Development Council and Vilayanur Viswanathan June 12, 2018.

Manwaring M. 2018c. Telephone conversation between Michael Manwaring and Vilayanur Viswanathan December 6, 2018.

Manwaring M. 2018d. Email communication between Michael Manwaring and Vilayanur Viswanathan December 6, 2018.

Maxwell. 2018a. “Ultracapacitor Overview.” Accessed on July 20, 2018 at <http://www.maxwell.com/products/ultracapacitors>.

- Maxwell. 2018b. "Ultracapacitors: Transforming the Grid." Accessed on July 20, 2018 at http://www.maxwell.com/images/documents/PowerGrid_CaseStudies_3001287_EN_1.pdf.
- May G, A Davidson, and B Monahov. 2018. "Lead batteries for utility energy storage: A review." *Journal of Energy Storage* 15(2018):145-157.
- McLaren J, P Gagnon, K Anderson, E Elgqvist, R Fu, and T Rem. 2016. *Battery Energy Storage Market: Commercial Scale, Lithium-ion Projects in the U.S.* NREL/PR-6A20-67235, National Renewable Energy Laboratory, Golden, Colorado.
- Miller R. 2018. Correspondence from Rick Miller of HDR, Inc. E-mail from Rick Miller to Vilayanur Viswanathan of PNNL, received June 12, 2018.
- Mina A. 2014. "Public-Domain Test Data Showing Key Benefits and Applications of the UltraBattery." Australian Energy Storage Alliance. December 16, 2014. Accessed on July 26, 2018 at <https://energystoragealliance.com.au/public-domain-test-data-showing-key-benefits-applications-ultrabattery/>.
- Minear E. 2018a. Correspondence between Erin Minear of EPRI and Vilayanur Viswanathan of PNNL. July 12, 2018.
- Minear E. 2018b. Telephone communication between Erin Minear and Vilayanur Viswanathan of PNNL. October 1, 2018.
- Miraldi A. 2018. Correspondence between Andy Miraldi of FZSoNick, Inc. and Vilayanur Viswanathan of PNNL. July 12, 2018.
- Morris C. 2018. "Tesla is getting close to the magic battery cost number that will turbocharge demand." *Evannex*. June 19, 2018. Accessed on July 26, 2018 at <https://evannex.com/blogs/news/tesla-is-getting-close-to-the-magic-battery-cost-number-that-will-turbocharge-demand>.
- Mouser. 2018. "Maxwell HC Series Ultracapacitor Datasheet." Accessed on September 5, 2018 at http://www.mouser.com/ds/2/257/datasheet_hc_series_1013793-1640.pdf.
- MWH. 2009. "Technical Analysis of Pumped Storage and Integration with Wind Power in the Pacific Northwest." MWH-HDC-T12. Bellevue, Washington. August 2009.
- MWH. 2009. "Technical Analysis of Pumped Storage and Integration with Wind Power in the Pacific Northwest." Accessed on 4 December 2018 at <https://www.hydro.org/wp-content/uploads/2017/08/PS-Wind-Integration-Final-Report-without-Exhibits-MWH-3.pdf>.
- Newbery D. 2016. "A Simple Introduction to the Economics of Storage: Shifting Demand and Supply over Time and Space." EPRG Working Paper. Imperial College London and University of Cambridge – Energy Policy Research Group. October 2016.
- Newell SA, JM Hagerty, K Spees, JP Pfeifenberger, and Q Liao. 2018. "Cost of New Estimates for Combustion Turbine and Combined Cycle Plants in PJM." June 1, 2018. Accessed on July 3, 2018 at http://files.brattle.com/files/6068_cost_of_new_entry_estimates_for_combustion_turbine_and_combined_cycle_plants_in_pjm.pdf.

- NHA (National Hydropower Association). 2017. “Challenges and Opportunities for New Pumped Storage Development.” White Paper. National Hydropower Association Pumped Storage Development Council. Accessed on 4 December, 2018 at https://www.hydro.org/wp-content/uploads/2017/08/NHA_PumpedStorage_071212b1.pdf.
- Nikolewski R. 2017. “Pump it up: Water officials looking for offers to build a hydro storage plant at the San Vincent Reservoir.” *The San Diego Union-Tribune*. July 31, 2017. Accessed on July 17, 2018 at <http://www.sandiegouniontribune.com/business/sd-fi-sanvicente-pumped-20170726-story.html>.
- Ning G, R White, and B Popov. 2006. “A generalized cycle life model of rechargeable Li-ion batteries.” *Electrochimica Acta* 51:2012-2022.
- Noack J, L Wietschel, N Roznyatovskaya, K Pinkwart, and J Tubke. 2016. “Techno-economic modeling and analysis of redox flow battery systems.” *Energies* 2016(9):627.
- Nøvik H, L Lia, and M Wigestrands. 2014. “Horizontal trash rack – a new intake concept for efficient backflushing.” *Journal of Applied Water Engineering and Research* 2:81-90. 10.1080/23249676.2014.953607.
- NREL (National Energy Technology Laboratory). 2013. “Recovery Act: Advanced Hydrogen Turbine Development—Siemens Energy.” Accessed on July 3, 2018 at <https://www.netl.doe.gov/File%20Library/Research/Coal/energy%20systems/turbines/NT42644.pdf>.
- Olson A, N Schlag, K Patel, and G Kwok. 2014. *Capital Cost Review of Generation Technologies: Recommendations for WECC’s 10- and 20-Year Studies*. Accessed on July 3, 2018 at https://www.wecc.biz/Reliability/2014_TEPPC_Generation_CapCost_Report_E3.pdf.
- Outback Storage (OS). 2018. “Containers Delivered on Site.” Accessed on January 15, 2019 at <https://outbackstoragecontainers.com/40-foot-shipping-containers-for-sale>.
- PG&E (Pacific Gas & Electric). 2018. “PG&E Proposes Four New Cost-effective Energy Storage Projects to CPUC.” Press Release. June 29, 2018. Accessed July 27, 2018 at https://www.pge.com/en/about/newsroom/newsdetails/index.page?title=20180629_pge_proposes_four_new_cost-effective_energy_storage_projects_to_cpuc.
- Posawatz T. 2018. “Mine is Bigger: Why Larger EV Batteries are not the Answer.” July 23, 2018. Accessed August 8, 2018 at <https://www.forbes.com/sites/tonyposawatz/2018/07/23/mine-is-bigger-why-bigger-bigger-ev-batteries-are-not-the-answer/#681f215f1837>.
- PowerTech Systems. 2015. “Lithium-ion vs Lead-Acid Cost Analysis.” Accessed on July 11, 2018 at <https://www.powertechsystems.eu/home/tech-corner/lithium-ion-vs-lead-acid-cost-analysis/>.
- RapidTables. 2018. “kWh to BTU Conversion.” Accessed on August 3, 2018 at https://www.rapidtables.com/convert/energy/kWh_to_BTU.html.
- Rastler D. 2010. *Electricity Energy Storage Technology Options: A White Paper Primer on Applications, Costs and Benefits*. EPRI-1020676, Final Report, December 2010, Electric Power Research Institute, Palo Alto, California.
- RedT Energy Storage. 2018. “Gen 2 machine pricing starting at \$490/kWh.” Accessed on July 22 at <https://redtenergy.com/first-redt-gen-2-machine-dispatched-manufacturing-facility/>.

Rehman S, L Al-Hadhrami, and M Alam. 2015. “Pumped hydro energy storage system: A technological review.” *Renewable and Sustainable Energy Reviews*. 44. doi:10.1016/j.rser.2014.12.040.

Research Interfaces. 2018. “Lithium-ion Batteries for Large-Scale Grid Energy Storage.” April 14, 2018. Accessed October 4, 2018 at <https://researchinterfaces.com/lithium-ion-batteries-grid-energy-storage/>.

Rodrigues GD. 1990. “Operating the World’s Largest Lead/Acid Battery Energy Storage System.” *Journal of Power Sources* 31(1990):311-320.

Safari M. 2018. “Battery Electric Vehicles: Looking Behind to Move Forward.” *Energy Policy* 115:54-65. doi: <https://doi.org/10.1016/j.enpol.2017.12.053> (2017).

Sahay K and B Dwivedi. 2009. “Supercapacitors Energy Storage System for Power Quality Improvement: An Overview.” *Journal of Electrical Systems* 5(4).

Samsung. 2018. “ESS Batteries – Top Safety & Reliability Solutions.” Samsung SDI, April 2018. Accessed October 4, 2018 at http://www.samsungsdi.com/upload/ess_brochure/201804_SamsungSDI%20ESS_EN.PDF

Schoenung SM. 2011. “Overview of Energy Storage Cost Analysis.” Pre-Conference Workshop. Conference: EUCI. Houston, Texas, January 24, 2011.

Seipp T. 2018. Correspondence from Thorsten Seipp of Volterion GmbH, E-mail from T. Seipp to Vilayanur Viswanathan of PNNL, received August 6, 2018.

Selmon E and H Wynne. 2017. “Energy Storage Technologies for the Bulk Grid: Will Lithium-Ion Batteries Continue to Dominate Grid Storage?” *Sector & Sovereign Research*. March 1, 2017. Accessed on July 11, 2018 at <http://www.ssrllc.com/publication/energy-storage-technologies-for-the-bulk-grid-will-lithium-ion-batteries-continue-to-dominate-grid-storage/>.

SENA - Shell Energy North America. 2017. Final License Application-Hydro Battery Pearl Hill, Exhibit A: Description of Existing and Proposed Project Facilities and Components. Houston, Texas.

Shan R and P O’Connor. 2018. “Memo for data request about cost & performance of PSH.” E-mail from R. Shan to Vilayanur Viswanathan of PNNL, June 20, 2018.

Siemens. 2017. “CAES Systems at Siemens.” Presentation sent via e-mail by Robert Bailie of Siemens to Vilayanur Viswanathan of PNNL, July 31, 2018.

Siemens. 2018a. “Roundtrip Efficiency Characterization for Dresser-Rand SMARTCAES Compressed Air Energy Storage Systems.” May 3, 2018. Email communication between Robert Bailie of Siemens and Vilayanur Viswanathan of PNNL, May 10, 2018.

Siemens. 2018b. “Salt Locations – North America and Europe.” Email communications between Robert Bailie of Siemens and Vilayanur Viswanathan of PNNL. August 2, 2018.

Slovick M. 2018. “Automotive Is Driving the SiC Power Market.” *Electronic Design*. July 11, 2018. Accessed on October 05, 2018 at <https://www.electronicdesign.com/automotive/automotive-driving-sic-power-market>.

- Solarquotes. 2018. « Sodium Nickel Chloride batteries. » *Solarquotes*. Accessed on July 20, 2018 at <https://www.solarquotes.com.au/battery-storage/battery-types/sodium/>.
- Spector J. 2017a. “Tesla Fulfilled its 100-Day Australia Battery Bet. What’s That Mean for the Industry?” *Greentech Media*, June 2017. Accessed July 20, 2018 at <https://www.greentechmedia.com/articles/read/how-vistra-and-flexgen-made-the-largest-battery-project-in-texas-pencil-out#gs.pjCBddU>.
- Spector J. 2017b. “How Vistra and FlexGen Made the Largest Battery in Texas Pencil Out.” *Greentech Media*, November 2017. Accessed July 20, 2018 at https://www.greentechmedia.com/articles/read/tesla-fulfills-australia-battery-bet-whats-that-mean-industry#gs.sd_nzK8.
- Steffen B. 2012. “Prospects for pumped-hydro storage in Germany.” *Energy Policy* 45(2012):420-429.
- Stornetic. 2018. “Powerful Storage System for Grid Services.” Accessed on July 26, 2018 at https://stornetic.com/assets/downloads/stornetic_general_presentation.pdf.
- Tecate Group. 2018. “Ultracapacitor & Supercapacitor Frequently Asked Questions.” Accessed September 5, 2018 at <https://www.tecategroup.com/ultracapacitors-supercapacitors/ultracapacitor-FAQ.php>.
- UET (UniEnergy Technologies). 2015. “Maximizing Value through UET Energy Storage for Utilities, Microgrids, Commercial & Industrial.” Presentation. September. Accessed December 2018 at http://uettechnologies.com/images/product/UET_Product_IntroSheet.pdf.
- UET (UniEnergy Technologies). 2018. “UNIFLEX™ Flow Battery Preliminary Data Sheet.” Accessed on December 5, 2018 at www.uettechnologies.com.
- Uhrig M, S Koenig, MR Suriyah, and T. Leibfried. 2016. “Lithium-based vs. Vanadium Redox Flow Batteries – A Comparison for Home Storage Systems.” *Energy Procedia* 99(2016):35-43. <https://doi.org/10.1016/j.egypro.2016.10.095>.
- Uría-Martínez R, M Johnson, and P O’Connor. 2018. *2017 Hydropower Market Report*. Oak Ridge National Laboratory. U.S. Department of Energy Office of Energy Efficiency & Renewable Energy. DOE/EE-1737. Oak Ridge, Tennessee.
- USBR (United States Bureau of Reclamation). “Mt. Elbert Pumped-Storage Powerplant: Fryingpan-Arkansas Project.” Accessed on July 10, 2018 at <https://www.usbr.gov/projects/pdf.php?id=46>.
- Valavi M and A Nysveen. 2018. “Variable-Speed Operation of Hydropower Plants: Past, present, and future.” *2016 XXII International Conference on Electrical Machines (ICEM)*. pp. 640-646. IEEE 1077-2618/18. Lausanne, Switzerland. doi: 10.1109/ICELMACH.2016.7732593.
- Vartanian C and R Hellested. 2018. “FACTS for Very Large Scale DC (BESS, PV) Grid Interconnect, Design Concepts and Cost Effective Applications.” Mitsubishi Electric Power Products. US Department of Energy Office of Electricity Electric Storage Power Electronics Workshop, Albuquerque, New Mexico, July 17-18, 2018.
- Vechy S. 2018. E-mail communication between S. Vechy and Vilayanur Viswanathan of PNNL, received July 2, 2018.

- Viswanathan V, A Crawford, D Stephenson, S Kim, W Wang, B Li, E Coffey, G Graff, P Balducci, M Kintner-Meyer, and V Sprenkle. 2014. “Cost and performance model for redox flow batteries.” *Journal of Power Sources* 247:1040-1051. <https://doi.org/10.1016/j.jpowsour.2012.12.023>.
- Wang J, K Lu, L Ma, J Wang, M Dooner, S Miao, Li, Jian, and D Wang. 2017. “Overview of Compressed Air Energy Storage and Technology Development.” *Energies* 10(2017):991. doi:10.3390/en10070991.
- Watanabe C. 2017. “Why Battery Cost Could Put the Brakes on Electric Car Sales.” Bloomberg. November 28, 2017. Accessed on July 26, 2018 at <https://www.bloomberg.com/news/articles/2017-11-28/electric-cars-need-cheaper-batteries-before-taking-over-the-road>.
- Witt A, B Hadjerioua, R Martinez, and N Bishop. 2015. *Evaluation of the Feasibility and Viability of Modular Pumped Storage Hydro (m-PSH) in the United States*. ORNL/TM-2015/ 559, Oak Ridge National Laboratory, Oak Ridge, Tennessee.
- Witt A, D Chalise, B Hadjerioua, M Manwaring, and N Bishop. 2016. *Development and Implications of a Predictive Cost Methodology for Modular Pumped Storage Hydropower (m-PSH) Projects in the United States*. ORNL/TM-2016/590, Oak Ridge National Laboratory, Oak Ridge, Tennessee.
- Wright P. 2014. “Trends in Renewable Energy and Storage.” Goldman Sachs - North American Energy Summit. June 10, 2014. Accessed on July 26, 2018 at <https://www.goldmansachs.com/our-thinking/pages/north-american-energy-summit/reports/beci-trends-in-renewable-energy-and-storage.pdf>.
- Yang S. 2018. Correspondence from Stephanie Yang of EoS. E-mail communication between S. Yang and V Viswanathan, received July 11, 2018.
- Yeung M. 2008. “Helms Pumped Storage Plant Northwest Wind Integration Forum Workshop.” Pacific Gas and Electric Company. Accessed on December 10, 2018 at https://www.nwcouncil.org/sites/default/files/ManhoYeung_1.pdf.
- Zakeri B and S Syri. 2015. “Electrical energy storage systems: A comparative life cycle cost analysis.” *Renewable and Sustainable Energy Reviews* 42 (2015) 569–596.
- Zhang Q and R White. 2008. “Capacity fade analysis of lithium ion cell.” *Journal of Power Sources* 179 (2008):793–798.

Appendix A

Questionnaire Supplied to Various Storage Vendors

Questions for Battery Energy Storage System Developers (Grid Scale Storage)

Pacific Northwest National Laboratory study on energy storage system cost and performance for the U.S. Department of Energy.

Objective: To compare cost and performance of various energy storage technologies. Minimum system power = 500 kW.

DC system (two or more columns provided if you have two different systems on offer).

Specifications	System 1	System 2
Rated Power (kW) and associated energy (kWh)		
Rated Energy (kWh) and associated power (kW)		
Round-Trip Efficiency at rated power		
Round-Trip Efficiency at power corresponding to rated energy		
Ramp rate (% of rated power/s or MW/s)		
Response time (s) from rest to rated power without communication lag		
DC battery cost \$/kWh (\$/Rated energy in kWh)		
If above costs do not include BMS, heat exchange costs, please specify these costs		
Cycle life at various % DoD		
	20% DoD	
	50% DoD	
	80% DoD	
Calendar life at various temperatures		
	25 deg C	
	35 deg C	
	45 deg C	
Active heat exchanger (HEX)?		
	If yes, type of HEX	
System footprint		
System weight (kg)		
Operating cost (other than costs associated with RTE)		
Maintenance cost (with details for scheduled maintenance)		

AC system

Specifications	System 1	System 2
PCS Rated Power (kW or kVA) and associated rated energy (kWh)		
Rated Energy (kWh) and associated power (kW)		
Round-Trip Efficiency at rated power		
Round-Trip Efficiency at power corresponding to rated energy		
Ramp rate (% of rated power/s or MW/s)		
Response time (s) from rest to rated power without communication lag		
Communication lag (s)		
PCS cost (\$/kW)		
PCS footprint		
PCS weight (kg)		
Operating cost for PCS (other than costs associated with RTE)		
Maintenance cost for PCS (with details for scheduled maintenance)		
System installation cost		
Recent installation sites		
Systems specifications (rated kW, kWh)		
System cost without installed costs included		
Installation costs		
# of years operating		
System throughput (cumulative discharged kWh)		

Questions for Capacitor Energy Storage System Developers (Grid Scale Storage)

Pacific Northwest National Laboratory study on Energy Storage System cost and performance for the U.S. Department of Energy.

Objective: To compare cost and performance of various energy storage technologies. Minimum system power = 500 kW.

DC system (two or more columns provided if you have two different systems on offer)

Specifications	System 1	System 2
Rated Power (kW) and associated energy (kWh)		
Rated Energy (kWh) and associated power (kW)		
Round-Trip Efficiency at rated power		
Round-Trip Efficiency at power corresponding to rated energy		
Ramp rate (% of rated power/s or MW/s)		
Response time (s) from rest to rated power without communication lag		
DC capacitor cost \$/kWh (\$/Rated energy in kWh)		
If above costs do not include capacitor management system, heat exchange costs, please specify these costs		
Cycle life at various % DoD		
		20% DoD
		50% DoD
		80% DoD
Calendar life at various temperatures		
		25 deg C
		35 deg C
		45 deg C
Active heat exchanger (HEX)?		
		If yes, type of HEX
System footprint		
System weight (kg)		
Operating cost (other than costs associated with RTE)		
Maintenance cost (with details for scheduled maintenance)		

AC system

Specifications	System 1	System 2
PCS Rated Power (kW or kVA) and associated rated energy (kWh)		
Rated Energy (kWh) and associated power (kW)		
Round-Trip Efficiency at rated power		
Round-Trip Efficiency at power corresponding to rated energy		
Ramp rate (% of rated power/s or MW/s)		
Response time(s) from rest to rated power without communication lag		
Communication lag (s)		
PCS cost (\$/kW)		
PCS footprint		
PCS weight (kg)		
Operating cost for PCS (other than costs associated with RTE)		

Questions for Flywheel Energy Storage System Developers (Grid Scale Storage)

Pacific Northwest National Laboratory study on Energy Storage System cost and performance for the U.S. DOE Office of Electricity.

Objective: To compare cost and performance of various energy storage technologies. Minimum system power = 500 kW.

AC system (two columns provided if you have two or more different systems on offer).

Specifications	System 1	System 2
Maintenance cost for PCS (with details for scheduled maintenance)		
System installation cost		
Recent installation sites		
Systems specifications (rated kW, kWh)		
System cost without installed costs included		
Installation costs		
# of years operating		
System throughput (cumulative discharged kWh)		

Appendix B

PCS, BOP, C&C, and O&M Costs for Various Technologies

Type	PCS + System Controls Cost (\$/kW) Low	PCS + System Controls Cost (\$/kW) High	Electric BOP (\$/kW) Low	Electric BOP (\$/kW) High	Construction & Commissioning Low	Construction & Commissioning High	O&M Fixed \$/kW-yr Low	O&M Fixed \$/kW-yr High	O&M Variable \$/kW-hr Low	O&M Variable \$/kW-hr High	Source	
Lithium-ion		500	100		180		6	12			Lahiri (2017)	
	230	470	90	120	150	180	6	14	0.0003		Aquino (2017)	
	230	470	90	120	140	180	6	14	0.0003		Aquino (2017)	
	230	470	90	120	140	180	6	14	0.0003		Aquino (2017)	
	430	620	80	100	120	180	6	11			DNV GL (2016)	
	430	620	80	100	120	180	6	11			DNV GL (2016)	
	430	620	80	100	120	180	6	11			DNV GL (2016)	
									10	0.0003		Manuel (2014)
		570							20			DiOrio (2015)
Sodium sulfur	130	300									Damato (2017)	
	580	870	100	125	140	200	7	15			Aquino et al. (2017)	
Lead acid	580	870	100	125	140	200	7	12			DNV GL (2016)	
	150	350	80	120	150	180	7	15	0.0003		Aquino et al. (2017)	
Redox flow	600	890	100	124	140	200	7	12			DNV GL (2016)	
			100	125	140	200	7	16	0.0003		Aquino et al. (2017)	
							20	30			Greenspon (2017)	
CAES			450	550	3.125	12.5					Siemens CAES systems AG 2017 (0.87 ²)	
							18.7		0.00228		Iowa Stored Energy Park (2012)	
					75	87.5	18.9	18.9	0.0023		Aquino et al. (2017)	
PSH							6.2	43.3			Aquino et al. (2017)	
						5	20				ORNL	
Flywheel							5.56				Aquino et al. (2017)	
							5.8		0.0003		Manuel (2014)	
							4.5				Kinetic Traction (2018)	

Appendix C

Calculations for RTE Degradation of Battery Storage Technologies

Based on the open-circuit voltage for each chemistry, the final round-trip efficiency (RTE)/initial RTE was estimated for a 50 percent increase in cell internal resistance. The annual rate of decrease in RTE was then calculated using the calendar life for each chemistry.

Table C.1. Detailed Calculations for Estimation on RTE Degradation Rate for Various Battery Storage Technologies

Final RTE/ Initial RTE	0.959	0.956	0.898	0.878	0.847	0.956
RTE loss per year	0.005	0.0034	0.054	0.015	0.004	0.0035
RTE Year i+1/ RTE Year i	0.995	0.997	0.946	0.985	0.996	0.997
Year	Final RTE /Initial	Final RTE /Initial	Final RTE /Initial	Final RTE /Initial	Final RTE /Initial	Final RTE /Initial
1	1	1	1	1	1	1
2	0.995	0.997	0.946	0.985	0.996	0.997
3	0.990	0.993	0.895	0.970	0.992	0.993
4	0.985	0.990		0.956	0.988	0.990
5	0.980	0.986		0.941	0.984	0.986
6	0.975	0.983		0.927	0.980	0.983
7	0.970	0.980		0.913	0.976	0.979
8	0.966	0.976		0.900	0.972	0.976
9	0.961	0.973		0.886	0.968	0.972
10	0.956	0.970		0.873	0.965	0.969
11		0.967			0.961	0.966
12		0.963			0.957	0.962
13		0.960			0.953	0.959
14		0.957			0.949	
15					0.945	

Appendix D
Annualized Cost Values

Table D.1. Annualized Cost Values by Technology (\$/kWh), 2018

	Capital Cost	BOP	PCS	C&C	O&M	Total
Sodium-sulfur	\$87.25	\$3.30	\$11.55	\$17.56	\$2.92	\$122.58
Li-ion	\$43.49	\$4.01	\$11.55	\$11.55	\$2.91	\$73.51
Lead acid	\$101.31	\$9.74	\$34.09	\$68.58	\$2.70	\$216.42
Sodium metal halide	\$96.18	\$3.43	\$12.02	\$15.80	\$2.89	\$130.32
Zinc-hybrid cathode	\$42.53	\$4.01	\$14.04	\$27.76	\$2.91	\$91.25
Redox flow	\$73.19	\$3.30	\$11.54	\$25.06	\$3.04	\$116.13
Pumped storage hydro	\$18.03	\$0.00	\$0.00	\$0.00	\$1.24	\$19.26
Compressed air	\$11.39	\$0.00	\$0.00	\$0.00	\$1.30	\$12.69
Flywheel	\$2,936.04	\$0.00	\$0.00	\$56.76	\$76.39	\$3,069.19
Ultracapacitor	\$6,893.67	\$1,719.12	\$6,016.92	\$10.22	\$240.43	\$14,880.36
Combustion turbine	\$111.39	\$0.00	\$0.00	\$0.00	\$38.07	\$149.46

Table D.2. Annualized Cost Values by Technology (\$/kW), 2018

	Capital Cost	BOP	PCS	C&C	O&M	Total
Sodium-sulfur	\$348.99	\$13.20	\$46.20	\$70.22	\$11.54	\$490.15
Li-ion	\$173.96	\$16.05	\$46.22	\$46.22	\$11.47	\$293.92
Lead acid	\$405.24	\$38.96	\$136.38	\$274.31	\$10.64	\$865.53
Sodium metal halide	\$384.72	\$13.74	\$48.09	\$63.20	\$11.40	\$521.15
Zinc-hybrid cathode	\$170.11	\$16.05	\$56.17	\$111.05	\$11.47	\$364.85
Redox flow	\$292.78	\$13.19	\$46.16	\$100.23	\$12.02	\$464.37
Pumped storage hydropower	\$288.40	\$0.00	\$0.00	\$0.00	\$19.83	\$308.24
Compressed air	\$182.25	\$0.00	\$0.00	\$0.00	\$20.85	\$203.10
Flywheel	\$283.80	\$0.00	\$0.00	\$5.49	\$3.72	\$293.01
Ultracapacitor	\$51.22	\$12.77	\$44.71	\$0.08	\$0.02	\$108.80
Combustion turbine	\$111.39	\$0.00	\$0.00	\$0.00	\$15.65	\$127.05

Table D.3. Annualized Cost Values by Technology (\$/kWh), 2025

	Capital Cost	BOP	PCS	C&C	O&M	Total
Sodium-sulfur	\$61.38	\$3.13	\$6.96	\$16.76	\$2.37	\$90.60
Li-ion	\$30.33	\$3.81	\$8.47	\$15.41	\$2.35	\$60.37
Lead acid	\$85.72	\$9.25	\$20.55	\$77.00	\$2.18	\$194.70
Sodium metal halide	\$66.23	\$3.26	\$7.25	\$15.11	\$2.34	\$94.19
Zinc-hybrid cathode	\$30.81	\$3.81	\$8.47	\$26.32	\$2.35	\$71.76
Redox flow	\$51.83	\$3.13	\$6.96	\$23.74	\$2.47	\$88.12
Pumped storage hydropower	\$18.03	\$0.00	\$0.00	\$0.00	\$1.24	\$19.26
Compressed air	\$11.39	\$0.00	\$0.00	\$0.00	\$1.30	\$12.69
Flywheel	\$2,936.04	\$0.00	\$0.00	\$0.00	\$76.39	\$3,012.43
Ultracapacitor	\$6,893.67	\$1,633.16	\$4,418.14	\$0.00	\$240.43	\$13,185.41
Combustion turbine	\$111.39	\$0.00	\$0.00	\$0.00	\$38.07	\$149.46

Table D.4. Annualized Cost Values by Technology (\$/kW), 2025

	Capital Cost	BOP	PCS	C&C	O&M	Total
Sodium-sulfur	\$245.51	\$12.54	\$27.85	\$67.05	\$9.32	\$362.27
Li-ion	\$121.32	\$15.25	\$33.86	\$61.62	\$9.26	\$241.31
Lead acid	\$342.89	\$37.02	\$82.22	\$308.02	\$8.59	\$778.74
Sodium metal halide	\$264.91	\$13.05	\$28.99	\$60.46	\$9.21	\$376.62
Zinc-hybrid cathode	\$123.25	\$15.25	\$33.86	\$105.27	\$9.26	\$286.89
Redox flow	\$207.32	\$12.53	\$27.83	\$94.96	\$9.70	\$352.33
Pumped storage hydropower	\$288.40	\$0.00	\$0.00	\$0.00	\$19.83	\$308.24
Compressed air	\$182.25	\$0.00	\$0.00	\$0.00	\$20.85	\$203.10
Flywheel	\$283.80	\$0.00	\$0.00	\$0.00	\$3.72	\$287.52
Ultracapacitor	\$51.22	\$12.13	\$32.83	\$0.00	\$0.02	\$96.21
Combustion turbine	\$111.39	\$0.00	\$0.00	\$0.00	\$15.65	\$127.05

This report is being prepared for the U.S. Department of Energy (DOE). As such, this document was prepared in compliance with Section 515 of the Treasury and General Government Appropriations Act for fiscal year 2001 (public law 106-554) and information quality guidelines issued by DOE. Though this report does not constitute “influential” information, as that term is defined in DOE’s information quality guidelines or the Office of Management and Budget’s Information Quality Bulletin for Peer Review, the study was reviewed both internally and externally prior to publication.

NOTICE

This report was prepared as an account of work sponsored by an agency of the United States government. Neither the United States government nor any agency thereof, nor any of their employees, makes any warranty, express or implied, or assumes any legal liability or responsibility for the accuracy, completeness, or usefulness of any information, apparatus, product, or process disclosed, or represents that its use would not infringe privately owned rights. Reference herein to any specific commercial product, process, or service by trade name, trademark, manufacturer, or otherwise does not necessarily constitute or imply its endorsement, recommendation, or favoring by the United States government or any agency thereof. The views and opinions of authors expressed herein do not necessarily state or reflect those of the United States government or any agency thereof.

Available electronically at OSTI.gov <http://www.osti.gov>

Available for a processing fee to U.S. Department of Energy
and its contractors, in paper, from:

U.S. Department of Energy Office of Scientific and Technical Information
P.O. Box 62
Oak Ridge, TN 37831-0062
OSTI <http://www.osti.gov>
Phone: 865.576.8401
Fax: 865.576.5728
Email: reports@osti.gov

Available for sale to the public, in paper, from:

U.S. Department of Commerce
National Technical Information Service
5301 Shawnee Road
Alexandria, VA 22312
NTIS <http://www.ntis.gov>
Phone: 800.553.6847 or 703.605.6000
Fax: 703.605.6900
Email: orders@ntis.gov



<https://www.energy.gov/eere/water/hydrowires-initiative>

