

Analysis of Refrigeration Units in Off Grid PV/Wind Hybrid Systems on Tribal Land

Manuelito Chief
University of Denver
Anthony Martino, Manager (Org. 08824) Sandra Begay, Mentor
Sandia National Laboratories¹
Albuquerque, NM
August 2018

Abstract

This paper looks at the performance of residential refrigeration units in off-grid photovoltaic and small wind hybrid (PV/wind) systems with battery storage. Off grid hybrid power systems, dispatched by Navajo Tribal Utility Authority (NTUA), allow Navajo Nation residents in rural areas to have the benefits of electricity. On the Navajo Nation, the rural and rugged nature of the land results in a high capital cost to connecting a house to the grid. In this case, a hybrid PV/wind power generation system may be used at a much lower cost to the customer. In providing affordable power systems to customers, the systems are designed to provide adequate power for use. This requires a constant conservative use of electricity. For systems with refrigerators which are large alternating current (AC) loads, there are performance issues that arise. NTUA reports that new energy star rated refrigerators have performance issues in working with these off grid systems. This paper looks at ways to improve the performance of these systems with the use of a refrigeration unit. This involves looking at conventional refrigerators with its operation. This paper also looks at alternative methods of refrigeration. Also, the power system is looked at to increase the performance in maintaining a proper balance of the system. Lastly, solutions will be recommended to solve the refrigeration issues faced by NTUA.

¹ Sandia National Laboratories is a multimission laboratory managed and operated by National Technology & Engineering Solutions of Sandia, LLC, a wholly owned subsidiary of Honeywell International Inc., for the U.S. Department of Energy's National Nuclear Security Administration under contract DE-NA0003525

Acknowledgements

I would like to acknowledge those who made this research possible and made valuable contribution to this work. This includes the Department of Energy Office of Indian Energy for the financial sponsorship that allowed me to have this internship through the Indian Energy Program at Sandia National Laboratories. I would also like to thank Navajo Tribal Utility Authority (NTUA) for this research topic and allowing us to learn from their Renewable Energy Program on the Navajo Nation. I would also like to thank Sandra Begay for her mentorship and insight given to me throughout this internship. Her mentorship challenged my thinking about tribal energy and it was very valuable in my research experience and throughout the internship.

Table of Contents

1.	Introduction.....	4
2.	Photovoltaic (PV)/Wind Power System	5
3.	Refrigeration Methods.....	7
	Vapor Compression Refrigeration	8
	Single Speed AC Compressor	8
	Variable Speed AC Compressor.....	9
	Variable Speed DC Compressor.....	9
	Vapor Absorption Refrigeration	10
	Thermoelectric Refrigeration.....	11
4.	Photovoltaic Power System Design	12
	Batteries	12
	Inverter.....	13
	Super Capacitor.....	14
	Smart Technology	14
5.	Proposition	15
6.	Recommendation.....	16
7.	References.....	17

1. Introduction

Electricity is still a luxury on many rural tribal reservations. In the United States, there are people living on reservations that don't have the same access to electricity as other Americans. The Energy Information Administration reports that the US population which lacks access to electricity is 1.4%, whereas 14.2% of the population on tribal reservations do not have access to electricity today [1]. In comparison to the national average, lack of electricity access on reservations is 10 times higher. Seventy-five percent (75%) of the individuals without electricity access reside on the Navajo Reservation [1]. The Navajo Tribal Utility Authority (NTUA) estimates that 34,000 families do not have access to electricity [2]. As a result of no access to electricity, they also have no ability to store fresh food through refrigeration. With only 13 full-service grocery stores servicing the Navajo Nation, an area of 27,425 square miles (the approximate equivalent size of West Virginia), there is no access to fresh food without travelling long distances [4, 5]. This becomes a burden on low income residents. However, easy access to processed, high calories food remains. For this reason, there is a need to provide the option of refrigeration for residents in these remote locations on tribal reservations. This would provide residents the ability to store fresh food for longer periods of time, as well as provide refrigeration for medical purposes.

The Navajo Tribal Utility Authority was established in 1959 to provide utility services to the Navajo Reservation [6]. Today, 32% of the population still does not have electricity, which is result of high installation cost and little funding in extending electrical line [3]. The cost to extend one mile of electrical service can be as low as \$35,000 to as high as \$50,000 due to the rural nature of the reservation [7]. NTUA first began providing Solar units to residents who live far from the power line in 1993. In 2002, NTUA established the Off-Grid Residential Power and Refrigeration Program which provides Solar photovoltaic (PV) with small wind units (PV/wind) to customers. This type of system is suitable for customers, because renewable energy resources are available in all locations in unlimited amounts regardless of whether there is an existing power line. These types of systems can be quickly installed at a much lower cost than extending electrical service. Today, NTUA currently offers four units to their customers: 640W PV, 880W PV with 400W Wind, 1080W PV with 400W Wind, and 1800W PV with 400W Wind. They also offer the option for a refrigeration unit with the larger systems for their customers. In 2015, NTUA had a total of 260 units dispatched [8]. In 2010, a 1080W PV w/ 400W Wind with an energy star rated refrigerator was made available [8]. Then in 2012, an option for a 1800W PV/Wind system was added [8] which was made possible through DOE Energy Efficiency Community Block Grants (EECBG) funding. These systems are offered to customers at rates of \$75 or \$100 per month based on an established tariff. However, because the refrigeration unit is the largest power consumer in these systems, problems can arise in their operation over time and when other electrical loads are present.

This paper addresses a problem brought to Sandia National Laboratories by the NTUA General Manager. NTUA customers are reporting that the Energy Star rated refrigerators have difficulty working with off-grid units. For this reason and when these problems arise, NTUA must go out to the location and reset the system. This paper focuses on providing NTUA a solution for providing refrigeration that can be used with off-grid Solar PV units. This includes first looking at the basics of a Solar PV/wind system to understand how the system operates. Then the methods of refrigeration are considered to understand how conventional refrigeration works, as well as what alternatives are available. Next, the power system is discussed to provide areas that can result in better performance of the system to work with refrigeration. Lastly, a solution is proposed based on factors such as performance, cost, availability, and ease-of-implementation.

2. Photovoltaic (PV)/Wind Power System

In order to examine the refrigerator that can be used with an off grid Solar PV/Wind system, it is necessary to first understand the possible configurations for Solar PV and Wind systems. Solar Photovoltaics are energy systems that utilize renewable energy resources from the sun to produce electricity [10]. This allows electricity to be produced using wherever sunlight is available. For this reason, Solar PV is commonly used for off-grid applications where access to electricity is limited. There are various tribes who utilize this technology including the following: Navajo Nation – Off-Grid Solar PV units, Hopi – Off Grid Houses, Hualapai – Off Grid Tourism, Ramona Band – Off Grid EcoResort, and Agua Caliente – Off Grid Trading Post. There are two configurations for using Solar PV for residential applications: off-grid, and grid-connected. An off-grid PV system involves the powering a residence using only the Solar PV system, such as the Navajo Nation PV/Wind units, Hopi PV units, and Ramona Band EcoResort. On the other hand, a grid-connected PV system is connected to the electrical grid. This configuration requires the resident to have available access to the electrical grid. An example of this configuration is on Hopi Tewa Culture center, who's Solar PV system with battery storage system was recently been connected to the grid. The operation of a Solar PV system is based on the availability of the sun. This means the electrical power output from the system is dependent on the behavior of the sun throughout the day. The output power is max when the solar panel is directly facing the sun. Sun tracking systems allow the

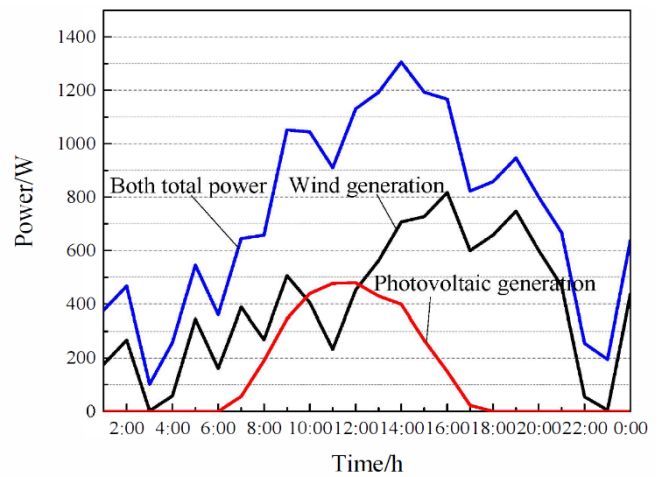
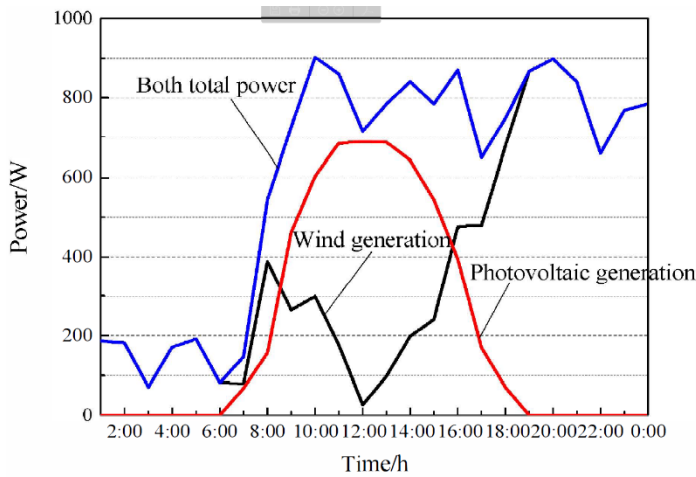

solar panel to follow the sun's path throughout the day. However, this may introduce more areas of maintenance. On the other hand, the solar panel can be adjusted twice a year for winter and summer as NTUA currently does. However, the output for a Solar PV is also susceptible to other uncontrollable factors, such as unforeseen weather characteristics including storms or extended cloudy periods. For this reason, a wind energy system is used to obtain additional power output throughout the entire day, including the night time. The output for this type of hybrid system is shown in Figure 1. The output from Solar PV is max when the sun is directly overhead around noon time. Also, the figure shows the output from wind will differ from day to day and will fluctuate. When the two sources are combined, it offers a more reliable output throughout the entire day.

To further increase the power output from the system, a Battery Energy Storage System (BESS) is used. In an article, a BESS was implemented in a hybrid (PV/Wind) power system to closely match the load profile throughout the day [11]. This allows the unused energy generated during the day to be stored and used later. With an implemented battery storage, a charge controller is required to monitor battery charging for safe charging and prevent over charge. Another important aspect in the balance of a PV system is the type of electrical load. Many electrical components today internally use direct current or DC power. This is easy for Solar PV, because the output from PV panels is DC. However, if the electrical load requires an alternating or AC power supply, an inverter is required to convert from DC to AC. Many household appliances require AC power. Appliances,



Fig 2. Field visit to off grid PV/Wind system in Kayenta, AZ.

like conventional refrigerators, require AC power to operate. The size of the system is based on the anticipated electrical usage. First, the battery is sized to satisfy the anticipated electrical usage. The solar panels are then sized to satisfy the requirement for charging the battery. The balance of the system involves the balance of the load and the electrical generation. The system must maintain this proper balance at all times to ensure smooth operation. NTUA currently uses this type of system for their off grid residents. Figure 2 shows the PV/Wind system that a resident currently uses in Kayenta, AZ.

3. Refrigeration Methods

To analyze the type of refrigerator that may be used with an off-grid Solar PV/Wind system, the methods available for refrigeration must be understood. There are three classifications for refrigeration methods: non-cyclic, cyclic, and thermoelectric. The non-cyclic method is the simplest, in that it involves using ice or dry ice to cool a contained area. However, it requires constant resources for ice/dry ice. This option is not used for constant refrigeration and is not viable for residents in rural locations. The cyclic method involves a refrigeration cycle that removes heat from the refrigeration space to the external space. The cyclic method can be split into either a vapor cycle or gas cycle. The gas cycle involves using a fluid that does not change phases (remains a gas) during the cycle, such as air. However, the gas cycle is less efficient in comparison to the vapor cycle. Therefore, it is typically not used. The vapor cycle can be further split into the vapor absorption cycle and the vapor compression cycle. These two methods are used today.

Lastly, the thermoelectric method uses the Peltier Effect to cool the refrigeration space in comparison to the outer space. Most refrigerators today work off the vapor compression cycle. Through the vapor compression cycle, cooling is achieved by putting refrigerant through continuous phase transitions between liquid and gas [12]. In this processes, the refrigerant absorbs heat from the refrigeration space and rejects heat from the surrounding space. A refrigerator that uses the vapor compression cycle is made up of four main components: a compressor, condenser,

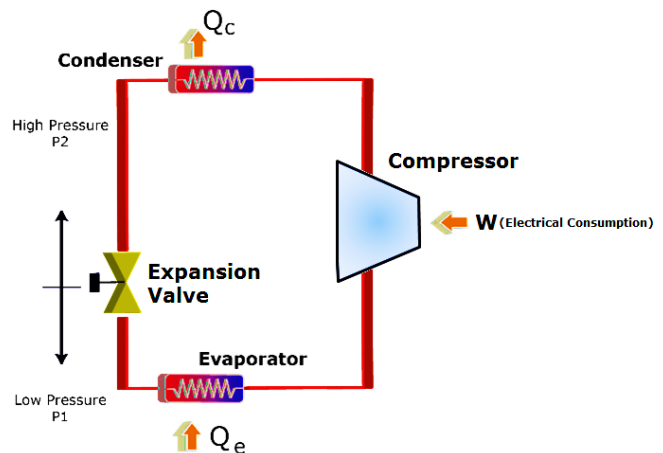
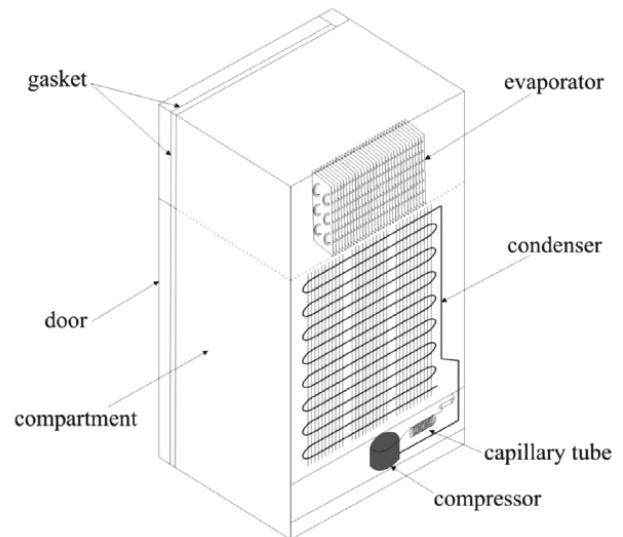

evaporator, and capillary tube/expansion valve [12], shown in Figure 3. In this method of refrigeration, a compressor is used to drive the process.

The vapor compression cycle begins with the compressor. The refrigerant is compressed, causing the refrigerant to heat and turn into a gas. It then passes through the condenser where the refrigerant dissipates heat and turns back into a liquid. After passing through a capillary tube, it goes through the evaporator where it evaporates, and results in absorbing heat from the inside of the refrigerator. This process is continuous in the cooling of the refrigerator. A diagram of this process is shown in Figure 4.

Vapor Compression Refrigeration

A. Single Speed AC Compressor

There are several different compressor that can be used in the vapor compression type refrigerator. Traditionally, conventional refrigerators that use the vapor compression use a single speed AC compressor, because it is simple and easy to implement. The process involves a simple on-off operation of the compressor for cooling the refrigerator. When a refrigerator needs to be cooled, the compressor turns on at full speed. Once it reaches the correct temperature, the compressor turns off. This on-off operation is represented in the figure shown in Figure 5. The power drawn by the refrigerator increase and decreases which corresponds to the on/off operation of the compressor. The advantage to this type of compressor is the simple on-off operation. When the refrigerator need to be cool, the compressor is turned on. Once the refrigerator is within the temperature limits, the compressor then turns off.

However, there are disadvantages to using this type of compressor. One disadvantage is that the refrigerator will require a large surge of current each time it starts the motor. This corresponds to a larger amount of power needed to start the motor. As seen in the Figure 6a, the startup power can be as high as 35% higher than the steady state power consumption of the refrigerator. From another analysis of a Hotpoint 15.6-cu. ft. top freezer conventional refrigerator, the load profile under a period of normal operation and under loads and defrosting cycle was obtained and is shown in Figure 6b [14]. There are several aspects shown from this data, including the fact that power surges are present in the starting of the compressor motor.

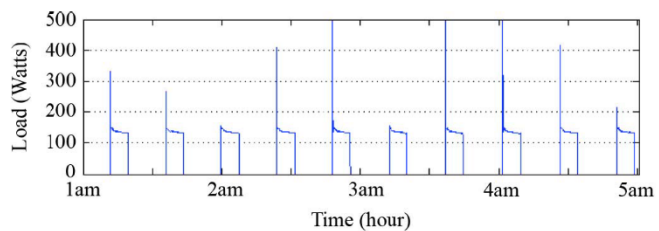
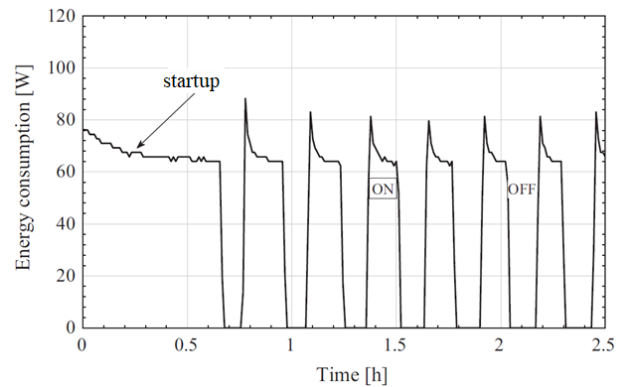

(a)

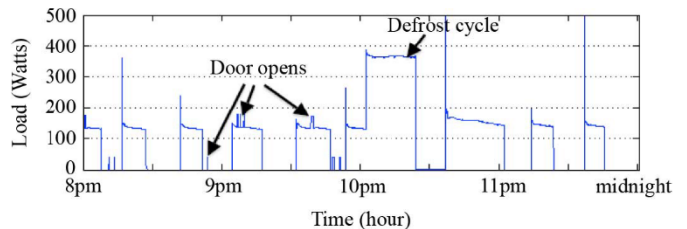

Also, power consumption increases as result of using an incandescent light bulb in the unit and the using the refrigerator defrost cycle [14]. The analysis in this paper reports similar findings with a larger side-by-side refrigerator [14].

B. Variable Speed AC Compressor

Another type of compressor that is use is a variable speed AC compressor. Opposed to the single speed compressor, this compressor can operate at various speeds. This allows for various states of operation as opposed to the on-off operation of the single speed compressor. For example, instead of operating at speeds of 3000 rpm or 0 rpm, it can operate anywhere between 4000 rpm and 1000 rpm, as seen in Figure 7. This allows the compressor to run at low speed or high speed depending on the internal refrigerator temperature. This minimizes the amount of times the refrigerator temperature will go above the set temperature. The advantage to this refrigerator is that the compressor remains on, not requiring a surge of power to start the motor. There are various companies today who take advantage of this type of compressor. Commercial brands like LG and Samsung are among those who use variable speed AC compressors, which are also known as inverter compressors. One example is the LG LTNC11121V model which is a 11 cu. ft. Top Freezer Refrigerator, and uses LG’s inverter compressor technology [15]. It is currently priced at \$699.99. However, this refrigerator is not energy star rated, drawing an estimated 339 kWh per year or 928.8 Whr per day. The process involves using an inverter to drive a variable speed compressor. This type of compressor can solve the problem of surges from the refrigerator. However as seen in the LG refrigerator case, it can still consume more energy than most conventional refrigerators. In addition, an inverter is still required because these refrigerators use AC power.

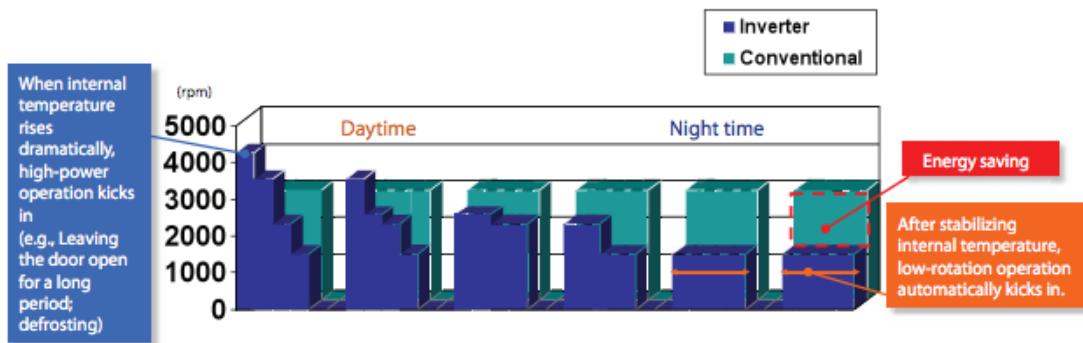

Fig 7. Comparison of an Inverter and Conventional Compressor [16].

C. Variable Speed DC Compressor

Another type of compressor is a DC variable speed compressor. This type of compressor does not require an AC power supply. Instead, the compressor will operate using a DC power supply. In a PV/Wind system, this allows the refrigerator to operate without the need for an inverter. This eliminates the losses in power conversion in the inverter from DC to AC, which ranges between 2% and 10% at best. An example of a DC variable speed compressor is the Danfoss/Secop compressor. There have been cases where a conventional refrigerator was

modified to use a DC compressor. Authors S. Kaplanis and N. Papanastasiou stated in their project to modified a conventional refrigerator to a solar refrigerator through changing the AC compressor to a Danfoss/Secop BD50F DC compressor [17]. It was concluded that conversion from AC to DC compressor resulted in eliminating the need for an inverter, less power loss, as well as increase the solar insolation utilization to the level of 92% for a speed value ratio of 2.5 [17]. This is a case where a conventional refrigerator can be modified to serve as a solar refrigerator. There are also refrigerators that utilize a DC compressor. Solar refrigerator manufactures, such as Sunfrost, SunDazer, Ecosolarcool, Unique, and Smad, are examples of manufactures that make DC refrigerators utilizing this type of compressor. These refrigerators vary depending on size, insulation, refrigeration configuration, and energy efficiency. The refrigerators are compared in the Table 1, which were found around a size of 10 cu. ft. The Unique refrigerator appears to be the lowest in price at \$999, while offering a decent amount of refrigerator space and a freezer. Another option is the chest refrigerator also offered by Unique. The refrigerator offered by Smad has two compartments that can operate as either a refrigerator or freezer, however, cost is higher and storage space is small.

A refrigerator with a DC compressor would be desirable in an off-grid PV/Wind system. This would allow the refrigerator to be connected directly to the charge controller, eliminating the need for an inverter to convert from DC to AC. By eliminating the inverter, this configuration would eliminate the possibility of problems arising from the inverter. This type of refrigerator also draw less power. As seen in Table 1, the power requirement is shown, as well as the Watts per hour for 24 hours operation (Whr/24hr) for each refrigerator.

Table 1. Comparison of solar DC refrigerators.

Brand	Model	Type (R/F)	Size (CU. FT)	Power Requirement (W)	Whr Draw/24hr		Ahr Draw/24hr		Price	Vendor
					@32C/90F	@21C/70F	@32C/90F	@21C/70F		
SunFrost	RF16	Top Freezer R+F	14.3	-	700	480	58	40	\$3,445	SunFrost
SunFrost	R10	Upright Type R	9.13	-	280	170	23	13	\$2,085	SunFrost
SunDanzer	DCRF290	Top Freezer R + F	10.2	80	800	500	-	-	\$1,399	SunDanzer
SunDanzer	DCR225	Chest Type R	7.9	80	198	-	17	8	\$1,250	Northern Arizona Wind & Sun
SunDanzer	DCF225	Chest Type F	7.9	80	532	-	44	30	\$1,250	Northern Arizona Wind & Sun
Ecosolarcool	ESCFR300DS	Chest Type R + F	10.5	80	*300 (Cooling)/570 (Freezing)		-		\$1,300	Ecosolarcool
Ecosolarcool	ESCR260GE	Top Freezer R + F	9.2	72	*550		-		\$1,299	Ecosolarcool
Unique	UGP-260L W	Top Freezer R + F	9.0	56	*572		*24		\$999	Costco
Unique	UGP-290L1	Top Freezer R + F	10.3	56	*524		*24		\$1,399	Sun-powergeneration
Smad	B071ZP2ZVC	Chest Type R + F	7.5	57	*530		-		\$1,339	Amazon

*Ambient Temperature @ 25C.

Absorption Refrigeration

Another method that is used today for refrigeration is the vapor absorption cycle. This method is a cyclic method similar to the vapor compression method. However, this method varies in that a compressor is not need.

Instead of using a compressor, the vapor absorption method uses heat to drive the process of refrigeration. In the refrigeration cycle, the refrigerant changes from gas back to a liquid is when heat is required. The advantage is that this process for refrigeration can be driven when there is a heat source. This can lead to using fuel or solar energy to drive this process. However, this type of refrigeration is not used due to inefficiency in comparison to vapor compression refrigeration. This method is used in applications where refrigeration cannot be driven using the compression method, including where electricity is limited or unavailable. A Liquid Propane (LP) refrigerator is an example of a refrigerator that uses this vapor absorption. Another example is using a Solar Thermal refrigerator. It operates by using solar energy to heat refrigerant that is used in the absorption cycle. With a Solar Thermal refrigerator, solar collectors are needed to heat the refrigerant.

Because a LP refrigerator uses propane, it is commonly used in off-grid applications where electricity is unavailable and propane is available. On the Navajo reservation, some residents without electricity use this type of refrigeration. However, this requires a constant supply of propane. It also requires the ability to refill the propane and transport it over a distance. For a 10 cu. ft. LP refrigerator, about 1.5 lbs. of fuel is consumed per day [28]. Over a course of one year, 547.5 lbs. of fuel is consumed. In 2018, the average propane cost in Arizona is \$2.55 per gallon [29]. This would amount to a cost of \$1,395.87 annually. This does not take into consideration the cost for transportation of the fuel. Over several years, the cost can start to add up in comparison to a refrigerator that is depended on a PV/Wind system. A PV/Wind system would eliminate the need for a constant refilling of propane and cost.

Thermoelectric Refrigeration

Another type of refrigerator is a thermoelectric refrigerator. Thermoelectric refrigeration works using the Peltier Effect, which does not use a cycle or require refrigerant. This refrigerator works by applying a voltage across plates of two different conductors, which creates a temperature difference between the hot and cold plate. This type of refrigeration can be seen in Figure 8. The disadvantage to this type of refrigeration

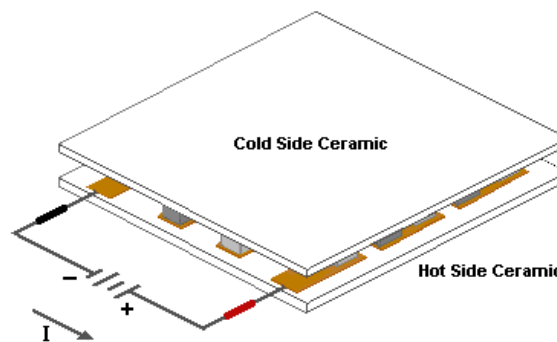

is that the operation is dependent on the ambient temperature. During the winter time when ambient temperature is lower, the refrigeration temperature may be freezing. However in the summer with a higher ambient temperature, the refrigerator temperature may be just enough to keep food cool. Typically, refrigerators of this type creates cools the food unto to 40°F. There are advantages to this type of refrigeration, including that there are less mechanical parts. The only mechanical part is a fan, which is used to move heat from the hot plate. Another feature of this refrigerator is that it can provide heating in addition to cooling. The amount of cooling of this refrigerator can also be controlled by controlling the voltage between the two plates. However, this type of refrigerators are typically used for cooling in applications such as camping or keeping drink cool. For this reason,

off-the-shelf thermoelectric refrigerators are available in smaller and compact sizes. The Coleman 40 Qt. Power Chill Cooler is an example of a thermoelectric cooler available with a capacity of 1.34 cu. ft.[19]. For this cooler, it cools food to 40°F cooler than the surrounding temperature. However, it is a small capacity cooler and draws 60W of power. The required power is comparable to the solar refrigerators. This type of refrigerator would not work in an environment that had cold winters and hot summers. For this reason, this type of refrigerator would not work for off-grid residents.

4. Photovoltaic Power System Design

Another area to consider for increasing the performance of the refrigeration unit in the off-grid system is to analyze the power system or the PV/Wind system. As discussed previously, conventional refrigerators operate using an on-off cycle due to the use of a single speed AC compressor. This may result in periodic surges in the system. The power system should be able to handle the power requirements of the refrigeration unit while allowing other loads to simultaneously be connected to the system. If the power system does not consider the surges by a refrigerator that operates on this on-off cycle, it may result in problems when other loads are present. This can result in decrease performance of the refrigeration unit, or cause power disturbances to the loads. In a project by R. Allain, the power consumption of a conventional refrigerator was recorded over a 24 hour period [20]. It was found that a refrigerator requires large amounts of power each time the compressor turns on. In the figure, the surge power at the startup of the compressor is much larger than the normal operating power. Therefore, it is important to ensure that the power system is well maintain to keep it running at its top performance.

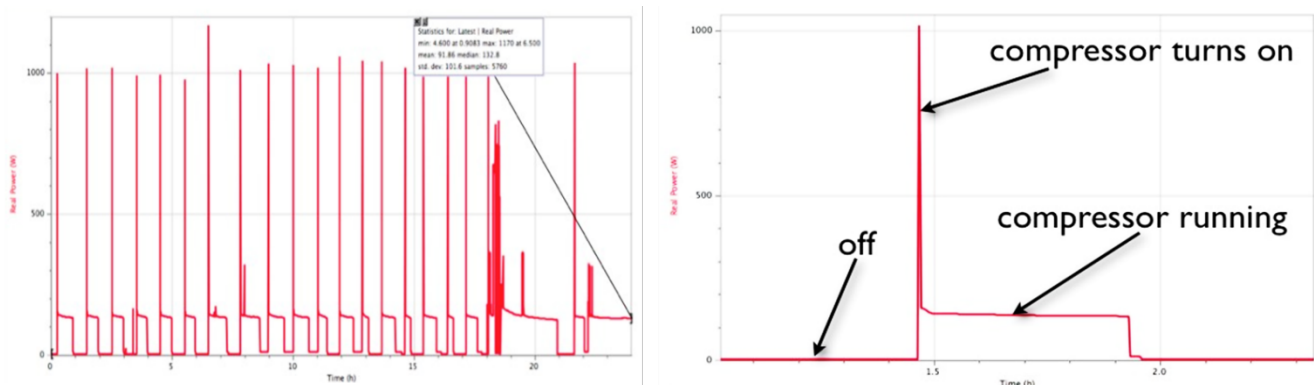

Fig 9. Left: Real power consumption of a conventional refrigerator over a 24 hour period. Right: Graph of a single on-off cycle [20].

A. Batteries

One component of the power system to closely monitor is the batteries. The batteries are one area to consider for the conventional refrigeration characteristics and to keep the refrigerator performing. Each battery varies in terms of chemistry, capacity, discharge rate, depth of discharge, cost, and maintenance. When dealing with system implementations for low income tribal customers, cost is a major concern. This requires the least cost solution to be chosen. Typically, Lead Acid batteries are used, because they are the less expensive in comparison to other types of batteries.

There are three common types of batteries: Flooded, AGM (Absorbent Glass Mat), and Gel. Traditionally, the Flooded type is used. Today, the batteries that are starting to be used more are both AGM and Gel, which are considered sealed batteries and maintenance free. Aside from Lead Acid batteries, there is also the Nickle Iron which less use with solar systems. Iron Edison, which is company that makes these batteries for residential solar, offers a Nickle Iron Deep Cycle Flooded type battery [21]. Lithium Ion batteries are another type which are used. Companies such as Tesla uses this type of battery for the Tesla Powerwall Battery. This battery offers benefits including less maintenance, high depth of discharge, and it doesn't require ventilation [22]. However, it is more expensive than lead acid, and the batteries require circuit protection to keep voltage and current within safe limits [22]. In applications on the Navajo reservation, where many residents have low income, the customers may not be able to afford these specialty batteries. However, it is important to make sure that proper operation and maintenance (O&M) is done to keep the batteries performing at their best.

One area of concern is overcharging. A main concern is with the batteries that are considered no-maintenance batteries – AGM and GEL batteries. When Lead Acid batteries are overcharged, it can cause “gassing”, in which pressure in the battery is released by water loss in the battery [23]. “Gassing” is the reason why lead acid batteries must be refilled with distilled water. This can also happen for the AGM and GEL type batteries where the relief caps open and vent [24]. However, this results in decrease of the battery capacity. This brings the issue that even if a battery is “maintenance free”, there are still procedures which must be kept to ensure that the battery is performing at its best. This is true in a system that is designed to only have a refrigerator as the main electrical load. If the battery degrades in capacity, there is no doubt that it will have problems with a conventional refrigerator and other electrical loads if present. Routine operation and maintenance involving cleaning batteries, maintaining proper battery chemistry, ventilation, and maintaining proper charge/discharge patterns is important in keeping the power system performing so it can run large loads such as a refrigerator.

B. Inverter

Another crucial component that can affect the performance of a refrigerator is the inverter. The inverter in the power system converts from DC supplied by the solar panel and batteries into AC. Household loads in the US today operate using household outlets at 120V AC. However, most household loads today often convert from 120V AC to DC to operate on DC or convert back to their own AC frequency. For example, cell phones, laptop, and TVs internally operate using DC. However, appliances such as conventional refrigerators require AC current to operate. For this reason, the inverter needs to be chosen based on the anticipated loads. This includes the power requirements and load type.

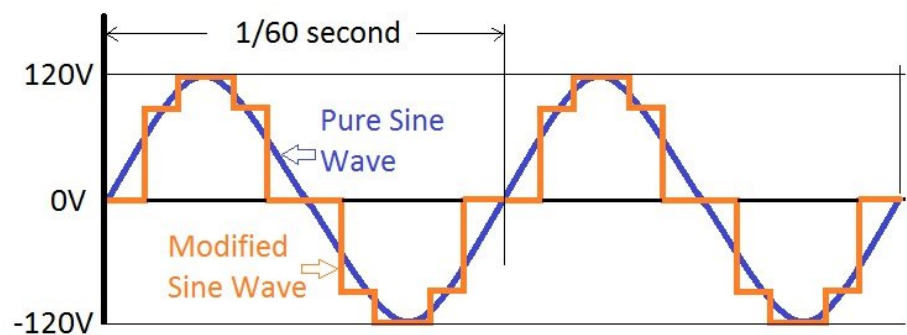

First, the inverter needs to be able to convert enough power to meet the load demand. In addition to this, it must be able to handle power surges for short periods of time. Many inverters have a rated power and a surge power that can handle this surge for a short period of time. In the system with refrigeration units, the starting current of the conventional refrigerator needs to be taken into consideration, which is typically three times the running current. Therefore, the inverter needs to be chosen to ensure the inverter can supply power to the refrigerator as well as the surges it may require. In addition, other loads must also be taken into consideration such as TVs, coffee makers, or space heaters. Another important aspect of an inverter is output power quality. Inexpensive inverters will have an approximation of a sine wave. This results in a signal that is not a pure sine wave, as seen in Figure 11. Some loads can have problems when using a modified sine wave. Many times, it is the electronics in these loads that will have interferences which result in harmonics from the modified sine wave. Appliances, such as a refrigerator, will also have problems, including not running as efficiently in comparison to if it were being supplied a pure sine wave. For this reason, an area of consideration is ensuring that an inverter is chosen with a pure sine wave output and that satisfies the required peak (surge) power requirements.

C. Super Capacitor

There is future technology that would help with the problem of surges faced in the PV/Wind system. One component, known as a super capacitor, is an energy storage device that acts as a high-capacity capacitor. The advantages to a super capacitor involves the ability for fast response. A capacitor holds little amount of power, however, it can release large amounts of power in short time. In a system such as a PV/Wind off grid system, a super capacitor could serve to supply the surges in the system. In the article “Battery life enhancement using hybridization of battery and UC”, a super capacitor was used to increase the life of a battery in a Hybrid Energy Storage System (HESS) [26]. The supercapacitor will decrease the amount of times a battery is discharged due to fluctuations in the load. As with any battery, there is a limited amount of charge cycles throughout its lifetime. If a super capacitor would decrease the amount of power supplied by the battery, it would decrease the amount of times the battery is being discharged. Therefore, the life of the battery would be increased. However, the problem with supercapacitors are that they are new technology. They are not used as much as lead acid batteries (old technology). For this reason, supercapacitors have a high cost. The cost for a single cell can be as much as \$60. There is potential for implementations of supercapacitors in future for not only residential applications, but also microgrids with hybrid energy storage systems (HESS). Although the cost may be expensive, it may be desirable in locations where residents do not have electrical line service, but still need to power large electrical loads such as refrigeration, heating/cooling, or power tools.

D. Smart Technology

To further increase the efficiency of the system, there is a need for smarter use of energy. New technology can allow this smarter use of energy through smart technology. This involves using the loads in a way that is smarter to decrease the amount of energy that is lost or wasted. This includes a Smart Home and Smart Loads. A Smart Home can monitor the loads and the power generation. On the other hand, Smart Loads can be controlled by a Smart Home. This can allow loads to be classified based on priority. When there is limited amount of energy available, the loads of less priority may be turned off first. Figure 12 shows the classification of common loads [27]. For example, the refrigerator is the highest priority. Other loads such as TV, radio, toaster might be turned off first before the refrigerator. There are also current technology known as Smart Inverters which are able to record trends in electrical usage. This can allow the resident/utility to monitor electrical usage and identify problems before they arise. If an electrical load is not working properly, it may be drawing large amounts of power which can be seen using the Smart Inverter. Although the cost for these devices may be expensive, smart technology may help these systems in using electricity smarter.

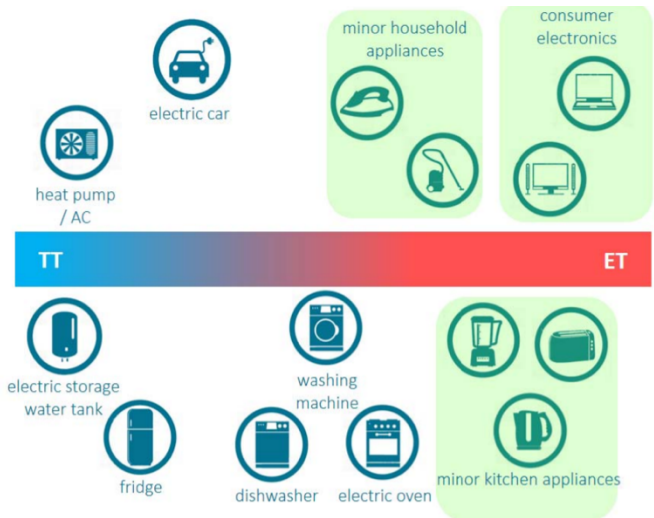

5. Proposition

Conventional refrigerators are not designed to be used with a small off-grid Solar PV/Wind system. This is evident in the large start up current required by conventional refrigerators. This characteristic may require more power than can be supplied by a small system. There are alternatives to conventional refrigeration as was discussed in this paper. There are several possible solutions to the refrigeration problem faced by NTUA and the Solar PV/Wind units with refrigerators.

The first suggested solution is to purchase a solar refrigerator. Solar refrigerators use a DC variable speed compressor that don't require the excessive amount of current to start up the refrigerator. The cheapest option that was found was the Unique UGP-260L W 9.0 cu. ft. Top Freezer, priced at \$999 (see Table 1). The other solar refrigerators for a similar size cost around \$1300. These refrigerators are designed to be used with Solar PV systems.

Another option is to convert the conventional refrigerators to a solar refrigerator. This involves switching the AC compressor with a DC variable speed compressor, such as the Danfoss/Secop BD50F DC compressor. However, this option requires the labor to switch out the compressors and may require the additional training to switch out the compressors. With these two options, efficiency can be improved as result of eliminating the inverter and using a variable speed compressor.

The last option is to use a propane refrigerator, which does not require electrical power. However, the cost was calculated to be \$1400 per year for fuel alone. Additionally, it requires the resident to transport fuel several times a year. This option after the first year exceeds the cost of a solar refrigerator.

6. Recommendation

This paper looked at the performance problem brought to Sandia National Laboratories by NTUA, which involved issues concerning Energy Star Rated refrigerators and off-grid Solar PV/Wind systems. It was found that conventional refrigerators operate using vapor compression and use a single speed AC compressor. These conventional refrigerators have a characteristic that involves drawing large amounts of current at start up to start the motor in the compressor. In the case of conventional refrigerators, this is frequency and periodic even in times of no activity. It was found that these off-grid systems may not be able to supply this instantaneous power to start these refrigerators, especially if other loads are present. Other refrigerators includes a conventional refrigerator that uses an “inverter compressor”. However, these types of refrigerators are expensive, and many available off-the-shelf refrigerators are not energy efficient.

The solution involves using a refrigerator with a variable speed DC compressor. This may involve purchasing a solar refrigerator (seen in Table 1) or modifying a conventional refrigerator to use a DC compressor. Using a LP refrigerator is also an option, but the annual cost is \$1400 per year. The lowest cost and easiest solution is to buy a solar refrigerator. The Unique UGP-260L W 9.0 cu. ft. Top Freezer may be an option which is priced at \$999. Conventional refrigerators are not designed to be used with Solar PV systems. They are designed to be connected to the grid where there is a large amount of available power. When dealing with small systems with limited amounts of available power, the refrigerator must be designed with this in mind. For these reasons, a solar refrigerator should be used with the Solar PV/Wind systems.

7. References

- [1] Energy.gov. (2000). Energy Consumption and Renewable Energy Development Potential on Indian Lands. [online] Available at: <https://www.energy.gov/sites/prod/files/2017/06/f34/EIA2000.pdf>.
- [2] Publicpower.org. (2018). Light Up Navajo Nation Facts. [online] Available at: <https://www.publicpower.org/system/files/documents/FLYER-LIGHT%20UP%20NAVAJO%2018JUN18a.pdf>.
- [3] Testimony by the Navajo Nation to the Regulatory Commission, Washington, DC. Grid Reliability and Resilience Pricing, Docket No. RM 8-1-000, October 2017
- [4] Partners In Health. (2018). Navajo Nation. [online] Available at: <https://www.pih.org/country/navajo-nation>.
- [5] Diné Policy Institute (DPI), Dine College, Apr-2014. [Online]. Available: <https://www.dinecollege.edu/wp-content/uploads/2018/04/dpi-food-sovereignty-report.pdf>.
- [6] Ntua.com. (2018). Navajo Tribal Utility Authority. [online] Available at: <http://www.ntua.com/aboutus.html>.
- [7] Navajo-Hopi Observer News. (n.d.). Solar Power brings light to some Navajo homes. [online] Available at: <https://www.nhnews.com/news/2017/feb/28/solar-power-brings-light-some-navajo-homes/> [Accessed 1 Sep. 2018].
- [8] Terry, Derrick, "Renewable Energy Program" PowerPoint. July 23, 2015
- [9] "Solar Photovoltaic Technology Basics | NREL", Nrel.gov, 2018. [Online]. Available: <https://www.nrel.gov/workingwithus/re-photovoltaics.html>. [Accessed: 01- Sep- 2018].
- [10] Yuqing Zhang and Haiying Li, "Study on the off-grid type wind-solar photovoltaic hybrid generating system," 2016 IEEE Transportation Electrification Conference and Expo, Asia-Pacific (ITEC Asia-Pacific), Busan, 2016, pp. 854-857
- [11] M. Liu, W. J. Lee and L. K. Lee, "Wind and PV hybrid renewable system dispatch using battery energy storage," 2013 North American Power Symposium (NAPS), Manhattan, KS, 2013, pp. 1-5.
- [12] J.M. Belman-Flores, J.M. Barroso-Maldonado, A.P. Rodríguez-Muñoz, G. Camacho-Vázquez, "Enhancements in domestic refrigeration, approaching a sustainable refrigerator – A review", *Renewable and Sustainable Energy Reviews*, vol. 51, pp. 955-968, 2015.
- [13] Araner, "The Vapor Compression Refrigeration Cycle, Step By Step," Araner, 31-Aug-2018. [Online]. Available: <https://www.araner.com/blog/vapor-compression-refrigeration-cycle/>.
- [14] M. Pipattanasomporn, M. Kuzlu, S. Rahman and Y. Teklu, "Load Profiles of Selected Major Household Appliances and Their Demand Response Opportunities," in *IEEE Transactions on Smart Grid*, vol. 5, no. 2, pp. 742-750, March 2014.
- [15] LEAT, "LG LTNC11121V: 24 Inch Wide Compact Top Freezer Refrigerator | LG USA," LG 11 cu. ft. Top Freezer Refrigerator, 12-Aug-2018.
- [16] A. Jain, "Refrigerators with Inverter technology can help save electricity," Bijli Bachao, 07-Jun-2018. [Online]. Available: <https://www.bijlibachao.com/refrigerators/refrigerators-with-inverter-technology-can-help-save-electricity.html>.
- [17] S. Kaplanis and N. Papanastasiou, "The study and performance of a modified conventional refrigerator to serve as a PV powered one", *Renewable Energy*, vol. 31, no. 6, pp. 771-780, 2006.
- [18] Pollock Industries, "How A TE Cooler Works," This Is How A Thermoelectric Module Works by ADVANCED THERMOELECTRIC (POLLOCK INDUSTRIES). [Online]. Available: <https://www.electracool.com/moduleworking.htm>.
- [19] Duane, "40 Quart PowerChill™ Hot/Cold Thermoelectric Cooler," COLEMAN, 28-Oct-2017. [Online]. Available: <https://www.coleman.com/40-quart-powerchill-hotcold-thermoelectric->

- cooler/3000001495.html?cgid=coleman-coolersandwaterjugs-hardcoolers#prefn1=coolerType&prefv1=Thermoelectric&start=1.
- [20] R. Allain, "Power and Electric Motors," *Wired*, 01-May-2018. [Online]. Available: <https://www.wired.com/2011/11/power-and-electric-motors/>.
- [21] Iron Edison, Iron Edison Nickel-Iron Batteries: Clean Energy Storage for a New Generation. [Online]. Available: <https://ironedison.com/nickel-iron-ni-fe-battery>.
- [22] "Is Lithium-ion the Ideal Battery?," *Charging Lithium-Ion Batteries – Battery University*. [Online]. Available: https://batteryuniversity.com/index.php/learn/archive/is_lithium_ion_the_ideal_battery
- [23] "Battery Basics," *Progressive Dynamics*. [Online]. Available: <https://www.progressivedyn.com/service/battery-basics/>. [Accessed: 01-Sep-2018].
- [24] "Gel vs AGM Batteries," *SunWize | Power Independence*, 14-Jun-2018. [Online]. Available: <https://www.sunwize.com/gel-vs-agm-batteries/>.
- [25] "Pure Sine Wave vs. Modified Sine Wave Inverters- What's the Difference?," *Alternative Energy Store*, 27-Oct-2015. [Online]. Available: <https://www.altestore.com/blog/2015/10/pure-sine-wave-vs-modified-sine-wave-whats-the-difference/>.
- [26] Y. V. Mahadik and K. Vadirajacharya, "Battery life enhancement using hybridization of battery and UC," 2017 International Conference on Circuit ,Power and Computing Technologies (ICCPCT), Kollam, 2017, pp. 1-3.
- [27] A. Baldauf, "A smart home demand-side management system considering solar photovoltaic generation," 2015 5th International Youth Conference on Energy (IYCE), Pisa, 2015, pp. 1-5.
- [28] "Off Grid Refrigeration: Solar Electric Vs Propane," *Off Grid refrigeration solar electric vs propane*. [Online]. Available: <http://www.sunfrost.com/blog/off-grid-refrigeration-solar-electric-vs-propane/>.
- [29] "Weekly U.S. Propane Residential Price (Dollars per Gallon)," *Chinese coal-fired electricity generation expected to flatten as mix shifts to renewables - Today in Energy - U.S. Energy Information Administration (EIA)*. [Online]. Available: <https://www.eia.gov/dnav/pet/hist/LeafHandler.ashx?>