

---

# QUADRENNIAL TECHNOLOGY REVIEW

## AN ASSESSMENT OF ENERGY TECHNOLOGIES AND RESEARCH OPPORTUNITIES



Chapter 3: Enabling Modernization of the  
Electric Power System  
September 2015



## Issues and RDD&D Opportunities

- Fundamental changes in electricity generation and use are requiring the electricity system to perform in ways for which it was not designed—requiring new capabilities and system designs to maintain historical levels of reliability.
- American industry and commerce demand affordable, high-quality power with high reliability to support an increasingly digital economy. As the nation's critical services become more digital and automated, power disruptions have potentially greater consequences.
- Advanced technologies to plan, manage, monitor, and control electricity delivery are needed to enable safe and reliable two-way flow of electricity and information, support growing numbers of distributed energy resources, and support customers participating in electricity markets as both power suppliers and demand managers.
- Research, development, demonstration, and deployment opportunities exist to accomplish the following:
  - Develop and refine interoperable grid architectures and new system designs
  - Develop software and visualization tools that use new data from transmission and distribution system devices for enhanced, real-time operations and control
  - Research material innovations and develop transmission and distribution component designs for higher performance, reliability, and resilience
  - Embed intelligence, communication, and control capabilities into distributed energy resources and systems such as microgrids to support grid operations
  - Improve energy storage capabilities and systems designs that lower costs while increasing capacity and performance, and facilitating integration
  - Develop high-fidelity planning models, tools, and simulators and a common framework for modeling, including databases
  - Design innovative technologies and resilient and adaptive control systems to improve physical- and cyber-security of the grid

# 3

## Enabling Modernization of the Electric Power System

### 3.1 Introduction

The electric power system is facing increasing stress due to fundamental changes in both supply and demand technologies. On the supply side, there is a shift from large synchronous generators to lighter-weight generators (e.g., gas-fired turbines) and variable resources (renewables). On the demand side, there is a growing number of distributed and variable generation resources, as well as a shift from large induction motors to rapidly increasing use of electronic converters in buildings, industrial equipment, and consumer devices. The communications and control systems are also transitioning from analog systems to systems with increasing digital control and communications; from systems with a handful of control points at central stations to ones with potentially millions of control points.

All the while, the system is being asked to perform in ways and in a context for which it was not designed. The result is a system that is under increasing stress from these and other factors and requires much greater flexibility, agility, and ability to dynamically optimize grid operations in time frames that are too fast for human operators. Fundamental advances in the power system are needed to address these changes and ensure system reliability. The Southwest Blackout in 2011, for example, was the result of a cascading failure that took place in seconds—too fast for human intervention. These fundamental changes, however, also open a set of opportunities that can be tapped to significantly improve performance, lower costs, and address our national energy challenges. The research needs that can help realize these opportunities are described in this chapter.

The U.S. electric power system is the centerpiece of the nation's energy economy. Of the roughly 97 quads (quadrillion British thermal unit) of energy used in the United States in 2014, about 38 quads were transformed into 3,900 terawatt-hours of electricity for delivery by an extensive infrastructure of more than 19,000 generators, 55,000 transmission substations, 642,000 miles of high-voltage lines, and 6.3 million miles of distribution lines to serve 145 million customers.<sup>1</sup> Electricity generation accounts for the largest proportion of U.S. energy use: nearly all of the nation's coal, nuclear, and non-biomass renewable sources consumed and one-third of natural gas sources (see Figure 3.1). The system is owned and operated by more than 3,000 utilities and is overseen by thousands of municipal, state, and federal officials.

Virtually every aspect of American commerce and industry depends on the continuous availability of affordable electric power. Electricity use is projected to grow by 25% from 2013 to 2040.<sup>2</sup> Although the rate of growth in electricity use will continue to slow—as it has since the 1950s, largely due to energy-efficiency improvements and a transition toward a service-based economy (moving away from heavy manufacturing)—the nation's reliance on a reliable, efficient, and resilient power grid is rising. This dependency grows as businesses, homes, and communities increasingly integrate digital technologies and automated systems into nearly all aspects of modern life. This dependence is highlighted when widespread power interruptions affect whole communities and regions due to catastrophic natural disasters.

An increasing reliance on electricity presents significant challenges for utilities, state-level decision makers, and other stakeholders, who must improve reliability and resilience while cost-effectively managing the fundamental changes required to meet the needs of a low-carbon, digital economy. The electric power system is currently undergoing significant changes in the sources we rely on to generate electricity, the means by which we receive electricity, and even in the ways we consume electricity.

**Figure 3.1** Estimated U.S. Energy Use in 2014: ~98.3 Quads

Credit: Lawrence Livermore National Laboratory

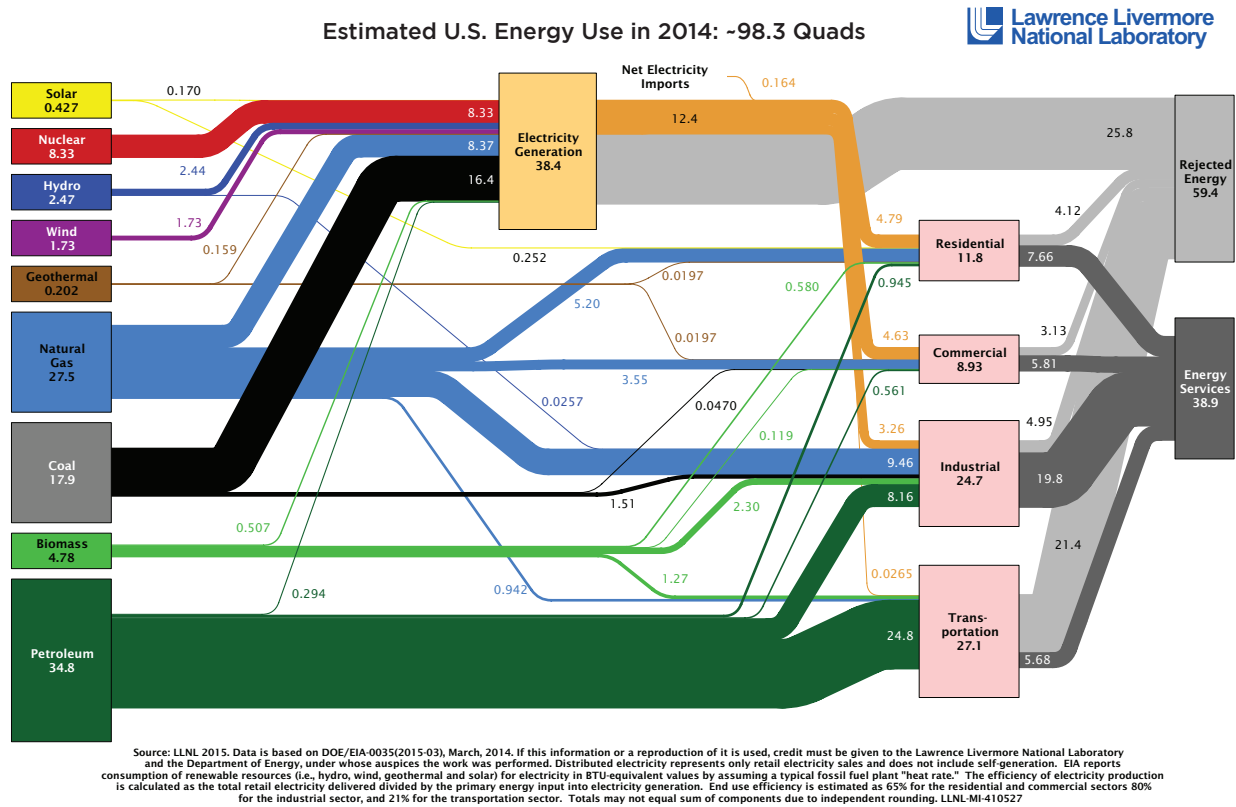

Electricity generation accounts for a significant portion of annual U.S. energy use, including nearly all coal, nuclear, and non-biomass renewable sources, and nearly a third of natural gas.

This chapter of the Quadrennial Technology Review (QTR) focuses on the research, development, demonstration, and deployment (RDD&D) needs to develop a modern electric power system. Yet, it is important to note that the reliable delivery of electricity also depends on the structure and dynamics of electricity markets as well as federal, state, and local policies and regulations. These issues are addressed in the 2015 Quadrennial Energy Review.

### 3.1.1 Modernization of the Electric Power System

The U.S. electric power system has provided highly reliable electricity for more than a century, yet much of the current electric grid was designed and built decades ago using system design models and organizational principles that must be restructured to meet the needs of a low-carbon, digital economy. The traditional architecture was based on large-scale generation remotely located from consumers, hierarchical control structures with minimal feedback, limited energy storage, and passive loads. This traditional architecture is graphically illustrated in Figure 3.2.

This traditional system was not designed to meet many emerging trends, such as greater adoption of relatively low inertia generation sources, growing penetration of distributed generation resources, and the need for greater resilience. As described in several recent studies, a modern grid must be more flexible, robust, and agile.<sup>3</sup> It must have the ability to dynamically optimize grid operations and resources, rapidly detect and mitigate disturbances, integrate diverse generation sources (on both the supply and demand sides), integrate demand response and energy-efficiency resources, enable consumers to manage their electricity use and participate in markets, and provide strong protection against physical and cyber risks.<sup>4</sup> These features must be incorporated as the electric grid transitions from the traditional design to the design of the future.

**Figure 3.2** Traditional Electricity Delivery System

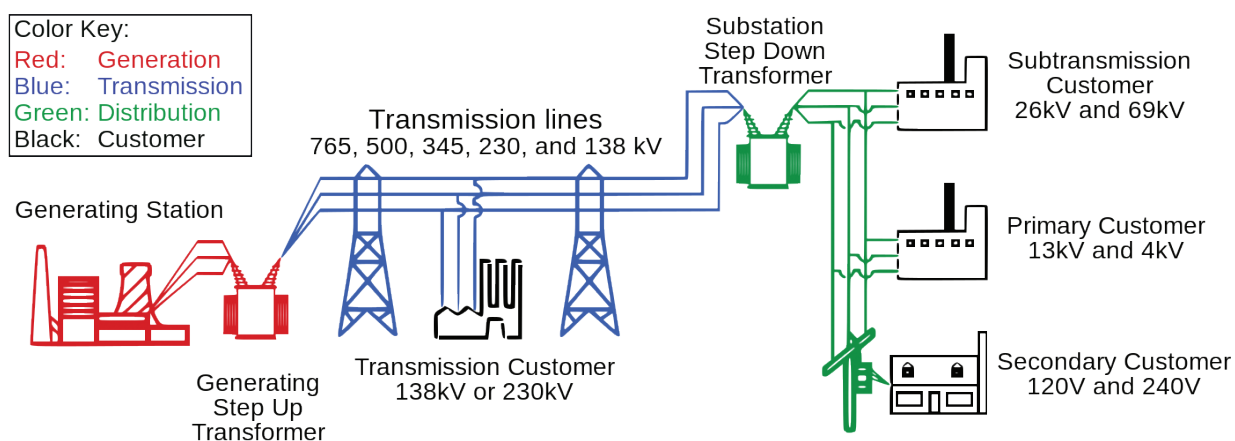

The traditional architecture was based on large-scale generation; centralized, one-way control; and passive loads.

Figure 3.3 shows an example of how the system can transform from the traditional centralized model to an integrated hybrid centralized/decentralized system with increasing communications and computing capabilities. This transition to a modern grid requires the adoption of advanced technologies, such as smart meters, automated feeder switches, fiber optic and wireless networks, storage, and other new hardware. These devices require a new communication and control layer to manage a changing mix of supply- and demand-side resources and provide new services.<sup>5</sup> New technologies for electricity delivery—along with other infrastructure improvements, capacity additions, and changes in market structures and public policies—are needed to enable safe and reliable two-way flow of both electricity and information, support growing numbers of distributed energy resources, and support growing numbers of customers participating in electricity markets as both power suppliers and demand managers.

Grid modernization must encompass the application of intelligent technologies, next-generation components with “built-in” cybersecurity protections, advanced grid modeling and applications, distributed generation, and innovative control system architectures. The Electric Power Research Institute and others estimate this will require \$338–\$476 billion of new investment (in addition to investments for reliability and replacement) over the next twenty years.<sup>6</sup> This transformation must be efficient and cost-effective to achieve a more reliable, resilient, and clean electric power sector for the United States.

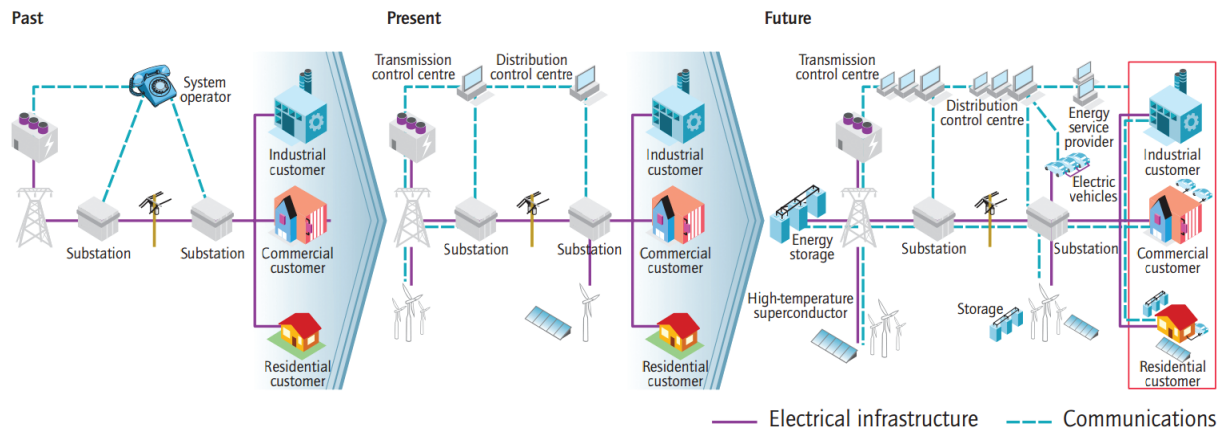
**Figure 3.3** Evolution of the Electric Power GridCredit: © OECD/IEA 2011 Technology Roadmap: Smart Grids, IEA Publishing. License: <http://www.iea.org/t&c/termsandconditions/>

The electric power grid is evolving to include more distributed control; two-way flows of electricity and information; more energy storage; and new market participants, including consumers as energy producers.

### 3.1.2 Drivers for Changes in the Electric Power System

Far-reaching changes in technologies, markets, and public policies are transforming electricity delivery. There are five key trends driving this transformation:

- Changing mix and characteristics of electricity generation sources that are shifting electricity generation from relatively few large central station plants to many smaller and sometimes variable generators
- Changing demand loads in retail electricity markets resulting from demographic and economic shifts; the adoption of more energy-efficient, end-use technologies; growing consumer participation; broader electrification; and use of electronic converters (rather than induction motors and other types of loads with favorable inertia and droop curves)<sup>7</sup>
- Integration of smart grid technologies for managing complex power systems, driven by the availability of advanced technologies that can better manage progressively challenging loads
- Growing expectations for a resilient and responsive power grid in the face of more frequent and intense weather events, cyber and physical attacks, and interdependencies with natural gas and water systems
- Aging electricity infrastructure that requires new technologies to enable better failure detection, upgrade capabilities, and improve cybersecurity

#### Changing Mix and Characteristics of Electricity Generation Sources

The nation's electric generation mix is in the midst of substantial change. From 2000 to 2013, natural gas' share of the power generation mix grew from about 16% to more than 27%, and the renewables share increased from more than 9% to about 13%, while coal's share decreased from almost 53% to about 40%.<sup>8</sup> These trends are projected to continue.

Because electricity is not easily stored, balancing authorities must continuously match electricity supply with demand on a second-by-second basis to maintain reliability. The growing penetration of variable generation resources, such as wind and solar, adds higher levels of non-dispatchable resources to the system.<sup>9</sup> With more variable generation, transmission system operators require tools and resources to maintain reliability while addressing the need for short, steep ramps; the potential for over-generation—particularly with distributed generation where curtailment is not readily achievable; and decreased frequency response. These changes require new ways for managing grid operations to increase the flexibility of the system such as expanding balancing areas, increasing the ramping capability of the generation fleet, using dispatchable demand resources, adding power flow controllers, and increasing energy storage to maintain reliability.

### Changing Demand Loads in Retail Electricity Markets

Changes in customer preferences are also affecting utility markets and electricity delivery.<sup>10</sup> For example, growing installations of more affordable rooftop photovoltaic (PV) arrays and more energy-efficient appliances, buildings, and industrial equipment, are reducing the amount of electricity needed from power companies. This is changing the traditional business models of the regulated utility industry.<sup>11</sup>

Consumers are increasingly becoming “prosumers” who both use and produce electricity. For example, the number of homes in the United States with solar PV installations has grown from 15,500 in 2004 to more than 600,000 by the end of 2014. The total generation capacity of residential PV today is about 1,460 megawatts (MW), and more than 80% of that capacity was added in the past four years.<sup>12</sup>

The use of digital electronics and computer controls in homes, offices, and factories is also on the rise, enabling the nation’s electricity consumers to operate more efficiently and expand capabilities for improving productivity and performance. Changes from purely electro-mechanical to power-electronic-based components affect power quality requirements and other aspects of grid operations. For example, in many industrial and consumer applications, induction motor loads have been replaced by variable speed drive systems. Fans, pumps, and motors—in applications ranging from sewage treatment to air conditioning—have been equipped with electronic drive systems that offer increased control, and tremendous efficiency gains. However, the electronic drive systems decouple the inertia of these motor loads from the system, preventing them from supporting the stability of the grid during disturbances.

In addition, these drive systems regulate the power delivered to the motor. When the power system voltage is declining, indicating an abnormal condition on the system, the power consumption of most system loads will decline proportionally. However, electronically coupled loads can continue to draw full power, exacerbating the abnormal condition, leading to voltage collapse.

On the horizon are prospects for growing fleets of plug-in electric vehicles that could increase electricity demand in the transportation sector, which today is fueled mostly with petroleum (92%).<sup>13</sup> If sales projections—of a compound annual growth rate of 18.6% between 2013 and 2022—are realized and continue, electric vehicle charging will be a significant new source of electricity demand. With the installation of smart meters, and the application of time-based rates, electric grid management techniques could be used to encourage off-peak charging to mitigate peak demands and avoid the need for costly capacity additions.

## Integration of Smart Grid Technologies for Managing Complex Power Systems

New digital devices and communications and control systems (often referred to as “smart grid” devices) are improving the ability of operators to monitor and manage electric transmission and distribution systems

**Figure 3.4** Spending on Smart Grid Technologies 2008-2013, with Projections to 2017

Credit: Bloomberg New Energy Finance

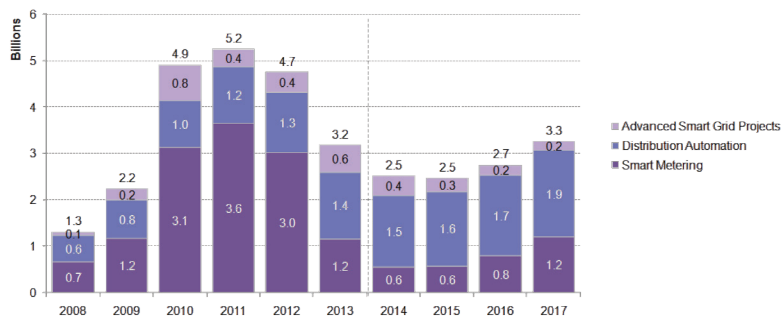

Smart grid spending spiked from 2010 to 2012, in part due to American Recovery and Reinvestment Act of 2009 (ARRA) smart grid funding, and is projected to continue steadily through 2017.

and customers. This has created challenges in managing and analyzing large volumes of data and the need to develop new tools for data management, visualization, and analytics.<sup>15</sup>

While technology advancements for monitoring the system are occurring, such as the deployment of PMU technology, further advancement is needed in the control systems, algorithms, and grid models that utilize these data.<sup>16</sup> For example, PMU technology can detect low-frequency oscillations that were missed by supervisory control and data acquisition (SCADA) systems, allowing operators to take action and prevent widespread disturbances (see Figure 3.5). However, the use of data for automated, coordinated, system-level control remains an area of research rather than practice. At the distribution level, automated controls for voltage and reactive power management technologies are now being deployed by some utilities to address power quality requirements and enhance conservation.

**Figure 3.5** Comparison between Voltage Signals from the Event as Captured by SCADA versus PMU Data for Western Electricity Coordinating Council Wind Farm Oscillations

Credit: Iknor Singh, “Synchrophasor Technology Use Cases - Wind Farm Oscillation Detection and Mitigation,” Electric Power Group, LLC (2014): Figure 3, screenshot from Phasor Grid Dynamics Analyzer.

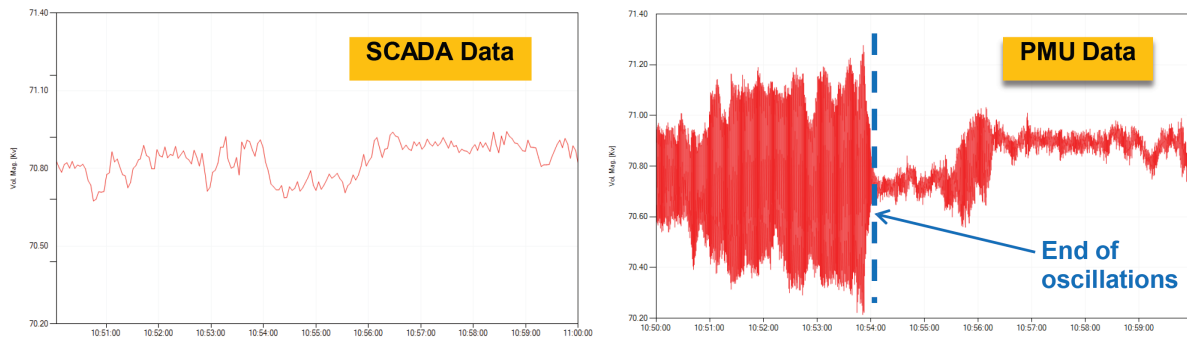

PMU data provides data at significantly shorter timescales, improving operators’ understanding of grid operations and speed in detecting potential disturbances.



## Growing Expectations for a Resilient and Responsive Power Grid

Electricity disruptions are estimated to cost the economy roughly \$80 billion or more annually and seriously endanger public health and safety.<sup>17</sup> The growing interdependence of the electricity infrastructure with other critical infrastructures (such as communications and information technology, water, fuels, and transportation) is increasing the consequences of power outages.

Natural disasters such as Hurricane Katrina and Superstorm Sandy demonstrate the overwhelming economic and human loss that results when storms devastate large areas and damage the electric power system.<sup>18</sup> Increasing weather-related outages (as demonstrated in Figure 3.6) can affect millions of people and cause economic losses of \$10 billion or more from power disruptions.<sup>19</sup> Yet, severe storms are not the only threat; sophisticated cyber attacks have emerged as a high-risk source of potential harm, requiring strong cybersecurity technologies and practices from design through implementation.<sup>20</sup>

A variety of techniques are being evaluated to address these new requirements and boost the resilience of the electric power system. For example, the development and deployment of new technologies and systems is helping utilities to reduce the frequency and duration of outages, and boost outage management capabilities that shorten restoration times when outages do occur. Microgrids, used at some hospital complexes, industrial parks, municipal areas, and universities, can be operated as an “island” when local and regional power is disrupted, and then resynchronized when power is restored. Equipment health sensors on substation transformers and other equipment can be used for preventive maintenance to reduce device failures and mitigate power outages.

### Aging Electricity Infrastructure

The traditional electricity architecture was designed for “passive” loads and communications with distributed components was not necessary. As aging infrastructure is replaced, and smart meters and other digital communication and control devices proliferate, operators will require advanced control systems and distribution management systems that can securely manage new digital technology and use the new data to inform system operations.

Currently, 70% of large power transformers and transmission lines are twenty-five years or older, and 60% of circuit breakers are thirty years or older.<sup>21</sup> A catastrophic failure of a transmission asset threatens system reliability, and changing system dynamics may increase the likelihood that this can happen. As assets are replaced, there is an opportunity to install next-generation, higher-performance components, but overall cost needs to be managed and optimized.

**Figure 3.6** Weather-Related Grid Disruptions, 2000-2012

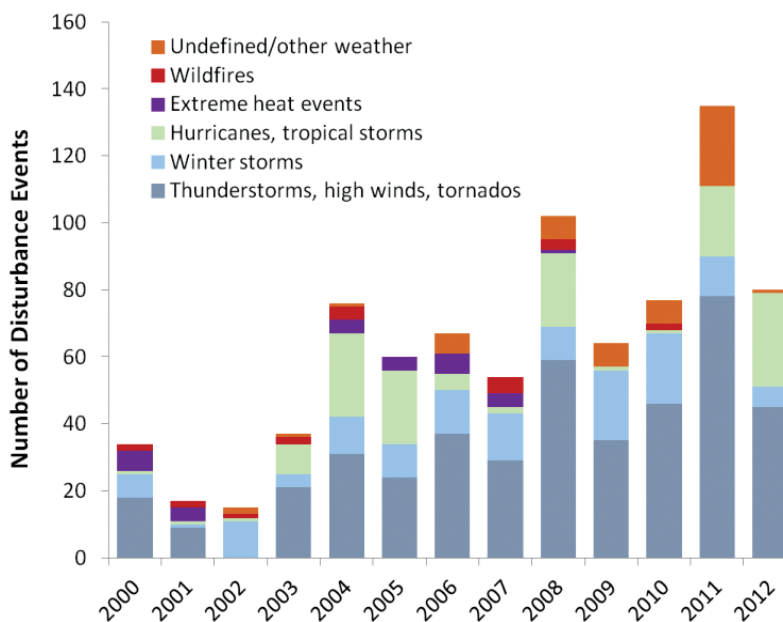

Trends show steadily increasing weather-related grid disruptions, with major disruptions every few years.

### 3.1.3 RDD&D for Modernizing the Electric Power System

The development of new technologies and investments in new infrastructure to modernize the electric power system is largely a private-sector responsibility. Utilities, power providers, consumers, and technology developers make investment decisions in complex and changing regulatory and market conditions. This may cause decision makers to seek locally optimized solutions based on regulatory and economic constraints. Through collaborative RDD&D, DOE can help to catalyze, accelerate, and facilitate the adoption of advanced technologies, tools, and techniques that will benefit the overall system.

DOE invests in grid-related energy RDD&D projects that have large societal and system-wide benefits and are too risky for the private sector to develop on its own. These projects are part of an overall strategy that complements and expands upon existing RDD&D being performed by the private sector and others. In addition, researchers at federal laboratories can help develop new ideas and concepts, promote information sharing and technology transfer, and facilitate collaborations among industry groups and academia to spur innovation and invention.

Investments in RDD&D are needed to help accelerate grid modernization for several reasons:

- **National security:** While the private sector has the primary responsibility for developing, building, and operating the nation's electric power system, electricity is critical to commerce and society; any sustained outage can jeopardize human health and safety, as well as national security. Critical infrastructure protection and resilience are a shared public-private responsibility. DOE investments in cyber- and physical-security RDD&D can help develop innovative solutions to mitigate systemic vulnerabilities, enhance overall national security, and reduce economic impact of major disruptions.
- **Infrastructure resilience:** Electricity outages are increasing due to climate change-influenced effects such as severe weather events and rising sea-water levels. However, the uncertainty regarding these risks and other factors has resulted in little private sector investment.
- **Clean energy goals:** While the transformation of the electric power system may be gradual, federal investments could help align and accelerate the transition to meet national goals. Advanced technology options are needed to address the increased complexity and faster system dynamics, especially as the dependence on variable and distributed generation grows. Seamless integration of advanced technologies will also require the convening power of the federal government to ensure interoperability across different regulatory structures and organizational boundaries.
- **Catalyzing private-sector innovation:** The development and now widespread U.S. adoption of synchrophasor technologies for wide-area situational awareness is an example of DOE RDD&D investments catalyzing private sector investment and innovation that would not have happened without DOE support. DOE electricity R&D investments focus on technologies with insufficient private sector investment, but which could produce large public benefits if successfully commercialized.

Building a robust and resilient system as the transformation takes place, rather than a piecemeal approach, helps ensure that we effectively address national challenges.

Large-scale changes in electricity generation, demand, and customer roles are creating technical challenges for the U.S. electric power system that will require new technologies and capabilities. Both the transmission and distribution system, and the underlying grid architecture, will require transformational changes to address emerging technical issues.

## 3.2 Technical Issues Underpinning Grid Modernization

The United States is facing shifting patterns of energy supply and demand, changing operational and market environments, and an evolving risk environment, as discussed in Section 3.1. The complex infrastructure and long-established technical approaches to managing the grid make adapting to the changing environment challenging. This section outlines the component structures of the grid and the related technical challenges.

### 3.2.1 Transmission System

The bulk transmission system is the backbone of the electric grid and has historically provided the opportunity for economies of scale in generation plants to provide low-cost electricity. This network of high-voltage lines (more than 100 kilovolts) connects large-scale generators to distribution. The rapidly changing generation mix is producing power flows that are different than what the network was built to accommodate. This leads to system congestion that costs rate-payers billions of dollars every year. Over the last decade, annual congestion costs ranged between \$529 million and more than \$2 billion in PJM, the largest system operator in the United States.<sup>22</sup>

The August 14, 2003 Northeast Blackout highlights the extent to which the power system has become interconnected over time. The outage affected an estimated fifty million people and 61,800 MW of electric load. In some parts of the United States, electrical power was not restored for four days, affecting nearly all aspects of modern life.<sup>23</sup> The event demonstrated the need for reliability-related software tools to improve wide-area, real-time situational awareness, as well as more effective use of system protection measures.

Phase-angle separation is an indicator of grid stress, and can be detected using PMUs. Figure 3.7 shows the phase-angle separation that occurred shortly before the 2003 blackout, and what the operators could have observed had the technology been in place at that time. These measurements indicate the health of the power system.<sup>24</sup> They form the foundation for advanced applications, such as wide-area situational awareness and state estimation, system dynamics monitoring, system model validation, and in the near future, automated response-based controls.

**Figure 3.7** Example of Analysis using Synchrophasor Data: August 14, 2003 Blackout

Credit: North American Electric Reliability Corporation

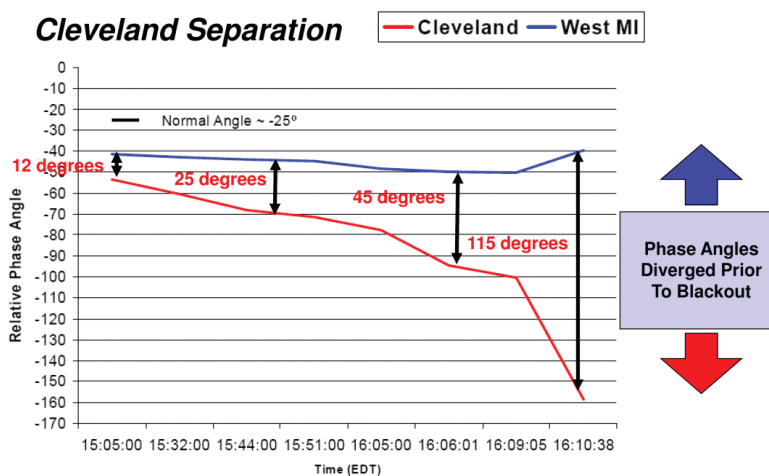

Note: Angles are based on data from blackout investigation. Angle reference is Browns Ferry.

Operators may have detected the phase-angle separation that preceded the 2003 blackout had PMU technology been in place.

Under the American Recovery and Reinvestment Act (ARRA) of 2009, DOE supported the deployment of more than 1,300 PMUs across the nation—over a fivefold increase of the previously installed base. Without a sufficient density of PMUs, monitoring the emerging wide-area system dynamics would not be possible and thus, control of the entire grid could remain inadequate. One of the challenges for utilities today is that they may not have an adequate amount of sensor installations, and thus may not be able to observe their entire network.

The September 8, 2011 Southwest Blackout illustrates the need to link “real-time” situational awareness tools with “faster-than-real-time” or predictive analytical capabilities to evaluate potential risks and contingencies. It also highlights the limits to the speed at which humans can respond to a disturbance to manually execute mitigating actions. A system disturbance occurred in the Pacific Southwest, leading to cascading outages that left approximately 2.7 million customers without power, some for up to twelve hours.<sup>25</sup>

The 2011 Southwest Blackout disturbance is demonstrated by the sequence of events in Figure 3.8. When the event interval is less than the ability to respond, there is a cascading effect. This means that the region of impact from the disturbance could be expanding. It illustrates the intensity and changing state of the system, to which the operators must understand and respond. While data may arrive every two to four seconds, calculations depicting the state of the system and possible contingencies can take minutes or hours to assess. In the case of severe disturbances, the electric power system could transition to an unstable state within seconds, making it extremely challenging for operators to act without decision support capabilities or well-aligned planning analysis based on fast state estimation.

**Figure 3.8** Illustrative Sequence of Cascading Events in the 2011 Southwest Blackout

Credit: Pacific Northwest National Laboratory

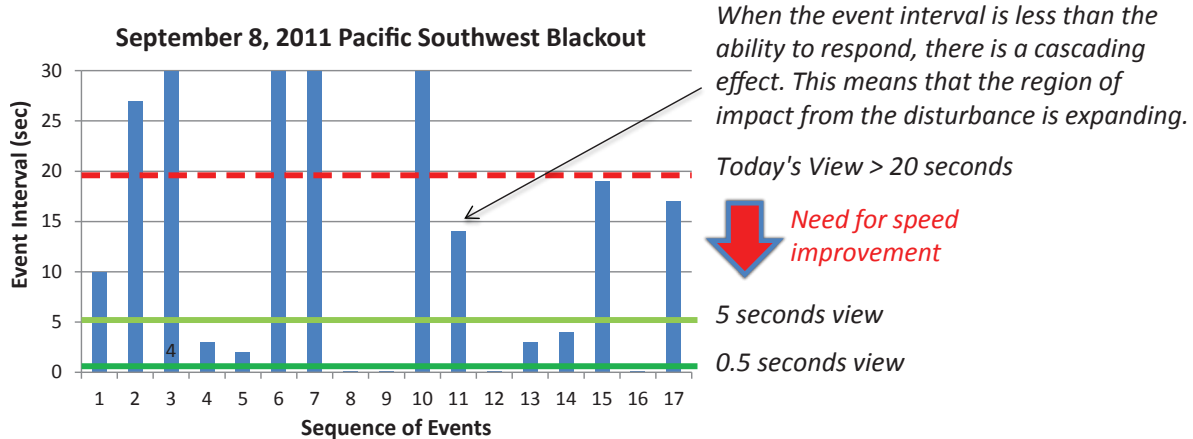

Many of the cascading events occurred in intervals of less than twenty seconds and some in intervals of less than five seconds, R&D is needed to perform state estimation in less than one second to allow operators the ability to detect and respond to cascading events.

The transition from traditional to modern electric transmission systems has been accelerated by public and private investments under the ARRA Smart Grid program. With the deployment of more than 1,300 networked PMUs, as noted above (contributing to a total of more than 1,800 now deployed throughout the North American network),<sup>26</sup> grid operators across the country now have greater visibility into system conditions. Tools are being developed to use synchrophasor data for grid planning and operations.<sup>27</sup> Over time, using these data to improve capabilities for managing power flows and addressing faults will help prevent minor disturbances from cascading into regional outages.

**Figure 3.9** California ISO Projected Electricity Supply

Credit: California Independent System Operator Corporation

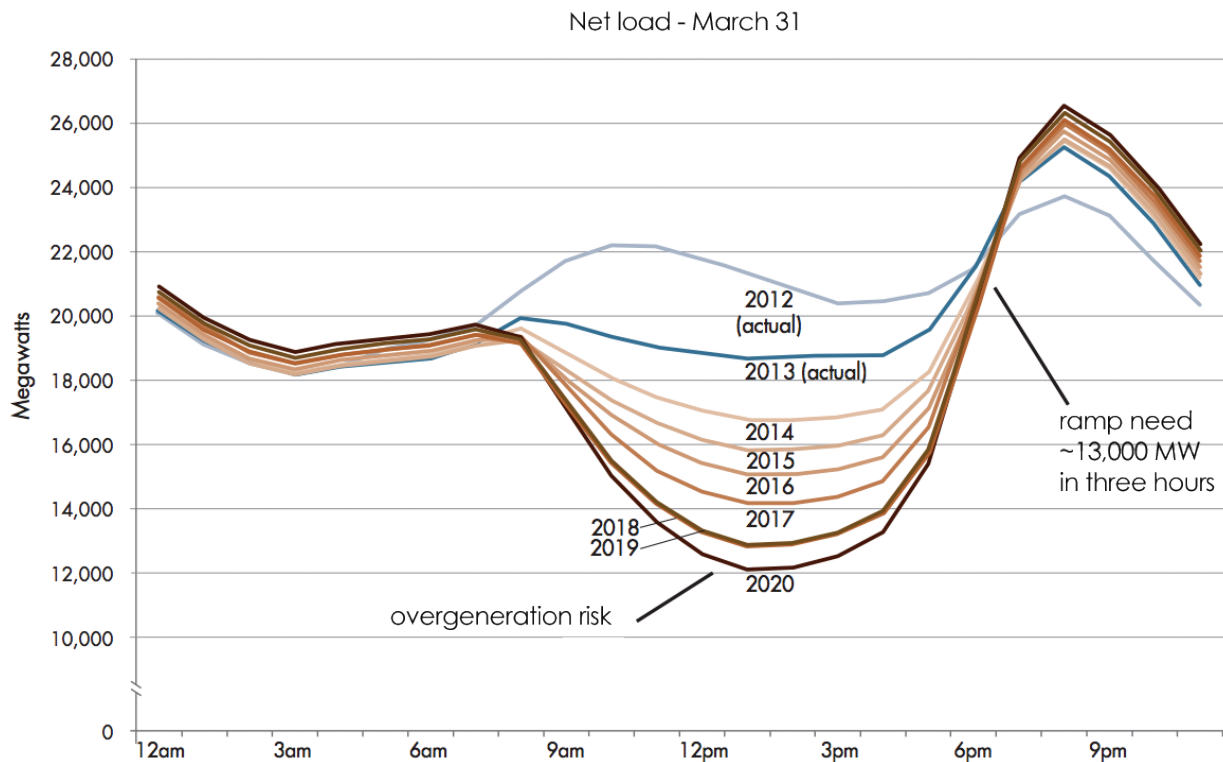

In projected scenarios, variable renewable generation is plentiful midday, but decreases just as energy demand spikes in the early evening—requiring increased system flexibility to meet challenges with steep ramps and over-generation risks. Note the offset of the vertical scale.

New operating conditions are also emerging with the addition of renewable power, distributed generation, and energy storage at the transmission and distribution levels, as well as changing load characteristics. The “duck curve” (see Figure 3.9) illustrates the emerging conditions, including short, steep ramps; over-generation risk; and decreased frequency response.<sup>28</sup>

### 3.2.2 Distribution System

The distribution system, from distribution substations down to customers, was originally designed to be relatively passive. Typical distribution systems deliver electricity using distribution feeders and radial lines with control equipment operated through timed set points. While this design paradigm is sufficient to provide customers with basic, reliable electrical service at affordable costs, it cannot meet today’s needs for greater resilience, power quality, and consumer participation. Industry estimates show that approximately 90% of outage minutes originate on the distribution system. Because of the large number of connections (e.g., 145 million customers and 6.3 million miles of distribution lines), it is also often the most expensive part of the electricity delivery system and most difficult to upgrade.

New distributed energy technologies have been developed and demonstrated and are increasingly being connected to the grid. These include high-efficiency reciprocating engines, wind generators, plug-in electric vehicles, PV systems, micro-turbines, fuel cells, and energy storage systems. Ongoing improvements in

interconnection standards (e.g., IEEE Standard 1547) are defining the requirements that these technologies must meet for safe and reliable integration with utility electrical networks. These standards address issues such as power quality, voltage limits, and operating behavior to ensure that new technologies do not jeopardize the safety or reliability of the electric power system. Some interconnection cases require engineering studies, computer simulations, and the addition of new hardware and protective devices to ensure continued system operation and reliability.

To ensure line voltages remain within limits throughout the day, voltage regulation equipment with simple control set points and fixed schedules are used. This control paradigm is based on local sensors, electro-mechanical devices, and “static” intelligence achieved through engineering analysis of predictable loads. Advances in distribution automation technologies can improve system performance. Additionally, current system protection is achieved through fuses, breakers, and relays, while outages are located typically based on customer calls. This protection and outage management paradigm will also need to evolve using smart technologies.

As energy technologies advance and become more affordable, from distributed generation to home energy management systems, customers will have the ability to better manage their energy use and produce their own electricity. Enabling customers to become active participants in electric power system operations and energy exchanges will require a fundamental shift in how the distribution system is designed, controlled, and protected. Maintaining reliability, power quality, and safety in this new operating environment will require new and improved capabilities.

The transition from traditional to modern electric distribution systems using smart grid technologies is under way, but efforts are in the very earliest stages of development and deployment. DOE’s Smart Grid Investment Grants helped install thousands of automated feeder switches and capacitor banks, along with power line and equipment health sensors. These devices have shown the potential to enable fewer and shorter outages, and reduce energy requirements by using automated controls for voltage and reactive power management.<sup>29</sup> New tools and techniques are now needed to integrate and operate these devices through modernized distribution management systems.

### 3.2.3 Grid Architecture

The architecture of the grid will need to transform as the modernization process progresses. The characteristics of the future grid will be distinctly different from those of the current system (see Figure 3.10). This transformation is an enormous undertaking for utilities, regulators, consumers, manufacturers, and other electric power industry stakeholders.

Grid architecture design provides the “structure” of the grid and thereby determines the essential bounds on what can and cannot be done within that framework. It is essential to recognize what these bounds

**Figure 3.10** Comparison of Key Attributes of Current and Future Systems

Current System	Future Paradigm
<ul style="list-style-type: none"> <li>• Monolithic</li> <li>• Centralized generation</li> <li>• Decisions driven by cost</li> <li>• Vulnerable to catastrophic events</li> <li>• Limited energy choices</li> <li>• Vulnerable to new threats</li> </ul>	<ul style="list-style-type: none"> <li>• Modular and agile</li> <li>• Centralized and distributed generation</li> <li>• Decisions driven by cost and environmental sustainability</li> <li>• Contained events</li> <li>• Personalized energy options</li> <li>• Inherently secure against threats</li> </ul>

are, to change them where necessary, and to understand the interactions and consequences of the various grid structures. The discipline of grid architecture provides a modern set of methods to assist in thinking about grid complexities, to aid in understanding interactions and technical gaps, to enable new capabilities and remove old unnecessary limits, and

**Figure 3.11** Grid Architecture Structure Types

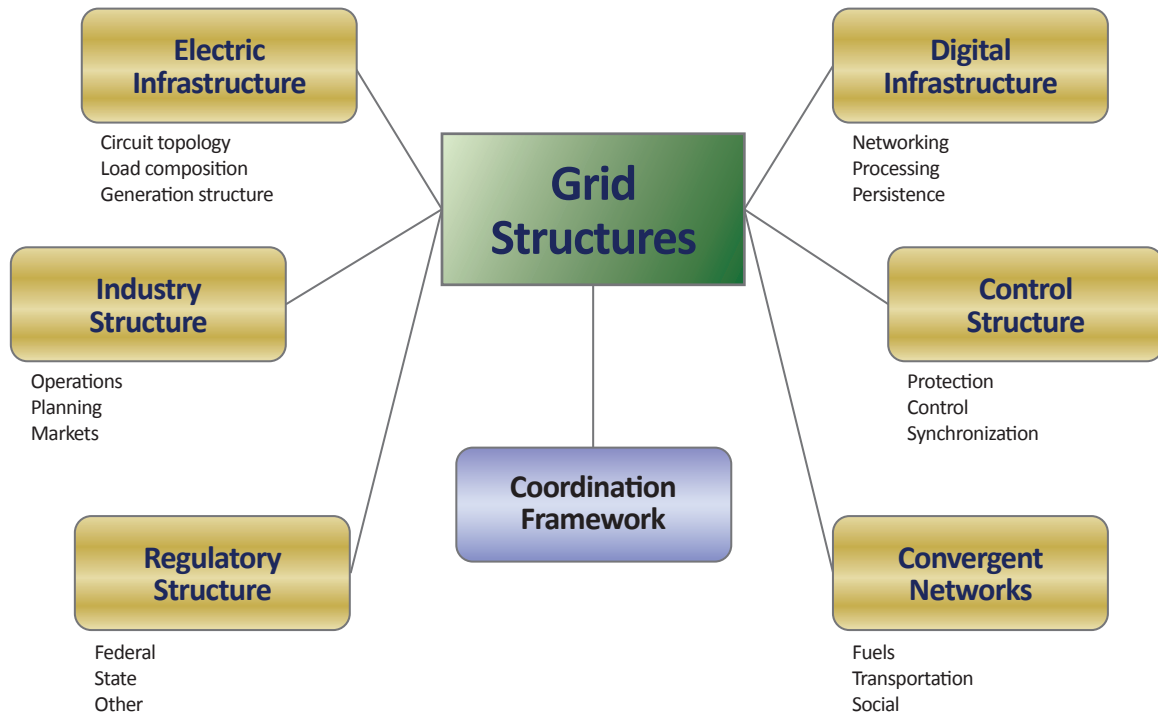

The grid can be viewed as six interrelated structures and a coordination framework to understand the needs and requirements necessary to meet the performance expectations of a digital economy.

to support communication among stakeholders. Actions to develop this modern grid architecture include the coordinated advancement of standards across the electric power system, including device characteristics, communications requirements, security, and other system aspects.

Figure 3.11 outlines the various structures that the grid needs to relate to in order to provide the maximum flexibility to satisfy the required performance expectations.

The structures of the grid are already changing, requiring broader changes across the system. This, in addition to the move toward enabling prosumer participation and interaction with the grid—especially in commercial buildings, is also leading to issues in managing reliability at the distribution level and coordinating large numbers of devices and systems outside of the utility’s domain.

Consequently, the definitions of roles and responsibilities at the distribution level are changing, leading to both regulatory and industry changes. These changes will affect the design of key technologies such as protection and control systems and information and communications technology systems. At the same time, in some parts of the country, electric power systems are converging with natural gas systems, electric transportation systems, and social networks—which all impact grid control and communication. Energy storage may help to balance supply and demand and better integrate a changing generation mix, but will require a control architecture that optimally integrates storage as a resource. Critical changes are needed in the structure of controls systems, coordination frameworks, communications, and overall industry structure. It is critical that these changes be viewed, understood, rearchitected, and managed simultaneously, as these systems are deeply interconnected.

Figure 3.12 Fundamental Changes in Power System Characteristics

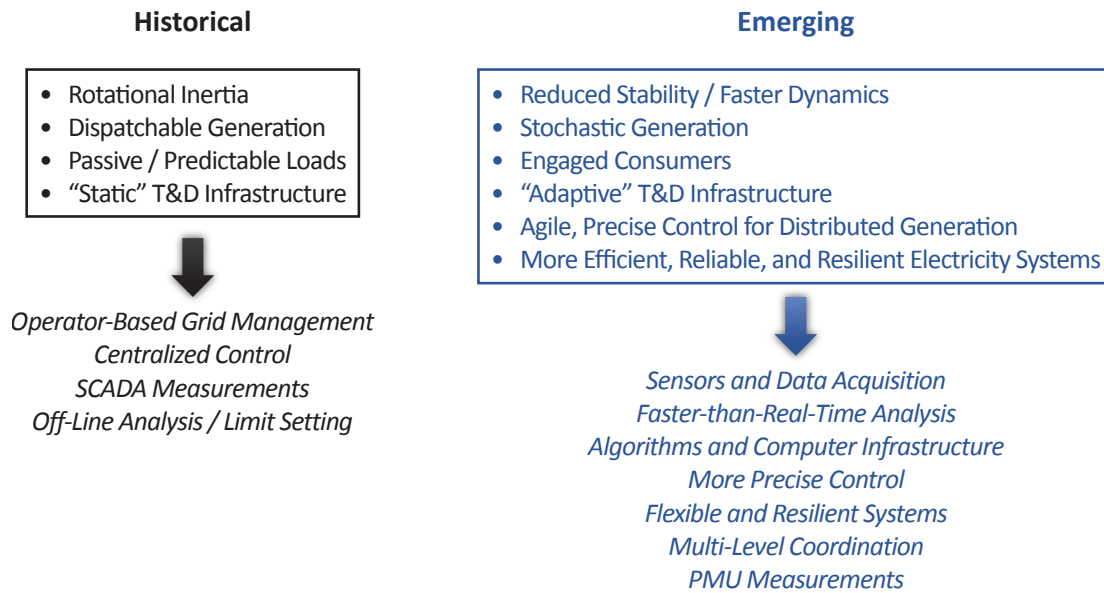

### 3.2.4 Moving Toward a Modern Electric Power System

The changing grid environment not only places new requirements on electric power systems, but also changes their intrinsic behavior (see Figure 3.12). Simply put, as generator and load characteristics change, the operational performance of the broader power system will be affected. Understanding these operational characteristics is integral to identifying the RDD&D needed for modern power systems.

**More precise control of the electric power system is needed to manage the changing generation mix.** Lower natural gas prices have increased the adoption of typically lightweight, fuel-efficient, and fast-responding natural gas generation, while some coal-fired plants have retired.<sup>30</sup> In addition, economics and policy have driven the adoption of renewables on both the transmission and distribution system. This shift from large, synchronous units to a mixture of lightweight, variable, and non-synchronous generators, along with changing load, has affected the rotating mass (i.e., inertial response) used to help balance and stabilize the power system in response to transient effects that can follow a sudden loss of generation or a transmission line.<sup>31</sup> If load and generation are not balanced, it spontaneously creates system stability issues.

**More rapid and precise control improves stability and aids in the transition to a more resilient system with refined margins.**<sup>32</sup> As the power system evolved, significant operating margins and sufficient redundancy were added to address uncertainty and reduce the risk of outage. The operating context has now changed, and the use of larger operating margins and reserves to reduce this risk may not be practical or cost effective. Events that were once uncommon now occur more frequently and can be potentially significant, due in part to variable renewables and changing load characteristics that are having a greater impact on power system behavior. Research into new risk-management strategies, along with control and planning approaches, are needed to reduce reserve margins while improving reliability and economics.



**Changing demand is also altering the behavior of the power system.** Residential, commercial, and industrial customers are becoming more involved in managing and generating electricity. Three interrelated and complementary factors contribute to this growing trend

- The increased availability of digital and control technologies
- State policies that encourage and incentivize the deployment of energy-efficiency practices and renewable energy technologies (distributed energy resources)
- Growing concerns regarding reliability, resilience, and security

**Increased use of distributed energy resources and smart controls in end-use devices provides opportunities for increased efficiency and management of contingencies or other events for improved reliability.** However, it also requires new levels of data communication and coordination deployed down through the distribution system and to the end user. Advanced metering infrastructure (AMI) technology, including interval meters, communications networks, and data management systems, are becoming more affordable and widespread. It is estimated that there will be more than sixty-five million smart meters deployed nationally in 2015.<sup>33</sup> Smart meters provide information that can help customers better manage their consumption of energy, with access to that data dramatically enhanced as a result of the Green Button Initiative. Deploying AMI with residential customer technologies, such as programmable communicating thermostats, coupled with variable, time-based rates can reduce electricity demand during peak periods, resulting in more efficient use of transmission and distribution assets. In one case, Oklahoma Gas & Electric observed up to 30% peak demand reduction for customers enrolled in its variable rate program.<sup>34</sup>

Table 3.1 summarizes key characteristics of traditional and modern electric power systems and shows the RDD&D needs for accomplishing electric grid modernization in a timely, efficient, and cost-effective manner. This table is a result of extensive collaboration between the public and private sectors. Over the last several years, DOE has conducted more than sixty workshops, peer reviews, requests for information, and other outreach mechanisms to better understand the issues and needs facing the private sector, states, and local and tribal communities in building, operating, and maintaining a reliable electric power system.

The table represents only high-level categories of needs, and the relative importance of factors will vary significantly as a result of unique local and regional conditions and environmental and economic constraints. There are significant technical challenges to address, including the need for better-performing and lower-cost technologies, tools, and techniques. A robust national RDD&D portfolio is essential for success.

### 3.3 RDD&D Needs to Modernize the Electric Power System

The transition to a modern grid will create new technical challenges for an electric power system that was not designed for today's requirements. Customers have never relied more on electricity, nor been so involved in where and how it is generated, stored, and used. Utilities will continue retrofitting the existing infrastructure with smart digital devices and communication technologies needed to enable the highly distributed, two-way flow of information and energy. Reliability, resilience, and security will remain a top priority as aging infrastructure and changing demand, supply, and market structures create new operational challenges. The drivers discussed in Section 3.1 and the technical issues in Section 3.2 create not only challenges but opportunities to advance the capabilities of today's electricity delivery system. Grid modernization requires a coordinated, well-considered RDD&D program that involves both the public and private sectors. The following subsections outline RDD&D needs for control systems, transmission and distribution components, distributed energy resources, electric energy storage, planning tools, and physical- and cybersecurity.

**Table 3.1** Moving from Traditional to Modern Electric Power Systems—RDD&D Needs

Electric systems	Characteristics		RDD&D needs
	Traditional	Modern	
Generation	<ul style="list-style-type: none"> <li>■ Centralized</li> <li>■ Dispatchable</li> <li>■ Large thermal plants</li> <li>■ Mechanically coupled</li> </ul>	<ul style="list-style-type: none"> <li>■ Centralized and distributed</li> <li>■ More stochastic</li> <li>■ Efficient and flexible units</li> <li>■ Electronically coupled</li> </ul>	<ul style="list-style-type: none"> <li>■ Planning tools</li> <li>■ Energy storage</li> <li>■ Control coordination</li> <li>■ Flexible thermal generators</li> </ul>
Transmission	<ul style="list-style-type: none"> <li>■ SCADA for status visibility (sampling, not high definition)</li> <li>■ Operator-based controls (primarily load following and balancing)</li> <li>■ Destabilizing effects</li> <li>■ Congestion, despite underutilized capacity (limited flow control)</li> <li>■ Threats/vulnerabilities not well defined</li> </ul>	<ul style="list-style-type: none"> <li>■ High-fidelity, time-synchronized measurements</li> <li>■ Breadth and depth in visibility</li> <li>■ Automatic control</li> <li>■ Switchable network relieves capacity constraints</li> <li>■ Threats are considered and risks are appropriately managed</li> </ul>	<ul style="list-style-type: none"> <li>■ Multi-terminal, high-voltage direct current</li> <li>■ Low-cost power flow controller technologies</li> <li>■ Next-generation energy management systems (EMS)</li> <li>■ Integrated planning tools</li> <li>■ Security</li> <li>■ Low-cost bulk storage</li> </ul>
Distribution	<ul style="list-style-type: none"> <li>■ Limited visibility</li> <li>■ Limited controllability</li> <li>■ Radial design (one-way flow)</li> <li>■ Floating on transmission</li> <li>■ Increasing fault currents and voltage issues stressing system</li> <li>■ Aging assets (unknown effects)</li> </ul>	<ul style="list-style-type: none"> <li>■ Enhanced observability</li> <li>■ Local, autonomous coordination</li> <li>■ Network design and two-way flow</li> <li>■ Backbone of delivery system</li> <li>■ Self-healing</li> <li>■ Active monitoring of asset conditions</li> </ul>	<ul style="list-style-type: none"> <li>■ Security</li> <li>■ Microgrids</li> <li>■ Advanced distribution management systems</li> <li>■ Distribution and asset sensors</li> <li>■ Solid-state transformer</li> <li>■ Smart voltage regulation equipment</li> <li>■ Community storage</li> </ul>
Customers	<ul style="list-style-type: none"> <li>■ Uniformly high reliability, but insensitive to upstream issues</li> <li>■ Energy consumers (kilowatt hour)</li> <li>■ Predictable behavior based on historical needs and weather</li> <li>■ Interconnection without integration</li> <li>■ Growing intolerance to sustained outages</li> </ul>	<ul style="list-style-type: none"> <li>■ Customer-determined reliability/power quality</li> <li>■ Prosumers (integrated)</li> <li>■ Variable behavior and technology adoption patterns</li> <li>■ Plug/play functionality</li> <li>■ Kept informed during outages (and before)</li> <li>■ Hybrid alternating current/direct current distribution</li> <li>■ Data access (outage/usage)</li> </ul>	<ul style="list-style-type: none"> <li>■ Single-customer microgrids</li> <li>■ Building EMS</li> <li>■ Distributed energy resource integration</li> <li>■ Security</li> <li>■ Transactive controls</li> <li>■ Behind-the-meter storage</li> <li>■ Low-cost sensors</li> </ul>

### 3.3.1 Control Systems—Transmission and Distribution

Evolving system-level challenges underscore the need for a new class of monitoring, control, and analytic capabilities. These challenges include the integration of large amounts of variable generation at both transmission and distribution levels, increased susceptibility of the system to destabilizing events, and rapidly

developing security issues. In the last few years, parallel computing techniques, inexpensive high-speed communications, advanced modeling frameworks, and wide-area coordination mechanisms have become available, and together hold the promise for faster simulation methods and more robust control approaches necessary for operating modern grid systems.

### Control Systems—Transmission

Traditional monitoring and control approaches are no longer sufficient to meet evolving needs for observability and controllability. A modern power system requires dynamic and wide-area view, fast and predictive analytics, and system-wide coordination. Table 3.2 summarizes some of these key distinctions between traditional and modern transmission system control.

**Table 3.2** Key Monitoring and Control Attributes for the Evolving Power System

Traditional		Modern	
Observability	Controllability	Observability	Controllability
<p><b>Static, slow, and local view:</b> Weather, flows on key lines, voltages on key buses, tie flows, line status, generator status, real-power output, and predictable seasonal flow patterns</p>	<p><b>Reactive (deterministic), high-level control:</b> Balancing and load following, discretized demand response, and transmission limit determination based on simulation studies  <b>[Eliminate and/or avoid risk]</b></p>	<p><b>Dynamic, fast, and global perspective:</b> Resource forecasts, interdependencies, grid stress, grid robustness, dangerous oscillations, frequency instability, voltage instability, reliability margin, and field asset information</p>	<p><b>Predictive (probabilistic), system-wide coordination:</b> Generator coordination (dispatch and control), topology and flow control, and demand-side coordination  <b>[Manage risk]</b></p>

### Dynamic and Wide-Area View

Grid measurements from a robust network of PMUs can be used to indicate the health of the power system.<sup>35</sup> They form the foundation for advanced applications, such as wide-area situational awareness and state estimation, system dynamics monitoring, and system model validation. Communications networks (see Figure 3.13<sup>36</sup>) of varying technologies and speeds are used to transmit synchronized phasor (or synchrophasor) measurement data from the PMUs to operations centers, where the information is displayed to help operators understand grid conditions. The primary need now is for advanced software tools and platforms that can fully make use of the vast amount of information available from PMUs.

Synchrophasor data can help facilitate the integration of renewable energy into the power system.<sup>37</sup> Variable generation can cause undesirable fluctuations in system frequency if not managed properly. Real-time monitoring of the grid’s frequency with PMUs enables operators to closely monitor system conditions and take appropriate actions to maintain stability.<sup>38</sup>

To accommodate variable generation, operators must ensure that there is sufficient flexibility in the rest of the system to keep the system in balance. System flexibility can come from a number of sources, including spinning reserves, existing generator ramping capability, power flows between balancing areas, demand response, energy storage, and distributed energy resources. This highlights the need for the emerging controls approach to ensure an adequate amount of sensors are deployed along with an ability to coordinate resources across the entire power system.

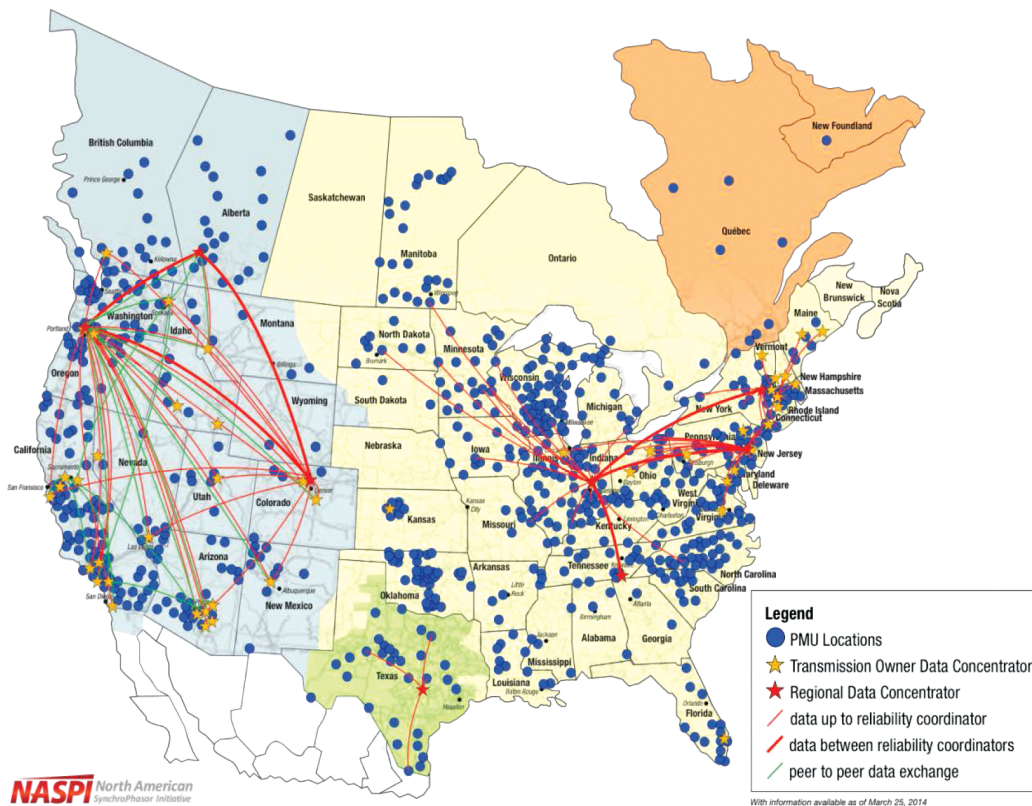
**Figure 3.13** Data Flows from Transmission Owners to Regional Hubs, Between Reliability Coordinators, and Between Transmission Operators

Thousands of networked PMUs now exist across the United States and Canada, sharing operational data across wide interconnections.

### Fast and Predictive Analytics

The need for fast and predictive analytics is further amplified by security events such as a physical attack or cyber assault on critical infrastructure. This includes links to “real-time” situational awareness tools for evaluating potential risks and contingencies (see Figure 3.14). The time it takes to analyze the situation, make a decision, and perform the system change must be faster than the interval to the next event. In the emerging operational environment of electricity delivery systems, security and observability are closely coupled. “Real-time” monitoring, analytics, and control—built on a strong foundation of measurements and models—are one key step toward detection and mitigation of these unprecedented security challenges.

The models that are essential to enhancing the operators’ understanding of system conditions and addressing situations (when complete measurement information is not available) are not developed enough to capture the emerging behavior. The visibility enabled by the new PMU infrastructure allows operators to see things they could not see before. However, there is a need to develop a cognitive model for operator behavior that captures the decision process from the human’s point of view. This forms the basis for visualization and intelligent alarming so that the operator is not overwhelmed with information, and can easily ascertain the source of the problem (and effective mitigation approaches, as appropriate).

Accelerating the analysis run time through algorithmic parallelization and model reduction/relaxation has been successfully demonstrated in the laboratory setting and holds promise for more robust control approaches and the scalability needed for future grid energy management systems. However, these time benefits are still

**Figure 3.14** Pathway to Speed Improvements in Analytical Decision Making

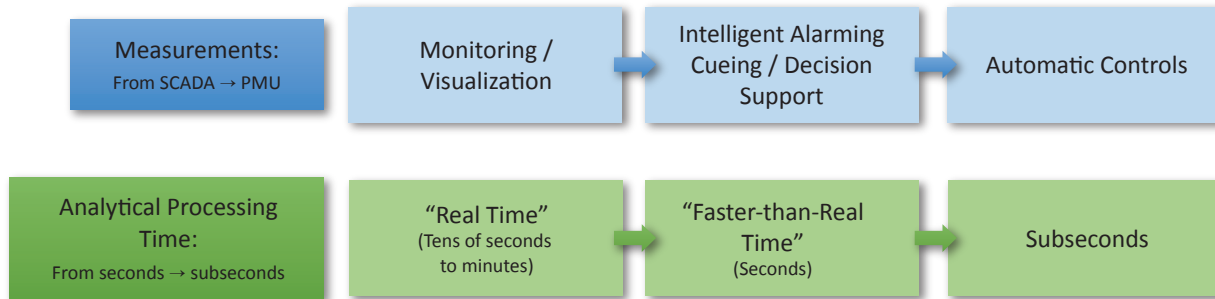

As measurement technologies improve, the analytical processing time also needs to be reduced, from tens of seconds to subseconds, to move from monitoring and visualization to automated controls.

constrained by the operator's ability to visualize and respond to the event, typically on the order of tens of seconds or minutes. In the near future, as the system complexity continues to grow, automated control becomes essential. This will extend to protective systems that look at coordination across the system.

### System-Wide Coordination

The traditional operating philosophy and deterministic N-1 reliability criterion—that the system must be able to tolerate the outage of any single component—may be inadequate to meet reliability and resilience objectives in this new environment. System flexibility provides the capability to manage dynamic conditions, and can come from a number of sources. The emerging control system must coordinate resources across the entire system, from load to balancing area. Broad coordination adds complexity, expands the number of control actions to be considered, and further reinforces the need for enhanced scalable functionality to support decision making. This coordination extends to operations planning—unit commitment, fuel scheduling, interchange scheduling, day-ahead markets—and the optimization algorithms, models, and tools needed for these functions. In the near future, operators will no longer be constrained to the generator, including load frequency control and economic dispatch, as a primary means to balance the broader power system. Connectivity to the distribution network, as well as to the consumer through smart appliances and demand-response programs, will expand the options available to achieve reliability and complement the benefits of interregional transmission capacity.

### Control Systems—Distribution

#### *Deep and Comprehensive Visibility*

Currently, most distribution system operators have limited visibility into the conditions and state of the system, except for assets at a distribution substation. However, many utilities can monitor assets along the distribution feeders and control switches remotely after disturbances. As more distributed energy resources are deployed, visibility deep into the system (e.g., along a feeder to a utility meter and possibly beyond) will be needed to ensure reliability and power quality, as well as to enable advanced applications. The installation of approximately 50 million smart meters, covering 43% of U.S. homes, has been a tremendous advancement in improving distribution visibility and helping identify customer outages before customers call to complain. However, phenomena associated with system dynamics and protection require fast, high-resolution sensors that can inform operations on the order of milliseconds (see Figure 3.15), which outlines fault clearing duration for various protective devices.

**Figure 3.15** Times Associated with Clearing a Fault (URCI = Universal Remote Circuit Interrupter)<sup>39</sup>

Credit: Southern California Edison Company

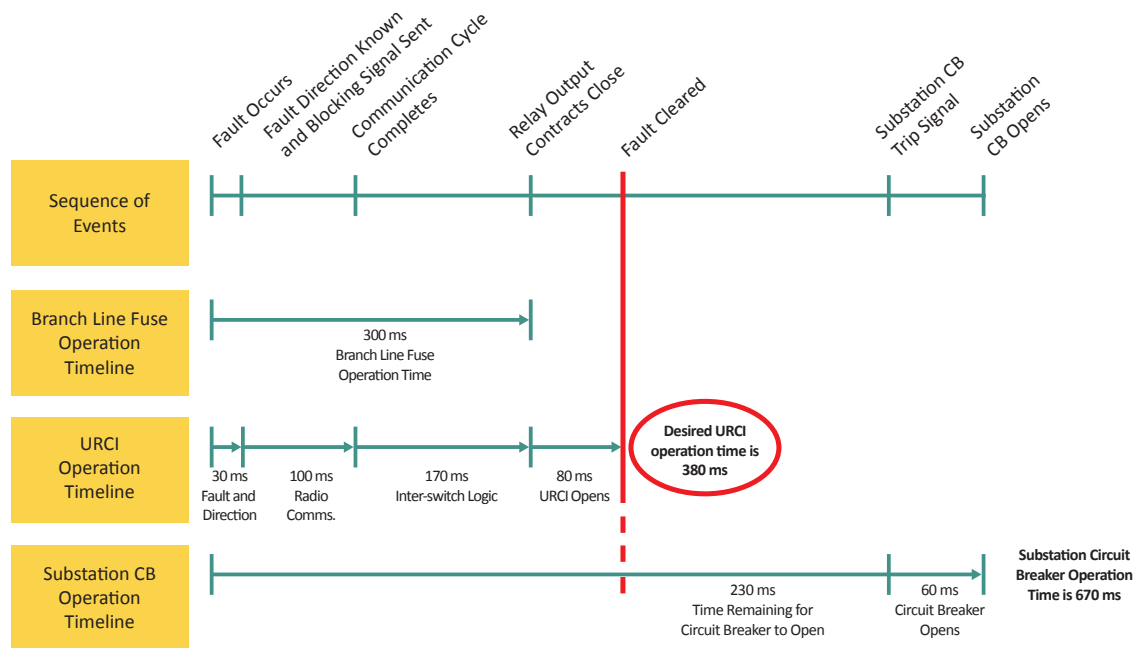

High-resolution sensors are needed, as system protection and fault clearing require action to be taken in milliseconds.

Because of the size of the distribution system, high-resolution sensors will need to be low cost for broad deployment. Micro-synchrophasors, or distribution PMUs, are one technology that can provide the enhanced visibility needed for the future grid. Other technologies include sensors that provide configuration and/or real-time condition information on field assets. Advanced applications using the sensor data can help map and update the topology of distribution systems, determine asset health, enable “real-time” distribution operations, strengthen the physical-cyber posture, and accelerate post-event recovery. It is also necessary to ensure that secure and low-latency communication channels (e.g., private or public) are available to handle the new data streams. Communications and data management requirements such as transfer rates, latency, accuracy, and storage must link to applications.

#### *Distribution Automation and Outage Management*

Utilities are adopting information and communication technologies to optimize operations and support decision making to improve system performance. Coupling high-resolution data streams with computational advances will enable faster, predictive capabilities. As the distribution system becomes more complex with more points of control and load becomes less predictable, new technologies and tools will be needed to help operators interpret data, visualize information, predict conditions, and make better and faster control actions to ensure reliability and safety.

Fault location isolation and service restoration, or “self-healing,” is an application that combines automated feeder switches with either distributed or centralized intelligence to clear faults and improve system reliability. Another application of distribution automation is Volt/volt-ampere-reactive optimization (VVO). Measurement data are coupled with intelligence to actively control distribution devices to meet the reactive power needs of loads while maintaining voltage limits to improve power quality. Conservation voltage reduction, an extension of VVO, has been demonstrated to improve system efficiency. By optimizing the voltage, it is possible to reduce

energy consumption by 5%–10% and achieve peak power reductions from 1.0%–2.5%.<sup>40</sup> Future opportunities include integrating distributed energy resources, such as smart loads, smart buildings, microgrids, and other technologies, for VVO and advanced applications.

### Coordination and Control of Distributed Resources

Demand-response programs have been offered by utilities since the 1970s to reduce peak loads during times of system stress and to keep monthly demand charges down. The coordination and control of these resources was managed by the utility through direct control or voluntary requests to certain customers for a financial incentive. Connectivity and integration of distributed resources with system operations poses significant challenges.

The potential orders of magnitude increase in points of control introduced by customer participation is shown in Table 3.3. Recent experiences with the aggregation of demand response resources into electricity market structures presents a potential framework for coordination of distributed energy resources. However, the physical constraints imposed by current distribution system designs will require careful consideration of safety, reliability, and power quality implications. The coordination and control of distributed resources will be highly dependent on the availability of intelligent devices, communication infrastructure, and distribution automation capabilities. While the impacts of distributed energy resources (DER) integration are just now beginning to surface in high-penetration regions, there is a trend toward increased DER deployment that will require improved integration and control capabilities. It also requires improved understanding of customer electricity service needs, behavior, and direct customer benefits (such as improved comfort or preventive maintenance of electrical equipment). If automated demand response, for example, can be advanced with less compromise in service to consumers, the likelihood of higher customer participation—and therefore more response for the grid—increases.

As the number of active customers grows, centralized command-and-control dispatch may become impractical. Additionally, because most of the assets are owned by consumers and third-party service providers, coordination with grid operations needs to appeal to the owners' self-interest (e.g., rewards for their participation). New coordination and control concepts are needed to achieve optimization over multiple-actor objectives, which can be synergistic or competing, and both local and system needs.

Transactive energy is an advanced concept that could contribute to the optimal balancing of supply and demand at all levels of the grid. Through the use of signals that include the cost of energy, operations, and customer-defined value, customer and third-party assets can compete or exchange for the provision of grid services and coordinate with grid operations. The evolution of this control concept is shown in Figure 3.16.<sup>42</sup> Customers begin with self-optimization and intelligent coordination with the distribution operator. As participation

**Table 3.3** Estimated Number of Nodes/Control Points per Entity Type <sup>41</sup>

Entity type	Number of nodes
Regional	<20
Control area	~200
Distribution	~1,500
Market participant	~500
Supply	~10,000
Building	~150,000,000

**Figure 3.16** Stages of Adoption of Transactive Operations for Industry

Credit: The GridWise Transactive Energy Framework is a work of the GridWise Architecture Council

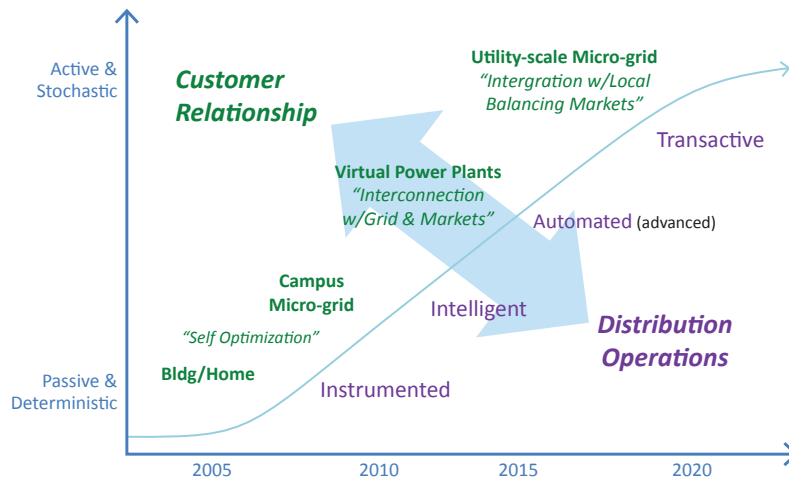

As the customer relationship moves from being passive and deterministic to active and stochastic, distribution operations must also advance to optimally balance supply and demand among multiple participants.

signals, and the assets must be capable of negotiating and transacting a range of market-driven energy services with the grid and each other. Before this concept can be realized, the theoretical foundation for combining economics with scalable system controls (while still ensuring robustness and stability) must be established.

### 3.3.2 Transmission and Distribution Components

The primary objectives for next-generation transmission and distribution components are improved performance, reliability, and affordability. Improved situational awareness and monitoring can enhance asset maintenance and maximize their utility. However, emerging grid challenges and the desired capabilities in the future grid will require new hardware solutions. For example, increased deployment of distributed generation and improvements in energy efficiency are making it more likely that there will be instances where electric power is injected from a customer premise back into the distribution system. This reverse power flow can result in excessive heating of distribution transformers, as shown in Figure 3.17,<sup>43</sup> and potentially reduce the lifespan of a transformer.

Opportunities exist to improve current designs and leverage advances in new materials such as wide-band gap semiconductors, magnetics, insulators, and nanotechnology (e.g., nanostructures, nanoengineering) to increase performance. New component technology requirements will need to balance improved functionalities that support greater consumer self-generation, improve resilience, and increase flexibility while managing total costs.

#### Advanced Transformers

Transformers are one of the fundamental building blocks of today's electric grid, with every kilowatt-hour (kWh) of electricity delivered flowing through at least one. Large power transformers (LPTs) are mature technologies that are designed to be extremely reliable and highly efficient. Distribution transformers are also

becomes more numerous, active, and geographically dispersed, automation and fully transactive distribution operations will be needed to maintain cost-effective grid operations. This could include advancements in distributed optimization and control.

For this concept to work, the signal must be transparent and reflect the true value of the asset's contribution at all levels of the grid for all relevant value streams. Additionally, these signals must be communicated to the various distributed assets, the assets must have local intelligence and control capabilities to respond to the opportunities presented by these



**Figure 3.17** Excessive Transformer Heating from Reversed Power Flows

Credit: Southern California Edison Company

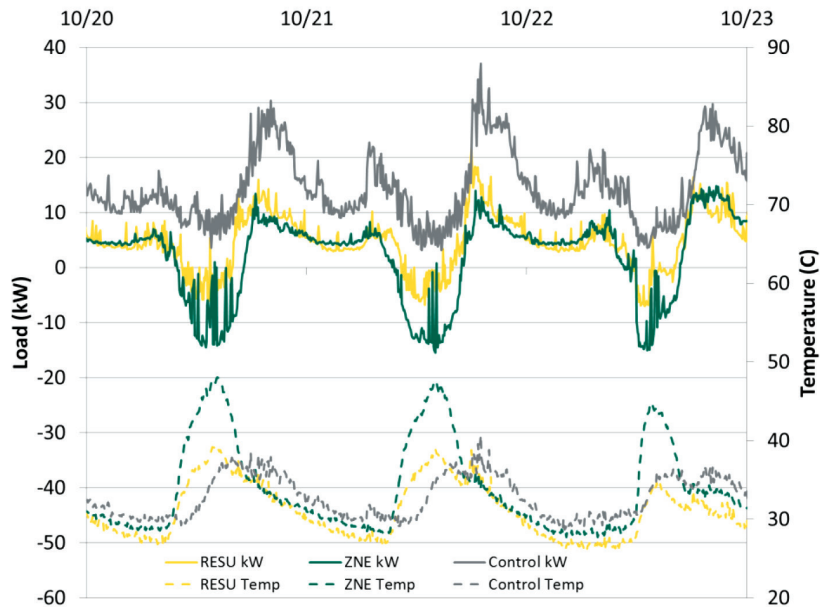

Key: **RESU** = residential energy storage unit; customers have storage available, thereby dampening the magnitude of power injection to the grid, resulting in less-severe temperature increases. **ZNE** = residential zero-net-energy customer; customers have the opportunity for more frequent power injection to the grid, resulting in higher temperatures. **Control** = residential control group customer.

Distributed generation may allow customers to inject energy back into the distribution grid. This reverse power flow can result in excessive heating of distribution transformers.

mature technologies, but are facing more dynamic voltage fluctuations and the potential of reversed current flows as more distributed energy resources are deployed. Understanding how these changes will impact the efficiency, lifetime, performance, design, and protection of these critical components through modeling and analysis is critical for the reliability of the future grid.

#### *Next-Generation Power Transformers*

Best-in-class LPTs can operate with up to 99.85% efficiency, but these devices are large, heavy, and expensive.<sup>44</sup> When failures occur, high costs, highly tailored specifications, lengthy production lead times, and difficult transportation and installation procedures can impact system recovery. These issues motivate the need for research in smaller, lightweight transformers that maintain or enhance reliability and efficiency. Research in core materials, winding materials, and magnetic device configuration has the potential to produce gains in this area. In addition, nearly 50% of reported LPT failures are associated with failures or degradation of insulating subcomponents, highlighting an opportunity for advanced insulators and dielectric materials.<sup>45</sup> Low-loss magnetic cores and low-resistance windings, such as high-temperature superconductors (HTS), can improve transformer efficiency. Additionally, development of new alloys can decrease the amount of iron and copper required, potentially lowering costs. To the extent possible, security enhancements should be embedded into the physical design of LPTs. Resistance to geomagnetically induced currents, electromagnetic pulses, and physical attacks should be incorporated into LPT designs.

### Solid-State Distribution Transformers

A solid-state distribution transformer (SSDT) is a design concept that combines power electronic devices and high-frequency magnetics (see Figure 3.18<sup>46</sup>) that can lead to smaller, more compact transformers and provide new control capabilities. SSDTs are not drop-in replacements for distribution transformers, but will be utilized in strategic locations for their enhanced functionality and flexibility. For instance, an SSDT can be used to mesh radial segments of the distribution network, can perform voltage regulation, supply reactive power, and be used to form hybrid alternating current (AC) and direct current (DC) systems. They can be used to manage the interaction of microgrids with utility systems, regulating the process of disconnecting and reconnecting, quickly and precisely changing the direction and magnitude of power flow, and limiting fault currents. The potential SSDT global market could grow dramatically by 2020.<sup>47</sup>

**Figure 3.18** Conceptual Diagram for Solid-State Distribution Transformer Function

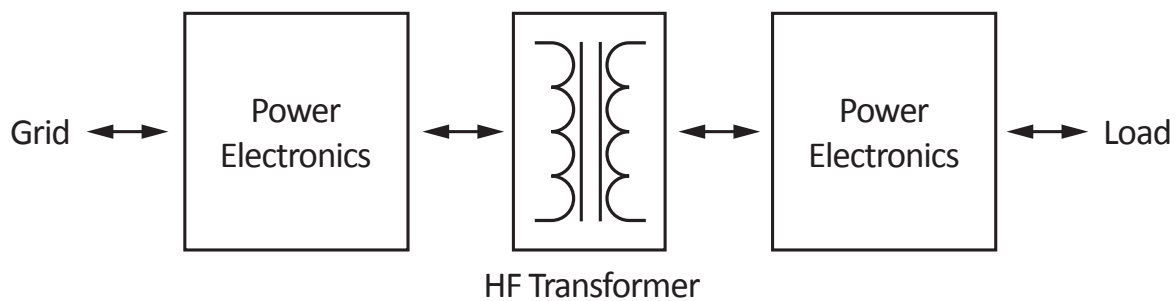

SSDTs combine power electronic devices and high-frequency magnetics to lead to smaller designs.

Current SSDT designs are based on silicon insulated gate bipolar transistors (IGBTs) and face challenges associated with cost, reliability, and efficiency. Leveraging advances in wide bandgap semiconductor materials such as silicon carbide (SiC) and gallium nitride (GaN) can enable new designs and configurations that could be more cost-effective. However, significant advances in power electronic devices using these new materials are needed to achieve the high-power, high-frequency, and high-reliability requirements of an SSDT design. Trade-offs among system performance, device voltage ratings, and price must be weighed in future designs, configurations, and applications. Focused research is needed to develop new solid-state materials and components to meet these unique requirements. An SSDT can provide services in the distribution network for which current markets do not attribute a specific monetary value. This presents a difficulty in valuing the benefit of an SSDT and setting a price for competitive market entry.

### Power Flow Controllers

Electric power on the grid flows according to the laws of physics and follows the path of least resistance. During periods of high demand, bottlenecks develop on the transmission system that can prevent access to lower-cost energy resources such as wind and solar. These congestion costs can be quite significant. Greater deployment of power flow controllers can directly alleviate line congestion, increase asset utilization, and optimize generator dispatch for cost savings. Additionally, the enhanced grid flexibility can support increased penetration of variable renewable resources and improve system resilience. For example, if an area is experiencing an outage due to damaged components, power flow controllers can route power around those affected areas and continue to provide electricity to critical loads.

### *Low-Cost Flexible AC Transmission Systems*

Flexible AC transmission systems (FACTS) devices are a family of technologies that combine power electronic devices with capacitors and inductors to provide a range of control capabilities to the transmission and distribution system. FACTS devices can provide reactive power support, enhance voltage stability, increase power transfer capabilities, and improve system stability. As more variable renewable resources are deployed, these dynamic control capabilities will become more important.<sup>48</sup> The cost associated with the use of power electronic devices limits the situations in which FACTS devices are utilized. Further research geared toward new system designs and advanced power electronic devices can help to bring costs down to \$10–\$40/kVAR, making the technology competitive with other methods of power flow and voltage control.

Traditionally, FACTS installations have been large projects, comparable to substations in physical size and cost. Research efforts geared toward enhancing modularity and scalability will enable lower-cost, lower-capacity FACTS devices to be coordinated in their use. These distributed FACTS devices can address system changes, growth, and expansion in a way that is cost effective. Though several devices have been proposed, enhanced system visibility and control algorithms are required to effectively coordinate the actions of these devices.

### *High-Voltage Direct Current Converters*

High-voltage direct current (HVDC) converters can be considered a mature technology with broad deployment in transmission systems worldwide. HVDC systems have proven to be economical for transferring bulk power over long distance, for undersea applications, for isolating AC systems, and for interconnecting asynchronous networks. Voltage source converters (VSCs) based on silicon IGBTs represent a recent technological advance that provides more flexibility and simplicity in system designs. Additionally, VSCs have inherent black start capabilities, enable multi-terminal configurations, and are easier to deploy. However, this technology still faces challenges with power ratings, efficiency, and cost. Opportunities exist to improve the cost-effectiveness of VSC technology by increasing system efficiency. Reducing losses from 1.4%–1.6% per converter to 0.7% would make VSCs comparable in efficiency to the more mature line-commutated converters (LCCs) based on silicon thyristors.

Costs for HVDC converter stations can be reduced by leveraging new designs, topologies, and advanced power electronic devices based on SiC or GaN. These materials allow for higher-temperature and higher-frequency operation, which translates to smaller passive components and thermal management systems, reducing overall system costs. Additionally, new power electronic device architectures can fundamentally change the design paradigm for HVDC, because current technologies are based on vertical devices.

Research in modular multilevel converters (MMCs) can enable higher-voltage and higher-power applications, using market-available semiconductor devices. MMCs reduce stress on switching components, enhancing reliability. Multi-terminal HVDC networks (MTDC) have seen application in offshore wind collector systems, but have the potential to enhance system reliability for onshore applications as well. Controls for the coordination of MTDC terminals must be perfected before commercial systems are widely deployed. Medium-voltage direct current converter applications, such as improving resilience by connecting substations, increasing efficiency through DC distribution buses, and for nested or networked microgrids, are other areas that should be assessed.

## Protection Equipment

Undesirable or excessive current flows or over-voltages arising from natural events (e.g., lightning strikes, geomagnetic disturbance), normal system operations (e.g., switching surges, transients), or fault conditions (e.g., an unintentional short circuit or partial short circuit) can damage or destroy expensive grid components such as power transformers, HVDC converters, and FACTS devices. As power flows and system dynamics change and advanced technologies are deployed, the role, design, and configuration of protective equipment will need to evolve.

### *HVDC Circuit Protection*

HVDC protection systems must be enhanced to ensure reliability. Circuit breakers help to electrically isolate circuits and components under normal operating conditions or in emergency situations such as during sustained faults. While these technologies are mature for high voltage AC applications, they are not as mature for HVDC applications. For advanced multi-terminal HVDC networks to be realized, reliable HVDC circuit breakers with matching power ratings are needed. Initial research has been conducted in electro-mechanical, solid-state, and hybrid HVDC circuit breakers. However, material and design innovations can help drive down costs, increase power ratings, and accelerate technology deployment. In addition, MTDC networks require advanced methods for DC fault identification and location. Since many components within HVDC networks are in isolated, and even undersea, locations, these enhancements will aid in system protection, maintenance, and restoration.

### *Fault Current Limiters*

The maximum fault current in a system tends to increase over time due to more interconnections, existence of parallel conducting paths, and the additions of distributed generation.<sup>49</sup> Fault current limiters are devices that can limit these excessive currents in transmission and distribution networks to manageable levels. An additional benefit includes decreasing the required fault current rating of the equipment they are protecting, thus alleviating the need for expensive upgrades to handle growing fault currents. Systems based on power electronic devices can also be used to limit fault currents, but the technology is still in development.

### *Surge Arresters*

Increased use of power-electronics-based controllers can increase the power system's susceptibility to lightning strikes, over-voltages, and other phenomena if proper protections are not in place. Surge arresters operate by providing a path to ground when an undesirable voltage is reached in transmission or distribution systems. Most arresters are characterized by their ability to withstand lightning strikes, which can result in power-electronic-based systems with significant over-voltage margins, thereby increasing costs. Improving surge arresters with more dynamic abilities to withstand lightning strikes can help lower costs for future grid transmission and distribution components that use semiconductor devices. However, more detailed analysis is required to investigate the feasibility of using surge arresters for broader system protection.

## Advanced Cables and Conductors

Cables, conductors, and their connectors are as fundamental as transformers to the electricity delivery system. These components form the backbone of the grid, carrying power generated from centralized and distributed sources, along designated rights-of-way and distribution feeders, to customers. The U.S. Energy Information Administration estimates that 6% of all electricity generated in the United States is lost in transmission and distribution equipment.<sup>50</sup> These technologies can be improved by leveraging material advances and improved designs. These enhancements will also need to consider manufacturability to manage costs.

### *Overhead Conductors*

Overhead transmission lines are typically aluminum conductors reinforced with steel for added strength and are designed to operate at rated power/thermal levels. While carrying high currents, resistive heating will increase operating temperatures, leading to sagging. Excessive conductor sagging can result in safety hazards and increase the risk of power failures if the line contacts another object. Innovations that exhibit lower resistance, are stronger and lighter, and have better thermal management can improve the performance of overhead conductors. New materials such as ultra-conductive copper are projected to produce a 50% reduction in resistivity while simultaneously increasing strength and thermal conductivity.<sup>51</sup> Other innovations, such as coatings, to reduce corrosion, minimize icing, and increase heat dissipation can also extend the lifetime of overhead conductors.

### *Underground Cables*

Underground cables are more complicated and expensive than overhead conductors, as they need insulation, shielding, and a way to dissipate heat, and are costly to install. By reducing the conductor resistivity, more power can be delivered through similarly sized cables. For example, cables that use HTS wire can transmit up to ten times more power than conventional cables or can carry equivalent power at much lower voltages.<sup>52</sup> However, the use of this technology is limited because of the high costs associated with HTS systems. In addition to innovations for the conductor, advances in cable insulating materials can improve power rating and help dissipate heat more quickly to increase capacity. Embedded sensors and new installation techniques can also improve system maintenance and lower costs.

### *Advanced Connectors*

Connectors provide the necessary mechanical and electrical coupling between adjacent power line segments. Power transmission capacity can be limited by the connector-conductor contact resistance, and disruption can occur if the conductors pull out. Advances in connector design, surface modification to reduce oxidation, and improvements in contact strength and electrical resistance can enhance system performance. Integration of sensors to monitor connector conditions can also increase system reliability and reduce the maintenance costs.

## **3.3.3 Distributed Energy Resources**

Increased deployment of distributed generation, electric vehicles, and other new customer-sited technologies introduces operational challenges, but also presents opportunities if they are well integrated into system operations. Decentralized control paradigms and distributed approaches for the provision of grid services will need to be designed to ensure that each distributed energy resource can maximize customer benefit while providing safe and secure system integration. By leveraging advances in the design of individual devices, improved control methodologies, and telecommunication infrastructure, it is possible to use these distributed energy resources to help achieve system goals, address emerging phenomena, and provide system flexibility.

### **Grid-Enabled Customer Resources**

Grid-enabled customer resources are individual technologies connected at customer premises (within a building, campus, or industrial plant downstream of a utility meter) that can be used to provide services to the asset owner or to the grid. These technologies can be characterized as enhancements made to discrete loads, distributed generation, and other customer-owned technologies to enable connectivity and responsiveness to grid operations. Development of “smart” devices focuses on embedding local intelligence, communications, and control capabilities, which may be addressable by a utility or third party, or may be fully autonomous.<sup>53</sup> Advancing these technologies from communication-enabled resources to seamlessly integrated resources will require inherent cybersecurity, broad interoperability, proper characterization, and development of validated models.

### *Smart Loads*

There are many opportunities to make a variety of loads more “grid-friendly.” Automated responsive equipment can be designed to detect voltage and frequency or respond to signals from control systems. However, challenges remain with ensuring that these loads will be capable of providing grid services without jeopardizing the quality and reliability of their primary function. Smart loads may include building or industrial control systems that are optimized for individual services, such as lighting, heating, cooling, ventilation, pumping, and processing, but can also interact with utility or operator signals. A large opportunity exists for communications-enabled thermal energy storage systems (hot and cold), such as electric water heaters, that can provide enhanced system flexibility. Advancing smart loads will require consideration of how efficiency improvements will need to be optimized with the provision of grid services.

### *Smart Distributed Generation*

Current interconnection standards require distributed generation to disconnect when system voltage or frequency deviates from normal parameters in order to protect power system equipment and ensure the safety of line workers. Abnormal voltage and frequency conditions typically occur when contingency reserves are needed, such as when a large generator is tripped or a transmission line is disconnected. In these situations, the automatic loss of significant distributed generation can actually exacerbate the initial problem. To prevent contributing to system instability during a disturbance, smart distributed generation technologies will need to meet new operational requirements and functionality. Smart solar PV inverters have been developed to mitigate some of these challenges, but coordination with distribution system operations remains a gap. Other distributed generation resources such as back-up diesel generators, combined heat and power systems, and fuel cells can also have capabilities enabled to provide automated or coordinated control to support grid operations.

### *Smart Electric Vehicles Supply Equipment*

The projected increase in deployment of electric vehicles presents a unique challenge and opportunity for the grid. These moving “batteries” can result in very large system loads when charged in coincidence with the evening peak of residential distribution networks. Development of smart electric vehicle supply equipment can enable electric vehicles to participate in utility demand-response programs or other load-management schemes to support grid operations.<sup>54</sup> Other technology options being pursued include embedded communication and control capabilities in the electric vehicles themselves to provide grid services and vehicle-to-grid applications where the electric vehicle can serve as a source of power. As with other loads, the challenge remains with characterization, modeling, and optimizing the primary function of the technology, namely transportation, with the support of grid operations.

## **Integrated Systems**

As the number and types of smart technologies expand, they will likely grow into integrated systems consisting of multiple grid-enabled customer resources that operate as a single group. These technologies are characterized by coordination of and optimization between various individual distributed technologies—through advanced measurement, communications, modeling, and controls—that provide energy and grid services upstream of a utility meter. Integrated system technologies require close coordination with distribution control systems and present unique challenges in terms of value proposition, regulation, and operation, especially with multiple actors and multiple objectives.

### *Smart Buildings*

Buildings consume roughly 74% of total electricity and 50% of total natural gas production. This realization presents the opportunity for increasing energy efficiency, meeting customer needs and comfort levels, and supporting grid operations simultaneously. Residential and commercial buildings, as well as industrial plants,

consist of many physical assets that can be regarded as an energy ecosystem. From power sources (distributed generation), to loads (appliances and machines), to storage (batteries and thermal energy), and controls (building energy management systems), buildings and industrial plants can have all the components that form an integrated electric power system.<sup>55</sup> However, communication and control capabilities are limited between these various assets, and interoperability standards are yet to be developed. This results in numerous proprietary control and communication standards developed by independent manufacturers. Proper characterization, improved interoperability, and new controls, are required to enable the optimal coordination of electrical resources housed within buildings and industrial plants.

### Microgrids

A microgrid is a group of interconnected loads and distributed energy resources within clearly defined electrical boundaries that acts as a single controllable entity with respect to the grid. It can connect and disconnect from the grid to enable it to operate in both grid-connected or island mode and can be nested one within another, as shown in Figure 3.19.<sup>56</sup> Microgrids deployed today are generally facilities with generation, such as large university campuses and military bases, or hospitals. A smart building that can island and reconnect to the distribution system would be considered a microgrid as well. One rapidly

increasing role of microgrids is the shift from niche applications (e.g., energy surety) to the provision of services and benefits from the management of multiple distributed energy resources, such as electric storage, rooftop solar PV, and electric vehicles, in conjunction with building loads. Challenges exist in the development of more complex controllers for microgrids, exploring the benefits of DC microgrid designs, and coordinating nested and networked microgrids with each other and with other distributed energy resources.

### 3.3.4 Electric Energy Storage

Electric energy storage technologies are characterized by their bidirectional response capability to store and discharge electric power on command. These technologies can provide various benefits to the grid, such as supporting system balance, improving economic dispatch, enhancing power quality and stability, and deferring infrastructure investments. Certain electricity storage technologies can also be deployed in communities or behind the customer meter to contribute to emergency preparedness and resilience. The future grid will likely require a substantial deployment of electric energy storage to provide system flexibility and enhance control capabilities.

Pumped hydro storage (PHS) is the predominant source of grid storage today, accounting for more than 95% of storage deployed in the United States. However, siting constraints, environmental concerns, and cost make new, large-scale deployments difficult. With increasing penetration of variable renewable resources, needs for

**Figure 3.19** Different Microgrid Configurations

Credit: Sandia National Laboratories

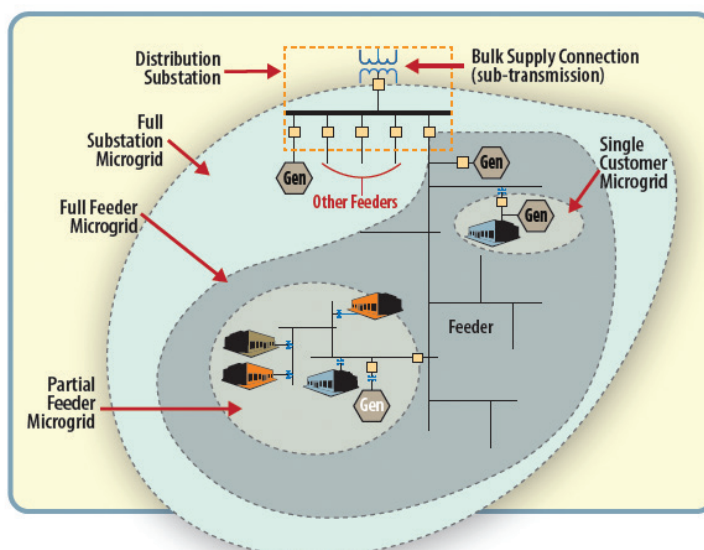

Microgrids can exist in multiple configurations: independently, networked along a feeder, or nested within another.

increased operating reserves are expected, which energy storage technologies can fulfill. There are many electric energy storage technologies available, and each has its own distinctive performance characteristics that make it generally more suited for particular grid applications, as illustrated in Figure 3.20.<sup>57</sup> The applicability of a technology can be primarily determined according to its power rating and energy capacity, which are typically related as a function of time. Other technical characteristics to consider are round-trip efficiencies, cycle life, depth of discharge, and ramp rates.

One of the major challenges common across the various technologies is cost, which includes all subsystem components, installation, and integration costs. While there is a strong focus on reducing the cost of the “energy storage” component, such as battery chemistries or the spinning mass in a flywheel, this component only constitutes approximately 30%–40% of the total system cost. A total systems approach is needed to reduce balance-of-system costs and achieve the desired cost and performance targets in Table 3.4. Other common challenges include improving the safety of these technologies and assessing the appropriate value streams for the multiple services electric energy storage can provide.

### Bulk Energy Storage Technologies

Bulk energy storage technologies are characterized by large storage capacities and long discharge times that are generally used to shift large amounts of electricity. PHS and compressed air energy storage (CAES) are two technologies capable of discharge times in tens of hours to days with power ratings that can reach 1,000 MW or more.<sup>58</sup> PHS is a mature technology currently used at many locations in the United States and around the world,<sup>59</sup> while only two operational CAES plants exist worldwide, with one in Alabama and the other in Germany.

Feasibility studies indicate PHS projects may be practically sized up to 4,000 MW and currently operate at about 76%–85% efficiency, depending on design. New capabilities of PHS, through the use of variable speed pumping, are opening up the potential for the provision of additional services to increase system flexibility. New turbine designs, optimized operations, and better controls can increase the efficiency of PHS.

**Figure 3.20** Applications of Electric Energy Storage Technologies

Credit: Sandia National Laboratories

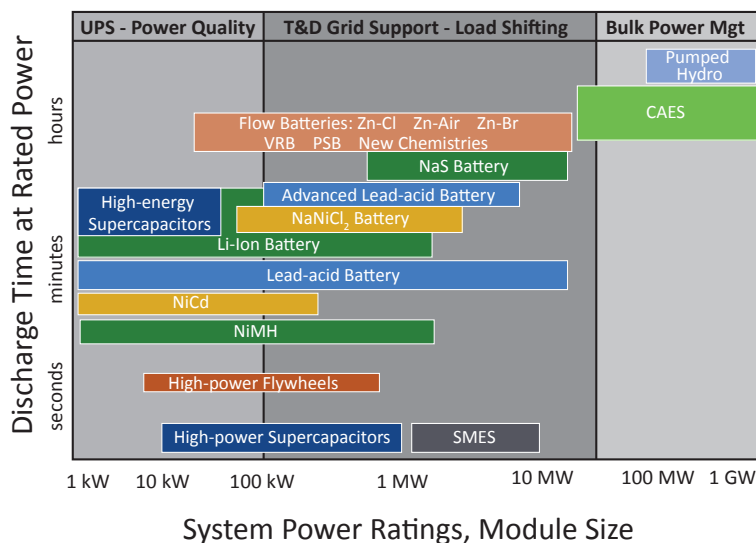

Energy storage technologies have distinct performance characteristics that make them suited for particular grid applications.

Greater deployment of cavern-CAES technology is limited because it requires a solution-mined salt dome, a relatively rare geologic formation, in which to make sealed caverns to store the pressurized air. Porous media-CAES (PM-CAES) does not require this kind of geologic formation, making the opportunity for this technology significantly larger. As more natural gas reservoirs are depleted, PM-CAES can leverage these reservoirs, which have already demonstrated storage integrity. Fundamental research is needed for PM-CAES to understand the impact of air storage on surrounding geologic regions, as well as full system designs.



**Table 3.4** Cost and Performance Targets for Electric Energy Storage Technologies

<b>Range of baselines</b>	<b>System capital cost by energy:</b> \$805–\$10,020/kWh <b>Levelized cost:</b> \$0.01–\$0.64/kWh/cycle <b>System efficiency:</b> 75%–92% <b>Cycle life:</b> 4,500–225,000 over life of plant <b>System capital cost by power:</b> \$300–\$4,600/kW
<b>Near-term targets</b>	<b>System capital cost by energy:</b> less than \$250/kWh <b>Levelized cost:</b> less than \$0.20/kWh/cycle <b>System efficiency:</b> more than 75% <b>Cycle life:</b> more than 4,000 cycles <b>System capital cost by power:</b> less than \$1,750/kW
<b>Long-term targets</b>	<b>System capital cost by energy:</b> less than \$150/kWh <b>Levelized cost:</b> less than \$0.10/kWh/cycle <b>System efficiency:</b> more than 80% <b>Cycle life:</b> more than 5,000 cycles <b>System capital cost by power:</b> less than \$1,250/kW

## Battery Technologies

Batteries are a broad family of devices that store and release electric energy through electrochemical reactions. Battery technologies have been successfully deployed in both distributed and centralized applications in various sizes and can be used for both energy and power applications. However, they have not yet realized widespread deployment because of challenges in energy density, power performance, lifetime, charging capabilities, safety, and system life cycle cost, inclusive of waste and disposal. Many different battery chemistries and designs under investigation can be leveraged to meet cost and performance targets. For example, metal-air batteries such as zinc-air or lithium-air provide the opportunity for high energy densities and low costs because only one electrode is required. While there are many battery technologies in the market today, the scalability and technical potential for new battery chemistries and designs will continue to drive innovation.

### *Lead Acid Batteries*

Lead acid batteries are a low-cost and mature technology. However, utility-scale deployments have been limited because of their weight, large volume, cycle-life limitations, and maintenance needs. Advanced lead-carbon batteries exhibit high charge and discharge rates with no apparent detrimental effects like those typically experienced with traditional lead acid batteries. Advanced lead acid systems with design and material innovations can lead to a low-cost option for grid applications.

### *Sodium-Sulfur Batteries*

Sodium-sulfur (NaS) batteries are a commercial technology with several demonstrated grid applications. NaS batteries have significant potential for broader use because of long discharge times (~six hours), relatively high round-trip efficiencies (~75%), and quick-ramp rates. There are opportunities to improve this technology by lowering operating temperatures and exploring new sodium chemistries.

### *Lithium Ion Batteries*

Lithium-ion (Li-ion) batteries have emerged as the fastest-growing technology for electric energy storage. By leveraging the commercial availability for consumer electronic applications, Li-ion is now being positioned as the leading platform for plug-in hybrid electric vehicles (PHEVs) and all-electric vehicles. Transportation applications use large-format cells and packs with energy capacities of 15–20 kWh for PHEVs and up to 85 kWh

for all-electric vehicles. These packs can be integrated into systems for grid applications that require less than four hours of energy storage capacity. Li-ion systems dominate the current deployment landscape for grid-scale electric energy storage in the United States. However, there are many Li-ion chemistries that exist (e.g., lithium-sulfur), each with different power-versus-energy characteristics that can be explored for new system designs.

#### *Flow Batteries*

Instead of solid electrodes and a liquid electrolyte in typical batteries, the electrodes are liquid and the electrolyte is a solid in flow batteries. This configuration provides the unique ability for the energy storage capacity to scale with the volume of the liquid electrode, independent of the power rating, making this technology extremely flexible. Additionally, flow batteries have several advantages over traditional batteries, including deep discharges, high cycle-life, and extremely long unit life. However, flow batteries face challenges with low energy densities and integrated design requirements.

The most mature flow battery is based on a vanadium chemistry that suffers from cost, toxicity, and corrosive limitations. Research can help to determine the environmental risk factors of vanadium and to improve energy densities of the chemistry. Opportunities for less expensive alternatives to vanadium include chemistries based on organic chemicals such as quinones. Other chemistries such as iron-chromium, zinc-bromine, and zinc-iodide can provide system-level advantages such as simpler designs, higher energy densities, and the use of more Earth-abundant materials for reduced costs.

#### *Power Technologies*

Power technologies can be charged and discharged relatively quickly, but they tend to suffer from limited energy storage capacity. These technologies are often used in applications such as frequency regulation, power quality, and as an uninterruptible power supply.

#### *Flywheels*

Flywheels are commercially available technologies that store energy in a spinning mass called a rotor. Electric energy is converted to kinetic energy and converted back through the use of a bidirectional power conversion system. Flywheels exhibit excellent cycle-life compared to other technologies with estimates in excess of 100,000 full charge-discharge cycles. Other benefits include low maintenance, long life spans of up to twenty years, and no toxic components.<sup>60</sup> Opportunities for advanced designs and new materials can lead to reduced friction and increased rotor strength, improving efficiencies and energy capacity.

#### *Superconducting Magnetic Energy Storage*

Superconducting magnetic energy storage (SMES) is a commercial technology that stores electric energy in a magnetic field generated from a DC current circulating in a superconducting coil. SMES has the highest round-trip efficiency of any electric energy storage technology, but they are costly to manufacture and maintain. Additionally, the refrigeration system needed for the superconductor introduces large parasitic losses. Use of superconducting materials with higher-operating temperatures and efficiency improvements in refrigeration systems could lower total system costs.

#### *Electrochemical Capacitors*

Capacitors store electricity directly as electrical charge rather than converting the energy into another form (e.g., chemical energy in batteries, kinetic energy in flywheels). This principle makes the energy storage process fast, reversible, and efficient. Capacitors also have little degradation in performance over time, increasing reliability. Currently, electrochemical capacitors can store significantly more energy than dielectric and electrolytic capacitors, but are cost prohibitive. Developments in materials such as composites and nanoparticle coatings that combine low resistivity, high capacitance, and low costs could lead to next-generation electrochemical capacitors.<sup>61</sup>

## Hydrogen Energy Storage Systems

Hydrogen energy storage (HES) systems typically involve the production of hydrogen from electricity via electrolyzers in which electrical energy is used to split water molecules into hydrogen and oxygen gas. This hydrogen can be stored or used in other sectors such as manufacturing, transportation, or end use. Running stored hydrogen through fuel cells or a combustion generator can produce electricity, reversing the process. Some life cycle cost studies indicate that HES systems can be competitive with battery systems and could be a viable alternative to PHS and CAES for bulk energy applications.<sup>62</sup> However, advances will be needed in the development of these systems to address high costs; low round-trip efficiencies; safety concerns; and the need for high-volume, high-pressure storage tanks.

### 3.3.5 Planning Tools

As the nation transitions to a modern grid, advanced planning tools and simulators will become critical to making well-informed decisions regarding system changes and infrastructure investments. From transmission expansion and production cost modeling to component designs and protection schemes, these tools are used to study various aspects of the grid and assess trade-offs between choices. Figure 3.21<sup>63</sup> depicts the spatial scale (from an individual solar panel sitting on a rooftop to the entire North American continent) and the temporal scale (from microseconds to decades) over which planning tools are needed to support decisions that have significant implications. For example, planning tools help determine operating limits and the amount of reserves needed for a particular region. Inaccuracies can lead to conservative limits that raise system operating costs or improper settings for protection schemes that could result in wide-area disturbances.

**Figure 3.21** Scales of Power Systems Operations and Planning

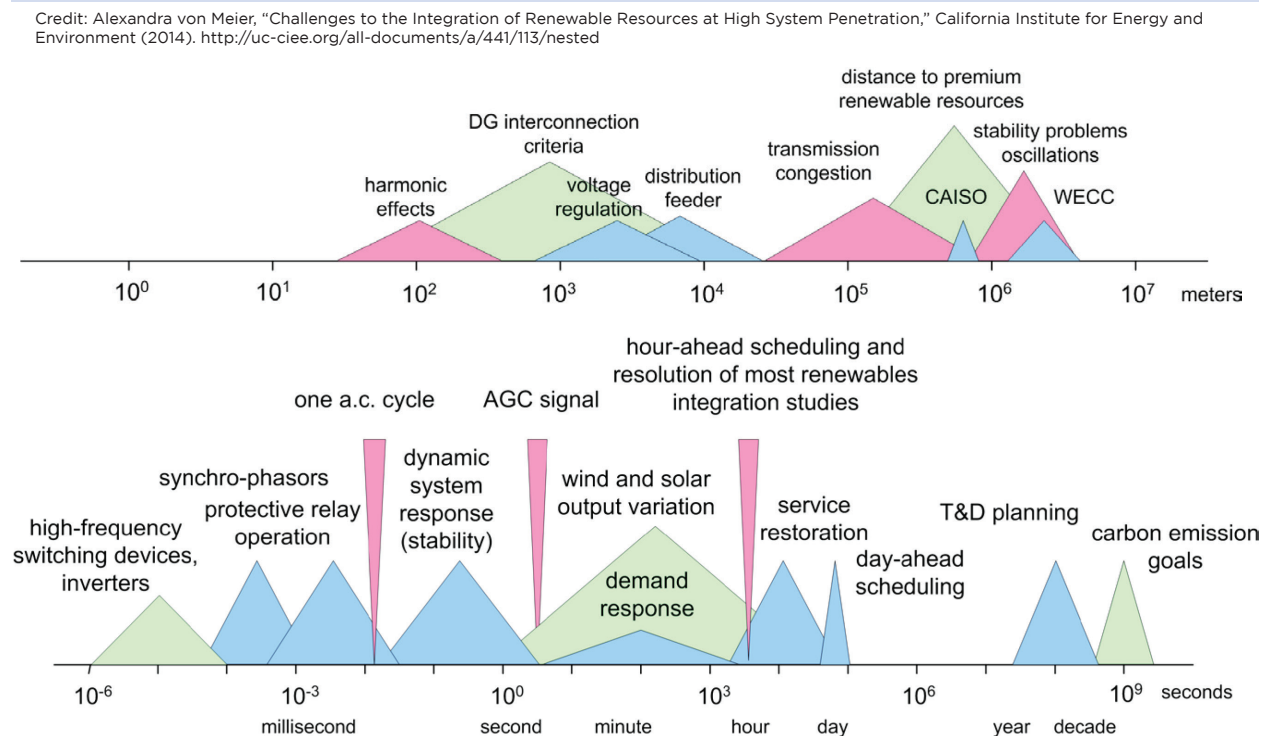

Planning tools are needed to support decisions over a large range of spatial scales (from an individual solar panel sitting on a rooftop to the entire North American continent) and temporal scales (from microseconds to decades).

The accuracy of any modeling or simulation result is limited by the availability and accuracy of data, the accuracy and precision of underlying models, assumptions used, computational capabilities available, and run times. Advancements in planning tools and simulators will need to address these various facets to help stakeholders evaluate the merits of technology, policy, regulatory, and market options. The growing interconnectivity, interdependencies, and complexity of the electric power system are also requiring tools with enhanced modeling capabilities.

### Improved Models and Simulators

Development of high-fidelity modeling and simulation tools can improve the accuracy of grid planning, operations, and decision making. Many recent innovations can be leveraged to capture and better reflect observed phenomena. For example, the availability of high-resolution sensors (e.g., PMUs) can be used to validate models, and advanced computing platforms (e.g., parallel processing) can be used to accelerate run times. Additionally, open-source frameworks (e.g., GridLAB-D) can be used to foster interoperability, and mathematical advancements can be used to address uncertainty and risk. If the integration of the real-world data streams can be done effectively and efficiently, models and simulators can automatically update and self-calibrate to reflect changing conditions and improve accuracy. Many of the innovations made for off-line planning tools and simulators can also be adopted or extended for use in the operational environment. As the grid transitions to one that is analytically driven and controlled, foundational improvements in operational models and simulators becomes even more critical. Validation of reduced-order models using real world data and established use cases is needed before automation and model-based control can be fully trusted. Additionally, significant amounts of information will need to be rapidly processed and fed into these models and simulators.

### Framework for Tool Interoperability

A common, systematic framework in which existing tools from disparate technical domains converge on mutual boundary conditions can help address emerging questions stemming from growing interdependencies and complexity. A prototype environment Framework for Network Co-Simulation integrates tools across multiple domains and scales.<sup>64</sup> The National Rural Electric Cooperative Association is also developing an open modeling framework based on Pacific Northwest National Laboratory's GridLAB-D. More work is needed in this area to accelerate the development and application of this environment to keep pace with the needs of the future grid. Another important aspect of tool interoperability is the development of accurate, comprehensive, and harmonized data sets that can be broadly used. Data sources that should be collected and harmonized include weather, load profiles (including composition), device models, grid asset location and specifications, generator location and performance, storm history, communications, geographic, water, and others. One major challenge in assembling data is the inconsistent naming conventions used for the same grid assets among different data sets. These discrepancies can lead to errors and limitations in modeling results. Another challenge is the costs (e.g., labor and time) associated with the collection, scrubbing, and organization of data. Mechanisms to connect offline data sets with sources from an operational environment would greatly facilitate the process.

### Decision-Making Tools

While the development of next-generation planning tools and simulators provides tremendous analytical capabilities for answering complex questions, the majority of grid stakeholders may not have the expertise to use these tools, or may have limited access to the required computational resources. Decision-making tools that are publicly accessible and user-friendly can support the transition to a future grid. These tools can also help with economic decision making by establishing a common reference for answering the often contentious

questions around valuation, costs, and benefits of particular technologies or options. Dashboards and Web-based tools that can run on desktops and are sufficiently accurate can help regulators, policymakers, energy developers, and other institutional entities quickly understand the impact of their choices. Future opportunities include developing simple interfaces that can link with the more complex planning tools and simulators to blend ease of use and analytical rigor, and leveraging cloud-based computing to permit broader access to advanced analytical capabilities.

### 3.3.6 Physical and Cybersecurity

Ensuring the nation’s electric power system is adequately protected against physical and cyber threats is a shared public and private sector responsibility. While the private sector has the primary responsibility, long-term or widespread outages can have severe consequences for human health and safety and national security. Coordinated actions are needed to ensure appropriate, timely, and effective allocation of resources.

In the face of more frequent and intense weather events, along with potential for cyber and physical attacks, there are growing expectations for a resilient and responsive power system to meet not only reliability objectives, but also security concerns. The resilience and responsiveness is enabled by the introduction of information and communication technologies, and their integration with advanced and legacy devices in ways not previously envisioned can increase vulnerabilities, given the emerging threat landscape. Since 2010, the international energy cybersecurity environment has experienced an increase in cyber attacks. The sophistication and effectiveness of this new era of malware mark a significant change in state actor-level threats to the energy sector and the U.S. economy. There is also evidence that nation-states are increasing cyber-spying and attacks on U.S. utilities and equipment suppliers. These threats demand energy delivery control systems that are secure in every aspect and resilient during a cyber incident.

Simultaneously, the increased frequency and intensity of extreme weather events and potential attacks on electrical infrastructure require more careful consideration of physical security. While the Metcalf Substation attack in 2013 gained national attention because of the apparent military tactics used, attacks on electric power systems are not new. Utilities have faced physical threats from copper theft at substations to the occasional individual shooting insulators or conductors. It is important to consider that theft and vandalism rank fairly low when compared to outages caused by weather, faulty equipment, or unknown circumstances (see Figure 3.22<sup>65</sup>).

**Figure 3.22** 2014 Reported Power Outages by Eight Possible Causes

Credit: Eaton

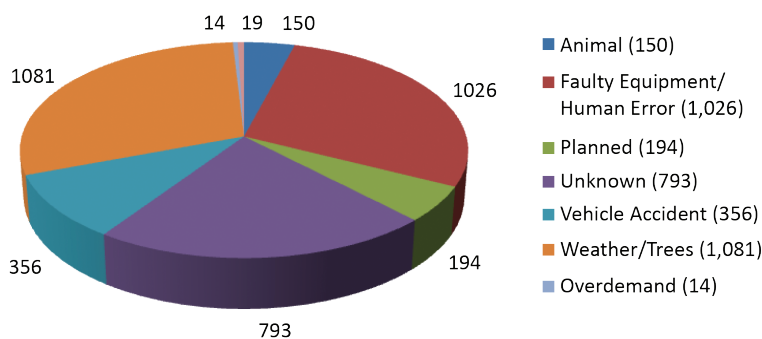

The highest number of unplanned outages are caused by weather, faulty equipment, and unknown circumstances.

Utilities will only adopt security measures that align with their risk-management strategy. Physically hardening and protecting the entire electric power system—with more than 5,800 major power plants, 55,000 substations, and more than 642,000 miles of high-voltage transmission lines<sup>66</sup>—is impractical. Solutions that are developed will need to balance between the risks an entity is willing to accept and the risks that it must address. As threats will not go away, it is important that the future electric power system be designed and operated to be more resilient so that it can continue its critical functions after an event. It is also important that measures developed will not interfere with the energy delivery functions of the devices and components they are meant to protect.

Based on recommendations developed by energy asset owners and operators, suppliers, government entities, national laboratories, and academics,<sup>67</sup> security activities should focus on the following:

- Building a culture of security
- Assessing and monitoring risk
- Developing and implementing new protective measures to reduce risk
- Managing incidents
- Sustaining security improvements

The objective of these activities is to position the energy sector at an advantage over adversaries or natural threats and reduce the risk that an incident will result in disruption of electricity delivery.

### Cybersecurity

Cybersecurity is a serious and ongoing security, safety, and economic challenge for the electricity sector. The sector comprises organizations that vary significantly in their size, functions, capabilities, and criticality. The electric power system is mostly owned and operated by the private sector, but is critical to the nation's security. While electricity service providers address threats and vulnerabilities associated with their assets, systems, and networks on a daily basis, effective collaboration with the public sector is needed to address the scale of threats, sharing of information, and RDD&D to develop systems that are inherently resistant to disruption.

Cybersecurity in the electricity sector is often broken down into measures for systems with operational technology (OT) or information technology (IT). IT systems are typically used to support business, human resources, and other non-operational functions, whereas OT systems are typically used to transfer data and commands that are critical to operating and protecting the grid itself. OT systems differ from IT systems with regard to data availability challenges. High-speed data transfer is needed for reliable electricity operations. Protection schemes require precise timing and therefore may not tolerate the latency that might be injected by encryption or other security measures. Another challenge unique to OT systems is that patches and upgrades require extensive testing and validation to ensure that the change does not jeopardize operations. As these technologies evolve, there is also an increasing need to consider the vulnerabilities arising from the convergence of IT and OT. Some of the key parameters to guide effective cybersecurity RDD&D for energy delivery systems are shown in Table 3.5.

The North American Electric Reliability Corporation (NERC) Critical Infrastructure Protection standards provide mandatory standards for protecting the bulk power system against cyber events. These standards are enforced by the Federal Energy Regulatory Commission. No such standards exist for distribution system assets and systems.

Spurred by funding under ARRA, significant progress has been made in developing and implementing comprehensive methodologies to better protect the power system from cyber attacks. The National Institute of Standards and Technology launched the Smart Grid Interoperability Panel (SGIP). The SGIP is a public-private partnership to foster the development of interoperability and cybersecurity standards. The SGIP developed *Guidelines for Smart Grid Cyber Security*, which has been instrumental in guiding the deployment of cybersecurity protections for the smart grid.

In 2005, DOE, the U.S. Department of Homeland Security, and Natural Resources-Canada worked with the energy sector to develop the *Roadmap for Energy Delivery Control Systems Cybersecurity* (originally called the *Roadmap to Secure Energy Sector Control Systems*). The roadmap provides a guide for public and private activities to enhance cybersecurity across the energy sector with a vision for resilient energy delivery control systems that can survive a cyber incident while sustaining critical functions.

**Table 3.5** Cybersecurity R&D Parameters

<b>Time latency</b>	<ul style="list-style-type: none"><li>■ ≤ Four milliseconds for protective relaying</li><li>■ Sub-seconds for transmission wide-area situational awareness monitoring</li><li>■ Seconds for substation and feeder SCADA</li><li>■ Minutes for monitoring noncritical equipment and some market pricing information</li><li>■ Hours for meter reading and longer-term market pricing information</li><li>■ Days/weeks/months for collecting long-term data, such as power quality information</li></ul>
<b>Integrity assurances</b>	<ul style="list-style-type: none"><li>■ Data have not been modified without authorization</li><li>■ Source of data is authenticated</li><li>■ Timestamp associated with the data are known and authenticated</li><li>■ Quality of data is known and authenticated</li></ul>
<b>Confidentiality</b>	<ul style="list-style-type: none"><li>■ Privacy of customer information</li><li>■ Electric market information</li><li>■ General corporate information, such as payroll, strategic plans, etc.</li></ul>

Since 2005, DOE has been working with the electricity industry, federal partners, and academia to implement the roadmap. Significant progress has been made in using the roadmap to develop and commercialize tools and guidance. Some recent examples include the following:

- **SIEGate** (Secure Information Exchange Gateway) provides secure, flexible, real-time, and reliable information exchange for electric grid applications. It consolidates data exchange to reduce the external attack surface and costs of maintaining multiple data exchange systems.
- **Padlock** is a cybersecurity gateway device that provides strong access controls, central collection of log data, enhanced serial and Ethernet data communication security, and password management for field devices.
- **exeGuard** protects energy delivery computers from unexpected cyber activity, including attempts to inject malicious code or alter settings without proper authentication.
- **NetAPT** (Network Access Policy Tool) helps energy utilities map their control system communication paths, including for critical cyber assets, in minutes rather than days, and verifies that these paths conform to the utility's security policy.

However, many other technical advances are needed to address gaps and evolving challenges.

#### *Improved Situational Awareness*

As cyber and physical threats evolve, technologies and capabilities to assess the “state of security” for the grid will be needed. Cyber-physical models, analytical tools, and performance metrics can help enable this capability. Moving to real-time analytics and the ability to co-simulate cyber and physical systems are both methods that can be used to perform non-traditional contingency planning. While not used directly for operations, information on electricity prices and capacity provides a gateway that can impact power flow management. Identifying other aspects of nontraditional contingency planning, increasing the speed of detecting compromises, and improving the situational awareness of the security posture, both cyber and physical, are all important areas to investigate.

### Scalable Secure Communications

Communicating at speed with thousands (even millions) of devices is unachievable with today’s technology. The use of cloud computing by the electric sector and the trend toward the “Internet of things” can support the scaling issue, but present unique challenges for cybersecurity measures. For example, the utilization of public

Figure 3.23 Cross-Organizational Chain of Trust

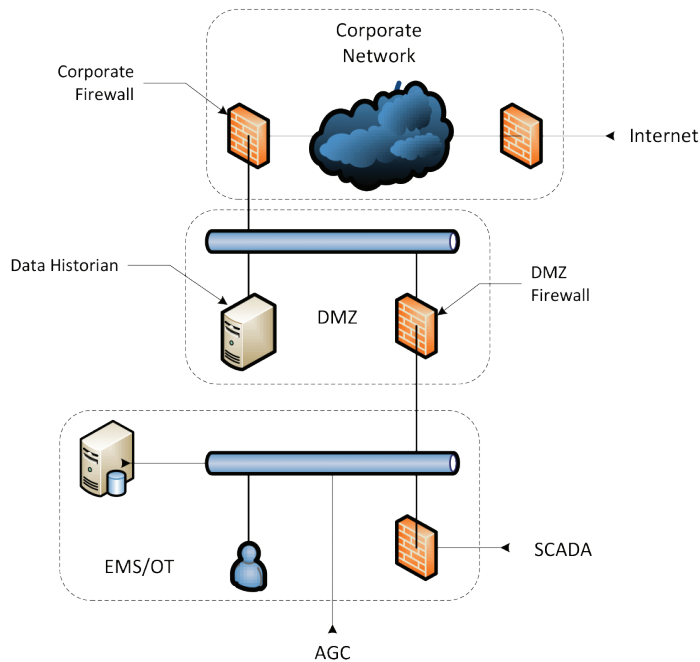

DMZs segment corporate and operational networks, yet trusted communications still allow information and data to pass across domains and between organizations.

### Trusted Data Exchanges

Today utilities employ demilitarized zones (DMZs) that segment corporate and operational networks. However, electricity sector information and data are still required to be passed across domains and between organizations for efficient operations. Figure 3.23 shows a schematic of this architecture. Organizations should be able to move customer data without compromise, securely exchange corporate or operational data with other organizations if required, and be able to rely on data transfers for operations even if part of the system has been compromised by cyber attacks. Importantly, the operational networks that control electricity delivery must be designed to reject, and be resilient to, a cyber incident that may have penetrated the corporate network defenses. Cybersecurity technologies should consist of end-to-end data delivery, computation, and power applications that are able to respond jointly, quickly, and seamlessly across the various domains.

### Real-Time Investigation, Mitigation, and Recovery

Resilient control systems should be able to survive a cyber incident while sustaining critical functions and be able to “ride through” or adapt to a cyber incident. In a modernized grid, control systems should be able to operate with part(s) of the system or its component devices, including applications and data, compromised by malicious intrusion. Critical electricity delivery functions should be sustained while forensic investigations

key infrastructures may not be practical for large-scale deployments. Another aspect of secure communications is the physical security of the assets associated with the underlying IT and OT systems. Technologies that can enable manufacturing of inherently secure devices can facilitate adoption of advanced security technologies. High-performance data management techniques, and analytics that can handle the growing amount of data transfers for security purposes are other areas to investigate. Another challenge is that protocols engineered for legacy IT and OT components may not operate as intended in current computing and networking environments and are vulnerable to manipulation.



proceed to understand the extent and consequence of the compromise, followed by development of mitigations and recovery to normal operations. Another potential response to a threat is logical islanding, which extends the classical islanding concept to cyber assets, refusing or distrusting connections from peer systems that appear to be compromised or malfunctioning.

#### *Cybersecurity Capabilities and Efforts Database*

Identifying available cybersecurity capabilities is a necessity to ensure gaps in cybersecurity technology development are addressed and not overlooked. This will reduce redundancy of efforts, yet identify potential areas of overlap that would ensure greater cybersecurity. A repository of efforts currently resides on the ieRoadmap website,<sup>69</sup> which is searchable by organization and maturity. However, there currently is no capability to identify redundancies and gaps, or to have confidence that all available technology is identified.

### Physical Security

Physical security measures include activities that can harden assets, improve situational awareness, deter and respond to man-made threats, and mitigate risks. Winter storms, earthquakes, vandalism, and numerous other physical threats can be addressed through RDD&D efforts. Key needs are risk assessment tools and processes to determine the most vulnerable portions of the grid and the most appropriate solution to implement to manage costs. Efforts will require consideration of operations and the impacts of physical threats on the cyber domain, such as attacks and disruptions to critical communication channels.

#### *Smart Materials*

Many substation components are exposed because they require heat transfer to the surrounding air to maintain normal operations and may require access for maintenance. Concrete barriers may protect assets but would not prevent an intruder from walking inside the substation. RDD&D of smart materials that can be used in electrical transmission and distribution components that prevent or self-heal from damage would be valuable. Components that can benefit from smart materials include insulators (bushings and transmission line), transformers (conservators, cooling vanes, and tanks), circuit breakers (bushings and tanks), and voltage stability components (capacitors and inductors). Other smart material innovations that could be applied to transmission and distribution lines include super-hydrophobic coatings that facilitate deicing during winter storms.

#### *Operational Response to Intrusion/Damage*

Protection relays for physical components are typically set so the system will go to its safest state, de-energized, in the event a threshold limit is exceeded. These schemes occur primarily at the transmission level and are critical for reliable operations. However, if a fault occurs due to vandalism or an attack, protection relays may not be set appropriately and other components can remain energized or exceed thresholds, resulting in permanent damage. Automatic operational schemes could be armed after an intelligent adversary was detected within the boundaries of a substation or switchyard and identify resilient configurations for the remaining system to survive the loss of this particular substation. Other predictive system configurations, including adaptive relaying, topological switching, and intentional islanding with microgrids, are areas of investigation.

#### *High-Impact, Low-Frequency Events*

The electricity industry has long studied the effects of high-impact, low-frequency (HILF) events, such as risks posed by coordinated attacks, pandemics, and geomagnetic disturbance or electromagnetic pulses.<sup>69</sup> Work published by NERC in 2012 made thirty-three recommendations in the areas of operations, monitoring, communications, short/long-term system planning, protection and control, interdependencies with other critical infrastructures, and others.<sup>70</sup> Many of these recommendations currently have R&D efforts at national laboratories.

Another area that could be investigated is HILF events on other sectors or sub-sectors where the second order impact would be to the electrical subsector. Examples include inadequate transportation of fuel for electric generation such as coal by rail or constraints on the natural gas supply, such as during the recent polar vortex. As the electric power system becomes more interconnected, understanding and analyzing the impact of interdependencies from these events is a critical area of research.

### System Recovery

While cyber- and physical-security measures can mitigate and prevent the impact of incidents, there will be times when the system will fail from known or unknown threats. RDD&D into technologies and mechanisms that can accelerate system recovery are critical to improving the resilience of the grid. While improvements to control systems and distribution automation can facilitate recovery from disruptions, there are steps in the resoration process that will require human intervention, such as the replacement of damaged cyber and physical assets.

#### *Damage Assessment and Predictions*

Analysis and prediction of how a storm or an event (e.g., HILF scenarios) may damage assets in an area can facilitate preparation and prioritization of resources to respond to the event. These capabilities can be extended to include the assessment and prediction of compromised assets resulting from a cyber incident. Proper preparation, staging, and training can accelerate restoration, but advanced analytics after an event can also facilitate recovery. Opportunities exist to integrate data from various channels and sources that may be limited or incomplete to support system restoration. Examples include using social media, integrating weather forecasting with outage management systems, and considering flood and transportation models into logistics and planning.

#### *Large Power Transformer Availability*

LPTs are critical assets with lead times of thirty-five weeks or more after receipt of order. In the event LPTs are damaged, the availability and suitability of a replacement becomes the priority. Standardization of transformer specifications can reduce this lead time to approximately twenty weeks and cut costs by 15% or more.<sup>71</sup> While standardization can help system recovery of LPTs, many legacy substations face challenges from customized solutions. Industry currently has transformer-sharing programs, but opportunities exist to identify new mechanisms to ensure transformer availability. For example, retrofit of transformers from coal plant retirements can serve as a temporary supply of LPTs and could shorten the time of replacement from months to weeks for critical facilities.

#### *Portable Power Delivery Equipment*

As with transformers, damage of other critical electricity delivery assets can impact the time it takes to recover from an event. Portable power delivery equipment that can be used to help restore power to communities may be a useful area to explore. A prototype for a recovery transformer has been demonstrated and concepts of mobile substations have been explored.<sup>72</sup> While not a permanent replacement, these technologies could allow power plants to come online at a reduced capacity until an actual replacement could be manufactured, shipped, and installed. Other options for portable power delivery equipment can be explored.

### 3.4 Conclusion

The traditional electricity infrastructure has provided reliable electricity for more than a century, but today's energy requirements are rapidly changing. Changes in the supply and generation mix, evolving demand loads, and the transition of consumers to active “prosumers” are all creating technical challenges for an aging electricity infrastructure. The proliferation of new digital control and communication devices brings new opportunities for managing distributed generation and storage, but creates new security and integration challenges. Simultaneously, growing dependence on highly reliable electricity for national and economic security makes electricity resilience a top priority. A modern electric grid must be more flexible, agile, and dynamic—able to integrate and optimize a wide mix of generators, loads, and storage capabilities.

These trends create new technical requirements for the power grid and redefine its fundamental design and operational structures. Profoundly different generation and load characteristics will affect power system behavior and overall operational performance. These changes in operational characteristics help to define the RDD&D requirements of modern electric power systems (see Table 3.6).

From the technology assessments presented in this chapter, RDD&D opportunities were identified in seven high-impact areas needed to build the fundamental capabilities required for a modern electric power grid. Table 3.7 summarizes the opportunities for RDD&D to meet the technical challenges of a grid in transition.

**Table 3.6** Fundamental Changes in Power System Characteristics

Historical	Emerging
<ul style="list-style-type: none"> <li>■ Rotational inertia</li> <li>■ Dispatchable generation</li> <li>■ Passive and predictable loads</li> <li>■ Static transmission and distribution structure</li> </ul>	<ul style="list-style-type: none"> <li>■ Fast dynamics with reduced stability</li> <li>■ Stochastic generation</li> <li>■ Engaged customers</li> <li>■ Adaptive transmission and distribution structure</li> <li>■ Agile and precise control for distributed generation</li> <li>■ Highly efficient, reliable, and resilient system</li> </ul>

**Table 3.7** Summary of RDD&D Opportunities

Area	RDD&D opportunities
Grid design and interoperability	<ul style="list-style-type: none"> <li>■ Development, analysis, and refinement of grid architecture, designs, and associated structures</li> <li>■ Standards to ensure interoperability between various resources and with control systems</li> </ul>
Control systems for transmission and distribution	<ul style="list-style-type: none"> <li>■ Development of advanced software, models, and visualization tools using high-speed data from PMUs and other sensors to provide robust “real-time” monitoring, control, detection, and mitigation of system conditions</li> <li>■ New distribution-level technologies and tools to interpret and visualize data, predict conditions, and enable faster control to ensure reliability and safety</li> <li>■ Innovative control approaches to coordinate and manage distributed resources in conjunction with transmission system operations</li> </ul>
Transmission and distribution components	<ul style="list-style-type: none"> <li>■ Material innovations for high-power, high-frequency, and high-reliability grid applications, including wide bandgap semiconductors</li> <li>■ Component designs, topologies, and systems based on solid-state devices that lead to higher performance, increased reliability, resilience, and lower costs</li> </ul>
Distributed energy resources	<ul style="list-style-type: none"> <li>■ Advanced “smart” technologies (e.g., loads, generators, electric vehicles) with embedded local intelligence, communication, and control capabilities</li> <li>■ Controllers for integrated systems such as smart buildings and microgrids</li> </ul>
Electrical energy storage	<ul style="list-style-type: none"> <li>■ Materials research to lower costs, increase energy density; increase capacity; improve performance; and reduce lifetime impacts, including disposal</li> <li>■ Full system designs that address costs (e.g., subsystem, installation, and integration) along with round-trip efficiencies, cycle life, depth of discharge, ramp rates, and safety</li> <li>■ Solid-state control systems to better integrate storage in the grid</li> </ul>
Planning tools	<ul style="list-style-type: none"> <li>■ High-fidelity models, tools, and simulators that are user-friendly and accessible to decision makers</li> <li>■ Common framework for modeling and co-simulation of tools from disparate technical domains (e.g., power flow, communications, and markets)</li> </ul>
Physical- and cybersecurity	<ul style="list-style-type: none"> <li>■ Tools for nontraditional contingency planning and situational awareness of the security posture, both cyber and physical</li> <li>■ Resilient and adaptive control systems that can survive an incident while sustaining critical functions</li> <li>■ Innovative technologies to assess system trust, identify and eradicate embedded malware, and techniques to validate security of supply chain</li> </ul>

# Chapter 3: Enabling Modernization of the Electric Power System

## Technology Assessments

- 3A** Cyber and Physical Security
- 3B** Designs, Architectures, and Concepts
- 3C** Electric Energy Storage
- 3D** Flexible and Distributed Energy Resources
- 3E** Measurements, Communications, and Control
- 3F** Transmission and Distribution Components

[See online version.]

### Endnotes

- <sup>1</sup> Energy Information Administration. "Monthly Energy Review." DOE/EIA-0035(2015/05), May 2015. Available at: <http://www.eia.gov/mer>.
- <sup>2</sup> Energy Information Administration. "Annual Energy Outlook 2015 with Projections to 2040." DOE/EIA-0383(2015), Washington, DC: EIA. Office of Integrated and International Energy Analysis, April 2015. Accessed August 2015: <http://www.eia.gov/forecasts/aeo/>.
- <sup>3</sup> GridWise Alliance and U.S. Department of Energy (DOE). "The Future of the Grid: Evolving to Meet America's Needs." No. GS-10F-0103J, Subtask J3806.0002. Work performed by Energetics Incorporated, Columbia, MD: DOE, December 2014. Accessed March 27, 2015. Miller, C.; Martin, M.; Pinney, D.; Walker, G. "Achieving a Resilient and Agile Grid." NRECA, April 2014. Edison Electric Institute. "Disruptive Challenges: Financial Implications and Strategic Responses to a Changing Retail Electric Business." Prepared by Peter Kind, January 2013. Available at: <http://www.eei.org/ourissues/finance/documents/disruptivechallenges.pdf>.
- <sup>4</sup> GridWise Alliance and U.S. Department of Energy (DOE). "The Future of the Grid: Evolving to Meet America's Needs. No. GS-10F-0103J, Subtask J3806.0002. Work performed by Energetics Incorporated, Columbia, MD: DOE, December 2014. Accessed March 27, 2015.
- <sup>5</sup> International Energy Agency. "Technology Roadmap: Smart Grid." OECD/IEA. Paris, France, 2011. Accessed March 27, 2015: [http://www.iea.org/publications/freepublications/publication/smartgrids\\_roadmap.pdf](http://www.iea.org/publications/freepublications/publication/smartgrids_roadmap.pdf).
- <sup>6</sup> Electric Power Research Institute. "Estimating the Costs and Benefits of the Smart Grid. 2011. Available at: <http://ipu.msu.edu/programs/MIGrid2011/presentations/pdfs/Reference%20Material%20-%20Estimating%20the%20Costs%20and%20Benefits%20of%20the%20Smart%20Grid.pdf>.
- <sup>7</sup> Droop curves reflect the changes in system frequency on the load.
- <sup>8</sup> U.S. Energy Information Administration. "Monthly Energy Review." February 2015. Available at: <http://www.eia.gov/totalenergy/data/monthly/#electricity>.
- <sup>9</sup> California ISO. "Fast Facts: What the Duck Curve Tells Us About Managing a Green Grid. 2013. Accessed March 27, 2015: [http://www.caiso.com/Documents/FlexibleResourcesHelpRenewables\\_FastFacts.pdf](http://www.caiso.com/Documents/FlexibleResourcesHelpRenewables_FastFacts.pdf).
- <sup>10</sup> One example is as follows: Black and Veatch. "San Diego Distributed Solar PV Impact Study, July 9, 2013." Accessed March 27, 2015: <http://catcher.sandiego.edu/items/usdlaw/pv-impact-study-2013-draft.pdf>.
- <sup>11</sup> Kiefer, T. A. "Ike: Disruptions to Utility Business Models." *T&D World Magazine*, May 15, 2014. Accessed March 27, 2015: <http://tdworld.com/generation-renewables/disruptions-utility-business-models>.
- <sup>12</sup> Solar Energy Industries Association. "Solar Industry Data, December 2014." Accessed March 27, 2015: <http://www.seia.org/research-resources/solar-industry-data>.
- <sup>13</sup> U.S. Energy Information Administration. "Monthly Energy Review: February 2015." Available at: <http://www.eia.gov/totalenergy/data/monthly/>.
- <sup>14</sup> U.S. Department of Energy (DOE). "2014 Smart Grid System Report." Washington, DC, August 2014. Accessed March 27, 2015: <http://energy.gov/sites/prod/files/2014/08/f18/SmartGrid-SystemReport2014.pdf>.
- <sup>15</sup> Accenture. "Achieving High Performance in Smart Grid Data Management." 2010. Accessed March 27, 2015: [https://www.smartgrid.gov/sites/default/files/doc/files/Achieving\\_High\\_Performance\\_in\\_Smart\\_Grid\\_Data\\_Management\\_201012.pdf](https://www.smartgrid.gov/sites/default/files/doc/files/Achieving_High_Performance_in_Smart_Grid_Data_Management_201012.pdf).

- <sup>16</sup> U.S. Department of Energy. “Office of Electricity Delivery and Energy Reliability. Summary of the North American Synchronphasor Initiative (NASPI) Activity Area.” June 2012. Accessed March 27, 2015: <http://www.energy.gov/oe/downloads/north-american-synchronphasor-initiative-naspi-program-information>.
- <sup>17</sup> LaCommare, K.; Eto, J. “Cost of Power Interruptions to Electricity Consumers in the United States.” Ernest Orlando Lawrence Berkeley National Laboratory for the U.S. Department of Energy, 2006. <http://emp.lbl.gov/sites/all/files/REPORT%20lbnl%20-%2058164.pdf>. Lineweber, D.; McNulty, S. “The Cost of Power Disturbances to Industrial & Digital Economy Companies.” Prepared by Primen for the Electric Power Research Institute, 2001.
- <sup>18</sup> Executive Office of the President. “Economic Benefits of Increasing Electric Grid Resilience to Weather Outages.” Prepared by the President’s Council of Economic Advisers and the U.S. Department of Energy Office of Electricity Delivery and Energy Reliability, with assistance from the White House Office of Science and Technology, August 2013. Available at: [http://energy.gov/sites/prod/files/2013/08/f2/Grid%20Resiliency%20Report\\_FINAL.pdf](http://energy.gov/sites/prod/files/2013/08/f2/Grid%20Resiliency%20Report_FINAL.pdf).
- <sup>19</sup> U.S.-Canada Power System Outage Task Force. “Final Report on the August 14, 2003, Blackout in the United States and Canada: Causes and Recommendations.” April 2004. Accessed March 27, 2015: <http://energy.gov/sites/prod/files/oeprod/DocumentsandMedia/BlackoutFinal-Web.pdf>.
- <sup>20</sup> U.S. Department of Energy and the North American Electric Reliability Corporation. “High-Impact, Low-Frequency Event Risk to the North American Bulk Power System.” June 2010.
- <sup>21</sup> Global Environment Fund and Center for Smart Energy. “The Emerging Smart Grid: Investment and Entrepreneurial Potential in the Electric Power Grid of the Future.” October 2005. Available at: [http://assets.fiercemarkets.net/public/smartgridnews/sgnr\\_2007\\_0801.pdf](http://assets.fiercemarkets.net/public/smartgridnews/sgnr_2007_0801.pdf).
- <sup>22</sup> Monitoring Analytics. “2012 Quarterly State of the Market Report for PJM: January through March.” Section 10: “Congestion and Marginal Losses.” 2012; pp. 167-188. Accessed March 27, 2015: [http://www.monitoringanalytics.com/reports/PJM\\_State\\_of\\_the\\_Market/2012/2012q1-som-pjm-sec10.pdf](http://www.monitoringanalytics.com/reports/PJM_State_of_the_Market/2012/2012q1-som-pjm-sec10.pdf). Monitoring Analytics. “2014 State of the Market Report for PJM.” March 2015, p. 397. Accessed May 2015: [http://www.monitoringanalytics.com/reports/PJM\\_State\\_of\\_the\\_Market/2014/2014-som-pjm-volume2-sec11.pdf](http://www.monitoringanalytics.com/reports/PJM_State_of_the_Market/2014/2014-som-pjm-volume2-sec11.pdf).
- <sup>23</sup> U.S.-Canada Power System Outage Task Force. “Final Report on the August 14, 2003, Blackout in the United States and Canada: Causes and Recommendations.” April 2004. Accessed March 27, 2015: <http://energy.gov/sites/prod/files/oeprod/DocumentsandMedia/BlackoutFinal-Web.pdf>.
- <sup>24</sup> U.S. Department of Energy. “Office of Electricity Delivery and Energy Reliability, Synchronphasor Technologies & their Deployment in the Recovery Act Smart Grid Programs. August 2013, p. 2. Accessed March 27, 2015: [https://www.smartgrid.gov/sites/default/files/doc/files/Synchronphasor%20Report%2008%2009%202013%20DOE%20%282%29%20version\\_0.pdf](https://www.smartgrid.gov/sites/default/files/doc/files/Synchronphasor%20Report%2008%2009%202013%20DOE%20%282%29%20version_0.pdf).
- <sup>25</sup> Staffs of the Federal Energy Regulatory Commission and North American Electric Reliability Corporation. “Arizona-Southern California Outages on September 8, 2011: Causes and Recommendations.” April 2012, Staff Report. Available at: <http://www.ferc.gov/legal/staff-reports/04-27-2012-ferc-nerc-report.pdf>.
- <sup>26</sup> U.S. Department of Energy, Office of Electricity Delivery and Energy Reliability. “Synchronphasor Technologies & Their Deployment in the Recovery Act Smart Grid Programs.” August 2013. Accessed March 27, 2015: [https://www.smartgrid.gov/sites/default/files/doc/files/Synchronphasor%20Report%2008%2009%202013%20DOE%20%282%29%20version\\_0.pdf](https://www.smartgrid.gov/sites/default/files/doc/files/Synchronphasor%20Report%2008%2009%202013%20DOE%20%282%29%20version_0.pdf).
- <sup>27</sup> North American Electric Reliability Corporation. “Real-Time Application of Synchronphasors for Improving Reliability.” October 2010. Available at: <http://www.nerc.com/docs/oc/rapirtf/RAPIR%20final%20101710.pdf>.
- <sup>28</sup> California Independent System Operator. “Demand Response and Energy Efficiency Roadmap: Maximizing Preferred Resources.” December 2013. Available at: <http://www.caiso.com/Documents/DR-EERoadmap.pdf>.
- <sup>29</sup> Additional details associated with American Recovery and Reinvestment Smart Grid Investment Grants are available at [www.smartgrid.gov](http://www.smartgrid.gov).
- <sup>30</sup> U.S. Energy Information Administration. “Today in Energy: Natural Gas and Renewable Shares of Electricity Generation to Grow, Coal Still Largest.” February 10, 2012. <http://www.eia.gov/todayinenergy/detail.cfm?id=4950>.
- <sup>31</sup> North American Electric Reliability Corporation. “Potential Bulk System Reliability Impacts of Distributed Resources.” August 2011. Available at: [http://www.nerc.com/docs/pc/ivgtf/IVGTF\\_TF-1-8\\_Reliability-Impact-Distributed-Resources\\_Final-Draft\\_2011.pdf](http://www.nerc.com/docs/pc/ivgtf/IVGTF_TF-1-8_Reliability-Impact-Distributed-Resources_Final-Draft_2011.pdf).
- <sup>32</sup> Miller, C.; Martin, M.; Pinney, D.; Walker, G. “Achieving a Resilient and Agile Grid.” NRECA Cooperative Research Network, April 2014, version 1.0. Available at: [http://www.nreca.coop/wp-content/uploads/2014/05/Achieving\\_a\\_Resilient\\_and\\_Agile\\_Grid.pdf](http://www.nreca.coop/wp-content/uploads/2014/05/Achieving_a_Resilient_and_Agile_Grid.pdf).
- <sup>33</sup> The Edison Foundation Institute for Electric Innovation. “Utility-Scale Smart Meter Deployments, Plans, and Proposals.” May 2012. Available at: [http://www.edisonfoundation.net/iee/documents/iee\\_smartmeterrollouts\\_0512.pdf](http://www.edisonfoundation.net/iee/documents/iee_smartmeterrollouts_0512.pdf).
- <sup>34</sup> U.S. Department of Energy. “Demand Response Defers Investment in New Power Plants in Oklahoma.” April 2013. Available at: <https://www.smartgrid.gov/sites/default/files/doc/files/OGE%20CBS%20case%20study.pdf>.
- <sup>35</sup> U.S. Department of Energy. “Office of Electricity Delivery and Energy Reliability, Synchronphasor Technologies & Their Deployment in the Recovery Act Smart Grid Programs.” August 2013, p. 2. Accessed March 27, 2015: [https://www.smartgrid.gov/sites/default/files/doc/files/Synchronphasor%20Report%2008%2009%202013%20DOE%20%282%29%20version\\_0.pdf](https://www.smartgrid.gov/sites/default/files/doc/files/Synchronphasor%20Report%2008%2009%202013%20DOE%20%282%29%20version_0.pdf).
- <sup>36</sup> North American Synchronphasor Initiative (NASPI). “PMUs and Synchronphasor Data Flows in North America, as of March 19, 2014.” p. 5. Accessed March 27, 2015: [https://www.smartgrid.gov/sites/default/files/doc/files/naspi\\_pmu\\_data\\_flows\\_map\\_20140325.pdf](https://www.smartgrid.gov/sites/default/files/doc/files/naspi_pmu_data_flows_map_20140325.pdf).
- <sup>37</sup> For detailed RE applications for synchronphasors, see U.S. Department of Energy, Office of Electricity Delivery and Energy Reliability, and North American Synchronphasor Initiative (NASPI), “NASPI Technical Report—Synchronphasor Technology and Renewables Integration.” June 7, 2012. Accessed March 27, 2015: [https://www.smartgrid.gov/sites/default/files/doc/files/NASPI-NREL\\_renewables\\_integration\\_with\\_synchronphasors.pdf](https://www.smartgrid.gov/sites/default/files/doc/files/NASPI-NREL_renewables_integration_with_synchronphasors.pdf).

- <sup>38</sup> U.S. Department of Energy. “Synchrophasor Technologies & Their Deployment in the Recovery Act Smart Grid Programs.” August 2013, p. 6. Available at: [https://www.smartgrid.gov/document/synchrophasor\\_technologies\\_and\\_their\\_deployment\\_recovery\\_act\\_smart\\_grid\\_programs](https://www.smartgrid.gov/document/synchrophasor_technologies_and_their_deployment_recovery_act_smart_grid_programs).
- <sup>39</sup> Southern California Edison. “Technology Performance Report #1—Irvine Smart Grid Demonstration: A Regional Smart Grid Demonstration Project.” Available at: [https://www.smartgrid.gov/sites/default/files/doc/files/SCE-ISGD-TPR-1\\_Final.pdf](https://www.smartgrid.gov/sites/default/files/doc/files/SCE-ISGD-TPR-1_Final.pdf).
- <sup>40</sup> U.S. Department of Energy, Office of Electricity Delivery and Energy Reliability. “Smart Grid Investment Grant Program: Application of Automated Controls for Voltage and Reactive Power Management—Initial Results.” December 2012. Accessed March 27, 2015: <https://www.smartgrid.gov/sites/default/files/doc/files/VVO%20Report%20-%20Final.pdf>.
- <sup>41</sup> GridWise Architecture Council. “GridWise Transactive Energy Framework Version 1.1.” January 2015. Accessed March 27, 2015: [http://www.gridwiseac.org/pdfs/te\\_framework\\_report\\_pnnl-22946.pdf](http://www.gridwiseac.org/pdfs/te_framework_report_pnnl-22946.pdf).
- <sup>42</sup> Ibid.
- <sup>43</sup> Southern California Edison. “Technology Performance Report #1—Irvine Smart Grid Demonstration: A Regional Smart Grid Demonstration Project.” p. 70. Available at: [https://www.smartgrid.gov/sites/default/files/doc/files/SCE-ISGD-TPR-1\\_Final.pdf](https://www.smartgrid.gov/sites/default/files/doc/files/SCE-ISGD-TPR-1_Final.pdf).
- <sup>44</sup> ABB. “Power Transformers: Built for Reliability and Efficiency.” 2011. Available at: [http://www05.abb.com/global/scot/scot252.nsf/veritydisplay/a2492a9e17a69c1a83257984002ada63/\\$file/Global\\_low%20res.pdf](http://www05.abb.com/global/scot/scot252.nsf/veritydisplay/a2492a9e17a69c1a83257984002ada63/$file/Global_low%20res.pdf).
- <sup>45</sup> U.S. Department of Energy, Office of Electricity Delivery and Energy Reliability. “Large Power Transformers and the U.S. Electric Grid. April 2014, Update. Accessed March 27, 2015: <http://energy.gov/sites/prod/files/2014/04/f15/LPTStudyUpdate-040914.pdf>.
- <sup>46</sup> Rathod, D. K. “Solid State Transformer (SST) Review of Recent Developments.” *Advance in Electronic and Electric Engineering*, ISSN 2231-1297, (4:1), 2014; pp. 45-50. Accessed March 27, 2015: [http://www.ripublication.com/aeer\\_spl/aeer4n1spl\\_07.pdf](http://www.ripublication.com/aeer_spl/aeer4n1spl_07.pdf).
- <sup>47</sup> MarketsandMarkets, “Solid State (Smart) Transformer Market is expected to reach \$5,043.39 million at CAGR of 82.3% by 2020.” PRWeb, February 23, 2013. Accessed March 27, 2015: <http://www.prweb.com/releases/solid-state-smart/transformer-market/prweb10458931.htm>.
- <sup>48</sup> Fairley, P. “Flexible AC Transmission: The FACTS Machine.” *IEEE Spectrum*, December 30, 2010. Accessed March 27, 2015: <http://spectrum.ieee.org/energy/the-smarter-grid/flexible-ac-transmission-the-facts-machine>.
- <sup>49</sup> Electric Power Research Institute (EPRI). “Superconducting Fault Current Limiters: Technology Watch 2009.” EPRI, Palo Alto, CA, 2009. 1017793. Accessed March 27, 2015: <http://www.smartgridnews.com/artman/uploads/1/000000000001017793.pdf>.
- <sup>50</sup> U.S. Energy Information Administration. “Frequently Asked Questions: How Much Electricity Is Lost in Transmission and Distribution in the United States?” Last Updated: May 7, 2014. Accessed March 27, 2015: <http://www.eia.gov/tools/faqs/faq.cfm?id=105&t=3>.
- <sup>51</sup> Hjortstam, O.; et al. “Can We Achieve Ultra-Low Resistivity in Carbon Nanotube-Based Metal Composites?” *Appl. Phys. A* (78), 2004; p. 1175.
- <sup>52</sup> American Superconductor (AMSC). “Superconductor Cable Systems.” 2013. Accessed March 27, 2015: [http://www.amsc.com/gridtec/superconductor\\_cable\\_systems.html](http://www.amsc.com/gridtec/superconductor_cable_systems.html).
- <sup>53</sup> Ruth, M. F.; Kroposki, B. “Energy Systems Integration: An Evolving Energy Paradigm.” *The Electricity Journal* (27:6), July 2014; pp. 36–47. Accessed March 27, 2015: <http://www.sciencedirect.com/science/article/pii/S1040619014001195#vt0010>.
- <sup>54</sup> Argonne National Laboratory. “Smart Grid EV Communication Module.” Accessed March 27, 2015: <http://www.anl.gov/technology/project/smart-grid-ev-communication-module>.
- <sup>55</sup> Basu, C.; Ghatikar, G.; Bansal, P. “Enabling Efficient, Responsive, and Resilient Buildings: A Collaboration Between the United States and India.” Presented and published at the IEEE Proceedings on Smart Grid and the New Energy Economy, Chicago, IL, September 2013. LBNL-6594E.
- <sup>56</sup> DOE Microgrid Exchange Group. “Microgrid Definition.” October 2010.
- <sup>57</sup> Sandia National Laboratories. “DOE/EPRI, 2013 Electricity Storage Handbook in Collaboration with NRECA.” SAND2013-5131, Albuquerque, NM, and Livermore, CA: July 2013. Accessed March 27, 2015: <http://energy.gov/sites/prod/files/2013/08/f2/ElecStorageHndbk2013.pdf>.
- <sup>58</sup> Sandia National Laboratories. “DOE/EPRI, 2013 Electricity Storage Handbook in Collaboration with NRECA.” SAND2013-5131, Albuquerque, NM, and Livermore, CA: July 2013. Accessed March 27, 2015: <http://energy.gov/sites/prod/files/2013/08/f2/ElecStorageHndbk2013.pdf>.
- <sup>59</sup> Yang, C.-J.; Jackson, R. B. “Opportunities and Barriers to Pumped-hydro Energy Storage in the United States.” *Renewable and Sustainable Energy Reviews* (15: 1), 2011; pp. 839-844.
- <sup>60</sup> Sandia National Laboratories. “DOE/EPRI, 2013 Electricity Storage Handbook in Collaboration with NRECA.” SAND2013-5131, Albuquerque, NM, and Livermore, CA, July 2013. Accessed March 27, 2015: <http://energy.gov/sites/prod/files/2013/08/f2/ElecStorageHndbk2013.pdf>.
- <sup>61</sup> Leonard, K.C. “Ultracapacitors for Off-Grid Solar Energy Applications.” SolRayo, LLC. Available at: [http://www.solrayo.com/SolRayo/Off-Grid\\_Solar\\_Energy\\_Applications\\_files/Ultracapacitors%20for%20Off-Grid%20Solar%20Applications.pdf](http://www.solrayo.com/SolRayo/Off-Grid_Solar_Energy_Applications_files/Ultracapacitors%20for%20Off-Grid%20Solar%20Applications.pdf).
- <sup>62</sup> Steward, D.; Saur, G.; Penev, M.; Ramsden, T. “Lifecycle Cost Analysis of Hydrogen versus Other Technologies for Electrical Energy Storage.” National Renewable Energy Lab, Technical Report NREL/TP-560-46719, November 2009.
- <sup>63</sup> von Meier, A. “The Supple Grid: Challenges and Opportunities for Integrating Renewable Generation.” Presented at the UC Center Sacramento, May 9, 2013. Accessed March 27, 2015: [http://ucss.ucdavis.edu/VonMeier\\_SuppleGrid\\_5\\_9\\_13.pdf](http://ucss.ucdavis.edu/VonMeier_SuppleGrid_5_9_13.pdf).
- <sup>64</sup> Kalsi, K.; Fuller, J. C.; Tuffner, F. K.; Lian, J.; Zhang, W.; Marinovici, L. D.; Fisher, A. R.; Chassin, F. C.; Hauer, M. L. “Integrated Transmission and Distribution Control.” No. PNNL-22157. Pacific Northwest National Laboratory (PNNL), Richland, WA (US), 2013.

- <sup>65</sup> Eaton. “Power Outage Annual Report: Blackout Tracker: United States Annual Report 2014.” Available at: [www.eaton.com/blackouttracker](http://www.eaton.com/blackouttracker).
- <sup>66</sup> U.S. Government Accountability Office. “Transmission Lines: Issues Associated with High-Voltage Direct-Current Transmission Lines Along Transportation Rights of Way.” GAO-08-347R. Published February 1, 2008. Publicly Released February 1, 2008. Accessed March 27, 2015: <http://www.gao.gov/products/GAO-08-347R>.
- <sup>67</sup> Energy Sector Control Systems Working Group. “Roadmap to Achieve Energy Delivery Systems Cybersecurity.” September 2011. Accessed March 27, 2015: [http://energy.gov/sites/prod/files/Energy%20Delivery%20Systems%20Cybersecurity%20Roadmap\\_finalweb.pdf](http://energy.gov/sites/prod/files/Energy%20Delivery%20Systems%20Cybersecurity%20Roadmap_finalweb.pdf).
- <sup>68</sup> Energy Sector Control Working Group. “Interactive Energy Roadmap to Achieve Energy Delivery Systems Cybersecurity.” 2015. Accessed March 27, 2015: <https://www.controlsroadmap.net/Pages/default.aspx>.
- <sup>69</sup> North American Electric Reliability Corporation and the U.S. Department of Energy. “High-Impact, Low-Frequency Event Risk to the North American Bulk Power System.” June 2010. Accessed March 27, 2015: <http://energy.gov/sites/prod/files/High-Impact%20Low-Frequency%20Event%20Risk%20to%20the%20North%20American%20Bulk%20Power%20System%20-%202010.pdf>.
- <sup>70</sup> North American Electricity Reliability Corporation. “Severe Impact Resilience Task Force, Severe Impact Resilience: Considerations and Recommendations.” May 9, 2012. Accessed March 27, 2015: [http://www.nerc.com/docs/oc/sirtf/SIRTF\\_Final\\_May\\_9\\_2012-Board\\_Accepted.pdf](http://www.nerc.com/docs/oc/sirtf/SIRTF_Final_May_9_2012-Board_Accepted.pdf).
- <sup>71</sup> Dvorak, P. “How Standardized Power Transformers Step up More than Voltage for Wind Farms.” Wind Power Engineering & Development, June 26, 2014. Accessed March 27, 2015: <http://www.windpowerengineering.com/construction/transportation/standardized-power-transformers-step-voltage-wind-farms/>.
- <sup>72</sup> U.S. Department of Energy. “Benefits of Using Mobile Transformers and Mobile Substations for Rapidly Restoring Electrical Service.” August 2006.



