

Building America Special Research Project: High-R Walls Case Study Analysis

Research Report - 0903

March 11, 2009 (Rev. June 8, 2011)

John Straube and Jonathan Smegal

Abstract:

Many concerns, including the rising cost of energy, climate change concerns, and demands for increased comfort, have lead to the desire for increased insulation levels in many new and existing buildings. More building codes are being modified to require higher levels of thermal control than ever before. This report considers a number of promising wall systems that can meet the requirement for better thermal control. Unlike previous studies, this one considers performance in a more realistic matter, including some true three-dimensional heat flow and the relative risk of moisture damage.



Building America Special Research Project a High-R Walls Case Study Analysis a

2009 08 07 P,

Rev. 2011 06 08 P,

P,

P,

P,

P,

P,

P,

P,

P,

P,

Jonathan Smegal MASC
John Straube, PhD, P,Eng ,

,

,

,

,

,

,

,

,

Building Science Corporation ,
30 Forest Street ,
Somerville, MA 02143 ,

www.buildingscience.com ,

,

Table of Contents

- A. Introduction 1
 - 1. Objective..... 1
 - 2. Scope..... 2
 - 3. Approach..... 2
- B. Analysis 2
 - 1. Wall Assemblies Reviewed..... 2
 - 2. Analysis Criteria..... 2
 - 2.1 Heat flow analysis 3
 - 2.2 Hygrothermal Analysis 9
 - 2.3 Enclosure Durability 27
 - 2.4 Buildability..... 27
 - 2.5 Material Use 28
 - 2.6 Cost o 28
- C. Results 28
 - 1. Case 1: Standard Construction Practice..... 28
 - 1.2 Case 2: Advanced framing with insulated sheathing..... 31
 - 1.3 Case 3: Interior 2x3 horizontal strapping..... 34
 - 1.4 Case 4: Double Stud 37
 - 1.5 Case 5: Truss Wall 40
 - 1.6 Case 6: Structural Insulated Panel Systems (SIPs) 43
 - 1.7 Case 7: Insulated Concrete Forms (ICFs)..... 45
 - 1.8 Case 8: Advanced framing with spray foam..... 48
 - 1.9 Case 9: Hybrid Wall Insulation – Flash and Fill..... 50
 - 1.10 Case 10: Double Stud Wall with Spray Foam..... 53
 - 1.11 Case 11: Offset Frame Wall with Exterior Spray Foam 55
 - 1.12 Case 12: Exterior Insulation Finish System (EIFS) 58
- D. Conclusions..... 61
- E. Works Cited..... 65

A. Introduction

Many concerns, including the rising cost of energy, climate change concerns, and demands for increased m comfort, have lead to the desire for increased insulation levels in many new and existing buildings. More m building codes are being modified to require higher levels of thermal control than ever before. This report m considers a number of promising wall systems that can meet the requirement for better thermal control. m Unlike previous studies, this one considers performance in a more realistic matter, including some true three-m dimensional heat flow and the relative risk of moisture damage. m

In some cases, increasing the quantity of insulation may result in an increased risk of moisture-related issues m when the exterior surfaces of the enclosure are kept colder in cold weather, and the interior surfaces are kept m cooler in warm weather. This may result in increased condensation, and increased freeze thaw potential or m decay potential of the assembly in different situations. Analysis is required to predict the potential m hygrothermal risks due to increasing the amount of insulation (R-value) in the enclosure. m

High R-values for framed wall assemblies are defined here as ranging from approximately R18 to R40 and m above depending on the geographic location and climate conditions. A high R-value wall in the south will be m considerably less than a high R-value in a cold climate. The analysis in this report includes a sum m mary of m historical wall construction types and R-values, current construction strategies, as well as walls that will m likely become popular in the future based on considerations such as energy and material availability. m

Previous work, largely stemming from research in the 1970's and 1980's, involved postulating newer m assemblies with improved R-values. R-value was, and often still is, defined as the "clear wall" R-value (no m framing effects accounted for) or the total amount of insulation installed in the assembly. The increased m moisture risks were rarely considered. m

A study currently being conducted by the National Research Council of Canada (NRC) is investigating and m developing durable and energy efficient wall assemblies for Northern Canada. In the first stage of the NRC m study, meetings with the northern com m unities and investigations of the houses were conducted. A m literature review covering selection criteria for possible envelope assemblies in Northern Canada, current m wall systems and systems to consider was written (Saïd 2006). Walls are currently undergoing extreme m temperature testing in the NRC laboratory in Ottawa, Canada. All of the walls being tested by the NRC are m constructed with a polyethylene air and vapor barrier and none of the walls are constructed with exterior m insulation (Rousseau, et al. 2008). m

The Cold Climate Housing Research Center (CCHRC) of Alaska has conducted field monitoring tests on m different wall systems, specifically to assess the moisture-related performance of high performance wall m systems. Several tests were conducted on a test hut at the University of Alaska Southeast, in Juneau AK (8574 m HDD65 or 4763 HDD18) (Smegal and Straube 2006), and others were conducted on the CCHRC main office m building in Fairbanks Alaska (13980 HDD65 or 7767 HDD18) constructed in 2007. Streaming data and wall m drawings can be viewed on the CCHRC website showing the thermal performance of the wall systems (CCHRC m 2007). CCHRC also successfully completed construction of a high R-value house as part of the Building m American program in Haida, Am and the report can be found online (BSC 2008). m

Some of the walls for this high R-value study were chosen based on the literature review of the NRC report, m and references to construction techniques from both the NRC and CCHRC will be made throughout this m report. Some walls have been built by niche builders since the early 1980's. m

1. OBJECTIVE

The objective of this study is to identify highly-insulated building enclosure wall systems based on selected m criteria, resulting in a durable affordable, and resource efficient enclosure that provides a comfortable living m environment in different climate zones. This report will present the analysis of different enclosure wall m strategies and present their advantages and disadvantages according to several comparison criteria. m

2. SCOPE

This study is limited to wall systems for cold climates. Further studies should be conducted to address other components of the building enclosure such as roofs and foundations. In general, only cold climates are considered in this report since enclosures in cold climates benefit the greatest from a highly insulated building enclosure, but important conclusions can also be drawn for other climate zones.

3. APPROACH

This study examines thermal and moisture control, durability, buildability, cost and material use. The quantitative analysis for each wall system is based on a two-dimensional steady-state heat flow modeling program and a one-dimensional dynamic heat and moisture (hygrothermal) model. Minneapolis, MN in IECC climate Zone 6 was used as the representative cold climate for most of the modeling, because of the cold winter weather, and fairly warm and humid summer months. In cold climates, a building's enclosure is often the most important factor limiting heat loss, both in terms of insulation and air tightness.

B. Analysis

1. WALL ASSEMBLIES REVIEWED

Because there are a number of variables possible for each possible wall system depending on the local practices, climate, and architect or general contractor preferences, an attempt was made to choose the most common wall systems and make notes and comments about other alternatives during analysis. This list of chosen systems is explained in more detail in the analysis section for each wall system.

- Case 1a : Standard Construction Practice with 2x6 framing
- Case 1b : Standard Construction Practice with 2x4 framing
- Case 2a : Advanced Framing with 1" of XPS insulated sheathing
- Case 2b : Advanced Framing with 4" of XPS insulated sheathing
- Case 3 : Interior 2x3 horizontal strapping
- Case 4 : Double Stud
- Case 5 : Truss Wall
- Case 6 : Structural Insulated Panel Systems (SIPs)
- Case 7 : Insulated Concrete Forms (ICFs)
- Case 8a : Advanced Framing with low density (0.5 pcf) spray foam
- Case 8b : Advanced Framing with high density (2.0 pcf) spray foam
- Case 9: Hybrid system with high density (2.0 pcf) (Flash and Fill) spray foam and fibrous insulation
- Case 10: Double Stud wall with 2" of high density (2.0 pcf) spray foam and fibrous insulation
- Case 11: Exterior high density (2.0 pcf) (Offset Frame Wall) spray foam with fibrous cavity insulation
- Case 12: Exterior Insulation Finish System (EIFS)

2. ANALYSIS CRITERIA

A comparison matrix will be used to quantitatively compare all of the different wall system strategies. A value between 1 (poor performance) and 5 (excellent performance) will be assigned, upon review of the analysis, to each of the comparison criteria for each wall. An empty comparison matrix is shown below in Table 1 as an example.

Table 1: Criteria comparison matrix

	Thermal Control	Durability (wetting/drying)	Buildability	Cost	Material Use	Total
Criteria Weighting	1	1	1	1	1	
Case 1: Standard Construction						
Case 2: Advanced Framing with Insulated Shtg						
Case 3: Interior Strapping						
Case 4: Double Stud						
Case 5: Truss Wall						
Case 6: SIPs						
Case 7: ICF						
Case 8: Sprayfoam						
Case 9: Flash and Fill (2" spuf and cell.)						
Case10: Double stud with 2" spray foam and cell.						
Case 11: Offset Framing (ext. Spray foam insul.)						
Case 12: EIFS with fibrous fill in space						

The criteria scores will be summed for each test wall, and the walls with the highest scores are the preferred options assuming all of the comparison criteria are weighted equally. It is also possible to weight the different comparison criteria asymmetrically depending on the circumstances surrounding a particular wall design. The weightings for each wall will fall between 1 (least important) and 5 (most important). The weighting is multiplied by the comparison criteria score and added to other weighted values. An example of the weighted conclusion matrix will be shown in the Conclusions section.

One of the benefits of using a comparison matrix is that it allows a quantitative comparison when some of the criteria, such as cost may be poorly defined or highly variable. For example, even though the exact costs of different insulations may be uncertain, fiberglass batt insulation is always less expensive than low density (0.5 pcf) spray foam which is less expensive than high density (2.0 pcf) spray foam, so these systems can be ranked accordingly regardless of the actual costs.

2.1 Heat flow analysis

Two dimensional heat flow analysis was conducted for each test wall using Therm 5.2, a two-dimensional steady-state finite element software package developed by the Lawrence Berkeley National Laboratory at the University of California. Therm was used to calculate the thermal performance of each of the different proposed assemblies including thermal bridging effects.

In many cases, it is generally assumed that installing an R13 fiberglass batt into a 2x4 stud wall leads to wall performance of R13. This does not take into account thermal bridging of the wall framing including the studs, rim joist and top and bottom plates which allows heat to bypass the insulation decreasing the whole wall R-value. Therm can predict the impact of thermal bridging and determine a whole wall R-value that considers the rim joist, wall framing and top plate(s).

The effect of thermal bridging and different framing details requires a metric more complex than just a single R -value to allow for meaningful comparisons. Five R -values have been and are used in the building industry. Oak Ridge National Labs (ORNL) proposed a number of definitions in (Christian and Kosny 1995). We have found it useful to add some and extend their definitions.

1. Installed Insulation R -value

This R -value is commonly referenced in building codes and used by industry. This is simply the R -value labeled on the product installed in the assembly.

2. Center-of-Cavity R -value

The R -value at a line through an assembly that contains the most insulation, and the least framing, typically, the middle of a stud-bay in framed construction.

3. Clear wall R -value

R -value of an assembly containing only insulation and minimum necessary framing materials at a clear section with no windows, corners, columns, architectural details, or interfaces with roofs, foundations or other walls.

4. Whole-wall R -value

R -value for the whole opaque assembly including all additional structural elements (such as double studs), and typical enclosure interface details, including wall/wall (corners), wall/roof, wall/floor, wall/door, and wall/window connections.

5. True R -value

The R -value of an enclosure assembly that includes all thermal bridging, air leakage, wind washing, convective loops, radiation enhancements, thermal and hygric mass, and installation defects.

Each of these measures is progressively more realistic. The True R -value is very difficult to measure without field samples.

The whole-wall R -value will be approximated in this analysis. To accurately calculate this whole-wall R -value, the wall in question was divided into three sections, modeled individually, and then the results were combined with a weighted average.

The R -value of the wall section was simulated in plan view to best represent the thermal bridging effects of wall studs as shown in Figure 1. This section is similar to a clear-wall R -value except that the studs are placed closer together to more accurately represent actual numbers of wood framing elements used in real wall systems. The height of the wall section for simulation purposes is 92 inches.

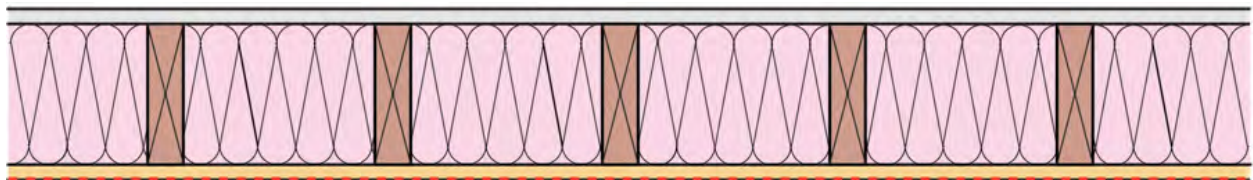

Figure 1 : Plan view of wall section for Therm simulation

The top plate was simulated in section view to assess the importance of the thermal bridging of the top plate(s). This section was eight inches in height since the thermal effect of the top plate will influence the effectiveness of the cavity insulation in its vicinity. The U -value of this detail was calculated over the entire height as indicated by the red dashed line in Figure 2.

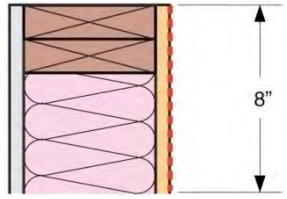

Figure 2: Top plate simulation with 8" of wall

The rim joist was also simulated in a vertical section to take into account the thermal bridging effects of the , bottom plate, sill plate, floor sheathing and rim joist. It was simulated with eight inches of wall above the , floor sheathing to take into account any changes in the insulation caused by thermal bridging effects. ,

The concrete foundation was included beneath the rim joist to determine the effects of the interface between , the foundation and wood framing, but the concrete was not included in the R-value calculation as indicated , by the red dashed line in Figure 3.

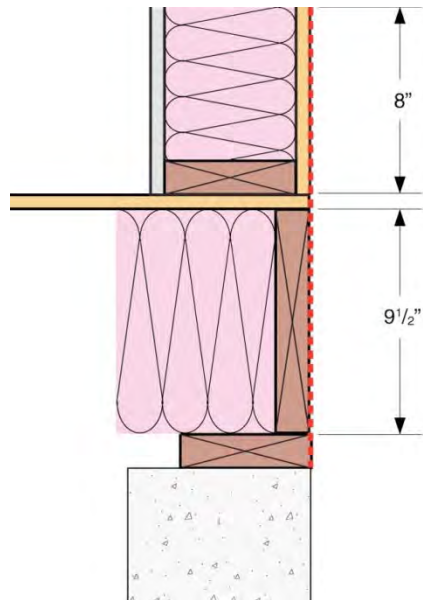

Figure 3 : Rim joist simulation with 8" of wall

Although Therm is a two-dimensional modeling software it was used to model three-dimensional geometries. , For example, at the rim joist, there are floor joists connected to the rim joist alternating with pockets of , insulation. When this is drawn and modeled in plan view (Figure 4), the effective R-value of just this section , through the assembly can , be determined. ,

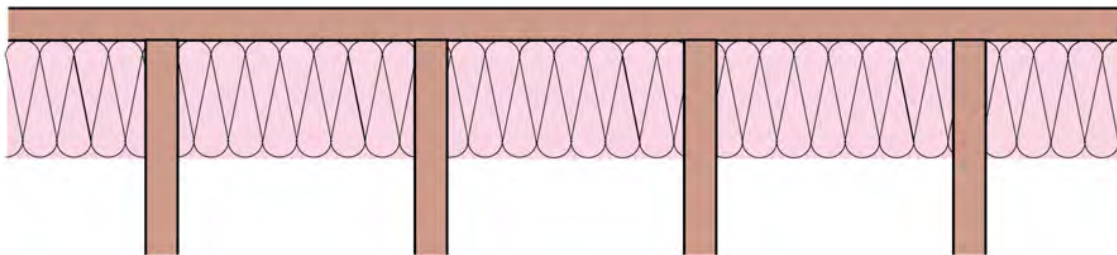

Figure 4 : Plan section of rim joist, floor joists, and fiberglass batt insulation

A fictitious material is then made in the Therm library that has the effective thermal properties of the insulation and floor joists and used in the section profile for modeling of the rim joist system (shown in red in Figure 3).

Once the R-values are calculated for all three sections of a wall system, The Whole Wall R-value is calculated by taking the weighted average of the individual components as shown in the equation below. The total wall height from the bottom plate to the top plate is nine feet.

Total wall R-value = R-value top plate x height of top plate over all wall height + R-value of rim joist x height of rim joist over all wall height +

R-value of wall section x h / overall wall height x

One drawback of Therm is that it cannot accurately represent air leakage and insulation installation defects, both of which can significantly lower the effective R-value of the assembly by bypassing the insulation in the wall system. There are four main ways in which air leakage affects interact with the enclosure as shown in Figure 5.

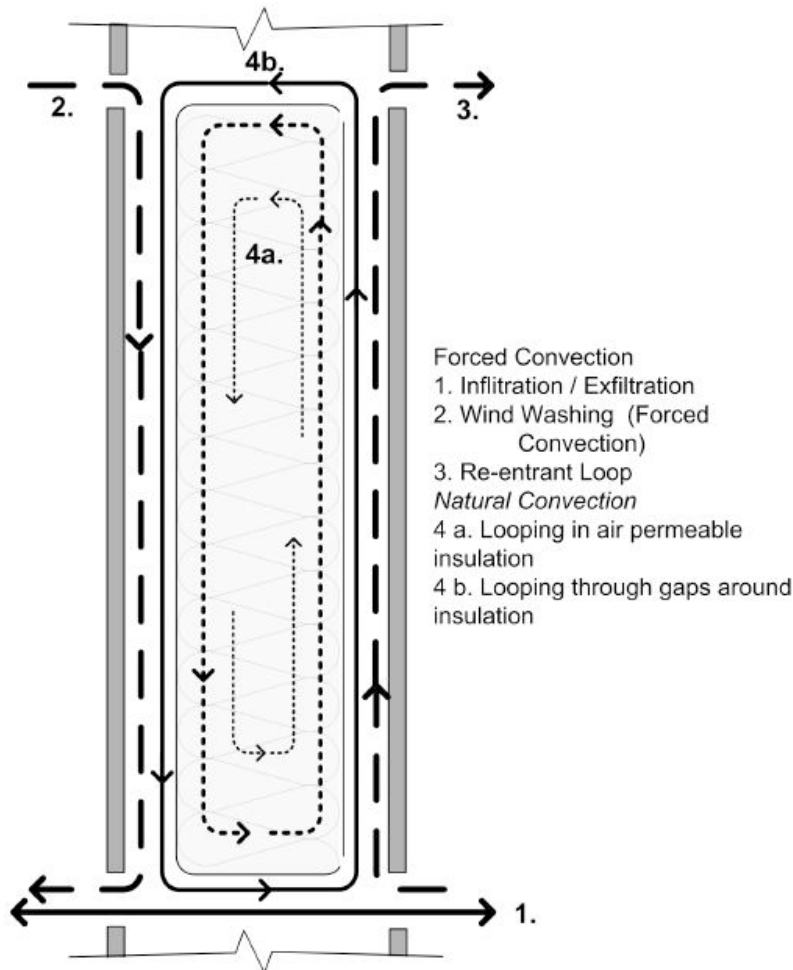

Figure 5 : Common Convective Heat Flow Paths in Enclosures

One of the most common areas for air leakage is at the rim joist where fiberglass batts are often stuffed into the cavities between the ceiling joists. In houses that are constructed using this method it is quite common to feel air leakage through the assembly at the rim joist bypassing the insulation even without imposing a

pressure difference across the enclosure. Air tightness of the building enclosure has begun to improve in cold climates for the most part to address occupancy comfort issues and contractor call-backs.

Both cellulose and fiberglass batt insulation have similar R-values per inch according to ASTM's testing standards, but in practice, standard installation for both fiberglass batt and cellulose generally result in higher installed R-values for cellulose compared to fiberglass batt. Fiberglass batts are almost always installed with air gaps against either the drywall or exterior sheathing and fiberglass installers are generally not careful installing fiberglass batts, leading to air gaps around plumbing, electrical and other obstacles in the stud space. These air gaps can lead to convective looping in the stud space as well as poorly insulated locations resulting in cold spots around obstacles that could increase the risk of moisture condensation.

Cellulose installation is blown into place, and fills the entire stud space between the exterior sheathing and drywall, around all obstacles without leaving air gaps. Cellulose has also been shown to have better convection suppression resulting in less convective looping and, in some studies, tighter building enclosures. Neither cellulose nor fiberglass batt is an air barrier, so an air barrier should always be used with either insulation.

Since air leakage cannot be simulated using Therm, the increased convective looping and air movement around poorly installed batt insulation relative to cellulose insulation, and to a lesser extent blown-in or sprayed fiberglass cannot be captured numerically in this study. Also, the convection suppression through the cellulose insulation relative to the fiberglass batt insulation cannot be fully appreciated using this analysis.

All of the Therm analysis were conducted with an interior temperature of 20°C (68°F) and an exterior temperature of -20°C (-4°F) so the results could be compared. Because the R-value is a weak function of the temperature difference across the enclosure, the results may vary slightly for different temperatures.

A list of some of the most common materials and their respective conductivities used in the two dimensional Therm analysis are shown in Table 2. Where there was some discrepancy in the choice of conductivity that should be used for modeling, values from the ASHRAE Handbook of Fundamentals were selected.

Film conductance values of 8.3 W/m²K for the interior surface and 34.0 W/m²K for the exterior surface were used for all Therm simulations.

Table 2 : Conductivity values used for two dimensional heat flow analysis

Enclosure Component	Thermal Conductivity k [W/mK]	R-value per inch [hr·°F·ft ² /Btu]
R8 Fiberglass Batt (2.5")	0.045	3.1
R13 Fiberglass Batt (3.5")	0.039	3.7
R19 Fiberglass Batt (5.5")	0.042	3.4
Extruded Polystyrene (XPS)	0.029	4.9
Expanded Polystyrene (EPS)	0.038	3.7
Framing lumber	0.140	1.0
Cellulose Insulation	0.040	3.5
0.5 pcf spray foam	0.037	3.8
2.0 pcf spray foam	0.025	5.7
OSB	0.140	1.0

One of the considerations for thermal modeling was the number of framing components in the wall system. This is usually measured as using the "framing factor", or percentage of a wall cross-sectional area that is comprised of framing elements. For example, a 2x4 stud spacing in a typical wall system is sixteen inches (405 mm) on centre. Modeling the wall with a stud spacing of 16 inches o.c. (Figure 6) results in a framing

factor of approximately 9%. This method of analysis ignores many of the framing members present in real walls including double studs at windows, partition walls, corners, etc.



Figure 6 : Typical framing 16"o.c. - 9% framing factor

Field studies have shown that the actual average framing factor, using 16" o.c. framing, including studs, bottom plate and top plates throughout an entire house are closer to 23-25% (Carpenter and Schumacher 2003). Modeling was conducted to investigate the impact on effective R-value for a wall system with 23% (Figure 7) framing factor and with 9% framing factor. It was found that the Clear Wall R-value of a wall section insulated with R13 fiberglass batt decreased from R12.6 to R10.1 when a more realistic 25% framing factor was used. This results in a Whole Wall R-value decrease from R12 to R10 when the more realistic 25% framing factor was used. The reason that neither wall section achieved a Clear wall or Whole Wall R13 is because of the thermal bridging effects of the studs, one of the underlying issues in using Installed Insulation R-values to describe enclosure systems.

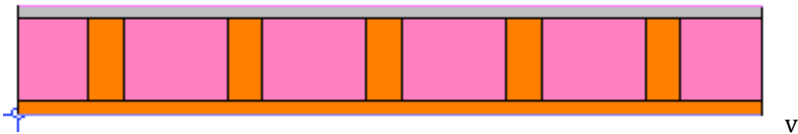

Figure 7 : Actual average framing factor of 23% in standard construction

Most of the framed walls in this analysis were proposed with advanced framing techniques (also described as Optimum Value Engineering, OVE) that include 2x6 framing, 24" o.c., and single top plates. Field studies have also been conducted on advanced framed walls, and it was found that the average framing factor is approximately 16%. For comparison purposes, all of the standard wood framed wall sections were simulated with a framing factor of 25% and advanced framed walls were modeled with 16% framing factor.

Table 3 shows all of the Whole Wall R-values calculated using Therm simulations. The thermal performance is further discussed for each wall system in the following sections.

Table 3 : R-values for analyzed wall systems

Case	Description	Whole Wall R-value	Rim Joist	Clear Wall R-value	Top Plate	Framing Fraction
1a	2x6 AF, 24"oc, R19FG + OSB	15.2	12.3	16.1	12.5	16%
1aii	2x6, 16"oc, R19FG + OSB (25%ff)	13.7	12.3	14.1	12.5	25%
1b	2x4 AF, 24"oc, R13FG + OSB	11.1	9.8	11.5	9.8	16%
1bii	2x4, 16"oc, R13FG + OSB (25%ff)	10.0	9.8	10.1	9.8	25%
2a	2x6 AF, 24"oc R19FG + 1" R5 XPS	20.2	18.5	20.6	20.3	16%
2b	2x6 AF, 24"oc R19FG + 4" R20 XPS	34.5	29.0	35.6	35.4	16%
3	2x6 AF, 24"oc, 2x3 R19+R8 FG	21.5	13.4	23.5	18.4	16%
4	Double stud wall 9.5" R34 cellulose	30.1	14.4	33.5	28.8	
5	Truss wall 12" R43 cellulose	36.5	18.6	40.5	34.4	
6a	SIPs (3.5" EPS)	14.1	12.3	14.5	10.6	
6b	SIPs (11.25" EPS)	36.2	14	41.6	28.2	
7a	ICF - 9" foam ICF (5" EPS)	20.2		20.2		
7b	ICF - 15" foam ICF (5" EPS)	20.6		20.6		
7c	ICF - 14" cement woodfiber ICF with Rockwool	17.4		17.4		
8a	2x6 AF, 24" o.c., 5" 2 pcf R29 SPF, OSB	19.1	13.6	20.3	19.5	16%
8b	2x6 AF, 24" o.c., 5.5" R21 0.5 pcf SPF, OSB	16.5	13.1	17.2	16.6	16%
9	2x6 AF, 24"oc, 2" SPF and 3.5" cellulose	17.5	13.2	18.4	17.7	16%
10	Double stud with 2" 2.0 pcf foam, 7.5" cell.	32.4	15.9	36.2	28.5	
11	Offset frame wall with ext. spray foam	37.1	18.8	40.6	41.9	16%
12	2x6 AF, 24"oc, EIFS - 4" EPS	30.1	23.8	31.4	31.1	16%

*AF - Advanced Framing

m

2.2 Hygrothermal Analysis

Hygrothermal analysis is the combined analysis of heat and moisture movement. For this research, WUFI® m from the Fraunhofer Institut Bauphysik was used to determine the hygrothermal performance of the chosen m wall systems. m

WUFI® was used only to investigate wood framed walls. ICF and SIPs walls are not subject to the same moisture-related failure mechanisms as wood framed walls and hence, to model with WUFI® would provide m little useful information. m

Vinyl siding was chosen as the cladding system for the analysis as it is the most widely used residential m cladding system in North America, and it can be found in almost any geographic area. m

Minneapolis MN was chosen as the climate to compare all of the chosen wall systems. Minneapolis is in DOE m climate zone 6, which experiences cold wintertime temperatures as well as some warm humid summer m temperatures. m

A Class I or II vapor retarder is required according to the International Residential Building Code (IRC) on the m interior of the framing in zones 5,6,7,8 and marine 4. This will control vapor condensation on the sheathing m in the winter months as shown in Figure 9. The RH at the sheathing did not reach elevated levels in Case 1 m (framed walls with OSB sheathing) with the Class I vapor retarder in WUFI®. There are some exceptions to m the interior vapor control layer if a sufficient amount of insulation and vapor control is installed on the m exterior. m

Often times, the 6-mil polyethylene vapor barrier is also used as the air barrier. This is very difficult to detail m correctly, and because it may not be air tight, there is a considerable risk to air leakage condensation on the m sheathing should interior air leak into the enclosure. m

WvFI® was used to simulate three different scenarios which can cause performance problems for wall v systems; wintertime condensation, summer inward vapor drives, and simulated drying following a wetting v event. v

2.2.1. Moisture Balance

Assessing moisture related durability risks involves three different moisture processes; wetting, drying and v moisture redistribution. These three processes in combination with the safe storage capacity will determine v the risk of moisture damage to a building enclosure assembly (Figure 8). v

Wetting of the enclosure is most often caused by rain, air leakage condensation, vapour condensation, v plumbing leaks and built in construction moisture. Minimizing these sources with good design details for v shedding rain, air tightness, and vapour control will help decrease the risk of moisture related durability v failure. v

Drying is important since nearly all building enclosures will experience wetting at some point. Assemblies v that can dry to both the interior and exterior generally have an advantage and can manage more frequent v wettings. v

The safe storage capacity of an individual material or enclosure system is fundamental to good building v design. Over the last 50 years, there have been changes to buildings that decrease the safe storage capacity v and increase the risk of moisture related durability. Four of these changes are listed below (Lstiburek 2007). v

- 1.v Increasing the thermal resistance of the building enclosure v
- 2.v Decreasing the permeability of the linings that we put on the interior and exterior of the enclosure v
- 3.v Increasing the mould and water sensitivity of the building materials v
- 4.v Decreasing the buildings ability to store and redistribute moisture. v

These changes to building enclosures and materials increase the need for good enclosure design with water v management details and maximizing the drying potential. It is rarely economical to build an enclosure with v no risk of wetting but managing the risk is important. In any building enclosure, building materials should be v chosen based on moisture tolerance that correlate to the risk of moisture in the enclosure. In all cases drying v should be maximized, and attention to good design details should be used. v

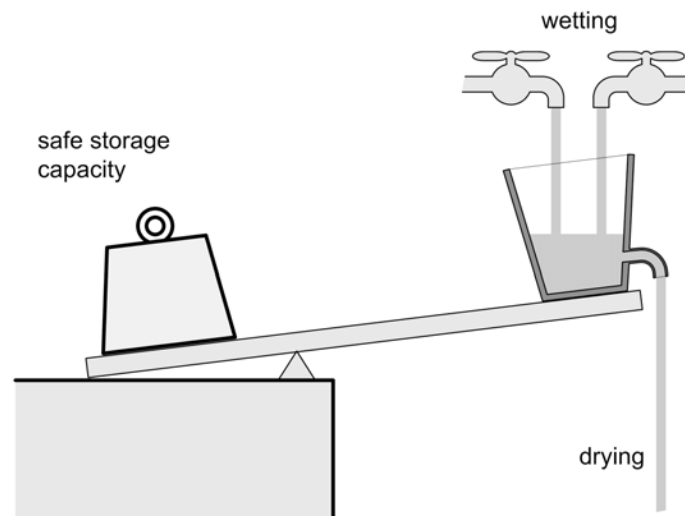

Figure 8 : Moisture balance

2.2.2. Wintertime Condensation

Wintertime diffusion and air leakage condensation potential was determined for each case. The diffusion r condensation potential was determined by analyzing the relative humidity at the interior surface of the r sheathing (or other condensation plane) during the cold winter months. The interior relative humidity for r these simulations was sinusoidal condition varying from a minimum of 30% in the winter to a maximum of r 60% in the summer. The interior relative humidity is strongly correlated to occupancy behavior and r ventilation strategies. Typically, the relative humidity in a cold climate will decrease to between 20% and r 30% in the winter months. In extremely cold climates this could decrease even further. If humidification is r used, or there is inadequate ventilation in a relatively airtight enclosure, the RH could increase to 40 or 50% r which increases the risks significantly. r

In the 2007 supplement to the International residential code, three classes of vapor control were defined for r enclosure systems (1 U_s perm = 57.4 ng/(s·m²·Pa)) r

- Class I: 0.1 perm or less (eg. sheet polyethylene) r
- Class II: 0.1 < perm ≤ 1.0 perm (eg. kraft faced fiberglass batts , some vapor barrier paints) r
- Class III: 1.0 < perm ≤ 10 perm (latex paint) r

Class I or II vapor retarders are required on the interior side of framed walls in Zones 5, 6, 7, 8 and marine 4 r (IRC N1102.5). Under some conditions, such as vented claddings or insulated sheathings, a Class III vapor r retarder is allowed by the code (IRC Table N1102.5.1). r

Figure 9 shows a comparison of the relative humidity caused by vapor diffusion at the sheathing for Case 1, r standard construction, and Case 2, advanced framing with insulated sheathing. A polyethylene vapor barrier r is installed on the interior of the framing in Case 1, vapor barrier paint is used for Case 2 with 1" of XPr r insulated sheathing, and latex paint is used for Case 2 with 4" of XP_s insulated sheathing. Table 4 shows the r vapor control strategies and permeance values for all four walls compared in Figure 9. r

Table 4 : Vapor control strategies and permeance values for Case 1 and 2

Case	Description	Vapor Control	Permeance	
			[US perms]	[ng/(s·m ² ·Pa)]
1a	2x6 AF, 24"oc, R19FG + OSB	poly	0.07	4.0
1b	2x4, 16"oc, R13FG + OSB	poly	0.07	4.0
2a	2x6 AF, 24"oc R19FG + 1" R5 XPS	vapor retarder paint	1.0	57.8
2b	2x6 AF, 24"oc R19FG + 4" R20 XPS	latex paint	10.7	616.7

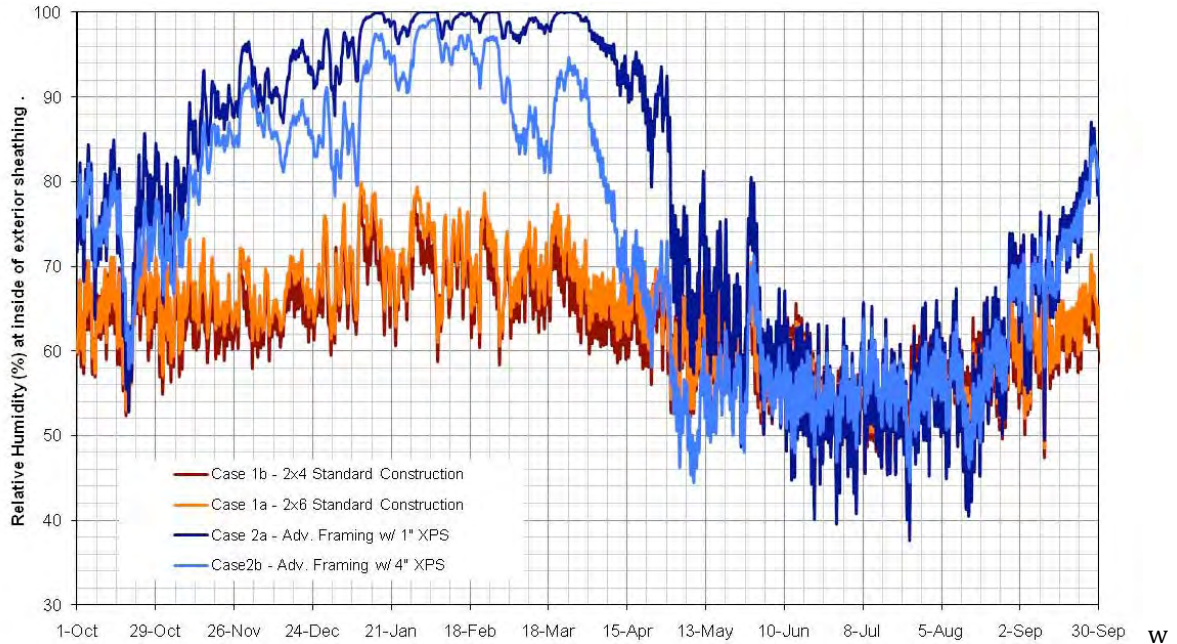

Figure 9 : Winter time sheathing relative humidity for Case 1 and Case 2

The advanced framing wall (Case 2) with 1" of XPS was modeled with the minimum amount of vapor control w required (Class II vapor retarder - 1 perm or 57 ng/Pa•s•m2) according to the IRC. The elevated moisture w levels during the winter months are only a small concern, since the XPS is not moisture sensitive, and w temperatures are quite low in the winter months, minimizing moisture related risks. The advanced framing w all with 4" of XPS insulated sheathing does not require any extra vapor control layers according to the IRC w because it qualifies as having more than R-11.25 insulated exterior sheathing over 2x6 wood framing. w

Figure 10 shows the potential for air leakage condensation for Case 1 and Case 2. This analysis shows the w dewpoint of the interior air and the temperature of the sheathing for both Case 1 and Case 2. When the w temperature of the sheathing falls below the interior dewpoint line (black line) the potential for air leakage w condensation exists. The severity of condensation increases the further below the dewpoint line the w sheathing temperature falls and the length of time the sheathing temperature is below the interior air w dewpoint line, since drying is minimal during periods of condensation. w

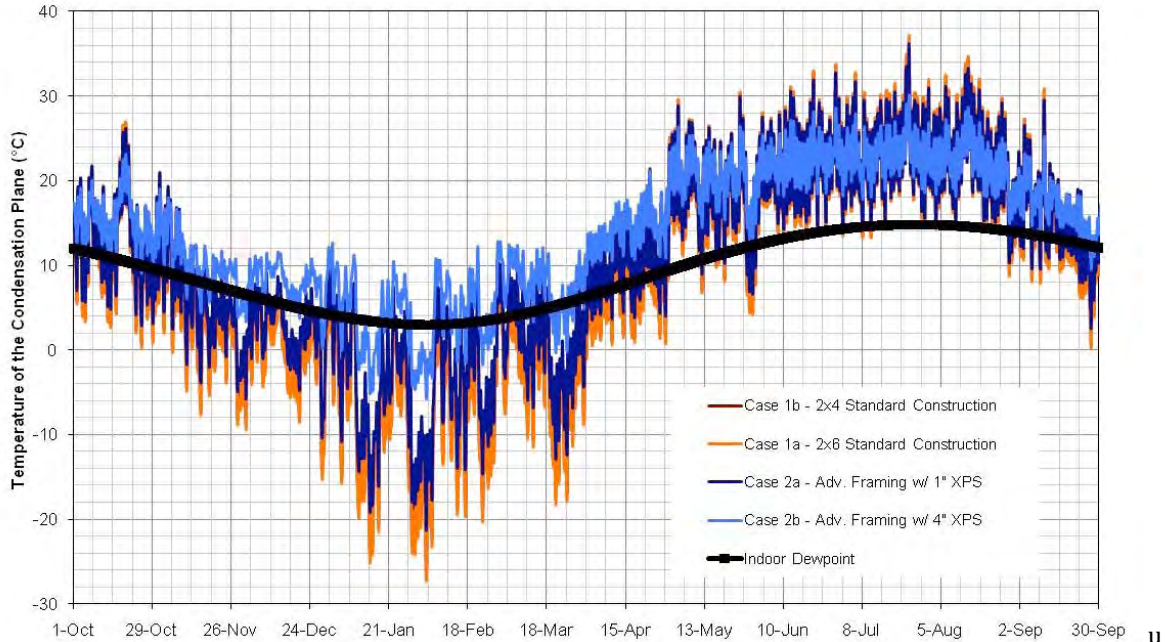

Figure 10 : Winter air leakage condensation potential for Case 1 and Case 2

The risk of air leakage condensation is greatest on the standard construction walls, and slightly improved on the advanced framing wall with 1" of XPS. The wall with 4" of insulated sheathing has the least risk of moisture related durability issues from air leakage condensation because of the short periods of time the interior face of the sheathing is below the dewpoint. When the hours of potential condensation are added together over the entire year, Case 1 with 2x4 construction and 2x6 construction have approximately 4400 and 4500 hours respectively of potential condensation. Case 2 with 1" of insulated sheathing experiences approximately 3800 hours of potential condensation and Case 2 with 4" of insulated sheathing only experiences 1200 hours of potential air leakage condensation.

One method of improving the risk of air leakage condensation in standard construction is by using a hybrid wall system (Case 9). In our analysis a hybrid wall system consists of advanced framing (2x6 24"oc) with OSB sheathing and 2" of high density (2.0 pcf) spray foam installed against the interior of the sheathing. This spray foam can be an excellent air barrier if installed properly and because it is vapor semi-impermeable, the temperature of the condensation plane increases (Figure 11). Two inches of high density spray foam was chosen because it is reported as being the maximum thickness that can be sprayed in one pass on any surface. This hybrid wall has approximately the same amount of condensation potential as Case 2 with 4" of exterior XPS and will be significantly less expensive than Case 8 with 5" of high density spray foam. Unfortunately, it also has much less R-value, and still suffers from thermal bridging.

u

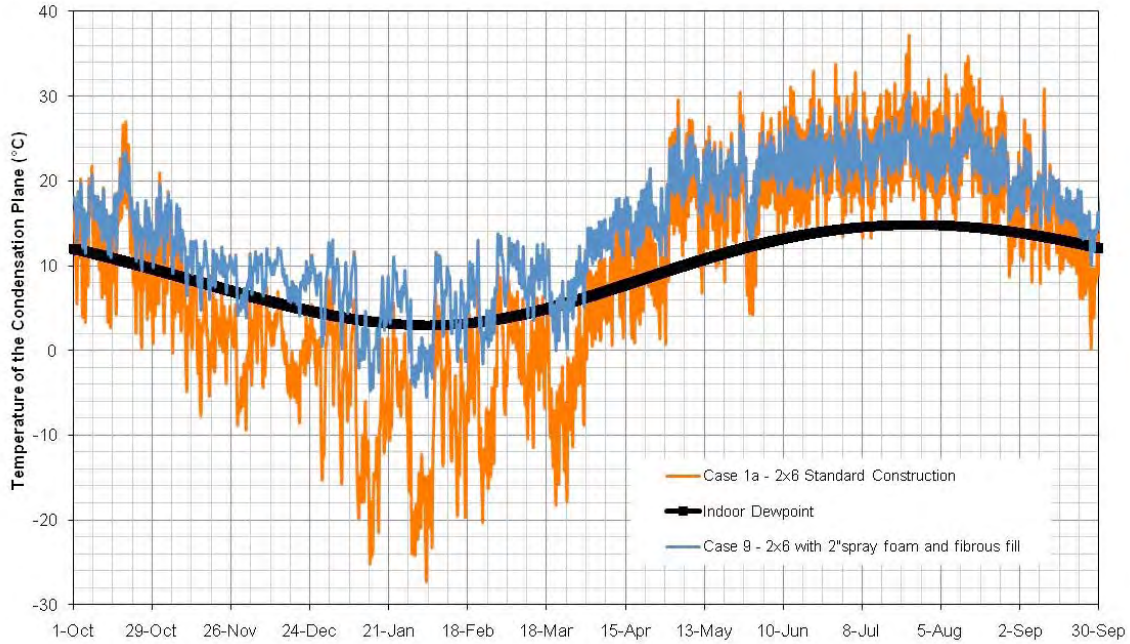

Figure 11 : Winter air leakage condensation potential for Case 1 and Case 9

The winter time sheathing relative humidities for Cases 3, 4, and 5 without air leakage are shown in Figure 12. Constructing these walls with a Class I - 6-mil polyethylene vapor control layer, there is no risk to moisture related issues on the sheathing from vapor diffusion in the winter.

1

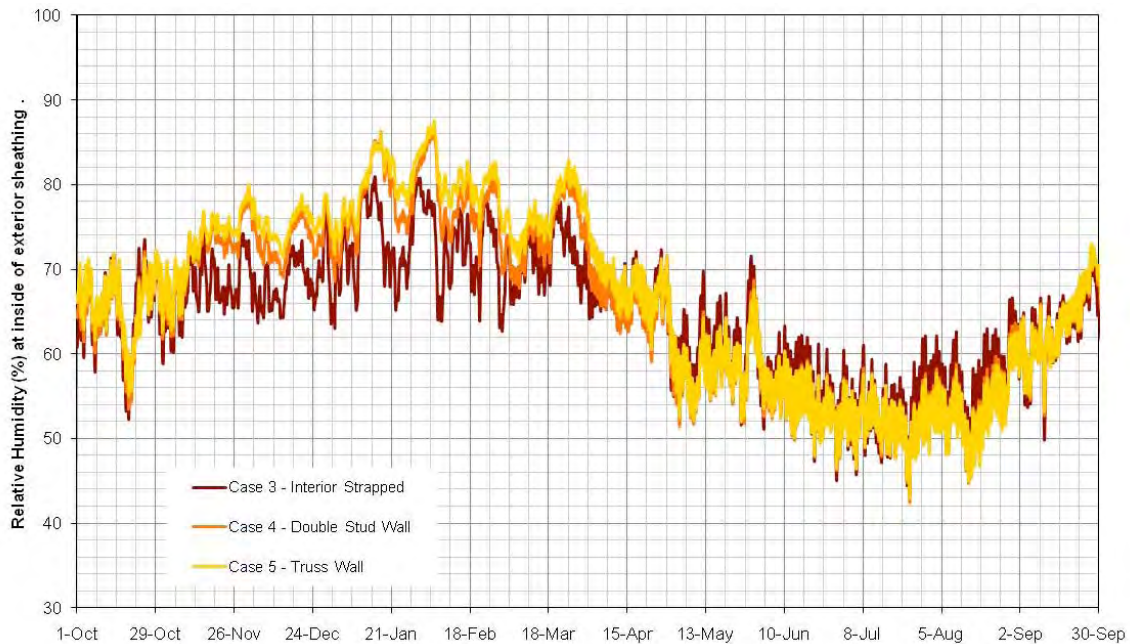

Figure 12 : Winter time sheathing relative humidity for Case 3, Case 4, and Case 5

Winter time air leakage condensation potential for Cases 3, 4, and 5 are shown in Figure 13. The sheathing temperatures of all three of the walls spent a significant portion of the year below the dew point of the interior air because of the increased thermal resistance of the wall system. This means that considerable care

must be given to all air tightness details, or there will be a high risk of moisture related durability issues from u air leakage. u

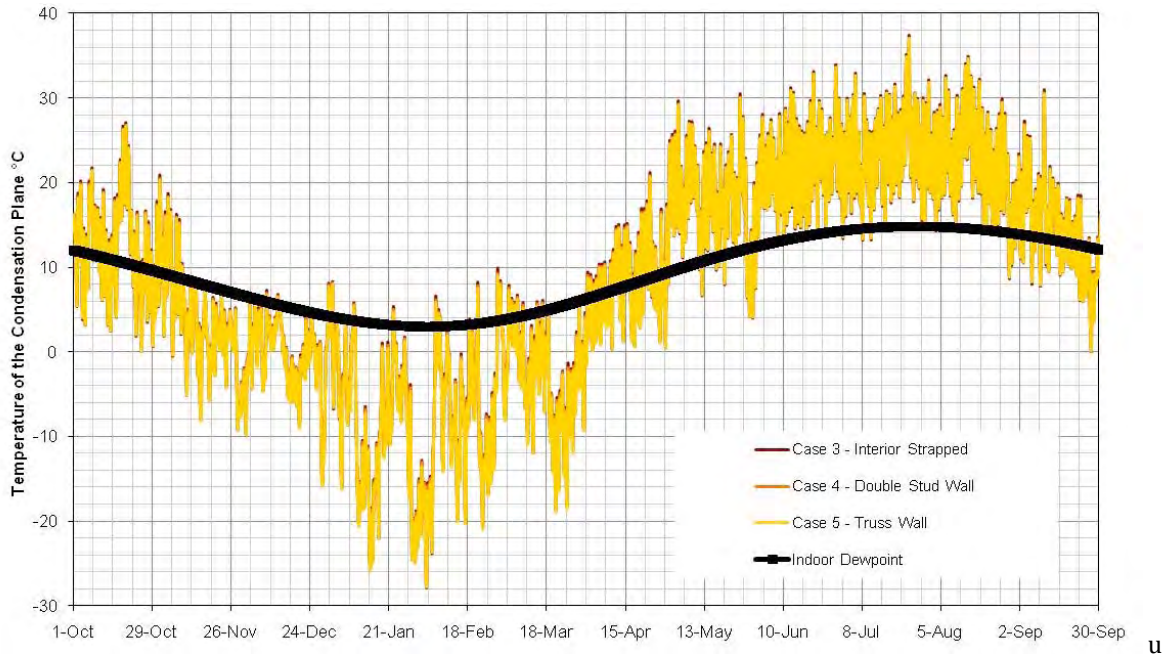

Figure 13 : Winter air leakage condensation potential for Case 3, Case 4, and Case 5

Increasing the temperature of the condensation plane can be done by adding spray foam to the interior u surface of the exterior sheathing. Case 10 is a double stud wall with 2” of high density foam sprayed against u the sheathing from the interior. Increased vapor resistant insulation raises the temperature of both the u diffusion and air leakage condensation planes. Analysis showed that the condensation plane temperature was u increased throughout the winter months but that there was still a risk of condensation related damage to the u enclosure if air leakage occurs. Figure 14 shows that in Minneapolis (Du E climate zone 6) 2” of high density u spray foam may not be enough to reduce the potential condensation risk to a satisfactory level. u

Case 10 with 2” of spray foam spends considerably more time below the interior dewpoint compared to Case u 9 (hybrid wall) which also has 2” of high density spray foam. The difference in condensation potential is u caused by the ratio of the insulation amounts on the interior and exterior of the condensation plane. The u remaining 3.5” of the stud space can be filled with an R19 FG batt or cellulose. The increased convection u suppression of cellulose insulation is not as critical to this enclosure assembly because of the air tightness of u the two inches of spray foam insulation, but will still do a better job of reducing gaps around services, and u other places that fiberglass batt is prone to convective looping. The increased thermal resistance of the u double stud wall ensures that the condensation plane is kept much cooler. This is a critical consideration to u designing a wall enclosure for a specific climate. The double stud walls with 2” of high density spray foam u would likely work successfully with little risk in a Climate zone 6 or lower. Alternately, open cell foam could u be used to fill the double stud wall although a vapour retarding coating would be needed in cold climates. A u mid-density foam, with moderate vapor permeance could also be used as a full fill. u

u

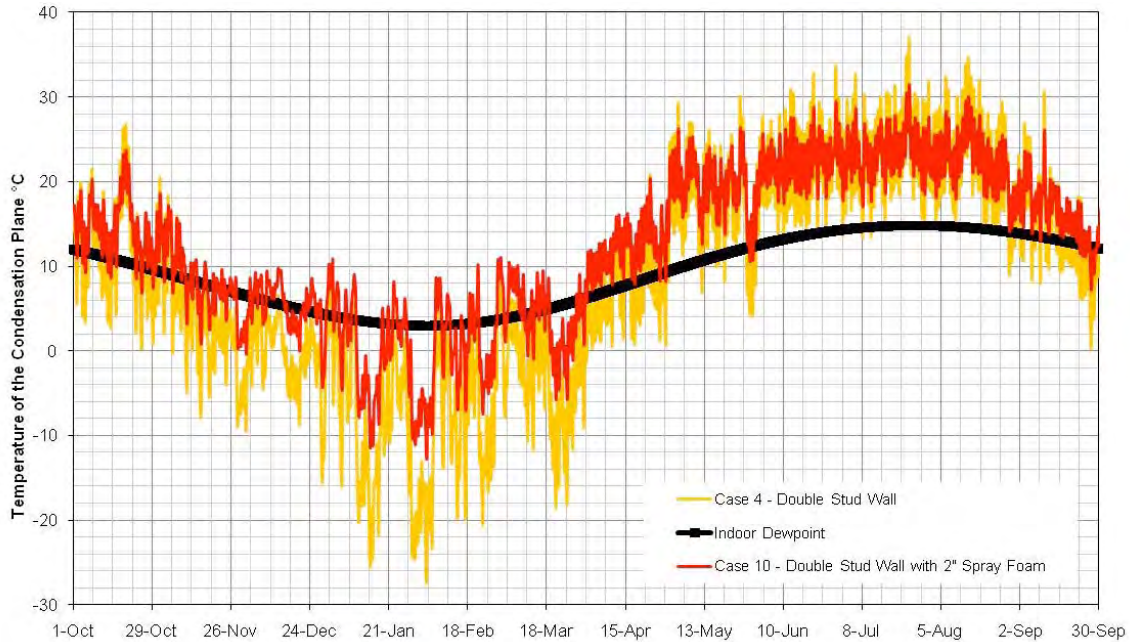

Figure 14 : Winter air leakage condensation potential for Case 4 and Case 10

One wall system becoming more popular in cold climates is a wall constructed with exterior foam insulation, sometimes referred to as an Offset frame wall. This has many advantages over traditional wall construction techniques, and can be used for both new construction and retrofits. Figure 15 shows high density spray foam being installed over the existing exterior sheathing during a retrofit. The surface of the foam becomes the drainage plane, air barrier and vapor barrier of the enclosure. Cladding can be attached directly to the exterior framing that tie back to the framing of the house, and are very stiff and supportive once the foam has been installed.

In this case, the exterior framing was attached with 8" spikes using a spacer to ensure that the exterior framing was the correct distance from the sheathing. Because of the strength and rigidity of the high density spray foam insulation, no additional support is needed for fiber cement siding.



Figure 15 : Installation of high density spray foam in an Offset Framed Wall in a cold climate

In the case of new construction, wood sheathing may not be necessary on the exterior of the structural wall framing to support the spray foam. Removing the sheathing would decrease the cost and work considerably. Other membranes, such as housewraps may be used to support the foam during installation, but more analysis and research may be required before installing spray foam directly on housewraps.

Analysis of the possible wintertime condensation for a Truss Wall constructed with 12" cellulose insulation (Case 5) and constructed with 4.5" of exterior high density foam and 5.5" of fibrous fill in the stud cavity (Case 11) is shown in Figure 16. The sheathing (or foam supporting membrane) never reaches the interior dew point temperature in DOE climate zone 6. In a very extreme cold climate, more foam could be added to the outside or the stud space insulation could be removed which would also decrease the condensation potential.

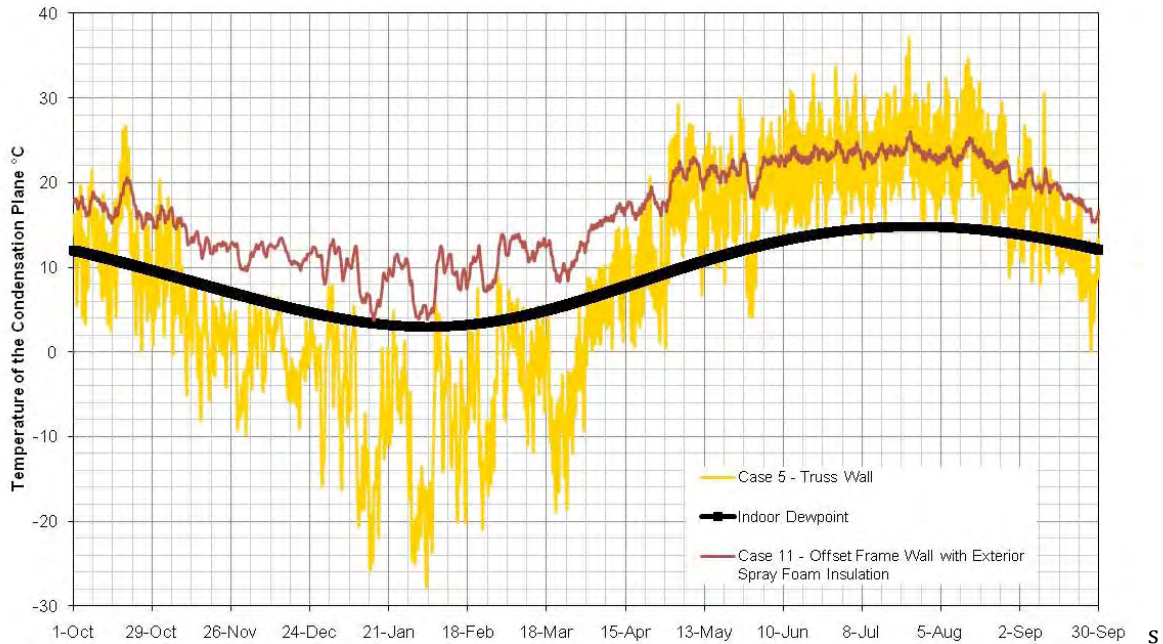

Figure 16 : Winter time air leakage condensation potential for Case 5 and Case 11

There are other advantages to an offset frame wall with exterior foam besides the decreased risk for condensation potential in the enclosure. A house can be dried in very quickly with exterior spray foam insulation, which means that the house is weather proof against rain and snow. This is very important in arctic regions with a very short construction season. Once the foam is installed on the exterior, interior work such as insulation, drywall and finishes can be finished as desired.

There were complaints from the remote areas of Northern Canada (according to the NRC) that when foam board was shipped to be used as exterior insulation, it always arrived broken, which is why they preferred not to use it. High density spray foam is shipped as two liquid components that are combined during the spray foam installation process. Many more board feet of spray foam can be shipped on the same truck than the equivalent board feet of EPS or XPS board foam insulation. This application is ideal for remote climates.

The sheathing relative humidities for Case 8, the spray foam wall, is shown below in Figure 17. The sheathing relative humidities with high density foam, and low density foam with a vapor barrier show no risks of moisture related issues caused by vapor diffusion. The wall system with low density foam and no vapor control layer may experience some risk to moisture related durability issues depending on the climate.

s

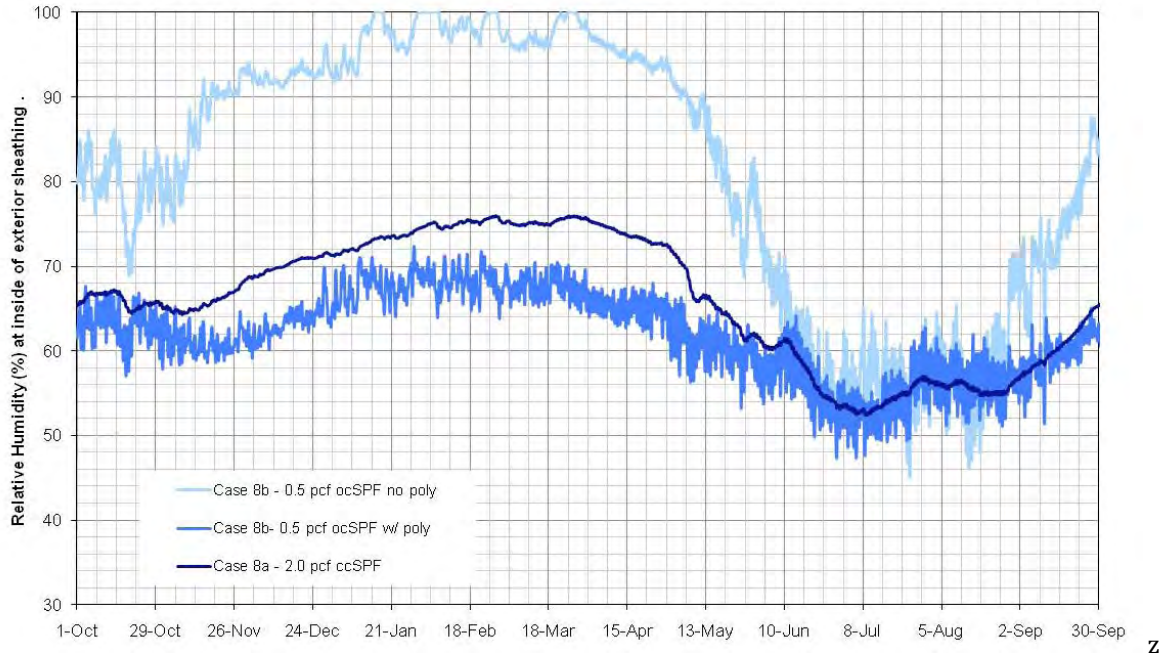

Figure 17 : Winter time sheathing relative humidity for Case 8

A vapor control layer should be used with low-density foam in climate zone 6 based on this hygrothermal analysis. More analysis is required to determine what level of vapor control is required to minimize risk. It may be possible to use a Class II vapor barrier (IBC 2007 supplement). In climate zones warmer than climate zone 6, it may be possible to use 0.5 pcf spray foam with much less risk of moisture related durability issues. More analysis should be conducted on this specific case in different climate zones before design recommendations can be made.

Air leakage condensation potential of Case 8 is shown in Figure 18. Because both low and high density spray foams form an air barrier when installed properly, interior air will not pass the interior surface of the foam. There is no risk of any moisture related durability issues in the walls insulated with spray foam in this analysis.

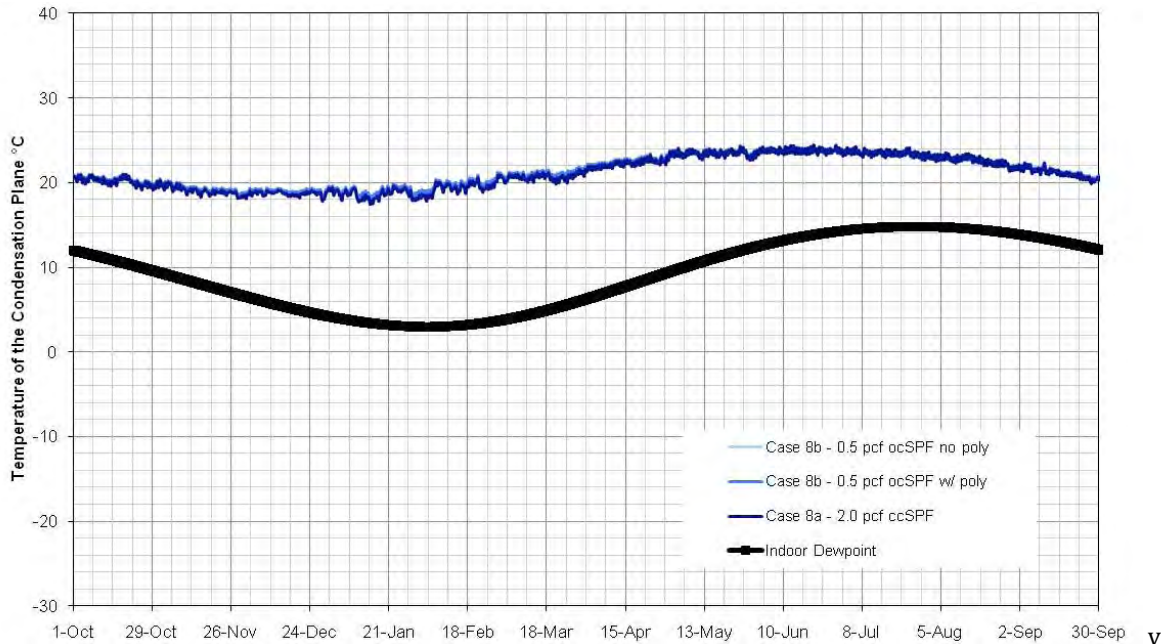

Figure 18 : Winter air leakage condensation potential for Case 8

2.2.3. Summer Inward Vapor Drives

Summer inward vapor drives occur when moisture stored in the cladding is heated and driven into the v enclosure by a large vapor pressure gradient. Both field testing, and modeling have shown that assemblies v that have reservoir claddings such as stucco, adhered stone veneer and concrete, that absorb and store water, v are much more susceptible to summer inward vapor drives. During field testing, moisture has been observed v condensing on the interior polyethylene vapor barrier and may run down the polyethylene to the bottom v plate if enough water condenses. v

Inward vapor drives were compared in this analysis using vinyl siding as the cladding. This type of cladding v does not stress the wall systems from an inward vapor drive perspective but still gives a basis for comparison v of the different wall systems. More analysis should be done in the future to more accurately predict the v amount of inward vapor drive in cold climates using reservoir claddings (masonry, stucco, adhered stone v etc.). v

Analysis was conducted by graphing the relative humidity at the vapor barrier, or drywall surface in the v absence of a vapor barrier, between the months of May and September. v

Figure 19 shows the comparison of Case 1, standard construction, Case 2, advanced framing with insulated v sheathing, and Case 9 hybrid wall. Standard construction experiences higher relative humidities at peak v times because of the polyethylene vapor barrier, and lack of vapor control on the exterior. The advanced v framing with insulated sheathing walls have some vapor control at the exterior surface of the wall system, v and no polyethylene vapor barrier to limit drying to the interior. The advanced framing wall with 1" v has a slightly elevated relative humidity when compared to the wall with 4" of Xv v because of the 1 perm (57 v ng/Pa•s•m2) paint layer on the drywall slowing drying to the interior, and less vapor control at the exterior v surface. The hybrid wall performs very similarly to the advanced framing with 4" of Xv v

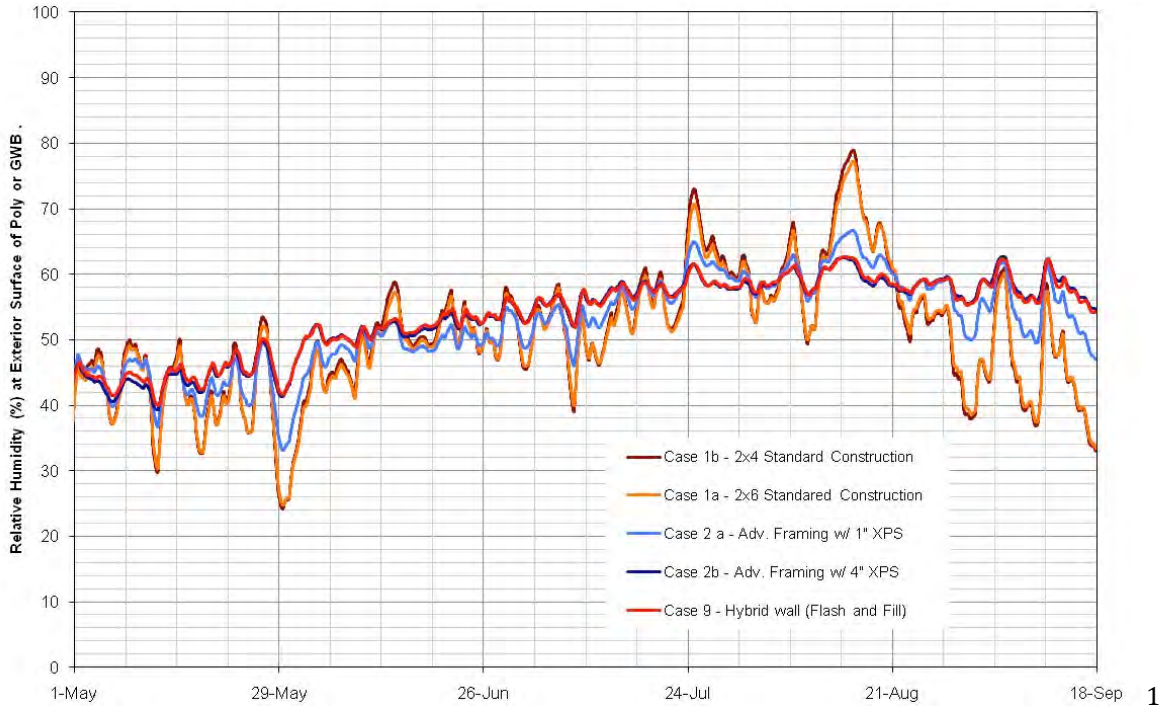

Figure 19 : Inward vapor drive relative humidity of poly or GWB for Case 1, Case 2, and Case 9

Inward vapor drives of Cases 3, 4, and 5 (Figure 20) show there is very little performance difference between the test walls, and none of the walls experience any moisture related durability issues caused by inward vapor drives. Case 4, double stud construction, and Case 5, truss wall, experience slightly lower relative humidities because of the moisture buffering effect of the cellulose insulation.

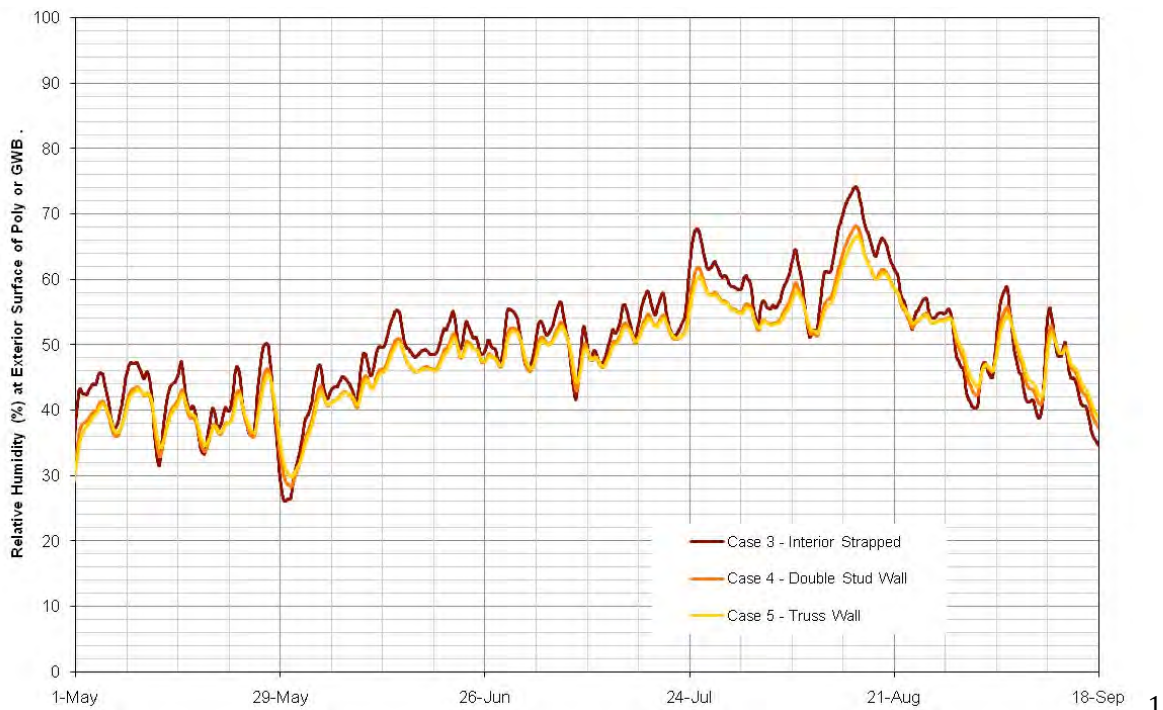

Figure 20 : Inward vapor drive relative humidity of poly or GWB for Case 3, Case 4, and Case 5

A double stud wall with 2" of high density foam (Case 10) with and without an interior vapor barrier was , compared to Case 4, a double stud wall filled with cellulose in Figure 21. There was an improvement in , performance when two inches of foam were used on the exterior and an interior vapor barrier was installed. , The foam restricted the inward vapor drive, and the poly controlled vapor from the interior environment. , Although this wall showed lower relative humidities with respect to summer inward vapor drives, it is never , recommended to have a high level of vapor control on both sides of the wall system. This substantially , increases the risk of moisture related durability issues, should any water get into the wall cavity. This could , be improved by adding more foam to the exterior surface, and less vapor control to the interior, with a Class , II or III vapor control layer depending on climate. More specific analysis is required before design , recommendations , an , e determined. ,

Case 10 without an interior vapor barrier experiences slightly elevated relative humidity levels, likely due to , the interior relative humidity. In a more severe testing condition for summer inward vapor drives, this wall , would likely have lower relative humidity to Case 4, the standard double stud wall. ,

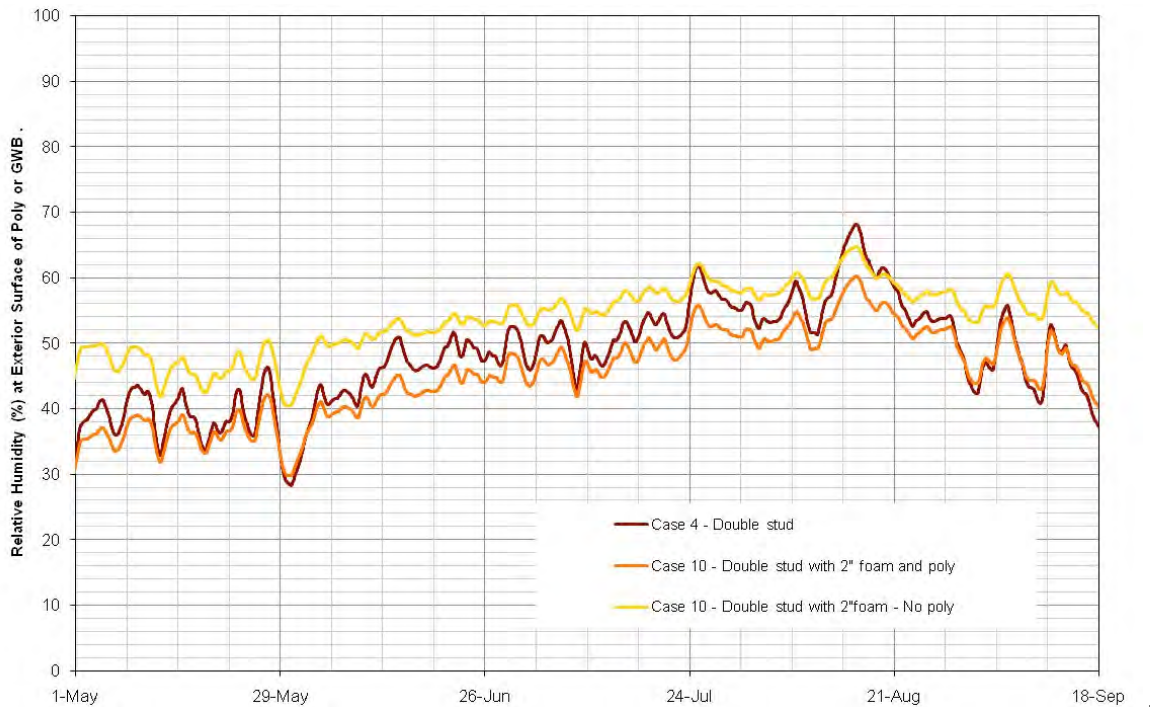

Figure 21 : Inward vapor drive relative humidity of poly or GWB for Case 4, and Case 10

Analysis of inward vapor drives on the spray foam walls shows that the walls without polyethylene vapor , barrier dry adequately to the interior, but the low density spray foam wall with poly has elevated relative , humidities because of the vapor control layer (Figure 22). ,

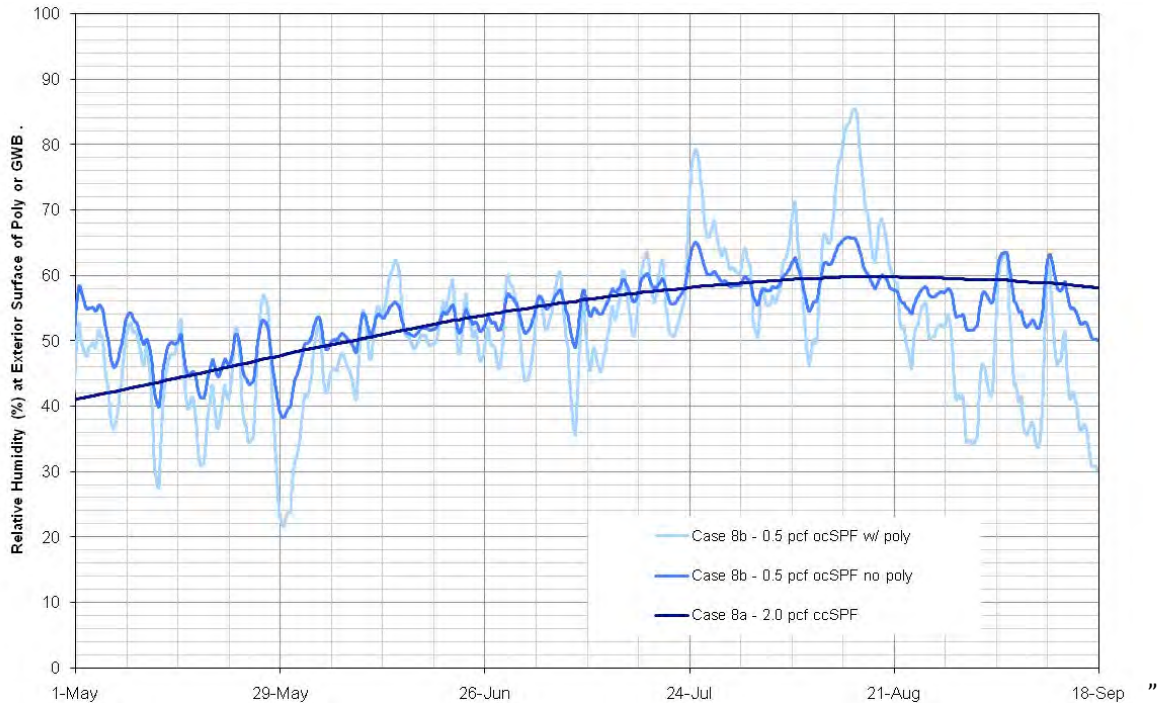

Figure 22 : Inward vapor drive relative humidity of poly or GWB for Case 8

The inward vapor drive for the offset frame wall (Case 11) with exterior foam insulation was compared to Case 3, a truss wall with only cellulose insulation, and Case 8 with 5 1/2" of high density spray foam in the cavity space in Figure 23.

Both Case 8 and Case 11 perform very similarly, with slightly higher relative humidities than Case 4, although there is no risk of moisture related damage from inward vapor drives in of the walls (Figure 23). Had the cladding been a moisture storage cladding, it is suspected that both Case 8 with spray foam in the stud space, and Case 11 with exterior foam would have much lower relative humidities than Case 5 because of the vapor control of the high density spray foam.

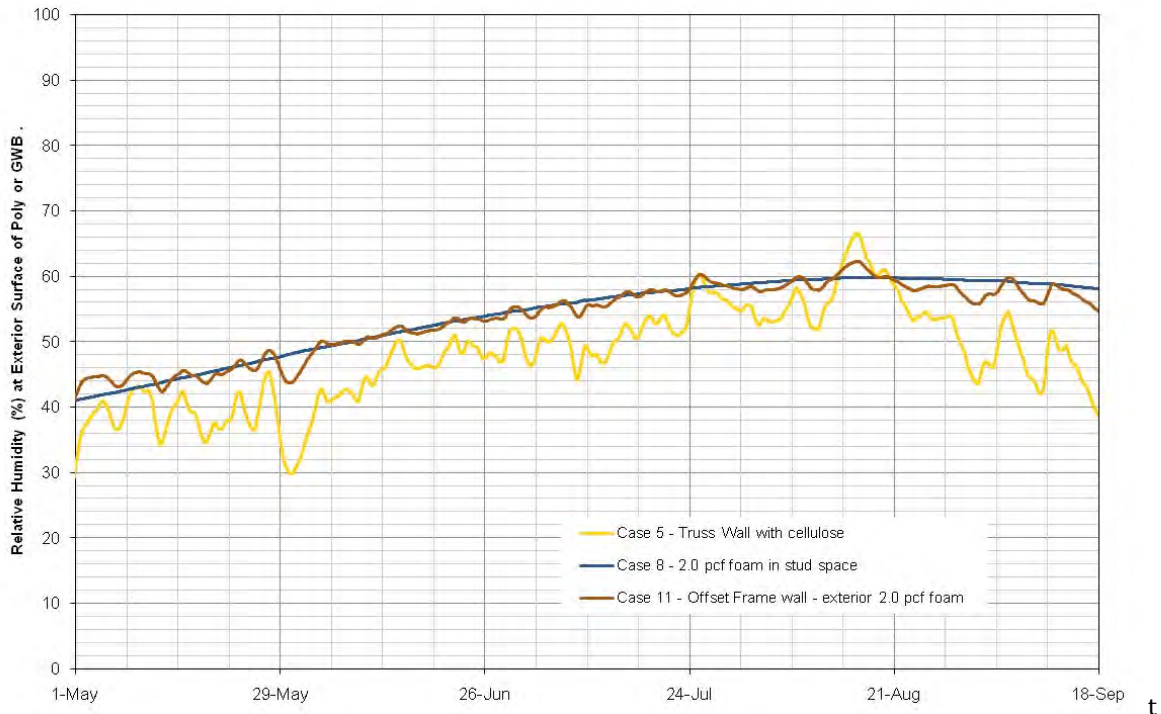

Figure 23 : Inward vapor drive relative humidity of poly or GWB for Cases 5, 8, and 11

2.2.4. Wall Drying

The third analysis conducted by using WUFI® hygrothermal modeling is the drying ability of the different wall systems. Drying was quantified by beginning the simulation with elevated sheathing moisture content (250 kg/m³) in the wall systems and observing the drying curve of the wetted layer. In walls without OSB sheathing a wetting layer was applied between the insulated sheathing and fiberglass batt insulation with similar physical properties to fiberglass insulation. Drying is a very important aspect of durability since there are many sources of possible wetting including rain leakage, air leakage condensation and vapor diffusion condensation. If a wall is able to dry adequately, it can experience some wetting without any long-term durability risks.

The drying curves of Case 1 (standard construction), and Case 2 (advanced framing with insulated sheathing) are shown in Figure 24. The slowest drying wall is the advanced framing with 1" of exterior insulation and interior vapor control paint because there are lower permeance layers on both the interior and exterior of the enclosure. The OSB in the standard construction walls dry only marginally quicker than advanced framing with insulated sheathing, which is likely insignificant in the field. In the advanced framing wall, the wetting layer is immediately interior of the XPS sheathing, and drying is predominantly to the interior.

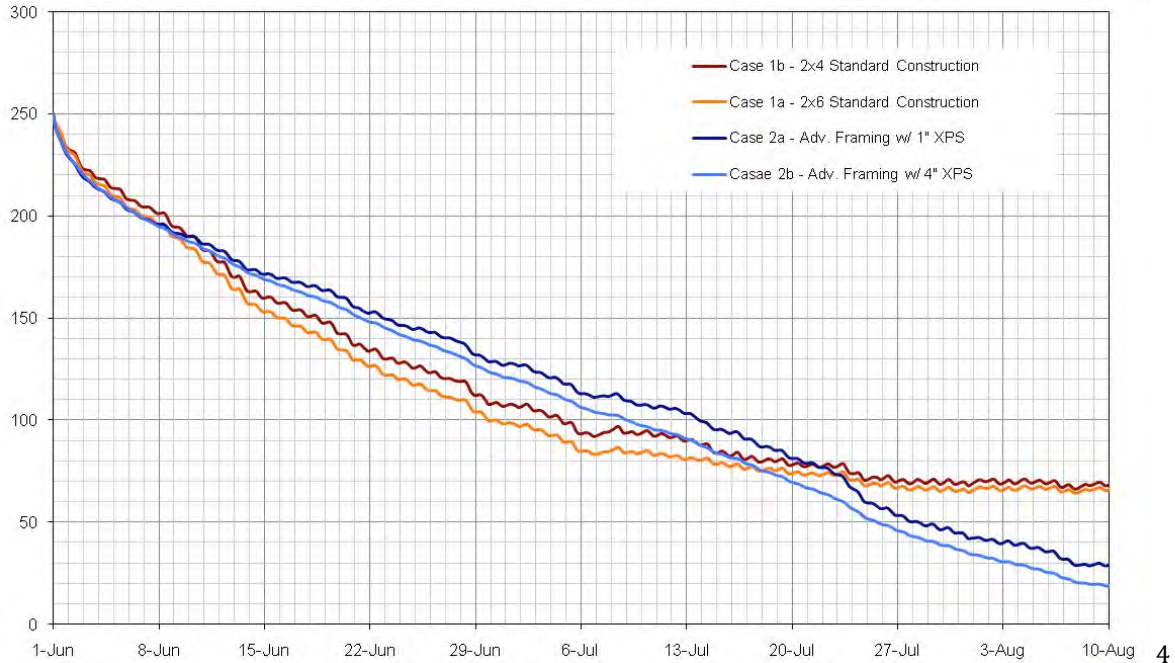

Figure 24 : Drying Curves for Case 1 and Case 2

Figure 25 shows that the drying curves of the interior strapped wall, the double stud wall, and the truss wall are all very similar, with no significant differences. These three walls perform very similarly to the standard construction walls in Figure 24.

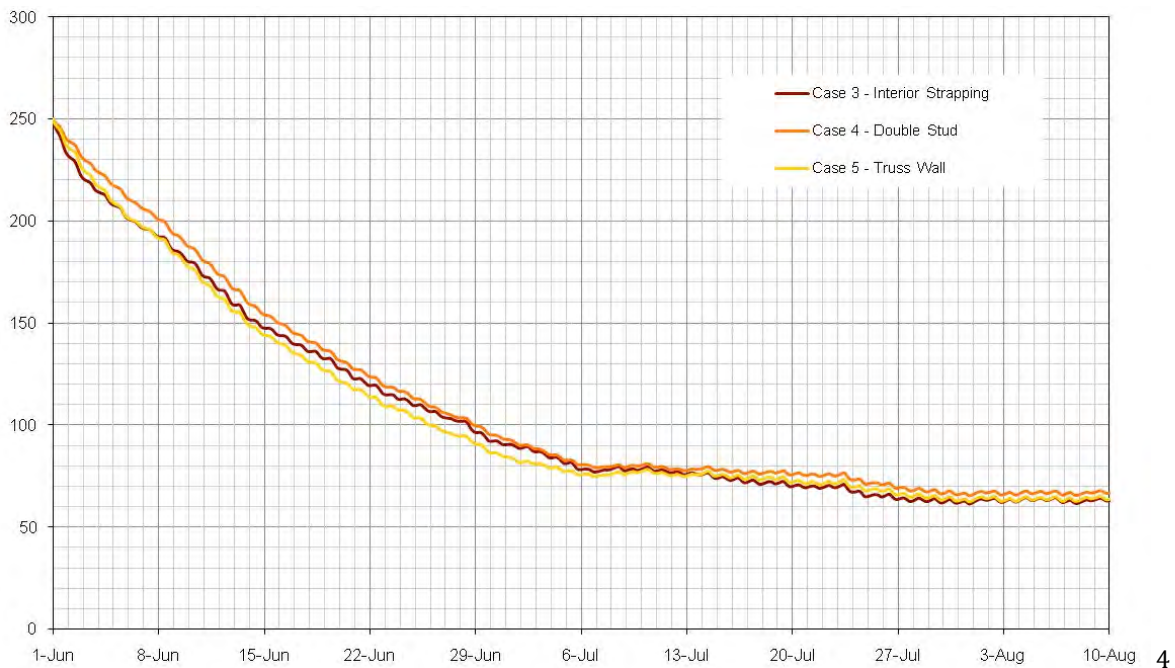

Figure 25 : Drying curves for Case 3, Case 4, and Case 5

The drying curves for spray foam insulated walls, Case 8, are shown in Figure 26. The quickest drying wall is the low density spray foam without a poly vapor barrier. Both the high density spray foam and the low density spray foam with poly both dry more slowly because of the decreased permeance of the building enclosure and inhibited drying.

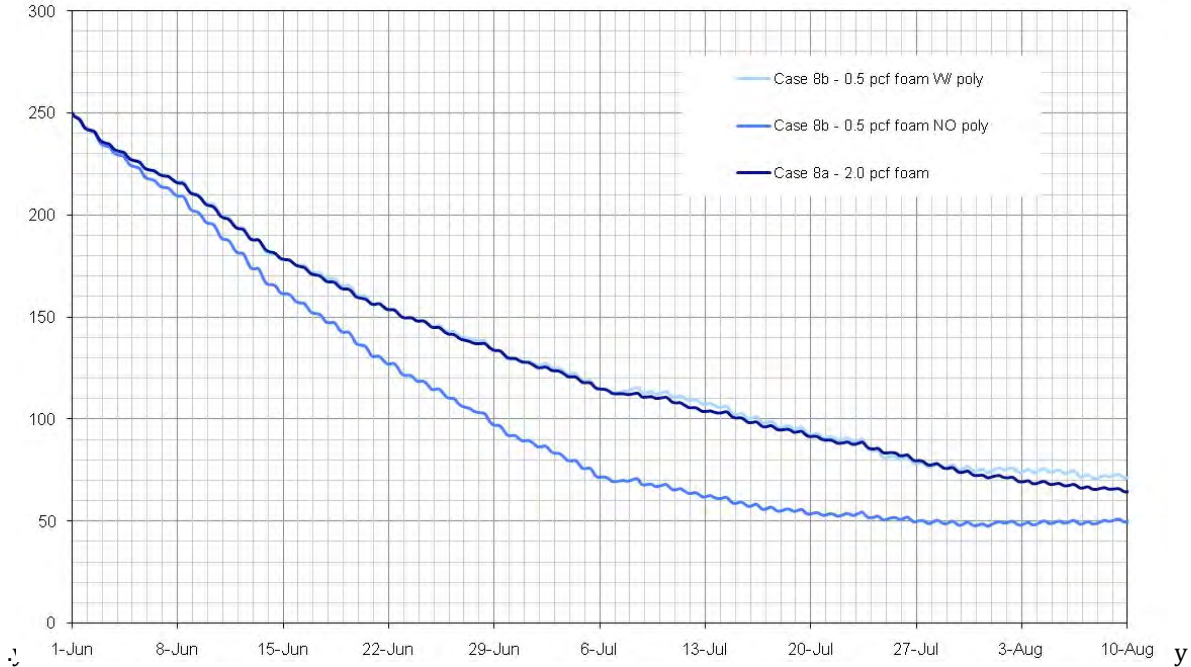

Figure 26 : Drying curves for Case 8

Comparing the double stud wyll with cellulose insulation (Case 4) with the double stud wyll with spray foam y and cellulose (Cyse 10), Cyse 4 dried more quickly than Case 10 both with and without a interior polyethylene y vapor barrier. With 12" of moisture buffering cellulose insulation in Cyse 4, it appears thyt the wyll is able to y quickly buffer and redistribute the moisture of a single wetting event and then release it slowly, mostly to the exterior of the OSB. Neither wall would suffer moisture related durability issues following a single wetting y event but repeated wetting events to the OSB will increase the risk of moisture related durability issues. y



Figure 27 : Drying Curves for Case 4, and Case 10 with and without a poly vapor barrier

The offset wall enclosure with exterior spray foam dried very slowly compared to the truss wall of Case 5 y with cellulose insulation. The wall system with exterior high density spray foam is unable to dry to the y

exterior due to the vapor control of the spray foam. The interior relative humidity is elevated in the spring and summer months which would also affect the vapor pressure gradient and drying potential. The sheathing in Case 11 is not significantly affected by the solar energy of the sun and the warm summer temperatures, nor is it in contact with cellulose insulation to buffer the wetting event.

In Case 5, with cellulose insulation against the wet OSB sheathing, the cellulose absorbed and redistributed the moisture, helping the OSB dry more quickly. Installing fiberglass batt insulation against the sheathing does not redistribute moisture and the OSB will stay wetter longer. Cellulose insulation is more susceptible to repeated wetting events because of its organic nature than fiberglass batt. Both of these wall systems would be at risk for moisture related damage if they were wetted repeatedly and both walls are able to handle rare wetting events.



Figure 28 : Drying Curves for Case 5 and Case 11

2.3 Enclosure Durability

Durability of the building enclosure system was also used to classify the different wall construction scenarios. Durability is used in this report to group together multiple durability related criteria such as rain control, drying of water leakage events, air leakage condensation, built in moisture, and susceptibility of different building materials to moisture related issues. The durability assessment will be determined from hygrothermal modeling, as well as qualitatively based on the knowledge and experience of building material characteristics such as vapor permeability, and hygric buffering capacity, and susceptibility to moisture related damage.

2.4 Buildability

Buildability is a key comparison criteria for practical purposes. Often the general contractor and trades will influence design decisions based on the perceived complexity of different construction techniques or deviation from their standard practice. Any enclosure system and detailing should be buildable on a production level to achieve the greatest benefit even though the trades are often resistant to changes in construction practices. The susceptibility of the enclosure system to poorly constructed water management details and poor workmanship is also considered in buildability.

2.5 Material Use

Material use is becoming a critical design issue with the increasing concerns of depleting resources, and with increasing costs of materials and energy. Some construction strategies use more construction materials such as the double stud wall, and the advantages of increased thermal control should be balanced against the disadvantages of increasing the building materials and embodied energy. In some cases, materials that have less embodied energy, or recycled material, such as cellulose insulation could be used instead of the more energy intensive fiberglass batt insulation.

2.6 Cost

The factor which generally has the greatest influence on implementation of a building enclosure strategy, particularly for production builders, is cost. Because the cost of some materials varies significantly depending on location and case-specific relationships between builders and suppliers, the cost of a building enclosure system will be perceived relative to other systems. For example, it's accepted that R19 fiberglass batt is less expensive than low-density (0.5 pcf) spray foam, which is less expensive than high density (2.0 pcf) spray foam. The strategy of a comparison matrix for the test wall assemblies is able to use relative values for cost rather than exact costs.

C. Results

1. CASE 1: STANDARD CONSTRUCTION PRACTICE

For this analysis, standard construction practice includes OSB sheathing, 2x4 or 2x6 framing 16" oc, fiberglass batt insulation, a 6-mil polyethylene vapor barrier and taped and painted ½" drywall. (Figure 29) Historically, this has been used for residential wall construction in most areas of North America.

w

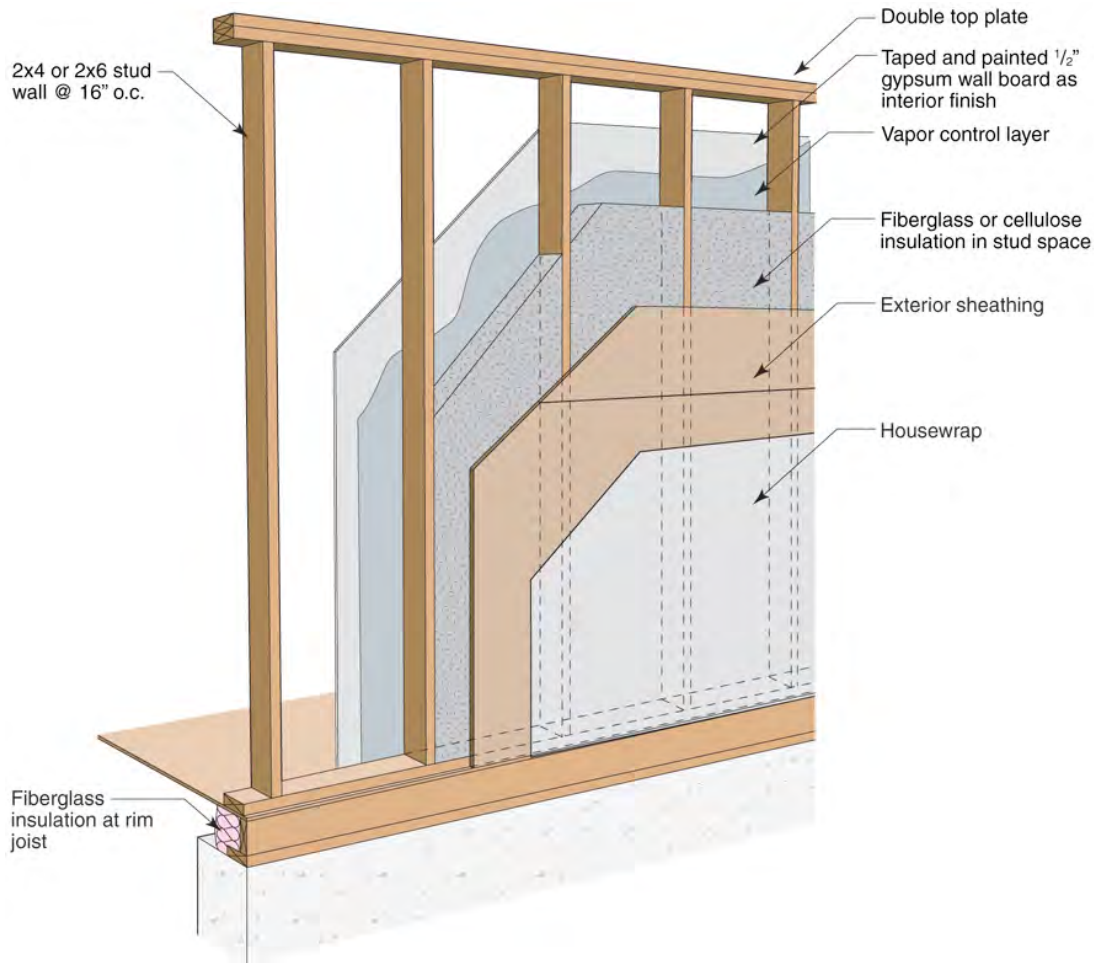

Figure 29 : Standard construction practice

1.1.1. Thermal Control

Fiberglass batt installed in a 2x4 wall system has an installed insulation value of R13, and fiberglass batt in a 2x6 wall system has an installed insulation value of R19. There are several different densities that can be used to provide slightly different R-values (e.g., 3.5" thick batts are available in R11, R12, R13 and R15 ratings). Other insulations that could be used in this assembly include densepack or spray applied cellulose, spray applied fiberglass, and spray foam (Case 8). Regardless of the insulation used in the cavity space, the framing components of the wall act as thermal bridges between the interior drywall and the exterior sheathing and this affects the whole wall R-value of the assembly. Figure 30 shows the vertical and horizontal wall sections used in Therm to determine the whole wall R-values for standard construction practices.

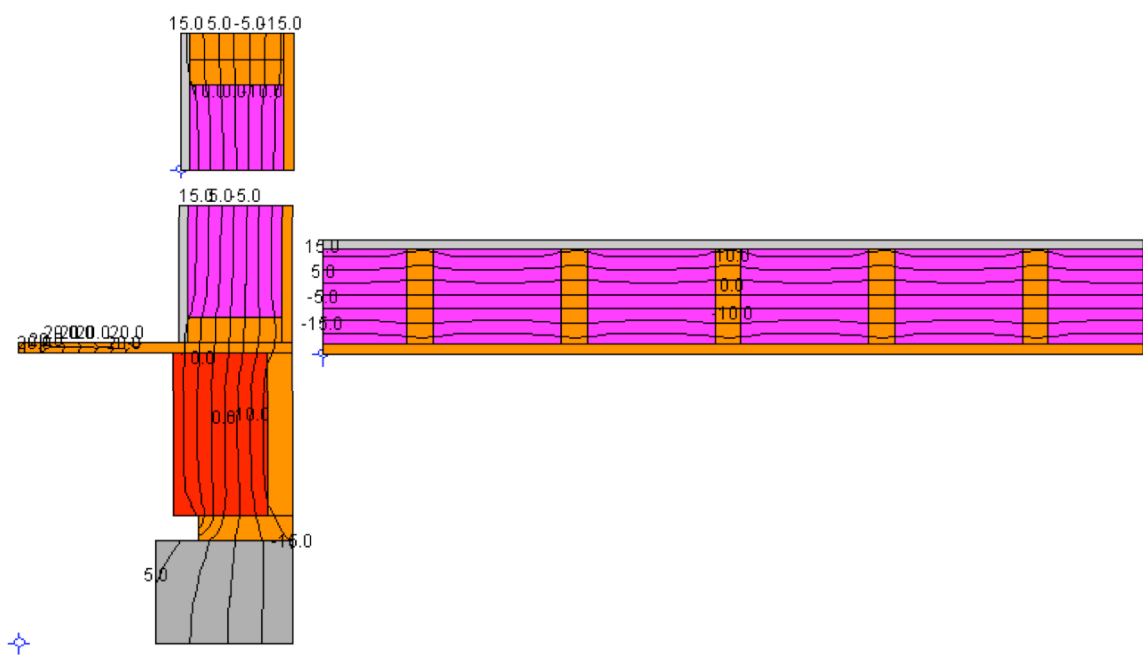

Figure 30 : Therm modeling of Case 1 - 2x6 construction

As stated previously, studies have shown that even when using a stud spacing of 16" o.c., which corresponds to a framing factor of approximately 9%, the actual average framing factor can be considerably higher, between 23 and 25%. For comparison between the different cases, framing factors of 16% were used to limit the variables and determine the effects of other variables.

Table 5 shows a summary of the R-values calculated for the three different components of both the 2x4 and the 2x6 standard construction practice. These insulation values are not considered high-R wall systems in cold climates.

Table 5 : Summary of R-value results from Therm modeling for Case 1

Case	Description	Whole Wall R value	Rim Joist	Clear Wall R value	Top Plate
1a	2x6 AF, 24"oc, R19FG + OSB	15.2	12.3	16.1	12.5
1aii	2x6, 16"oc, R19FG + OSB (25%ff)	13.7	12.3	14.1	12.5
1b	2x4 AF, 24"oc, R13FG + OSB	11.1	9.8	11.5	9.8
1bii	2x4, 16"oc, R13FG + OSB (25%ff)	10.0	9.8	10.1	9.8

Neither of the two most common insulations, fiberglass or cellulose, control air flow. Cellulose does a better job of suppressing convection because it fills the gaps that are typically left during typical fiberglass batt installation. Blown-in fiberglass also helps address the gaps left during fiberglass batt installation but is relatively new, and not as widely used as cellulose.

Air tightness can be significantly improved by using an airtight insulation such as sprayfoam at the rim joist.

1.1.2. Moisture Control

Analysis of the air leakage condensation potential from a poorly detailed air barrier results in approximately 4400 and 4500 hours of potential condensation for the 2x4 and 2x6 standard construction walls respectively when the temperature of the exterior sheathing is less than the dew point of the interior air. (Figure 10)

These walls are unable to dry to the interior, but generally are able to dry fairly well to the exterior depending on the cladding type. Wv FI® showed that with a ventilated cladding like vinyl siding, the sheathing in both of the standard construction walls decreased from 250 kg/m³ to 100 kg/m³ in 29-34 days (Figure 24).

1.1.3. Constructability and Cost

Generally speaking, all of the trades and construction industry are very familiar with building the Case 1 wall system. Cladding attachment is straightforward, and the only education necessary may be air tightness details to increase the overall building performance.

1.1.4. Other Considerations

The amount of material used in this type of construction is the standard against what other walls will be compared since it has been the standard of construction in many places of many years. Standard construction uses less framing and wood sheathing than a double stud wall construction (Case 4), but more than advanced framing material. Using cellulose insulation instead of fiberglass not only increases the fire resistance for the enclosure wall, it also decreases the embodied energy used in construction.

1.2 Case 2: Advanced framing with insulated sheathing

Advanced framing techniques are becoming more popular for residential construction because of several advantages. These practices have been adopted by some smaller builders, but not on many large scale production developments. The main difference with advanced framing is 2x6 framing lumber on 24" o.c. with a single top plate. The idea of advanced framing is to reduce the framing factor of the wall system in the areas by good design, such as corners and penetrations. A single top plate is structurally possible if stack framing is used, which means the framing from one floor is lined up directly with the framing above and below it to create a continuous load path. In many cases of advanced framing, insulated sheathing is used either in place of or in combination with wood sheathing. This is important for thermal performance to minimize thermal bridging effects.

For this analysis, 1" and 4" insulated sheathing is considered (Figure 31). Insulating sheathing up to 1.5" thick does not change any of the other details such as windows installation and cladding attachment, but insulating sheathing at thicknesses of 2" and greater requires some slightly different design details for window and door installation as well as cladding attachment. Most of these details have already been designed and can be found in building science resources.

v

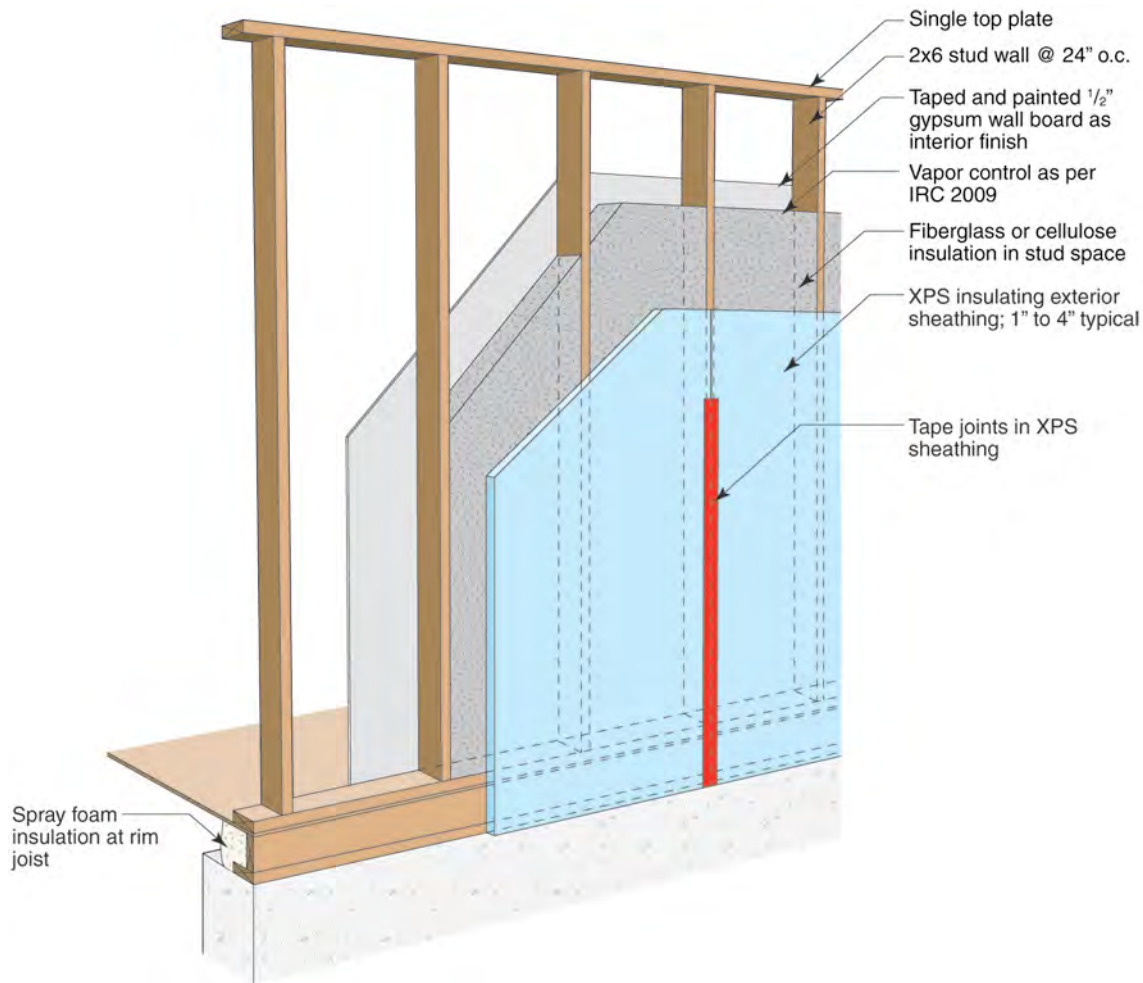

Figure 31 : Advanced framing construction

u

1.2.1. Thermal Control

Thermal control is improved over standard construction practices by adding insulating sheathing to the exterior of the framing in place of OuB. This insulation is typically board foam which includes expanded polystyrene (EPS), extruded polystyrene (XPS) and polyisocyanurate (PIC). PIC is often reflective aluminum foil faced which also helps control radiation losses in some cases. Thicknesses of insulation have been installed that range from $\frac{3}{4}$ " to 4" on wall systems. Often times, when 4" of insulation is added, it will be done with two 2" layers with the joints offset both horizontally and vertically. Fiberglass batt, blown fiberglass or cellulose could be used in the stud space. The biggest thermal advantage of the insulating sheathing is decreasing the thermal bridging of the framing members through the thermal barrier.

Drawings from Therm show the vertical and horizontal sections which indicate increased thermal protection at both the rim joist and top plate, decreasing heat flow through the thermal bridges.

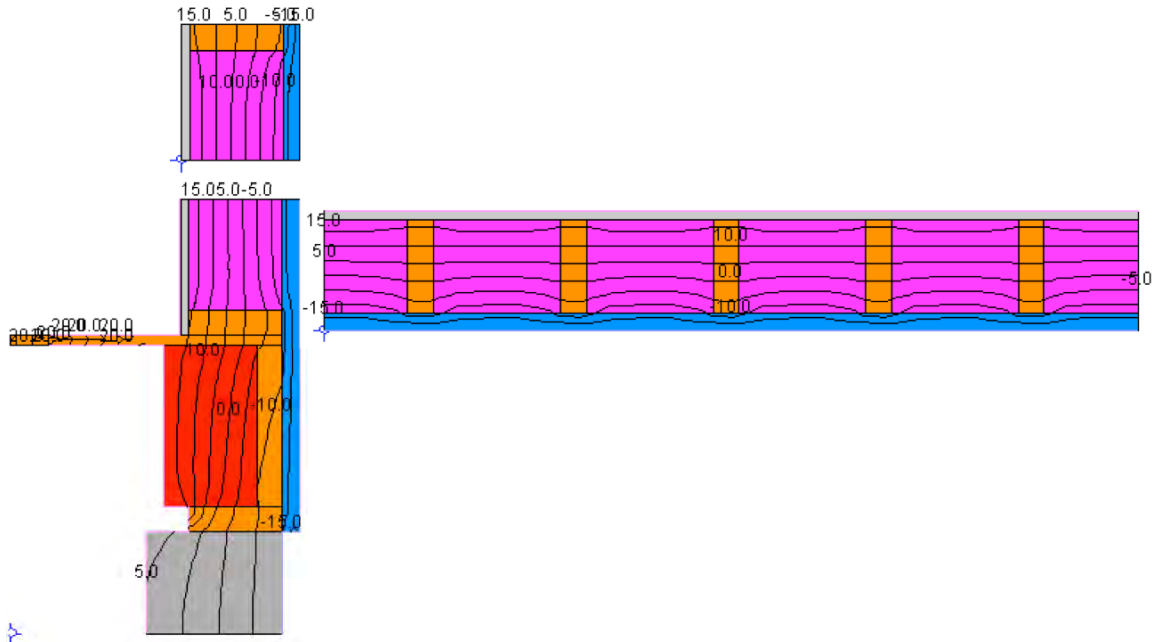

Figure 32 : Therm modeling of Case 2 advanced framing with 1" XPS insulated sheathing

Analysis shows that when substituting 1" of Xs S (R5) for the OSB in a standard 2x6 wall with a 16% framing factor, the clear wall R-value increases from 16.1 to 20.6, an increase of R4.5. Since the OSB was removed from the standard construction wall, this is actually a difference of R5.1, which is greater than the R-value of the insulation that was added. If the framing factor was higher, or metal studs were used, an even greater increase in the R-value for 1" of XPS can be seen. For example, increasing the conductivity of the studs by an order of magnitude results in an increase of R6.5 for 1" of R5 XPS sheathing over standard construction. This is an example of the importance of reducing the thermal bridging through the enclosure.

The calculated R-values for both of the advanced framing walls are shown in Table 6.

Table 6 : Summary of R-value results from Therm modeling for Case 2

Case	Description	Whole Wall R value	Rim Joist	Clear Wall R value	Top Plate
2a	2x6 AF, 24"oc R19FG + 1" R5 XPS	20.2	18.5	20.6	20.3
2b	2x6 AF, 24"oc R19FG + 4" R20 XPS	34.5	29.0	35.6	35.4

1.2.2. Moisture Control

The Therm results show that the interior surface of the foam is at a higher temperature than the standard construction wall which will decrease the potential for both vapor diffusion condensation and air leakage condensation. According to the IRC, a Class I or II vapor retarder is still required depending on the R-value of the insulated sheathing and the wall framing used. Table N1102.5.1 from the IRC shows that for climate Zone 6, with insulating sheathing $R_s = 11.25$ on a 2x6 wall, only a Class III vapor retarder is required.

There is some risk of winter time condensation from vapor diffusion depending on the level of vapor retarder and the interior temperature and relative humidity conditions. Figure 9 shows that with 1" of XPS some condensation is possible on the surface of the insulated sheathing. Since the Xs S is not moisture sensitive, some condensation will not affect the durability of the wall system.

Air leakage condensation may still be a concern, although not as great as with standard construction. There are approximately 3800 hours and 1200 hours of potential air leakage condensation when the temperature of the insulated sheathing is below the dew point of the interior air for 1" of XPS and 4" of XPS respectively.

Both of the advanced framing walls dry slower than the standard construction walls because drying to the exterior is throttled by the low vapor permeance XPS (Figure 24).

There is less inward vapor drive in the advanced framing walls with insulated sheathing than the standard construction since vapor is slowed at the sheathing, and allowed to dry more readily to the interior (Figure 19). The relative humidity peaks are considerably higher in the standard construction walls than the advanced framing walls.

1.2.3. Constructability and Cost

There is some education and training required for the successful construction of advanced framing walls with insulated sheathing. The changes are very minimal for insulated sheathing thicknesses of 1.5" and less, but for insulating sheathing thicknesses of 2" and greater, special details are required for cladding attachment and window and door installation.

Some solutions have been found for cladding attachment directly to 3/4" strapping anchored to the framing members, but in some areas, building code officials require letters from the specific building materials companies before allowing construction.

1.2.4. Other Considerations

The R-value of a wall system can be increased more than the added value of insulation by minimizing the thermal bridging with exterior insulating sheathing. Advanced framing techniques use less framing lumber than traditional construction, which is a savings of both money and embodied energy while reducing the framing fraction. Similar to traditional construction, using cellulose in the stud space will decrease the embodied energy of the insulation and increase the fire resistance of the wall system.

1.3 Case 3: Interior 2x3 horizontal strapping

Horizontal interior strapping is a method of reducing the thermal bridging through the wall framing, protecting the vapor barrier against penetrations, and adding more insulation.

w

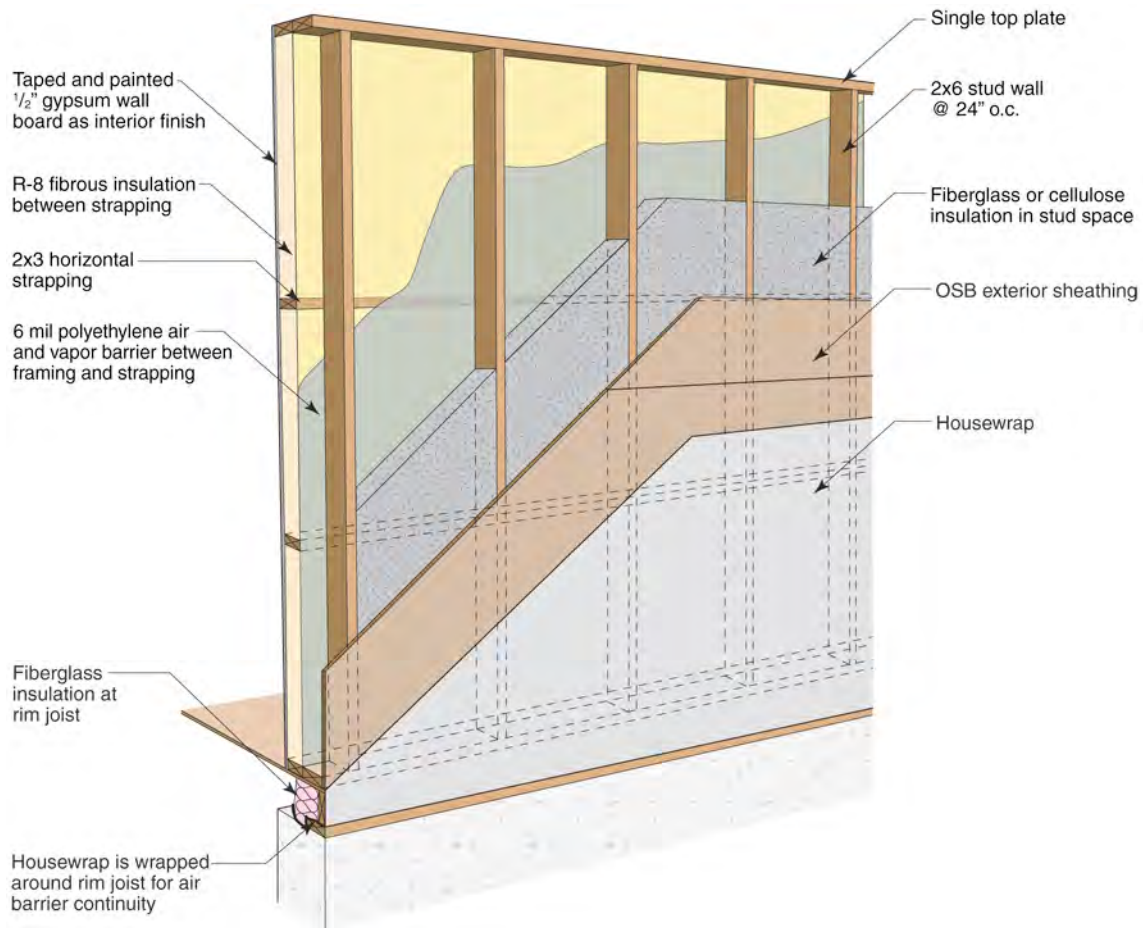

Figure 33 : 2x6 wall construction with interior strapping

1.3.1. Thermal Control

The horizontal strapping added to the wall allows for an extra 2.5" of insulation. This is commonly in the form of R8 fiberglass, which totals an installed insulation R-value of R27 for the wall assembly. For the Therm simulation four interior strapping elements were used as shown in the drawing.

Thermal bridging is decreased through the vertical studs but there is still thermal bridging at the top and bottom plates. Thermal losses due to air leakage are likely been minimized by installing the polyethylene vapor barrier against the wall framing. This means fewer penetrations are required for services and wiring resulting in greater air tightness than standard construction.

Therm was used to determine the whole wall R-value of the interior strapping wall. Figure 34 shows the horizontal and vertical sections from the Therm analysis.

-

-

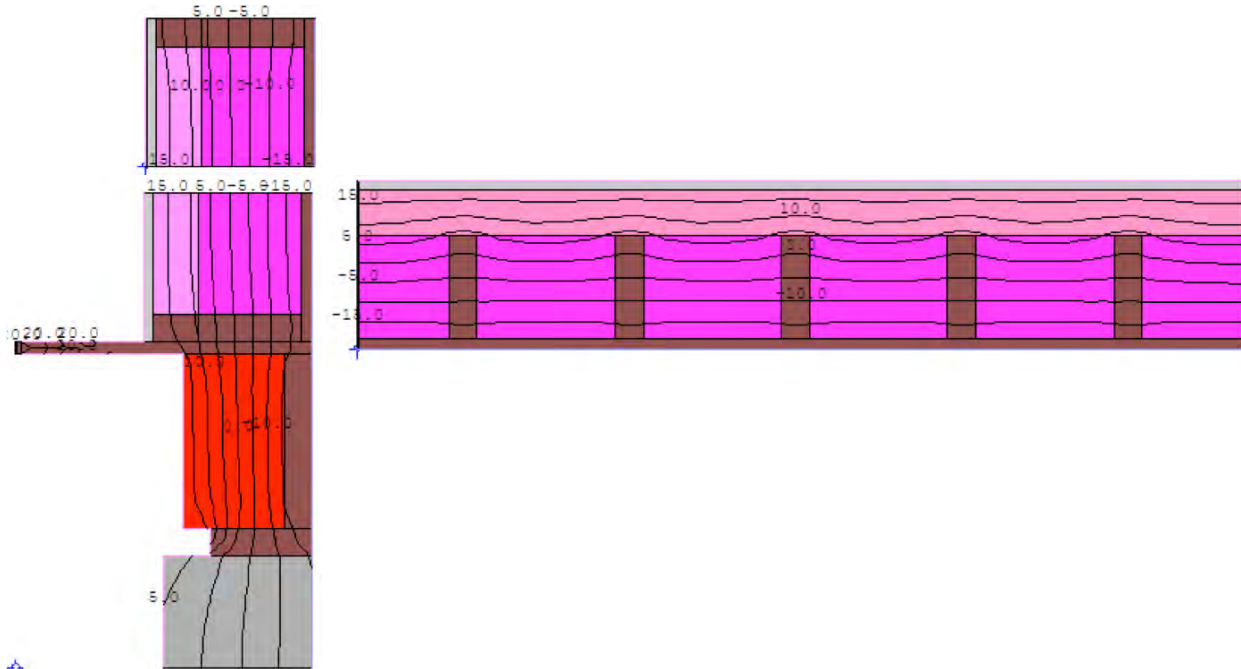

Figure 34 : Therm analysis of horizontally strapped wall

The Whole wall R-value of the wall assembly was determined to be R21.5 (Table 7). This means that even by adding R8 to the standard 2x6 wall, this results in an increase of R6.3 because of the thermal bridging that is not addressed. The rim joist R-value can be improved with more insulation, and better airtightness.

Table 7 : Calculated R-value of an interior horizontal strapped wall

Case	Description	Whole Wall R value	Rim Joist	Clear Wall R value	Top Plate
3	2x6 AF, 24"oc, 2x3 R19+R8 FG	21.5	13.4	23.5	18.4

1.3.2. Moisture Control

The control of both vapor diffusion condensation and air leakage condensation is increased since there are fewer penetrations in the air/vapor barrier of the wall assembly.

The potential for vapor diffusion condensation is very similar to the standard construction assemblies (Figure 12). The temperature of the sheathing is kept only slightly colder because of the increased insulation beyond standard construction which results in a small increase in the potential intensity of air leakage condensation.

There does not appear to be any risk of moisture related durability from vapor diffusion assuming the vapor barrier is adequately installed.

Air leakage condensation potential is slightly increased from the standard construction walls with a total of approximately 4600 hours of potential condensation through the winter.

Analysis of the summertime inward vapor drives shows very similar results between the standard construction practices in Case 1 and the interior strapped wall.

Drying of the interior strapped wall shows slightly improved performance over the standard construction practice, by a few days for the OSB to reach 100 kg/m³.

The interior strapped wall performed very similarly to the standard construction practice in terms of moisture control.

1.3.3. Constructability and Cost

Constructing a wall with interior horizontal strapping is not a normal construction technique in most places. It would require some education and training in the design details, such as window installation, but cladding attachment is the same, and the wall system would be less susceptible to workmanship issues on the vapor barrier, since there are far fewer penetrations required through the air/vapor barrier. Additional costs would be incurred due to the addition of both horizontal strapping and the installation of additional batt insulation as well as some more installation time. The mechanical and electrical services should see a reduction in cost since that the horizontal framing does not require as much drilling or modification to distribute the services. The mechanical and electrical trades would also not have to take the time to seal as many locations as in standard vapor and air barrier practices.

1.3.4. Other Considerations

It would be possible to use cellulose insulation between the polyethylene vapor barrier and the exterior sheathing, which would increase the fire resistance, and decrease the embodied energy. There is more framing required to construct these walls, and the tradeoff in adding insulation is not quite made up in the overall R-value of the assembly.

1.4 Case 4: Double Stud

Double stud walls are most commonly used as interior partition walls in multifamily construction because of their noise reducing effect and increased fire resistance. They can also be used as a highly insulated exterior enclosure wall in cold climates.

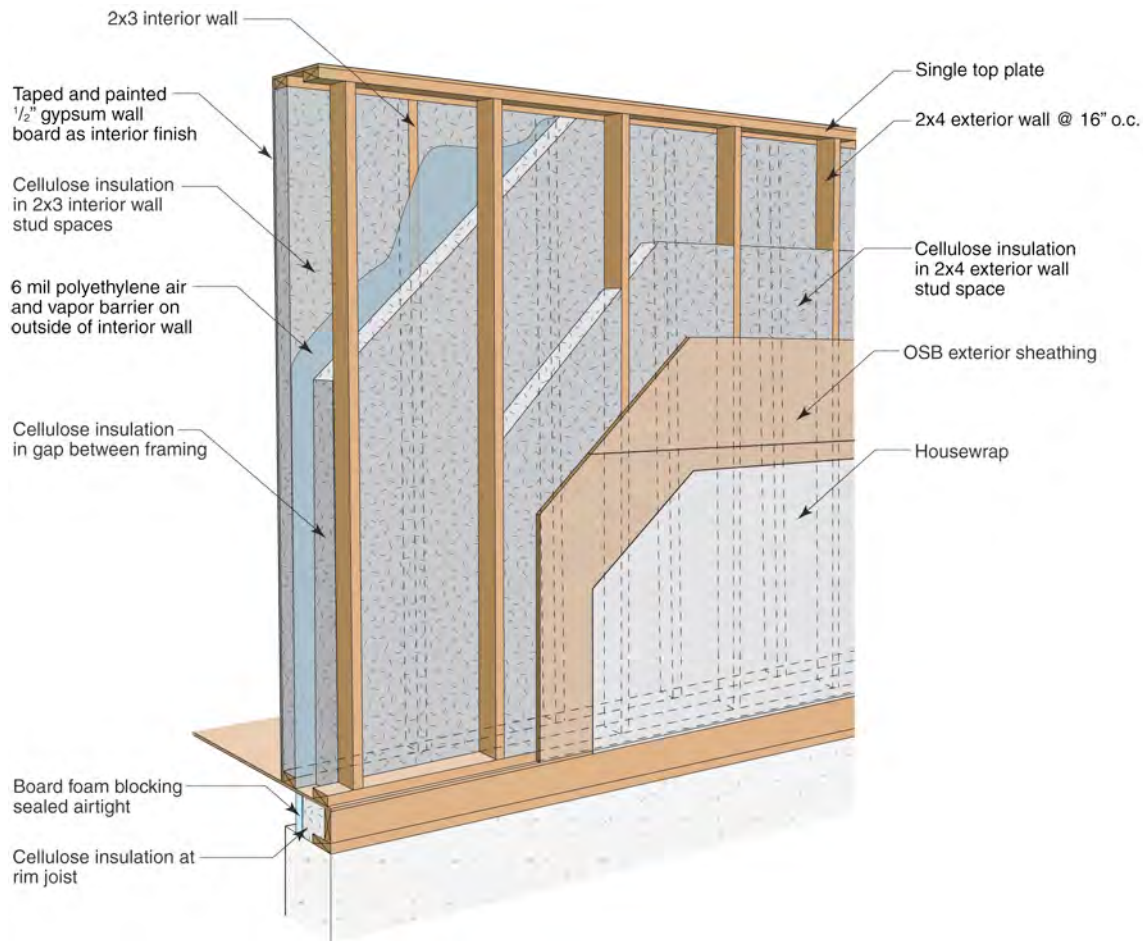

Figure 35 : Double stud wall

1.4.1. Thermal Control

This wall is typically built with an exterior structural wall using standard construction practices, a gap on the interior filled with insulation, and a second wall that is non-structural, used to support services and drywall. The interior wall studs are often installed further than 16" o.c., since it is not used for structural purposes. For the Therm simulation the exterior structural members were spaced 16" o.c. and the interior framed wall used to support the drywall and insulation was spaced at 24" o.c. The framing spacing becomes less important for simulations, and field installation, when there is a significant thermal break between the exterior and interior environments. The actual placement and alignment of interior and exterior framing members will depend on many variables such as windows, doors, corners, and the building practices of the framing crew. It is also common to use a double top plate on the exterior structural wall but for this analysis a single top plate was simulated. As with the framing members, a single or double top plate has less impact on the thermal performance for walls with significant thermal breaks between the interior and exterior. It is possible to install the 6-mil polyethylene Class I vapor barrier on the back of the interior wall by installing the plastic when the wall is on the floor, and then lifting the wall into place and securing, making sure to seal the plastic at the top and bottom. This produces a more continuous air/vapor barrier since fewer penetrations are needed for services when compared to the standard framing methods although this may increase the perceived complexity to an unsatisfactory level for some builders.

One advantage observed in the field of installing the air/vapor barrier on the interior framing is one large cavity space that is easier and quicker to insulate with cellulose insulation.

The gap between the two walls can be varied, and produces a much more effective thermal bridge between the two rows of framing than the horizontal interior strapping in Case 3. Often the insulation of choice is cellulose because it is easy to install in wide wall cavities, and will not have the spaces that can occur if fiberglass batt were installed incorrectly (as it commonly is).

The Therm model (Figure 36) shows the space between the two separate walls that helps act as thermal break. Since the gap between the walls can be changed, the R-value will depend on the designed wall thickness. In this analysis, 9.5" of cellulose was used which has an installed insulation R-value of approximately R34. Therm analysis shows that with the existing thermal bridging and rim joist, the whole wall R-value is approximately R30 which is only a slight reduction from the clear wall R-value. The R-value can be improved by improving the rim joist detail: more insulation, better airtightness, and better insulation of the concrete foundation.

w

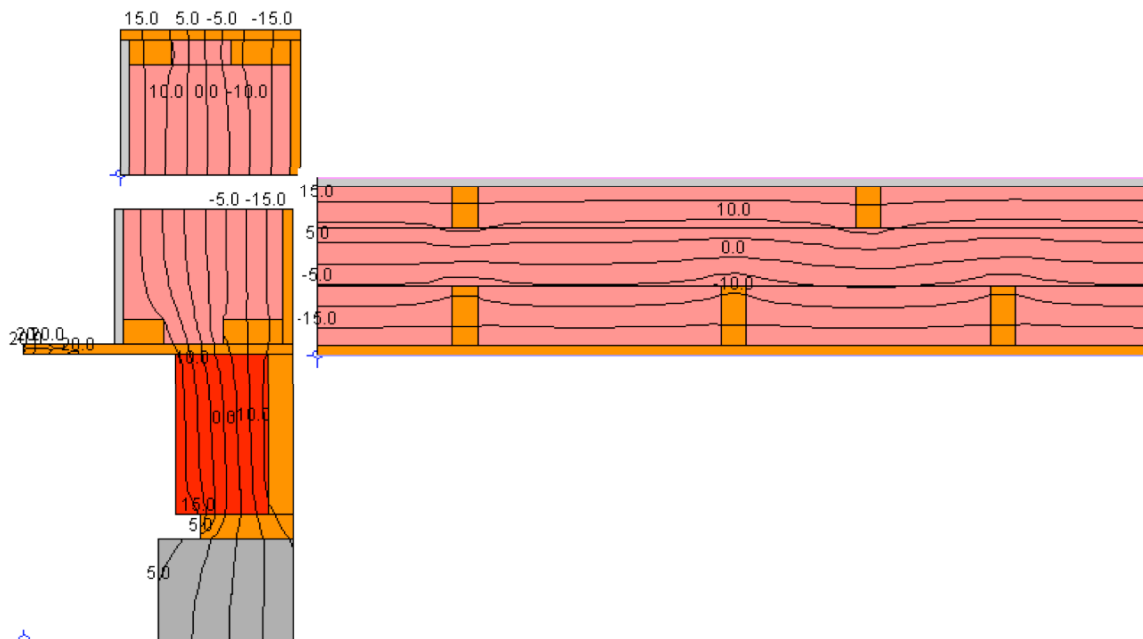

w

Figure 36 : Therm model of the double stud wall

Table 8 : Calculated R-value of a double stud wall

Case	Description	Whole Wall R value	Rim Joist	Clear Wall R value	Top Plate
4	Double stud wall 9.5" R34 cellulose	30.1	14.4	33.5	28.8

w

1.4.2. Moisture Control

Moisture control in the form of air leakage condensation and vapor diffusion condensation is controlled with a 6-mil polyethylene vapor barrier that can be installed on the back side of the interior wall or directly behind the drywall. Installing the poly on the back side of the interior wall, if possible, helps reduce the amount of air leakage condensation because fewer penetrations are needed and the air barrier can be more continuous.

Because of the greatly increased thermal performance, the sheathing is kept colder than standard construction and therefore the probability and intensity of vapor diffusion and air leakage condensation increases. There are approximately 4600 hours of potential wintertime condensation hours, similar to Case 3 with interior horizontal strapping but because the temperature of the sheathing is colder, the amount of condensation would increase for the same amount of air leakage (Figure 13).

In the summer time the potential inward driven moisture condensation is slightly less than the standard construction walls (Figure 20). This is because the cellulose in the insulation cavity has some buffering effect of moisture, so with a non-reservoir cladding such as vinyl siding, the buffering capacity is not overcome. The outcome may be different with a cladding such as stucco or adhered stone veneer.

In the drying analysis, the double stud wall performs very similarly to the standard construction practice as well as the interior strapped wall drying to 100 kg/m³ in 28 days (Figure 25).

1.4.3. Constructability and Cost

There is some education and training required with this construction technique, mostly with the window boxes and window installation. In any construction where the wall is much thicker than standard construction, window bucks (plywood boxes) are required for window installation. The cladding attachment is the same as normal construction practices.

1.4.4. Other Considerations

There is considerable extra framing required for the double stud wall which should be considered during design. If the exterior dimensions of the building are fixed, there is also a significant reduction in the interior floor area because of the thickness of the walls. Cellulose increases the fire resistance of the wall system, and allows for buffering and redistribution of enclosure moisture as long as the buffering capacity is not overwhelmed.

z

1.5 Case 5: Truss Wall

The truss wall is a construction technology that is not as widely known as the other cases being considered. It provides a great deal of insulation space, minimizes thermal bridging through the wall by using plywood gusset plates, and covers the rim joist with insulation (the rim joist is generally a location of significant air leakage and thermal bridging). Also, unlike the double stud wall, the increased wall width is to the exterior of the structural wall, which does not compromise indoor floor area.

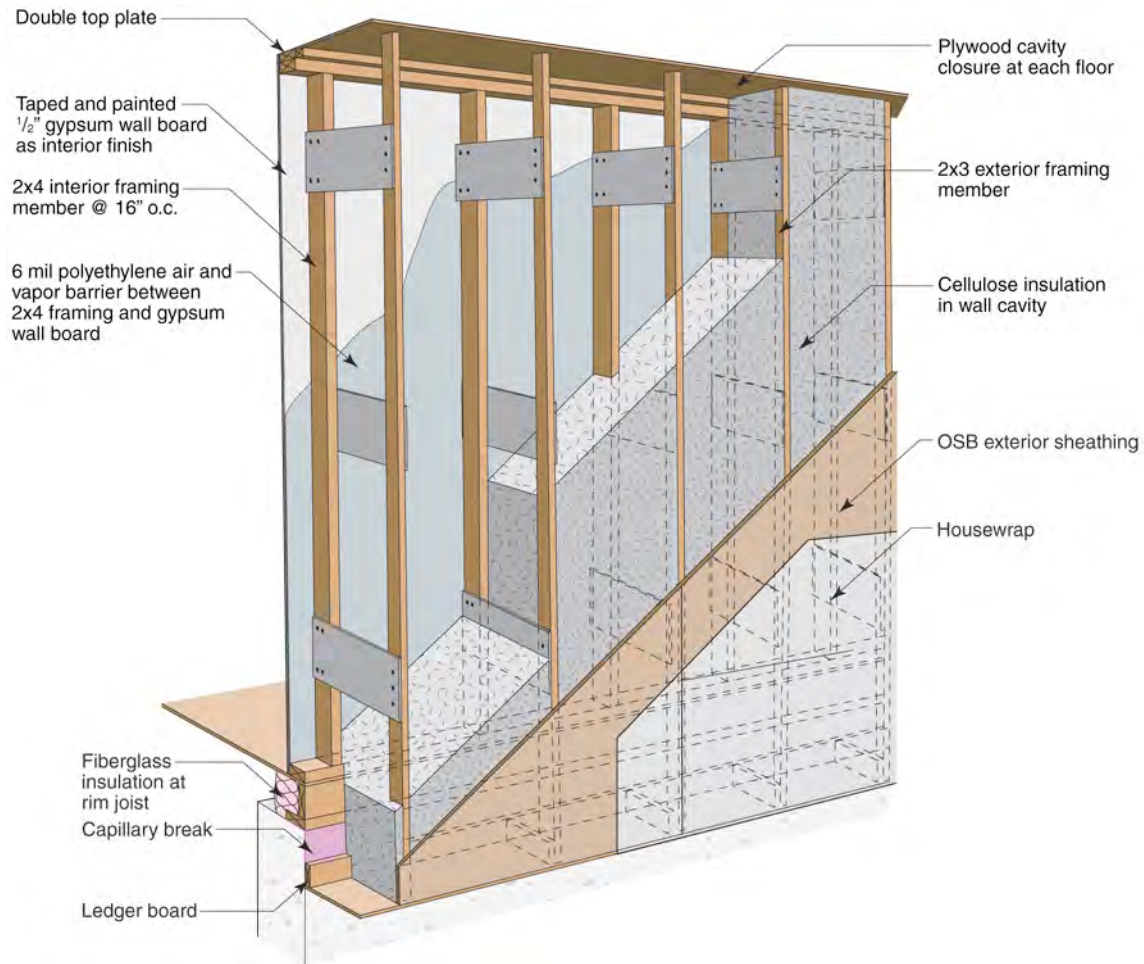

Figure 37 : Truss wall construction

z

1.5.1. Thermal Control

The goal of this wall is to provide as much space as possible for insulation to increase the thermal z performance. In this analysis, an insulation cavity of 12 inches was constructed through the wall system. z This was filled with cellulose to achieve a nominal R-value of R43, the highest R-value of any of the walls z analyzed. z

Therm was used to predict the whole wall R-value of this high-R assembly (Figure 38), and a value of R36.5 z was calculated. Looking at the three individual components, the clear wall R-value is R40, but both the top z plate and rim joist exhibited lower values. It is likely that a high heel truss with wide overhangs would be z utilized for the attic and the attic space insulation would extend out over the top plate creating continuous z insulation over the plates reducing the thermal bridging. This is not a commonly constructed wall but it was z felt that a double top plate is more likely to be used than a single top plate for construction. It is possible to z construct the same wall with a single top plate instead. z

The wall schematic in Figure 37 shows that every structural wall stud has a corresponding exterior framing z member for cladding attachment. In practice this is unlikely to happen because of extra framing studs z commonly used for construction. It is more likely that there will be some structural wall members without a z corresponding exterior framing member as was simulated in Therm (Figure 38). Similar to the double stud z wall, the actual number and spacing of structural members has little influence on the whole wall R-value z because of the significant thermal break of the insulation between the interior and exterior framing members. z

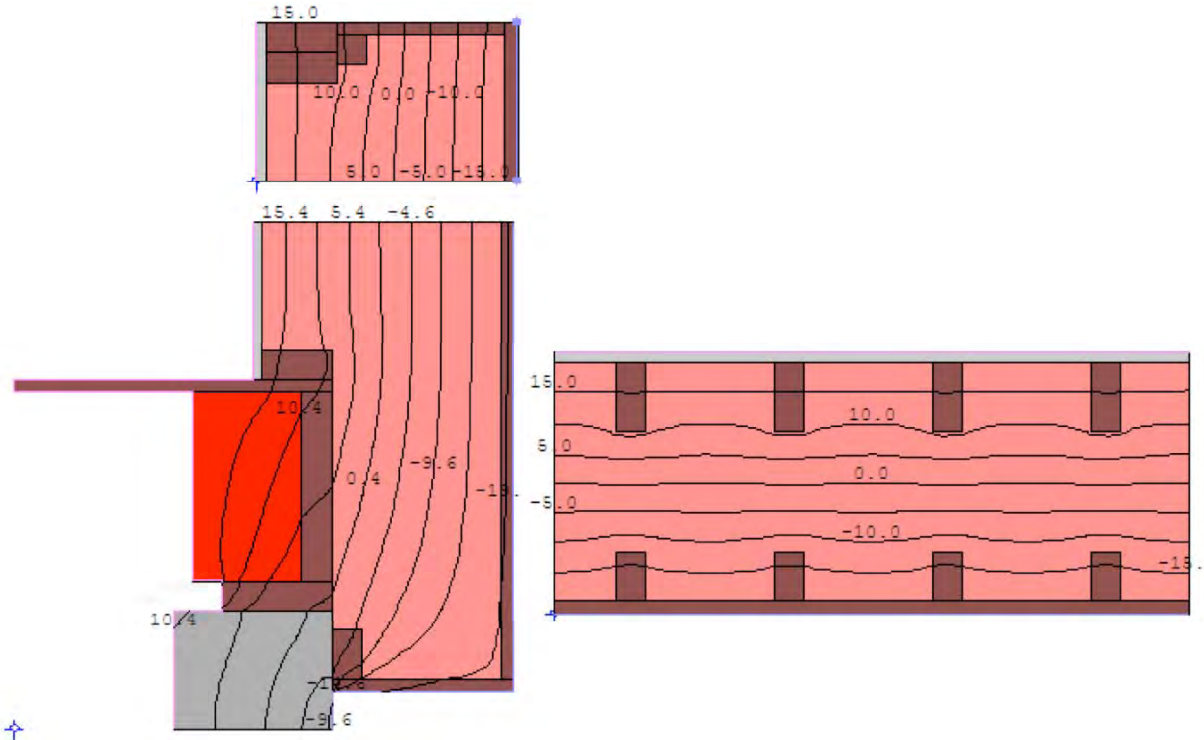

Figure 38 : Therm results of the truss wall

Table 9 : Calculated R-value for truss wall

Case	Description	Whole Wall R value	Rim Joist	Clear Wall R value	Top Plate
5	Truss wall 12" R43 cellulose	36.5	18.6	40.5	34.4

1.5.2. Moisture Control

Vapor diffusion control and air leakage control are particularly important in this assembly since it has the greatest insulation value and the coldest winter sheathing temperatures. The truss wall has similar winter sheathing relative humidities to the double stud wall, but the relative humidities are slightly higher because of the lower sheathing temperature. There are approximately 4600 hours of potential winter time condensation, but the intensity of condensation is slightly greater than the double stud wall, again, because of the lower sheathing temperature (Figure 13).

The truss wall is very similar to the double stud wall although slightly lower in summertime inward vapor drive relative humidity at the vapor barrier (Figure 20). This is likely because of the increased moisture distribution and buffering from the increased amount of cellulose insulation in the truss wall.

Analysis of the drying results shows that the truss wall dries two or three days faster than both the double stud wall and the interior strapping wall (Figure 25) which is also because of the greater redistribution and buffering of moisture.

There is an increased risk of problems with the vapor control layer in the truss wall than both the double stud wall and the interior strapping wall, since the polyethylene vapor barrier will have penetrations for services and wiring. If the polyethylene sheet is also being relied on as the air barrier, which is common, this could lead to the highest risk of moisture related durability issues in all three similar test walls.

1.5.3. Constructability and Cost

The truss wall appears to require more time and energy to construct than the double stud wall. This strategy would likely not be considered by a production builder under normal conditions. Cladding attachment will be the same as the traditional construction. This wall appears to be highly dependent on good workmanship (even more so than the double stud Case 4 and interior strapping Case 3), as holes in the air barrier could result in serious moisture related durability issues from air leakage condensation. If a proper airtight drywall approach is used, this could help resolve any issues with holes in the polyethylene air and vapor barrier.

1.5.4. Other Considerations

This system seems both energy and work intensive, constructing gussets, and installing the exterior framing wall and is unlikely to be used except possibly in the coldest of locations where extremely high R-values are required. There are other alternatives that may have more appeal and less risk such as Cases 10 and 11 further in this report.

1.6 Case 6: Structural Insulated Panel Systems (SIPs)

SIPs are constructed by sandwiching foam board on both sides with OSB. The foam most commonly used is EPS because of its low cost and availability, but SIPs have also been produced with XPS and even PIC in some cases to increase the R-value per inch.

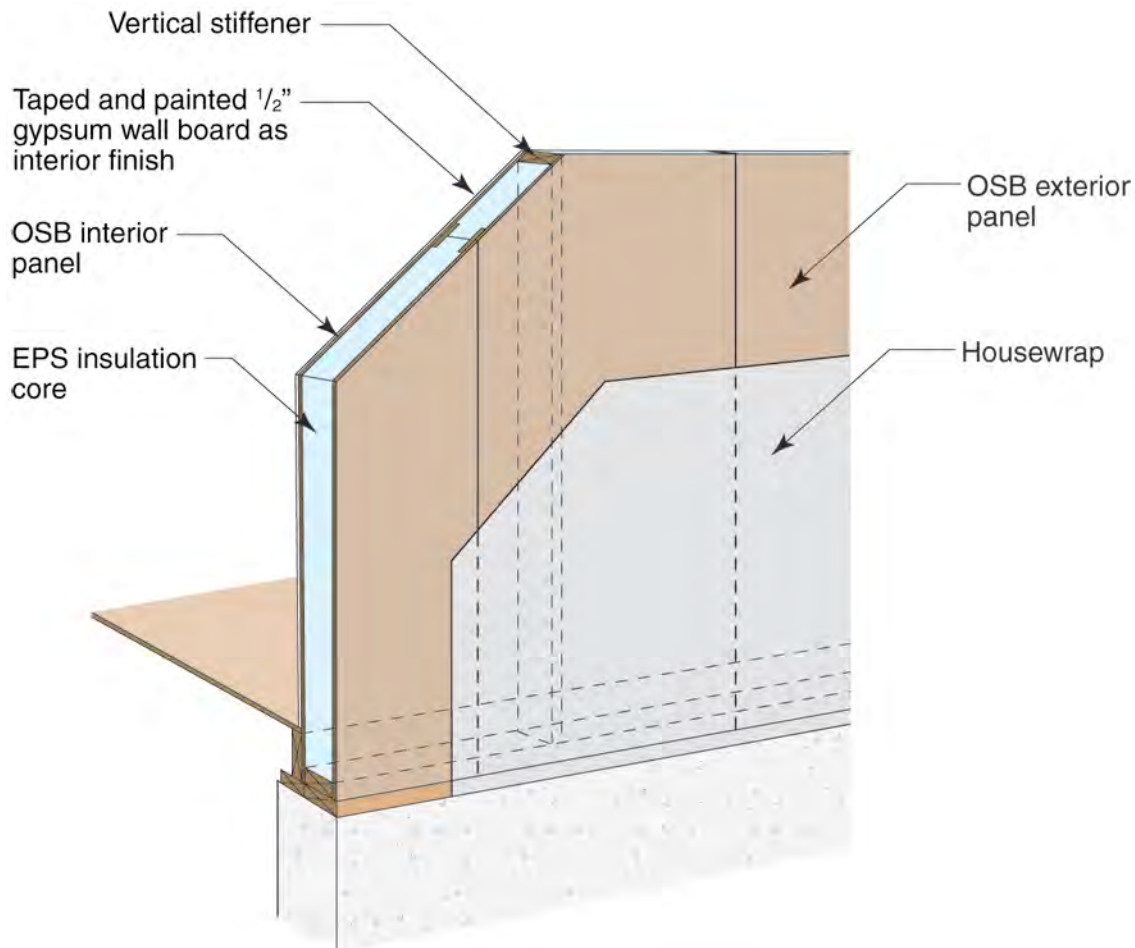

Figure 39 : SIPs wall construction

1.6.1. Thermal Control

SIPs are generally constructed with a thickness of EPS foam that matches the thickness of standard framing lumber (ie. 3.5", 5.5", 7.5"). This allows framing lumber to be inserted between the sheets of OSB in places where it is structurally required. EPS has a range of conductivity values but was modeled for this report using an R-value of R3.7/inch.

SIPs panels provide a fairly continuous plane of insulation, but quite often there are considerable thermal bridges around punched openings, the top and bottom of the panels, and sometimes through vertical reinforcement between panels.

The nominal value of this SIPs panel is R13, but because of a lack of thermal bridging through the wall (Figure 39), the calculated clear wall R-value of the wall is approximately R14.5 when the OSB and air films are taken into account. The whole wall R-value is approximately 13.6 when the top and bottom plate thermal bridges are accounted for (Table 10), which is actually higher than the installed insulation R-value.

Generally the cladding is applied directly to the exterior over a sheathing membrane, and possibly a drainage cavity, and the drywall is applied directly to the inside face. It is possible to increase the R-value of the assembly by adding insulation to the interior or exterior of the SIPs panel but it may not be cost effective.

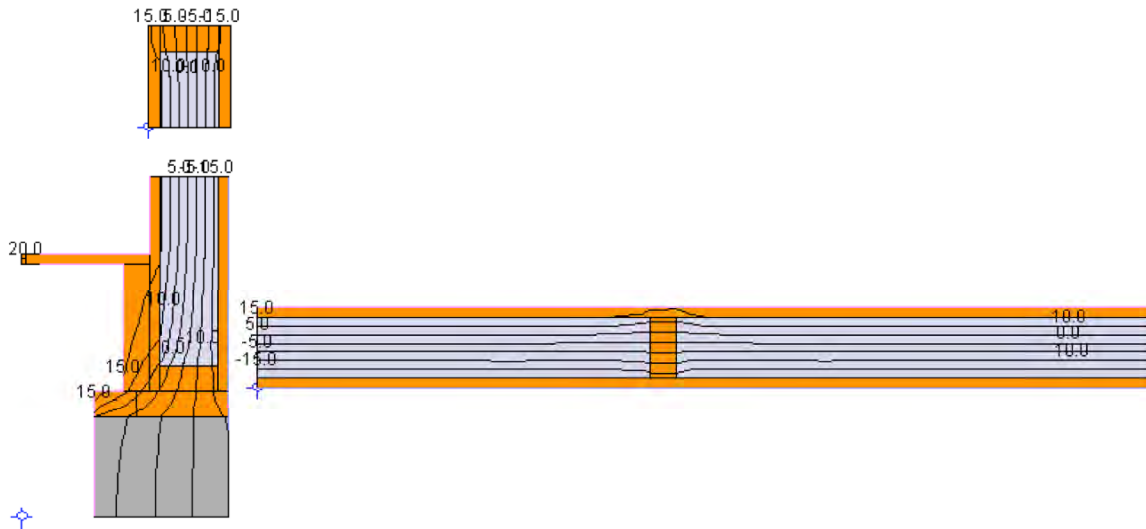

Figure 40 : Therm results of SIPs panel analysis

Table 10 : Calculated R-value for a Sips wall system

Case	Description	Whole Wall R value	Rim Joist	Clear Wall R value	Top Plate
6a	SIPs (3.5" EPS)	14.1	12.3	14.5	10.6
6b	SIPs (11.25" EPS)	36.2	14	41.6	28.2

1.6.2. Moisture Control

The plane of the SIPs wall provides a good air and vapor barrier between the interior and exterior environments. Historically, there were problems at the joints between SIPs panels where air would leak from the interior space to the exterior surface and condense against the back of the sheathing during the heating season in cold climates (SIPA 2002). Any SIPs failures have been reported to be caused by this air leakage r condensation mechanism.

Currently there are better practice guides and standards applied to the installation and construction of SIPs panels and in new buildings these moisture-related durability issues are rare. q

1.6.3. Constructability and Cost

Construction with SIPs panels requires training and education about construction techniques and design details. Generally, houses built from SIPs panels have very simple layouts and roof designs to help simplify the design of details at SIPs joints and roof-wall interfaces. q

1.6.4. Other Considerations

This is a fairly simple, yet durable solution if constructed properly. EPS foam is the least energy intensive to produce of all the board foams, and this technique requires far less framing lumber than other standard techniques, but twice as much OSB as normal framing with a single layer of exterior sheathing. During field installation it has been observed that there are often significant thermal bridges around penetrations, and depending on the structural loading of the SIPs panel, there may be multiple vertical stiffeners which also act as thermal bridges. As with all cases, the whole wall R-value makes assumptions regarding the occurrence of framing member thermal bridging, and in the field it is likely that the whole wall R-value is slightly lower than simulations indicate. q

The 3.5" SIPs panel is not considered a High-R wall system, but as the thickness level, and insulation are increased, this system could be considered for more extreme cold climates. q

1.7 Case 7: Insulated Concrete Forms (ICFs)

The most common type of ICF consists of two sides of EPS of varying thickness and a poured in place concrete core. This combination of insulation and concrete provides both the thermal component and the structural component of the enclosure. A much smaller portion of the market share are ICFs constructed of a cement wood fiber instead of EPS, and have varying amounts of insulation. q

q

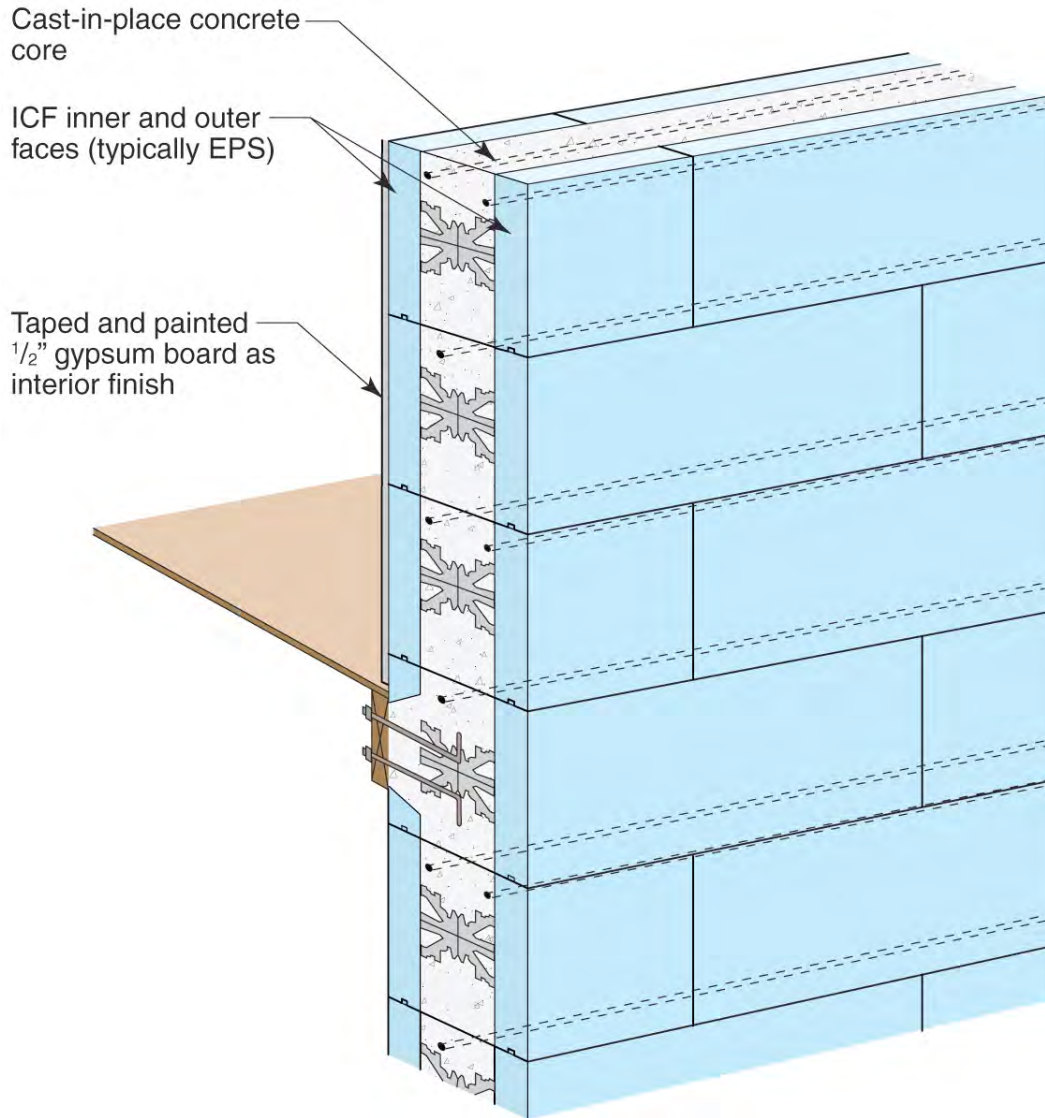

Figure 41 : ICF wall construction

y

1.7.1. Thermal Control

The ICF wall provides a barrier to both vapor and air flow across the enclosure. Care must still be taken at the penetrations for windows, doors and services to prevent air from moving through the enclosure, reducing the effectiveness of the insulation.

Therm analysis was used to determine the whole wall R-value of two different ICF systems. Figure 42 shows an 9" ICF with 2.5" of EPS on both the interior and exterior, and 4" of concrete. This has an R-value of 20.2. In comparison a 15" foam ICF with 5 total inches of EPS has an R-value of 20.6

y

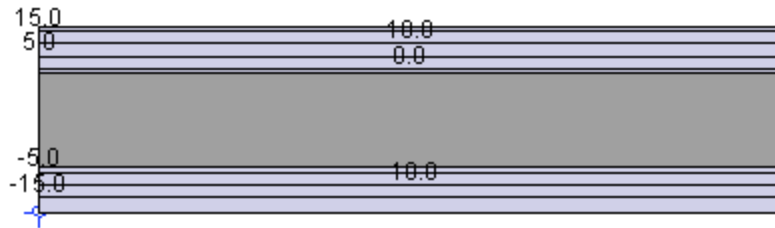

Figure 42 : Nine inch foam ICF with five inches of EPS

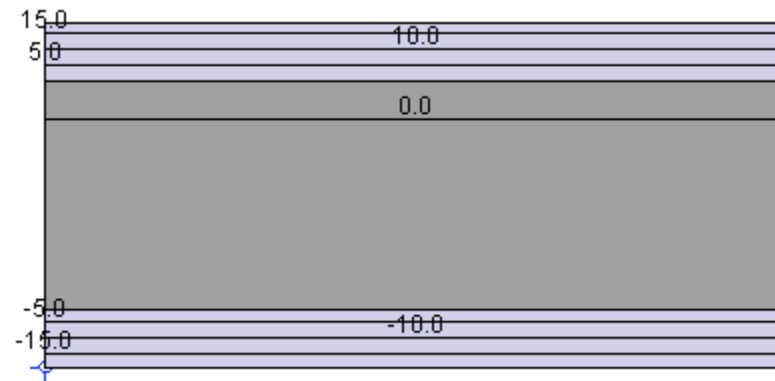

Figure 43 : Fifteen inch foam ICF with five inches of EPS

Neither of these ICF strategies would be considered a high-R enclosure in a cold climate, but these could be combined with an interior insulated framed wall or a layer of spray foam on the exterior to increase the thermal performance. The good airtightness, and the use of convection-immune rigid foam insulation means that the thermal performance is reliably delivered.

1.7.2. Moisture Control

Most ICF walls are vapor barriers that do not allow vapor to pass through easily. This also means that the wet concrete in the ICF form will retain an elevated moisture content for an extended period of time. The ICF wall system should be designed to allow to dry as easily as possible, in both directions.

One of the failure mechanisms of ICF walls is improperly flashed openings that allow water to drain into the enclosure through windows, and doors, and service penetrations. Since there is no storage component to the enclosure materials, all of the water will pass through, affecting the interior finishes.

1.7.3. Constructability and Cost

ICFs are more expensive than standard construction but they are generally easy to use with some training on where and how to use steel reinforcement if necessary and installing services. Blocks are simply stacked on top of each other and concrete is poured into the centre. There have been reported issues with gaps left in the concrete or blocks breaking under the internal pressure of the concrete, and there may be issues with lining up the interior edges of the ICF blocks to provide a perfectly flat substrate for drywall installation, but all of these problems can be dealt with through training and quality control.

1.7.4. Other Considerations

An ICF wall uses less concrete than the comparison structural wall made of only concrete, but concrete requires significantly more embodied energy than some other alternative building materials such as wood framing. ICFs appear to be ideally suited to use in areas where there is a risk of flooding or severe moisture damage, since it is much more tolerant of severe wetting events. The resistance to hurricane wind loads and

deris d. m. age is also very high. ICFs are ideal for basements and multi-story residential and . being . adopted as the dominant choice in some markets. .

There are many different design possibilities for ICF construction with regards to design details, which may have an effect on both the durability and thermal performance. Field investigations have shown that this construction strategy is not immune to serious moisture related risks such as bulk water leakage, window leakage, and mould if installed incorrectly. .

1.8 Case 8: Advanced framing with spray foam

Polyurethane spray foam can be used in the stud cavity instead of fiberglass or cellulose insulation. Spray foam forms a very good air barrier when installed correctly and can be installed as low density (0.5 pcf) or high density (2.0 pcf) foam. .

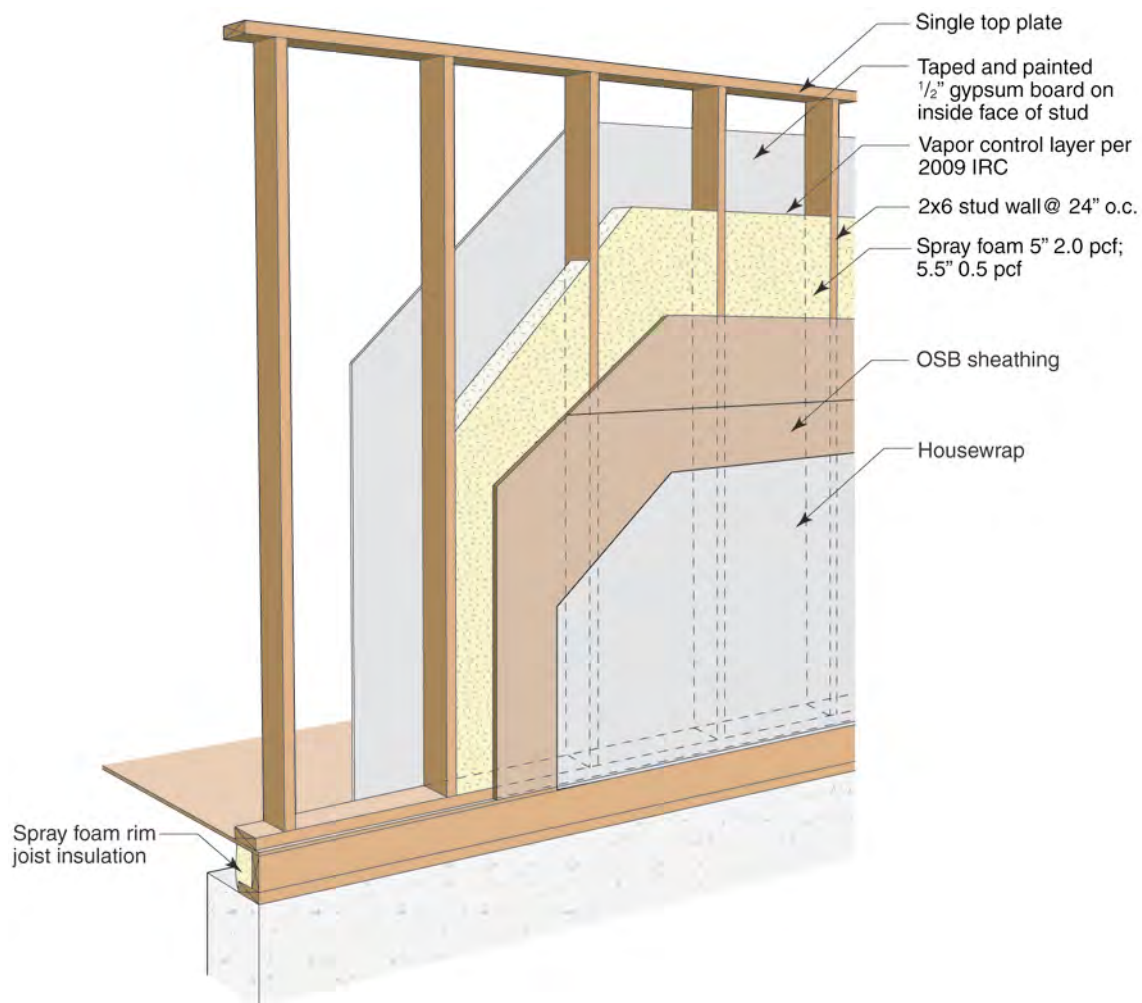

Figure 44 : 2x6 wall construction with spray foam insulation

1.8.1. Thermal Control

Using Therm to model different wall enclosure strategies does not accurately represent the benefits of spray foam insulation. Properly installed spray foam insulation completely stops air flow movement through and .

around the insulation so decreases in R-value associated with air leakage do not occur, either in the stud w space or at the rim joist. There are different published R-values for both low and high density insulation but w in this analysis for Case 8, 5.5" of R21 low density foam, and 5" of R28 high density foam were used. High w density foam is installed short of the edge of the cavity to minimize trimming of the foam, while low density w foam is softer, and installed to the edge of the cavity so that the excess can be trimmed flush with the stud w all framing. w

Similar to standard construction practices, using spray foam does not address the concern of thermal w bridging through the framing material as can be seen in Figure 45. w

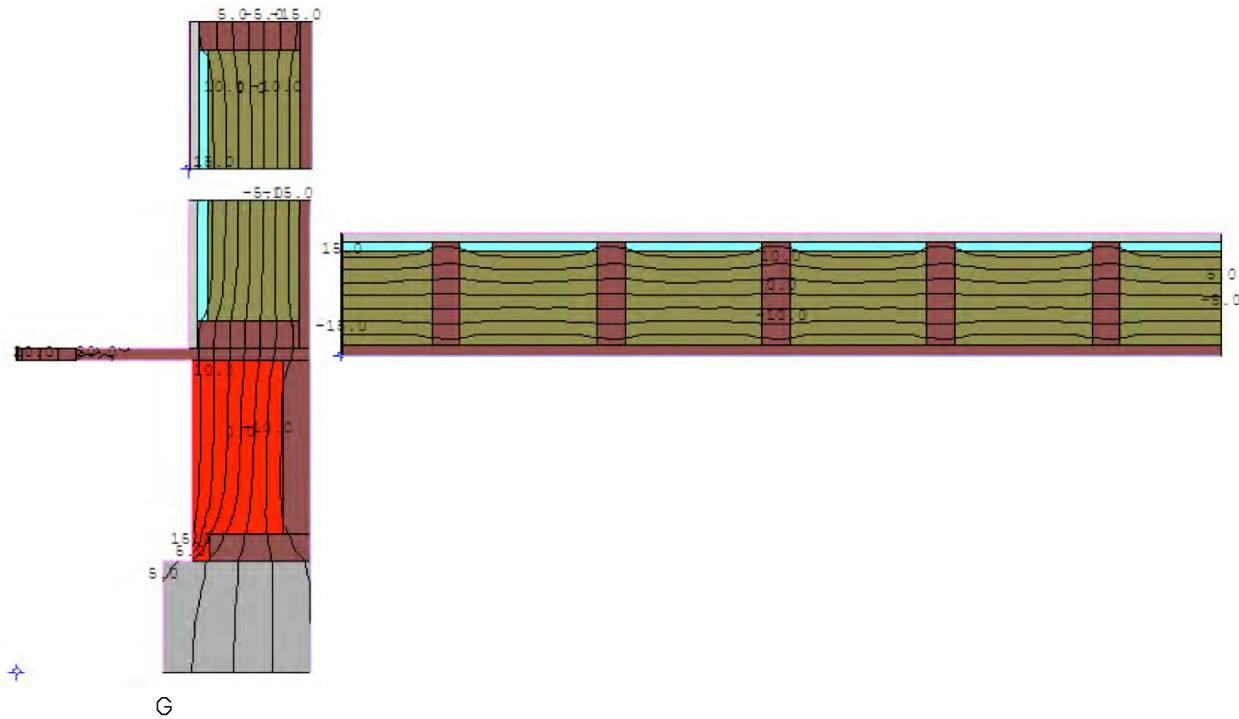

Figure 45 : Therm modeling of spray foam wall and rim joist

Calculating the whole wall R-values for the two spray foam assemblies results in R-values of R19.1 for high density spray foam, and R16.5 for the low density spray foam. The whole wall R-value of low density foam w decreased by almost R4.5 versus the installed insulation R-value (from R20.9 to R16.5) because of thermal w bridging. The whole wall R-value of the high density foam insulated wall decreased R9 from the installed w insulation R-value due to the thermal bridging. w

Table 11 : Therm results of spray foam insulation analysis

Case	Description	Whole Wall R value	Rim Joist	Clear Wall R value	Top Plate
8a	2x6 AF, 24" o.c., 5" 2 pcf R29 SPF, OSB	19.1	13.6	20.3	19.5
8b	2x6 AF, 24" o.c., 5.5" R21 0.5 pcf SPF, OSB	16.5	13.1	17.2	16.6

1.8.2. Moisture Control

High density spray foam is both an air and vapor barrier. This limits the movement of moisture vapor and air w leakage condensation. Low density foam is an air barrier, but it is permeable to water vapor and is w susceptible to vapor diffusion condensation. Low density foam was modeled both with and without a class I w vapor retarder to determine the performance differences of a class I vapor barrier with low density foam in w climate Zone 6. w

Both the high density foam and the low density foam with a vapor barrier had some of the lowest sheathing relative humidities in the winter months of all of the tested wall cases. The low density foam without a vapor barrier experienced high sheathing relative humidities sustained above 95% through the winter months (Figure 13).

Analysis of air leakage condensation shows that because the spray foam is an air barrier, there would be no condensation caused by air leakage, since the surface temperature of the interior face of the foam is always warmer than the dew point of the interior air (Figure 14).

Analysis of the summertime inward vapor drive shows that the low density spray foam with a poly vapor barrier experienced the highest relative humidity peaks of any of the test walls, approximately 5% higher than standard construction practice.

The high density foam and the low density foam without a vapor barrier experienced some of the lowest relative humidities of test walls because they were allowed to dry very easily to the interior.

Drying results (Figure 21) showed that the low density foam without poly dried to 100 kg/m³ in approximately 28 days similar to some of the other test walls, but the high density foam and low density foam with a vapor barrier took approximately 43 days to dry to 100 kg/m³.

1.8.3. Constructability and Cost

This wall is easier to build than standard construction wall, since no care is required at installing fiberglass batts. The costs can be perceived as prohibitively expensive which is why spray foam is often only used where a perfect air barrier is required, and may be difficult to install, such as garage-house interface and rim joists.

1.8.4. Other Considerations

With the new era of environmentally friendly products, many spray foam companies are marketing green spray foams that are less or harmful to the environment. In most cases, spray foam may need to be protected with a fire rated material according to the code.

1.9 Case 9: Hybrid Wall Insulation – Flash and Fill

In this analysis, hybrid walls consist of two inches of 2.0 pcf closed cell foam sprayed against the interior surface of the exterior sheathing, and three and a half inches of fiberglass. Instead of fiberglass batt, cellulose or sprayed fiberglass could also be used. Flash and Fill or Flash and Batt is often used to describe the combination of spray foam and cellulose, or spray foam and fiberglass batt respectively. The framing strategy used is advanced framing with 2x6s 24" on centre with a single top plate. Spray foam insulation helps considerably with the air tightness of the wall assembly and will increase the temperature of the potential wintertime condensation plane. Two inches of high density spray foam in the cavity also decreases the need for an interior vapor control layer which simplifies construction.

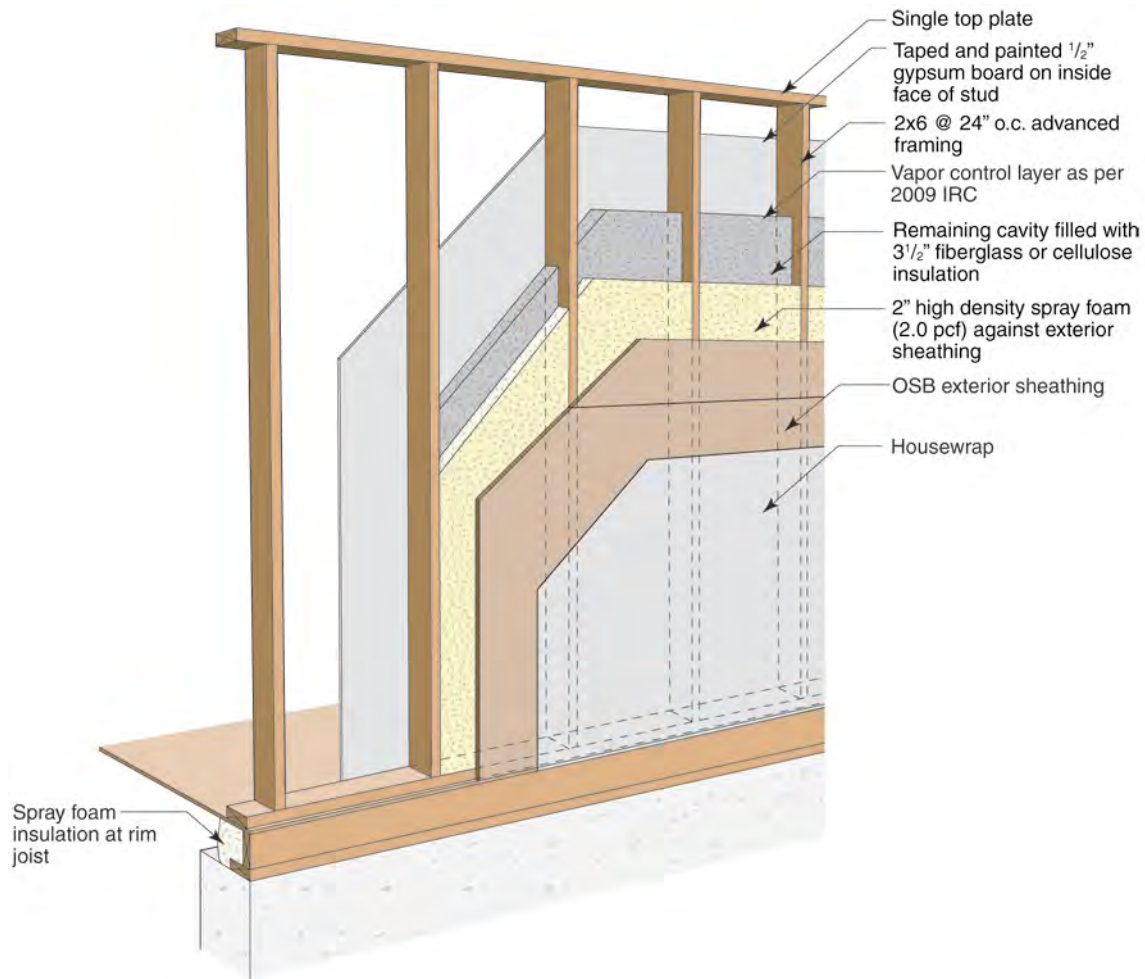

Figure 46 : Hybrid wall construction with 2" spray foam and fibrous fill

1.9.1. Thermal Control

The hybrid wall provides an increase in thermal control over the standard wall construction. Unfortunately, adding a high quality, air tight insulation between the framing does not address the issue of thermal bridging of the framing materials. Heat lost by air leakage can be greatly reduced by using the spray foam insulation, thus increases the true R-value. The whole wall R-value increases from R15.2 to R17.5 when comparing the same framing strategy with only fiberglass insulation (Case 1a) to Case 9. This improvement alone may not be enough to justify the added cost, but the heat lost from air leakage would also be greatly reduced through the wall and rim joist improving energy efficiency and human comfort.

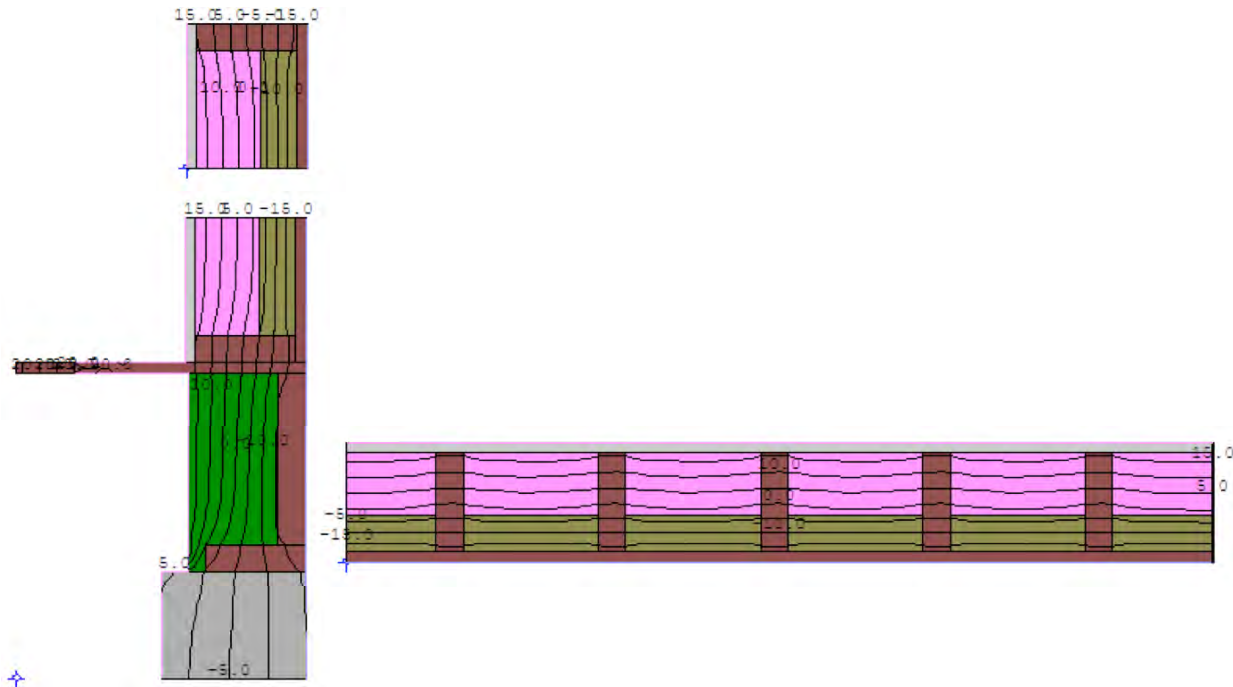

Figure 47 : Therm analysis of hybrid wall system

Table 12 : Calculated R-value for a hybrid wall system

Case	Description	Whole Wall R value	Rim Joist	Clear Wall R value	Top Plate
9	2x6 AF, 24"oc, 2" SPF and 3.5" fibrous fill	17.5	13.2	18.4	17.7

1.9.2. Moisture Control

This wall performs very similarly to the Case 2 with 4" of exterior insulation with respect to summer inward vapor drives as shown in Figure 19.

During the winter months, there is a significant improvement in the potential air leakage condensation on the condensation plane in the hybrid wall, from the standard construction wall, as shown in Figure 11 because the condensation plane is kept warmer by the vapor impermeable spray foam insulation.

One disadvantage of this wall system over advanced framing with exterior insulation (Case 2) is that the sheathing is kept much colder in Case 9. Keeping enclosure materials warm and dry with exterior insulation has been known to increase enclosure durability since the 1960s (Hutcheon 1964).

1.9.3. Constructability and Cost

The constructability of this system is as easy as standard construction but the cost of construction is higher w than using exclusively fiberglass insulation. This wall system is not as prone to air leakage moisture related damage as standard construction walls.

1.9.4. Other Considerations

Adding high density spray foam insulation in the cavity increases the stiffness and strength of the wall systems. This could be particularly helpful in high wind loads or when impact resistance is required as in tornado or hurricane zones. Spray foam is the most reliable method to achieve air tightness in residential w

construction and comes with the added bonus of thermal insulation. High density foam is easy to transport to remote locations, and increases the moisture related durability of the enclosure.

1.10 Case 10: Double Stud Wall with Spray Foam

Case 10 with spray foam insulation was chosen to try and improve the moisture related durability of the double stud wall in Case 4 which used cellulose insulation in the cavity space. The thermal performance of Case 4 was quite good, but the air leakage condensation potential could lead to premature enclosure failure. Case 10 analysis was conducted with two inches of spray foam since that is usually the maximum thickness that is sprayed in one pass during 2.0 pcf foam installation. This should increase the temperature of the condensation plane, thus increasing the moisture durability of the wall system. Depending on the climate zone for construction, more spray foam could be used to further decrease the risk of moisture related damage. Analyzing different thicknesses of spray foam for this single wall system are beyond the scope of this analysis report, but should be considered before this wall is constructed.

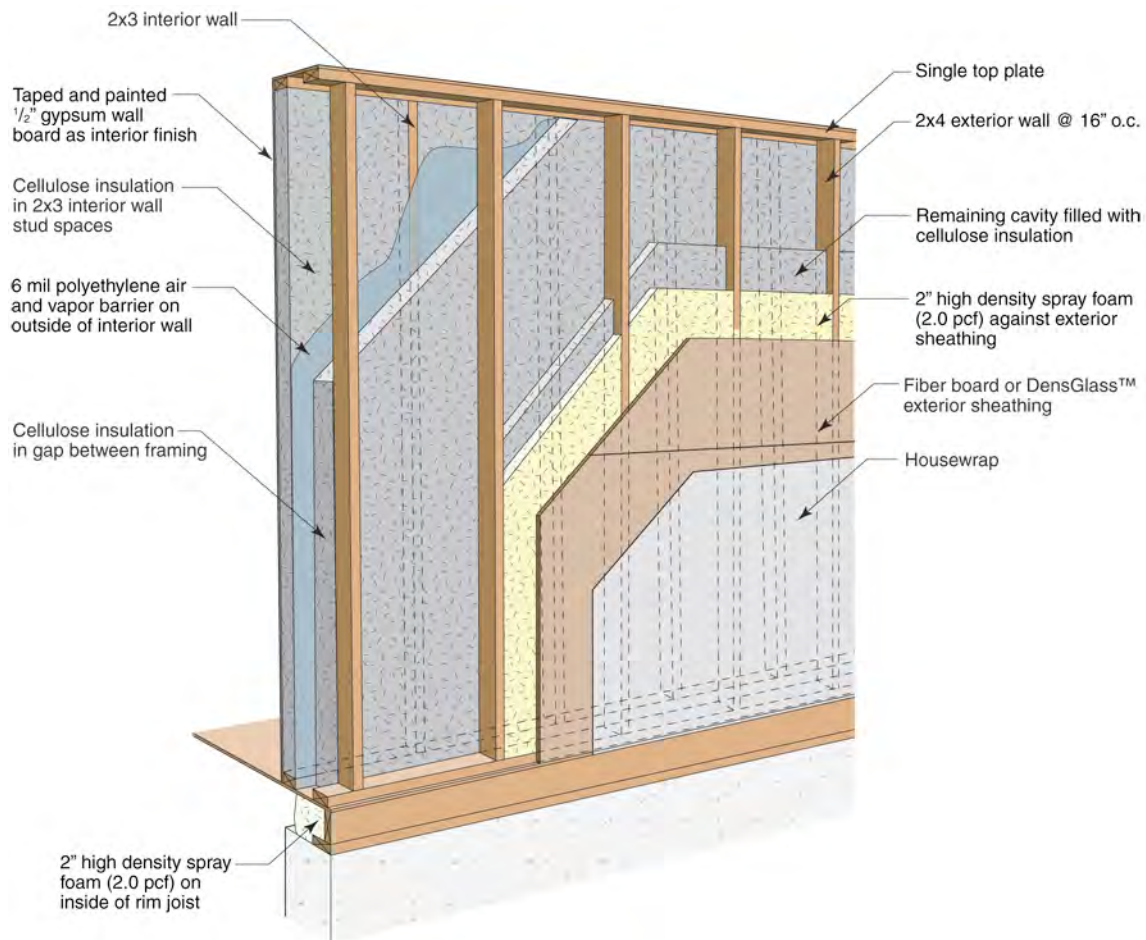

Figure 48 : Double stud wall with 2" of spray foam and cellulose fill

1.10.1. Thermal Control

This wall system has a slight improvement in whole wall R-value over Case 4, without spray foam insulation increasing from R30.1 to R32.4. This is only a minimal increase in the calculated whole wall R-value, but as in all cases with spray foam, there are improvements to the true R-value due to decreasing the air leakage through the wall and rim joist.

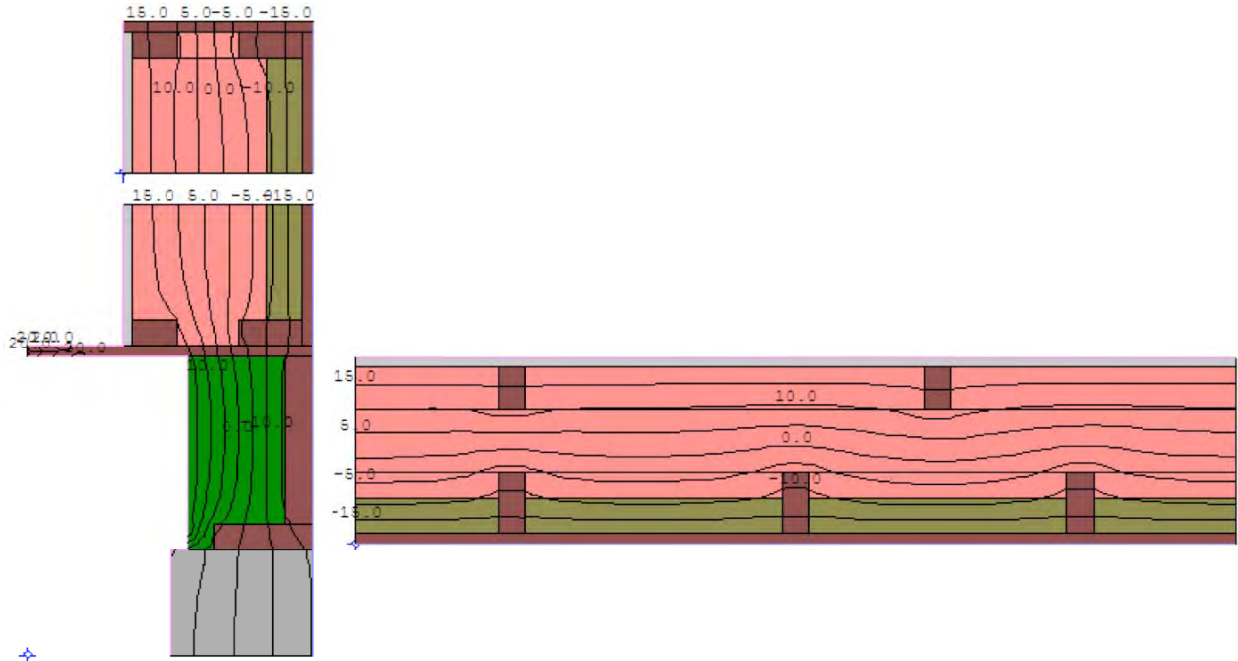

Figure 49 : Therm analysis of double stud wall construction with spray foam

Table 13 : Calculated whole wall R-value for a double stud wall system with 2" spray foam

Case	Description	Whole Wall R value	Rim Joist	Clear Wall R value	Top Plate
10	Double stud with 2" 2.0 pcf foam, 7.5" cell.	32.4	15.9	36.2	28.5

1.10.2. Moisture Control

The most evident improvement to adding spray foam was shown in Figure 14 with less wintertime condensation potential. There are still periods of wintertime condensation risk in climate zone 6, though risks have been improved, and more spray foam would decrease the risk even further in climate zone 6 and should likely be required in colder areas. The hours of potential wintertime condensation decreased from approximately 4600 hours for Case 4 to approximately 2300 for Case 10 with spray foam insulation.

There is very little change to the drying results when comparing the double stud wall with and without spray foam insulation. The sheathing retains its moisture longer in Case 10 because the moisture can only dry to the exterior and is not buffered at all on the interior surface by the cellulose insulation (Figure 27). There are no significant changes to the summertime inward vapor drive by adding 2" of high density spray foam to the sheathing of the double stud wall (Figure 21). If a moisture storage cladding was used for simulations, adding the spray foam may reduce the inward vapor drive because of the vapor resistance of the spray foam.

1.10.3. Constructability and Cost

This wall system uses more framing material than most of the other test wall assemblies. The cost of this wall system is high relative to most of the other options, but does provide very high thermal resistance.

1.10.4. Other Considerations

The majority of the insulation is cellulose which is the lowest embodied energy insulation and readily available. The ratio of cellulose to spray foam insulation can be changed depending on the climate zone for construction to limit the potential winter time condensation.

Spray foam will burn, and therefore should always be protected by fire rated material, which in this case is the cellulose insulation.

1.11 Case 11: Offset Frame Wall with Exterior Spray Foam

Case 11 was included because of the increasing need for a retrofit solution that saves energy, increases durability and does not affect the interior space. This strategy also has several advantages as a new construction strategy as well, especially in extreme climates with a short construction season.

Standing lumber off of the sheathing using plywood trusses allows the cladding to be directly attached without requiring more exterior sheathing. High density foam acts as the drainage plane, air barrier, vapor barrier, and thermal control layer. Using plywood gusseted trusses can be a little work intensive since they all need to be made to identical dimensions.

An alternative solution to the traditional truss wall is shown in Figure 15. This method is less energy intensive in preparation. It uses large nails or spikes to support the framing lumber for the cladding installation. A spacer was used between the sheathing and the framing lumber to ensure even spacing and then was removed after the nails were installed. Even though this method does not appear to be strong enough to support cladding, it has supported approximately 200 lbs on a single truss prior to installing the foam, and is considerably stronger following the installation of the spray foam. An alternative method proposed for spacing the lumber off of the sheathing is to use plastic sleeves (possibly PVC pipe) which are cut to a constant length and used to set the depth of the nails that attach the lumber by driving the nails through the centre of them.

t

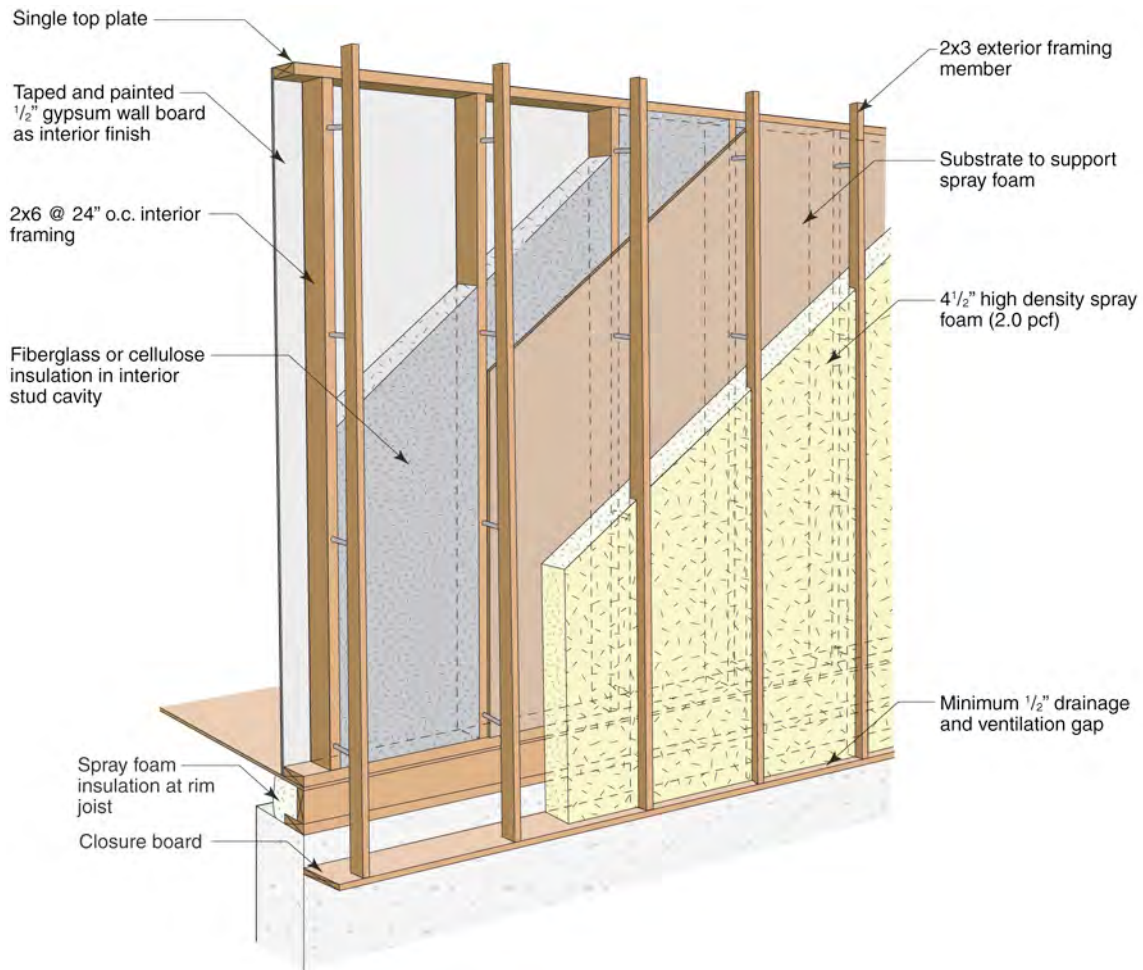

Figure 50 : Offset frame wall construction with exterior spray foam

1.11.1. Thermal Control

This wall with 4.5 inch-s of high d-nsity spray foam and 5.5 inches of fibrous insulation has a whole wall R-value of approximately R37, the highest total wall R-value of all walls analyzed which is, in part, because of the lack of thermal bridges through the entire system. Spray foam is installed over the rim joist, over the exterior of the wall, and up to th- soffit, wh- re id- ally, it meets with th- spray foam in th- attic. -

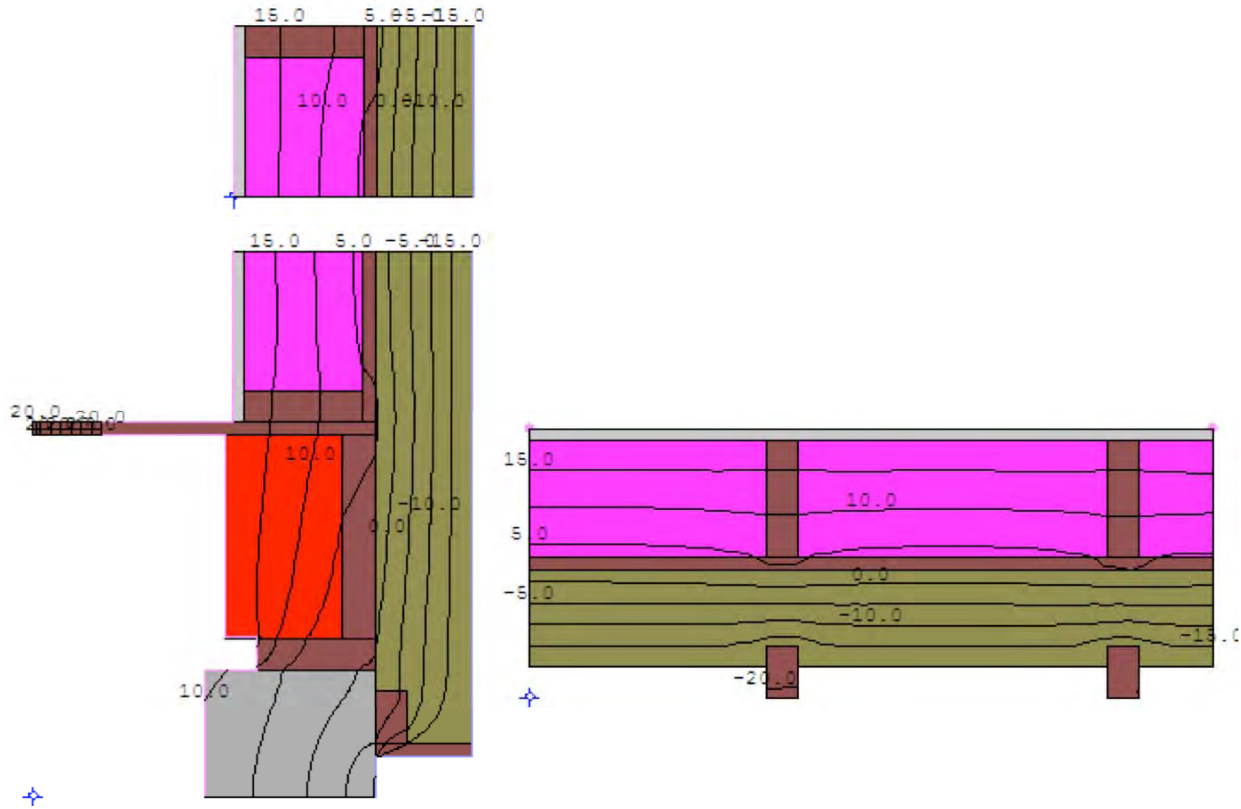

Figure 51 : Therm analysis of an offset truss wall with exterior spray foam

Table 14 : Calculated whole wall R-value for an offset framed wall with exterior spray foam

Case	Description	Whole Wall R value	Rim Joist	Clear Wall R value	Top Plate
11	Offset frame wall with ext. spray foam	37.1	18.8	40.6	41.9

1.11.2. Moisture Control

Because of the high level of vapor control in the exterior spray foam insulation, a vapor barrier is not required on the interior of the wall assembly. This allows any necessary drying to occur to the interior. In Minneapolis, (climate zone 6) there is no risk of winter time condensation on the interior of the exterior sheathing (Figure 16).

The summer time inward vapor drive sheathing relative humidity does not change significantly with the addition of the exterior foam (Figure 23). The relative humidity increases slightly in Case 11 because of the higher interior relative humidity, the low solar inward vapor drive load, and the inability for the exterior spray foam wall to dry to the outside.

The sheathing remains wet during the drying test significantly longer with exterior insulation than without since there is no moisture buffering capacity in the fiberglass batt in Case 11, and there is significant moisture buffering capacity of the cellulose insulation in Case 5 (Figure 28).

1.11.3. Constructability and Cost

High density spray foam is a relatively expensive choice for an insulation strategy. In this case, it provides great thermal resistance, reduced thermal bridging, and minimizes air leakage. Some of these benefits will

result into operating energy costs savings, but other benefits can not be easily quantified such as greater occupant comfort, and quite possibly higher resale value in an uncertain energy future.

1.11.4. Other Considerations

This method could be used as a retrofit without greatly affecting the interior, or for new construction. It is a very quick, high quality method of sealing the exterior and drying in the interior during construction, so that care can be taken with the interior work including wiring, plumbing and HVAC. This is ideal for locations with short construction seasons. Since the foam is transported in liquid phase, more board feet of foam (and R-value) can be transported on a transport truck than any other type of insulation.

1.12 Case 12: Exterior Insulation Finish System (EIFS)

Using an exterior insulation finish system (EIFS) is a valid option for cladding in almost every climate zone. The thickness of the exterior insulation can be varied to provide the thermal resistance required in combination with the stud space insulation. EIFS was one of the cladding strategies used on the CCHRC head office in Fairbanks AK (13980 HDD65 or 7767 HDD18) which is considered to be an extremely cold climate.

There is a stigma attached to EIFS because of the large number of failures in various climates in the past. Field and laboratory observations and testing have shown that this cladding technique is an effective and durable wall assembly, if drainage and water management details are constructed correctly. In most cases, during failures, water was trapped behind the EIFS due to poor water management details which eventually rotted the sheathing, causing corrosion and rot of the wall assembly. A properly detailed continuous drainage plane will ensure that this is a successful cladding technique in any climate zone.

Fiberglass-faced gypsum board exterior sheathing was used instead of OSB in the simulation because it is generally used underneath EIFS cladding systems due to its moisture tolerance.

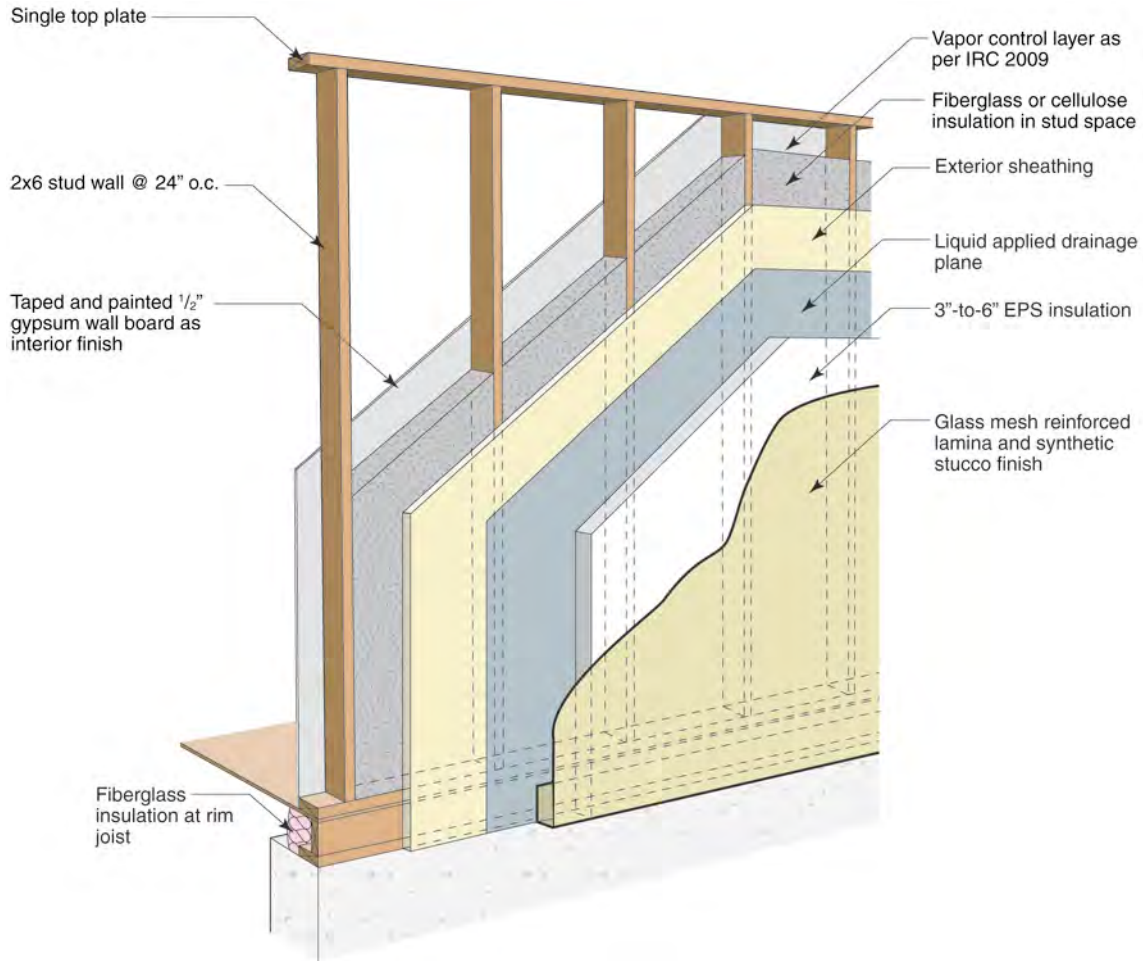

Figure 52 : Wall construction using the EIFS cladding system

1.12.1. Thermal Control

The amount of insulation installed on the exterior of the advanced framing will determine the thermal control of the assembly. In this analysis we used four inches of EPS board foam insulation, and achieved a whole wall R-value of R30. This strategy addresses the thermal bridging of both the framing and the rim joist and is very similar to advanced framing with four inches of XPS insulation in Case 2.

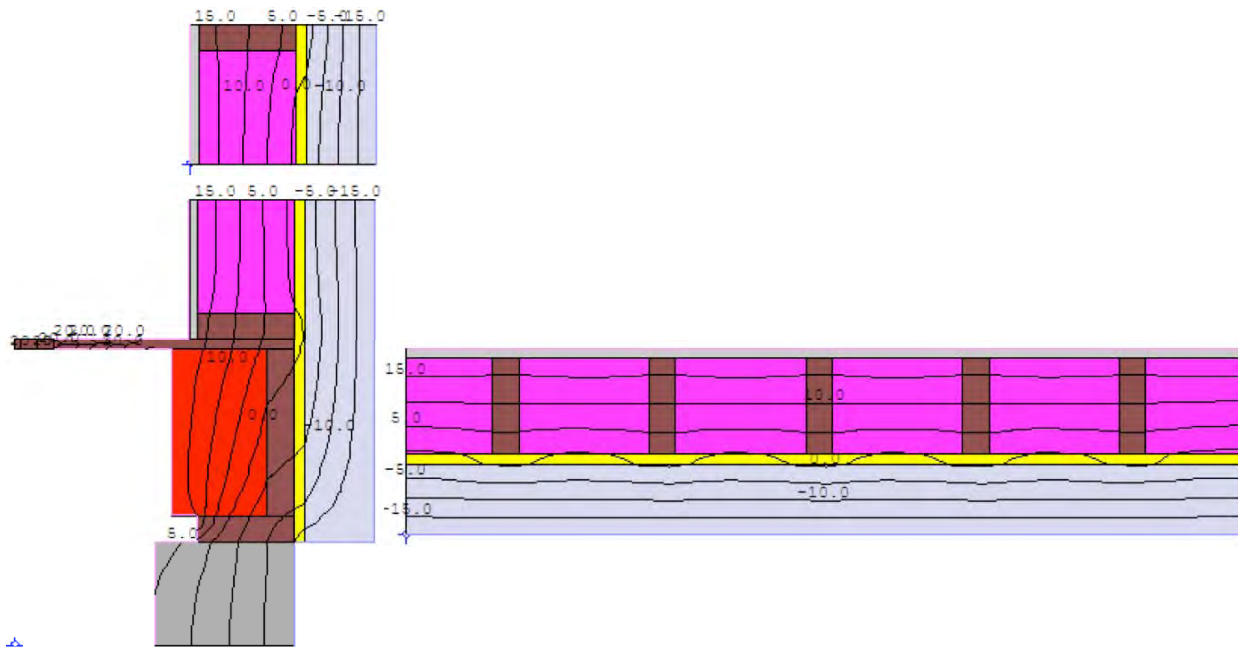

Figure 53 : Thermal analysis of an EIFS wall system

Table 15 : Calculated whole wall R-value for a EIFS wall system with 4" of EPS

Case	Description	Whole Wall R value	Rim Joist	Clear Wall R value	Top Plate
12	2x6 AF, 24"oc, EIFS - 4" EPS	30.1	23.8	31.4	31.1

1.12.2. Moisture Control

The moisture management details for this cladding type can be challenging but EIFS companies generally provide good documentation and design details with their product. For example, both Sto Corp and Dryvit Systems provide many details for all of their products on their websites to help builders and designers with moisture management details.

The performance of this wall system was nearly identical in winter time condensation, drying and summer time inward vapor drives to Case 2 with 4" of XPS insulation. EPS is more vapor permeable than XPS insulation, but laminate coating applied to the EPS insulation is usually less than 1 US perm.

1.12.3. Constructability and Cost

Because of the stucco appearance of this cladding system, it can be more expensive depending on the architectural detailing. EIFS is generally only done if the appearance of stucco is specifically desired. It is approximately the same performance and cost to use advanced framing with four inches of XPS insulation and cladding.

1.12.4. Other Considerations

EIFS are generally chosen when the owner or architect wants a stucco finish on a building. There are no significant performance differences between EIFS and the advanced framing with exterior insulation shown in Case 2. Both strategies minimize thermal bridging, and increase the temperature of the potential wintertime air leakage condensation plane. The main differences are the appearance of the finished cladding surface and water drainage details.

D. Conclusions

Whole wall R-values for all of the assemblies were calculated using Therm and the summary is shown in w Table 16 below. In some of the analyzed cases, different types or thicknesses of insulation may be used w depending on climate zone and local building practice. An attempt was made to choose the most common w strategies and list all assumptions made for wall construction. w

Table 16 : Summary of all calculated R-values

Case	Description	Whole Wall R-value	Rim Joist	Clear Wall R-value	Top Plate
1bii	2x4, 16"oc, R13FG + OSB (25%ff)	10.0	9.8	10.1	9.8
1b	2x4 AF, 24"oc, R13FG + OSB	11.1	9.8	11.5	9.8
1aii	2x6, 16"oc, R19FG + OSB (25%ff)	13.7	12.3	14.1	12.5
6a	SIPs (3.5" EPS)	14.1	12.3	14.5	10.6
1a	2x6 AF, 24"oc, R19FG + OSB	15.2	12.3	16.1	12.5
7a	ICF - 8" foam ICF (4" EPS)	16.4		16.4	
8b	2x6 AF, 24" o.c., 5.5" R21 0.5 pcf SPF, OSB	16.5	13.1	17.2	16.6
7c	ICF - 14" cement woodfiber ICF with Rockwool	17.4		17.4	
9	2x6 AF, 24"oc, 2" SPF and 3.5" cellulose	17.5	13.2	18.4	17.7
8a	2x6 AF, 24" o.c., 5" 2 pcf R29 SPF, OSB	19.1	13.6	20.3	19.5
2a	2x6 AF, 24"oc R19FG + 1" R5 XPS	20.2	18.5	20.6	20.3
7b	ICF - 15" foam ICF (5" EPS)	20.6		20.6	
3	2x6 AF, 24"oc, 2x3 R19+R8 FG	21.5	13.4	23.5	18.4
4	Double stud wall 9.5" R34 cellulose	30.1	14.4	33.5	28.8
12	2x6 AF, 24"oc, EIFS - 4" EPS	30.1	23.8	31.4	31.1
10	Double stud with 2" 2.0 pcf foam, 7.5" cell.	32.4	15.9	36.2	28.5
2b	2x6 AF, 24"oc R19FG + 4" R20 XPS	34.5	29.0	35.6	35.4
6b	SIPs (11.25" EPS)	36.2	14	41.6	28.2
5	Truss wall 12" R43 cellulose	36.5	18.6	40.5	34.4
11	Offset frame wall with ext. spray foam	37.1	18.8	40.6	41.9

*AF - Advanced Framing

w

The walls analyzed in this report can be grouped into three groups based on their calculated whole wall R-w values. The first group have whole wall R-values less than approximately R20. These walls are not w considered High-R wall systems for cold climates. w

The second group of walls have whole wall R-values of approximately R-20. According to the IECC, the w requirement for climate zones 7 and 8 is an installed R-value of R21. This report has shown that the whole R-w value is less than the installed insulation R-value in almost every case, which means that often, the walls that w the IECC allow in extremely cold climates are actually performing at a whole wall R-value of between R15 and w R20. This is unacceptable in the future of uncertain oil reserves, increasing energy costs, and decreasing w environmental health. w

The third group of walls have whole wall R-values greater than R30. This is what the construction industry w has been achieving in very small numbers, such as Building America prototype homes, and small custom w home builders. The R-value of walls in the category can be modified easily by either decreasing or increasing w the amount of insulation depending on the specific construction conditions. All of the walls in category three w have minimized thermal bridging which increases the effectiveness of insulation. w

The potential for wintertime air leakage was compared for all test walls, and the summary of the results are w shown in Table 17. The walls were ranked from the least hours of potential condensation to the greatest. w This potential condensation is only an issue if the airtightness details aren't constructed properly, but should w still be used to assess the potential risk of a wall system, considering that field observations show the air w barrier detailing is rarely perfect. w

Table 17 : Hours of potential winter time air leakage condensation

Case	Description	Hours of Potential Condensation
8b	2x6 AF, 24" o.c., 5.5" R21 0.5 pcf SPF, OSB	0
8a	2x6 AF, 24" o.c., 5" 2 pcf R29 SPF, OSB	0
11	Offset frame wall with ext. spray foam	0
9	2x6 AF, 24"oc, 2" SPF and 3.5" cell or FG	934
2b	2x6 AF, 24"oc R19FG + 4" R20 XPS	1189
12	2x6 AF, 24"oc, EIFS - 4" EPS	1532
10	Double stud with 2" 2.0 pcf foam, 7.5" cell.	2284
2a	2x6 AF, 24"oc R19FG + 1" R5 XPS	3813
1a	2x6 AF, 24"oc, R19FG + OSB	4379
1b	2x4 AF, 24"oc, R13FG + OSB	4503
4	Double stud wall 9.5" R34 cellulose	4576
3	2x6 AF, 24"oc, 2x3 R19+R8 FG	4594
5	Truss wall 12" R43 cellulose	4622

*AF - Advanced Framing

The comparison matrix explained in the introduction was completed according to the analysis of each wall section in this report (Table 18), and it was found that three walls achieved the highest score of 20 out of a possible 25 points. The advanced framing wall (Case 2), sprayfoam insulation wall (Case 8) and EIFS wall (Case 12) achieved scores of 20 using an even weighting system of all selection criteria.

The main issue with most of the wood framed walls without exterior insulation is the probability of wintertime air leakage condensation depending on the quality of workmanship and the attention to detail. Inspections of production builder construction quality leads to skepticism regarding the quality of the air barrier in most wall systems. It is always good building practice to design enclosures that will perform as well as possible regardless of the human construction factor.

,

,

,

,

,

,

,

,

,

,

,

Table 18 : Wall Comparison Chart

	Thermal Control	Durability (wetting/drying)	Buildability	Cost	Material Use	Total
Criteria Weighting	1	1	1	1	1	
Case 1: Standard Construction	1	3	5	5	3	17
Case 2: Advanced Framing with Insulated Shtg	4	4	4	4	4	20
Case 3: Interior Strapping	3	3	3	4	4	17
Case 4: Double Stud	4	3	3	3	2	15
Case 5: Truss Wall	4	3	2	3	3	15
Case 6: SIPs	4	4	3	3	3	17
Case 7: ICF	4	5	4	2	3	18
Case 8: Sprayfoam	5	5	4	2	4	20
Case 9: Flash and Fill (2" spuf and cell.)	4	4	4	3	4	19
Case10: Double stud with 2" spray foam and cell.	5	4	3	3	3	18
Case 11: Offset Framing (ext. Spray foam insul.)	5	5	4	3	2	19
Case 12: EIFS with fibrous fill in space	5	5	4	3	3	20

Adding exterior insulation to most wall systems has many durability and energy benefits. Two dimensional heat flow modeling has shown that exterior insulation is very effective at minimizing the thermal bridging losses of wall framing, and hygrothermal modeling showed reduced condensation potential in the wall from vapor diffusion and air leakage, as well as increased drying potential to the interior with reasonable interior relative humidities. Adding exterior insulation was shown to increase the effectiveness of the fiberglass batt insulation in the stud space and increase the clear wall R-value greater than the amount of insulation added. This becomes even more important with higher thermal bridging such as a high framing factor or steel studs. Adding exterior insulation greater than approximately R5, the installed insulation u-value can be added directly to the clear wall R-value and is approximately equal to the increase in whole wall R-value since most of the thermal bridging is addressed.

Hygrothermal modeling showed that traditional double stud walls, truss walls and interior strapped walls are at a greater risk of air leakage condensation because of the air permeable insulation, and cold exterior surface. Hybrid walls are a good strategy to help overcome this problem by using vapor impermeable spray foam insulation against the exterior, which increases the temperature of the condensation plane. The amount of spray foam required in a hybrid system is dependent on the climate zone for construction, but it may be difficult to get a high enough u value or thermal bridge control in cold climates for net zero housing.

ICF and SIP walls both have insulation integral to the system, but require more insulation for a High u value wall assembly. Experience and modeling indicate that both of these techniques are susceptible to moisture issues if the details are not done correctly. SIPs are particularly susceptible to air leakage at the panel joints, and ICF walls need well designed penetrations, to avoid water ingress.

In extreme cold climates, and remote areas, high density spray foam appears to address most of the concerns that have been reported by NRC during visits and interviews with local residents. High density spray foam is easy to ship and install, not subject to damage during transit, and allows some variations in construction quality levels since it is both an air and vapor barrier. High density spray foam can be used in different wall construction strategies as demonstrated in this report, either on its own or as part of an insulation strategy with other insulations types. An offset frame wall with high density spray foam has the added advantage of drying in a house very quickly in the short construction season so that work can be done on the interior during inclement weather.

y

E. Works Cited

BSC. "BSP-035: Designs that Work: Very Cold Climate (Juneau, AK)." *buildingscience.com information*. 2008. <http://www.buildingscience.com/documents/primers/bsp-035-designs-that-work-very-cold-climate-h-juneau-ak/section-2-the-basic-very-cold-climate-house/view?searchterm=haida%20house>. h

Carpenter, S C, and C J Schumacher. "Characterization of Framing Factors for Wood-Framed Low-Rise Residential Buildings." *ASHRAE Transactions v 109, Pt 1.*, 2003. h

CCHRC. "Cold Climate Housing Research Center." *Research and Testing Facility*. 2007. http://www.cchrc.org/research+_testing+facility.aspx. h

Christian, J E, and hKosny. "Towards a National Opaque Wall Rating Label." *U.S. DOE VI Thermal Envelope I Conference*. 1995. h

Hutcheon, N B. "CBD-50. Principles Applied to an Insulated Masonry Wall." *Canadian Building Digest*, 1964. h

Kosny, hAn, David Yarbrough, Phillip Childs, and Syed Azam Mohiuddin. "How the Same Wall Can Have Several Different R-Values: Relations Between Amount of Framing and Overall Thermal Performance in Wood and Steel-Framed Walls." *Buildings X. ASHRAE*, 2007. h

Lstiburek, J. *YouTube*. May 3, 2007. http://www.youtube.com/watch?v=D_IhtDR3p0c&feature=channel_page h (accessed March 6, 2009). h

Niemz, Peter. "Untersuchungen zur Wärmeleitfähigkeit ausgewählter einheimischer und fremdlandischer Holzarten." *Verlag für Architektur und technische Wissenschaften, Bauphysik* 29 (2007): 311-312. h

Rousseau, M.Z., S.M. Cornick, M.N. Said, W Maref, and M.M. Manning. *PERD 079 Project - Report Task 4 - Review of Work Plan & Selection of Wall Assemblies*. Ottawa, Canada: National Research Council Canada, 2008. h

Said, M.N.A. *Task 2: Literature Review: Building Envelope, Heating, and Ventilating Practices and Technologies for Extreme Climates*. Ottawa, Canada: National Research Council Canada, 2006. h

Simpson, William, and Anton TenWolde. "Physical Properties and Moisture Relations of Wood." In *Wood Handbook*, 3-1 - 3-24. Madison, Wh Forest Products Laboratory, 1999. h

SIPA. "SIPA Report on the Juneau, Alaska Roof Issue." *Structural Insulated Panel Association*. February 2002. <http://www.sips.org/content/technical/index.cfm?PageID=161> (accessed 03 10, 2009). h

Smegal, Jonathan, and John Straube. *CCHRC Test Trailer at University of Alaska Southeast*. Waterloo, Canada: h Balanced Solutions Inc., 2006. h

Straube, John, and Eric Burnett. *Building Science for Building Enclosures*. Westford: Building Science Press, h 2005. h

h

h

About this Report

This report was prepared with the cooperation of the U.S. Department of Energy's, Building America Program.

Direct all correspondence to: Building Science Corporation, 30 Forest Street, Somerville, MA 02143.

Limits of Liability and Disclaimer of Warranty:

Building Science documents are intended for professionals. The author and the publisher of this article have used their best efforts to provide accurate and authoritative information in regard to the subject matter covered. The author and publisher make no warranty of any kind, expressed or implied, with regard to the information contained in this article.

The information presented in this article must be used with care by professionals who understand the implications of what they are doing. If professional advice or other expert assistance is required, the services of a competent professional shall be sought. The author and publisher shall not be liable in the event of incidental or consequential damages in connection with, or arising from, the use of the information contained within this Building Science document.