



Energy Management for Motor Driven Systems

The energy savings network—plug into it



Energy Management for Motor-Driven Systems

Prepared by
Gilbert A. McCoy and
John G. Douglass
Washington State University
Cooperative Extension Energy Program
Olympia, Washington



Funded by
The Bonneville Power Administration



Reproduced by
The U.S. Department of Energy
Office of Industrial Technologies



Acknowledgments

The authors wish to thank the Bonneville Power Administration (BPA) for funding this project. Particular thanks are due to Craig Wohlgemuth of Bonneville's Technical Assessment/R&D Group for his encouragement, direction and support. Portions of this guidebook have been adapted from two unpublished 1994 reports prepared by Carroll, Hatch & Associates for the Bonneville Power Administration. Appreciation is extended to John Vranizan of Carroll, Hatch & Associates and to Rob Gray of the Washington State Energy Office's Spokane office for information and/or reviews provided. Vicki Zarrell provided review, proofing, and technical editing services.

A first version of this guidebook was completed in 1996 by the Washington State Energy Office with funding from BPA contract No. DE-B179-93BP08158, Task Order No. 96AT63464. Subsequently, enhancements and research results were incorporated into this revision by the Washington State University Cooperative Extension Energy Program using Power Washington oil overcharge funds.

The U.S. Department of Energy, Office of Industrial Technologies would like to thank the Bonneville Power Administration for their efforts in producing this document.

This publication has been reproduced by DOE/Office of Industrial Technologies.

Disclaimer

This guidebook was prepared by the Washington State Energy Office and Washington State University Cooperative Extension Energy Program with funding from the Bonneville Power Administration. Neither the United States, the Bonneville Power Administration, the State of Washington, the Washington State Energy Office, the Washington State University Cooperative Extension Energy Program, nor any of their contractors, subcontractors, or their employees, makes any warranty, expressed or implied, or assumes any legal responsibility for the accuracy, completeness, or usefulness of any information, apparatus, product, or process disclosed within this guidebook.

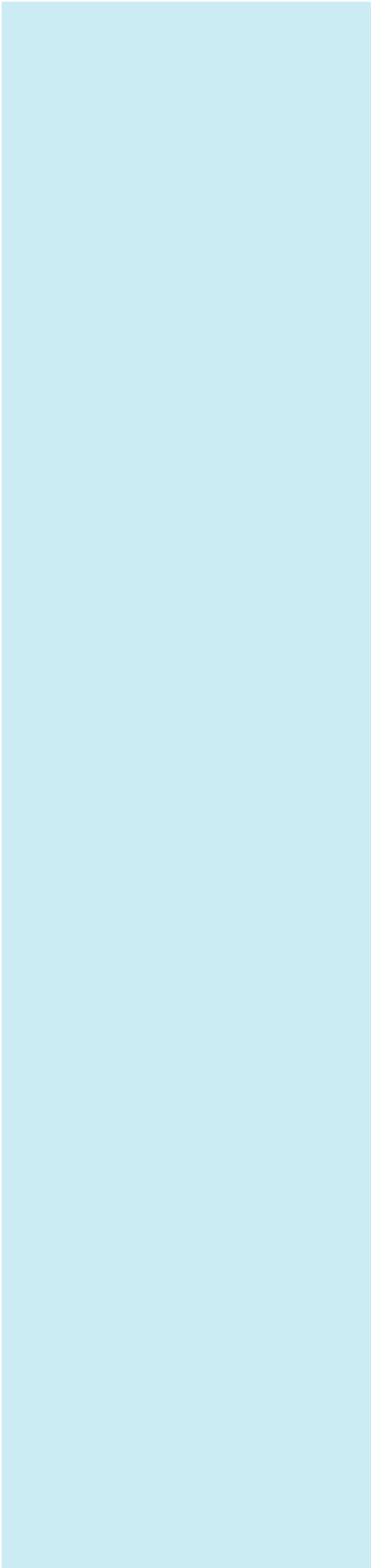

This publication will assist you to establish a facility energy-management program, to identify and evaluate energy conservation opportunities involving motor-driven equipment, and to design a motor improvement plan. These actions will help you:

- ✓ Reduce energy costs,
- ✓ Improve motor-driven system reliability and efficiency,
- ✓ Increase productivity, and
- ✓ Minimize unscheduled downtime.

In the Guide you will find:

- How to set up a successful energy management program (Chapter 1).
- How you can use utility bills, plant production data, and utility rate information to “target” potentially cost-effective energy conservation, demand reduction and power factor correction opportunities (Chapter 2).
- Plant distribution system troubleshooting and “tune-up” tips (Chapter 3).
- A description of motor testing instruments and field survey techniques (Chapter 4).
- Methodologies for analyzing motor improvement opportunities (Chapter 5). Chapter 5 illustrates how you can use measured information to determine the load imposed on the motor by driven equipment and its efficiency at that load point.
- How to determine the dollar benefits associated with appropriate energy conservation and demand reduction actions (Chapter 6).
- Motor improvement planning basics (Chapter 7). This chapter provides advice regarding the assessment of new motor purchase, repair, downsizing, and replacement decisions and shows how to incorporate findings into your motor improvement plan.
- Power factor correction assessment techniques (Chapter 8). This chapter gives examples illustrating the sensitivity of power factor correction benefits to utility rate schedules.
- How to establish both preventative and predictive maintenance programs (Chapter 9).

*Call the OIT Clearinghouse (800) 862-2086 to obtain your copy of **MotorMaster+**. Both the OIT Clearinghouse and the Electric Ideas Clearinghouse (800) 872-3568 [(360) 956-2237 outside BPA's service territory] stand ready to assist you regarding motor and motor-driven equipment efficiency issues.*

Throughout this guidebook we identify sources of additional information, such as **MotorMaster+**. **MotorMaster+** is an energy-efficient motor selection and energy management software package. The capabilities of **MotorMaster+** include:

- Automatic motor load and efficiency estimation based upon field data measurements.
- Ability to select replacement motors from an internal database of over 27,000 one-to-2,000 hp NEMA Design B, C and D motors.
- Ability to analyze conservation benefits due to purchase and use of energy efficient motors in new, rewind, or retrofit applications.

Chapter 1 Energy Management for Motor-Driven Systems	1-1
Elements of a Successful Energy Management Program	1-2
1. Secure Top Management Commitment	1-2
2. Appoint an Energy Coordinator	1-2
3. Obtain Employee Cooperation	1-3
4. Conduct Energy Surveys	1-3
5. Organize Energy Data	1-4
6. Analyze Survey Results	1-5
7. Set Conservation Goals	1-5
8. Develop Organization-Wide Energy Management Plan ..	1-5
9. Implement Engineering Changes	1-5
10. Monitor and Evaluate Results	1-7
Conclusion	1-7
Chapter 2 Understanding Your Utility Bill	2-1
Organizing Utility Bills and Production Data	2-1
Interpreting Utility Charges	2-4
Service Charge	2-5
Energy Charge	2-5
Demand Charge	2-6
Power Factor Charges	2-6
Optional Rate Schedules	2-9
Time-of-Use Rates	2-9
Interruptible, Curtailment and Customer Generator Rates	2-9
Using Billing Data to Identify Opportunities	2-10
Checklist for Electricity Cost Savings	2-11
Chapter 3 Industrial Electrical Systems	3-1
The Plant Electrical Distribution System	3-2
Over and Under Voltage	3-2
Voltage Unbalance	3-3
Troubleshooting and Tuning your In-Plant Distribution System ...	3-5
Troubleshooting Poor Contacts	3-5
Voltage Drop Survey	3-6
Infrared Thermography	3-6
Troubleshooting Voltage Unbalance	3-7
Troubleshooting Over and Under Voltage	3-8
Troubleshooting Low Power Factor	3-9
Troubleshooting Undersized Conductors	3-9
Troubleshooting Insulation Leakage	3-9

Chapter 4 Taking Field Measurements	4-1
Safety Considerations	4-1
Constructing the Motor List and Inventory Database	4-2
Acquiring Motor Nameplate Data	4-2
Load-Time Profiles	4-3
Measuring Operating Values	4-4
Data Gathering Approaches	4-5
Safety Issues in Data Gathering	4-6
Voltage Measurements.....	4-6
Current Measurements	4-7
Power Factor Measurements	4-7
Purchasing Motor Testing Instruments	4-8
Voltage Meters	4-8
Current Meters	4-8
Tachometers.....	4-9
Power and Power Factor Meters.....	4-10
Multi-channel Power Loggers.....	4-11
Motor Analyzers.....	4-11
Industrial Practices	4-12
Chapter 5 Motor Load and Efficiency Estimation Techniques	5-1
Input Power Measurements.....	5-1
Line Current Measurements	5-2
The Slip Method.....	5-3
Variable Load Levels	5-5
Determining Motor Efficiency	5-6
Computerized Load and Efficiency Estimation Techniques ...	5-8
Chapter 6 Energy, Demand, and Dollar Savings Analysis	6-1
Calculating Annual Energy and Demand Savings	6-1
Assessing Economic Feasibility	6-2
Chapter 7 Motor Improvement Planning	7-1
Energy Efficient Alternatives	7-1
Upon Failure Alternatives	7-2
Without an Existing Motor Failure	7-5
<i>MotorMaster+</i> : Motor Energy Management Software	7-2
Motor Resizing.....	7-6
Conclusion	7-10

Chapter 8 Power Factor Correction	8-1
The Concept of Power Factor	8-1
Power Factor Penalties	8-2
Power Factor Improvement	8-3
Sizing and Locating Power Factor Correction Capacitors	8-4
Sizing Capacitors for Individual Motor and Entire Plant Loads	8-6
Benefits of Power Factor Correction	8-8
Additional Benefits of Power Factor Correction	8-10
Power Factor Correction Costs	8-11
Avoiding Harmonic Resonances When Installing Capacitors ...	8-12
Chapter 9 Preventative and Predictive Maintenance Planning	9-1
Cleaning	9-2
Lubrication	9-3
Mountings, Couplings, and Alignment	9-5
Operating Conditions	9-6
Thermal, Vibration and Acoustic Tests	9-9
Electrical Tests	9-10
Storage and Transport	9-11
Appendixes	A-1
Appendix A: Motor Nameplate and Field Test Data Form	A-1
Appendix B: Average Efficiencies for Standard and Energy Efficient Motors at Various Load Points	B-1
Appendix C: Motor Energy Savings Calculation Form	C-1
Appendix D: Power Factor Correction Capacitor Suppliers	D-1

Figures and Tables

Figures

- 1-1 Typical Energy Management Team Organization Chart
- 1-2 Steps in an Energy Management Program
- 2-1 Energy Use Profile Reports
- 2-2 Sawmill Energy Consumption Disaggregation
- 2-3 Billing Statement
- 2-4 Electric Demand Meters
- 3-1 Typical Facility Single-Line Diagram
- 3-2 Acceptable Voltage Range for Systems and Motors
- 3-3 Motor Voltage Unbalance Derating Curve
- 3-4 Effects of Voltage Unbalance on Motor Losses
- 4-1 Motor Nameplate
- 4-2 Industrial Three Phase Circuit
- 4-3 Instrument Connection Locations
- 5-1 Relationships Between Power, Current, Power Factor and Motor Load
- 5-2 Depiction of Motor Losses
- 7-1 Motor Performance at Part-Load
- 7-2 Motor Efficiency Improvement Action Plan
- 8-1 The “Power Triangle”
- 8-2 Power Factor as a Function of Motor Load
- 8-3 Locating Capacitors on Motor Circuits
- 8-4 Apparent Power Requirements Before and After Adding Power Factor Correction Capacitors
- 9-1 Effect of Voltage Variation on Induction Motor Performance Characteristics

Tables

- 2-1** Sawmill Energy End Use Summary
- 3-1** Acceptable System Voltage Ranges
- 4-1** Typical Motor Load Types
- 4-2** Coupling Types
- 5-1** Induction Motor Synchronous Speeds
- 5-2** Characteristics of Motor Loads
- 7-1** Motor Repair Versus Replace Analysis
- 7-2** Existing Motor Replacement Analysis
- 7-3** Motor Downsizing Example
- 8-1** Industries That Typically Exhibit Low Power Factor
- 8-2** Sizing Guide for Capacitors on Individual Motors
- 8-3** Multipliers to Determine Capacitor Kilovars Required for Power Factor Correction
- 9-1** Grease Compatibility

Glossary for Equations

The following variable names are used in equations in this publication:

P_i	= Three phase power in kW
P_j	= Power dissipated in a junction in watts
P_2	= Corrected input power
P_1	= Input power before correction
P_{Apparent}	= Apparent power in kVA
$P_{\text{Apparent1}}$	= Apparent power before PF correction in kVA
$P_{\text{Apparent2}}$	= Apparent power after PF correction in kVA
P_{Reactive}	= Reactive power in kVAR
P_{ir}	= Input power at full rated load in kW
P_o	= Actual output horsepower
P_{o2}	= Corrected output power
P_{o1}	= Output power before correction
P_{or}	= Nameplate rated horsepower
PF	= Power factor as a decimal
PF_1	= Original power factor
PF_2	= Power factor after correction
V	= RMS voltage, mean line to line of 3 phases
V_{maxdev}	= Line to line phase voltage deviating most from mean of 3 phases
V_j	= RMS voltage across a junction
V_r	= Nameplate rated voltage
I	= RMS current, mean of 3 phases
I_j	= RMS current through a junction
I_r	= Nameplate rated current
kWh	= Electric energy in kWh
kWh_{savings}	= Annual electric energy saved in kWh
kW_{billed}	= Adjusted or billable demand
kW_{demand}	= Measured electric demand in kW
kW_{saved}	= Savings from efficiency improvement in kW

kVA_{demand1}	= kVA demand before PF correction
kVA_{demand2}	= kVA demand after PF correction
N	= Number of days in billing period
e	= Efficiency as operated in %
e_2	= Corrected efficiency
e_1	= Efficiency before correction
e_{std}	= Efficiency of a standard motor as operated in %
e_{EE}	= Efficiency of an energy efficient motor as operated in %
e_{fl}	= Efficiency at full rated load as a decimal
Load	= Output power as a % of rated power
S	= Measured speed in RPM
S_r	= Nameplate full load speed
S_s	= Synchronous speed in RPM
Slip	= Synchronous speed - Measured speed in RPM
hours	= Annual operating hours
$\$_{\text{savings}}$	= Total annual dollar savings
$\$_{\text{demand}}$	= Monthly demand dollar charge
$\$_{\text{energy}}$	= Dollar charge per tailblock kWh
$\$_{\text{premium}}$	= Price premium for energy efficient motor compared to standard
$\$_{\text{rebate}}$	= Utility rebate for energy efficient motor
$\$_{\text{new}}$	= New motor cost
$\$_{\text{inst}}$	= Installation cost
PB	= Simple payback in years
% reduction	= Percent reduction in distribution losses
R	= Resistance in ohms
Unbal	= Voltage unbalance in %

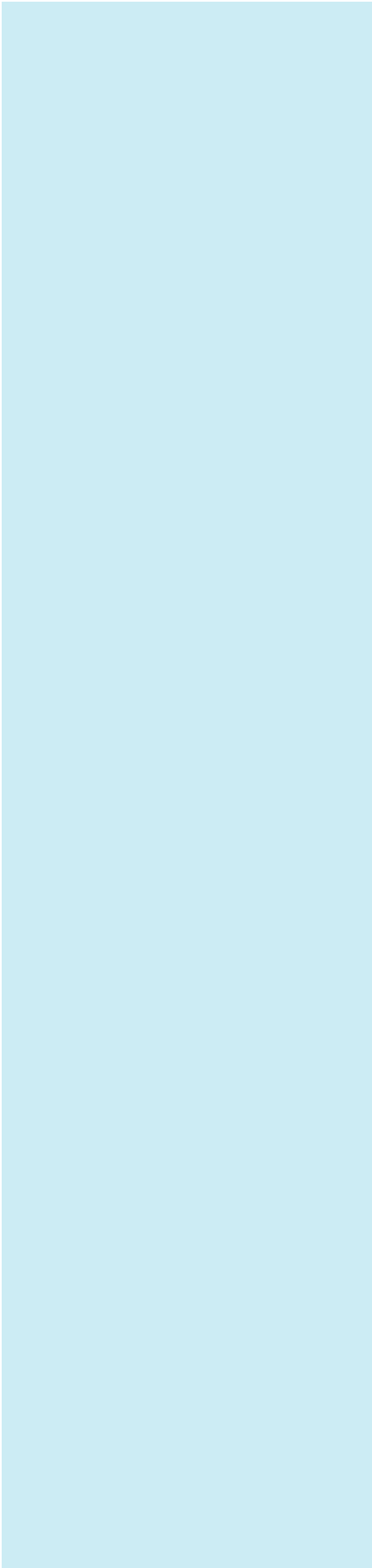

Introduction

This energy management guidebook is designed to assist the industrial facility engineer to reduce energy costs through:

- Identifying and analyzing motor driven system energy conservation opportunities,
- Troubleshooting and tuning the in-plant electrical distribution system,
- Correcting for power factor,
- Understanding utility billing statements, and
- Establishing a preventative and predictive maintenance program.

Why should industrial plant staff work to save energy? One answer is money.¹⁻¹ Ever-increasing utility costs reduce profits, erode capital and maintenance budgets, increase product costs, and reduce competitiveness.

A common misconception within industry has been to equate an energy reduction or conservation program with the concept of turning off equipment and shutting down processes. Instead, the program of energy management challenges plant staff to produce the products or services with the absolute minimum energy consumption.¹⁻² The objective is to minimize energy usage through production efficiency gains, while procuring the lowest cost and most reliable supplies of fuel and power.¹⁻³

In addition to reduced energy costs and potentially increased

profits, industries that take advantage of energy efficiency opportunities often gain additional benefits such as:¹⁻⁴

- More productive state-of-the-art-technology that improves a facility's competitive edge and improves global competitiveness;
- Improved environmental performance and compliance with environmental and pollution abatement regulations; and
- An enhanced public image as an environmentally friendly or "green" company.

Energy management is not a one-person responsibility or a one-time investment in conservation measures. Energy management is an ongoing effort marked by gradual improvements in energy-efficiency.¹⁻² A successful energy management process is marked by:

- Maximizing production efficiency,
- Minimizing energy consumption,
- Maintaining a high energy load factor,
- Correcting for low power factor, and
- Acquiring and using economical supplies of energy.

Energy management does not just happen. Effective energy management occurs when the idea and practices associated with energy management become part of the "corporate culture."

A rule-of-thumb is one person-year for each \$1 million of annual energy expenditures.

As progress is made, the commitment can be reduced to one person-year for every \$2 - \$5 million spent annually.

Elements of a Successful Energy Management Program

Energy-management consists of a well structured team effort to create energy awareness: collect and organize energy cost and consumption data; identify, analyze and implement energy conservation opportunities; and monitor results. The program must be accomplished without placing an undue burden on plant maintenance or engineering staff.¹⁻²

Ten “Key Elements” that are crucial to success of an energy management program are:

1. Secure Top Management Commitment

Top management must be committed to a motor-driven systems energy conservation program.¹⁻⁶ To a substantial degree, management’s attitude toward energy conservation will determine the success of the energy plan.¹⁻¹ Management must be willing to provide both personnel and financial resources.

Employees will apply their best efforts to an energy conservation program only if their management displays awareness of the program’s importance.¹⁻⁶

2. Appoint an Energy Coordinator

A plant energy coordinator should be appointed to guide energy management efforts.¹⁻² The energy coordinator should have an energy background with energy management being a primary duty.¹⁻⁷

The energy coordinator can be likened to a coach: mobilizing resources, providing sound advice, motivating others, and providing support.¹⁻¹ The coordinator should be responsible for energy management activities such as:¹⁻²

- Making energy management an integral part of every department.
- Providing operators, foremen, and maintenance staff with tools they need to be part of an energy management team.
- Analyzing trends in energy use and efficiency and identifying areas of concern.
- Informing plant management of roadblocks to energy use reduction while suggesting ways to remove them.
- Stimulating interest in the installation of energy saving measures.
- Assisting in the development of energy use standards.
- Reviewing plans for plant expansions, process modifications, and equipment purchases to ensure that energy is used efficiently.
- Directing the activities of outside consultants, and
- Preparing monthly or bi-monthly facility energy efficiency reports so that management can be continuously updated on motor-driven system improvements, energy savings, and cost reductions.

3. Obtain Employee Cooperation

The cooperation of operations and maintenance staff is vital to the success of any energy management effort.¹⁻² In most cases, the effectiveness of an energy improvement program is proportional to the effort and time the energy coordinator and department representatives are allowed to spend on it.¹⁻⁶ Recognize and support internal “idea champions”. An idea champion is the prime mover: the person with the vision, desire, and persistence to promote a conservation project or approach and to see it through to completion.¹⁻¹

An energy committee should be established, with representatives from each department expected to make recommendations and conduct investigations. Participants in an energy committee help create that “critical mass” that is crucial for success. A sense of “ownership” develops commitment.¹⁻¹ A typical energy management team organizational chart is depicted in Figure 1-1.¹⁻⁶

4. Conduct Energy Surveys

An initial plant energy survey shows where and how energy is being used and/or wasted.¹⁻⁶ An inventory of energy-using equipment should be prepared, showing basic energy use data (usually obtained from equipment nameplates) and indicating typical running time and operating profiles. Without basic audit information, it is impossible to tell whether equipment is operating unnecessarily or wastefully. The basic survey information is also needed to set standards, and to measure the performance of an individual piece of equipment, a processing line, or a department.¹⁻⁶

Survey information also assists the energy coordinator to “target” and focus efforts on the most energy-intensive equipment in a facility. Potential conservation savings are greatest where losses are the largest. Auditors should concentrate on motor-driven systems where:¹⁻⁸

- The motor running time exceeds 1,000 hours per year;

Figure 1-1 Typical Energy Management Team Organization Chart

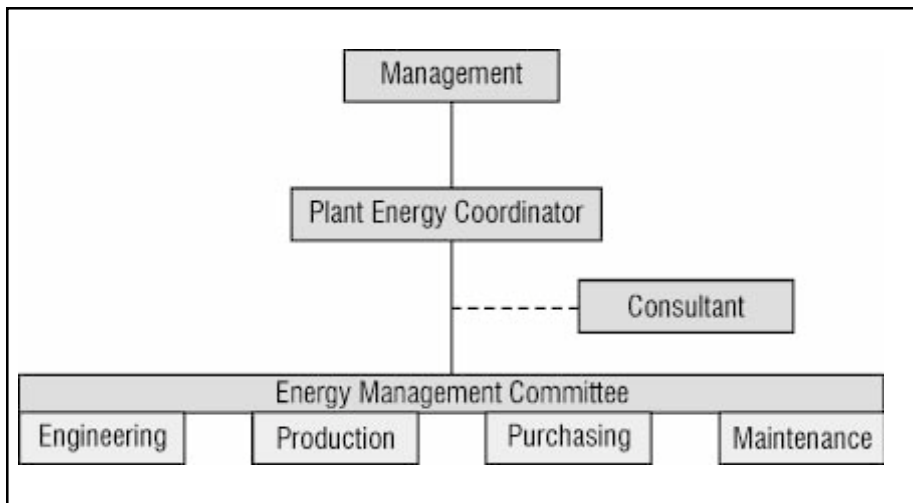

- Applications require larger horsepower motors. Typically, motors above 20 hp represent only 20 percent of the overall motor population yet consume 60 percent of motor driven equipment energy.
 - Loads are nearly constant and operation is at or near the full-load point for the majority of the time.
 - Energy and power or demand charges are high. In some locations, energy rates are as high as \$.12/kWh. With higher electrical rates, expenditures for conservation measures yield a much more rapid payback on investment.
 - Utility rebate or demand management program incentives exist.
- Determine the cost of energy wasted.
 - Request that department-level energy committee members develop procedures to reduce waste or to identify barriers or equipment limitations that prevent waste reduction.

5. Organize Energy Data

To convince plant management of the value of motor systems management, you must make them aware of energy's impact on operations. High-energy costs may not be perceived as a concern until energy costs can be compared with other costs at the facility level.¹⁻¹ In order for energy conservation opportunities to compete for resources, top level managers must understand the scope of the problem.

The logical place to begin gathering information on energy use is with utility bills. Obtain a copy of your rate schedule from your electric utility and determine whether alternative schedules are available for your facility. Obtain electrical energy consumption and cost data for at least a one-year period in order to establish a base period.¹⁻⁵ Check whether patterns exist in the use and cost of energy. Is the amount of money spent for energy higher during certain portions of the year? It is helpful to graph energy use and costs using an energy accounting or spreadsheet program.

Chapter 2 shows you how to interpret your utility's rate schedule and use billing data

The initial physical plant survey should be conducted department by department. It should document wasteful operations and identify obvious sources of losses that can be corrected immediately. The survey will also reveal where energy and/or process flow metering should be installed. (One rule of thumb states that in-plant metering is economically justified when the annual cost of energy exceeds five times the cost of the meter.)¹⁻⁶

One survey approach is to:¹⁻²

- Determine the energy consumption rates and costs for major equipment in each department.
- Ask the department-level energy committee members to determine how long equipment operates and how long it is in service without performing a useful task.

to target potentially cost-effective energy-conservation, power factor correction and demand reduction opportunities.

6. Analyze Survey Results

After the plant energy survey is complete, construct energy balances for each department, process, and piece of energy-consuming equipment in your facility. An energy balance quantifies the total energy output against the total energy supplied to a system, indicating how effectively the supplied energy is utilized.¹⁻⁶ By comparison with process requirements or known energy intensity standards, you can detect whether energy is being used inefficiently and, if so, to what extent? On-line monitoring systems may have to be installed to compute energy balances at the department, process, or equipment level.¹⁻⁶

Energy surveys and balances provide the basic information necessary for analyzing energy conservation opportunities. The analysis is typically conducted by a plant engineer and examines the capital and installation costs, and annual energy and dollar savings associated with alternative conservation actions. The analyst must address considerations such as disruption of industry operations, effect on product quality and yield, technological risk, maintenance requirements, technology availability, vendor reliability, and training and skilled personnel requirements.¹⁻⁴

7. Set Conservation Goals

Energy management programs typically set yearly goals for specific reductions in baseline energy intensity, usage, or cost. Although realistic goals may be difficult to set initially, goals are absolutely necessary. Without goals, there is no method for measuring performance.¹⁻²

8. Develop an Organization-Wide Energy Management Plan

Good energy management begins and ends with decision makers. The energy management program, depicted in Figure 1-2, illustrates information necessary for making informed decisions.¹⁻⁹

The energy management or motor improvement plan includes policies, goals, assignments, training needs, an assessment of the costs and benefits (energy savings, demand reduction, productivity gains) associated with conservation opportunities, implementation time-lines, and a description of feedback and reporting mechanisms.

9. Implement Engineering Changes

Energy audits or technical assistance studies gathering dust represent lost opportunities to save money.¹⁻¹ *Implement engineering changes!*

The energy-management plan generally calls for identifying and implementing the most cost-effective measures first. Ideally, all measures meeting the company's return-on-investment criteria are funded.

Often, however, the first step in starting an energy management program is to install measures that enable energy savings to build quickly.¹⁻⁷ This approach builds confidence and trust and allows

momentum to build, which is necessary to overcome barriers and change an organization's culture.

One approach to incrementally "growing" a comprehensive program is to choose

Figure 1-2 Steps in an Energy Management Program

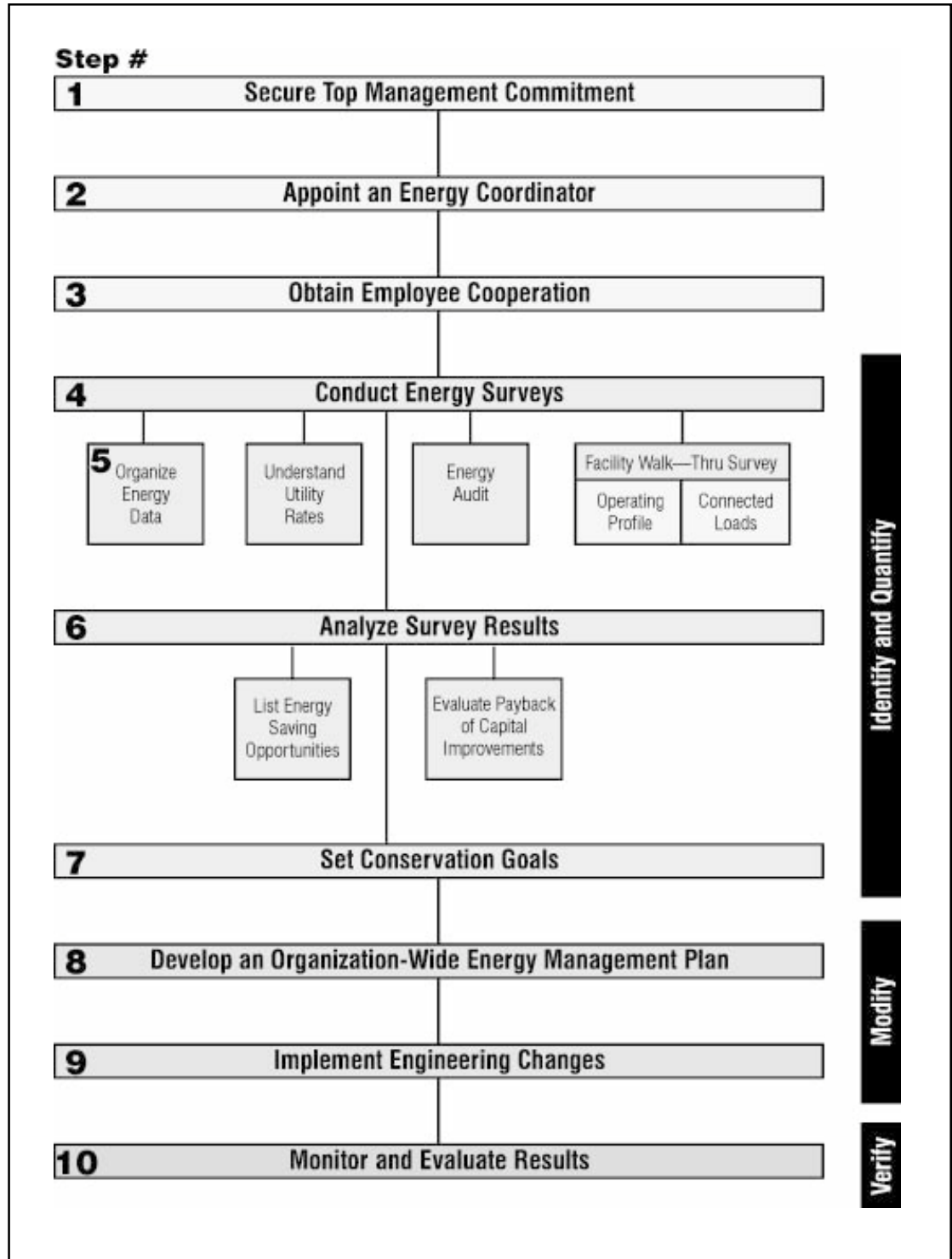

a small, low-investment project from your list of possibilities that can be charged to a routine maintenance budget. Once you have selected a small project, double check its payback. Errors can be embarrassing and you are out to prove your and your energy committee's abilities as energy managers. Complete the project and thoroughly document costs, performance and energy savings. Then submit a project summary to plant management. Once you have completed the first project, choose another. Size doesn't matter. Once the two projects have been successfully completed, approach plant management with a larger endeavor that cannot be financed within maintenance budgets.¹⁻¹⁰

10. Monitor and Evaluate Results

Monthly, bi-monthly, or quarterly reports of energy use are essential feedback for making the energy management program visible to both plant management and department level staff. Evaluate conservation measure performance and periodically report energy intensity, usage and cost data so that management "sees" the benefits associated with conservation investments.

Share success to build support. Make the program visible. Monitoring data can also provide recognition or awards for exceeding energy reduction goals or for exemplary performance or teamwork.

Conclusion

The average energy cost as a proportion of manufacturing production costs is about three percent. Historically, industrial firms have viewed energy costs as largely outside their control, and as fixed costs that are not significant enough to warrant special attention. Today, a host of energy-efficient technologies, techniques, and approaches has emerged and energy management is being increasingly recognized for its potential to improve the "bottom line". **For example, if energy represents three percent of production costs, and profits amount to 20 percent of production costs, then reducing net energy costs by one-third can result in a five percent gain in profits.**¹⁻⁴

Energy management is worth pursuing, with the greatest benefit potential within energy-intensive industries that have not implemented aggressive energy-efficiency programs in the past.¹⁻⁴

The level of effort justified depends on how much money is spent for energy each year. A rule-of-thumb is one person-year for each \$1 million expended annually. As progress is made and energy management becomes the normal way of operating, the level of involvement can be reduced to one person-year for every \$2 - \$5 million spent annually.¹⁻²

References

Chapter 1

-
- 1-1 Washington Association of School Administrators, “Energy Excellence in Public Schools.” Washington State Energy Office
 - 1-2 Wayne L. Stebbins, “Keeping the Energy Management Process Alive,” *Plant Engineering*, June 3, 1993
 - 1-3 J. Smith, “Developing a Coherent Corporate Energy Strategy,” *Energy Management and Environmental Sourcebook*, Proceedings of the 14th World Energy Engineering Congress, October 23-25, 1991.
 - 1-4 M.F. Hopkins, et. al., “Industrial Demand Side Management: A Status Report,” Battelle Pacific Northwest Laboratory, PNL-10567, May 1995
 - 1-5 Thomas Bear and Karl Peters, “Getting an Energy Management System Up and Running,” *I&CS*, July 1994.
 - 1-6 “Energy Management for Industry” Electric Ideas Clearinghouse Technology Update, Bonneville Power Administration, February 1993
 - 1-7 David L. Lewis, Washington State Energy Office “Turning Rust into Gold: Planned Facility Management,” *Public Administration Review*, Vol. 51, No. 6, November/December 1991
 - 1-8 Reliance Electric, “A-C Motor Efficiency: A Guide to Energy Conservation,” B-7087-5
 - 1-9 A & C Consultants, Inc., “Managing Energy in Local Government Facilities,” Washington State Energy Office, WAOENG-87-07, March 1987
 - 1-10 “Selling Energy Management,” *Energy Access* Washington State Energy Office, WAOENG-89-47, September 1989

Chapter 2

Understanding Your Utility Bill

This section illustrates various billing strategies that may be applicable at your facility. Contact your utility account representative for detailed information about your rate schedule.

The first step in reducing energy costs is understanding where your energy dollars go.²⁻² How much energy goes to lighting, air conditioning, air compressors, or to refrigeration systems? What portion of the electrical bill is for electrical energy consumption (kWh) versus peak power demand (kW)? Are demand charges ratcheted, i.e. monthly charges linked to the highest power draw over the preceding year? Is a power factor penalty or kVA charge levied? Are rates seasonally differentiated or higher during certain periods of the day? Is a declining or inverted block structure used for assessing energy charges? The answers to these questions tell you where to look for both energy and dollar savings.²⁻²

Organizing Utility Bills and Production Data

Energy accounting involves recording and analyzing both energy use and cost data. This process helps you:²⁻³

- Account for current energy use,
 - Identify or target areas with the greatest savings potential,
 - Justify capital expenditure decisions,
 - Observe the results of conservation investments,
 - Gain management support,
 - Detect consumption increases,
 - Identify billing errors; and
- Compare the energy efficiency of your facility or process to similar facilities or processes.
- To initiate an energy accounting program:
- Locate all meters and submeters within a facility.
 - Determine which building or process is served by each meter.
 - Obtain copies of all utility bills for at least a one-year period.
 - Obtain monthly and annual feedstock, production, or throughput data at the facility and/or process level.
 - Sort utility bills by building and/or meter, and organize bills into 12-month blocks using meter read dates.
 - Organize historical energy and production data so that energy management performance can be measured against a baseline year. Typically, the year prior to initiating an energy management program is selected as the baseline.²⁻³
 - Ensure that your facility is on the proper utility rate schedule. Often, electrical utilities offer different schedules — such as General Service, Large General Service, Primary General Service, High Voltage General Service, or High Voltage Interruptible Service — based upon the type and reliability of services provided.²⁻¹ The “best” schedule for your facility may change over time.

Concepts of Power and Energy

The basic unit of power in electrical terms is the watt. Since this unit is very small, a unit one thousand times as large (the kilowatt) is frequently used. One megawatt is one thousand kilowatts. One horsepower is 746 watts or 0.746 kW.

Power is the rate of energy use. The amount of energy used by a motor-driven system is directly proportional to the power draw of the system times the length of time it is in operation. Since power is expressed in kilowatts and time in hours, the conventional unit of energy is kilowatt-hours (kWh).²⁻¹

Power and energy measurements are used to determine loads on equipment, energy consumption, running costs, and to verify proper system sizing and operation. To measure power, we use a power meter or take advantage of the fact that power is proportional to the product of circuit voltage (V) amperage or current (I) and power factor (PF).²⁻¹ For a three-phase system:

$$P_i = \frac{V \times I \times PF \times \sqrt{3}}{1000}$$

Where:

P_i = Three phase power in kW

V = RMS voltage, mean line to line of 3 phases

I = RMS current, mean of 3 phases

PF = Power factor as a decimal

You can present information about your energy use in a graphical format as shown in Figure 2-1. Energy management performance is often indicated in terms of 12-month rolling average energy consumption. Because industrial plants may expand or undertake modifications to increase production rates, the rolling average is typically normalized to reflect an energy-intensity ratio such as kWh/square foot-year or kWh/unit of production per year. For industrial facilities, energy efficiency is properly expressed as a reduction in the energy required to produce

a unit of product. Information typically presented in graphs includes:²⁻³

- Electricity consumption by month (kWh) for a given facility, meter, or process
- Electrical demand by month (kW)
- Energy and demand costs by month
- “Rolling Average” energy consumption
- “Rolling Average” energy intensity (kWh/unit of product)
- Facility production by month

Figure 2-1
Energy Use Profile Reports

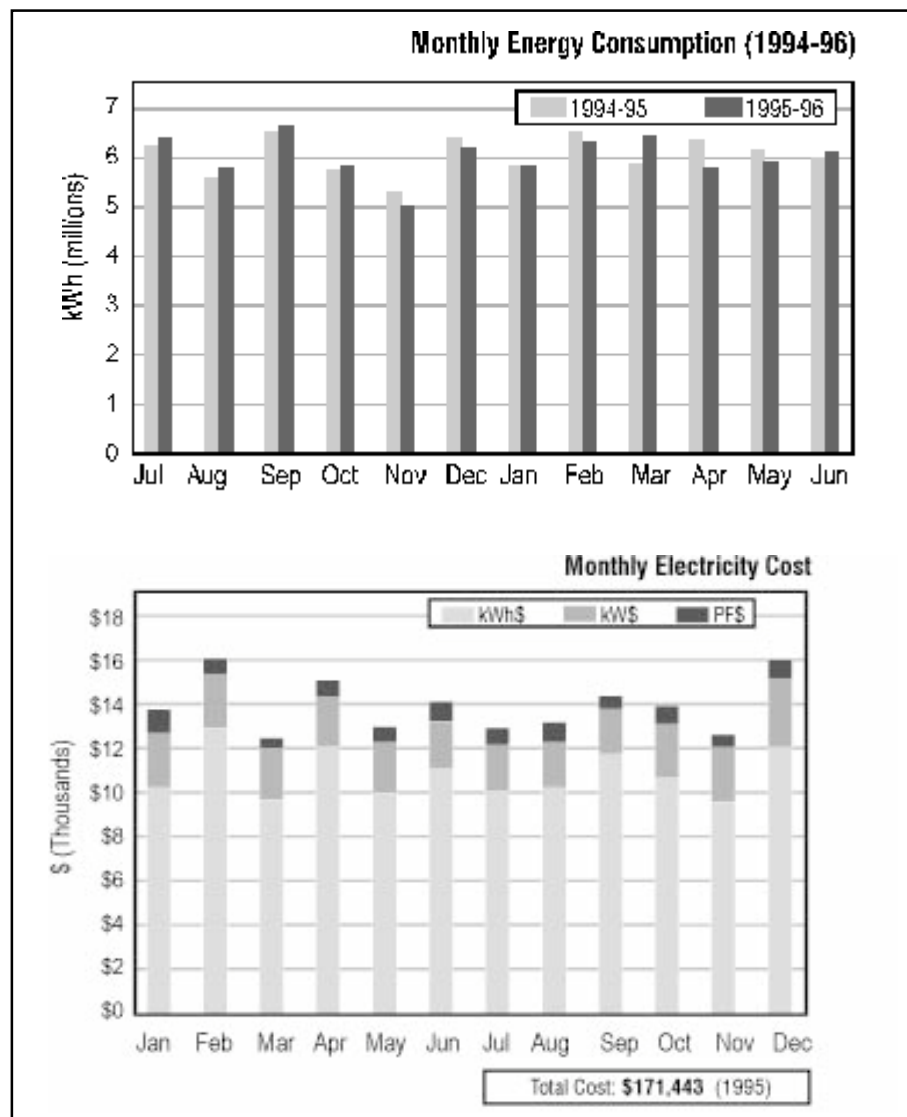

In the *rolling average* method of energy accounting, you calculate billing data each month by dropping the oldest month from the total and adding the newest. This method eliminates widely-fluctuating values due to variable meter reading dates or seasonal processes. It allows for simple comparison of the present year's energy use or energy intensity with any previous year. A graph of this type remains flat if no significant changes in energy consumption or process efficiency occur.²⁻³

Once a baseline energy consumption profile is established, you can identify the load with the process and ultimately with the motor-driven equipment. You can then begin to identify where to focus your energy conservation efforts. A summary of energy end uses in a sawmill is given in Table 2-1 and shown in Figure 2-2. You should also examine seasonal loads, consumption trends, annual energy and cost savings, and anomalies or unexplained peaks in energy use or demand. Such peaks may indicate equipment malfunction or a meter reading error.²⁻³

Table 2-1.
Sawmill Energy End Use Summary

Process	Electricity Use, kWh	Percentage of Total Use	Cost
Blowers	484,600	4.8%	\$12,115
Chippers	101,600	1.0%	2,540
Air Compressors	1,911,200	19.0%	47,480
Hog	76,700	0.8%	1,917
Hydraulic Motors	857,800	8.5%	21,445
Saw Motors	2,092,000	20.8%	52,300
Planer Motors	132,700	1.3%	3,317
Kiln Fans	2,033,800	20.2%	50,845
Boiler Fans	268,900	2.7%	6,722
Lights	376,400	3.7%	9,410
Misc.	1,741,390	17.3%	43,534
Totals	10,077,090	100.0%	\$251,925

Figure 2-2
Sawmill Energy Consumption Disaggregation

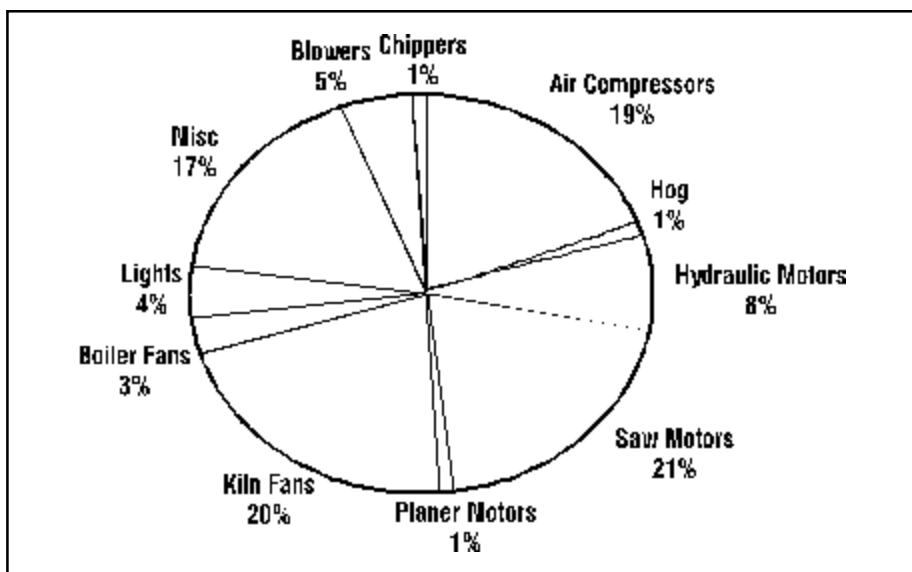

Interpreting Utility Charges

Look at your electric bill. A typical bill is shown in Figure 2-3. The bill tells you how much to pay, but generally does not tell you where the total came from or why. In fact, most bills include two, three, or four separate charges.^{2-1,2-2} These different charges vary widely from utility to utility. Therefore, your strategies to reduce energy costs depend heavily upon the rate structure applicable to your facility.

While your utility bill indicates how much energy and power you used, the rate structure is your guide for determining how costs are allocated and computed.²⁻²

Let's examine the most common charges shown in Figure 2-3, a sample monthly commercial/industrial billing statement. The descriptions below relate to numbers on Figure 2-3.

1. Service days - The number of days in the billing cycle.
2. Meter number - The number shown on the face of the meter.
3. Meter type - You could have one or more of the following types of meters;
 - A. Energy and Demand - this measures kWh (Kilowatt-hours) and kW (Kilowatt),
 - B. Reactive Energy only - this measures kVARh (Kilovolt-amp-hour reactance) which is used to bill for power factor less than 95%, and
 - C. Energy, Demand, and Power Factor - this meter has the capability to measure all three.
4. Meter Reading - The actual reading taken from the meter.
5. Multiplier - This meter multiplier used in calculating the kW demand, total kWh consumption or total kVARh consumption is on the front of the meter.
6. Consumption - The actual meter reading multiplied by the meter multiplier in units of kWh or kVARh. Reactive power is the non-working power caused by magnetizing currents required to operate inductive devices such as transformers, motors and lighting ballasts and is used as the basis for power factor charges.
7. Demand - This is the actual kW demand and is calculated by multiplying the kW meter reading by the meter multiplier. The demand kW shown is the highest kW recorded by the meter in any one 15 minute period for the billing period.
8. Power Factor - The Power Factor % shown on the bill is determined from the kVARh consumption described above, along with the *real* (working) power and *apparent* (total) power. The actual charge for power factor below 95% is calculated by multiplying the kVARh consumption by the kVARh rate.
9. Rate Code - This is the rate that applies to the meter number shown. For customers with multiple meters, more than one rate schedule may apply.
10. Unit Charge - The rate being charged for the rate code shown. If the rate is not shown, you have a time-of-use meter. In this circumstance, a second statement is included with your bill which shows the off peak and on peak schedule charges.
11. Service Charge - A monthly charge often referred to as the basic, facilities, or customer charge. It is generally stated as a fixed cost based on transformer size.

Service Charge

This monthly charge is often referred to as the basic, facilities, or customer charge. The service charge is designed to recover fixed utility costs associated with activities such as operations and maintenance, administration, metering, and billing. It is generally stated as a fixed cost based on transformer size. Some utilities establish a minimum billing amount or offer a variable service charge which is dependent upon peak demand.^{2,2} Typical service charge structures are given in Example 1.

Example 1: Basic Service Charge Structures

- Basic monthly charge:
\$760
- Facilities charge:
\$2,865 per month

Energy Charge

All rate schedules include an energy charge.^{2,2} The energy charge is based upon the total number of kWh consumed over the billing period. Many utilities offer energy charges that are seasonally differentiated while some offer rates which vary with the time of day. Some utilities charge the same rate for all kWh used, while others charge different rates for different quantities or “blocks” of energy. You should use the “tailblock” or marginal energy cost when calculating the feasibility of conservation investments.

With a declining block schedule, the charge per kWh is reduced for each successive block, making the cost-per-unit less when more electricity is used.^{2,1} With an “inverted” block structure, the unit price increases for each

You may be able to lower your plant's electricity costs by revising operating schedules, replacing inefficient equipment, or selecting a different utility rate schedule that better fits your pattern of electricity use.

Ask your electric utility representative for printed rate schedules that describe the various rates available and illustrate how charges are calculated. Most electric utilities are willing to change a customer's rate schedule free of charge.^{2,4}

Figure 2-3

Billing Statement

ACCOJNT NUMBER		SERVICE ADDRESS						DUE DATE	AMOUNT DUE			
								09-06-95	\$50,990.19			
CUSTOMER NAME							PREVIOUS CHARGES	62,970.32				
							PAYMENTS - THANK YOU	62,970.32 CR				
							BALANCE FORWARD	.00				
Billing Period		Meter Reading		Multiplier	Consumption kWh	Demand kW	Power Factor	Rate Code	Unit Charge	Amount		
Start	End	Veter Number	Type								Present	Previous
07-24-95	08-22-95	218839	kWh	40983	30538	10				146.23		
07-24-95	08-22-95	040597	kWh	98236	7721310	2.0250				5,760.90		
07-24-95	08-22-95		Demd	35.75		10		357.5		464.75		
07-24-95	08-22-95	116231	kVh	74697	70763	10			91	55.00		
07-24-95	08-22-95	110939	kWh	96391	27739	10		86520		2,370.65		
07-24-95	08-22-95		Demd	24.30		10		246.0		322.50		
07-24-95	08-22-95	011252	kWh	10030	9988	40		3680		121.44		
07-24-95	08-22-95	049054	kVh	99082	36246	100		28330	91	396.62		
07-24-95	08-22-95	048202	kWh	48924	42490	100		643400		10,775.10		
07-24-95	08-22-95		Demd	.01		100		1383.0		815.97		
07-24-95	08-22-95	028439	kWh	56979	51611	1		5362		176.95		
07-24-95	08-22-95	91219	kVh	54215	41505	10		127100		177.94		
07-24-95	08-22-95	89971	kWh	58139	20687	10		374820		9,557.91		
07-24-95	08-22-95		Demd	39.54		10		636.4		827.32		
07-24-95	08-22-95	090690	kVh	93095	30610	10		24750	78	34.65		
TOTAL CHARGES THIS PERIOD										50,990.19		
SERVICE CHARGE										1,000.00		
AMOUNT DUE										\$51,990.19		

Ratcheted Demand Charges

Some utilities use what is called a “ratchet” clause. The concept is that the demand charge should reflect the generating, transmission, and distribution capacity required to meet your peak demand over the year, not just for the current billing period. For example, your monthly demand charge may be the greater of the metered demand or a percentage of the greatest demand recorded during the preceding 11 months. With this type of rate structure, indicated in Example 6, abnormal electrical consumption from using backup equipment during an upset period or from a plant restart can affect charges over an entire year.

incremental block. Consolidate meters to take full advantage of declining block rate schedules. A sample declining block rate structure is depicted in Example 2.

Example 2: Declining Block Rate Structure

■ 3.636¢ per kWh for the first 40,000 kWh

3.336¢ per kWh for all additional kWh

Demand Charge

Peak demand charges can account for half of the electric bill in an industrial plant. Demand is a charge based upon your maximum or peak rate of energy use. The demand charge is designed to recover utility costs associated with providing enough generating, transmission and distribution capacity to meet your peak electrical load.

A typical demand meter averages demand over a specified “demand interval,” usually 15 or 30 minutes. (In this instance, short periods of intense use, such as a ten-second start-up of a motor, have little or no effect on demand.) At the end of each interval, the meter resets to zero and the measurement begins again.^{2,2} The meter, however, stores or records the largest average demand interval in the billing period. “Sliding window” demand meters record demand and then scan for the largest demand interval regardless of starting time.^{2,2} You are then billed for a peak demand that is somewhat higher than that obtained with a conventional meter. A demand meter is depicted in Figure 2-4.^{2,3}

A few utilities base their demand charge on a facility’s instantaneous peak. In this case, short periods of intense use such as a

ten-second start-up of a motor (or start-up of motors after a power outage) can significantly affect demand. Eliminate spikes by sequencing the start-up of large motors so that their peak demands are staggered.

Types of Demand Charges

Direct Demand Charges

You may be billed directly for demand charges at a rate from less than \$2/kW per month to over \$25/kW, depending upon your utility.^{2,2} In the Northwest, both demand and energy charges are higher in the winter months than the summer months.

Like energy, demand charges may be levied in a declining or inverted block structure. Sometimes the initial block is offered at no charge, with a fixed charge assessed for all demand exceeding the minimum value. Typical rate schedule language for direct demand charges is illustrated in Example 3.

Example 3: Direct Demand Charge

■ For each kW of billing demand

Winter	Summer
\$1.69	\$1.13

■ All kW of maximum demand between 7:00 a.m. and 10:00 p.m., Monday through Friday at \$1.16 per kW

Demand Incorporated Into Service Charges

Some utilities incorporate a demand component into their basic charges. Others vary the basic charge based upon the facility demand. This type of rate structure is indicated in Example 4. This charge may be in addition to other demand charges.^{2,2}

Example 4: Incorporation of Demand into Basic or Service Charges

- If load size is over 300 kW: \$115 + \$0.80 per kW

Linkage of Demand and Energy Charges

Some utilities have rate schedules that include demand payments in their energy charges. The energy charge in this case is broken into a block structure where block size varies according to facility demand. For instance, you might pay a higher rate for the first 100 kWh per kW of demand, with a lower rate for all additional energy use. This type of rate structure is depicted in Example 5.

Example 5: Linkage of Demand and Energy Charges

- 6.510¢ per kWh for the first 85 kWh per kW of demand but for not less than the first 1,000 kWh
- 4.199¢ per kWh for the next 8,000 kWh
- 3.876¢ per kWh for all additional kWh
- 2.815¢ per kWh for the first 200 kWh per kVA of demand but not less than 1,000,000 kWh
- 2.394¢ per kWh for all additional kWh

Racheted Demand Charges

Some utilities use what is called a “ratchet” clause. The concept is that the demand charge should reflect the generating, transmission, and distribution capacity required to meet your peak demand over the year, not just for the current billing period. For example, your monthly demand charge may be the greater of the metered demand or a percentage of the greatest demand recorded during the preceding 11 months. With this type of rate structure, indicated in Example 6, abnormal electrical consumption from using backup equipment during an upset period or from a plant restart can affect charges over an entire year.

Example 6: Ratcheted Demand Charges

- The minimum charge is 100 percent of the maximum demand charge established during the preceding eleven months.
- Billing months of April through November: the highest demand established during the month, but not less than 60 percent of the highest demand established during the previous winter season.

Reduce ratchet charges by reducing your maximum demand. For example, avoid simultaneously operating large pumps and compressors that are needed only occasionally. Carefully plan when to operate large equipment during the months of your greatest electric demand. The more level your month-to-month demand, the closer you will come to paying only for actual demand each month.²⁻⁴

Figure 2-4 Electric Demand Meters

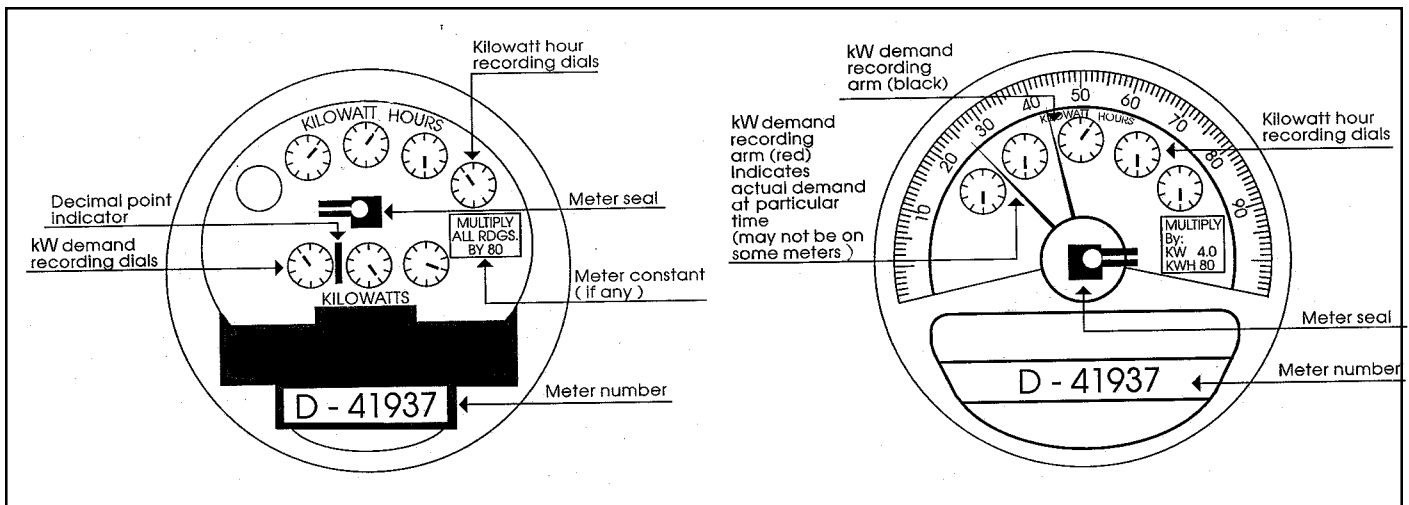

If you are on a time-of-use rate, shift as many operations to off-peak as possible. Significant investments in added equipment may be justified by savings in energy and demand charges. You may be able to use automation to control start-ups, minimizing the need for additional people to work during off-peak hours.

If your facility is not on a time-of-use rate, find out whether your electric utility offers such rates. You may be able to reduce costs by switching to time-of-use rates.

Minimum Demand Charges

Some utilities build a minimum monthly charge into their assessment of demand charges. With this type of rate structure, given in Example 7, energy conservation or demand-limiting measures would produce no additional benefit once the monthly demand drops below the minimum value.

Example 7: Minimum Demand Charges

- *\$5,500 for the first 3,000 kVA or less. \$1.10 for each additional kVA.*
- *The highest average 30-minute demand recorded during the month, or 4,400 kVA, whichever is higher.*

Power Factor Charges

Inductive motor loads require an electromagnetic field to operate. Reactive power, measured in kilovolt-amperes reactive, circulates between the generator and the load to excite and sustain the magnetic field. Reactive power does not perform “work” and is not recorded on the utility’s energy or demand meters, yet the utility’s transmission and distribution system must be large enough to provide it. Working power, measured in kW, and reactive power together make up the apparent power (measured in kilovolt-amperes or kVA).

Power factor is the ratio of working power to apparent power. Power factor measures how effectively electricity is being used. A high power factor indicates the efficient use of electrical power, while a low power factor indicates poor utilization of the incoming electrical current supplied by the utility.²⁻⁶ Techniques for sizing and locating power factor correction capacitors and for determining the cost-effective-

ness of power factor correction actions are given in Chapter 7.

Utilities generally assess a penalty for low power factor. Various methodologies exist for calculating the penalty. You need to understand your utility’s calculation method in order to determine the benefits associated with potential power factor improvements.

Types of Power Factor Penalties

kVA Billing

As shown in Example 8, the utility may measure and bill for every kilovolt-amp of apparent power or primary period (peak) kVA supplied, including reactive current.

Example 8: kVA Billing

- *Demand charge: \$2.49 per kVA of billing demand*
- *Primary kVA charge: \$24,000 which includes 2,000 primary kVA plus \$12.10 for each additional primary kVA.*

Direct Reactive Energy Charges

As indicated in Example 9, reactive power may be measured and a reactive energy charge levied (in ¢/kVARh).

Example 9: Direct Reactive Energy Charges

- *Reactive power charge: 0.061¢ per reactive kilovolt ampere-hour (kVARh)*

Demand Billing with a Power Factor Adjustment

In the following calculation the utility bills at normal demand rates with a demand surcharge or multiplier included to account for low power factor.

Equation 2-1

$$\text{kW}_{\text{billed}} = \frac{\text{kW}_{\text{demand}} \times 0.95}{\text{PF}}$$

Where:

$\text{kW}_{\text{billed}}$ = Adjusted or billable demand

$\text{kW}_{\text{demand}}$ = Measured electric demand in kW

PF = Power factor as a decimal

Given a facility power factor of 84 percent, the utility would obtain a 13 percent increase in billable demand.

$$\left(\frac{0.95}{0.84} = 1.13\right)$$

Example 10 shows a rate schedule with a penalty for facilities operating below a 95 percent power factor.

Example 10: Demand Billing with a Power Factor Adjustment

- *The demand charge, before adjustment for power factor, will be increased 1 percent for each 1 percent by which the average power factor is less than 0.95 lagging.*

Excess kVAR Reactive Demand Charges

With this method the utility imposes a direct charge for the use of magnetizing power in excess of some percentage of kW demand. For example, if the charge was 60 cents per kVAR for everything over 40 percent of kW, and a 4,000 kW peak load existed, then the utility would provide up to 1,600 kVAR at no cost. Excess kVAR is billable at the specified rate. This type of rate structure is illustrated in Example 11.

Example 11: Excess kVAR Reactive

Demand Charges

- *The maximum 15-minute reactive demand for the month in kilovolt amperes in excess of 40 percent of the kilowatt demand for the same month will be billed at 45¢ per kVAR of such excess reactive demand.*

Optional Rate Schedules

Time-of-Use Rates

By charging more during the peak period, when incremental costs are highest, time-of-use utility rates send accurate marginal-cost price signals to customers. Periods of heavy electricity use are typically defined as “peak” hours; periods of lower use are “shoulder” hours, with times of lowest use deemed “off-peak.” Energy charges between peak and off-peak times might vary by over 10¢/kWh.

Similarly, your demand charges may be computed at a much higher rate if your highest-demand interval occurs during the “peak” hours.²⁴

Interruptible, Curtailment, and Customer Generator Rates

Upon request from the electric utility, customers on interruptible rates must lower their demand. They can do this by turning off some or all of their large electrically-driven equipment or they can use emergency generators or engine-driven pumps instead of utility-supplied power.²⁻⁴

To obtain interruptible, curtailment, or customer generator rates, the customer enters into a load management agreement to interrupt or reduce plant loads at the request of the power company during the occasional times of peak demand. In return, the

Find out whether your electric utility offers “interruptible,” “curtailment,” or “customer generator” rates. If you are thinking of using an emergency generator on a regular basis, analyze operating conditions as well as your ability to maintain the generator. Talk with your account representative about a load management agreement.

Ask your utility account representative the following questions:²⁻⁴

- *What other rate schedules are available for the plant? Would they be less costly?*
- *What are the months in the power company's "peak season?"*
- *Do time-of-use rates exist? How are the peak, shoulder and off-peak periods defined and what are the corresponding energy costs?*
- *Is there a ratchet clause? Which months in the past year were affected by the ratchet clause? What was the additional annual cost?*
- *What was the peak month kW demand? How much lower must it be to eliminate ratchet charges in the future?*
- *Are there any power factor penalties in effect for this plant? What is the annual cost?*
- *Is a "customer generator" or other load management rate available? What are the requirements? What are the benefits?*

power company applies lower rates to the demand charge on the bill for the duration of the agreement. Penalties for nonconformance, however, are high.²⁻⁴

Using Billing Data to Identify Opportunities

Understanding your electric utility bill — knowing how your demand meter works and how power factor penalties are assessed — is crucial for the energy coordinator. Energy and demand costs are controllable, and the benefits of implementing energy conservation, demand management, or power factor correction are directly related to the way your facility operates and the structure of your rate schedule. While power factor correction is not generally undertaken for energy conservation reasons (power factor correction does result in a reduction in electrical resistance or I²R losses within the plant distribution system), it can be very cost-effective and result in significant reductions in your utility bill.

With energy data in hand, you can assess the feasibility of demand management measures by computing the facility load factor. Load factor is the ratio of your facility's average to peak-demand and indicates how effectively demand is allocated. Calculate your monthly load factor for a 12-month period so a minimum, maximum, and annual average can be determined.²⁻⁵ A sample load factor calculation is given in Example 12.

If your load factor varies significantly from billing period to billing period, your operation should be carefully reviewed. If your annual load factor is less than 80 percent, opportunities for in-plant demand reduction measures might exist. In contrast, if your facility has a load factor which is constantly above 80 percent, there is likely little potential for demand-limiting measures in your plant.²⁻⁵

If your facilities have low load factors, you must determine the load profile — or load variation by time of day or month — for major processes or pieces of

Example 12: Determining Your Load Factor

$$LF = \frac{\text{kWh}}{\text{kW}_{\text{demand}} \times 24 \times N} \times 100\%$$

Where

- LF = Load factor in %
- kWh = Electric energy in kWh
- kW_{demand} = Electric demand in kW
- N = Number of days in billing period

Sample Billing Information —

Energy Use	Demand	Period
1,132,000 kWh	2,880 kW	30 Days

Sample Load Factor Calculation —

$$LF = \frac{1,132,000}{2,880 \times 24 \times 30} \times 100\% = 54.6\%$$

equipment within the plant. Compile load data through conducting periodic measurements at a predetermined sampling rate or by installing continuous metering or data logging equipment.

Finally, you must be familiar with a host of energy conservation as well as demand management approaches. Demand management requires that you know how and why tasks are performed at specific times; you can then determine whether any jobs can be scheduled at a different time with little or no effect on production.²⁻⁵ You must also understand the weekly demand profile in each season to determine whether opportunities exist to reduce peak demand or shift load to off-peak periods.

Demand control measures include energy conservation measures plus equipment scheduling, load shedding, time clocks and duty cyclers, interlocks, programmable controllers, energy management systems, adjustable speed drives, and the use of emergency generators to displace large loads during peak demand periods.²⁻⁵

Checklist for Electricity Cost Savings

- ✓ *Compare rate schedules and use the one best suited to your operation.*
- ✓ *Train operators and maintenance workers to be aware of the time of day for utility on-peak charges. Run motors and other electric loads off-peak whenever possible.*
- ✓ *Encourage routine energy-saving practices and follow recommended maintenance procedures.*
- ✓ *Use sequenced start-ups, and avoid scheduling periodic equipment testing during peak hours.*
- ✓ *Install capacitors to reduce power factor charges.*
- ✓ *Use standby generators to reduce peak demand.²⁻⁴*

References

Chapter 2

-
- 2-1 A & C Consultants, Inc., “Managing Energy in Local Government Facilities,” Washington State Energy Office, WAOENG-87-07, March 1987
 - 2-2 Washington Energy Extension Service, “Understanding Commercial Electric Bills,” January 1986
 - 2-3 “Energy Accounting,” Electric Ideas Clearinghouse Technology Update, Bonneville Power Administration, November 1991
 - 2-4 Electric Power Research Institute, “Understanding Your Electric Bill: Cost-Saving Strategies for Industrial and Large Electric Power Consumers,” BR-104028, 1994.
 - 2-5 “Electrical Demand Control For Industry” Electric Ideas Clearinghouse Technology Update, Bonneville Power Administration, February 1993
 - 2-6 “Power Factor Correction: A Guide for the Plant Engineer,” Commonwealth Sprague Capacitor, Inc., PF-2000E, October 1991

Chapter 3

Industrial Electrical Systems

The plant energy coordinator is the person who can be most effective in increasing electrical energy efficiency in the plant. However, in order to do so, the energy coordinator needs some basic measurement tools and an understanding of how induction motors relate to the in-plant electrical distribution system.

The electrical utility delivers power to the industrial user at a specified service voltage. A step-down transformer converts the utility voltage to the in-plant

distribution system voltage. Additional transformers may be present to reduce the distribution voltage to a motor's nominal voltage, i.e. 480 volts. The utilization voltage, the voltage value at the motor leads, is the nominal voltage less the voltage drops between the points of transformation and end use. The single-line diagram in Figure 3-1 shows the service voltage, distribution voltage, and utilization voltage values.

Figure 3-1
Typical Facility Single-Line Diagram 3-6

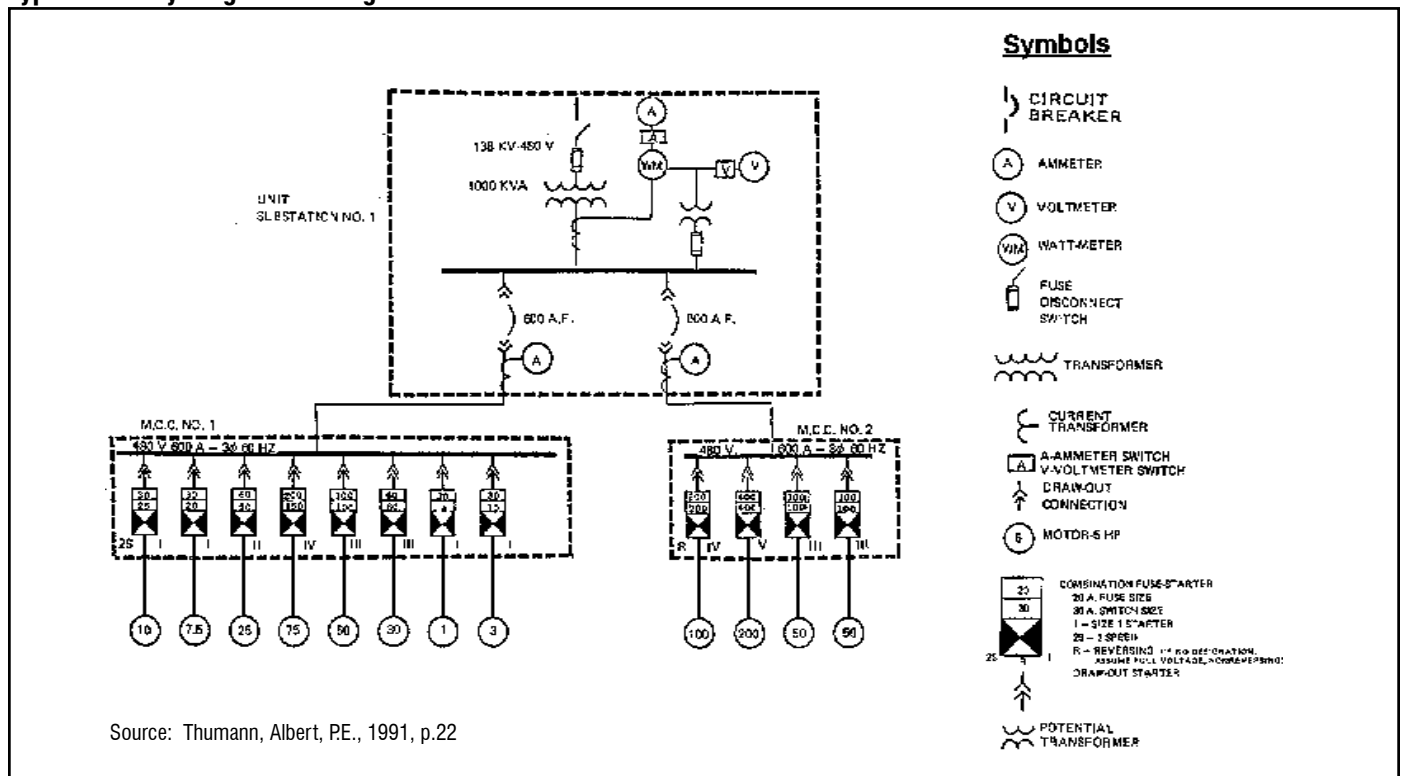

Voltage Definitions

All voltages are phase-to-phase voltage, unless specifically designated otherwise.

- **Service Voltage** describes the voltage value at the point where the utility delivers service to the industrial user.
- **Nominal Voltage** describes the general voltage class that applies to the system, i.e., 120V, 240V, 480V.
- **Utilization Voltage** describes the value of voltage at the motor leads.

The Plant Electrical Distribution System

Utilities are concerned with meeting two principal criteria when they supply power to their customers. First, the utility strives to deliver power at a voltage that is within an acceptable voltage range. Second, the utility makes efforts to provide polyphase (three phase) power where the phase-to-phase voltage is balanced or close to being the same between all phases.³⁻¹

Over and Under Voltage

The utility is obligated to deliver power to the 480V industrial user's **service** entrance in the range from a low of 456V to a high of 504V ($480 \pm 5\%$). In practice, the service voltage is usually maintained within a tight range. It is common to experience the service voltage remaining in a range of 475V to 485V.³⁻²

Acceptable in-plant distribution **system** delivery voltage values as defined by IEEE and ANSI standards are summarized in Table 3-1.³⁻² When the average of the three-phase voltages exceeds the value ranges in Table 3-1, the system is out of compliance. No field measurements or analysis should be undertaken until the

system is brought into compliance. Service voltage correction usually begins by contacting the serving utility.

Figure 3-2 illustrates the relationship between system voltage and motor voltage.

In most northwest industrial facilities the nominal in-plant voltage is 480V. Delta type electrical systems always refer to "line to line" voltage values. "Wye" type electrical systems refer to "line to line" and "line to neutral" voltage values. One will frequently see a voltage described as 277/480. This means that the voltage from the line-to-neutral is 277V and the voltage from line-to-line is 480V.³⁻¹

Usual **utilization voltage conditions**, defined in the National Electrical Manufacturers Association (NEMA) Standards Publication MG 1-1993, Rev. 1, *Motors and Generators*, include operation within a tolerance of ± 10 percent of a motor's rated voltage.³⁻²

The custom by NEMA members is to rate motors at 95.8 percent of nominal system voltage. For example, motors intended for use on 480V systems are rated at 460V ($95.8\% \times 480V$) and motors intended for use on 240V systems are rated at 230V ($95.8\% \times 240V$). Motors can be allowed to operate

Table 3-1
Acceptable System Voltage Ranges

Nominal System Voltage	Allowable Limits %	Allowable Voltage Range
120V (L - N)	$\pm 5\%$	114V - 126V
240V (L - L)	$\pm 5\%$	228V - 252V
480V (L - L)	$\pm 5\%$	456V - 504V

on voltages as low as 95.6 percent of their specified voltage rating. Thus, a motor rated at 460V can operate at 440V ($460V \times 0.956$). As long as the phase-to-phase voltages are balanced, the motor need not be derated.³⁻¹

If the voltage at the motor feeder is increased, the magnetizing current increases. At some point, depending upon design of the motor, saturation of the core iron will increase and overheating will occur. At about 10 to 15 percent over voltage both efficiency and power factor significantly decrease for standard efficiency motors while the full-load slip decreases. The starting current, locked rotor torque, and break-down torque all significantly increase with over voltage conditions.

If a motor is operated under voltage, even within the allowable ten percent limit, the motor will draw increased current to produce the torque requirements imposed by the load. This causes an increase in both stator and rotor I²R losses, and overheating at full-load or service factor

operation. Low voltages can also prevent the motor from developing an adequate starting torque.³⁻²

Voltage Unbalance

A voltage unbalance occurs when there are unequal voltages on the lines to a polyphase induction motor. This unbalance in phase voltages causes the line currents to be out of balance. The unbalanced currents cause torque pulsations, vibrations, increased mechanical stress on the motor, and overheating of one and possibly two of the phase windings. Voltage unbalance has a detrimental effect on motors. Motor efficiency suffers when motors are subjected to significant voltage unbalances. When efficiency falls, energy drawn by the motor dissipates as heat in the core and in the windings. Useful torque at the shaft is reduced.

Ultimately, the motor can fail from insulation breakdown. Figure 3-3 is a derating curve published by NEMA. The amount of derating for a motor is described by the curve as a function of voltage unbalance.

Figure 3-2
Acceptable Voltage Range for Systems and Motors

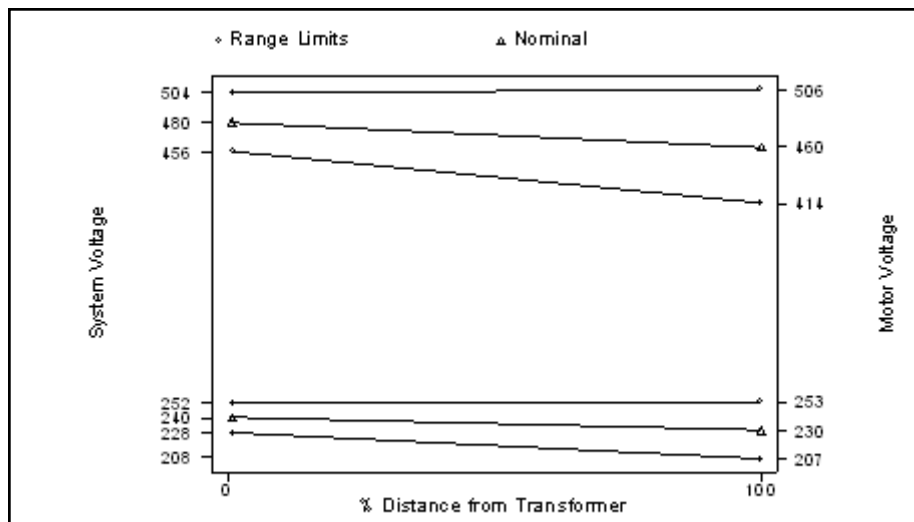
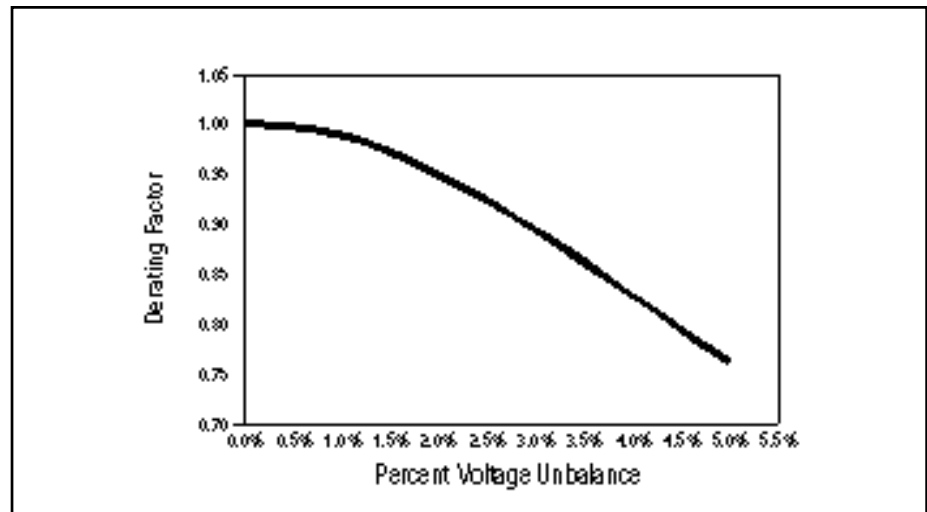

Figure 3-3
Motor Voltage Unbalance Derating Curve



Unbalance of more than one percent requires that a motor be derated and may void a manufacturer's warranty. **NEMA recommends against the use of motors where the unbalance is greater than five percent.**^{3-1, 3-2, 3-3}

NEMA defines voltage unbalance as 100 times the maximum deviation of the line voltage from the average voltage on a three-phase system, divided by the average voltage (see example below). Most utilities attempt to control the service voltage unbalance to less than two percent.

Example 3-1
Determining Voltage Unbalance

Voltage unbalance is defined by NEMA as 100 times the maximum deviation of the utilization voltage from the average voltage on a three-phase system divided by the average voltage.

$$\text{Unbal} = 100 \times \frac{|V_{\text{maxdev}} - V|}{V}$$

Where:

- Unbal = Voltage unbalance in %
- V_{maxdev} = Line to line phase voltage deviating most from mean of 3 phases
- V = RMS voltage, mean line to line of 3 phases

For example, if the measured line-to-line voltages are 462, 463, and 455 volts, the average is 460 volts. The voltage unbalance is:

$$(460-455)/460 \times 100\%=1.1\%$$

With a well-designed electrical distribution system in the plant, the amount of unbalance at the load and motor control centers should be about the same as the degree of unbalance at the service entrance. When the unbalance is significantly different at the load centers, there is a phase voltage drop problem between the service entrance panel and the load centers. The unbalancing problems must be found within the plant and corrected prior to recording motor data.^{3-1, 3-3}

A utility attempts to load individual phases in a balanced fashion through the process of alternating single phase loads and other similar practices. An industrial user must also exert an effort to balance loads. Analytical techniques for balancing loads are straightforward and are discussed in the Troubleshooting and Tuning Your In-Plant Distribution System section of this chapter.

A qualified person should take utilization voltage measurements at each motor control center or principal motor feeder. **When a utilization voltage unbalance is in excess of one percent, the system can benefit from voltage correction.** The effect of unbalance not only distorts potential energy savings, but it may cause irreparable damage to equipment.^{3-1, 3-3}

Troubleshooting and Tuning your In-Plant Distribution System

Maintenance of in-plant electrical distribution systems is often neglected, with increased costs ultimately being paid in the forms of decreased safety (due to increased fire hazard), decreased motor life, increases in unsched-

uled downtime, and lost productivity.

See the Bonneville Power Administration publication, *Keeping the Spark in Your Electrical System: An Industrial Electrical Distribution System Guidebook*, for additional information.

You can improve efficiency through eliminating common problems such as poor contacts, voltage unbalance, over and under voltage, low power factor, undersized conductors, and insulation leakage.^{3-4, 3-5} You should troubleshoot and correct the in-plant distribution system before taking field data measurements.

Begin the electrical distribution system tune-up with a search for and correction of poor contacts, since these are most likely to result in a catastrophic system failure and possibly a fire. Correction of poor power factor is the next step, since this is generally the source of the greatest utility cost savings. The system should then be examined for voltage unbalance and over/under voltage conditions due to their detrimental effect on motor performance and motor life. Finally, survey for insulation leakage and undersized conductors.³⁻⁴

Troubleshooting Poor Contacts

The first step in optimizing your industrial electrical distribution system is to detect and correct any problems due to poor connections. High temperatures are commonly caused by loose and dirty contacts. Such contacts are found in switches, circuit breakers, fuse clips, and terminations. These problems are the most cost effective to correct. Poor contacts can be caused by:³⁻⁴

Safety Considerations

This guidebook discusses the type of measurements the electrician must take. The guidebook is not meant to instruct a person on how to be an electrician, nor is it meant to train a person in proper safety techniques. The guidebook assumes instructions will be followed by qualified electricians who are trained in safety practices regarding industrial electrical systems. Persons who are not properly qualified in industrial electrical techniques should not attempt to take any measurements.

- Loose cable terminals and bus bar connections.
- Corroded terminals and connections.
- Poor crimps or bad solder joints.
- Loose, pitted, worn, or poorly adjusted contacts in motor controllers or circuit breakers.
- Loose, dirty, or corroded fuse clips or manual disconnect switches.

Detection should begin with either infrared thermography or a voltage drop survey of the power panels and motor control centers. Advantages of a voltage drop survey are that the survey can be done in-house with existing equipment and that problems can often be detected before they would be with infrared thermography. Voltage drop measurements should be taken at a time when the plant is heavily loaded.³⁻⁴

During the voltage drop or infrared survey, the electrician can visually inspect suspected trouble areas for:³⁻⁴

- Discoloration of insulation or contacts.
- Compromised insulation ranging from small cracks to bare conductors.
- Oxidation of conductor metals.
- Presence of contaminants such as dirt.
- Mismatched cables in common circuits.
- Aluminum cables connected to lugs marked for copper wire.

Voltage Drop Survey

A voltage drop survey can be done with a simple hand-held millivolt-meter. You can use a two-stage process to quickly identify problems without indi-

vidually testing each component. Use extreme caution and wear lineman's gloves. Voltage drop measurements are taken first from the main distribution panel to the motor control center, then from the motor control center to the motor leads. An example for a typical motor circuit is to measure the voltage drop from the bus bar to the load side of the motor starter.³⁻⁴



Comparing the magnitude of voltage drop with other phases supplying the load can alert the electrician to poor connections. The electrician can make component-by-component voltage drop measurements on suspect circuits to isolate and eliminate poor connections.³⁻⁴

Infrared Thermography

Infrared thermography is a quick and reliable method for identifying and measuring temperatures of components operating at unreasonably elevated temperatures. ***High temperatures are a strong indication of both energy wastage and pending failure.*** High resistance connections are self aggravating since they generate high temperatures which further reduce component conductivity and increase the operating temperature.³⁻⁴

Once the infrared survey is complete, the plant electrician can focus on the located hot spots. A millivolt meter or milliohmmeter is recommended for measuring the voltage drop and resistance, respectively, across high temperature connections and connections not shown on the thermographs. These measurements can be used to determine if the hot spot indicated in the infrared image is due to a problem with the component itself or if heat is being radiated from an adjacent source.³⁻⁴

Troubleshooting Voltage Unbalance

Further efforts to optimize your electrical distribution system should include a survey of loads to detect and correct voltage unbalances. *Unbalances in excess of one percent should be corrected as soon as possible.* A voltage unbalance of less than one percent is satisfactory.

Figure 3-4 displays motor loss increases caused by voltage unbalance. Left uncorrected, the increased losses require motor derating per Figure 3-3. The following causes of voltage unbalance can be detected by sampling the voltage balance at a few locations:³⁻⁴

- Selection of wrong taps on the distribution transformer.
- Presence of a large, single-phase distribution transformer on a polyphase system, whether it is under load or not.
- Asymmetrical (unbalanced) transformer windings delivering different voltages.
- Faulty operation of automatic equipment for power factor correction.
- Unbalanced three-phase loads (such as lighting or welding).
- Single-phase loads unevenly distributed on a polyphase system, or a large single-phase load connected to two conductors on a three-phase system.
- Well-intentioned changes, such as improvements in the efficiency of single-phase lighting loads, which inadvertently bring a previously balanced polyphase supply into unbalance (possibly wasting more energy than was saved).

- Highly reactive single-phase loads such as welders.
- Irregular on/off cycles of large loads such as arc furnaces or major banks of lights.
- Unbalanced or unstable polyphase supply from the grid.

The following problems may be more critical in nature, resulting in two-phase operation³⁻⁴:

- An open phase on the primary side of a three-phase transformer in the distribution system.
- Single phase-to-ground faults.
- Failure or disconnection of one transformer in a three-phase delta-connected bank.
- Faults, usually to ground, in the power transformer.
- A blown fuse or other open circuit on one or two phases of a three-phase bank of power-factor correction capacitors.
- Certain kinds of single-phase failures in adjustable frequency drives and other motor controls.

Figure 3-4
Effects of Voltage Unbalance on Motor Losses

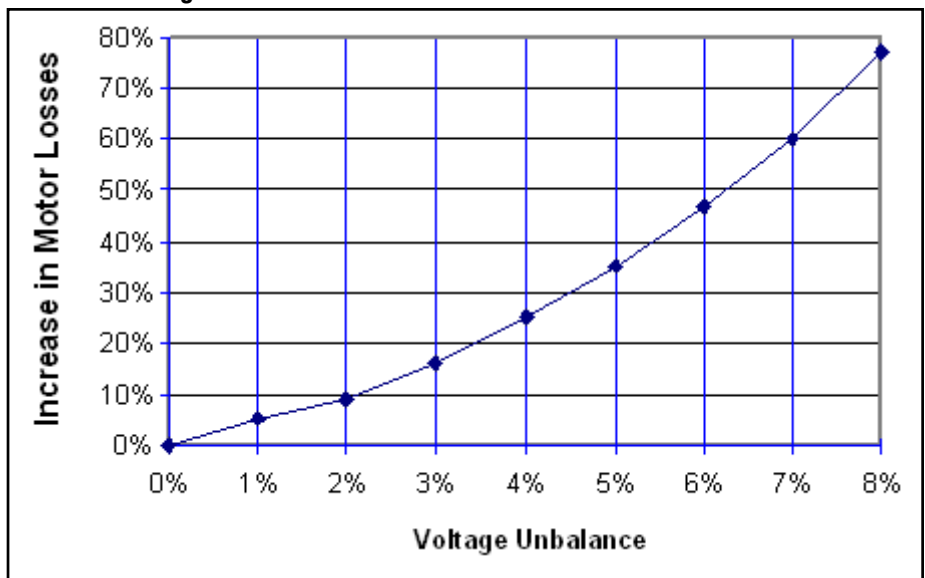

The following problems can be isolated to a particular circuit and may require a load-by-load survey to detect:

- Unequal impedances in power-supply conductors, capacitors, or distribution wiring.
- Certain kinds of motor defects.

Constant loads can be checked by measuring voltage-to-ground on each phase with a hand-held voltmeter. Highly variable loads may require simultaneous measurement of all three phases with monitoring over time. Monitoring instruments can periodically measure and record the voltage, current, power factor, and total harmonic distortion on each phase.

Proper system balancing can be maintained by:^{3,4}

- Checking that unloaded transformer voltage balance does not exceed a minimum 1.25 percent step per tap.
- Checking and verifying electrical system single-line diagrams to ensure that single-phase loads are evenly distributed.
- Regularly monitoring voltages on all phases to verify that a minimal unbalance exists.
- Installing ground fault indicators.
- Conducting annual infrared thermographic inspections.
- Installing sensitive phase voltage monitors.

Before making changes to your distribution system, consider the impact on the resulting phase-to-phase balance.

Troubleshooting Over and Under Voltage

Over or under voltage conditions can result from:^{3,4}

- Incorrect selection of motors for the rated voltage. Examples include a 230 volt motor on a 208 volt circuit.
- Incorrect transformer tap settings.
- Unequal branch line losses resulting in dissimilar voltage drops within the system. Often a panel will be supplied with a slight over voltage in the hope of supplying the correct voltage to the motor control centers (MCCs). However, voltage drop differences can result in an over voltage at some MCCs while others are under voltage.

A common situation involving under voltage occurs in application of 208-230 volt motors on 208 volt systems. Commercial buildings frequently use 208 volt three-phase power. It is the three phase line-to-line voltage corresponding to 120 volts line-to-neutral provided for single phase lights and receptacles. There is no change in motor wiring connection for the two voltages. While 208-230 volt motors tolerate 208 volts, they are optimized for the more common 230 volts.

208 volts is a nominal system voltage; voltage at the motor terminals may even be lower. Additional losses occur when a 208-230 volt motor is operated at or below 208 volts. The motor will exhibit a lower full-load efficiency, run hotter, slip more, produce less torque, and may have a shorter life. It is best to supply 200 volt motors for use on a 208 volt system, especially if voltage at the motor terminals sometimes falls below 208 volts.

Until 200 volt motors can be provided, it is recommended that system voltage be tapped at the high end of the acceptable range for single phase loads and that distribution losses are minimized.

System voltage can be modified by:

- Adjusting the transformer tap settings.
- Installing automatic tap-changing equipment where system loads vary greatly through the course of the day.
- Installing power factor correction capacitors that raise the system voltage while correcting for power factor.

Troubleshooting Low Power Factor

Analysis of utility bills will usually reveal if you have a power factor problem. Even if the utility does not bill directly for power factor, a low power factor can raise your kWh and demand billing. This is because of real power wasted in excess transformer and line losses associated with the flow of reactive power. Correcting power factor will reduce the line current and the associated I^2R losses in the entire distribution system. A comprehensive discussion of power factor including detecting and correcting low power factor is presented in Chapter 8.

Troubleshooting Undersized Conductors

As plants expand, conductors sized for the original load are often undersized for the new loads they are required to carry. *Undersized conductors present an additional resistive load on the circuit, similar to a poor connection.* The cost of replacing or supplementing these conductors is often prohibitive from the

standpoint of energy cost savings. However, the cost may be substantially less when done during expansion or retrofit projects.³⁻⁴

Troubleshooting Insulation Leakage

Electrical insulation leakage can occur as a result of extreme temperature, abrasion, moisture or chemical contamination, and age.

Resistance is approximately halved for every 10°C temperature increase. Abrasion occurs due to vibration or movement under magnetic forces such as occurs with poorly secured end turns in a motor's winding. Some of the worst chemical contamination is that associated with electroconductive particles like salt or coal dust. Moisture often intrudes when a motor has long enough off time to completely cool and is in an environment with high relative humidity. Even without such harsh threats, insulation testing and trending, at least annually, is advisable.

Insulation leakage can only be detected by use of a megohmmeter. It is possible to perform testing at the motor control panel so that cables are tested as well as the motor. Cables are not usually a source of significant leakage unless they are very old and contaminated, but they provide easy electrical access to the motor from the motor control system. Information on performing insulation testing is provided in Chapter 9.

References

Chapter 3

-
- 3-1 Carroll, Hatch & Associates, Inc., “An Electric Motor Energy Efficiency Guide and Technical Reference Manual”, (Draft) June 1994, Bonneville Power Administration, Revision 4, April 1995 (Draft)
- 3-2 Gilbert A. McCoy and John G. Douglass, “Energy Efficient Electric Motor Selection Handbook,” U.S. Department of Energy, DOE/GO-10096-290, August 1996
- 3-3 Carroll, Hatch & Associates, Inc., “A Procedure for Developing an Energy Efficiency Plan for the Use of Electric Motors in an Industrial Setting,” (Draft) June 1994
- 3-4 “Electrical Distribution System Tune-Up,” Electric Ideas Clearinghouse Technology Update, Bonneville Power Administration, January 1995
- 3-5 Rob Gray, Washington State Energy Office, “Keeping the Spark in Your Electrical System: An Industrial Electrical Distribution Maintenance Guidebook,” Funded by Bonneville Power Administration, U.S. Department of Energy, PacifiCorp, Portland General Electric and Tacoma City Light, October 1995
- 3-6 Albert Thumann, P.E., “Introduction to Efficient Electrical Systems Design,” The Fairmont Press, Inc., GA, 1991.

Chapter 4

Taking Field Measurements

Field evaluation of motors is essential in making informed decisions regarding motor selection and use. The amount of money you can save by purchasing an energy efficient over a standard motor depends upon motor size, annual hours of use, load factor, efficiency gain (at the load point), and the serving utility's charges for electrical energy and demand.⁴¹ Field measurements are necessary to establish the load imposed upon an existing motor by its driven equipment and to determine motor efficiency at its load point.

Safety Considerations



Safety is an important consideration when using test instruments. Plant electricians and equipment operators are hopefully well trained in safety and guided by company policies for working close to live circuits and moving machinery. This guidebook will occasionally recommend caution in making certain measurements. This is not intended to be a replacement for thorough safety training and adherence to company policies.

The absence of a caution statement certainly does not mean an action is inherently safe. Company policies vary depending upon plant environment, insurance requirements, government regulations, and management's commitment to safety. Any action described in this book which

conflicts with your company safety procedures, conflicts with your safety training, creates exposure beyond your normal workday experience, or simply seems unsafe, should be omitted!

Particular caution is recommended when working with current- or power-recording devices. Many of these are either assembled from components or designed with the expectation that they will be connected when circuits are unpowered, then left alone after they are powered. Some have alligator clips that require fingers to be close to conductors or are hard to connect when wearing line worker's gloves. Some (particularly multi-channel devices intended for research-oriented monitoring) have wiring panels that do not separate 480 volt terminal areas from low voltage sensor wires. Others have metal enclosures that require grounding which is sometimes challenging in portable applications. Some have enclosures which may not be sufficient for the environmental exposure they will experience while deployed. Use of any recording device may require that control panel doors be left open, exposing personnel to danger unless you mark the area with ribbon and signs. Regrettably, most voltage leads are unfused. If possible, leads should be fused, ideally at the clip end. Fuses should be fast-blow and 1/4 amp or less. Even 1/4 amp can be fatal or cause permanent neurological damage if sustained for several seconds.



This guidebook assumes instructions will be followed by qualified electricians. Persons who are not properly qualified in industrial electrical techniques should not attempt to take any measurements.

Constructing the Motor List and Inventory Database

The energy coordinator should prepare a strategy for surveying and analyzing plant motors. Divide the plant into logical areas and make a list of motors to be reviewed. Motors which are significant energy users should head the list. Motors that operate for extended periods of time and larger motors should also be on the list. Conversely, small motors that run intermittently should be placed toward the end of the list.

^{4-2, 4-3}

Depending upon size of the plant and complexity of the manufacturing process, it may be appropriate to list only motors which exceed minimum size and operating duration criteria. Each plant will have to establish appropriate thresholds. Typical selection criteria include:

- Three phase, NEMA Design B motors
- 10 to 600 hp
- At least 2,000 hours per year of operation
- Constant load (not intermittent, cyclic or fluctuating)
- Older and/or rewind standard efficiency motors
- Easy access
- A readable nameplate
- Non-specialty motors

Once you have a short list of motors, you can collect data on each motor and use the *Motor-Master+* software to determine the benefits of replacing it with an energy-efficient unit. (*MotorMaster+* is discussed in detail in

Chapter 7.) Create an inventory database with a file for each motor. Appendix A contains a *Motor Nameplate and Field Test Data Form*, while Appendix C provides a *Motor Energy Savings Calculation Form*. Examine replacement alternatives and develop a contingent plan of action. Then when a motor fails, you can quickly implement the preferred repair or replacement plan. ^{4-2, 4-3} Include the following information in your inventory database:

- Individual motor identification and nameplate data
- Full load efficiency, speed, and amperage
- Operating motor voltage, amperage, and power factor
- Speed of motor and driven equipment while under load
- Annual hours of operation
- Accurate motor load (in kW)
- Motor efficiency at its operating point
- Action to be taken at failure, i.e., repair or replacement specifications

Acquiring Motor Nameplate Data

Motor analysis requires that information from the motor nameplate be entered into your inventory database. A typical motor nameplate, indicated in Figure 4-1, contains both descriptive and performance-based data such as full-load efficiency, power factor, amperage, and operating speed. You can use this information to determine the load imposed upon the motor by its driven equipment and the motor efficiency at its load point.

Depending upon the motor age and manufacturer practices, not all of the desired information appears on every motor nameplate. It is not unusual for power factor and efficiency to be missing. When data is not present, you must find the required data elsewhere. The motor manufacturer is a logical source.^{4,2, 4,3}

The motor age in years and its rewind history should also be recorded. Obtain this data from company records or from the recollection of people who have worked at the plant and can recall motor histories. Identify the coupling type, describe the motor load (device being driven), identify load modulation devices such as throttling valves or inlet dampers, and record the driven-equipment speed. Lists of load and coupling types are contained in Tables 4-1 and 4-2.

Load-Time Profiles

The energy coordinator needs to determine the hours per year each motor operates. Annual operating hours can be estimated by constructing a motor operating profile. Such a profile, included in Appendix A—*Motor Nameplate and Field Test Data Form*, requires you to provide input regarding motor use on various shifts during work days, normal weekends, and holidays.

The nature of the load being served by the motor is also important. Motors coupled to variable speed drives and operating with low load factors or that serve intermittent, cyclic, or randomly acting loads are not cost-effective candidates for replacement with energy efficient units.

Figure 4-1
Motor Nameplate

INDUCTION MOTOR			
MODEL: 5K254AK205		SERIAL NO.: 1105842	
HP 15	SERVICE FACTOR 1.15	TIME RATING CONT	
FL RPM 1775	ENCLOSURE ODP		
VOLTS 230/460	CYCLES 60	PHASE 3	
FL AMPS 38.6/19.3	FULL-LOAD POWER FACTOR 87.2%		
TYPE K	FRAME 254T	NEMA CLASS DESIGN B	CODE G
INSULATION CLASS B		MAXIMUM AMBIENT 40° C	
DRIVE END AFBMA BRG 45B003		OPP DIVE END AFBMA BRG 35B002	
Full-load Efficiency: 91.7%			
WHEN ORDERING RENEWAL PARTS, GIVE MOTOR MODEL NUMBER			
NAME OF MANUFACTURER			

**Table 4-1
Typical Motor Load Types**

Load List
Centrifugal Fan
Centrifugal Pump
Compressor—screw compressor, reciprocating compressor, centrifugal compressor
Extruder
Conveyer
Crushers/Milling
Blenders/Mixers
Grinder
Machine Tools (Lathes, Sanders)
Crane
Planer
Positive Displacement Pump
ASD ¹ /Centrifugal Fan
ASD ¹ /Centrifugal Pump
ASD ¹ /Compressor
Other
¹ Adjustable speed drive

Table 4-2

Coupling Types
Direct Shaft
Worm Gear
Helical Gear
Bevel Gear
Roller Chains
Silent Chains
V-Belts
Synchronous Belts
Flat Belts
Other

Measuring Operating Values

In a three-phase power system it is necessary to measure the following at each motor:

- phase-to-phase voltage between all three phases,
- current values for all three phases,
- power factor in all three phases, and
- operating speed of motor and driven load.

Equipment necessary for these measurements include:

- voltmeter or multimeter
- clamp-on ammeter
- power factor meter
- tachometer

Meters should be of adequate quality to read true RMS values. This guidebook proceeds on the basis that adequate quality meters are being used by the electrician.

When the motor operates at a constant load, only one set of measurements is necessary.

When the motor operates at two or three distinct load points, measurements are required at each load because the current and power factor values vary with changes in load level. The electrician can then determine the weighted average motor load.

A motor that drives a random-acting load presents a difficult measurement problem. The electrician should take a number of measurements and estimate the current and power factor that best represent the varying load. These values are used with the voltage to determine the typical power required by the load.^{4-1,4-3}

Motor and driven-equipment speeds must be measured as closely as possible, ideally with a strobe tachometer. Motor speed is important because a replacement motor should duplicate the existing motor speed. When driving centrifugal loads (fans and pumps), the motor load is highly sensitive to operating speed. An energy efficient motor usually operates at a slightly higher speed than a standard motor. The higher speed may result in an increase in speed-sensitive loads; this can negate savings due to improved motor efficiency. A speed comparison is necessary to properly evaluate an energy-efficient motor conservation opportunity.^{4-1,4-3}

Enter field measurement values for each motor on the *Motor Nameplate and Field Test Data Form* (Appendix A).

Data Gathering Approaches

A diagram of a typical three-phase power system serving a “delta” motor load configuration is shown in Figure 4-2. To evaluate the motor operation, you need to collect nameplate data plus use a multimeter and analog power factor meter to record voltage, amperage, and power factor on each service phase or leg. Take readings on all three legs and average them. Figure 4-3 indicates how measurements are taken with hand-held instruments. It is also useful to use a strobe tachometer to measure the speed of both the motor and the driven equipment.

Sensitivity of Motor Load to Operating Speed

For centrifugal loads such as fans or pumps, even a minor change in a motor’s full-load speed translates into a significant change in load and annual energy consumption. Fan or “affinity” laws indicate that the horsepower loading imposed on a motor by centrifugal load varies as the third power or cube of its rotational speed. In contrast, the quantity of air flow or water delivered varies linearly with speed.

Some energy-efficient motors tend to operate with reduced “slip” or at a slightly higher speed than their standard-efficiency counterparts. This small difference - an average of only 5 to 10 RPM for 1800-RPM synchronous speed motors - is significant. A seemingly-minor 20 RPM increase in a motor’s full-load rotational speed from 1740 to 1760 RPM can result in a 3.5 percent increase in the load placed upon the motor by the rotating equipment. A 40 RPM increase can boost energy consumption by seven percent, completely offsetting the energy and dollar savings typically expected from purchase of an energy efficient motor.⁴⁻¹

To maximize energy savings with cube law loads, be sure to select an energy-efficient replacement motor that has a full-load operating speed that is the same or less than that of your original motor. With belt driven equipment, motor speed is not important if you replace pulleys so that the original rotating equipment speed is maintained.

Figure 4-2
Industrial Three-Phase Circuit

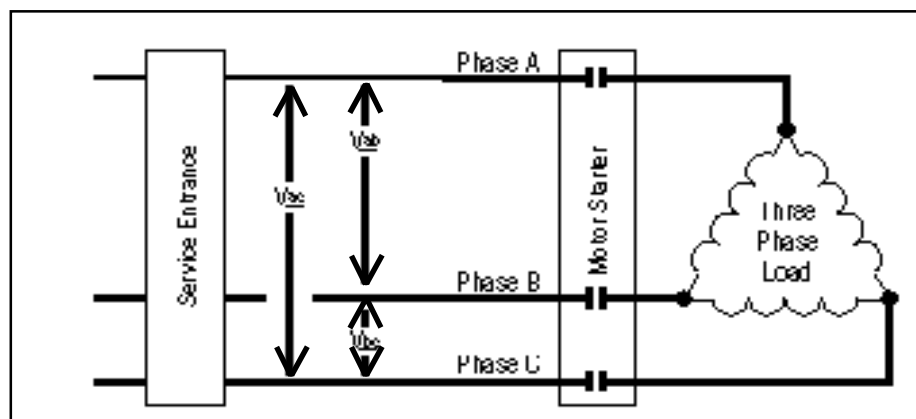
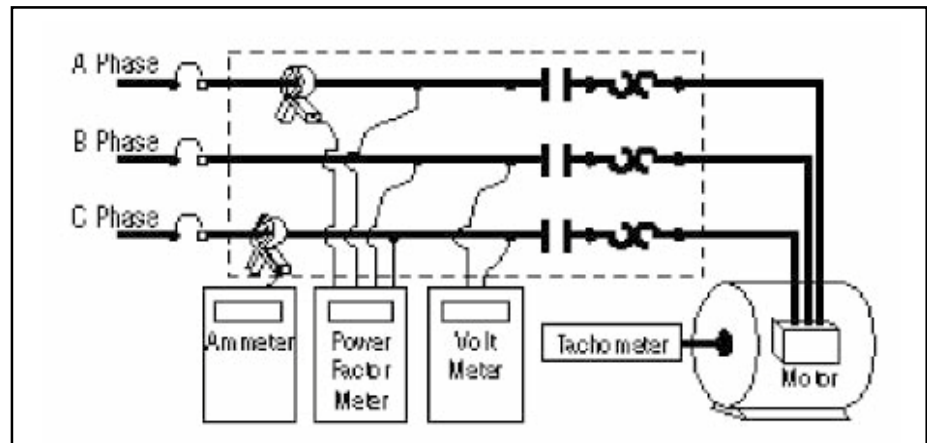

Figure 4-3
Instrument Connection Locations



Power supplied to the motor can be measured with a single instrument when a “direct reading” meter is available. The direct reading meter uses current transformers and voltage leads to reliably sense and display power in watts or kW. Direct reading instruments are more costly than typical multimeters. Until recently, it was not common for direct reading meters to be found in industrial plants. This situation is improving with the availability of digital direct-reading power meters.^{4-2, 4-3}

Safety Issues in Data Gathering

- Hand-held instruments are not recommended for sensing voltage levels above 600 volts.
- Line-worker’s gloves should be used.
- The unconnected leads of some current transducers (CTs) can inflict a dangerous electrical shock. This is of significance when connecting a CT to a *separate* readout or recording device. The wound or conventional CTs have either a voltage or current output. The safer (voltage output) type is an internally-loaded current transformer,

meaning it has an internal precision shunt resistor shorting the secondary; the output leads are connected across the internal shunt so a low voltage output is provided. The current output type is merely an unloaded transformer, so the output is a current, requiring a current-sensing device. Always connect a current output CT to the recording device *before* closing it around a live conductor. Otherwise, dangerously high voltage will appear across the open leads.

Voltage Measurements

Utilization Voltage

Utilization voltage should be checked first. A convenient place to take measurements is at a motor starter enclosure. A hand-held voltmeter or multimeter can be used to measure the phase-to-phase voltages. In a three-phase system the electrician should measure three values, V_{ab} , V_{bc} and V_{ca} (See Figure 4-3.) For a 480 volt system, utilization and service voltage levels should be within the range of 456V to 504V ($480V \pm 5\%$).

The voltage unbalance should be calculated. The utilization voltage unbalance should not be greater than one percent. **System voltage unbalance and over and under voltage problems need to be corrected before valid motor analyses can take place.** A system voltage unbalance exceeding one percent aggravates motor performance to the extent that recorded data may be meaningless.

Service Voltage

When the utilization voltage unbalance is greater than one percent, the electrician must check the voltage values at the service entrance. Measurements should be made at or as close to the service entrance as possible. This set of measurements allows the electrician to determine voltage balance as delivered by the utility. If the service voltage unbalance is less than one percent, the utilization unbalance problem is within the plant distribution system. It is then the electrician's responsibility to find and fix the problem.^{4,3}

Service voltage unbalance greater than one percent should be brought to the attention of the local electric utility for correction. Data acquisition techniques discussed in this guidebook are intended for the secondary side of in-plant distribution system power transformers. Hand-held instruments are not recommended for sensing voltage levels above 600 volts.^{4,2, 4,3}

Current Measurements



A hand-held ammeter with a clamp-on CT (current transducer) is convenient and effective for measuring the line current. It is only necessary to enclose the conductor within the clamp-on device. The current may be read directly from the meter. Current readings, designated I_a , I_b , and I_c , should be taken for each phase. Line-worker's gloves should be used.

Power Factor Measurements

Power factor should be measured with a power factor meter. Measure phase power factor by clamping the current sensing element on one phase while attaching voltage leads to the other phases. Take care that the proper voltage lead is used with the current sensing device.

An alternative to power factor measurement is power measurement. Some instruments can measure both. With either power or power factor known, the other can be calculated (see Chapter 5, Equation 5-1)

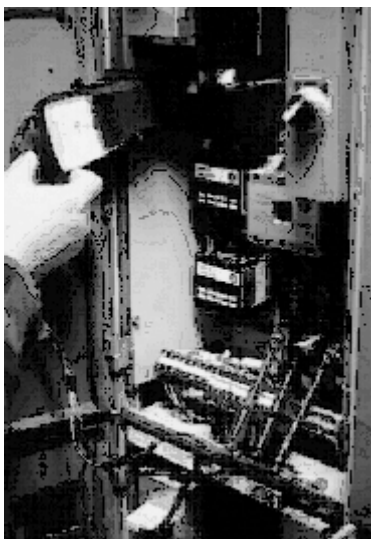

Before a valid motor energy savings analysis can take place, you need to correct system voltage unbalance and under voltage problems.

Purchasing Motor Testing Instruments

When shopping for electrical testing instruments, one can easily be overwhelmed by the variety of choices and wide range of prices. Three things tend to affect the price: harmonics handling capability, range, and features. To be a smart shopper requires knowledge of your plant environment.

Most manufacturers are well represented in industrial catalogs that market “instruments”. Many manufacturers also use an extensive chain of independent “local reps”. It is good to get connected with a local representative. A good local rep can usually supply extensive manufacturer’s information about a product and may also represent competing products for comparison. Ideally, they will have a good understanding of the advantages and disadvantages of each product.

1. Voltage Meters



Hand held multimeters usually are used for measuring AC and DC voltage, current, and resistance.

The upper voltage range should not exceed 600 volts. No attempt should be made to measure higher voltages with hand held instruments.

Multimeters are used mainly as voltmeters in an industrial plant. The resistance scales generally do not go low enough for measuring motor winding resistance, and at

the high resistance scales they have insufficient source voltage for measuring insulation resistance. The ampere scales are not directly useful for measuring motor current, but many product lines accommodate a clamp-on AC current transducer as an accessory. Some manufacturers even have clamp-on accessories that can be used in conjunction with the voltage leads for measuring power and or power factor.

2. Current Meters

Clamp-on ammeters are about as commonplace as multimeters. Two kinds are in common use. One is a clamp-on current transducer that feeds an output signal to a separate multi-meter for reading on the milliamp or milivolt scale.



The other is a self-contained direct clamp-on device. With the latter, reading the instrument may be a challenge because it sometimes must be thrust deep into a box and oriented at an inconvenient angle to access a conductor. Many instruments accommodate this problem with a pivoting display or a hold switch that can lock the display for reading after the instrument is removed from the conductor. This is an important feature.

Clamp-on current meters sense current in one of two alternative ways, either by a simple current transformer or a Hall-effect

sensor. The latter are less common and more expensive. Both have operable iron jaws that clamp around the conductor, forming an iron ring in which magnetic flux is induced by the conductor current. The current transformer type has a simple multi-turn winding around the ring to inductively sense the changing flux. The Hall-effect type has no winding, but a narrow gap in the iron ring in which a sensor is placed. The advantage of the Hall-effect sensor is its frequency range. It works for DC and very low frequencies as well as responding better to higher frequencies. Current and power meters intended for use on either side of variable frequency drives often use Hall-effect current sensors to handle the severe harmonics and sometimes low fundamental frequencies.



The unconnected leads of some CTs can inflict a dangerous electrical shock. This is of significance when connecting a CT to a *separate* readout or recording device. The wound or conventional current transducers (CTs) have either a voltage or current output. The safer (voltage output) type is an internally-loaded current transformer, meaning it has an internal precision shunt resistor shorting the secondary; the output leads are connected across the internal shunt so a low voltage output is provided. The current output type is merely an unloaded transformer, so the output is a current, requiring a current-sensing device. Always connect a current output CT to the recording device *before* closing it around a live conductor. Otherwise, dangerously high voltage will appear across the open leads.

Range is particularly important with ammeters or current transducers. These generally do not span the entire range of plant needs without overloading at the high end or providing poor accuracy at the low end. Also, physical size is a limitation. It may be difficult to squeeze large CTs into a small panel. Likewise it may be difficult to reach around large conductors with CTs of lower range, which tend to be smaller. Care must be taken to select the product or products that will span the necessary range. Power monitors that use a lot of CTs because of unbalanced three-phase capability or multi-channel monitoring usually use internally shunted CTs. Often a wide range of relatively inexpensive CTs can be provided and accommodated with a minor scaling change to the recorder's program.

3. Tachometers



There are several types of tachometers. Some require making contact with the rotating machinery while others do not. Avoid the contact type.

The most common type of non-contact tachometer is the strobe tach. Strobe tachs are simply electronic strobe lights with an adjustable strobe rate and a very precise readout in flashes per minute. Battery-powered units are somewhat less common than 120-V plug-in models, but for most users the convenience is definitely worth the extra cost.

Power Quality Considerations

If variable speed drives, induction heaters, or other electronic loads are on the system, voltage harmonics should be expected. Extreme current harmonics are present in circuits feeding these loads. The purchaser should describe this electrical environment to the equipment supplier and determine the capability of alternative devices to accurately measure such “dirty” power.

At the minimum, devices which sense voltage or current must operate on a true RMS principle. Those that do not, will read inaccurately when harmonics are present.

Even knowing an instrument operates on the true RMS principle is not completely sufficient because all are limited by the magnitude and frequency of harmonics they can handle and still read accurately. One index of this capability is the crest factor, which is the ratio of peak value to RMS value of a wave form. A perfect sine wave has a crest value of 1.414. True RMS instruments should have a crest factor of 3.0 or better.

Unfortunately, crest value alone is not a complete descriptor of harmonic content. Harmonics caused by most electronic loads cause the current crest factor to be higher and the voltage crest factor to be lower than sinusoidal. An instrument needs to be capable of measuring accurately across the frequency range of the harmonics. The frequency of harmonics is expressed either in Hz or the order of harmonic. To convert order to frequency, simply multiply by 60. Most high quality electrical testing instruments specify the frequency range over which their accuracy is maintained.

Strobe tachs are very accurate, but subject to certain operator errors which can be reduced with practice. The operator adjusts the strobe rate until the rotating equipment appears to freeze or stop in the light. The rpm of the equipment is hopefully equal to the strobe rate displayed, but it might also be an integer multiple of the displayed strobe rate. Rotating equipment with repeating features (like blades on a fan) can also trick the user. Always watch a single feature, like a shaft keyway, and start at the lowest plausible strobe rate.

Some non-contact tachometers are passive, i.e., they do not require the operator to adjust a strobe rate while watching for motion to freeze. These determine speed by sensing reflected natural light or light from their own source which may be a laser and/or infrared. This can be convenient, but beware of models that require you to stop the machinery and affix a reflector to the rotating part before speed can be read.

4. Power and Power Factor Meters

There are many instruments available which measure power, power factor, or both. Having the ability to directly read power eliminates the need to calculate it as described in chapter 5. The simplest instruments have connections as shown in figure 4-3. Be sure to choose a model with 3-phase capability; many can be switched between 3-phase and single phase.

The one-CT instrument shown in Figure 4-3 can only be accurate with balanced voltage and current. If it is unbalanced, three readings must be taken with the

CT on each phase and the readings averaged. Better results under unbalanced conditions can be obtained using an instrument with three CTs. These tend to be more expensive, especially if they are configured as a multi-function power analyzer.

5. Multi-channel Power Loggers

Probably the most complicated instrument system likely to be used in a plant is a multi-channel power logger. These are available in more than one configuration. In packaged units, there is usually a central module with three voltage leads and a terminal block for two or more trios of CTs. The central module is both a logger and a transducer; it computes power based upon voltage and the current from the CTs and records the power. All loads must be on the same voltage source since there is only one set of voltage leads. CTs are marked by phase, so phase identification markings must be present at each load.

There are numerous variations on the above configuration. Some products consist of a central logger with remote power transducers. Interconnections typically follow voltage, current, or pulse conventions used in industrial Programmable Logic Controller (PLC) systems. Often they can be



equipped with a computer interface, phone modems, or radio transmitters for remote data retrieval.

6. Motor Analyzers



There are a variety of products that are termed motor analyzers. Of special interest are three substantial but portable units which have recently appeared on the market, claiming to compute motor efficiency. These are the Motor Monitor, developed by Vectron for the Energy Corporation of New Zealand, the MAS-1000 of Niagara Instrument Corporation of New York, and Motor-Check, a German product manufactured by Vogelsang & Benning and marketed in the U.S. by the A.H. Holden Company of Minnesota.

All have connections to the motor to sense current, voltage and speed. Speed is sensed magnetically or optically. Certain nameplate information must be entered via keyboard. The devices all require winding resistance, which must be

obtained with the motor shut down; usually the required micro-ohmmeter is built into the tester. All require no-load data which must be obtained with the motor uncoupled and running at idle. Fortunately, none require any sort of torque sensor, because it would be nearly impossible to affix one in many field situations.

Industrial Practices

A survey was conducted regarding the capability of industrial plant personnel to obtain field measurements which are used to predict motor performance.

Surveys were sent to 65 industries in northwest Oregon and southwest Washington. There were 29 responses. Every firm had a voltmeter and an ammeter. Twenty-two responded that their company had a tachometer. Only eight respondents indicated they had the ability to measure power factor. The survey provides a basis for concluding that most companies estimate motor load based solely on speed or current readings.^{4-2, 4-3}

References Chapter 4

-
- 4-1 Gilbert A. McCoy and John G. Douglass
“Energy Efficient Electric Motor Selection
Handbook,” U.S. Department of Energy, DOE/
GO-10096-290, August 1996.
 - 4-2 Carroll, Hatch & Associates, Inc., “An Electric Motor
Energy Efficiency Guide and Technical Reference
Manual”, (Draft) June 1994
 - 4-3 Carroll, Hatch & Associates, Inc., “A Procedure
for Developing an Energy Efficiency Plan for
the Use of Electric Motors in an Industrial
Setting,” (Draft), June 1994

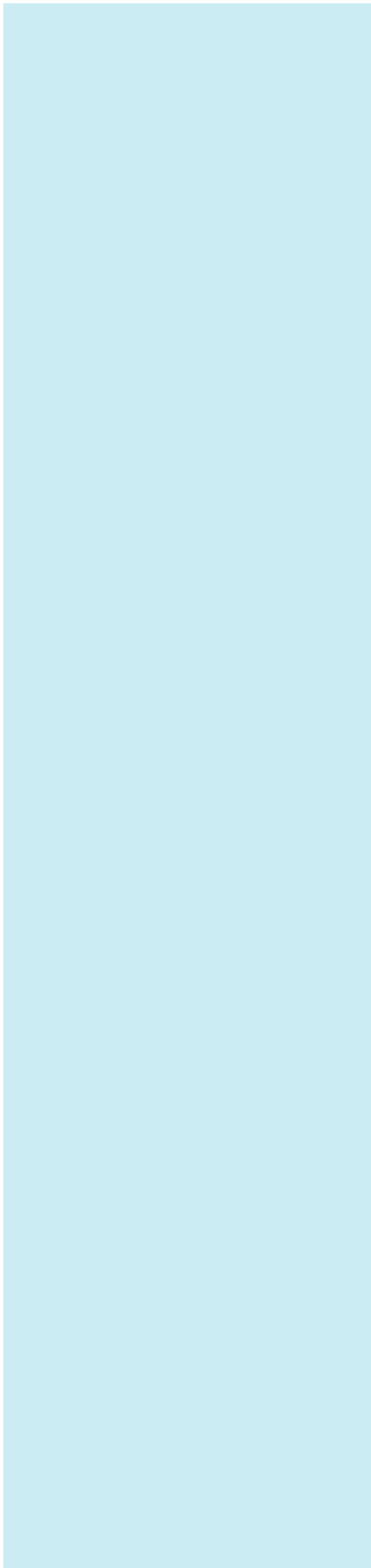

Chapter 5

Motor Load and Efficiency Estimation Techniques

To compare operating costs of an existing motor and a more efficient replacement unit, you need to determine operating hours, efficiency improvement values, and load. Part-load is a term used to describe the actual load served by the motor as compared to the rated full-load capability of the motor. Motor part-loads may be estimated through using input power, amperage, or speed measurements. Several load estimation techniques are briefly discussed.

Input Power Measurements

When “direct-read” power measurements are available, we recommend using them to estimate motor part-load. With measured parameters taken from hand-held instruments, you can use Equation 5-1 to calculate the three-phase input power to the loaded motor.

You can then quantify the motor’s part-load by comparing the measured input power under load to the power required when the motor operates at rated capacity. The relationship is shown in Equation 5-3.

Equation 5-1

$$P_i = \frac{V \times I \times PF \times \sqrt{3}}{1000}$$

Where:

P_i	= Three phase power in kW
V	= RMS voltage, mean line to line of 3 phases
I	= RMS current, mean of 3 phases
PF	= Power factor as a decimal

Equation 5-2

$$P_{ir} = P_{or} \times \frac{0.7457}{e_{fl}}$$

Where:

P_{ir}	= Input power at full rated load in kW
P_{or}	= Nameplate rated horsepower
e_{fl}	= Efficiency at full rated load

Equation 5-3

$$\text{Load} = \frac{P_i}{P_{ir}} \times 100\%$$

Where:

Load	= Output power as a % of rated power
P_i	= Measured three phase power in kW
P_{ir}	= Input power at full rated load in kW

Example 5-1 Input Power Calculation

An existing motor is identified as a 40 hp, 1,800 rpm unit with an open drip-proof enclosure. The motor is 12 years old and has not been rewound.

The electrician makes the following measurements:

Measured Values:

$$\begin{array}{lll} V_{ab} = 467V & I_a = 36 \text{ amps} & PF_a = 0.75 \\ V_{bc} = 473V & I_b = 38 \text{ amps} & PF_b = 0.78 \\ V_{ca} = 469V & I_c = 37 \text{ amps} & PF_c = 0.76 \end{array}$$

$$V = (467 + 473 + 469) / 3 = 469.7 \text{ volts}$$

$$I = (36 + 38 + 37) / 3 = 37 \text{ amps}$$

$$PF = (0.75 + 0.78 + 0.76) / 3 = 0.763$$

Equation 5-1 reveals:

$$P_i = \frac{469.7 \times 37 \times 0.763 \times \sqrt{3}}{1000} = 22.97 \text{ kw}$$

Line Current Measurements

The current load estimation method is recommended when only amperage measurements are available. The amperage draw of a motor varies approximately linearly with respect to load, down to about 50 percent of full load. (See Figure 5-1) Below the 50 percent load point, due to reactive magnetizing current requirements, power factor degrades and the amperage curve becomes increasingly non-linear. In the low load region, current measurements are no longer a

Figure 5-1
Relationships Between Power, Current, Power Factor and Motor Load

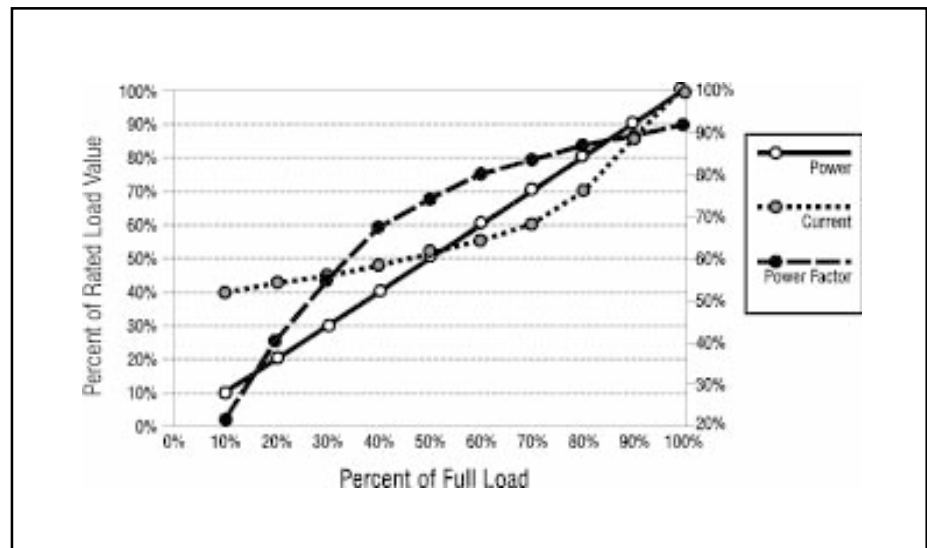

useful indicator of load. Both nameplate full-load and no-load current values apply only at the rated motor voltage. Thus, root mean square current measurements should always be corrected for voltage. If the supply voltage is below that indicated on the motor nameplate, the measured amperage value is correspondingly higher than expected under rated conditions and must be adjusted downwards. The converse holds true if the supply voltage at the motor terminals is above the motor rating. The equation that relates motor load to measured current values is shown in Equation 5-4.

The Slip Method

The slip method is recommended when only motor operating speed measurements are available. The synchronous speed of an induction motor depends on the frequency of the power supply and on the number of poles for which the motor is wound. The higher the frequency, the faster a motor runs. The more poles the motor has, the slower it runs. Table 5-1 indicates typical synchronous speeds.

The actual speed of the motor is less than its synchronous speed with the difference between the synchronous and actual speed referred to as slip. The amount of slip present is proportional to the load imposed upon the motor by the driven equipment. The motor load can be estimated with slip measurements as shown in Equation 5-5 and Example 5-2.

**Table 5-1
Induction Motor Synchronous
Speeds**

Poles	60 Hertz
2	3,600
4	1,800
6	1,200
8	900
10	720
12	600

Equation 5-4

$$\text{Load} = \frac{I}{I_r} \times \frac{V}{V_r} \times 100\%$$

Where:

- Load = Output power as a % of rated power
- I = RMS current, mean of 3 phases
- I_r = Nameplate rated current
- V = RMS voltage, mean line to line of 3 phases
- V_r = Nameplate rated voltage

Equation 5-5

$$\text{Load} = \frac{\text{Slip}}{S_s - S_r} \times 100\%$$

Where:

Load = Output power as a % of rated power

Slip = Synchronous speed - Measured speed in RPM

S_s = Synchronous speed in RPM

S_r = Nameplate full load speed

Example 5-2: Slip Load Calculation

Given: Synchronous speed in RPM = 1,800

Nameplate full load speed = 1,750

Measured speed in RPM = 1,770

Nameplate rated horsepower = 25 HP

Determine actual output horsepower.

From Equation 5-5

$$\text{Load} = \frac{1,800 - 1,770}{1,800 - 1,750} \times 100\% = 60\%$$

Actual output horsepower would be $60\% \times 25\text{HP} = 15\text{HP}$

The speed/slip method of determining motor part-load has been favored due to its simplicity and safety advantages. Most motors are constructed such that the shaft is accessible to a tachometer or a strobe light.

The accuracy of the slip method is, however, limited by multiple factors. The largest uncertainty relates to the 20 percent tolerance that NEMA allows manufacturers in their reporting of nameplate full-load speed.

Given this broad tolerance, manufacturers generally round their reported full-load speed values to some multiple of 5 rpm. While 5 rpm is but a small percent of the full-load speed

and may be thought of as insignificant, the slip method relies on the difference between full-load nameplate and synchronous speeds. Given a 40 rpm “correct” slip, a seemingly minor 5 rpm disparity causes a 12 percent change in calculated load.

Slip also varies inversely with respect to the motor terminal voltage squared—and voltage is subject to a separate NEMA tolerance of ± 10 percent at the motor terminals.⁵⁻⁶ A voltage correction factor can, of course, be inserted into the slip load equation. The revised slip load, can be calculated as shown in Equation 5-6.⁵⁻³

Equation 5-6

$$\text{Load} = \frac{\text{Slip}}{S_s - S_r} \times \frac{V_r}{V^2} \times 100\%$$

Where:

- Load = Output power as a % of rated power
- Slip = Synchronous speed - Measured speed in RPM
- S_s = Synchronous speed in RPM
- S_r = Nameplate full load speed
- V = RMS voltage, mean line to line of 3 phases
- V_r = Nameplate rated voltage

An advantage of using the current-based load estimation technique is that NEMA MG1-12.47 allows a tolerance of only 10 percent when reporting nameplate full-load current. In addition, motor terminal voltages only affect current to the first power, while slip varies with the square of the voltage.⁵⁻⁶

While the voltage-compensated slip method is attractive for its simplicity, its precision should not be overestimated. **The slip method is generally not recommended for determining motor loads in the field.**

Variable Load Levels

When the load is variable, you must determine the average load imposed upon the motor. That can be accomplished through long-term monitoring of the input power. If there are two load levels (for instance a water supply pump motor that operates continuously but against two different static heads), both motor loads can be measured. Determine the weighted average load by timing each motor load period. When many load levels exist, you must monitor loads over a period of time and estimate the weighted average load level.

When loads fluctuate randomly, hand-held instruments provide only a glimpse of the overall load profile. To obtain valid data in random load situations you need to use recording meters with integrating capabilities. Examples of various load types are given in Table 5-2.^{5-2, 5-3}

Table 5-2
Characteristics of Motor Loads

Description of Motor Use	Type of Load
Centrifugal Supply Air Fan Motor	Constant, but will change slightly with outside air temperature.
Conveyor with Continuous and Constant Load	Constant
Boiler Feed Water Pump Motor, "On-Off" Control	Starts/stops. Constant while on.
Hydraulic Power Unit Motor, "On and Bypass" Control	Two levels of different but constant values.
Air Compressor Motor with "Load/Unload" Control	Two levels of different but constant values.
Air Compressor Motor with "Inlet Valve" Control	Random load.

Determining Motor Efficiency

The NEMA definition of energy efficiency is the ratio of its useful power output to its total power input and is usually expressed in percentage as shown in Equation 5-7.

By definition, a motor of a given rated horsepower is expected to deliver that quantity of power in a mechanical form at the motor shaft.^{5-4, 5-5}

Figure 5-2 is a graphical depiction of the process of converting electrical energy to mechanical energy. Motor losses are the difference between the input and output power. Once the motor efficiency has been determined and the input power is known, you can calculate output power.

NEMA design A, B, and E motors up to 500 hp in size are required to have a full-load efficiency value (selected from a table of nominal efficiencies) stamped on the nameplate. Most analyses of motor energy conservation savings assume that the existing motor is operating at its nameplate efficiency. This assumption is reasonable above the 50 percent load point as motor efficiencies generally peak at around 3/4 load with performance at 50 percent load almost identical to that at full-load. Larger horsepower motors exhibit a relatively flat efficiency curve down to 25 percent of full-load.

Equation 5-7

$$e = \frac{0.7457 \times P_{or} \times \text{Load}}{P_i}$$

Where:

- e = Efficiency as operated in %
- P_{or} = Nameplate rated horsepower
- Load = Output power as a % of rated power
- P_i = Three phase power in kW

Figure 5-2
Depiction of Motor Losses

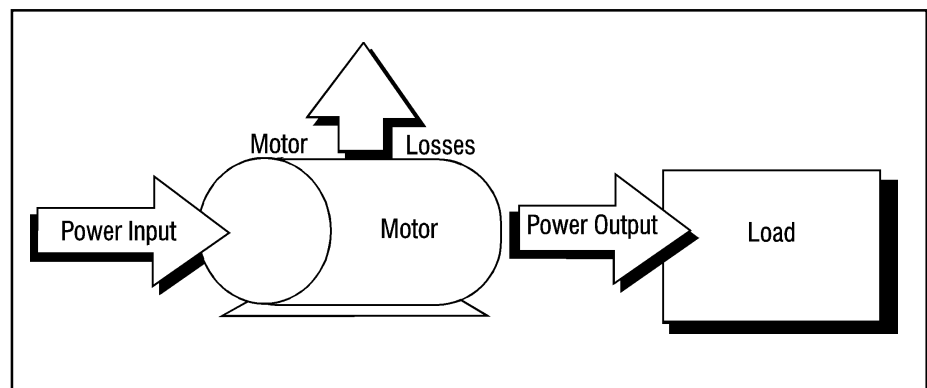

It is more difficult to determine the efficiency of a motor that has been in service a long time. It is not uncommon for the nameplate on the motor to be lost or painted over. In that case, it is almost impossible to locate efficiency information. Also, if the motor has been rewound, there is a probability that the motor efficiency has dropped slightly.

When nameplate efficiency is missing or unreadable, you must determine the efficiency value at the operating load point for the motor. If available, record significant nameplate data and contact the motor manufacturer. With the style, type, and serial number, the manufacturer can identify approximately when the motor was manufactured. Often the manufacturer will have historical records and can supply nominal efficiency values as a function of load for a family of motors.^{5-4, 5-4}

When the manufacturer cannot provide motor efficiency values, you may use estimates from Appendix B. Appendix B contains nominal efficiency values at full, 75, 50, and 25 percent load for typical standard-efficiency motors of various sizes and with synchronous speeds of 900, 1200, 1800, and 3600 rpm. Appendix B is derived from the *MotorMaster+* database and indicates “industry average” full and part-load performance for all standard-efficiency motors currently on the market.⁵⁻⁵

Three steps are used to estimate efficiency and load. First, use power, amperage or slip measurements to identify the load imposed on the operating motor. Second, obtain a motor part-load efficiency value consistent with the approximated load either from the manufacturer or by interpolating from the data supplied in

Appendix B. Finally, derive a revised load estimate using both the power measurement at the motor terminals and the part-load efficiency value as shown in Equation 5-8.

For rewound motors, you should make an adjustment to the efficiency values in Appendix B. Tests of rewound motors show that rewound motor efficiency is less than that of the original motor. To reflect the typical rewind losses, you should generally subtract two points from your standard motor efficiency on smaller motors (<40 hp) and subtract one point for larger motors. **Shops with the best quality-control practices can often rewind with no significant efficiency degradation.**

Equation 5-8

$$\text{Load} = \frac{P_i \times e}{P_{or} \times 0.7457}$$

Where:

- Load = Output power as a % of rated power
- P_i = Three phase power in kW
- e = Efficiency as operated in %
- P_{or} = Nameplate rated horsepower

Computerized Load and Efficiency Estimation Techniques

The Oak Ridge National Laboratory has developed ORMEL96 (Oak Ridge Motor Efficiency and Load, 1996), a computer program which uses an equivalent circuit method to estimate the load and efficiency of an in-service motor. Only nameplate data and a measurement of rotor speed are required to compute both the motor efficiency and load factor. Dynamometer tests have shown that the method produces efficiency estimates that average within ± 3 percentage points of actual. This accuracy is valid for motor loads ranging from 25 to 100 percent of rated capacity.⁵⁻⁷ The program allows the user to enter optional measured data, such as stator resistance, to improve accuracy of the efficiency estimate.

Motor efficiency estimation methods and devices were evaluated at the Motor Systems Resource Facility at Oregon State University in 1997. Efficiencies calculated by three motor analyzers and several algorithms and computer programs were compared to dynamometer determined efficiencies on five motors under numerous operating conditions. The three analyzers and one analytical method performed well. Errors were less than three percent for all motors and less than one percent for newer motors in good condition on a balanced power supply. These methods were also demonstrated in the field but were not embraced because of the labor-intensive necessity to uncouple the motors and perform a no-load run. The analytical method avoids an expensive tester, but still requires a wattmeter with good accuracy at very low power factor.

Recently at least two manufacturers of motor current-signature predictive maintenance analyzers have introduced products that advertise capability for determining efficiency. The manufacturers claim that this is accomplished without necessity for uncoupling. Connecting through existing potential transducers and current transducers allows testing on medium voltage motors.

References Chapter 5

- 5-1 J. D. Kueck, J.R. Gray, R. C. Driver and J. S. Hsu, "Assessment of Available Methods for Evaluating In-Service Motor Efficiency," Oak Ridge National Laboratory, (Draft) January 1996
- 5-2 "MChEff: A Computer Program for In-Service Estimation of Motor Efficiency and Load Using the ORNL Nameplate Equivalent Circuit Method," Oak Ridge National Laboratory; August 1995
- 5-3 Gilbert A. McCoy and John G. Douglass, "Energy Efficient Electric Motor Selection Handbook," U.S. Department of Energy, DOE/GO-10096-290, August 1996.
- 5-4 Carroll, Hatch & Associates, Inc., "An Electric Motor Energy Efficiency Guide and Technical Reference Manual" (Draft) June 1994
- 5-5 Carroll, Hatch & Associates, Inc., "A Procedure for Developing an Energy Efficiency Plan for the Use of Electric Motors in an Industrial Setting," (Draft) June 1994
- 5-6 Richard L. Nailen, "Finding True Power Output Isn't Easy," Electrical Apparatus, February 1994
- 5-7 P. J. Otaduy, "ORMEL96 (Oak Ridge Motor Efficiency and Load, 1996) User's Guide," Oak Ridge National Laboratory, March 1996
- 5-8 Annette von Jouanne, Alan Wallace, Johnny Douglass, Craig Wohlgemuth, and Gary Wainwright, "A Laboratory Assessment on In-Service Motor Efficiency Testing Methods" submitted for publication at the IEEE-International Electric Machines and Drives Conference Milwaukee, WI, May 1997

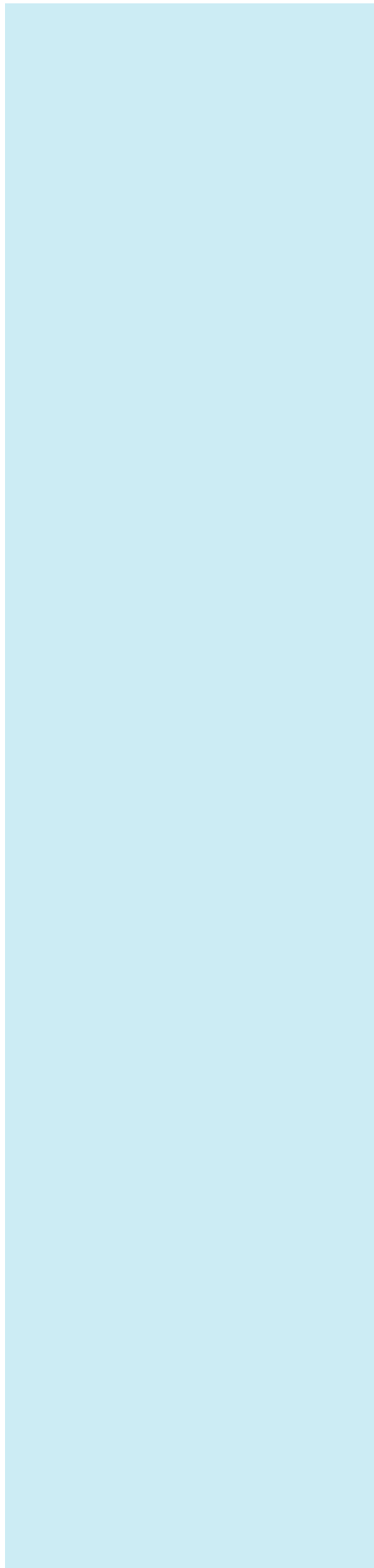

Chapter 6

Energy, Demand, and Dollar Savings Analysis

This chapter illustrates how to use field measurements to determine demand reductions, energy savings, and the simple payback on investment in a new or replacement energy efficient motor.

Calculating Annual Energy and Demand Savings

To determine the annual dollar savings from the purchase of an energy efficient motor, you first need to estimate the annual energy savings. Energy efficient motors require fewer input kilowatts to provide the same output as a standard-efficiency motor. The difference in efficiency between the energy-efficient motor and a comparable standard motor determines the demand or kilowatt savings. For two similar motors operating at the same load, but

having different efficiencies, Equation 6-1 is used to calculate the kW reduction.⁶⁻³ The kW savings are the demand reduction. The annual energy savings are then calculated as shown in Equation 6-2.

Equations 6-1 through 6-3 apply to motors operating at a specified constant load. For varying loads, you can apply the energy savings equation to each portion of the cycle where the load is relatively constant for an appreciable period of time. The total energy savings is then the sum of the savings for each load period. The equations are not applicable to motors operating with pulsating or random loads or for loads that cycle at rapidly repeating intervals.

Equation 6-1

$$\text{kW}_{\text{saved}} = 100 \times 75 \times 0.7457 \times \left(\frac{1}{92} - \frac{1}{95} \right) = 1.92 \text{ kW}$$

Where:

- kW_{saved} = Savings from efficiency improvement in kW
- P_{or} = Nameplate rated horsepower
- Load = Output power as a % of rated power
- e_{std} = Efficiency of a standard motor as operated in %
- e_{EE} = Efficiency of an energy efficient motor as operated in %

Equation 6-2

$$\text{kWh}_{\text{savings}} = \text{kW}_{\text{saved}} \times \text{hours}$$

Where:

$\text{kWh}_{\text{savings}}$ = Annual electric energy saved in kWh

kW_{saved} = Savings from efficiency improvement in kW

hours = Annual operating hours

You can now use the demand savings and annual energy savings along with utility rate schedule information to estimate your annual reduction in operating costs. This calculation of total annual cost savings is shown in Equation 6-3. Be sure to apply any seasonal and declining block energy charges.

Equation 6-3

$$\$_{\text{savings}} = \left(\text{kW}_{\text{saved}} \times 12 \times \$_{\text{demand}} \right) + \left(\text{kWh}_{\text{savings}} \times \$_{\text{energy}} \right)$$

Where:

$\$_{\text{savings}}$ = Total annual dollar savings

kW_{saved} = Savings from efficiency improvement in kW

$\$_{\text{demand}}$ = Monthly demand dollar charge

$\text{kWh}_{\text{savings}}$ = Annual electric energy saved in kWh

$\$_{\text{energy}}$ = Dollar charge per tailblock kWh

Assessing Economic Feasibility

Because of better design and higher quality materials, premium efficiency motors typically cost 15 to 30 percent more than their energy efficient counterparts. In many situations (new motor purchase, repair, or motor replacement) you quickly recover this price premium through energy cost savings. To determine the economic feasibility of installing premium efficiency motors, examine the total annual energy savings in relation to the price premium. Appendix C contains a Motor Energy Savings Calculation Form.

Most industrial plant managers require that, based on a simple payback analysis, investments be recovered through energy savings within one to three years. The simple payback is defined as the period of time required for the savings from an investment to equal the initial or incremental cost of the investment. For initial motor purchases or replacement of burned-out and rewindable motors, the simple payback period for the extra investment in an premium efficiency motor is the ratio of the price premium (less any available utility rebate) to the total annual electrical dollar savings. This calculation is shown in Equation 6-4.

Equation 6-4

$$PB = \frac{\$_{\text{premium}} - \$_{\text{rebate}}}{\$_{\text{savings}}}$$

Where:

PB = Simple payback in years

$\$_{\text{premium}}$ = Price premium for premium efficiency motor compared to energy efficient

$\$_{\text{rebate}}$ = Utility rebate for premium efficiency motor

$\$_{\text{savings}}$ = Total annual dollar savings

For replacements of operational motors, the simple payback is the ratio of the full cost of purchasing and installing a new premium or energy efficient motor relative to the total annual electrical savings. This calculation is shown in Equation 6-5.

Equation 6-5

$$PB = \frac{\$_{\text{new}} + \$_{\text{inst}} - \$_{\text{rebate}}}{\$_{\text{savings}}}$$

Where:

PB = Simple payback in years

$\$_{\text{new}}$ = New motor cost

$\$_{\text{inst}}$ = Installation cost

$\$_{\text{rebate}}$ = Utility rebate for premium efficiency motor

$\$_{\text{savings}}$ = Total annual dollar savings

Example:

The following analysis for replacing a 100 hp TEFC motor operating at 75 percent of full rated load illustrates how to use Equations 6-1 through 6-4. The analysis determines the cost-effectiveness of purchasing a replacement premium efficiency motor having a 3/4-load efficiency of 95.7% instead of an energy efficient motor.

Kilowatts saved:

From Equation 6-1

$$\text{kW}_{\text{saved}} = 100 \times 75 \times 0.7457 \times \left(\frac{1}{94.5} - \frac{1}{95.7} \right) = 0.74 \text{ kW}$$

This is the amount of power conserved by the energy efficient motor during each hour of use. Multiply this by the number of operating hours at the indicated load to obtain annual energy savings.

Energy saved:

From Equation 6-2

$$\text{kWh}_{\text{savings}} = 0.74 \times 8000 = 5,936$$

Assuming utility energy and demand charges of \$0.04/kWh and \$5.00 per kW per month:

From Equation 6-3

$$\text{\$}_{\text{savings}} = (0.74 \times 12 \times \$5.00) + (5,936 \times \$0.04) = \$282$$

In this example, installing an premium efficiency motor reduces the utility billing by \$576 per year. The simple payback for the incremental cost associated with a premium efficiency motor purchase is the ratio of the price premium or incremental cost to the total annual cost savings.

Assuming a price premium of \$900, the simple payback on investment is:

From Equation 6-4

$$\text{PB} = \frac{\$900 - \$0}{\$282} = 3.2 \text{ yrs}$$

The additional investment required to buy an energy efficient motor is recovered within 1.6 years. Premium efficient motors can often rapidly pay for themselves through reduced energy consumption. After this initial payback period, the annual savings will continue to be reflected in lower operating costs and will add to your firm's profits.

References

Chapter 6

-
- 6-1 Gilbert A. McCoy and John G. Douglass, "Energy Efficient Electric Motor Selection Handbook," U.S. Department of Energy, DOE/GO-10096-290, August 1996.

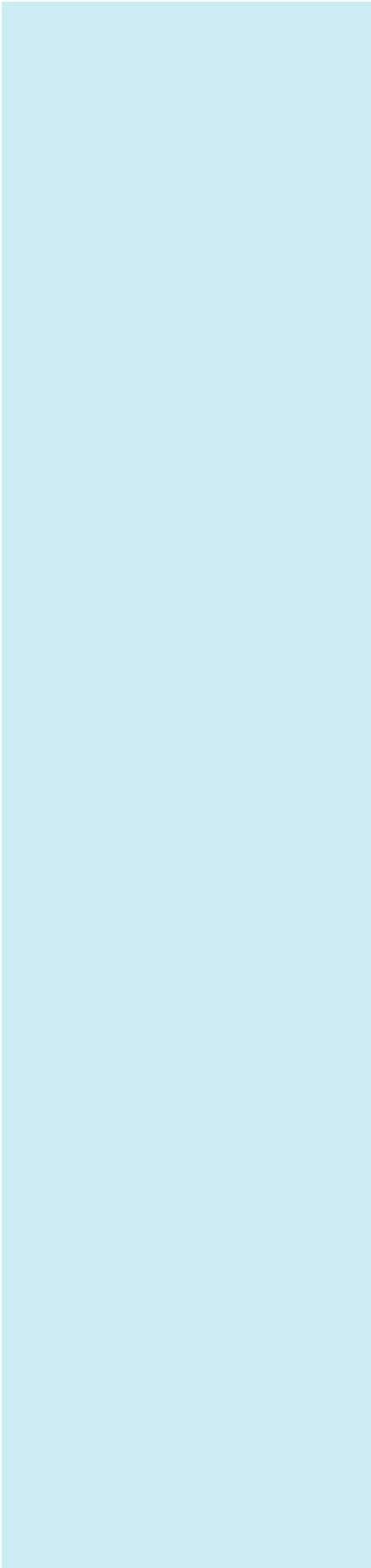

A company should plan ahead so that it can make timely decisions on energy-efficient motor replacements. Take the following planning steps for each motor in the plant that meets minimum size requirements:

- Accurately determine motor load in kW.
- Accurately establish the power factor for each motor at load.
- Establish the existing motor efficiency.
- Determine annual operating hours.
- If the motor is under 50% loaded, consider replacement with a smaller motor either from company inventory or from new stock. If a new motor alternative is preferred, compare an energy-efficient with a standard-efficiency unit.
- If the existing motor were to fail, analyze the use of a rewind motor against use of a new standard and a new energy-efficient motor.
- Recommend the most cost-effective alternative.
- Obtain prior approval to use the “best” approach.
- Establish an action plan to be carried out once the “triggering event” takes place.

If the analysis indicates a simple payback period or other economic performance value that

meets your company guidelines, a change may be warranted right away. Most of the time the “triggering event” is that the existing motor must be replaced. By planning ahead, you can execute the plan on short notice and acquire the best available motor for your particular need.

Energy Efficient Alternatives

After you determine the load, operating hours, and efficiency of each existing motor, you are ready to develop an action plan. There are a number of alternatives to consider and analyze. There are two principal types of situations encountered. One set of analyses is based on the event of existing motor failure, while the second set of analyses assumes no failure of the existing motor. The alternatives are:

- **Upon Failure of Existing Motor**
 - Repair the motor.
 - Replace motor with a new standard motor.
 - Replace motor with a new energy-efficient motor.
- **Without Existing Motor Failure**
 - The motor can be left to operate just as it is.
 - The motor can be replaced immediately with a higher efficiency motor.

MotorMaster+: Motor Energy Management Software

*The Bonneville Power Administration and the U.S. Department of Energy Motor Challenge Program have supported the development of **MotorMaster+**, an energy efficient motor selection and energy-management tool.*

***MotorMaster+** software supports industrial energy management activities by providing:*

- *The ability to select the “best” available new or replacement motor through accessing an internal database of price and performance information for over 27,000 1-to-2000 hp industrial motors;*
- *A plant motor inventory module where motor nameplate data, operating information and field measurements are linked to utility, facility, and process information;*
- *Capability to automatically estimate in-place motor load and efficiency;*
- *The ability to scan for motors which operate under abnormal or sub-optimum power supply conditions;*
- *Descriptor search capability to assist you in targeting energy-intensive systems and replacing inefficient motors;*
- *Inventory management functions including maintenance logs and spare tracking;*
- *Analysis features for rapidly determining the annual energy, demand and dollar savings resulting from selecting and using an energy-efficient motor in a new purchase or retrofit application;*
- *The ability to analyze “batches” or selected populations of inventory for motor rewind, downsizing, or replacement of operable standard with energy-efficient motors;*
- *Energy accounting features including utility billing, plant production and energy conservation and greenhouse gas emission reduction summary reports;*
- *Life cycle costing capability, including the ability to compute the after-tax return on investment in an energy-efficient product.*

*Call the Motor Challenge Information Clearinghouse (800) 862-2086 to obtain information on motors and motor-driven equipment, for technical consultation, and for your copy of **MotorMaster+**.*

With either situation, the alternatives can include downsizing if the existing motor is oversized. **MotorMaster+** allows for side-by-side comparison of annual energy costs due to operation of motors of different horsepower.

Upon Failure Alternatives

When a motor fails, there are two alternatives.

Repair the Motor

The least capital cost approach is generally to repair the failed motor. This often means rewinding of the stator in addition to mechanical repairs such as bearing replacement. The motor must be out of service during repair.

For a major rebuild to be justified, the original stator and rotor must be in serviceable or reasonably-repairable condition. Repair of significant rotor or stator core damage is generally only cost effective on larger motors.

Replace with a New Motor

When replacement is chosen, it is often cost effective to select a new premium efficiency motor. Exceptions can occur if there is an existing standard motor in inventory and/or annual operating hours are very low.

When a previously rewound standard efficiency motor fails, the opportunity to replace it with an energy efficient model can tip the scale from repair to replacement. Replacing the motor with another standard efficiency motor is usually not cost effective unless annual operating hours are very low or electricity is very inexpensive.

The economic analysis for deciding whether to repair or replace a failed motor is straight-forward. The “do

nothing” alternative doesn’t exist. The least capital cost alternative, repairing the failed motor, becomes the base case. The biggest challenge is estimating the cost of the motor repair and its prospective efficiency after repair.

The principal difference in all of the alternatives is the amount of energy that will be used to satisfy motor losses. The logic used to evaluate the alternatives will seek to identify the operating cost for each alternative. It is then possible to compare both the incremental cost of the alternative and also the operating cost reduction associated with the alternative.

Energy consumed in motor losses is computed in terms of kilowatt-hours

(kWh). The difference in operating cost is readily computed upon examining the utility rate schedule.

In the following example (Table 7-1), *MotorMaster+* identified a new premium efficiency motor. The software determined comparative performance values based on an energy cost of \$.04/kWh and a monthly demand charge of \$2/kW. You can also calculate these values with the equations provided in Chapter 6. The comparison of alternatives, provided in Table 7-1, indicates an attractive 1.0 year simple payback on the investment in a premium efficiency replacement motor. The failed motor could either be rewound and retained as a spare, junked, or sold for its salvage value.

Table 7-1
Motor Repair Versus Replace Analysis

	Original Standard Efficiency Motor	Repair Motor	New Premium Efficiency	Motor Units
Motor Size	40	40	40	hp
Load	75	75	75	%
Nominal Efficiency	88.5	88.5	94.5	%
Motor Rewind Loss	-	2.0	-	%
Operating Hours	6,000	6,000	6,000	Hours
Cost (Repair/Purchase)	-	\$880	\$1,764	\$
Premium efficiency motor rebate	-	-	\$300	\$
Annual Energy Use	151,729	155,237	142,095	kWh/Year
Annual Energy Cost	\$6,069	\$6,209	\$5,684	\$/Year
Demand Charge	\$607	\$621	\$568	\$/Year
Savings compared to repair			Savings	
Energy			13,142	kWh/Year
Energy Value			\$525	\$/Year
Demand			2.2	kW
Demand Cost			\$53	\$/Year
Total Saved			\$578	\$/Year
Simple Payback			1.0	Years

Additional alternatives may be considered. There could be a suitable surplus or repaired motor in inventory, which would avoid the new motor purchase price. As discussed earlier in this chapter, either an inventory motor or a new motor could be a smaller size. The **MotorMaster+** “Compare” routine will compare motors of different horsepower. It will even adjust the output power for part load operating speed differences when “cube law” loads (e.g., centrifugal pumps or fans) are driven.

You must weigh several factors in making a good decision. These include:

1. Cost of the proposed replacement motor
2. Efficiency of proposed motor
3. Downtime cost for each alternative (if different)
4. Cost to repair the existing motor
5. Efficiency of the existing motor after repair
6. Availability of a utility rebate

Items 1 and 2 are available from **MotorMaster+**, the motor manufacturer, or distributor. Item 3 may be equal for each alternative. Generally it is quicker to repair large or special motors, but distributors usually have standard and energy-efficient non-specialty smaller size motors in stock. Items 4 and 5 are the most difficult to quantify.

In the motor comparison window of **MotorMaster+** a default cost of repairing an existing motor is provided, but it can be overwritten. Indeed, it usually needs to be overwritten because there is too much variation in motor repair cost to rely on the default number for investment decisions. Repair cost

varies with the extent of damage, geographical location, overtime requirements, and type of stator impregnation. Moreover, repairs are usually provided by other than manufacturers’ shops, so there is not an annual update of repair costs in the **MotorMaster+** database. Two sources of better information on repair cost exist. Users can maintain their own cost database from records of recent repairs. Users can also subscribe to an annually-updated motor repair cost guide. Vaughens’ Price Publishing Inc. produces a price estimator that is widely used.⁷⁻¹

Determining an “appropriate” rewind efficiency loss is somewhat like projecting how many points the home team will score when you don’t know who they are playing. The default efficiency loss in **MotorMaster+** is merely intended to be central to a plausible range of zero to about five percent. There have not been enough before/after studies done to establish a statistically-valid mean efficiency reduction. In most cases there will be an efficiency loss between 0.5 percent and two percent. A two percent reduction is a reasonable estimate for motors under 40 hp rewind in a shop with unknown quality practices, while 0.5 percent is a reasonable estimate for motors over 40 hp rewind in a good shop with a well-run quality management program.⁷⁻²

Motors **can** be rewound with no efficiency loss whatsoever. Efficiency degradation following rewind is caused either by aspects of the original failure that cannot economically be completely repaired, or by errors or shortcuts occurring in the repair. Either way, selecting a shop with a sound quality management system is the best precaution. Electrical Apparatus Service Association (EASA)

supports their members with a quality management program called EASA-Q. Member shops can participate at various levels. For non-EASA shops, look for evidence of a quality management program based upon ISO 9000.

Without an Existing Motor Failure

Leave the Present Situation As Is

An energy coordinator has a number of demands on his or her time. It may be that the benefit of reducing motor losses is not a high priority when compared to other duties competing for the limited time available. The immediate cost of keeping a working standard motor is zero. Savings may simply accrue too slowly to justify investment in a new more efficient motor. Each plant is different and decisions concerning relative importance of projects are best left to those responsible for operation of the plant.

Replace Operating Motor with a New Energy-Efficient Motor

An energy efficient replacement motor can always be found in the same frame size and with comparable starting torque and locked rotor current as the existing motor. The average energy efficient motor turns at a fraction of a percent higher speed than its standard counterpart. In many centrifugal pump and fan applications, this characteristic will increase flow and energy consumption. This can diminish expected savings. Fortunately, full load speed varies among energy-efficient motors and a model can usually be found to closely match the speed of all but the slowest standard efficiency motors.

Table 7-2 illustrates the benefits of replacing an existing standard efficiency motor with an energy-efficient unit. Again, the new motor price and performance information is extracted from **MotorMaster+**. The software determined comparative performance values based on an energy cost of \$.04/kWh and a monthly demand charge of \$2/kW.

The 6.8 year simple payback in this example is longer than the criteria used by most industry decision makers. Replacing a working motor is usually not cost effective. Payback, however, is very sensitive to individual circumstances. An operating time of 8,000 hours or a utility rebate would reduce the payback period, and a higher demand or energy cost would reduce it even further.

Other factors can contribute to a decision to replace a working motor. You may be nearing a scheduled downtime for a process line, and age or predictive maintenance trends may portend trouble from an existing motor. It may be very wise to replace the motor rather than risk an unscheduled shutdown of a process line. See Chapter 9 for more information on predictive maintenance.

Motor Resizing

Historically, the plant electrician is responsible for keeping motors in good operation. It was, and still is, common for part of a manufacturing plant to be down because of a single electric motor failure. Under these circumstances, the plant electrician works quickly to replace the failed unit so there is minimal disruption to the plant operating schedule. The best way to minimize downtime is to have a replacement motor on hand, ready to

Table 7-2
Existing Motor Replacement Analysis

	Original Standard Efficiency Motor	New Energy- Efficient Motor	Units
Motor Size	40	40	hp
Load	75	75	%
Nominal Efficiency	90.4	94.4	%
Operating Hours	6,000	6,000	Hours
Motor Cost	-	\$1,764	\$
Installation Cost	-	\$105	\$
Annual Energy Use	148,507	142,246	kWh/Year
Annual Energy Cost	\$5,940	\$5,690	\$
Demand Charge	\$594	\$569	\$/Year
Savings		Savings	
Energy		6,261	kWh/Year
Energy Cost		\$250	\$/Year
Demand		1.0	kW
Demand Cost		\$25	\$/Year
Total Saved		\$275	\$/Year
Simple Payback		6.8	Years

install. However, it is too costly to have a spare for every motor in the plant. Thus, when the proper size replacement is not in inventory, the electrician typically places the next larger motor available into service.

The intention is to have the failed motor rebuilt and then put back into service when time permits. However, there is rarely enough time to replace a temporary working motor, so the motor that is returned from the repair shop goes into inventory, waiting for another motor to fail. In this way, the size of motors at many industrial facilities grows over time.

The power delivered by a motor is determined by the interaction between the motor and the load.

An AC motor turns at a speed determined by the AC frequency and its design (i.e. number of magnetic poles). This speed is absolutely exact in synchronous motors and only varies (with torque loading) by a few percent in induction motors. In essence, the motor determines at what speed the load will run. Any load (pump, fan, conveyor, etc.) has a characteristic torque demand, i.e. for any running speed, it resists with a certain torque. This relationship is the torque-speed curve. So, when motor and load are coupled together, the motor dictates the running speed and the load dictates the torque required.

Power delivered by the motor is proportional to speed times torque.

This leads to some interesting and counter-intuitive results. Suppose an 1800 rpm 50 hp motor delivers 50 hp to a certain load. If it is replaced by an 1800 rpm 100 hp motor, it will still deliver only 50 hp to the load. The load is oblivious to the *potential* power of a motor, and only responds by requiring a certain torque commensurate with its driven speed.

This requires rethinking the meaning of rated horsepower. Rated horsepower is neither the horsepower that is invariably delivered nor the maximum horsepower that can be delivered. It is the nominal horsepower for which the manufacturer publishes “full load” parameters such as efficiency, current, amps, maximum temperature rise, etc. If a certain load resists with a lower torque at motor nameplate speed, the motor will oblige, delivering the lower torque and less than rated power. If a load requires more than the motor’s rated torque to operate at the motor’s nameplate rpm, the motor will attempt to deliver more than its rated torque and horsepower.

There is, of course, a limit to overloading. Small or brief overloads will be accommodated successfully, albeit with a decrease in efficiency and an increase in operating temperature. With greater or longer overloads, motor lifetime is sharply reduced. With still greater overloads, the motor will not start and accelerate to running speed, and it will either burn out or trip circuit protectors.

Downsizing can be a money saver for two reasons:

- When purchasing replacement motors, smaller motors tend to cost less.

- An underloaded motor operates less efficiently and with lower power factor than a motor loaded at 75 to 100 percent of rated power.

Power factor begins to drop off fairly rapidly as load is reduced, but there has been some tendency to overstate the drop in efficiency at part load. Motor efficiency curves vary by horsepower and model, but most peak near 75 percent load and still provide near nameplate efficiency at half load. Below half load, efficiency begins to drop off dramatically. Performance curves for two typical motors are presented in Figure 7-1. When comparing an existing motor to a downsized replacement, be sure to use the appropriate part load efficiency for each motor. Since larger motors exhibit higher efficiency over their load range, it is common to find a larger motor’s half load efficiency to be greater than the full load efficiency of a replacement motor rated at half the power output.

The first step in considering downsizing is to determine loading on the existing motor using methods discussed in Chapter 5. For variable loading, be sure to make this determination when the motor is operating at its highest load. As a rule of thumb, it is best not to downsize to where the replacement motor is more than 75 percent loaded. This rule can be exceeded when you are certain of the maximum loading.

Even with the same number of poles, motors vary slightly in full load speed. This is an important consideration in resizing because the torque of some loads is very sensitive to rpm. The most notable examples are fans and pumps which are working primarily against

Figure 7-1
Motor Performance at Part Load

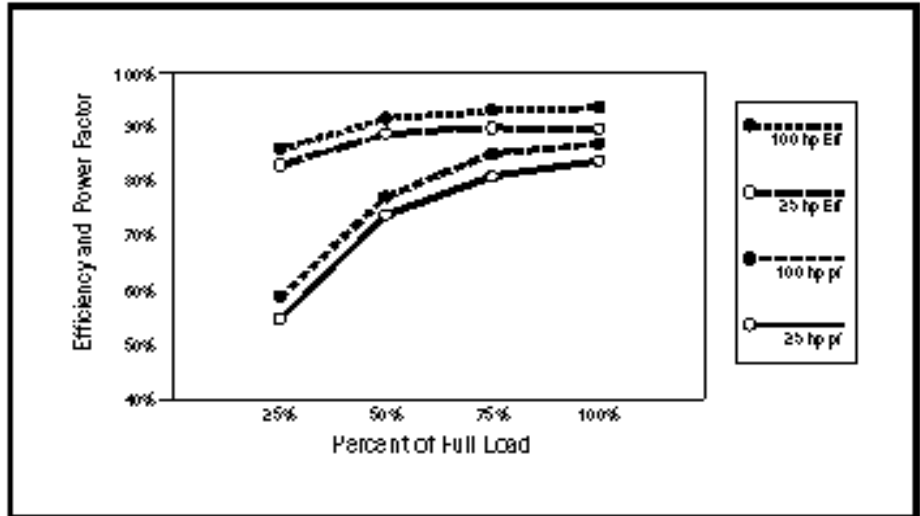

flow friction (as opposed to a high static discharge head). In these applications, a one percent reduction in speed produces a one percent reduction in flow, but a three percent reduction in shaft power.

An example will be valuable in appreciating the concept of downsizing motors. Table 7-3 is an analysis of downsizing a lightly loaded, existing 75 hp motor. A careful check of motor load by the electrician reveals that the maximum (peak) load encountered is 30 hp. The peak load is short in duration (one hour per day). The potential replacement motor (40 hp, energy-efficient) is forecast to operate at 75% load. The values for efficiency and power factor have been selected to reflect the load. You will develop data of this nature as you follow the motor analysis procedures described in Chapter 5.

In the example shown in Table 7-3, installation of a replacement motor is expected to result in a reduced electrical demand of 1.7 kW. The value of energy savings will depend

on the number of hours the motor is operated and the cost of electrical energy. If the load in this example were a continuously-operated conveyor with constant loading, the value of energy saved (at \$0.04 per kWh) would be almost \$600 per year ($8,760 \text{ hr/yr} \times 1.7 \text{ kW} \times \$0.04/\text{kWh}$). A new motor costs about \$1,500. The existing motor would likely be a good candidate motor for downsizing.

The decision to change out the existing motor is also influenced by one or more of the following:

- Length of service life in present motor
- Operating hours
- Availability of a smaller motor in company inventory
- An inducement or incentive from the local utility
- The ability of the energy coordinator to analyze the situation and propose an economically-sound change

The skilled electrician will also notice that with the smaller, energy-efficient motor the required power output is being delivered, while at the same time the current to the motor has been reduced by about 25%. Current reductions decrease the I^2R (line) losses throughout the distribution system and allow load centers to serve more load without exceeding capacity.

Table 7-3
Motor Downsizing Example

		Existing Motor 75 hp	Replacement Motor 40 hp	Units
1	Load Imposed on Motor	40.0%	75.0%	%
2	Average Volts - V	476.0	476.0	Volts
3	Average Current - I	44.2	33.9	Amps
4	Power Factor - pf at load point	69.9%	85.0%	%
5	Input power - P_{in}	25.5	23.8	kW
6	Motor Efficiency - ϵ at load point	87.9%	94.1%	%
7	Output Power - P_{out}	22.4	22.4	kW
8	Motor Losses ($P_{in} - P_{out}$)	3.1	1.4	kW
9	Power Savings	0	1.7	kW

Conclusion

A motor systems management plan has many benefits. The history of maintenance actions, load levels, and operating environment is important information when a motor goes to the repair shop.

Another very important planning benefit is that you know in advance what action to take with each motor (either immediately, upon a failure, or during scheduled downtime). An example of this information is presented in Figure 7-2. This can be accompanied by individual recommendations for replacement motors, simple paybacks computed on an individual motor basis, or by a comprehensive life-cycle-cost analysis for batch actions on multiple motors.

Figure 7-2
Motor Efficiency Improvement Action Plan

Old Motor	New Motor
Motor # 1	Replace <u>W / EE</u> When Failed
Motor # 2	Downsize / Replace <u>W / EE</u> When Failed
Motor # 3	Immediate Replacement <u>W / EE</u>
Motor # 4	Replace <u>W/Standard</u> or Repair When Failed
Motor # 5	Investigate ASD Potential

References

Chapter 7

-
- 7-1 “Vaughen’s Complete Price Guide for Motor Repairs & New Motors,” 1995, Vaughen’s Price Publishing Co. Inc., Pittsburgh, PA
 - 7-2 Vince Schueler and Johnny Douglass, “Quality Electric Motor Repair: A Guidebook for Electric Utilities,” 1995, Bonneville Power Administration, Portland, OR

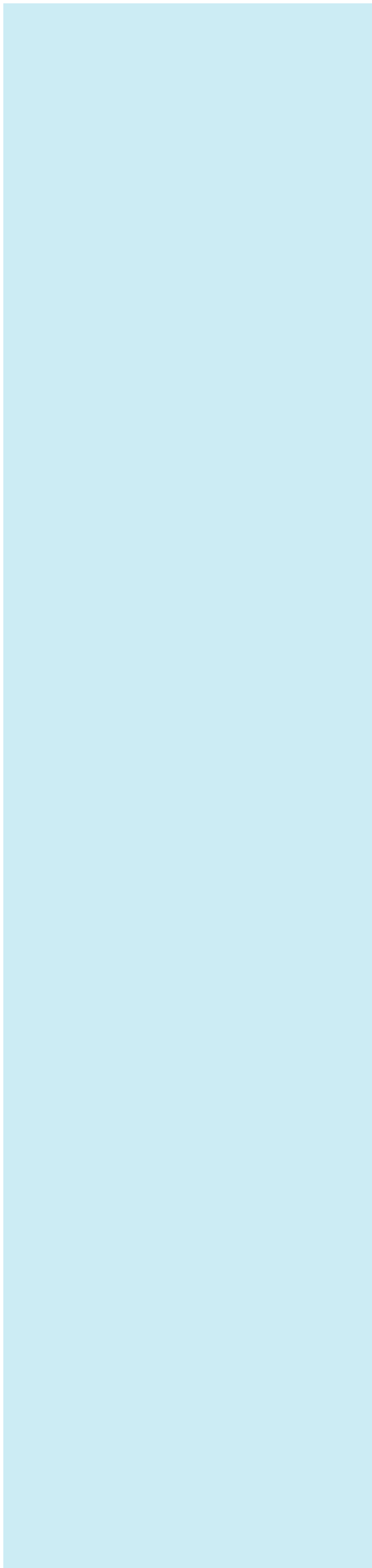

Chapter 8

Power Factor Correction

The Concept of Power Factor

Power factor is a measure of how effectively electrical power is being used. A high power factor (approaching unity) indicates efficient use of the electrical distribution system while a low power factor indicates poor use of the system.⁸⁻¹

Many loads in industrial electrical distribution systems are inductive. Examples include motors, transformers, fluorescent lighting ballasts, and induction furnaces.⁸⁻¹ The line current drawn by an inductive load consists of two components: **magnetizing current** and **power-producing current**.

The magnetizing current is the current required to sustain the electro-magnetic flux or field strength in the machine. This component of current creates

reactive power that is measured in kilovolt-amperes reactive (kVAR). **Reactive** power doesn't do useful "work," but circulates between the generator and the load. It places a heavier drain on the power source, as well as on the power source's distribution system.

The **real** (working) power-producing current is the current that reacts with the magnetic flux to produce the mechanical output of the motor.^{8-2,8-3} **Real** power is measured in kilowatts (kW) and can be read on a wattmeter. **Real** (working) power and **reactive** power together make up **apparent** power. **Apparent** power is measured in kilovolt-amperes (kVA).⁸⁻¹

Power factor is the ratio of real power to **apparent** power. To determine power factor (PF), divide real power (kW) by **apparent** power (kVA). In a sinusoidal system, the result is also referred to as the cosine θ .

Equation 8-1

$$PF = \frac{P_i}{P_{\text{Apparent}}} = \text{cosine } \theta$$

Where:

PF = Power factor as a decimal

P_i = Three phase power in kW

P_{Apparent} = Apparent power in kVA

Terminology

■ Apparent Power

This value is determined by multiplying the current times voltage. In a three-phase circuit, multiply the average phase-to-phase voltage, times the average line current, times the square root of 3 divided by 1,000. The units are kilovolt-amperes (kVA).

$$P_{\text{Apparent}} = \frac{V_{\text{X}} I_{\text{X}} \sqrt{3}}{1000}$$

■ Reactive Power

This term describes the magnetizing requirements of an electric circuit containing inductive loads. The value of magnetizing power is determined by multiplying the Apparent Power by the sine of the phase angle, θ , between the voltage and the current. Units are kilovolt-amperes reactive (kVAR).

$$P_{\text{Reactive}} = P_{\text{Apparent}} \times \sin \theta$$

■ Real Power

This term is what electricians deal with in plant loads. Previous references in this guidebook to “power” have all meant **real** power. Real power is related to Apparent Power by the cosine of the phase angle, θ , between voltage and current. Units are kilowatts (kW).

$$P_{\text{i}} = P_{\text{Apparent}} \times \cos \theta$$

$$P_{\text{i}} = P_{\text{Apparent}} \times \text{PF}$$

Another way to visualize power factor and demonstrate the relationship between kW, kVAR and kVA, is the right “power” triangle illustrated in Figure 8-1. The hypotenuse of the triangle represents the **apparent** power (kVA) which is simply the system voltage multiplied by the amperage times the square root of three (for a three-phase system) divided by 1,000. The right side of the triangle represents the **reactive** power (kVAR). The base of the triangle represents the **real** or working power, measured in kW. The angle between the kW and kVA legs of the triangle is the phase angle θ .⁸⁻⁴

Figure 8-1
The Power Triangle

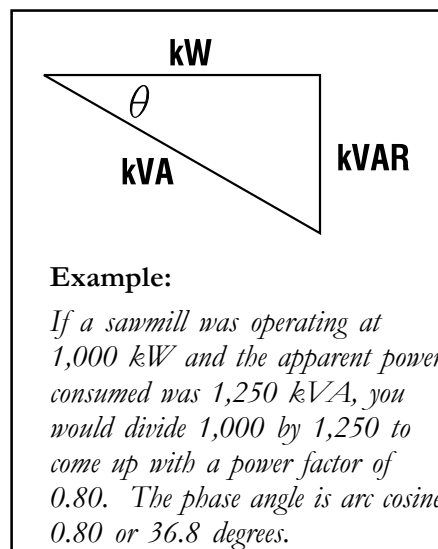

Power factor is also referred to as **leading** or **lagging**. In the case of the magnetizing current, the power factor is lagging, in that the current follows the voltage waveform. The amount of lag is the electrical phase angle between the voltage and the current. Power factor is equal to the cosine of the phase angle between the voltage and current waveforms.

Power Factor Penalties

When a utility serves an industrial plant that has poor power factor, the utility must supply higher current levels to serve a given load. In a situation where real power demand (kW) at two plants is the same, but one plant has an 85 percent power factor while the other has a 70 percent power factor, the utility must provide 21 percent more current to the second plant to meet that same demand. Conductors and transformers serving the second plant would need 21 percent more carrying capacity than those provided to the first plant. Additionally, resistance losses (I^2R) in the distribution conductors would be 46 percent greater in the second plant.^{8-2, 8-3}

A utility is paid primarily on the basis of energy consumed and peak demand supplied. Without a power factor billing element, the utility would receive no more income from the second plant than from the first. As a means of compensation for the burden of supplying extra current, utilities typically establish a “power factor penalty” in their rate schedules. A minimum power factor value is established, usually 95 percent. When the customer’s power factor drops below the minimum value, the utility collects “low power factor” revenue. As shown in the “Benefits of Power Factor Correction” section of this chapter, the lower the actual power factor, the greater the penalty.^{8-2, 8-3}

Power Factor Improvement

Some strategies for improving your power factor are:

- **Use the highest-speed motor that an application can accommodate.**

Two-pole (nominal 3600 rpm) motors have the highest power factors; power factor decreases as the number of poles increases.⁸⁻⁵

- **Size motors as close as possible to the horsepower demands of the load.**

A lightly loaded motor requires little real power. A heavily loaded motor requires more real power. Since the reactive power is almost constant, the ratio of real power to reactive power varies with induction motor load, and ranges from about 10 percent at no load to as high as 85 percent or more at full load.^{8-2,8-3,8-5} (See Figure 8-2) An oversized motor, therefore, draws more reactive current at light load than does a smaller motor at full load.

Low power factor results when motors are operated at less

than full-load. This often occurs in cyclic processes (such as circular saws, ball mills, conveyors, compressors, grinders, extruders, or punch presses) where motors are sized for the heaviest load. In these applications, power factor varies from moment to moment. Examples of situations where low power factors (from 30 percent to 50 percent) occur include a surface grinder performing a light cut, an unloaded air compressor, and a circular saw spinning without cutting.⁸⁻¹ The industries shown in Table 8-1 typically exhibit low power factors and do not fully utilize the incoming current supplied by the electrical utility.^{8-1,8-6}

- **Add power factor correction capacitors to your in-plant distribution system.**

Power capacitors serve as leading reactive current generators and counter the lagging reactive current in the system. By providing reactive current, they reduce the total amount of current your system must draw from the utility.⁸⁻¹

The Bonneville Power Administration has produced the Industrial Power Factor Analysis Guidebook. Software designed for the Microsoft® Windows™ operating environment is available to make the power factor correction process as simple as possible. The Guidebook addresses the following topics:

- *How to tell if your plant could benefit from capacitors.*
- *How to select capacitor schemes to eliminate power factor penalties and minimize losses.*
- *How to perform detailed plant surveys to collect sufficient data to determine where to put capacitors.*
- *Why the power system must be built with extra capacity to supply power.*
- *How reactive power contributes to additional losses.*
- *How capacitors, synchronous machines, and static (adaptive) power compensators correct for power factor.*
- *When to use switched and fixed capacitors.*
- *How and when capacitors contribute to harmonic distortion problems and how to predict this.*
- *How capacitors can fall prey to harmonics and switching transients and what to do about it.*

The Guidebook (\$25) and Software (\$395) are available from Bonneville Power Administration. Send check to Accounting Operations, Mailstop FRO, BPA, P.O. Box 6040, Portland OR 97228.

Figure 8-2
Power Factor as a Function of Motor Load

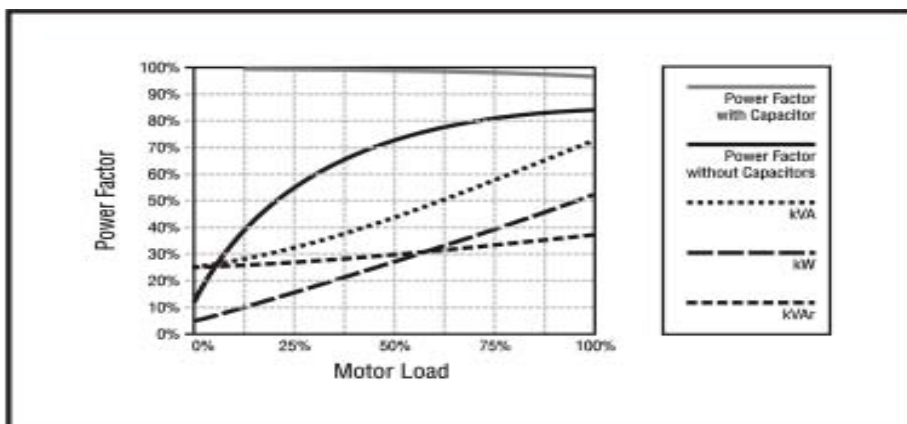

Table 8-1
Industries That Typically Exhibit Low Power Factor

Industry	Uncorrected Power Factor
Saw mills	45% - 60%
Plastics (extruders)	55% - 70%
Machine shops	40% - 65%
Plating, textiles, chemicals, breweries	65% - 75%
Foundries	50% - 80%
Chemicals	65% - 75%
Textiles	65% - 75%
Arc welding	35% - 60%
Cement Works	78% - 80%
Printing	55% - 70%

Sizing and Locating Power Factor Correction Capacitors

Once you decide that your facility can benefit from power factor correction, you need to choose the optimum type, size, number, and strategic locations for capacitors in your plant. The unit for rating power factor capacitors is the kVAR, equal to 1,000 volt-amperes of reactive power. The kVAR rating signifies how much reactive power a capacitor will provide.⁸⁻¹

The value of individual motor reactive power is cumulative toward the overall plant reactive power. Therefore, when you improve the power factor of a single motor, you are reducing the plant's reactive power requirement.

The greatest power factor correction benefits are derived when you place capacitors at the source of reactive currents. It is thus common to distribute capacitors on **motors throughout an industrial**

plant.^{8-6,8-7} This is a good strategy when capacitors must be switched to follow a changing load. If your plant has many large motors, 25 hp and above, it is usually economical to install one capacitor per motor and switch the capacitor and motor together.⁸⁻¹

Switched capacitors don't require separate switch control equipment when they are located on the load side of motor contactors. Thus, capacitors installed on the larger motors are nearly as economical as fixed banks installed at motor control centers. When some switching is required, the most economical method is to install a base amount of fixed capacitors that are always energized, with the remainder on the larger motors and switched when the motors are energized. Observe load patterns in order to determine good candidate motors to receive capacitors.

If your plant contains many small motors (in the 1/2 to 10 hp size range), it may be more economical to group the motors and place single capacitors or banks of capacitors at, or near, the motor

control centers. If capacitors are distributed for loss reduction and also need to be switched, you can install an automatic power factor controller in a motor control center; this provides automatic compensation and may be more economical than capacitors on each of the small motors fed from that control center.⁸⁻⁶ Often the best solution for plants with large and small motors is to specify both types of capacitor installations.^{8-1,8-6} Sometimes, only an isolated trouble spot requires power factor correction. This may be the case if your plant operates welding machines, induction heaters, or D-C drives.⁸⁻¹ Facilities with very large loads typically benefit from a combination of individual load, group load, and banks of fixed and automatically-switched capacitor units.

Advantages of individual capacitors at the load include⁸⁻¹:

- Complete control. Capacitors don't cause problems on the line during light load conditions.
- No need for separate switching. The motor always operates with its capacitor.
- Improved motor performance due to reduced voltage drops.
- Motors and capacitors can be easily relocated together.
- Easier to select the right capacitor for the load.
- Reduced line losses.
- Increased system capacity.

The advantages of bank installations at the feeder or service entry are⁸⁻¹:

- Lower cost per kVAR.

- Lower installation costs.
- Total plant power factor improves which reduces or eliminates utility power factor penalty charges.
- Total kVAR may be reduced, as all capacitors are on-line even when some motors are switched off.
- Automatic switching ensures the exact amount of power factor correction and eliminates overcapacitance and resulting overvoltages.

If your facility operates at a constant load around-the-clock, fixed capacitors are the best solution. If load is variable such as eight-hour shifts five days a week, you'll require switched units to decrease capacitance during times of reduced load.⁸⁻¹

If your feeders or transformers are overloaded, or if you wish to add additional load to already loaded lines, you should apply power factor correction at the load. If your facility has excess current-carrying capacity, you can install capacitor banks at main feeders.

Figure 8-3
Locating Capacitors on Motor Circuits

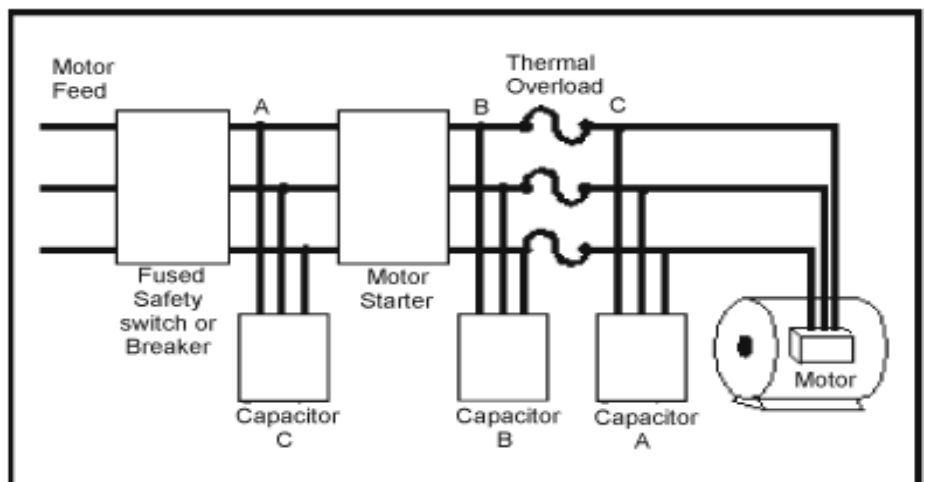

Three options, indicated in Figure 8-3, exist for installing capacitors at the motor:⁸⁻¹

Location A — motor side of overload relay

- New motor installations in which overloads can be sized in accordance with reduced current draw
- Existing motors when no overload change is required

Location B — between the starter and overload relay

- Existing motors when placement at A would allow overload current to surpass code

Location C — line side of starter

- Motors that are jogged, plugged, reversed
- Multi-speed motors
- Starters with open transition and starters that disconnect/reconnect capacitor during cycle
- Motors that start frequently
- Motor loads with high inertia

Sizing Capacitors for Individual Motor and Entire Plant Loads

Capacitors which are installed across the motor terminals and switched with the motor should not be sized larger than the amount of kVAR necessary to raise the motor no-load power factor to 100 percent.⁸⁻⁵ Use Table 8-2 to size capacitors for individual motor loads. Look up the type of motor frame, synchronous speed (RPM), and horsepower. The table indicates the kVAR necessary to correct the power factor to 95 percent.^{8-1,8-6}

If you know the total plant load (kW), your present power factor, and the power factor you intend to achieve, use Table 8-3 to identify the required capacitance.⁸⁻¹ This table is useful for sizing banks of capacitors which may be located at motor control centers, feeders, branch circuits, or the plant service entrance.

Table 8-2
Sizing Guide for Capacitors on Individual Motors
 kVAR to correct typical motor to 0.95 PF; motor and capacitor switched as single unit. (ANSI/NEMA MGI - 1978)

NEMA Code	B																		C		D	Wound Rotor
	Before 1955						U-Frame						T-Frame						4-6	8	6	
Poles	2	4	6	8	10	12	2	4	6	8	10	12	2	4	6	8	10	12	1800	900	1200	
HP=3	1.5	1.5	1.5	2	2.5	3.5	1	1	1	2			1.5	1.5	2.5	3	3	4				
5	2	2	2	3	4	4.5	1	2	2	2			2	2.5	3	4	4	5				
7.5	2.5	2.5	3	4	5.5	6	1	2	4	4			2.5	3	4	5	5	6				
10	3	3	3.5	5	6.5	7.5	2	2	4	5	5	5	4	4	5	6	7.5	8				
15	4	4	5	6.5	8	9.5	4	4	4	5	5	5	5	5	6	7.5	8	10	5	5	5	
20	5	5	6.5	7.5	9	12	4	5	5	5	10	10	6	6	7.5	9	10	12	5	6	6	
25	6	6	7.5	9	11	14	5	5	5	5	10	10	7.5	7.5	8	10	12	18	6	6	6	
30	7	7	9	10	12	16	5	5	5	10	10	10	8	8	10	14	15	23	7.5	9	10	
40	9	9	11	12	15	20	5	10	10	10	10	15	12	13	16	18	23	25	10	12	12	
50	12	11	13	15	19	24	5	10	10	15	15	20	15	18	20	23	24	30	12	15	15	
60	14	14	15	18	22	27	10	10	10	15	20	25	18	21	23	26	30	35	18	18	18	
75	17	16	18	21	26	33	15	15	15	20	25	30	20	23	25	28	33	40	19	23	23	
100	22	21	25	27	33	40	15	20	25	25	40	45	23	30	30	35	40	45	27	27	30	
125	27	26	30	33	40	48	20	25	30	30	45	45	25	36	35	42	45	50	35	38	38	
150	33	30	35	38	48	53	25	30	30	40	45	50	30	42	40	53	53	60	38	45	45	
200	40	38	43	48	60	65	35	40	60	55	55	60	35	50	50	65	68	90	45	60	60	
250	50	45	53	58	70	78	40	40	60	80	60	100	40	60	63	82	88	100	54	70	70	
300	58	53	60	65	80	88	45	45	80	80	80	120	45	68	70	100	100	120	65	90	75	
350	65	60	68	75	88	95	60	70	80	80			50	75	90	120	120	135				
400	70	65	75	85	95	105	60	80	80	160			75	80	100	130	140	150				
450	75	68	80	93	100	110	70	100					80	90	120	140	160	160				
500	78	73	83	98	108	115	70						100	120	150	160	180	180				

**Table 8-3
Multipliers to Determine Capacitor Kilovars Required for Power Factor Correction**

ORIGINAL POWER FACTOR	Corrected Power Factor																		
	0.80	0.81	0.82	0.83	0.84	0.85	0.86	0.87	0.88	0.89	0.90	0.91	0.92	0.93	0.94	0.95	0.96	0.99	1.0
0.50	0.982	1.008	1.034	1.060	1.086	1.112	1.139	1.165	1.192	1.220	1.248	1.276	1.306	1.337	1.369	1.403	1.440	1.589	1.732
0.51	0.937	0.962	0.989	1.015	1.041	1.067	1.094	1.120	1.147	1.175	1.203	1.231	1.261	1.292	1.324	1.358	1.395	1.544	1.687
0.52	0.893	0.919	0.945	0.971	0.997	1.023	1.050	1.076	1.103	1.131	1.159	1.187	1.217	1.248	1.280	1.314	1.351	1.500	1.643
0.53	0.850	0.876	0.902	0.928	0.954	0.980	1.007	1.033	1.060	1.088	1.116	1.144	1.174	1.205	1.237	1.271	1.308	1.457	1.600
0.54	0.809	0.835	0.861	0.887	0.913	0.939	0.966	0.992	1.019	1.047	1.075	1.103	1.133	1.164	1.196	1.230	1.267	1.416	1.559
0.55	0.769	0.795	0.821	0.847	0.873	0.899	0.926	0.952	0.979	1.007	1.035	1.063	1.093	1.124	1.156	1.190	1.227	1.376	1.519
0.56	0.730	0.756	0.782	0.808	0.834	0.860	0.887	0.913	0.940	0.968	0.996	1.024	1.054	1.085	1.117	1.151	1.188	1.337	1.480
0.57	0.692	0.718	0.744	0.770	0.796	0.822	0.849	0.875	0.902	0.930	0.958	0.986	1.016	1.047	1.079	1.113	1.150	1.299	1.442
0.58	0.655	0.681	0.707	0.733	0.759	0.785	0.812	0.838	0.865	0.893	0.921	0.949	0.979	1.010	1.042	1.076	1.113	1.262	1.405
0.59	0.619	0.645	0.671	0.697	0.723	0.749	0.776	0.802	0.829	0.857	0.885	0.913	0.943	0.974	1.006	1.040	1.077	1.226	1.369
0.60	0.583	0.609	0.635	0.661	0.687	0.713	0.740	0.766	0.793	0.821	0.849	0.877	0.907	0.938	0.970	1.004	1.041	1.190	1.333
0.61	0.549	0.575	0.601	0.627	0.653	0.679	0.706	0.732	0.759	0.787	0.815	0.843	0.873	0.904	0.936	0.970	1.007	1.156	1.299
0.62	0.516	0.542	0.568	0.594	0.620	0.646	0.673	0.699	0.726	0.754	0.782	0.810	0.840	0.871	0.903	0.937	0.974	1.123	1.266
0.63	0.483	0.509	0.535	0.561	0.587	0.613	0.640	0.666	0.693	0.721	0.749	0.777	0.807	0.838	0.870	0.904	0.941	1.090	1.233
0.64	0.451	0.477	0.503	0.529	0.555	0.581	0.608	0.634	0.661	0.689	0.717	0.745	0.775	0.806	0.838	0.872	0.909	1.068	1.201
0.65	0.419	0.445	0.471	0.497	0.523	0.549	0.576	0.602	0.629	0.657	0.685	0.713	0.743	0.774	0.806	0.840	0.877	1.026	1.169
0.66	0.388	0.414	0.440	0.466	0.492	0.518	0.545	0.571	0.598	0.626	0.654	0.682	0.712	0.743	0.775	0.809	0.846	0.995	1.138
0.67	0.358	0.384	0.410	0.436	0.462	0.488	0.515	0.541	0.568	0.596	0.624	0.652	0.682	0.713	0.745	0.779	0.816	0.965	1.108
0.68	0.328	0.354	0.380	0.406	0.432	0.458	0.485	0.511	0.538	0.566	0.594	0.622	0.652	0.683	0.715	0.749	0.786	0.935	1.078
0.69	0.299	0.325	0.351	0.377	0.403	0.429	0.456	0.482	0.509	0.537	0.565	0.593	0.623	0.654	0.686	0.720	0.757	0.906	1.049
0.70	0.270	0.296	0.322	0.348	0.374	0.400	0.427	0.453	0.480	0.508	0.536	0.564	0.594	0.625	0.657	0.691	0.728	0.877	1.020
0.71	0.242	0.268	0.294	0.320	0.346	0.372	0.399	0.425	0.452	0.480	0.508	0.536	0.566	0.597	0.629	0.663	0.700	0.849	0.992
0.72	0.214	0.240	0.266	0.292	0.318	0.344	0.371	0.397	0.424	0.452	0.480	0.508	0.538	0.569	0.601	0.635	0.672	0.821	0.964
0.73	0.186	0.212	0.238	0.264	0.290	0.316	0.343	0.369	0.396	0.424	0.452	0.480	0.510	0.541	0.573	0.607	0.644	0.793	0.936
0.74	0.159	0.185	0.211	0.237	0.263	0.289	0.316	0.342	0.369	0.397	0.425	0.453	0.483	0.514	0.546	0.580	0.617	0.766	0.909
0.75	0.132	0.158	0.184	0.210	0.236	0.262	0.289	0.315	0.342	0.370	0.398	0.426	0.456	0.487	0.519	0.553	0.590	0.739	0.882
0.76	0.105	0.131	0.157	0.183	0.209	0.235	0.262	0.288	0.315	0.343	0.371	0.399	0.429	0.460	0.492	0.526	0.563	0.712	0.855
0.77	0.079	0.105	0.131	0.157	0.183	0.209	0.236	0.262	0.289	0.317	0.345	0.373	0.403	0.434	0.466	0.500	0.537	0.686	0.829
0.78	0.052	0.078	0.104	0.130	0.156	0.182	0.209	0.235	0.262	0.290	0.318	0.346	0.376	0.407	0.439	0.473	0.510	0.659	0.802
0.79	0.026	0.052	0.078	0.104	0.130	0.156	0.183	0.209	0.236	0.264	0.292	0.320	0.350	0.381	0.413	0.447	0.484	0.633	0.776
0.80	0.000	0.026	0.052	0.078	0.104	0.130	0.157	0.183	0.210	0.238	0.266	0.294	0.324	0.355	0.387	0.421	0.458	0.609	0.750
0.81		0.000	0.026	0.052	0.078	0.104	0.131	0.157	0.184	0.212	0.240	0.268	0.298	0.329	0.361	0.395	0.432	0.581	0.724
0.82			0.000	0.026	0.052	0.078	0.105	0.131	0.158	0.186	0.214	0.242	0.272	0.303	0.335	0.369	0.406	0.555	0.698
0.83				0.000	0.026	0.052	0.079	0.105	0.132	0.160	0.188	0.216	0.246	0.277	0.309	0.343	0.380	0.529	0.672
0.84					0.000	0.026	0.053	0.079	0.106	0.134	0.162	0.190	0.220	0.251	0.283	0.317	0.354	0.503	0.646
0.85						0.000	0.027	0.053	0.080	0.108	0.136	0.164	0.194	0.225	0.257	0.291	0.328	0.477	0.620
0.86							0.000	0.026	0.053	0.081	0.109	0.137	0.167	0.198	0.230	0.264	0.301	0.450	0.593
0.87								0.000	0.027	0.055	0.083	0.111	0.141	0.172	0.204	0.238	0.275	0.424	0.567
0.88									0.000	0.028	0.056	0.084	0.114	0.145	0.177	0.211	0.248	0.397	0.540
0.89										0.000	0.028	0.056	0.086	0.117	0.149	0.183	0.220	0.369	0.512
0.90											0.000	0.028	0.058	0.089	0.121	0.155	0.192	0.341	0.484
0.91												0.000	0.030	0.061	0.093	0.127	0.164	0.313	0.456
0.92													0.000	0.031	0.063	0.097	0.134	0.283	0.426
0.93														0.000	0.032	0.066	0.103	0.252	0.395
0.94															0.000	0.034	0.071	0.220	0.363
0.95																0.000	0.037	0.186	0.329
0.96																	0.000	0.149	0.292
0.97																		0.108	0.251
0.98																		0.060	0.203
0.99																		0.000	0.143
																			0.000

Instructions: 1. Find the present power factor in column 1. 2. Read across to optimum power factor column. 3. Multiply that number by kW demand.

Example: If your plant consumed 410 kW, was currently operating at 73% power factor and you wanted to correct power factor to 95%, you would:

1. Find 0.73 in column 1. 2. Read across to 0.95 column. 3. Multiply 0.607 by 410 = 249 (round to 250).
4. You need 250 kVAR to bring your plant to 95% power factor.

If you don't know the existing power factor level of your plant, you will have to calculate it before using this table.

To calculate existing power factor: kW divided by kVA = Power Factor

The power triangle in Figure 8-4 indicates the demands on a plant distribution system before and after adding capacitors to improve power factor. By increasing the power factor from 70 percent to 95 percent, the apparent power is reduced from 1,420 kVA to 1,050 kVA, a reduction of 26 percent.

Benefits of Power Factor Correction

The cost-effectiveness of power factor correction depends upon such variables as utility power factor penalties, the need for additional system capacity, energy and demand cost, hours of facility operation, distribution system wire sizes, and the distance between the motor and the electrical meter.⁸⁻⁸ As shown in the following examples, it is critical to understand your utility's rate structure in order to assess the benefits or reduction in utility billing due to power factor correction.⁸⁻¹

Figure 8-4
Apparent Power Requirements Before and After Adding Power Factor Correction Capacitors

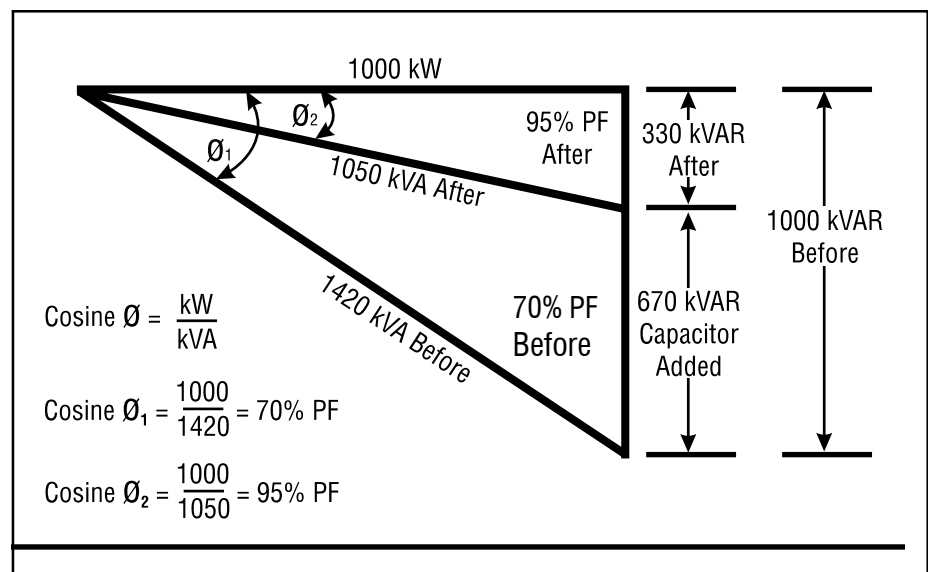

Example 8-1

Utility Rate Schedule: The utility measures and bills based upon total current used (working plus reactive current) at \$3.50/kVA Demand.

Plant Conditions: Assume a constant 4,600 kVA demand with an 80 percent power factor. Correct to 95 percent power factor.

Billing Before Power Factor Correction	Billing After Power Factor Corrected to 95%
$4,600 \text{ kVA} \times \$3.50 =$ $\$16,100/\text{month}$	$\text{kW}_{\text{demand}} = \text{kVA}_{\text{demand } 1} \times \text{PF}_1$ $= 4,600 \times 0.8 = 3,680$ $\text{kVA}_{\text{demand } 2} = \frac{\text{kW}_{\text{demand}}}{\text{PF}_2}$ $\text{kVA}_{\text{demand } 2} = \frac{3,680}{0.95} = 3,873$ <p>Where:</p> $\text{kVA}_{\text{demand } 1} = \text{kVA demand before PF correction}$ $\text{kVA}_{\text{demand } 2} = \text{kVA demand after PF correction}$ $\text{kW}_{\text{demand}} = \text{Electric demand in kW}$ $\text{PF}_1 = \text{Original power factor}$ $\text{PF}_2 = \text{Power factor after correction}$ <p><i>Corrected Billing</i></p> $3,873 \text{ kVA} \times \$3.50 = \$13,555/\text{month}$

Savings are (\$16,100-\$13,555) x 12 months = \$30,540/year

Up to \$61,000 could be spent on power factor correction equipment if plant management would support a two-year simple payback on investment.⁸⁻⁹

Example 8-2

Utility Rate Schedule: In this scenario, the utility charges according to kW demand (\$4.50/kW) and includes a surcharge or adjustment for low power factor. The following formula shows a billing adjustment based upon a desired 95 percent power factor.

$$\text{kW}_{\text{billed}} = \text{kW}_{\text{demand}} \times \frac{0.95}{\text{PF}}$$

Where:

$\text{kW}_{\text{billed}}$ = Adjusted or billable demand

$\text{kW}_{\text{demand}}$ = Measured electric demand in kW

PF = Power factor as a decimal

The multiplier applies to power factors up to 0.95.

Plant Conditions: For our sample facility, the original demand is 4,600 kVA \times 0.80 or 3,680 kW.

Billing Before Power Factor Correction	Billing After Power Factor Corrected to 95%
$\frac{3,680 \text{ kW} \times 0.95}{0.80}$ <p>= 4,370 \times \$4.50 = \$19,665/month or \$235,980/year</p>	<p>= 3,680 \times \$4.50 = \$16,560/month or \$198,720/year</p>

Savings are \$37,260/year

Additional Benefits of Power Factor Correction

The “Industrial Electrical Distribution Systems Guidebook” contains worksheets for calculating the benefits of correcting individual motor and total plant power factor.⁸⁻¹⁰

Power factor correction capacitors increase system current-carrying capacity, reduce voltage drops, and decrease distribution system resistance (I^2R) losses.⁸⁻¹ Increasing the power factor from 75 percent to 95 percent results in a 21 percent lower current when

serving the same kW load.

Through adding power factor correction capacitors to your system, you can add additional kW load without increasing line currents, wire size, transformer size, or facility kVA charges. By including power factor correction capacitors in new construction or facility expansions, you can reduce project costs through decreasing the sizes of transformers, cables, busses, and switches.⁸⁻¹ In practice, however, ampacity ratings are a function of full-load equipment values; therefore, size reductions may be precluded by electrical codes.

Poor power factor contributes to power losses in the in-plant distribution system. Calculate the power loss by squaring the line current and multiplying by the circuit resistance (I^2R). Generally, distribution system losses are small — a typical industrial plant will suffer only a 2 percent loss in the cables if the cables are loaded to full capacity.⁸⁻⁶ Reductions in losses (upstream of the power factor correction capacitor locations) are calculated by the relationship shown in Equation 8-2:⁸⁻¹

Excessive current draws due to low power factors also cause excessive system voltage drops. Operating motor-driven equipment under low voltage conditions results in efficiency decreases, motor overheating, and subsequent diminished motor life. By adding power factor correction capacitors, you can restore operating voltage to proper design conditions.

Power Factor Correction Costs

The average installed cost of capacitors on a 480-volt system is about \$30 per kVAR. Automatic power factor controllers or capacitors with harmonic filters cost more. These features are typically associated with capacitors exceeding 100 kVAR. A single, large capacitor bank has a lower installed cost than multiple small installations scattered throughout the plant. The cost per kVAR for small capacitors on motors is substantially higher due to labor and materials costs. The cost for large banks is lower on a per kVAR basis because of the economy of scale. The installed cost per kVAR of capacitance is also lower at higher voltages. At higher voltage levels (2400V and up) unit costs are generally about \$6 - \$12 per kVAR installed.⁸⁻⁶ Suppliers of capacitors are listed in Appendix D.

Equation 8-2

$$\% \text{ reduction} = 100 - 100 \times \left(\frac{PF_1}{PF_2} \right)^2$$

Where:

% reduction = Percent reduction in distribution losses

PF_1 = Original power factor

PF_2 = Power factor after correction

Short circuit MVA represents system impedance. It is the current (in millions of amperes) that would be drawn by a short circuit, multiplied by the no-load voltage of the system at the point of interest. In reality, circuit protectors would blow before short circuit current could stabilize, so it is defined by linearly extrapolating the volts-per-amp system voltage drop, at moderate load, down to zero system volts.

Avoiding Harmonic Resonances When Installing Capacitors

Approximately twenty percent of industrial plants that install and operate capacitors must pay careful attention to the creation of steady state harmonic resonances.⁸⁻
⁶ The resonant frequency created with a capacitor and system inductance is calculated by Equation 8-3. As shown in the equation, the square root of the short circuit MVA divided by the capacitor MVAR indicates the resultant harmonic for the system under study.⁸⁻¹¹

Equation 8-3

$$h_f = \sqrt{\frac{\text{MVA short circuit}}{\text{MVAR capacitor}}}$$

If the resonant frequency is near to an odd harmonic, consider reducing capacitor MVA to bring the system out of tune with that harmonic. This is particularly important if you have a known source of these harmonics. For example, adjustable speed drives can be a significant source of 5th and 7th harmonics.

Resonant conditions near the 3rd, 5th, 7th, 11th, and 13th harmonic are usually the most troublesome.⁸⁻
¹¹ Harmonics cause additional noise on the line and generate heat. This heat can cause failure of capacitors or transformers. Consult with your capacitor supplier or a specialist in harmonic mitigation. Many vendors offer harmonic analysis services and will assist you to properly select and install power factor correction equipment. Appendix D contains a list of manufacturers of power factor correction capacitors.

Example 8-3

Consider a case where a 1200 kVAR capacitor is to be installed on a 12.47 kV system at a location where the three phase short circuit current is 2800 amps.

$$\text{MVA}_{\text{shortcircuit}} = 2800 \text{ amps} \times 12.47 \text{ kV} \times \frac{\sqrt{3}}{1,000,000} = 60.5$$

$$\text{MVAR}_{\text{capacitor}} = 1200 \text{ kVAR}/1000 = 1.2 \text{ MVAR and } h_f = \sqrt{\frac{60.5}{1.2}} = 7.1$$

References Chapter 8

- 8-1 “Power Factor Correction: A Guide for the Plant Engineer,” Commonwealth Sprague Capacitor, Inc., PF-2000E, October 1991
- 8-2 Carroll, Hatch & Associates, Inc., “An Electric Motor Energy Efficiency Guide and Technical Reference Manual,” (Draft) June 1994.
- 8-3 Carroll, Hatch & Associates, Inc., “A Procedure for Developing an Energy Efficiency Plan for the Use of Electric Motors in an Industrial Setting,” (Draft), June 1994.
- 8-4 “Reducing Power Factor Cost,” Electric Ideas Clearinghouse Technology Update, Bonneville Power Administration, April 1991.
- 8-5 Edward Ader and William Finley, *Compensating for Low Power Factor*, Plant Engineering, June 17, 1993.
- 8-6 “Industrial Power Factor Analysis Guidebook,” Bonneville Power Administration, DOE/BP-42892-1, April 1995.
- 8-7 Portland General Energy Systems, “Power Quality for Electrical Contractors: Application Guide, Volume 7: Recommended Practices,” Electric Power Research Institute, December 1994.
- 8-8 *Power Factor Correction Equals Big Savings*, Georgia Tech Research Institute, Conserver, March 1991.
- 8-9 Fred L. Montgomery, *The Dollars and Sense of Power Factor Correction*, AIPE Facilities Management, Operations & Engineering, September/October 1989.
- 8-10 Rob Gray, Washington State Energy Office, “Keeping the Spark in Your Electrical System: An Industrial Electrical Distribution Systems Guidebook,” Funded by the Bonneville Power Administration, U.S. Department of Energy, Pacificorp, Portland General Electric and Tacoma City Light, October 1995.
- 8-11 PSI Energy, *Avoiding Steady-State Harmonic Resonances When Installing Capacitors*, Power Clinic Tech Tip, Issue Number 7.

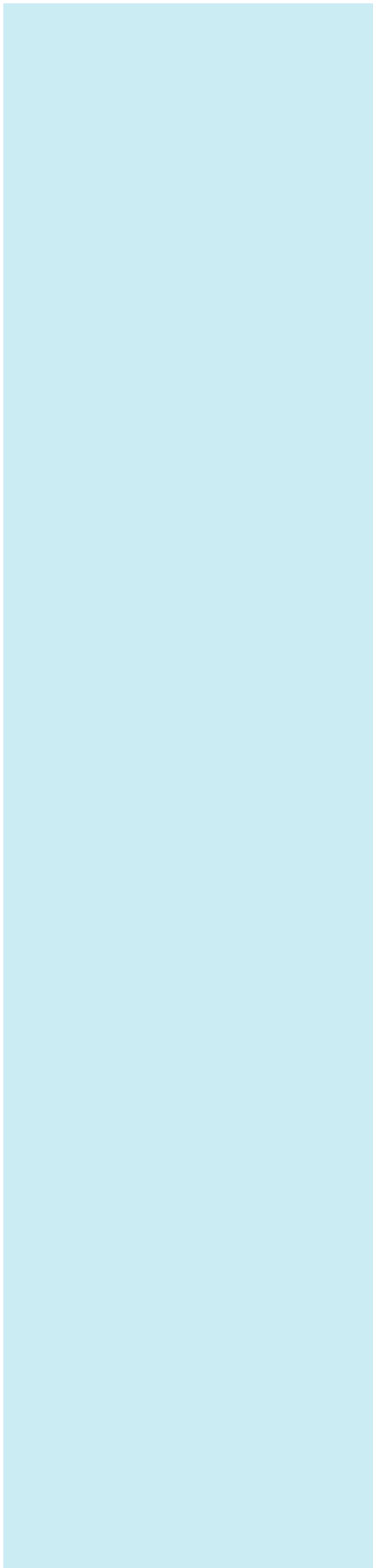

Chapter 9

Preventative and Predictive Maintenance Planning

Everyone knows that maintenance is good. The traditional purpose has been two-fold: keep equipment from failing prematurely and keep equipment calibrated for optimum performance. Both of these objectives can be thought of as preventative maintenance. A two-year Factory Mutual study reveals that effective preventative maintenance programs could have prevented more than half the losses associated with electrical equipment failure. It also showed that well-maintained motors dramatically improve a facility's overall efficiency.⁹⁻¹

More recently, attention has been directed at predictive maintenance. Predictive maintenance refers to scheduled testing and measurement, and trending of the results over time. Proper analysis of the results can predict an impending failure so that necessary repair, cleaning, or alignment can be scheduled before a costly catastrophe occurs.

A good maintenance program contains elements of both predictive and preventative maintenance (PPM). Both involve scheduled actions to the motors and controls as well as record keeping. Depending upon your situation, it may be efficient to merge the two activities. However, depending upon the organization of your maintenance staff, and the service intervals you select, it may be beneficial to

separate the tasks on some basis other than predictive versus preventative.

Mechanical tasks like lubrication and cleaning might require a different schedule and different tradespeople than electrical tasks. Vibration and acoustic testing could fit in either category. Some tasks like infra-red scanning or dry ice cleaning could require an outside contractor operating on yet another schedule. You must design a system to fit your unique situation. This chapter will discuss key elements of any good plan but it can not dictate details.

To have an effective maintenance plan, all four of the following must be executed well:

- **Identify responsible personnel**
Personnel must be designated for the necessary activities. Best results follow when staff buy in to the concept of PPM. This is most likely to occur when they are given the necessary training and tools, and they participate in developing the maintenance plan.
- **Establish a schedule**
Establishing a schedule is an iterative process. It is often necessary to prescribe somewhat frequent intervals at first, then experiment with lengthening the intervals. Some activities can actually be harmful if performed too frequently (e.g. high voltage insulation testing and bearing

greasing). If you observe that certain test results progress uniformly, you can establish a definite and often longer interval. If bearings survive well at a given lubrication interval, you can experiment with a longer lubrication interval. Revise, but do not abandon the schedule.

■ **Keep records**

Record keeping can be done in a number of different ways. Using printed cards or data sheets is the oldest method and may be sufficient. There are certain advantages to going “high tech” with a laptop computer or special electronic recording device for data entry. One advantage is that analysis routines can be set up to graph trends without a second “handling” of penciled forms by a data entry operator. The costliest approach involves special test instruments that connect electrically and actually enter measured data into computer files. Certain actions like recording lubrication and cleaning are not amenable to such devices. New products that bring maintenance into the “information age” are evolving rapidly. Keep abreast of these developments.

■ **Analyze results**

Testing and record keeping are only as good as the follow-up analysis. There are various software tools to help. Spreadsheets and database programs are useful for storing and manipulating data and especially for graphing trends. A third category of software, the statistical package, is often overlooked but

may be the best of all. There are certain special applications software packages that are tailored to this type of record keeping and analysis. **MotorMaster** + contains an excellent motor inventory module that is dedicated to keeping track of motor performance trends and calculating the most cost effective alternatives when motors fail or become obsolete.

The following sections cover major categories and make recommendations on servicing and testing. Some of the recommendations may seem too costly to be justifiable for small inexpensive motors. If so, omit them, but remember to consider the *total* cost of an untimely motor failure. The unscheduled downtime and loss of materials in process can far exceed the cost of the motor.

Cleaning

A clean motor is more than just a pretty motor. Avoid too many thick coats of paint or dirt buildups which can foul heat transfer surfaces. Why is dirt bad? Dirt is a very general word that can mean many things: dust, corrosive buildups, sugary syrups from food processing, electro-conductive contaminants like salt deposits or coal dust. It can damage a motor in three ways. It can attack the electrical insulation by abrasion or absorption into the insulation. It can contaminate lubricants and destroy bearings.

A clean motor runs cooler. Dirt builds up on the fan-cooled motor inlet openings and fan blades. This reduces the flow of air and increases the motor operating temperature. Dirt on the surface of the motor reduces heat transfer

by convection and radiation. This is especially critical for totally enclosed motors since all the cooling takes place on the outside surface. Heavily loaded motors are especially vulnerable to overheating, so they have little tolerance for dirt.

Surface dirt can be removed by various means, depending upon its composition. Compressed air (30 psi maximum), vacuum cleaning and direct wipe down with rags or brushes are usually used. There has been a recent introduction of dry ice “sand” blasting. This is usually done by a special contractor. The dry ice is less abrasive than mineral deposits, is non-electro-conductive, and leaves no residue other than the removed dirt.

Dirt inside the motor is more difficult to remove. It is best to keep it from getting inside. A totally enclosed motor helps in this regard, but fine dust can invade and destroy even an explosion-proof motor. Some larger motors can be provided with a filter in the ventilation air passages to keep out dirt. Keeping moisture out can decrease the attachment of dirt inside the motor and reduce the electrical conductivity of some contaminants. This will reduce the frequency with which the motor must be disassembled for cleaning.

Lubrication

Many small or integral horsepower motors have factory-sealed bearings that do not require re-lubrication. All others require lubrication. Unfortunately, lubrication can be more art than science.

Motor manufacturers’ recommendations should be followed initially. Eventually, with some experimentation and analysis of well-kept records, you may discover that a different type of lubricant or lubrication interval is better. It is good to compare experience with others in your same industry because the operating environment has a great effect upon re-lubrication requirements. Consult with your motor repair shop. By inspecting bearings and analyzing failures, the repairer may be able to tell if you are using the wrong lubricants, lubrication methods, or intervals.

Typical lubrication intervals vary from less than three months (for larger motors subject to vibration, severe bearing loads, or high temperature) to five years for integral horsepower motors with intermediate use. Motors used seasonally should be lubricated annually before the season of use.⁹⁻²

One cannot merely be conservative and over-lubricate. There are many ways that improper lubrication shortens bearing life. Re-lubrication with a different grease can cause bearing failure when two incompatible greases mix. Grease consists of an oil in some type of constituent to give it body or thickness so that it doesn’t run out of the bearing. Mixing greases with incompatible constituents can cause the components of the mixed grease to separate or harden. Table 9-1 is a guide to compatibility of grease bases.⁹⁻³

Adding too much grease or greasing too frequently can force grease past the bearing shield or seal into the motor, resulting in winding damage. Merely having

*Some of these recommendations may seem too costly to be justifiable for small inexpensive motors. If so, omit them. But remember to consider the **total** cost of an untimely motor failure.*

too much grease in the bearing itself can prevent proper flow of the grease around the rollers. Sometimes bearing failures due to over-lubrication are interpreted as insufficient lubrication and intervals are made even shorter.

Perhaps the worst problem with greasing is introduction of contaminants. Contamination occurs when strict cleanliness standards are not followed in grease storage and application. It may be wise to buy grease in more expensive individual cartridges rather than large quantities that are subject to contamination when refilling grease guns. Take special care with grease fittings. Clean the fitting before filling and keep the grease gun nozzle covered when not injecting grease.

When selecting oil or grease, begin with the motor manufacturers' recommendations. However, these sometimes are quite general

or have allowed unexplained bearing failures. In this case, review alternative lubricant specifications and select a type compatible with the known contaminants in your operating environment. For severe situations, a synthetic lubricant may be best. Consult with lubricant vendors, the motor manufacturer, and your repair shop. Lubricants vary in their tolerance to temperature, water, salt or acids.

Finally, remember to completely remove old lubricant before trying a different one. If this is impossible, relubricate soon after introduction of a new lubricant. If there is a plug under a grease lubricated bearing, remove this when first greasing with a new grease to encourage flushing of the old. Some authorities recommend running the motor for about an hour with the plug out to help flush the old grease. The Electrical Apparatus Service

**Table 9-1
Grease Compatibility**

	Aluminum Complex	Barium	Calcium	Calcium 12-hydroxy	Calcium Complex	Clay	Lithium	Lithium 12-hydroxy	Lithium Complex	Polyurea
Aluminum Complex	X	I	I	C	I	I	I	I	C	I
Barium	I	X	I	C	I	I	I	I	I	I
Calcium	I	I	X	C	I	C	C	B	C	I
Calcium 12-hydroxy	C	C	C	X	B	C	C	C	C	I
Calcium Complex	I	I	I	B	X	I	I	I	C	C
Clay	I	I	C	C	I	X	I	I	I	I
Lithium	I	I	C	C	I	I	X	C	C	I
Lithium 12-hydroxy	I	I	B	C	I	I	C	X	C	I
Lithium Complex	C	I	C	C	C	I	C	C	X	I
Polyurea	I	I	I	I	C	I	I	I	I	X

I=Incompatible C=Compatible B=Borderline

Association recommends removing the plug for all regreasing to purge the bearing of excess grease.⁹⁻⁴ The advisability of this practice depends upon the geometry of the bearing cavities and type of seal/shield. Again, consult the manufacturer or repairer.

Mountings, Couplings, and Alignment

Mounting is not really a maintenance issue, but if it is inadequate, it can result in serious maintenance problems. The entire structure must be rigid with a flat coplanar surface for the four mounting legs. The same applies to the structure for mounting the load. Both motor and load structure must be rigidly bound to the floor or a common structure. Failure to provide a solid mounting can lead to vibration or deflection which leads to bearing failure.

Vertical motors can be even more demanding than horizontal motors because the mounting circle constitutes a small footprint for a large mass cantilevered above. Pliancy in the mounting structure can exacerbate low frequency vibration to which vertical motors are vulnerable. Always check hold-down bolts/dowels at every maintenance interval and do a visual check for cracks or other failures of the mounting system.

Coupling alignment is often promoted for energy efficiency. Energy loss in couplings is sometimes overstated, but proper alignment is always important to bearing and coupling life. A slight misalignment can dramatically increase the lateral load on bearings. It can also shorten the

life of the coupling. One source attributes 45% to 80% of bearing and seal failures to misalignment.⁹⁻⁵

Alignment means that the centerline of the motor and load shaft coincide. If they are parallel, but do not coincide, this is *parallel misalignment*. If the centerlines are not parallel but they intersect inside the coupling, this is *angular misalignment*. It is certainly possible to have misalignment in both respects.

Misalignment is usually the result of errors in installation. However misalignment sometimes develops after installation. This can occur if the mounting structure is not completely rigid, if vibration or impact causes something to slip, or if dirty or bent shims were originally used. Alignment should be checked soon after installation and less frequently after that if there are no conditions likely to cause misalignment. If there is evidence of misalignment, such as vibration, warm bearings or couplings, unusual noise, or rubber crumbs under the coupling, check alignment.

Most users align couplings with a dial indicator. To check for angular misalignment, mount the indicator on one shaft and contact the other coupling flange with the plunger parallel to the shaft. To check for parallel misalignment, arrange the plunger radial to the flange. Rotate the shafts through at least 180° and ideally 360°, checking for runout. For misalignment in the horizontal plane, loosen motor mounting bolts and reposition the motor. For any misalignment in the vertical plane, shims must be added or removed. Angular

By trending a motor's operating conditions over time, you may detect problems that are developing in the motor, load, or power distribution system.

vertical misalignment requires unequal application of shims between shaft end and opposite end feet. Apply shims so that the motor rests with equal weight on both diagonal pairs of feet (i.e., there is no rocking of the motor before tightening bolts). Shims and the work area around motor feet must be completely clean. Discard any shims that are bent or scuffed. Always make a final alignment check after the mounting bolts are torqued.

Alignment is not easy. Many frustrating trial and error cycles of position and remeasure can be required. There are computer devices and software available to help in choosing shim size and positioning, but nothing makes it completely easy. In recent years, laser alignment devices have become the rage. They are accurate and easy to use, particularly where long extensions would be required to mount dial indicators. The laser devices simplify attachment, eliminate the problem of compliance of dial indicator mounting arms, and are usually associated with (or directly connected to) computer devices that prescribe the adjustments necessary at all four legs.

Belt drives are entirely different from couplings, but they have their own needs for vigilant care. The most important thing is to control their tension. If belts are too loose, they tend to vibrate, wear rapidly, and waste energy through slippage. If they are too tight, they will also wear excessively and can dramatically shorten bearing life through excessive lateral loading.

Belt drives require parallel alignment between motor and load shaft and require drive and

driven pulleys to be in the same plane. You can usually check both of these conditions with a good straight edge. Once aligned, with a rigid base, alignment tends to hold constant much better than belt tension.

When belts appear worn or require over-tensioning to prevent slip, they should be replaced. Always replace multiple V-belts at the same time with a matched set. Re-check new V-belt tension several times until they complete their break-in stretching (usually within the first 48 operating hours).

Consider replacing V-belts with synchronous belts (sometimes called cog belts) to eliminate slip loss. However, before doing so, determine whether slip is necessary in your application to protect the motor and load from jamming. Slip is sometimes required in systems that perform crushing or pumping of fluids with entrained solids. Operators sometimes rely upon the horrible screech to alert them that a jam has occurred.

Operating Conditions

Motor operating conditions affect efficiency and reliability. Record operating conditions at regular intervals. This will ensure that they are within tolerances for the motor. Also, trending these conditions can allow early detection of problems developing in the motor, load, or power distribution system.

Operating speed and voltage, and current on all three phases should be recorded. Also record power and power factor; these can both be determined by using either a power factor meter or power

meter. Refer to Chapter 4 for information on selecting appropriate test instruments for these measurements. For belt drive applications, also record speed of the load; it can be compared to motor speed over time to detect changes in slippage.

A significant change in voltage is not likely to be caused by the motor, but it affects the way the motor performs. Figure 9-1 shows how various full load performance parameters tend to change with a departure from nameplate voltage. At part load the changes in power factor and efficiency are worse with overvoltage, but only slight at undervoltage.

A change in current is usually associated with a change in shaft load. However, other factors can be involved such as a change in voltage as discussed above. Refer to Equation 5-4 to correct load estimates for a voltage change. An increase in current after motor repair may signal degradation from the failure and repair, such as turning down the rotor diameter to clean up a rub. This will be accompanied by an increased power factor and lower efficiency. It is best to determine shaft load change by determining input power with a power meter or combining a power factor reading with voltage and current readings using Equation 5-1. Output power still needs to be adjusted

Figure 9-1

Effect of Voltage Variation on Induction Motor Performance Characteristics

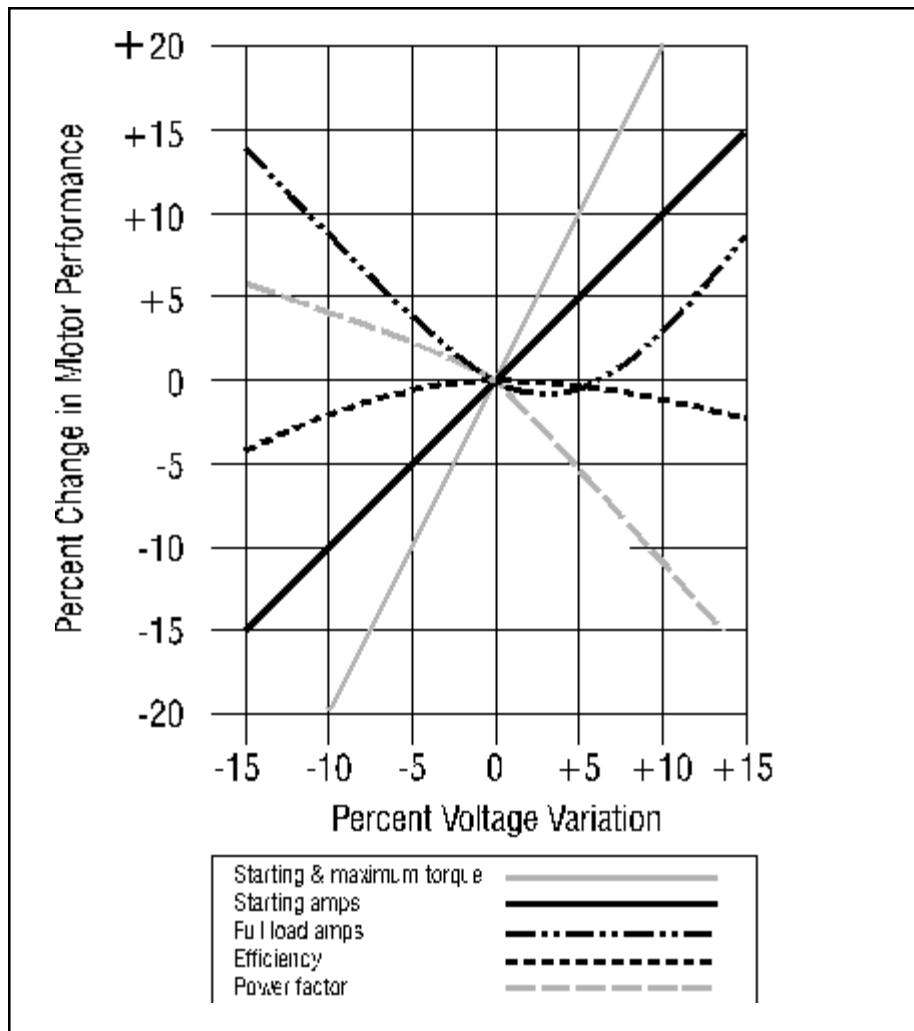

for efficiency differences which are associated with voltage change as indicated in Figure 9-1.

When power changes, it usually means something is changing in the load. With a centrifugal pump, a reduction in power may mean damage to an impeller. Inspect for variations in fluid flow and discharge pressure. With belt drives, a reduction in power may mean a slipping belt. With fans and blowers, a reduction in power generally signals clogging of filters or obstruction of duct work. Since motor speed only varies by a couple of percent from idle to full load, load changes are associated with changes in torque by the load. Understand how your load torque requirement varies with operating conditions. Power changes can then be used to detect load problems.

It is very important to note phase balance because unbalance can dramatically reduce motor efficiency and life. Check both voltage and current balance. A slight voltage unbalance can cause a larger motor current unbalance.

It is important not to mistake this situation for a motor problem. If there is a large current unbalance with little or no voltage unbalance, the motor may be at fault. A delta wound motor will still draw some current from all phases even with an open circuit in one phase winding. Take the motor off line and perform a winding resistance check. Aim for zero voltage unbalance. Unbalance over 2% is cause for immediate action.

With any of the measured conditions, do not assume the condition has progressively changed over time. Many conditions associated with the load or power supply vary during the day, even minute to minute. These can be picked up with a recording logger left in place for several hours or days. Often the patterns immediately hint at an explanation which may even be normal behavior. Other times, certain fluctuations remain an unsolved mystery.

An excellent tracking tool for managing your motor inventory and keeping track of power supply and loading conditions is the *MotorMaster+* software.

Equation 9-1

$$\frac{P_{02}}{P_{01}} = \frac{P_2 \times e_2}{P_1 \times e_1}$$

Where:

P_{02} = Corrected output power

P_{01} = Output power before correction

e_2 = Corrected efficiency

e_1 = Efficiency before correction

P_2 = Corrected input power

P_1 = Input power before correction

Consult the Motor Challenge Information Clearinghouse at (800) 862-2086 for availability of this product.

Thermal, Vibration and Acoustic Tests

Certain non-electrical tests can reveal problems that either result from or cause motor components to deteriorate.

Thermal

Thermal testing is a good indicator. It is not possible to measure surface temperature of a motor only once and infer its efficiency or general health. However, over time, increases in temperature which cannot be explained by other observed factors often signal problems.

Use a good contact thermometer at maintenance intervals. (Maintenance personnel can sometimes get early warning of a developing problem by cautiously touching the middle of the motor and bearing locations daily.) Measure temperature after the motor has been running long enough for temperature to stabilize. A greater increase in temperature at the bearing location than in the middle of the motor suggests a bearing problem. Verify adequate lubrication and schedule a bearing change *soon*. If it is a small motor on a non-critical application, it is sometimes sufficient to obtain a spare and wait.

A temperature increase away from the bearings is usually associated with something external to the motor that can harm the motor. Check for:

- An increase in loading,
- Obstruction of cooling air flow,

- Under-voltage,
- Development of a voltage unbalance condition,
- Line harmonics,
- Recent multiple starts, plugging, or jogging.

In variable speed drive powered motors, low speed without a dramatic torque reduction can cause overheating. Check with the drive and motor manufacturer regarding minimum safe speed for the torque loading.

Some larger motors have temperature sensors built right into the stator slots. This makes recording and trending temperature easy. When rewinding large or critical motors that do not have temperature sensors, consider having the sensors installed. Not only can they allow trending, they can be connected to protection equipment that sounds an alarm or shuts down the motor when temperature limits are exceeded.

Vibration

A change in vibration often signals a bearing problem. It can also signal other problems like a load imbalance, bent shaft, rotor damage, coupling misalignment, increase or change in line harmonics, or even voltage unbalance.

Many instruments are available to measure vibration. They vary from very sophisticated equipment that reads vibration and prints frequency profiles to simple hand-held gadgets with a row of resonating reeds.

Increased vibration at multiples of line frequency often signals electrical problems like harmonics. Vibration at 120 Hz can be indicative of phase unbalance. Vibrations at low multiples of actual rpm suggest mechanical

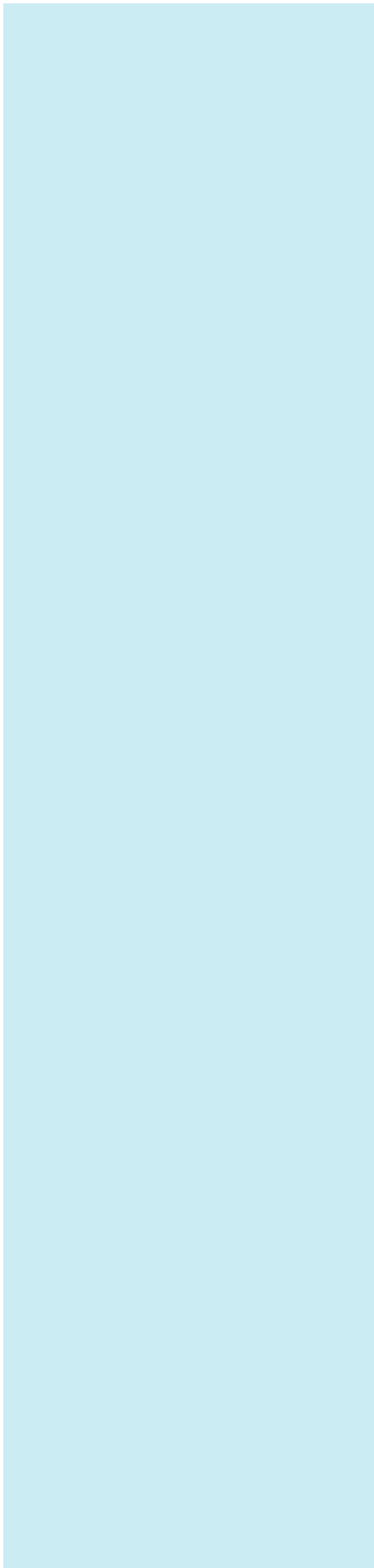

imbalance within the motor or load, or failure of some part of the mounting. Bearing problems are usually high frequency vibrations that may not be exact multiples of either line frequency or rpm. Instrument manufacturers usually provide analysis documentation that assists in diagnosing causes of certain vibration changes.

Acoustic

Audible vibration can often alert experienced personnel to problems. The most common of these are bearing problems. Electronic ultrasonic listening equipment can sometimes detect certain bearing problems like pitting from arcing or the occurrence of arcing in the windings.

Electrical Tests

Certain electrical tests should be periodically performed on the motor and motor circuit. Tests performed on the motor generally detect insulation problems. Tests performed on the distribution system frequently detect loose connections in the motor circuit, and can also detect winding errors in the motor.

Insulation resistance testing is the most important predictive motor electrical test. There are a number of special insulation resistance tests that can reveal degradation in insulation. Some can be used to trend degradation and foresee impending failures so a motor can be pulled for a clean and bake. This can avoid a costly or irreparable failure. These tests are known variously as AC or DC High Potential (Hi-Pot) test, surge comparison testing, polarization index (P-I) test, etc. The methods are too involved for complete description here, but numerous

materials are available to guide in their application.^{9-8, 9-9, 9-10, 9-11, 9-12, 9-13}

The motor circuit needs maintenance and inspection, too. Fuses degrade and develop high resistance. Connections become loose because of thermal cycling and creep. Aluminum components are particularly vulnerable to creep, the tendency to deform slowly over time with stress. Contacts become burned and worn so they “make” with high resistance or fail to “make” simultaneously. At annual maintenance intervals tighten connections with a torque wrench. Then, check connections and contacts with a micro-ohmmeter. Trend the results to reveal changes. It is difficult to give guidelines on acceptable resistance because of the tremendous difference in current between motors of different power and voltage. Sometimes it helps to determine reasonableness by converting the resistance values to watts lost or voltage drop. This is easily done with the Ohm’s law equations. (See Equation 9-2.)

It is inconvenient and time consuming to de-energize circuits to perform circuit troubleshooting maintenance. Some people supplement this with infrared thermography. Smaller firms often contract for this service. Equipment varies from small hand-held non-contact thermometers to devices that give color images of equipment with the colors correlated to temperature. This technology can identify trouble spots quickly without having to de-energize circuits. Various ANSI, IEEE, and NEMA standards give guidance on limits of temperature rise and ultimate temperatures for various electrical system components.

Motor circuit analysis is growing in popularity. This service is often offered by private contractors. The process usually consists of connecting proprietary test equipment to the circuit at the motor control panel. The equipment generally energizes the circuit with some sort of low power signal or pulsing, followed by an analysis of the circuit response with a computerized detector. Circuit resistance including motor winding resistance is determined. Sources of inductance and capacitance are measured and asymmetries detected.

A very comprehensive guidebook on maintaining distribution system health and symmetry is *Keeping the Spark in Your Electrical System: An Industrial Electrical Distribution Maintenance Guidebook*.⁹⁻⁷ It covers all aspects of the electrical distribution system including methods of testing and diagnosis, cost of uncorrected problems, and maintenance issues.

Storage and Transport

Motors can fail sitting on the shelf. Indeed, they can have a shorter life unpowered than continuously running. Lubricant can drain away from bearing surfaces and expose them to air and moisture. Even a tiny rust pit from such exposure can begin a progressive failure when the motor is put into service. High humidity is also an enemy to the winding insulation. Most insulation will absorb moisture from the air to a degree that significantly reduces dielectric strength. Vibrations can damage ball and roller bearings when the shaft is not turning. This is most common when motors are installed in high vibration equipment and subject to long periods not running, but it sometimes happens in transportation and storage areas subject to vibration.

Several things are necessary to reduce the stress of storage. If motors are connected, they should be started and run up to

Equation 9-2

$$V_j = I_j \times R$$

$$P_j = I_j^2 \times R$$

Where:

V_j = RMS voltage across a junction

I_j = RMS current through a junction

R = Resistance in ohms

P_j = Power dissipated in a junction in watts

temperature at least monthly; weekly is better in high relative humidity areas. For motors in storage, rotate the shaft at least monthly to reposition the bearings and distribute the lubricant.

Humidity control is imperative in storage areas. During cold weather, this can usually be accomplished by heating the storage area. If there are no sources of moisture (people, coffee makers, rain leaks, etc.), a 15°F rise above outdoor temperature will bring relative humidity under 70%, no matter how humid it is outside. During moderate to hot weather, dehumidification or air conditioning may be necessary. Some motors can be equipped with internal heaters by the manufacturer or when being rewound. These can be connected to keep the windings 10-20°F warmer than ambient when the motor is not running. When heaters are not installed, the motor can be connected to a low voltage DC power supply so that the windings serve as a low power heater. The power supply needs to be either current regulated or provided at a voltage determined by winding resistance. Consult your motor repairer for recommendations on a power supply. If a motor is to be put into service after prolonged storage in less than ideal conditions, warm it for a day or more before powering it.

Before shipping a motor, block the shaft to prevent axial and radial movement. If it is oil lubricated, drain the oil and tag the reservoir as empty.

References Chapter 9

- 9-1 “Quality Partnering: A Guide to Maximizing Your Electromechanical Systems,” Electrical Apparatus Service Association, St. Louis, MO
- 9-2 Todd Litman, “Efficient Electric Motor Systems,” The Fairmont Press, Inc., 1995, Lilburn, GA
- 9-3 “Incompatibility of Greases,” *NSK Techtalk* Vol. 01, No. 02, April 1992, Technical Tip-Sheet of the NSK Corporation
- 9-4 “How to Get the Most From Your Electric Motors,” Electrical Apparatus Service Association, St. Louis, MO
- 9-5 Richard L. Nailen, “Managing Motors,” Barks Publications Inc., 1991, Chicago, IL
- 9-6 “Electrical Engineering Pocket Handbook,” Electrical Apparatus Service Association, 1993, St. Louis, MO
- 9-7 Rob Gray, Washington State Energy Office, “Keeping the Spark in Your Electrical Distribution System: An Industrial Electrical Distribution Maintenance Guidebook,” Bonneville Power Administration, United States Department of Energy, PacifiCorp, Portland General Electric, Tacoma Public Utilities, October 1995.
- 9-8 “EASA Standards for the Repair of Electrical Apparatus,” The Electrical Apparatus Service Association, St. Louis, MO
- 9-9 Institute of Electrical and Electronics Engineers, “IEEE Std. 43-1974(R1991) IEEE Recommended Practice for Testing Insulation Resistance of Rotating Machinery.” (ANSI)
- 9-10 Institute of Electrical and Electronics Engineers, “IEEE Std. 95-1977 (R1991) IEEE Recommended Practice for Insulation Testing of Large AC Rotating Machinery with High Direct Voltage.” (ANSI)

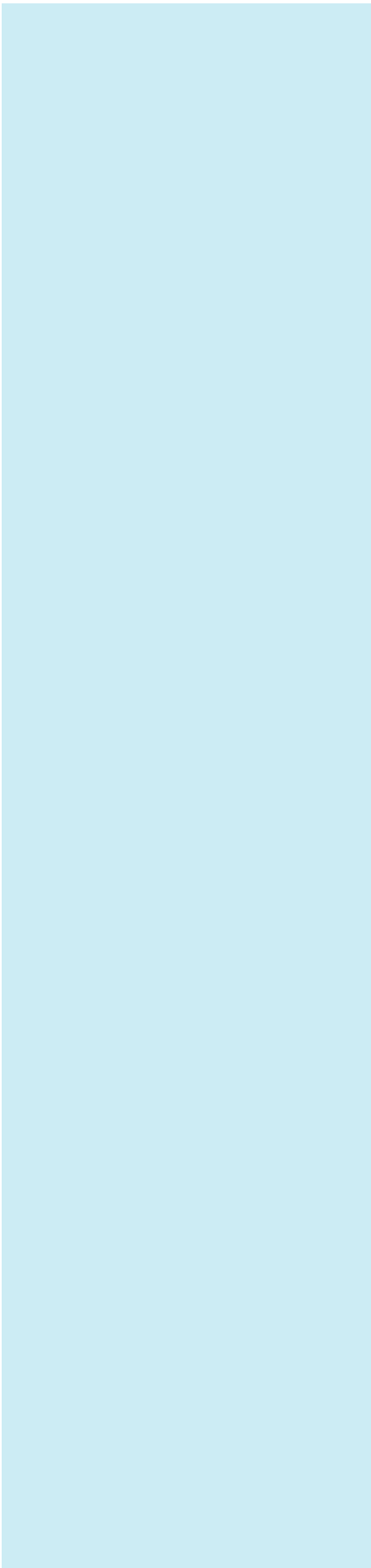
- 
- 9-11 National Electric Manufacturers Association, “NEMA Std. MG 1-1993 (R3): Motors and Generators.” Virginia, 1995.
 - 9-12 Howard W. Penrose, “Field Testing Electric Motors for Inverter Application,” Transactions: Electrical Manufacturing & Coil Winding '96, Electrical Manufacturing & Coil Winding Association, Inc.
 - 9-13 David E. Schump, “Predict Motor Failure with Insulation Testing,” Plant Engineering, September 1996

Appendix A

Motor Nameplate and Field Test Data Form

Employee Name _____
 Company _____
 Date _____

Facility/Location _____
 Department _____
 Process _____

General Data

Serving Electrical Utility _____
 Energy Rate (\$/kWh) _____
 Monthly Demand Charge (\$/kW/mo.) _____
 Application _____
Type of equipment that motor drives
 Coupling Type _____
 Motor Type (Design A,B,C,D _____
 AC,DC, etc.)
 Motor Purchase Date / Age _____
 Rewound Yes No

Motor Nameplate Data

1. Manufacturer _____
2. Motor ID Number _____
3. Model _____
4. Serial Number _____
5. NEMA Design Type _____
6. Size (hp) _____
7. Enclosure Type _____
8. Synchronous Speed (RPM) _____
9. Full Load Speed (RPM) _____
10. Voltage Rating _____
11. Frame Designation _____
12. Full Load Amperage _____
13. Full Load Power Factor (%) _____
14. Full Load Efficiency (%) _____
15. Service Factor Rating _____
16. Temperature Rise _____
17. Insulation Class _____
18. kVA Code _____

Motor Operating Profile

	Weekdays Days/Year	Wknd/Holiday Days/Year
Hours	1st Shift _____	_____
Per	2nd Shift _____	_____
Day	3rd Shift _____	_____

Annual Operating Time _____ hours/year

Type of load (Place an "X" by the most appropriate type)

- ___ 1. Load is quite steady, motor "On" during shift
- ___ 2. Load starts, stops, but is constant when "On"
- ___ 3. Load starts, stops, and fluctuates when "On"

Answer the following only if #2 or #3 above was selected:

% of time load is "on" _____%

Answer the following only if #3 was selected:

Estimate average load as a % of motor size _____%

Measured Data

Supply Voltage

By Voltmeter

Line-	V _{ab} _____	V _{avg} _____
to-	V _{bc} _____	
Line	V _{ca} _____	

Input Amps

By Ampmeter

A _a _____	A _{avg} _____
A _b _____	
A _c _____	

Power Factor (PF) _____

Input Power (kW) _____

If available. Otherwise equal to:

$$V_{avg} \times A_{avg} \times PF \times \sqrt{3} / 1000$$

Motor Operating Speed _____

By Tachometer

Driven Equipment Operating Speed _____

Appendix B

Average Efficiencies for Standard Efficiency Motors at Various Load Points

Efficiencies for 900 rpm, Standard Efficiency Motors								
Motor Size	Load Level In Percent							
	ODP				TEFC			
	100 %	75%	50%	25%	100%	75%	50%	25%
10	87.2	87.6	86.3	78.3	86.8	87.6	86.8	77.3
15	87.8	88.8	88.2	79.6	87.5	88.7	88.1	79.1
20	88.2	89.2	88.0	81.8	89.2	89.9	89.2	82.6
25	88.6	89.2	88.0	83.0	89.7	90.3	89.1	78.6
30	89.9	90.7	90.2	84.5	89.6	90.5	86.5	84.1
40	91.0	91.8	91.7	86.2	90.5	91.4	85.5	85.0
50	90.8	91.9	91.1	87.1	90.2	91.0	90.2	84.9
75	91.7	92.4	92.1	86.5	91.6	91.8	91.0	87.0
100	92.2	92.2	91.8	85.8	92.4	92.5	92.0	83.6
125	92.9	92.3	91.7	86.9	93.0	93.1	92.1	87.9
150	93.3	93.1	92.6	89.5	93.0	93.4	92.5	NA
200	92.8	93.5	93.1	NA	93.7	94.1	93.4	NA
250	93.1	93.5	93.0	NA	91.7	94.8	94.5	NA
300	93.1	93.7	92.9	92.7	94.4	94.2	93.7	NA

Efficiencies for 1200 rpm, Standard Efficiency Motors								
Motor Size	Load Level In Percent							
	ODP				TEFC			
	100 %	75%	50%	25%	100%	75%	50%	25%
10	87.3	86.9	85.7	78.5	87.1	87.7	86.4	80.3
15	87.4	87.5	86.8	80.8	88.2	88.1	87.3	80.7
20	88.5	89.2	88.8	84.1	89.1	89.7	89.4	82.8
25	89.4	89.7	89.3	85.0	89.8	90.5	89.8	83.5
30	89.2	90.1	89.8	87.6	90.1	91.3	90.7	84.6
40	90.1	90.4	90.0	85.8	90.3	90.1	89.3	85.3
50	90.7	91.2	90.9	86.9	91.6	92.0	91.5	86.7
75	92.0	92.5	92.3	88.6	91.9	91.6	91.0	87.2
100	92.3	92.7	92.2	87.4	92.8	92.7	91.9	86.5
125	92.6	92.9	92.8	87.9	93.0	93.0	92.6	88.7
150	93.1	93.3	92.9	89.7	93.3	93.8	93.4	91.1
200	94.1	94.6	93.5	91.5	94.0	94.3	93.6	NA
250	93.5	94.4	94.0	91.9	94.6	94.5	94.0	NA
300	93.8	94.4	94.3	92.9	94.7	94.8	94.0	NA

Efficiencies for 1800 rpm, Standard Efficiency Motors

Motor Size	Load Level In Percent							
	ODP				TEFC			
	100 %	75%	50%	25%	100%	75%	50%	25%
10	86.3	86.8	85.9	80.0	87.0	88.4	87.7	80.0
15	88.0	89.0	88.5	82.6	88.2	89.3	88.4	80.7
20	88.6	89.2	88.9	83.3	89.6	90.8	90.0	83.4
25	89.5	90.6	90.0	86.6	90.0	90.9	90.3	83.4
30	89.7	91.0	90.9	87.3	90.6	91.6	91.0	85.6
40	90.1	90.0	89.0	86.3	90.7	90.5	89.2	84.2
50	90.4	90.8	90.3	88.1	91.6	91.8	91.1	86.3
75	91.7	92.4	92.0	87.7	92.2	92.5	91.3	87.1
100	92.2	92.8	92.3	89.2	92.3	92.1	91.4	85.5
125	92.8	93.2	92.7	90.7	92.6	92.3	91.3	84.0
150	93.3	93.3	93.0	89.2	93.3	93.1	92.2	86.7
200	93.4	93.8	93.3	90.7	94.2	94.0	93.1	87.8
250	93.9	94.4	94.0	92.6	93.8	94.2	93.5	89.4
300	94.0	94.5	94.2	93.4	94.5	94.4	93.3	89.9

Efficiencies for 3600 rpm, Standard Efficiency Motors

Motor Size	Load Level In Percent							
	ODP				TEFC			
	100 %	75%	50%	25%	100%	75%	50%	25%
10	86.3	87.7	86.4	79.2	86.1	87.2	85.7	77.8
15	87.9	88.0	87.3	82.8	86.8	87.8	85.9	79.5
20	89.1	89.5	88.7	85.2	87.8	89.6	88.3	79.7
25	89.0	89.9	89.1	84.4	88.6	89.6	87.9	79.3
30	89.2	89.3	88.3	84.8	89.2	90.0	88.7	81.0
40	90.0	90.4	89.9	86.9	89.0	88.4	86.8	79.7
50	90.1	90.3	88.7	85.8	89.3	89.2	87.3	82.0
75	90.7	91.0	90.1	85.7	91.2	90.5	88.7	82.5
100	91.9	92.1	91.5	89.0	91.2	90.4	89.3	83.8
125	91.6	91.8	91.1	88.8	91.7	90.8	89.2	82.6
150	92.0	92.3	92.0	89.2	92.3	91.7	90.1	85.6
200	93.0	93.0	92.1	87.9	92.8	92.2	90.5	84.9
250	92.7	93.1	92.4	87.1	92.7	92.5	91.2	90.3
300	93.9	94.3	93.8	90.4	93.2	92.8	91.1	89.9

Appendix C Motor Energy Savings Calculation Form

Employee Name _____

Company _____

Date _____

Facility/Location _____

Department _____

Process _____

Motor Nameplate & Operating Information

Manufacturer _____

Motor ID Number _____

Size (hp) _____

Enclosure Type _____

Synchronous Speed (RPM) _____

Full Load Speed (RPM) _____

Full Load Amperage _____

Full Load Power Factor (%) _____

Full Load Efficiency (%) _____

Motor Load and Efficiency Determination

Load _____
Input Power(kW) / [Motor Size(hp) x 0.746 / Efficiency at Full Load]

Motor Efficiency at Operating Load _____
(Interpolate from Appendix B)

Energy Savings and Value

kW saved _____
Input Power - [Load x hp x 0.746 / Efficiency of Replacement Motor at Load Point]

kWh saved _____
kW saved x Annual Operating Hours

Utility Rates

Energy Rate (\$/kWh) _____

Monthly Demand Charge (\$/kW/mo.) _____

Annual Operating Hours (hrs/yr.) _____

Annual Energy Use and Cost

Input Power (kW) _____

Annual Energy Use _____
Input Power x Annual Operating Hours

Annual Energy Cost _____
Annual Energy Use x Energy Rate

Annual Demand Cost _____
Input Power x Monthly Demand Charge x 12

Total Annual Cost _____
Annual Energy Cost + Annual Demand Cost

Total Annual Savings

Total Annual Savings \$ _____
(kW saved x 12 x Monthly Demand Charge) + (kWh saved x Energy Rate)

Economic Justification

Cost for Replacement Motor _____
(or Incremental Cost for New Motor)

Simple Payback (years) _____
(Cost for Replacement Motor + Installation Charge - Utility Rebate) / Total Annual Savings

Appendix D Power Factor Correction Capacitor Suppliers

ASC Industries Inc./
Power Distribution Group
8967 Pleasantwood Avenue NW
North Canton, OH 44720-0523
Phone: (216) 499-1210

ASEA Brown boveri Inc./
ABB Power T & D Co., Inc.
630 Sentry Park
Blue Bell, PA 19422
Phone: (215) 834-7400

Aerovox Inc.
370 Faunce Corner Road
North Dartmouth, MA 02747
Phone: (508) 995-8000

Brush Fuses Inc.
800 Regency Drive
Glendale Heights, IL 60139-2286
Phone: (708) 894-2221

Commonwealth Sprague
Capacitor, Inc.
Brown Street
North Adams, MA 01247
Phone: (413) 664-4466

Delta Start Inc.
3550 Mayflower Drive
PO Box 10429
Lynchburg, VA 24506-0429
Phone: (800) 368-3017

General Electric Company
Industry Sales and Services
Division
1 River Road
Schenectady, NY 12345
Phone: (518) 385-2211

Graybar Electric Company, Inc.
34 North Meramec Avenue
PO Box 7231
St. Louis, MO 63172-9910
Phone: (314) 727-3900

North American Capacitor
Company
7545 Rockville Road
PO Box 1284
Indianapolis, IN 46206
Phone: (317) 273-0090

Plastic Capacitors, Inc.
2623 N. Pulaski Road
Chicago, IL 60639
Phone: (312) 489-2229

Ronk Electrical Industries, Inc.
PO Box 160
Nokomis, IL 62075-0160
Phone: (217) 563-8333



**FOR ADDITIONAL INFORMATION,
PLEASE CONTACT:**

The OIT Information Clearinghouse
Phone: (800) 862-2086
Fax: (360) 586-8303

Please send any comments,
questions, or suggestions to
webmaster.oit@ee.doe.gov

Visit our home page at
www.oit.doe.gov.

Office of Industrial Technologies
Energy Efficiency
and Renewable Energy
U.S. Department of Energy
Washington, DC 20585



DOE/MC-10021
Reprinted February 2000