

Draft Surplus Plutonium Disposition Supplemental Environmental Impact Statement

**Volume 2
(Appendices A through K)**

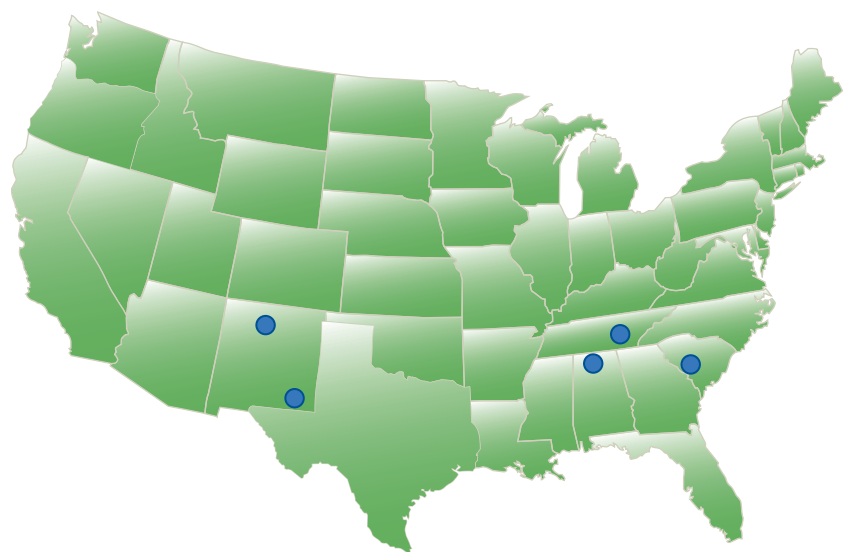

Savannah River Site – South Carolina



Sequoyah Nuclear Plant – Tennessee



Browns Ferry Nuclear Plant – Alabama



Waste Isolation Pilot Plant – New Mexico



Los Alamos National Laboratory – New Mexico



National Nuclear Security Administration
U.S. Department of Energy
Office of Fissile Materials Disposition
and
Office of Environmental Management
Washington, DC

AVAILABILITY OF THE
DRAFT SURPLUS PLUTONIUM DISPOSITION
SUPPLEMENTAL ENVIRONMENTAL IMPACT STATEMENT
(SPD Supplemental EIS)

To submit comments on this *SPD Supplemental EIS*, or to
request a copy, please contact:

Sachiko McAlhany, NEPA Document Manager
SPD Supplemental EIS
U.S. Department of Energy
P.O. Box 2324
Germantown, MD 20874-2324
Telephone: 1-877-344-0513
Email: spdsupplementaleis@saic.com



Printed with soy ink on recycled paper

COVER SHEET

Lead Agency: U.S. Department of Energy (DOE) / National Nuclear Security Administration (NNSA)

Cooperating Agency: Tennessee Valley Authority

Title: *Draft Surplus Plutonium Disposition Supplemental Environmental Impact Statement*
(SPD Supplemental EIS) (DOE/EIS-0283-S2)

Locations: South Carolina, New Mexico, Alabama, and Tennessee

For further information or for copies of this Draft SPD Supplemental EIS, contact:

Sachiko McAlhany, NEPA Document Manager
SPD Supplemental EIS
U.S. Department of Energy
P.O. Box 2324
Germantown, MD 20874-2324
Telephone: 1-877-344-0513
E-mail: spdsupplementaleis@saic.com

For general information on the DOE National Environmental Policy Act (NEPA) process, contact:

Carol M. Borgstrom, Director
Office of NEPA Policy and Compliance
U.S. Department of Energy
1000 Independence Avenue, SW
Washington, DC 20585-0103
Telephone: 202-586-4600, or leave a message
at 1-800-472-2756

This document is available on the *SPD Supplemental EIS* website (<http://nnsa.energy.gov/nepa/spdsupplementaleis>), the DOE NEPA website (<http://energy.gov/nepa/nepa-documents>), and the Savannah River Operations Office website (<http://www.srs.gov/general/pubs/envbul/nepa1.htm>) for viewing and downloading.

Abstract: On March 28, 2007, DOE published a Notice of Intent (NOI) in the *Federal Register* (72 FR 14543) to prepare the *SPD Supplemental EIS* to evaluate the potential environmental impacts at the Savannah River Site (SRS) in South Carolina of disposition pathways for surplus weapons-usable plutonium (referred to as “surplus plutonium”) originally planned for immobilization. The proposed actions and alternatives included construction and operation of a new vitrification capability in K-Area, processing in H-Canyon/HB-Line and the Defense Waste Processing Facility (DWPF), and fabricating mixed oxide (MOX) fuel in the MOX Fuel Fabrication Facility (MFFF) currently under construction in F-Area. Before the *Draft SPD Supplemental EIS* was issued, DOE decided to modify the scope of this *SPD Supplemental EIS* and evaluate additional alternatives. Therefore, on July 19, 2010 and again on January 12, 2012, DOE issued amended NOIs (75 FR 41850 and 77 FR 1920) announcing its intent to modify the scope of this *SPD Supplemental EIS* and to conduct additional public scoping.

The public scoping periods extended from March 28, 2007, through May 29, 2007; July 19, 2010 through September 17, 2010; and January 12, 2012 through March 12, 2012. Scoping meetings were conducted on April 17, 2007, in Aiken, South Carolina; April 19, 2007, in Columbia, South Carolina; August 3, 2010, in Tanner, Alabama; August 5, 2010, in Chattanooga, Tennessee; August 17, 2010, in North Augusta, South Carolina; August 24, 2010, in Carlsbad, New Mexico; August 26, 2010, in Santa Fe, New Mexico; and February 2, 2012, in Pojoaque, New Mexico. A summary of the comments received during the public scoping periods is provided in Chapter 1 of this *SPD Supplemental EIS* and available on the project website at <http://nnsa.energy.gov/nepa/spdsupplementaleis>.

DOE has revised the scope of this *SPD Supplemental EIS* to refine the quantity and types of surplus plutonium, evaluate additional alternatives (including additional pit disassembly and conversion options), no longer

consider in detail one of the alternatives identified in the 2007 NOI (ceramic can-in-canister immobilization), and revise DOE's preferred alternative. In this *SPD Supplemental EIS*, DOE describes the environmental impacts of alternatives for disposition of 13.1 metric tons (14.4 tons) of surplus plutonium for which DOE has not made a disposition decision, including 7.1 metric tons (7.8 tons) of plutonium from pits that were declared excess to national defense needs after publication of the 2007 NOI, and 6.0 metric tons (6.6 tons) of surplus non-pit plutonium. The analyses also encompass potential use of MOX fuel in reactors at the Sequoyah and Browns Ferry Nuclear Plants of the Tennessee Valley Authority (TVA).

In this *SPD Supplemental EIS*, DOE evaluates the No Action Alternative and four action alternatives for disposition of 13.1 metric tons (14.4 tons) of surplus plutonium: (1) Immobilization to DWPF Alternative – glass can-in-canister immobilization of both surplus non-pit and disassembled and converted pit plutonium and subsequent filling of the canister with high-level radioactive waste (HLW) at DWPF at SRS; (2) MOX Fuel Alternative – fabrication of the disassembled and converted pit plutonium and much of the non-pit plutonium into MOX fuel at MFFF, for use in domestic commercial nuclear power reactors to generate electricity, and disposition of the surplus non-pit plutonium that is not suitable for MFFF as transuranic waste at the existing Waste Isolation Pilot Plant (WIPP), a deep geologic repository in southeastern New Mexico; (3) H-Canyon/HB-Line to DWPF Alternative – processing the surplus non-pit plutonium in the existing H-Canyon/HB-Line at SRS with subsequent disposal as HLW (i.e., vitrification in the existing DWPF), and fabrication of the pit plutonium into MOX fuel at MFFF; and (4) WIPP Alternative – processing the surplus non-pit plutonium in the existing H-Canyon/HB-Line for disposal as transuranic waste at WIPP, and fabrication of the pit plutonium into MOX fuel at MFFF. Under all alternatives, DOE would also disposition as MOX fuel, 34 metric tons (37.5 tons) of surplus plutonium in accordance with previous decisions. The 34 metric tons (37.5 tons) of plutonium would be fabricated into MOX fuel at MFFF, for use at domestic commercial nuclear power reactors. Within each action alternative, DOE also evaluates options for pit disassembly and conversion to, among other things, disassemble nuclear weapons pits and convert the plutonium metal to an oxide form for disposition. Under three of the options, DOE would not build a stand-alone Pit Disassembly and Conversion Facility in F-Area at SRS, which DOE had previously decided to construct (65 FR 1608).

Preferred Alternative: The MOX Fuel Alternative is DOE's Preferred Alternative for surplus plutonium disposition. DOE's preferred option for pit disassembly and the conversion of surplus plutonium metal, regardless of its origins, to feed for MFFF is to use some combination of facilities at Technical Area 55 at Los Alamos National Laboratory and K-Area, H-Canyon/HB-Line, and MFFF at SRS, rather than to construct a new stand-alone facility. This would likely require the installation of additional equipment and other modifications to some of these facilities. DOE's preferred alternative for disposition of surplus plutonium that is not suitable for MOX fuel fabrication is disposal at WIPP. The TVA does not have a preferred alternative at this time regarding whether to pursue irradiation of MOX fuel in TVA reactors and which reactors might be used for this purpose.

Public Involvement: Comments on this *Draft SPD Supplemental EIS* should be submitted within 60 days of the publication of the U.S. Environmental Protection Agency's Notice of Availability in the *Federal Register* to ensure consideration in preparation of the *Final SPD Supplemental EIS*. DOE will consider comments received after the 60-day comment period to the extent practicable. Written comments may be submitted to Sachiko McAlhany via postal mail to the address provided above, via email to spdsupplementaleis@saic.com, or by toll-free fax to 1-877-865-0277. Public hearings on this *Draft SPD Supplemental EIS* will be held during the comment period. The dates, times, and locations of these hearings will be published in a DOE *Federal Register* notice and will also be announced by other means, including the project website, newspaper advertisements, and notification to persons on the mailing list. Information on this *SPD Supplemental EIS* can be found on the project website at <http://nnsa.energy.gov/nepa/spdsupplementaleis>.

TABLE OF CONTENTS

TABLE OF CONTENTS

Volume 2 Appendices A through K

Table of Contents.....	vii
List of Figures.....	xvi
List of Tables.....	xvii
Acronyms, Abbreviations, and Conversion Charts.....	xxv

Appendix A

Related National Environmental Policy Act Reviews and *Federal Register* Notices

A.1	Related NEPA Reviews – Surplus Plutonium Disposition.....	A-1
A.1.1	Historical NEPA Reviews.....	A-1
A.1.2	Recent NEPA Reviews for Development of This <i>Surplus Plutonium Disposition Supplemental Environmental Impact Statement</i>	A-5
A.2	Other Related DOE NEPA Reviews.....	A-5
A.2.1	Pit Storage at the Pantex Plant	A-5
A.2.2	Transuranic Waste Disposal at the Waste Isolation Pilot Plant	A-6
A.2.3	Plutonium Recovery through the Global Threat Reduction Initiative.....	A-6
A.2.4	Pit Disassembly and Conversion at the Los Alamos National Laboratory	A-7
A.2.5	Interim Management of Nuclear Materials at Savannah River Site.....	A-7
A.2.6	Vitrification of High-Level Radioactive Waste at Savannah River Site.....	A-7
A.2.7	Disposition of Surplus Highly Enriched Uranium	A-8
A.2.8	Waste Management.....	A-9
A.3	Related TVA NEPA Reviews	A-9
A.3.1	Browns Ferry Nuclear Plant.....	A-9
A.3.2	Sequoyah Nuclear Plant.....	A-10
A.4	Related <i>Federal Register</i> Notices.....	A-10
A.4.1	Federal Register Notices for the <i>Surplus Plutonium Disposition Supplemental Environmental Impact Statement</i>	A-10
A.4.2	Other Related <i>Federal Register</i> Notices	A-23
A.5	References.....	A-26

Appendix B

Facilities Description

B.1	Savannah River Site.....	B-7
B.1.1	F-Area Facilities	B-7
B.1.1.1	Pit Disassembly and Conversion Facility	B-7
B.1.1.2	Mixed Oxide Fuel Fabrication Facility	B-10
B.1.1.3	Waste Solidification Building.....	B-13
B.1.1.4	F/H-Laboratory.....	B-15

B.1.2	K-Area Complex	B-15
B.1.2.1	Immobilization Capability	B-16
B.1.2.2	Pit Disassembly and Conversion Project at K-Area	B-18
B.1.2.3	K-Area Storage	B-19
B.1.2.4	K-Area Interim Surveillance	B-19
B.1.2.5	K-Area Pit Disassembly Glovebox	B-20
B.1.3	H-Area Facilities – H-Canyon/HB-Line	B-20
B.1.4	S-Area Facilities	B-23
B.1.4.1	Defense Waste Processing Facility	B-23
B.1.4.2	Glass Waste Storage Buildings	B-25
B.1.5	E-Area Waste Management Facilities	B-25
B.2	Los Alamos National Laboratory	B-26
B.2.1	Plutonium Facility	B-26
B.2.2	Los Alamos National Laboratory Support Facilities	B-27
B.3	Waste Isolation Pilot Plant	B-28
B.4	Reactor Sites Using Mixed Oxide Fuel	B-29
B.5	References	B-31

Appendix C

Evaluation of Human Health Effects from Normal Operations

C.1	Introduction	C-1
C.2	Assessment Approach	C-1
C.2.1	Meteorological Data	C-1
C.2.2	Population Data	C-3
C.2.3	Agricultural Data	C-6
C.2.4	Source Term Data	C-6
C.2.5	Other Calculation Assumptions	C-8
C.3	Savannah River Site	C-9
C.3.1	K Area Storage, K Area Interim Surveillance Capability, K-Area Pit Disassembly and Conversion Project, and Pit Disassembly in K-Area Gloveboxes	C-12
C.3.1.1	Construction	C-12
C.3.1.2	Operations	C-12
C.3.2	Immobilization Capability in K-Area	C-17
C.3.2.1	Construction	C-17
C.3.2.2	Operations	C-17
C.3.3	H Canyon/HB Line	C-19
C.3.3.1	Construction	C-19
C.3.3.2	Operations	C-19
C.3.4	Mixed Oxide Fuel Fabrication Facility (including Metal Oxidation)	C-24
C.3.4.1	Construction	C-24
C.3.4.2	Operations	C-24
C.3.5	Pit Disassembly and Conversion Facility in F-Area	C-27
C.3.5.1	Construction	C-27
C.3.5.2	Operations	C-27
C.3.6	Waste Solidification Building	C-28
C.3.6.1	Construction	C-28
C.3.6.2	Operations	C-28
C.3.7	Defense Waste Processing Facility	C-30
C.3.7.1	Construction	C-30
C.3.7.2	Operations	C-30

C.4	Los Alamos National Laboratory	C-31
C.4.1	Los Alamos National Laboratory Plutonium Facility	C-31
C.4.1.1	Construction.....	C-31
C.4.1.2	Operations.....	C-31
C.5	Combined Impacts under Each Alternative	C-33
C.5.1	No Action Alternative.....	C-33
C.5.2	Immobilization to DWPF Alternative	C-34
C.5.3	MOX Fuel Alternative	C-35
C.5.4	H-Canyon/HB-Line to DWPF Alternative.....	C-38
C.5.5	WIPP Alternative.....	C-45
C.6	References.....	C-49

Appendix D

Evaluation of Human Health Effects from Facility Accidents

D.1	Impact Assessment Methods for Facility Accidents.....	D-1
D.1.1	Introduction.....	D-1
D.1.1.1	Risk.....	D-2
D.1.1.2	Uncertainties and Conservatism	D-2
D.1.2	Safety Strategy.....	D-3
D.1.2.1	General Safety Strategy for Plutonium Facilities.....	D-3
D.1.2.2	Design Process.....	D-4
D.1.3	U.S. Department of Energy Facility Accident Identification and Quantification	D-4
D.1.3.1	Background.....	D-4
D.1.3.2	Identification of Accident Scenarios and Frequencies.....	D-5
D.1.3.3	Identification of Material at Risk.....	D-8
D.1.3.4	Identification of Material Potentially Released to the Environment.....	D-9
D.1.4	Evaluation of Accident Consequences.....	D-10
D.1.4.1	Potential Receptors	D-10
D.1.4.2	Modeling of Dispersion of Releases to the Environment	D-10
D.1.4.3	Modeling of Consequences of Releases to the Environment.....	D-12
D.1.5	Accident Scenarios for Surplus Plutonium Disposition Facilities	D-12
D.1.5.1	Accident Scenario Consistency	D-12
D.1.5.2	Facility Accident Scenarios	D-15
D.1.5.2.1	Existing K Area Material Storage Area/K Area Interim Surveillance	D-15
D.1.5.2.2	Pit Disassembly and Conversion Facility at F-Area.....	D-19
D.1.5.2.3	Pit Disassembly and Conversion Capability at K-Area.....	D-21
D.1.5.2.4	Pit Disassembly Capability in K-Area Glovebox.....	D-24
D.1.5.2.5	Immobilization Capability at K-Area.....	D-26
D.1.5.2.6	Mixed Oxide Fuel Fabrication Facility	D-29
D.1.5.2.7	Waste Solidification Building	D-33
D.1.5.2.8	H Canyon/HB Line	D-38
D.1.5.2.9	Defense Waste Processing Facility	D-45
D.1.5.2.10	Glass Waste Storage Buildings	D-45
D.1.5.2.11	Los Alamos National Laboratory Plutonium Facility	D-46
D.2	Radiological Impacts of Facility Accidents.....	D-55
D.2.1	K Area Storage/K Area Interim Surveillance Capability Accident Impacts	D-55
D.2.2	Pit Disassembly and Conversion Facility at F-Area Accident Impacts	D-55
D.2.3	Pit Disassembly and Conversion Project at K-Area Accident Impacts.....	D-55
D.2.4	Pit Disassembly Capability at K-Area Accident Impacts	D-55
D.2.5	Immobilization Capability at K-Area Accident Impacts.....	D-55
D.2.6	Mixed Oxide Fuel Fabrication Facility Accident Impacts	D-61
D.2.7	Waste Solidification Building Accident Impacts	D-61
D.2.8	H Canyon/HB Line Accident Impacts	D-61

D.2.9	Los Alamos National Laboratory Plutonium Facility Accident Impacts	D-61
D.2.9.1	Potential Land Contamination Following Severe Earthquakes.....	D-66
D.2.9.2	Combined Impacts from TA-55 Building Collapses and Fires Resulting from a Beyond-Design-Basis Earthquake	D-66
D.3	Chemical Accidents	D-67
D.3.1	Savannah River Site Chemical Accidents Impacts	D-67
D.3.2	Los Alamos National Laboratory Chemical Accidents Impacts	D-67
D.4	Uncertainties	D-68
D.5	References	D-69

Appendix E

Evaluation of Human Health Effects from Transportation

E.1	Introduction	E-1
E.2	Scope of Assessment	E-1
E.2.1	Transportation-related Activities	E-1
E.2.2	Radiological Impacts	E-1
E.2.3	Nonradiological Impacts	E-2
E.2.4	Transportation Modes	E-2
E.2.5	Receptors	E-3
E.3	Packaging and Transportation Regulations	E-3
E.3.1	Packaging Regulations	E-4
E.3.2	Transportation Regulations	E-5
E.4	Transportation Analysis Impact Methodology	E-6
E.4.1	Transportation Routes	E-8
E.4.2	Radioactive Material Shipments	E-13
E.4.3	Radionuclide Inventories	E-15
E.5	Incident-free Transportation Risks	E-16
E.5.1	Radiological Risk.....	E-16
E.5.2	Nonradiological Risk	E-17
E.5.3	Maximally Exposed Individual Exposure Scenarios	E-17
E.6	Transportation Accident Risks	E-18
E.6.1	Methodology	E-18
E.6.2	Accident Rates	E-19
E.6.3	Accident Severity Categories and Conditional Probabilities	E-20
E.6.4	Atmospheric Conditions	E-21
E.6.5	Acts of Sabotage or Terrorism	E-22
E.7	Risk Analysis Results	E-22
E.8	Impact of Hazardous Waste and Construction and Operational Material Transport	E-39
E.9	Chemical Impacts.....	E-40
E.10	Onsite Transports.....	E-41
E.10.1	Onsite Shipments Related to Pit Disassembly and Conversion Options.....	E-42
E.10.2	Onsite Shipments Related to Disposition Options	E-44
E.10.3	Onsite Shipments Related to Support Activities	E-46
E.11	Conclusions	E-47
E.12	Long-term Impacts of Transportation	E-47

E.13	Uncertainty and Conservatism in Estimated Impacts	E-48
E.13.1	Uncertainties in Material Inventory and Characterization	E-49
E.13.2	Uncertainties in Containers, Shipment Capacities, and Number of Shipments	E-49
E.13.3	Uncertainties in Route Determination.....	E-49
E.13.4	Uncertainties in the Calculation of Radiation Doses	E-49
E.13.5	Uncertainties in Traffic Fatality Rates	E-50
E.14	References.....	E-51

Appendix F

Impacts of Pit Disassembly and Conversion Options

F.1	Air Quality	F-2
F.1.1	PDCF at F-Area at SRS	F-6
F.1.2	PDC at K-Area at SRS.....	F-6
F.1.3	PF-4 at LANL and MFFF at SRS	F-7
F.1.4	PF-4 at LANL and H-Canyon/HB-Line and MFFF at SRS.....	F-7
F.2	Human Health	F-7
F.2.1	Normal Operations.....	F-7
F.2.1.1	PDCF at F-Area at SRS	F-10
F.2.1.2	PDC at K-Area at SRS.....	F-10
F.2.1.3	PF-4 at LANL and MFFF at SRS	F-11
F.2.1.4	PF-4 at LANL and H-Canyon/HB-Line and MFFF at SRS.....	F-12
F.2.2	Accidents	F-13
F.2.2.1	PDCF at F-Area at SRS	F-16
F.2.2.2	PDC at K-Area at SRS.....	F-16
F.2.2.3	PF-4 at LANL and MFFF at SRS	F-16
F.2.2.4	PF-4 at LANL and H-Canyon/HB-Line and MFFF at SRS.....	F-17
F.3	Socioeconomics.....	F-18
F.3.1	PDCF at F-Area at SRS	F-19
F.3.2	PDC in K-Area at SRS.....	F-19
F.3.3	PF-4 at LANL and MFFF at SRS	F-20
F.3.4	PF-4 at LANL and H-Canyon/HB-Line and MFFF at SRS.....	F-20
F.4	Waste Management.....	F-21
F.4.1	PDCF in F-Area at SRS	F-21
F.4.2	PDC at K-Area at SRS.....	F-24
F.4.3	PF-4 at LANL and MFFF at SRS	F-25
F.4.4	PF-4 at LANL and H-Canyon/HB-Line and MFFF at SRS.....	F-26
F.5	Transportation.....	F-28
F.6	Environmental Justice	F-28
F.7	Other Resource Areas.....	F-29
F.7.1	Land Resources.....	F-29
F.7.1.1	PDCF at F-Area at SRS	F-29
F.7.1.2	PDC at K-Area at SRS.....	F-29
F.7.1.3	PF-4 at LANL and MFFF at SRS	F-30
F.7.1.4	PF-4 at LANL and H-Canyon/HB-Line and MFFF at SRS.....	F-30
F.7.2	Geology and Soils	F-31
F.7.2.1	PDCF at F-Area at SRS	F-31
F.7.2.2	PDC at K-Area at SRS.....	F-32
F.7.2.3	PF-4 at LANL and MFFF at SRS	F-32
F.7.2.4	PF-4 at LANL and H-Canyon/HB-Line and MFFF at SRS.....	F-32

F.7.3	Water Resources	F-32
F.7.3.1	PDCF at F-Area at SRS	F-33
F.7.3.1.1	Surface Water.....	F-33
F.7.3.1.2	Groundwater.....	F-35
F.7.3.2	PDC at K-Area at SRS.....	F-35
F.7.3.2.1	Surface Water.....	F-35
F.7.3.2.2	Groundwater.....	F-36
F.7.3.3	PF-4 at LANL and MFFF at SRS	F-36
F.7.3.3.1	Surface Water.....	F-36
F.7.3.3.2	Groundwater.....	F-37
F.7.3.4	PF-4 at LANL and H-Canyon/HB-Line and MFFF at SRS.....	F-37
F.7.3.4.1	Surface Water.....	F-37
F.7.3.4.2	Groundwater.....	F-38
F.7.4	Noise	F-38
F.7.4.1	PDCF at F-Area at SRS	F-38
F.7.4.2	PDC at K-Area at SRS.....	F-39
F.7.4.3	PF-4 at LANL and MFFF at SRS	F-39
F.7.4.4	PF-4 at LANL and H-Canyon/HB-Line and MFFF at SRS.....	F-39
F.7.5	Ecological Resources	F-39
F.7.5.1	PDCF at F-Area at SRS	F-40
F.7.5.2	PDC at K-Area at SRS.....	F-40
F.7.5.3	PF-4 at LANL and MFFF at SRS	F-41
F.7.5.4	PF-4 at LANL and H-Canyon/HB-Line and MFFF at SRS.....	F-41
F.7.6	Cultural Resources	F-42
F.7.6.1	PDCF at F-Area at SRS	F-42
F.7.6.2	PDC at K-Area at SRS.....	F-43
F.7.6.3	PF-4 at LANL and MFFF at SRS	F-43
F.7.6.4	PF-4 at LANL and H-Canyon/HB-Line and MFFF at SRS.....	F-44
F.7.7	Infrastructure.....	F-45
F.7.7.1	PDCF at F-Area at SRS	F-45
F.7.7.2	PDC at K-Area at SRS.....	F-45
F.7.7.3	PF 4 at LANL and MFFF at SRS	F-45
F.7.7.4	PF-4 at LANL and H-Canyon/HB-Line and MFFF at SRS.....	F-47
F.8	References	F-48

Appendix G
Impacts of Plutonium Disposition Options

G.1	Air Quality	G-2
G.1.1	Immobilization and DWPF	G-2
G.1.2	MOX Fuel.....	G-4
G.1.3	H-Canyon/HB-Line and DWPF.....	G-4
G.1.4	WIPP Disposal.....	G-4
G.2	Human Health	G-5
G.2.1	Normal Operations.....	G-5
G.2.1.1	Immobilization and DWPF.....	G-5
G.2.1.2	MOX Fuel.....	G-8
G.2.1.3	H-Canyon/HB-Line and DWPF.....	G-8
G.2.1.4	WIPP Disposal.....	G-8
G.2.2	Accidents	G-9
G.2.2.1	Immobilization and DWPF.....	G-9
G.2.2.2	MOX Fuel.....	G-12
G.2.2.3	H-Canyon/HB-Line and DWPF.....	G-12
G.2.2.4	WIPP Disposal.....	G-13

G.3	Socioeconomics	G-13
	G.3.1 Immobilization and DWPF.....	G-13
	G.3.2 MOX Fuel.....	G-16
	G.3.3 H-Canyon/HB-Line and DWPF.....	G-16
	G.3.4 WIPP Disposal.....	G-17
G.4	Waste Management	G-17
	G.4.1 Immobilization and DWPF.....	G-17
	G.4.2 MOX Fuel.....	G-19
	G.4.3 H-Canyon/HB-Line and DWPF.....	G-20
	G.4.4 WIPP Disposal.....	G-20
G.5	Transportation	G-21
G.6	Environmental Justice	G-22
G.7	Other Resource Areas	G-22
	G.7.1 Land Resources.....	G-22
	G.7.1.1 Immobilization and DWPF.....	G-22
	G.7.1.2 MOX Fuel.....	G-22
	G.7.1.3 H-Canyon/HB-Line and DWPF.....	G-22
	G.7.1.4 WIPP Disposal.....	G-23
	G.7.2 Geology and Soils.....	G-23
	G.7.2.1 Immobilization and DWPF.....	G-23
	G.7.2.2 MOX Fuel.....	G-24
	G.7.2.3 H-Canyon/HB-Line and DWPF.....	G-24
	G.7.2.4 WIPP Disposal.....	G-24
	G.7.3 Water Resources.....	G-24
	G.7.3.1 Immobilization and DWPF.....	G-24
	G.7.3.1.1 Surface Water.....	G-24
	G.7.3.1.2 Groundwater.....	G-25
	G.7.3.2 MOX Fuel.....	G-25
	G.7.3.2.1 Surface Water.....	G-25
	G.7.3.2.2 Groundwater.....	G-26
	G.7.3.3 H-Canyon/HB-Line and DWPF.....	G-26
	G.7.3.3.1 Surface Water.....	G-26
	G.7.3.3.2 Groundwater.....	G-27
	G.7.3.4 WIPP Disposal.....	G-27
	G.7.3.4.1 Surface Water.....	G-27
	G.7.3.4.2 Groundwater.....	G-27
	G.7.4 Noise.....	G-27
	G.7.5 Ecological Resources.....	G-28
	G.7.5.1 Immobilization and DWPF.....	G-28
	G.7.5.2 MOX Fuel.....	G-29
	G.7.5.3 H-Canyon/HB-Line and DWPF.....	G-29
	G.7.5.4 WIPP Disposal.....	G-30
	G.7.6 Cultural Resources.....	G-30
	G.7.6.1 Immobilization and DWPF.....	G-30
	G.7.6.2 MOX Fuel.....	G-31
	G.7.6.3 H-Canyon/HB-Line and DWPF.....	G-31
	G.7.6.4 WIPP Disposal.....	G-31
	G.7.7 Infrastructure.....	G-32
	G.7.7.1 Immobilization and DWPF.....	G-32
	G.7.7.2 MOX Fuel.....	G-32
	G.7.7.3 H-Canyon/HB-Line and DWPF.....	G-34
	G.7.7.4 WIPP Disposal.....	G-34
G.8	References	G-35

**Appendix H
Impacts of Principal Plutonium Support Facilities**

H.1	Principal Savannah River Site Plutonium Support Facilities	H-2
H.1.1	Air Quality	H-3
H.1.2	Human Health	H-3
H.1.2.1	Incident-Free Operations	H-3
H.1.2.2	Accidents	H-5
H.1.2.2.1	K-Area Storage and K-Area Interim Surveillance	H-5
H.1.2.2.2	Waste Solidification Building	H-6
H.1.2.2.3	Accidents Involving K-Area Support Activities and WSB	H-7
H.1.3	Socioeconomics	H-7
H.1.3.1	K-Area Storage	H-7
H.1.3.2	K Area Interim Surveillance	H-7
H.1.3.3	Waste Solidification Building	H-8
H.1.4	Waste Management	H-8
H.1.4.1	K-Area Storage	H-8
H.1.4.2	K-Area Interim Surveillance	H-8
H.1.4.3	Waste Solidification Building	H-9
H.1.4.4	E-Area	H-9
H.1.5	Transportation	H-9
H.1.6	Environmental Justice	H-10
H.1.7	Other Resource Areas	H-10
H.1.7.1	Water Resources	H-10
H.1.7.1.1	K-Area Storage and K-Area Interim Surveillance	H-10
H.1.7.1.2	Waste Solidification Building	H-10
H.1.7.2	Noise	H-10
H.1.7.3	Infrastructure	H-11
H.1.7.3.1	K-Area Storage and K-Area Interim Surveillance	H-11
H.1.7.3.2	Waste Solidification Building	H-11
H.2	Principal Los Alamos National Laboratory Plutonium Support Facilities	H-11
H.3	References	H-13

**Appendix I
Impacts of Mixed Oxide Fuel Use in Domestic Commercial Nuclear Power Reactors**

I.1	Impacts of Irradiating Mixed Oxide Fuel at Tennessee Valley Authority Reactor Sites	I-1
I.1.1	Construction Impacts	I-2
I.1.2	Operational Impacts	I-2
I.1.2.1	Air Quality	I-2
I.1.2.2	Human Health Risk	I-3
I.1.2.3	Socioeconomics	I-10
I.1.2.4	Waste Management and Used Nuclear Fuel	I-10
I.1.2.5	Transportation	I-10
I.1.2.6	Environmental Justice	I-12
I.1.2.7	Other Resource Areas	I-13

I.2	Impacts of Irradiating Mixed Oxide Fuel at Generic Commercial Nuclear Power Reactor Sites.....	I-14
I.2.1	Construction Impacts	I-14
I.2.2	Operational Impacts	I-14
I.2.2.1	Air Quality	I-14
I.2.2.2	Human Health Risk.....	I-15
I.2.2.3	Socioeconomics	I-17
I.2.2.4	Waste Management and Used Nuclear Fuel	I-17
I.2.2.5	Transportation.....	I-17
I.2.2.6	Environmental Justice.....	I-18
I.2.2.7	Other Resource Areas	I-19
I.3	References.....	I-20

Appendix J

Evaluation of Select Reactor Accidents with Mixed Oxide Fuel Use at the Browns Ferry and Sequoyah Nuclear Plants

J.1	Introduction.....	J-1
J.2	Background.....	J-1
J.2.1	Operation with Mixed Oxide Fuel	J-3
J.2.2	Sequoyah and Browns Ferry Nuclear Plant Low-Enriched Uranium and Partial Mixed Oxide Core Inventory Development	J-4
J.2.3	Meteorological Data.....	J-8
J.2.4	Population Data.....	J-8
J.3	Reactor Accident Identification and Quantification	J-10
J.3.1	Design-Basis Accidents	J-13
J.3.1.1	Browns Ferry Design-Basis Accident Analysis.....	J-15
J.3.1.2	Sequoyah Design-Basis Accident Analysis	J-16
J.3.2	Beyond-Design-Basis Accidents.....	J-16
J.3.3	Beyond-Design-Basis Accident Analysis	J-19
J.3.3.1	Browns Ferry Beyond-Design-Basis Accident Analysis	J-19
J.3.3.2	Sequoyah Beyond-Design-Basis Accidents.....	J-20
J.3.3.3	Consideration of Other Severe Accidents.....	J-21
J.3.4	Overall Modeling Results	J-23
J.4	Uncertainties.....	J-24
J.5	References.....	J-26

Appendix K

Contractor Disclosure Statement	K-1
--	------------

LIST OF FIGURES

Appendix B

Figure B-1	Locations of Major Facilities Evaluated in this <i>Surplus Plutonium Disposition Supplemental Environmental Impact Statement</i>	B-1
Figure B-2	Savannah River Site Location and Operations Areas	B-2
Figure B-3	Los Alamos National Laboratory Location and Technical Areas	B-3
Figure B-4	Location of Facilities in Technical Area 55	B-4
Figure B-5	Pit Disassembly and Conversion Capability in the Pit Disassembly and Conversion Facility in F-Area or the Pit Disassembly and Conversion Project in K-Area	B-9
Figure B-6	Mixed Oxide Fuel Fabrication Process	B-12
Figure B-7	Metal Oxidation Process	B-13
Figure B-8	Typical Reactor Fuel Assembly	B-14
Figure B-9	Cutaway of Can-in-Canister	B-16
Figure B-10	Immobilization Capability	B-17
Figure B-11	H-Canyon/HB-Line Plutonium Processing for MOX Fuel	B-20
Figure B-12	HB-Line Repackaging for Waste Isolation Pilot Plant Disposal	B-23
Figure B-13	Transuranic Package Transporter Model 2	B-26

Appendix E

Figure E-1	Transportation Risk Assessment	E-7
Figure E-2	Analyzed National and Regional Truck Routes from Savannah River Site	E-11
Figure E-3	Analyzed National and Regional Truck Routes from Los Alamos National Laboratory	E-12

LIST OF TABLES

Appendix B

Table B-1	Proposed Facility Construction and Modification Summary	B-5
Table B-2	Duration of Facility Construction and Operations (years)	B-6
Table B-3	Maximum Annual/Total Plutonium Throughput Analyzed (metric tons).....	B-7

Appendix C

Table C-1	Savannah River Site Joint Frequency Distribution Data.....	C-2
Table C-2	Los Alamos National Laboratory Joint Frequency Distribution Data	C-3
Table C-3	Estimated Population Surrounding the Savannah River Site F Area in the Year 2020	C-4
Table C-4	Estimated Population Surrounding the Savannah River Site K Area in the Year 2020.....	C-4
Table C-5	Estimated Population Surrounding the Savannah River Site H Canyon/S Area in the Year 2020.....	C-5
Table C-6	Estimated Population Surrounding the Los Alamos National Laboratory Plutonium Facility in the Year 2020.....	C-5
Table C-7	Stack Parameters.....	C-6
Table C-8	Annual Radiological Releases from K Area Interim Surveillance Capability Activities.....	C-6
Table C-9	Annual Radiological Releases from the Immobilization Capability	C-7
Table C-10	Annual Radiological Releases from H Canyon/HB Line Processing of Surplus Plutonium to the Defense Waste Processing Facility	C-7
Table C-11	Annual Radiological Releases from the Mixed Oxide Fuel Fabrication Facility	C-7
Table C-12	Annual Radiological Releases from the Pit Disassembly and Conversion Facility and the Pit Disassembly and Conversion Project at K-Area	C-7
Table C-13	Annual Radiological Releases from the Waste Solidification Building	C-7
Table C-14	Annual Radiological Releases from Metal Oxidation at the Mixed Oxide Fuel Fabrication Facility	C-7
Table C-15	Annual Radiological Releases from Pit Disassembly and Conversion Activities at the Los Alamos National Laboratory Plutonium Facility.....	C-8
Table C-16	Radiological Impacts on Workers from K Area Storage Operations.....	C-14
Table C-17	Radiological Impacts on the Public from Operation of the K Area Interim Surveillance Capability.....	C-15
Table C-18	Radiological Impacts on Workers from Operation of the K Area Interim Surveillance Capability.....	C-15
Table C-19	Radiological Impacts on the Public from Operation of the Pit Disassembly and Conversion Project in K-Area.....	C-16
Table C-20	Radiological Impacts on Workers from Operation of the Pit Disassembly and Conversion Project in K-Area.....	C-16
Table C-21	Radiological Impacts on Workers from Pit Disassembly Activities in K Area Gloveboxes	C-17
Table C-22	Radiological Impacts on the Public from Operation of the K-Area Immobilization Capability.....	C-18
Table C-23	Radiological Impacts on Workers from Operation of the K-Area Immobilization Capability	C-18
Table C-24	Radiological Impacts on the Public from Operation of H Canyon/HB Line – Processing Surplus Non-Pit Plutonium for Transfer to the Defense Waste Processing Facility.....	C-21
Table C-25	Radiological Impacts on Workers from Operation of H Canyon/HB Line – Processing Surplus Non-Pit Plutonium for Transfer to the Defense Waste Processing Facility.....	C-21
Table C-26	Radiological Impacts on the Public from Operation of H Canyon/HB Line – Pit and Metal Conversion to Oxide for Mixed Oxide Fuel Fabrication	C-22
Table C-27	Radiological Impacts on Workers from Operation of H Canyon/HB Line – Pit and Metal Conversion to Oxide for Mixed Oxide Fuel Fabrication	C-22
Table C-28	Radiological Impacts on the Public from Operation of H Canyon/HB Line – Processing to the Waste Isolation Pilot Plant.....	C-23

Table C-29	Radiological Impacts on Workers from Operation of H Canyon/HB Line – Processing to the Waste Isolation Pilot Plant.....	C-23
Table C-30	Radiological Impacts on the Public from Operation of the Mixed Oxide Fuel Fabrication Facility	C-25
Table C-31	Radiological Impacts on Workers from Operation of the Mixed Oxide Fuel Fabrication Facility	C-25
Table C-32	Radiological Impacts on the Public from Operation of Metal Oxidation Furnaces at the Mixed Oxide Fuel Fabrication Facility	C-26
Table C-33	Radiological Impacts on Workers from Operation of Metal Oxidation Furnaces at the Mixed Oxide Fuel Fabrication Facility	C-26
Table C-34	Radiological Impacts on the Public from Operation of the Pit Disassembly and Conversion Facility in F-Area.....	C-27
Table C-35	Radiological Impacts on Workers from Operation of the Pit Disassembly and Conversion Facility in F-Area.....	C-28
Table C-36	Radiological Impacts on the Public from Operation of the Waste Solidification Building	C-29
Table C-37	Radiological Impacts on Workers from Operation of the Waste Solidification Building.....	C-29
Table C-38	Potential Incremental Radiological Impacts on Workers from Operation of the Defense Waste Processing Facility.....	C-31
Table C-39	Potential Radiological Impacts on the Public from Pit Disassembly and Conversion Operations at the Los Alamos National Laboratory Plutonium Facility.....	C-32
Table C-40	Potential Radiological Impacts on Workers from Pit Disassembly and Conversion Operations at the Los Alamos National Laboratory Plutonium Facility	C-32
Table C-41	Radiological Impacts on Workers from Operations Under the No Action Alternative	C-33
Table C-42	Radiological Impacts on the Public from Operations Under the No Action Alternative	C-34
Table C-43	Radiological Impacts on Workers from Operations Under the Immobilization to DWPF Alternative	C-36
Table C-44	Radiological Impacts on the Public from Operations Under the Immobilization to DWPF Alternative	C-37
Table C-45	Radiological Impacts On Workers from Operations Under the MOX Fuel Alternative.....	C-39
Table C-46	Radiological Impacts on the Public from Operations Under the MOX Fuel Alternative	C-40
Table C-47	Radiological Impacts On Workers from Operations Under the H Canyon/HB-Line to DWPF Alternative	C-42
Table C-48	Radiological Impacts on the Public from Operations Under the H-Canyon/HB-Line to DWPF Alternative	C-43
Table C-49	Potential Radiological Impacts On Workers from Operations Under the WIPP Alternative	C-46
Table C-50	Radiological Impacts on the Public from Operations Under the WIPP Alternative	C-47

Appendix D

Table D-1	Accident Scenarios and Source Terms for the K-Area Material Storage Area/K Area Interim Surveillance Capability.....	D-18
Table D-2	Accident Scenarios and Source Terms for the Pit Disassembly and Conversion Facility at F-Area	D-21
Table D-3	Accident Scenarios and Source Terms for the Pit Disassembly and Conversion Project at K-Area	D-23
Table D-4	Accident Scenarios and Source Terms for the Pit Disassembly Capability in a Glovebox at K-Area	D-26
Table D-5	Accident Scenarios and Source Terms for the Immobilization Capability Under the Immobilization to DWPF Alternative.....	D-29
Table D-6	Accident Scenarios and Source Terms for the Mixed Oxide Fuel Fabrication Facility Under All Alternatives.....	D-32
Table D-7	Accident Scenarios and Source Terms for the Waste Solidification Building.....	D-37
Table D-8	Accident Scenarios and Source Terms for the H Canyon/HB Line Under All Alternatives.....	D-44
Table D-9	Accident Scenarios and Source Terms for the Los Alamos National Laboratory Plutonium Facility Pit Disassembly and Conversion Capability.....	D-54

Table D-10	Accident Impacts for the K-Area Storage/K-Area Interim Surveillance	D-56
Table D-11	Accident Impacts for the Pit Disassembly and Conversion Facility at F-Area.....	D-57
Table D-12	Accident Impacts for the Pit Disassembly and Conversion Project at K-Area	D-58
Table D-13	Accident Impacts for the Pit Disassembly Capability in K-Area.....	D-59
Table D-14	Accident Impacts for the Can-in-Can Immobilization Capability at K-Area.....	D-60
Table D-15	Accident Impacts for the Mixed Oxide Fuel Fabrication Facility Including the Metal Oxidation Capability.....	D-62
Table D-16	Accident Impacts for the Waste Solidification Building	D-63
Table D-17	Accident Impacts for H Canyon/HB Line.....	D-64
Table D-18	Accident Impacts for PF-4 Pit Disassembly and Conversion	D-65

Appendix E

Table E-1	Offsite Transport Truck Route Characteristics	E-10
Table E-2	Material or Waste Type and Associated Container Characteristics	E-14
Table E-3	Low-Level and Mixed Low-Level Radioactive Waste Radionuclide Concentrations.....	E-15
Table E-4	Radioisotopic Content of Transport Packages Containing Unirradiated Boiling Water Reactor and Pressurized Water Reactor Fuel	E-16
Table E-5	Risk Factors per Shipment of Radioactive Material and Waste.....	E-23
Table E-6	Risks of Transporting Radioactive Material and Waste – No Action Alternative	E-25
Table E-7	Risks of Transporting Radioactive Material and Waste – Immobilization to DWPF Alternative	E-26
Table E-8	Risks of Transporting Radioactive Material and Waste – MOX Fuel Alternative	E-28
Table E-9	Risks of Transporting Radioactive Material and Waste – H-Canyon/HB-Line to DWPF Alternative	E-31
Table E-10	Risks of Transporting Radioactive Material and Waste – WIPP Alternative	E-33
Table E-11	Estimated Dose to Maximally Exposed Individuals Under Incident Free Transportation Conditions	E-37
Table E-12	Estimated Dose to the Population and to Maximally Exposed Individuals Under the Maximum Reasonably Foreseeable Accident.....	E-38
Table E-13	Estimated Impacts of Construction Material Transport	E-39
Table E-14	Estimated Impacts of Hazardous Waste Transport	E-40
Table E-15	Average Annual Number of Onsite Waste Shipments due to Construction and Modifications from Disassembly and Conversion Options.....	E-42
Table E-16	Pit Disassembly and Conversion Facility Average Annual Number of Onsite Waste Shipments due to Operations from Disassembly and Conversion Options.....	E-42
Table E-17	Average Annual Number of Onsite Waste Shipments due to Construction and Modifications for Disposition Options.....	E-45
Table E-18	Average Annual Number of Onsite Waste Shipments due to Operations for Disposition Options	E-45
Table E-19	Average Annual Number of Onsite Waste Shipments due to Operations of Support Facilities	E-46
Table E-20	Cumulative Transportation-Related Radiological Collective Doses and Latent Cancer Fatalities (1943 to 2073).....	E-48

Appendix F

Table F-1	Estimated Air Pollutant Concentrations at Site Boundary from Construction of, or Modifications to, Pit Disassembly and Conversion Facilities	F-3
Table F-2	Peak Year Air Pollutant Emissions from Construction of, or Modifications to, Pit Disassembly and Conversion Facilities	F-4
Table F-3	Estimated Air Pollutant Concentrations at Site Boundary from Operation of Pit Disassembly and Conversion Facilities	F-5
Table F-4	Potential Radiological Impacts on Involved Workers from Pit Disassembly and Conversion Options	F-8
Table F-5	Potential Radiological Impacts on the Public from Pit Disassembly and Conversion Options	F-9
Table F-6	Risks to the General Public within 50 Miles (80 kilometers) from Limiting Accidents Associated with Pit Disassembly and Conversion Options	F-14

Table F-7	Risks to the MEI and Noninvolved Worker from Limiting Accidents Associated with Pit Disassembly and Conversion Options.....	F-15
Table F-8	Peak Annual Socioeconomic Impacts associated with Construction of Pit Disassembly and Conversion Options.....	F-18
Table F-9	Peak Annual Socioeconomic Impacts associated with Operation of Pit Disassembly and Conversion Options.....	F-19
Table F-10	Summary of Waste Management Capacities at the Savannah River Site	F-22
Table F-11	Summary of Waste Management Capacities at Los Alamos National Laboratory.....	F-22
Table F-12	Average Annual Construction Waste Generation from PDCF at the Savannah River Site	F-23
Table F-13	Total Construction Waste Generation from PDCF at the Savannah River Site	F-23
Table F-14	Peak Annual Operations Waste Generation from PDCF at the Savannah River Site and PF-4 at Los Alamos National Laboratory.....	F-23
Table F-15	Average Annual Construction Waste Generation from PDC at the Savannah River Site	F-24
Table F-16	Total Construction Waste Generation from PDC at the Savannah River Site	F-24
Table F-17	Peak Annual Operations Waste Generation from PDC at the Savannah River Site and PF-4 at Los Alamos National Laboratory.....	F-25
Table F-18	Average Annual Construction Waste Generation from MFFF at the Savannah River Site and PF-4 at Los Alamos National Laboratory	F-25
Table F-19	Total Construction Waste Generation from MFFF at the Savannah River Site and PF-4 at Los Alamos National Laboratory.....	F-26
Table F-20	Peak Annual Operations Waste Generation from MFFF at the Savannah River Site and PF-4 at Los Alamos National Laboratory	F-26
Table F-21	Average Annual Construction Waste Generation from K-Area, H-Canyon/HB-Line, and MFFF at the Savannah River Site, and PF-4 at Los Alamos National Laboratory	F-27
Table F-22	Total Construction Waste Generation from K-Area, H-Canyon/HB-Line, and MFFF at the Savannah River Site, and PF-4 at Los Alamos National Laboratory	F-27
Table F-23	Peak Annual Operations Waste Generation from K-Area, H-Canyon/HB-Line, and MFFF at the Savannah River Site, and PF-4 at Los Alamos National Laboratory	F-28
Table F-24	Use of Geologic and Soils Materials during Construction under the Pit Disassembly and Conversion Options.....	F-31
Table F-25	Nonhazardous Wastewater Generated During Pit Disassembly and Conversion Facility Operations.....	F-34
Table F-26	Peak Annual Construction Infrastructure Requirements Associated with Pit Disassembly and Conversion Options.....	F-46
Table F-27	Peak Annual Operational Infrastructure Requirements Associated with Pit Disassembly and Conversion Options.....	F-46

Appendix G

Table G-1	Estimated Air Pollutant Concentrations at the Site Boundary from Operations at Plutonium Disposition Facilities	G-3
Table G-2	Estimated Air Pollutant Emissions from Testing and Operation of Diesel Generators for the K-Area Immobilization Capability.....	G-4
Table G-3	Potential Radiological Impacts on Involved Workers from Plutonium Disposition Options at the Savannah River Site	G-6
Table G-4	Potential Radiological Impacts on the Public from Plutonium Disposition Options at the Savannah River Site	G-7
Table G-5	Risks to the Public within 50 Miles (80 kilometers) from Limiting Accidents Associated with Plutonium Disposition Options at the Savannah River Site.....	G-10
Table G-6	Risk to the Maximally Exposed Individual and Noninvolved Worker from Limiting Accidents Associated with Plutonium Disposition Options at the Savannah River Site	G-11
Table G-7	Peak Annual Socioeconomic Impacts from Construction in Support of Plutonium Disposition Options at the Savannah River Site	G-14
Table G-8	Peak Annual Socioeconomic Impacts from Facility Operations in Support of Plutonium Disposition Options at the Savannah River Site	G-15
Table G-9	Immobilization and DWPf Option Average Annual Construction Waste Generation.....	G-18

Table G-10	Immobilization and DWPF Option Total Construction Waste Generation	G-18
Table G-11	Immobilization and DWPF Option Peak Annual Operations Waste Generation.....	G-19
Table G-12	MOX Fuel Option Peak Annual Operations Waste Generation	G-19
Table G-13	H-Canyon/HB-Line and DWPF Option Peak Annual Operations Waste Generation	G-20
Table G-14	WIPP Disposal Option Average Annual Construction Waste Generation.....	G-20
Table G-15	WIPP Disposal Option Total Construction Waste Generation	G-21
Table G-16	WIPP Disposal Option Peak Annual Operations Waste Generation	G-21
Table G-17	Peak Annual Construction Infrastructure Requirements from Plutonium Disposition Options at the Savannah River Site	G-33
Table G-18	Peak Annual Operational Infrastructure Requirements from Plutonium Disposition Options at the Savannah River Site	G-33

Appendix H

Table H-1	Estimated Air Pollutant Concentrations from Operation of the Waste Solidification Building.....	H-4
Table H-2	Potential Radiological Impacts on Involved Workers from Operation of K-Area Storage, K-Area Interim Surveillance, and the Waste Solidification Building	H-4
Table H-3	Potential Radiological Impacts on the Public from Operation of K-Area Storage, K-Area Interim Surveillance, and the Waste Solidification Building.....	H-5
Table H-4	Limiting Accidents Associated with K-Area Storage, K-Area Interim Surveillance, and the Waste Solidification Building	H-6
Table H-5	Annual Socioeconomic Impacts from Operation of K-Area Storage, K-Area Interim Surveillance, and the Waste Solidification Building	H-8
Table H-6	Waste Management Impacts for the K-Area Interim Surveillance Capability.....	H-9
Table H-7	Waste Management Impacts for the Waste Solidification Building	H-9
Table H-8	Annual Infrastructure Requirements from Operation of K-Area Storage, K-Area Interim Surveillance, and the Waste Solidification Building	H-11

Appendix I

Table I-1	Reactor Operating Power Level.....	I-1
Table I-2	Criteria Pollutant Emissions from Shipping Unirradiated MOX Fuel to the Browns Ferry and Sequoyah Nuclear Plants	I-3
Table I-3	Estimated Dose to the Public from Continued Operation of the Browns Ferry and Sequoyah Nuclear Plants in the Year 2020 (partial mixed oxide or low-enriched uranium core).....	I-4
Table I-4	Summary of Environmental Consequences from Design-Basis Accidents at the Browns Ferry and Sequoyah Nuclear Plants.....	I-6
Table I-5	Summary of Environmental Consequences from Beyond Design-Basis Accidents at the Browns Ferry and Sequoyah Nuclear Plants.....	I-7
Table I-6	Ratio of Design-Basis Accident Impacts for a Partial Mixed Oxide Fuel Core Compared to a Full Uranium Fuel Core Reactor (partial mixed oxide fuel core doses/full low-enriched uranium fuel core doses).....	I-8
Table I-7	Ratio of Beyond Design-Basis Accident Impacts for a Partial Mixed Oxide Fuel Core Compared to a Full Uranium Fuel Core Reactor (partial mixed oxide fuel core doses/full low-enriched uranium fuel core doses).....	I-8
Table I-8	Additional Used Nuclear Fuel Assemblies Generated by Mixed Oxide Fuel Irradiation	I-10
Table I-9	Transportation Impacts Associated with the Shipment of Unirradiated Mixed Oxide Fuel to the Browns Ferry and Sequoyah Nuclear Plants (assuming one Type B Cask per shipment)	I-11
Table I-10	Criteria Pollutant Emissions from Shipping Unirradiated MOX Fuel to a Generic Commercial Nuclear Reactor.....	I-15
Table I-11	Ratio of Doses from Reactor Accidents for a Partial Mixed Oxide Fuel Core Compared to a Full Low-Enriched Uranium Fuel Core (partial mixed oxide fuel core dose/full low-enriched uranium fuel core dose)	I-16
Table I-12	Transportation Impacts Associated with the Shipment of Unirradiated Mixed Oxide Fuel to a Generic Commercial Nuclear Reactor (assuming one Type B Cask per shipment)	I-17

Appendix J

Table J-1	Partial Mixed Oxide and Full Low-Enriched Uranium Core Inventories for the Sequoyah and Browns Ferry Nuclear Power Plants	J-6
Table J-2	Projected Year 2020 Population near the Browns Ferry Nuclear Plant	J-9
Table J-3	Projected Year 2020 Population near the Sequoyah Nuclear Plant	J-9
Table J-4	Browns Ferry Nuclear Plant Design-Basis Accident Impacts	J-15
Table J-5	Sequoyah Nuclear Plant Design-Basis Accident Impacts	J-16
Table J-6	Beyond-Design-Basis Accident Source Term Release Fractions	J-18
Table J-7	Browns Ferry Nuclear Plant Beyond-Design-Basis Accident Impacts	J-20
Table J-8	Sequoyah Nuclear Plant Beyond-Design-Basis Accident Impacts	J-21
Table J-9	Ratio of Accident Impacts for Partial Mixed Oxide Fuel and Full Low-Enriched Uranium Fuel Cores (Partial Mixed Oxide Fuel Doses/Full Low-Enriched Uranium Fuel Doses)	J-23

**ACRONYMS, ABBREVIATIONS, AND CONVERSION
CHARTS**

ACRONYMS, ABBREVIATIONS, AND CONVERSION CHARTS

ALARA	as low as reasonably achievable
AREVA	AREVA fuel fabrication plant
ARF	airborne release fraction
ARIES	Advanced Recovery and Integrated Extraction System
BFN	Browns Ferry Nuclear Plant
BMP	best management practice
BWR	boiling water reactor
CCC	criticality control container
CFR	<i>Code of Federal Regulations</i>
CMRR-NF	Chemistry and Metallurgy Research Building Replacement Nuclear Facility
CPA	cargo palette assemblies
CRT	cargo restraint transporters
CSSC	Container Surveillance and Storage Capability
CSWTF	Central Sanitary Wastewater Treatment Facility
D&D	decontamination and decommissioning
DHS	U.S. Department of Homeland Security
DMO	direct metal oxidation
DOE	U.S. Department of Energy
DOT	U.S. Department of Transportation
DR	damage ratio
DSA	Documented Safety Analysis
DUF ₆	depleted uranium hexafluoride
DUNH	depleted uranyl nitrate, hexahydrate
DWPF	Defense Waste Processing Facility
EA	environmental assessment
EIS	environmental impact statement
EPA	U.S. Environmental Protection Agency
EPRI	Electric Power Research Institute
ETP	F- and H-Area Effluent Treatment Project
FEMA	Federal Emergency Management Agency
FFTF	Fast Flux Test Facility
FONSI	Finding of No Significant Impact
FR	<i>Federal Register</i>
FGE	fissile gram equivalent
GDP	Gross Domestic Product
GTRI	Global Threat Reduction Initiative
GWSB	Glass Waste Storage Building
Hanford	Hanford Site
HC/HBL	H-Canyon/HB Line
HEPA	high-efficiency particulate air
HEU	highly enriched uranium

HLW	high-level radioactive waste
HUFP	Hanford Unirradiated Fuel Package
HVAC	heating, ventilating, and air conditioning
HWR	heavy-water reactor
IPE	Individual Plant Examination
ISLOCA	interfacing systems loss-of-coolant accident
JFD	joint frequency distribution
KAMS	K-Area Material Storage capability
KIS	K-Area Interim Surveillance capability
LANL	Los Alamos National Laboratory
LCF	latent cancer fatality
LEU	low-enriched uranium
LLNL	Lawrence Livermore National Laboratory
LLW	low-level radioactive waste
LOCA	loss-of-coolant accident
LPF	leak path factor
LTA	lead test assembly
MAR	material at risk
MEI	maximally exposed individual
MFFF	Mixed Oxide Fuel Fabrication Facility
MLLW	mixed low-level radioactive waste
MOX	mixed oxide
MSA	K-Area Material Storage Area
MT	metric ton
NAAQS	National Ambient Air Quality Standards
NEPA	National Environmental Policy Act
NNSA	National Nuclear Security Administration
NNSS	Nevada National Security Site
NOI	Notice of Intent
NPDES	National Pollutant Discharge Elimination System
NRC	U.S. Nuclear Regulatory Commission
NRF	National Response Framework
NRHP	National Register of Historic Places
NRIA	Nuclear/Radiological Incident Annex
ORNL	Oak Ridge National Laboratory
Pantex	Pantex Plant
PC	performance category
PCB	polychlorinated biphenyl
PDC	Pit Disassembly and Conversion capability
PDCF	Pit Disassembly and Conversion Facility
PF-4	Plutonium Facility
PIDADS	perimeter intrusion, detection, assessment and delay system
POC	pipe overpack container
PRA	probabilistic risk assessment

psig	pounds per square inch gauge
PWR	pressurized water reactors
RANT	Radioassay and Nondestructive Testing Facility
RF	respirable fraction
RFETS	Rocky Flats Environmental Technology Site
RLUOB	Radiological Laboratory/Utility/Office Building
RLWTF	Radioactive Liquid Waste Treatment Facility
ROD	Record of Decision
ROI	Region of Influence
SAR	safety analysis report
SCDHEC	South Carolina Department of Health and Environmental Control
SGTR	steam generator tube rupture
SHPO	State Historic Preservation Office
SQN	Sequoyah Nuclear Plant
SRARP	Savannah River Archaeological Research Program
SRS	Savannah River Site
STA	Secure Transportation Asset
SWPPP	Storm Water Pollution Prevention Plan
TA	technical area
TRAGIS	Transportation Routing Analysis Geographic Information System
TRU	transuranic waste
TRUPACT-II	Transuranic Package Transporter Model 2
TSCA	Toxic Substances Control Act
TVA	Tennessee Valley Authority
UFSAR	Updated Final Safety Analysis Report
U.S.C.	United States Code
VRM	Visual Resource Management
WIPP	Waste Isolation Pilot Plant
WSB	Waste Solidification Building
Y-12	Y-12 National Security Complex
°C	degrees Celsius
°F	degrees Fahrenheit

CONVERSIONS

METRIC TO ENGLISH			ENGLISH TO METRIC		
Multiply	by	To get	Multiply	by	To get
Area					
Square meters	10.764	Square feet	Square feet	0.092903	Square meters
Square kilometers	247.1	Acres	Acres	0.0040469	Square kilometers
Square kilometers	0.3861	Square miles	Square miles	2.59	Square kilometers
Hectares	2.471	Acres	Acres	0.40469	Hectares
Concentration					
Kilograms/square meter	0.16667	Tons/acre	Tons/acre	0.5999	Kilograms/square meter
Milligrams/liter	1 ^a	Parts/million	Parts/million	1 ^a	Milligrams/liter
Micrograms/liter	1 ^a	Parts/billion	Parts/billion	1 ^a	Micrograms/liter
Micrograms/cubic meter	1 ^a	Parts/trillion	Parts/trillion	1 ^a	Micrograms/cubic meter
Density					
Grams/cubic centimeter	62.428	Pounds/cubic feet	Pounds/cubic feet	0.016018	Grams/cubic centimeter
Grams/cubic meter	0.0000624	Pounds/cubic feet	Pounds/cubic feet	16,018.5	Grams/cubic meter
Length					
Centimeters	0.3937	Inches	Inches	2.54	Centimeters
Meters	3.2808	Feet	Feet	0.3048	Meters
Kilometers	0.62137	Miles	Miles	1.6093	Kilometers
Radiation					
Sieverts	100	Rem	Rem	0.01	Sieverts
Temperature					
<i>Absolute</i>					
Degrees C + 17.78	1.8	Degrees F	Degrees F - 32	0.55556	Degrees C
<i>Relative</i>					
Degrees C	1.8	Degrees F	Degrees F	0.55556	Degrees C
Velocity/Rate					
Cubic meters/second	2118.9	Cubic feet/minute	Cubic feet/minute	0.00047195	Cubic meters/second
Grams/second	7.9366	Pounds/hour	Pounds/hour	0.126	Grams/second
Meters/second	2.237	Miles/hour	Miles/hour	0.44704	Meters/second
Volume					
Liters	0.26418	Gallons	Gallons	3.7854	Liters
Liters	0.035316	Cubic feet	Cubic feet	28.316	Liters
Liters	0.001308	Cubic yards	Cubic yards	764.54	Liters
Cubic meters	264.17	Gallons	Gallons	0.0037854	Cubic meters
Cubic meters	35.314	Cubic feet	Cubic feet	0.028317	Cubic meters
Cubic meters	1.3079	Cubic yards	Cubic yards	0.76456	Cubic meters
Cubic meters	0.0008107	Acre-feet	Acre-feet	1233.49	Cubic meters
Weight/Mass					
Grams	0.035274	Ounces	Ounces	28.35	Grams
Kilograms	2.2046	Pounds	Pounds	0.45359	Kilograms
Kilograms	0.0011023	Tons (short)	Tons (short)	907.18	Kilograms
Metric tons	1.1023	Tons (short)	Tons (short)	0.90718	Metric tons
ENGLISH TO ENGLISH					
Acre-feet	325,850.7	Gallons	Gallons	0.000003046	Acre-feet
Acres	43,560	Square feet	Square feet	0.000022957	Acres
Square miles	640	Acres	Acres	0.0015625	Square miles

a. This conversion is only valid for concentrations of contaminants (or other materials) in water.

METRIC PREFIXES

Prefix	Symbol	Multiplication factor
exa-	E	1,000,000,000,000,000,000 = 10 ¹⁸
peta-	P	1,000,000,000,000,000 = 10 ¹⁵
tera-	T	1,000,000,000,000 = 10 ¹²
giga-	G	1,000,000,000 = 10 ⁹
mega-	M	1,000,000 = 10 ⁶
kilo-	k	1,000 = 10 ³
deca-	D	10 = 10 ¹
deci-	d	0.1 = 10 ⁻¹
centi-	c	0.01 = 10 ⁻²
milli-	m	0.001 = 10 ⁻³
micro-	μ	0.000 001 = 10 ⁻⁶
nano-	n	0.000 000 001 = 10 ⁻⁹
pico-	p	0.000 000 000 001 = 10 ⁻¹²

APPENDIX A
RELATED NATIONAL ENVIRONMENTAL POLICY ACT
REVIEWS AND *FEDERAL REGISTER* NOTICES

APPENDIX A

RELATED NATIONAL ENVIRONMENTAL POLICY ACT REVIEWS AND FEDERAL REGISTER NOTICES

Appendix A includes a description of related National Environmental Policy Act (NEPA) reviews (Sections A.1, A.2, and A3) and includes *Federal Register* Notices specific to the *Surplus Plutonium Disposition Supplemental Environmental Impact Statement (SPD Supplemental EIS)* and lists other related *Federal Register* Notices (Section A.4).

A.1 Related NEPA Reviews – Surplus Plutonium Disposition

This section describes past NEPA reviews related to the Surplus Plutonium Disposition Program. The Surplus Plutonium Disposition Program is a subset of activities related to the long-term storage of weapons-usable fissile material (highly enriched uranium [HEU] and plutonium) and to the disposition of weapons-usable plutonium that has been, or in the future may be, declared surplus to U.S. defense needs. The NEPA documents that have been developed in support of decisions related to long-term storage and disposition of fissile materials are described in the following paragraphs, including documents specific to surplus plutonium disposition activities at the Savannah River Site (SRS) and Los Alamos National Laboratory (LANL).

The section is divided into Section A.1.1, Historical NEPA Reviews, and Section A.1.2, Recent NEPA Reviews for the Development of This *Surplus Plutonium Disposition Supplemental Environmental Impact Statement*.

A.1.1 Historical NEPA Reviews

In 1996, the U.S. Department of Energy (DOE) issued the *Storage and Disposition of Weapons-Usable Fissile Materials Final Programmatic Environmental Impact Statement (Storage and Disposition PEIS)* (DOE/EIS-0229) (DOE 1996c). The *Storage and Disposition PEIS* evaluated the potential environmental consequences of alternative strategies for the long-term storage and disposition of plutonium declared surplus to U.S. defense needs.

On January 21, 1997, in the *Storage and Disposition PEIS* Record of Decision (ROD) (62 *Federal Register* [FR] 3014), DOE announced its decision to pursue a dual-path strategy for disposition that would allow immobilization of some or all of the surplus plutonium in glass or ceramic material for disposal in a geologic repository, and fabrication of some surplus plutonium into mixed oxide (MOX) fuel for irradiation in existing domestic commercial nuclear power reactors, with subsequent disposal of the used fuel in a geologic repository. For plutonium storage, DOE decided to consolidate part of its surplus plutonium inventory by upgrading and expanding existing and planned facilities at the Pantex Plant (Pantex) near Amarillo, Texas (for plutonium pits), and SRS (for non-pit plutonium). These decisions were modified by later RODs.

In 1998, DOE prepared the *Supplement Analysis for Storing Plutonium in the Actinide Packaging and Storage Facility and Building 105-K at the Savannah River Site* (DOE 1998b). DOE prepared this supplement analysis to evaluate plutonium storage in K-Area at SRS prior to completion of the Actinide Packaging and Storage Facility. The storage option would support early closure of the Rocky Flats Environmental Technology Site (RFETS) and early deactivation of plutonium storage facilities at Hanford. In an amended *Storage and Disposition PEIS* ROD (63 FR 43386), DOE decided to proceed with accelerated shipment of surplus non-pit plutonium from RFETS to SRS before completion of the Actinide Packaging and Storage Facility, as well as the relocation of all Hanford surplus non-pit plutonium to SRS, pending disposition. Consistent with the January 1997 ROD for the *Storage and Disposition PEIS* (62 FR 3014), however, DOE decided to only implement the movement of the RFETS and Hanford surplus non-pit plutonium inventories to SRS if SRS were selected as the immobilization

site. In a 2001 ROD (66 FR 7888), DOE announced cancellation of the Actinide Packaging and Storage Facility in an amendment to the RODs for both the *Storage and Disposition PEIS* and the *Final Environmental Impact Statement, Interim Management of Nuclear Materials (IMNM EIS)*.

In 1998, DOE issued the *Final Environmental Impact Statement on Management of Certain Plutonium Residues and Scrub Alloy Stored at the Rocky Flats Environmental Technology Site* (DOE/EIS-0277F) (DOE 1998a). In several RODs for this environmental impact statement (EIS), DOE decided to dispose of certain plutonium scrap and residues at the Waste Isolation Pilot Plant (WIPP) near Carlsbad, New Mexico (63 FR 66136, 64 FR 8068, 64 FR 47780, 66 FR 4803, and 68 FR 44329).¹

In 1998, DOE prepared the *Pit Disassembly and Conversion Demonstration Environmental Assessment and Research and Development Activities* (DOE 1998c). In this environmental assessment, DOE analyzed a demonstration project at LANL to determine the feasibility of an integrated pit disassembly and conversion system as part of the surplus plutonium disposition strategy. This demonstration involved the disassembly of pits and conversion of the recovered plutonium to plutonium oxide. The demonstration helped develop the design and operational parameters for the pit disassembly and conversion project. The plutonium oxide produced by this program would be used in the Mixed Oxide Fuel Fabrication Facility (MFFF). The Finding of No Significant Impact (FONSI) for this environmental assessment was issued in August 1998 (DOE 1998d).

In 1999, DOE issued the *Surplus Plutonium Disposition Environmental Impact Statement (SPD EIS)* (DOE 1999), which tiered from the *Storage and Disposition PEIS*. In the *SPD EIS*, DOE evaluated, among other things, disposition of surplus plutonium by immobilization of the plutonium at specific DOE sites and by fabrication of MOX fuel for use in existing domestic commercial nuclear power reactors at specific commercial reactor sites. DOE also evaluated the construction and operation of a Pit Disassembly and Conversion Facility (PDCF); construction and operation of an MFFF, including the amount of plutonium that would be dispositioned by this approach; and an immobilization facility, including the technology to be used and the amount of plutonium that would be immobilized. Four DOE sites were considered for construction and operation of these facilities: the Hanford Site (Hanford) in Washington, the Idaho National Laboratory (at that time called the Idaho National Engineering and Environmental Laboratory) in Idaho, Pantex in Texas, and SRS in South Carolina. Six reactors at three sites were considered for irradiation of MOX fuel: Catawba Nuclear Station Units 1 and 2 in South Carolina, McGuire Nuclear Station Units 1 and 2 in North Carolina, and North Anna Power Station Units 1 and 2 in Virginia.

On January 11, 2000, DOE issued a ROD for the *SPD EIS* (65 FR 1608), in which DOE announced its decision to implement a hybrid approach to surplus plutonium disposition, wherein approximately 17 metric tons (19 tons) of surplus plutonium would be immobilized in a ceramic form, and up to 33 metric tons (36 tons) of surplus plutonium would be fabricated into MOX fuel and irradiated in existing domestic commercial nuclear power reactors. The ROD also announced that the three facilities needed to implement this approach—PDCF, MFFF, and the immobilization facility—would be constructed and operated at SRS.

In 2002, DOE prepared the *Supplement Analysis for Storage of Surplus Plutonium Materials in the K-Area Material Storage Facility at the Savannah River Site* (DOE 2002). In this supplement analysis DOE evaluated the potential for storage beyond 10 years at the K-Area Material Storage Facility (KAMS) (now known as the K-Area Material Storage Area), and concluded that potential impacts from the continued storage of surplus non-pit plutonium in KAMS for up to 50 years are not substantially different from those addressed in the original analysis of storage in the Actinide Packaging and Storage Facility contained in the *Storage and Disposition PEIS*. In a 2002 amended ROD (67 FR 19432) informed by this

¹ *Disposition of used nuclear fuel was evaluated in DOE's Programmatic Spent Nuclear Fuel Management and Idaho National Engineering Laboratory Environmental Restoration and Waste Management Programs Final Environmental Impact Statement (DOE/EIS-0203-F) (DOE1995c).*

supplement analysis, DOE amended the *Storage and Disposition PEIS* and *SPD EIS* RODs, and made the following decisions: cancellation of the immobilization portion of the disposition strategy; selection of the immediate implementation of consolidated long-term storage at SRS of surplus non-pit plutonium stored separately at RFETS and SRS; and authorization of consolidated long-term storage in KAMS. These decisions removed the basis for contingency contained in the previous RODs, which had conditioned transport of surplus non-pit plutonium from RFETS to SRS for storage on the selection of SRS as the site for the immobilization facilities. DOE left unchanged its prior decision to continue storage of surplus non-pit plutonium at Hanford, Idaho National Laboratory, and LANL, pending disposition (or movement to lag storage at a disposition facility). DOE also stated that storage of plutonium and the ultimate disposition of that plutonium were separate actions addressed separately in the *Storage and Disposition PEIS*, and that, while previous RODs combined these actions, such combination was not required to implement either decision and served no programmatic purpose. The amended ROD also stated that DOE was evaluating changes to the MOX fuel portion of the Surplus Plutonium Disposition Program, including a revised strategy to dispose of 34 metric tons (37 tons) of surplus plutonium in a MOX-only approach, to implement the 2000 PMDA.

DOE issued the *Supplement Analysis and Amended Record of Decision, Changes Needed to the Surplus Plutonium Disposition Program* (DOE/EIS-0283-SA1) in April 2003 (DOE 2003b) and made the associated determination that no additional NEPA analysis was needed to process into MOX fuel 6.5 metric tons (7.2 tons) of non-pit plutonium originally intended for immobilization (referred to as “alternate feedstock”) or to implement the MFFF design changes identified during the detailed-design process (68 FR 20134). The amended ROD announced DOE’s decision to disposition as MOX fuel 34 metric tons (37 tons) of surplus plutonium, including the alternate feedstock. The supplement analysis and amended ROD did not address the remaining surplus non-pit plutonium that had been intended for immobilization.

Since that time, most of the surplus non-pit plutonium in storage at various DOE sites around the United States has been moved to SRS for consolidated long-term storage pending disposition, consistent with the 2002 amended ROD; the *Supplement Analysis, Storage of Surplus Plutonium Materials at the Savannah River Site* (DOE/EIS-0229-SA-4) (DOE 2007a); and an amended ROD issued in 2007 (72 FR 51807) regarding surplus plutonium from Hanford, LANL, and Lawrence Livermore National Laboratory (LLNL). Surplus plutonium from Hanford has been moved to SRS, whereas material movements from LANL and LLNL are ongoing.

As part of the MOX approach, DOE had analyzed, in the *SPD EIS*, the potential environmental impacts of fabricating up to 10 MOX fuel lead assemblies² at five DOE sites and irradiation of these lead assemblies at existing domestic commercial nuclear power reactor sites, followed by postirradiation examination at two other sites. In the *SPD EIS* ROD, LANL was selected as the site for lead assembly fabrication and Oak Ridge National Laboratory was selected as the site for post-irradiation examination. Because of schedule impacts and programmatic considerations, the *Supplement Analysis for the Fabrication of Mixed Oxide Fuel Lead Assemblies in Europe* (DOE/EIS-0229-SA-3) (DOE 2003a) was prepared in 2003 and supported a subsequent amended *SPD EIS* ROD (68 FR 64611) announcing the change in the lead assembly fabrication location to existing MOX fuel fabrication facilities in Europe.

In 2005, DOE prepared the *Environmental Assessment for the Safeguards and Security Upgrades for Storage of Plutonium Materials at the Savannah River Site* (DOE 2005a). DOE prepared this environmental assessment to evaluate installation and operation of the K-Area Container Surveillance and Storage Capability (CSSC) for non-pit plutonium surveillance and stabilization, deinventory of plutonium from F-Area for storage in K-Area, storage of plutonium in DOE-STD-3013 containers, and installation of safeguards and security upgrades in K-Area and the Advanced Tactical Training Area. In the resulting FONSI, DOE determined that implementation of the proposed action was not expected to have a

² A MOX fuel lead assembly is a prototype reactor fuel assembly containing MOX fuel that is used to test fuel performance in a nuclear reactor.

measurable impact on the human environment and that an EIS was not required (DOE 2005b). Since the initial FONSI was issued on this environmental assessment, DOE has issued a revised FONSI (DOE 2010b). In the revised FONSI, DOE explains that the features originally planned for CSSC have been replaced by the Stabilization and Packaging Project in K-Area. This project would provide the capability to comply with DOE-STD-3013 requirements for stabilization and long-term storage of plutonium-bearing materials and would replace the compliance feature of CSSC. The types of equipment, processes, and technology proposed for use in the Stabilization and Packaging Project are the same as, or similar to, those originally proposed for CSSC.

In 2005, the U.S. Nuclear Regulatory Commission (NRC)³ prepared the *Environmental Impact Statement on the Construction and Operation of a Proposed Mixed Oxide Fuel Fabrication Facility at the Savannah River Site, South Carolina (MFFF EIS)* (NRC 2005a). In the *MFFF EIS*, NRC evaluated the environmental impacts of construction and operation of MFFF to fabricate 34 metric tons (37 tons) of surplus plutonium into MOX fuel and two connected actions, the construction and operation of PDCF and a Waste Solidification Building (WSB). NRC made a final NEPA recommendation in the *MFFF EIS*, concluding that the applicable environmental requirements and the proposed mitigation measures would eliminate or substantially lessen any potential adverse environmental impacts associated with MFFF (NRC 2005a).

In November 2008, DOE issued the *Supplement Analysis for Construction and Operation of a Waste Solidification Building at the Savannah River Site* (DOE/EIS-0283-SA-2) (DOE 2008c). In this supplement analysis to the *SPD EIS*, DOE evaluated construction and operation of a stand-alone WSB to treat liquid low-level radioactive waste (LLW) and high-activity and stripped-uranium liquid waste streams from MFFF and PDCF. On December 10, 2008, DOE decided to construct and operate a stand-alone WSB in close proximity to MFFF and the planned PDCF in F-Area at SRS (73 FR 75088), rather than incorporate the equipment to treat and solidify liquid LLW and liquid transuranic (TRU) waste into MFFF and PDCF as was evaluated in the *SPD EIS*. WSB is now under construction.

In three interim action determinations approved in December 2008, September 2009, and March 2011, DOE decided to process approximately 0.6 metric tons (0.7 tons) of surplus non-pit plutonium through H-Canyon/HB-Line and the Defense Waste Processing Facility (DWPF) (DOE 2008b, 2009b), and later decided to dispose of 85 kilograms (187 pounds) of the 0.6 metric tons (0.7 tons) at WIPP (DOE 2011a). Because of the small quantities involved relative to the 6 metric tons (6.6 tons) of non-pit plutonium to be evaluated in this *SPD Supplemental EIS*, it was determined that processing this material would not affect DOE's ultimate selection of disposition alternatives. Therefore, these actions were determined to be allowable interim actions in accordance with DOE regulations for implementing NEPA (10 CFR 1021.104 and 1021.211).

In an interim action determination approved in October 2011, DOE decided to process an additional 0.5 metric tons (0.55 tons) of surplus non-pit plutonium through H-Canyon/HB-Line for disposal at WIPP (DOE 2011d). Because of the small quantities involved relative to the 6 metric tons (6.6 tons) of non-pit plutonium being evaluated in the *SPD Supplemental EIS*, and because this material does not lend itself to disposition using other alternatives, it was determined that disposal of this material as TRU waste would not affect DOE's ultimate selection of disposition alternatives. Therefore, this action was determined to be an allowable interim action (10 CFR 1021.104 and 1021.211).

In an interim action determination approved in April 2011 (DOE 2011b), DOE evaluated modifying the design of MFFF to provide the flexibility to manufacture a variety of fuel types, including fuel for boiling-water reactors and next-generation light-water reactors. DOE's evaluation shows that impacts of modifying the design and operating the facility to manufacture a variety of fuel types are bounded by existing safety analyses and analyses in the *SPD EIS* (DOE 1999), and no additional potentially adverse

³ The Strom Thurmond National Defense Authorization Act for Fiscal Year 1999 (42 U.S.C. 5842) amended the Energy Reorganization Act of 1974 to provide NRC with regulatory and licensing authority over MFFF.

impacts have been identified. The proposed modifications would have no effect on DOE's selection of alternative plutonium preparation or disposition alternatives following completion of this *SPD Supplemental EIS*. Therefore, this action was determined to be an allowable interim action (10 CFR 1021.104 and 1021.211).

In an interim action determination approved in June 2012 (DOE 2012), DOE evaluated preparation of up to 2.4 metric tons (2.6 tons) of plutonium metal and oxide as feed material for the MFFF using H-Canyon/HB-Line at SRS. This material is a subset of the 6.5 metric tons (7.2 tons) of non-pit metal and oxides previously determined for use as MOX fuel as decided in an Amended ROD (68 FR 20134), described above. DOE determined that the impacts of processing these materials would be significantly less than historical levels of operating H-Canyon/HB-Line, and that use of these facilities in the near term, prior to selection of an option for plutonium conversion, would not limit the choice of alternatives being evaluated in this *SPD Supplemental EIS*. Therefore, this action was determined to be an allowable interim action (10 CFR 1021.104 and 1021.211).

A.1.2 Recent NEPA Reviews for Development of This *Surplus Plutonium Disposition Supplemental Environmental Impact Statement*

In 2007, DOE issued a Notice of Intent (NOI) (72 FR 14543) to prepare this *SPD Supplemental EIS* to evaluate the potential environmental impacts of surplus plutonium disposition capabilities that would be constructed and operated at SRS to provide a disposition pathway for surplus non-pit plutonium originally planned for immobilization. In the 2007 NOI, DOE stated that its Preferred Alternative was to construct and operate a new vitrification capability within an existing building at SRS to immobilize most of the surplus non-pit plutonium, and to process some of the surplus non-pit plutonium in the existing H-Canyon/HB-Line and DWPF at SRS. The NOI also stated that DOE would analyze the impacts of fabricating some (up to approximately one-third) surplus non-pit plutonium into MOX fuel.

Subsequently, DOE decided to evaluate additional alternatives. Therefore, on July 19, 2010, DOE issued an amended NOI (75 FR 41850) announcing its intent to modify the scope of this *SPD Supplemental EIS* and to conduct additional public scoping. DOE revised the scope of this *SPD Supplemental EIS* to refine the quantity and types of surplus plutonium, evaluate additional alternatives, and no longer consider in detail one of the alternatives identified in the 2007 NOI (ceramic can-in-canister immobilization). In addition, DOE had identified a glass can-in-canister immobilization approach as its Preferred Alternative in the 2007 NOI for the non-pit plutonium then under consideration; the 2010 amended NOI explained that DOE would evaluate a glass can-in-canister immobilization alternative in this *SPD Supplemental EIS*, but that DOE did not have a preferred alternative.

To evaluate additional options for pit disassembly and conversion, on January 12, 2012, DOE issued a second amended NOI (77 FR 1920) announcing its intent to modify the scope of this *SPD Supplemental EIS* and to conduct additional public scoping.

A.2 Other Related DOE NEPA Reviews

Activities related to the Surplus Plutonium Disposition Program include storage of pits at Pantex, plutonium recovery through the Global Threat Reduction Initiative (GTRI), plutonium processing at LANL, and the management of nuclear materials at SRS. In addition, disposition of surplus plutonium may involve the use of the DWPF and the high-level radioactive waste (HLW) management system at SRS, waste management facilities at SRS and LANL, and WIPP. Therefore, NEPA documents related to these facilities are described below.

A.2.1 Pit Storage at the Pantex Plant

Final Environmental Impact Statement for the Continued Operation of the Pantex Plant and Associated Storage of Nuclear Weapon Components (Pantex Sitewide EIS) (DOE 1996b). The *Pantex Sitewide EIS* evaluated activities associated with ongoing operations at Pantex, including onsite pit storage and transportation. The ROD, published in the *Federal Register* on January 27, 1997 (62 FR 3880), announced DOE's decision to implement the Preferred Alternative evaluated in the *Pantex Sitewide EIS*,

including interim storage of up to 20,000 pits at Pantex. DOE and its semiautonomous National Nuclear Security Administration (NNSA) published four supplement analyses for the *Pantex Sitewide EIS*, the most recent in October 2008 (DOE/NNSA 2008). The supplement analyses indicated that the identified and projected impacts for all resource areas, including cumulative impacts, were not substantially changed from those identified in the *Pantex Sitewide EIS* and ROD, nor did they represent significant new circumstances or information relative to environmental concerns. The *SPD Supplemental EIS* analyzes transportation of surplus pits from Pantex to the pit disassembly and conversion site and relies on the *Pantex Sitewide EIS* for impacts of interim storage of pits at Pantex.

The analysis in the *Pantex Sitewide EIS* indicates: operation of Pantex, including the continued storage of pits, was judged to not increase the potential for offsite contamination (DOE 1996b:p. S-17). Offsite concentrations of air pollutants were estimated to be below Effects Screening Levels and would not adversely affect human health (DOE 1996b:Table S-1). Potential radiological impacts from Pantex operations resulted from a range of activities, including weapons assembly, weapons disassembly, and interim storage of pits. Potential exposures of the public from site operations could come from releases of small amounts of tritium and doses to any member of the public would be a small fraction of a millirem (DOE 1996b:Chapter 4, Section 4.14.2.1). Worker doses from site operations, which include active weapons assembly and disassembly as well as interim storage of pits, would result in average worker doses of approximately 100 millirem per year (DOE 1996b:Chapter 4, Section 4.14.2.1). Additional worker doses were estimated from operations whereby pits would be packaged for transfer to another site, such as SRS or LANL. Collective worker impacts for packaging 8,000 to 20,000 pits for transfer to another site ranged from 113 to 283 person-rem (DOE 1996b:p. S-10).

A.2.2 Transuranic Waste Disposal at the Waste Isolation Pilot Plant

Final Environmental Impact Statement for the Waste Isolation Pilot Plant (DOE/EIS-0026) and two associated SEISs (DOE/EIS-0026-S-1 and DOE/EIS-0026-S-2) (DOE 1990, 1997b). In the *Final Environmental Impact Statement for the Waste Isolation Pilot Plant* and two SEISs issued in 1990 and 1997, DOE analyzed the development, operation, and transportation activities associated with WIPP, a mined repository for TRU waste near Carlsbad, New Mexico. In the 1997 *Waste Isolation Pilot Plant Disposal Phase Final Supplemental Environmental Impact Statement (WIPP SEIS II)*, DOE analyzed the impacts from management and operation of WIPP to support disposal of TRU waste. DOE determined that the operation of WIPP during the period when it would be accepting waste shipments from around the DOE complex could be accomplished safely and that WIPP would not be expected to result in any long-term (over 10,000 years) impacts on human health as long as the repository was not disturbed after decommissioning (DOE 1997b). In the ROD associated with the 1997 *WIPP SEIS II* (63 FR 3624), DOE announced its decision that WIPP would be developed and begin accepting TRU waste for disposal. Since then, DOE published eight supplement analyses of the 1997 *WIPP SEIS II*. The supplement analyses indicated that the identified and projected impacts for all resource areas, including cumulative impacts, were not substantially changed from those previously evaluated, nor did they represent significant new circumstances or information relative to environmental concerns (DOE 2009a).

TRU waste produced as a result of surplus plutonium disposition activities would be required to meet WIPP waste acceptance criteria and would then be shipped to WIPP for disposal. The TRU waste (including non-pit plutonium packaged for disposal at WIPP) associated with the proposed alternatives being analyzed in this *SPD Supplemental EIS* would not be expected to change any of the impacts previously analyzed in the *WIPP SEIS II*, and would use, at most, 10 percent of the contact-handled TRU waste capacity for WIPP as authorized under the WIPP Land Withdrawal Act.

A.2.3 Plutonium Recovery through the Global Threat Reduction Initiative

Environmental Assessment for the U.S. Receipt and Storage of Gap Material—Plutonium and Finding of No Significant Impact (DOE/EA-1771) (DOE 2010a). In this environmental assessment, DOE assessed the potential environmental impacts of transporting to SRS for storage pending final disposition up to 100 kilograms (220 pounds) of plutonium that the United States may accept from at-risk foreign locations

as part of the GTRI. A final decision on the acceptance of any particular shipment of plutonium from a foreign country is contingent on confirmation that the material: (1) poses a threat to U.S. national security; (2) is susceptible to being used in an improvised nuclear device; (3) presents a high risk of terrorist threat; (4) has no other reasonable pathway to assure security from theft or diversion; and (5) meets the acceptance criteria of the storage facility at SRS. Acceptance of material also requires adequate storage capacity to accommodate the material at SRS. In the FONSI, DOE determined that the impacts of implementing the proposed action are not significant (DOE 2010a). Gap material plutonium would be dispositioned along with U.S. surplus plutonium. The disposition of plutonium materials that are recovered through the GTRI program and brought to SRS are analyzed in this *SPD Supplemental EIS*.

A.2.4 Pit Disassembly and Conversion at the Los Alamos National Laboratory

Site-Wide Environmental Impact Statement for Continued Operation of Los Alamos National Laboratory, Los Alamos, New Mexico (LANL SWEIS) (DOE/EIS-0380) (DOE 2008a). DOE prepared this sitewide EIS to evaluate the impacts associated with the continued operation of LANL. The activities analyzed in the *LANL SWEIS* include the production of plutonium oxide at LANL for use in MFFF at SRS. In the 2008 ROD for the *LANL SWEIS* (73 FR 55833), DOE selected the No Action Alternative, including the ability to produce plutonium oxide on site and to ship such materials from LANL to other sites within the DOE complex, including SRS. In the 2009 ROD (74 FR 33232), DOE decided to proceed with seismic upgrades to the Plutonium Facility at Technical Area 55. This *SPD Supplemental EIS* evaluates expanding the pit disassembly and conversion capabilities at LANL.

A.2.5 Interim Management of Nuclear Materials at Savannah River Site

Final Environmental Impact Statement, Interim Management of Nuclear Materials (IMNM EIS) (DOE/EIS-0220) (DOE 1995b). In the *IMNM EIS*, DOE assessed the potential environmental impacts of actions necessary to manage nuclear materials then stored at SRS until decisions on their ultimate disposition were made and implemented. Construction of a new Actinide Packaging and Storage Facility was included in the analysis. In many cases (e.g., for existing non-pit plutonium stored in vaults at SRS and plutonium-239 solutions), analyses in the *IMNM EIS* assumed that material was to be stored until DOE made “long-term storage or disposition decisions.” In the December 19, 1995, ROD (60 FR 65300), DOE selected stabilization methods and storage for the majority of “vulnerable” nuclear materials at SRS, selected the facilities in F- and H-Areas (including H-Canyon/HB-Line) to be utilized, and announced the decision to build the Actinide Packaging and Storage Facility. In the November 14, 1997, supplemental ROD (62 FR 61099), DOE announced its decision to implement processing and storage for vitrification in DWPF as an additional method for managing non-pit plutonium and uranium stored in vaults. DOE is currently using this method to process up to 0.6 metric tons (0.7 tons) of surplus non-pit plutonium in H-Canyon/HB-Line with subsequent vitrification in DWPF. In a 2001 ROD (66 FR 7888), DOE announced cancellation of the Actinide Packaging and Storage Facility in an amendment to the RODs for both the *Storage and Disposition PEIS* and the *IMNM EIS*.

A.2.6 Vitrification of High-Level Radioactive Waste at Savannah River Site

Final Environmental Impact Statement, Defense Waste Processing Facility, Savannah River Plant, Aiken, S.C. (DWPF EIS) (DOE/EIS-0082). In the 1982 *DWPF EIS*, DOE evaluated alternatives for construction and operation of DWPF at SRS. Nuclear materials production activities at SRS have produced HLW that is stored on site in tanks. The function of DWPF is to vitrify the low-volume, high-activity radioactive fraction of the tank waste (the sludge and salt fractions) that will be stored in stainless steel containers on site pending a decision on their ultimate disposal. The *DWPF EIS* ROD announcing DOE’s decision to proceed with the construction and operation of DWPF was published in June 1982 (47 FR 23801). Surplus plutonium disposition activities evaluated in this *SPD Supplemental EIS* include the use of DWPF to fill additional canisters with waste resulting from the processing of surplus plutonium in H-Canyon/HB-Line, and to fill canisters containing immobilized plutonium in can-in-canister assemblies.

Defense Waste Processing Facility Supplemental Environmental Impact Statement (DWPF Supplemental EIS) (DOE/EIS-0082-S) (DOE 1994). In 1994, DOE issued the *DWPF Supplemental EIS*, which evaluated changes in the HLW process proposed after the 1982 *DWPF EIS* was issued. In the *DWPF Supplemental EIS* ROD, DOE announced that it would complete the construction and startup testing of DWPF using the in-tank precipitation process to separate the high-activity fraction from the liquid waste (60 FR 18589).

Savannah River Site Salt Processing Alternatives Final Supplemental Environmental Impact Statement (DOE/EIS-0082-S2) (DOE 2001). In 2001, DOE prepared this supplemental environmental impact statement (SEIS) to select an alternative technology for separating the high-activity fraction from the low-activity fraction of the radioactive salt waste after DOE determined that in-tank precipitation could not meet production goals and safety requirements. In a ROD for this SEIS, DOE determined that any of the alternatives evaluated could be implemented with only small and acceptable environmental impacts, and decided to implement the caustic-side solvent extraction process, to be housed in the Salt Waste Processing Facility (66 FR 52752).

Supplement Analysis, Salt Processing Alternatives at the Savannah River Site (DOE/EIS-0082-S2-SA-01) (DOE 2006). In this supplement analysis, DOE evaluated the impacts of a new interim salt processing capability to process a specified fraction of the salt waste stored in the F- and H-Area tank farms. Use of this interim capability would allow DOE to continue removing and stabilizing the high-activity sludge waste and would accelerate the cleanup and closure of the tanks. In a ROD for this supplement analysis, DOE announced its decision to proceed with the use of the interim salt processing capability to continue uninterrupted use of DWPF and to allow use of the Salt Waste Processing Facility at higher capacity as soon as it comes on line (71 FR 3834).

A.2.7 Disposition of Surplus Highly Enriched Uranium

Disposition of Surplus Highly Enriched Uranium Final Environmental Impact Statement (DOE/EIS-0240) (DOE 1996a). In this EIS, DOE analyzed the environmental impacts associated with alternatives for the disposition of surplus U.S.-origin HEU (including the use of H-Canyon/HB-Line), both to support U.S. nuclear weapons nonproliferation policy by reducing global stockpiles of excess weapons-usable fissile materials and to recover the economic value of the materials to the extent feasible. In the ROD for this EIS (61 FR 40619), DOE announced its decision to implement a Highly Enriched Uranium Disposition Program, which is currently ongoing, to render surplus HEU non-weapons-usable by blending the HEU down to low-enriched uranium (LEU). The ROD describes DOE's plans to sell a portion of the LEU for use as feedstock for commercial nuclear power plant fuel fabrication and to dispose of the remaining LEU as LLW. H-Canyon/HB-Line at SRS was one of the facilities selected for blending HEU down to LEU. HEU from pit disassembly and conversion would be recovered for disposition in the Highly Enriched Uranium Disposition Program.

Supplement Analysis, Disposition of Surplus Highly Enriched Uranium (DOE/EIS-0240-SA1) (DOE 2007b). DOE/NNSA prepared this supplement analysis to evaluate the ongoing Highly Enriched Uranium Disposition Program and propose new initiatives, including new end-users for existing program material, new disposal pathways for existing discarded HEU, and downblending additional quantities of HEU through H-Canyon/HB-Line, consistent with current activities.

Final Site-wide Environmental Impact Statement for the Y-12 National Security Complex (Y-12 SWEIS) (DOE/EIS-0387) (DOE 2011c). As one of NNSA's major production facilities, the Y-12 National Security Complex (Y-12) is the primary site for enriched uranium processing and storage, and one of the primary manufacturing facilities for maintaining the U.S. nuclear weapons stockpile. Y-12 supplies nuclear weapons components, dismantles weapons components, safely and securely stores and manages special nuclear material, supplies special nuclear material for use in naval and research reactors, and disposes surplus materials. The *Y-12 SWEIS* analyzes the potential environmental impacts of reasonable alternatives for ongoing and foreseeable future operations, facilities, and activities at Y-12. Therefore, the impacts of storage of HEU at Y-12 are covered by the analyses presented in the

Y-12 SWEIS. The *Y-12 SWEIS* also covers activities related to the receipt and management of surplus HEU that will result from pit processing in PDCF or a pit disassembly and conversion capability. The impacts of incremental shipments to Y-12 of surplus HEU from pit disassembly and conversion are analyzed in this *SPD Supplemental EIS*.

A.2.8 Waste Management

NEPA analyses related to disposal of TRU waste at WIPP are addressed in Section A.2.2. Additional waste management NEPA documents related to the actions evaluated in this *SPD Supplemental EIS* are described in this section.

Savannah River Site Waste Management Final Environmental Impact Statement (DOE/EIS-0217) (DOE 1995a). DOE issued this EIS to provide a basis for selection of a sitewide approach to managing present and future wastes generated at SRS. The associated ROD (60 FR 55249) stated that DOE would configure its waste management system according to the moderate treatment alternative described in the EIS.

Final Waste Management Programmatic Environmental Impact Statement for Managing Treatment, Storage, and Disposal of Radioactive and Hazardous Waste (Waste Management PEIS) (DOE/EIS-0200-F) (DOE 1997a). DOE published the *Waste Management PEIS* as a DOE complex-wide study of the environmental impacts of managing five types of waste generated by past, present, and future nuclear defense and research activities. The *Waste Management PEIS* provided information on the impacts of various siting configurations that DOE used to decide at which sites to locate additional treatment, storage, and disposal capacity for each waste type. As applicable, waste resulting from action taken in the *SPD EIS* and this *SPD Supplemental EIS* would be treated, stored, and disposed of in accordance with the RODs associated with the *Waste Management PEIS*. DOE published four RODs associated with this programmatic EIS. In the ROD related to TRU waste and its three subsequent revisions (63 FR 3629, 65 FR 82985, 66 FR 38646, and 67 FR 56989), DOE decided that each DOE site that currently has or will generate TRU waste would prepare its TRU waste for disposal and store it on site until it could be shipped to WIPP for disposal. The *Waste Management PEIS* stated that DOE may approve, after NEPA review, shipments of TRU waste from sites where it may be impractical to prepare the waste for disposal to sites where DOE has or will have the necessary capability, including SRS. In addition, DOE approved the transfer of TRU waste from the Sandia National Laboratories in New Mexico to LANL for storage and preparation for disposal at WIPP. In the ROD related to non-wastewater hazardous waste (63 FR 41810), DOE decided to continue using offsite facilities for the treatment of major portions of such waste generated at DOE sites. In the ROD related to immobilized HLW (64 FR 46661), DOE decided to store such waste in a final form at the site of generation until transfer to an ultimate disposition site. In the ROD related to mixed low-level radioactive waste (MLLW) and LLW (65 FR 10061), DOE decided to perform minimal treatment of LLW at all sites and continue, to the extent practicable, onsite disposal of LLW at a number of sites, including SRS. DOE decided to treat MLLW at a number of sites, including SRS, with disposal at Hanford or the Nevada National Security Site (formerly known as the Nevada Test Site). This decision regarding MLLW and LLW does not preclude the use of commercial disposal sites.

The impacts of operation of waste management facilities at LANL are evaluated in the *LANL SWEIS* (DOE 2008a).

A.3 Related TVA NEPA Reviews

NEPA documents related to TVA's commercial nuclear power reactors at the Browns Ferry and Sequoyah Nuclear Plants are summarized below.

A.3.1 Browns Ferry Nuclear Plant

Final Supplemental Environmental Impact Statement for Browns Ferry Nuclear Plant Operating License Renewal (TVA 2002). This EIS was prepared by TVA to address the potential environmental impacts associated with TVA's proposal for NRC to renew the operating licenses for the extended operation of

Units 1, 2, and 3 at its Browns Ferry Nuclear Plant, located in Limestone County, Alabama. The operating licenses were renewed by NRC on May 4, 2006 (NRC 2006). Renewal of the operating licenses allows operation for an additional 20 years beyond the original 40-year operating license terms. NEPA, which created the need for EISs, was signed into law in 1970. Construction of the Browns Ferry Nuclear Plant started in 1967; therefore, its construction predated NEPA and an EIS was not prepared.

Generic Environmental Impact Statement for License Renewal of Nuclear Plants, Supplement 21, Regarding Browns Ferry Nuclear Plant, Units 1, 2, and 3, Final Report (NUREG-1437, Supplement 21) (NRC 2005b). This EIS was prepared by NRC in response to an application submitted to NRC by TVA to renew the operating licenses for Browns Ferry Nuclear Plant, Units 1, 2, and 3, for an additional 20 years under 10 CFR Part 54. This EIS includes NRC's analysis of the environmental impacts of the proposed action, the environmental impacts of alternatives to the proposed action, and mitigation measures available for reducing or avoiding adverse impacts. On May 4, 2006, NRC approved Browns Ferry's renewed licenses, allowing Units 1, 2, and 3 to operate through 2033, 2034, and 2036, respectively.

A.3.2 Sequoyah Nuclear Plant

Final Environmental Impact Statement for Sequoyah Nuclear Plant, Units 1 and 2 (TVA 1974). Based on information presented in the *Final Environmental Statement for Sequoyah Nuclear Plant, Units 1 and 2*, NRC approved construction and operation of the Sequoyah reactors. Construction of the Sequoyah Nuclear Plant was completed in 1980, and operating licenses were approved for Unit 1 in 1980 and Unit 2 in 1981. Unit 1 received its full power license on September 17, 1980, and began commercial operation on July 1, 1981. Unit 2 received its full power license on September 15, 1981, and began commercial operation on June 1, 1982.

Final Supplemental Environmental Impact Statement for Sequoyah Nuclear Plant Units 1 and 2 License Renewal, Hamilton County, Tennessee (TVA 2011). In June 2011, TVA issued a final SEIS to address the potential environmental impacts associated with TVA's application to NRC to renew the operating licenses for the Sequoyah Nuclear Plant. This SEIS supplements the original EIS prepared in 1974. The license renewals, if issued by NRC, would allow the plant to continue to operate for an additional 20 years beyond the current operating licenses, which would otherwise expire in 2020 (Unit 1) and 2021 (Unit 2). On August 18, 2011, the TVA Board of Directors decided to proceed with an application to NRC to extend the operation of Sequoyah Nuclear Plant Units 1 and 2 for a period of 20 years (76 FR 55723).

A.4 Related Federal Register Notices

A.4.1 Federal Register Notices for the Surplus Plutonium Disposition Supplemental Environmental Impact Statement

1920

Federal Register / Vol. 77, No. 8 / Thursday, January 12, 2012 / Notices

SUMMARY: The U.S. Department of Energy (DOE) announces its intent to modify the scope of the *Surplus Plutonium Disposition Supplemental Environmental Impact Statement (SPD Supplemental EIS, DOE/EIS-0283-S2)* and to conduct additional public scoping. DOE issued its Notice of Intent (NOI) to prepare the SPD Supplemental EIS on March 28, 2007, and issued an Amended NOI on July 19, 2010. DOE now intends to further revise the scope of the SPD Supplemental EIS primarily to add additional alternatives for the disassembly of pits (a nuclear weapons component) and the conversion of plutonium metal originating from pits to feed material for the Mixed Oxide (MOX) Fuel Fabrication Facility (MFFF), which DOE is constructing at the Savannah River Site (SRS) in South Carolina. Under the proposed new alternatives, DOE would expand or install the essential elements required to provide a pit disassembly and/or conversion capability at one or more of the following locations: Technical Area 55 (TA-55) at the Los Alamos National Laboratory (LANL) in New Mexico, H-Canyon/HB-Line at SRS, K-Area at SRS, and the MFFF at SRS. In addition, DOE has decided not to analyze an alternative, described in the 2010 Amended NOI, to construct a separate Plutonium Preparation (PuP) capability for non-pit plutonium because the necessary preparation activities are adequately encompassed within the other alternatives.

The MOX fuel alternative is DOE's preferred alternative for surplus plutonium disposition. DOE's preferred alternative for pit disassembly and the conversion of surplus plutonium metal, regardless of its origins, to feed for the MFFF is to use some combination of facilities at TA-55 at LANL, K-Area at SRS, H-Canyon/HB-Line at SRS and MFFF at SRS, rather than to construct a new stand-alone facility. This would likely require the installation of additional equipment and other modifications to some of these facilities. DOE's preferred alternative for disposition of surplus plutonium that is not suitable for MOX fuel fabrication is disposal at the Waste Isolation Pilot Plant (WIPP) in New Mexico.

DATES: DOE invites Federal agencies, state and local governments, Native American tribes, industry, other organizations, and members of the public to submit comments to assist in identifying environmental issues and in determining the appropriate scope of the SPD Supplemental EIS. The public scoping period will end on March 12, 2012. DOE will consider all comments

DEPARTMENT OF ENERGY

Second Amended Notice of Intent To Modify the Scope of the Surplus Plutonium Disposition Supplemental Environmental Impact Statement and Conduct Additional Public Scoping

AGENCY: U.S. Department of Energy, National Nuclear Security Administration.

ACTION: Amended Notice of Intent.

received or postmarked by March 12, 2012. Comments received after that date will be considered to the extent practicable. Also, DOE asks that Federal, State, local, and tribal agencies that desire to be designated cooperating agencies on the SPD Supplemental EIS contact the National Environmental Policy Act (NEPA) Document Manager at the addresses listed under **ADDRESSES** by the end of the scoping period. The Tennessee Valley Authority (TVA) is a cooperating agency for sections of the EIS as described below. DOE will hold a public scoping meeting:

- February 2, 2012 (5:30 p.m. to 8 p.m.) at Cities of Gold Hotel, 10-A Cities of Gold Road, Pojoaque, NM 87501.

The scoping period announced in this second Amended NOI will allow for additional public comment and for DOE to consider any new information that may be relevant to the scope of the SPD Supplemental EIS. Because the additional alternatives do not involve new locations except for LANL, and because there have been two previous scoping periods for this SPD Supplemental EIS, DOE does not intend to hold additional scoping meetings except at Pojoaque, NM, or to extend the scoping period beyond that announced herein.

ADDRESSES: Please direct written comments on the scope of the SPD Supplemental EIS to Ms. Sachiko McAlhany, SPD Supplemental EIS NEPA Document Manager, U.S. Department of Energy, P.O. Box 2324, Germantown, MD 20874-2324. Comments on the scope of the SPD Supplemental EIS may also be submitted via email to spdsupplementaleis@saic.com or by toll-free fax to (877) 865-0277. DOE will give equal weight to written, email, fax, telephone, and oral comments. Questions regarding the scoping process and requests to be placed on the SPD Supplemental EIS mailing list should be directed to Ms. McAlhany by any of the means given above or by calling toll-free (877) 344-0513.

For general information concerning the DOE NEPA process, contact: Carol Borgstrom, Director, Office of NEPA Policy and Compliance (GC-54), U.S. Department of Energy, 1000 Independence Avenue SW., Washington, DC 20585-0103; telephone (202) 586-4600, or leave a message toll-free (800) 472-2756; fax (202) 586-7031; or send an email to askNEPA@hq.doe.gov. This second Amended NOI will be available on the Internet at <http://energy.gov/nepa>.

SUPPLEMENTARY INFORMATION:

Background

To reduce the threat of nuclear weapons proliferation, DOE is engaged in a program to disposition its surplus, weapons-usable plutonium in a safe, secure, and environmentally sound manner, by converting such plutonium into proliferation-resistant forms not readily usable in nuclear weapons. The U.S. inventory of surplus plutonium is in several forms. The largest quantity is plutonium metal in the shape of pits (a nuclear weapons component). The remainder is non-pit plutonium, which includes plutonium oxides and metal in a variety of forms and purities.

DOE already has decided to fabricate 34 metric tons (MT) of surplus plutonium into MOX fuel in the MFFF (68 FR 20134, April 24, 2003), currently under construction at SRS, and to irradiate the MOX fuel in commercial nuclear reactors used to generate electricity, thereby rendering the plutonium into a spent fuel form not readily usable in nuclear weapons.

DOE announced its intent to prepare a SPD Supplemental EIS in 2007 to analyze the potential environmental impacts of alternatives to disposition about 13 MT of surplus plutonium (72 FR 14543; March 28, 2007). DOE issued an Amended NOI in 2010 "to refine the quantity and types of surplus weapons-usable plutonium material, evaluate additional alternatives, and no longer consider in detail one alternative identified" in the 2007 NOI (75 FR 41850; July 19, 2010).¹ The 2007 NOI and 2010 Amended NOI are available at <http://www.nnsa.energy.gov/nepa/spdsupplementaleis> and details from them are not reproduced in this second Amended NOI.

In the 2010 Amended NOI, DOE proposed to revisit its decision to construct and operate a new Pit Disassembly and Conversion Facility (PDCF) in the F-Area at SRS (65 FR 1608; January 11, 2000) and analyze an alternative to install and operate the pit disassembly and conversion capabilities in an existing building in K-Area at SRS. With this second Amended NOI, DOE is proposing to analyze additional

¹ The 2010 Amended NOI describes changes in the inventory of surplus plutonium to be analyzed in the SPD Supplemental EIS, though the total quantity remained about 13 MT. On March 30, 2011, DOE made an amended interim action determination to disposition approximately 85 kilograms (0.085 MT) of surplus, non-pit plutonium via the Defense Waste Processing Facility at SRS or disposal at the Waste Isolation Pilot Plant (WIPP) in New Mexico. On October 17, 2011, DOE made another interim action determination to dispose of 500 kilograms (0.5 MT) of surplus, non-pit plutonium at WIPP. These determinations do not affect the range of reasonable alternatives to be analyzed in the SPD Supplemental EIS.

alternatives for pit disassembly and conversion, which could involve the use of TA-55 at LANL, H-Canyon/HB-Line at SRS, K-Area at SRS, and the MFFF at SRS. These alternatives are described below under Potential Range of Alternatives.

Purpose and Need for Agency Action

DOE's purpose and need remains to reduce the threat of nuclear weapons proliferation worldwide by conducting disposition of surplus plutonium in the United States in an environmentally safe and timely manner. Comprehensive disposition actions are needed to ensure that surplus plutonium is converted into proliferation-resistant forms.

Potential Range of Alternatives

Since the 2010 Amended NOI, DOE has reconsidered the potential alternatives for pit disassembly and conversion. DOE now is proposing to analyze additional alternatives.

The EIS analysis will account for the possibility that DOE could use some combination of facilities at TA-55 at LANL, K-Area at SRS, H-Canyon/HB-Line at SRS, and MFFF at SRS to disassemble pits, and produce feed for the MFFF.

DOE has determined that the construction of a separate Plutonium Preparation (PuP) capability would not be required because the alternatives that are being considered for the disposition of non-pit plutonium include any necessary preparation activities.

The complete list of alternatives that DOE proposes to analyze in detail in the SPD Supplemental EIS is provided below.

Surplus Plutonium Disposition

DOE will analyze four alternative pathways to disposition surplus plutonium. There are constraints on the type or quantity of plutonium that may be dispositioned by each pathway. For example, there are safety (criticality) limits on how much plutonium can be sent to the Defense Waste Processing Facility (DWPF) at SRS, and some plutonium is not suitable for fabrication into MOX fuel. Accordingly, DOE expects to select two or more alternatives following completion of the SPD Supplemental EIS.

- H-Canyon/DWPF—DOE would use the H-Canyon at SRS to process surplus non-pit plutonium for disposition. Plutonium materials would be dissolved, and the resulting plutonium-bearing solutions would be sent to a sludge batch feed tank and then to DWPF at SRS for vitrification. Depending on the quantity, adding additional plutonium to the feed may

increase the amount of plutonium in some DWPF canisters above historical levels.

- **Glass Can-in-Canister**

Immobilization—DOE would install a glass can-in-canister immobilization capability in K-Area at SRS. The analysis will assume that both surplus pit and non-pit plutonium would be vitrified within small cans, which would be placed in a rack inside a DWPF canister and surrounded with vitrified high-level waste. This alternative is similar to one evaluated in the 1999 Surplus Plutonium Disposition EIS (SPD EIS; DOE/EIS-0283), except that the capability would be installed in an existing rather than a new facility. Inclusion of cans with vitrified plutonium would substantially increase the amount of plutonium in some DWPF canisters above historical levels.

- **WIPP**—DOE would provide the capability to prepare and package non-pit plutonium using existing facilities at SRS for disposal as transuranic waste at WIPP, provided that the material would meet the WIPP waste acceptance criteria. This alternative may include material that, because of its physical or chemical configuration or characteristics, could not be prepared for MFFF feed material and material that could be disposed at WIPP with minimal preparation.

- **MOX Fuel—Plutonium feed material**, beyond the 34 MT for which a decision already has been made, would be fabricated into MOX fuel at the MFFF, and the resultant MOX fuel would be irradiated in commercial nuclear power reactors. For purposes of analyzing this alternative, the EIS will assume all the surplus pit and some of the surplus non-pit plutonium would be dispositioned in this manner.

Pit Disassembly and Conversion Capability

Plutonium pits must be disassembled prior to disposition and, for the MOX alternative, plutonium metal from pits or non-pit material must be converted to an oxide form to be used as feed in producing MOX Fuel. DOE will analyze the potential environmental impacts of conducting pit disassembly and/or conversion activities in five different facilities to support its prior decision to disposition 34 MT of surplus plutonium by fabrication into MOX fuel and also any decision subsequent to this SPD Supplemental EIS to disposition additional surplus plutonium as MOX fuel. The Pit Disassembly and Conversion Capability Alternatives that NNSA proposes to analyze are:

- **PDCF in K-Area at SRS**—DOE would construct, operate, and

eventually decommission a stand-alone PDCF to disassemble pits and convert plutonium pits and other plutonium metal to an oxide form suitable for feed to the MFFF, as described in the SPD EIS and consistent with DOE's record of decision for that EIS (65 FR 1608; January 11, 2000).

- **Pit Disassembly and Conversion Capability in K-Area at SRS**—DOE would construct, operate, and eventually decommission equipment in K-Area at SRS necessary to perform the same functions as the PDCF. The alternative would include reconfiguration of ongoing K-Area operations necessary to accommodate construction and operation of the pit disassembly and conversion capability.

- **New alternatives for pit disassembly and conversion:**
 - **LANL/MFFF**—DOE would expand existing capabilities in the plutonium facility (PF-4) in Technical Area-55 at LANL to disassemble pits and provide plutonium metal and/or oxide for use as feed material in MFFF at SRS. DOE also may add a capability to the MFFF to oxidize plutonium metal.

- **LANL/MFFF/K-Area/H-Canyon/HB-Line at SRS**—DOE would expand existing capabilities in the plutonium facility (PF-4) in Technical Area-55 at LANL to disassemble pits and provide plutonium metal and potentially oxide for use as feed material in MFFF at SRS. DOE also may add a capability to the MFFF to oxidize plutonium metal. To augment the capability to provide feed material to the MFFF, DOE also would disassemble pits in K-Area at SRS and process plutonium metal to an oxide form at the H-Canyon/HB-Line at SRS.

Reactor Operations

MOX fuel will be irradiated in commercial nuclear reactors used to generate electricity, thereby rendering the plutonium into a spent fuel form not readily usable in nuclear weapons.

- DOE and TVA will analyze the potential environmental impacts of any reactor facility modifications necessary to accommodate MOX fuel operation at up to five TVA reactors—the three boiling water reactors at Browns Ferry, near Decatur and Athens, AL, and the two pressurized water reactors at Sequoyah, near Soddy-Daisy, TN. DOE and TVA will analyze the potential environmental impacts of operating these reactors using a core loading with the maximum technically and economically viable number of MOX fuel assemblies.

- DOE will analyze the potential environmental impacts of irradiating MOX fuel in a generic reactor in the United States to provide analysis for any

additional future potential utility customers.

Potential Decisions

The SPD Supplemental EIS will not reconsider decisions already made to disposition surplus plutonium, other than the decision to construct and operate the PDCF. DOE already has decided to fabricate 34 MT of surplus plutonium into MOX fuel in the MFFF (68 FR 20134; April 24, 2003), currently under construction at SRS, and to irradiate the MOX fuel in commercial nuclear reactors used to generate electricity. Subsequent to completion of the SPD Supplemental EIS, DOE will decide, based on programmatic, engineering, facility safety, cost, and schedule information, and on the environmental impact analysis in the SPD Supplemental EIS, which pit disassembly and conversion alternative(s) to implement to provide feed to the MFFF, which alternative(s) to implement for preparation of non-pit plutonium for disposition, whether to use the MOX alternative to disposition additional surplus plutonium (beyond 34 MT), and which alternative(s) disposition path(s) to implement for surplus plutonium that will not be dispositioned as MOX fuel. DOE may determine that it can best meet its full range of requirements in each of these areas by implementing two or more of the alternatives analyzed in the SPD Supplemental EIS. It is also possible that DOE may determine that its full range of requirements may be best met by implementing a composite set of actions that would be drawn from within the scope of the set of alternatives proposed and analyzed in the SPD Supplemental EIS.

DOE considers those alternatives that would avoid extensive construction and/or facility modification for the pit disassembly and conversion capability and non-pit plutonium preparation capability as having particular merit and, thus, has identified its preferred alternative for this proposed action. For non-pit plutonium preparation and pit disassembly and conversion of plutonium metal to MFFF feed for the manufacture of MOX fuel, DOE's preferred alternative is to use some combination of existing facilities, with additional equipment or modification, at TA-55 at LANL, K-Area at SRS, H-Canyon/HB-Line at SRS, and MFFF at SRS, rather than to construct a new, standalone facility. The MOX fuel alternative is DOE's preferred alternative for surplus plutonium disposition. DOE's preferred alternative for disposition of surplus plutonium

that is not suitable for MOX fuel fabrication is disposal at WIPP.

As stated in the 2010 Amended NOI, DOE and TVA are evaluating use of MOX fuel in up to five TVA reactors at the Sequoyah and Browns Ferry Nuclear Plants. TVA will determine whether to pursue irradiation of MOX fuel in TVA reactors, and will determine which reactors to use initially for this purpose, should TVA and DOE decide to use MOX fuel in TVA reactors.

Potential Environmental Issues for Analysis

DOE has tentatively identified the following environmental issues for analysis in the SPD Supplemental EIS. The list is presented to facilitate comment on the scope of the SPD Supplemental EIS, and is not intended to be comprehensive or to predetermine the potential impacts to be analyzed.

- Impacts to the general population and workers from radiological and nonradiological releases, and other worker health and safety impacts.
- Impacts of emissions on air and water quality.
- Impacts on ecological systems and threatened and endangered species.
- Impacts of waste management activities, including storage of DWPF canisters and transuranic waste pending disposal.
- Impacts of the transportation of radioactive materials, reactor fuel assemblies, and waste.
- Impacts that could occur as a result of postulated accidents and intentional

destructive acts (terrorist actions and sabotage).

- Potential disproportionately high and adverse effects on low-income and minority populations (environmental justice).
- Short-term and long-term land use impacts.
- Cumulative impacts.

NEPA Process

The first scoping period for the SPD Supplemental EIS began on March 28, 2007, and ended on May 29, 2007, with scoping meetings in Aiken and Columbia, SC. DOE began a second public scoping period with publication of an Amended NOI on July 19, 2010, and continuing through September 17, 2010. Public scoping meetings were held in Tanner, AL; Chattanooga, TN; North Augusta, SC; and Carlsbad and Santa Fe, NM.

Following the scoping period announced in this second Amended NOI, and after considering all scoping comments received, DOE will prepare a Draft SPD Supplemental EIS. DOE will announce the availability of the Draft SPD Supplemental EIS in the **Federal Register** and local media outlets. Comments received on the Draft SPD Supplemental EIS will be considered and addressed in the Final SPD Supplemental EIS. DOE currently plans to issue the Final SPD Supplemental EIS in late 2012. DOE will issue a record of decision no sooner than 30 days after publication by the Environmental Protection Agency of a Notice of

Availability of the Final SPD Supplemental EIS.

Other Agency Involvement

The Tennessee Valley Authority is a cooperating agency with DOE for preparation and review of the sections of the SPD Supplemental EIS that address operation of TVA reactors using MOX fuel assemblies. DOE invites Federal and non-Federal agencies with expertise in the subject matter of the SPD Supplemental EIS to contact the NEPA Document Manager (see **ADDRESSES**) if they wish to be a cooperating agency in the preparation of the SPD Supplemental EIS.

Issued at Washington, DC, on January 6, 2012.

Thomas P. D'Agostino,

Undersecretary for Nuclear Security,

[FR Doc. 2012-445 F]led 1-11-12; 10:45 am]

BILLING CODE 6450-01-P

DEPARTMENT OF ENERGY

Amended Notice of Intent to Modify the Scope of the Surplus Plutonium Disposition Supplemental Environmental Impact Statement and Conduct Additional Public Scoping

AGENCY: U.S. Department of Energy, National Nuclear Security Administration.

ACTION: Amended Notice of Intent.

SUMMARY: The U.S. Department of Energy (DOE) announces its intent to modify the scope of the *Surplus Plutonium Disposition Supplemental Environmental Impact Statement* (SPD Supplemental EIS, DOE/EIS-0283-S2) and to conduct additional public scoping. DOE issued its Notice of Intent¹ (NOI) to prepare the SPD Supplemental EIS on March 28, 2007 (72 FR 14543). DOE now intends to revise the scope of the SPD Supplemental EIS to refine the quantity and types of surplus weapons-usable plutonium material, evaluate additional alternatives, and no longer consider in detail one alternative identified in the NOI (ceramic can-in-canister immobilization). Also, DOE had identified a glass can-in-canister immobilization approach as its preferred alternative in the NOI; DOE will continue to evaluate that alternative but currently does not have a preferred alternative.

DOE now proposes to analyze a new alternative to install the capability in K-Area at the Savannah River Site (SRS) to, among other things, disassemble nuclear weapons pits (a weapons component) and convert the plutonium metal to an oxide form for fabrication into mixed uranium-plutonium oxide (MOX) reactor fuel in the Mixed Oxide Fuel Fabrication Facility (MFFF); under this alternative, DOE would not build the Pit Disassembly and Conversion Facility (PDCF), which DOE previously decided to construct. This K-Area project also would provide capabilities needed to prepare plutonium for other disposition alternatives evaluated in the SPD Supplemental EIS and to support the ongoing plutonium storage mission in K-Area. DOE also proposes to evaluate a new alternative to dispose of some surplus non-pit plutonium as transuranic waste at the Waste Isolation Pilot Plant (WIPP) in New Mexico, provided the plutonium would meet the criteria for such disposal. In addition, DOE will analyze the potential

¹The NOI identified the title of the document as the *Supplemental Environmental Impact Statement for Surplus Plutonium Disposition at the Savannah River Site*.

environmental impacts of using MOX fuel in up to five reactors owned by the Tennessee Valley Authority (TVA) at the Sequoyah (near Soddy-Daisy, TN) and Browns Ferry (near Decatur and Athens, AL) nuclear stations. TVA will be a cooperating agency with DOE for preparation and review of the sections of the SPD Supplemental EIS that address operation of TVA reactors.

DATES: DOE invites Federal agencies, state and local governments, Native American tribes, industry, other organizations, and members of the public to submit comments to assist in identifying environmental issues and in determining the scope of the SPD Supplemental EIS. The public scoping period will end on September 17, 2010. DOE will consider all comments received or postmarked by September 17, 2010. Comments received after that date will be considered to the extent practicable. Also, DOE asks that Federal, state, and local agencies that desire to be designated cooperating agencies on the SPD Supplemental EIS contact the National Environmental Policy Act (NEPA) Document Manager at the addresses listed under **ADDRESSES** by the end of the scoping period. DOE will hold five public scoping meetings:

- August 3, 2010 (5:30 p.m. to 8 p.m.) at Calhoun Community College, Decatur Campus, Aerospace Building, 6250 Highway 31 North, Tanner, AL 35671
- August 5, 2010 (5:30 p.m. to 8 p.m.) at Chattanooga Convention Center, 1150 Carter Street, Chattanooga, TN 37402
- August 17, 2010 (5:30 p.m. to 8 p.m.) at North Augusta Municipal Center, 100 Georgia Avenue, North Augusta, SC 29841
- August 24, 2010 (5:30 p.m. to 8 p.m.) at Best Western Stevens Inn, 1829 S. Canal Street, Carlsbad, NM 88220
- August 26, 2010 (5:30 p.m. to 8 p.m.) at Courtyard by Marriott Santa Fe, 3347 Cerrillos Road, Santa Fe, NM 87507

ADDRESSES: Please direct written comments on the scope of the SPD Supplemental EIS to Ms. Sachiko McAlhany, SPD Supplemental EIS NEPA Document Manager, U.S. Department of Energy, P.O. Box 2324, Germantown, MD 20874-2324. You may also send comments on the scope of the SPD Supplemental EIS via e-mail to spd_supplementaleis@saic.com, or via the Web site, <http://www.spdsupplementaleis.com>; or by toll-free fax to 877-865-0277. DOE will give equal weight to written, e-mail, fax, and oral comments. Questions regarding the scoping process and requests to be placed on the distribution list for this Supplemental EIS should be directed to

Ms. McAlhany by any of the means given above or by calling toll-free 877-344-0513.

For general information concerning the DOE NEPA process, contact: Carol Borgstrom, Director, Office of NEPA Policy and Compliance (GC-54), U.S. Department of Energy, 1000 Independence Avenue, SW, Washington, D.C. 20585-0103; telephone 202-586-4600, or leave a message at 1-800-472-2756; fax 202-586-7031; or send an e-mail to AskNEPA@hq.doe.gov. This Amended NOI will be available on the Internet at nepa.energy.gov.

SUPPLEMENTARY INFORMATION:

Background

To reduce the threat of nuclear weapons proliferation, DOE is engaged in a program to disposition its surplus, weapons-usable plutonium in a safe, secure, and environmentally sound manner by converting such plutonium into proliferation-resistant forms that can never again be readily used in nuclear weapons. The SPD Supplemental EIS will analyze the potential environmental impacts of reasonable alternatives² to disposition approximately 7 metric tons (MT)³ of additional plutonium from pits ("pit plutonium"; a pit is the core of a nuclear weapon) which were declared surplus to national defense needs after publication of the NOI and were not included in DOE's prior decisions. The SPD Supplemental EIS also will analyze reasonable disposition alternatives for approximately 6 MT⁴ of non-pit plutonium. DOE also intends to evaluate the potential impacts associated with disposition of additional plutonium to account for the possibility that the United States may declare additional

² The disposition alternatives to be analyzed in the SPD Supplemental EIS are not expected to change the type of material to be processed into MOX fuel or to change the annual throughput, annual environmental impacts, or the types of waste generated by the MFFF.

³ In 2007, the United States declared 9 MT of pit plutonium as surplus to U.S. defense needs. Approximately 2 MT are included in the 34 MT of surplus and future-declared surplus plutonium that DOE previously decided to fabricate into MOX fuel (68 FR 20134, April 24, 2003), leaving approximately 7 MT of additional surplus pit plutonium for disposition.

⁴ The 2007 NOI for the SPD Supplemental EIS stated that the scope would include up to 13 MT of surplus non-pit plutonium that DOE had previously planned to immobilize, although of that 13 MT, DOE had decided in 2003 to fabricate approximately 6.5 MT of this non-pit plutonium into MOX fuel (68 FR 20134, April 24, 2003). Since publication of the NOI in 2007, DOE has decided to disposition approximately 0.6 MT of non-pit plutonium via H-Canyon and the Defense Waste Processing Facility (see footnote 6). Thus, DOE now plans to analyze disposition options for approximately 6 MT of surplus non-pit plutonium.

plutonium to be surplus in the future and, as analyzed in the *Environmental Assessment for the U.S. Receipt and Storage of Gap Material—Plutonium* (DOE/EA-1771, May 2010), small quantities of plutonium (totaling up to 100 kilograms) that the United States may accept from at-risk foreign locations as part of the Global Threat Reduction Initiative.

The SPD Supplemental EIS will not reconsider decisions already made to disposition surplus plutonium, other than the decision discussed below to construct a stand-alone PDCF. DOE already has decided to fabricate 34 MT of surplus plutonium into MOX fuel in the MFFF (68 FR 20134, April 24, 2003), currently under construction at SRS, and to irradiate the MOX fuel in commercial nuclear reactors used to generate electricity, thereby rendering the plutonium into a spent fuel form not readily usable in nuclear weapons. DOE has set aside approximately 4 MT of surplus plutonium in the form of unirradiated reactor fuel for non-defense programmatic use (e.g., reactor fuels research and development) as explained in the 2007 NOI (72 FR 14543, March 28, 2007), and approximately 7 MT of surplus plutonium is contained in irradiated reactor fuel and, thus, already is in a proliferation-resistant form (see 65 FR 1608, January 11, 2000). Finally, DOE already has disposed of approximately 3 MT of surplus plutonium scrap and residues at WIPP as transuranic waste⁵ and has decided to process approximately 0.6 MT at SRS through the H-Canyon, ultimately to be incorporated into vitrified high-level waste at the Defense Waste Processing Facility (DWPF).⁶

Previously Completed NEPA Analyses and Decisions Made

In the *Storage and Disposition of Weapons-Usable Fissile Materials Programmatic EIS* (Storage and Disposition PEIS, DOE/EIS-0229, December 1996), DOE evaluated six candidate sites for plutonium disposition facilities and three categories of disposition technologies that would convert surplus plutonium into a form that would meet the Spent

Fuel Standard.⁷ The three categories were: Deep Borehole Category (two options); Immobilization Category (three options); and Reactor Category (four options). DOE also analyzed a No Action Alternative. DOE selected a dual-path strategy for disposition that would allow immobilization of some or all of the surplus plutonium in glass or ceramic material for disposal in a geologic repository, and fabrication of some surplus plutonium into MOX fuel for irradiation in existing domestic commercial reactor(s), with subsequent disposal of the spent fuel in a geologic repository⁸ (62 FR 3014, January 21, 1997). DOE also decided that an immobilization facility would be located either at the Hanford Site in Washington or at SRS.

In November 1999, DOE issued the *Surplus Plutonium Disposition EIS* (SPD EIS, DOE/EIS-0283). The SPD EIS tiered from the Storage and Disposition PEIS and included an analysis of the potential environmental impacts associated with alternative technologies and sites to implement the dual-path plutonium disposition strategy. The SPD EIS also analyzed the impacts of using MOX fuel in certain domestic commercial reactors to generate electricity. In January 2000, DOE decided to construct and operate three disposition facilities at SRS: (1) the MFFF to fabricate up to 33 MT of surplus plutonium into MOX fuel⁹; (2)

⁷ Under that standard, the surplus weapons-usable plutonium should be made as inaccessible and unattractive for weapons use as the much larger and growing quantity of plutonium that exists in spent nuclear fuel from commercial power reactors.

⁸ DOE has since decided to terminate the program to develop a Yucca Mountain repository for geologic disposal of spent nuclear fuel and high-level waste. DOE has established a Blue Ribbon Commission on America's Nuclear Future (Blue Ribbon Commission) to develop and recommend alternative storage and disposal approaches for spent nuclear fuel and high-level waste. Notwithstanding termination of the Yucca Mountain program, DOE remains committed to meeting its obligations to manage and ultimately dispose of spent nuclear fuel and high-level waste. The Blue Ribbon Commission will conduct a comprehensive review of the back-end of the fuel cycle and evaluate alternative approaches for meeting these obligations. The Blue Ribbon Commission will provide the opportunity for a meaningful dialogue on how best to address this challenging issue and will provide recommendations to DOE for developing a safe, long-term solution to managing the Nation's spent nuclear fuel and high-level waste.

⁹ In the 2000 Record of Decision (ROD), DOE noted that it had awarded a contract to Duke Engineering & Services, COGEMA Inc., and Stone & Webster (known as DCS) that included reactor irradiation of MOX fuel at Duke Energy's Catawba and McGuire Nuclear Stations. The SPD EIS and ROD also addressed two Virginia Power reactors at the North Anna Nuclear Station in Virginia. Virginia Power's involvement in the MOX program ended soon thereafter.

⁵ Disposal of certain plutonium scrap and residues at WIPP was undertaken pursuant to several records of decision (63 FR 66136, December 1, 1998; 64 FR 8068, February 18, 1999; 64 FR 47780, September 1, 1999; 66 FR 4803, January 18, 2001; 68 FR 44329, July 28, 2003).

⁶ The decisions to process approximately 0.6 MT of surplus non-pit plutonium through H-Canyon and DWPF are contained in two interim action determinations approved at SRS on December 8, 2008, and September 25, 2009.

a PDCF to disassemble nuclear weapons pits and convert the plutonium metal to an oxide form for use as feed material for the MFFF; and (3) an immobilization facility using ceramic can-in-canister technology that would allow for the immobilization of approximately 17 MT of surplus plutonium (65 FR 1608, January 11, 2000). Using the can-in-canister technology, DOE was to immobilize plutonium in a ceramic form, seal it in cans, and place the cans in canisters to be filled with borosilicate glass containing intensely radioactive high-level waste at DWPF.

In 2002, DOE cancelled the immobilization portion of the plutonium disposition strategy (67 FR 19432, April 19, 2002). In 2003, DOE affirmed the MOX-only approach for plutonium disposition, in which 34 MT (increased from 33 MT) of surplus plutonium, including approximately 6.5 MT of the non-pit plutonium originally intended for immobilization, would be dispositioned by fabrication into MOX fuel for use in power reactors (68 FR 20134, April 24, 2003).

In 2005, DOE completed an *Environmental Assessment for the Safeguards and Security Upgrades for Storage of Plutonium Materials at SRS* (DOE/EA-1538, 2005) and issued a Finding of No Significant Impact. Among other things, this Environmental Assessment analyzed impacts associated with installation of a Container Surveillance and Storage Capability (CSSC) in an existing facility in K-Area at SRS. The CSSC capabilities are encompassed within what DOE refers to as the Plutonium Preparation Project (PuP). One phase of the PuP would provide stabilization and packaging capabilities, including direct metal oxidation, to fulfill plutonium storage requirements pursuant to DOE-STD-3013, Stabilization, Packaging, and Storage of Plutonium-Bearing Materials.

In 2007, DOE decided to consolidate surplus non-pit plutonium stored separately at the Hanford Site, the Los Alamos National Laboratory (LANL), and the Lawrence Livermore National Laboratory (LLNL) to a single storage location in K-Area at SRS, pending disposition (72 FR 51807, September 11, 2007). Shipments from Hanford have been completed, and shipments from LANL and LLNL to SRS for consolidated storage are continuing.

In 2008, DOE completed a supplement analysis (DOE/EIS-0283-SA-2) related to the treatment and solidification of certain liquid low-level radioactive waste and transuranic waste to be generated by the MFFF and PDCF. DOE decided to construct and operate a stand-alone waste solidification

building in the F-Area at SRS (73 FR 75088, December 10, 2008); this facility is now under construction.

2007 Notice of Intent and Public Scoping Comments

On March 28, 2007, DOE issued an NOI (72 FR 14543) to prepare the SPD Supplemental EIS in order to evaluate the potential environmental impacts of disposition alternatives for up to approximately 13 MT of surplus, non-pit weapons-usable plutonium originally planned for immobilization. In the 2007 NOI, DOE stated that its preferred alternative was to construct and operate a new vitrification facility within an existing building at SRS to immobilize some of the surplus, non-pit plutonium, and to process some of the surplus, non-pit plutonium in the existing H-Canyon and DWPF at SRS. That NOI also explained that DOE would analyze the impacts of fabricating some (up to approximately one-third) of the surplus, non-pit plutonium into MOX fuel.

The original scoping period for the SPD Supplemental EIS began on March 28, 2007, and ended on May 29, 2007. Scoping meetings were held in Aiken, SC, and in Columbia, SC, on April 17 and 19, 2007, respectively. Some commentors favored the glass can-in-canister alternative for the entire surplus plutonium inventory, while others favored use of as much surplus plutonium as possible as feed material for the MFFF. One commentor asked that DOE identify the quantities of surplus plutonium by form and proposed disposition pathway. DOE will consider these comments, and others received during the upcoming scoping period, when preparing the Draft SPD Supplemental EIS.

Purpose and Need for Action

DOE's purpose and need remains, as stated in the SPD EIS, to reduce the threat of nuclear weapons proliferation worldwide by conducting disposition of surplus plutonium in the United States in an environmentally safe and timely manner. Comprehensive disposition actions are needed to ensure that surplus plutonium is converted into proliferation-resistant forms.

Proposed Action and Alternatives

In the SPD Supplemental EIS, DOE will analyze the potential environmental impacts of alternatives for the disposition of approximately 7 MT of surplus pit plutonium and approximately 6 MT of surplus non-pit plutonium. DOE also will analyze the impacts of irradiating MOX fuel in TVA reactors at the Sequoyah and Browns

Ferry nuclear stations and will analyze options for the construction and operation of the PDCF and PuP capabilities at SRS. Brief descriptions of the alternatives DOE proposes to evaluate in the SPD Supplemental EIS are provided below.

- PDCF—DOE would construct and operate a stand-alone PDCF facility in F-Area at SRS to convert plutonium pits and other plutonium metal to an oxide form suitable for feed to the MFFF, as described in the SPD EIS and consistent with DOE's decision announced in the 2000 Record of Decision (ROD) for that EIS (65 FR 1608, January 11, 2000).

- PuP—DOE would install and operate the plutonium processing equipment required to store and prepare non-pit plutonium for disposition through any of the alternative pathways (MOX fuel, H-Canyon/DWPF, Glass Can-in-Canister, and WIPP). Differences in required capabilities for the alternatives will be evaluated in the SPD Supplemental EIS. The PuP project would be installed in K-Area at SRS.

- Combined PDCF/PuP Capability—DOE would install and operate a capability in K-Area at SRS necessary to perform the functions of both PDCF and PuP. The analysis will include reconfiguration of ongoing K-Area operations necessary to accommodate construction and operation of the combined capability.

- H-Canyon/DWPF—DOE would use the H-Canyon facility to process surplus non-pit plutonium for disposition. Plutonium materials would be dissolved, and the resulting plutonium-bearing solutions would be sent to a sludge batch feed tank and then to DWPF for vitrification. Within this alternative, DOE will analyze the potential environmental impacts of adding additional plutonium to the DWPF feed, which may increase the amount of plutonium in some DWPF canisters above historical levels.

- Glass Can-in-Canister—DOE would establish and operate a glass can-in-canister capability in K-Area at SRS. The analysis will assume that both surplus pit and non-pit plutonium would be vitrified within small cans, which would be placed in a rack inside a DWPF canister and surrounded with vitrified high-level waste. This alternative is similar to one evaluated in the SPD EIS, except that the capability would be installed in an existing rather than a new facility. Within this alternative DOE will analyze the potential environmental impacts of adding cans of vitrified plutonium to some of the DWPF canisters, which would increase the amount of

plutonium in those DWPF canisters above historical levels.

- **WIPP**—DOE would establish and operate a capability to prepare and package non-pit plutonium using PuP (or the combined PDCF/PuP capability) and other existing facilities at SRS for disposal as transuranic waste at WIPP, provided that the material would meet the WIPP waste acceptance criteria. This alternative may include material that, because of its physical or chemical configuration or characteristics, could not be prepared for MFFF feed material.

- **MOX Fuel**—PDCF, PuP, or the combined PDCF/PuP capabilities would be used to prepare some surplus plutonium as feed for the MFFF, and the resultant MOX fuel would be irradiated in commercial nuclear reactors. The analysis will assume that all of the surplus pit and some of the surplus non-pit plutonium would be dispositioned in this manner.

- **Reactor Operations**—DOE will evaluate the impacts of construction of any reactor facility modifications¹⁰ necessary to accommodate MOX fuel operation at five TVA reactors—the three boiling water reactors (BWRs) at Browns Ferry and the two pressurized water reactors (PWRs) at Sequoyah. DOE will evaluate the impacts of operation of these reactors using a core loading with the maximum technically and economically viable number of MOX fuel assemblies.

DOE no longer proposes to evaluate in detail the ceramic can-in-canister alternative identified in the 2007 NOI for the SPD Supplemental EIS. In the SPD EIS, DOE identified no substantial differences between the ceramic can-in-canister and glass can-in-canister approaches in terms of expected environmental impacts to air quality, waste management, human health risk, facility accidents, facility resource requirements, intersite transportation, and environmental justice. DOE infrastructure and expertise associated with the ceramic technology has not substantially evolved or matured since 2003. In contrast, DOE has maintained research, development, and production infrastructure capabilities for glass waste forms. Therefore, DOE has decided that the glass can-in-canister technology is sufficiently representative of both technologies in terms of understanding potential environmental impacts and that the relative technical maturity of the glass can-in-canister

¹⁰ The SPD Supplemental EIS also will evaluate environmental impacts from potential minor modifications to the MFFF that may be needed to accommodate fabrication of TVA reactor MOX fuel.

approach gives it a greater chance of meeting DOE mission needs.

Potential Decisions

Since initiating the SPD Supplemental EIS process in 2007, DOE has continued to evaluate alternatives for disposition of surplus plutonium. DOE is evaluating the advantages and disadvantages of combining the PDCF and the PuP to accomplish the functions of both projects in an existing facility in K-Area at SRS. DOE will decide, based on programmatic, engineering, facility safety, cost, and schedule information, and the environmental impact analysis in the SPD Supplemental EIS, whether to implement the combined project in K-Area at SRS (PDCF/PuP) or to separately construct and operate PDCF in F-Area and PuP in K-Area at SRS.

DOE also will decide which alternatives to use for disposition of approximately 7 MT of surplus weapons-usable pit plutonium and approximately 6 MT of surplus weapons-usable non-pit plutonium for which DOE has not made a disposition decision.

DOE is evaluating alternatives for surplus non-pit plutonium that currently does not meet the specification for disposition through the MFFF. While this material could be immobilized for disposition using the glass can-in-canister alternative, DOE is evaluating three other alternative disposition paths: processing through H-Canyon and incorporation into vitrified high-level waste at DWPF; preparation for disposal at WIPP; and pretreatment to make the material suitable as feed for the MFFF.

In addition, the contract with Duke Energy Company to irradiate MOX fuel in four of its reactors terminated in late 2008. At present, DOE and TVA are evaluating use of MOX fuel in up to five TVA reactors at the Sequoyah and Browns Ferry nuclear stations, near Soddy-Daisy, TN, and Decatur and Athens, AL, respectively. DOE and TVA will determine whether to pursue irradiation of MOX fuel in TVA reactors and will determine which reactors to use initially for this purpose should DOE and TVA decide to use MOX fuel in TVA reactors.

Potential Environmental Issues for Analysis

DOE has tentatively identified the following environmental issues for analysis in the SPD Supplemental EIS. The list is presented to facilitate comment on the scope of the SPD Supplemental EIS and is not intended to be comprehensive or to predetermine the potential impacts to be analyzed.

- Impacts to the general population and workers from radiological and nonradiological releases, and other worker health and safety impacts.

- Impacts of emissions on air and water quality.

- Impacts on ecological systems and threatened and endangered species.

- Impacts from waste management activities, including from storage of DWPF canisters and transuranic waste pending disposal.

- Impacts from the transportation of radioactive materials, reactor fuel assemblies, and waste.

- Impacts of postulated accidents and from terrorist actions and sabotage.

- Potential disproportionately high and adverse effects on low-income and minority populations (environmental justice).

- Short-term and long-term land use impacts.

NEPA Process

Following the scoping period announced in this Amended Notice of Intent, and after consideration of comments received during scoping, DOE will prepare a Draft SPD Supplemental EIS. DOE will announce the availability of the Draft SPD Supplemental EIS in the **Federal Register** and local media outlets. Comments received on the Draft SPD Supplemental EIS will be considered and addressed in the Final SPD Supplemental EIS. DOE will issue a ROD no sooner than 30 days after publication by the Environmental Protection Agency of a Notice of Availability of the Final SPD Supplemental EIS.

Other Agency Involvement

The Tennessee Valley Authority will be a cooperating agency with DOE for preparation and review of the sections of the SPD Supplemental EIS that address operation of TVA reactors using MOX fuel assemblies. DOE invites Federal and non-Federal agencies with expertise in the subject matter of the SPD Supplemental EIS to contact the NEPA Document Manager (*see ADDRESSES*) if they wish to be a cooperating agency in the preparation of the SPD Supplemental EIS.

Issued in Washington, DC, on 13 July, 2010.

Thomas P. D'Agostino,

Administrator, National Nuclear Security Administration.

[FR Doc. 2010-17519 Filed 7-16-10; 8:45 am]

BILLING CODE 6450-01-P

plutonium disposition capabilities that would be constructed and operated at the Savannah River Site (SRS) near Aiken, South Carolina. DOE completed the *Surplus Plutonium Disposition (SPD) EIS* (DOE/EIS-0283) in November 1999, and on January 11, 2000, published a Record of Decision (ROD) in the **Federal Register** (65 FR 1608). DOE decided to dispose of approximately 17 metric tons of plutonium surplus to the nation's defense needs using an immobilization process and up to 33 metric tons by using the surplus plutonium as feedstock in the fabrication of mixed oxide (MOX) fuel to be irradiated in commercial reactors. DOE selected the SRS as the site for all surplus plutonium disposition facilities. Subsequently, DOE cancelled the immobilization portion of its disposition strategy due to budgetary constraints (ROD, 67 FR 19432, April 19, 2002). The selection of the SRS as the location for disposition facilities for up to 50 metric tons of surplus plutonium remains unchanged. Site preparation for the MOX Fuel Fabrication Facility at the SRS began in November 2005.

The 2002 decision left DOE with about 13 metric tons of surplus plutonium that does not have a defined path to disposition (about 4 metric tons of the 17 metric tons originally considered for immobilization has been designated for programmatic use). DOE has been investigating alternative disposition technologies and will now prepare an *SEIS for Surplus Plutonium Disposition at the SRS* (DOE/EIS-0283-S2) to evaluate the potential environmental impacts of those alternatives. DOE's preferred alternative is to construct and operate a vitrification facility within an existing building at the SRS. This facility would immobilize plutonium within a lanthanide borosilicate glass inside stainless steel cans. The cans then would be placed within larger canisters to be filled with vitrified high-level radioactive waste in the Defense Waste Processing Facility (DWPF) at the SRS. The canisters would be suitable for disposal in a geologic repository. DOE also would prepare some of the surplus plutonium for disposal by processing it in the H-Canyon at the SRS, then sending it to the high-level waste tanks and DWPF. DOE seeks to take this action to reduce the threat of nuclear weapons proliferation worldwide by disposing of surplus plutonium in the United States in a safe and environmentally sound manner. The preferred vitrification technology, along with processing in H-Canyon, would fulfill this need for

DEPARTMENT OF ENERGY

Notice of Intent To Prepare a Supplemental Environmental Impact Statement for Surplus Plutonium Disposition at the Savannah River Site

AGENCY: Department of Energy.

ACTION: Notice of Intent.

SUMMARY: The U.S. Department of Energy (DOE) intends to prepare a Supplemental Environmental Impact Statement (SEIS) to evaluate the potential environmental impacts of

disposition of surplus plutonium materials that are not planned for disposition via fabrication into MOX fuel.

DATES: DOE invites Federal agencies, state and local governments, Native American tribes, industry, other organizations, and members of the public to submit comments to assist in identifying environmental issues and in determining the appropriate scope of the SEIS. The public scoping period starts with the publication of this notice in the **Federal Register** and will continue until May 29, 2007. Comments received after this date will be considered to the extent practicable. Also, DOE requests Federal, State, and local agencies that desire to be designated as cooperating agencies on the SEIS to contact the NEPA Document Manager at the addresses listed under **ADDRESSES** by the end of the scoping period. DOE will hold two public scoping meetings:

- April 17, 2007 (5:30 p.m.–10 p.m.) at Newberry Hall, 117 Newberry Street, SW., Aiken, SC.

- April 19, 2007 (5:30 p.m.–10 p.m.) at the Columbia Marriott Hotel, 1200 Hampton Street, Columbia, SC.

DOE officials will be available to answer questions about plutonium disposition and the proposed alternatives at both locations beginning at 5:30 p.m. DOE will provide a brief presentation on the SEIS, then, beginning about 6:30 p.m., accept public comments on the scope of the SEIS.

ADDRESSES: Comments or questions regarding the scoping process, requests to be placed on the SEIS distribution list, and comments on the scope of the SEIS should be addressed to Mr. Andrew R. Grainger, NEPA Document Manager, Savannah River Operations Office, P.O. Box B, Aiken, SC 29802; toll-free telephone 1-800-881-7292; fax 803-952-7065; or e-mail drew.grainger@srs.gov.

For general information concerning the DOE NEPA process, contact: Carol Borgstrom, Director, Office of NEPA Policy and Compliance (GC-20), U.S. Department of Energy, 1000 Independence Avenue, SW., Washington, DC 20585-0103; telephone 202-586-4600, or leave a message at 1-800-472-2756; fax 202-586-7031; or send an e-mail to askNEPA@eh.doe.gov. This NOI will be available on the Internet at <http://www.oh.doe.gov/nepa>.

SUPPLEMENTARY INFORMATION:

Background

After the end of the Cold War, the United States declared 50 metric tons of plutonium surplus to the defense needs

of the nation. At that time, plutonium materials were in various forms and various stages of the material manufacturing and weapons fabrication processes and were located at several weapons complex sites that DOE had operated in the preceding decades. DOE began the process of placing these materials in safe, stable configurations for storage until disposition strategies could be developed and implemented.

In the *Storage and Disposition of Weapons-Usable Fissile Materials Programmatic EIS* (Storage and Disposition PEIS, DOE/EIS-0229, December 1996), DOE evaluated six candidate sites for siting plutonium disposition facilities and three categories of disposition technologies that would convert surplus plutonium into a form that would meet the Spent Fuel Standard.¹ The three categories were: Deep Borehole Category (two options); Immobilization Category (three options: vitrification, ceramic immobilization, electrometallurgical treatment); and Reactor Category (four options). DOE also analyzed a No Action Alternative. DOE selected a dual-path strategy for disposition involving immobilization of surplus plutonium in glass or ceramic material for disposal in a geologic repository, and burning other surplus plutonium as MOX fuel in existing domestic commercial reactor(s) with subsequent disposal of the spent fuel in a geologic repository (ROD, 62 FR 3014, January 21, 1997). DOE also decided that an immobilization facility would be located at Hanford in Washington or at the SRS.

In November 1999, DOE issued the *Surplus Plutonium Disposition EIS*. The SPD EIS tiered from the Storage and Disposition PEIS and included an analysis of alternative technologies and sites to implement the dual-path plutonium disposition strategy. In January 2000, DOE decided to construct and operate a MOX Fuel Fabrication Facility at the SRS to use up to 33 metric tons of surplus plutonium to fabricate MOX fuel and to construct and operate a new immobilization facility at the SRS (referred to as the Plutonium Immobilization Plant) using the ceramic can-in-canister technology allowing for the immobilization of approximately 17 metric tons of surplus plutonium (ROD, 65 FR 1608, January 11, 2000). Using this technology, DOE would immobilize plutonium in a ceramic form, seal it in cans, and place the cans in canisters filled with borosilicate glass containing

¹ Under that standard, the surplus weapons-usable plutonium should be made as inaccessible and unattractive for weapons use as the much larger and growing quantity of plutonium that exists in spent nuclear fuel from commercial power reactors.

intensely radioactive high-level waste at the existing DWPF. DOE stated that the can-in-canister approach would complement existing site missions, take advantage of existing infrastructure and staff expertise, and enable DOE to use an existing facility, DWPF.

In 2002, DOE cancelled the immobilization portion of the plutonium disposition strategy (ROD, 67 FR 19432, April 19, 2002). The selection of the SRS as the location for disposition facilities for up to 50 metric tons of surplus plutonium remains unchanged. In November 2005, DOE began site preparation at SRS for the MOX Fuel Fabrication Facility.

For purposes of this NEPA analysis, DOE will assume that the surplus plutonium to be disposed of will include some of the plutonium already stored at the SRS and some that DOE could move to the SRS from other sites (e.g., Hanford in Washington, Los Alamos National Laboratory in New Mexico, and Lawrence Livermore National Laboratory in California). DOE previously evaluated the transfer and storage of surplus plutonium from other sites in the Storage and Disposition PEIS and the SPD EIS. In addition, DOE will analyze the potential environmental impacts of these proposed shipments to, and subsequent storage in, the K-Area at the SRS in a supplement analysis (pursuant to 10 CFR 1021.314(c)). Upon completion of the supplement analysis, DOE will determine whether to issue an Amended ROD or conduct additional NEPA review, as appropriate. As explained in a prior ROD, "in addition to achieving the ultimate goal of permanent disposition of surplus plutonium materials, DOE independently needs to improve the configuration of the storage system for these materials, pending disposition" (67 FR 19433, April 19, 2002).

In addition to completing appropriate environmental reviews in compliance with NEPA, prior to shipping surplus weapons-usable plutonium to the SRS that would have been disposed of in the Plutonium Immobilization Plant, DOE must comply with Section 3155. Disposition of Defense Plutonium at the Savannah River Site, of Public Law 107-107, National Defense Authorization Act for Fiscal Year 2002, Section 3155(d) of this law requires that DOE prepare a plan that identifies a disposition path for such surplus plutonium.

Purpose and Need for Action

DOE's purpose and need for proposing this immobilization process has not changed since the SPD EIS was prepared. DOE needs to reduce the threat of nuclear weapons proliferation

worldwide by disposing of surplus plutonium in the United States in a safe and environmentally sound manner. As stated in the ROD for the SPD EIS, DOE needs to ensure that plutonium produced for nuclear weapons and declared surplus to national security needs, now and in the future, is never again used for nuclear weapons. In addition, because of the cancellation of the immobilization portion of the disposition strategy in 2002, DOE is responsible for approximately 13 metric tons of declared surplus plutonium that does not have a defined disposition path. This situation needs to be addressed in light of DOE's ongoing responsibility to ensure the safe disposition of surplus plutonium.

Potential Range of Alternatives

In September 2005, DOE approved the Mission Need for a Plutonium Disposition Project at the SRS to address up to approximately 13 metric tons of surplus plutonium without an identified disposition path. The Mission Need is the first step in DOE's project management process, in accordance with DOE Order 413.3A, Program and Project Management for the Acquisition of Capital Assets.

DOE completed a technical review of alternative technologies in May 2006, which identified four potentially viable alternatives for completing the disposition of surplus plutonium. Three of these four alternatives will be evaluated in the SEIS.

- A glass can-in-canister approach installed in K-Area at the SRS. Plutonium would be vitrified within small cans, which would be placed in a rack inside a DWPF canister and surrounded with vitrified high-level waste. This alternative is similar to one evaluated in the SPD EIS, except that the capability would be installed in an existing rather than a new facility. Also, the currently proposed facility would be designed to immobilize approximately 13 metric tons of surplus plutonium rather than 17 metric tons as evaluated in the SPD EIS. (This is DOE's Preferred Alternative.)

- A ceramic can-in-canister approach installed in K-Area at the SRS. Plutonium would be incorporated in a ceramic material and placed in small cans, which would be placed in a rack inside a DWPF canister and surrounded with vitrified high-level waste. This alternative is similar to that initially selected by DOE following analysis in the SPD EIS. As with the glass can-in-canister approach, the two primary differences are that the SEIS will evaluate installing the capability in an existing rather than a new facility, and

the SEIS will assume the disposition of approximately 13 metric tons of surplus plutonium, rather than 17 metric tons.

- Disposition using the MOX Fuel Fabrication Facility. This alternative would rely on facilities to be constructed at the SRS for disposition by using the surplus plutonium as feedstock in the fabrication of MOX fuel to be irradiated in commercial reactors. DOE anticipates that less than a third of the 13 metric tons of surplus plutonium that are the subject of this SEIS would meet the specifications for use as MOX Fuel Fabrication Facility feedstock.

Under each of the three alternatives, DOE would process some surplus plutonium for disposal using the H-Canyon. Plutonium materials would be dissolved, and the resulting plutonium-bearing solutions would be sent to the SRS liquid radioactive waste tanks then to DWPF for vitrification. DOE is evaluating the continued use of H-Canyon for uranium processing in a separate NEPA document—a supplement analysis scheduled for completion in 2007. Decisions regarding future operations of H-Canyon have a bearing on the availability of the facility to process surplus plutonium (i.e., processing for plutonium disposition would occur while H-Canyon is operating primarily for uranium processing).

The SEIS also will evaluate a No Action alternative of continued storage of the surplus plutonium.

DOE has determined that the fourth alternative identified in the May 2006 technical review is not reasonable, and thus, it will not be evaluated in detail in the SEIS. This alternative involved disposing of the entire 13 metric tons of surplus plutonium through H-Canyon and DWPF. Disposing of the entire 13 metric tons of surplus plutonium by using the H-Canyon facilities would result in extending operation of those facilities many years beyond the estimated 2019 date for completion of its currently approved mission of preparing spent nuclear fuel and highly-enriched uranium materials for disposition, and would also extend the planned operation of DWPF and the high-level waste system. Furthermore, implementation of this alternative would require security upgrades to make H-Canyon a Category I nuclear facility, which is inconsistent with the Department's plans to enhance security and reduce costs throughout the complex by reducing the number of such facilities. The additional cost of these security upgrades and extended operations are estimated to be several billion dollars.

Invitation to Comment

DOE invites Federal agencies, state and local governments, Native American tribes, industry, other organizations, and members of the public to provide comments on the proposed scope, alternatives, and environmental issues to be analyzed in the *Supplemental EIS for Surplus Plutonium Disposition at the SRS*. DOE will consider all such comments and other relevant information in defining the scope and analyses for the SEIS. Comments should be submitted as described under **DATES** and **ADDRESSES** above.

Potential Environmental Issues for Analysis

DOE has tentatively identified the following environmental issues for analysis in the *Supplemental EIS for Surplus Plutonium Disposition at the SRS*. The list is presented to facilitate comment on the scope of the SEIS and is not intended to be comprehensive nor to predetermine the alternatives to be analyzed or their potential impacts.

- Impacts to the general population and workers from radiological and nonradiological releases.
- Worker health and safety, including impacts from the use of chemicals.
- Long-term health and environmental impacts.
- Impacts of emissions on air and water quality.
- Impacts on ecological systems and threatened and endangered species.
- Impacts from waste management activities.
- Impacts from the transportation of radioactive materials and waste.
- Impacts of postulated accidents and from terrorist actions and sabotage.
- Potential disproportionately high and adverse effects on low-income and minority populations (environmental justice).
- Short-term and long-term land use impacts.

NEPA Process

Following the scoping period announced in this Notice of Intent, and after consideration of comments received during scoping, DOE will prepare a Draft *SEIS for Surplus Plutonium Disposition at the SRS*. DOE will announce the availability of the Draft SEIS in the **Federal Register** and local media outlets. DOE plans to issue the Draft SEIS by January 2008. Comments received on the Draft SEIS will be considered and addressed in the Final SEIS, which DOE anticipates issuing by July 2008. DOE will issue a ROD no sooner than 30 days after

14546

Federal Register / Vol. 72, No. 59 / Wednesday, March 28, 2007 / Notices

publication by the Environmental
Protection Agency of a Notice of
Availability of the Final SEIS.

Issued in Washington, DC, on March 21,
2007.

Eric J. Fygi.

Acting General Counsel.

[FR Doc. E7-5591 Filed 3-27-07; 8:45 am]

BILLING CODE 6450-01-P

A.4.2 Other Related *Federal Register* Notices

Surplus Plutonium Disposition

73 FR 75088, December 10, 2008

Amended Record of Decision: Surplus Plutonium Disposition; Waste Solidification Building

72 FR 51807, September 11, 2007

Amended Record of Decision: Storage of Surplus Plutonium Materials at the Savannah River Site

70 FR 6047, February 4, 2005

Nuclear Regulatory Commission; Duke Cogema Stone and Webster's Proposed Mixed Oxide Fuel Fabrication Facility; Notice of Availability of Final Environmental Impact Statement

68 FR 64611, November 14, 2003

Amended Record of Decision: Surplus Plutonium Disposition Program

68 FR 20134, April 24, 2003

Amended Record of Decision: Surplus Plutonium Disposition Program

67 FR 19432, April 19, 2002

Amended Record of Decision: Surplus Plutonium Disposition Program

65 FR 1608, January 11, 2000

Record of Decision for the Surplus Plutonium Disposition Final Environmental Impact Statement

63 FR 43386, August 13, 1998

Notice of Amended Record of Decision: Storage and Disposition of Weapons-Usable Fissile Materials

62 FR 3014, January 21, 1997

Record of Decision for the Storage and Disposition of Weapons-Usable Fissile Materials Final Programmatic Environmental Impact Statement

Defense Waste Processing Facility at the Savannah River Site

71 FR 3834, January 24, 2006

Amended Record of Decision: Savannah River Site Salt Processing Alternatives

66 FR 52752, October 17, 2001

Record of Decision: Savannah River Site Salt Processing Alternatives

60 FR 18589, April 12, 1995

Record of Decision; Defense Waste Processing Facility at the Savannah River Site, Aiken, South Carolina

47 FR 23801, June 1, 1982

Record of Decision: Defense Waste Processing Facility, Savannah River Plant, Aiken, South Carolina

Interim Management of Nuclear Materials at the Savannah River Site

68 FR 44329, July 28, 2003

Amended Record of Decision: Interim Management of Nuclear Materials; Savannah River Site Waste Management

67 FR 45710, July 10, 2002

Supplemental Record of Decision: Interim Management of Nuclear Materials

66 FR 55166, November 1, 2001

Amended Record of Decision: Interim Management of Nuclear Materials

66 FR 7888, January 26, 2001

Amended Record of Decision: Interim Management of Nuclear Materials

62 FR 61099, November 14, 1997

Supplemental Record of Decision: Savannah River Operations Office; Interim Management of Nuclear Materials at the Savannah River Site

62 FR 17790, April 11, 1997

Supplemental Record of Decision and Supplement Analysis Determination: Savannah River Operations Office; Interim Management of Nuclear Materials at the Savannah River Site

61 FR 48474, September 13, 1996

Supplemental Record of Decision: Savannah River Operations Office; Interim Management of Nuclear Materials at the Savannah River Site

61 FR 6633, February 21, 1996

Supplemental Record of Decision: Savannah River Operations Office; Interim Management of Nuclear Materials at the Savannah River Site

60 FR 65300, December 19, 1995

Record of Decision and Notice of Preferred Alternatives: Savannah River Operations Office; Interim Management of Nuclear Materials at Savannah River Site

Plutonium Facility at the Los Alamos National Laboratory

74 FR 33232, July 10, 2009

Record of Decision: Site-Wide Environmental Impact Statement for the Continued Operation of Los Alamos National Laboratory, Los Alamos, NM

73 FR 55833, September 19, 2008

Record of Decision: Site-Wide Environmental Impact Statement for the Continued Operation of Los Alamos National Laboratory, Los Alamos, NM

Waste Isolation Pilot Plant

69 FR 39456, June 30, 2004

Revision to the Record of Decision for the Department of Energy's Waste Isolation Pilot Plant Disposal Phase

67 FR 69512, November 18, 2002

Amendment to a Record of Decision: Waste Isolation Pilot Plant Disposal Phase Supplemental Environmental Impact Statement

66 FR 4803, January 18, 2001

Amended Record of Decision: Management of Certain Plutonium Residues and Scrub Alloy Stored at the Rocky Flats Environmental Technology Site

64 FR 47780, September 1, 1999

Amendment to a Record of Decision: Management of Certain Plutonium Residues and Scrub Alloy Stored at the Rocky Flats Environmental Technology Site

64 FR 8068, February 18, 1999

Second Record of Decision on Management of Certain Plutonium Residues and Scrub Alloy Stored at the Rocky Flats Environmental Technology Site

63 FR 66136, December 1, 1998

Record of Decision on Management of Certain Plutonium Residues and Scrub Alloy Stored at the Rocky Flats Environmental Technology Site

63 FR 3624, January 23, 1998

Record of Decision for the Department of Energy's Waste Isolation Pilot Plant Disposal Phase

A.5 References

DOE (U.S. Department of Energy), 1990, *Final Supplemental Environmental Impact Statement for the Waste Isolation Pilot Plant*, DOE/EIS-0026-FS, Washington, DC, January.

DOE (U.S. Department of Energy), 1994, *Defense Waste Processing Facility Supplemental Environmental Impact Statement*, DOE/EIS-0082-S, Savannah River Site, Aiken, South Carolina, November.

DOE (U.S. Department of Energy), 1995a, *Savannah River Site Waste Management Final Environmental Impact Statement*, DOE/EIS-0217, Savannah River Operations Office, Aiken, South Carolina, July.

DOE (U.S. Department of Energy), 1995b, *Final Environmental Impact Statement, Interim Management of Nuclear Materials*, DOE/EIS-0220, Savannah River Site, Aiken, South Carolina, October.

DOE (U.S. Department of Energy), 1995c, *Programmatic Spent Nuclear Fuel Management and Idaho National Engineering Laboratory Environmental Restoration and Waste Management Programs Final Environmental Impact Statement*, DOE/EIS-0203, Office of Environmental Management, Idaho Operations Office, April.

DOE (U.S. Department of Energy), 1996a, *Disposition of Surplus Highly Enriched Uranium Final Environmental Impact Statement*, DOE/EIS-0240, Office of Fissile Materials Disposition, Washington, DC, June.

DOE (U.S. Department of Energy), 1996b, *Final Environmental Impact Statement for the Continued Operation of the Pantex Plant and Associated Storage of Nuclear Weapon Components*, DOE/EIS-0225, Albuquerque Operations Office, Albuquerque, New Mexico, September.

DOE (U.S. Department of Energy), 1996c, *Storage and Disposition of Weapons-Usable Fissile Materials Final Programmatic Environmental Impact Statement*, DOE/EIS-0229, Office of Fissile Materials Disposition, Washington, DC, December.

DOE (U.S. Department of Energy), 1997a, *Final Waste Management Programmatic Environmental Impact Statement for Managing Treatment, Storage, and Disposal of Radioactive and Hazardous Waste*, DOE/EIS-0200-F, Office of Environmental Management, Washington, DC, May.

DOE (U.S. Department of Energy), 1997b, *Waste Isolation Pilot Plant Disposal Phase Final Supplemental Environmental Impact Statement*, DOE/EIS-0026-S-2, Carlsbad Area Office, Carlsbad, New Mexico, September.

DOE (U.S. Department of Energy), 1998a, *Final Environmental Impact Statement on Management of Certain Plutonium Residues and Scrub Alloy Stored at the Rocky Flats Environmental Technology Site*, DOE/EIS-0277F, Office of Environmental Management, Washington, DC, August.

DOE (U.S. Department of Energy), 1998b, *Supplement Analysis for Storing Plutonium in the Actinide Packaging and Building K-105 at the Savannah River Site*, DOE/EIS-0229-SA-1, Savannah River Operations Office, Aiken, South Carolina, July.

DOE (U.S. Department of Energy), 1998c, *Pit Disassembly and Conversion Demonstration Environmental Assessment and Research and Development Activities*, DOE/EA-1207, Savannah River Operations Office, Aiken, South Carolina, August.

DOE (U.S. Department of Energy), 1998d, *Finding of No Significant Impact, Pit Disassembly and Conversion Demonstration Environmental Assessment and Research and Development Activities*, DOE/EA-1207, Office of Fissile Materials Disposition, Washington, DC, Aiken, South Carolina, August.

DOE (U.S. Department of Energy), 1999, *Surplus Plutonium Disposition Final Environmental Impact Statement*, DOE/EIS-0283, Office of Fissile Materials Disposition, Washington, DC, November.

DOE (U.S. Department of Energy), 2001, *Savannah River Site Salt Processing Alternatives Final Supplemental Environmental Impact Statement*, DOE/EIS-0082-S2, Savannah River Operations Office, Aiken, South Carolina, June.

DOE (U.S. Department of Energy), 2002, *Supplement Analysis for Storage of Surplus Plutonium Materials in the K-Area Material Storage Facility at the Savannah River Site*, DOE/EIS-0229-SA-2, Office of Environmental Management, Washington, DC, February.

DOE (U.S. Department of Energy), 2003a, *Supplement Analysis for the Fabrication of Mixed Oxide Fuel Lead Assemblies in Europe*, DOE/EIS-0229-SA3, Office of Fissile Materials Disposition, Washington, DC, November.

DOE (U.S. Department of Energy), 2003b, *Supplement Analysis and Amended Record of Decision, Changes Needed to the Surplus Plutonium Disposition Program*, DOE/EIS-0283-SA1, Office of Fissile Materials Disposition, Washington, DC, April.

DOE (U.S. Department of Energy), 2005a, *Environmental Assessment for the Safeguards and Security Upgrades for Storage of Plutonium Materials at the Savannah River Site*, DOE/EA-1538, Savannah River Operations Office, Aiken, South Carolina, December.

DOE (U.S. Department of Energy), 2005b, *Finding of No Significant Impact for the Safeguards and Security Upgrades for Storage of Plutonium Materials at the Savannah River Site*, Savannah River Operations Office, Aiken, South Carolina, December 16.

DOE (U.S. Department of Energy), 2006, *Supplement Analysis Salt Processing Alternatives at the Savannah River Site*, DOE/EIS-0082-S2-SA-01, Savannah River Operations Office, Aiken, South Carolina, January.

DOE (U.S. Department of Energy), 2007a, *Supplement Analysis, Storage of Surplus Plutonium Materials at the Savannah River Site*, DOE/EIS-0229-SA-4, Office of Environmental Management, Washington, DC, September 5.

DOE (U.S. Department of Energy), 2007b, *Supplement Analysis, Disposition of Surplus Highly Enriched Uranium*, DOE/EIS-0240-SA1, Office of Fissile Materials Disposition, Washington, DC, October.

DOE (U.S. Department of Energy), 2008a, *Final Site-Wide Environmental Impact Statement for Continued Operation of Los Alamos National Laboratory, Los Alamos, New Mexico*, DOE/EIS-0380, National Nuclear Security Administration, Los Alamos Site Office, Los Alamos, New Mexico, May.

DOE (U.S. Department of Energy), 2008b, *Interim Action Determination, Processing of Plutonium Materials from the DOE Standard 3013 Surveillance Program in H-Canyon at the Savannah River Site*, Savannah River Operations Office, Aiken, South Carolina, December 8.

DOE (U.S. Department of Energy), 2008c, *Supplement Analysis for Construction and Operation of a Waste Solidification Building at the Savannah River Site*, DOE/EIS-0283-SA-2, Savannah River Operations Office, Aiken, South Carolina, November.

DOE (U.S. Department of Energy), 2009a, *Supplement Analysis for the Waste Isolation Pilot Plant Site-Wide Operations*, DOE/EIS-0026-SA-07, Carlsbad Field Office, Carlsbad, New Mexico, May.

DOE (U.S. Department of Energy), 2009b, *Interim Action Determination, Processing of Plutonium Materials in H-Canyon at the Savannah River Site*, Savannah River Operations Office, Aiken, South Carolina, September 25.

DOE (U.S. Department of Energy), 2010a, *Environmental Assessment for the U.S. Receipt and Storage of Gap Material – Plutonium and Finding of No Significant Impact*, DOE/EA-1771, National Nuclear Security Administration, Washington, DC, May. OFFICIAL USE ONLY

DOE (U.S. Department of Energy), 2010b, *Revised Finding of No Significant Impact for Safeguards and Security Upgrades for Storage of Plutonium Materials at the Savannah River Site*, Savannah River Operations Office, Aiken, South Carolina, July 30.

DOE (U.S. Department of Energy), 2011a, *Amended Interim Action Determination, Disposition of Plutonium Materials from the Department of Energy (DOE) Standard 3013 Surveillance Program at the Savannah River Site*, Savannah River Operations Office, Aiken, South Carolina, March 30.

DOE (U.S. Department of Energy), 2011b, *Interim Action Determination, Flexible Manufacturing Capability for the Mixed Fuel Fabrication Facility (MFFF)*, Savannah River Operations Office, Aiken, South Carolina, April 1.

DOE (U.S. Department of Energy), 2011c, *Final Site-Wide Environmental Impact Statement for the Y-12 National Security Complex*, DOE/EIS-0387, Y-12 Site Office, Oak Ridge, Tennessee, February.

DOE (U.S. Department of Energy), 2011d, *Interim Action Determination, Disposition of Certain Plutonium Materials Stored at the Savannah River Site*, Savannah River Operations Office, Aiken, South Carolina, October 17.

DOE (U.S. Department of Energy), 2012, *Interim Action Determination, Use of H-Canyon/HB-Line to Prepare Feed for the Mixed Oxide Fuel Fabrication Facility at the Savannah River Site*, Savannah River Operations Office, Aiken, South Carolina, June 26.

DOE/NNSA (U.S. Department of Energy/National Nuclear Safety Administration), 2008, *Supplement Analysis for the Final Environmental Impact Statement for the Continued Operation of the Pantex Plant and Associated Storage of Nuclear Weapon Components*, DOE-EIS-0225/SA-04, October.

NRC (U.S. Nuclear Regulatory Commission), 2005a, *Environmental Impact Statement on the Construction and Operation of a Proposed Mixed Oxide Fuel Fabrication Facility at the Savannah River Site, South Carolina*, NUREG-1767, Office of Nuclear Material Safety and Safeguards, Washington, DC, January.

NRC (U.S. Nuclear Regulatory Commission), 2005b, *Generic Environmental Impact Statement for License Renewal of Nuclear Plants, Regarding Browns Ferry Nuclear Plant, Units 1, 2, and 3, Final Report*, NUREG-1437, Supplement 21, Office of Nuclear Reactor Regulation, Washington, DC, June.

NRC (U.S. Nuclear Regulatory Commission), 2006, *NRC Renews Browns Ferry Nuclear Plant Operating Licenses for an Additional 20 Years*, *NRC News, No. 06-061 2006, Office of Public Affairs, Washington, DC, May 4.*

TVA (Tennessee Valley Authority), 1974, *Final Environmental Statement for Sequoyah Nuclear Plant, Units 1, and 2*, Washington, DC.

TVA (Tennessee Valley Authority), 2002, *Final Supplemental Environmental Impact Statement for Browns Ferry Nuclear Plant Operating License Renewal*, Athens, Alabama, March.

TVA (Tennessee Valley Authority), 2011, *Final Supplemental Environmental Impact Statement for Sequoyah Nuclear Plant Units 1 and 2 License Renewal, Hamilton County, Tennessee*, Project Number: 2009-61, Knoxville, Tennessee, June.

APPENDIX B
FACILITIES DESCRIPTION

APPENDIX B FACILITIES DESCRIPTION

This appendix presents information about the facilities at the Savannah River Site (SRS) near Aiken, South Carolina, Los Alamos National Laboratory (LANL) in Los Alamos, New Mexico, the Waste Isolation Pilot Plant (WIPP) near Carlsbad, New Mexico, and the two Tennessee Valley Authority (TVA) nuclear power reactor sites (Browns Ferry Nuclear Plant and Sequoyah Nuclear Plant) that would be involved in surplus plutonium disposition as discussed in this *Draft Surplus Plutonium Disposition Supplemental Environmental Impact Statement (SPD Supplemental EIS)*. **Figure B-1** shows the locations of these facilities.

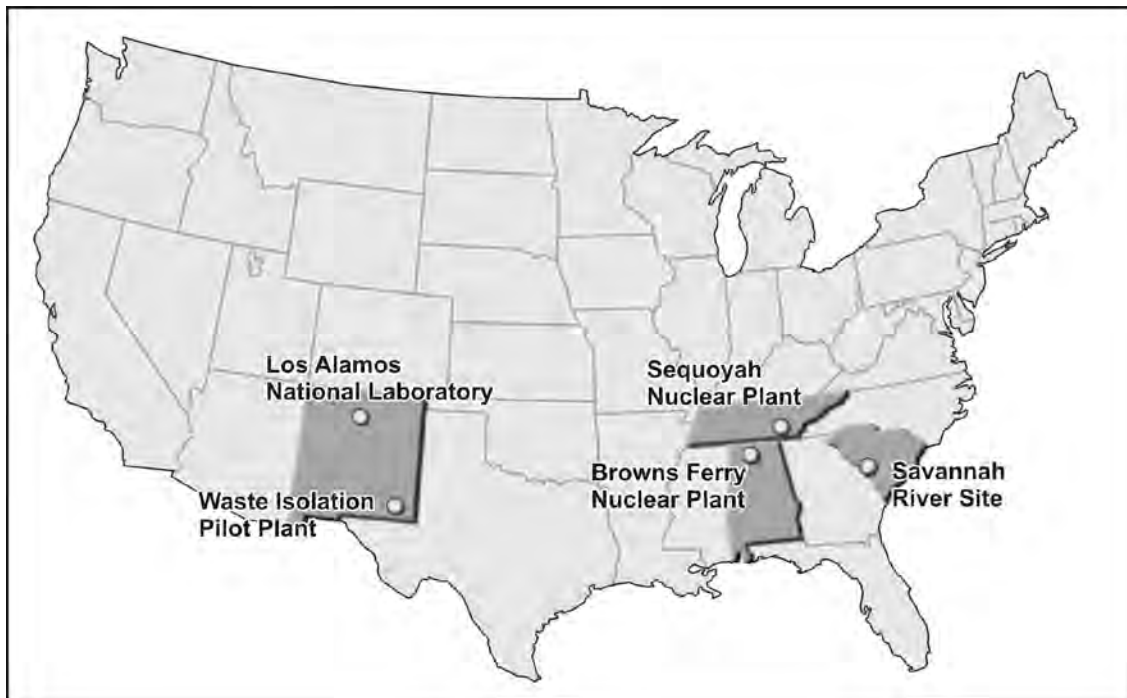

Figure B-1 Locations of Major Facilities Evaluated in this *Surplus Plutonium Disposition Supplemental Environmental Impact Statement*

Figure B-2 shows the principal areas at SRS and highlights the areas at which facilities evaluated in this *SPD Supplemental EIS* are located:

- F-Area, the location of the Mixed Oxide Fuel Fabrication Facility (MFFF), the F/H-Laboratory, and the Waste Solidification Building (WSB) and the proposed location of the Pit Disassembly and Conversion Facility (PDCF)
- K-Area, the location of the K-Area Complex, which houses the existing K-Area plutonium storage and K-Area Interim Surveillance (KIS) capabilities, and is the proposed location for the plutonium immobilization capability and the K-Area Pit Disassembly and Conversion Project (PDC)
- H-Area, the location of H-Canyon/HB-Line
- S-Area, the location of the Defense Waste Processing Facility (DWPF) and Glass Waste Storage Buildings (GWSBs)
- E-Area, the location of waste management operations

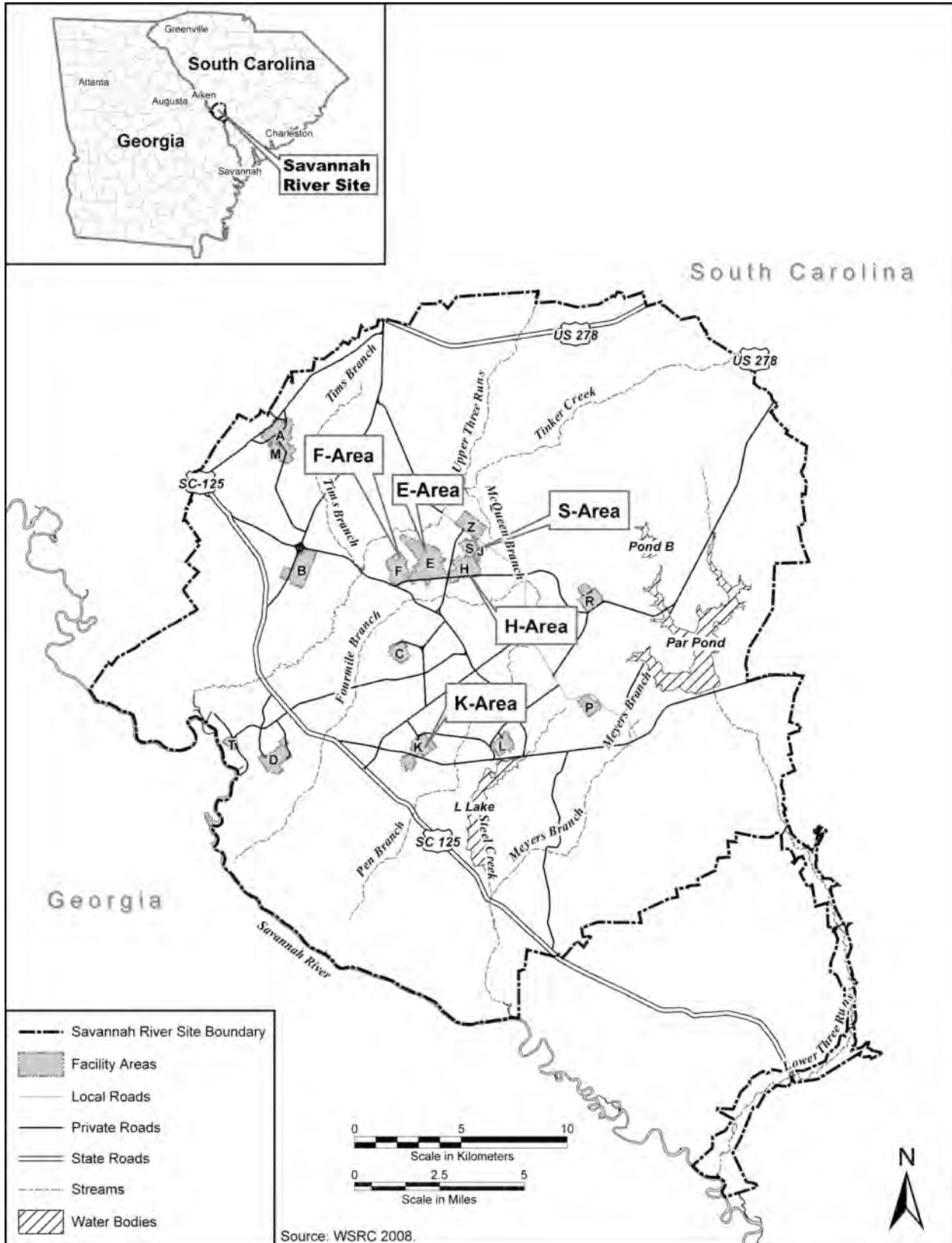

Figure B-2 Savannah River Site Location and Operations Areas

About 2 metric tons (2.2 tons) of plutonium oxide are being prepared for mixed oxide (MOX) feed through the Advanced Recovery and Integrated Extraction System Program (ARIES) in the Plutonium Facility (PF-4) at Technical Area 55 (TA-55) at LANL. The U.S. Department of Energy (DOE) is analyzing the impacts of expansion and operation of ARIES at LANL for additional pit disassembly and conversion to provide plutonium metal and oxide for MOX feed. **Figure B-3** shows the locations of LANL and TA-55 at LANL and **Figure B-4** shows the location of PF-4 at TA-55.

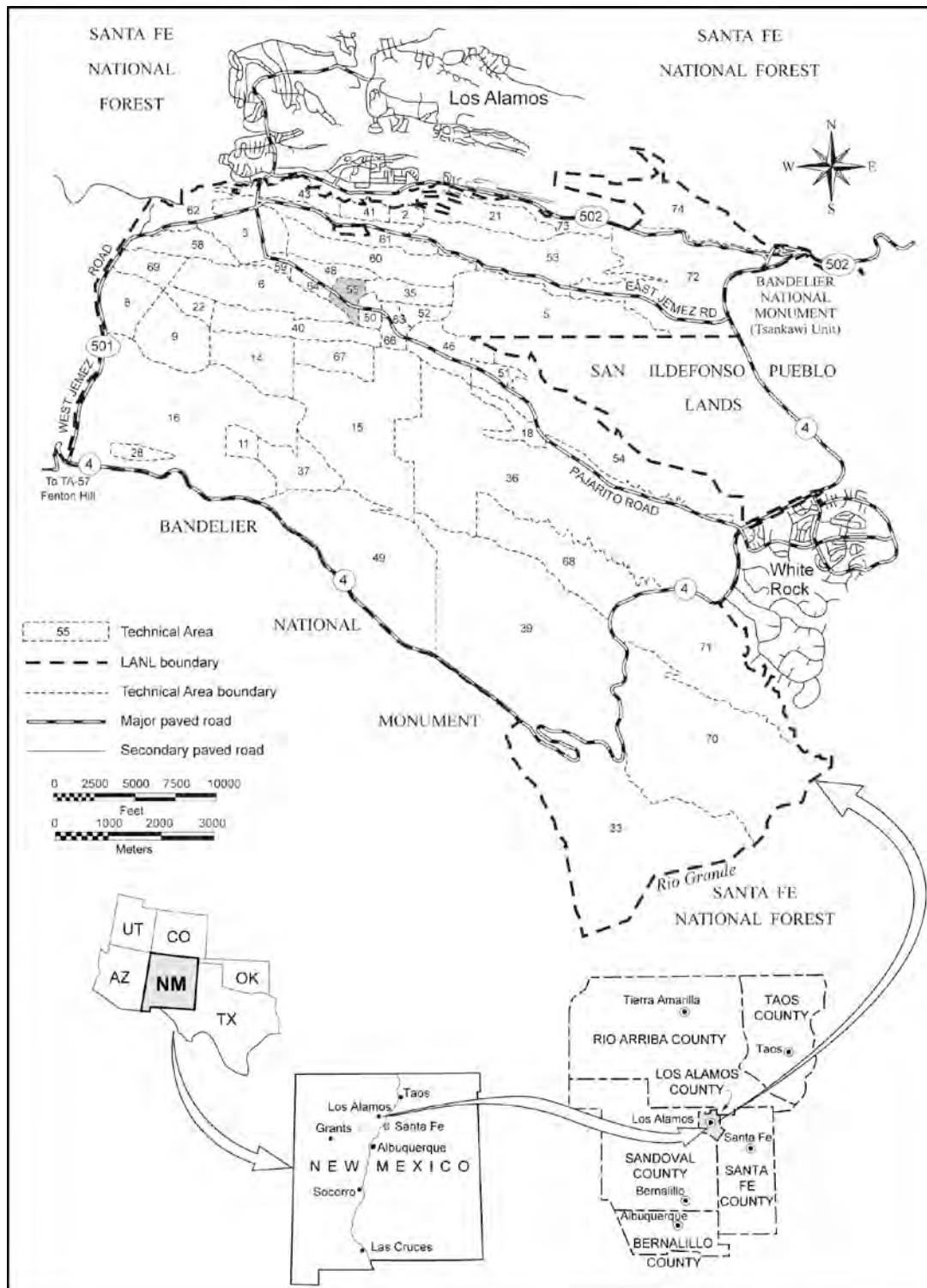

Figure B-3 Los Alamos National Laboratory Location and Technical Areas

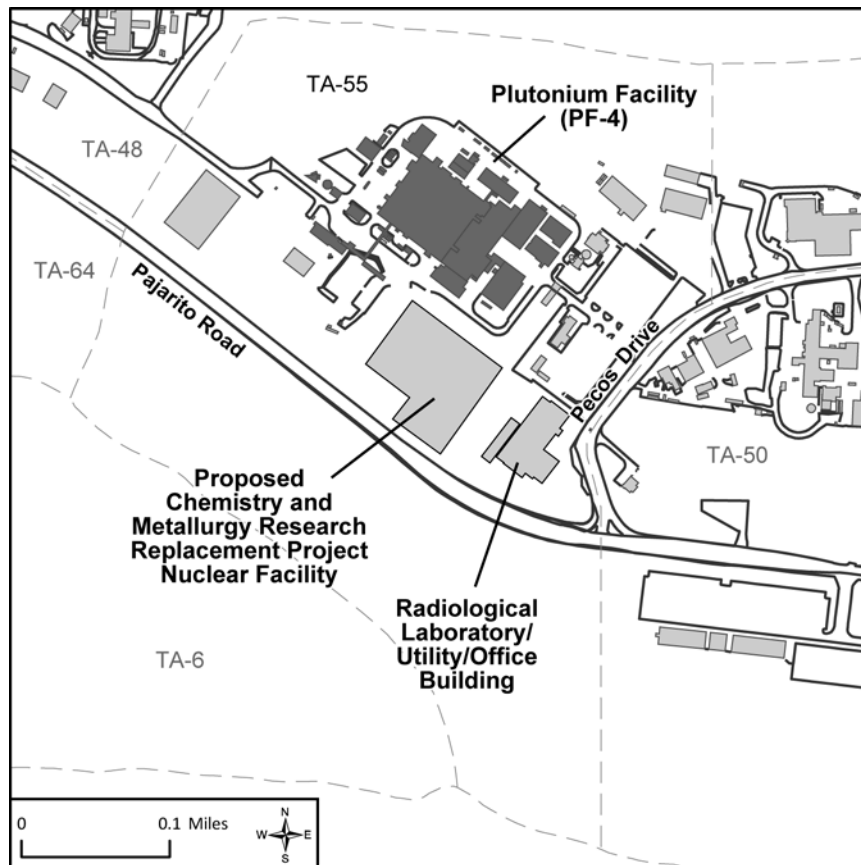

Figure B-4 Location of Facilities in Technical Area 55

In addition, 6 metric tons (6.6 tons) of surplus non-pit plutonium are evaluated for disposal as transuranic (TRU) waste at WIPP, and 45.1 metric tons (49.7 tons) of plutonium are evaluated for irradiation in domestic commercial nuclear power reactors. **Table B-1** summarizes the construction and facility modifications that may be required, depending on the *SPD Supplemental EIS* alternative and the pit disassembly and conversion option. **Table B-2** shows the duration of construction and operations of the facilities under each of the alternatives. Chapter 4 of this *SPD Supplemental EIS* presents the impacts of the five surplus plutonium disposition alternatives, four action alternatives and the No Action Alternative. The alternatives are composed of pit disassembly and conversion options (Appendix F) and disposition options (Appendix G). **Table B-3** shows the maximum annual and the total surplus plutonium throughput analyzed for each of the affected facilities under each of the alternatives.

Table B–1 Proposed Facility Construction and Modification Summary^a

<i>Facility</i>	<i>Description</i>
Facility Construction	
PDCF at F-Area at SRS	New facility construction would disturb approximately 50 acres.
PDC at K-Area at SRS	New facility construction would disturb approximately 30 acres.
Immobilization capability in K-Area at SRS	New facility construction would disturb approximately 2 acres. Modifications to the K-Area Complex would occur to support plutonium immobilization.
Facility Modification	
MFFF at F-Area at SRS	Minor modification to support plutonium conversion using metal oxidation furnaces would be internal to MFFF, which is already under construction.
K-Area glovebox at SRS	Modifications of a glovebox would be conducted within an existing facility structure at K-Area to support pit disassembly activities.
H-Canyon/HB-Line (dissolution to DWPF)	Some tanks or piping in H-Canyon would be changed out or reconfigured to increase plutonium storage volume or capacity. The scrap recovery south line in HB-Line would be reactivated and additional equipment added to implement processes to minimize equipment corrosion and increase dissolution throughput rates.
H-Canyon/HB-Line (oxide production)	New equipment, including one new HB-Line glovebox, would be required to supply plutonium oxide feed for MFFF; H-Canyon might add new, or change out or reconfigure existing, tanks or piping to increase plutonium solutions storage and processing capabilities.
H-Canyon/HB-Line (preparation for WIPP)	Minor modifications would be conducted within existing structures for surplus plutonium preparation and pipe overpack container interim storage for WIPP disposal.
DWPF at S-Area at SRS	Minor modifications to an existing structure to accommodate can-in-canisters from the plutonium immobilization capability would include new canister storage racks, a closed-circuit television system, a remote manipulator, and other modified equipment.
PF-4 at TA-55 at LANL	Modifications to the existing PF-4 would be made to support an enhanced pit disassembly and conversion capability; temporary disturbance of up to 2 acres would occur to accommodate a construction trailer and worker parking area.
Domestic commercial nuclear power reactors	Use of MOX fuel is expected to require only minor modifications within existing structures.

DWPF = Defense Waste Processing Facility; LANL = Los Alamos National Laboratory; MFFF = Mixed Oxide Fuel Fabrication Facility; MOX = mixed oxide; PDC = Pit Disassembly and Conversion Project; PDCF = Pit Disassembly and Conversion Facility; PF-4 = Plutonium Facility; SRS = Savannah River Site; TA = Technical Area; WIPP = Waste Isolation Pilot Plant.

^a Different impacts of facility construction and modification activities may occur, depending on the particular alternative and pit disassembly and conversion option addressed in this *Surplus Plutonium Disposition Supplemental Environmental Impact Statement*.

Note: To convert acres to hectares, multiply by 0.40469.

Source: DOE 1999; LANL 2012; SRNS 2012; WSRC 2008.

Table B-2 Duration of Facility Construction and Operations (years)

Facility	Alternative				
	No Action	Immobilization to DWPF	MOX Fuel	H-Canyon/ HB-Line to DWPF	WIPP
Construction					
Immobilization	N/A	6	N/A	N/A	N/A
Metal Oxidation Furnaces in MFFF ^a	N/A	9	9	9	9
PDCF	13	13	13	13	13
PDC in K-Area	N/A	N/A	13	13	13
H-Canyon/HB-Line	N/A	N/A	N/A	N/A	N/A
PF-4 at LANL	N/A	8	8	8	8
Operations					
Pit Disassembly and Conversion					
PDCF	10	12	12	12	12
PDC in K-Area	N/A	N/A	12	12	12
H-Canyon/HB-Line ^b	N/A	14	14	14	14
Oxidation Furnaces in MFFF	N/A	20	20	20	20
PF-4 at LANL	7	7-22 ^c	7-22 ^c	7-22 ^c	7-22 ^c
Disposition					
MFFF	21	21	24	23	23
Immobilization	N/A	10	N/A	N/A	N/A
H-Canyon/HB-Line (dissolution to DWPF) ^d	N/A	N/A	N/A	13	N/A
H-Canyon/HB-Line ^d (oxide production)	N/A	N/A	6	N/A	N/A
H-Canyon/HB-Line ^d (prep for WIPP)	N/A	N/A	10-16	N/A	13-30
DWPF ^d	N/A	10	6 ^e	13	N/A
Support Facilities					
K-Area storage ^f	40	20	up to 22	up to 22	up to 22
KIS ^f	40	15	7	10	7
WSB	21	21	24	23	23

DWPF = Defense Waste Processing Facility; Immobilization = K-Area plutonium immobilization capability; KIS = K-Area Interim Surveillance capability; LANL = Los Alamos National Laboratory; MFFF = Mixed Oxide Fuel Fabrication Facility; MOX = mixed oxide; N/A = not applicable; PDC = Pit Disassembly and Conversion Project; PDCF = Pit Disassembly and Conversion Facility; PF-4 = Plutonium Facility; WIPP = Waste Isolation Pilot Plant; WSB = Waste Solidification Building.

^a Installation of furnaces could take place during construction or operation of MFFF.

^b Pits would be disassembled at PF-4 at LANL or at K-Area and plutonium would be converted to plutonium oxide at H-Canyon/HB-Line.

^c Values are for processing 2 metric tons of plutonium metal and up to 35 metric tons of plutonium metal.

^d The assumed operational period for H-Canyon/HB-Line and DWPF only reflects the years required to disposition surplus plutonium.

^e Although oxide production at H-Canyon would generate a small volume of liquid radioactive waste that would be sent to the tank farm for storage over a period of approximately 6 years, vitrification of this waste at DWPF would result in the generation of approximately 2 additional canisters, an activity that takes 2 days to accomplish.

^f The assumed operational periods are from 2012 forward.

Source: LANL 2012; SRNS 2012.

Table B–3 Maximum Annual/Total Plutonium Throughput Analyzed (metric tons)

Facility	Alternative									
	No Action		Immobilization to DWPF		MOX Fuel		H-Canyon/ HB-Line		WIPP	
	Annual	Total	Annual	Total	Annual	Total	Annual	Total	Annual	Total
Pit Disassembly and Conversion										
PDCF	3.5	28	3.5	35	3.5	35	3.5	35	3.5	35
PDC in K-Area	N/A		N/A		3.5	35	3.5	35	3.5	35
MFFF Oxidation	N/A		3.4	34	3.5	35	3.5	35	3.5	35
H-Canyon/HB-Line ^a	N/A		1	10	1	10	1	10	1	10
PF-4 at LANL	0.3	2	2.5	35 ^b	2.5	35 ^b	2.5	35 ^b	2.5	35 ^b
Disposition										
Immobilization	N/A		13.1		N/A		N/A		N/A	
MFFF Fabrication	3.5	34	3.5	34	3.5	45.1	3.5	41.1	3.5	41.1
H-Canyon/HB-Line (Prep for MFFF)	N/A		N/A		0.7	4	N/A		N/A	
H-Canyon/HB-Line (Dissolution to DWPF)	N/A		N/A		N/A		0.5	6	N/A	
H-Canyon/HB-Line (Prep for WIPP)	N/A		N/A		0.2	2	N/A		0.5	6
DWPF	N/A		1.3	13.1	– ^c		0.5	6	– ^c	

DWPF = Defense Waste Processing Facility; Immobilization = K-Area plutonium immobilization capability; LANL = Los Alamos National Laboratory; MFFF = Mixed Oxide Fuel Fabrication Facility; MOX = mixed oxide; N/A = not applicable; PDC = Pit Disassembly and Conversion Project; PDCF = Pit Disassembly and Conversion Facility; PF-4 = Plutonium Facility; WIPP = Waste Isolation Pilot Plant.

^a Pits would be disassembled at PF-4 at LANL or at K-Area and plutonium would be converted to plutonium oxide at H-Canyon/HB-Line.

^b Total plutonium throughput would vary from 2 to 35 metric tons, depending on the pit disassembly and conversion option selected. Production of 2 metric tons of plutonium oxide at LANL is part of the No Action Alternative and base program regardless of the option selected

^c No plutonium disposition using DWPF, but operations at H-Canyon/HB-Line would generate waste resulting in a small number of HLW canisters.

Note: To convert metric tons to tons, multiply by 1.1023.

B.1 Savannah River Site

B.1.1 F-Area Facilities

F-Area at SRS is where PDCF would be built should DOE reaffirm its January 11, 2000, decision to construct this facility (65 FR 1608). F-Area facilities also include MFFF and WSB, both of which are under construction.

B.1.1.1 Pit Disassembly and Conversion Facility

A standalone PDCF would be built on a 50-acre (20-hectare) parcel near MFFF and WSB at F-Area. Once completed, PDCF would encompass less than 23 acres (9.3 hectares). The primary mission of PDCF would be to: (1) receive surplus weapons-usable plutonium in the form of pits and other plutonium metals, (2) convert the plutonium metal to plutonium oxide, and (3) remove any residual classified attributes through blending of the converted plutonium oxide. Once the plutonium oxide is blended, it would be sealed in DOE-STD-3013 containers¹ for transfer to MFFF for production of MOX fuel.

¹ Containers that meet the specifications in DOE Standard 3013, Stabilization, Packaging, and Storage of Plutonium-Bearing Materials, DOE-STD-3013-2012 (DOE 2012a).

Since the issuance of previous National Environmental Policy Act (NEPA) analyses (DOE 1999, 2003), DOE has instituted several design enhancements (WSRC 2008):

- Added a 43,380-square-foot (4,030-square-meter) sand filter for final air treatment
- Added a metal oxidation step for metallic uranium, deleted a gallium removal system, deleted a tritium extraction furnace, changed the hydride-oxidation system to a hydride/dehydride system with additional high-efficiency particulate air (HEPA) filtration and a hydrogen generator, and repositioned some equipment
- Added sprinklers to gloveboxes operated in a non-inert atmosphere
- Added a grouting process for floor sweepings in the waste management area, glovebox sweepings, and lab-concentrated liquids
- Upgraded the security measures and design of the facility to minimize the opportunity for intruder access
- Deleted the unclassified vaults
- Reduced the Plutonium Processing Building area to 153,600 square feet (14,300 square meters); the Plutonium Processing Building includes a main process area plus loading dock, safe haven (a location that protects workers while simultaneously restricting potential intruder access), interstitial space, and firefighting water containment basin
- Increased total support area to 155,400 square feet (14,400 square meters), including the Mechanical and Support Equipment Building, Utility Building, Fan House, Sand Filter Structure, Entry Control Facility, Diesel Storage Building, and Administration Building

Figure B-5 shows PDCF material flows and processes. Pits transported from the Pantex Plant near Amarillo, Texas, would be disassembled and the plutonium would be separated from other materials. Other byproducts from the disassembly process would be packaged, stored, and shipped to DOE sites. The plutonium metal that was bonded with highly enriched uranium (HEU) and other materials would be size-reduced, then chemically separated from these materials via a hydride/dehydride process. All mechanically and/or chemically separated plutonium from pits or plutonium metal would be converted within metal oxidation furnaces to plutonium oxide and used as feed for MFFF (SRNS 2012). The facility would be designed with a nominal throughput rate of 3.5 metric tons (3.9 tons) of plutonium metal per year. The plutonium oxide product would meet DOE-STD-3013 requirements (DOE 2012a) and would be stored in vaults and transported within the facility using DOE-STD-3013-compliant containers (WSRC 2008).

The primary PDCF buildings include the Plutonium Processing Building, Mechanical and Support Equipment Building, Utility Building, Fan House and Exhaust Stack, Sand Filter Structure, and Administration Building. The Plutonium Processing Building would house the activities needed to receive surplus weapons-usable plutonium, process pits and plutonium metal parts, and ship products to MFFF or other locations for disposition. Areas where plutonium would be processed or stored would be designed to survive natural phenomena hazard events and potential accidents. The Plutonium Processing Building would be a bermed underground Nuclear Material Hazard Category 2 reinforced-concrete structure with a total floorspace of 153,600 square feet (14,300 square meters) and more than 20 glovebox lines. The gloveboxes would be connected by an overhead trolley system, which would be used to transfer material between gloveboxes so that the material would remain within containment. The Plutonium Processing Building would house industrial lathes, metal oxidation furnaces, hydride reactors, robotic manipulators, oxide-blending equipment, and welding equipment.

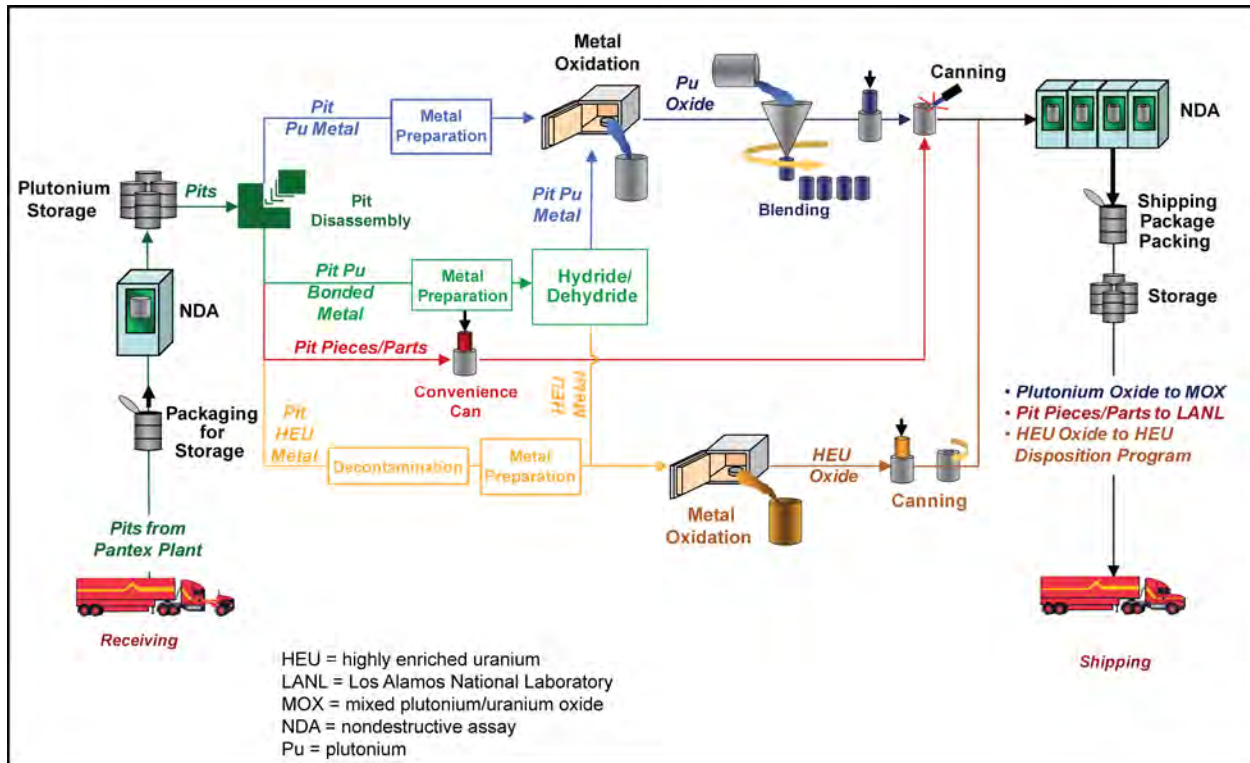

Figure B-5 Pit Disassembly and Conversion Capability in the Pit Disassembly and Conversion Facility in F-Area or the Pit Disassembly and Conversion Project in K-Area

The Mechanical and Support Equipment Building would house service functions to support operations that would occur at the Plutonium Processing Building, including heating, ventilating, and air conditioning (HVAC) equipment; mechanical, control and communications, and electrical power distribution equipment; uninterruptible power supplies; emergency generators; a facility control room; shower and locker areas; and offices.

The Utility Building would house the standby power supply system and other electrical and mechanical equipment for the PDCF complex. The Fan House would be designed to draw air from the Sand Filter and then exhaust through a stack. The Fan House would house fans, required ductwork, a control room, and a storage room. The Sand Filter would be a single-level, below-grade structure that would house sand filter functions and a limited amount of supporting mechanical equipment. The Pedestrian and Vehicle Portal would provide a security checkpoint for pedestrians and vehicles. The Administration Building would be located next to the Sand Filter.

Activities involving radioactive materials or externally contaminated containers of radioactive materials would be conducted within gloveboxes interconnected by a conveyor system to move materials between process steps. Gloveboxes would remain sealed and operate independently, except during material transfer, and would include inert atmospheres, where appropriate. Safety features would limit the temperature and pressure inside the gloveboxes and ensure that operations maintain criticality safety. The glovebox atmosphere would be kept at a lower pressure than surrounding areas, so that any leaks of gases or suspended particulates would be contained and filtered. The ventilation system would include HEPA filters and a sand filter and would be designed to preclude the spread of airborne radioactive particulates or hazardous chemicals within the facility or to the environment.

PDCF would be designed to minimize waste generation and effluent discharges. Radioactive solid wastes would be packaged in accordance with the acceptance criteria of the receiving disposal facility and sent to E-Area for any needed additional packaging before onsite or offsite disposal. Mixed radioactive and hazardous wastes would be sent to appropriate offsite treatment, storage, or disposal facilities

(WSRC 2008). Solid nonhazardous wastes would be sent to the Three Rivers Regional Landfill at SRS. Higher-activity laboratory wastes from PDCF would be transferred to WSB to be treated and solidified, while lower-activity liquid radioactive wastes would be combined with other low-activity liquid streams and piped to the Effluent Treatment Project (ETP) for processing.

Small quantities of radioactive isotopes, including plutonium isotopes, americium-241, and tritium gas, may be emitted to the atmosphere. Condensate and blowdown discharge would be routed to the SRS Central Sanitary Wastewater Treatment Facility. No direct releases of process liquids to surface water are expected.

B.1.1.2 Mixed Oxide Fuel Fabrication Facility

Currently under construction in F-Area, MFFF will produce completed MOX fuel assemblies containing plutonium and uranium oxides for irradiation in existing domestic commercial nuclear power reactors, including pressurized-water reactors (PWRs) and boiling-water reactors (BWRs). MFFF will operate in accordance with decisions made by DOE and announced in the January 11, 2000, Record of Decision (ROD) for the *Surplus Plutonium Disposition Environmental Impact Statement (SPD EIS)* (65 FR 1608) and the April 24, 2003, amended ROD (68 FR 20134), and pursuant to the license, when issued by the U.S. Nuclear Regulatory Commission (NRC), which is based on analysis in the *Environmental Impact Statement on the Construction and Operation of a Proposed Mixed Oxide Fuel Fabrication Facility at the Savannah River Site, South Carolina (MFFF EIS)* (NRC 2005). DOE made an interim action determination in April 2011 (SRS 2011) regarding modifications to manufacture a variety of fuel types.

Since issuance of the *SPD EIS* (DOE 1999), enhancements to the design of MFFF have occurred because of: (1) improvements recognized as part of the detailed design process, (2) changes in the amount of MOX fuel to be fabricated, and (3) the decision to accept certain non-pit plutonium with higher levels of impurities or different impurities than originally planned (alternate feedstock). Equipment has been added to process this alternate feedstock to produce a form suitable for use as feed for MFFF (DOE 2003). In addition, if DOE's National Nuclear Security Administration (NNSA) makes the decision to install a plutonium oxidation capability in MFFF, additional furnace gloveboxes and a storage glovebox would be installed within MFFF.

MFFF is being built on an 87-acre (35-hectare) site at F-Area. After construction, MFFF will occupy about 17 acres (6.9 hectares), and encompass about 440,000 square feet (41,000 square meters) of floor space (DOE 2003). MFFF will receive plutonium oxide from the K-Area storage capability, PDC in K-Area (in the event PDC is constructed), the nearby PDCF (in the event PDCF is constructed), PF-4 at LANL, and/or H-Canyon/HB-Line (if this option is selected), and send certain liquid wastes (i.e., high-alpha, stripped uranium) to WSB for processing. In addition, if a plutonium oxidation capability is installed in MFFF, plutonium metal may be shipped from LANL to MFFF. Also, MFFF will receive depleted uranium dioxide from Richland, Washington. Existing SRS infrastructure, security, emergency services, waste management, and environmental monitoring will support the MOX fuel fabrication mission.

MFFF's design includes the MOX Fuel Fabrication Building and support structures, including the Secured and Receiving Warehouses, the Administration Building, and the Technical Support and Reagents Processing Buildings. All buildings, except for the Administration Building and the Receiving Warehouse, will be enclosed within a double-fenced perimeter intrusion, detection, assessment system. This protected area will encompass about 14 acres (5.7 hectares) (NRC 2005).

The MOX Fuel Fabrication Building is designed to meet structural and safety standards for storing and processing special nuclear material. The walls, floors, and building roof will be built of reinforced concrete. Areas that will contain plutonium are designed to survive natural phenomenon hazards, such as earthquakes, extreme winds, floods, and tornadoes, as well as potential accidents (DOE 1999). The MOX Fuel Fabrication Building will have three major functional areas. The MOX Processing Area includes the blending and milling, pelletizing, sintering, grinding, fuel rod fabrication, fuel bundle assembly, laboratory, and storage areas. The Aqueous Polishing Area houses processes to remove

impurities from plutonium oxide feedstock. The Shipping and Receiving Area contains equipment and facilities to handle materials entering and exiting the MOX Processing and Aqueous Polishing Areas (NRC 2005). The MFFF design includes a ventilation system to maintain lower pressure in rooms with higher levels of contamination. Operations having the potential to release contamination will be performed in sealed gloveboxes. Airborne emissions from MFFF will pass through two HEPA filters in series before discharge from a continuously monitored 120-foot (37-meter) stack.

If NNSA makes the decision to use MFFF to convert plutonium metal to plutonium oxide for use in the MFFF, the MOX Fuel Fabrication Building would be modified with the installation of metal oxidation furnaces and associated gloveboxes. These modifications would not change the planned footprint of the building (SRNS 2012). No new structures would need to be constructed. Existing rooms would need only minor modification for the installation of oxidation equipment.²

The Secured Warehouse will receive and store most of the materials, supplies, and equipment needed for facility operations, while the Receiving Warehouse will receive and store materials not requiring special handling in the Secured Warehouse. The Technical Support Building will provide services such as health physics, electronics and mechanical maintenance, personnel locker rooms, and first aid. The Reagents Processing Building will contain chemical storage areas, partitioned to prevent inadvertent chemical interactions and equipped with spill containment systems and drip pads, and facilities for preparation of chemical solutions used mainly in the aqueous polishing process. Chemicals will be transferred to the Aqueous Polishing Area of the MOX Fuel Fabrication Building via piping within a below-grade concrete trench between the two buildings (NRC 2005).

Mixed Oxide Fuel Fabrication Process

Figure B–6 illustrates the MOX fuel fabrication process, which consists of two steps: feed material processing and fuel fabrication. The scope of subsequent processing operations for each batch of feed would depend on its isotopic, chemical, and impurity content. Most feed materials would begin with the aqueous polishing process to remove impurities, such as gallium, americium, aluminum, and fluorides. This process would include: (1) dissolution of plutonium oxide in nitric acid using a silver nitrate catalyst; (2) removal of impurities using a solvent extraction process; and (3) conversion of plutonium from a nitrate solution to an oxide powder using an oxalate precipitation, filtration, and drying process. A stripping step would separate and remove uranium from the plutonium solution, resulting in a stripped uranium waste stream that would be collected and ultimately sent to WSB. Calciner offgas (nitrogen oxide) would be routed through a treatment unit and HEPA filters before being discharged through an exhaust stack. Filtered oxalic mother liquors (i.e., oxalic acid remaining after reacting with oxidized plutonium to precipitate plutonium oxalate) would be concentrated, treated, and recycled. The plutonium oxide would be evaluated to ensure that it meets fabrication specifications and transferred, as needed, to the MOX fuel fabrication process (NRC 2005).

Since issuance of the *SPD EIS* in 1999, equipment has been added to the MFFF design to process some of the impure non-pit plutonium originally destined for immobilization and referred to as “alternate feedstock.” Equipment has been added to crush, mill, and decrease the particle size; homogenize the alternate feedstock; characterize and determine impurity content; and remove additional impurities. As needed, chlorides would be removed as chlorine gas, which would be converted in a scrubber to a solution that would be disposed of after solidification as low-level radioactive waste (LLW). After this initial processing, the alternate feedstock would be sent to the plutonium polishing unit to be processed in the same manner as other plutonium oxide feed, and transferred as needed for MOX fuel fabrication (DOE 2003).

² Installation of the oxidation furnaces could be performed during MFFF construction or operation.

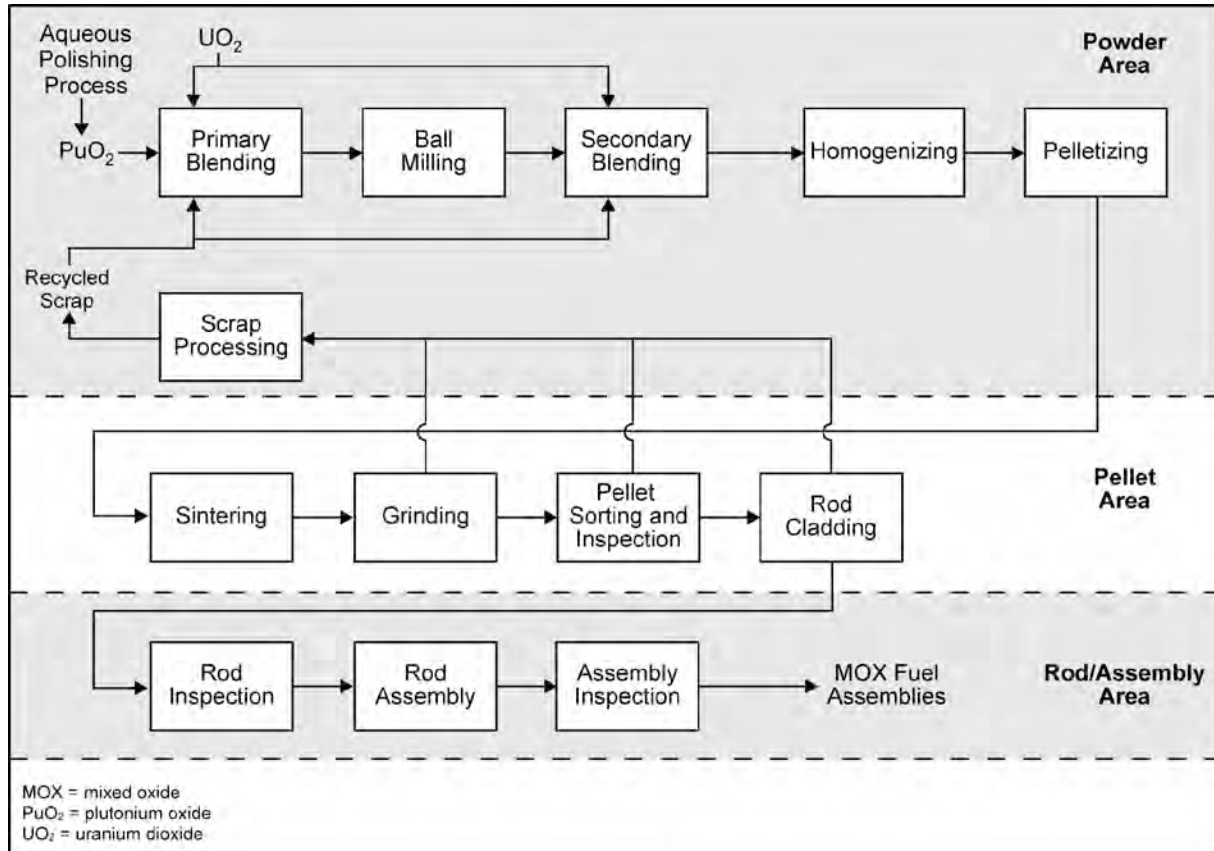

Figure B-6 Mixed Oxide Fuel Fabrication Process

Figure B-7 illustrates the plutonium oxidation process that would take place if NNSA decides to add this capability to MFFF. Metal feed from PF-4 at LANL would be stored in K-Area before being transported to MFFF for conversion into plutonium oxide. The plutonium oxide powder would be sent to the aqueous polishing process and transferred as needed for MOX fuel fabrication.

MOX fuel fabrication begins with blending and milling plutonium oxide powder to ensure consistency in isotopic concentration. Then, depleted uranium oxide and plutonium oxide powders are blended and milled to ensure uniform distribution of plutonium oxide in the MOX fuel, and to adjust the particle size of the MOX powder. The MOX powder is pressed into pellets, sintered (i.e., baked at high temperature), and ground to proper dimensions. Materials and pellets would be inspected at each stage, and rejected materials would be recycled through the process. Most operations would be performed within sealed gloveboxes with inert atmospheres. Sintering furnaces would be sealed, and offgases would be filtered and monitored before release to the atmosphere (DOE 1999).

Finished pellets would be loaded into empty fuel rods at the fuel rod fabrication area, sealed, inspected, decontaminated, and bundled into fuel assemblies (**Figure B-8**). Fuel assemblies could be prepared for both PWRs and BWRs. Fuel assemblies could consist entirely of MOX fuel rods or a mixture of MOX and low-enriched uranium (LEU) fuel rods. For the latter design, LEU rods would be fabricated at a commercial facility and brought to MFFF for assembly with MOX fuel rods. Rejected fuel assemblies would be disassembled and the materials recycled. Completed fuel assemblies would be stored pending shipment to existing domestic commercial nuclear power reactors using NNSA's Secure Transportation Asset (DOE 1999).

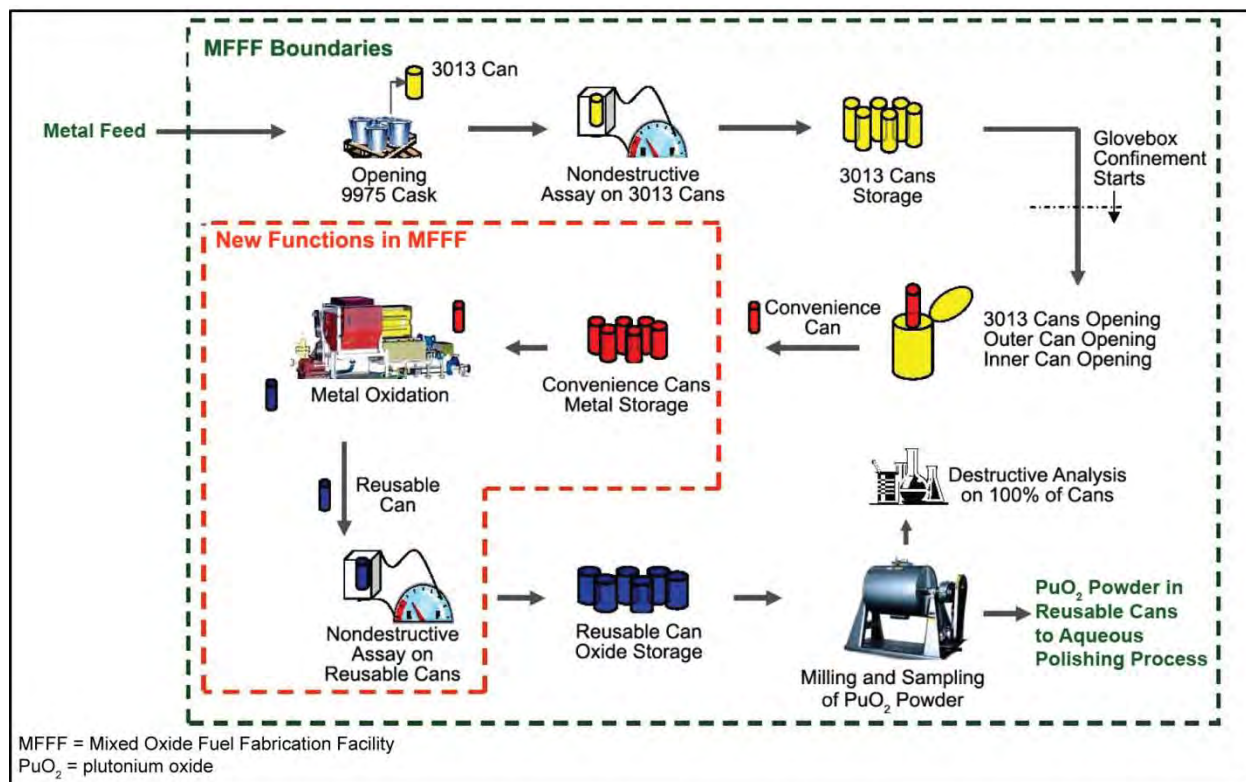

Figure B-7 Metal Oxidation Process

A liquid americium waste stream generated by the aqueous polishing process would be combined with an excess acid stream from the nitric acid recovery process and an alkaline wash stream into a high-alpha activity process stream to be piped to WSB, where it would be treated and solidified for disposal at WIPP as contact-handled TRU waste. Stripped uranium from the aqueous polishing process would be diluted with depleted uranyl nitrate hexahydrate and transferred to WSB for further treatment. An LLW stream would be piped to the onsite ETP for further treatment and disposal (NRC 2005).

Solid wastes from MFFF are expected to include glovebox gloves, equipment, tools, wipes, and glovebox and HEPA filters. These materials would be transferred to a waste packaging glovebox to remove residual plutonium. The plutonium would be recycled and the waste materials packaged, assayed, and disposed of as contact-handled TRU waste or LLW, as appropriate (DOE 1999). Contact-handled TRU waste would be transferred to E-Area for staging and subsequent shipment to WIPP for disposal. LLW would be disposed of at onsite or offsite DOE or commercial disposal facilities.

B.1.1.3 Waste Solidification Building

WSB is under construction on a 15-acre (6.1-hectare) site at F-Area next to the proposed PDCF site to process two liquid waste streams from MFFF and one from PDCF operations at F-Area or PDC operations at K-Area, assuming either of these facilities is constructed.³ A standalone WSB was not evaluated in the *SPD EIS*, but was evaluated by NRC in the *MFFF EIS* (NRC 2005), and by DOE in the *Storage and Disposition of Weapons-Usable Fissile Materials Final Programmatic Environmental Impact Statement (Storage and Disposition PEIS)* (DOE 1996) and in a supplement analysis to the *SPD EIS* (DOE 2008b).

³ WSB was originally proposed to treat five MFFF and PDCF waste streams, but an evaluation of options to use existing SRS waste management facilities showed that treating minimally contaminated wastewater from MFFF and PDCF at ETP rather than at WSB would be optimal (Cantey 2008).

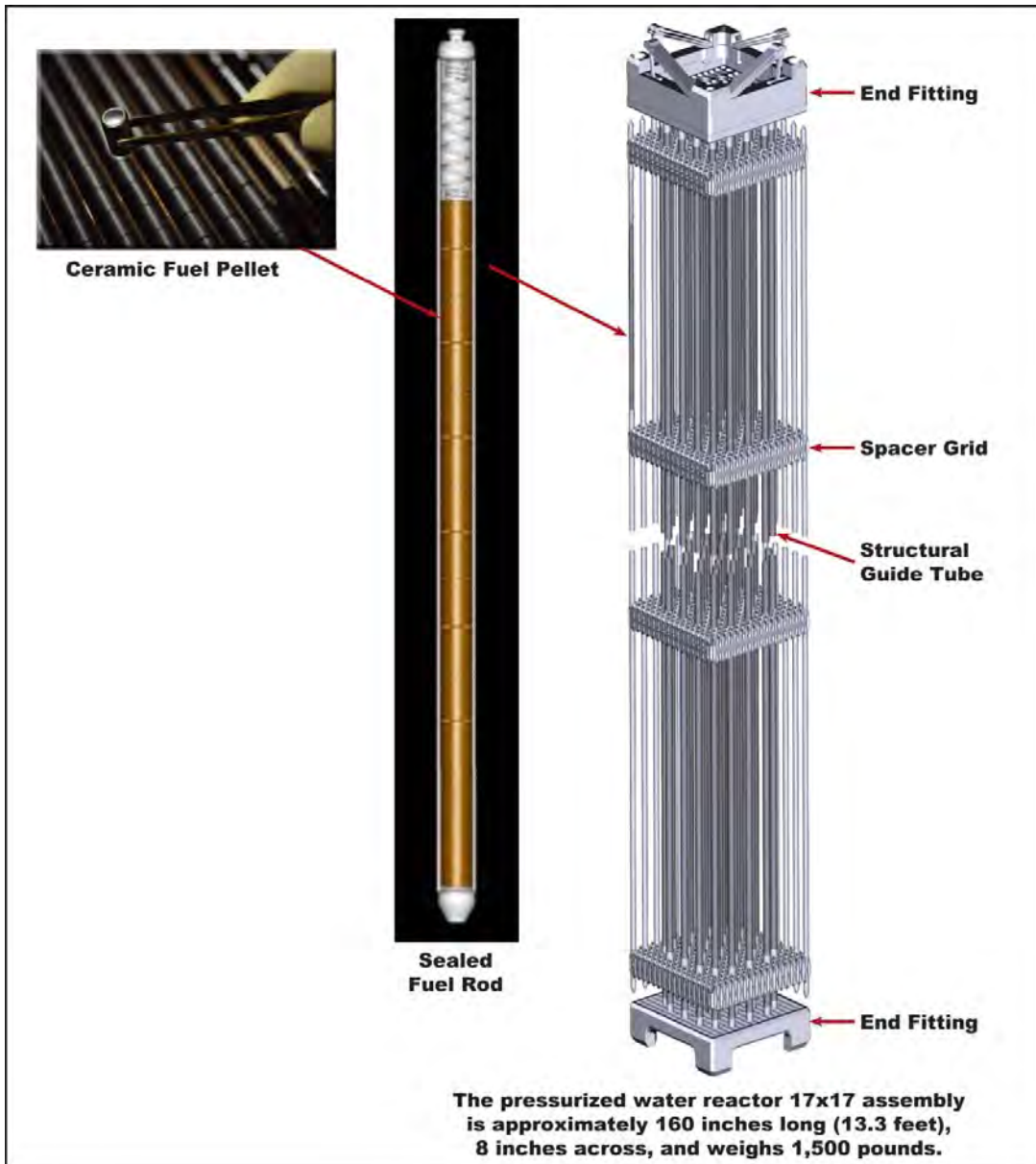

Figure B-8 Typical Reactor Fuel Assembly

WSB will occupy about 9 acres (3.6 hectares). The WSB design includes a Process Building, a covered staging area for interim storage of waste containers, an exhaust stack, and additional support facilities, including office trailers, a truck unloading area, a caustic and acid tank area, and a diesel generator. The Process Building will be a two-story reinforced-concrete structure, with a first level covering about 33,000 square feet (3,100 square meters) and a total floorspace of about 38,000 square feet (3,500 square meters). The Process Building will be located at grade and contain waste concentration and cementation equipment for processing low-activity and high-activity liquid waste, an analytical laboratory, control room, and some plant services. Liquid wastes will be solidified directly in drums inside dedicated enclosures. Secondary containment features, such as dikes, tanks, sumps, and jackets with associated leak detection or monitoring equipment, will be provided for areas with the potential for spills. Non-shielded areas will be dedicated to cold chemical feeds, steam generation, administration, electrical feeds, diesel electrical generation, the exhaust stack, floor drain collection, and drum receipt and storage (DOE 2008b).

WSB will receive two waste streams transferred from MFFF through underground, double-walled stainless steel lines: a high-activity (high-alpha) waste stream and a low-activity (stripped uranium) waste

stream. WSB may also receive a low-activity laboratory waste stream either transferred through underground, double-walled stainless steel lines or shipped in trucks. Waste streams will be stored at WSB in tanks pending subsequent treatment, including neutralization, volume reduction by evaporation, and cementation. Condensed overheads from the evaporators will be either transferred through a lift station and piping to ETP if the overheads meet the waste acceptance criteria for that facility or routed back through WSB processes for further treatment prior to discharge through a permitted outfall (DOE 2008b).

Waste acceptance criteria are being developed for incoming liquid waste, including strict requirements on contaminants of concern, to ensure that these contaminants would not pose a hazard to WSB workers or necessitate additional treatment processes to meet waste acceptance criteria of subsequent treatment or disposal facilities. Liquid waste streams will be processed in WSB into solid LLW and contact-handled TRU waste forms acceptable for disposal. Solid TRU wastes will be shipped to WIPP. Solid LLW will be sent to onsite disposal facilities, such as the E-Area facilities, or to offsite disposal facilities, such as the Nevada National Security Site or commercial facilities. Any mixed low-level waste (MLLW) will be disposed of at offsite facilities. Sanitary wastewater from WSB will be transferred to the SRS Central Sanitary Waste Water Treatment System (DOE 2008b).

Major pieces of process equipment include tanks, pipes, evaporators, cementation equipment, agitators, and pumps. The WSB design includes a ventilation system to maintain lower pressure in rooms that have the potential for higher levels of contamination. Air exhausted from different process areas, gloveboxes, and certain process vessels would be routed through HEPA filters before being discharged from the WSB stack. The 50-foot- (15-meter-) high stack would have an internal diameter of about 5 feet (1.5 meters) and carry an exhaust flow of about 60,000 cubic feet (1,700 cubic meters) per minute. WSB is designed to provide radiation shielding for workers and confinement of airborne contamination, in accordance with appropriate natural phenomenon and other hazard criteria (e.g., high-activity process piping and vessels would be isolated by automatic valves should a seismic event be detected). The process facility includes fire detection and alarm systems, as well as an automatic fire suppression system. A standby diesel generator provides backup power, if needed (DOE 2008b).

Minor design changes to WSB would be needed if DOE decides, following completion of this *SPD Supplemental EIS*, to proceed with construction of PDC at K-Area. Rather than constructing a pipeline to carry laboratory waste from PDCF, DOE would construct and operate the capability needed at WSB to receive and store liquid waste delivered in trucks from PDC operations.

B.1.1.4 F/H-Laboratory

The F/H-Laboratory at SRS is a large complex designed to accommodate a variety of missions. The facility was designed to be flexible and adaptable to changing needs and missions, and it would provide an analytical support capability for new facilities, such as the K-Area PDC if it is constructed, as well as continue to provide analytical support services for currently operating SRS facilities, such as H-Canyon/HB-Line. Minor modifications may be needed at F/H-Laboratory if PDC is constructed and operated or if H-Canyon/HB-Line is used to support conversion of pit plutonium to plutonium oxide. Samples analyzed at the F/H-Laboratory in support of plutonium management activities would account for only a small fraction of the overall activities performed there (SRNS 2012).

B.1.2 K-Area Complex

K-Reactor was constructed in the 1950s in K-Area to produce tritium and plutonium. K-Reactor was initially shut down in 1988 and then underwent seismic and structural upgrades for its restart in 1991. K-Reactor was operated for the last time in 1992, placed in a cold-standby condition in 1993, shut down in 1996, and subsequently deactivated. Nuclear fuel and equipment needed for reactor operation were removed, as were irradiated materials stored in the Disassembly Basin (deinventoried in 2002). The building was later modified for nuclear material storage (DNFSB 2003).

Structures and security at K-Area have been upgraded to house plutonium storage and surveillance capabilities, including K-Area storage and KIS. The physical security protection strategy for K-Area is based on a graded and layered approach supported by a guard force trained to detect, deter, and neutralize adversary activities. Facilities are protected by staffed and automated access control systems, barriers, surveillance systems, and intrusion detection systems (DOE 2007b).

B.1.2.1 Immobilization Capability

The immobilization capability proposed under the Immobilization to DWPF Alternative would convert surplus plutonium to an oxide form, as needed, and then immobilize the plutonium oxide within a glass matrix. The immobilized plutonium would be sealed in cans, loaded into magazines, placed inside DWPF canisters (Figure B-9), and transferred to DWPF to be filled with vitrified HLW. The filled canisters would be sealed and transferred to GWSBs for storage pending final disposition.

Immobilization Capability Construction

An immobilization capability would be constructed inside the K-Area Complex. Existing equipment and piping currently installed in several areas at the K-Area Complex would be removed to accommodate the new facility, decontaminated as necessary, and properly recycled or disposed of. As needed to minimize the potential for airborne emissions, work would be performed within a temporary enclosure, with exhaust routed to the reactor building ventilation system and main stack discharge. In addition, the Cooling Water Reservoir would be drained and the remaining sludge removed and disposed of, and the Cooling Water Pumphouse would be removed. Solid radioactive wastes are expected to include LLW and MLLW. Some hazardous, polychlorinated biphenyl (PCB), and asbestos waste may be generated, as well as some radioactive and nonradioactive liquid wastes (SRS 2006; WSRC 2008).

Support operations would be housed at the K-Area Complex in existing adjacent buildings or in new construction. Approximately 2 acres (0.8 hectares) of land in previously disturbed portions of K-Area would be disturbed during construction.

Plutonium conversion and immobilization operations would be carried out in a series of gloveboxes; confinement barriers would separate the immobilization capability into zones to control the spread of possible airborne contamination. As needed, operations within gloveboxes would be conducted in inert atmospheres. The exhaust from gloveboxes would be passed through HEPA filters and a sand filter before discharge to the stack. A fire protection system with automatic fire detection and suppression capability would be included in gloveboxes (except for gloveboxes with inert atmospheres). General area coverage would be provided by an automatic fire detection and sprinkler system, with the locations and depths of possible standing water

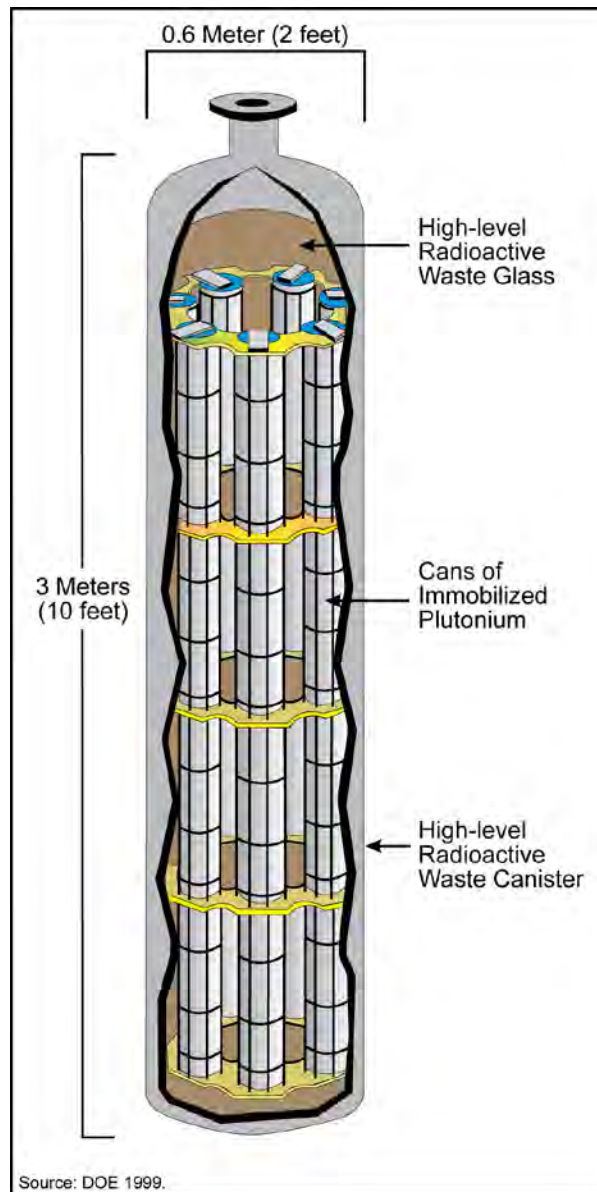

Figure B-9 Cutaway of Can-in-Canister

controlled to ensure criticality safety. Fire-rated walls would be constructed to ensure personnel safety. An HVAC system would be installed, as would compressed gas systems providing dry, breathing, and instrument air; and helium, argon, and other gases. Public address and telecommunications systems and health and safety monitoring systems, such as nuclear incident and continuous air monitors, would be installed.

An uninterruptible power supply and standby generators would provide backup power to ensure that critical systems would remain operational during any power interruptions. New domestic, process, cooling water, and sanitary sewer lines would be installed and supported by existing infrastructure at K-Area (DOE 1999; SRS 2007b, 2007c, 2007k, 2007l, 2007m, 2007n, 2007o; WSRC 2008).

Site work would include investigation of site conditions; temporary and permanent erosion and sedimentation controls; site preparation, excavation, and backfill; installation of access walkways, driveways, and parking areas; installation of utilities (i.e., process water, domestic water, sanitary sewer, electrical); and final grading and provision of stormwater drainage and ground cover. Some existing utility lines would require removal or relocation (SRS 2007j).

Immobilization Capability Operations

Figure B–10 shows a flow diagram of the glass can-in-canister immobilization capability. As indicated in the figure, immobilization activities would occur at both the K-Area immobilization capability and DWPF. The immobilization capability would generate up to about 61 can-in-canisters per year, each canister containing about 16 kilograms (35 pounds) of immobilized plutonium in up to 28 cans. This would result in an annual plutonium throughput of about 1 metric ton (1.1 tons).

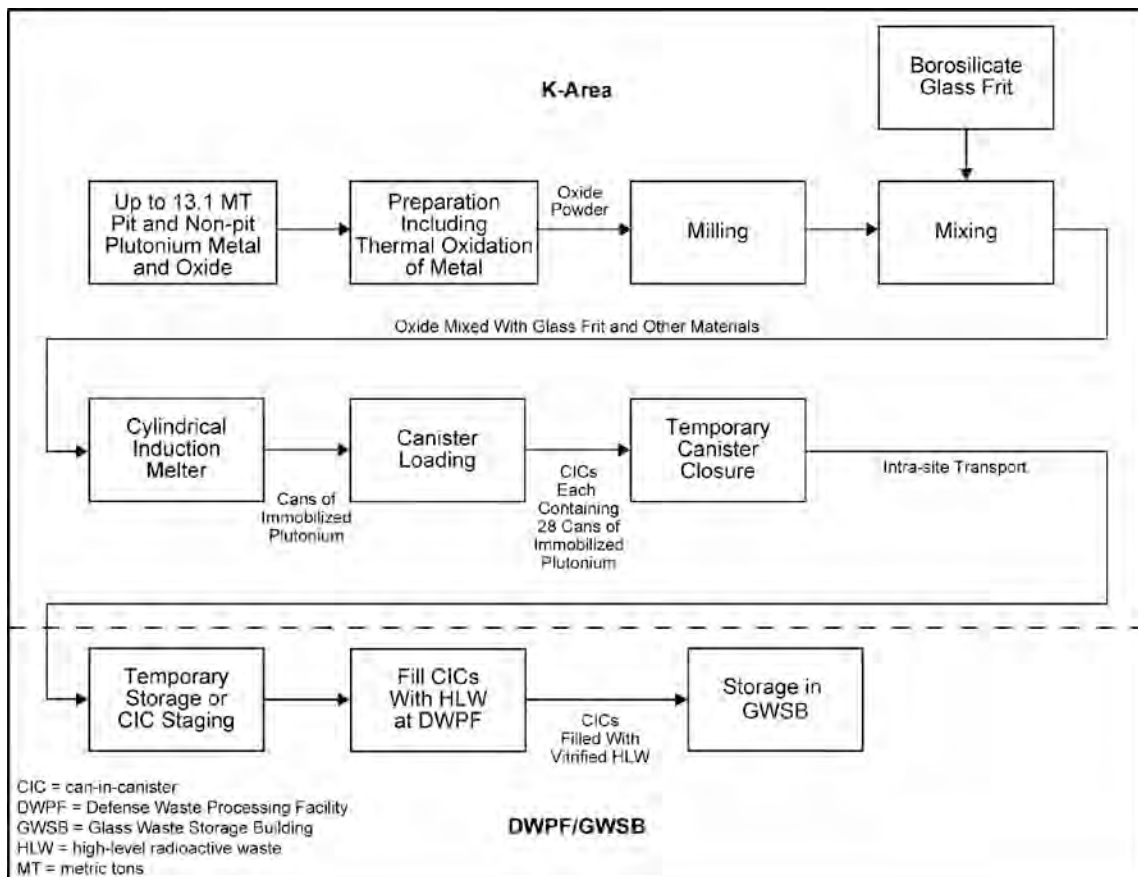

Figure B–10 Immobilization Capability

Non-pit plutonium would be brought to the immobilization capability from K-Area storage, while pit plutonium in oxide form would be brought to the immobilization capability from PDCF, H-Canyon/HB-Line, or LANL. Plutonium oxide would be removed from the Type B shipping packages and transferred to a glovebox for inspection. Clean oxides not requiring conversion would be stored pending immobilization. Metals and alloys would be converted to oxide in one of two metal oxidation furnaces housed within gloveboxes. The cladding from the Fast Flux Test Facility (FFTF) fuel would be removed and the fuel pellets sorted according to fissile material content. Pellets containing plutonium or enriched uranium would be ground to an acceptable particle size for proper mixing with the glass frit (small glass particles) (DOE 1999, 2007a; SRS 2007d, 2007p, 2007q).

Plutonium oxide feed would be prepared to produce individual batches with the desired composition, and then milled to reduce the size of the oxide powder to achieve faster and more-uniform distribution during the subsequent melting process. The milled oxide would be blended with borosilicate glass frit containing neutron absorbers (e.g., gadolinium, boron, hafnium). The mixture would be melted in a platinum/rhodium melter vessel and drained into stainless steel cans. The cans would be sealed, leak-tested, assayed, and transferred out of the immobilization system within bagless cans using a bagless transfer system.⁴ The cans may be temporarily stored or placed directly into magazines that would be inserted through the throat of the DWPF high-level radioactive waste (HLW) canister and locked into a framework inside the canister. A temporary closure plug would be installed in the opening in the top of the canister and, following leak testing, the canister would be loaded into a shielded transportation box for transport in a specialized vehicle, the Shielded Canister Transporter, to DWPF (DOE 1999, 2007a; SRS 2007e, 2007f, 2007g, 2007r). The loaded DWPF canisters could be temporarily stored at the GWSBs pending collection of a sufficient number for a campaign at DWPF.

Immobilization operations are expected to generate contact-handled TRU waste, LLW, MLLW, hazardous waste, and nonhazardous solid waste. Waste would be generated, staged, assayed, packaged, and temporarily stored in several rooms located throughout the facility. TRU waste could include metal cladding from fuel elements, spent filters, contaminated beryllium pieces and cuttings, used containers and equipment, paper and cloth wipes, analytical and quality-control samples, and solidified inorganic solutions. TRU waste would be treated, packaged, and certified as compliant with WIPP waste acceptance criteria before shipment. LLW would be disposed of in onsite or offsite disposal facilities, while MLLW and hazardous wastes would be sent off site for appropriate treatment before disposal in permitted offsite facilities. Solid nonhazardous wastes would be sent to the Three Rivers Regional Landfill at SRS. DOE does not expect that liquid LLW would be generated during normal operations (DOE 1999; SRS 2006).

Immobilization operations would result in airborne emissions of small quantities of nonradioactive pollutants, such as fluorides, hydrochloric acid, nickel and nickel oxides, beryllium and beryllium oxides, nitrogen oxides, volatile organic compounds, or particulate matter. Small quantities of uranium, plutonium, neptunium, and americium isotopes could also be released (WSRC 2008). The exceedingly small emissions from facility gloveboxes would pass through HEPA filters and a sand filter before being discharged from the stack (SRS 2007k).

B.1.2.2 Pit Disassembly and Conversion Project at K-Area

PDC may be constructed and operated in K-Area at SRS. Pits would be disassembled and pit plutonium would be processed into physical and chemical forms suitable for disposition by MOX fuel fabrication. Pit disassembly and conversion processes at PDC would be similar to those described for PDCF (Section B.1.1.1).

Gloveboxes and other equipment required for safe pit disassembly and conversion would be installed within the K-Area Complex following removal of unneeded equipment, rerouting of piping, and any

⁴ *The bagless transfer system allows for contamination-free removal of the filled cans from the immobilization system without compromising the integrity of the glovebox.*

needed decontamination. Some support systems, such as a fanhouse, exhaust tunnel, stack, and diesel generator building, would be constructed within K-Area. Approximately 30 acres (12 hectares) of land would be disturbed. PDC operations would require the provision of additional support systems in the project area, including filtered ventilation systems independent of existing building ventilation. The ventilation systems would be seismically qualified with emergency diesel generators and redundantly designed to maintain process areas at a negative air pressure relative to the atmosphere. Exhaust from the process gloveboxes would be routed through HEPA filtration and then through the main building exhaust system.

A storage capability for pit and non-pit plutonium may be provided at PDC, including container storage racks and drum storage. Oxidation, material stabilization, and packaging would include equipment such as a can puncture device, multi-can cutter, furnace, material weighing and transfer equipment, a bagless transfer system, and an outer can welder with leak detection capability.

The process for preparation of pit plutonium for MOX fuel fabrication would be essentially the same as that described in Section B.1.1.1 for PDCF (see Figure B-5). The plutonium pits would be disassembled and the plutonium and other materials recovered, with the plutonium being converted to a plutonium oxide powder. Pit plutonium would be processed at a design throughput of 3.5 metric tons (3.9 tons) of plutonium per year.

The process would be designed to minimize waste generation and effluents. Construction activities may generate LLW and MLLW; TRU waste; hazardous and nonhazardous waste; and asbestos, PCB, and mixed PCB wastes. Radioactive wastes, asbestos, and PCB wastes would be generated during removal of old facilities and equipment and decontamination of building surfaces. LLW would be packaged in accordance with the acceptance criteria of the receiving disposal facility and sent to E-Area for any needed additional packaging before onsite or offsite disposal. Mixed radioactive and hazardous wastes would be sent to appropriate offsite treatment, storage, and disposal facilities (WSRC 2008). Toxic Substances Control Act (TSCA) and mixed TSCA wastes would be sent to offsite facilities for treatment and disposal. Solid nonhazardous wastes would be sent to the Three Rivers Regional Landfill at SRS.

PDC would provide for filtration and monitoring of the ventilation exhaust to minimize releases of radioactive isotopes to the atmosphere. Sanitary wastewater would be routed to the Central Sanitary Wastewater Treatment Facility for processing before discharge from a permitted outfall at G-Area. No direct releases of process liquids to surface water are expected (SRNS 2012).

B.1.2.3 K-Area Storage

The principal SRS facility for plutonium storage is located in K-Area.⁵ The former reactor confinement area and adjacent areas were modified to form a large warehouse called the K-Area Material Storage Area (MSA). The K-Area MSA consists of two structurally independent buildings: the Process Building and the Stack Building. These buildings and adjacent buildings are separated by expansion joints that allow independent movement and would minimize the interaction of structures during a seismic event. Plutonium is stored in the K-Area MSA in DOE-STD-3013 containers nested within Type B shipping containers. This is a robust packaging configuration that serves as confinement against possible release of contamination during transportation and storage (DNFSB 2003; DOE 2002). The K-Area MSA is also used for receiving and storing plutonium in DOE-STD-3013 containers from offsite locations, including plutonium oxide produced at LANL to provide feed to MFFF.

B.1.2.4 K-Area Interim Surveillance

Operating since 2007, KIS provides the capability for destructive and nondestructive examination of stored plutonium materials. Nondestructive examination capabilities include weight verification, visual inspections, digital radiography, and gamma ray analysis, while destructive capabilities include can

⁵ In a September 11, 2007, amended ROD, DOE announced its decision to consolidate storage of surplus plutonium from several DOE sites at the K-Area MSA, then called the K-Area Material Storage, or KAMS (72 FR 51807).

puncturing for headspace gas sampling and can cutting for oxide sampling. Interim repackaging capabilities are available for safe storage of the material pending eventual disposition. Building modifications made to accommodate KIS included installation of a glovebox and associated equipment; upgrades of ventilation, filtration, and fire protection systems; and the addition of backup power capability (DOE 2005c).

B.1.2.5 K-Area Pit Disassembly Glovebox

If DOE/NNSA decides to use H-Canyon/HB-Line for processing pit plutonium, a glovebox would be modified or installed within the K-Area Complex to be used for pit disassembly. Equipment for opening pits and size-reducing pit materials would be installed in the glovebox. A nuclear incident monitoring system and control access system upgrades would be installed in the facility (SRNS 2012). After disassembly, pit components would be size-reduced, packaged into dissolvable cans, and shipped to H-Area (see **Figure B-11**).

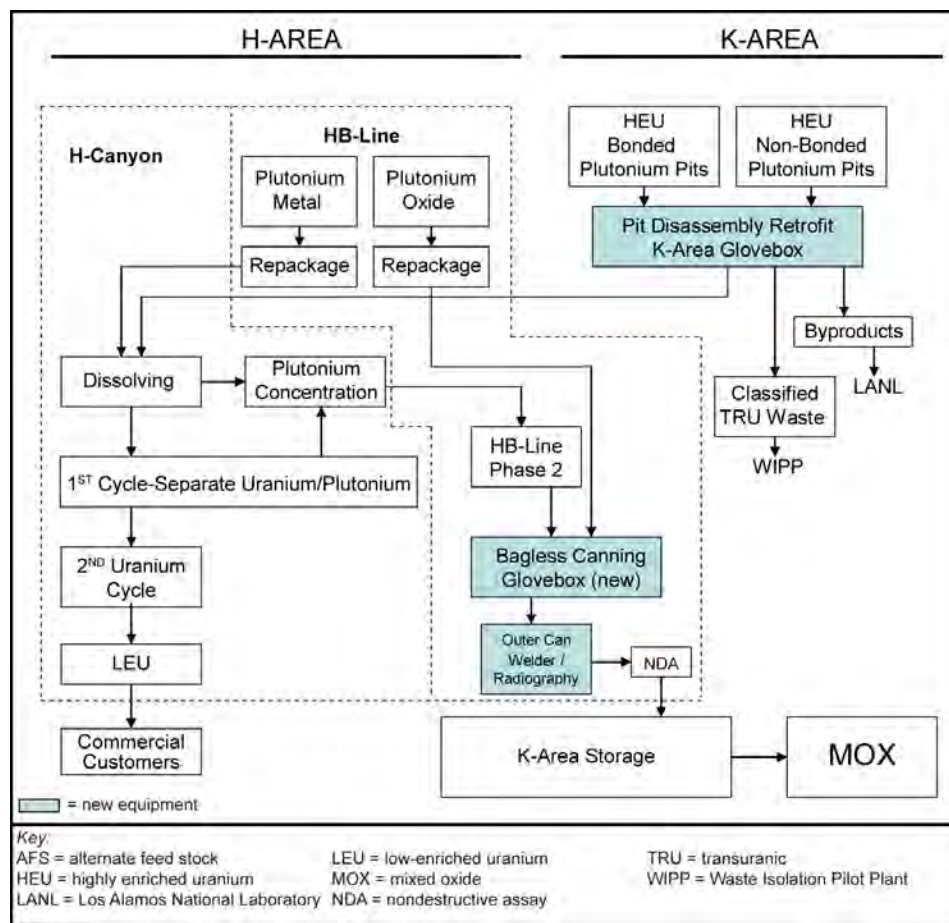

Figure B-11 H-Canyon/HB-Line Plutonium Processing for MOX Fuel

B.1.3 H-Area Facilities – H-Canyon/HB-Line

H-Area is the location of H-Canyon/HB-Line, which is being evaluated in this *SPD Supplemental EIS* for processing pit and non-pit plutonium for disposition. H-Canyon was built in the 1950s and has been operating since 1955, using a solvent extraction process for recovery of uranium from used nuclear fuel (also known as spent nuclear fuel) primarily from SRS nuclear reactors, although several modifications were made to recover other strategic materials. HB-Line, located on top of H-Canyon, was built in the early 1980s to support production of plutonium-238 for deep space missions and to recover legacy materials stored at H-Canyon. In 1992, DOE decided to phase out chemical processing for defense

purposes at H-Canyon/HB-Line, and the H-Canyon/HB-Line mission transitioned to stabilization of nuclear materials, including nuclear reactor fuels, plutonium-238 and neptunium-237, and plutonium-239 solutions (SRS 2007h).

H-Canyon is a large, reinforced-concrete structure named for the two parallel processing areas (i.e., canyons) in the structure that house the series of tanks, process vessels, and other equipment used in the chemical separations process. The canyons are 560 feet (170 meters) long, an average of 20 feet (6.1 meters) wide, and 66 feet (20 meters) high. Processing operations involving high radiation levels occur in the hot canyon, and processing operations involving lower radiation levels occur in the warm canyon. A center section between the canyons houses offices, a control room, and support equipment (e.g., HVAC equipment). H-Canyon/HB-Line operations use steam to heat process vessels in H-Canyon and to transfer solutions through process cycles, electricity for powering lights and equipment and heating HB-Line dissolvers and process vessels, compressed air to provide pressure for process monitoring systems and to power some control systems, and process water for process cooling and other purposes (DOE 1995b). These operations are supported by several additional H-Area facilities, including a building for receipt, storage, and distribution of bulk chemicals; acid recovery; water and solvent handling; and liquid evaporation.

Material processed in H-Canyon is dissolved in nitric acid before entering the solvent extraction process. Process preparation includes removal of solid impurities and chemical adjustment. The first cycle of the solvent extraction process separates the solution into a product stream and a raffinate stream. The product stream from the first cycle is sent to subsequent solvent extraction cycles for further purification. A solvent recovery operation washes the solvent to remove impurities, which are treated as a low-activity waste stream, and to recover and recycle the solvent. Liquids from these processes are reduced in volume and eventually neutralized for rejection as waste to the H-Area liquid radioactive carbon steel waste tanks.

Separate ventilation systems serve areas in H-Canyon/HB-Line that contain radioactive processing equipment. These systems maintain the air pressure at levels below the pressure of the outside air or areas occupied by workers so that air always flows into the process areas. Air from the process areas is treated and filtered before being released to the atmosphere through a 200-foot- (61-meter-) tall stack (DOE 1995b). Offgases from the H-Canyon dissolvers are passed through condensers and a silver nitrate reactor to remove iodine before further filtration by fiberglass filters and discharge through the stack. Emissions from other H-Canyon areas may be passed through HEPA or fiberglass filters before discharge to the sand filters and stack, while air from liquid process areas in the Support Building is sent to the sand filter and discharged from the stack. The original sand filters for H-Canyon are 100-foot- (30-meter-) long by 240-foot- (73-meter-) wide by 25-foot- (7.6-meter-) deep concrete structures with 8-foot- (2.4-meter-) deep beds made of coarse stone and succeeding layers of increasingly finer gravel and sand. Newer sand filters constructed in 1976 operate in parallel with the original filters and are similarly constructed, but have design enhancements (WSRC 2008).

The separations process generates high-activity (high-alpha) aqueous acid waste streams containing most of the radioactive decay products and chemical salts used in processing, plus several low-activity aqueous waste streams. These waste streams are sent to evaporators to reduce their volumes. The feed to the evaporators in the hot canyon originates from the primary separation process. The evaporator overheads, containing most of the water and acid and very little of the radioactive decay products and chemicals, are transferred to tanks for acid recovery and recycling. The fission products and chemicals in the evaporator concentrate are neutralized and sent to the H-Area liquid radioactive waste tanks for storage pending vitrification in DWPF (DOE 1995b).

Solid LLW and contact-handled TRU waste streams generated from H-Canyon/HB-Line operations are treated and packaged for disposal. LLW may be shipped to onsite or offsite disposal facilities; contact-handled TRU waste is disposed of at WIPP.

There are two primary pathways for liquid effluents (DOE 1995a). In the first pathway, condensates from evaporators containing low levels of radionuclides flow to ETP for further treatment, if necessary, before

discharge through a permitted outfall. In the second pathway, canyon cooling water passes through coils inside the vessels, flows back out of the canyon and is cooled and recirculated or released to a permitted outfall. If radioactivity is detected in this cooling water, it is diverted to retention basins, then treated/cleaned by ETP prior to release through a permitted outfall.

For processing pit plutonium (Figure B-11), the dissolvable cans containing plutonium metal would be received at H-Canyon and discharged into a canyon dissolver. The dissolved solutions would be transferred to the separations process, during which any uranium present in the material would be recovered. Dissolved plutonium solution would be converted to plutonium oxide in HB-Line, packaged, and sent to K-Area for storage until processing for disposition by immobilization or through MFFF.

H-Canyon/HB-Line is being considered for processing the surplus non-pit plutonium into plutonium oxide for MOX fuel fabrication at MFFF. Plutonium processing in H-Canyon/HB-Line would start with dissolution of the majority of the material that is in oxide form in HB-Line, and dissolution of most of the metals in H-Canyon. If required, vacuum salt distillation pretreatment in HB-Line would separate plutonium from chloride and fluoride salts. The dissolved solutions would then be transferred to the separations process, during which any uranium present in the material would be recovered. Plutonium would be converted to plutonium oxide at HB-Line, packaged, and sent to K-Area for storage until processing for disposition at MFFF.

H-Canyon/HB-Line is also being considered for disposition of non-pit plutonium via dissolution followed by transfer to DWPF for vitrification with HLW. The plutonium solutions would be transferred primarily to the DWPF sludge feed tank in the liquid radioactive waste tank farm pending vitrification at DWPF. Administrative and engineered controls defined in the safety basis documentation and Technical Safety Requirements for H-Canyon/HB-Line would ensure subcritical nuclear conditions during all processing operations.

H-Canyon/HB-Line could also be used to prepare non-pit plutonium for disposal at WIPP (**Figure B-12**). Shipping packages (9975 shipping containers) containing DOE-STD-3013 containers would be shipped to HB-Line, where the 3013 containers would be cut open in an existing glovebox. Metals would be converted to an oxide using an existing or new furnace. Oxide would be repackaged into suitable cans, mixed/blended with Termination of Safeguards, or inert material, and loaded into Pipe Overpack Containers (POCs). The Termination of Safeguards material would be added to reduce the plutonium content to less than 10 percent by weight and inhibit plutonium material recovery and could include dry mixtures of commercially available materials. These loaded POCs would then be transferred to E-Area, where WIPP characterization activities would be performed. These characterization activities include nondestructive assay, digital radiography, and headspace gas sampling for each POC to be shipped to WIPP. Once POCs have successfully passed the characterization process and meet WIPP waste acceptance criteria they would be shipped to WIPP in Transuranic Package Transporter Model 2 (TRUPACT-II) shipping containers.

If the unirradiated FFTF fuel cannot be disposed of by direct disposal to WIPP, the unirradiated FFTF fuel would be disassembled and could be prepared for disposal through H-Canyon/HB-Line and vitrification at DWPF or disposal at WIPP. Disposition of unirradiated FFTF materials through H-Canyon/HB-Line to DWPF would require disassembly of the fuel pins and repackaging into carbon steel containers suitable for dissolution in H-Canyon. The WIPP Disposal Option would require installation of an additional glovebox or laboratory-type hood to remove the fuel pellets from the fuel pins and load them into suitable transfer cans. Existing gloveboxes in HB-Line could be used to perform the operations to crush the pellets into a powder, load the powder into a suitable can, mix/blend with inert material, assay, package the loaded can into a POC, and transfer to E-Area before shipment to WIPP.

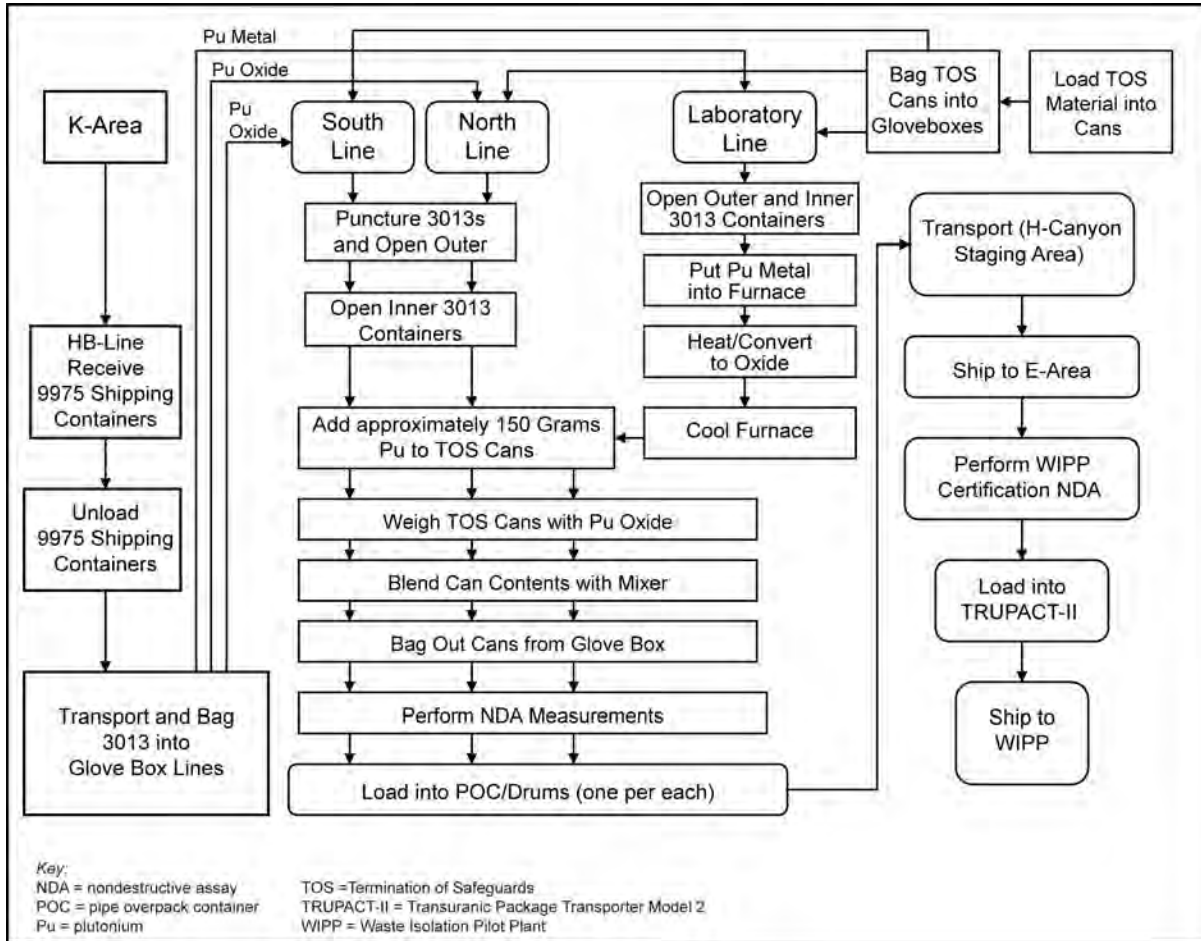

Figure B-12 HB-Line Repackaging for Waste Isolation Pilot Plant Disposal

A number of upgrades are being considered that would enhance processing of surplus non-pit plutonium in H-Canyon/HB-Line. Additional storage vessels and equipment may be needed for processing the surplus non-pit plutonium considered in this *SPD Supplemental EIS*.⁶ H-Canyon/HB-Line would need to operate through 2019 to support the PF-4, H-Canyon/HB-Line, and MFFF Option for pit disassembly and conversion under the MOX Fuel Alternative, or 2024 to support the H-Canyon/HB-Line to DWPF Alternative.

B.1.4 S-Area Facilities

B.1.4.1 Defense Waste Processing Facility

DWPF was built in S-Area to vitrify the several million gallons of liquid HLW stored in 49 large underground tanks. Canister filling, the final process step of both the proposed immobilization and H-Canyon/HB-Line dissolution processes, would occur at DWPF. The DWPF complex consists of the Vitrification Facility and support structures, including the GWSBs.

Liquid wastes from the SRS separations facilities are stored in tank farms where the liquids are processed to reduce the volume of the waste and separate it into sludge and salt components. These processing steps generate a low-activity liquid waste stream that is treated at ETP before being discharged to the environment through a permitted outfall. Before vitrification in DWPF, sludge and salt components go through separate pretreatment steps that, in the case of salt waste, produce a high-activity (high-alpha) stream that is vitrified at DWPF, and a low-activity stream that is disposed of in the Saltstone Facility

⁶ Addition of a third dissolver is under consideration for H-Canyon independent of surplus plutonium processing (SRNS 2012).

adjacent to DWPF. Within the Vitrification Facility, sludge from the Extended Sludge Washing Facility is treated with nitric acid, and any mercury in the sludge is recovered (WSRC 2008). The sludge is mixed with borosilicate glass frit and used as feed for the melter, where the mixture is heated to form molten glass. Canisters of vitrified waste from DWPF are stored in the GWSBs.

Until recently, the HLW vitrified in DWPF consisted of sludge waste pretreated in the Extended Waste Processing Facility. The current waste feed vitrified in DWPF is composed of treated sludge and slurry from a salt pretreatment process. Salt pretreatment includes an actinide removal process and modular caustic-side solvent extraction system that separates the salt waste into a high-activity (high-alpha) stream for vitrification in DWPF and a low-activity stream to be processed at the Saltstone Facility. Starting around 2013, the remaining salt waste would be pretreated in a newly constructed Salt Waste Processing Facility (DOE 2007c; SRR 2009a; SRS 2007i; 71 FR 3834). As discussed in the description of the Immobilization to DWPF Alternative, in Chapter 2, Section 2.3.2, of this *SPD Supplemental EIS*, any plutonium going to DWPF must be received by 2026 to avoid affecting the current DWPF schedule.

Vitrification of High-Level Radioactive Waste in Standard Canisters

Vitrification and canister-filling operations at DWPF would be the same for the plutonium-bearing solutions processed through H-Canyon/HB-Line as operations for the other HLW sludge vitrified at DWPF. Upon receipt at DWPF, empty canisters are moved individually through an inspection area to the melt cell. Borosilicate glass frit is mixed with liquid waste and the mixture is sent to the melter, where the mixture is heated until it is molten. The molten glass waste mixture is slowly poured into the canisters, requiring about a day to fill each canister. Any contamination on the outside surface of the canister is removed, and the canister is plugged, welded closed, and inspected. A Shielded Canister Transporter moves each filled and sealed canister to a nearby GWSB for storage pending offsite storage or disposal (DOE 1999; SRS 2007a). Canisters measure about 2 feet (0.6 meters) in diameter by 10 feet (3 meters) long (Figure B-9). Individual canisters weigh about 1,000 pounds (450 kilograms) when empty and about 5,000 pounds (2,300 kilograms) when filled with vitrified HLW.

Processing surplus plutonium through H-Canyon/HB-Line would increase the number of HLW canisters to be generated and stored. The number of additional HLW canisters would depend on the quantity of surplus plutonium processed through H-Canyon/HB-Line and DWPF and on the plutonium concentration within the feed material. Processing 6 metric tons (6.6 tons) of surplus plutonium would generate up to 20 to 48 additional canisters. A range in the number of additional canisters is contemplated because DOE is developing options for increasing the plutonium loading from the current level of 897 grams per cubic meter (0.06 pounds per cubic foot) to a range of 2,500 to 5,400 grams of plutonium per cubic meter (0.16 to 0.34 pounds per cubic foot). The addition of gadolinium in the plutonium stream to absorb neutrons, thus ensuring criticality safety during DWPF processing, would minimize the plutonium waste mass and HLW canister generation.

Minor modifications, such as installation of a dedicated transfer line, may be made to the H-Area tank farm to support the quantity of non-pit plutonium being considered under the H-Canyon/HB-Line to DWPF Alternative (SRNS 2012).

Vitrification of Immobilized Plutonium Can-in-Canisters

Canister-filling operations in DWPF would be essentially the same process for both the can-in-canisters containing immobilized plutonium from the K-Area immobilization capability and the regular canisters that would be filled with the plutonium processed through H-Canyon/HB-Line, as described in Section B.1.3. The canisters from the K-Area immobilization capability would be heavier than the empty canisters usually processed in DWPF, and would have higher radiation fields (DOE 1999, 2007a:11). To minimize the physical and radiological impacts on facility operation, these canisters would be transferred to the melter through the normal exit route for the poured canisters. Minor modifications to DWPF to accommodate these canisters would include new canister storage racks, a closed-circuit television system, a remote manipulator, and other modified equipment (WSRC 2008).

Each filled can-in-canister would weigh up to 6,120 pounds (2,800 kilograms), about 1,100 pounds (500 kilograms) heavier than a standard HLW canister (WSRC 2008). The number of canisters to be generated and stored at the GWSBs would depend on the amount of surplus plutonium processed and the amount of plutonium per can. About 12 percent of the glass can-in-canister volume would be taken up by the cans of immobilized plutonium and structural internals. Because the cans of immobilized plutonium and internals would displace a similar volume of vitrified HLW, implementing the Immobilization to DWPF Alternative would increase the number of HLW canisters to be generated and stored to about 95 HLW canisters.

B.1.4.2 Glass Waste Storage Buildings

The *Defense Waste Processing Facility Supplemental Environmental Impact Statement* (DOE 1994) addressed the environmental impacts associated with constructing one or more GWSBs with a total capacity of 10,000 HLW canisters. To date, two GWSBs have been constructed and are operating in S-Area. The first storage building is a below-grade, seismically qualified vault containing vertical storage. The vault is equipped with forced ventilation cooling to remove radioactive decay heat from the canisters. An industrial-steel-frame building encloses the operating area directly above the storage vault, and a 5-foot- (1.5-meter-) thick concrete floor separates the storage vault from the operating area. The second storage building is 200 by 200 feet (61 by 61 meters), and is similar in design to the first storage building, but, among other differences, does not require forced ventilation for canister cooling (DOE 2006; SRS CAB 2004). The estimated storage capacity for the two storage buildings is approximately 4,590 canisters (SRR 2009b). Construction of a third storage building is planned.

Filled containers of vitrified waste would be transported from DWPF, one canister at a time, using the Shielded Canister Transporter, to one of the GWSBs (DOE 2005a). At the storage building, the shielding plug of a storage vault would be removed, the waste canister would be lowered from the Shielded Canister Transporter to the storage vault, and the shielding plug replaced. The GWSBs may also be used for temporary storage of can-in-canisters of immobilized plutonium from K-Area pending collection of a sufficient number for a vitrification campaign in DWPF. Canisters would be stored in the GWSBs until a disposition path for HLW is determined.

B.1.5 E-Area Waste Management Facilities

Existing facilities in E-Area at SRS would be used for storage, staging, and shipping of TRU waste, LLW, and MLLW generated by surplus plutonium disposition activities. E-Area is located in the Industrial Core Management Area between F-Area and H-Area (see Figure B–2). It consists of approximately 330 acres (134 hectares) and includes the TRU Waste Storage Pads, LLW Disposal Vaults, Low-Activity Waste Vaults, Intermediate-Level Waste Vaults, Engineered Trenches, and Very-Low-Activity Waste Disposal Trenches (slit trenches) (DOE 2005b; WSRC 2004). The TRU Waste Storage Pads would be used for accumulation of TRU waste, MLLW, and hazardous waste before shipment offsite for disposal.

Because the TRU waste would be certified to be in compliance with WIPP waste acceptance criteria at the generating facilities, additional extensive pre-shipment characterization would be generally not be required at E-Area. TRU waste would be loaded in TRUPACT-II (**Figure B–13**) or HalfPACT shipping containers. These containers are NRC-licensed Type B casks designed specifically for the transport of TRU waste. They have undergone extensive testing to demonstrate the ability to provide safe containment of TRU waste. The TRUPACT-II cask is 8 feet (2.4 meters) wide and 10 feet (3.0 meters) high and can hold up to fourteen 55-gallon drums or two standard waste boxes, each having a capacity of 1.8 cubic meters (63 cubic feet) (DOE 2012b). The HalfPACT cask is 8 feet (2.4 meters) wide and 7.5 feet (2.3 meters) high and can hold up to seven drums (DOE 2012b). Up to three TRUPACT-II containers could be loaded on a truck; however, shipments must meet weight restrictions and some shipments use a smaller cask. Each truck would be tracked by emergency response and law enforcement officials via the satellite TRANSCOM, DOE's unclassified Tracking and Communications System (DOE 2012c).

LLW may be disposed of at E-Area in the Low-Activity Waste Vaults, Intermediate-Level Waste Vaults, Engineered Trenches, or Very-Low-Activity Waste Disposal Trenches (slit trenches). LLW may also be shipped off site for disposal at the Nevada National Security Site or licensed commercial facilities, as would all MLLW. Shipments would use licensed commercial carriers and would be performed in compliance with applicable Federal and state regulations. Hazardous waste could be shipped off site for treatment and disposal directly from the generating facility if it is logistically advantageous to do so instead of first transporting it to E-Area. Nonhazardous waste would be shipped directly from the generating facility to onsite disposal facilities. Appendix E provides additional information on transportation of waste to the disposal facilities.

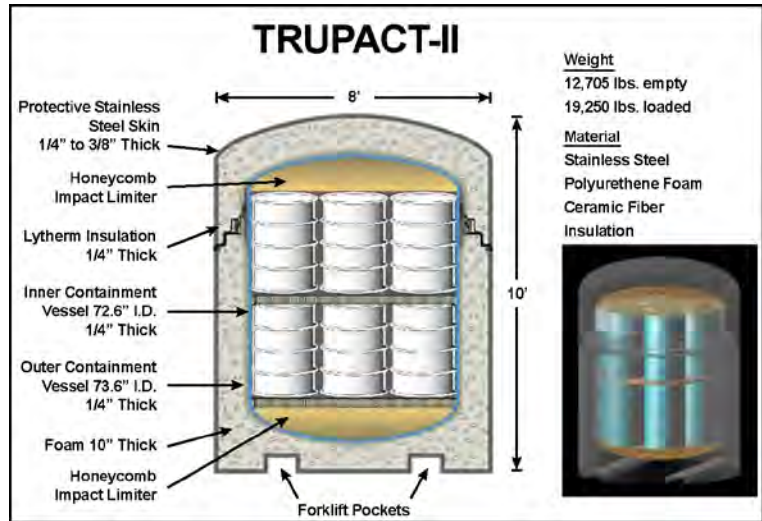

Figure B-13 Transuranic Package Transporter Model 2

B.2 Los Alamos National Laboratory

B.2.1 Plutonium Facility

DOE/NNSA proposes to use PF-4 at LANL for disassembly and conversion of some or all plutonium pits addressed in this *SPD Supplemental EIS*. LANL was originally established in 1943 as “Project Y” of the Manhattan Project in northern New Mexico, within what is now the Incorporated County of Los Alamos. Project Y had a single national defense mission—to build the world’s first nuclear weapon. After World War II ended, Project Y was designated a permanent research and development laboratory, the Los Alamos Scientific Laboratory. It was renamed LANL in the 1980s, when its mission was expanded from defense and related research and development to incorporate a wide variety of new assignments in support of Federal Government and private sector programs. LANL is now a multidisciplinary, multipurpose institution primarily engaged in theoretical and experimental research and development.

LANL occupies about 40 square miles (104 square kilometers) of land on the eastern flank of the Jemez Mountains along the area known as the Pajarito Plateau. The terrain in the LANL area consists of mesa tops and canyon bottoms that trend in a west-to-east manner, with the canyons intersecting the Rio Grande to the east of LANL. LANL operations occur within numerous facilities located over 47 designated technical areas within the LANL boundaries and at other leased properties situated near LANL (see Figure B-3). PF-4 is located in TA-55, in the west-central portion of LANL, approximately 1.1 miles (1.8 kilometers) south of the Los Alamos townsite. TA-55 facilities provide research and applications in chemical and metallurgical processes for recovering, purifying, and converting plutonium and other actinides into many compounds and forms, as well as research into material properties and fabrication of parts for research and stockpile applications. A perimeter intrusion, detection, assessment and delay system (PIDADS) surrounds all nuclear facilities in TA-55.

The ARIES line at PF-4 is operating at demonstration capacity (based on single-shift operation) to produce 2 metric tons (2.2 tons) of plutonium oxide as early feed material for MFFF. These operations would continue under all alternatives analyzed in the *SPD Supplemental EIS*. Under some of the pit disassembly and conversion options under the action alternatives, the LANL ARIES program would be expanded to produce 35 metric tons (38.6 tons) of plutonium oxide feed.

Upgrades are currently being implemented at the existing ARIES Program and are included in the 2008 *Final Site-Wide Environmental Impact Statement for the Continued Operation of the Los Alamos National Laboratory, Los Alamos, New Mexico* (DOE 2008a). These upgrades include:

- Modifications of pit disassembly lathe, already operating in PF-4, that will be used by LANL's existing ARIES program
- Installation of hydride/dehydride equipment
- Acquisition and installation of second plutonium metal oxidation furnace
- Installation of second mill/blend machine
- Installation of four new safes in the basement
- Installation of new part storage boxes in two gloveboxes

If DOE decides to expand the ARIES capabilities, PF-4 would be equipped with the capability to handle full production of plutonium metal and plutonium oxide. The projected increased production rate would require additional modifications to PF-4, including modifications and reconfigurations of rooms, vaults, and gloveboxes where pit disassembly and conversion equipment and operations would be placed. Twenty gloveboxes would be decontaminated and decommissioned, 18 gloveboxes modified, and 18 new gloveboxes installed. The current ARIES program uses about 4,500 square feet (420 square meters) and the expansion would require another 3,000 square feet (280 square meters) for a total of 7,500 square feet (700 square meters). Construction work would last approximately 8 years. A double-wide construction trailer and parking for up to 60 employees would be required. The total disturbed area outside PF-4 would be less than 2 acres (0.8 hectares).

The pit disassembly and conversion capability at PF-4 would be similar to the capability at SRS illustrated in Figure B-5. Pits would be shipped from the Pantex Plant to PF-4. After disassembly and processing, the plutonium oxide and plutonium metal would be shipped to SRS. Plutonium oxide would be available for direct use at MFFF for MOX fuel fabrication, while metallic plutonium would be converted to plutonium oxide at H-Canyon/HB-Line or in oxidation furnaces installed at MFFF. This plutonium oxide would then be available for MOX fuel fabrication.

There is minimal storage capacity for wastes at TA-55, so timely management of wastes generated by TA-55 activities is essential for maintaining facility capacity. Before a new activity or change to an existing activity can be performed in PF-4, it must be vetted through an approval process that considers its potential impact on waste management, including the types and volumes of waste to be generated. Before any waste can be generated, the waste originator must work with the TA-55 Waste Management Coordinator to plan the life cycle for the wastes. The TA-55 Waste Management Coordinator works with waste originators to complete documentation that characterizes all waste streams to ensure compliance with treatment, storage, and disposal facility waste acceptance criteria. Waste storage sites throughout TA-55, including treatment, storage, and disposal sites, produce waste packages that meet LANL, state, and Federal criteria for handling and storage, and ensure waste items or packages meet TA-54 LLW disposal and offsite waste acceptance criteria. Radioactive liquid waste discharges would travel to the TA-50 Radioactive Liquid Waste Treatment Facility (RLWTF) via a piping system. Solid LLW may be shipped directly to an offsite permitted disposal site, or sent to TA-54 for staging before shipment off site. MLLW and hazardous waste would be transported to TA-54 for staging before shipment off site for treatment and disposal. TRU waste would be characterized by generators as it is prepared in drums and transported to TA-54 for WIPP certification (LANL 2012).

B.2.2 Los Alamos National Laboratory Support Facilities

Pit disassembly and conversion work at PF-4 would be supported by laboratory analysis functions at the Chemistry and Metallurgy Research Building in TA-3 (Figure B-3) and the Radiological Laboratory/Utility/Office Building (RLUOB) at TA-55 (Figure B-4) (LANL 2012:031512). The

Chemistry and Metallurgy Research Building is a nuclear facility that was constructed as an actinide chemistry and metallurgy research facility between 1949 and 1952. Its current missions include analytical chemistry and materials characterization, destructive and nondestructive analysis, and actinide research and processing. RLUOB is a newly constructed administrative and support function building located adjacent to PF-4. In addition to office space, utilities, and training classrooms, RLUOB contains radiological laboratory space (DOE 2011:2-6, 2-9).

The principal facility for treating radioactive liquid waste at LANL is RLWTF, located in TA-50. RLWTF consists of the treatment facility, support buildings, and liquid and chemical storage tanks, and receives liquid waste from various sites across LANL. Several upgrades to RLWTF have been implemented in recent years to upgrade the tank farm, install new ultrafiltration and reverse osmosis equipment, and install new nitrate reduction equipment. RLWTF Outfall Number 051 discharges into Mortandad Canyon. RLWTF is slated for replacement with a new facility in accordance with the 2008 *LANL SWEIS* ROD (73 FR 55833); this new facility is being planned with an evaporation unit to eliminate liquid discharges into the environment (DOE 2011:3-66).

TA-54 is the current location of most of LANL's solid radioactive waste and chemical waste capabilities. LLW generated at LANL may be disposed at Area G in TA-54 or staged therein before being shipped off site (beginning in 2008, most LLW generated by LANL operations has been disposed of offsite). Other waste types such as MLLW and hazardous waste are staged at Area G for offsite treatment and/or disposal. TRU waste is characterized at Area G before it is transported to the Radioassay and Nondestructive Testing Facility (RANT), also located in TA-54, and loaded into TRUPACT packages for shipment to WIPP (LANL 2012).

Because of the requirements in a 2005 Compliance Order on Consent between DOE/NNSA and the New Mexico Environmental Department (DOE 2008a:2-9), the waste management capabilities in Area G are being transitioned to other locations along the Pajarito Road corridor (i.e., other locations on the same mesa as TA-54). Consequently, it is expected that characterization of TRU waste from pit disassembly and conversion activities at PF-4 would shift to the RANT facility where TRUPACT-loading would also occur. After it becomes operational, management of TRU waste from pit disassembly and conversion activities could also occur at the new TRU Waste Facility planned for construction in TA-63. LLW, MLLW, and hazardous waste management capabilities would be transitioned to other locations in TA-54. DOE decided to transition the waste management capabilities at LANL (73 FR 55833), including construction of the new TRU Waste Facility in TA-63, based on the analysis in the 2008 *LANL SWEIS* (DOE 2008a).

B.3 Waste Isolation Pilot Plant

WIPP, near Carlsbad, New Mexico, is the only facility authorized to dispose of TRU waste generated by defense activities. The WIPP repository is located in thick, stable, and ancient salt beds 2,150 feet (655 meters) below the ground surface. The Waste Isolation Pilot Plant Land Withdrawal Act (Public Law No. 102-579) authorized the disposal of up to 175,600 cubic meters (6.2 million cubic feet) of TRU waste generated by the Nation's atomic energy defense activities. TRU waste is waste that contains alpha particle-emitting radionuclides with atomic numbers greater than uranium (92) and half-lives greater than 20 years in concentrations greater than 100 nanocuries per gram of waste.

In 1997, DOE issued the *Waste Isolation Pilot Plant Disposal Phase Final Supplemental Environmental Impact Statement (WIPP SEIS-II)* (DOE 1997), which addressed the management of TRU waste at DOE sites and the management and disposal of TRU waste at WIPP. The January 23, 1998, ROD (63 FR 3624) for the *WIPP SEIS-II* announced DOE's decision to dispose of up to 175,600 cubic meters (6.2 million cubic feet) of TRU waste generated by defense activities at WIPP after preparation to meet the WIPP waste acceptance criteria. This waste included TRU waste generated since 1970 and TRU waste that DOE would generate over the next 35 years. DOE's total TRU waste inventory at its sites (stored TRU waste and projected generation of TRU waste through 2033) in the *WIPP SEIS-II* was 170,000 cubic meters (6 million cubic feet). This inventory is referred to as the "basic inventory." DOE

recognized that additional TRU waste not included in the *WIPP SEIS-II* site inventory might be identified that would be suitable for disposal at WIPP. For that reason, DOE assumed an additional 5,600 cubic meters (198,000 cubic feet) of projected TRU waste and analyzed the transportation and disposal of 175,600 cubic meters (6.2 million cubic feet) of TRU waste under the Proposed Action in the *WIPP SEIS-II* (DOE 1997).

The 1996 *Storage and Disposition PEIS* (DOE 1996) considered, but dismissed, an option that would have allowed for the disposal of the Nation's entire inventory, at the time estimated at 50 metric tons (55 tons), of surplus plutonium at WIPP. The *Storage and Disposition PEIS* stated that this option would exceed WIPP's capacity. It also stated that this option would likely require amendment of the Waste Isolation Pilot Plant Land Withdrawal Act, associated regulations, draft or pending regulatory compliance documents, and the planning basis for WIPP waste acceptance criteria, among other things (DOE 1996). Because a much smaller amount of surplus plutonium (up to 6 metric tons [6.6 tons]) is now being considered for disposal at WIPP, DOE now considers this to be a reasonable alternative that should be evaluated in this *SPD Supplemental EIS*.

For disposition of surplus non-pit plutonium by disposal at WIPP, the volumes and corresponding numbers of shipments of TRU waste transported to WIPP would depend on the quantity of surplus plutonium contained within the disposal containers (the POCs). POCs are presently limited to 200 fissile gram equivalents, although DOE is pursuing approval to raise the limit to 400 fissile gram equivalents per container. These larger capacity containers are called criticality control containers. The larger limit would halve the volumes of TRU waste generated from processing the surplus non-pit plutonium, and halve the number of waste shipments to WIPP. For the purposes of this *SPD Supplemental EIS*, both 200 and 400 fissile gram equivalents per container are analyzed (Appendix E). Shipping FFTF fuel directly in its current packaging (Hanford Unirradiated Fuel Package, or HUFPP), instead of repackaging the fuel into POCs would reduce the number of containers and the number of shipments.

B.4 Reactor Sites Using Mixed Oxide Fuel

Most commercial nuclear power reactors currently operating in the United States could use MOX fuel. It is not expected that a reactor's operations would need to change significantly to allow it to use MOX fuel. Prior to being allowed to use MOX fuel, the reactor operator would be required to obtain a license amendment from NRC. Assuming a reactor operator is granted such a license amendment by NRC to allow it to use MOX fuel in one or more of its reactors, MOX fuel would be shipped from SRS to the reactor sites using NNSA's Secure Transportation Asset. After an acceptance inspection at the reactor site, the MOX fuel would be stored in a secure location at the reactor site until it was loaded into the reactor during one of its standard refueling outages. Fresh MOX fuel presents a slightly higher risk of higher doses to workers due to the presence of plutonium and other actinides compared to LEU fuel. Worker doses would be required to continue to meet Federal regulatory dose limits and any reactor proposing to use MOX fuel would be required by NRC to take steps within its as low as reasonably achievable (ALARA) program to limit any increase in doses to workers that may occur from use of MOX fuel.

From the storage location, both MOX and LEU fuel assemblies would be loaded into the reactor. This *SPD Supplemental EIS* analyzes the use of a core with up to 40 percent MOX fuel in a reactor. MOX fuel assemblies would remain in the reactor in accordance with the utility's operating plan. When the MOX fuel completes its fuel cycle, it would be withdrawn from the reactor in accordance with the reactor's refueling procedures and placed in the reactor's used fuel storage pool for cooling alongside other used fuel. No major changes are expected in the reactor's used fuel storage plans to accommodate the used MOX fuel. The amount of decay heat would be slightly higher in MOX used fuel rods than in LEU used fuel rods and this small difference would be expected to be managed using standard used fuel pool and dry cask practices.

Appendix I, Section I.1, of this *SPD Supplemental EIS*, discusses the potential environmental impacts associated with using MOX fuel in reactors at TVA's Browns Ferry and Sequoyah Nuclear Plants, in Alabama and Tennessee, respectively. Section I.2 discusses the potential environmental impacts associated with using MOX fuel in other commercial nuclear power reactors at other locations in the United States. Appendix J presents discussion of the impacts of postulated accidents in commercial reactors operating with a partial MOX core compared to the impacts with an LEU core.

B.5 References

Cantey, T., 2008, National Nuclear Security Administration, Aiken, South Carolina, personal communication (memorandum) to File, “Documentation to the Alternatives Analysis to Define WSB Scope,” August 21.

DNFSB (Defense Nuclear Facilities Safety Board), 2003, *Plutonium Storage at the Department of Energy’s Savannah River Site, Report to Congress*, Washington, DC, December.

DOE (U.S. Department of Energy), 1994, *Final Supplemental Environmental Impact Statement, Defense Waste Processing Facility, Savannah River Site, Aiken, South Carolina*, DOE/EIS-0082-S, Savannah River Operations Office, Aiken, South Carolina, November.

DOE (U.S. Department of Energy), 1995a, *Savannah River Site Waste Management Final Environmental Impact Statement*, DOE/EIS-0217, Savannah River Operations Office, Aiken, South Carolina, July.

DOE (U.S. Department of Energy), 1995b, *Final Environmental Impact Statement Interim Management of Nuclear Materials*, DOE/EIS-0220, Savannah River Site, Aiken, South Carolina, October.

DOE (U.S. Department of Energy), 1996, *Storage and Disposition of Weapons-Usable Fissile Materials Final Programmatic Environmental Impact Statement*, DOE/EIS-0229, Office of Fissile Materials Disposition, Washington, DC, December.

DOE (U.S. Department of Energy), 1997, *Waste Isolation Pilot Plant Disposal Phase Final Supplemental Environmental Impact Statement*, DOE/EIS-0026-S-2, Carlsbad Area Office, Carlsbad, New Mexico, September.

DOE (U.S. Department of Energy), 1999, *Surplus Plutonium Disposition Final Environmental Impact Statement*, DOE/EIS-0283, Office of Fissile Materials Disposition, Washington, DC, November.

DOE (U.S. Department of Energy), 2002, *Supplement Analysis for Storage of Surplus Plutonium Materials in the K-Area Material Storage Facility at the Savannah River Site*, DOE/EIS-0229-SA-2, Office of Environmental Management, Washington, DC, February.

DOE (U.S. Department of Energy), 2003, *Changes Needed to the Surplus Plutonium Disposition Program, Supplement Analysis and Amended Record of Decision*, DOE/EIS-0283-SA1, Office of Fissile Materials Disposition, Washington, DC, April.

DOE (U.S. Department of Energy), 2005a, “High Level Waste System at SRS,” HLW Overview, January 19.

DOE (U.S. Department of Energy), 2005b, *Savannah River Site End State Vision*, Aiken, South Carolina, July 26.

DOE (U.S. Department of Energy), 2005c, *Environmental Assessment for the Safeguards and Security Upgrades for Storage of Plutonium Materials at the Savannah River Site*, DOE/EA-1538, Savannah River Operations Office, Aiken, South Carolina, December.

DOE (U.S. Department of Energy), 2006, “Startup of Second Nuclear Waste Storage Facility at the Savannah River Site,” *DOE News*, Savannah River Operations Office, Aiken, South Carolina, July 10.

DOE (U.S. Department of Energy), 2007a, *Plan for Alternative Disposition of Defense Plutonium and Defense Plutonium Materials That were Destined for the Cancelled Plutonium Immobilization Plant*, Washington, DC, August.

DOE (U.S. Department of Energy), 2007b, *Supplement Analysis Storage of Surplus Plutonium Materials at the Savannah River Site*, DOE/EIS-0229-SA-4, Office of Environmental Management, Washington, DC, September 5.

DOE (U.S. Department of Energy), 2007c, "Saltstone Successfully Resumes Operations," *Savannah River Site News and Events*, November 28.

DOE (U.S. Department of Energy), 2008a, *Final Site-Wide Environmental Impact Statement for Continued Operation of Los Alamos National Laboratory, Los Alamos, New Mexico*, DOE/EIS-0380, National Nuclear Security Administration, Los Alamos Site Office, Los Alamos, New Mexico, May.

DOE (U.S. Department of Energy), 2008b, *Supplement Analysis for Construction and Operation of a Waste Solidification Building at the Savannah River Site*, DOE/EIS-0283-SA-2, Savannah River Operations Office, Aiken, South Carolina, November.

DOE (U.S. Department of Energy), 2011, *Final Supplemental Environmental Impact Statement for the Nuclear Facility Portion of the Chemistry and Metallurgy Research Building Replacement Project at Los Alamos National Laboratory, Los Alamos, New Mexico*, DOE/EIS-0350-S1, National Nuclear Security Administration, Los Alamos Site Office, Los Alamos, New Mexico, August.

DOE (U.S. Department of Energy), 2012a, *Stabilization, Packaging, and Storage of Plutonium-Bearing Materials*, DOE-STD-3013-2012, Washington, DC, March.

DOE (U.S. Department of Energy), 2012b, *Transuranic Waste Transportation Containers* (accessed March 16, 2012, <http://www.wipp.energy.gov/fctshts/factsheet.htm#>).

DOE (U.S. Department of Energy), 2012c, "TRANSCOM, Shipment Tracking, U.S. Department of Energy," (accessed at <http://tcc.transcom.energy.gov>), May 14.

LANL (Los Alamos National Laboratory), 2012, *Surplus Plutonium Disposition Supplemental Environmental Impact Statement Data Call Response*, Los Alamos, New Mexico.

NRC (U.S. Nuclear Regulatory Commission), 2005, *Environmental Impact Statement on the Construction and Operation of a Proposed Mixed Oxide Fuel Fabrication Facility at the Savannah River Site, South Carolina*, NUREG-1767, Office of Nuclear Material Safety and Safeguards, Washington, DC, January.

SRNS (Savannah River Nuclear Solutions, LLC), 2012, *Surplus Plutonium Disposition Supplemental Environmental Impact Statement, Data Call Response*, Aiken, South Carolina.

SRR (Savannah River Remediation, LLC), 2009a, *Interim Salt Waste Processing: Actinide Removal Process and Modular Caustic Side Solvent Extraction Unit*, Aiken, South Carolina, November.

SRR (Savannah River Remediation, LLC), 2009b, *Defense Waste Processing Facility*, Aiken, South Carolina, November.

SRS (Savannah River Site), 2006, *Waste Study for the Plutonium Disposition Project in the K Area Complex*, SK-DA-WM-0001, Rev. B, Aiken, South Carolina, November 9.

SRS (Savannah River Site), 2007a, *Facts About the Savannah River Site: Defense Waste Processing Facility*, Washington Savannah River Company, Aiken, South Carolina, December.

SRS (Savannah River Site), 2007b, Scope of Work M-SOW-K-00022, Rev. 0, for Balance of Plant – Water Systems (U), Plutonium Disposition Project (U) Project M09A, March.

SRS (Savannah River Site), 2007c, Scope of Work M-SOW-K-00021, Revision 0, for Balance of Plant – Air Systems (U), Plutonium Disposition Project (U) Project M09A, April.

SRS (Savannah River Site), 2007d, Scope of Work M-SOW-K-00019, Revision 0, for Oxidation System (U), Plutonium Disposition Project (U) Project M09A, March.

SRS (Savannah River Site), 2007e, Scope of Work M-SOW-K-00014, Revision 0, for Milling and Mixing System (U), Plutonium Disposition Project (U) Project M09A, March.

SRS (Savannah River Site), 2007f, Scope of Work M-SOW-K-00011, Revision 0, for Vitrification System (U), Plutonium Disposition Project (U) Project M09A, March.

SRS (Savannah River Site), 2007g, Scope of Work M-SOW-K-00017, Revision 1, for Can-in-Canister Loading, Storage, and Transport System (U), Plutonium Disposition Project (U) Project M09A, March.

SRS (Savannah River Site), 2007h, *Facts About the Savannah River Site: H Canyon*, Washington Savannah River Company, Aiken, South Carolina, April.

SRS (Savannah River Site), 2007i, SRS Environmental Report, *High-Level Waste Disposition*, WSRC Public Affairs, Aiken, South Carolina.

SRS (Savannah River Site), 2007j, Scope of Work C-SOW-K-00012, Revision 0, for Site Work (U), Plutonium Disposition Project (U) Project M09A, April.

SRS (Savannah River Site), 2007k, Scope of Work M-SOW-K-00020, Revision 0, for Heating, Ventilation, and Air Conditioning (HVAC) Systems (U), Plutonium Disposition Project (U) Project M09A, April.

SRS (Savannah River Site), 2007l, Scope of Work J-SOW-K-00003, Revision 1, for Health and Safety Monitoring System (U), Plutonium Disposition Project (U) Project M09A, April.

SRS (Savannah River Site), 2007m, Scope of Work E-SOW-K-00017, Revision 0, for Electrical Power Supply System (U), Plutonium Disposition Project (U) Project M09A, April.

SRS (Savannah River Site), 2007n, Scope of Work E-SOW-K-00018, Revision 0, for Public Address and Telecommunications Systems (U), Plutonium Disposition Project (U) Project M09A, April.

SRS (Savannah River Site), 2007o, Scope of Work F-SOW-K-00001, Revision 0, for Fire Protection System (U), Plutonium Disposition Project (U) Project M09A, April.

SRS (Savannah River Site), 2007p, Scope of Work M-SOW-K-00026, Revision 0, for Green Fuel Disassembly System (U), Plutonium Disposition Project (U) Project M09A, April.

SRS (Savannah River Site), 2007q, Scope of Work M-SOW-K-00013, Revision 0, for Feed Preparation System (U), Plutonium Disposition Project (U) Project M09A, April.

SRS (Savannah River Site), 2007r, Scope of Work M-SOW-K-00015, Revision 0, for Bagless Transfer System (U), Plutonium Disposition Project (U) Project M09A, April.

SRS (Savannah River Site), 2011, *Interim Action Determination, Flexible Manufacturing Capability for the Mixed Fuel Fabrication Facility (MFFF)*, Savannah River Operations Office, Aiken, South Carolina, April 1.

SRS CAB (Savannah River Site Citizens Advisory Board), 2004, Recommendation 183, Glass Waste Storage Building #1 and #2 Long-Term Impact, Aiken, South Carolina, March 11.

WSRC (Westinghouse Savannah River Company), 2004, *Closure Plan for the E-Area Low-level Waste Facility*, WSRC-RP-2000-00425, Rev. 4, Aiken, South Carolina, May.

WSRC (Washington Savannah River Company), 2008, *Surplus Plutonium Disposition Supplemental Environmental Impact Statement* Data Call Response, Aiken, South Carolina.

APPENDIX C
EVALUATION OF HUMAN HEALTH EFFECTS FROM
NORMAL OPERATIONS

APPENDIX C

EVALUATION OF HUMAN HEALTH EFFECTS FROM NORMAL OPERATIONS

C.1 Introduction

This appendix presents detailed information on the potential impacts on humans associated with incident-free (normal) releases of radioactivity from the facilities proposed in this *Draft Surplus Plutonium Disposition Supplemental Environmental Impact Statement (SPD Supplemental EIS)* to be used for the disposition of surplus plutonium. This information supports the human health risk assessments described in Chapter 4, Section 4.1.2, of this *SPD Supplemental EIS*. Site-specific input data used in the evaluation of these human health impacts are provided or referenced, as appropriate. Resulting impacts can be compared to criteria invoked in U.S. Department of Energy (DOE) Order 458.1 for protection of the public (10 millirem per year from airborne pathways and 100 millirem per year total from all pathways); and Title 10 of the *Code of Federal Regulations (CFR)*, Part 835, for protection of workers at Savannah River Site (SRS) and Los Alamos National Laboratory (LANL) (5,000 millirem per year).

C.2 Assessment Approach

The dose assessments performed for this *SPD Supplemental EIS* were based on site-specific environmental data, facility-specific data, and assumptions related to various exposure parameters. Appendix F, Section F.10, of the *Surplus Plutonium Disposition Final Environmental Impact Statement (SPD EIS)* (DOE 1999) describes the methods that were used for the assessments for this *SPD Supplemental EIS*. The GENII Version 2 (GENII Environmental Dosimetry System, Version 2] computer code (Version 2.10) was used to calculate the projected doses from normal operations at SRS and LANL. The GENII computer code was developed under quality assurance plans based on the American National Standards Institute Standard NQA-1, is one of the toolbox models that meets DOE Order 414.1C, and is overseen by DOE's Office of Quality Assurance Policy and Assistance. All steps of code development were documented and tested, and hand calculations verified the code's implementation of major transport and exposure pathways for a subset of the radionuclide library. The code was reviewed by the U.S. Environmental Protection Agency (EPA) Science Advisory Board and a separate, EPA-sponsored, independent peer review panel. The quality assurance of GENII Version 2 has been reviewed by DOE (DOE 2003c) and continues to be rigorously reviewed with each updated version released by Pacific Northwest National Laboratory, the developer of the code.

C.2.1 Meteorological Data

The meteorological data used in the SRS and LANL dose assessments were created from joint frequency distribution (JFD) files. A JFD file is a table listing the percentage of time the wind blows in a certain direction, within a certain range of speeds, and within a certain stability class. JFD data for SRS were based on measurements taken at the nearby Vogtle Nuclear Power Plant over a 5-year period (1998 through 2002) at a height of 33 feet (10 meters); JFD data for LANL were based on measurements taken at Technical Area 6 (TA-6) over a 9-year period (1991 through 1999) at a height of 36.7 feet (11.2 meters). Average annual rainfall, meteorological station parameters, and windspeed midpoints were used in the normal operational assessments. **Tables C-1** and **C-2** present the JFD data used in the SRS and LANL analyses.

Table C-1 Savannah River Site Joint Frequency Distribution Data

Average Wind-speed (m/s)	Stability Class	Direction in Which the Wind Blows															
		S	SSW	SW	WSW	W	WNW	NW	NNW	N	NNE	NE	ENE	E	ESE	SE	SSE
Vogtle Nuclear Power Plant: 10-Meter Height, Based on 1998 through 2002 Meteorological Data																	
0.94	A	0.01	0.01	0.01	0.01	0.01	0.01	0.01	0.01	0.02	0.01	0.02	0.02	0.01	0.01	0.01	0.01
	B	0.01	0	0.01	0.01	0.01	0.01	0.02	0.01	0.01	0	0.01	0	0.01	0	0	0
	C	0.01	0.03	0	0.02	0.02	0.02	0.03	0.02	0.01	0.02	0.02	0.02	0.01	0.01	0.01	0.02
	D	0.17	0.18	0.17	0.12	0.18	0.14	0.13	0.17	0.17	0.15	0.18	0.18	0.14	0.15	0.15	0.13
	E	0.28	0.29	0.29	0.3	0.34	0.36	0.37	0.44	0.64	0.41	0.48	0.46	0.41	0.31	0.31	0.19
	F	0.25	0.29	0.28	0.29	0.42	0.35	0.32	0.33	0.45	0.45	0.42	0.49	0.5	0.32	0.23	0.18
	G	0.4	0.27	0.41	0.37	0.44	0.46	0.3	0.32	0.28	0.42	0.55	0.64	0.61	0.39	0.33	0.37
1.66	A	0.02	0.05	0.02	0.03	0.04	0.04	0.02	0.02	0.06	0.04	0.05	0.06	0.04	0.02	0.03	0.01
	B	0.03	0.04	0.03	0.03	0.01	0.03	0.03	0.05	0.03	0.04	0.05	0.02	0.02	0.02	0.02	0.03
	C	0.07	0.03	0.03	0.04	0.06	0.04	0.05	0.03	0.08	0.06	0.06	0.06	0.08	0.06	0.05	0.04
	D	0.36	0.28	0.26	0.26	0.28	0.19	0.22	0.27	0.32	0.25	0.33	0.37	0.33	0.31	0.26	0.27
	E	0.26	0.26	0.32	0.39	0.41	0.48	0.49	0.71	0.68	0.55	0.68	0.66	0.41	0.33	0.3	0.22
	F	0.18	0.13	0.18	0.24	0.33	0.31	0.32	0.3	0.39	0.38	0.66	0.65	0.42	0.33	0.19	0.16
	G	0.13	0.04	0.07	0.18	0.24	0.15	0.14	0.11	0.14	0.3	0.54	0.49	0.41	0.17	0.07	0.1
2.35	A	0.07	0.09	0.08	0.15	0.15	0.12	0.1	0.07	0.09	0.13	0.13	0.14	0.16	0.06	0.04	0.05
	B	0.07	0.07	0.08	0.11	0.09	0.06	0.05	0.04	0.07	0.11	0.11	0.12	0.13	0.06	0.06	0.08
	C	0.15	0.15	0.12	0.15	0.11	0.11	0.09	0.07	0.15	0.13	0.15	0.19	0.22	0.12	0.14	0.15
	D	0.71	0.58	0.67	0.62	0.57	0.36	0.27	0.41	0.52	0.5	0.57	0.61	0.57	0.46	0.46	0.51
	E	0.34	0.46	0.71	0.68	0.73	0.58	0.63	0.72	0.62	0.62	0.74	0.6	0.59	0.45	0.31	0.3
	F	0.14	0.15	0.24	0.38	0.29	0.18	0.14	0.18	0.14	0.24	0.27	0.29	0.16	0.13	0.08	0.09
	G	0.04	0.03	0.03	0.08	0.07	0.04	0.04	0.04	0.06	0.11	0.17	0.13	0.12	0.04	0.01	0.05
3.30	A	0.11	0.07	0.08	0.17	0.24	0.13	0.09	0.05	0.1	0.17	0.2	0.25	0.21	0.13	0.1	0.11
	B	0.1	0.07	0.08	0.09	0.09	0.04	0.03	0.04	0.05	0.11	0.12	0.1	0.14	0.11	0.09	0.14
	C	0.16	0.13	0.14	0.16	0.18	0.1	0.07	0.08	0.1	0.17	0.21	0.17	0.22	0.09	0.12	0.16
	D	0.4	0.45	0.8	0.71	0.39	0.23	0.32	0.25	0.26	0.42	0.43	0.43	0.51	0.46	0.24	0.33
	E	0.25	0.29	0.53	0.44	0.27	0.18	0.34	0.24	0.18	0.29	0.39	0.2	0.37	0.35	0.17	0.16
	F	0.05	0.05	0.06	0.09	0.02	0.01	0.01	0.02	0.01	0.04	0.02	0	0.02	0.01	0.01	0.03
	G	0.01	0	0	0	0	0	0.01	0	0	0.02	0	0	0	0	0	0
4.35	A	0.06	0.04	0.13	0.15	0.1	0.03	0.03	0.04	0.04	0.08	0.11	0.18	0.19	0.1	0.06	0.03
	B	0.07	0.03	0.05	0.09	0.08	0.03	0.03	0.01	0.03	0.04	0.08	0.08	0.11	0.09	0.03	0.04
	C	0.07	0.07	0.06	0.13	0.1	0.03	0.04	0.03	0.04	0.07	0.13	0.1	0.15	0.09	0.06	0.03
	D	0.22	0.13	0.54	0.48	0.21	0.1	0.12	0.16	0.11	0.16	0.21	0.24	0.37	0.29	0.11	0.12
	E	0.05	0.06	0.23	0.17	0.09	0.06	0.11	0.06	0.05	0.11	0.11	0.06	0.12	0.16	0.08	0.04
	F	0	0.02	0.02	0.01	0	0	0	0	0	0	0	0	0.01	0.02	0	0
	G	0	0	0	0	0	0	0	0	0	0	0	0	0	0	0	0
5.87	A	0.01	0.03	0.03	0.07	0.02	0	0.01	0.01	0.01	0.03	0.05	0.06	0.05	0.04	0.04	0
	B	0.01	0.02	0.02	0.05	0.02	0.01	0	0	0.01	0.02	0.05	0.05	0.05	0.08	0.03	0.01
	C	0.01	0.01	0.03	0.04	0	0	0.01	0.03	0.01	0.02	0.05	0.05	0.1	0.11	0.04	0
	D	0.06	0.08	0.16	0.22	0.05	0.02	0.1	0.04	0.02	0.09	0.1	0.13	0.21	0.21	0.08	0.04
	E	0.03	0.03	0.06	0.1	0.05	0.03	0.02	0.02	0.02	0.04	0.03	0.02	0.03	0.07	0.02	0.02
	F	0	0	0.01	0	0	0	0	0	0	0	0	0	0	0.01	0	0
	G	0	0	0	0	0	0	0.01	0	0	0	0	0	0	0	0	0

m/s = meters per second.

Note: To convert meters per second to miles per hour, multiply by 2.237; meters to feet, by 3.2808.

Table C–2 Los Alamos National Laboratory Joint Frequency Distribution Data

Average Wind-speed (m/s)	Stability Class	Direction in Which the Wind Blows																
		S	SSW	SW	WSW	W	WNW	NW	NNW	N	NNE	NE	ENE	E	ESE	SE	SSE	
Technical Area 6: 11.2-Meter Height, Based on 1991 through 1999 Meteorological Data																		
0.78	A	0.11	0.2	0.42	0.73	0.83	0.69	0.75	0.59	0.33	0.17	0.11	0.06	0.06	0.06	0.07	0.07	
	B	0.03	0.07	0.13	0.2	0.19	0.13	0.13	0.14	0.11	0.06	0.04	0.02	0.02	0.02	0.02	0.02	
	C	0.07	0.14	0.16	0.21	0.23	0.14	0.11	0.16	0.19	0.13	0.07	0.04	0.03	0.03	0.03	0.03	0.04
	D	0.75	0.63	0.51	0.39	0.4	0.36	0.36	0.48	0.77	0.78	0.7	0.57	0.52	0.49	0.62	0.65	
	E	0.4	0.24	0.15	0.08	0.07	0.08	0.09	0.13	0.24	0.39	0.47	0.41	0.33	0.33	0.41	0.45	
	F	0.36	0.2	0.12	0.04	0.05	0.05	0.06	0.07	0.12	0.21	0.39	0.49	0.69	0.61	0.64	0.48	
2.45	A	0.07	0.1	0.26	0.4	0.53	0.79	1.16	1.14	0.63	0.22	0.11	0.07	0.07	0.06	0.08	0.07	
	B	0.06	0.13	0.32	0.38	0.4	0.43	0.53	0.96	0.82	0.36	0.16	0.1	0.07	0.07	0.09	0.07	
	C	0.15	0.42	0.57	0.43	0.51	0.44	0.28	0.98	1.73	0.9	0.47	0.26	0.18	0.16	0.23	0.12	
	D	0.92	0.89	0.47	0.17	0.22	0.23	0.13	0.45	1.49	2.51	2.39	1.58	1.32	1.31	1.67	0.93	
	E	0.29	0.12	0.05	0.01	0.01	0.02	0.02	0.04	0.14	0.45	0.97	1.86	1.5	1.23	2.66	0.84	
	F	0.11	0.04	0	0	0	0	0.01	0.01	0.03	0.04	0.14	0.76	3.12	3.3	1.15	0.3	
4.47	A	0.01	0	0	0	0	0	0.01	0.02	0.03	0.03	0.02	0.01	0.01	0.01	0.01	0.01	
	B	0.02	0.02	0.02	0	0	0	0.03	0.16	0.33	0.25	0.18	0.08	0.03	0.02	0.05	0.04	
	C	0.06	0.2	0.16	0.02	0.01	0.02	0.03	0.56	1.55	1.01	0.62	0.63	0.38	0.27	0.36	0.08	
	D	0.07	0.23	0.05	0.01	0.01	0.01	0	0.11	0.25	0.63	0.61	0.75	1.62	1.74	0.86	0.1	
	E	0	0	0	0	0	0	0	0	0	0	0.01	0.03	0.2	0.45	0.05	0	
	F	0	0	0	0	0	0	0	0	0	0	0	0	0.11	0.18	0	0	
6.93	A	0	0	0	0	0	0	0	0	0	0	0	0	0	0	0	0	
	B	0	0	0	0	0	0	0	0	0.01	0.01	0	0	0	0	0	0	
	C	0	0.01	0	0	0	0	0	0.01	0.04	0.06	0.05	0.06	0.02	0.02	0.03	0	
	D	0.01	0.04	0	0	0	0	0	0.02	0.06	0.16	0.15	0.33	0.88	1.1	0.22	0.01	
	E	0	0	0	0	0	0	0	0	0	0	0	0	0	0	0	0	
	F	0	0	0	0	0	0	0	0	0	0	0	0	0	0	0	0	
9.61	A	0	0	0	0	0	0	0	0	0	0	0	0	0	0	0	0	
	B	0	0	0	0	0	0	0	0	0	0	0	0	0	0	0	0	
	C	0	0	0	0	0	0	0	0	0	0	0	0	0	0	0	0	
	D	0	0	0	0	0	0	0	0	0	0	0.01	0.02	0.12	0.29	0.03	0	
	E	0	0	0	0	0	0	0	0	0	0	0	0	0	0	0	0	
	F	0	0	0	0	0	0	0	0	0	0	0	0	0	0	0	0	

m/s = meters per second.

Note: To convert meters per second to miles per hour, multiply by 2.237; meters to feet, by 3.2808.

C.2.2 Population Data

The SRS and LANL population distributions were based on data from the 2010 census (Census 2011) for areas within 50 miles (80 kilometers) of the locations for the proposed facilities. The 2010 populations derived from the census were projected to the year 2020, which was selected as the representative year for full-scale operations, by calculating a linear trend developed using data from the 1990, 2000, and 2010 decennial censuses (Census 1990, 2001, 2011). The populations were spatially distributed on a circular grid with 16 directions and 10 radial distances out to 50 miles (80 kilometers). The grids were centered in F-Area, K-Area, and H-Canyon/S-Area, the locations from which radionuclides were assumed to be released during incident-free operations at SRS, and in TA-55 (the location of the Plutonium Facility [PF-4]) at LANL. During the population distribution allocation process, those individuals who were geographically situated within a sector that was entirely on SRS or LANL property were moved (for the analysis) to an adjoining sector to ensure that no individuals were assessed as if they were living on DOE property. **Tables C–3, C–4, C–5, and C–6** present the population data used for the dose assessments.

Table C-3 Estimated Population Surrounding the Savannah River Site F-Area in the Year 2020

<i>Direction</i>	<i>Distance (miles)</i>									
	<i>0-1</i>	<i>1-2</i>	<i>2-3</i>	<i>3-4</i>	<i>4-5</i>	<i>5-10</i>	<i>10-20</i>	<i>20-30</i>	<i>30-40</i>	<i>40-50</i>
NNE	0	0	0	0	0	656	4,800	3,518	7,694	42,519
NE	0	0	0	0	0	83	3,061	3,636	7,593	29,767
ENE	0	0	0	0	0	0	3,751	4,703	5,559	36,655
E	0	0	0	0	0	0	4,179	5,841	10,017	7,181
ESE	0	0	0	0	0	0	3,827	3,897	2,222	3,072
SE	0	0	0	0	0	0	847	2,813	5,720	11,984
SSE	0	0	0	0	0	0	540	696	1,641	4,168
S	0	0	0	0	0	0	561	1,520	6,420	5,071
SSW	0	0	0	0	0	0	849	2,389	4,894	3,053
SW	0	0	0	0	0	129	1,511	6,768	2,023	2,042
WSW	0	0	0	0	0	185	2,370	4,786	2,493	6,240
W	0	0	0	0	0	417	8,852	15,191	6,868	8,114
WNW	0	0	0	0	0	1,810	6,446	162,172	76,799	17,746
NW	0	0	0	0	0	1,432	18,907	99,702	28,091	4,320
NNW	0	0	0	0	0	1,701	30,484	17,430	12,366	3,588
N	0	0	0	0	0	2,599	35,691	11,508	8,609	11,894
Total Population	868,681									

Note: Centered on 33.2865 degrees latitude, 81.6776 degrees longitude; to convert miles to kilometers, multiply by 1.6093.
 Source: Census 1990, 2001, 2011.

Table C-4 Estimated Population Surrounding the Savannah River Site K-Area in the Year 2020

<i>Direction</i>	<i>Distance (miles)</i>									
	<i>0-1</i>	<i>1-2</i>	<i>2-3</i>	<i>3-4</i>	<i>4-5</i>	<i>5-10</i>	<i>10-20</i>	<i>20-30</i>	<i>30-40</i>	<i>40-50</i>
NNE	0	0	0	0	0	0	2,902	4,316	6,368	21,981
NE	0	0	0	0	0	0	2,615	4,595	4,887	15,086
ENE	0	0	0	0	0	0	3,025	6,005	7,184	25,043
E	0	0	0	0	0	0	6,221	4,117	6,807	4,402
ESE	0	0	0	0	0	70	1,377	3,243	3,169	4,542
SE	0	0	0	0	0	101	573	3,255	6,388	9,070
SSE	0	0	0	0	0	137	437	789	2,642	2,842
S	0	0	0	0	0	105	735	2,577	6,685	7,785
SSW	0	0	0	0	0	130	1,458	2,140	3,934	5,861
SW	0	0	0	0	0	195	1,111	2,202	1,973	2,369
WSW	0	0	0	0	0	255	2,676	7,619	1,830	6,902
W	0	0	0	0	0	199	2,871	5,430	5,251	5,888
WNW	0	0	0	0	0	168	5,136	74,953	46,827	17,351
NW	0	0	0	0	0	102	5,820	126,058	128,104	7,723
NNW	0	0	0	0	0	0	9,829	44,403	16,769	7,836
N	0	0	0	0	0	0	12,539	40,535	7,792	15,063
Total Population	809,378									

Note: Centered on 33.2113 degrees latitude, 81.6648 degrees longitude; to convert miles to kilometers, multiply by 1.6093.
 Source: Census 1990, 2001, 2011.

Table C–5 Estimated Population Surrounding the Savannah River Site H-Canyon/S-Area in the Year 2020

<i>Direction</i>	<i>Distance (miles)</i>									
	<i>0–1</i>	<i>1–2</i>	<i>2–3</i>	<i>3–4</i>	<i>4–5</i>	<i>5–10</i>	<i>10–20</i>	<i>20–30</i>	<i>30–40</i>	<i>40–50</i>
NNE	0	0	0	0	0	540	3,856	3,583	8,771	49,916
NE	0	0	0	0	0	106	3,071	3,576	7,862	29,112
ENE	0	0	0	0	0	0	4,461	4,026	6,763	46,879
E	0	0	0	0	0	90	5,025	5,504	9,170	6,300
ESE	0	0	0	0	0	95	5,214	2,923	2,358	3,069
SE	0	0	0	0	0	0	1,207	3,931	5,313	11,442
SSE	0	0	0	0	0	0	531	790	2,003	4,788
S	0	0	0	0	0	0	576	1,028	6,318	4,899
SSW	0	0	0	0	0	0	639	2,573	4,883	3,089
SW	0	0	0	0	0	29	1,152	4,688	2,343	1,963
WSW	0	0	0	0	0	24	1,623	7,431	2,512	6,110
W	0	0	0	0	0	211	5,205	20,875	7,684	8,718
WNW	0	0	0	0	0	1,542	4,871	154,496	116,020	15,646
NW	0	0	0	0	0	910	14,490	77,733	27,595	3,876
NNW	0	0	0	0	0	2,460	41,140	22,390	13,315	4,999
N	0	0	0	0	0	1,051	14,991	9,559	7,835	14,500
Total Population	886,267									

Note: Centered on 33.2913 degrees latitude, 81.6403 degrees longitude; to convert miles to kilometers, multiply by 1.6093.
 Source: Census 1990, 2001, 2011.

Table C–6 Estimated Population Surrounding the Los Alamos National Laboratory Plutonium Facility in the Year 2020

<i>Direction</i>	<i>Distance (miles)</i>									
	<i>0–1</i>	<i>1–2</i>	<i>2–3</i>	<i>3–4</i>	<i>4–5</i>	<i>5–10</i>	<i>10–20</i>	<i>20–30</i>	<i>30–40</i>	<i>40–50</i>
NNE	21	1,114	762	130	0	120	997	1,658	364	249
NE	7	302	888	593	101	396	6,077	6,108	1,644	3,724
ENE	0	0	363	247	37	295	19,447	4,459	2,442	3,801
E	0	0	58	26	31	327	6,413	2,883	1,259	1,944
ESE	0	4	0	10	18	5,611	2,607	51,893	2,926	3,003
SE	0	0	0	0	0	444	2,155	65,473	8,134	552
SSE	0	0	0	0	3	73	927	1,657	1,403	878
S	0	0	0	0	3	31	755	3,230	2,016	9,380
SSW	0	0	0	1	4	32	488	2,704	14,870	142,556
SW	0	0	0	1	2	36	153	880	2,867	32,582
WSW	0	0	0	0	1	36	209	809	1,493	274
W	0	0	0	0	0	62	292	457	416	769
WNW	0	0	30	0	0	56	249	269	1,567	341
NW	0	898	1,610	21	0	32	125	153	155	181
NNW	11	1,158	1,960	229	0	49	157	198	140	159
N	84	782	857	52	0	73	421	485	385	187
Total Population	447,541									

Note: Centered on 35.8817 degrees latitude, 106.2983 degrees longitude; to convert miles to kilometers, multiply by 1.6093.
 Source: Census 1990, 2001, 2011.

C.2.3 Agricultural Data

Ingestion exposures from atmospheric transport include ingestion of farm products and inadvertent ingestion of soil. Farm products include leafy vegetables, other vegetables, cereal grains, fruit, cow’s milk, beef, poultry, and eggs. The concentration in plants at the time of harvest was evaluated as the sum of contributions from deposition onto plant surfaces, as well as uptake through the roots. Pathways by which animal products may become contaminated include animal ingestion of contaminated plants, water, and soil. The human consumption rates used in the dose assessments for the maximally exposed individual (MEI) and average exposed individual in the surrounding population were those provided in U.S. Nuclear Regulatory Commission (NRC) Regulatory Guide 1.109, *Calculation of Annual Doses to Man From Routine Releases of Reactor Effluents for the Purpose of Evaluating Compliance With 10 CFR 50*, Appendix I (NRC 1977).

C.2.4 Source Term Data

Table C-7 presents the stack parameters for SRS and LANL facilities. Stack heights and release locations were provided in the responses to the facility data requests supporting this *SPD Supplemental EIS* (DOE/NNSA 2012; LANL 2012; SRNS 2012; WSRC 2008), and the *SPD EIS* (DOE 1999).

Table C-7 Stack Parameters

<i>Stack Parameter</i>	<i>KIS</i>	<i>PDC</i>	<i>Immobilization Capability</i>	<i>H-Canyon/ HB-Line</i>	<i>MFFF^a</i>	<i>PDCF</i>	<i>WSB</i>	<i>LANL PF-4</i>
Height (meters)	15.2	24.4	28.0	59.4	36.6	36.6	15.2	9.5
Area (square meters)	0.073	4.7	3.6	14.9	5.3	5.9	1.8	0.679

KIS = K-Area Interim Surveillance; LANL = Los Alamos National Laboratory; MFFF = Mixed Oxide Fuel Fabrication Facility; PDC = Pit Disassembly and Conversion Project; PDCF = Pit Disassembly and Conversion Facility; PF-4 = Plutonium Facility; WSB = Waste Solidification Building.

^a The same stack would be used for potential releases from fuel fabrication activities at MFFF as well as potential releases from metal oxidation furnaces if they are installed at MFFF.

Note: To convert meters to feet, multiply by 3.2808; square meters to square feet, by 10.764

Source: DOE 1999; DOE/NNSA 2012; LANL 2012; SRNS 2012; WSRC 2008.

Tables C-8 through C-14, respectively, present the estimated incident-free radiological releases, based on plutonium-239 dose equivalents, associated with operations at the following SRS facilities: K-Area Interim Surveillance (KIS), the K-Area immobilization capability, H-Canyon/HB-Line processing to the Defense Waste Processing Facility (DWPF), the Mixed Oxide Fuel Fabrication Facility (MFFF) at F-Area, the Pit Disassembly and Conversion Facility (PDCF) at F-Area and the Pit Disassembly and Conversion Project (PDC) at K-Area, the Waste Solidification Building (WSB) at F-Area, and metal oxidation at MFFF. **Table C-15** presents estimated incident-free radiological releases from pit disassembly and conversion activities at LANL’s PF-4. Plutonium-equivalent source term estimates were derived using Federal Guidance Report 13 (EPA 1999) dose factors. The source terms were either provided directly or derived from empirical source term data conveyed in responses to facility data requests supporting this *SPD Supplemental EIS* (DOE/NNSA 2012; SRNS 2012; LANL 2012) and the *SPD EIS* (DOE 1999). Source terms were not provided in the data responses for some of the H-Canyon/HB-Line activities addressed in this *SPD Supplemental EIS* (i.e., processing plutonium metal to an oxide for transfer to MFFF, processing non-pit plutonium for disposal at WIPP, and processing non-pit plutonium for fabrication into MOX fuel at MFFF); rather, dose estimates were provided.

Table C-8 Annual Radiological Releases from K-Area Interim Surveillance Capability Activities

<i>Isotope (curies per year)</i>	<i>All Alternatives</i>
Plutonium-239 dose equivalent	1.6×10^{-7}

Note: Radionuclide releases converted to a plutonium-239-dose-equivalent release using Federal Guidance Report 13 dose factors (EPA 1999).

Source: SRNS 2012.

Table C–9 Annual Radiological Releases from the Immobilization Capability

<i>Isotope (curies per year)</i>	<i>Immobilization to DWPF Alternative</i>
Plutonium-239 dose equivalent	1.8×10^{-6}

DWPF = Defense Waste Processing Facility.

Note: Radionuclide releases converted to a plutonium-239-dose-equivalent release using Federal Guidance Report 13 dose factors (EPA 1999). To convert metric tons to tons, multiply by 1.1023.

Source: SRNS 2012.

Table C–10 Annual Radiological Releases from H-Canyon/HB-Line Processing of Surplus Plutonium to the Defense Waste Processing Facility

<i>Isotope (curies per year)</i>	<i>H-Canyon/HB-Line to DWPF Alternative</i>
Plutonium-239 dose equivalent	1.2×10^{-5}

DWPF = Defense Waste Processing Facility.

Note: Radionuclide releases converted to a plutonium-239-dose-equivalent release using Federal Guidance Report 13 dose factors (EPA 1999). To convert metric tons to tons, multiply by 1.1023.

Source: SRNS 2012; WSRC 2008.

Table C–11 Annual Radiological Releases from the Mixed Oxide Fuel Fabrication Facility

<i>Isotope (curies per year)</i>	<i>Alternative</i>		
	<i>No Action and Immobilization to DWPF Alternatives</i>	<i>H-Canyon/HB-Line to DWPF and WIPP Alternatives</i>	<i>MOX Fuel Alternative</i>
Plutonium-239 dose equivalent	1.0×10^{-4}	1.1×10^{-4}	1.2×10^{-4}

DWPF = Defense Waste Processing Facility; MOX = mixed oxide; WIPP = Waste Isolation Pilot Plant.

Note: Radionuclide releases converted to a plutonium-239-dose-equivalent release using Federal Guidance Report 13 dose factors (EPA 1999). To convert metric tons to tons, multiply by 1.1023.

Source: SRNS 2012; WSRC 2008.

Table C–12 Annual Radiological Releases from the Pit Disassembly and Conversion Facility and the Pit Disassembly and Conversion Project at K-Area

<i>Isotope (curies per year)</i>	<i>Alternative</i>	
	<i>PDCF (All Alternatives)</i>	<i>PDC at K-Area (MOX Fuel, H-Canyon/HB-Line to DWPF, and WIPP Alternatives)</i>
Plutonium-239 dose equivalent	3.1×10^{-3}	4.0×10^{-3}

DWPF = Defense Waste Processing Facility; MOX = mixed oxide; PDC = Pit Disassembly and Conversion Project;

PDCF = Pit Disassembly and Conversion Facility; WIPP = Waste Isolation Pilot Plant.

Note: Radionuclide releases converted to a plutonium-239-dose-equivalent release using Federal Guidance Report 13 dose factors (EPA 1999).

Source: SRNS 2012.

Table C–13 Annual Radiological Releases from the Waste Solidification Building

<i>Isotope (curies per year)</i>	<i>All Alternatives</i>
Plutonium-239 dose equivalent	9.3×10^{-5}

Note: Radionuclide releases converted to a plutonium-239-dose-equivalent release using Federal Guidance Report 13 dose factors (EPA 1999).

Source: SRNS 2012.

Table C–14 Annual Radiological Releases from Metal Oxidation at the Mixed Oxide Fuel Fabrication Facility

<i>Isotope (curies per year)</i>	<i>Alternative</i>
	<i>Immobilization to DWPF, MOX Fuel, H-Canyon/HB-Line to DWPF, and WIPP Alternatives</i>
Plutonium-239 dose equivalent	8.3×10^{-4}

DWPF = Defense Waste Processing Facility; MOX = mixed oxide; WIPP = Waste Isolation Pilot Plant.

Note: Radionuclide releases converted to a plutonium-239-dose-equivalent release using Federal Guidance Report 13 dose factors (EPA 1999).

Source: SRNS 2011a.

Table C–15 Annual Radiological Releases from Pit Disassembly and Conversion Activities at the Los Alamos National Laboratory Plutonium Facility

<i>Isotope (curies per year)</i>	<i>Alternative</i>	
	<i>No Action, Immobilization to DWPF, MOX Fuel, H-Canyon/HB-Line to DWPF, and WIPP Alternatives (process 2 metric tons)</i>	<i>Immobilization to DWPF, MOX Fuel, H-Canyon/HB-Line to DWPF, and WIPP Alternatives (process 35 metric tons)</i>
Plutonium-239 dose equivalent	2.4×10^{-4}	2.0×10^{-3}

DWPF = Defense Waste Processing Facility; MOX = mixed oxide; WIPP = Waste Isolation Pilot Plant.

Note: Radionuclide releases converted to a plutonium-239-dose-equivalent release using Federal Guidance Report 13 dose factors (EPA 1999). To convert metric tons to tons, multiply by 1.1023.

Source: LANL 2012.

Because activities associated with the K-Area storage only involve receipt, storage, and shipping of materials within certified shipping containers, no airborne radiological emissions would result from these activities.

Under the H-Canyon/HB-Line to DWPF Alternative, DWPF would vitrify surplus plutonium dissolved at H-Canyon/HB-Line with liquid high-level radioactive waste (HLW). Filled canisters of vitrified HLW would be stored at the S-Area Glass Waste Storage Buildings pending their ultimate disposition. It was estimated that the additional production would require an increase in DWPF operations by a range of 2 weeks to 3 months. The plutonium mixed with the HLW would not add any significant contribution to the DWPF normal release source term. Similarly, no plutonium would be released from the can-in-canisters containing immobilized plutonium that would be vitrified at DWPF under the Immobilization to DWPF Alternative. Therefore, no incremental increases in normal releases or impacts on onsite or offsite receptors from DWPF or the Glass Waste Storage Buildings are expected (SRNS 2012; WSRC 2008).

C.2.5 Other Calculation Assumptions

To estimate the radiological impacts of incident-free operation of the plutonium facilities at SRS and LANL, the following additional assumptions and factors were considered, in accordance with the guidelines established in NRC Regulatory Guide 1.109 (NRC 1977):

- Receptors were assumed to be exposed to radioactive material deposited on the ground from facility emissions. Exposure pathways include direct exposure, inhalation, and translocation through the food chain.
- The annual external exposure time to the plume and soil contamination was assumed to be 0.7 years for the MEI.
- The annual external exposure time to the plume and soil contamination was assumed to be 0.5 years for the population.
- The annual inhalation exposure time to the plume was assumed to be 1 year for the MEI and general population.
- The exposed individual and population were assumed to have the characteristics and habits (e.g., inhalation and ingestion rates) of adult humans.
- A finite plume (i.e., Gaussian) model was assumed for air immersion doses. Other pathways evaluated were ground exposure, inhalation, ingestion of food crops, and ingestion of animal products.
- The calculated doses were assumed to be 50-year committed effective doses from 1 year of intake.

In addition to the calculation assumptions listed above, a risk estimator of 0.0006 latent cancer deaths per rem or person-rem (600 cancer deaths per 1 million rem or person-rem) received by workers or members of the public was used in the impact assessments (DOE 2003a).

C.3 Savannah River Site

The following subsections present the potential incident-free radiological impacts that could occur from each of the separate facilities/processes at SRS. Human health risks from construction and normal operations were evaluated for several individual and population groups, including facility workers, a hypothetical MEI at the site boundary, and the regional population.

For the purposes of this *SPD Supplemental EIS*, a worker is a facility worker who is directly or indirectly involved with operations at a facility and might receive an occupational radiation exposure due to direct radiation (neutron, x-ray, beta, or gamma) or through radionuclides released as a part of normal operations. Direct radiation exposure from plutonium materials or contaminants in the material (e.g., americium-241) and residual amounts of similar material (contamination) within the facility would dominate the potential occupational exposure to onsite workers. Noninvolved workers outside of the facility would not be subject to direct radiation exposure due to building shielding and appreciable distances between operational facilities, but could be exposed to operational releases.

Workers at SRS may receive radiation doses slightly above those received by an individual at an offsite location. The 5-year average dose measured using thermoluminescent dosimeters near the burial grounds at the center of the site (E-Area) was 123 millirem; the 5-year average dose at an offsite control location (Highway 301) was 85 millirem. Because the onsite location is near active radioactive waste management operations, the dose may be conservatively high and not representative of other locations at the site. The 5-year average dose at another onsite monitoring location (D-Area) was 74 millirem, lower than the offsite location (SRNS 2009, 2010, 2011b; WSRC 2007, 2008). This implies that there could be no significant difference between doses at onsite and offsite locations. Using the higher onsite location as a basis and adjusting the doses for a 2080-hour work-year, a worker could receive an annual dose of about 9 millirem from being employed at SRS. A 9 millirem dose is an increase of about 3 percent over the average annual dose one would receive from all sources of natural background radiation. The additional dose results in an increased annual risk of a latent fatal cancer of 5×10^{-6} or 1 chance in 200,000.

For this *SPD Supplemental EIS*, all of the materials released due to plutonium operations would be hydrogen-3 (tritium) and particulates (primarily plutonium isotopes and americium-241) that would be released through tall stacks. Particulates would be filtered through high-efficiency particulate air filters, sand filters, or both, before being released. These filter systems are designed to protect the onsite workforce and the public from normal and accidental releases. Normal releases are very small—in the microcurie to millicurie-per-year range in most cases. Monitoring results for SRS are reported in the annual site environmental reports, which indicate that the doses to the onsite populations are primarily from natural background radiation. During some past operations periods, airborne releases from reactor and used fuel operations have occurred, including releases of tritium, noble gases, iodine, and fission products. During recent operations, airborne releases of tritium from tritium operations and fission products from used fuel processing have occurred. As indicated in the annual site environmental reports, normal concentrations of plutonium in the air are very small and are at a level similar to those in other parts of the country.

Radiation Basics

What is radiation? Radiation is energy emitted from unstable (radioactive) atoms in the form of atomic particles or electromagnetic waves. This type of radiation is also known as ionizing radiation because it can produce charged particles (ions) in matter.

What is radioactivity? Radioactivity is produced by the process of radioactive atoms trying to become stable, a process termed "decay." Radiation is emitted in the process. In the United States, radioactivity is commonly measured in units called curies, where 1 curie is equal to 3.7×10^{10} disintegrations (decay transformations) per second. Internationally, radioactivity is generally measured in units called becquerels, where 1 becquerel is equal to 1 disintegration per second (1 curie = 3.7×10^{10} becquerels).

What is radioactive material? Radioactive material is any material containing unstable atoms that emit radiation.

What are the four basic types of ionizing radiation?

Alpha particles — Alpha particles consist of two protons and two neutrons. They can travel only a few centimeters in air and can be stopped easily by a sheet of paper or by the skin's surface.

Beta particles — Beta particles are smaller and lighter than alpha particles and have the mass of a single electron. A high-energy beta particle can travel a few meters in the air. Beta particles can pass through a sheet of paper, but may be stopped by a thin sheet of aluminum foil or glass.

Gamma rays — Gamma rays (and x-rays), unlike alpha or beta particles, are waves of pure energy. Gamma radiation is very penetrating and can travel several hundred feet in the air. Gamma radiation requires a thick wall of concrete, lead, or steel to stop it.

Neutrons — A neutron is an atomic particle that has about one-quarter the weight of an alpha particle. Like gamma radiation, it can easily travel several hundred feet in the air. Neutron radiation is most effectively stopped by materials with high hydrogen content, such as water or plastic.

What are the sources of radiation?

Natural sources of radiation — Sources include cosmic radiation from the sun and outer space; natural radioactive elements in the Earth's crust; natural radioactive elements in the human body; and radon gas from the radioactive decay of uranium that is naturally present in the soil.

Manmade sources of radiation — Sources include medical radiation (x-rays, medical isotopes); consumer products (TVs, luminous dial watches, smoke detectors); nuclear technology (nuclear power plants, industrial x-ray machines); and fallout from past worldwide nuclear weapons tests or accidents (such as at the Chernobyl nuclear plant in Ukraine).

What is radiation dose? Radiation dose is the amount of energy in the form of ionizing radiation absorbed per unit mass of any material. For people, radiation dose is the amount of energy absorbed in human tissue. In the United States, radiation dose is commonly measured in units called rads or rem; a smaller fraction of the rem is the millirem (1/1,000 of 1 rem). Internationally, radiation dose is generally measured in units called sieverts, where 1 rem = 0.01 sievert.

Person-rem (or person-sievert) is a unit of collective radiation dose applied to populations or groups of individuals; it is the sum of the doses received by all the individuals of a specified population.

What is the average annual radiation dose from natural and manmade sources? Globally, humans are exposed constantly to radiation from the solar system and the Earth's rocks and soil. This natural radiation contributes to the natural background radiation that always surrounds us. Manmade sources of radiation also exist, including medical and dental x-rays, household smoke detectors, and materials released from nuclear and coal-fired power plants. The average individual in the United States annually receives about 625 millirem of radiation dose from all background sources, of which about half is received from natural sources such as cosmic and terrestrial radiation and radon-220 and -222 in homes. Most of the remaining radiation dose is received from diagnostic x-rays and nuclear medicine (NCRP 2009).

What are the effects of radiation on humans? Radiation can cause a variety of adverse health effects in humans. Health impacts of radiation exposure, whether from external or internal sources, generally are identified as somatic (i.e., affecting the exposed individual) or genetic (i.e., affecting descendants of the exposed individual). Radiation is more likely to produce somatic than genetic effects. The somatic risks of most importance are induced cancers. Except for leukemia, which can have an induction period (time between exposure to the carcinogen and cancer diagnosis) of as little as 2 to 7 years, most cancers have an induction period of more than 20 years.

For uniform irradiation of the body, cancer incidence varies among organs and tissues; the thyroid and skin demonstrate a greater sensitivity than other organs. Such cancers, however, also produce relatively low mortality rates because they are relatively amenable to medical treatment. Because fatal cancer is the most serious effect of environmental and occupational radiation exposures, estimates of cancer fatalities, rather than cancer incidence, are herein presented. These estimates are referred to as "latent cancer fatalities" (LCFs) because the cancer may take many years to develop.

Numerical fatal cancer estimates presented herein were obtained using a linear no-threshold (LNT) extrapolation from the nominal risk estimated for lifetime total cancer mortality that results from a large dose of radiation. Use of the LNT approach is the basis for current radiation protection regulations to protect the public and workers. According to the LNT extrapolation, if a certain radiation dose has an associated risk of a cancer, one-tenth of that dose would have one-tenth of the risk. Thus, the cancer risk is not 0, however small the dose. In accordance with DOE guidance, a risk factor of 0.0006 LCFs per rem was used in this *SPD Supplemental EIS* as the conversion factor for all radiological exposures up to 20 rem per individual. A risk factor of 0.0012 was used for individual doses of 20 rem or greater.

How certain are estimates of cancer risk from radiation? There is considerable uncertainty about cancer risks associated with low doses of radiation (i.e., doses well below 10 rem [0.1 sievert]), as well as with the assumption of a linear extrapolation of cancer risk at these low doses.

A number of radiation health scientists and organizations, such as the Health Physics Society, the United Nations Scientific Committee on Effects of Atomic Radiation, the National Council on Radiation Protection and Measurements, the French Academy of Medicine, and the French Academy of Sciences, have expressed reservations that the currently used cancer risk conversion factors, which are based on epidemiological studies at high doses (i.e., doses exceeding 5 to 10 rem), may not apply at low doses. These organizations suggest the effects of small doses are overstated and may in fact not result in any adverse health effects. One of the reasons they cite is the body's natural ability to repair itself from low levels of radiation by stimulating cell repair mechanisms.

As indicated by the results for the offsite MEI, the annual potential doses from normal releases (on the order of 0.01 millirem) are small fractions (approximately 0.003 percent) of the natural background radiation dose of 311 millirem per year (see Chapter 3, Section 3.1.6.1). A conservative estimate of the dose to a noninvolved onsite SRS worker was calculated using the GENII Version 2 computer code. Assuming no shielding, a location 1,000 meters (3,300 feet) from the SRS facility that would result in the highest offsite MEI dose, and 2,080 hours per year of exposure, the noninvolved worker would receive an incremental annual dose of about 0.010 millirem. This dose is small and comparable to the dose received by the MEI. The small doses to noninvolved workers from normal facility operations were not evaluated any further in this *SPD Supplemental EIS*. Doses to the offsite MEI, the offsite population, and the noninvolved worker under accident conditions were evaluated, as described in Appendix D of this *SPD Supplemental EIS*.

C.3.1 K-Area Storage, K-Area Interim Surveillance Capability, K-Area Pit Disassembly and Conversion Project, and Pit Disassembly in K-Area Gloveboxes

C.3.1.1 Construction

There would be no radiological risk to members of the public from potential construction or modification at the K-Area Complex facilities associated with storage, surveillance, or pit disassembly and conversion. Construction worker exposures to radiation derived from other activities at the site, past or present, would be kept as low as reasonably achievable (ALARA). Construction workers would be monitored (badged), as appropriate. Limited demolition, removal, and decontamination actions at K-Area were completed in January 2008; however, it is possible that new construction associated with PDC or pit disassembly gloveboxes could take place within areas that nevertheless exhibit residual contamination levels. PDC construction activities would include 2 years of decontamination and equipment removal from K-Area. The 28 PDC workers involved in decontamination and equipment removal would receive an average annual dose of 18 millirem. This would result in a collective worker dose of 0.5 person-rem per year and a total dose of 1.0 person-rem over the anticipated 2-year construction period (SRNS 2012).

For K-Area glovebox modifications, there would be an average annual dose of 100 millirem to 20 construction workers. This would result in a collective worker dose of 2.0 person-rem per year and 4.0 person-rem over the anticipated 2-year construction period (SRNS 2012).

C.3.1.2 Operations

Under the No Action Alternative, surplus plutonium disposition operations would continue at SRS largely as described and evaluated in the *SPD EIS* (DOE 1999) and subsequent supplement analyses, as well as the *Environmental Impact Statement on the Construction and Operation of a Proposed Mixed Oxide Fuel Fabrication Facility at the Savannah River Site, South Carolina (MFFF EIS)* (NRC 2005). Where planned operations have changed substantially and might affect potential worker radiological exposures, they are noted.

Program activities under the No Action Alternative that would result in doses to workers include the following:

- *K-Area Storage*. Storage of non-pit plutonium in K-Area and gradual transfer to MFFF were previously evaluated in the first supplement analysis for the *SPD EIS (SPD EIS SA-1)* (DOE 2003b); the *Storage and Disposition of Weapons-Usable Fissile Materials Final Programmatic Environmental Impact Statement (Storage and Disposition PEIS)* (DOE 1996), including its first (SA-1) (DOE 1998), second (SA-2) (DOE 2002), and fourth (SA-4) (DOE 2007) supplement analyses; and the *Environmental Assessment for the Safeguards and Security Upgrades for Storage of Plutonium Materials at the Savannah River Site (Safeguards*

and Security EA) (DOE 2005b). Material storage in the K-Area Complex in support of the surplus plutonium disposition program would continue for about 40 years.¹

- *KIS*. Operation of KIS would support the ongoing plutonium storage container surveillance mission (DOE 2005b). KIS operations would continue for about 40 years.

Under the Immobilization to DWPF Alternative, the following possible program activities would result in worker doses:

- *K-Area Storage*. Activities at this area would be similar to those as discussed under the No Action Alternative, including removal of shipping containers from storage for transport to other onsite facilities. Worker impacts would be similar to those from current and recent container receipt and placement activities in storage locations. No net increase in worker impacts is expected. K-Area storage operations in support of the surplus plutonium disposition program would continue for 20 years.
- *KIS*. Operation of KIS would support plutonium storage container surveillance (DOE 2005b). KIS operations would continue for 15 years.
- *Pit disassembly*. Under the PF-4 at LANL and H-Canyon/HB-Line and MFFF at SRS Option for pit disassembly and conversion, disassembly of plutonium pits would be performed using equipment installed in a K-Area glovebox with the plutonium being transferred to H-Canyon/HB-Line for oxidation. Pit disassembly operations would continue for 14 years.

Under the MOX Fuel Alternative, the following program activities would result in worker doses:

- *K-Area Storage*. K-Area storage operations in support of the surplus plutonium disposition program, as discussed under the No Action Alternative, would continue for 22 years.
- *KIS*. Operation of KIS would be the same as under the Immobilization to DWPF Alternative. KIS operations would continue for about 7 years.
- *PDC*. Under the option to construct PDC at K-Area to carry out the pit disassembly and conversion function, this facility would operate for a period of 12 years.
- *Pit disassembly*. Pit disassembly would be the same as under the Immobilization to DWPF Alternative, operating for 14 years.

Under the H-Canyon/HB-Line to DWPF Alternative, the following program activities would result in worker doses:

- *K-Area Storage*. K-Area storage operations in support of the surplus plutonium disposition program, as discussed under the No Action Alternative, would continue for 22 years.
- *KIS*. Operation of KIS would be the same as under the Immobilization to DWPF Alternative. KIS operations would continue for about 10 years.
- *PDC*. Operation of PDC at K-Area would be the same as under the MOX Fuel Alternative, operating for a period of 12 years.
- *Pit disassembly*. Pit disassembly would be the same as under the Immobilization to DWPF Alternative, operating for 14 years.

¹ The K-Area Material Storage Area is the principal capability at K-Area for plutonium storage.

Under the WIPP Alternative, program activities that would result in worker doses include the following:

- *K-Area Storage.* K-Area storage operations in support of the surplus plutonium disposition program, as discussed under the No Action Alternative, would continue for 22 years.
- *KIS.* Operation of KIS would be the same as under the Immobilization to DWPF Alternative. KIS operations would continue for about 7 years.
- *PDC.* Operation of PDC at K-Area would be the same as under the MOX Fuel Alternative, operating for a period of 12 years.
- *Pit disassembly.* Pit disassembly would be the same as under the Immobilization to DWPF Alternative, operating for 14 years.

Under all alternatives, because surplus plutonium activities for K-Area storage only involve receipt, storage, and shipping of materials within certified shipping containers that are not opened, no airborne radiological emissions would occur from these activities during normal operations. At KIS, the shipping packages would be opened and the DOE-STD-3013 containers (DOE 2012) would be opened within a glovebox. Small amounts of plutonium could become airborne within the glovebox and be transported through high-efficiency particulate air filters and a stack to the atmosphere. Workers performing these activities would be exposed to direct gamma and neutron radiation from plutonium in shipping packages, DOE-STD-3013 containers, and gloveboxes. At PDC, it is expected that workers would be exposed to direct gamma and neutron radiation from the handling of pit material. Small amounts of plutonium could become airborne from metal oxidation and be transported through high-efficiency particulate air filters and a stack to the atmosphere. For disassembly of pits within a K-Area glovebox, workers would be exposed to direct gamma and neutron radiation from plutonium. For the option of disassembling pits in K-Area gloveboxes, oxidation of the pit metal would occur in H-Canyon/HB-Line. No emissions of offsite consequence are expected from K-Area glovebox pit disassembly activities.

Table C-16 presents the projected incident-free radiological impacts on workers from storage operations at K-Area. The total numbers of projected LCFs are also reported for the differing periods of operation per alternative. As indicated above, no impacts to the public are expected due to the absence of airborne emissions.

Table C-16 Radiological Impacts on Workers from K-Area Storage Operations

Impact Area	Alternative				
	No Action	Immobilization to DWPF	MOX Fuel	H-Canyon/ HB-Line to DWPF	WIPP
Operational Years for K-Area Storage	40	20	22	22	22
Total Workforce					
Number of radiation workers	24	24	24	24	24
Collective dose (person-rem per year)	8.9	8.9	8.9	8.9	8.9
Annual LCFs ^a	0 (0.005)	0 (0.005)	0 (0.005)	0 (0.005)	0 (0.005)
Life-of-Project LCFs ^a	0 (0.2)	0 (0.1)	0 (0.1)	0 (0.1)	0 (0.1)
Average Worker					
Dose (millirem per year) ^b	370	370	370	370	370
Annual LCF risk	0.0002	0.0002	0.0002	0.0002	0.0002
Life-of-Project LCF risk	0.009	0.004	0.005	0.005	0.005

DWPF = Defense Waste Processing Facility; LCF = latent cancer fatality; MOX = mixed oxide; WIPP = Waste Isolation Pilot Plant.

^a Numbers of LCFs in the worker population are whole numbers; the statistically calculated values are provided in parentheses.

^b Engineering and administrative controls would be implemented to maintain individual worker doses below 2,000 millirem per year and as low as reasonably achievable (DOE 2005a, 2009).

Source: DOE 1998; SRNS 2012.

Tables C–17 through C–21 present the projected incident-free radiological impacts on workers and the public from operations at KIS and PDC and from pit disassembly activities in K-Area gloveboxes (SRNS 2012; WSRC 2008). The total numbers of projected LCFs are also reported for the differing periods of operation per alternative.

Table C–17 Radiological Impacts on the Public from Operation of the K-Area Interim Surveillance Capability

Impact Area	Alternative				
	No Action	Immobilization to DWPF	MOX Fuel	H-Canyon/ HB-Line to DWPF	WIPP
Operational Years for KIS	40	15	7	10	7
Population within 50 Miles (80 kilometers)					
Annual dose (person-rem)	4.3×10^{-5}	4.3×10^{-5}	4.3×10^{-5}	4.3×10^{-5}	4.3×10^{-5}
Percent of natural background radiation ^a	1.7×10^{-8}	1.7×10^{-8}	1.7×10^{-8}	1.7×10^{-8}	1.7×10^{-8}
Annual LCFs ^b	0 (3×10^{-8})	0 (3×10^{-8})	0 (3×10^{-8})	0 (3×10^{-8})	0 (3×10^{-8})
Life-of-Project LCFs ^b	0 (1×10^{-6})	0 (4×10^{-7})	0 (2×10^{-7})	0 (3×10^{-7})	0 (2×10^{-7})
Maximally Exposed Individual					
Annual dose (millirem)	8.5×10^{-7}	8.5×10^{-7}	8.5×10^{-7}	8.5×10^{-7}	8.5×10^{-7}
Percent of natural background radiation ^a	2.7×10^{-7}	2.7×10^{-7}	2.7×10^{-7}	2.7×10^{-7}	2.7×10^{-7}
Annual LCF risk	5×10^{-13}	5×10^{-13}	5×10^{-13}	5×10^{-13}	5×10^{-13}
Life-of-Project LCF risk	2×10^{-11}	8×10^{-12}	4×10^{-12}	5×10^{-12}	4×10^{-12}
Average Exposed Individual within 50 Miles (80 kilometers)^c					
Annual dose (millirem)	5.3×10^{-8}	5.3×10^{-8}	5.3×10^{-8}	5.3×10^{-8}	5.3×10^{-8}
Annual LCF risk	3×10^{-14}	3×10^{-14}	3×10^{-14}	3×10^{-14}	3×10^{-14}
Life-of-Project LCF risk	1×10^{-12}	5×10^{-13}	2×10^{-13}	3×10^{-13}	2×10^{-13}

DWPF = Defense Waste Processing Facility; KIS = K-Area Interim Surveillance; LCF = latent cancer fatality; MOX = mixed oxide; WIPP = Waste Isolation Pilot Plant.

^a The annual natural background radiation dose assumed for SRS is 311 millirem for the average individual; the population within 50 miles (80 kilometers) of K-Area in 2020 would receive a dose of about 252,000 person-rem.

^b Numbers of LCFs in the population are whole numbers; the statistically calculated values are provided in parentheses.

^c Obtained by dividing the population dose by the number of people projected to live within 50 miles (80 kilometers) of the SRS facilities in 2020 (approximately 809,000 for K-Area).

Table C–18 Radiological Impacts on Workers from Operation of the K-Area Interim Surveillance Capability

Impact Area	Alternative				
	No Action	Immobilization to DWPF	MOX Fuel	H-Canyon/ HB-Line to DWPF	WIPP
Operational Years for KIS	40	15	7	10	7
Total Workforce					
Number of radiation workers	40	40	40	40	40
Collective dose (person-rem per year)	25	25	25	25	25
Annual LCFs ^a	0 (0.02)	0 (0.02)	0 (0.02)	0 (0.02)	0 (0.02)
Life-of-Project LCFs ^a	1 (0.6)	0 (0.2)	0 (0.1)	0 (0.2)	0 (0.1)
Average Worker					
Dose (millirem per year) ^b	630	630	630	630	630
Annual LCF risk	0.0004	0.0004	0.0004	0.0004	0.0004
Life-of-Project LCF risk	0.02	0.006	0.003	0.004	0.003

DWPF = Defense Waste Processing Facility; KIS = K-Area Interim Surveillance; LCF = latent cancer fatality; MOX = mixed oxide; WIPP = Waste Isolation Pilot Plant.

^a Numbers of LCFs in the worker population are whole numbers; the statistically calculated values are provided in parentheses.

^b Engineering and administrative controls would be implemented to maintain individual worker doses below 2,000 millirem per year and as low as reasonably achievable (DOE 2005a, 2009).

Source: SRNS 2012; WSRC 2008.

Table C–19 Radiological Impacts on the Public from Operation of the Pit Disassembly and Conversion Project in K-Area

Impact Area	Alternative				
	No Action	Immobilization to DWPF	MOX Fuel	H-Canyon/ HB-Line to DWPF	WIPP
Operational Years for PDC	N/A	N/A	12	12	12
Population within 50 Miles (80 kilometers)					
Annual dose (person-rem)	N/A	N/A	0.44	0.44	0.44
Percent of natural background radiation ^a	N/A	N/A	0.00018	0.00018	0.00018
Annual LCFs ^b	N/A	N/A	0 (0.0003)	0 (0.0003)	0 (0.0003)
Life-of-Project LCFs ^b	N/A	N/A	0 (0.003)	0 (0.003)	0 (0.003)
Maximally Exposed Individual					
Annual dose (millirem)	N/A	N/A	0.0061	0.0061	0.0061
Percent of natural background radiation ^a	N/A	N/A	0.0020	0.0020	0.0020
Annual LCF risk	N/A	N/A	4×10^{-9}	4×10^{-9}	4×10^{-9}
Life-of-Project LCF risk	N/A	N/A	4×10^{-8}	4×10^{-8}	4×10^{-8}
Average Exposed Individual within 50 Miles (80 kilometers)^c					
Annual dose (millirem)	N/A	N/A	0.00055	0.00055	0.00055
Annual LCF risk	N/A	N/A	3×10^{-10}	3×10^{-10}	3×10^{-10}
Life-of-Project LCF risk	N/A	N/A	4×10^{-9}	4×10^{-9}	4×10^{-9}

DWPF = Defense Waste Processing Facility; LCF = latent cancer fatality; MOX = mixed oxide; N/A = not applicable;

PDC = Pit Disassembly and Conversion Project; WIPP = Waste Isolation Pilot Plant.

^a The annual natural background radiation dose assumed for SRS is 311 millirem for the average individual; the population within 50 miles (80 kilometers) of K-Area in 2020 would receive a dose of about 252,000 person-rem.

^b Numbers of LCFs in the population are whole numbers; the statistically calculated values are provided in parentheses.

^c Obtained by dividing the population dose by the number of people projected to live within 50 miles (80 kilometers) of the SRS facilities in 2020 (approximately 809,000 for K-Area).

Table C–20 Radiological Impacts on Workers from Operation of the Pit Disassembly and Conversion Project in K-Area

Impact Area	Alternative				
	No Action	Immobilization to DWPF	MOX Fuel	H-Canyon/ HB-Line to DWPF	WIPP
Operational Years for PDC	N/A	N/A	12	12	12
Total Workforce					
Number of radiation workers	N/A	N/A	383	383	383
Collective dose (person-rem per year)	N/A	N/A	190	190	190
Annual LCFs ^a	N/A	N/A	0 (0.1)	0 (0.1)	0 (0.1)
Life-of-Project LCFs	N/A	N/A	1 (1.4)	1 (1.4)	1 (1.4)
Average Worker					
Dose (millirem per year) ^b	N/A	N/A	500	500	500
Annual LCF risk	N/A	N/A	0.0003	0.0003	0.0003
Life-of-Project LCF risk	N/A	N/A	0.004	0.004	0.004

DWPF = Defense Waste Processing Facility; LCF = latent cancer fatality; MOX = mixed oxide; N/A = not applicable;

PDC = Pit Disassembly and Conversion Project; WIPP = Waste Isolation Pilot Plant.

^a Numbers of LCFs in the worker population are whole numbers; the statistically calculated values are provided in parentheses.

^b Engineering and administrative controls would be implemented to maintain individual worker doses below 2,000 millirem per year and as low as reasonably achievable (DOE 2005a, 2009).

Source: SRNS 2012; WSRC 2008.

Table C–21 Radiological Impacts on Workers from Pit Disassembly Activities in K-Area Gloveboxes

<i>Impact Area</i>	<i>Alternative</i>				
	<i>No Action</i>	<i>Immobilization to DWPF</i>	<i>MOX Fuel</i>	<i>H-Canyon/ HB-Line to DWPF</i>	<i>WIPP</i>
Operational Years for Pit Disassembly Activities in K-Area Gloveboxes	N/A	14	14	14	14
Total Workforce					
Number of radiation workers	N/A	50	50	50	50
Collective dose (person-rem per year)	N/A	38	38	38	38
Annual LCFs ^a	N/A	0 (0.02)	0 (0.02)	0 (0.02)	0 (0.02)
Life-of-Project LCFs ^a	N/A	0 (0.3)	0 (0.3)	0 (0.3)	0 (0.3)
Average Worker					
Dose (millirem per year)	N/A	760	760	760	760
Annual LCF risk	N/A	0.0005	0.0005	0.0005	0.0005
Life-of-Project LCF risk	N/A	0.006	0.006	0.006	0.006

DWPF = Defense Waste Processing Facility; LCF = latent cancer fatality; MOX = mixed oxide; N/A = not applicable; WIPP = Waste Isolation Pilot Plant.

^a Numbers of LCFs in the worker population are whole numbers; the statistically calculated values are provided in parentheses.

^b Engineering and administrative controls would be implemented to maintain individual worker doses below 2,000 millirem per year and as low as reasonably achievable (DOE 2005a, 2009).

Source: SRNS 2012; WSRC 2008.

C.3.2 Immobilization Capability in K-Area

C.3.2.1 Construction

There would be no radiological risk to members of the public from the construction of a new immobilization capability at K-Area. The majority of the construction activities would occur in areas where dose rates would be close to background radiation levels, and there would be a limited amount of equipment in place that would require decontamination and removal. Due to the nature of contamination, the external dose rates from this equipment would be low. Total dose rates for the 2 years of decontamination and equipment removal during the construction phase would be about 3.3 person-rem per year; the average estimated dose rate would be about 92 millirem per worker per year for a member of the exposed construction workforce of 72 workers (SRNS 2012). The total construction workforce dose would be 6.6 person-rem over the 2-year period. Construction worker exposures to radiation derived from other activities at the site, past or present, would be kept ALARA. Construction workers would be monitored (badged) as appropriate.

C.3.2.2 Operations

Under the Immobilization to DWPF Alternative, program activities that would result in worker and potentially offsite population doses are the processing of 13.1 metric tons (14.4 tons) of surplus plutonium in a new immobilization capability within K-Area. Processing this material is anticipated to require about 10 years of operation. This period of operation was used for projecting potential total numbers of latent cancers. **Tables C–22** and **C–23** present the projected incident-free radiological impacts of operation of the new immobilization capability.

Table C–22 Radiological Impacts on the Public from Operation of the K-Area Immobilization Capability

Impact Area	Alternative				
	No Action	Immobilization to DWPF	MOX Fuel	H-Canyon/ HB-Line to DWPF	WIPP
Operational Years for Immobilization	N/A	10	N/A	N/A	N/A
Population within 50 Miles (80 kilometers)					
Annual dose (person-rem)	N/A	0.00062	N/A	N/A	N/A
Percent of natural background radiation ^a	N/A	2.5×10^{-7}	N/A	N/A	N/A
Annual LCFs	N/A	0 (4×10^{-7})	N/A	N/A	N/A
Life-of-Project LCFs ^b	N/A	0 (4×10^{-6})	N/A	N/A	N/A
Maximally Exposed Individual					
Annual dose (millirem)	N/A	7.5×10^{-6}	N/A	N/A	N/A
Percent of natural background radiation ^a	N/A	2.4×10^{-6}	N/A	N/A	N/A
Annual LCF risk	N/A	5×10^{-12}	N/A	N/A	N/A
Life-of-Project LCF risk	N/A	5×10^{-11}	N/A	N/A	N/A
Average Exposed Individual within 50 Miles (80 kilometers)^c					
Annual dose (millirem)	N/A	7.7×10^{-7}	N/A	N/A	N/A
Annual LCF risk	N/A	5×10^{-13}	N/A	N/A	N/A
Life-of-Project LCF risk	N/A	5×10^{-12}	N/A	N/A	N/A

DWPF = Defense Waste Processing Facility; LCF = latent cancer fatality; MOX = mixed oxide; N/A = not applicable; WIPP = Waste Isolation Pilot Plant.

^a The annual natural background radiation dose assumed for SRS is 311 millirem for the average individual; the population within 50 miles (80 kilometers) of K-Area in 2020 would receive a dose of about 252,000 person-rem.

^b Numbers of LCFs in the population are whole numbers; the statistically calculated values are provided in parentheses.

^c Obtained by dividing the population dose by the number of people projected to live within 50 miles (80 kilometers) of the SRS facility in 2020 (approximately 809,000 for K-Area).

Table C–23 Radiological Impacts on Workers from Operation of the K-Area Immobilization Capability

Impact Area	Alternative				
	No Action	Immobilization to DWPF	MOX Fuel	H-Canyon/ HB-Line to DWPF	WIPP
Operational Years for Immobilization	N/A	10	N/A	N/A	N/A
Total Workforce					
Number of radiation workers	N/A	314	N/A	N/A	N/A
Collective dose (person-rem per year)	N/A	310	N/A	N/A	N/A
Annual LCFs ^a	N/A	0 (0.2)	N/A	N/A	N/A
Life-of-Project LCFs ^a	N/A	2 (1.9)	N/A	N/A	N/A
Average Worker					
Dose (millirem per year) ^b	N/A	1,000	N/A	N/A	N/A
Annual LCF risk	N/A	0.0006	N/A	N/A	N/A
Life-of-Project LCF risk	N/A	0.006	N/A	N/A	N/A

DWPF = Defense Waste Processing Facility; LCF = latent cancer fatality; MOX = mixed oxide; N/A = not applicable; WIPP = Waste Isolation Pilot Plant.

^a Numbers of LCFs in the worker population are whole numbers; the statistically calculated values are provided in parentheses.

^b Engineering and administrative controls would be implemented to maintain individual worker doses below 2,000 millirem per year and as low as reasonably achievable (DOE 2005a, 2009).

Source: SRNS 2012.

C.3.3 H-Canyon/HB-Line

C.3.3.1 Construction

Under any of the action alternatives, implementation of the PF-4, H-Canyon/HB-Line, and MFFF Option for pit disassembly and conversion would require modifications at the H-Canyon/HB-Line to support dissolution of metal and conversion to plutonium oxide feed for MFFF (pit disassembly would occur in a K-Area glovebox; see Section C.3.1). Modification activities may result in construction workforce doses (up to an average dose of 25 millirem per year) to 10 workers. Annual workforce doses are not expected to exceed 0.25 person-rem per year; over the 2 years required for these modifications, the workforce would receive a collective dose of 0.50 person-rem (SRNS 2012).

No significant modifications to H-Canyon/HB-Line would be needed to enable processing of surplus plutonium to prepare it for vitrification at DWPF under the H-Canyon/HB-Line to DWPF Alternative. Any equipment modifications or piping realignments would be conducted as part of normal operations.

Under the WIPP Alternative, construction workforce doses (up to an average dose of 58 millirem per worker per year) to 10 workers may result from modifications at the H-Canyon/HB-Line to support preparation of up to 6 metric tons (6.6 tons) of plutonium to WIPP. A total potential construction workforce dose of 1.2 person-rem would occur over the estimated 2-year modification duration (SRNS 2012; WSRC 2008).

Under the MOX Fuel Alternative, H-Canyon/HB-Line may require modifications to dissolve and prepare 4 metric tons (4.4 tons) of non-pit plutonium as feed for MOX fuel fabrication and/or prepare 2 metric tons (2.2 tons) of surplus plutonium for WIPP disposal. The amount of modification work needed to accommodate these actions would depend on the planned processing rate. Modifications would range from minor modifications that would be made as part of normal operations to the level of modifications discussed above for preparation of 6 metric tons (6.6 tons) of non-pit plutonium for WIPP disposal.

There would be no radiological risks to members of the public from any of the potential modification scenarios of H-Canyon/HB-Line.

C.3.3.2 Operations

Processing 6 metric tons of non-pit plutonium for transfer to DWPF. Under the H-Canyon/HB-Line to DWPF Alternative, 6 metric tons (6.6 tons) of surplus non-pit plutonium could be dissolved, processed, and transferred to the liquid radioactive waste tank farm to become part of the feed to the HLW vitrification system at DWPF. No changes are expected in air or liquid emissions and discharges under this processing option. Dissolution, storage, and transfer of surplus plutonium are currently being performed under existing permits (WSRC 2008).

No changes in worker radiological exposure rates at H-Canyon/HB-Line are expected due to this processing option versus other materials normally handled at H-Canyon/HB-Line. H-Canyon/HB-Line missions currently include dissolution, storage, and transfer of surplus plutonium, and controls are in place for limiting personnel doses. Projected doses are estimated for each material type prior to the start of a campaign (WSRC 2008).

The total dose for a previous processing campaign of approximately 0.05 metric tons (0.055 tons) of plutonium-beryllium material was conservatively estimated to result in a collective dose of 0.728 person-rem to all fissile material handlers. Scaling this dose rate to the processing rate of 0.55 metric tons (0.61 tons) per year for processing 6 metric tons (6.6 tons) to DWPF, yields an annual dose of about 8 person-rem. This dose is highly dependent on the material included with the plutonium. An estimated 46 full-time radiation workers would support this H-Canyon/HB-Line processing option during the

operational timeframe of this *SPD Supplemental EIS*; however, only 20 to 30 percent of this workforce would be directly involved with the processing of surplus plutonium material; using the above information, the calculated annual dose for these workers would be 580 millirem. Typical doses would be expected to be lower than this calculated value (SRNS 2012). For all workers under this processing option, the SRS ALARA goal of 500 millirem per year was assumed.

Processing this material is expected to require about 13 years of operation under the H-Canyon/HB-Line to DWPF Alternative. This period of operation was used to project the total numbers of LCFs for all receptors.

Processing 10 metric tons of pit and metallic plutonium for transfer to MFFF. Under all of the action alternatives, if the PF-4, H-Canyon/HB-Line, and MFFF Option for pit disassembly and conversion were implemented, up to 10 metric tons (11 tons) of surplus plutonium could be processed through the H-Canyon/HB-Line and sent to MFFF. Processing this material is expected to require about 14 years of operation under all action alternatives. This period of operation was used to project the total numbers of LCFs for all receptors.

Processing 4 metric tons of non-pit plutonium for transfer to MFFF. Under the MOX Fuel Alternative, 4 metric tons (4.4 tons) of non-pit plutonium would be processed through H-Canyon/HB-Line and sent to MFFF for MOX fuel. Processing this material is expected to require about 6 years.

Processing non-pit plutonium for shipment to WIPP. Under the MOX Fuel Alternative, 2 metric tons (2.2 tons) of surplus plutonium could be processed through H-Canyon/HB-Line in preparation for ultimate transport to WIPP. Under the WIPP Alternative, 6 metric tons (6.6 tons) could be processed through H-Canyon/HB-Line. Processing this material is expected to require about 10 years of operation under the MOX Fuel Alternative and about 13 years under the WIPP Alternative. These periods of operation were used to project the total numbers of LCFs for all receptors.

Tables C-24 through **C-29** present the projected incident-free radiological impacts at H-Canyon/HB-Line for all three processing scenarios discussed above.

Table C–24 Radiological Impacts on the Public from Operation of H-Canyon/HB-Line – Processing Surplus Non-Pit Plutonium for Transfer to the Defense Waste Processing Facility

Impact Area	Alternative				
	No Action	Immobilization to DWPF	MOX Fuel	H-Canyon/HB-Line to DWPF	WIPP
Operational Years for H-Canyon/HB-Line Processing to DWPF	N/A	N/A	N/A	13	N/A
Population within 50 Miles (80 kilometers)					
Annual dose (person-rem)	N/A	N/A	N/A	0.0060	N/A
Percent of natural background radiation ^a	N/A	N/A	N/A	2.2×10^{-6}	N/A
Annual LCFs ^b	N/A	N/A	N/A	0 (4×10^{-6})	N/A
Life-of-Project LCFs ^b	N/A	N/A	N/A	0 (5×10^{-5})	N/A
Maximally Exposed Individual					
Annual dose (millirem)	N/A	N/A	N/A	4.3×10^{-5}	N/A
Percent of natural background radiation ^a	N/A	N/A	N/A	1.4×10^{-5}	N/A
Annual LCF risk	N/A	N/A	N/A	3×10^{-11}	N/A
Life-of-Project LCF risk	N/A	N/A	N/A	4×10^{-10}	N/A
Average Exposed Individual within 50 Miles (80 kilometers) ^c					
Annual dose (millirem)	N/A	N/A	N/A	6.8×10^{-6}	N/A
Annual LCF risk	N/A	N/A	N/A	4×10^{-12}	N/A
Life-of-Project LCF risk	N/A	N/A	N/A	5×10^{-11}	N/A

DWPF = Defense Waste Processing Facility; LCF = latent cancer fatality; MOX = mixed oxide; N/A = not applicable; WIPP = Waste Isolation Pilot Plant.

^a The annual natural background radiation dose assumed for SRS is 311 millirem for the average individual; the population within 50 miles (80 kilometers) of H-Area in 2020 would receive a dose of about 276,000 person-rem.

^b Numbers of LCFs in the population are whole numbers; the statistically calculated value is provided in parentheses.

^c Obtained by dividing the population dose by the number of people projected to live within 50 miles (80 kilometers) of the SRS facility in 2020 (approximately 886,000 for H-Area).

Note: To convert metric tons to tons, multiply by 1.1023.

Table C–25 Radiological Impacts on Workers from Operation of H-Canyon/HB-Line – Processing Surplus Non-Pit Plutonium for Transfer to the Defense Waste Processing Facility

Impact Area	Alternative				
	No Action	Immobilization to DWPF	MOX Fuel	H-Canyon/HB-Line to DWPF	WIPP
Operational Years for H-Canyon/HB-Line Processing to DWPF	N/A	N/A	N/A	13	N/A
Total Workforce					
Number of radiation workers ^a	N/A	N/A	N/A	14	N/A
Collective dose (person-rem per year)	N/A	N/A	N/A	7.0	N/A
Annual LCFs ^b	N/A	N/A	N/A	0 (0.004)	N/A
Life-of-Project LCFs ^b	N/A	N/A	N/A	0 (0.05)	N/A
Average Worker					
Dose (millirem per year) ^c	N/A	N/A	N/A	500	N/A
Annual LCF risk	N/A	N/A	N/A	0.0003	N/A
Life-of-Project LCF risk	N/A	N/A	N/A	0.004	N/A

DWPF = Defense Waste Processing Facility; LCF = latent cancer fatality; MOX = mixed oxide; N/A = not applicable; WIPP = Waste Isolation Pilot Plant.

^a It was estimated that no more than 30 percent of the 46 radiation workers at H-Canyon would be involved with plutonium processing activities under the H-Canyon/HB-Line to DWPF Alternative (i.e., 14 radiation workers).

^b Numbers of LCFs in the worker population are whole numbers; the statistically calculated value is provided in parentheses.

^c Engineering and administrative controls would be implemented to maintain individual worker doses below 2,000 millirem per year and as low as reasonably achievable (DOE 2005a, 2009).

Source: SRNS 2012.

Note: To convert metric tons to tons, multiply by 1.1023.

Table C–26 Radiological Impacts on the Public from Operation of H-Canyon/HB-Line – Pit and Metal Conversion to Oxide for Mixed Oxide Fuel Fabrication

Impact Area	Alternative				
	No Action	Immobilization to DWPF	MOX Fuel	H-Canyon/HB-Line to DWPF	WIPP
Operational Years for H-Canyon/HB-Line Processing to MFFF	N/A	14	14	14	14
Population within 50 Miles (80 kilometers)					
Annual dose (person-rem)	N/A	0.26	0.26	0.26	0.26
Percent of natural background radiation ^a	N/A	9.6×10^{-5}	9.6×10^{-5}	9.6×10^{-5}	9.6×10^{-5}
Annual LCFs ^b	N/A	0 (0.0002)	0 (0.0002)	0 (0.0002)	0 (0.0002)
Life-of-Project LCFs ^b	N/A	0 (0.002)	0 (0.002)	0 (0.002)	0 (0.002)
Maximally Exposed Individual					
Annual dose (millirem)	N/A	0.0024	0.0024	0.0024	0.0024
Percent of natural background radiation ^a	N/A	0.00077	0.00077	0.00077	0.00077
Annual LCF risk	N/A	1×10^{-9}	1×10^{-9}	1×10^{-9}	1×10^{-9}
Life-of-Project LCF risk	N/A	2×10^{-8}	2×10^{-8}	2×10^{-8}	2×10^{-8}
Average Exposed Individual within 50 Miles (80 kilometers)^c					
Annual dose (millirem)	N/A	0.00029	0.00029	0.00029	0.00029
Annual LCF risk	N/A	2×10^{-10}	2×10^{-10}	2×10^{-10}	2×10^{-10}
Life-of-Project LCF risk	N/A	2×10^{-9}	2×10^{-9}	2×10^{-9}	2×10^{-9}

DWPF = Defense Waste Processing Facility; LCF = latent cancer fatality; MFFF = Mixed Oxide Fuel Fabrication Facility; MOX = mixed oxide; N/A = not applicable; WIPP = Waste Isolation Pilot Plant.

^a The annual natural background radiation dose assumed for SRS is 311 millirem for the average individual; the population within 50 miles (80 kilometers) of H-Area in 2020 would receive a dose of about 276,000 person-rem.

^b Numbers of LCFs in the population are whole numbers; the statistically calculated values are provided in parentheses.

^c Obtained by dividing the population dose by the number of people projected to live within 50 miles (80 kilometers) of the SRS facility in 2020 (approximately 886,000 for H-Area).

Note: Potential public impacts from the separate processing of 4 metric tons (4.4 tons) of non-pit plutonium for feed to MFFF (applicable under the MOX Fuel Alternative only) would be subsumed within the values provided in the MOX Fuel column.

Source: SRNS 2012.

Table C–27 Radiological Impacts on Workers from Operation of H-Canyon/HB-Line – Pit and Metal Conversion to Oxide for Mixed Oxide Fuel Fabrication

Impact Area	Alternative				
	No Action	Immobilization to DWPF	MOX Fuel	H-Canyon/HB-Line to DWPF	WIPP
Operational Years for H-Canyon/HB-Line Processing to MFFF	N/A	14	14	14	14
Total Workforce					
Number of radiation workers	N/A	100	100	100	100
Collective dose (person-rem per year)	N/A	29	29	29	29
Annual LCFs ^a	N/A	0 (0.02)	0 (0.02)	0 (0.02)	0 (0.02)
Life-of-Project LCFs ^a	N/A	0 (0.2)	0 (0.2)	0 (0.2)	0 (0.2)
Average Worker					
Dose (millirem per year) ^b	N/A	290	290	290	290
Annual LCF risk	N/A	0.0002	0.0002	0.0002	0.0002
Life-of-Project LCF risk	N/A	0.002	0.002	0.002	0.002

DWPF = Defense Waste Processing Facility; LCF = latent cancer fatality; MFFF = Mixed Oxide Fuel Fabrication Facility; MOX = mixed oxide; N/A = not applicable; WIPP = Waste Isolation Pilot Plant.

^a Numbers of LCFs in the worker population are whole numbers; the statistically calculated values are provided in parentheses.

^b Engineering and administrative controls would be implemented to maintain individual worker doses below 2,000 millirem per year and as low as reasonably achievable (DOE 2005a, 2009).

Note: Potential worker impacts from the separate processing of 4 metric tons (4.4 tons) of non-pit plutonium for feed to MFFF (applicable under the MOX Fuel Alternative only) would be subsumed within the values provided in the MOX Fuel column.

Source: SRNS 2012.

Table C–28 Radiological Impacts on the Public from Operation of H-Canyon/HB-Line – Processing to the Waste Isolation Pilot Plant

Impact Area	Alternative				
	No Action	Immobilization to DWPF	MOX Fuel ^a	H-Canyon/HB-Line to DWPF	WIPP ^a
Operational Years for H-Canyon/HB-Line Processing to WIPP	N/A	N/A	10	N/A	13
Population within 50 Miles (80 kilometers)					
Annual dose (person-rem)	N/A	N/A	0.26	N/A	0.26
Percent of natural background radiation ^b	N/A	N/A	9.6×10^{-5}	N/A	9.6×10^{-5}
Annual LCFs ^c	N/A	N/A	0 (0.0002)	N/A	0 (0.0002)
Life-of-Project LCFs ^c	N/A	N/A	0 (0.002)	N/A	0 (0.002)
Maximally Exposed Individual					
Annual dose (millirem)	N/A	N/A	0.0024	N/A	0.0024
Percent of natural background radiation ^b	N/A	N/A	0.00077	N/A	0.00077
Annual LCF risk	N/A	N/A	1×10^{-9}	N/A	1×10^{-9}
Life-of-Project LCF risk	N/A	N/A	1×10^{-8}	N/A	2×10^{-8}
Average Exposed Individual within 50 Miles (80 kilometers)^d					
Annual dose (millirem)	N/A	N/A	0.00029	N/A	0.00029
Annual LCF risk	N/A	N/A	2×10^{-10}	N/A	2×10^{-10}
Life-of-Project LCF risk	N/A	N/A	2×10^{-9}	N/A	2×10^{-9}

DWPF = Defense Waste Processing Facility; LCF = latent cancer fatality; MOX = mixed oxide; N/A = not applicable; WIPP = Waste Isolation Pilot Plant.

^a Under the MOX Fuel Alternative, 2 metric tons (2.2 tons) of material would be processed; under the WIPP Alternative, 6 metric tons (6.6 tons) of material would be processed.

^b The annual natural background radiation dose assumed for SRS is 311 millirem for the average individual; the population within 50 miles (80 kilometers) of H-Area in 2020 would receive a dose of about 276,000 person-rem.

^c Numbers of LCFs in the population are whole numbers; the statistically calculated values are provided in parentheses.

^d Obtained by dividing the population dose by the number of people projected to live within 50 miles (80 kilometers) of the SRS facility in 2020 (approximately 886,000 for H-Area).

Source: SRNS 2012.

Table C–29 Radiological Impacts on Workers from Operation of H-Canyon/HB-Line – Processing to the Waste Isolation Pilot Plant

Impact Area	Alternative				
	No Action	Immobilization to DWPF	MOX Fuel ^a	H-Canyon/HB-Line to DWPF	WIPP ^a
Operational Years for H-Canyon/HB-Line Processing to WIPP	N/A	N/A	10	N/A	13
Total Workforce					
Number of radiation workers	N/A	N/A	130	N/A	130
Collective dose (person-rem per year)	N/A	N/A	20	N/A	60
Annual LCFs ^b	N/A	N/A	0 (0.01)	N/A	0 (0.04)
Life-of-Project LCFs ^b	N/A	N/A	0 (0.1)	N/A	0 (0.5)
Average Worker					
Dose (millirem per year) ^c	N/A	N/A	150	N/A	460
Annual LCF risk	N/A	N/A	0.00009	N/A	0.0003
Life-of-Project LCF risk	N/A	N/A	0.0009	N/A	0.004

DWPF = Defense Waste Processing Facility; LCF = latent cancer fatality; MOX = mixed oxide; N/A = not applicable; WIPP = Waste Isolation Pilot Plant.

^a Under the MOX Fuel Alternative, 2 metric tons (2.2 tons) of material would be processed; under the WIPP Alternative, 6 metric tons (6.6 tons) of material would be processed.

^b Numbers of LCFs in the worker population are whole numbers; the statistically calculated values are provided in parentheses.

^c Engineering and administrative controls would be implemented to maintain individual worker doses below 2,000 millirem per year and as low as reasonably achievable (DOE 2005a, 2009).

Source: SRNS 2012.

C.3.4 Mixed Oxide Fuel Fabrication Facility (including Metal Oxidation)

C.3.4.1 Construction

MFFF is already under construction and the only potential modifications to MFFF would be the installation of metal oxidation furnaces under any of the action alternatives. Approximately 140 construction workers would be involved in this activity over an estimated 3.5-year timeframe. Metal oxidation furnaces would be installed in an area set aside in MFFF (i.e., separate from the fuel fabrication operations), so construction workers would not be expected to receive any occupation radiation doses. There would be no radiological risk to members of the public from these construction activities at MFFF.

C.3.4.2 Operations

Under the No Action Alternative, surplus plutonium disposition operations would continue at SRS largely as described and evaluated in the *SPD EIS* (DOE 1999), the first supplement analysis to the *SPD EIS* (DOE 2003b), and the *MFFF EIS* (NRC 2005). Where planned operations have changed substantially and might affect potential worker radiological exposures, they are noted. Program activities under the No Action Alternative that would result in worker doses include fabrication of 34 metric tons (37.5 tons) of surplus plutonium into MOX fuel at MFFF. This is expected to require about 21 years of operation. The same MFFF throughput and operational time frame apply under the Immobilization to DWPF Alternative.

Under the H-Canyon/HB-Line to DWPF and WIPP Alternatives, operational activities that would result in worker doses at MFFF include processing 34 metric tons (37.5 tons) of surplus plutonium, as previously evaluated, as well as processing 7.1 metric tons (7.8 tons) of additional surplus pit plutonium (not previously analyzed). Processing operations associated with the additional 7.1 metric tons (7.8 tons) of pit plutonium would be similar to those for the other material previously evaluated and would extend the operating life of MFFF by 2 years, to a total of 23 years. Annual worker exposures would be similar to those previously analyzed, but the total exposures would increase in proportion to the extension of the facility's operating life.

Under the MOX Fuel Alternative, operational activities that would result in worker doses at MFFF include processing 34 metric tons (37.5 tons) of surplus plutonium (previously analyzed); an additional 7.1 metric tons (7.8 tons) of surplus pit plutonium (not previously analyzed); and an additional 4 metric tons (4.4 tons) of surplus non-pit plutonium (not previously analyzed), or a total of 45.1 metric tons (49.7 tons) of surplus plutonium. Impacts from MOX fuel fabrication of the additional 7.1 metric tons (7.8 tons) of pit plutonium would be similar to the impacts of processing other material previously evaluated. The impacts of MOX fuel fabrication of 4 metric tons (4.4 tons) of non-pit plutonium after initial preparation of the material at H-Canyon/HB-Line would likewise be similar to the impacts of processing other material previously evaluated. The net effect of processing the additional plutonium under the MOX Fuel Alternative would be to increase the operating life of MFFF to a total of 24 years. Annual worker exposures would be similar to those previously analyzed, but the cumulative exposures would increase in proportion to the extension of the facility's operating life.

Under any of the action alternatives, two of the options for pit disassembly and conversion include the use of metal oxidations furnaces installed in MFFF for converting 35 metric tons (38.6 tons) of surplus plutonium to plutonium oxide. The operations would occur over a period of 20 years.

Tables C-30 and C-31 present the projected incident-free radiological impacts of MFFF operations. **Tables C-32 and C-33** present the projected incident-free radiological impacts from operation of metal oxidation furnaces at MFFF.

Table C–30 Radiological Impacts on the Public from Operation of the Mixed Oxide Fuel Fabrication Facility

Impact Area	Alternative				
	No Action	Immobilization to DWPF	MOX Fuel	H-Canyon/ HB-Line to DWPF	WIPP
Operational Years for MFFF	21	21	24	23	23
Population within 50 Miles (80 kilometers)					
Annual dose (person-rem)	0.045	0.045	0.052	0.050	0.050
Percent of natural background radiation ^a	1.7×10^{-5}	1.7×10^{-5}	1.9×10^{-5}	1.9×10^{-5}	1.9×10^{-5}
Annual LCFs ^b	0 (3×10^{-5})	0 (3×10^{-5})	0 (3×10^{-5})	0 (3×10^{-5})	0 (3×10^{-5})
Life-of-Project LCFs ^b	0 (0.0006)	0 (0.0006)	0 (0.0007)	0 (0.0007)	0 (0.0007)
Maximally Exposed Individual					
Annual dose (millirem)	0.00050	0.00050	0.00058	0.00055	0.00055
Percent of natural background radiation ^a	0.00016	0.00016	0.00019	0.00018	0.00018
Annual LCF risk	3×10^{-10}	3×10^{-10}	4×10^{-10}	3×10^{-10}	3×10^{-10}
Life-of-Project LCF risk	6×10^{-9}	6×10^{-9}	8×10^{-9}	8×10^{-9}	8×10^{-9}
Average Exposed Individual within 50 Miles (80 kilometers) ^c					
Annual dose (millirem)	5.2×10^{-5}	5.2×10^{-5}	6.0×10^{-5}	5.7×10^{-5}	5.7×10^{-5}
Annual LCF risk	3×10^{-11}	3×10^{-11}	4×10^{-11}	3×10^{-11}	3×10^{-11}
Life-of-Project LCF risk	7×10^{-10}	7×10^{-10}	9×10^{-10}	8×10^{-10}	8×10^{-10}

DWPF = Defense Waste Processing Facility; LCF = latent cancer fatality; MFFF = Mixed Oxide Fuel Fabrication Facility; MOX = mixed oxide; WIPP = Waste Isolation Pilot Plant.

^a The annual natural background radiation dose assumed for SRS is 311 millirem for the average individual; the population within 50 miles (80 kilometers) of F-Area in 2020 would receive a dose of about 270,000 person-rem.

^b Numbers of LCFs in the population are whole numbers; the statistically calculated values are provided in parentheses.

^c Obtained by dividing the population dose by the number of people projected to live within 50 miles (80 kilometers) of the SRS facilities in 2020 (approximately 869,000 for F-Area).

Note: To convert metric tons to tons, multiply by 1.1023.

Table C–31 Radiological Impacts on Workers from Operation of the Mixed Oxide Fuel Fabrication Facility

Impact Area	Alternative				
	No Action	Immobilization to DWPF	MOX Fuel	H-Canyon/ HB-Line to DWPF	WIPP
Operational Years for MFFF	21	21	24	23	23
Total Workforce					
Number of radiation workers	450	450	450	450	450
Collective dose (person-rem per year)	51	51	51	51	51
Annual LCFs ^a	0 (0.03)	0 (0.03)	0 (0.03)	0 (0.03)	0 (0.03)
Life-of-Project LCFs ^a	1 (0.6)	1 (0.6)	1 (0.7)	1 (0.7)	1 (0.7)
Average Worker					
Dose (millirem per year) ^b	110	110	110	110	110
Annual LCF risk	0.00007	0.00007	0.00007	0.00007	0.00007
Life-of-Project LCF risk	0.001	0.001	0.002	0.002	0.002

DWPF = Defense Waste Processing Facility; LCF = latent cancer fatality; MFFF = Mixed Oxide Fuel Fabrication Facility; MOX = mixed oxide; WIPP = Waste Isolation Pilot Plant.

^a Numbers of LCFs in the worker population are whole numbers; the statistically calculated values are provided in parentheses.

^b Engineering and administrative controls would be implemented to maintain individual worker doses below 2,000 millirem per year and as low as reasonably achievable (DOE 2005a, 2009).

Note: To convert metric tons to tons, multiply by 1.1023.

Source: SRNS 2012.

Table C–32 Radiological Impacts on the Public from Operation of Metal Oxidation Furnaces at the Mixed Oxide Fuel Fabrication Facility

Impact Area	Alternative				
	No Action	Immobilization to DWPF	MOX Fuel	H-Canyon/ HB-Line to DWPF	WIPP
Operational Years for Oxidation at MFFF	N/A	20	20	20	20
Population within 50 Miles (80 kilometers)					
Annual dose (person-rem)	N/A	0.37	0.37	0.37	0.37
Percent of natural background radiation ^a	N/A	0.00014	0.00014	0.00014	0.00014
Annual LCFs ^b	N/A	0 (0.0002)	0 (0.0002)	0 (0.0002)	0 (0.0002)
Life-of-Project LCFs ^b	N/A	0 (0.004)	0 (0.004)	0 (0.004)	0 (0.004)
Maximally Exposed Individual					
Annual dose (millirem)	N/A	0.0041	0.0041	0.0041	0.0041
Percent of natural background radiation ^a	N/A	0.0013	0.0013	0.0013	0.0013
Annual LCF risk	N/A	2 × 10 ⁻⁹	2 × 10 ⁻⁹	2 × 10 ⁻⁹	2 × 10 ⁻⁹
Life-of-Project LCF risk	N/A	5 × 10 ⁻⁸	5 × 10 ⁻⁸	5 × 10 ⁻⁸	5 × 10 ⁻⁸
Average Exposed Individual within 50 Miles (80 kilometers) ^c					
Annual dose (millirem)	N/A	0.00043	0.00043	0.00043	0.00043
Annual LCF risk	N/A	3 × 10 ⁻¹⁰	3 × 10 ⁻¹⁰	3 × 10 ⁻¹⁰	3 × 10 ⁻¹⁰
Life-of-Project LCF risk	N/A	5 × 10 ⁻⁹	5 × 10 ⁻⁹	5 × 10 ⁻⁹	5 × 10 ⁻⁹

DWPF = Defense Waste Processing Facility; LCF = latent cancer fatality; MFFF = Mixed Oxide Fuel Fabrication Facility; MOX = mixed oxide; N/A = not applicable; WIPP = Waste Isolation Pilot Plant.

^a The annual natural background radiation dose assumed for SRS is 311 millirem for the average individual; the population within 50 miles (80 kilometers) of F-Area in 2020 would receive a dose of about 270,000 person-rem.

^b Numbers of LCFs in the population are whole numbers; the statistically calculated values are provided in parentheses.

^c Obtained by dividing the population dose by the number of people projected to live within 50 miles (80 kilometers) of the SRS facilities in 2020 (approximately 869,000 for F-Area).

Table C–33 Radiological Impacts on Workers from Operation of Metal Oxidation Furnaces at the Mixed Oxide Fuel Fabrication Facility

Impact Area	Alternative				
	No Action	Immobilization to DWPF	MOX Fuel	H-Canyon/ HB-Line to DWPF	WIPP
Operational Years for Oxidation at MFFF	N/A	20	20	20	20
Total Workforce					
Number of radiation workers	N/A	35	35	35	35
Collective dose (person-rem per year)	N/A	2.3	2.3	2.3	2.3
Annual LCFs ^a	N/A	0 (0.001)	0 (0.001)	0 (0.001)	0 (0.001)
Life-of-Project LCFs ^a	N/A	0 (0.03)	0 (0.03)	0 (0.03)	0 (0.03)
Average Worker					
Dose (millirem per year) ^b	N/A	65	65	65	65
Annual LCF risk	N/A	0.00004	0.00004	0.00004	0.00004
Life-of-Project LCF risk	N/A	0.0008	0.0008	0.0008	0.0008

DWPF = Defense Waste Processing Facility; LCF = latent cancer fatality; MFFF = Mixed Oxide Fuel Fabrication Facility; MOX = mixed oxide; N/A = not applicable; WIPP = Waste Isolation Pilot Plant.

^a Numbers of LCFs in the worker population are whole numbers; the statistically calculated values are provided in parentheses.

^b Engineering and administrative controls would be implemented to maintain individual worker doses below 2,000 millirem per year and as low as reasonably achievable (DOE 2005a, 2009).

Source: SRNS 2012.

C.3.5 Pit Disassembly and Conversion Facility in F-Area

C.3.5.1 Construction

There would be no radiological risk to the public from the construction of PDCF. Construction worker exposures to radiation derived from other activities at the site, past or present, would also be kept within ALARA levels. Construction workers would be monitored (badged) as appropriate.

C.3.5.2 Operations

Under the No Action Alternative, surplus plutonium disposition operations would proceed at SRS largely as described and evaluated in the *SPD EIS* (DOE 1999), *SPD EIS SA-1* (DOE 2003b), and *MFFF EIS* (NRC 2005). Program activities under the No Action Alternative that would result in worker doses and radiological emissions include processing surplus plutonium at PDCF over a period of 10 years, as evaluated in the *SPD EIS SA-1* (DOE 2003b) and the *MFFF EIS* (NRC 2005), with transfer of the liquid wastes to WSB.

Under the Immobilization to DWPF, MOX Fuel, H-Canyon/HB-Line to DWPF, and WIPP Alternatives, processing additional pit plutonium would extend the operating life to a total of 12 years (for example, see Chapter 2, Section 2.3). Annual worker and public exposures would be similar to those previously analyzed, but the cumulative exposures would increase in proportion to the extension of the facility’s operating life. **Tables C–34** and **C–35** present the projected incident-free radiological impacts of PDCF operations.

Table C–34 Radiological Impacts on the Public from Operation of the Pit Disassembly and Conversion Facility in F-Area

Impact Area	Alternative				
	No Action	Immobilization to DWPF	MOX Fuel	H-Canyon/ HB-Line to DWPF	WIPP
Operational Years for PDCF	10	12	12	12	12
Population within 50 Miles (80 kilometers)					
Annual dose (person-rem)	0.46	0.46	0.46	0.46	0.46
Percent of natural background radiation ^a	0.00017	0.00017	0.00017	0.00017	0.00017
Annual LCFs ^b	0 (0.0003)	0 (0.0003)	0 (0.0003)	0 (0.0003)	0 (0.0003)
Life-of-Project LCFs ^b	0 (0.003)	0 (0.003)	0 (0.003)	0 (0.003)	0 (0.003)
Maximally Exposed Individual					
Annual dose (millirem)	0.0055	0.0055	0.0055	0.0055	0.0055
Percent of natural background radiation ^a	0.0018	0.0018	0.0018	0.0018	0.0018
Annual LCF risk	3 × 10 ⁻⁹	3 × 10 ⁻⁹	3 × 10 ⁻⁹	3 × 10 ⁻⁹	3 × 10 ⁻⁹
Life-of-Project LCF risk	3 × 10 ⁻⁸	4 × 10 ⁻⁸	4 × 10 ⁻⁸	4 × 10 ⁻⁸	4 × 10 ⁻⁸
Average Exposed Individual within 50 Miles (80 kilometers) ^c					
Annual dose (millirem)	0.00053	0.00053	0.00053	0.00053	0.00053
Annual LCF risk	3 × 10 ⁻¹⁰	3 × 10 ⁻¹⁰	3 × 10 ⁻¹⁰	3 × 10 ⁻¹⁰	3 × 10 ⁻¹⁰
Life-of-Project LCF risk	3 × 10 ⁻⁹	4 × 10 ⁻⁹	4 × 10 ⁻⁹	4 × 10 ⁻⁹	4 × 10 ⁻⁹

DWPF = Defense Waste Processing Facility; LCF = latent cancer fatality; MOX = mixed oxide; PDCF = Pit Disassembly and Conversion Facility; WIPP = Waste Isolation Pilot Plant.

^a The annual natural background radiation dose assumed for SRS is 311 millirem for the average individual; the population within 50 miles (80 kilometers) of F-Area in 2020 would receive a dose of about 270,000 person-rem.

^b Numbers of LCFs in the population are whole numbers; the statistically calculated values are provided in parentheses.

^c Obtained by dividing the population dose by the number of people projected to live within 50 miles (80 kilometers) of the SRS facilities in 2020 (approximately 869,000 for F-Area).

Source: SRNS 2012.

Table C-35 Radiological Impacts on Workers from Operation of the Pit Disassembly and Conversion Facility in F-Area

Impact Area	Alternative				
	No Action	Immobilization to DWPF	MOX Fuel	H-Canyon/ HB-Line to DWPF	WIPP
Operational Years for PDCF	10	12	12	12	12
Total Workforce					
Number of radiation workers	383	383	383	383	383
Collective dose (person-rem per year)	190	190	190	190	190
Annual LCFs ^a	0 (0.1)	0 (0.1)	0 (0.1)	0 (0.1)	0 (0.1)
Life-of-Project LCFs ^a	1 (1.4)	1 (1.4)	1 (1.4)	1 (1.4)	1 (1.4)
Average Worker					
Dose (millirem per year) ^b	500	500	500	500	500
Annual LCF risk	0.0003	0.0003	0.0003	0.0003	0.0003
Life-of-Project LCF risk	0.003	0.004	0.004	0.004	0.004

DWPF = Defense Waste Processing Facility; LCF = latent cancer fatality; MOX = mixed oxide; PDCF = Pit Disassembly and Conversion Facility; WIPP = Waste Isolation Pilot Plant.

^a Numbers of LCFs in the worker population are whole numbers; the statistically calculated values are provided in parentheses.

^b Engineering and administrative controls would be implemented to maintain individual worker doses below 2,000 millirem per year and as low as reasonably achievable (DOE 2005a, 2009).

Source: SRNS 2012.

C.3.6 Waste Solidification Building

C.3.6.1 Construction

Potential impacts associated with the construction of WSB were previously analyzed (DOE 2008). No addition construction or modifications are evaluated in the *SPD Supplemental EIS*.

C.3.6.2 Operations

Under all alternatives, surplus plutonium disposition operations would proceed at SRS largely as described and evaluated in the *SPD EIS* (DOE 1999), *SPD EIS SA-1* (DOE 2003b), and the *MFFF EIS* (NRC 2005). Program activities under all alternatives, including processing liquid wastes from MFFF and PDCF, would result in worker doses and radiological air emissions. **Tables C-36** and **C-37** present the projected incident-free radiological impacts of WSB operations.

Table C–36 Radiological Impacts on the Public from Operation of the Waste Solidification Building

Impact Area	Alternative				
	No Action	Immobilization to DWPF	MOX Fuel	H-Canyon/ HB-Line to DWPF	WIPP
Operational Years for WSB	21	23	24	23	23
Population within 50 Miles (80 kilometers)					
Annual dose (person-rem)	0.031	0.031	0.031	0.031	0.031
Percent of natural background radiation ^a	1.1×10^{-5}	1.1×10^{-5}	1.1×10^{-5}	1.1×10^{-5}	1.1×10^{-5}
Annual LCFs ^b	0 (2×10^{-5})	0 (2×10^{-5})	0 (2×10^{-5})	0 (2×10^{-5})	0 (2×10^{-5})
Life-of-Project LCFs ^b	0 (0.0004)	0 (0.0004)	0 (0.0004)	0 (0.0004)	0 (0.0004)
Maximally Exposed Individual					
Annual dose (millirem)	0.00063	0.00063	0.00063	0.00063	0.00063
Percent of natural background radiation ^a	0.00020	0.00020	0.00020	0.00020	0.00020
Annual LCF risk	4×10^{-10}	4×10^{-10}	4×10^{-10}	4×10^{-10}	4×10^{-10}
Life-of-Project LCF risk	8×10^{-9}	9×10^{-9}	9×10^{-9}	9×10^{-9}	9×10^{-9}
Average Exposed Individual within 50 Miles (80 kilometers) ^c					
Annual dose (millirem)	3.6×10^{-5}	3.6×10^{-5}	3.6×10^{-5}	3.6×10^{-5}	3.6×10^{-5}
Annual LCF risk	2×10^{-11}	2×10^{-11}	2×10^{-11}	2×10^{-11}	2×10^{-11}
Life-of-Project LCF risk	5×10^{-10}	5×10^{-10}	5×10^{-10}	5×10^{-10}	5×10^{-10}

DWPF = Defense Waste Processing Facility; LCF = latent cancer fatality; MOX = mixed oxide; WIPP = Waste Isolation Pilot Plant; WSB = Waste Solidification Building.

^a The annual natural background radiation dose assumed for SRS is 311 millirem for the average individual; the population within 50 miles (80 kilometers) of F-Area in 2020 would receive a dose of about 270,000 person-rem.

^b Numbers of LCFs in the population are whole numbers; the statistically calculated values are provided in parentheses.

^c Obtained by dividing the population dose by the number of people projected to live within 50 miles (80 kilometers) of the SRS facilities in 2020 (approximately 869,000 for F-Area).

Table C–37 Radiological Impacts on Workers from Operation of the Waste Solidification Building

Impact Area	Alternative				
	No Action	Immobilization to DWPF	MOX Fuel	H-Canyon/ HB-Line to DWPF	WIPP
Operational Years for WSB	21	23	24	23	23
Total Workforce					
Number of radiation workers	50	50	50	50	50
Collective dose (person-rem per year)	25	25	25	25	25
Annual LCFs ^a	0 (0.02)	0 (0.02)	0 (0.02)	0 (0.02)	0 (0.02)
Life-of-Project LCFs ^a	0 (0.3)	0 (0.3)	0 (0.4)	0 (0.3)	0 (0.3)
Average Worker					
Dose (millirem per year) ^b	500	500	500	500	500
Annual LCF risk	0.0003	0.0003	0.0003	0.0003	0.0003
Life-of-Project LCF risk	0.006	0.007	0.007	0.007	0.007

DWPF = Defense Waste Processing Facility; LCF = latent cancer fatality; MOX = mixed oxide; WIPP = Waste Isolation Pilot Plant; WSB = Waste Solidification Building.

^a Numbers of LCFs in the worker population are whole numbers; the statistically calculated values are provided in parentheses.

^b Engineering and administrative controls would be implemented to maintain individual worker doses below 2,000 millirem per year and as low as reasonably achievable (DOE 2005a, 2009).

Source: SRNS 2012.

C.3.7 Defense Waste Processing Facility

C.3.7.1 Construction

There would be no radiological risk to the public from modifications to DWPF. Construction worker exposures to radiation derived from other activities at the site, past or present, would be kept ALARA. Construction workers would be monitored (badged) as appropriate. Doses associated with modifications would be minimal, resulting in less than 0.1 person-rem to the workforce. DWPF modifications are only expected under the Immobilization to DWPF Alternative (SRNS 2012; WSRC 2008).

C.3.7.2 Operations

All action alternatives, with the exception of the WIPP Alternative, would rely on DWPF to handle the additional material processed through H-Canyon/HB-Line or the immobilization capability. Annual worker exposures would be similar to those previously analyzed in the *Final Environmental Impact Statement, Defense Waste Processing Facility, Savannah River Plant* (DOE 1982) and the *Final Supplemental Environmental Impact Statement, Defense Waste Processing Facility* (DOE 1994). The cumulative exposures would increase in proportion to the extension of the facility's operating life.

Under the Immobilization to DWPF Alternative, 13.1 metric tons (14.4 tons) of surplus plutonium in cans would be transferred to DWPF to be encapsulated in canisters of HLW. Although additional HLW canisters would be generated (see Chapter 2, Section 2.2.1), no additional glass would be poured. Glass would simply be poured into additional canisters due to the 12 percent reduction in space for vitrified HLW within the 790 can-in-canister assemblies. No plutonium would be released from the canisters that would be processed at DWPF, so there would be no net increase in normal atmospheric radiological releases from DWPF (SRNS 2012; WSRC 2008).

Under the MOX Fuel Alternative, 4 metric tons (4.4 tons) of non-pit plutonium would be processed at H-Canyon/HB-Line, creating waste that would generate approximately 2 additional canisters; under all action alternatives however, it is possible to process 10 metric tons (11 tons) of pit and metallic plutonium at H-Canyon/HB-Line, resulting in waste generating approximately 5 additional canisters.

Under the H-Canyon/HB-Line to DWPF Alternative, 6 metric tons (6.6 tons) of surplus plutonium from H-Canyon/HB-Line would be transferred for vitrification with HLW at DWPF. The plutonium mixed with the HLW would not contribute substantially to the DWPF normal release source term, so no incremental normal releases from DWPF are expected from these alternatives (SRNS 2012; WSRC 2008). Therefore, no incremental normal releases from DWPF are expected under any of the alternatives (SRNS 2012; WSRC 2008). **Table C-38** presents the projected incident-free radiological impacts on workers from DWPF operations.

Table C–38 Potential Incremental Radiological Impacts on Workers from Operation of the Defense Waste Processing Facility

Impact Area	Alternative				
	No Action	Immobilization to DWPF	MOX Fuel	H-Canyon/ HB-Line to DWPF	WIPP
Operational Years for DWPF	N/A	10	6	13	N/A
Total Workforce					
Number of radiation workers ^a	N/A	25	5	8	N/A
Collective dose (person-rem per year)	N/A	5.9	1.2	1.9	N/A
Annual LCFs ^b	N/A	0 (0.004)	0 (0.0007)	0 (0.001)	N/A
Life-of-Project LCFs ^b	N/A	0 (0.04)	0 (0.004)	0 (0.01)	N/A
Average Worker					
Dose (millirem per year) ^c	N/A	240	240	240	N/A
Annual LCF risk	N/A	0.0001	0.0001	0.0001	N/A
Life-of-Project LCF risk	N/A	0.001	0.0009	0.002	N/A

DWPF = Defense Waste Processing Facility; LCF = latent cancer fatality; MOX = mixed oxide; N/A = not applicable; WIPP = Waste Isolation Pilot Plant.

^a Numbers represent full-time-equivalent workers based on an estimate that no more than 1 to 5 percent of the dose to the 500 badged workers at DWPF would be due to plutonium processing activities (plutonium canister handling, vitrification of additional plutonium-canister material, and handling/staging of plutonium-vitrified material for transport to the Glass Waste Storage Building).

^b Numbers of LCFs in the worker population are whole numbers; the statistically calculated values are provided in parentheses.

^c Engineering and administrative controls would be implemented to maintain individual worker doses below 2,000 millirem per year and as low as reasonably achievable (DOE 2005a, 2009).

Note: To convert metric tons to tons, multiply by 1.1023.

Source: DOE 1994: Section 4.1.11.2; SRNS 2012; WSRC 2008.

C.4 Los Alamos National Laboratory

C.4.1 Los Alamos National Laboratory Plutonium Facility

C.4.1.1 Construction

There would be no radiological risk to the public from any potential modification activities (e.g., glovebox installations/modifications/decontamination and decommissioning (D&D) and installation of equipment) at PF-4. Construction worker doses are expected; however, they were estimated not to exceed an annual workforce dose of 18 person-rem per year to 60 workers (about 40 full-time equivalent workers) (LANL 2012), which is equal to an average construction worker dose of 300 millirem per year. This equates to a total potential construction workforce dose of 140 person-rem over the estimated 8 years of facility modifications. This workforce would be monitored (badged).

C.4.1.2 Operations

Under all alternatives analyzed in this *SPD Supplemental EIS*, some level of pit disassembly and conversion processing would occur at PF-4. For all alternatives, under the PDCF Option for pit disassembly and conversion, and for the MOX, H-Canyon/HB-Line, and WIPP Alternatives, under the PDC Option for pit disassembly and conversion, 2 metric tons (2.2 tons) of plutonium would be processed at PF-4. For all action alternatives under the PF-4 and MFFF Option and the PF-4, H-Canyon/HB-Line, and MFFF Option for pit disassembly and conversion, 35 metric tons (38.6 tons) of plutonium would be processed at PF-4. **Tables C–39** and **C–40** present the projected incident-free radiological impacts from PF-4 pit disassembly and conversion operations.

Table C–39 Potential Radiological Impacts on the Public from Pit Disassembly and Conversion Operations at the Los Alamos National Laboratory Plutonium Facility

Impact Area	Alternative				
	No Action	Immobilization to DWPF	MOX Fuel	H-Canyon/ HB-Line to DWPF	WIPP
Operational Years for Processing at LANL PF-4 (2 MT Case/35 MT Case)	7	7/22	7/22	7/22	7/22
Population within 50 Miles (80 kilometers)					
Annual dose (person-rem)	0.025	0.025/0.21	0.025/0.21	0.025/0.21	0.025/0.21
Percent of natural background radiation ^a	1.2×10 ⁻⁵	1.2×10 ⁻⁵ / 9.8×10 ⁻⁵	1.2×10 ⁻⁵ / 9.8×10 ⁻⁵	1.2×10 ⁻⁵ / 9.8×10 ⁻⁵	1.2×10 ⁻⁵ / 9.8×10 ⁻⁵
Annual LCFs ^b	0 (2×10 ⁻⁵)	0 (2×10 ⁻⁵ / 1×10 ⁻⁴)	0 (2×10 ⁻⁵ / 1×10 ⁻⁴)	0 (2×10 ⁻⁵ / 1×10 ⁻⁴)	0 (2×10 ⁻⁵ / 1×10 ⁻⁴)
Life-of-Project LCFs ^b	0 (1×10 ⁻⁴)	0 (1×10 ⁻⁴ / 3×10 ⁻³)	0 (1×10 ⁻⁴ / 3×10 ⁻³)	0 (1×10 ⁻⁴ / 3×10 ⁻³)	0 (1×10 ⁻⁴ / 3×10 ⁻³)
Maximally Exposed Individual					
Annual dose (millirem)	0.0097	0.0097/0.081	0.0097/0.081	0.0097/0.081	0.0097/0.081
Percent of natural background radiation ^a	0.0020	0.0020/0.017	0.0020/0.017	0.0020/0.017	0.0020/0.017
Annual LCF risk	6×10 ⁻⁹	6×10 ⁻⁹ / 5×10 ⁻⁸	6×10 ⁻⁹ / 5×10 ⁻⁸	6×10 ⁻⁹ / 5×10 ⁻⁸	6×10 ⁻⁹ / 5×10 ⁻⁸
Life-of-Project LCF risk	4×10 ⁻⁸	4×10 ⁻⁸ / 1×10 ⁻⁶	4×10 ⁻⁸ / 1×10 ⁻⁶	4×10 ⁻⁸ / 1×10 ⁻⁶	4×10 ⁻⁸ / 1×10 ⁻⁶
Average Exposed Individual within 50 Miles (80 kilometers)^c					
Annual dose (millirem)	5.6×10 ⁻⁵	5.6×10 ⁻⁵ / 4.7×10 ⁻⁴	5.6×10 ⁻⁵ / 4.7×10 ⁻⁴	5.6×10 ⁻⁵ / 4.7×10 ⁻⁴	5.6×10 ⁻⁵ / 4.7×10 ⁻⁴
Annual LCF risk	3×10 ⁻¹¹	3×10 ⁻¹¹ / 3×10 ⁻¹⁰	3×10 ⁻¹¹ / 3×10 ⁻¹⁰	3×10 ⁻¹¹ / 3×10 ⁻¹⁰	3×10 ⁻¹¹ / 3×10 ⁻¹⁰
Life-of-Project LCF risk	2×10 ⁻¹⁰	2×10 ⁻¹⁰ / 6×10 ⁻⁹	2×10 ⁻¹⁰ / 6×10 ⁻⁹	2×10 ⁻¹⁰ / 6×10 ⁻⁹	2×10 ⁻¹⁰ / 6×10 ⁻⁹

DWPF = Defense Waste Processing Facility; LANL = Los Alamos National Laboratory; LCF = latent cancer fatality; MOX = mixed oxide; MT = metric tons; PF-4 = Plutonium Facility; WIPP = Waste Isolation Pilot Plant; WSB = Waste Solidification Building.

^a The annual natural background radiation dose at LANL is 480 millirem for the average individual; the population within 50 miles (80 kilometers) in 2020 would receive a dose of about 215,000 person-rem.

^b Numbers of LCFs in the population are whole numbers; the statistically calculated values are provided in parentheses.

^c Obtained by dividing the population dose by the number of people projected to live within 50 miles (80 kilometers) of LANL PF-4 in 2020 (approximately 448,000).

Note: To convert metric tons to tons, multiply by 1.1023.

Source: LANL 2012.

Table C–40 Potential Radiological Impacts on Workers from Pit Disassembly and Conversion Operations at the Los Alamos National Laboratory Plutonium Facility

Impact Area	Alternative				
	No Action	Immobilization to DWPF	MOX Fuel	H-Canyon/ HB-Line to DWPF	WIPP
Operational Years for Processing at LANL PF-4 (2 MT Case/35 MT Case)	7	7/22	7/22	7/22	7/22
Total Workforce					
Number of radiation workers	85	85/253	85/253	85/253	85/253
Collective dose (person-rem per year)	29	29/190	29/190	29/190	29/190
Annual LCFs ^a	0 (0.02)	0 (0.02/0.1)	0 (0.02/0.1)	0 (0.02/0.1)	0 (0.02/0.1)
Life-of-Project LCFs ^a	0 (0.1)	0 (0.1)/3 (2.5)	0 (0.1)/3 (2.5)	0 (0.1)/3 (2.5)	0 (0.1)/3 (2.5)
Average Worker					
Dose (millirem per year) ^b	340	340/760	340/760	340/760	340/760
Annual LCF risk	0.0002	0.0002/0.0005	0.0002/0.0005	0.0002/0.0005	0.0002/0.0005
Life-of-Project LCF risk	0.001	0.001/0.01	0.001/0.01	0.001/0.01	0.001/0.01

DWPF = Defense Waste Processing Facility; LANL = Los Alamos National Laboratory; LCF = latent cancer fatality;

MOX = mixed oxide; MT = metric tons; PF-4 = Plutonium Facility; WIPP = Waste Isolation Pilot Plant.

^a Numbers of LCFs in the worker population are whole numbers; the statistically calculated value is provided in parentheses.

^b Engineering and administrative controls would be implemented to maintain individual worker doses below 2,000 millirem per year and as low as reasonably achievable (DOE 2005a, 2009).

Note: To convert metric tons to tons, multiply by 1.1023.

Source: LANL 2012.

C.5 Combined Impacts under Each Alternative

C.5.1 No Action Alternative

Construction. Construction workers would be monitored (badged), as appropriate. The impacts of construction of PDCF at F-Area would be the same under all alternatives. The only potential dose to workers would be from background radiation levels at SRS (see Section C.3). None of these exposures are expected to result in any additional LCFs to construction workforces.

Because there is no ground surface contamination in F-Area where PDCF would be constructed, there would be no additional radiological releases to the environment or impacts on the general population from ground disturbing construction activities at this location (DOE 1999; NRC 2005:4-7).

Operations. Tables C–41 and C–42 summarize the potential radiological impacts on workers and the general public, respectively, under the No Action Alternative. To facilitate comparison of the potential impacts of the alternatives, the estimated annual doses and latent cancer fatality (LCF) risks over the life of each facility are presented. The impacts over each facility's operating time frame were determined by multiplying the annual impacts by each facility's projected operating period.

Waste management activities would be conducted in support of surplus plutonium activities under this alternative at E-Area at SRS and principally at TA-54 at LANL. These activities are expected to result in negligible incremental impacts to both workers and the public from the staging of transuranic (TRU) waste awaiting shipment to WIPP, from potential storage of mixed low-level radioactive waste (MLLW) pending offsite shipment, or from storage or disposal of low-level radioactive waste (LLW).

Table C–41 Radiological Impacts on Workers from Operations Under the No Action Alternative

Impact Area	SRS					LANL
	Support Facilities			Pit Disassembly and Conversion	Disposition	Pit Disassembly and Conversion
	K-Area Storage	KIS	WSB	PDCF	MFFF	PF-4
Total Workforce						
Number of radiation workers	24	40	50	383	450	85
Collective dose (person-rem per year)	8.9	25	25	192	51	29
Annual LCFs ^a	0 (0.005)	0 (0.02)	0 (0.02)	0 (0.1)	0 (0.03)	0 (0.02)
Life-of-Project LCFs ^a	0 (0.2)	1 (0.6)	0 (0.3)	1	0 (0.6)	0 (0.1)
Average Worker						
Dose (millirem per year) ^b	370	630	500	500	113	340
Annual LCF risk	0.0002	0.0004	0.0003	0.0003	0.00007	0.0002
Life-of-Project LCF risk	0.009	0.02	0.006	0.003	0.001	0.001

KIS = K-Area Interim Surveillance; LANL = Los Alamos National Laboratory; LCF = latent cancer fatality; MFFF = Mixed Oxide Fuel Fabrication Facility; PDCF = Pit Disassembly and Conversion Facility; PF-4 = Plutonium Facility; SRS = Savannah River Site; WSB = Waste Solidification Building.

^a Numbers of LCFs in the worker population are whole numbers; the statistically calculated values are provided in parentheses.

^b Engineering and administrative controls would be implemented to maintain individual worker doses below 2,000 millirem per year and as low as reasonably achievable (DOE 2005a, 2009).

Table C-42 Radiological Impacts on the Public from Operations Under the No Action Alternative

Impact Area	SRS					LANL
	Principal Support Facilities			Pit Disassembly and Conversion Option	Disposition	Pit Disassembly and Conversion Option
	K-Area Storage ^a	KIS	WSB	PDCF	MFFF	PF-4
Population within 50 Miles (80 kilometers)						
Annual dose (person-rem)	0	4.3×10^{-5}	0.031	0.46	0.045	0.025
Percent of natural background radiation ^b	0	1.7×10^{-8}	1.1×10^{-5}	0.00017	1.7×10^{-5}	1.2×10^{-5}
Annual LCFs	0	0 (3×10^{-8})	0 (2×10^{-5})	0 (0.0003)	0 (3×10^{-5})	0 (2×10^{-5})
Life-of-Project LCFs ^c	0	0 (1×10^{-6})	0 (0.0004)	0 (0.003)	0 (0.0006)	0 (1×10^{-4})
Maximally Exposed Individual						
Annual dose (millirem)	0	8.5×10^{-7}	0.00063	0.0055	0.00050	0.0097
Percent of natural background radiation ^b	0	2.7×10^{-7}	0.00020	0.0018	0.00016	0.0020
Annual LCF risk	0	5×10^{-13}	4×10^{-10}	3×10^{-9}	3×10^{-10}	6×10^{-9}
Life-of-Project LCF risk	0	2×10^{-11}	8×10^{-9}	3×10^{-8}	6×10^{-9}	4×10^{-8}
Average Exposed Individual within 50 Miles (80 kilometers)^d						
Annual dose (millirem)	0	5.3×10^{-8}	3.6×10^{-5}	0.00053	0.000052	5.6×10^{-5}
Annual LCF risk	0	3×10^{-14}	2×10^{-11}	3×10^{-10}	3×10^{-11}	3×10^{-11}
Life-of-Project LCF risk	0	1×10^{-12}	5×10^{-10}	3×10^{-9}	7×10^{-10}	2×10^{-10}

KIS = K-Area Interim Surveillance; LANL = Los Alamos National Laboratory; LCF = latent cancer fatality; MFFF = Mixed Oxide Fuel Fabrication Facility; PDCF = Pit Disassembly and Conversion Facility; PF-4 = Plutonium Facility; SRS = Savannah River Site; WSB = Waste Solidification Building.

^a There would be no releases to the atmosphere resulting from storage of plutonium at K-Area and, therefore, no resulting public impacts.

^b To provide perspective, doses can be compared to the estimated doses these same receptors would receive from natural background radiation (311 millirem per year assumed for SRS and 480 millirem per year at LANL for the average individual).

^c Total number of LCFs in the population is a whole number; the statistically calculated total values are provided in parentheses.

^d Obtained by dividing the SRS population dose by the number of people projected to live within 50 miles (80 kilometers) of the SRS facilities in 2020 (approximately 809,000 for K-Area, 869,000 for F-Area, and 886,000 for H-Area), as well as by dividing the LANL population dose by the number of people projected to live within 50 miles (80 kilometers) of LANL PF-4 in 2020 (approximately 448,000).

C.5.2 Immobilization to DWPF Alternative

Construction. Construction workers would be monitored (badged) as appropriate. Under the Immobilization to DWPF Alternative, construction of the new immobilization capability at the K-Area Complex and minor modifications to DWPF to accommodate receipt of can-in-canisters from the immobilization capability would be required. The majority of the construction activities would occur in areas with dose rates close to background radiation levels, although there would be existing equipment that would require decontamination and removal. The total construction workforce dose would be 6.6 person-rem over the estimated 2 years during which decontamination and equipment removal would occur (see Section C.3.2.1).

Under the PF-4, H-Canyon/HB-Line, and MFFF Option, construction workforce doses would result from glovebox-related modifications at H-Canyon/HB-Line and glovebox modifications at K-Area. A total construction workforce dose of 0.5 person-rem could occur during the 2 years of modifications at H-Canyon/HB-Line (see Section C.3.3.1) A total construction workforce dose of 4.0 person-rem could occur during the 2 years of decontamination and equipment removal that would be required to support modifications in K-Area (see Section C.3.1.1).

The impacts of construction of PDCF at F-Area would be the same under all alternatives. The only potential dose to workers would be from background radiation levels at SRS (see Section C.3). Under the PF-4 and MFFF Option or the PF-4, H-Canyon/HB-Line, and MFFF Option, construction workers involved in the installation of metal oxidation furnaces at MFFF would likely receive doses only from background radiation levels at SRS.

At LANL PF-4, potential construction activities (e.g., glovebox installations, modifications, D&D, and installation of equipment) would be necessary to allow pit disassembly and conversion of up to 35 metric tons (38.6 tons) of plutonium. This could result in a total construction workforce dose of 140 person-rem over the estimated 8-year construction duration at the facility (see Section C.4.1.1).

None of these exposures is expected to result in any additional LCFs in construction workforces.

Construction of PDCF would not result in radiological impacts on the general population at the site boundary and beyond. Similarly, installation of metal oxidation furnaces in MFFF would not result in radiological impacts on the public. Construction of the immobilization capability at the K-Area Complex would involve decontamination, demolition, construction, and modification activities, including removal of contaminated equipment and piping. No radiological impacts on the public from these activities are expected, however, because all operations involving radioactive materials would occur within the K-Area reactor building and would be subject to strict controls (WSRC 2008). Releases of radioactive materials to the environment caused by modifications to DWPF to accommodate the can-in-canisters are not expected. In addition, no impacts on the public would result from modifications to H-Canyon/HB-Line or modifications to a K-Area glovebox.

Operations. **Tables C-43** and **C-44** summarize the potential radiological impacts on workers and the general public, respectively, under the Immobilization to DWPF Alternative. To facilitate comparison of the potential impacts of the alternatives, the estimated annual doses and LCF risks over the life of each facility are presented. The impacts over each facility's operating timeframe were determined by multiplying the annual impacts by each facility's projected operating period.

Activities at E-Area in support of the Immobilization to DWPF Alternative are expected to result in negligible incremental impacts on both workers and the public from the staging of TRU waste awaiting shipment to WIPP, from potential storage of MLLW pending offsite shipment, and from storage or disposal of LLW. Similarly, at LANL, no incremental impacts on either workers or the public are expected from operations at the waste management facilities.

C.5.3 MOX Fuel Alternative

Construction. Under the PDC Option, construction of PDC at K-Area would entail decontamination and removal of existing equipment. The total workforce dose over the 2 years required for decontamination and equipment removal in support of PDC construction would be 1.0 person-rem (see Section C.3.1.1)

Under the PF-4, H-Canyon/HB-Line, and MFFF Option, construction worker doses would be the same as discussed for the Immobilization to DWPF Alternative. A total construction workforce dose of 0.5 person-rem could occur during the 2 years of modifications at H-Canyon/HB-Line (see Section C.3.3.1) A total construction workforce dose of 4.0 person-rem could occur during the 2 years of decontamination and equipment removal that would be required to support modifications in K-Area (see Section C.3.1.1).

The impacts of construction of PDCF at F-Area would be the same under all alternatives. The only potential dose to workers would be from background radiation levels at SRS (see Section C.3). Under the PF-4 and MFFF Option or the PF-4, H-Canyon/HB-Line, and MFFF Option, construction workers involved in the installation of metal oxidation furnaces at MFFF would likely receive doses only from background radiation levels at SRS.

Table C-43 Radiological Impacts on Workers from Operations Under the Immobilization to DWPF Alternative

Impact Area	Support Facilities			Pit Disassembly and Conversion Options						Disposition		
	K-Area Storage	KIS	WSB	PDCF	PF-4 at LANL and MFFF ^a at SRS		PF-4 at LANL and H-Canyon/HB-Line and MFFF ^a at SRS			Immobilization Capability	DWPF	MFFF
					Metal Oxidation Furnaces at MFFF	PF-4 (2 MT Case/35 MT Case)	SRS		PF-4 (2 MT Case/35 MT Case)			
							H-Canyon/HB-Line/K-Area Glovebox ^b	Metal Oxidation Furnaces at MFFF				
Total Workforce												
Number of radiation workers	24	40	50	383	35	85 / 253	100 / 50	35	85 / 253	314	25	450
Collective dose (person-rem per year)	8.9	25	25	192	2.3	29 / 190	29 / 38	2.3	29 / 190	314	5.9	51
Annual LCFs ^c	0 (0.005)	0 (0.02)	0 (0.02)	0 (0.1)	0 (0.001)	0 (0.02 / 0.1)	0 (0.02 / 0.02)	0 (0.001)	0 (0.02 / 0.1)	0 (0.2)	0 (0.004)	0 (0.03)
Life-of-Project LCFs ^c	0 (0.1)	0 (0.2)	0 (0.3)	1	0 (0.03)	0 (0.1) / 3	0 (0.3) / 0 (0.3)	0 (0.03)	0 (0.1) / 3	2	0 (0.04)	1 (0.6)
Dose (millirem per year) ^d	370	630	500	500	65	340 / 760	290 / 760	65	340 / 760	1,000	236	113
Annual LCF Risk	0.0002	0.0004	0.0003	0.0003	0.00004	0.0002 / 0.0005	0.0002 / 0.0005	0.00004	0.0002 / 0.0005	0.0006	0.0001	0.00007
Life-of-Project LCF Risk	0.004	0.006	0.007	0.004	0.0008	0.001 / 0.01	0.002 / 0.006	0.0008	0.001 / 0.01	0.006	0.001	0.001

DWPF = Defense Waste Processing Facility; KIS = K-Area Interim Surveillance; LANL = Los Alamos National Laboratory; LCF = latent cancer fatality; MFFF = Mixed Oxide Fuel Fabrication Facility; MT = metric tons; PDCF = Pit Disassembly and Conversion Facility; PF-4 = Plutonium Facility; SRS = Savannah River Site; WSB = Waste Solidification Building;

^a At SRS, pit conversion would be carried out at MFFF using metal oxidation furnaces and/or at H-Canyon/HB-Line.

^b At SRS, conversion of plutonium metal in H-Canyon/HB-Line would complement pit disassembly occurring in a K-Area glovebox.

^c Numbers of LCFs in the worker population are whole numbers; the statistically calculated values are provided in parentheses.

^d Engineering and administrative controls would be implemented to maintain individual worker doses below 2,000 millirem per year and as low as reasonably achievable (DOE 2005a, 2009).

Note: To convert metric tons to tons, multiply by 1.1023.

Table C–44 Radiological Impacts on the Public from Operations Under the Immobilization to DWPF Alternative

Impact Area	Support Facilities			Pit Disassembly and Conversion Options						Disposition			
	K-Area Storage ^a	KIS	WSB	PDCF	PF-4 at LANL and MFFF ^a at SRS		PF-4 at LANL and H-Canyon/HB-Line and MFFF ^a at SRS				Immobilization Capability	DWPF ^c	MFFF
					Metal Oxidation Furnaces at MFFF	PF-4 (2 MT Case/ 35 MT Case)	SRS		PF-4 (2 MT Case/ 35 MT Case)				
							H-Canyon/HB-Line ^b	Metal Oxidation Furnaces at MFFF					
Population within 50 Miles (80 kilometers)													
Annual dose (person-rem)	0	4.3×10^{-5}	0.031	0.46	0.37	0.025/0.21	0.26	0.37	0.025/0.21	0.00062	0	0.045	
Percent of natural background radiation ^d	0	1.7×10^{-8}	1.1×10^{-5}	0.00017	0.00014	$1.2 \times 10^{-5} / 9.8 \times 10^{-5}$	9.6×10^{-5}	0.00014	$1.2 \times 10^{-5} / 9.8 \times 10^{-5}$	2.5×10^{-7}	0	1.7×10^{-5}	
Annual LCFs ^e	0	$0 (3 \times 10^{-8})$	$0 (2 \times 10^{-5})$	0 (0.0003)	0 (0.0002)	$0 (2 \times 10^{-5} / 1 \times 10^{-4})$	0 (0.0002)	0 (0.0002)	$0 (2 \times 10^{-5} / 1 \times 10^{-4})$	$0 (4 \times 10^{-7})$	0	$0 (3 \times 10^{-5})$	
Life-of-Project LCFs ^e	0/0	$0 (4 \times 10^{-7})$	0 (0.0004)	0 (0.003)	0 (0.004)	$0 (1 \times 10^{-4} / 3 \times 10^{-3})$	0 (0.002)	0 (0.004)	$0 (1 \times 10^{-4} / 3 \times 10^{-3})$	$0 (4 \times 10^{-6})$	0	0 (0.0006)	
Maximally Exposed Individual													
Annual dose (millirem)	0	8.5×10^{-7}	0.00063	0.0055	0.0041	0.0097/0.081	0.0024	0.0041	0.0097/0.081	7.5×10^{-6}	0	0.00050	
Percent of natural background radiation ^d	0	2.7×10^{-7}	0.00020	0.0018	0.0013	0.0020/0.017	0.00077	0.0013	0.0020/0.017	2.4×10^{-8}	0	0.00016	
Annual LCF risk	0	5×10^{-13}	4×10^{-10}	3×10^{-9}	2×10^{-9}	$6 \times 10^{-9} / 5 \times 10^{-8}$	1×10^{-9}	2×10^{-9}	$6 \times 10^{-9} / 5 \times 10^{-8}$	5×10^{-12}	0	3×10^{-10}	
Life-of-Project LCF risk	0/0	8×10^{-12}	9×10^{-9}	4×10^{-8}	5×10^{-8}	$4 \times 10^{-8} / 1 \times 10^{-6}$	2×10^{-8}	5×10^{-8}	$4 \times 10^{-8} / 1 \times 10^{-6}$	5×10^{-11}	0	6×10^{-9}	
Average Exposed Individual within 50 Miles (80 kilometers)^f													
Annual dose (millirem)	0	5.3×10^{-8}	3.6×10^{-5}	0.00053	0.00043	$5.6 \times 10^{-5} / 4.7 \times 10^{-4}$	0.00029	0.00043	$5.6 \times 10^{-5} / 4.7 \times 10^{-4}$	7.7×10^{-7}	0	5.2×10^{-5}	
Annual LCF risk	0	3×10^{-14}	2×10^{-11}	3×10^{-10}	3×10^{-10}	$3 \times 10^{-11} / 3 \times 10^{-10}$	2×10^{-10}	3×10^{-10}	$3 \times 10^{-11} / 3 \times 10^{-10}$	5×10^{-13}	0	3×10^{-11}	
Life-of-Project LCF risk	0/0	5×10^{-13}	5×10^{-10}	4×10^{-9}	5×10^{-9}	$2 \times 10^{-10} / 6 \times 10^{-9}$	2×10^{-9}	5×10^{-9}	$2 \times 10^{-10} / 6 \times 10^{-9}$	5×10^{-12}	0	7×10^{-10}	

DWPF = Defense Waste Processing Facility; KIS = K-Area Interim Surveillance; LANL = Los Alamos National Laboratory; LCF = latent cancer fatality; MFFF = Mixed Oxide Fuel Fabrication Facility; MT = metric tons; PDCF = Pit Disassembly and Conversion Facility; PF-4 = Plutonium Facility; SRS = Savannah River Site; WSB= Waste Solidification Building.

^a There would be no releases to the atmosphere from K-Area storage activities and, therefore, no resulting public impacts.

^b Potential doses to members of the public from pit disassembly activities in K-Area gloveboxes would be extremely small due to *de minimis* releases from such activities and would be expected to be a fraction of those from the K-Area Interim Surveillance Capability (SRNS 2012).

^c There would be no additional releases to the atmosphere from DWPF facility operations associated with this alternative and therefore no resulting public impacts.

^d To provide perspective, doses can be compared to the estimated doses these same receptors would receive from natural background radiation (311 millirem per year assumed for SRS and 480 millirem per year at LANL for the average individual).

^e The number of LCFs in the population is a whole number; the statistically calculated total values are provided in parentheses.

^f Obtained by dividing the population dose by the number of people projected to live within 50 miles (80 kilometers) of the SRS facilities and LANL PF-4 in 2020 (approximately 809,000 for K-Area, 869,000 for F-Area, and 886,000 for H-Area; 448,000 for LANL PF-4).

Note: To convert metric tons to tons, multiply by 1.1023.

At LANL PF-4, construction activities would be the same as discussed under the Immobilization to DWPF Alternative for pit disassembly and conversion of 35 metric tons (38.6 tons) of plutonium. This could result in a total construction workforce dose of 140 person-rem over the estimated 8-year construction duration at the facility (see Section C.4.1.1).

None of these exposures is expected to result in any additional LCFs in construction workforces.

Construction of PDCF would not result in radiological impacts on the general population at the site boundary and beyond. Similarly, potential PDC construction activities would not be expected to result in any radiological impacts on the public. In addition, no impacts on the public would result from modification to H-Canyon/HB-Line or from modifications to a K-Area glovebox. Any other potential construction activities, such as at MFFF (e.g., installation of metal oxidation furnaces), would not result in radiological impacts on the public. Similarly, PF-4 construction activities at LANL would not result in any radiological impacts on the public.

Operations. **Tables C–45** and **C–46** summarize the potential radiological impacts on workers and the general public, respectively, under the MOX Fuel Alternative. To facilitate comparison of the potential impacts of the alternatives, the estimated annual doses and LCF risks over the life of each facility are presented. The impacts over each facility's operating timeframe were determined by multiplying the annual impacts by each facility's projected operating period.

Activities at E-Area, in support of the MOX Fuel Alternative are expected to result in negligible incremental impacts on both workers and the public from the staging of TRU waste awaiting shipment to WIPP or any potential MLLW pending offsite shipment, as well as storage/disposal of LLW. Similarly, at LANL, no incremental impacts on either workers or the public are expected from operations at the waste management support facilities.

C.5.4 H-Canyon/HB-Line to DWPF Alternative

Construction. The impacts of construction activities under the H-Canyon/HB-Line to DWPF Alternative would be the same as those under the MOX Fuel Alternative for all potential facilities and functions at F-, K-, or H-Area at SRS, as well as at PF-4 at LANL.

As an additional note under this alternative, however, there could likely be minor modifications at H-Canyon/HB-Line to prepare non-pit plutonium for DWPF vitrification. Operators may change out or reconfigure some tanks and/or piping to increase plutonium storage capacity. Furthermore, HB-Line may reactivate its scrap recovery south line and change out some unused equipment and add additional equipment to implement vacuum salt distillation and sodium peroxide fusion in the effort to minimize equipment corrosion and increase dissolving-throughput-rates. However, no incremental doses to such construction/modification workers carrying out such functions would be expected.

In all cases, no construction worker exposures are expected to result in additional LCFs to construction workforces.

As is the case in the alternatives discussed above, none of the construction would result in any radiological impacts to the public.

Operations. **Tables C–47** and **C–48** summarize the potential radiological impacts on workers and the general public, respectively, under the H-Canyon/HB-Line to DWPF Alternative. To facilitate comparison of the potential impacts of the alternatives, the estimated annual doses and LCF risks over the life of each facility are presented. The impacts over each facility's operating time frame were determined by multiplying the annual impacts by each facility's projected operating period.

Table C-45 Radiological Impacts On Workers from Operations Under the MOX Fuel Alternative

Impact Area	Support Facilities			Pit Disassembly and Conversion Options						Disposition		
	K-Area Storage	KIS	WSB	PDCF / PDC	PF-4 at LANL and MFFF ^a at SRS		PF-4 at LANL and H-Canyon/HB-Line and MFFF ^a at SRS			DWPF	MFFF	H-Canyon/HB-Line Preparation for WIPP
					Metal Oxidation Furnaces at MFFF	PF-4 (2 MT Case/ 35 MT Case)	SRS		PF-4 (2 MT Case/ 35 MT Case)			
							H-Canyon/HB-Line/ K-Area Glovebox ^b	Metal Oxidation Furnaces at MFFF				
Total Workforce												
Number of radiation workers	24	40	50	383 / 383	35	85 / 253	100 / 50	35	85 / 253	5	450	130
Collective dose (person-rem per year)	8.9	25	25	192 / 192	2.3	29 / 190	29 / 38	2.3	29 / 190	1.2	51	20
Annual LCFs ^c	0 (0.005)	0 (0.02)	0 (0.02)	0 (0.1 / 0.1)	0 (0.001)	0 (0.02 / 0.1)	0 (0.02 / 0.02)	0 (0.0010)	0 (0.02 / 0.1)	0 (0.0007)	0 (0.03)	0 (0.01)
Life-of-Project LCFs ^c	0 (0.1)	0 (0.1)	0 (0.4)	1 / 1	0 (0.03)	0 (0.1) / 3	0 (0.2) / 0 (0.3)	0 (0.03)	0 (0.1) / 3	0 (0.004)	1 (0.7)	0 (0.1)
Average Worker												
Dose (millirem per year) ^d	370	630	500	500 / 500	65	340 / 760	290 / 760	65	340 / 760	236	113	150
Annual LCF Risk	0.0002	0.0004	0.0003	0.0003 / 0.0003	0.00004	0.0002 / 0.0005	0.0002 / 0.0005	0.00004	0.0002 / 0.0005	0.0001	0.00007	0.00009
Life-of-Project LCF Risk	0.005	0.003	0.007	0.004 / 0.004	0.0008	0.001 / 0.01	0.002 / 0.006	0.0008	0.001 / 0.01	0.0008	0.002	0.0009

DWPF = Defense Waste Processing Facility; KIS = K-Area Interim Surveillance; LANL = Los Alamos National Laboratory; LCF = latent cancer fatality; MFFF = Mixed Oxide Fuel Fabrication Facility; MOX = mixed oxide; MT = metric tons; PDC = Pit Disassembly and Conversion Project; PDCF = Pit Disassembly and Conversion Facility; PF-4 = Plutonium Facility; SRS = Savannah River Site; WIPP = Waste Isolation Pilot Plant; WSB= Waste Solidification Building.

^a At SRS, pit conversion would be carried out at MFFF using metal oxidation furnaces and/or at H-Canyon/HB-Line.

^b At SRS, conversion of plutonium metal in H-Canyon/HB-Line would complement pit disassembly occurring in a K-Area glovebox.

^c The numbers of LCFs in the worker population are whole numbers; statistically calculated values are provided in parentheses.

^d Engineering and administrative controls would be implemented to maintain individual worker doses below 2,000 millirem per year and as low as reasonably achievable (DOE 2005a, 2009).

Note: To convert metric tons to tons, multiply by 1.1023.

Table C-46 Radiological Impacts on the Public from Operations Under the MOX Fuel Alternative

Impact Area	Support Facilities			Pit Disassembly and Conversion Options						Disposition		
	K-Area Storage ^a	KIS	WSB	PDCF / PDC	PF-4 at LANL and MFFF ^a at SRS		PF-4 at LANL and H-Canyon/HB-Line and MFFF ^a at SRS			DWPF ^c	MFFF ^d	H-Canyon/HB-Line Preparation for WIPP
					Metal Oxidation Furnaces at MFFF	PF-4 (2 MT Case / 35 MT Case)	SRS		PF-4 (2 MT Case / 35 MT Case)			
							H-Canyon/HB-Line ^b	Metal Oxidation Furnaces at MFFF				
Population within 50 Miles (80 kilometers)												
Annual dose (person-rem)	0	4.3×10^{-5}	0.031	0.46 / 0.44	0.37	0.025 / 0.21	0.26	0.37	0.025 / 0.21	0	0.052	0.26
Percent of natural background radiation ^e	0	1.7×10^{-8}	1.1×10^{-5}	0.00017 / 0.00018	0.00014	$1.2 \times 10^{-5} / 9.8 \times 10^{-5}$	9.6×10^{-5}	0.00014	$1.2 \times 10^{-5} / 9.8 \times 10^{-5}$	0	1.9×10^{-5}	9.6×10^{-5}
Annual LCFs ^f	0	$0 (3 \times 10^{-8})$	$0 (2 \times 10^{-5})$	$0 (0.0003 / 0.0003)$	$0 (0.0002)$	$0 (2 \times 10^{-5} / 1 \times 10^{-4})$	$0 (0.0002)$	$0 (0.0002)$	$0 (2 \times 10^{-5} / 1 \times 10^{-4})$	0	$0 (3 \times 10^{-5})$	$0 (0.0002)$
Life-of-Project LCFs ^f	0	$0 (2 \times 10^{-7})$	$0 (0.0005)$	$0 (0.003 / 0 (0.003))$	$0 (0.004)$	$0 (1 \times 10^{-4} / 3 \times 10^{-3})$	$0 (0.002)$	$0 (0.004)$	$0 (1 \times 10^{-4} / 3 \times 10^{-3})$	0	$0 (0.0007)$	$0 (0.002)$
Maximally Exposed Individual												
Annual dose (millirem)	0	8.5×10^{-7}	0.00063	0.0055 / 0.0061	0.0041	0.0097 / 0.081	0.0024	0.0041	0.0097/0.081	0	0.00058	0.0024
Percent of natural background radiation ^e	0	2.7×10^{-7}	0.00020	0.0018 / 0.0020	0.0013	0.0020 / 0.017	0.00077	0.0013	0.0020/0.017	0	0.00019	0.00077
Annual LCF risk	0	5×10^{-13}	4×10^{-10}	$3 \times 10^{-9} / 4 \times 10^{-9}$	2×10^{-9}	$6 \times 10^{-9} / 5 \times 10^{-8}$	1×10^{-9}	2×10^{-9}	$6 \times 10^{-9} / 5 \times 10^{-8}$	0	4×10^{-10}	1×10^{-9}
Life-of-Project LCF risk	0	4×10^{-12}	9×10^{-9}	$4 \times 10^{-8} / 4 \times 10^{-8}$	5×10^{-8}	$4 \times 10^{-8} / 1 \times 10^{-6}$	2×10^{-8}	5×10^{-8}	$4 \times 10^{-8} / 1 \times 10^{-6}$	0	8×10^{-9}	1×10^{-8}
Average Exposed Individual within 50 Miles (80 kilometers)^g												
Annual dose (millirem)	0	5.3×10^{-8}	3.6×10^{-5}	0.00053 / 0.00055	0.00043	$5.6 \times 10^{-5} / 4.7 \times 10^{-4}$	0.00029	0.00043	$5.6 \times 10^{-5} / 4.7 \times 10^{-4}$	0	6.0×10^{-5}	0.00029
Annual LCF risk	0	3×10^{-14}	2×10^{-11}	$3 \times 10^{-10} / 3 \times 10^{-10}$	3×10^{-10}	$3 \times 10^{-11} / 3 \times 10^{-10}$	2×10^{-10}	3×10^{-10}	$3 \times 10^{-11} / 3 \times 10^{-10}$	0	4×10^{-11}	2×10^{-10}
Life-of-Project LCF risk	0	2×10^{-13}	5×10^{-10}	$4 \times 10^{-9} / 4 \times 10^{-9}$	5×10^{-9}	$2 \times 10^{-10} / 6 \times 10^{-9}$	2×10^{-9}	5×10^{-9}	$2 \times 10^{-10} / 6 \times 10^{-9}$	0	9×10^{-10}	2×10^{-9}

Impact Area	Support Facilities			Pit Disassembly and Conversion Options					Disposition			
	K-Area Storage ^a	KIS	WSB	PDCF / PDC	PF-4 at LANL and MFFF ^a at SRS		PF-4 at LANL and H-Canyon/HB-Line and MFFF ^a at SRS			DWPF ^c	MFFF ^d	H-Canyon/HB-Line Preparation for WIPP
					Metal Oxidation Furnaces at MFFF	PF-4 (2 MT Case / 35 MT Case)	SRS		PF-4 (2 MT Case / 35 MT Case)			
							H-Canyon/HB-Line ^b	Metal Oxidation Furnaces at MFFF				

DWPF = Defense Waste Processing Facility; KIS = K-Area Interim Surveillance; LANL = Los Alamos National Laboratory; LCF = latent cancer fatality; MFFF = Mixed Oxide Fuel Fabrication Facility; MOX = mixed oxide; MT = metric tons; PDC = Pit Disassembly and Conversion Project; PDCF = Pit Disassembly and Conversion Facility; PF-4 = Plutonium Facility; SRS = Savannah River Site; WIPP = Waste Isolation Pilot Plant; WSB = Waste Solidification Building.

^a There would be no releases to the atmosphere from storage of plutonium at K-Area and, therefore, no public impacts.

^b Potential doses to members of the public from pit disassembly activities in K-Area gloveboxes would be extremely small due to *de minimis* releases from such activities, and would be expected to be a fraction of those from the K-Area Interim Surveillance Capability (SRNS 2012).

^c There would be no additional releases to the atmosphere from DWPF facility operations associated with this alternative and, therefore, no resulting public impacts.

^d At MFFF, 45.1 metric tons of plutonium would be processed over a 24-year period; this would result in an estimated annual throughput rate difference of about 15 percent over the duration of the No Action Alternative (34 metric tons over 21 years).

^e To provide perspective, doses can be compared to the estimated doses these same receptors would receive from natural background radiation (311 millirem per year at SRS and 480 millirem per year at LANL for the average individual).

^f The number of LCFs in the population is a whole number; the statistically calculated total values are provided in parentheses.

^g Obtained by dividing the population dose by the number of people projected to live within 50 miles (80 kilometers) of the SRS facilities and LANL PF-4 in 2020 (approximately 809,000 for K-Area, 869,000 for F-Area, and 886,000 for H-Area; 448,000 for LANL PF-4).

Note: To convert metric tons to tons, multiply by 1.1023.

Table C-47 Radiological Impacts On Workers from Operations Under the H-Canyon/HB-Line to DWPF Alternative

Impact Area	Support Facilities			Pit Disassembly and Conversion Options						Disposition		
	K-Area Storage	KIS	WSB	PDCF / PDC	PF-4 at LANL and MFFF ^a at SRS		PF-4 at LANL and H-Canyon/HB-Line and MFFF ^a at SRS			DWPF	MFFF	H-Canyon/HB-Line (Dissolution to DWPF)
					Metal Oxidation Furnaces at MFFF	PF-4 (2 MT Case/ 35 MT Case)	SRS		PF-4 (2 MT Case/ 35 MT Case)			
							H-Canyon/HB-Line/K-Area Glovebox ^b	Metal Oxidation Furnaces at MFFF				
Total Workforce												
Number of radiation workers	24	40	50	383 / 383	35	85 / 253	100 / 50	35	85 / 253	8	450	14
Collective dose (person-rem per year)	8.9	25	25	192 / 192	2.3	29 / 190	29 / 38	2.3	29 / 190	1.9	51	7.0
Annual LCFs ^c	0 (0.005)	0 (0.02)	0 (0.02)	0 (0.1 / 0.1)	0 (0.001)	0 (0.02 / 0.1)	0 (0.02 / 0.02)	0 (0.001)	0 (0.02 / 0.1)	0 (0.001)	0 (0.03)	0 (0.004)
Life-of-Project LCFs ^c	0 (0.1)	0 (0.2)	0 (0.3)	1 / 1	0 (0.03)	0 (0.1) / 3	0 (0.2) / 0 (0.3)	0 (0.03)	0 (0.1) / 3	0 (0.02)	1 (0.7)	0 (0.06)
Average Worker												
Dose (millirem per year) ^d	370	630	500	500 / 500	65	340 / 760	290 / 760	65	340 / 760	236	113	500
Annual LCF Risk	0.0002	0.0004	0.0003	0.0003 / 0.0003	0.00004	0.0002 / 0.0005	0.0002 / 0.0005	0.00004	0.0002 / 0.0005	0.0001	0.00007	0.0003
Life-of-Project LCF Risk	0.005	0.004	0.007	0.004 / 0.004	0.0008	0.001 / 0.01	0.002 / 0.006	0.0008	0.001 / 0.01	0.002	0.002	0.004

DWPF = Defense Waste Processing Facility; KIS = K-Area Interim Surveillance; LANL = Los Alamos National Laboratory; LCF = latent cancer fatality; MFFF = Mixed Oxide Fuel Fabrication Facility; MT = metric tons; PDC = Pit Disassembly and Conversion Project; PDCF = Pit Disassembly and Conversion Facility; PF-4 = Plutonium Facility; SRS = Savannah River Site; WSB= Waste Solidification Building.

^a At SRS, pit conversion would be carried out at MFFF using metal oxidation furnaces and/or at H-Canyon/HB-Line.

^b At SRS, conversion of plutonium metal in H-Canyon/HB-Line would complement pit disassembly occurring in a K-Area glovebox.

^c The numbers of LCFs in the worker population are whole numbers; statistically calculated values are provided in parentheses.

^d Engineering and administrative controls would be implemented to maintain individual worker doses below 2,000 millirem per year and as low as reasonably achievable (DOE 2005a, 2009).

Note: To convert MT to tons, multiply by 1.1023.

Table C-48 Radiological Impacts on the Public from Operations Under the H-Canyon/HB-Line to DWPF Alternative

Impact Area	Support Facilities			Pit Disassembly and Conversion Options						Disposition		
	K-Area Storage ^a	KIS	WSB	PDCF / PDC	PF-4 at LANL and MFFF ^a at SRS		PF-4 at LANL and H-Canyon/HB-Line and MFFF ^a at SRS			DWPF ^c	MFFF ^d	H-Canyon/HB-Line Dissolution to DWPF
					Metal Oxidation Furnaces at MFFF)	PF-4 (2 MT Case/ 35 MT Case)	SRS		PF-4 (2 MT Case/ 35 MT Case)			
							H-Canyon/HB-Line ^b	Metal Oxidation Furnaces at MFFF)				
Population within 50 Miles (80 kilometers)												
Annual dose (person-rem)	0	4.3×10^{-5}	0.031	0.46 / 0.44	0.37	0.025/0.21	0.26	0.37	0.025/0.21	0	0.050	0.0060
Percent of natural background radiation ^e	0	1.7×10^{-8}	1.1×10^{-5}	0.00017 / 0.00018	0.00014	$1.2 \times 10^{-5} / 9.8 \times 10^{-5}$	9.6×10^{-5}	0.00014	$1.2 \times 10^{-5} / 9.8 \times 10^{-5}$	0	1.9×10^{-5}	2.2×10^{-6}
Annual LCFs ^f	0	0 (3×10^{-8})	0 (2×10^{-5})	0 (0.0003 / 0.0003)	0 (0.0002)	0 ($2 \times 10^{-5} / 1 \times 10^{-4}$)	0 (0.0002)	0 (0.0002)	0 ($2 \times 10^{-5} / 1 \times 10^{-4}$)	0	0 (3×10^{-5})	0 (4×10^{-6})
Life-of-Project LCFs ^f	0 / 0	0 (2×10^{-7})	0 (0.0005)	0 (0.003) / 0 (0.003)	0 (0.004)	0 ($1 \times 10^{-4} / 3 \times 10^{-3}$)	0 (0.002)	0 (0.004)	0 ($1 \times 10^{-4} / 3 \times 10^{-3}$)	0	0 (0.0007)	0 (5×10^{-5})
Maximally Exposed Individual												
Annual dose (millirem)	0	8.5×10^{-7}	0.00063	0.0055 / 0.0061	0.0041	0.0097/0.081	0.0024	0.0041	0.0097/0.081	0	0.00055	4.3×10^{-5}
Percent of natural background radiation ^e	0	2.7×10^{-7}	0.00020	0.0018 / 0.0020	0.0013	0.0020/0.017	0.00077	0.0013	0.0020/0.017	0	0.00018	1×10^{-5}
Annual LCF risk	0	5×10^{-13}	4×10^{-10}	$3 \times 10^{-9} / 4 \times 10^{-9}$	2×10^{-9}	$6 \times 10^{-9} / 5 \times 10^{-8}$	1×10^{-9}	2×10^{-9}	$6 \times 10^{-9} / 5 \times 10^{-8}$	0	3×10^{-10}	3×10^{-11}
Life-of-Project LCF risk	0 / 0	4×10^{-12}	9×10^{-9}	$4 \times 10^{-8} / 4 \times 10^{-8}$	5×10^{-8}	$4 \times 10^{-8} / 1 \times 10^{-6}$	2×10^{-8}	5×10^{-8}	$4 \times 10^{-8} / 1 \times 10^{-6}$	0	8×10^{-9}	3×10^{-10}
Average Exposed Individual within 50 Miles (80 kilometers)^g												
Annual dose (millirem)	0	5.3×10^{-8}	3.6×10^{-5}	0.00053 / 0.00055	0.00043	$5.6 \times 10^{-5} / 4.7 \times 10^{-4}$	0.00029	0.00043	$5.6 \times 10^{-5} / 4.7 \times 10^{-4}$	0	5.7×10^{-5}	6.8×10^{-6}
Annual LCF risk	0	3×10^{-14}	2×10^{-11}	$3 \times 10^{-10} / 3 \times 10^{-10}$	3×10^{-10}	$3 \times 10^{-11} / 3 \times 10^{-10}$	2×10^{-10}	3×10^{-10}	$3 \times 10^{-11} / 3 \times 10^{-10}$	0	3×10^{-11}	4×10^{-12}
Life-of-Project LCF risk	0 / 0	2×10^{-13}	5×10^{-10}	$4 \times 10^{-9} / 4 \times 10^{-9}$	5×10^{-9}	$2 \times 10^{-10} / 6 \times 10^{-9}$	2×10^{-9}	5×10^{-9}	$2 \times 10^{-10} / 6 \times 10^{-9}$	0	8×10^{-10}	5×10^{-11}

Impact Area	Support Facilities			Pit Disassembly and Conversion Options					Disposition			
	K-Area Storage ^a	KIS	WSB	PDCP / PDC	PF-4 at LANL and MFFF ^a at SRS		PF-4 at LANL and H-Canyon/HB-Line and MFFF ^a at SRS			DWPF ^c	MFFF ^d	H-Canyon/HB-Line Dissolution to DWPF
					Metal Oxidation Furnaces at MFFF	PF-4 (2 MT Case/35 MT Case)	SRS		PF-4 (2 MT Case/35 MT Case)			
							H-Canyon/HB-Line ^b	Metal Oxidation Furnaces at MFFF				

DWPF = Defense Waste Processing Facility; KIS = K-Area Interim Surveillance; LANL = Los Alamos National Laboratory; LCF = latent cancer fatality; MFFF = Mixed Oxide Fuel Fabrication Facility; MT = metric tons; PDC = Pit Disassembly and Conversion Project; PDCP = Pit Disassembly and Conversion Facility; PF-4 = Plutonium Facility; SRS = Savannah River Site; WSB= Waste Solidification Building.

^a There would be no releases to the atmosphere from storage of plutonium at K-Area and, therefore, no resulting public impacts for either of the cases presented.

^b Potential doses to members of the public from pit disassembly activities in K-Area gloveboxes would be extremely small due to *de minimis* releases from such activities, and would be expected to be a fraction of those from the K-Area Interim Surveillance Capability (SRNS 2012).

^c There would be no additional releases to the atmosphere from DWPF facility operations associated with this alternative and, therefore, no resulting public impacts.

^d At MFFF, 41.1 metric tons of plutonium would be processed over a 23-year period; this would result in an estimated annual throughput rate difference of about 10 percent over the duration of the No Action Alternative (34 metric tons over 21 years).

^e To provide perspective, doses can be compared to the estimated doses these same receptors would receive from natural background radiation (311 millirem per year assumed for SRS and 480 millirem per year at LANL for the average individual).

^f The number of LCFs in the population is a whole number; the statistically calculated total values are provided in parentheses.

^g Obtained by dividing the population dose by the number of people projected to live within 50 miles (80 kilometers) of the SRS facilities and LANL PF-4 in 2020 (approximately 809,000 for K-Area, 869,000 for F-Area, and 886,000 for H-Area; 448,000 for LANL PF-4).

Note: To convert MT to tons, multiply by 1.1023.

Activities at E-Area in support of the H-Canyon/HB-Line to DWPF Alternative are expected to result in negligible incremental impacts to both workers and the public from the staging of TRU waste awaiting shipment to WIPP or any potential MLLW pending offsite shipment, as well as storage/disposal of LLW. Similarly, at LANL, no incremental impacts on either workers or the public are expected from operations at the waste management facilities.

C.5.5 WIPP Alternative

Construction. The impacts of construction discussed under the MOX Fuel Alternative would also apply to the WIPP Alternative. In addition, under the option to dispose of 6 metric tons (6.6 tons) of plutonium to WIPP, modifications would be required at H-Canyon/HB-Line. The total construction workforce dose of 1.2 person-rem would occur over the estimated 2 years required for modifications (see C.3.3.1).

In all cases, no construction worker exposures are expected to result in additional LCFs in construction workforces.

As is the case in the alternatives discussed above, none of the construction would result in any radiological impacts on the public.

Operations. **Tables C-49** and **C-50** summarize the potential radiological impacts on workers and the general public, respectively, under the WIPP Alternative. To facilitate comparison of the potential impacts of the alternatives, the estimated annual doses and LCF risks over the life of each facility are presented. The impacts over each facility's operating timeframe were determined by multiplying the annual impacts by each facility's projected operating period.

Activities at E-Area in support of the WIPP Alternative are expected to result in negligible incremental impacts on both workers and the public from the staging of TRU waste awaiting shipment to WIPP or any potential MLLW pending offsite shipment, as well as storage/disposal of LLW. Similarly, at LANL, no incremental impacts on either workers or the public are expected from operations at the waste management facilities.

Table C-49 Potential Radiological Impacts On Workers from Operations Under the WIPP Alternative

Impact Area	Support Facilities			Pit Disassembly and Conversion Options						Disposition	
	K-Area Storage	KIS	WSB	PDCF / PDC	PF-4 at LANL and MFFF ^a at SRS		PF-4 at LANL and H-Canyon/HB-Line and MFFF ^a at SRS			MFFF	H-Canyon/HB-Line (Preparation for WIPP)
					Metal Oxidation Furnaces at MFFF	PF-4 (2 MT Case/35 MT Case)	SRS		PF-4 (2 MT Case/35 MT Case)		
							H-Canyon/HB-Line / K-Area Glovebox ^b	Metal Oxidation Furnaces at MFFF			
Total Workforce											
Number of radiation workers	24	40	50	383 / 383	35	85 / 253	100 / 50	35	85 / 253	450	130
Collective dose (person-rem per year)	8.9	25	25	190 / 190	2.3	29 / 190	29 / 38	2.3	29 / 190	51	60
Annual LCFs ^c	0 (0.005)	0 (0.02)	0 (0.02)	0 (0.1 / 0.1)	0 (0.001)	0 (0.02 / 0.1)	0 (0.02 / 0.02)	0 (0.001)	0 (0.02 / 0.1)	0 (0.03)	0 (0.04)
Life-of-Project LCFs ^c	0 (0.1)	0 (0.1)	0 (0.4)	1 / 1	0 (0.03)	0 (0.1) / 3	0 (0.2) / 0 (0.3)	0 (0.03)	0 (0.1) / 3	1 (0.7)	0 (0.5)
Average Worker											
Dose (millirem per year) ^d	370	630	500	500 / 500	65	340 / 760	290 / 760	65	340 / 760	110	460
Annual LCF Risk	0.0002	0.0004	0.0003	0.0003 / 0.0003	0.00004	0.0002 / 0.0005	0.0002 / 0.0005	0.00004	0.0002 / 0.0005	0.00007	0.0003
Life-of-Project LCF Risk	0.005	0.003	0.007	0.004 / 0.004	0.0008	0.001 / 0.01	0.002 / 0.006	0.0008	0.001 / 0.01	0.002	0.004

KIS = K-Area Interim Surveillance; LANL = Los Alamos National Laboratory; LCF = latent cancer fatality; MFFF = Mixed Oxide Fuel Fabrication Facility; MT = metric tons; PDC = Pit Disassembly and Conversion Project; PDCF = Pit Disassembly and Conversion Facility; PF-4 = Plutonium Facility; SRS = Savannah River Site; WIPP = Waste Isolation Pilot Plant; WSB = Waste Solidification Building.

^a At SRS, pit conversion would be carried out at MFFF using metal oxidation furnaces and/or H-Canyon/HB-Line.

^b At SRS, conversion of plutonium metal in H-Canyon/HB-Line would complement pit disassembly occurring in a K-Area glovebox.

^c The numbers of LCFs in the worker population are whole numbers; statistically calculated values are provided in parentheses.

^d Engineering and administrative controls would be implemented to maintain individual worker doses below 2,000 millirem per year and as low as reasonably achievable (DOE 2005a, 2009).

Note: To convert metric tons to tons, multiply by 1.1023.

Table C-50 Radiological Impacts on the Public from Operations Under the WIPP Alternative

Impact Area	Support Facilities			Pit Disassembly and Conversion Options						Disposition		
	K-Area Storage ^a	KIS	WSB	PDCF / PDC	PF-4 at LANL and MFFF ^a at SRS		PF-4 at LANL and H-Canyon/HB-Line and MFFF ^a at SRS			DWPF ^c	MFFF ^d	H-Canyon/HB-Line Preparation for WIPP
					Metal Oxidation Furnaces at MFFF	PF-4 (2 MT Case/ 35 MT Case)	SRS		PF-4 (2 MT Case/ 35 MT Case)			
							H-Canyon/HB-Line ^b	Metal Oxidation Furnaces at MFFF				
Population within 50 Miles (80 kilometers)												
Annual dose (person-rem)	0	4.3×10^{-5}	0.031	0.46 / 0.44	0.37	0.025 / 0.21	0.26	0.37	0.025 / 0.21	0	0.050	0.26
Percent of natural background radiation ^e	0	1.7×10^{-8}	1.1×10^{-5}	0.00017 / 0.00018	0.00014	$1.2 \times 10^{-5} / 9.8 \times 10^{-5}$	9.6×10^{-5}	0.00014	$1.2 \times 10^{-5} / 9.8 \times 10^{-5}$	0	1.9×10^{-5}	9.6×10^{-5}
Annual LCFs ^f	0	$0 (3 \times 10^{-8})$	$0 (2 \times 10^{-5})$	$0 (0.0003 / 0.0003)$	$0 (0.0002)$	$0 (2 \times 10^{-5} / 1 \times 10^{-4})$	$0 (0.0002)$	$0 (0.0002)$	$0 (2 \times 10^{-5} / 1 \times 10^{-4})$	0	$0 (3 \times 10^{-5})$	$0 (0.0002)$
Life-of-Project LCFs ^f	0/0	$0 (2 \times 10^{-7})$	$0 (0.0005)$	$0 (0.003 / 0 (0.003))$	$0 (0.004)$	$0 (1 \times 10^{-4} / 3 \times 10^{-3})$	$0 (0.002)$	$0 (0.004)$	$0 (1 \times 10^{-4} / 3 \times 10^{-3})$	0	$0 (0.0007)$	$0 (0.002)$
Maximally Exposed Individual												
Annual dose (millirem)	0	8.5×10^{-7}	0.00063	0.0055 / 0.0061	0.0041	0.0097/0.081	0.0024	0.0041	0.0097/0.081	0	0.00055	0.0024
Percent of natural background radiation ^e	0	2.7×10^{-7}	0.00020	0.0018 / 0.0020	0.0013	0.0020/0.017	0.00077	0.0013	0.0020/0.017	0	0.00018	0.00077
Annual LCF risk	0	5×10^{-13}	4×10^{-10}	$3 \times 10^{-9} / 4 \times 10^{-9}$	2×10^{-9}	$6 \times 10^{-9} / 5 \times 10^{-8}$	1×10^{-9}	2×10^{-9}	$6 \times 10^{-9} / 5 \times 10^{-8}$	0	3×10^{-10}	1×10^{-9}
Life-of-Project LCF risk	0/0	4×10^{-12}	9×10^{-9}	$4 \times 10^{-8} / 4 \times 10^{-8}$	5×10^{-8}	$4 \times 10^{-8} / 1 \times 10^{-6}$	2×10^{-8}	5×10^{-8}	$4 \times 10^{-8} / 1 \times 10^{-6}$	0	8×10^{-9}	2×10^{-8}
Average Exposed Individual within 50 Miles (80 kilometers)^g												
Annual dose (millirem)	0	5.3×10^{-8}	3.6×10^{-5}	0.00053 / 0.00055	0.00043	$5.6 \times 10^{-5} / 4.7 \times 10^{-4}$	0.00029	0.00043	$5.6 \times 10^{-5} / 4.7 \times 10^{-4}$	0	5.7×10^{-5}	0.00029
Annual LCF risk	0	3×10^{-14}	2×10^{-11}	$3 \times 10^{-10} / 3 \times 10^{-10}$	3×10^{-10}	$3 \times 10^{-11} / 3 \times 10^{-10}$	2×10^{-10}	3×10^{-10}	$3 \times 10^{-11} / 3 \times 10^{-10}$	0	3×10^{-11}	2×10^{-10}
Life-of-Project LCF risk	0/0	2×10^{-13}	5×10^{-10}	$4 \times 10^{-9} / 4 \times 10^{-9}$	5×10^{-9}	$2 \times 10^{-10} / 6 \times 10^{-9}$	2×10^{-9}	5×10^{-9}	$2 \times 10^{-10} / 6 \times 10^{-9}$	0	8×10^{-10}	2×10^{-9}

Impact Area	Support Facilities			Pit Disassembly and Conversion Options						Disposition			
	K-Area Storage ^a	KIS	WSB	PDCF / PDC	PF-4 at LANL and MFFF ^a at SRS		PF-4 at LANL and H-Canyon/HB-Line and MFFF ^a at SRS				DWPF ^c	MFFF ^d	H-Canyon/HB-Line Preparation for WIPP
					Metal Oxidation Furnaces at MFFF	PF-4 (2 MT Case/ 35 MT Case)	SRS		PF-4 (2 MT Case/ 35 MT Case)				
							H-Canyon/HB-Line ^b	Metal Oxidation Furnaces at MFFF					

DWPF = Defense Waste Processing Facility; KIS = K-Area Interim Surveillance; LANL = Los Alamos National Laboratory; LCF = latent cancer fatality; MFFF = Mixed Oxide Fuel Fabrication Facility; MT = metric tons; PDC = Pit Disassembly and Conversion Project; PDCF = Pit Disassembly and Conversion Facility; PF-4 = Plutonium Facility; SRS = Savannah River Site; WIPP = Waste Isolation Pilot Plant; WSB= Waste Solidification Building.

^a There would be no releases to the atmosphere from the K-Area storage and, therefore, no resulting public impacts for either of the cases presented.

^b Potential doses to members of the public from pit disassembly activities in K-Area gloveboxes would be extremely small due to *de minimis* releases from such activities, and would be expected to be a fraction of those from the K-Area Interim Surveillance Capability (SRNS 2012).

^c There would be no additional releases to the atmosphere from DWPF facility operations associated with this alternative and, therefore, no resulting public impacts.

^d At MFFF, 41.1 metric tons of plutonium would be processed over a 23-year period; this would result in an estimated annual throughput rate difference of about 10 percent over the duration of the No Action Alternative (34 metric tons over 21 years).

^e To provide perspective, doses can be compared to the estimated doses these same receptors would receive from natural background radiation (311 millirem per year assumed for SRS and 480 millirem per year at LANL for the average individual).

^f The number of LCFs in the population is a whole number; the statistically calculated total values are provided in parentheses.

^g Obtained by dividing the population dose by the number of people projected to live within 50 miles (80 kilometers) of the SRS facilities and LANL PF-4 in 2020 (approximately 809,000 for K-Area, 869,000 for F-Area, and 886,000 for H-Area; 448,000 for LANL PF-4).

Note: To convert metric tons to tons, multiply by 1.1023.

C.6 References

Census (U.S. Census Bureau), 1990, 1990 Decennial Census, Summary File 1, Detailed Tables, Table P010. Hispanic Origin by Race (accessed at <http://factfinder2.census.gov/faces/nav/jsf/pages/index.xhtml>), April 1.

Census (U.S. Census Bureau), 2001, *Decennial Census, 2000 Summary File 1*, Table P008. Hispanic or Latino by Race (accessed at <http://factfinder2.census.gov/faces/nav/jsf/pages/index.xhtml>), July 27.

Census (U.S. Census Bureau), 2011, *Decennial Census, 2010 Census Summary File 1*, Table P5, Hispanic or Latino Origin by Race; Universe – Total Population (available at http://www2.census.gov/census_2010/04-Summary_File_1/), August 25.

DOE (U.S. Department of Energy), 1982, *Final Environmental Impact Statement, Defense Waste Processing Facility, Savannah River Plant, Aiken, S.C.*, DOE/EIS-0082, Office of Defense Waste and Byproducts Management, Washington, DC, February.

DOE (U.S. Department of Energy), 1994, *Final Supplemental Environmental Impact Statement, Defense Waste Processing Facility, Savannah River site, Aiken, South Carolina*, DOE/EIS-0082-S, Savannah River Operations Office, Aiken, South Carolina, November.

DOE (U.S. Department of Energy), 1996, *Storage and Disposition of Weapons-Usable Fissile Materials Final Programmatic Environmental Impact Statement*, DOE/EIS-0229, Office of Fissile Materials Disposition, Washington, DC, December.

DOE (U.S. Department of Energy), 1998, *Supplement Analysis for Storing Plutonium in the Actinide Packaging and Storage Facility and Building 105-K at the Savannah River Site*, DOE/EIS-0229-SA-1, Office of Fissile Materials Disposition, Aiken, South Carolina, July.

DOE (U.S. Department of Energy), 1999, *Surplus Plutonium Disposition Final Environmental Impact Statement*, DOE/EIS-0283, Office of Fissile Materials Disposition, Washington, DC, November.

DOE (U.S. Department of Energy), 2002, *Supplement Analysis for Storage of Surplus Plutonium Materials in the K-Area Material Storage Facility at the Savannah River Site*, DOE/EIS-0229-SA-2, Office of Environmental Management, Washington, DC, February.

DOE (U.S. Department of Energy), 2003a, *Estimating Radiation Risk from Total Effective Dose Equivalent (TEDE), ISCORS Technical Report No. 1*, DOE/EH-412/0015/0802, Rev. 1, Office of Environmental Policy and Guidance, January.

DOE (U.S. Department of Energy), 2003b, *Changes Needed to the Surplus Plutonium Disposition Program, Supplement Analysis and Amended Record of Decision*, DOE/EIS-0283-SA1, Office of Fissile Materials Disposition, Washington, DC, April.

DOE (U.S. Department of Energy), 2003c, *GENII Computer Code Application Guidance for Documented Safety Analysis, Interim Report*, DOE-EH-4.2.1.4-Interim-GENII, Rev. 1, Office of Environment, Safety and Health, Washington, DC, September.

DOE (U.S. Department of Energy), 2005a, *DOE Standard Radiological Control*, DOE-STD-1098-99, Change Notice 1, Washington, DC, March.

DOE (U.S. Department of Energy), 2005b, *Environmental Assessment for the Safeguards and Security Upgrades for Storage of Plutonium Materials at the Savannah River Site*, DOE/EA-1538, Savannah River Operations Office, Aiken, South Carolina, December.

DOE (U.S. Department of Energy), 2007, *Supplement Analysis for the Storage of Surplus Plutonium Materials at the Savannah River Site*, DOE/EIS-0229-SA-4, Office of Environmental Management, September 5.

DOE (U.S. Department of Energy), 2008, *Supplement Analysis for Construction and Operation of a Waste Solidification Building at the Savannah River Site*, DOE/EIS-0283-SA-2, Savannah River Operations Office, Aiken, South Carolina, November.

DOE (U.S. Department of Energy), 2009, *Radiological Control*, DOE-STD-1098-2008, Change Notice 1, Washington, DC, May.

DOE (U.S. Department of Energy), 2012, *Stabilization, Packaging, and Storage of Plutonium-Bearing Materials*, DOE-STD-3013-2012, Washington, DC, March.

DOE/NNSA (U.S. Department of Energy/National Nuclear Security Administration), 2012, *NEPA Source Document for Pit Disassembly and Conversion (PDC) Project*, Document No. SRB-2502-10-0014, Rev. A, Office of Defense Nuclear Nonproliferation, Denver, Colorado.

EPA (U.S. Environmental Protection Agency), 1999, *Cancer Risk Coefficients for Environmental Exposure to Radionuclides*, Federal Guidance Report No. 13, EPA 402-R-99-001, Office of Radiation and Indoor Air, Washington, DC, September.

LANL (Los Alamos National Laboratory), 2012, *Final Report, Data Call to Support the Surplus Plutonium Disposition Supplemental Environmental Impact Statement*, LA-UR-12-00634, Los Alamos, New Mexico, February.

NCRP (National Council on Radiation Protection and Measurements), 2009, *Ionizing Radiation Exposure of the Population of the United States*, NCRP Report No. 160, Bethesda, Maryland, March 3.

NRC (U.S. Nuclear Regulatory Commission), 1977, *Calculation of Annual Doses to Man From Routine Releases of Reactor Effluents for the Purpose of Evaluating Compliance With 10 CFR 50, Appendix I*, Regulatory Guide 1.109, Office of Standards Development, Rev. 1, Washington, DC, October.

NRC (U.S. Nuclear Regulatory Commission), 2005, *Environmental Impact Statement on the Construction and Operation of a Proposed Mixed Oxide Fuel Fabrication Facility at the Savannah River Site, South Carolina*, NUREG-1767, Office of Nuclear Material Safety and Safeguards, Washington, DC, January.

SRNS (Savannah River Nuclear Solutions, LLC), 2009, *Savannah River Site Environmental Report for 2008*, SRNS-STI-2009-00190, Aiken, South Carolina, September 15.

SRNS (Savannah River Nuclear Solutions, LLC), 2010, *Savannah River Site Environmental Report for 2009*, SRNS-STI-2010-00175, Aiken, South Carolina, September 8.

SRNS (Savannah River Nuclear Solutions, LLC), 2011a, *Radionuclide Source Term for Direct Metal Oxide (DMO) at the Mixed Oxide Fuel Fabrication Facility (MFFF)*, SRNS-TR-2011-00227, Rev. 0, August 10.

SRNS (Savannah River Nuclear Solutions, LLC), 2011b, *Savannah River Site Environmental Report for 2010*, SRNS-STI-2011-00059, Aiken, South Carolina, September 15.

SRNS (Savannah River Nuclear Solutions, LLC), 2012, *Surplus Plutonium Disposition Supplemental Environmental Impact Statement* Data Call Response, Aiken, South Carolina.

WSRC (Washington Savannah River Company), 2007, *Savannah River Site Environmental Report for 2006*, WSRC-TR-2007-00008, Aiken, South Carolina.

WSRC (Washington Savannah River Company), 2008, *Surplus Plutonium Disposition Supplemental Environmental Impact Statement* Data Call Response, Aiken, South Carolina, June.

APPENDIX D
EVALUATION OF HUMAN HEALTH EFFECTS FROM
FACILITY ACCIDENTS

APPENDIX D

EVALUATION OF HUMAN HEALTH EFFECTS FROM FACILITY ACCIDENTS

Appendix D presents an evaluation of the effects on human health from accidents associated with the disposition of surplus plutonium at facilities at the Savannah River Site (SRS) and Los Alamos National Laboratory (LANL). Section D.1 presents the basic methodologies used to identify and evaluate the potential accidents associated with facilities at SRS and LANL that would be used under the options and alternatives, including the No Action Alternative.

The methodology used to evaluate potential impacts from Department of Energy (DOE) facility accidents is presented in Section D.1. Detailed accident scenarios and potential source terms are developed in Section D.1.5 for the SRS and LANL facilities. In many cases, if a facility would be used under an option or alternative, there is little difference in the bounding accidents that might be associated with that option. More typically, the only real change in the accident risks associated with the different surplus plutonium disposition options at a facility would be the length of time that the facility might operate. Where it is reasonable to identify how options might change the type of accidents or their magnitude at a facility, those changes are identified. For example, accidents and source terms associated with the addition of metal oxidation operations at the Mixed Oxide Fuel Fabrication Facility (MFFF) and changes in the amount of pits processed at LANL between the No Action and action alternatives were explicitly identified in the appropriate sections to help the reader understand how the potential options and alternatives might change accident risks at a specific facility.

The potential radiological impacts for each of the SRS and LANL facilities that might be used for surplus plutonium disposition are identified in Section D.2. Section D.3 discusses the potential impacts of chemical accidents at these facilities and finds that, because of the nature of the operations, the impacts of accidents associated with the use of chemicals are generally limited to the immediate vicinity of the accident and present negligible risks to the public.

D.1 Impact Assessment Methods for Facility Accidents

D.1.1 Introduction

The potential for facility accidents and the magnitude of their consequences are important factors for making reasonable choices among the various surplus plutonium disposition alternatives in this *Draft Surplus Plutonium Disposition Supplemental Environmental Impact Statement (SPD Supplemental EIS)*. Guidance on the implementation of Title 40 of the *Code of Federal Regulations* (CFR) 1502.22, as amended (40 CFR 1502.22), requires the evaluation of impacts that have a low frequency of occurrence, but large consequences. Further, public comments received during the scoping process indicate the public's concern with facility safety and health risks and the need to address these concerns in the decisionmaking process.

For the No Action Alternative, potential accidents are defined in existing facility documentation, such as safety analysis reports (SARs), documented safety analyses (DSAs), hazards assessment documents, National Environmental Policy Act (NEPA) documents, and probabilistic risk assessments (PRAs). The accidents include radiological and chemical accidents that have a low frequency of occurrence, but large consequences, and a spectrum of other accidents that have a higher frequency of occurrence and smaller consequences. The data in these documents include accident scenarios, materials at risk (MAR), source terms (quantities of hazardous materials released to the environment), and consequences.

For each facility, a hazards analysis document identifying and estimating the effects of all major hazards that could affect the environment, workers, and the public would be issued in conjunction with the conceptual design package. Additional accident analyses for identified major hazards would be provided

in a preliminary SAR issued during the period of definitive design (Title II) review. A final SAR would be prepared during the construction period and issued before testing begins as final documented evidence that the new facility could be operated in a manner that would not pose any undue risk to the health and safety of workers and the public.

In determining the potential for facility accidents and the magnitude of their consequences, this *SPD Supplemental EIS* considers two important concepts in the presentation of results: (1) risk and (2) uncertainties and conservatism.

D.1.1.1 Risk

One type of metric that can be obtained from the accident analysis results presented in the *Surplus Plutonium Disposition Final Environmental Impact Statement (SPD EIS)* (DOE 1999) is accident risk. Risk is usually defined as the product of the consequences and estimated frequency of a given accident. Accident consequences may be presented in terms of dose (e.g., person-rem) or health effects (e.g., latent cancer fatalities [LCFs]). The accident frequency is the number of times the accident is expected to occur over a given period of time (e.g., per year). In general, the frequency of design-basis and beyond-design-basis accidents is much lower than 1 per year and, therefore, is approximately equal to the probability of the accident over 1 year. If an accident is expected to occur once every 1,000 years (i.e., a frequency of 0.0010 per year) and the consequence of the accident is 5 LCFs, then the risk is $0.0010 \times 5 = 0.0050$ LCFs per year.

A number of specific types of risk can be directly calculated from the results of the MACCS2 [MELCOR Accident Consequence Code System] computer code (NRC 1990, 1998) reported in the *SPD EIS*. One type, average individual risk, is the product of the total consequences experienced by the population and the accident frequency divided by the population within 50 miles (80 kilometers) of the facility where the accident might occur.¹ For example, if an accident has a frequency of 0.0010 per year, the consequence thereof is 5 LCFs, and the population in which the fatalities occur is 100,000, then the average individual risk is $1.0 \times 10^{-3} \times 5/100,000 = 5.0 \times 10^{-8}$ LCFs per year. This metric is meaningful only when the mean value for consequence is used because risk itself is not a random parameter, even though it involves underlying randomness. It is noteworthy that the value of the average individual risk depends on the size of the area for which the population is defined. In general, the larger the area considered, the smaller the average individual risk for a given accident. The selection of a 50-mile (80-kilometer) radius is common practice.

It is also possible to calculate population risk, which is the product of the total consequences experienced by the population and accident frequency. For example, if an accident has a frequency of 0.0010 per year and the consequence of the accident is 5 LCFs, then the population risk is $0.0010 \times 5 = 0.0050$ LCFs per year. Population risk is a measure of the expected number of LCFs experienced by the population as a whole over the course of a year.

D.1.1.2 Uncertainties and Conservatism

The analyses of accidents are based on calculations relevant to hypothetical sequences of events and models of their effects. The models provide estimates of the frequencies, source terms, pathways for dispersion, exposures, and effects on human health and the environment that are as realistic as possible within the scope of the analysis. In many cases, minimal experience with the postulated accidents leads to uncertainty in the calculation of their consequences and frequencies. This fact has prompted the use of models or input values that yield conservative estimates of consequence and frequency. All alternatives have been evaluated using uniform methods and data, allowing for a fair comparison of all alternatives.

¹ Population data for each facility considered in this SPD Supplemental EIS can be found in Appendix C.

Although average individual and population risks can be calculated from the information in the *SPD EIS*, the equations for such calculations involve accident frequency, a parameter whose calculation is subject to considerable uncertainty. The uncertainty in estimates of the frequency of highly unlikely events can vary over several orders of magnitude. This is the reason accident frequencies are reported in the *SPD EIS* qualitatively, in terms of broad frequency bins, as opposed to numerically. Similarly, any metric that includes frequency as a factor will have at least as much, and generally more, uncertainty associated with it. Therefore, the consequence metrics have been preserved as the primary accident analysis results, and accident frequencies have been identified qualitatively, to provide a perspective on risk that does not imply an unjustified level of precision.

D.1.2 Safety Strategy

D.1.2.1 General Safety Strategy for Plutonium Facilities

For general plutonium facilities like those evaluated in this *SPD Supplemental EIS*, the general safety strategy requires the following:

- Plutonium materials be contained at all times with multiple layers of confinement that prevent the materials from reaching the environment.
- Energy sources that are large enough to disperse the plutonium and threaten confinement be minimized.

This basic strategy means that operational accidents, including spills, impacts, fires, and operator errors, never have sufficient energy available to threaten the multiple levels of confinement that are always present within a plutonium facility. The final layer of confinement is the reinforced-concrete structure and the system of barriers and multiple stages of high-efficiency particulate air (HEPA) filters or, in some cases, an additional sand filter, that limit the amount of material that could be released to the environment even in the worst realistic internal events.

The operational events that present the greatest threats to confinement are large-scale internal fires that, if they did occur, could present heat and smoke loads that threaten the building's HEPA filter systems. For modern plutonium facilities, the safety strategy is (1) to prevent large internal fires by limiting energy sources, such as flammable gases and other combustible materials, to the point that a wide-scale, propagating fire is not physically possible and (2) to defeat smaller internal fires with fire-suppression systems.

Modern plutonium operations are designed and operated such that the estimated frequency of any large fire within the facility would fall into the "extremely unlikely" category and would require multiple violations of safety procedures to introduce sufficient flammable materials into the facility to support such a fire. Any postulated large-scale fire in a modern plutonium facility that would be expected to result in severe consequences if it occurred would be categorized as a "beyond-design-basis" event and would fall into the "beyond extremely unlikely" category.

Earthquakes present the greatest design challenges for these facilities due to the requirement to prevent substantial releases of radioactive materials to the environment during and after a severe earthquake. For safety analysis purposes, it is often assumed that, after a very severe earthquake that exceeds the design loading levels of the facility equipment, enclosures, and building structure and confinement, a substantial release of radioactive material within the facility would occur. This assumption allows designers and safety analysts to determine the additional design features that may be needed to ensure greater containment and confinement of the radioactive MAR, even in an earthquake so severe that major damage to a new, reinforced-concrete facility could occur. In these safety analyses, it is often assumed that major safety systems are not in place, such that estimates of the mitigation effectiveness of each of the safety systems (or controls) can be estimated.

The accident scenarios selected for inclusion in this *SPD Supplemental EIS* are those that would present the greatest risk of radiological exposure to members of the public. Because of the reinforced nature of the surplus plutonium disposition facilities, these scenarios all require substantial additions of energy, either from a widespread internal fire or through a severe natural disaster such as an earthquake so severe that building safety systems exceed their design limits and confinement of the plutonium materials within the building is lost. Thus, any of the accidents presented in this *SPD Supplemental EIS* with frequencies of 1 in 10,000 per year or less would fall into the “beyond-design-basis” category and have probabilities that would fall into the “extremely unlikely” or “beyond extremely unlikely” category. None of these postulated events is expected to occur during the life of the facilities.

D.1.2.2 Design Process

The proposed surplus plutonium disposition facilities at SRS would be designed to comply with current Federal, state, and local laws; DOE Orders; and industrial codes and standards. This would result in a plant that is highly resistant to the effects of natural phenomena, including earthquakes, floods, tornadoes, and high winds, as well as credible events as appropriate to the site, such as fire, explosions, and manmade threats.

The design process for the proposed facilities would comply with the requirements for safety analysis and evaluation in DOE Order 420.1B (DOE 2005b) and DOE-STD-1189-2008 (DOE 2008a). These documents require the safety assessment to be an integral part of the design process to ensure compliance with all DOE construction and operation safety criteria by the time the facilities are constructed and in operation.

The safety analysis process begins early in the conceptual design with the identification of hazards that could produce unintended adverse safety consequences for workers or the public. As the design develops, hazard analyses are performed to identify events that could result in a release of hazardous material. The kinds of events considered include equipment failures, spills, human errors, fires, explosions, criticality, earthquakes, electrical storms, tornadoes, floods, and aircraft crashes. These postulated events become focal points for design changes or improvements to prevent unacceptable accidents. The analyses continue as the design progresses, their objective being to assess the need for safety equipment and the performance of such equipment. Eventually, the safety analyses are formally documented in safety-basis documents.

D.1.3 U.S. Department of Energy Facility Accident Identification and Quantification

D.1.3.1 Background

Identification of accident scenarios for the proposed facilities is fairly straightforward. The proposed facilities are simple, and their processes have been used in other facilities for other purposes. From an accident identification and quantification perspective, therefore, these processes are well known and understood. Very few of the proposed activities would differ from activities at other facilities.

New facilities would likely be designed, constructed, and operated to provide an even lower accident risk than other facilities that have been used for these types of processes. The new facilities would benefit from lessons learned in the operation of similar processes. They would be designed to surpass existing plutonium facilities in their ability to reduce the frequency of accidents and mitigate any associated consequences.

A large experience base exists for the design of the proposed facilities and processes. Because the principal hazard for workers and the public from plutonium is the inhalation of very small particles, the safety management approach that has evolved is centered on control of those particles. The control approach is to perform all operations that could release airborne plutonium particles in gloveboxes. A glovebox protects workers from inhalation of the particles and provides a convenient means for filters to collect any particle that becomes airborne. Air from gloveboxes, operating areas, and buildings is

exhausted through multiple stages of HEPA filters (and possibly sand filters) and monitored for radioactivity prior to release from the building. These exhaust systems are designed for effective performance even under the severe conditions of design-basis accidents, such as major fires involving an entire process line.

While the new processes and facilities would be designed to reduce the risks of a wide range of possible accidents to a level deemed acceptable, some risks would remain. As with all engineered structures—e.g., houses, bridges, dams—there is some level of earthquake or high wind that the structure could not survive. While new plutonium facilities must be designed to very high standards—for instance, they must survive, with little plutonium release, a 1-in-10,000-years earthquake—an accident more severe than the design-basis can always be postulated. Current DOE standards require new facilities to be designed to prevent, to the extent possible, all credible process-related accidents, as well as to withstand, control, and mitigate such accidents should they occur. For safety analysis purposes, credible accidents are generally defined as accidents with frequencies greater than 1 in 1 million per year, including such natural phenomena as earthquakes, high winds, and flooding. The accidents considered in the design, construction, and operation of these facilities are generally called design-basis accidents.

In addition to the accident risks from the design-basis accidents, the new facilities would face risks from beyond-design-basis accidents. For most plutonium facilities, the design-basis accidents include all types of process-related accidents that have occurred in past operations, such as major spills, leaks, transfer errors, process-related fires, explosions, and nuclear criticalities. Certain natural-phenomenon-initiated accidents also meet the DOE design-basis criteria. For example, these facilities are designed to survive a design-basis earthquake as discussed above. However, all new plutonium facilities, as manmade structures, could collapse under the influence of a strong enough earthquake. Such an earthquake would be considered a beyond-design-basis earthquake and its frequency would be considered to range from “extremely unlikely” to “beyond extremely unlikely.” For most new plutonium facilities, the worst possible accident would be a beyond-design-basis earthquake that results in partial or total collapse of the structure, followed by spills, possibly fires, and loss of confinement of the plutonium powder. External events, such as the crash of a large aircraft into the structure with an ensuing fuel-fed fire, are also conceivable. At most locations away from major airports, however, the likelihood of a large aircraft crash is less than 1 in 10 million per year.

The accident analysis reported in the *SPD EIS* is less detailed than a formal PRA or facility safety analysis because it addresses bounding accidents (accidents with a low frequency of occurrence and large consequences), as well as a representative spectrum of possible operational accidents (accidents with a high frequency of occurrence and small consequences). The technical approach for the selection of accidents is consistent with the DOE Office of NEPA Oversight’s *Recommendations for the Preparation of Environmental Assessments and Environmental Impact Statements* (DOE 2004b), which recommends consideration of two major categories of accidents: design-basis accidents and beyond-design-basis accidents.

D.1.3.2 Identification of Accident Scenarios and Frequencies

A range of design-basis and beyond-design-basis accident scenarios has been identified for each of the surplus plutonium disposition technologies (DOE 1999). For each technology, the process-related accidents possible during construction and operation of the facility have been evaluated to ensure that either their consequences are small or their frequency of occurrence is extremely low.

All of the analyzed accidents would involve a release of small, respirable plutonium particles or direct gamma and neutron radiation and, to a lesser extent, fission products from a nuclear criticality. Analyses of each proposed operation for accidents involving hazardous chemicals are reflected in the data reports supporting the *SPD EIS*. However, because the quantities of hazardous chemicals to be handled are small relative to those of many industrial facilities, no major chemical accidents were identified. The general categories of process-related accidents considered include the following:

- Drops or spills of materials within and outside the gloveboxes
- Fires involving process equipment or materials, as well as room or building fires
- Explosions initiated by the process equipment or materials or by conditions or events external to the process
- Nuclear criticalities

The analyses considered synergistic effects and determined that the only significant source of such effects would be a seismic event (i.e., a design-basis seismic event or a seismically induced total collapse). The synergy would be due to the common-cause initiator (i.e., seismic ground motion). This was accounted for by summing population doses and LCFs for alternatives in which facilities would be located at the same site. Doses to the maximally exposed individual (MEI) were not summed because an individual would only receive a summed dose if the MEI were located along the line connecting the release points from two facilities and the wind were blowing along the same line at the time of the accident. The likelihood of this happening is very small.

For each of these accident categories, a conservative preliminary assessment of consequence was made and, where consequences were significant, one or more bounding accident scenarios were postulated. The building confinement and fire-suppression systems would be adequate to reduce the risks of most spills and minor fires. The systems would be designed to prevent, to the extent practicable, larger fires and explosions. Great efforts have always been made to prevent nuclear criticalities, which have the potential to kill workers in their immediate vicinity. In all cases, implementation of a Criticality Safety Program and standard practices are expected to keep the frequency of accidental nuclear criticalities as low as possible.

The proposed surplus plutonium disposition facilities are expected to meet or exceed the requirements of DOE Order 420.1B, *Facility Safety* (DOE 2005b), or the requirements of 10 CFR Part 70, *Domestic Licensing of Special Nuclear Material*, if the proposed facility is licensed by the U.S. Nuclear Regulatory Commission (NRC). Because DOE and, if applicable, NRC design criteria require that new plutonium-processing buildings be of very robust, reinforced-concrete construction, very few events outside the building would have sufficient energy to threaten the building confinement. The principal concern would be the crash of a large commercial or military aircraft into the facility. Such an event, however, is highly unlikely. Only those crashes with a frequency greater than 1×10^{-7} per year are addressed in the *SPD EIS* and this *SPD Supplemental EIS*.

Design-basis and beyond-design-basis natural-phenomenon-initiated accidents are also considered. Because of the robust nature of the construction of new plutonium facilities, the only design-basis natural-

The SASSI Computer Code and Its Use at the Savannah River Site

For seismic analysis and design of high-hazard U.S. Department of Energy (DOE) nuclear facilities, the computer program SASSI [A System for the Analysis of Soil-Structure Interaction] has been used for evaluation of soil-structure interaction (SSI) effects between a building and its supporting soil. Users have recently observed that, under a certain combination of structure complexities and soil properties, a SASSI computational subroutine called the subtraction method can provide suspect results. In addition, multiple versions of the code have been acquired and modified by different entities, and there are questions about software control and quality assurance (Christenbury 2011).

In response, DOE formed an SSI team with the intent of developing a complex-wide solution to issues associated with the SASSI subtraction method. In April 2011, the Defense Nuclear Facilities Safety Board recommended that DOE broaden its effort to include additional national experts on the team and address additional issues (Winokur 2011).

The results of the SSI team assessment are pending, as is DOE's implementation of any new requirements. A preliminary assessment for the Savannah River Site (SRS), however, has been performed to determine the "window of conditions" (i.e., the combination of the types of structures and soils) that could lead to suspect results. Based on what is known about SRS structures and soils, it is not believed that any SRS facilities would fall within that window and be susceptible to the technical issue. The SASSI code has not been modified at SRS, and it is believed that the code has been adequately controlled and meets current site software quality assurance requirements (Christenbury 2011).

At the time of the publication of this *SPD Supplemental EIS*, it is premature to draw conclusions about the need for additional analyses of SRS structures or to speculate about further modifications or use of the SASSI code or additional quality assurance procedures.

phenomenon-initiated accidents with the potential to affect the facility interior are seismic events. Similarly, seismic events also bound the consequences and risks posed by beyond-design-basis natural phenomena.

The suite of generic accidents in the *Storage and Disposition of Weapons-Usable Fissile Materials Final Programmatic Environmental Impact Statement (Storage and Disposition PEIS)* (DOE 1996) was considered in the analysis of accidents for the *SPD EIS*. However, the more-detailed design information in the surplus plutonium disposition data reports was the primary basis for the identification of accidents because it most accurately represents the expected facility configuration. The fire on the loading dock and the oxyacetylene explosion in a process cell were unsupported by this information, so they were not included in the *SPD EIS*.

Since publication of the *SPD EIS*, a number of the facilities that are evaluated in this *SPD Supplemental EIS* have had DSAs prepared. The purposes of the DSAs under the current DOE practices are well defined, but differ in fundamental ways from some of the past DOE safety analysis practices. The current high-level goals of the DSAs are, very simply, to identify all of the things that can go wrong, without consideration of preventive or mitigation features, in a hazards analysis. The suite of hazards was evaluated to determine the approximate magnitude of the consequences and frequency range, then binned by the levels of risk to workers and the public. Safety controls are then identified to prevent these events to the extent practicable and, if the events are not preventable, to reduce their frequency and the magnitude of their potential consequences.

A central focus of the accident analyses in the current DSAs is to demonstrate that, with the safety controls in place, the potential bounding accidents have sufficiently low probabilities and consequences that their risk is acceptable. In general, the DSAs do not attempt to establish a credible bounding estimate of either probabilities or consequences. As such, the source terms presented for the bounding consequence estimates are often very conservative and may not be realistic or credible. In addition, the actual probabilities of the scenarios may be much lower than the bounding frequency category assigned.

This presents a challenge for selecting accidents for analysis in this *SPD Supplemental EIS* and reporting their likelihood and consequences, because the goal of this *SPD Supplemental EIS* is to present realistic estimates of accident risks so that fair comparisons can be made among alternatives. If, for example, the accident risks for one facility or alternative are presented based on realistic estimates and the accident risks for another facility or alternative are presented based on bounding, very conservative accident risks, balanced comparisons are not possible. The mitigative aspect of this problem, however, is that the accident risks for all of the plutonium disposition facilities are very low. Thus, while differences in the accident risks may be “artificial” because of the methods used to develop these risks, the differences are at accident risk levels that are very low.

The design-basis accidents descriptions and source terms that were reported in recent SRS facility DSAs were based on unmitigated design-basis accidents. Each of the facilities has been designed and would be operated to reduce the likelihood of these accidents to the extent practicable. Design features and operating practices would also limit the extent of any accidents and mitigate the consequences for the workers, public, and environment if they occurred. As with all new SRS facilities, it is expected that the safety controls would be sufficient such that the likelihood of any of these accidents occurring would be “extremely unlikely,” and if the accidents occurred, the likelihood of consequences of the magnitude reported in the draft DSA and this *SPD Supplemental EIS* are probably “beyond extremely unlikely” and, therefore, are not credible.

Accident frequencies are generally grouped into the bins of “anticipated,” “unlikely,” “extremely unlikely,” and “beyond extremely unlikely,” with estimated frequencies of greater than 1×10^{-2} , 1×10^{-2} to 1×10^{-4} , 1×10^{-4} to 1×10^{-6} , and less than 1×10^{-6} per year, respectively. The accidents evaluated represent a spectrum of accident frequencies and consequences ranging from low-frequency/high-consequence to high-frequency/low-consequence events. However, given the preliminary nature of the

designs under consideration, it was not possible to quantitatively assess the frequency of occurrence of all the events addressed. The evaluation does not indicate the total risk of operating the facility, but does provide information on high-risk events that could be used to develop an accident risk ranking of the various alternatives.

D.1.3.3 Identification of Material at Risk

For each accident scenario, the MAR—generally plutonium—was identified. Plutonium has a wide range of chemical and isotopic forms. The sources of plutonium vary among the various candidate facilities and, for specific facilities, among various alternatives. The vulnerability of material generally depends on the form of that material, the degree and robustness of containment, and the energetics of the potential accident scenario (DOE 1999). For example, plutonium stored in strong, tight storage containers is not generally vulnerable to simple drops or spills, but may be vulnerable in a total collapse earthquake scenario. The isotopic composition of the MAR will vary, depending on the feed source. The assumed isotopic compositions used in the *SPD EIS* have been updated for this *SPD Supplemental EIS*, now that more-recent information is available on the potential feeds. For the K-Area facilities, including the immobilization capability, a worst-case composition for a DOE-STD-3013 (DOE 2012a) container (also called a 3013 container or 3013 can) was assumed that is about 88 percent plutonium-239, 0.04 percent plutonium-238, and 6.25 percent americium-241 by weight (DOE/NNSA 2012). For HB-Line and H-Canyon, the same types of materials were assumed to be processed, so the same composition was used. For the Waste Solidification Building (WSB), the bounding composition from the *Waste Solidification Building Preliminary Documented Safety Analysis (WSB DSA)* (WSRC 2008b) was used. For all others, compositions used in the *SPD EIS* (DOE 1999) were used.

At some of the facilities, HEU is also present. For these analyses, the weight fraction for uranium-234, uranium-235, uranium-236, and uranium-238 were assumed to be 0.01, 0.931, 0.005, and 0.054 (DOE/NNSA 2012). For the accidents considered in this *SPD Supplemental EIS*, the contribution to dose from HEU releases are negligible when released in conjunction with plutonium.

Tritium (hydrogen-3, a radioactive isotope of hydrogen) could also be present in some of these facilities. It would typically be stored on a “getter” bed that requires electrical heating to drive off the tritium. For these accident analyses, the tritium is assumed to be released as tritiated water vapor, which is more biologically important than tritium gas.

Plutonium-239 dose equivalents: For some facilities, the exact quantities for MAR, including plutonium, HEU, and tritium, as well as the isotopic composition of some forms of plutonium, are sensitive from a security perspective. The exact quantities and locations are typically classified for security reasons. Many safety analyses have adopted the strategy of using a convenient surrogate, plutonium-239 dose equivalents, for the actual quantities, forms, and isotopic composition of the materials. With this approach, the masses or activities of certain quantities of material, such as weapons-grade plutonium (or a mixture of various types of plutonium, HEU, and tritium), can be expressed in terms of the amount of plutonium-239 that would result in the same radiological dose upon inhalation.

For plutonium isotopes, the relative inhalation hazard is similar for plutonium-238, -239, -240, and -242. Plutonium-241 is less hazardous. Plutonium decays with time and americium-241 builds up. The relative inhalation hazard of americium-241 is higher than that of plutonium-239. As a result, the relative hazard of plutonium (and americium-241) materials is highly dependent on the composition of the plutonium isotopes, and more importantly, on the amount of americium-241 in the mixture. For example, the dose from inhalation of 1 gram of weapons-grade plutonium, such as the mixture assumed for the Pit Disassembly and Conversion Facility (PDCF) in F-Area (92.35 percent plutonium-239 and 1 percent americium-241), would have the same dose as inhalation of 2.086 grams (0.0736 ounces) of plutonium-239 (DOE/NNSA 2012). For K-Area Material Storage Area (MSA)/K-Area Interim Surveillance (KIS)-type plutonium (87.8 percent plutonium-239 and 6.25 percent americium-241), the effect of the much higher americium-241 is large, and inhalation of 1 gram (0.0353 ounces) of KIS

plutonium would have the same dose as inhalation of 6.475 grams (0.228 ounces) of plutonium-239 (DOE/NNSA 2012). Quantities of other materials, such as HEU and tritium, can also be expressed in terms of plutonium-239 dose equivalents. For example, the dose from inhalation of 1 gram (0.0353 ounces) of HEU (of a particular enrichment) would have the same dose as inhalation of 0.000446 grams (1.57×10^{-5} ounces) of plutonium-239, and the inhalation (including skin adsorption) of 1 gram (0.0353 ounces) of tritium as tritiated water vapor would have the same dose as inhalation of 0.0486 grams (0.0017 ounces) of plutonium-239 (DOE/NNSA 2012).

Hazardous chemicals: On an industrial scale, the quantities of hazardous chemicals are generally small. The occupational risks are generally limited to material handling and are managed under the required industrial hygiene program. While some facilities, such as H-Canyon, have larger tanks of materials such as nitric acid, these quantities are still small relative to quantities at most industrial facilities and only represent a local worker hazard. No substantial hazardous chemical releases are expected.

D.1.3.4 Identification of Material Potentially Released to the Environment

The amount and particle size distribution of material aerosolized in an accident generally depends on the form of that material, the degree and robustness of containment, and the energetics of the potential accident scenario. Once the material is aerosolized, it must still travel through building confinement and filtration systems or bypass the systems before being released to the environment.

A standard DOE formula was used to estimate the source term for each accident at each of the proposed surplus plutonium facilities:

$$\text{Source Term} = \text{MAR} \times \text{DR} \times \text{ARF} \times \text{RF} \times \text{LPF}$$

where:

MAR = material at risk (curies or grams)

DR = damage ratio

ARF = airborne release fraction

RF = respirable fraction²

LPF = leak path factor

The MAR is the amount of radionuclides (in curies of radioactivity or grams of each radionuclide) available for release when acted upon by a given physical stress or accident. The MAR is specific to a given process in the facility of interest. It is not necessarily the total quantity of material present; rather, it is that amount of material in the scenario of interest postulated to be available for release.

The damage ratio (DR) is the fraction of MAR exposed to the effects of the energy, force, or stress generated by the postulated event. For the accident scenarios discussed in this analysis, the value of the DR varies depending on the details of the accident scenario, but can range up to 1.0.

The airborne release fraction (ARF) is the fraction of material that becomes airborne due to the accident. The respirable fraction (RF) is the fraction of the material with a particulate aerodynamic diameter less than or equal to 10 microns (0.0004 inches) that could be retained in the respiratory system following inhalation. The value of each of these factors depends on the details of the specific accident scenario postulated. ARFs and RFs were estimated according to reference material in *Airborne Release Fractions/Rates and Respirable Fractions for Nonreactor Nuclear Facilities* (DOE 1994).

The leak path factor (LPF) accounts for the action of removal mechanisms (e.g., containment systems, filtration, and deposition) to reduce the amount of airborne radioactivity ultimately released to occupied spaces in the facility or the environment.

² Respirable fractions are not applied in the assessment of doses based on noninhalation pathways, such as criticality.

No accident scenarios were identified that would result in a substantial release of plutonium or other radionuclides via liquid pathways.

D.1.4 Evaluation of Accident Consequences

D.1.4.1 Potential Receptors

For each potential accident, information is provided on accident consequences and frequencies for three types of receptors: (1) a noninvolved worker, (2) the maximally exposed member of the public, and (3) the offsite population. The first receptor, a noninvolved worker, is a hypothetical individual working on site, but not involved in the proposed activity. Consistent with the *SPD EIS*, the noninvolved worker at SRS was assumed to be downwind at a point 1,000 meters (3,280 feet) from the accident. Such a person outside of the area was assumed to be unaware of the accident, and so the emergency actions needed for protection, and to remain in the plume for the entire passage. Workers within the area would be trained to respond to an emergency and are expected to take proper actions to limit their exposure to a radioactive plume. If they failed to take proper actions, they could receive higher doses. For the accidents addressed in this *SPD Supplemental EIS*, accidental releases would be through medium-to-tall stacks for all design-basis accidents. Maximum doses within the area where the plume first touches down could be 1.4 to 2.9 times higher than the doses at 1,000 meters (3,280 feet). At LANL, because of differences in the geography of the area, the noninvolved worker was conservatively assumed to be exposed to the full release, without any protection, at the technical area boundaries, and within a distance of about 220 meters (about 720 feet) of Technical Area 55 (TA-55).

The second receptor, a maximally exposed member of the public, is a hypothetical individual assumed to be at a location along the site boundary where he or she would receive the largest dose. Exposures received by this individual are intended to represent the highest doses to a member of the public. The third receptor, the offsite population, comprises all members of the public within 50 miles (80 kilometers) of the accident location.

Consequences for workers directly involved in the processes under consideration are addressed generically, without attempt at a scenario-specific quantification of consequences. The uncertainties involved in quantifying accident consequences become overwhelming for most radiological accidents due to the high sensitivity of dose values to assumptions about the details of the release and the location and behavior of the affected worker. Consequences for potential receptors as a result of plume passage were determined without regard for emergency response measures and, thus, are more conservative than would be expected if evacuation and sheltering were explicitly modeled. Instead, it was assumed that potential receptors would be fully exposed in fixed positions for the duration of plume passage, thereby maximizing their exposure to the plume. As discussed in Section D.1.4.2, a conservative estimate of total consequences was obtained by assuming that all released radionuclides contributed to the inhalation dose as opposed to removal of some of them from the plume by surface deposition; surface deposition is a less significant contributor to overall risk and is controllable through interdiction.

D.1.4.2 Modeling of Dispersion of Releases to the Environment

The Melcor Accident Consequence Code System (MACCS2) computer code (version 1.13.1) was used to estimate the consequences of accidents for the proposed facilities. A detailed description of the MACCS2 model is available in NRC documents NUREG/CR-4691 (NRC 1990) and NUREG/CR-6613 (NRC 1998). Originally developed to model the radiological consequences of nuclear reactor accidents, this code has been used for the analysis of accidents in many environmental impact statements and other safety documentation and is considered applicable to the analysis of accidents associated with the disposition of plutonium.

MACCS2 models the offsite consequences of an accident that releases a plume of radioactive materials into the atmosphere; specifically, the degree of dispersion versus distance as a function of historical wind direction, speed, and atmospheric conditions. Were such an accidental release to occur, the radioactive

gases and aerosols in the plume would be transported by the prevailing wind and dispersed in the atmosphere, and the population would be exposed to radiation. MACCS2 generates the distribution of downwind doses at specified distances, as well as the distribution of population doses out to 50 miles (80 kilometers).

For tritium releases, the tritium (as tritiated water vapor) inhalation dose conversion factor used in this *SPD Supplemental EIS* is 50 percent greater than the Federal Guidance Report 11 (EPA 1988) inhalation dose conversion factor used in MACCS2. This change incorporates the recommendation in the DOE MACCS2 guidance to account for the dose due to absorption of tritiated water vapor through the skin (DOE 2004a).

For other isotopes, the standard MACCS2 dose library was used. This library is based on Federal Guidance Report 11 (EPA 1988) inhalation dose conversion factors. For exposure to plutonium oxides and metal, the dominant pathway for exposure is inhalation of very small, respirable particles. Unlike tritiated water vapor, absorption through the skin is not a significant pathway for plutonium dose. For accidents involving release of plutonium, more-recent dose conversion factors, based on Federal Guidance Report 13 (EPA 1999), would result in estimated doses of about 15 to 43 percent of the values reported in this *SPD Supplemental EIS*, depending on the assumed form of the plutonium inhaled. Overall, the values reported in this *SPD Supplemental EIS* are both conservative and internally consistent. The uncertainties in the estimated source terms far outweigh the differences in the modeling and dose conversion factor models used in this *SPD Supplemental EIS*.

As implemented in this *SPD Supplemental EIS* for accidents at DOE facilities, the MACCS2 model evaluates doses due to inhalation of aerosols such as respirable plutonium, as well as exposure to the passing plume. This represents the major portion of the dose that a noninvolved worker or member of the public would receive as a result of a plutonium disposition facility accident. The longer-term effects of plutonium deposited on the ground and surface waters after the accident, including through resuspension and inhalation of plutonium and ingestion of contaminated crops, were not modeled for accidents involving DOE facilities in this *SPD Supplemental EIS*. These pathways have been studied and found not to contribute as significantly to dosage as inhalation, and they are controllable through interdiction. Instead, the deposition velocity of the radioactive material was set to zero, so that material that might otherwise be deposited on surfaces remains airborne and available for inhalation. This adds conservatism to inhalation doses that can become considerable at large distances (as much as two orders of magnitude of conservatism at the 50-mile [80-kilometer] limit). Thus, the method used in this *SPD Supplemental EIS* is conservative compared with the dose results that would be obtained if deposition and resuspension were taken into account.

Longer-term effects of fission products released during a nuclear criticality accident have been extensively studied. The principal concern is ingestion of iodine-131 via milk that becomes contaminated due to the ingestion of contaminated feed by milk cows. This pathway can be controlled and, in terms of the effects of an accidental criticality, doses from this pathway would be small.

The region around the facility is divided by a polar-coordinate grid centered on the facility itself. The user specifies the number of radial divisions and their endpoint distances. The angular divisions used to define the spatial grid correspond to the 16 directions of the compass.

Dose distributions were calculated in a probabilistic manner. Releases during each of the 8,760 hours of the year were simulated, resulting in a distribution of dose reflecting variations in weather conditions at the time of the postulated accidental release. The code outputs the conditional probability of exceeding an individual or population dose as a function of distance. The mean consequences are analyzed in this *SPD Supplemental EIS*.

Radiological consequences may vary somewhat as a result of variations in the duration of release. For longer releases, there is a greater chance of plume meander (i.e., variations in wind direction over the

duration of release). MACCS2 models plume meander by increasing the lateral dispersion coefficient of the plume for longer release durations, thus lowering the dose. For perspective, doses from a homogenous 1-hour release would be 30 percent lower than those of a 10-minute release as a result of plume meander; doses from a 2-hour release would be 46 percent lower. The other effect of longer release durations is involvement of a greater variety of meteorological conditions in a given release, which reduces the variance of the resulting dose distributions. This would tend to lower high-percentile doses, raise low-percentile doses, and have no effect on the mean dose.

For this *SPD Supplemental EIS* accident analysis, a duration of 10 minutes was assumed for all SRS facility accident releases. This is consistent with the accident phenomenology expected for all scenarios, with the possible exception of fire. Depending on the circumstances, the time between fire ignition and extinction may be considerably longer, particularly for the larger beyond-design-basis fires. However, even in a fire of long duration, it is possible to release substantial fractions of the total radiological source term in fairly short periods as the fire consumes areas of high MAR concentrations. The assumption of a 10-minute release duration for fire is intended to generically account for this circumstance.

For the LANL analyses, the approaches and evaluation of these accidents follow the methods used in the recent *Final Supplemental Environmental Impact Statement for the Nuclear Facility Portion of the Chemistry and Metallurgy Research Building Replacement Project at Los Alamos National Laboratory, Los Alamos, New Mexico* (DOE 2011a) and the earlier *Final Site-Wide Environmental Impact Statement for Continued Operation of Los Alamos National Laboratory, Los Alamos, New Mexico (LANL SWEIS)*, DOE/EIS-0380 (DOE 2008b).

D.1.4.3 Modeling of Consequences of Releases to the Environment

The probability coefficients for determining the likelihood of fatal cancer, given a dose, are taken from the *1990 Recommendations of the International Commission on Radiological Protection* (ICRP 1991) and DOE guidance (DOE 2004b). For low doses or low dose rates, probability coefficients of 6.0×10^{-4} fatal cancers per rem and person-rem are applied for workers and the general public (DOE 2003). For cases where the individual dose would be equal to or greater than 20 rem, the LCF risk was doubled (NCRP 1993). Additional information about radiation and its effects on humans is provided in Appendix C.

D.1.5 Accident Scenarios for Surplus Plutonium Disposition Facilities

Bounding design-basis and beyond-design-basis accident scenarios have been developed from accident scenarios presented in the *SPD EIS*, previous NEPA analyses, data call responses from SRS and LANL, and current safety analyses for the facilities (DOE 1999; WSRC 2006a, 2006b, 2007a, 2007b, 2007c, 2007d, 2007e, 2007f, 2007g, 2008a, 2008b, 2010, 2011; SRNS 2010, 2011a, 2011b, 2012). These scenarios are discussed in detail in these documents, along with specific assumptions for each facility and site.

D.1.5.1 Accident Scenario Consistency

In preparing the accident analysis for this *SPD Supplemental EIS*, the primary objective was to ensure consistency between the data reports so that the results of the analyses for the proposed surplus plutonium disposition alternatives could be compared. In spite of efforts by all parties, some inconsistencies exist between the data reports. This does not imply technical inaccuracy in any analysis; it merely reflects the uncertainties and reliance on conventions that are generally inherent in accident analyses. To provide a consistent analytical basis, information in the data reports was modified or augmented as described in this section.

Aircraft crash. It was decided early in the process of developing accident scenarios for the original *SPD EIS* that aircraft crash scenarios would not be provided in the data reports, but would be developed, as appropriate, directly for the *SPD EIS*. This practice was continued for this *SPD Supplemental EIS*.

Frequencies of an aircraft crash into each facility evaluated in the *SPD EIS* under each alternative were developed in accordance with the *Accident Analysis for Aircraft Crash Into Hazardous Facilities* (DOE 2006b). Facility-specific safety analyses indicate that the frequency of crashes involving aircraft capable of penetrating the subject facility (assumed to be all aircraft except those in general aviation) would generally be below 1.0×10^{-7} per year for all facilities.

Of the variety of impact conditions accounted for in the above frequency values (e.g., impact angle, direction, lateral distance from building center, and speed), only a fraction would have the potential to produce consequences comparable to those reported in the *SPD EIS*, while other impacts (grazing impacts and impacts on office areas) would not result in significant radiological impacts.

For SRS facilities for which an SAR or DSA was available, that information was used to determine whether an aircraft crash coupled with a release of material was credible. In most cases, the building would provide sufficient structural strength and shielding such that a release of radioactive material would not be likely.

Criticality. The source term for this criticality is based on a fission yield of 1.0×10^{19} fissions, which was used for all facilities. The source term was based on that given in DOE Handbook 3010-94 (DOE 1994). The estimated frequency of “extremely unlikely” (i.e., 1×10^{-6} to 1×10^{-4} per year) was also used because it is the bounding estimate.

Design-basis earthquake. Safety analyses for each facility present an analysis of a design-basis earthquake.

All the existing facilities that were considered in the *SPD EIS* have had seismic evaluations demonstrating that they meet the seismic evaluation requirements for a design-basis earthquake.

Beyond-design-basis earthquake. All of the proposed operations would be in either existing or new facilities that are expected to meet or exceed the requirements of DOE Order 420.1B (DOE 2005b) and DOE-STD-1020-2002, *Natural Phenomena Hazards Design and Evaluation Criteria for Department of Energy Facilities* (DOE 2002a), for reducing the risks associated with natural phenomenon hazards. The proposed facilities would be characterized as Performance Category 3 (PC-3) facilities. Such facilities would have to be designed or evaluated for a design-basis earthquake with a mean annual exceedance probability of 4×10^{-4} , corresponding to a return period of 2,500 years.

The numerical seismic design requirements detailed in DOE-STD-1020-2002 are structured such that there is assurance that specific performance goals would be met. For PC-3 plutonium facilities, the performance goal is to ensure occupant safety, continued operation, and hazard confinement for earthquakes with an annual probability exceeding approximately 1×10^{-4} . There is sufficient conservatism in the design of the buildings and the structures, systems, and components that are important to safety that this goal should be met, given that they are designed to withstand earthquakes with an estimated mean annual probability of 4×10^{-4} .

By contrast, nonnuclear structures at these sites and the surrounding community would be constructed to the regional standards of the *Uniform Building Code* at the time of construction. These peak acceleration values are 50 to 82 percent of the peak acceleration design requirements for plutonium facilities in the same area and correspond approximately to DOE PC-1 facilities with 500-year return intervals. During major earthquakes, structures built to these *Uniform Building Code* requirements are expected to suffer significantly more damage than reinforced-concrete structures designed for plutonium operations. At sites far from tectonic plate boundaries, deterministic techniques such as those used by NRC in evaluating safe-shutdown earthquakes for the siting of nuclear reactors have also been used to determine the maximum seismic ground motion requirements for facility designs. These techniques involve estimating the ground acceleration at the proposed facility by either assuming the largest historical earthquake within the tectonic province or by assessing the maximum earthquake potential of the appropriate tectonic structure or capable fault closest to the facility. For NRC-licensed reactors, this technique resulted in

safe-shutdown earthquakes with estimated return periods in the 1,000- to 100,000-year range (DOE 2002a).

The magnitude of potential earthquakes with return periods greater than 10,000 years is highly uncertain. For purposes of the *SPD EIS*, it was assumed that, at all the candidate sites, earthquakes with return periods in the 100,000- to 10-million-year range might result in sufficient ground motion to cause major damage to even a modern, well-engineered, and well-constructed plutonium facility. Therefore, in the absence of convincing evidence otherwise, a total collapse of the plutonium facilities was assumed to be scientifically credible and within the rule of reason for return intervals in this range.

The frequency of all beyond-design-basis earthquakes for all facilities is reported in the *SPD EIS* as “extremely unlikely to beyond extremely unlikely” (the PDCF data report estimated a frequency of less than 1×10^{-6} per year). They are reported as such because the uncertainties inherent in associating damage levels with earthquake frequencies become overwhelming below frequencies of about 1.0×10^{-5} per year.

Filtration efficiency. In the *SPD EIS*, the exhaust from most facilities, including the MFFF, PDCF, and the immobilization facilities, was assumed to be directed through two stages of testable HEPA filters to a stack. A building LPF of 1.0×10^{-5} was used for particulate releases with HEPA filters unless otherwise noted (DOE 1999). Several of the existing facilities and some of the proposed facilities would use a standalone sand filter as the primary filter system for exhaust that leaves the main process area building. In most cases, exhaust air from a glovebox or process room would first be filtered by one or more sets of testable HEPA filters that would be designated Safety Significant or Safety Class and expected to continue functioning during and after design-basis accidents. The more recent *Plutonium Vitrification Facility Consolidated Hazard Analysis (U)* (WSRC 2007a) indicates that the heating, ventilating, and air conditioning (HVAC) exhaust would go through a duct to the sand filter and a new stack.

For facilities with sand filters, the recent SRS safety analyses have only taken credit for the sand filter with its stated efficiency of 99.51 percent (or a penetration factor of 4.9×10^{-3}). For facilities with sand filters as the final safety system, this *SPD Supplemental EIS* follows SRS practice and only takes credit for that filter for design-basis accidents unless otherwise noted. In most cases, multiple HEPA filters within the building would likely provide significant filtration of particulates released during an accident before they were transported through the exhaust system to the sand filter and stack.

For the hypothetical Beyond-Design-Basis Earthquake and Fire, a consistent LPF was assumed across the facilities evaluated. In the *SPD EIS*, the beyond-design-basis earthquake accidents are hypothetical, are not based on detailed analysis, and are postulated simply to show a bounding level of impacts should the safety design and operational controls fail. For NEPA purposes, the goal is to show the impacts of realistic, physically possible events even if it is believed their probability is extremely low.

For comparison purposes, it is postulated that:

- The hypothetical beyond-design-basis accident is assumed to be an earthquake that exceeds the design-basis earthquake (PC-3) by a sufficient margin that gloveboxes fail, fire suppression systems fail, power fails, and some building confinement is lost. It is further assumed that a room-wide fire or multiple local fires might occur. The overall probability of the event, considering the conditional probabilities of fires following a beyond-design-basis earthquake, is expected to be in the 1×10^{-6} to 1×10^{-7} per year range.
- For new facilities and significantly upgraded facilities, it is assumed that they would be designed to fail gracefully. A building LPF of 0.1 is assumed and expected to be conservative. This factor should adequately represent an LPF for cracks in the building or transport through rubble.
- For older, existing facilities that have not been or are not planned to be upgraded, it is not generally known how they might fail in a beyond-design-basis earthquake but an LPF of 1 is considered unrealistic because even a rubble pile in a total building collapse offers some

impediment to particulates being released to the environment. Therefore, this SPD Supplemental EIS assumes an LPF of 0.25 for these facilities even though the LPF could be several times lower than this.

- For all facilities, an LPF of 1.0 was assumed for tritium or gaseous releases.

D.1.5.2 Facility Accident Scenarios

D.1.5.2.1 Existing K-Area Material Storage Area/K-Area Interim Surveillance

The K-Area MSA and KIS area have materials and activities that are common to several of the facilities and, hence potential accidents that have some common characteristics. Each of the facilities handles cans of plutonium metal or oxide that protect the materials inside from a wide range of accidents. Much of the material is in 3013 cans, which meet or exceed the requirements given in DOE STD-3013 (DOE 2012a).

K-Area MSA. The K-Area MSA is an area inside the decommissioned K-Area reactor building that was modified to store surplus plutonium. The K-Area MSA is within a robust structure and is designated a Hazard Category 2 Nuclear Facility. The area used for the K-Area MSA primarily consists of reinforced-concrete walls with solid concrete floor slabs. Plutonium is stored in the K-Area MSA in DOE-STD-3013 or other approved containers nested inside U.S. Department of Energy-certified Type B shipping packages. This robust packaging configuration serves as confinement against possible release of contamination. Within the K-Area MSA, the 3013 cans or other approved containers are required to remain in approved shipping containers at all times and, therefore, are not vulnerable to routine accidents. For example, a 9975 Type B shipping package consists of a stainless steel outer drum assembly, Celotex™ insulation, lead shielding, a secondary containment vessel, and a primary containment vessel. Plutonium metal or oxide is stabilized and packaged according to DOE-STD-3013. Type B shipping packages are designed to withstand fires with temperatures as high as 1,475 degrees Fahrenheit (800 degrees Celsius) for 30 minutes, as well as a wide spectrum of very severe transportation accidents. The environmental impacts of potential accidents associated with the K-Area MSA operations were discussed previously in the *Supplement Analysis for Storage of Surplus Plutonium Materials in the K-Area Material Storage Facility at the Savannah River Site* (DOE 2002b), as well as the *Supplement Analysis, Storage of Surplus Plutonium Materials at the Savannah River Site* (DOE 2007), and were found to be very small due to the robust packaging.

The *K-Area Complex Documented Safety Analysis (K-Area DSA)* (WSRC 2011) evaluates the storage of surplus plutonium, as well as other materials, in the existing K-Area reactor building. A range of potential hazards and accidents was evaluated in the *K-Area DSA*. That evaluation indicates that, because all of the plutonium is stored in 3013 cans that are then stored in Type B shipping packages, none of the design-basis accidents would release plutonium from the confinement of the 3013 cans and the Type B shipping packages. The combination of the 3013 cans and the Type B shipping packages provides sufficient protection from a range of fires, explosions, overpressurizations, external events, and natural phenomenon-initiated events, such that any event that would potentially result in a release was designated “beyond extremely unlikely” and was not evaluated in detail. As a result, the K-Area MSA is not required to have criticality accident alarms or a building confinement system.

None of the credible accidents identified, including all of the design-basis accidents, threatened the integrity of the packages. The *K-Area DSA* (WSRC 2011) did identify potential releases from a bounding, beyond-design-basis earthquake followed by a fire. The hypothetical event postulates collapse of the Actuator Tower through the roof of the building onto a storage array of Type B shipping packages. Debris from the collapse was assumed to crush the shipping package, or some sharp object could penetrate it. The worst-case release would be from impact stress on the shipping package, which could be modeled as a pressurized venting of plutonium oxide, and could release as much as 51 grams (1.8 ounces) of oxide per drum. The *K-Area DSA* indicated that as many as 125 shipping packages could be damaged

in this beyond-design-basis earthquake, for a total release of 6,380 grams (225 ounces) of plutonium. A much smaller release (about 10 percent of the total MAR) could also occur due to subsequent fires.

The probability of an event of this magnitude with this large a release is extremely small, as it requires the initiating event, a significantly beyond-design-basis earthquake, to cause the collapse; a collapse at the right location, a collapse onto 125 shipping containers designed to withstand very severe transportation accidents; a crash onto shipping containers containing oxide instead of metal; and damage and pressurized release from all containers. This scenario/release combination is not considered credible for analysis purposes in this *SPD Supplemental EIS*.

KIS. KIS became operational in 2007 and provides interim capability for nondestructive and destructive examination of plutonium materials. Nondestructive capabilities include weight verification, visual inspections, digital radiography, and prompt gamma analysis; destructive capabilities include can puncturing for headspace gas sampling and can cutting for oxide sampling. Repackaging capabilities are available at other facilities for safe storage of the material pending its eventual disposition. K-Area was modified to add equipment and tools to unload and reload DOE-STD-3013 containers from U.S. Department of Energy-certified Type B shipping packages; weigh and perform examinations of containers and shipping packages; and perform assays.

Potential accidents at KIS. The environmental impacts of potential accidents associated with KIS operations were discussed in the *Environmental Assessment for the Safeguards and Security Upgrades for Storage of Plutonium Materials at the Savannah River Site* (DOE 2005a), as well as the *Supplement Analysis, Storage of Surplus Plutonium Materials at the Savannah River Site* (DOE 2007), and were found to be very small due to the robust packaging and limited operations.

The environmental impacts of KIS operations have been evaluated in detail for KIS and the previously planned Container Surveillance and Storage Capability. These operations would be conducted in a glovebox and would involve one 3013 container at a time. Thus, the MAR for most operational accidents would be one container.

The *Environmental Assessment for the Safeguards and Security Upgrades for Storage of Plutonium Materials at the Savannah River Site* (DOE 2005a) states: “Implementing the surveillance program would require the loading and unloading of 9975 shipping packages, visual examination of a 3013 container, and the opening of 3013 containers. Opening the 3013 containers would be performed inside of a credited glovebox, which would protect the worker from exposure to the plutonium bearing materials. Although the processing of the plutonium introduces the possibility of different accidents, such as criticality, the scenario most likely to generate a significant release is still the design-basis fire. Safety features to prevent or mitigate this, and other credible accidents, include building design, engineered fire-suppression and detection systems, filtered ventilation systems, and procedural controls to preclude mishandling of the material.” This environmental assessment also states: “As the authorization basis documentation for the proposed activity is in preliminary form, consequence analysis for the bounding event is estimated based on the mitigated release of five maximally loaded plutonium containers. The estimated mitigated dose to a maximally exposed individual at the Site boundary associated with a pressurized release of five plutonium containers is less than 1,000 millirem.”

The consequences of radiological accidents in KIS and similar operations in the Container Surveillance and Storage Capability have subsequently been evaluated. The Washington Safety Management Solutions engineering calculation S-CLC-K-00208, from the *The Consequences of Releases from Potential Accidents in the 105-K Slug Vault* (WSMS 2006), evaluates a range of potential accidents involving KIS operations, including fires involving transuranic (TRU) waste containers and pressurized releases from a single 3013 container containing less than 4.5 kilograms (9.9 pounds) of plutonium or 5.0 kilograms (11 pounds) of plutonium oxide with worst-case isotopic composition. This calculation was used for the accident analyses reported in the *KIS DSA Addendum* (WSRC 2006b) to the *K-Area DSA* (WSRC 2011). The *KIS DSA Addendum* (WSRC 2006b) technical safety requirement mandates that at

least one stage of HEPA filters should be functioning during design-basis accidents, with an efficiency of at least 99.5 percent, or a building LPF of 0.005.

Analysis of the 3013 container surveillance operations for KIS identified the following broad categories of accidents: design-basis fire, design-basis explosion, design-basis loss of containment/confinement, design-basis nuclear criticality, design-basis external hazard, and design-basis natural phenomena. Based on the *KIS DSA Addendum* (WSRC 2006b) results of credible, mitigated accidents, several accidents were selected for presentation in this *SPD Supplemental EIS* to represent the bounding credible design-basis and beyond-design-basis accidents. Basic characteristics of each of these postulated accidents are described in this section. Additional discussion of scenario development based on consistency concerns was presented earlier in this appendix.

Fires. The bounding mitigated fire event is a postulated occurrence fire in the KIS vault that causes both a collapse of the KIS vault and pressurized release of 7 kilograms (15 pounds) of plutonium oxide at 1,000 pounds per square inch gauge (psig). The fire protection program, fire-suppression system, fire doors, and structural design should limit any fire and prevent the fire from heating 3013 containers to the point that a pressurized release would occur. For a pressure of 1,000 psig, the expected $ARF \times RF$ is 0.0284, which corresponds to approximately 175 grams (6.2 ounces), and was indicated as released to the building exhaust system, where the building HEPA filters would reduce the amount released to the stack. A building LPF of 5.0×10^{-3} was assumed for one stage of HEPA filters. Therefore, the mitigated release to the environment through the stack would be approximately 0.88 grams (0.031 ounces) of plutonium. A release of this magnitude would fall into the “extremely unlikely to beyond extremely unlikely” category.

Explosions. The bounding mitigated explosion event is a postulated deflagration or detonation in the glovebox that occurs just as a 3013 container is being punctured for sampling purposes. The *KIS DSA Addendum* (WSRC 2006b) indicates that the internal pressure should be within the 3013 container design rupture limit of 700 psig unless subjected to an external fire. For a pressure of 700 psig, the expected $ARF \times RF$ is 0.022, which corresponds to approximately 99 grams (3.5 ounces) from a drum containing 4,500 grams (160 ounces) of plutonium that is released to the building exhaust system, where the building HEPA filters would reduce the amount released to the stack. A building LPF of 5.0×10^{-3} was assumed for one stage of HEPA filters. Therefore, the mitigated release to the environment through the stack would be approximately 0.50 grams (0.018 ounces) of plutonium. A release of this magnitude would fall in the “extremely unlikely to beyond extremely unlikely” category.

Design-basis earthquake. The bounding design-basis earthquake was postulated to collapse the KIS vault and cause a fire that results in a pressurized release of 7 kilograms (15 pounds) of plutonium oxide to the room. Without a fire, no release is expected. Large, seismically induced fires that could start in the KIS vault or propagate into the KIS vault (PC-3, 3-hour-fire-rated barrier) from other areas are unlikely, even assuming an earthquake. A building LPF of 5.0×10^{-3} was assumed for one stage of HEPA filters. Therefore, the mitigated release to the environment through the stack would be approximately 0.031 grams (0.0011 ounces) of plutonium (WSRC 2006b). A release of this magnitude would fall in the “unlikely” category, with the estimated return interval for a design-basis earthquake of 2,500 years. Realistically, the conditional probability of a fire with sufficient magnitude and duration to cause a release would make this scenario even less likely.

Beyond-design-basis fire. A beyond-design-basis fire has been postulated in K-Area that would involve an unmitigated transuranic waste drum fire on the loading dock that burns with sufficient intensity and duration that all of the material in the drum is consumed. The expected $ARF \times RF$ is 0.0005, which corresponds to approximately 0.2 grams (0.007 ounces) of plutonium from a drum containing 450 grams (16 ounces) of plutonium oxide. Because this fire is postulated to occur outside the building a LPF of 1 was assumed. This accident was conservatively estimated to have a total frequency of 1×10^{-6} per year or lower.

Beyond-design-basis earthquake with fire. The bounding seismic event is a postulated seismic event that causes a fire in the KIS vault that burns with sufficient intensity and duration that a very high (1,000 psig) pressurized release of 7 kilograms (15 pounds) of plutonium oxide occurs. This accident is expected to result in much-higher releases than any credible accident. Consistent with the general assumptions for beyond-design-basis accident LPFs presented in Section D.1.5.1 for an older existing facility, a building LPF of 0.25 was assumed, although a more realistic value is likely to be at least a factor of several lower. The safety documents also consider a large, seismically induced fire that could start in the KIS vault or propagate into the KIS vault (PC-3, 3-hour-fire-rated barrier) from other areas. This accident was conservatively estimated to have a total frequency of 7.2×10^{-7} per year or lower (WSRC 2006b) and, hence, was not analyzed in the safety documents.

Table D–1 presents the postulated bounding accident scenarios. The unmitigated accidents were developed to determine the type of safety controls needed to prevent the accidents from happening and to reduce the potential consequences if the safety prevention systems failed. The postulated unmitigated accidents assumed bounding material inventories and bounding release mechanisms, with no credit taken for mitigation features such as building structure and filtration systems. With safety controls in place, the consequences of these bounding accidents would be substantially reduced by the building filtration systems, which would be designed to mitigate these accidents. Based on an LPF of 5.0×10^{-3} for a single HEPA filter, a stack release would reduce the quantities released to the environment with the exception of the beyond-design-basis accidents discussed above.

Table D–1 Accident Scenarios and Source Terms for the K-Area Material Storage Area/K-Area Interim Surveillance Capability

<i>Accident</i>	<i>Frequency (per year)</i>	<i>MAR (grams)</i>	<i>DR</i>	<i>ARF × RF</i>	<i>LPF</i>	<i>Release (grams)</i>
Criticality	Not credible	–	–	–	–	–
Fire in K-Area Interim Surveillance vault with 3013 can rupture at 1,000 psig	1×10^{-5} to 1×10^{-7} (extremely unlikely to beyond extremely unlikely)	6,173 Pu (7,000 PuO ₂)	1	0.0284	0.005	0.88 Pu 5.7 PuE
Explosion (deflagration of 3013 can during puncturing; can assumed to be at 700 psig)	1×10^{-5} to 1×10^{-7} (extremely unlikely to beyond extremely unlikely)	4,500 Pu (5,000 PuO ₂)	1	0.022	0.005	0.50 Pu 3.2 PuE
Design-basis earthquake	0.0004 (unlikely)	6,173 Pu (7,000 PuO ₂)	1	0.001	0.005	0.031 Pu 0.20 PuE
Beyond-design-basis fire (unmitigated transuranic waste drum fire)	$< 1 \times 10^{-6}$ (beyond extremely unlikely)	396 Pu (450 PuO ₂)	1	0.0005	1	0.20 Pu 1.3 PuE
Beyond-design-basis earthquake with fire (bounded by unmitigated pressurized 3013 can rupture due to an external fire and vault release [1,000 psig])	$< 1 \times 10^{-6}$ (beyond extremely unlikely)	6,173 Pu (7,000 PuO ₂)	1	0.0284	0.25	44 Pu 280 PuE

ARF = airborne release fraction; DR = damage ratio; LPF = leak path factor; MAR = material at risk; psig = pounds per square inch gauge; Pu = plutonium; PuE = plutonium-239 dose equivalent; PuO₂ = plutonium dioxide; RF = respirable fraction.

Note: To convert grams to ounces, multiply by 0.035274.

Source: WSMS 2006; WSRC 2006b, 2011.

Although both pit and non-pit plutonium could be handled in support of surplus plutonium disposition activities in K-Area, all of the plutonium involved is assumed to be non-pit plutonium. This is consistent with the safety analyses for these facilities and bounds the potential impacts of accidents. This material is assumed to have an americium-241 content of 6.25 percent. The relative inhalation hazard of this material is 6.47 times higher than plutonium-239 and about 3.1 times more hazardous than weapons-grade plutonium. The plutonium-239 dose equivalents for each source term are also included in Table D–1.

D.1.5.2.2 Pit Disassembly and Conversion Facility at F-Area

A wide range of potential accident scenarios was considered for PDCF. These scenarios are considered in detail in the *SPD EIS* (DOE 1999), as well as the ongoing safety analysis process as the facility is being designed, and are summarized for purposes of this *SPD Supplemental EIS* in the *NEPA Source Document for Pit Disassembly and Conversion Project (PDC NEPA Source Document)* (DOE/NNSA 2012) and SRNS 2012. Under all of the alternatives being considered in this *SPD Supplemental EIS*, PDCF could process pits and other plutonium metal (see Appendix B, Section B.1.1.1). PDCF would be designed and built to withstand design-basis natural phenomenon hazards such as earthquakes, winds, tornadoes, and floods, such that no unfiltered releases are expected.

Analysis of the proposed process operations for PDCF identified the following broad categories of accidents: design-basis fire, design-basis explosion, design-basis loss of containment/confinement, design-basis nuclear criticality, design-basis external hazard, and design-basis natural phenomenon. Based on the review of the safety documents of credible, mitigated accidents, several accidents were selected for presentation in this *SPD Supplemental EIS* to represent the bounding credible design-basis and beyond-design-basis accidents. Basic characteristics of each of these postulated accidents are described in this section. Additional discussion of scenario development based on consistency concerns was presented earlier in this appendix.

Aircraft crash. A crash of a large, heavy commercial or military aircraft directly into a reinforced-concrete facility could damage the structure sufficiently to breach confinement and disperse material into the environment. A subsequent fuel-fed fire could provide energy to further damage structures and equipment, aerosolize material, and drive materials into the environment. Source terms are highly speculative, but could exceed those from the beyond-design-basis earthquake. The frequency of such a crash is below 1×10^{-7} per year and was not evaluated.

Criticality. This accident was identified as “unlikely” (with a frequency greater than or equal to 10^{-4} and less than 10^{-2}) when unmitigated. The scenario represents a metal criticality. The metal was postulated to soften, resulting in a 100 percent release of fission products generated in the criticality. However, no aerosolized, respirable metal fragments were predicted to be released. Engineered and administrative controls should be available to ensure that the double-contingency principles³ are in place for all portions of the process. It was assumed that human error results in multiple failures, leading to an inadvertent nuclear criticality. The estimated frequency of this accident is in the range of 1×10^{-4} to 1×10^{-6} per year (“extremely unlikely”). A bounding source term resulting from 1×10^{19} fissions was assumed.

Explosion. The bounding radiological explosion is bounded by the postulated overpressurization of multiple oxide storage cans due to out-of-specification oxide product, as discussed below.

Fires. The safety analyses evaluated a range of fire scenarios, including glovebox fires, process fires, room fires, maintenance-related fires, dock fires, and fires associated with material transfer. The controls included in the facility design are expected to prevent or reduce the frequency of fires and to limit their severity. In most cases, when the planned controls are considered, the fire events identified in the hazards analysis have negligible risk.

Several fire scenarios were considered in more detail. The *PDC NEPA Source Document* (DOE/NNSA 2012) indicates that a fire in the product nondestructive assay module could release up to 3.4 grams (0.12 ounces) of plutonium-239 dose equivalents from the stack. A direct metal oxidation glovebox fire could release 2.4 grams (0.085 ounces) of plutonium-239 dose equivalents from the stack. A multi-room fire could release 15 grams (0.53 ounces) of plutonium-239 dose equivalents from the

³ DOE criticality standards require that process designs incorporate sufficient factors of safety to require at least two unlikely, independent, and concurrent changes in process conditions before a criticality accident is possible. This is known as the double-contingency principle.

stack. This bounding fire event is marginally in the “extremely unlikely” frequency bin and approaches the “beyond extremely unlikely” frequency bin when planned controls are considered.

Leaks or spills of nuclear material. The safety analyses evaluate a range of loss of containment or confinement scenarios, including those due to loss of cooling, excessive moisture, helium atmosphere problems, operator error, material transfer failures, and container defects. Several types of events could potentially lead to overpressurization of containers and rupture. Other events might involve operator mishandling events that result in dropping or impacting containers. The rigorous controls imposed on containers should prevent or mitigate most of these types of events. The bounding loss of containment event involves the overpressurization of six 3013 cans due to out-of-specification oxide products that are outside of a glovebox confinement/ventilation (DOE/NNSA 2012). This accident assumes that moisture significantly in excess of specifications remains in the cans and the radioactive heating of the water overpressurizes the container to the point of rupture. For this accident, 30 kilograms (66 pounds) of plutonium oxide were assumed to be MAR and a DR of 1.0 was assumed. The ARF for a high-pressure burst associated with a 3013 can was estimated at 0.108, with an RF of 0.7. Thus, about 2.3 kilograms (5.1 pounds) of oxide would be released to the room. The release to the environment would be limited by the Safety Class processing building confinement structure and the HVAC confinement ventilation system. The release would be filtered by the sand filter and released through the stack. A bounding release of 9.8 grams (0.35 ounces) of plutonium, or 20 grams (0.71 ounces) of plutonium-239-dose-equivalent material, was postulated. This accident’s frequency is categorized as “extremely unlikely to beyond extremely unlikely” because out-of-specification cans of oxide should not be present at PDCF and tests have demonstrated that the 3013 cans to be used at PDCF significantly exceed the performance requirements of DOE-STD-3013 (DOE 2012a).

Tornado. The *PDC NEPA Source Document* (DOE/NNSA 2012) considers a tornado-initiated accident that results in a tornado-generated missile impacting two Type B shipping packages of plutonium oxide. This scenario would result in a release of 0.37 grams (0.013 ounces) of plutonium-239-dose-equivalent material to the environment. This event is considered “extremely unlikely.” The risks from this event are bounded by the seismically induced fire, so it was not evaluated further.

Design-basis earthquake with fire. The *PDC NEPA Source Document* (DOE/NNSA 2012) also postulates a limited seismically induced fire in the Plutonium Processing Building, resulting in the release of all MAR inventory in the affected processing rooms. The fire was postulated to occur in the direct metal oxidation and canning areas. As specified in DOE-STD-1020-2002 (DOE 2002a), the mean probability of exceedance of a PC-3 design-basis earthquake is 1 in 2,500 years (4.0×10^{-4} per year). Furthermore, the conditional probability of a facility fire being induced by the design-basis earthquake was estimated as 8.67×10^{-3} in the fire risk analysis. The initiating frequency for a seismically induced facility fire is the product of these two frequencies, or 3.5×10^{-6} per year ($8.67 \times 10^{-3} \times 4.0 \times 10^{-4}$), resulting in the categorization of a seismically induced fire as an “extremely unlikely” event. Considering the conditional probability of a fire spreading beyond the direct metal oxidation and canning segments of the central processing area, the fire risk analysis concludes that a larger fire involving additional MAR is an “extremely unlikely to beyond extremely unlikely” event. This event was estimated to result in release of plutonium and tritium through the sand filter and stack, with the dose equivalent to 7.7 grams (0.27 ounces) of plutonium-239.

Beyond-design-basis earthquake with fire. The postulated beyond-design-basis earthquake was assumed to be of sufficient magnitude to initiate a facility-wide fire. This accident was postulated to result in loss of the PDCF fire-suppression system, as well as other controls, and to result in pressurizing the process building and releasing radioactive materials through the sand filter and the building confinement structure. As with the design-basis earthquake scenario, seismically induced glovebox failure was assumed to occur. Consistent with the general assumptions for beyond-design-basis accident LPFs presented in Section D.1.5.1 for a new facility, a LPF of 0.1 was assumed for the plutonium materials and 1 for tritium. These assumptions lead to the release of about 650 grams (23 ounces) of plutonium-239-

dose-equivalent materials to the environment during the beyond-design-basis earthquake with fire. The estimated frequency of this accident is in the range of 1×10^{-5} to 1×10^{-7} per year or lower (“extremely unlikely to beyond extremely unlikely”).

Accident scenarios and source terms assumed for PDCF under all of the alternatives are presented in **Table D–2**.

Table D–2 Accident Scenarios and Source Terms for the Pit Disassembly and Conversion Facility at F-Area

<i>Accident</i>	<i>Frequency (per year)</i>	<i>MAR (grams)</i>	<i>DR</i>	<i>ARF</i>	<i>RF</i>	<i>LPF</i>	<i>Release (grams)</i>
Criticality	1×10^{-4} to 1×10^{-6} (extremely unlikely)	–	–	–	–	–	1×10^{19} fissions
Product NDA room fire	1×10^{-4} to 1×10^{-6} (extremely unlikely)	3.3×10^5 PuE	Varies	0.108	0.7	0.0049	3.4 PuE
Multi-room fire	1×10^{-4} to 1×10^{-6} (extremely unlikely)	2.6×10^5 PuE	Varies	Varies	Varies	0.0049 (particulates) 1 (tritium)	15 PuE
Fire in direct metal oxidation glovebox	1×10^{-4} to 1×10^{-6} (extremely unlikely)	39,000 PuE	Varies	Varies	Varies	0.0049 (particulates) 1 (tritium)	2.4 PuE
Overpressurization of oxide storage cans	1×10^{-4} to 1×10^{-6} (extremely unlikely)	30,000 Pu oxide 55,000 PuE	1	0.108	0.7	0.0049	20 PuE
Design-basis earthquake with fire (limited)	1×10^{-5} to 1×10^{-7} (extremely unlikely to beyond extremely unlikely)	2.8×10^5 PuE	Varies	Varies	Varies	0.0049 (particulates) 1 (tritium)	7.7 PuE
Beyond-design-basis earthquake with fire	1×10^{-5} to 1×10^{-7} (extremely unlikely to beyond extremely unlikely)	1.6×10^6 PuE	1	Varies	Varies	0.1 (particulates) 1 (tritium)	650 PuE

ARF = airborne release fraction; DR = damage ratio; LPF = leak path factor; MAR = material at risk; NDA = nondestructive assay; Pu = plutonium; PuE = plutonium-239 dose equivalent; RF = respirable fraction.

Note: To convert grams to ounces, multiply by 0.035274.

Source: DOE/NNSA 2012; SRNS 2012.

D.1.5.2.3 Pit Disassembly and Conversion Capability at K-Area

Under the mixed oxide (MOX) Fuel, H-Canyon/HB-Line to the Defense Waste Processing Facility (DWPF), and WIPP Alternatives, the K-Area Pit Disassembly and Conversion Project (PDC) could process pits and other plutonium metal (see Appendix B, Section B.1.2.2). PDC is at an early state of safety analysis. Potential accidents associated with PDC are expected to be similar to those identified for PDCF in Section D.1.5.2.2.

An early evaluation of potential accidents for PDC was developed based on facility-specific safety analyses, and representative accidents were selected for inclusion in this *SPD Supplemental EIS* (DOE/NNSA 2012). A wide range of potential accident scenarios was considered for PDC (DOE/NNSA 2012). The analyses assumed that the K-Area PDC would be designed and built to withstand design-basis natural phenomenon hazards such as earthquakes, winds, tornadoes, and floods, such that no unfiltered releases are expected.

Aircraft crash. A crash of a large, heavy commercial or military aircraft directly into a reinforced-concrete facility could damage the structure sufficiently to breach confinement and disperse material into the environment. A subsequent fuel-fed fire could provide energy to further damage structures and equipment, aerosolize material, and drive materials into the environment. Source terms are highly speculative, but could exceed those of the beyond-design-basis earthquake. The frequency of such a crash is below 1×10^{-7} per year and was not evaluated.

Criticality. This accident was identified as “unlikely” (with a frequency in the range of 1×10^{-2} to 1×10^{-4} per year) when unmitigated. The scenario represents a metal criticality. The metal was postulated to soften, resulting in a 100 percent release of fission products generated in the criticality. However, no aerosolized respirable metal fragments were predicted to be released. Engineered and administrative

controls should be available to ensure that the double-contingency principles are in place for all portions of the process. It was assumed that human error results in multiple failures, leading to an inadvertent nuclear criticality. With the engineered and administrative controls, the estimated frequency of this accident is in the range of 1×10^{-4} to 1×10^{-6} per year (“extremely unlikely”). A bounding source term resulting from 1×10^{19} fissions was assumed.

Explosion. The bounding radiological explosion is bounded by the postulated overpressurization of multiple oxide storage cans due to out-of-specification oxide product, as discussed below.

Fires. The safety analyses evaluate a range of fire scenarios, including glovebox fires, process fires, room fires, maintenance-related fires, dock fires, and fires associated with material transfer. The controls included in the facility design are expected to prevent or reduce the frequency of fires and limit their severity. In most cases, when the planned controls are considered, the fire events identified in the hazards analysis have negligible risk.

Several fire scenarios were considered in more detail. The *PDC NEPA Source Document* (DOE/NNSA 2012) indicates that a fire in the product nondestructive assay module could release material with the plutonium-239 dose equivalent of up to 2.1 grams (0.074 ounces) if it involved pit plutonium from the stack. A multi-room fire could release up to 5.3 grams (0.19 ounces) of plutonium-239-dose-equivalent materials from the 150-foot (45.7-meter) stack. This bounding fire event is marginally in the “extremely unlikely” frequency bin and approaches the “beyond extremely unlikely” frequency bin when planned controls are considered.

In addition, a scenario involving fire in a direct metal oxidation glovebox was developed for this *SPD Supplemental EIS* (DOE/NNSA 2012). This scenario is a glovebox fire involving bounding quantities of plutonium oxide and tritium in the direct metal oxidation glovebox at risk. In this accident, a safety-class fire-suppression system would detect and extinguish an incipient fire, and no significant release is expected. A building LPF of 3.0×10^{-3} was assumed for the HEPA filter. Therefore, the mitigated release to the environment through the stack would be approximately 2.0 grams (0.071 ounces) of plutonium-239-dose-equivalent materials. For analysis purposes, this accident was assumed to fall in the “extremely unlikely” category; however, more realistically, a release of this magnitude would fall into the “extremely unlikely to beyond extremely unlikely” category.

Leaks or spills of nuclear material. The safety analyses evaluate a range of loss of containment or confinement scenarios, including those due to loss of cooling, excessive moisture, helium atmosphere problems, operator error, material transfer failures, and container defects. Several types of events could potentially lead to overpressurization of containers and rupture. Other events might involve operator mishandling events that result in dropping or impacting containers. The rigorous controls imposed on containers should prevent or mitigate most of these types of events. Fires were found to bound any leak or spill accident scenarios (DOE/NNSA 2012).

The bounding loss of containment event involves the overpressurization of six 3013 cans due to out-of-specification oxide products that are outside of glovebox confinement/ventilation (DOE/NNSA 2012). This accident assumes that moisture significantly in excess of specifications remains in the cans and the radioactive heating of the water overpressurizes the container to the point of rupture. For this accident, 30 kilograms (66 pounds) of plutonium oxide were assumed to be MAR, and a DR of 1.0 was assumed. The ARF for a high-pressure burst associated with a 3013 can was estimated at 0.108, with an RF of 0.7. Thus, about 2.3 kilograms (5.1 pounds) of oxide would be released to the room. The release to the environment would be limited by the Safety Class processing building confinement structure and the HVAC confinement ventilation system. The release would be filtered by the HEPA filter and released through the stack. A bounding release of 12 grams (0.42 ounces) of plutonium-239-dose-equivalent material was postulated. This accident’s frequency is categorized as “extremely unlikely to beyond extremely unlikely” because out-of-specification cans of oxide should not be present at PDC and tests have demonstrated that the 3013 cans to be used at PDC significantly exceed the performance requirements of DOE-STD-3013 (DOE 2012a).

Design-basis earthquake with fire. The PDC NEPA Source Document (DOE/NNSA 2012) also postulates a limited seismically induced fire resulting in the release of all MAR inventory in the affected processing rooms. The fire was postulated to involve the stabilization and packaging, canning, pit disassembly, and special recovery line areas. This event is categorized as an “extremely unlikely” event. Considering the conditional probability of a fire spreading beyond the direct metal oxidation and canning segments of the central processing area, it is reasonable to conclude that a larger fire involving additional MAR is an “extremely unlikely to beyond extremely unlikely” event. This event was estimated to release plutonium and tritium through the HEPA filters and stack, with the dose equivalent to 6.5 grams (0.23 ounces) of plutonium-239.

Tornado. The PDC NEPA Source Document (DOE/NNSA 2012) identifies a tornado-generated missile impacting two Type B shipping packages of plutonium oxide. This scenario would result in a release of 0.50 grams (0.018 ounces) of plutonium-239-dose-equivalent material to the environment. This event is considered “extremely unlikely.” The risks from this event are bounded by the seismically induced fire, so it was not evaluated further.

Beyond-design-basis earthquake with fire. The postulated beyond-design-basis earthquake was assumed to be of sufficient magnitude to initiate a facility-wide fire. This accident was postulated to result in loss of the PDC fire-suppression system, as well as other controls, and to result in pressurizing the process building and releasing radioactive materials through pathways that bypass the HEPA filter and the building confinement structure. Similar to the design-basis earthquake scenario, seismically induced glovebox failure was assumed to occur. Consistent with the general assumptions for beyond-design-basis accident LPFs presented in Section D.1.5.1 for an existing facility that is significantly upgraded, a LPF of 0.1 was assumed for the plutonium materials and 1 for tritium. Based on these assumptions, materials equivalent to about 690 grams (24 ounces) of plutonium-239 would be released to the environment by the beyond-design-basis earthquake with fire. The estimated frequency of this accident is in the range of 1×10^{-5} to 1×10^{-7} per year or lower (“extremely unlikely to beyond extremely unlikely”).

Accident scenarios and source terms for the PDC are presented in **Table D–3**.

Table D–3 Accident Scenarios and Source Terms for the Pit Disassembly and Conversion Project at K-Area

<i>Accident</i>	<i>Frequency (per year)</i>	<i>MAR (grams)</i>	<i>DR</i>	<i>ARF</i>	<i>RF</i>	<i>LPF</i>	<i>Release (grams)</i>
Criticality	1×10^{-4} to 1×10^{-6} (extremely unlikely)	–	–	–	–	–	1×10^{19} fissions
Product NDA room fire	1×10^{-4} to 1×10^{-6} (extremely unlikely)	310,000 PuE	Varies	0.108	0.7	0.003	2.1 PuE
Multi-room fire	1×10^{-4} to 1×10^{-6} (extremely unlikely)	260,000 PuE	Varies	Varies	Varies	0.003 (particulates) 1 (tritium)	5.3 PuE
Fire in direct metal oxidation glovebox	1×10^{-4} to 1×10^{-6} (extremely unlikely)	64,000 PuE	Varies	Varies	Varies	0.003 (particulates) 1 (tritium)	2.0 PuE
Overpressurization of oxide storage cans	1×10^{-4} to 1×10^{-6} (extremely unlikely)	30,000 Pu oxide 55,000 PuE	1	0.108	0.7	0.003	12 PuE
Design-basis earthquake with fire	1×10^{-4} to 1×10^{-6} (extremely unlikely)	4.1×10^5 PuE	Varies	Varies	Varies	0.003 (particulates) 1 (tritium)	6.5 PuE
Beyond-design-basis earthquake with fire	1×10^{-5} to 1×10^{-7} (extremely unlikely to beyond extremely unlikely)	2.2×10^6 PuE	Varies	Varies	Varies	0.1 (particulates) 1 tritium	690 PuE

ARF = airborne release fraction; DR = damage ratio; LPF = leak path factor; MAR = material at risk; NDA = nondestructive assay; Pu = plutonium; PuE = plutonium-239 dose equivalent; RF = respirable fraction.

Note: To convert grams to ounces, multiply by 0.035274.

Source: DOE/NNSA 2012; SRNS 2012.

D.1.5.2.4 Pit Disassembly Capability in K-Area Glovebox

Under the Immobilization to WIPP, MOX Fuel, H-Canyon/HB-Line to DWPF, and WIPP Alternatives, pits could be disassembled, resized, and packaged at a K-Area glovebox, with subsequent plutonium processing at H-Canyon/HB-Line (see Appendix B, Section B.1.2.5).

At this early stage of planning, it is assumed that the disassembly operations would occur either in the existing KIS glovebox or a similar existing or new glovebox in K-Area and that existing infrastructure and building confinement would be used. It is further assumed that the pits to be disassembled could be mechanically disassembled within a K-Area glovebox and that none of the disassembled components would contain tritium. It is also assumed that the disassembled pieces would be placed in transfer containers similar to those proposed for interim lag storage of similar components in PDC and then shipped to H-Area in accordance with SRS procedures. It is assumed that only one pit would be disassembled at a time within the glovebox. It is assumed that one or more pits would be in temporary storage awaiting disassembly, but if stored outside of a vault, they would be in an approved shipping container. As this activity is at an early stage of design, the amount of plutonium and uranium outside of the shipping container and considered MAR is expected to be a fraction of that identified in the K-Area PDC safety analyses. For analysis purposes, the material in interim storage that is at risk is assumed to be proportional to the processing rate at KIS, compared with PDC, or about 20 percent of that identified for PDC.

The accident scenarios for these limited operations would be a subset of those identified for the PDC operations in K-Area or PDCF in F-Area. As the final product from the K-Area disassembly would be metal pieces, no substantial inventory of oxide would be produced other than small amounts associated with TRU waste generated during the handling and disassembly operations. When compared with the conversion operations, there would be limited opportunities for release of materials from the glovebox other than through fires and a criticality. The following discussion identifies the potential changes and source terms associated with the limited pit disassembly operations proposed under this option.

Criticality. A criticality accident for pit disassembly operations similar to that identified for the K-Area PDC was postulated. This accident was identified as unlikely (with a frequency greater than or equal to 10^{-4} and less than 10^{-2}) when unmitigated. The scenario represents a metal criticality. The metal was postulated to soften, resulting in a 100 percent release of fission products generated in the criticality. However, no aerosolized respirable metal fragments were predicted to be released. Engineered and administrative controls should be available to ensure that the double-contingency principles are in place for all portions of the process. It was assumed that human error results in multiple failures, leading to an inadvertent nuclear criticality. The estimated frequency of this accident is in the range of 1×10^{-4} to 1×10^{-6} per year (“extremely unlikely”). A bounding source term resulting from 1×10^{19} fissions was assumed.

Explosion. No events were identified in the pit disassembly operations that would result in an explosion or release (DOE/NNSA 2012). A bounding explosion from a postulated overpressurization of multiple oxide storage cans due to out-of-specification oxide product was not considered credible for the materials under consideration.

Fires. The safety analyses evaluate a range of fire scenarios, including glovebox fires, process fires, room fires, maintenance-related fires, dock fires, and fires associated with material transfer. The controls included in the facility design are expected to prevent or reduce the frequency of fires and limit their severity. In most cases, when the planned controls are considered, the fire events identified in the hazards analysis have negligible risk.

Several fire scenarios were considered in more detail. The *PDC NEPA Source Document* (DOE/NNSA 2012) indicates that the source term associated with metal is generally a few percent of the source term associated with oxide releases. A bounding multi-room fire with a MAR of 8 kilograms (18 pounds) of metal pieces was assumed. It was conservatively assumed that 25 percent of the plutonium metal MAR is involved in a fire. No tritium was assumed to be at risk. A building LPF of

5.0×10^{-3} was assumed for a single existing HEPA filter with the existing 50-foot (15.2-meter) KIS stack. Therefore, the mitigated release to the environment from the stack would be up to 0.0025 grams (8.82×10^{-5} ounces) of pit plutonium, or 0.0052 grams (0.00018 ounces) of plutonium-239 dose equivalents. For analysis purposes, this accident was assumed to fall in the “extremely unlikely” category; however, more realistically, a release of this magnitude would fall into the “extremely unlikely to beyond extremely unlikely” category.

Leaks or spills of nuclear material. No events were identified in the pit disassembly operations that would result in a leak or spill release.

Design-basis earthquake with fire. The *PDC NEPA Source Document* (DOE/NNSA 2012) also postulates a limited seismically induced fire resulting in the release of all MAR inventory in the affected processing rooms. The fire was postulated to involve transfer containers containing plutonium metal pieces from the pit disassembly operations. A bounding estimate of the plutonium metal at risk is 16.4 kilograms (36.2 pounds), or 20 percent of the 82 kilograms (181 pounds) assumed to be at risk for the similar accident scenario for the K-Area PDC, although the actual MAR may be smaller with the limited disassembly operations postulated. This event is categorized as an “extremely unlikely” event. Considering the conditional probability of a fire spreading beyond the disassembly glovebox, it is reasonable to conclude that a larger fire involving additional MAR is an “extremely unlikely to beyond extremely unlikely” event. This event was estimated to release 0.0051 grams (0.000181 ounces) of plutonium, or 0.011 grams (0.00039 ounces) of plutonium-239 dose equivalents, through the HEPA filter and stack.

Tornado. The *PDC NEPA Source Document* (DOE/NNSA 2012) identifies a tornado-generated missile impacting two Type B shipping packages. With the pit disassembly operations at KIS, no substantial quantities of oxide would be generated and the releases from shipping packages with metal pieces would be negligible. The risks from this event are therefore bounded by the seismically induced fire, so it was not evaluated further.

Beyond-design-basis earthquake with fire. The postulated beyond-design-basis earthquake was assumed to be of sufficient magnitude to initiate a facility-wide fire. This accident was postulated to result in loss of the pit disassembly area fire-suppression system, as well as other controls, including building confinement. Similar to the design-basis earthquake scenario, seismically induced glovebox failure was assumed to occur. The fire was postulated to involve transfer containers containing plutonium metal pieces from the pit disassembly operations. A bounding estimate of the plutonium metal at risk is 26.8 kilograms (59.1 pounds), or 20 percent of the 134 kilograms (295 pounds) assumed to be at risk, and 32 kilograms (70.5 pounds) of HEU, or 25 percent of the HEU metal (160 kilograms or 353 pounds) in transfer containers assumed to be at risk for the similar accident scenario for the K-Area PDC, although the actual MAR may be much smaller with the limited disassembly operations postulated. Based on this release scenario, about 1.7 grams (0.060 ounces) of weapons-grade plutonium and 8.0 grams (0.282 ounces) of HEU were assumed to be released to the room for the beyond-design-basis earthquake. Consistent with the general assumptions for beyond-design-basis accident LPFs presented in Section D.1.5.1 for older existing facilities, a building LPF of 0.25 was assumed, although a more realistic value is likely to be at least a factor of several lower. A release of plutonium and HEU of this magnitude would be equivalent to releasing 0.88 grams (0.031 ounces) of plutonium-239. The estimated frequency of this accident is in the range of 1×10^{-5} to 1×10^{-7} per year or lower (“extremely unlikely to beyond extremely unlikely”).

Accident scenarios and source terms for the K-Area pit disassembly capability are presented in **Table D-4**.

Table D-4 Accident Scenarios and Source Terms for the Pit Disassembly Capability in a Glovebox at K-Area

<i>Accident</i>	<i>Frequency (per year)</i>	<i>MAR (grams)</i>	<i>DR</i>	<i>ARF</i>	<i>RF</i>	<i>LPF</i>	<i>Release (grams)</i>
Criticality	1×10^{-4} to 1×10^{-6} (extremely unlikely)	–	–	–	–	–	1×10^{19} fissions
Multi-room fire	1×10^{-4} to 1×10^{-6} (extremely unlikely)	8,000 WG Pu metal	0.25	0.0005	0.5	0.005	0.0025 Pu or 0.0052 PuE
Design-basis earthquake with fire (limited)	1×10^{-4} to 1×10^{-6} (extremely unlikely)	16,400 WG Pu metal	0.25	0.0005	0.5	0.005	0.0051 Pu or 0.011 PuE
Beyond-design-basis earthquake with fire	1×10^{-5} to 1×10^{-7} (extremely unlikely to beyond extremely unlikely)	26,800 WG Pu metal 32,000 HEU metal	0.25 0.25	0.0005 0.001	0.5 1	0.25 0.25	0.42 Pu, 2.0 HEU or 0.88 PuE

ARF = airborne release fraction; DR = damage ratio; HEU = highly enriched uranium; LPF = leak path factor;
 MAR = material at risk; Pu = plutonium; PuE = plutonium-239 dose equivalent; RF = respirable fraction; WG = weapons-grade.
 Note: To convert grams to ounces, multiply by 0.035274.
 Source: DOE/NNSA 2012.

D.1.5.2.5 Immobilization Capability at K-Area

Under the Immobilization to DWPF Alternative, an immobilization capability would be installed in the K-Area Complex which would convert surplus plutonium to an oxide and then immobilize the oxide within a glass matrix (see Appendix B, Section B.1.2.1). A wide range of potential accident scenarios are reflected in the immobilization facility data reports developed for the *SPD EIS* (DOE 1999) and the more recent *Plutonium Vitrification Facility Consolidated Hazard Analysis* (WSRC 2007a) and *K-Area Complex Plutonium Vitrification Nuclear Criticality Safety Design Guidance Document* (WSRC 2007b). The analyses assumed that the immobilization capability is located in a new or upgraded existing building designed to withstand design-basis natural phenomenon hazards such as earthquakes, winds, tornadoes, and floods, such that no unfiltered releases are expected. Additional discussion of scenario development based on consistency concerns can be found in Section D.1.5.1.

A DSA has not been performed for the proposed immobilization capability. The latest safety-related documents include the *Plutonium Vitrification Facility Consolidated Hazard Analysis* (WSRC 2007a), the *K-Area Complex Plutonium Vitrification Nuclear Criticality Safety Design Guidance Document* (WSRC 2007b), the *Conceptual Safety Design Report for Plutonium Vitrification Project in K-Area* (WSRC 2007c), and the *PDC NEPA Source Document* (DOE/NNSA 2012). These documents identify the basic process steps, material flows and inventories, and potential unmitigated hazards. The hazards analysis identifies the potential hazards or accidents and makes a preliminary selection of controls to reduce or eliminate these risks. If this alternative were selected, a detailed evaluation of the bounding accidents with release fractions and source terms would not be available until the DSA is performed.

This *SPD Supplemental EIS* presents a selection of bounding accidents that were identified in the *SPD EIS* for a generic immobilization facility, but with modifications to those scenarios to reflect the current proposed location and design as described in the hazards analysis. Thus, this *SPD Supplemental EIS* reflects, to the extent practicable, the immobilization capability design changes that have occurred since the *SPD EIS* was prepared in 1999. The design changes include changes in the process operations, building design, and safety controls. As a result, some of the bounding accident scenarios identified in the *SPD EIS* are no longer applicable. For example, the plutonium conversion process has changed from the “HYDOX” [hydride/oxidation] process, which required heating of the plutonium metal and hydrogen, to a metal oxidation process that does not use hydrogen and keeps the plutonium metal below the melting temperature. In addition, the current design is intended to reduce the likelihood and consequences of all of the accidents that have been identified.

In the *SPD EIS*, the exhaust from the immobilization facility was assumed to be directed through two stages of testable HEPA filters to a stack. The more recent *Plutonium Vitrification Facility Consolidated Hazard Analysis* (WSRC 2007a) indicates that the HVAC exhaust would go through a duct to the sand filter and a new stack. Thus, for the purposes of this *SPD Supplemental EIS*, the building exhaust was assumed to be filtered through a sand filter.

Analysis of the proposed process operations identified specific scenarios for the conversion process and the canister-handling portion of the process. Design-basis and beyond-design-basis earthquakes were identified for the overall facility in the *SPD EIS* (DOE 1999). Identified accidents specific to the plutonium conversion processes are similar to those identified for the metal oxidation processes in PDCF and include a criticality, an explosion in a direct metal oxidation furnace, and a direct metal oxidation furnace glovebox fire. Identified accidents in the immobilization area include a melter eruption and a melter spill. All of the scenarios identified with the canister-handling phase at DWPF were negligible compared with the conversion and immobilization scenarios.

Plutonium Conversion Operations

Criticality. Review of the possibility of accidents attributable to plutonium conversion operations indicated that the principal processes of concern include the direct metal oxidation furnace and the sorting/unpacking glovebox. Engineered and administrative controls should be available to ensure that double-contingency principles are in place for all portions of the process. It was assumed that human error could result in multiple failures leading to an inadvertent nuclear criticality. The estimated frequency of this accident is in the range of 1×10^{-4} to 1×10^{-6} per year (“extremely unlikely”). A bounding source term resulting from 1×10^{19} fissions was assumed.

Explosion in the direct metal oxidation furnace. The bounding radiological explosion for direct metal oxidation is expected to be a steam explosion due to a cooling water leak into the furnace. As with the PDCF steam explosion, cooling water was assumed to leak into the furnace and make contact with heated plutonium. The maximum MAR of 4.4 kilograms (9.7 pounds) of plutonium metal, which is the criticality safety limit within a single furnace, was assumed (WSRC 2007b). The water leak was assumed to enter the furnace at the worst possible time, when the material is near-molten. The DR was conservatively assumed to be 1.0. The initial plutonium present in the furnace was assumed to be molten metal. If the explosion event is treated as a liquid metal/steam explosion, the ARF can be conservatively assumed to be 1.0 with an RF of 0.5. The explosive energy would be sufficient to damage glovebox windows, but insufficient to threaten the building confinement or the HVAC filter system. Both the confinement structure and the HVAC confinement system would be designated as Safety Class and are expected to function as designed throughout this event. A building LPF of 4.9×10^{-3} was assumed for the sand filter. Therefore, the mitigated release to the environment through the sand filter stack would be approximately 10.8 grams (0.38 ounces) of plutonium. Because the direct metal oxidation furnace and cooling water system designs would be designated as “safety significant,” and the metal temperatures normally would be far below those required to melt the plutonium. This accident is not expected to occur in the life of the plant, and the initiating event frequency is “extremely unlikely to beyond extremely unlikely.”

Furnace-initiated glovebox fire (direct metal oxidation furnace). It was assumed that a fault in the direct metal oxidation furnace results in the ignition of any combustibles (e.g., bags) left inside the glovebox. The fire would be self-limiting, but could cause suspension of the radioactive material. It was also assumed that the glovebox (including the window) maintains its structural integrity, but the internal glovebox HEPA filter fails. All of the loose surface contamination within the glovebox, assumed to be 10 percent of the daily inventory of 4.5 kilograms (9.9 pounds) of plutonium in the direct metal oxidation furnace, was assumed to be involved. Based on an ARF of 6×10^{-3} , an RF of 0.01, and an LPF of 4.9×10^{-3} for the sand filter, a stack release of 1.3×10^{-4} grams (4.6×10^{-6} ounces) of plutonium was postulated. The estimated frequency of this accident is in the range of 1×10^{-4} to 1×10^{-6} per year (“extremely unlikely”).

Immobilization Activities

Melter eruption. A melter eruption could result from the buildup of impurities in or addition of impurities to the glass frit or melt. Impurities range from water, which could cause a steam eruption, to chemical contaminants, which could react at elevated temperatures to produce a highly exothermic reaction (eruption or deflagration). The resulting sudden pressure increase could propel the fissile-material-bearing melt liquid into the processing glovebox structure. However, the energy release would likely be insufficient to challenge the glovebox structure. It was assumed that the entire contents of the melter, about 1.4 kilograms (3.1 pounds) of plutonium, are ejected into the glovebox. Based on an ARF of 4×10^{-4} , an RF of 1, and an LPF of 4.9×10^{-3} for the sand filter, a stack release of 2.7×10^{-3} grams (9.5×10^{-5} ounces) of plutonium was postulated. The estimated frequency of this accident is approximately 2.5×10^{-3} per year, which is in the “unlikely” range.

Melter spill. A melter spill into the glovebox could occur due to improper alignment of the product glass cans during pouring operations. The melter glovebox enclosure and the offgas exhaust ventilation system would confine radioactive material released in the spill. The glovebox structure and its associated filtered exhaust ventilation system would not be affected by this event. It was assumed that the entire contents of the melter, about 1.4 kilograms (3.1 pounds) of plutonium, are spilled into the glovebox. On the basis of an ARF of 2.4×10^{-4} , an RF of 1, and an LPF of 4.9×10^{-3} for the sand filter, a stack release of 1.7×10^{-3} grams (6.0×10^{-5} ounces) of plutonium was postulated. The estimated frequency of this accident is approximately 3×10^{-3} per year, in the “unlikely” range.

Design-basis earthquake. The principal design-basis natural phenomenon event that could release material to the environment is the design-basis earthquake. While the major safety systems, including building confinement and the building HEPA filtration system, should continue to function, the vibratory motion is expected to suspend loose plutonium powder within gloveboxes and cause some minor spills. Particulates would be picked up by the ventilation system and filtered by the HEPA filters before release from the building. Most material storage containers were assumed to be engineered to withstand design-basis earthquakes without failing. For plutonium conversion, it was assumed that, at the time of the event, the entire day’s inventory (25 kilograms [55 pounds]) of plutonium is present in the form of oxide powder. For the glass immobilization portion, this includes oxide inventories from the rotary splitter, oxide grinding, blend melter, and feed storage. Although the source term is highly uncertain, an assessment of the MAR, ARF, and RF for each of the process areas indicated a potential for the release of 33 grams (1.2 ounces) of plutonium to the still-functioning building ventilation system and 1.7×10^{-1} grams (6.0×10^{-3} ounces) from the stack. The nominal frequency estimate for a design-basis earthquake affecting new DOE plutonium facilities is 4×10^{-3} per year, which is in the “unlikely” range.

Beyond-design-basis earthquake. The postulated beyond-design-basis earthquake was assumed to be of sufficient magnitude to cause total collapse of the process equipment, building walls, roof, and floors, as well as loss of the containment function of the building. The material in the building was assumed to be driven airborne by the seismic vibrations, free fall during the collapse, and impact. Material in storage containers in vault storage would be adequately protected from the scenario energetics. Consistent with the general assumptions for beyond-design-basis accident LPFs presented in Section D.1.5.1 for a significantly upgraded facility, a LPF of 0.1 was assumed for the plutonium materials with the release at ground level. Although the source term is highly uncertain, an assessment of the MAR, ARF, and RF for each of the process areas indicated a potential for the release of 17 grams (0.6 ounces) of plutonium to the facility with 1.7 grams (0.06 ounces) being released to the environment. The estimated frequency of this accident is in the range of 1×10^{-5} to 1×10^{-7} per year or lower (“extremely unlikely to beyond extremely unlikely”).

Can-in-Canister Operations at the Immobilization Capability

Can-handling accident (before shipment to DWPF). A can-handling accident would involve a can containing a vitrified glass log of plutonium material. Studies supporting DWPF (DOE 1999) indicate that the source term resulting from dropping or tipping a log of vitrified waste, even without credit for the

steel canister, would be negligible. The surplus plutonium immobilization technology results in a form with a durability that is comparable to that of the DWPF vitrified waste form. Consequently, no postulated can-handling event would result in a radioactive release to the environment.

Accident scenarios and source terms for the Immobilization to DWPF Alternative are presented in **Table D–5**. The immobilization capability could be used for pit or non-pit plutonium. For purposes of ensuring a conservative accident analysis, the plutonium is assumed to be non-pit plutonium. This material is assumed to have an americium-241 content of 6.25 percent. The relative inhalation hazard of this material is 6.47 times higher than plutonium-239 and about 3.1 times more hazardous than weapons-grade plutonium. The plutonium-239 dose equivalents for each source term are also included in Table D–5. If the accidents involved pit plutonium instead of non-pit plutonium, the plutonium-239-dose-equivalent MAR, doses, and risks would be about a factor of 3.1 lower.

Table D–5 Accident Scenarios and Source Terms for the Immobilization Capability Under the Immobilization to DWPF Alternative

<i>Accident</i>	<i>Frequency (per year)</i>	<i>MAR (grams)</i>	<i>DR</i>	<i>ARF</i>	<i>RF</i>	<i>LPF^a</i>	<i>Release (grams)</i>
Criticality	1×10^{-4} to 1×10^{-6} (extremely unlikely)	–	–	–	–	–	1×10^{19} fissions
Explosion in the direct metal oxidation furnace	1×10^{-5} to 1×10^{-7} (extremely unlikely to beyond extremely unlikely)	4,400 Pu	1	1	0.5	0.0049	10.8 Pu 70 PuE
Glovebox fire (direct metal oxidation furnace)	1×10^{-4} to 1×10^{-6} (extremely unlikely)	450 Pu	1	0.006	0.01	0.0049	0.00013 Pu 0.00084 PuE
Melter eruption	0.0025 (unlikely)	1,400 Pu	1	0.0004	1	0.0049	0.0027 Pu 0.018 PuE
Melter spill	0.003 (unlikely)	1,400 Pu	1	0.00024	1	0.0049	0.0016 Pu 0.011 PuE
Design-basis earthquake	0.0004 (unlikely)	Varies	Varies	Varies	Varies	0.0049	0.17 Pu 1.1 PuE
Beyond-design-basis earthquake	1×10^{-5} to 1×10^{-7} (extremely unlikely to beyond extremely unlikely)	Varies	Varies	Varies	Varies	0.1	1.7 Pu 11 PuE (ground level)

ARF = airborne release fraction; DR = damage ratio; LPF = leak path factor; MAR = material at risk; Pu = plutonium; PuE = plutonium-239 dose equivalent; RF = respirable fraction.
 Note: To convert grams to ounces, multiply by 0.035274.
 Source: DOE 1999.

D.1.5.2.6 Mixed Oxide Fuel Fabrication Facility

Under all of the alternatives considered in this *SPD Supplemental EIS*, the MFFF being constructed in F-Area would take feed material from the various facilities that may be involved with pit disassembly and conversion and use this material to produce MOX fuel for use in commercial light water reactors (see Appendix B, Section B.1.1.2). A wide range of potential accident scenarios was considered in the analysis reflected in the *SPD EIS* (DOE 1999) and supporting analyses, including the *Environmental Impact Statement on the Construction and Operation of a Proposed Mixed Oxide Fuel Fabrication Facility at the Savannah River Site, South Carolina (MFFF EIS)* (NRC 2005). The MFFF is located in a new building designed to withstand design-basis natural phenomenon hazards such as earthquakes, winds, tornadoes, and floods, such that no unfiltered releases are expected. That facility is under construction, is being regulated by the NRC, and meets all NRC safety requirements.

Analysis of the proposed process operations for MFFF identified the following broad categories of accidents: aircraft crash, criticality, design-basis earthquake, beyond-design-basis earthquake, explosion in sintering furnace, fire, and beyond-design-basis fire. Basic characteristics of each of these postulated accidents are described in this section. Additional discussion of scenario development based on consistency concerns can be found in Section D.1.5.1.

Aircraft crash. A crash of a large, heavy commercial or military aircraft directly into a reinforced-concrete facility could damage the structure sufficiently to breach confinement and disperse material into the environment. A subsequent fuel-fed fire could provide energy to further damage structures and equipment, aerosolize material, and drive materials into the environment. Source terms are highly speculative, but could exceed those of the beyond-design-basis earthquake. The frequency of such a crash is below 1×10^{-7} per year (“beyond extremely unlikely”) and was not evaluated.

Criticality. Review of the possibility of accidents at MFFF indicated no undue criticality risk associated with the proposed operations. Engineered and administrative controls should be available to ensure that double-contingency principles are in place for all portions of the process. It was assumed that human error could result in multiple failures, leading to an inadvertent nuclear criticality. The estimated frequency of this accident is in the range of 1×10^{-4} to 1×10^{-6} per year (“extremely unlikely”). A bounding source term resulting from 1×10^{19} fissions in solution was assumed.

Explosion in sintering furnace. The several furnaces proposed for the MOX fuel fabrication process all use nonexplosive mixtures of 6 percent hydrogen and 94 percent argon. Given the physical controls on the piping for nonexplosive and explosive gas mixtures, operating procedures, and other engineered safety controls, accidental use of an explosive gas is “extremely unlikely,” though not impossible. A bounding explosion or deflagration was postulated to occur in one of the three sintering furnaces in MFFF. Multiple equipment failures and operator errors would be required to lead to a buildup of hydrogen and an inflow of oxygen into the inert furnace atmosphere. As much as 5.6 kilograms (12.3 pounds) of plutonium in the form of MOX powder would be at risk, and a bounding ARF of 0.01 and RF of 1.0 were assumed. Based on an LPF of 1.0×10^{-5} for two HEPA filters, a stack release of 5.6×10^{-4} grams (2.0×10^{-5} ounces) of plutonium (in the form of MOX powder) was postulated. It was estimated that the frequency of this accident is in the range of 1×10^{-4} to 1×10^{-6} per year (“extremely unlikely”).

Ion exchange column exotherm. A thermal excursion within an ion exchange column was postulated to result from off-normal operations, degraded resin, or a glovebox fire. It was also assumed that the column venting/pressure relief valve fails to vent the overpressure, causing the column to rupture violently. The overpressure would release plutonium nitrate solution as an aerosol within the affected glovebox, which in turn would be processed through the ventilation system. The combined ARF and RF values for this scenario are 9.0×10^{-3} for burning resin and 6.0×10^{-3} for liquid behaving as a flashing spray on depressurization. Additionally, 10 percent of the resin was assumed to burn, yielding a combined ARF and RF value of 9.0×10^{-3} for loaded plutonium. Based on an LPF of 1.0×10^{-5} for two HEPA filters, a stack release of 2.4×10^{-5} grams (8.47×10^{-7} ounces) of plutonium was postulated.

With regard to probability, process controls are used to ensure that nitrated anion exchange resins are maintained in a wet condition, the maximum nitric acid concentration and the operating temperature are limited to safe values, and the time for absorption of plutonium in the resin is minimized. With these controls in place, the frequency of this accident was estimated to be in the range of 1×10^{-2} to 1×10^{-4} per year (“unlikely”).

Fire. It was assumed that the liquid organic solvent containing the maximum plutonium concentration leaks as a spray into the glovebox, builds to a flammable concentration, and is contacted by an ignition source. The combined ARF and RF value for this scenario is 1.0×10^{-2} for quiescent burning to self-extinguishment. Based on an LPF of 1.0×10^{-5} for two HEPA filters, a stack release of 4.0×10^{-6} grams (1.41×10^{-7} ounces) of plutonium was postulated. The frequency of this accident is in the “unlikely” range (1×10^{-2} to 1×10^{-4} per year).

Spill. Leakage of liquids from process equipment must be considered as an anticipated event. However, with multiple containment barriers, a release from the process room would be “extremely unlikely” (1×10^{-4} to 1×10^{-6} per year). A bounding scenario involves a liquid spill of concentrated aqueous plutonium solution, with 13.2 gallons (50 liters) accumulating before the leak is stopped. The ARF and RF values used for this scenario are 2.0×10^{-4} and 0.5, respectively. Based on an LPF of 1.0×10^{-5} for two HEPA filters, a stack release of 5.0×10^{-6} grams (1.76×10^{-7} ounces) of plutonium was postulated.

Design-basis earthquake. The principal design-basis natural phenomenon event that could release material to the environment is the design-basis earthquake. While the major safety systems, including building confinement and the building HEPA filtration system, should continue to function, the vibratory motion is expected to resuspend loose plutonium powder within gloveboxes and cause some minor spills. Particulates would be picked up by the ventilation system and filtered by the HEPA filters before release from the building. Material storage containers, including cans, hoppers, and bulk storage vessels, were assumed to be engineered to withstand design-basis earthquakes without failing. Although the source term is highly uncertain, an assessment of the MAR, ARF, and RF for each of the process areas indicated a potential for the release of 7.9 grams (0.28 ounces) of plutonium (in the form of MOX powder) to the still-functioning building ventilation system and 7.9×10^{-5} grams (2.8×10^{-6} ounces) from the stack. The nominal frequency estimate for a design-basis earthquake for new DOE plutonium facilities is 4×10^{-4} per year, which is in the “unlikely” range.

Beyond-design-basis fire. MFFF would be built and operated such that there would be insufficient combustible materials to support a large fire. To bound the possible consequences of a major fire, a large quantity of combustible materials was assumed to be introduced into the process area near the blending area, which contains a fairly large amount of plutonium. A major fire was assumed to occur that causes the building ventilation and filtration systems to fail, possibly due to clogged HEPA filters. A total of 11 kilograms (24 pounds) of plutonium in the form of MOX powder was assumed to be at risk. Based on an ARF of 6×10^{-3} , an RF of 0.01, and an LPF of 0.1 for two damaged, clogged HEPA filters, a ground-level release of 6.0×10^{-2} grams (2.1×10^{-3} ounces) of plutonium (in the form of MOX powder) was postulated. It was estimated that the frequency of this accident is less than 1×10^{-6} per year, which is in the “beyond extremely unlikely” range.

Beyond-design-basis earthquake. The postulated beyond-design-basis earthquake was assumed to be of sufficient magnitude to cause loss of the containment function of the building. Although the source term is highly uncertain, an assessment of the MAR, ARF, and RF for each of the process areas indicated a potential for the release of 95 grams (3.4 ounces) of plutonium (in the form of MOX powder) to the room is predicted. Consistent with the general assumptions for beyond-design-basis accident LPFs presented in Section D.1.5.1 for new facilities, a LPF of 0.1 was assumed for the plutonium materials with the release at ground level. The estimated frequency of this accident is in the range of 1×10^{-5} to 1×10^{-7} per year or lower (“extremely unlikely to beyond extremely unlikely”).

Plutonium metal oxidation capability at MFFF. In addition to the previously evaluated mission activities, under some options, MFFF would receive plutonium metal from pit disassembly operations and convert it to oxide. Plutonium metal oxidation technology and associated systems and equipment would be installed in MFFF to convert metal to oxide suitable for subsequent processing. The equipment, operations, and throughput were assumed to be similar to the operation evaluated for PDCF. For purposes of this analysis, it is assumed that plutonium metal oxidation is accomplished using direct metal oxidation furnaces. Under this option, the accident scenarios associated with PDCF plutonium metal oxidation operations would be added to the MFFF scenarios. It is expected that the overall inventories within MFFF outside of the metal oxidation technology would not change significantly, as metal oxidation just adds another source of feed for the other MFFF processes. The source term for the beyond-design-basis fire would be increased if the fire heated the cans and equipment within the metal oxidation capability.

The principal accident scenario associated with the metal oxidation operations is a severe fire in a metal oxidation glovebox. Based on the *PDC NEPA Source Document* (DOE/NNSA 2012), it was assumed that a direct metal oxidation glovebox fire could have about 15 kilograms (33 pounds) of plutonium as oxide in cans at risk under a fire scenario, as well as 6 kilograms (13 pounds) of plutonium as oxide within equipment. A DR of 0.25 was assumed for all. The cans of oxide were assumed to become moderately pressurized and to release oxide to the confinement system with an ARF of 0.1 and an RF of 0.7. For the oxide assumed to be within the equipment, an ARF of 0.005 and an RF of 0.4 were assumed. The overall release from the direct metal oxidation glovebox to the confinement would be about

266 grams (9.38 ounces) of plutonium. Based on an LPF of 1.0×10^{-5} for two HEPA filters, a stack release of 0.00266 grams (9.38×10^{-5} ounces) of plutonium was postulated. It was estimated that the frequency of this accident is in the range of 1×10^{-4} to 1×10^{-6} per year (“extremely unlikely”).

Beyond-Design-Basis Fire – Direct Metal Oxidation Addition. It was assumed that a beyond-design-basis fire would also encompass the direct metal oxidation glovebox and result in a release similar to that postulated for that event. Again assuming that a major fire might cause the building ventilation and filtration systems to fail, possibly due to clogged HEPA filters, an LPF of 0.1 for two damaged, clogged HEPA filters was assumed. Therefore, a ground-level release of 26.3 grams (0.928 ounces) of plutonium was postulated. It was estimated that the frequency of this accident is less than 1×10^{-6} per year, which is in the “beyond extremely unlikely” range.

Accident scenarios and source terms for MFFF under all SPD Supplemental EIS alternatives are presented in **Table D–6**. The additional accident scenarios associated with conversion of plutonium metal to oxide in the optional direct metal oxidation furnaces are also noted. For this facility, all of the plutonium involved was assumed to be plutonium suitable for use in MOX fuel and to have an americium-241 content of 1 percent, which is expected to bound the hazards associated with such plutonium. The relative inhalation hazard of this material is 2.086 times higher than pure plutonium-239. The plutonium-239 dose equivalents for each source term are also included in Table D–6.

Table D–6 Accident Scenarios and Source Terms for the Mixed Oxide Fuel Fabrication Facility Under All Alternatives

Accident	Frequency (per year)	MAR (grams)	DR	ARF	RF	LPF	Release (grams)
Criticality	1×10^{-4} to 1×10^{-6} (extremely unlikely)	–	–	–	–	–	1×10^{19} fissions
Explosion in sintering furnace	1×10^{-4} to 1×10^{-6} (extremely unlikely)	5,600 Pu	1	0.01	1	0.00001	0.00056 Pu 0.0012 PuE
Ion exchange exothermic reaction	1×10^{-2} to 1×10^{-4} (unlikely)	–	–	–	–	0.00001	0.000024 Pu 0.000050 PuE
Fire	1×10^{-2} to 1×10^{-4} (unlikely)	–	–	–	–	0.00001	4.0×10^{-6} Pu 8.3×10^{-6} PuE
Spill	1×10^{-4} to 1×10^{-6} (extremely unlikely)	50 liters	–	0.0002	0.5	0.00001	5.0×10^{-6} Pu 1.0×10^{-5} PuE
<u>Metal oxidation capability only:</u> Fire in direct metal oxidation glovebox causing pressurized release of oxide from cans and equipment ^a	1×10^{-4} to 1×10^{-6} (extremely unlikely)	15,000 Pu as oxide in cans 6,000 Pu as oxide in equipment	0.25 0.25	0.1 cans 0.005 equip.	0.7 cans 0.4 equip.	0.00001 0.00001	0.00263 Pu 3.0 $\times 10^{-5}$ Pu Total: 0.0056 PuE
Design-basis earthquake	0.0004 (unlikely)	–	–	–	–	0.00001	0.000079 Pu 0.00017 PuE
Beyond-design-basis fire	$< 1 \times 10^{-6}$ (beyond extremely unlikely)	11,000 mixed oxide fuel powder	1	0.006	0.01	0.1	0.06 Pu 0.13 PuE
Beyond-design-basis fire – additional metal oxidation contribution	$< 1 \times 10^{-6}$ (beyond extremely unlikely)	Additional 15,000 Pu as oxide in cans and 6,000 Pu as oxide in equipment	0.25 0.25	0.1 cans 0.005 equip.	0.7 cans 0.4 equip.	0.1 0.1	26 Pu 0.30 Pu Total: 55 PuE
Beyond-design-basis earthquake (MFFF only)	1×10^{-5} to 1×10^{-7} (extremely unlikely to beyond extremely unlikely)	Varies	Varies	Varies	Varies	0.1	9.5 Pu 20 PuE (ground level)

ARF = airborne release fraction; DR = damage ratio; equip. = equipment; LPF = leak path factor; MAR = material at risk; MFFF = Mixed Oxide Fuel Fabrication Facility; Pu = plutonium; PuE = plutonium-239 dose equivalent; RF = respirable fraction.

^a Scenario parameters for the metal oxidation capability are from DOE/NNSA 2012.

Note: To convert grams to ounces, multiply by 0.035274.

Source: DOE 1999, NRC 2005, DOE/NNSA 2012.

D.1.5.2.7 Waste Solidification Building

Under all of the alternatives considered in this SPD Supplemental EIS, the WSB being constructed in F-Area would process liquid radioactive waste in support of surplus plutonium disposition activities at SRS (see Appendix B, Section B.1.1.3). A wide range of potential accident scenarios were considered for the initial design of WSB in the *Environmental Report for MFFF* (DCS 2002) and the *MFFF EIS* (NRC 2005). The *WSB DSA* (WSRC 2008b) confirms that the initial accident scenarios, source terms, and impacts are bounding. The analyses demonstrate that WSB can withstand design-basis natural phenomenon hazards such as earthquakes, winds, tornadoes, and floods, such that no unfiltered releases are expected.

Analysis of the proposed process operations for the plutonium dissolution operations in WSB identified the following broad categories of accidents: aircraft crash, criticality, design-basis earthquake, beyond-design-basis earthquake, explosion, fire, and leaks or spills. Basic characteristics of each of these postulated accidents are described in this section. Additional discussion of scenario development based on consistency concerns can be found in Section D.1.5.1.

WSB processes high-activity waste and low-activity waste from MFFF and PDCF. The dominant radionuclide hazard in WSB is americium-241 in the high-activity waste. In the high-activity waste and total building inventory, americium-241 would represent over 99.9 percent of the alpha activity and radionuclide hazard if released to the environment. Therefore, the WSB inventory is normalized to americium-241 for identification of the MAR and source terms.

The following design-basis accident descriptions and source terms were based on the unmitigated design-basis accidents analyzed in the current *WSB DSA* (WSRC 2008b). WSB has been designed and would be operated to reduce the likelihood of these accidents to the extent practicable. The design features and operating practices would also limit the extent of any accident and mitigate the consequences for the workers, public, and environment if an accident occurred. As with all new SRS facilities, it is expected that the safety controls will be sufficient, such that the likelihood of any of these accidents happening is “extremely unlikely” or lower and that, if the accidents were initiated, the source terms and consequences of the magnitude reported in the facility DSAs and this *SPD Supplemental EIS* would be very conservative.

Criticality. A criticality is not considered credible at WSB (WSRC 2008b).

High-Activity Waste Process Room fire. It was postulated that a small fire starts within the High-Activity Waste Process Room or propagates from another location in the high-activity waste area. The fire propagates through the High-Activity Waste Process Room and heats high-activity waste solution in the high-activity waste tanks. The process solutions in the tanks are heated to boiling. The boiling action entrains radiological material, which is swept into the process vessel vent system and ultimately out the WSB stack. In this bounding scenario, no credit is taken for in-line process vessel vent system demisters or other design features that should reduce the severity of the accident. Further, because the process tanks are only separated by partitions extending halfway to the ceiling, it was conservatively assumed that all high-activity waste vessels may be involved as the fire progresses. Without safety controls, the release mechanism in this accident could be vigorous boiling in the high-activity waste tanks, which would entrain radiological material in the tanks.

The MAR for this scenario is the dose equivalent of 18.3 kilograms (40 pounds) of americium-241. The DR was assumed to be 1, so all of the MAR was assumed to be involved. A bounding ARF of 2.0×10^{-3} and an RF of 1 were applied for a boiling solution (DOE 1994) to determine the unmitigated source term, assuming fire mitigation controls fail. Therefore, the unmitigated source term is $18,300 \text{ grams} \times 2 \times 10^{-3} = 36.3 \text{ grams}$ (1.28 ounces) of americium-241 dose equivalent. With the proposed controls including fire-suppression and low-combustion design, there should be insufficient heat to cause vigorous boiling. If there were insufficient heat to vigorously boil the vessel contents, the $\text{ARF} \times \text{RF}$ value could be as low as 3.0×10^{-5} , resulting in a much lower source term and consequences

(WSRC 2008b). Because this is considered a design-basis accident in the *WSB DSA*, it is appropriate to assume these fire-limiting controls function in order to develop a realistic source term. Therefore, the mitigated source term is $18,300 \text{ grams} \times 3 \times 10^{-5} = 0.55 \text{ grams}$ (0.019 ounces) of americium-241 dose equivalent.

This scenario would be mitigated by design features that should limit the spread of the fire, such as the in-line process vessel vent system demisters (for which no credit is taken), HEPA filters, and elevated release from the stack. With a very conservative HEPA filter penetration factor of 1×10^{-5} , the amount released from the stack is conservatively bounded by $5.5 \times 10^{-6} \text{ grams}$ (1.9×10^{-7} ounces) of americium-241 dose equivalent.

High-activity waste process vessel hydrogen explosion. The high-activity waste tanks contain high concentrations of TRU radionuclides dissolved in an aqueous nitric acid solution. Hydrogen is abundantly produced through radiolytic decomposition of hydrogenous material (i.e., water) within the high-activity waste process vessels and removed through the process vessel vent system. With a loss of flow through the process vessel vent system, hydrogen can reach the lower flammable limit within a few hours, conservatively ignoring nitrates. The loss of exhaust flow in the process vessel vent system could be caused by loss of power, operator error, mechanical failure of the fans, line breaks, vent path plugging, or natural phenomenon hazard events. Once above the lower flammability limit, an ignition source from either static or electrical shorts could ignite the flammable gas.

The unmitigated source term (WSRC 2008b) was derived using the method described in the DOE Handbook, *Airborne Release Fractions/Rates and Respirable Fractions for Nonreactor Nuclear Facilities* (DOE 1994), for a vapor explosion in an enclosed space above the solution, equating the mass of respirable solution made airborne to the energy released and expressed in terms of equivalent mass of TNT [trinitrotoluene]. That analysis concluded that, with a stoichiometric hydrogen/air mixture of 10,000 liters (350 cubic feet), a vapor explosion would result in an airborne release of 13.8 grams (0.487 ounces) of americium-241 through the process vessel vent systems to demisters, HEPA filters, and the stack.

This scenario would be mitigated by design features that should maintain flow through the process vessel vent system. In addition, there should be sufficient time to take corrective actions before the hydrogen levels reach the lower flammable limit. With no credit taken for the in-line process vessel vent system demisters and a very conservative HEPA filter penetration factor of 1×10^{-5} , the amount released from the stack is conservatively bounded by $1.38 \times 10^{-4} \text{ grams}$ (4.87×10^{-6} ounces) of americium-241 dose equivalent.

Red oil explosion. A “red oil” explosion was included in the *WSB DSA* as a bounding, beyond-design-basis accident because of public interest in the accident and its potential consequences (WSRC 2008b).

The designs of PDCF and MFFF indicate that organic compounds that would be required to initiate a red oil explosion would only be present in the WSB feed in trace amounts. Because the red oil explosion is only possible at higher organic concentrations, this scenario was not considered as part of the WSB design-basis accident analysis, but is included as a beyond-design-basis accident (WSRC 2008b).

If high concentrations of organics were present in the WSB feed, an explosion could potentially occur in the high-activity waste evaporator. A red oil explosion is the product of a chemical reaction between nitric acid and tributyl phosphate at high temperatures in the presence of heavy metal solutions, producing pressure and explosive gases. Tributyl phosphate is used in the solvent extraction process in MFFF, which is the source of the waste streams to WSB. Such an explosion would result in the release of the contents of the evaporator to the High-Activity Waste Process Room.

The high-activity waste evaporator was assumed to hold up to 6.0 kilograms (13 pounds) of americium-241, as well as other radionuclides, and all were assumed to be released to the High-Activity Waste Process Room. A bounding ARF of 0.1 and an RF of 0.7 for superheated liquid (DOE 1994) were assumed to determine the unmitigated amount released to the room. Therefore, the unmitigated source

term for a high-pressure release to the room is $6,000 \text{ grams} \times 7 \times 10^{-2} = 420 \text{ grams}$ (15 ounces) of americium-241 dose equivalent (WSRC 2008b).

This scenario would be made “beyond extremely unlikely” by design features in PDCF and MFFF that should ensure the WSB feed contains only very low concentrations of organics. The impacts of a red oil explosion would be mitigated by the HEPA filters and elevated release from the stack. With a very conservative HEPA filter penetration factor of 1×10^{-5} , the amount released from the stack is conservatively bounded by $4.2 \times 10^{-3} \text{ grams}$ ($1.5 \times 10^{-4} \text{ ounces}$) of americium-241 dose equivalent.

Leaks/spills from high-activity waste process vessels and piping. A high-activity waste process vessel could leak due to loss of integrity due to corrosion, poor maintenance, or an operational error such as overfilling. The bounding MAR for any single leak or spill was assumed to be the entire inventory of the worst-case high-activity waste vessel, equivalent to 6.0 kilograms (13 pounds) of americium-241. Splashing and entrainment of process liquid were considered. The bounding ARF (2×10^{-4}) and RF (0.5) were derived from the DOE Handbook (DOE 1994), assuming a free fall spill of aqueous solutions with a 3-meter (9.8-foot) fall distance. Therefore, the unmitigated source term from the spill is $6,000 \text{ grams} \times 2 \times 10^{-4} \times 0.5 = 0.60 \text{ grams}$ (0.021 ounces) of americium-241 dose equivalent.

This scenario is considered to be in the “unlikely” category, but would fall into the “extremely unlikely” category with consideration of design features and operating practices that should limit the amount of material leaked or spilled. The impacts of a leak or spill would be mitigated by the HEPA filters and elevated release from the stack. Assuming a very conservative HEPA filter penetration factor of 1×10^{-5} , the amount released from the stack is conservatively bounded by $6.0 \times 10^{-6} \text{ grams}$ ($2.1 \times 10^{-7} \text{ ounces}$) of americium-241 dose equivalent.

Aircraft crash. The WSB DSA evaluates an aircraft crash as an unmitigated event in which an aircraft operating in the vicinity of WSB loses control and crashes into the building. The aircraft does not crash directly into the high-activity waste process area. The safety analysis (WSRC 2008b) concluded that it was not credible for an aircraft to directly affect the reduced area of concern associated with the high-activity waste process area. Rather, the aircraft was assumed to impact another portion of the building and break apart upon impact, resulting in fuel spills, missiles, and burning debris.

The WSB DSA did not credit the structure of the building or fire barriers between the high-activity waste process area and the rest of the building. Multiple fires were assumed to occur as a result of the fuel spill, resulting in a large propagating fire. This fire would eventually involve the high-activity waste process vessels and vigorously boil the liquid in the tanks. The major contributor to the dose would be the high-activity waste liquid inventory in the High-Activity Waste Process Room. Lesser contributors would include the high-activity waste liquid in the Cementation Area, the low-activity waste inventory, and the F/H Area Laboratory inventory.

The MAR involved in this scenario is 18.3 kilograms (40 pounds) of americium-241 and other associated radionuclides. The DR was assumed to be 1. A bounding ARF of 2.0×10^{-3} and an RF of 1 were applied for a boiling solution in the fire following the event to determine the unmitigated source term associated with thermal stress on liquids. The LPF was set equal to 1; therefore, the unmitigated source term is $18,300 \text{ grams} \times 2 \times 10^{-3} = 36.6 \text{ grams}$ (1.29 ounces) of americium-241 dose equivalent (WSRC 2008b).

If credit were taken for the building structure and fire barriers between the high-activity waste process area and the rest of the building, a fire of this magnitude could not occur and the source term and probability would be much lower. If there were insufficient heat to vigorously boil the vessel contents, the ARF \times RF value could be as low as 3.0×10^{-5} , resulting in much less severe consequences (WSRC 2008b). Because this is considered a design-basis accident in the WSB DSA, it is appropriate to assume these fire-limiting controls function in order to develop a realistic source term. Therefore, the mitigated source term is $18,300 \text{ grams} \times 3 \times 10^{-5} = 0.55 \text{ grams}$ (0.019 ounces) of americium-241 dose equivalent.

Because the frequency of a small aircraft crash into the building is extremely low, the probability of an aircraft crash followed by a fire of this magnitude is probably in the “beyond extremely unlikely” frequency category.

Design-basis earthquake. In this scenario, it was postulated that, during a seismic event, power to WSB is lost. Support systems such as electrical systems, electrical power to the facility, and building ventilation systems may fail to function either during or after a seismic event. It was assumed that, upon a loss of power and/or damage incurred from the seismic event, the process vessel vent system fails. This would allow hydrogen generated by radiolytic decomposition of the aqueous solution in the high-activity waste process solution tanks to begin to accumulate. Under worst-case conditions, the hydrogen level in a high-activity waste vessel could exceed the lower flammability limit in a few hours, conservatively ignoring nitrates. Additionally, a fire was assumed to start in either a maintenance area or laboratory area due to the presence of flammable materials and a relatively high combustible loading.

The WSB structure, process vessels, and pipes are designed to Natural Phenomena Hazard PC-3+ (seismic) criteria; therefore, the building structure, process tanks, and piping would remain intact during and after the design-basis seismic event.

The high-activity waste area is not routinely accessed, is designed with a low combustible loading, and is isolated by a seismically rated fire barrier. Though the possibility of electrical sparking and incipient fires cannot be ruled out in the high-activity waste area, a fire of sufficient intensity to release material from the high-activity waste area was not postulated. The potential for large post-seismic event fires in areas designed with low combustible loads and isolated by seismically qualified fire barriers is addressed in the beyond-design-basis earthquake evaluation.

A seismic event was assumed to disable the process vessel vent system and initiate a propagating fire in a laboratory or maintenance area. Hydrogen would accumulate in a high-activity waste process tank above the lower flammability limit. Hydrogen was conservatively assumed to accumulate in a 10,000-liter (350-cubic-foot) volume above the americium-241 solution. Conservatively ignoring nitrates in the americium-241 solution, a tank containing a maximum of 6 kilograms (13 pounds) of americium-241 would require almost 14 days to accumulate to a stoichiometric hydrogen/air mixture in this volume. If this mixture ignited, a vapor explosion in the headspace of the tank could occur, similar to that evaluated for the hydrogen explosion accident scenario.

Concurrently with this event, a fire was postulated to start in a laboratory or maintenance area and involve the radiological inventory outside the High-Activity Waste Process Room. This inventory is very small relative to the high-activity waste and represents a negligible dose potential to the MEI.

The source term for this event is similar to the source term developed for the bounding hydrogen explosion in a high-activity waste process tank. The mass of respirable solution made airborne due to the energy released by the vapor explosion was very conservatively assumed to be equivalent to the mass released that would result from the same amount of energy produced by detonation of an equivalent mass of TNT.

The unmitigated source term was derived (WSRC 2008b) using the method described in the DOE Handbook (DOE 1994) for a vapor explosion in an enclosed space above the solution, equating the mass of respirable solution made airborne to the energy released, expressed in terms of equivalent mass of TNT. That analysis concluded that, with a stoichiometric hydrogen/air mixture of 10,000 liters (350 cubic feet), a vapor explosion would result in an airborne release of 13.8 grams (0.487 ounces) of americium-241 through the process vessel vent system to demisters, HEPA filters, and the stack.

This scenario would be mitigated by design features that should maintain flow through the process vessel vent system. In addition, there should be sufficient time to take corrective actions before the hydrogen levels reach the lower flammable limit. Assuming no credit for the in-line process vessel vent system demisters and a very conservative HEPA filter penetration factor of 1×10^{-5} , the amount released from the

stack is conservatively bounded by 1.38×10^{-4} grams (4.87×10^{-6} ounces) of americium-241 dose equivalent.

Beyond-design-basis earthquake. WSB structural components, including process vessels and pipes, are qualified to Natural Phenomena Hazard PC-3+ (seismic) criteria. However, a more energetic seismic event could fail key WSB safety controls, such as high-activity waste vessels and fire walls, and initiate propagating fires.

In this accident scenario, a severe seismic event was postulated to occur in the immediate vicinity of WSB. The ground acceleration would be more severe than the natural phenomenon hazard PC-3+ (seismic) site criteria established for the facility. The resultant force would result in significant damage to load-bearing walls, including the 18-inch (46-centimeter) fire wall surrounding the High-Activity Waste Process Room. Further, the structural supports for high-activity waste tanks and piping would fail, resulting in a large spill of high-activity waste solution. For a seismically initiated fire to occur inside the process room with sufficient intensity to result in a significant release of high-activity waste solution, an ignition source must be present and sufficient combustibles must be available to fuel a large and intense fire that could boil the high-activity waste solution. The High-Activity Waste Process Room is designed with a low combustible loading, limited ignition sources, and no flammable gases or liquids that are typical potential initiators for post-seismic event fires. Therefore, for purposes of this *SPD Supplemental EIS*, a widespread post-seismic event fire is not considered credible.

For purposes of this *SPD Supplemental EIS*, the entire high-activity waste inventory was assumed to spill. The high-activity waste process MAR was assumed to be the maximum facility inventory, which is 18.3 kilograms (40 pounds) of americium-241 and other associated radionuclides. The DR was assumed to be 1. A bounding ARF of 2×10^{-4} and RF of 0.5 were applied to impact (spill) stresses. Consistent with the general assumptions for beyond-design-basis accident LPFs presented in Section D.1.5.1 for new facilities, a LPF of 0.1 was assumed. Therefore, the unmitigated source term is $18,300 \text{ grams} \times 2 \times 10^{-4} \times 0.5 \times 0.1 = 0.183 \text{ grams}$ (0.0065 ounces) americium-241 dose equivalent.

Accident scenarios and source terms for WSB under the No Action, Immobilization to DWPF, MOX Fuel, H-Canyon/HB-Line to DWPF, and WIPP Alternatives are presented in **Table D-7**.

No new substantial accident risks from the proposed new activities in this *SPD Supplemental EIS* have been identified (WSRC 2008a).

Table D-7 Accident Scenarios and Source Terms for the Waste Solidification Building

<i>Accident</i>	<i>Frequency (per year)</i>	<i>MAR (grams americium-241 dose equivalent)</i>	<i>DR</i>	<i>ARF</i>	<i>RF</i>	<i>LPF</i>	<i>Release (grams americium-241 dose equivalent)</i>
Criticality	Not credible	–	–	–	–	–	–
High-activity waste process vessel hydrogen explosion	1×10^{-4} to 1×10^{-6} (extremely unlikely)	13.8	1	–	–	0.00001	0.00014
High-Activity Waste Process Room fire	1×10^{-4} to 1×10^{-6} (extremely unlikely)	18,300	1	0.00003		0.00001	5.5×10^{-6}
Leak or spill	Unlikely	6,000	1	0.0002	0.5	0.00001	6×10^{-6}
Design-basis earthquake	0.0004 (unlikely)	13.8	1	–	–	0.00001	0.00014
Aircraft crash	$< 1 \times 10^{-7}$ (beyond extremely unlikely)	18,300	1	0.00003		1	0.55
Beyond-design-basis red oil explosion	$< 1 \times 10^{-6}$ (beyond extremely unlikely)	6,000	1	0.1	0.7	0.00001	0.0042
Beyond-design-basis earthquake	1×10^{-5} to 1×10^{-7} (extremely unlikely to beyond extremely unlikely)	18,300	1	0.0002	0.5	0.1	0.18

ARF = airborne release fraction; DR = damage ratio; LPF = leak path factor; MAR = material at risk; RF = respirable fraction.

Note: To convert grams to ounces, multiply by 0.035274.

Source: WSRC 2008b.

D.1.5.2.8 H-Canyon/HB-Line

Under the Immobilization to DWPF, MOX Fuel, H-Canyon/HB-Line to DWPF, and WIPP Alternatives considered in this *SPD Supplemental EIS*, H-Canyon/HB-Line could be used to support various surplus plutonium disposition activities (see Appendix B, Section B.1.3). As a result, a wide range of potential accident scenarios were considered for H-Canyon/HB-Line. These scenarios are considered in detail in the safety analyses and NEPA analyses for H-Canyon/HB-Line. The analyses demonstrate that H-Canyon/HB-Line can withstand design-basis natural phenomenon hazards such as earthquakes, winds, tornadoes, and floods, such that no unfiltered releases are expected.

Three options would use the H-Canyon/HB-Line processing capabilities to convert plutonium metal and oxides into a form suitable for oxide feed at MFFF, a blended oxide suitable for onsite shipment to E-Area and then on to the Waste Isolation Pilot Plant (WIPP), or a nitrate solution for vitrification with high-level radioactive waste in DWPF. The types of operations are similar to either ongoing or recent operations in the H-Canyon/HB-Line complex and would not introduce any new types of accidents into the facilities or substantially change the frequencies for the accidents analyzed. The operations proposed under the three options are well within H-Canyon/HB-Line capabilities, and existing safety systems would ensure the operations would be conducted safely. Because all of the operations involve dissolving metal and oxides and then handling and processing similar quantities of dispersible plutonium oxides, the bounding accidents, such as failure of cans of oxide and large fires, would be similar. The three options identified for use of H-Canyon/HB-Line are as follows:

Process plutonium for MFFF feed. Under this option, H-Canyon and HB-Line would be utilized in the following ways:

- H-Canyon would dissolve plutonium sent to it for processing.
- H-Canyon would store dissolved plutonium solution and provide it as feed to HB-Line.
- HB-Line would convert dissolved plutonium to plutonium oxide in the Phase II portion of the HB-Line⁴ for MFFF feed.
- H-Canyon would process HB-Line column raffinate and precipitator filtrate waste to recover plutonium for recycle or disposition at the Liquid Waste Tank Farm.

The surplus plutonium disposition-related MAR in HB-Line would be up to 50 kilograms (110 pounds) of plutonium oxide. The H-Canyon surplus plutonium disposition-related MAR would include the dissolved plutonium inventory, which should be bounded by an inventory of 1,000 kilograms (2,200 pounds) of plutonium-239 in an aqueous nitrate solution spread over several tanks (SRNS 2012).

Process non-pit plutonium for DWPF. Under this option, H-Canyon and HB-Line would dissolve surplus non-pit plutonium metal and oxide for subsequent vitrification with high-level radioactive waste in DWPF. Dissolution of the majority of the material in oxide form would occur in HB-Line, while the dissolution of most of the metals would occur in H-Canyon. The dissolved solutions would then be transferred to the separations process, during which any uranium present in the material would be recovered. The plutonium solutions would be transferred primarily to the DWPF sludge feed tank in the liquid radioactive waste tank farm pending vitrification at DWPF.

Process non-pit plutonium for WIPP. Under this option, plutonium would be processed utilizing the existing H-Canyon and HB-Line facilities to prepare the plutonium for subsequent disposition at WIPP. HB-Line would install new equipment in existing gloveboxes to open DOE-STD-3013 containers, remove the plutonium contents, blend the plutonium with materials to terminate safeguards, and package the result in Pipe Overpack Containers (POCs). H-Canyon would support HB-Line by providing

⁴ Phase II is the production line for plutonium and neptunium oxides.

temporary or interim storage of loaded POCs prior to their shipment to E-Area, if required. Once the POCs are loaded and ready for shipping, they would be transported to E-Area for storage, characterization, and shipment to WIPP. The addition of a muffle furnace to one of the glovebox lines would also be required to convert some metal to oxide prior to blending with termination-of-safeguards material.

If unirradiated Fast Flux Test Facility (FFTF) fuel cannot be dispositioned by direct disposal at WIPP, then the unirradiated FFTF fuel would have to be disassembled and could be disposed of at WIPP through processing at H-Canyon/HB-Line. Existing gloveboxes in HB-Line would be used to perform the operations to crush the pellets into a powder, load the powder into suitable cans, mix/blend the powder with inert material, assay the resulting material, package the loaded cans into POCs, and transfer the POCs to E-Area.

Because processing the oxides would occur primarily in HB-Line and would be a dry activity, the associated accident scenarios would primarily involve HB-Line operations. No changes would be expected in liquid process waste generation from either H-Canyon or HB-Line as a result of performing this mission. H-Canyon would provide support to HB-Line by providing temporary or interim storage of loaded POCs prior to shipment to E-Area if required. Thus, the potential accidents associated with ongoing H-Canyon operations would dominate any additional accident risks associated with this surplus plutonium disposition option.

Bounding accidents. The material processing and throughputs associated with any of the options for H-Canyon and HB-Line are not expected to add any new accident types. Accident scenarios and source terms are not expected to change. With longer periods of operation, the accident risks would continue for a longer period.

Analysis of the proposed process operations for plutonium dissolution operations in H-Canyon/HB-Line identified the following broad categories of accidents: aircraft crash, criticality, design-basis earthquake, beyond-design-basis earthquake, explosion, fire, and leaks or spills. Because H-Canyon and HB-Line are very robust structures and provide a high degree of inherent confinement, releases from almost all accidents would be confined within the structure and would be filtered through the sand filter prior to release to the environment. Of all of the accidents considered in the safety documents, accidents that result in room-wide fires present the greatest risks. The basic characteristics of each of these postulated accidents are described in this section. Additional discussion of scenario development based on consistency concerns can be found in Section D.1.5.1.

The potential for accidents and the potential accident consequences for workers and the environment from processing of the proposed surplus plutonium disposition materials is well within the scope of the accident scenarios, MARS, and consequences evaluated in the existing safety documents for H-Canyon (SRNS 2011a) and HB-Line (SRNS 2011b). These existing and prior safety documents have evaluated processing of both plutonium-239 and plutonium-238 materials; the latter material has a curie content of about a factor of 100 greater than that proposed for the surplus plutonium disposition program.

Both the H-Canyon and the HB-Line safety documents identify a range of accidents, including nuclear criticalities, spills, fires, explosions, natural phenomena such as earthquakes, and external events such as potential bounding accidents. For HB-Line, the dominant operational scenarios include explosions associated with the dissolvers in Phase I portion of the HB-Line,⁵ localized or widespread fires, and criticalities.

The HB-Line safety documents evaluate the consequences for a range of accidents using the actual inventories associated with ongoing processing campaigns at the time of the safety document preparation,

⁵ Phase I is the Scrap Recovery Line, which is used to dissolve and dispose of legacy plutonium materials.

which included dissolution of low-assay plutonium in Phase I dissolvers. The safety documents also evaluated a range of fires involving legacy materials in the old HB-Line, which would not be used for surplus plutonium disposition materials.

Although the current safety analysis for HB-Line (SRNS 2011b) is for somewhat different processing operations than those projected for the surplus plutonium disposition mission, the current safety basis, including accident scenarios and building MAR limits (SRNS 2011b, Table 5.5.7-1), would support the proposed surplus plutonium disposition operations.

Based on the current safety documents for HB-Line (SRNS 2011b), the most severe accidents include rupture of a 3013 container due to impact, a fifth- or sixth-level facility fire, and an earthquake with subsequent fire and post-seismic event hydrogen explosions in the process vessels. In each of these accidents, the HB-Line structure and containment system, including the sand filters, are expected to continue to function.

Both the H-Canyon and HB-Line safety analyses evaluated the potential for an inadvertent nuclear criticality, particularly in the dissolvers, and identified appropriate controls.

The H-Canyon safety analyses also evaluated a potential explosion–hydrogen deflagration due to radiolysis in the dissolvers and identified the controls necessary to dissolve plutonium materials. The potential accident risks for this type of accident are much less than the postulated hydrogen deflagration uncontrolled reaction and the tributyl phosphate/nitric acid explosions evaluated for other portions of the H-Canyon processes that are not associated with surplus plutonium disposition operations. The bounding explosion in the H-Canyon safety documents is a hydrogen explosion involving high-activity waste derived primarily from the processing of used nuclear fuel. This accident bounds any of the accidents associated with plutonium metal dissolution.

Because the dissolvers do not contain solvents, a fire would not be likely in that area. Fire events considered included a pyrophoric fire occurring in the crane vestibule or the H-Canyon material area, which could result from spontaneous ignition of plutonium metal, dropped dissolvable cans, defective can crimp seals, or operator error. This fire could involve the DOE-STD-3013-2004 limit of 4,400 grams (160 ounces) of plutonium (DOE 2012a). Based on an ARF of 6×10^{-3} , an RF of 0.01 and an LPF of 4.9×10^{-3} for the sand filter system, a stack release of 1.3×10^{-3} grams (4.6×10^{-5} ounces) of plutonium was postulated. The estimated frequency of this accident is in the range of 1×10^{-4} to 1×10^{-6} per year (“extremely unlikely”). Fires that result in a pressurized release of oxide would bound these metal fires.

Aircraft crash. A crash of a large, heavy commercial or military aircraft directly into a reinforced-concrete facility could damage the structure sufficiently to breach confinement and disperse material into the environment. A subsequent fuel-fed fire could provide energy to further damage structures and equipment, aerosolize material, and drive materials into the environment. Source terms are highly speculative, but could exceed those of the beyond-design-basis earthquake. At all SRS sites, the frequency of such a crash is below 1×10^{-7} per year, and so was not evaluated.

Criticality. Engineered and administrative controls should be available to ensure that the double-contingency principles are in place for all portions of the process. It was assumed that human error results in multiple failures, leading to an inadvertent nuclear criticality. The estimated frequency of this accident is in the range of 1×10^{-4} to 1×10^{-6} per year (“extremely unlikely”). A bounding source term resulting from 1×10^{19} fissions was assumed.

Explosions. The bounding explosion associated with surplus plutonium disposition material was assumed to be a hydrogen deflagration in a process vessel with plutonium liquid. A bounding quantity of 150,000 grams (5,300 ounces) of plutonium in solution was assumed to be at risk (SRNS 2012). Based on an ARF of 6×10^{-3} , an RF of 0.01, and an LPF of 4.9×10^{-3} for the sand filter system, a stack release of 0.044 grams (0.0016 ounces) of plutonium was postulated. The estimated frequency of this accident is in the range of 1×10^{-4} to 1×10^{-6} per year (“extremely unlikely”).

Within the portion of HB-Line that would be used for surplus plutonium disposition material dissolution and processing, the bounding explosion is a hydrogen explosion in a dissolver. A similar MAR or smaller is expected. The impacts of an explosion in HB-Line would be bounded by the H-Canyon explosion.

Fire. The bounding fire in H-Canyon involving surplus plutonium disposition plutonium metal was assumed to be a pyrophoric fire. This fire could involve the MAR limit of 4,400 grams (160 ounces) in a single 3013 container. The analysis also assumed an ARF of 5.0×10^{-4} and an RF of 0.5. Based on an LPF of 4.9×10^{-3} for the sand filter system, a stack release of 5.4×10^{-3} grams (1.9×10^{-4} ounces) was postulated. The estimated frequency of this accident is in the range of 1×10^{-2} to 1×10^{-4} per year (“unlikely”). This event is bounded by fires involving oxides and TRU waste in HB-Line.

A bounding fire event for HB-Line is described in the current safety analyses (SRNS 2011b). A large-scale fire, although unlikely, would have the potential to result in high-pressure releases of oxides from 3013 cans and lower-pressure releases of oxides from other, less robust containers or gloveboxes. Current safety analyses for HB-Line (SRNS 2011b) evaluate this accident with the current and legacy inventory of materials within the HB-Line rooms. Although the current analysis addressed somewhat different processing operations than those projected for the surplus plutonium disposition mission, the accident scenarios and building MAR limits (SRNS 2011b, Table 5.5.7-1) would support the proposed surplus plutonium disposition operations.

With the proposed surplus plutonium disposition operations in HB-Line, the bounding MAR for a level-wide fire in HB-Line would be 4,400 grams (160 ounces) of plutonium oxide in a single 3013 container, 50,000 grams (1,800 ounces) of non-pit plutonium as oxide in process (including WIPP material), 100,000 grams (3,500 ounces) of plutonium in solution in process, and 10,000 grams (350 ounces) of plutonium-239 dose equivalent as TRU waste (SRNS 2012).

Using the assumptions for response to these materials in a bounding fire event identified in the *Savannah River Site, H-Canyon & Outside Facilities, H-Area, Documented Safety Analysis (HB-Line DSA)* (SRNS 2011b, Table 3.4-1), including a bounding DR of 1 for most materials, the total release to the building would be as follows:

- Heating and overpressurization of 3013 container – Assuming a release at 1,000 psig due to overpressurization of a 3013 container with 4,400 grams (160 ounces) of plutonium resulting from a surrounding fire, a DR of 1, and an $ARF \times RF$ of 0.113, about 500 grams (18 ounces) would be released to the building.
- Heating oxide in process – Assuming a less than 25 psig release due to thermal stress of 50,000 grams (1,800 ounces) of plutonium as oxide, a DR of 1, and an $ARF \times RF$ of 0.002, 100 grams (3.5 ounces) of plutonium would be released to the building.
- Heating solution in process – Assuming boiling due to thermal stress of 100,000 grams (3,500 ounces) of plutonium in solution in process, a DR of 1, and an $ARF \times RF$ of 0.002, 200 grams (7.1 ounces) of plutonium would be released to the building.
- Burning TRU waste – Assuming that 20 percent of the 10,000 grams (350 ounces) is unconfined and subject to open burning with an $ARF \times RF$ of 0.01, 20 grams (0.71 ounces) of plutonium-239 dose equivalent would be released to the building. Assuming the remaining 80 percent is confined and subject to confined burning with an $ARF \times RF$ of 0.0005, 4 grams (0.14 ounces) of plutonium-239 dose equivalent would be released to the building.

Thus, for the bounding fire event, approximately 800 grams (28 ounces) of plutonium and 24 grams (0.85 ounces) of plutonium-239 dose equivalent could be released to the building. The building structure and confinement are expected to continue to function during this design-basis event so the release would be filtered through the sand filter system. Based on an LPF of 4.9×10^{-3} for the sand filter system, a stack release of 3.9 grams (0.14 ounces) of plutonium plus 0.12 grams (0.0042 ounces) of plutonium-239 dose

equivalent was postulated. The nominal frequency estimate for the combination of a severe fire following a design-basis earthquake would be in the range of 1×10^{-4} to 1×10^{-6} per year (“extremely unlikely”).

Leaks or spills of nuclear material. The bounding spill was assumed to be a breach of a dissolvable container. It was assumed that 2.0 kilograms (4.4 pounds) of plutonium-239 dose equivalent were MAR. Because the material would be in metal form, no substantial release is expected.

Once the plutonium is dissolved, a spill of the solution is possible and would bound any oxide spills. The spill or transfer error of plutonium solution was analyzed in the *H-Canyon DSA* (SRNS 2011a). Concerning the proposed surplus plutonium disposition operations in H-Canyon and HB-Line, the bounding MAR would be a spill of 320,000 grams (11,000 ounces) of plutonium as solution from the largest storage tank (SRNS 2012). Based on an ARF of 2×10^{-4} , an RF of 0.5, and an LPF of 4.9×10^{-3} for the sand filter system, a stack release of 0.16 grams (5.6×10^{-3} ounces) of plutonium was postulated. This accident has an estimated frequency in the range of 1×10^{-2} to 1×10^{-4} per year (“unlikely”).

Design-basis earthquake with fire. The design-basis event that presents the highest potential for release of material to the environment is a design-basis earthquake followed by a major fire. While the major safety systems, including building confinement and the building sand filter system, should continue to function, the vibratory motion is expected to result in spills of solution or low-energy spills of oxide and perhaps a pyrophoric fire, as described earlier.

H-Canyon. With the proposed surplus plutonium disposition operations in H-Canyon, the bounding MAR for an earthquake and fire in H-Canyon would be 8,800 grams (310 ounces) of plutonium as metal and 50,000 grams (1,800 ounces) of plutonium as oxide stored in Pipe Overpack Containers (Type B-like shipping containers) (SRNS 2012). The *H-Canyon DSA* (SRNS 2011a, Section 3.4.2.1) shows no credible scenarios for solutions subject to fires (SRNS 2012). The plutonium metal would be subject to burning if it were uncontained and exposed to transient fires associated with the seismic event and subsequent fires. A bounding DR of 1 with an ARF of 0.0005 and RF of 0.5 was assumed (SRNS 2011a, Table 3.4-10). Thus, a release of 2.2 grams (0.078 ounces) to the building was postulated.

The oxide stored in Type B-like shipping containers that are expected to survive severe transportation accidents is not expected to be vulnerable to the postulated fires and no release is expected.

Based on an LPF of 4.9×10^{-3} for the sand filter system, a stack release of 0.011 grams (0.00039 ounces) was postulated. The nominal frequency estimate for the combination of a severe fire following a design-basis earthquake would be in the range of 1×10^{-4} to 1×10^{-6} per year (“extremely unlikely”).

HB-Line. A subsequent large-scale fire, although unlikely, would have the potential to result in high-pressure releases of oxides from 3013 cans and lower-pressure releases of oxides from other, less robust containers or gloveboxes. Current safety analyses for HB-Line (SRNS 2011b) evaluate this accident with the current and legacy inventory of materials within the HB-Line rooms. That analysis (SRNS 2011b, Tables 3.4-15 and 3.4-16) indicates that the subsequent fire would be the dominant contributor to the overall source term and the release, which would be due to the seismic vibration and impacts only, would contribute about 1 percent to the overall source term. Thus, for purposes of this *SPD Supplemental EIS*, the vibration, impacts, and spill contribution would be negligible.

Although the current analysis is for somewhat different processing operations than those projected for the surplus plutonium disposition mission, the accident scenarios and building MAR limits (SRNS 2011b, Table 5.5.7-1) would support the proposed surplus plutonium disposition operations.

Concerning the proposed surplus plutonium disposition operations in HB-Line, the bounding MAR for a level-wide fire in HB-Line would be 4,400 grams (160 ounces) of plutonium oxide in a single 3013 container; 50,000 grams (1,800 ounces) of plutonium as oxide in process (including WIPP material); 100,000 grams (3,500 ounces) of plutonium in solution in process; and 10,000 grams (350 ounces) of plutonium equivalent as TRU waste (SRNS 2012). This is the same MAR identified for the bounding fire

event. Because the releases due to the seismic motion, spills, and subsequent impacts can be neglected, the total release due to the seismic release and subsequent fire can be approximated by the bounding level-wide fire in HB-Line evaluated earlier. Thus, the total fire contribution would be about 800 grams (28 ounces) of plutonium and 24 grams (0.85 ounces) of plutonium-239 dose equivalent released to the building.

The building structure and confinement are expected to continue to function during this design-basis event, so the release would be filtered through the sand filter system. Based on an LPF of 4.9×10^{-3} for the sand filter system, a stack release of 3.9 grams (0.14 ounces) of non-pit plutonium plus 0.12 grams (0.0042 ounces) of plutonium-239 dose equivalent was postulated. The nominal frequency estimate for the combination of a severe fire following a design-basis earthquake would be in the range of 1×10^{-4} to 1×10^{-6} per year (“extremely unlikely”).

Beyond-design-basis earthquake with fire. The postulated beyond-design-basis earthquake was assumed to be of sufficient magnitude to cause collapse of the process equipment, initiation of widespread fires, and loss of the containment function of the building. For purposes of this *SPD Supplemental EIS*, the surplus plutonium disposition program materials released are expected to be bounded by the postulated source terms associated with the design basis earthquake with fire for H-Canyon and HB-Line. As indicated for those accidents, the dominant contribution would come from the postulated fires in HB-Line that could overpressurize 3013 containers and heat oxides and solutions. For the bounding fire events, the release to the building due to proposed surplus plutonium activities was estimated at 2.2 grams (0.078 ounces) for H-Canyon and 800 grams (28 ounces) of plutonium plus 24 grams (0.85 ounces) of plutonium-239 dose equivalent from HB-Line activities. Concerning the beyond-design-basis event, the building confinement was assumed to have failed and releases were postulated at ground level. Consistent with the general assumptions for beyond-design-basis accident LPFs presented in Section D.1.5.1 for older facilities, a building LPF of 0.25 was assumed, although a more realistic value is likely to be at least a factor of several lower. The estimated frequency of this accident is in the range of 1×10^{-5} to 1×10^{-7} per year or lower (“extremely unlikely to beyond extremely unlikely”).

Accident scenarios and source terms for H-Canyon/HB-Line under the disposition alternatives are presented in **Table D-8**. These scenarios indicate that, for any of the surplus plutonium disposition options for use of H-Canyon/HB-Line, the accident releases are dominated by fires that result in the high-pressure rupture of 3013 cans of oxide or lower-pressure venting of other containers of oxide. Plutonium metal dissolution activities in H-Canyon present a much smaller accident risk than past used fuel dissolution involving large quantities of fission products and would not result in a significant radiological dose to the public. For purposes of analysis for this facility, all of the plutonium involved is assumed to be non-pit plutonium, with an assumed americium-241 content of 6.25 percent. The relative inhalation hazard of this material is 6.47 times higher than plutonium-239 and about 3.1 times more hazardous than weapons-grade plutonium. The plutonium-239 equivalents for each source term are also included in Table D-8. If the accidents involved pit plutonium instead of non-pit plutonium, the plutonium-239-dose-equivalent MAR, doses, and risks would be about a factor of 3.1 lower.

Table D-8 Accident Scenarios and Source Terms for the H-Canyon/HB-Line Under All Alternatives

<i>Accident^a</i>	<i>Frequency (per year)</i>	<i>MAR (grams)</i>	<i>DR</i>	<i>ARF</i>	<i>RF</i>	<i>LPF</i>	<i>Release^a (grams)</i>
Criticality	1 × 10 ⁻⁴ to 1 × 10 ⁻⁶ (extremely unlikely)	–	–	–	–	–	1 × 10 ¹⁹ fissions
Hydrogen explosion in H-Canyon dissolver	1 × 10 ⁻⁴ to 1 × 10 ⁻⁶ (extremely unlikely)	150,000 Pu in solution	1	0.006	0.01	0.0049	0.044 Pu 0.29 PuE
Fire (level-wide in HB-Line)	1 × 10 ⁻⁴ to 1 × 10 ⁻⁶ (extremely unlikely)	4,400 Pu in 3013	1	0.113		0.0049	2.4 Pu
		50,000 Non-pit Pu as oxide in process	1	0.002		0.0049	0.49 Pu
		100,000 Pu in solution in process	1	0.002		0.0049	0.98 Pu
		10,000 PuE as TRU waste	0.2 0.8	0.01 0.0005		0.0049 0.0049	0.098 PuE 0.020 PuE
		Total	–	–	–	–	3.9 Pu + 0.12 PuE or Total: 26 PuE
Leaks/spills of nuclear material (H-Canyon)	1 × 10 ⁻² to 1 × 10 ⁻⁴ (unlikely)	320,000 Pu as solution	1	0.0002	0.5	0.0049	0.16 Pu 1.0 PuE
Design-basis earthquake with fire (H-Canyon)	1 × 10 ⁻⁴ to 1 × 10 ⁻⁶ (extremely unlikely)	8,800 Pu metal	1	0.0005	0.5	0.0049	0.011 Pu
		50,000 Pu in shipping containers	0	–	–	0.0049	0
Design-basis earthquake with fire (HB-Line)	1 × 10 ⁻⁴ to 1 × 10 ⁻⁶ (extremely unlikely)	4,400 Pu in 3013	1	0.113		0.0049	2.4 Pu
		50,000 Non-pit Pu as oxide in process	1	0.002		0.0049	0.49 Pu
		100,000 Pu in solution in process	1	0.002		0.0049	0.98 Pu
		10,000 PuE TRU waste	0.2 0.8	0.01 0.0005		0.0049 0.0049	0.098 PuE 0.020 PuE
		Total	–	–	–	–	3.9 Pu + 0.12 PuE or 26 PuE
Beyond-design-basis earthquake with fire	1 × 10 ⁻⁵ to 1 × 10 ⁻⁷ (extremely unlikely to beyond extremely unlikely)	8,800 Pu metal	1	0.0005	0.5	0.25	0.55 Pu
		4,400 Pu in 3013	1	0.113		0.25	124 Pu
		50,000 Non-pit Pu as oxide in process	1	0.002		0.25	25 Pu
		100,000 Pu in solution in process	1	0.002		0.25	50 Pu
		10,000 PuE TRU waste	0.2 0.8	0.01 0.0005		0.25 0.25	5.0 PuE 1.0 PuE
		Total	–	–	–	–	200 Pu + 6.0 PuE or 1,300 PuE

ARF = airborne release fraction; DR = damage ratio; LPF = leak path factor; MAR = material at risk; Pu = plutonium; PuE = plutonium-239 dose equivalent; RF = respirable fraction; TRU=transuranic.

^a These scenarios and source terms were developed for surplus plutonium processing activities only and do not reflect other H-Canyon and HB-Line activities, including plutonium-238 activities and legacy contamination activities.

Note: To convert grams to ounces, multiply by 0.035274.

Source: SRNS 2011a, 2011b, 2012.

D.1.5.2.9 Defense Waste Processing Facility

Under the Immobilization to DWPF and H-Canyon/HB-Line to DWPF Alternatives considered in this *SPD Supplemental EIS*, DWPF in S-Area could be used to support various surplus plutonium disposition activities (see Appendix B, Section B.1.4.1).

Defense Waste Processing Facility Can-in-Canister Operations

Can-handling accidents and DWPF accidents were considered in the *SPD EIS* (DOE 1999), and no releases to the environment were predicted for vitrified plutonium canisters. The following accidents were considered:

Can-handling accident (before shipment to DWPF). A can-handling accident would involve a framework loaded with small cans containing vitrified plutonium material. Studies supporting the DWPF safety analyses indicate that the source term resulting from dropping vitrified waste, even without credit for the steel canister, would be negligible. The surplus plutonium immobilization technology would produce a waste form with a durability comparable to that of the DWPF vitrified waste form. Consequently, no postulated can-handling event would result in a radioactive release to the environment.

Melter spill (melt pour at DWPF). Analysis of a spill of melt material was included in studies performed in support of the DWPF safety analyses. According to that analysis, the source term resulting from dropping or tipping a log of vitrified waste, even without credit for the steel canister, would be negligible. Both surplus plutonium immobilization technologies (ceramic and glass) would produce a waste form with a durability comparable to that of the DWPF vitrified waste form. Consequently, it was postulated that no melter spill event would result in a radioactive release to the environment.

Canister-handling accident (after melt pour at DWPF). Analysis of events involving the handling and storage of vitrified waste canisters was included in studies performed in support of the DWPF safety analyses. Results of that analysis indicate that the source term resulting from the dropping or tipping of a log of vitrified waste, even without credit for the steel canister, would be negligible. The surplus plutonium immobilization technology would produce a waste form with a durability comparable to that of the DWPF vitrified waste form. Consequently, it was postulated that no canister-handling event would result in a radioactive release to the environment.

No new substantial accident risks from the proposed new activities in this *SPD Supplemental EIS* have been identified (WSRC 2008a).

D.1.5.2.10 Glass Waste Storage Buildings

Under the Immobilization to DWPF and H-Canyon/HB-Line to DWPF Alternatives considered in this *SPD Supplemental EIS*, Glass Waste Storage Buildings in S-Area could be used to store vitrified waste containing surplus plutonium (see Appendix B, Section B.1.4.2). Vitrified waste canister-handling accidents at the Glass Waste Storage Buildings were considered in the *SPD EIS* (DOE 1999), and no releases to the environment were predicted for canister-handling accidents. The following accident was considered:

Canister-handling accident (after melt pour at DWPF). Analysis of events involving the handling and storage of vitrified waste canisters was included in studies performed in support of the DWPF SAR. Results of that analysis indicate that the source term resulting from the dropping or tipping of a log of vitrified waste, even without credit for the steel canister, would be negligible. The surplus plutonium immobilization technology would produce a waste form with a durability comparable to that of the DWPF vitrified waste form. Consequently, it was postulated that no canister-handling event would result in a radioactive release to the environment.

D.1.5.2.11 Los Alamos National Laboratory Plutonium Facility

Under all alternatives, the LANL Plutonium Facility (PF-4) could process pits and other plutonium metal (see Appendix B, Section B.2.1). Accident analyses of PF-4 for this *SPD Supplemental EIS* were based on recent safety documents for TA-55, as summarized in the *Final Report, Data Call to Support the Surplus Plutonium Disposition Supplemental Environmental Impact Statement* (LANL 2012a). Approaches to evaluation of these accidents follow the methods used in the recent *Final Supplemental Environmental Impact Statement for the Nuclear Facility Portion of the Chemistry and Metallurgy Research Building Replacement Project at Los Alamos National Laboratory, Los Alamos, New Mexico* (DOE 2011a) and the earlier *LANL SWEIS* (DOE 2008b).

DOE has committed to seismic upgrades to PF-4 that would result in an updated safety-basis estimate (McConnell 2011) of mitigated consequences less than the 25 rem to the MEI (the DOE Evaluation Guideline described in DOE Standard 3009-94 [DOE 2006a]) for a seismically induced fire. Proposed future improvements that will be incorporated into PF-4 include fire-rated containers, seismically qualified fire-suppression systems, and seismically qualified portions of the confinement ventilation system.

The accident analyses for PF-4 are based on the late-2011, DOE-approved safety documents that reflect ongoing safety upgrades to improve the fire-suppression systems and the ability of the facility structure and confinement system to withstand design-basis earthquakes. These updated safety analyses address the safety concerns that have been identified by the independent Defense Nuclear Facilities Safety Board (DNFSB 2009, DOE 2011b, 2012b).

The TA-55 safety documents use a hazards analysis process based on guidance provided by the DOE Standard: *Preparation Guide for U.S. Department of Energy Nonreactor Nuclear Facility Safety Analysis Reports* (DOE 2006a). This process ranks the risk of each hazard based on the estimated frequency of occurrence and potential consequences to screen out low-risk hazards. Based on this process, a spectrum of accidents was selected. The selection process included, but was not limited to: (1) consideration of the impacts on the public and workers of high-frequency/low-consequence accidents and low-frequency/large-consequence accidents; (2) selection of the highest-impact accident in each accident category to envelope the impacts of all potential accidents; and (3) consideration of reasonably foreseeable accidents. The safety documents also include evaluation of low-frequency/large-consequence accidents that are considered to be beyond-design-basis accidents. In addition, the hazards and accident analyses consider the potential for accidents initiated by external events (e.g., aircraft crash, explosions in collocated facilities) and natural phenomena (e.g., wildfires, external flooding, earthquake, extreme winds, wind-blown projectiles). Accident scenarios initiated by human error were also evaluated.

Accident Scenario Selection

The safety documents for PF-4 start with hazard evaluations that systematically consider a wide range of potential hazards and identify the controls needed to prevent the incident from occurring or to mitigate the potential consequences should an incident occur. Incidents that could result in larger consequences or higher accident risks are further evaluated to identify the potential radiological consequences if the accident were to occur, as well as to identify controls to reduce the likelihood of the accident occurring and the potential radiological consequences to the extent practicable.

For facilities like PF-4, the general safety strategy requires the following:

- Plutonium materials must be contained at all times, with multiple layers of confinement that prevent the materials from reaching the environment.
- Energy sources that are large enough to disperse the plutonium and threaten confinement must be minimized.

This basic strategy means that operational accidents, including spills, impacts, fires, and operator errors, never have sufficient energy available to threaten the multiple levels of confinement that are always present within a plutonium facility. For PF-4, the final layer of confinement is the reinforced-concrete structure and the system of barriers and multiple stages of HEPA filters that limit the amount of material that could be released to the environment even in the worst realistic internal events.

The operational events that present the greatest threats to confinement are large-scale internal fires, which, if they did occur, could present heat and smoke loads that threaten the building's HEPA filter systems. For modern plutonium facilities, the safety strategy is to prevent large internal fires by limiting the energy sources, such as flammable gases and other combustible materials, to the point that a wide-scale, propagating fire is not physically possible, and to defeat smaller internal fires with fire-suppression systems.

Modern plutonium operations, such as PF-4, are designed and operated such that the estimated frequency of any large fire within the facility would fall into the "extremely unlikely" category and would require multiple violations of safety procedures to introduce sufficient flammable materials into the facility to support such a fire. Any postulated large-scale fire in a modern plutonium facility would be categorized as a "beyond-design-basis" event and is not expected to occur during the life of the facility.

Earthquakes present the greatest design challenges for these facilities due to the requirement to prevent substantial releases of radioactive materials to the environment during and after a severe earthquake. For safety analysis purposes, it is often assumed that, after a very severe earthquake that exceeds the design loading levels of the facility equipment, enclosures, and building structure and confinement, a substantial release of radioactive material within the facility occurs. This allows designers and safety analysts to determine which additional design features may be needed to ensure greater containment and confinement of the radioactive MAR, even in an earthquake so severe that major damage to a new, reinforced-concrete facility could occur. In these safety analyses, it is often assumed that major safety systems are not in place to enable estimation of the mitigation effectiveness of each of the individual safety systems (or controls).

The accident scenarios selected for inclusion in this *SPD Supplemental EIS* are the ones that would present the greatest risk of radiological exposure to members of the public. Because of the reinforced nature of the plutonium facilities, these scenarios would all require substantial additions of energy, either from a widespread internal fire or through a severe natural disaster such as an earthquake so severe that building safety systems exceed their design limits and confinement of the plutonium materials within the building is lost. Thus, any of the accidents presented in this *SPD Supplemental EIS* with frequencies of 1 in 10,000 per year or less would fall into the "beyond-design-basis" category and have probabilities that would fall into the "extremely unlikely" or "beyond extremely unlikely" category. None of these postulated events is expected to occur during the life of the facility.

The LPF accounts for the action of removal mechanisms (e.g., containment systems, filtration, and deposition) to reduce the amount of airborne radioactivity ultimately released to occupied spaces in the facility or the environment. LPFs are assigned in accident scenarios involving a major failure of confinement barriers; these LPFs are 1.0 (no reduction) or 0.1 for a more realistic evaluation of the transport of material out of storage containers and enclosures (such as gloveboxes) through the building equipment, damaged structures, and rubble to the environment. LPFs were assumed based on information included in the hazard analysis information for PF-4 (LANL 2012a).

Because the isotopic composition and shape of some of the nuclear materials are classified, the material inventory for some of the accident scenarios has been converted to dose-equivalent amounts of plutonium-239. The conversion was on a constant-consequence basis, so that the consequences calculated in the accident analyses are equivalent to what they would be if actual material inventories were used. The following sections describe the selected accident scenarios and corresponding source terms for the alternatives.

Accident scenarios considered included the following:

Criticality. The potential for a criticality exists whenever there is a sufficient quantity of nuclear material in an unsafe configuration. Although a criticality could affect the public, its effects would be primarily associated with workers near the accident.

This accident was identified as “unlikely” (with a frequency in the range of 1×10^{-2} to 1×10^{-4}) when unmitigated. The scenario represents a metal criticality. The metal was postulated to soften, resulting in a 100 percent release of fission products generated in the criticality. However, no aerosolized, respirable metal fragments were predicted to be released. Engineered and administrative controls should be available to ensure that the double-contingency principles are in place for all portions of the process. It was assumed that human error results in multiple failures, leading to an inadvertent nuclear criticality. With these engineered and administrative controls, the estimated frequency of this accident is in the range of 1×10^{-4} to 1×10^{-6} per year (“extremely unlikely”). A bounding source term resulting from 1×10^{19} fissions was assumed.

Spills. Spills of radioactive and/or chemical materials could be initiated by failure of process equipment and/or human error, natural phenomena, or external events. Radioactive and chemical material spills typically involve laboratory room quantities of materials that are relatively small compared to releases caused by fires and explosions. Laboratory room spills could affect members of the public, but represent a more serious risk to the laboratory room workers. Larger spills involving vault-size quantities are also possible.

The surplus plutonium disposition operations at PF-4 would use the Advanced Recovery and Integrated Extraction System (ARIES) facilities within PF-4. Accidents identified in the safety documents include spills of oxide, with a MAR of 4,500 grams (159 ounces) of weapons-grade plutonium, in the ARIES canning module, the ARIES Nondestructive Assay Area, or the ARIES Integrated Packaging System. For these spills, an ARF of 0.002 and an RF of 0.3 were estimated, which would result in a release of 2.7 grams (0.0952 ounces) to the building. Such a spill would not threaten the integrity of the building confinement system or the HEPA filters, so an LPF of 0.005 was estimated to be consistent with other surplus plutonium disposition facility analyses. LANL safety documents conservatively assume an LPF 10 times higher to account for the potential for open doors during evacuation of the building.

A spill of molten metal within the ARIES metal oxidation glovebox was also postulated. For this accident, a MAR of 4,500 grams (159 ounces), an ARF of 0.01, and an RF of 1.0 were estimated, which would result in a release of 45 grams (1.59 ounces) to the building. This spill would not threaten the integrity of the building confinement system or the HEPA filters, so an LPF of 0.005 was estimated to be consistent with other surplus plutonium disposition facility analyses. LANL safety documents conservatively assume an LPF 10 times higher to account for the potential for open doors during evacuation of the building.

Fire. Fires that occur in the facility could lead to the release of radioactive materials with potential impacts on workers and the public. Initiating events may include internal process and human error events; natural phenomena, such as an earthquake; or external events, such as an airplane crash into the facility. Combustibles near an ignition source could be ignited in a laboratory room containing the largest amounts of radioactive material. The fire may be confined to the laboratory room, propagate uncontrolled and without suppression to adjacent laboratory areas, or lead to a facility-wide fire. A fire or deflagration in a HEPA filter could also occur due to an exothermic reaction involving reactive salts and other materials. External fires (i.e., wildfires) were also considered. Though unlikely, a wildfire could directly affect the facility, in which case the scenario would be similar to fires initiated by the other means discussed above. A wildfire could also affect the infrastructure in the vicinity of LANL. Wildfires are discussed in more detail below.

The bounding glovebox fire identified in the safety documents (LANL 2012a) that would directly involve surplus plutonium disposition operations is a glovebox fire in the pyrochemical metal preparation area. For this accident, a MAR of 9,000 grams (317 ounces) of plutonium salt was assumed. For the fire with plutonium in a salt form, an ARF of 0.0005 and an RF of 0.5 were estimated, which would result in a release of 2.25 grams (0.0794 ounces) to the building. This accident would not threaten the integrity of the building confinement system or the HEPA filters, so an LPF of 0.005 was estimated to be consistent with other surplus plutonium disposition facility analyses. LANL safety documents conservatively assume an LPF 10 times higher to account for the potential for open doors during evacuation of the building.

The bounding fire for the facility identified in the safety documents (LANL 2012a) is a large fire within the TA-55 vault. For this accident, a MAR of 1,500 kilograms (3,310 pounds) of plutonium oxide was assumed. Because this material is in containers, a reasonable bounding DR of 0.1 was assumed. For the fire with plutonium oxide, an ARF of 0.0005 and an RF of 0.5 were estimated, which would result in a release of 37.5 grams (1.32 ounces) to the building. This accident might threaten the integrity of the building confinement system or the HEPA filters, so an LPF of 0.05 was estimated to be consistent with LANL safety document bounding assumptions (LANL 2012a).

Explosion. Explosions that could occur in the facility could lead to the release of radioactive materials, with potential impacts on workers and the public. Initiating events may include internal process and human error events; natural phenomena, such as an earthquake; or external events, such as an explosive gas transportation accident. Explosions could both disperse nuclear material and initiate fires that could propagate throughout the facility. An explosion of methane gas followed by a fire in a laboratory area could potentially propagate to other laboratory areas and affect the entire facility.

The bounding explosion identified in the safety documents (LANL 2012a) is a hydrogen deflagration from dissolution of plutonium metal. For this accident, the MAR is 1,040 grams (36.7 ounces) of plutonium salt or oxide. For the deflagration with plutonium in a salt form, an ARF of 0.2 and an RF of 1.0 were estimated, which would result in a release of 208 grams (7.34 ounces) to the building. For the deflagration with plutonium in an oxide form, an ARF of 0.005 and an RF of 0.3 were estimated, which would result in a release of 1.56 grams (0.0550 ounces) to the building. This accident would not be expected to threaten the integrity of the building confinement system or the HEPA filters, so an LPF of 0.005 was estimated to be consistent with other surplus plutonium disposition facility analyses. LANL safety documents conservatively assume an LPF 10 times higher to account for the potential for open doors during evacuation of the building (LANL 2012a).

Natural Phenomena. The potential accidents associated with natural phenomena include wildfires, earthquakes, high winds, flooding, and similar naturally occurring events. For PF-4, a severe earthquake could lead to the release of radioactive materials and exposure of workers and the public, as well as cause the partial collapse of facility structures, falling debris, and failure of gloveboxes and nuclear materials storage facilities. An earthquake could also initiate a fire that propagates throughout the facility and results in an unfiltered release of radioactive material to the environment. In addition to the potential exposure of workers and the public to radioactive and chemical materials, an accident could cause human injuries and fatalities from the force of the event, such as falling debris during an earthquake or the thermal effects of a fire.

Design-basis Earthquake with Spill. The analysis of the impacts of a severe, design-basis earthquake have been upgraded in the current safety documents for PF-4 in an attempt to provide a realistic, yet conservative, estimate of the potential impacts. These analyses have established limits for the MAR within the facility that ensure that, in all design-basis events, including a seismically induced spill or fire, the impacts on the maximally exposed offsite individual would be well below the 25-rem safety requirement in the DOE Evaluation Guideline described in DOE Standard 3009. In conjunction with engineered controls, the MAR limit is protected by administrative controls and technical safety requirements. According to the current safety documents, the MAR limit for PF-4 is 2,600 kilograms

(5,730 pounds) of plutonium-239 equivalent. All of this material was assumed to be at risk during the seismic event, and a DR of 1.0 is usually assumed in the LANL safety documents for this material. This is quite conservative in that spillage outside of the confinement of a glovebox is not expected in a design-basis earthquake.

Other material is also stored in robust containers, shipping containers, and vaults and is expected to survive extreme conditions, including the design-basis seismic event and likely a beyond-design-basis earthquake. Only a very small fraction of this excluded material would be at risk in beyond-design-basis events and is not expected to make a substantial contribution to the overall dose. Therefore, this material is not considered to be at risk and was excluded from the calculations.

The current safety documents evaluate an illustrative mix of quantities and forms of plutonium that would be typical of operations within PF-4. Because of the range of materials within the building, including plutonium-238-based heat source material, the quantities of MAR are expressed in terms of plutonium-239 dose equivalent.

Under the proposed expansion of surplus plutonium disposition operations (35 metric tons [38.6 tons]), the mix of MAR is expected to change to accommodate the new activities. The 2,600-kilogram (5,730-pound) limit of plutonium-239 dose equivalent material would not change. The mix of MAR would still have to be able to meet the 25-rem safety requirement in the DOE Evaluation Guideline described in DOE Standard 3009. Accordingly, some of the material now on the floor and in gloveboxes may have to be moved to robust storage to accommodate the expanded surplus plutonium disposition glovebox activities.

The MAR associated with the surplus plutonium disposition mission includes bulk plutonium dioxide powder, bulk metal, molten metal in casting furnaces, and tritium in getters (LANL 2012a). It was assumed that the typical or illustrative mix of MAR in other forms of plutonium within the building would remain as indicated in the safety documents and the overall building MAR would remain at 2,600 kilograms (5,730 pounds). Other ongoing work within the facility, including heat source material, would continue with typical or illustrative forms and quantities provided in the current safety documents.

Thus, for the design-basis earthquake with a spill, all of the surplus plutonium in various forms was assumed to be at risk. For purposes of this *SPD Supplemental EIS*, and to be more consistent with the analysis of other surplus plutonium disposition facilities with similar types of operations, a DR of 0.25 was assumed for these analyses. This is still judged to be quite conservative because spills outside of glovebox confinement are not expected.

Standard bounding ARFs and respirable fractions for spills are applied to each material type. The LANL safety documents indicate that the predicted LPF for the design-basis spill could vary depending on location within the building, but a general LPF of 0.05 was found to be a bounding, 95th percentile value. More realistically, the building confinement system would still work, including fans and HEPA filters, and the LPF would be less (LANL 2012a). A bounding source term equivalent to 10.2 grams (0.36 ounces) of plutonium-239 was estimated for the lower throughput case at PF-4 and 22.3 grams (0.79 ounces) of plutonium-239 for the higher throughput case (see Appendix B, Table-3B (LANL 2012b)).

Design-basis earthquake with spill plus fire. The safety analyses for PF-4 also address the potential impacts of a design-basis earthquake that spills MAR, followed by a fire. The spill-only scenario is evaluated above. The fire scenario includes the initiation of a fire as an additional source of energy contributing to the potential release of nuclear material from the facility. Although a seismic event is not expected to start a fire because of the very low combustible loading in the facility, the potential for a fire is considered a credible scenario given that ignition sources are present as part of normal operations. Therefore, the impact of seismically induced fires was evaluated, along with a purely mechanical release

caused by a seismic event. For purposes of determining the impacts of this bounding seismic event, the spill is assumed to occur first and contribute to the fire scenario source term.

The MAR due to surplus plutonium disposition operations and other ongoing activities is similar to the spill scenario, with the same amounts and types of MAR and DRs. The ARFs and RFs would differ for the fire event. The LANL safety documents indicate that the predicted LPF for the design-basis spill could vary depending on location within the building, but a general LPF of 0.18 was found to be a bounding, 95th percentile value for a widespread fire. More realistically, the building confinement system would still likely work, including fans and HEPA filters, and the LPF would be less (LANL 2012a). A bounding source term for the fire contribution to the design-basis earthquake was estimated to be equivalent to 18.9 grams (0.667 ounces) of plutonium-239 for the lower throughput case and 53.7 grams (1.89 ounces) of plutonium-239 for the higher throughput case (LANL 2012b).

A bounding source term for the design earthquake spill and subsequent fire was estimated to be equivalent to 29.0 grams (1.0 ounces) of plutonium-239 for the lower throughput case and 75.9 grams (2.68 ounces) of plutonium-239 for the higher throughput case (LANL 2012b).

The frequency of the accident was estimated to be on the order of 1 in 10,000 years, based on the fact that this facility is undergoing seismic retrofits to ensure that it meets current seismic standards and would perform its structural and safety confinement functions adequately in the LANL design-basis earthquake (estimated peak horizontal and vertical ground accelerations of 0.47 g and 0.51 g,⁶ respectively, with a return interval of about 2,500 years).

Beyond-design-basis earthquake with spill and fire. This accident scenario postulates an earthquake of greater intensity than the LANL design-basis earthquake that causes internal enclosures to topple and become damaged by falling debris. Combustibles in the facility are ignited and the fire engulfs or heats the radioactive MAR.

With this beyond-design-basis event, the MAR is expected to be similar to that estimated for the design-basis events. Material not listed as being at risk would be in robust containers and is expected to survive the seismic motion, falling debris, and localized fires. Thus, the MAR assumed for the design-basis seismic event would still be valid.

The DR for this beyond-design-basis seismic event was assumed to be 1.0. The ARFs and RFs would be similar to those estimated for the seismic spill and fire

It is expected that, in an event this severe, building confinement would fail and pathways would exist for the material that becomes airborne to be released directly to the environment. Consistent with the general assumptions for beyond-design-basis accident LPFs presented in Section D.1.5.1 for significantly upgraded facilities, an LPF of 0.1 was assumed for plutonium and 1 for tritium.

A bounding source term for the beyond-design-basis spill plus fire accident scenario was estimated to be equivalent to 123 grams (4.33 ounces) of plutonium-239 for the lower throughput case and 297 grams (10.5 ounces) of plutonium-239 for the higher throughput case (LANL 2012b). The frequency of an earthquake that results in wide-scale damage and loss of confinement for the building (on the order of once in 100,000 years), coupled with a widespread seismically initiated fire, was estimated to be in the range of 1×10^{-5} to 1×10^{-7} per year or lower (“extremely unlikely to beyond extremely unlikely”).

Wildfires. The potential impacts of wildfires on LANL were evaluated in Appendix D of the 2008 LANL SWEIS (DOE 2008b). Wildfires are a reasonably expected event in the region; in the LANL SWEIS, the annual frequency of occurrence was estimated to be 0.05 (once every 20 years). The evaluation included in the LANL SWEIS identified the facilities most at risk of radiological release in the event of a wildfire and did not include any buildings in TA-55. Wildfires such as the Las Conchas fire of June 2011 and

⁶ g = acceleration relative to free fall.

Cerro Grande fire of May 2000 are not expected to threaten these facilities because the shells of these facilities are constructed of noncombustible materials and a buffer area free of combustible materials is maintained around them. In recognition of the hazards of wildfire, forests are thinned as part of an ongoing wildfire mitigation program at LANL. The purpose of the thinning is to reduce the fuel load available in the event of a fire.

A wildfire in the LANL region could indirectly affect operations at LANL by interrupting electrical services and limiting access to roadways. In the event of a wildfire, the LANL emergency operations center would be activated and, as with the Las Conchas fire, if determined to be necessary, LANL and the townsite would be preemptively evacuated. If a regional wildfire disrupted the power provided to PF-4, emergency backup power would be provided locally to maintain the most important systems. Emergency backup power would be provided to PF-4 by the TA-3 power plant. Emergency backup generators dedicated to PF-4 would provide power to that facility. Plutonium materials stored within LANL plutonium facilities or in ongoing operations are generally stable in their configuration and would not require active cooling systems to keep them stable. Therefore, maintenance of power is not necessary to prevent significant releases to the environment.

Volcanism. A preliminary evaluation of volcanic hazards at LANL was reported in the *Preliminary Volcanic Hazards Evaluation for Los Alamos National Laboratory Facilities and Operations* (Keating et al. 2010). Based on an evaluation of information on the volcanic history of the region surrounding LANL, the report described the potential volcanic hazards to LANL from future eruptions in the region. The preliminary calculation of the recurrence rate for silicic eruptions is about 1×10^{-5} per year in the Valles caldera study region. Similarly, the preliminary calculation of the recurrence rate for basaltic eruptions along the Rio Grande rift is 2×10^{-5} per year. These recurrence rates were calculated by dividing the number of eruptive events by the active eruption period. The estimates of past recurrences rate are not the same as the probability of future eruptions that might affect a given facility. Although it cannot be ruled out, volcanism in the vicinity of TA-55 within the lifetime of the PF-4 operations is unlikely (Keating 2011).

DOE Standard: Natural Phenomena Hazards Site Characterization Criteria (DOE-STD-1022-94) identifies the potential hazards associated with volcanoes, including lava flows, ballistic projections, ash falls, pyroclastic flows and debris avalanches, mud flows and flooding, seismic activity, ground deformation, tsunamis, atmospheric effects, and acid rains and gases (DOE 2002c). The primary hazard to PF-4 from a silicic eruption would likely be fallout of volcanic ash and pumice from a silicic volcanic eruption plume. Based on the areal distribution of the deposits from past eruptions, the high terrain of the caldera rim to the west of LANL is expected to limit the eastward extent of lava flows and pyroclastic flows. Hazards from ballistic projections, ground deformation, and volcanic gases are also expected to be limited to a similar area within the topographic rim of the Valles caldera to the west of LANL. In the absence of local bodies of surface water, tsunamis are not expected to pose a hazard to TA-55. Atmospheric effects (volcanogenic thunderstorms with lightning) and acid rains may affect facilities at TA-55, but are not expected to result in acute effects on operations and materials within the confines of PF-4.

Ash fall may produce roof loading; loadings associated with ash fall may be sufficient to exceed design load limits for the TA-55 facilities. In that event, structural failure could occur. In such case, vaults and interior rooms should remain relatively intact. A related hazard would be secondary mobilization of ash fall by rain, forming mudflows. This possible hazard would be naturally mitigated by the relatively low slopes at TA-55 and the presence of deep canyons that would channel flows from the Jemez Mountains west of Los Alamos.

Lava flows may engulf or bury surface infrastructure and buildings. Basaltic lava flows may extend several kilometers from a vent and be up to several meters thick, with a temperature of 1,652 to 2,192 degrees Fahrenheit (900 to 1,200 degrees Celsius). Explosions and surges may damage surface and subsurface facilities within several hundred meters of a vent. Because ash falls have the potential to affect large areas, the probability of volcanism producing an eruptive vent, explosions and surges, or lava flows near the area of TA-55 likely would be lower than the probability of ash fall affecting TA-55.

Based on the expected similarities between the facility impacts of a seismically induced spill and fire event and the volcanic ash fall event, it is expected that the seismically induced event would result in consequences and risks similar to or greater than those for the volcanic ash fall event. The PF-4 seismic scenarios conservatively assumed that the following mechanisms would be available for release: powder spills such as those associated with the seismically initiated building collapse; localized fire-induced pressurized releases of powder from storage containers; and localized fires such as those associated with the facility-wide fire scenario. Localized fire-induced pressurized releases of powder from a limited number of storage containers were assumed to occur. Typical temperatures of ash falls, as indicated by the Pinatubo and Mount St. Helens eruptions are relatively cool (less than 86 degrees Fahrenheit [30 degrees Celsius]) (Keating 2011) and should not significantly impact the probability of fires associated with structural failures.

Because the release associated with structural failure resulting from ash fall loads is driven by the same physical phenomena, the MAR and the release mechanisms should be similar to those for the analyzed seismic events. Thus, conservative DRs and respirable release fractions applied to the material released as a result of impact or thermal stress for seismic events are applicable to the volcanic ash fall event. The building LPF conservatively assumed for the seismic analysis is expected to be the same as or higher than the LPF associated with volcanic ash fall events because the ash would contribute to the tortuousness of the leak path.

The frequency of the earthquake that results in wide-scale damage and loss of confinement for the building (on the order of once in 100,000 years), coupled with a widespread seismically initiated fire, was conservatively assumed to be 0.00001 per year for risk calculation purposes. This is expected to be the same order of magnitude as the upper limit for the volcanic events described above.

Airplane crash. The potential release of radioactive materials from an unintentional airplane crash into a building was considered in the safety documents. In accordance with DOE Standard 3014, an aircraft impact analysis was performed for PF-4 (LANL 2012a). This analysis concluded that the largest aircraft that would exceed the DOE Standard 3014 evaluation guideline of 10^{-6} (1 chance in 1 million) per year for an aircraft crash into PF-4 would be a general aviation aircraft (LANL 2012a). The overall probability that an aircraft will crash into PF-4 in a given year was calculated to be 5.6×10^{-6} . Accident impacts from larger aircraft were not considered further in this *SPD Supplemental EIS*. The impacts of a general aviation aircraft crash into PF-4 were evaluated and the facility structure and interior gloveboxes and containers are robust enough that only minor interior spills, but no substantial release from the building, are expected. This accident is bounded by other accidents addressed in this *SPD Supplemental EIS*.

Accident scenarios and source terms for pit disassembly and conversion capability in PF-4 are presented in **Table D-9**.

Table D-9 Accident Scenarios and Source Terms for the Los Alamos National Laboratory Plutonium Facility Pit Disassembly and Conversion Capability

<i>Accident</i>	<i>Frequency (per year)</i>	<i>MAR (grams)</i>	<i>DR</i>	<i>ARF</i>	<i>RF</i>	<i>LPF</i>	<i>Release (grams)</i>
Criticality	1×10^{-4} to 1×10^{-6} (extremely unlikely)	–	–	–	–	–	1×10^{19} fissions
Spill in ARIES	1×10^{-4} to 1×10^{-6} (extremely unlikely)	4,500	1	0.002	0.3	0.005	0.0135 Pu 0.028 PuE
Spill of molten metal in ARIES oxidation glovebox	1×10^{-4} to 1×10^{-6} (extremely unlikely)	4,500	1	0.01	1	0.005	0.225 Pu 0.47 PuE
Glovebox fire in the pyrochemical metal preparation	1×10^{-4} to 1×10^{-6} (extremely unlikely)	9,000	1	0.0005	0.5	0.005	0.0113 Pu 0.024 PuE
Fire in TA-55 vault	1×10^{-5} to 1×10^{-7} (extremely unlikely to beyond extremely unlikely)	1.5×10^6	0.1	0.0005	0.5	0.05	1.88 Pu 3.9 PuE
Hydrogen deflagration from dissolution of plutonium metal	1×10^{-5} to 1×10^{-7} (extremely unlikely to beyond extremely unlikely)	1,040 WG salt	1	0.2	1	0.005	1.04 Pu 2.2 PuE
		1,040 WG PuO ₂	1	0.005	0.3	0.005	0.0078 Pu 0.016 PuE
Design-basis earthquake with spill (spill contribution only)	1×10^{-4} to 1×10^{-6} (extremely unlikely)	Varies	0.25	Varies	Varies	0.05 Pu 1 tritium	10.2 PuE (2 MT case)
							22.3 PuE (35 MT case)
Design-basis earthquake with fire (fire contribution only)	1×10^{-4} to 1×10^{-6} (extremely unlikely)	Varies	0.25	Varies	Varies	0.18 Pu 1 tritium	18.9 PuE (2 MT case)
							53.7 PuE (35 MT case)
Design-basis earthquake with spill plus fire	1×10^{-4} to 1×10^{-6} (extremely unlikely)	Varies	0.25	Varies	Varies	Spill portion: 0.05 Fire portion: 0.18	29.0 PuE (2 MT case)
							75.9 PuE (35 MT case)
Beyond-design-basis earthquake with spill plus fire	1×10^{-5} to 1×10^{-6} (extremely unlikely)	Varies	1	Varies	Varies	0.1 Pu 1 tritium	123 PuE (2 MT case)
			1	Varies	Varies		297 PuE (35 MT case)

ARIES = Advanced Recovery and Integrated Extraction System; ARF = airborne release fraction; DR = damage ratio; LPF = leak path factor; MAR = material at risk; MT = metric tons; Pu = plutonium; PuE = plutonium-239 dose equivalent; PuO₂ = plutonium dioxide; RF = respirable fraction; TA = technical area; WG = weapons-grade.

Note: To convert grams to ounces, multiply by 0.035274.

Source: LANL 2012a, 2012b.

D.2 Radiological Impacts of Facility Accidents

D.2.1 K-Area Storage/K-Area Interim Surveillance Capability Accident Impacts

Table D–10 summarizes the impacts related to various accident scenarios for K-Area Storage and the KIS capability based on the source terms from Table D–1. Because only limited materials would be present at KIS, and there are few sources of energy, the likelihood of a major accident is very remote. Most incidents would not involve much energy, and any spill would be confined to the glovebox, with no radiological impact. For the bounding accidents identified in the *KIS DSA Addendum* (WSRC 2006b), radiological impacts on workers in the immediate facility of the incident and on those exposed to released material could be relatively high. The radiological impacts from beyond-design-basis earthquakes on involved and noninvolved workers could be high as well, but these seismic events would be of sufficient magnitude that the workers also would be at substantial risk of injury or death due to falling structural materials.

D.2.2 Pit Disassembly and Conversion Facility at F-Area Accident Impacts

The potential source terms and consequences of postulated bounding facility accidents for PDCF are presented in **Table D–11**. These scenarios and source terms were identified in Table D–2 and are based on accident scenarios and source terms summarized for purposes of this *SPD Supplemental EIS* in the *PDC NEPA Source Document* (DOE/NNSA 2012). For several scenarios, the accident sequences and source terms developed in the safety analyses did not take credit for designated safety controls that are expected to continue functioning during and after design-basis accidents. For these bounding accidents, the source terms developed may not be credible, and these accident frequencies are considered “extremely unlikely to beyond extremely unlikely.”

D.2.3 Pit Disassembly and Conversion Project at K-Area Accident Impacts

The potential source terms and consequences of postulated bounding facility accidents for PDC are presented in **Table D–12**. These scenarios and source terms were identified in Table D–3 and are based on accident scenarios summarized for purposes of this *SPD Supplemental EIS* in the *PDC NEPA Source Document* (DOE/NNSA 2012). For several scenarios, the accident sequences and source terms developed in the safety analyses did not take credit for designated safety controls that are expected to continue functioning during and after design-basis accidents. For these bounding accidents, the source terms developed may not be credible, and these accident frequencies are considered “extremely unlikely to beyond extremely unlikely.”

D.2.4 Pit Disassembly Capability at K-Area Accident Impacts

The potential source terms and consequences of postulated bounding facility accidents for pit disassembly are presented in **Table D–13**. These scenarios and source terms were identified in Table D–4 and are based on accident scenarios summarized for purposes of this *SPD Supplemental EIS* in the *PDC NEPA Source Document* (DOE/NNSA 2012). For several scenarios, the accident sequences and source terms developed in the safety analyses did not take credit for designated safety controls that are expected to continue functioning during and after design-basis accidents. For these bounding accidents, the source terms developed may not be credible, and these accident frequencies are considered “extremely unlikely to beyond extremely unlikely.”

D.2.5 Immobilization Capability at K-Area Accident Impacts

The potential source terms and consequences of postulated bounding facility accidents for the K-Area immobilization capability that were identified in Table D–5 are presented in **Table D–14**. For this facility, all of the plutonium involved is assumed to be non-pit plutonium. This material is assumed to have an americium-241 content of 6.25 percent. The relative inhalation hazard of this material is 6.47 times higher than that of plutonium-239 and about 3.1 times more hazardous than weapons-grade plutonium. If the accidents involved pit plutonium instead of non-pit plutonium, the plutonium-239-dose-equivalent MAR, doses, and risks would be about a factor of 3.1 lower than those reported in Table D–14.

Table D-10 Accident Impacts for the K-Area Storage/K-Area Interim Surveillance

Accident	Source Term ^a (grams)	Frequency (per year)	Impacts on Noninvolved Worker		Impacts on an MEI at the Site Boundary ^b		Impacts on Population within 50 Miles	
			Dose (rem)	Probability of an LCF ^c	Dose (rem)	Probability of an LCF ^c	Dose (person-rem)	LCFs ^d
Criticality	--	Not credible	–	–	–	–	–	–
Fire in KIS vault with 3013 can rupture at 1,000 psig	5.7 PuE	Extremely unlikely to beyond extremely unlikely	4.5	3×10^{-3}	0.18	1×10^{-4}	52	0 (0.03)
Explosion (deflagration of 3013 can during puncturing; can assumed to be at 700 psig)	3.2 PuE	Extremely unlikely to beyond extremely unlikely	2.5	2×10^{-3}	0.10	6×10^{-5}	29	0 (0.2)
Design-basis earthquake-vibration release	0.20 PuE	Unlikely	0.16	9×10^{-5}	0.0063	4×10^{-6}	1.8	0 (0.001)
Beyond-design-basis fire (unmitigated transuranic waste drum fire)	1.3 PuE	Beyond extremely unlikely	1.4	9×10^{-4}	0.042	3×10^{-5}	12	0 (0.007)
Beyond-design-basis earthquake with fire (bounded by unmitigated pressurized 3013 can due to an external fire and vault release [1,000 psig])	280 PuE	Beyond extremely unlikely	310	0.4	9.1	5×10^{-3}	2,500	2

KIS = K-Area Interim Surveillance; LCF = latent cancer fatality; MEI = maximally exposed individual; PuE = plutonium-239 dose equivalent; psig = pounds per square inch gauge.

^a Calculated using the source terms in Table D-1.

^b A site boundary distance of 5.5 miles was used.

^c For hypothetical individual doses equal to or greater than 20 rem, the probability of a latent cancer fatality was doubled; doses equal to or greater than 600 rem are assumed to result in a near-term fatality.

^d Numbers of LCFs in the population are whole numbers; the statistically calculated values are provided in parentheses for when the reported result is 1 or less.

Note: To convert grams to ounces, multiply by 0.035274; miles to kilometers by 1.6093.

Source: WSMS 2006; WSRC 2006b, 2011.

Table D–11 Accident Impacts for the Pit Disassembly and Conversion Facility at F-Area

<i>Accident</i>	<i>Source Term^a (grams)</i>	<i>Frequency (per year)</i>	<i>Impacts on Noninvolved Worker</i>		<i>Impacts on an MEI at the Site Boundary^b</i>		<i>Impacts on Population within 50 Miles</i>	
			<i>Dose (rem)</i>	<i>Probability of an LCF</i>	<i>Dose (rem)</i>	<i>Probability of an LCF</i>	<i>Dose (person- rem)</i>	<i>LCFs^c</i>
Criticality	1×10^{19} fissions	Extremely unlikely	0.073	4×10^{-5}	0.0051	3×10^{-6}	1.5	0 (0.0009)
Product NDA room fire	3.4 PuE	Extremely unlikely	0.77	5×10^{-4}	0.088	5×10^{-5}	40	0 (0.02)
Multi-room fire	15 PuE	Extremely unlikely	3.4	2×10^{-3}	0.039	2×10^{-4}	180	0 (0.1)
Direct metal oxidation glovebox fire	2.4 PuE	Extremely unlikely	0.54	3×10^{-4}	0.062	4×10^{-5}	28	0 (0.02)
Overpressurization of oxide storage cans	20 PuE	Extremely unlikely	4.5	3×10^{-3}	0.52	3×10^{-4}	240	0 (0.1)
Design-basis earthquake with fire (limited)	7.7 PuE	Extremely unlikely to beyond extremely unlikely	1.7	1×10^{-3}	0.20	1×10^{-4}	91	0 (0.05)
Beyond-design-basis earthquake with fire	650 PuE	Extremely unlikely to beyond extremely unlikely	720	0.9	19	1×10^{-2}	7,900	5

LCF = latent cancer fatality; NDA = nondestructive assay; MEI = maximally exposed individual; PuE = plutonium-239 dose equivalent.

^a Calculated using the source terms in Table D–2.

^b A site boundary distance of 5.85 miles was used.

^c Numbers of LCFs in the population are whole numbers; the statistically calculated values are provided in parentheses for when the reported result is 1 or less.

Note: To convert grams to ounces, multiply by 0.035274; miles to kilometers, by 1.6093.

Source: DOE/NNSA 2012; SRNS 2012

Table D-12 Accident Impacts for the Pit Disassembly and Conversion Project at K-Area

<i>Accident</i>	<i>Source Term^a (grams)</i>	<i>Frequency (per year)</i>	<i>Impacts on Noninvolved Worker</i>		<i>Impacts on an MEI at the Site Boundary^b</i>		<i>Impacts on Population within 50 Miles</i>	
			<i>Dose (rem)</i>	<i>Probability of an LCF^c</i>	<i>Dose (rem)</i>	<i>Probability of an LCF</i>	<i>Dose (person-rem)</i>	<i>LCFs^d</i>
Criticality	1×10^{19} fissions	Extremely unlikely	0.065	4×10^{-5}	0.0055	3×10^{-6}	1	0 (0.0006)
Fire in direct metal oxidation glovebox	2.0 PuE	Extremely unlikely	0.38	2×10^{-4}	0.056	3×10^{-5}	18	0 (0.01)
Product NDA room fire with pit plutonium	2.1 PuE	Extremely unlikely	0.39	2×10^{-4}	0.058	4×10^{-5}	19	0 (0.01)
Multi-room fire	5.3 PuE	Extremely unlikely	1.0	6×10^{-4}	0.15	9×10^{-5}	47	0 (0.03)
Overpressurization of oxide storage cans	12 PuE	Extremely unlikely	2.3	1×10^{-3}	0.33	2×10^{-4}	110	0 (0.06)
Design-basis earthquake with fire	6.5 PuE	Extremely unlikely	1.2	7×10^{-4}	0.18	1×10^{-4}	58	0 (0.03)
Beyond-design-basis earthquake with fire	690 PuE	Extremely unlikely to beyond extremely unlikely	770	0.9	22	3×10^{-2}	6,300	4

LCF = latent cancer fatality; MEI = maximally exposed individual; NDA = nondestructive assay; PuE = plutonium-239 dose equivalent.

^a Calculated using the source terms in Table D-3. All design-basis releases would be through a new HEPA filter and stack, assumed to be 150 feet high.

^b A site boundary distance of 5.5 miles was used.

^c For hypothetical individual doses equal to or greater than 20 rem, the probability of a latent cancer fatality was doubled.

^d Numbers of LCFs in the population are whole numbers; the statistically calculated values are provided in parentheses for when the reported result is 1 or less.

Note: To convert grams to ounces, multiply by 0.035274; miles to kilometers, by 1.0693.

Table D–13 Accident Impacts for the Pit Disassembly Capability in K-Area

<i>Accident</i>	<i>Source Term^a (grams)</i>	<i>Frequency (per year)</i>	<i>Impacts on Noninvolved Worker</i>		<i>Impacts on an MEI at the Site Boundary^b</i>		<i>Impacts on Population within 50 Miles</i>	
			<i>Dose (rem)</i>	<i>Probability of an LCF</i>	<i>Dose (rem)</i>	<i>Probability of an LCF</i>	<i>Dose (person-rem)</i>	<i>LCFs^c</i>
Criticality	1×10^{19} fissions	Extremely unlikely	0.18	1×10^{-4}	0.0066	4×10^{-6}	1.1	0 (6×10^{-4})
Multi-room fire	0.0052 PuE	Extremely unlikely	0.0041	2×10^{-6}	0.00016	1×10^{-7}	0.047	0 (3×10^{-5})
Design-basis earthquake with fire (limited)	0.011 PuE	Extremely unlikely	0.0087	5×10^{-6}	0.00035	2×10^{-7}	0.010	0 (6×10^{-5})
Beyond-design-basis earthquake with fire	0.88 PuE	Extremely unlikely to beyond extremely unlikely	0.98	6×10^{-4}	0.029	2×10^{-5}	8.0	0 (5×10^{-3})

LCF = latent cancer fatality; MEI = maximally exposed individual; PuE = plutonium-239 dose equivalent.

^a Calculated by using the source terms in Table D–4.

^b A site boundary distance of 5.5 miles was used.

^c Numbers of LCFs in the population are whole numbers; the statistically calculated values are provided in parentheses for when the reported result is 1 or less.

Note: To convert grams to ounces, multiply by 0.035274; miles to kilometers, by 1.6093.

Source: DOE/NNSA 2012.

Table D-14 Accident Impacts for the Can-in-Can Immobilization Capability at K-Area

<i>Accident</i>	<i>Source Term^a (grams)</i>	<i>Frequency (per year)</i>	<i>Impacts on Noninvolved Worker</i>		<i>Impacts on an MEI at the Site Boundary^b</i>		<i>Impacts on Population within 50 Miles</i>	
			<i>Dose (rem)</i>	<i>Probability of an LCF^c</i>	<i>Dose (rem)</i>	<i>Probability of an LCF</i>	<i>Dose (person-rem)</i>	<i>LCFs^d</i>
Criticality	1×10^{19} fissions	Extremely unlikely	0.1	6×10^{-5}	0.0061	4×10^{-6}	1.1	0 (6×10^{-4})
Explosion in direct metal oxidation furnace	70 PuE	Extremely unlikely to beyond extremely unlikely	27	3×10^{-2}	2.1	1×10^{-3}	630	0 (4×10^{-1})
Glovebox fire (direct metal oxidation furnace)	0.00084 PuE	Extremely unlikely	0.00033	2×10^{-7}	0.000025	2×10^{-8}	0.0076	0 (5×10^{-6})
Melter eruption	0.018 PuE	Unlikely	0.0070	4×10^{-6}	0.00054	3×10^{-7}	0.16	0 (1×10^{-4})
Melter spill	0.011 PuE	Unlikely	0.0043	3×10^{-6}	0.00033	2×10^{-7}	0.099	0 (6×10^{-5})
Design-basis earthquake	1.1 PuE	Unlikely	0.43	3×10^{-4}	0.033	2×10^{-5}	9.9	0 (6×10^{-3})
Beyond-design-basis earthquake	11 PuE	Extremely unlikely to beyond extremely unlikely	12	7×10^{-3}	0.36	2×10^{-4}	100	0 (6×10^{-2})

LCF = latent cancer fatality; MEI = maximally exposed individual; PuE = plutonium-239 dose equivalent.

^a Calculated using the source terms in Table D-5. Materials at risk are assumed to be non-pit plutonium. If accidents involved pit plutonium, the plutonium-239-dose-equivalent materials at risk, doses, and risks would be about a factor of 3.1 lower.

^b A site boundary distance of 5.5 miles was used.

^c For hypothetical individual doses equal to or greater than 20 rem, the probability of a latent cancer fatality was doubled.

^d Numbers of LCFs in the population are whole numbers; the statistically calculated values are provided in parentheses for when the reported result is 1 or less.

Note: To convert grams to ounces, multiply by 0.035274; miles to kilometers, by 1.6093.

Source: DOE 1999; WSRC 2007a, 2007b.

D.2.6 Mixed Oxide Fuel Fabrication Facility Accident Impacts

The potential source terms and consequences of postulated bounding facility accidents at MFFF are presented in **Table D–15**. These scenarios and source terms were identified in Table D–6 and are based on accident scenarios and source terms developed for the *SPD EIS* (DOE 1999) and the *MFFF EIS* (NRC 2005) for the MFFF and the *PDC NEPA Source Document* (DOE/NNSA 2012) for the optional metal oxidation process. If a metal oxidation process were added to the MFFF, the incremental and total impacts are also listed.

D.2.7 Waste Solidification Building Accident Impacts

The potential source terms and consequences of postulated bounding facility accidents for each facility option are presented in **Table D–16**. These scenarios and source terms for WSB were identified in Table D–7 and are based on accident scenarios and source terms developed for the *WSB DSA* (WSRC 2008b). For several scenarios, the accident sequences and source terms developed in the *WSB DSA* did not take credit for designated safety controls that are expected to continue functioning during and after design-basis accidents. For these bounding accidents, the source terms developed may not be credible, and the accident frequencies for scenarios with source terms of the magnitude indicated are likely “extremely unlikely to beyond extremely unlikely” even though the table may indicate that the frequency of some of the accidents may be “unlikely.”

D.2.8 H-Canyon/HB-Line Accident Impacts

The potential source terms and consequences for the postulated bounding facility accidents identified in Table D–8 for H-Canyon and HB-Line are presented in **Table D–17**. These scenarios and source terms were developed for surplus plutonium processing activities only and do not reflect other H-Canyon and HB-Line activities, including plutonium-238 and legacy contamination activities.

The H-Canyon safety documents (SRNS 2011a) evaluated a seismic event that results in damage to H-Canyon containment followed by fires that occur in the Hot Crane Maintenance Area, Truck Well, and Railroad Tunnel. This event was evaluated with both building confinement and the sand filters functioning as expected and with the hypothetical unmitigated case and a LPF of 1. For the postulated design basis seismic event with fires, the MEI dose at the site boundary was estimated to be 0.36 rem, a much larger value than that found for H-Canyon-related surplus plutonium procession activities. For the unmitigated case, with a hypothetical LPF of 1, the MEI dose was found to be 12 rem. A beyond-design-basis seismic event followed by multiple fires was postulated to involve more material at risk, but was not evaluated in detail. If a more realistic LPF of 0.25 were assumed, the MEI doses for non-SPD activities would be similar to those for H-Canyon and HB-Line activities.

At HB-Line, the postulated surplus plutonium disposition activities MAR is similar to the administrative limits in place for activities on the fifth and sixth levels that would support the proposed processing. Legacy equipment and process cabinets on the third and fourth levels contain some plutonium-238 contamination, but the safety documents (SRNS 2011b) indicate that even widespread fires on those levels with an unmitigated release would result in small offsite doses compared to the postulated process operations. Thus, the projected impacts to the public from a beyond-design-basis earthquake that causes failure of building confinement for H-Canyon and HB-Line are dominated by the postulated MAR associated with processing activities in HB-Line.

D.2.9 Los Alamos National Laboratory Plutonium Facility Accident Impacts

The potential source terms and consequences for the postulated bounding facility accidents identified in Table D–9 for PF-4 are presented in **Table D–18**. These scenarios and source terms were developed for surplus plutonium processing activities in addition to ongoing activities.

Table D-15 Accident Impacts for the Mixed Oxide Fuel Fabrication Facility Including the Metal Oxidation Capability

Accident	Source Term ^a (grams)	Frequency (per year)	Impacts on Noninvolved Worker		Impacts on an MEI at the Site Boundary ^b		Impacts on Population within 50 Miles	
			Dose (rem)	Probability of an LCF ^c	Dose (rem)	Probability of an LCF	Dose (person-rem)	LCFs ^d
Criticality	1×10^{19} fissions	Extremely unlikely	2.2×10^{-2}	1×10^{-4}	9.4×10^{-3}	6×10^{-6}	1.6	$0 (9 \times 10^{-4})$
Explosion in sintering furnace	0.0012 PuE	Extremely unlikely	1.1×10^{-3}	7×10^{-7}	5.1×10^{-5}	3×10^{-8}	0.014	$0 (9 \times 10^{-6})$
Ion exchange exothermic reaction	0.000050 PuE	Unlikely	4.8×10^{-5}	3×10^{-8}	2.1×10^{-6}	1×10^{-9}	0.00060	$0 (4 \times 10^{-7})$
Fire	8.3×10^{-6} PuE	Unlikely	7.9×10^{-6}	5×10^{-9}	3.5×10^{-7}	2×10^{-10}	0.00010	$0 (6 \times 10^{-8})$
Spill	1.0×10^{-5} PuE	Extremely unlikely	9.8×10^{-6}	6×10^{-9}	4.2×10^{-7}	3×10^{-10}	0.00012	$0 (7 \times 10^{-8})$
<u>Metal oxidation capability only</u> : Fire in direct metal oxidation glovebox causing pressurized release of oxide from cans and equipment ^e	0.0056 PuE	Extremely unlikely	5.4×10^{-3}	3×10^{-6}	2.4×10^{-4}	1×10^{-7}	0.067	$0 (4 \times 10^{-5})$
Design-basis earthquake	0.00017 PuE	Unlikely	1.6×10^{-4}	1×10^{-7}	7.2×10^{-6}	4×10^{-9}	0.0020	$0 (1 \times 10^{-6})$
Beyond-design-basis fire	0.13 PuE	Beyond extremely unlikely	1.4×10^{-1}	9×10^{-5}	5.6×10^{-3}	3×10^{-6}	1.6	$0 (9 \times 10^{-4})$
Beyond-design-basis earthquake induced fire – additional metal oxidation contribution	55 PuE	Beyond extremely unlikely	61	7×10^{-2}	2.4	1×10^{-3}	670	$0 (4 \times 10^{-1})$
Beyond-design-basis earthquake (MFFF only)	20 PuE	Extremely unlikely to beyond extremely unlikely	22	3×10^{-2}	0.86	5×10^{-4}	240	$0 (1 \times 10^{-1})$
Beyond-design-basis earthquake (MFFF plus metal oxidation in MFFF)	75 PuE	Extremely unlikely to beyond extremely unlikely	83	1×10^{-1}	3.2	2×10^{-3}	910	$1 (5 \times 10^{-1})$

DMO = direct metal oxide; LCF = latent cancer fatality; MEI = maximally exposed individual; MFFF = Mixed Oxide Fuel Fabrication Facility; PuE = plutonium-239 dose equivalent.

^a Calculated using the source terms in Table D-6.

^b A site boundary distance of 4.67 miles was used.

^c For hypothetical individual doses equal or greater than 20 rem, probability of a latent cancer fatality was doubled.

^d Numbers of LCFs in the population are whole numbers; the statistically calculated values are provided in parentheses for when the reported result is 1 or less.

^e Scenario parameters for the metal oxidation capability are from DOE/NNSA 2012.

Note: To convert grams to ounces, multiply by 0.035274; miles to kilometers, by 1.6093.

Source: DOE 1999, NRC 2005, DOE/NNSA 2012.

Table D–16 Accident Impacts for the Waste Solidification Building

<i>Accident</i>	<i>Source Term^a (grams americium-241 dose equivalent)</i>	<i>Frequency (per year)</i>	<i>Impacts on Noninvolved Worker</i>		<i>Impacts on an MEI at the Site Boundary^b</i>		<i>Impacts on Population within 50 Miles</i>	
			<i>Dose (rem)</i>	<i>Probability of an LCF^c</i>	<i>Dose (rem)</i>	<i>Probability of an LCF</i>	<i>Dose (person-rem)</i>	<i>LCFs^d</i>
Criticality	-	Not credible	-	-	-	-	-	-
High-activity waste process vessel hydrogen explosion	0.00014	Extremely unlikely	0.010	6×10^{-6}	0.00046	3×10^{-7}	0.13	0 (8×10^{-5})
High-Activity Waste Process Room fire	5.5×10^{-6}	Extremely unlikely	0.00042	3×10^{-7}	0.000019	1×10^{-8}	0.0053	0 (3×10^{-6})
Leak/spill	6×10^{-6}	Unlikely	0.00046	3×10^{-7}	0.00002	1×10^{-8}	0.0057	0 (3×10^{-6})
Design-basis earthquake	0.00014	Unlikely	0.010	6×10^{-6}	0.00046	3×10^{-7}	0.13	0 (8×10^{-5})
Aircraft crash	0.55	Beyond extremely unlikely	49	6×10^{-2}	1.9	1×10^{-1}	530	0 (3×10^{-1})
Beyond-design-basis red oil explosion	0.0042	Beyond extremely unlikely	0.32	2×10^{-4}	0.014	8×10^{-6}	4	0 (2×10^{-3})
Beyond-design-basis earthquake	0.18	Extremely unlikely to beyond extremely unlikely	16	1×10^{-2}	0.62	4×10^{-4}	180	0 (1×10^{-1})

LCF = latent cancer fatality; MEI = maximally exposed individual.

^a Calculated using the source terms and scenarios in Table D–7.

^b A site boundary distance of 4.67 miles was used.

^c For hypothetical individual doses equal or greater than 20 rem, probability of a latent cancer fatality was doubled.

^d Numbers of LCFs in the population are whole numbers; the statistically calculated values are provided in parentheses for when the reported result is 1 or less.

Note: To convert grams to ounces, multiply by 0.035274; miles to kilometers, by 1.6093.

Source: WSRC 2008b.

Table D-17 Accident Impacts for H-Canyon/HB-Line

<i>Accident^a</i>	<i>Source Term^b (grams)</i>	<i>Frequency (per year)</i>	<i>Impacts on Noninvolved Worker</i>		<i>Impacts on an MEI at the Site Boundary^c</i>		<i>Impacts on Population within 50 Miles</i>	
			<i>Dose (rem)</i>	<i>Probability of an LCF^d</i>	<i>Dose (rem)</i>	<i>Probability of an LCF^d</i>	<i>Dose (person-rem)</i>	<i>LCFs^e</i>
Criticality	1.0×10^{19} fissions	Extremely unlikely	0.034	2×10^{-5}	0.0028	2×10^{-6}	1.3	0 (0.0008)
Hydrogen explosion in H-Canyon dissolver	0.29 PuE	Extremely unlikely	0.017	1×10^{-5}	0.0046	3×10^{-6}	3.1	0 (0.002)
Fire (level-wide in HB-Line)	26 PuE	Extremely unlikely	1.6	9×10^{-4}	0.41	2×10^{-4}	280	0 (0.2)
Leak/spill of nuclear material (H-Canyon)	1.0 PuE	Unlikely	0.060	4×10^{-5}	0.016	9×10^{-6}	11	0 (0.006)
Design-basis earthquake with fire (H-Canyon)	0.071 PuE	Unlikely	0.0042	3×10^{-6}	0.0011	7×10^{-7}	0.76	0 (0.0005)
Design-basis earthquake with fire (HB-Line)	26 PuE	Extremely unlikely	1.6	9×10^{-4}	0.41	2×10^{-4}	280	0 (0.2)
Beyond-design-basis earthquake with fire	1,300 PuE (ground level)	Extremely unlikely to beyond extremely unlikely	1,400	1	26	2×10^{-2}	15,000	9

LCF = latent cancer fatality; MEI = maximally exposed individual; PuE = plutonium-239 dose equivalent.

^a These scenarios and source terms were developed for surplus plutonium processing activities only and do not reflect other H-Canyon and HB-Line activities, including plutonium-238 and legacy contamination activities. The projected doses from these other activities are similar to or smaller than those indicated above.

^b Calculated using the scenarios and source terms in Table D-8. These scenarios and source terms were developed for surplus plutonium processing activities only and do not reflect other H-Canyon and HB-Line activities, including plutonium-238 and legacy contamination activities.

^c A site boundary distance of 7.3 miles was used.

^d For hypothetical individual doses equal to or greater than 20 rem, the probability of a latent cancer fatality was doubled; doses equal to or greater than 600 rem are assumed to result in a near-term fatality.

^e Numbers of LCFs in the population are whole numbers; the statistically calculated values are provided in parentheses for when the reported result is 1 or less.

Note: To convert grams to ounces, multiply by 0.035274; miles to kilometers, by 1.6093.

Source: SRNS 2011a, 2011b, SRNS 2012.

Table D–18 Accident Impacts for PF-4 Pit Disassembly and Conversion

Accident	Source Term ^a (grams)	Frequency (per year)	Impacts on Noninvolved Worker		Impacts on an MEI at the Site Boundary ^b		Impacts on Population within 50 Miles	
			Dose (rem)	Probability of an LCF ^c	Dose (rem)	Probability of an LCF ^c	Dose (person-rem)	LCFs ^d
Criticality	1×10^{19} fissions	Extremely unlikely	0.33	0.0002	0.017	1×10^{-5}	3.5	0 (0.002)
Spill in ARIES	0.028 PuE	Extremely unlikely	0.048	0.00003	0.0014	9×10^{-7}	0.31	0 (0.0002)
Spill of molten metal in ARIES oxidation glovebox	0.47 PuE	Extremely unlikely	0.80	0.0005	0.024	1×10^{-5}	5.5	0 (0.003)
Glovebox fire in the pyrochemical metal preparation	0.024 PuE	Extremely unlikely	0.041	0.00002	0.0012	7×10^{-7}	0.28	0 (0.0002)
Fire in TA-55 vault (elevated release due to heat from the fire)	3.9 PuE	Extremely unlikely to beyond extremely unlikely	0.25	0.0002	0.046	3×10^{-5}	34	0 (0.02)
Hydrogen deflagration from dissolution of plutonium metal	2.2 PuE	extremely unlikely to beyond extremely unlikely	3.7	0.002	0.11	7×10^{-5}	26	0 (0.02)
Design-basis earthquake with spill (spill contribution only) ^e	10.2 PuE (2 MT case)	extremely unlikely	17	0.01	0.51	3×10^{-4}	120	0 (0.07)
	22.3 PuE (35 MT case)		38	0.05	1.1	7×10^{-4}	260	0 (0.2)
Design-basis earthquake with fire (fire contribution only) ^e	18.9 PuE (2 MT case)	extremely unlikely	32	0.04	0.95	6×10^{-4}	220	0 (0.1)
	53.7 PuE (35 MT case)		91	0.1	2.7	2×10^{-3}	630	0 (0.4)
Design-basis earthquake with spill plus fire ^e	29.0 PuE (2 MT case)	extremely unlikely	49	0.06	1.5	9×10^{-4}	340	0 (0.2)
	75.9 PuE (35 MT case)		130	0.2	3.8	2×10^{-3}	900	1 (0.5)
Beyond-design-basis earthquake with spill plus fire ^e	123 PuE (2 MT case)	Extremely unlikely to beyond extremely unlikely	210	0.3	6.2	4×10^{-3}	1,500	1 (0.9)
	297 PuE (35 MT case)		500	0.6	15	9×10^{-3}	3,500	2

ARIES = Advanced Recovery and Integrated Extraction System; LCF = latent cancer fatality; MEI = maximally exposed individual; MT = metric ton; PuE = plutonium-239 dose equivalent; TA-55 = Technical Area 55.

^a Calculated using the source terms in Table D–9.

^b A site boundary distance of 0.75 miles was used.

^c For hypothetical individual doses equal to or greater than 20 rem, the probability of a latent cancer fatality was doubled.

^d Numbers of LCFs in the population are whole numbers; the statistically calculated values are provided in parentheses for when the reported result is 1 or less.

^e Earthquake impacts assume a 10-minute puff release. For an 8-hour release, MEI doses would be 43 percent lower, non-involved worker doses would be 43 percent lower, and population doses would be 2 percent lower due to additional wind dispersion.

Note: To convert grams to ounces, multiply by 0.035274; metric tons to tons, by 1.1023; miles to kilometers, by 1.6093.

Source: LANL 2012a, 2012b.

D.2.9.1 Potential Land Contamination Following Severe Earthquakes

Seismic events that result in failure of building containment of plutonium facilities have the potential to release substantial quantities of plutonium, leading to concerns regarding surface contamination in the immediate vicinity of the facility. Even for severe earthquakes that could lead to major damage within the facility and building structure and failure of confinement systems, there should not be large energy sources to drive the materials that would typically be used in PF-4 out of the damaged building and rubble. Seismic collapse scenarios that result primarily in spills could release plutonium materials through the rubble, but that material generally would not travel far from the building site. Seismic collapse scenarios that involve large fires have the potential to loft materials such that transport of radioactive materials downwind might result in land contamination at levels that could require monitoring or additional actions.

Land contaminated with TRU waste material at levels above some screening level would likely require additional monitoring and evaluations to determine whether cleanup were appropriate. Estimations of land areas that might be contaminated are highly dependent on specific accident source terms and meteorological modeling assumptions. This is because the amount of radioactive material that may accumulate on the ground is highly dependent on the size of the particles that get through the building rubble and are released to the environment (which determines how fast they settle back to the ground), the specific accident conditions (e.g., whether or not a fire occurs), and specific meteorological conditions during the earthquake. In general, unless there is a fire that can effectively loft the plutonium particles into the air, most of the particles would return to the ground within a few hundred meters of the building location.

Areas with contamination at levels above some screening level would potentially need further action, such as radiation surveys or cleanup. Costs associated with these efforts, as well as continued monitoring activities, could vary widely depending upon the characteristics of the contaminated area and could range in the hundreds of million dollars per square kilometer for land decontamination (NASA 2006). In addition to the potential direct costs of radiological surveys, potential cleanup, and monitoring following an accident, there are potential secondary societal costs associated with the mitigation from large-consequence accidents. Those costs could include, but may not be limited to, the following:

- Temporary or longer-term relocation of residents
- Temporary or longer-term loss of employment
- Destruction or quarantine of agricultural products
- Land use restrictions (which could affect real estate values, businesses, and recreational activities)
- Public health effects and medical care

D.2.9.2 Combined Impacts from TA-55 Building Collapses and Fires Resulting from a Beyond-Design-Basis Earthquake

If a very severe earthquake were to occur in the Los Alamos area, nearby individuals could receive impacts from several facilities that might be damaged. Individuals close to and downwind from TA-55 might receive exposure from releases at the existing PF-4, as well as from the proposed Modified Nuclear Facility Portion of the Chemistry and Metallurgy Research Building Replacement (Modified CMRR-NF), should it be built. The Modified CMRR-NF would be designed to withstand an earthquake with a peak horizontal ground acceleration of 0.47 g (with a return period of 2,500 years) with limited releases. PF-4 was originally designed to a lower seismic standard (a peak horizontal ground acceleration of about 0.33 g), but it is in the process of being upgraded to withstand higher seismic loadings. When all upgrades are complete, PF-4 is expected to be able to survive the current design-basis earthquake (0.47 g) with limited releases. Both the upgraded PF-4 and the Modified CMRR-NF would have multi-layered defenses to limit releases from storage containers, gloveboxes, equipment, vaults, and the building. The

release mechanisms for either the PF-4 or the Modified CMRR-NF would be similar, and the total amount of radioactive material that could be released would be roughly proportional to the amounts and forms of materials that might be at risk in either facility. As proposed, the Modified CMRR-NF would likely have much less MAR in a severe seismic event than the PF-4.

D.3 Chemical Accidents

D.3.1 Savannah River Site Chemical Accidents Impacts

The potential for accidents involving hazardous chemicals associated with the proposed surplus plutonium disposition operations to affect noninvolved workers or the public is quite limited. The potential for hazardous chemical impacts on noninvolved workers and the public has been evaluated for many of the facilities that might use larger quantities of hazardous chemicals (SRNS 2010; WGI 2005), and no substantial impacts were found for noninvolved workers or the public. For the proposed pit disassembly and conversion project, potential hazardous chemicals were screened to determine whether any of the proposed chemicals or amounts that might be used poses a threat to collocated workers 100 meters (328 feet) from a spill or to an offsite individual. All potential concentrations from spills were found to be below the applicable protective guidelines (DOE/NNSA 2012).

Existing SRS facilities were evaluated for hazardous chemical impacts. Controls, such as inventory controls, are in place to limit those impacts. For example, the F/H Area Laboratory SAR indicates that chemical inventories are low enough when compared to emergency response planning guidelines to classify the facility as a general use facility in accordance with SRS guidelines (SRNS 2010).

Inventories of hazardous chemicals are maintained for each facility. The inventories for most chemicals are small, and the chemical accident risks are primarily to workers directly handling the chemicals. DOE safety programs are in place to minimize the risks to workers from both routine operations and accidents involving these materials.

Regarding risks from handling toxic or hazardous chemicals, worker safety programs at SRS are enforced via required adherence to Federal and state laws; DOE Orders and regulations; Occupational Safety and Health Administration and U.S. Environmental Protection Agency (EPA) guidelines; and plans and procedures for performing work, including training, monitoring, use of personal protective equipment, and administrative controls. Although chemical inventories have varied to a limited extent in recent years, administrative controls continually ensure that quantities do not approach those levels that pose undue risk due to storage, concentration, bulk quantity, or logistical factors.

Because of SRS's remote location and large size, there is no risk of chemical exposure to the surrounding public population resulting from normal site operations or accidents. Nevertheless, monitoring efforts and baseline studies are regularly performed. However, certain workers at SRS are at risk of chemical exposure depending upon their job function and proximity to various sources.

D.3.2 Los Alamos National Laboratory Chemical Accidents Impacts

The research nature of PF-4 operations requires the use, handling, and storage of a large variety of chemicals, but in relatively small quantities (e.g., a few grams to a few hundred liters). As such, there is an extensive list of chemicals that may be present for programmatic purposes, with quantities of regulated chemicals far below the threshold quantities set by EPA (40 CFR 68.130). The hazards associated with these chemicals are well understood and, because of the small quantities, can be managed using standard hazardous material and/or chemical handling programs. They pose minimal potential hazards to public health and the environment in an accident condition. Prior to initiating a new activity, a probabilistic hazards analysis would be performed to ensure that no onsite inventory exceeds the screening criterion of DOE-STD-1189, Appendix B (DOE 2008a). Accidents involving small laboratory quantities of chemicals would primarily present a risk to the involved worker in the immediate vicinity of the accident. There are

limited quantities of bulk quantities of chemicals stored at PF-4, and no bulk quantities would be needed to support the surplus plutonium disposition activities.

D.4 Uncertainties

The purpose of the analysis in this appendix is to compare the potential impacts from accidents related to alternatives for disposition of surplus plutonium, including the pit disassembly and conversion options and plutonium disposition options that may be implemented at SRS or LANL. The analyses are based on studies, data, and models that introduce levels of uncertainty into the analyses. The following paragraphs address recognized uncertainties in the analyses.

In the application of the MACCS2 v1.13.1 computer code, dose conversion factors from Federal Guidance Report 11 (EPA 1988) were used. A more recent version of dose conversion factors has been developed and is included in Federal Guidance Report 13 (EPA 1999). Using the updated dose conversion factors in Federal Guidance Report 13, the estimated doses from DOE facility accidents would increase for some key isotopes and decrease for other key isotopes. Overall, these differences are expected to be well within the much larger uncertainties associated with what might actually happen during an accident; for example, the amount of radioactive material that might actually escape a facility or the weather conditions at the time of the accident.

The analysis estimated the risk of a latent fatal cancer as a result of exposure to radiation by applying a constant factor of 0.0006 LCFs per rem or person-rem to all doses (except for individual doses of 20 rem are larger, the risk factor is doubled). This linear no-threshold extrapolation is the standard method for determining the health consequences of an accident, but may produce a misperception that these LCFs would actually occur. In reality, many of the individuals in the affected population could receive such a small dose of radiation that they would not suffer any health effects from the radiation. As discussed in Appendix C, Section C.3, a number of radiation health scientists and organizations have expressed reservations that the currently used cancer risk conversion factors, which are based on epidemiological studies of high doses (doses exceeding 5 to 10 rem), may not apply at low doses. In addition, because the affected population would receive increased health monitoring in the event of the accidents considered in this *SPD Supplemental EIS*, early detection of cancers may result in a lower number of cancer fatalities in the affected population than in a similar, unmonitored population. Nevertheless, the accident human health risk analysis in this appendix uses the linear no-threshold dose risk assumption.

D.5 References

Christenbury, G., 2011, U.S. Department of Energy, Savannah River Site, Aiken, South Carolina, personal communication (email) to V. Kay, U.S. Department of Energy, Savannah River Site, Aiken, South Carolina, “SASSI Info,” June 7.

DCS (Duke Cogema Stone & Webster), 2002, *Mixed Oxide Fuel Fabrication Facility Environmental Report Revision 1&2*, Docket Number 070-03098, Charlotte, North Carolina, July 11.

DNFSB (Defense Nuclear Facilities Safety Board), 2009, *Recommendation 2009-2 to the Secretary of Energy, Los Alamos National Laboratory Plutonium Facility Seismic Safety, October 26*.

DOE (U.S. Department of Energy), 1994, *Airborne Release Fractions/Rates and Respirable Fractions for Nonreactor Nuclear Facilities*, DOE-HDBK-3010-94, Washington, DC, December.

DOE (U.S. Department of Energy), 1996, *Storage and Disposition of Weapons-Usable Fissile Materials Final Programmatic Environmental Impact Statement*, DOE/EIS-0229, Office of Fissile Materials Disposition, Washington, DC, December.

DOE (U.S. Department of Energy), 1999, *Surplus Plutonium Disposition Final Environmental Impact Statement*, DOE/EIS-0283, Office of Fissile Materials Disposition, Washington, DC, November.

DOE (U.S. Department of Energy), 2002a, *Natural Phenomena Hazards Design and Evaluation Criteria for Department of Energy Facilities*, DOE-STD-1020-2002, Washington, DC, January.

DOE (U.S. Department of Energy), 2002b, *Supplement Analysis for Storage of Surplus Plutonium Materials in the K-Area Material Storage Facility at the Savannah River Site*, DOE/EIS-0229-SA-2, Washington, DC, February.

DOE (U.S. Department of Energy), 2002c, *DOE Standard: Natural Phenomena Hazards Site Characterization Criteria*, DOE-STD-1022-94, Reaffirmed with Errata, Washington, DC, April.

DOE (U.S. Department of Energy), 2003, *Estimating Radiation Risk from Total Effective Dose Equivalent (TEDE), ISCORS Technical Report No. 1*, DOE/EH-412/0015/0802, Rev. 1, Office of Environmental Policy and Guidance, January.

DOE (U.S. Department of Energy), 2004a, *MACCS2 Computer Code Application Guidance for Documented Safety Analysis*, DOE-EH-4.2.1.4-MACCS2-Code Guidance, Office of Environment, Safety and Health, Washington, DC, June.

DOE (U.S. Department of Energy), 2004b, *Recommendations for the Preparation of Environmental Assessments and Environmental Impact Statements*, Second Edition, Office of Environment, Safety and Health, Office of NEPA Policy and Compliance, Washington, DC, December.

DOE (U.S. Department of Energy), 2005a, *Environmental Assessment for the Safeguards and Security Upgrades for Storage of Plutonium Materials at the Savannah River Site*, DOE/EA-1538, Savannah River Operations Office, Aiken, South Carolina, December.

DOE (U.S. Department of Energy), 2005b, *Facility Safety*, DOE Order 420.1B, Office of Environment, Safety and Health, Washington, DC, December 22.

DOE (U.S. Department of Energy), 2006a, *Preparation Guide for U.S. Department of Energy Nonreactor Nuclear Facility Documented Safety Analyses*, DOE-STD-3009-2006, Change Notice 3, Washington, DC, March.

DOE (U.S. Department of Energy), 2006b, *Accident Analysis for Aircraft Crash Into Hazardous Facilities*, DOE-STD-3014-2006, Washington, DC, May.

DOE (U.S. Department of Energy), 2007, *Supplement Analysis, Storage of Surplus Plutonium Materials at the Savannah River Site*, DOE/EIS-0229-SA-4, Office of Environmental Management, Washington, DC, September 5.

DOE (U.S. Department of Energy), 2008a, *Integration of Safety into the Design Process*, DOE-STD-1189-2008, Washington, DC, March.

DOE (U.S. Department of Energy), 2008b, *Final Site-Wide Environmental Impact Statement for Continued Operation of Los Alamos National Laboratory, Los Alamos, New Mexico*, DOE/EIS-0380, National Nuclear Security Administration, Los Alamos Site Office, Los Alamos, New Mexico, May.

DOE (U.S. Department of Energy), 2011a, *Final Supplemental Environmental Impact Statement for the Nuclear Facility Portion of the Chemistry and Metallurgy Research Building Replacement Project at Los Alamos National Laboratory, Los Alamos, New Mexico*, DOE/EIS-0350-S1, National Nuclear Security Administration, Los Alamos Site Office, Los Alamos, New Mexico, August.

DOE (U.S. Department of Energy), 2011b, Letter from J.J. McConnell, Assistant Deputy Administrator for Nuclear Safety, Nuclear Operations, and Governance Reform, Office of Defense Programs, National Nuclear Security Administration, U.S. Department of Energy to P. S. Winokur, Chairman, Defense Nuclear Facilities Safety Board, "Deliverable 5.2.3 of the Implementation Plan for Recommendation 2009-2," November 15.

DOE (U.S. Department of Energy), 2012a, *Stabilization, Packaging, and Storage of Plutonium-Bearing Materials*, DOE-STD-3013-2012, Washington, DC, March.

DOE (U.S. Department of Energy), 2012b, Letter from J. J. McConnell, Assistant Deputy Administrator for Nuclear Safety, Nuclear Operations, and Governance Reform, Office of Defense Programs, National Nuclear Security Administration, U.S. Department of Energy to P. S. Winokur, Chairman, Defense Nuclear Facilities Safety Board, "Deliverable 5.4.4 of the Implementation Plan for Recommendation 2009-2," March 20.

DOE/NNSA (U.S. Department of Energy/National Nuclear Security Administration), 2012, *NEPA Source Document for Pit Disassembly and Conversion (PDC) Project*, SRB-25.02-10-0014, Rev. 0, Office of Defense Nuclear Nonproliferation, Denver, Colorado.

EPA (U.S. Environmental Protection Agency), 1988, *Limiting Values of Radionuclide Intake And Air Concentration and Dose Conversion Factors For Inhalation, Submersion, And Ingestion*, Federal Guidance Report No. 11, EPA 520/1-88-020, Office of Radiation Programs, Washington, DC, September.

EPA (U.S. Environmental Protection Agency), 1999, *Cancer Risk Coefficients for Environmental Exposure to Radionuclides*, Federal Guidance Report No. 13, EPA 402-R-99-001, Office of Radiation and Indoor Air, Washington, DC, September.

ICRP (International Commission on Radiological Protection), 1991, "1990 Recommendations of the International Commission on Radiological Protection," ICRP Publication 60, *Annals of the ICRP*, Pergamon Press, Elmsford, New York.

Keating, G. N., E. S. Schultz-Fellenz, and E. A. Miller, 2010, *Preliminary Volcanic Hazards Evaluation for Los Alamos National Laboratory Facilities and Operations, Current State of Knowledge and Proposed Path Forward*, LA-14426, Los Alamos National Laboratory, Los Alamos, New Mexico.

Keating, G., 2011, Los Alamos National Laboratory, Los Alamos, New Mexico, personal communication (email) to E. W. English, Los Alamos National Laboratory, Los Alamos, New Mexico, “Re: Draft Final CMRR-NF SEIS for Review,” July 20.

LANL (Los Alamos National Laboratory), 2012a, *Final Report, Data Call to Support the Surplus Plutonium Disposition Supplemental Environmental Impact Statement*, LA-UR-12-00634, Los Alamos, New Mexico, February.

LANL (Los Alamos National Laboratory), 2012b, *Surplus Plutonium Disposition Supplemental Environmental Impact Statement*, Data Call Materials.

McConnell, J. J., National Nuclear Security Administration, Office of Defense Programs, Washington, DC, 2011, personal communication (letter) to the P. S. Winokur, Defense Nuclear Facilities Safety Board, Washington, DC, “Status of Plutonium Facility Seismic Safety and Basis Analyses – Recommendation 2009-2,” June 28.

NASA (National Aeronautics and Space Administration), 2006, *Final Environmental Impact Statement for the Mars Science Laboratory Mission*, Washington, DC, November.

NCRP (National Council on Radiation Protection and Measurements), 1993, *Risk Estimates for Radiation Protection*, NCRP Report No. 115, Bethesda, Maryland, December 31.

NRC (U.S. Nuclear Regulatory Commission), 1990, *MELCOR Accident Consequence Code System (MACCS)*, NUREG/CR-4691 Vol. 3, Division of Systems Research, Office of Nuclear Regulatory Research, Washington, DC, February.

NRC (U.S. Nuclear Regulatory Commission), 1998, *Code Manual for MACCS2: Volume 1, User’s Guide*, NUREG/CR-6613, Division of systems Research, Office of Nuclear Regulatory Research, Washington, DC, May.

NRC (U.S. Nuclear Regulatory Commission), 2005, *Environmental Impact Statement on the Construction and Operation of a Proposed Mixed Oxide Fuel Fabrication Facility at the Savannah River Site, South Carolina*, NUREG-1767, Office of Nuclear Material Safety and Safeguards, Washington, DC, January.

SRNS (Savannah River Nuclear Solutions, LLC), 2010, *Central Laboratory Facility – Buildings 772-F, 772-1F, and 772-4F, Safety Analysis Report*, WSRC-SA-96-26, Rev. 10, Aiken, South Carolina, August.

SRNS (Savannah River Nuclear Solutions, LLC), 2011a, Savannah River Site, H-Canyon & Outside Facilities, H-Area, Documented Safety Analysis, S-DSA-H-0001, Rev. 3., Aiken, South Carolina, July. UNCLASSIFIED CONTROLLED NUCLEAR INFORMATION

SRNS (Savannah River Nuclear Solutions, LLC), 2011b, Savannah River Site, HB-Line, Documented Safety Analysis, U-DSA-H-0001, Aiken, South Carolina, September. UNCLASSIFIED CONTROLLED NUCLEAR INFORMATION

SRNS (Savannah River Nuclear Solutions, LLC), 2012, *Surplus Plutonium Disposition Supplemental Environmental Impact Statement Data Call Response*, Aiken, South Carolina.

WGI (Washington Group International), 2005, *Pit Disassembly and Conversion Facility Emergency Preparedness Hazards Assessment*, S-EHA-F-00005, Rev. C, Denver, Colorado, January 26.

Winokur, P. S., Defense Nuclear Facilities Safety Board, Washington, DC, 2011, personal communication (letter) to D. B. Poneman, U.S. Department of Energy, Washington, DC, "SASSI Technical and Software Quality Assurance Issues," April 8.

WSMS (Washington Safety Management Solutions, LLC), 2006, *The Consequences of Releases from Postulated Accidents in the 105-K Slug Vault (U)*, S-CLC-K-00208, Rev. 0, Aiken, South Carolina, May 16.

WSRC (Washington Savannah River Company), 2006a, *Savannah River Site, HB-Line, Safety Analysis Report*, WSRC-SA-2001-00009, Rev. 5, Aiken, South Carolina, August. UNCLASSIFIED CONTROLLED NUCLEAR INFORMATION

WSRC (Washington Savannah River Company), 2006b, *K-Area Interim Surveillance, K-Area Material Storage Facility, Documented Safety Analysis Addendum, Addendum 1 to the WSRC-SA-2002-00005*, Rev. 1, CN 5, Aiken, South Carolina, December. UNCLASSIFIED CONTROLLED NUCLEAR INFORMATION

WSRC (Washington Savannah River Company), 2007a, *Plutonium Vitrification Facility Consolidated Hazard Analysis (U)*, WSRC-TR-2007-00068, Rev. 0, Aiken, South Carolina, March.

WSRC (Washington Savannah River Company), 2007b, *K-Area Complex Plutonium Vitrification (Pu-Vit) Nuclear Criticality Safety Design Guidance Document*, WSRC-TR-2007-00025, Rev. 0, Aiken, South Carolina, March.

WSRC (Washington Savannah River Company), 2007c, *Conceptual Safety Design Report for Plutonium Vitrification Project in K-Area*, WSRC-RP-2007-00242, Rev. 0, Aiken, South Carolina, April. UNCLASSIFIED CONTROLLED NUCLEAR INFORMATION

WSRC (Washington Savannah River Company), 2007d, *Safety Analysis Report, Savannah River Site H-Canyon & Outside Facilities, H-Area*, WSRC-SA-2001-00008, Rev. 12, Aiken, South Carolina, June.

WSRC (Washington Savannah River Company), 2007e, *Accident Analysis for the 3013 Container Surveillance and Storage Capability Project (U)*, S-CLC-K-00237, Rev. A, Aiken, South Carolina, August.

WSRC (Washington Savannah River Company), 2007f, *K-Area Complex, 3013 Container Surveillance and Storage Capability, Preliminary Safety Design Report*, WSRC-SA-2007-00006, Rev. A (DRAFT), Aiken, South Carolina, September. UNCLASSIFIED CONTROLLED NUCLEAR INFORMATION

WSRC (Washington Savannah River Company), 2007g, *3013 Container Surveillance and Storage Capability Project - K-Area, Hazards Analysis (U)*, WSRC-TR-2005-00392, Rev. E, Aiken, South Carolina, September.

WSRC (Washington Savannah River Company), 2008a, "Surplus Plutonium Disposition Supplemental Environmental Impact Statement" Data Call Response, Aiken, South Carolina.

WSRC (Washington Savannah River Company), 2008b, *Waste Solidification Building Preliminary Documented Safety Analysis*, WSRC-SA-2003-00002, Rev. 0 HQD, May.

WSRC (Washington Savannah River Company), 2010, *Savannah River Site, HB-Line, Safety Analysis Report*, WSRC-SA-2001-00009, Rev. 8, Aiken, South Carolina, May. UNCLASSIFIED CONTROLLED NUCLEAR INFORMATION

WSRC (Washington Savannah River Company), 2011, *K-Area Complex Documented Safety Analysis*, WSRC-SA-2002-00005, Rev. 7, Aiken, South Carolina, September. UNCLASSIFIED CONTROLLED NUCLEAR INFORMATION

APPENDIX E
EVALUATION OF HUMAN HEALTH EFFECTS FROM
TRANSPORTATION

APPENDIX E

EVALUATION OF HUMAN HEALTH EFFECTS FROM TRANSPORTATION

E.1 Introduction

Transportation of any commodity involves a risk to both transportation crew members and members of the public. This risk results directly from transportation-related accidents and indirectly from increased levels of pollution from vehicle emissions, regardless of the cargo. The transport of certain materials, such as hazardous or radioactive waste, can pose an additional risk due to the unique nature of the material itself. To permit a complete appraisal of the environmental impacts of the alternatives, the human health risks associated with the transportation of radioactive materials and wastes, as well as nonradioactive hazardous waste, on public highways were assessed.

This appendix provides an overview of the approach used to assess the human health risks that could result from transportation. The topics in this appendix include the scope of the assessment, packaging and determination of potential transportation routes, the analytical methods used for the risk assessment (e.g., computer models), and important assessment assumptions. In addition, to aid in understanding and interpreting the results, specific areas of uncertainty are described with an emphasis on how those uncertainties may affect comparisons of the alternatives.

The risk assessment results are presented in this appendix in terms of “per-shipment” risk factors, as well as the total risks for a given alternative. Per-shipment risk factors provide an estimate of the risk from a single shipment. The total risks for a given alternative are estimated by multiplying the expected number of shipments by the appropriate per-shipment risk factors.

E.2 Scope of Assessment

The scope of the transportation human health risk assessment, including the alternatives and options, transportation activities, potential radiological and nonradiological impacts, transportation modes, and receptors, is described in this section. This evaluation focuses on using offsite public highways. Additional details of the assessment are provided in the remaining sections of this appendix.

E.2.1 Transportation-related Activities

The transportation risk assessment is limited to estimating the human health risks related to transportation for each alternative. This includes incident-free risks related to being in the vicinity of a shipment during transport or at stops, as well as accident risks. The impacts of increased transportation levels on local traffic flow or infrastructure are addressed in Chapter 4, Section 4.1.3, Socioeconomics, of this *Surplus Plutonium Disposition Supplemental Environmental Impact Statement (SPD Supplemental EIS)*.

E.2.2 Radiological Impacts

For each alternative, radiological risks (i.e., those risks that result from the radioactive nature of the materials) are assessed for both incident-free (normal) and accident transportation conditions. The radiological risk associated with incident-free transportation conditions would result from the potential exposure of people to external radiation in the vicinity of a shipment. The radiological risk from transportation accidents would come from the potential release and dispersal of radioactive material into

the environment during an accident and the subsequent exposure of people, or from an accident where there is no release of radioactive material but there is external radiation exposure to the unbreached container.

All radiological impacts are calculated in terms of radiation dose and associated health effects in the exposed populations. The radiation dose calculated is the total effective dose equivalent (see Title 10 of the *Code of Federal Regulations* [CFR], Part 20 [10 CFR Part 20]), which is the sum of the effective dose equivalent from external radiation exposure and the 50-year committed effective dose equivalent from internal radiation exposure. Radiation doses are presented in units of roentgen equivalent man (rem) for individuals and person-rem for collective populations. The impacts are further expressed as health risks in terms of latent cancer fatalities (LCFs) in exposed populations using dose-to-risk conversion factors recommended by the Interagency Steering Committee on Radiation Standards guidance (DOE 2002c). A health risk conversion factor of 0.0006 LCFs per rem or person-rem of exposure is used for both the public and workers (DOE 2002c).

E.2.3 Nonradiological Impacts

In addition to radiological risks posed by transportation activities, vehicle-related risks are also assessed for nonradiological causes (i.e., causes related to the transport vehicles, not the radioactive cargo) for the same transportation routes. The nonradiological transportation risks, which would be incurred for similar shipments of any commodity, are assessed for accident conditions. The nonradiological accident risk refers to the potential occurrence of transportation accidents that result in fatalities unrelated to the radioactive nature of the cargo.

Nonradiological risks during incident-free transportation conditions could also be caused by potential exposure to increased vehicle exhaust emissions. As explained in Section E.5.2, these emission impacts, in terms of excess latent mortalities, were not considered.

E.2.4 Transportation Modes

All shipments of radioactive and nonradioactive waste and construction materials are assumed to take place by exclusive-use truck. In addition to the use of commercial shippers for transport of radioactive waste and certain types of radioactive materials, shipment of several types of radioactive materials are assumed to occur using the National Nuclear Security Administration's (NNSA's) Secure Transportation Asset (STA), which consists of truck transport only (no rail transport is analyzed because rail is not part of the NNSA's STA used to transport radioactive materials, and the radioactive wastes to be generated would not be transported in large enough quantities to justify rail). For purposes of analysis, onsite and offsite shipments involving transport of special nuclear material,¹ such as plutonium, are assumed to occur using STAs.² Transport of unirradiated mixed oxide (MOX) fuel is the responsibility of the U.S. Department of Energy (DOE) and would occur using STAs. Note that the analysis in this *SPD Supplemental EIS* does not address the transport of used (irradiated) MOX fuel.

An STA may use a specially designed component of a tractor-trailer vehicle that is used by the Office of Secure Transportation of the DOE Albuquerque NNSA Service Center for the transport of special nuclear

¹ *Special nuclear material – as defined in Section 11 of the Atomic Energy Act: “(1) plutonium, uranium enriched in the isotope 233 or in the isotope 235, and any other material which the U.S. Nuclear Regulatory Commission determines to be special nuclear material, or (2) any material artificially enriched by any of the foregoing.”*

² *DOE's Office of Secure Transportation has determined that contractor-provided transportation configuration for mixed oxide fuel assemblies can be conducted under STA using escorted, commercial trucks. See Appendix I, Section I.1.2.5, regarding impacts associated with this transportation.*

materials, such as plutonium. Although details of vehicle enhancements and some operational aspects are classified, key characteristics are as follows (DOE 1999):

- Enhanced structural characteristics and a tie-down system to protect the cargo from impact
- Heightened thermal resistance to protect the cargo in case of fire
- Established operational and emergency plans and procedures governing the shipment of nuclear materials
- Federal agents who are armed Federal officers and have received vigorous specialized training
- An armored tractor component that provides Federal agent protection against attack and contains advanced communications equipment
- Specially designed escort vehicles containing advanced communications and additional Federal agents
- 24-hour-a-day, real-time communications to monitor the location and status of all STA shipments
- Significantly more stringent maintenance standards than those for commercial transport equipment

E.2.5 Receptors

Transportation-related risks are calculated and presented separately for workers and members of the general public. The workers considered are truck crew members involved in transportation and inspection of the packages. The general public includes all persons who could be exposed to a shipment while it is moving or stopped during transit. For incident-free operation, the affected population includes individuals living within 800 meters (0.5 miles) of each side of the road. Potential risks are estimated for the affected populations and the hypothetical maximally exposed individual (MEI). For incident-free operation, the MEI would be a resident living near the highway who is exposed to all shipments transported on the road. For accident conditions, the affected population includes individuals residing within 80 kilometers (50 miles) of the accident, and the MEI would be an individual located 100 meters (330 feet) directly downwind from the accident. The risk to the affected population is a measure of the radiological risk posed to society as a whole by the alternative being considered. As such, the impact on the affected population is used as the primary means of comparing various alternatives.

E.3 Packaging and Transportation Regulations

This section provides a high-level summary of packaging and transportation regulations. The CFR details regulations pertaining to the transportation of radioactive materials published by the U.S. Department of Transportation (DOT) (49 CFR Parts 106, 107, and 171–178) and U.S. Nuclear Regulatory Commission (NRC) (10 CFR Parts 20, 61, and 71). For the U.S. Postal Service, Publication 52, “Hazardous, Restricted, or Perishable Mail,” specifies the quantities of radioactive material prohibited in surface mail. Interested readers are encouraged to visit the cited resources for current specifics or to review DOT’s *Radioactive Material Regulations Review* (DOT 2008) for a comprehensive discussion on radioactive material regulations.

E.3.1 Packaging Regulations

The primary regulatory approach to promote safety from radiological exposure is the specification of standards for the packaging of radioactive materials. Packaging represents the primary barrier between the radioactive material being transported and radiation exposure to the public, workers, and the environment. Transportation packaging for radioactive materials must be designed, constructed, and maintained to contain and shield its contents during normal transport conditions. For highly radioactive material, such as high-level radioactive waste or used nuclear fuel, packaging must contain and shield the contents in the event of severe accident conditions. The type of packaging used is determined by the total radioactive hazard presented by the material within the packaging. Four basic types of packaging are used: Excepted, Industrial, Type A, and Type B. Specific requirements for these packages are detailed in 49 CFR 173.400. All packages are designed to protect and retain their content under normal operations.

Excepted packaging is limited to transporting materials with extremely low levels of radioactivity and very low external radiation. Industrial packaging is used to transport materials that, because of their low concentration of radioactive materials, present a limited hazard to the public and the environment. Type A packaging is designed to protect and retain its contents under normal transport conditions; because it is used to transport materials with higher radioactive content, it must maintain sufficient shielding to limit radiation exposure to handling personnel. Type A packaging, typically a 0.21-cubic-meter (55-gallon) drum or standard waste box, is commonly used to transport radioactive materials with higher concentrations or amounts of radioactivity than materials transported in Excepted or Industrial packages. Type B packaging is used to transport material with the highest radioactivity levels and is designed to protect and retain its contents under transportation accident conditions (described in more detail in the following sections). Packaging requirements are an important consideration for transportation risk assessment.

Radioactive materials shipped in Type A containers, or packagings, are subject to specific radioactivity limits identified as A1 and A2 values in 49 CFR 173.435 (“Table of A1 and A2 Values for Radionuclides”). In addition, external radiation limits, as prescribed in 49 CFR 173.441 (“Radiation Level Limitations”), must be met. If the A1 or A2 limits are exceeded, the material must be shipped in a Type B package unless it can be demonstrated that the material meets the definition of “low specific activity.” If the material qualifies as low specific activity as defined in 10 CFR Part 71 (“Packaging and Transportation of Radioactive Material”) and 49 CFR Part 173, it may be shipped in a shipping container such as Industrial or Type A Packaging (49 CFR 173.427); see also RAMREG-12-2008 (DOT 2008). Type B packages, or casks, are subject to the radiation limits in 49 CFR 173.441.

Type A packaging is designed to retain its radioactive contents in normal transport. Under normal conditions, a Type A package must withstand the following:

- Operating temperatures ranging from -40 degrees Celsius (°C) (-40 degrees Fahrenheit [°F]) to 70 °C (158 °F)
- External pressures ranging from 0.25 to 1.4 kilograms per square centimeter (3.5 to 20 pounds per square inch)
- Normal vibration experienced during transportation
- Simulated rainfall of 5 centimeters (2 inches) per hour for 1 hour
- Free fall from 0.3 to 1.2 meters (1 to 4 feet), depending on the package weight

- Water immersion-compression tests
- Impact of a 6-kilogram (13-pound) steel cylinder with rounded ends dropped from 1 meter (3.3 feet) onto the most vulnerable surface
- A compressive load of five times the mass of the gross weight of the package for 24 hours, or the equivalent of 13 kilopascals (1.9 pounds per square inch), multiplied by the vertically projected area of the package for 24 hours

Type B packagings are designed to retain their radioactive contents in both normal and accident conditions. In addition to the normal conditions outlined earlier, under accident conditions, a Type B package must withstand the following:

- Free drop from 9 meters (30 feet) onto an unyielding surface in a position most likely to cause damage
- Free drop from 1 meter (3.3 feet) onto the end of a 15-centimeter (6-inch) diameter vertical steel bar
- Exposure to temperatures of 800 °C (1,475 °F) for at least 30 minutes
- For all packages, immersion in at least 15 meters (50 feet) of water
- For some packages, immersion in at least 0.9 meters (3 feet) of water in an orientation most likely to result in leakage
- For some packages, immersion in at least 200 meters (660 feet) of water for 1 hour

Compliance with these requirements is demonstrated by using a combination of simple calculation methods, computer modeling techniques, or scale-model or full-scale testing of transportation packages or casks.

E.3.2 Transportation Regulations

The regulatory standards for packaging and transporting radioactive materials are designed to achieve the following four primary objectives:

- Protect persons and property from radiation emitted from packages during transportation by specific limitations on the allowable radiation levels
- Contain radioactive material in the package (achieved by packaging design requirements based on performance-oriented packaging integrity tests and environmental criteria)
- Prevent nuclear criticality (an unplanned nuclear chain reaction that could occur as a result of concentrating too much fissile material in one place)
- Provide physical protection against theft and sabotage during transit

DOT regulates the transportation of hazardous materials in interstate commerce by land, air, and water. DOT specifically regulates the carriers of radioactive materials and the conditions of transport, such as routing, handling and storage, and vehicle and driver requirements. DOT also regulates the labeling, classification, and marking of radioactive material packagings.

NRC regulates the packaging and transportation of radioactive material for its licensees, including commercial shippers of radioactive materials. In addition, under an agreement with DOT, NRC sets the standards for packages containing fissile materials and Type B packagings.

DOE, through its management directives, Orders, and contractual agreements, ensures the protection of public health and safety by imposing on its transportation activities standards equivalent to those of DOT and NRC. According to 49 CFR 173.7(d), packagings made by or under the direction of DOE may be used for transporting Class 7 materials (radioactive materials) when the packages are evaluated, approved, and certified by DOE against packaging standards equivalent to those specified in 10 CFR Part 71.

DOT also has requirements that help reduce transportation impacts. Some requirements affect drivers, packaging, labeling, marking, and placarding. Others specifying the maximum dose rate from radioactive material shipments help reduce incident-free transportation doses.

The Department of Homeland Security (DHS) is responsible for establishing policies for, and coordinating civil emergency management, planning, and interaction with, Federal Executive agencies that have emergency response functions in the event of a transportation incident. In the event a transportation incident involving nuclear material occurs, guidelines for response actions have been outlined in the National Response Framework (NRF) (DHS 2008a).

DHS would use the Federal Emergency Management Agency (FEMA), an organization within DHS, to coordinate Federal and state participation in developing emergency response plans and take responsibility for the development and the maintenance of the Nuclear/Radiological Incident Annex (NRIA) (DHS 2008b) to the NRF. NRIA/NRF describes the policies, situations, concepts of operations, and responsibilities of the Federal departments and agencies governing the immediate response and short-term recovery activities for incidents involving release of radioactive materials to address the consequences of the event.

DHS has the authority to activate Nuclear Incident Response Teams, which include DOE Radiological Assistance Program Teams that can be dispatched from regional DOE Offices in response to a radiological incident. These teams provide first-responder radiological assistance to protect the health and safety of the general public, responders, and the environment and to assist in the detection, identification and analysis, and response to events involving radiological/nuclear material. Deployed teams provide traditional field monitoring and assessment support, as well as a search capability.

E.4 Transportation Analysis Impact Methodology

The transportation risk assessment is based on the alternatives described in Chapter 2 of the *SPD Supplemental EIS*. **Figure E-1** summarizes the transportation risk assessment methodology. After the environmental impact statement (EIS) alternatives were identified and the requirements of the shipping campaign were understood, data was collected on material characteristics and accident parameters.

Transportation impacts calculated for the *SPD Supplemental EIS* are presented in two parts: impacts from incident-free or routine transportation and impacts from transportation accidents. Impacts of incident-free transportation and transportation accidents are further divided into nonradiological and radiological impacts. Nonradiological impacts could result from transportation accidents in terms of traffic fatalities. Radiological impacts of incident-free transportation include impacts on members of the public and crew from radiation emanating from materials in the shipment. Radiological impacts from accident conditions consider all foreseeable scenarios that could damage transportation packages, leading to releases of radioactive materials to the environment.

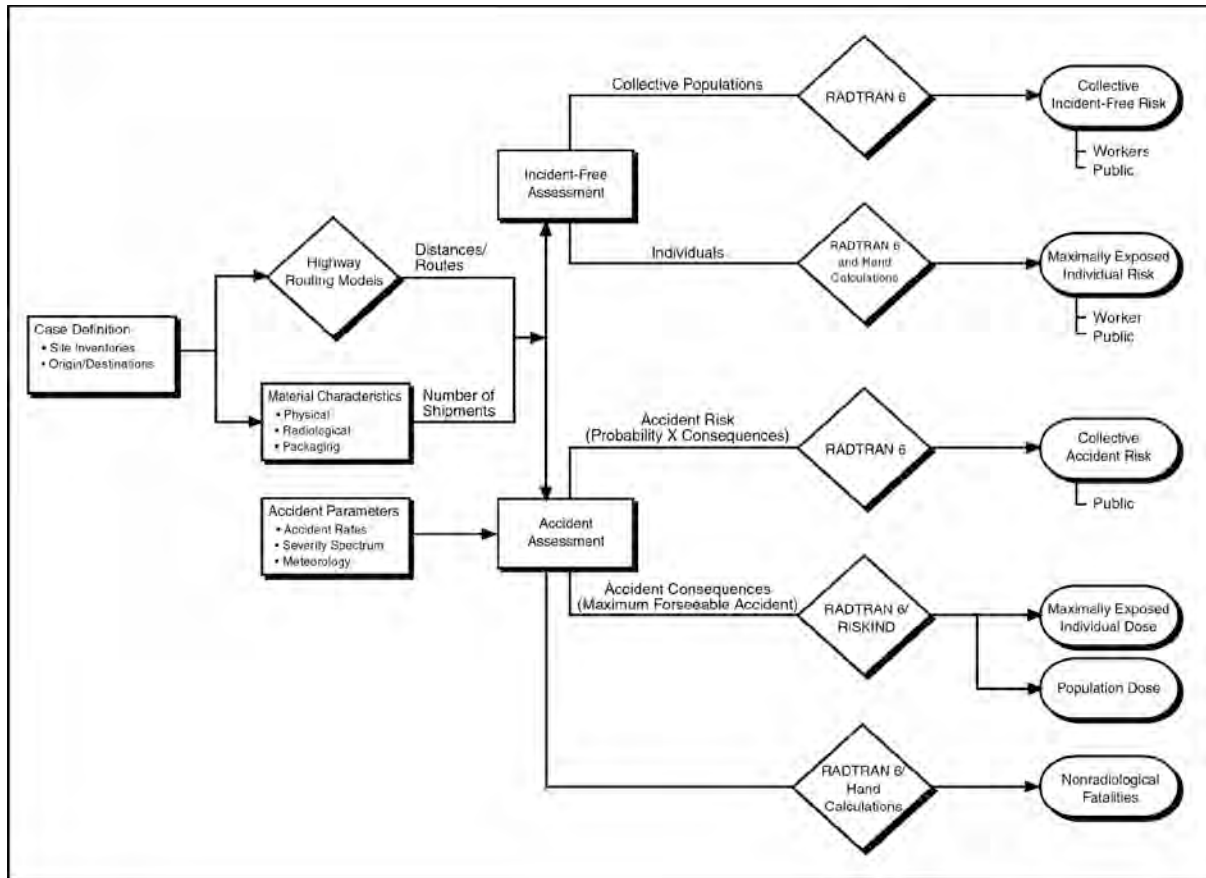

Figure E-1 Transportation Risk Assessment

The impact of transportation accidents is expressed in terms of probabilistic risk, which is the probability of an accident multiplied by the consequences of that accident and summed over all reasonably conceivable accident conditions. Hypothetical transportation accident conditions ranging from low-speed “fender-bender” collisions to high-speed collisions with or without fires were analyzed. The frequencies of accidents and consequences were evaluated using a method developed by NRC and originally published in the *Final Environmental Impact Statement on the Transportation of Radioactive Materials by Air and Other Modes*, NUREG-0170 (NRC 1977); *Shipping Container Response to Severe Highway and Railway Accident Conditions*, NUREG/CR-4829 (NRC 1987); and *Reexamination of Spent Fuel Shipping Risk Estimates*, NUREG/CR-6672 (NRC 2000). Hereafter, these reports are cited as: *Radioactive Material Transport Study*, NUREG-0170; *Modal Study*, NUREG/CR-4829; and *Reexamination Study*, NUREG/CR-6672. Radiological accident risk is expressed in terms of additional LCFs, and nonradiological accident risk is expressed in terms of additional traffic fatalities. Incident-free risk is also expressed in terms of additional LCFs.

Transportation-related risks are calculated and presented separately for workers and members of the general public. The workers considered are truck crew members involved in the actual transportation. The general public includes all persons who could be exposed to a shipment while it is moving or stopped during transit.

The first step in the ground transportation analysis was to determine the distances and populations along the routes. The Transportation Routing Analysis Geographic Information System (TRAGIS) computer program (Johnson and Michelhaugh 2003) was used to identify routes and the associated distances and populations for purposes of analysis. This information, along with the properties of the material being

shipped and route-specific accident frequencies, was entered into the RADTRAN 6 computer code (SNL 2009), which calculates incident and accident risks on a per-shipment basis. The risks under each alternative were determined by summing the products of per-shipment risks for each waste type by its number of shipments.

The RADTRAN 6 computer code was used for incident-free and accident risk assessments to estimate the impacts on populations, as well as for incident-free assessments associated with MEIs. RADTRAN 6 was developed by Sandia National Laboratories to calculate population risks associated with the transportation of radioactive materials by a variety of modes, including truck, rail, air, ship, and barge.

The RADTRAN 6 population risk calculations include both the consequences and probabilities of potential exposure events. The RADTRAN 6 code consequence analyses include the following exposure pathways: cloud shine, ground shine, direct radiation (from loss of shielding), inhalation (from dispersed materials), and resuspension (inhalation from resuspended materials) (SNL 2009). The collective population risk is a measure of the total radiological risk posed to society as a whole by the alternative being considered. As such, the collective population risk is used as the primary means of comparing the various alternatives.

The RISKIND computer code (Yuan et al. 1995) was used to estimate the doses to MEIs and populations for the worst-case maximum reasonably foreseeable transportation accident. The RISKIND computer code was developed for DOE's Office of Civilian Radioactive Waste Management to estimate potential radiological consequences and health risks to individuals and the collective population from exposures associated with the transportation of spent nuclear fuel; however, this code is also applicable to transportation of other cargo types, as the code can model complex atmospheric dispersion and estimate radiation doses to MEIs near the accident. Use of the RISKIND computer code as implemented in this *SPD Supplemental EIS* is consistent with direction provided in *A Resource Handbook on DOE Transportation Risk Assessment* (DOE 2002b).

The RISKIND calculations were conducted to supplement the collective risk results calculated with RADTRAN 6. Whereas the collective risk results provide a measure of the overall risks of each alternative, the RISKIND calculations are meant to address areas of specific concern to individuals and population subgroups. Essentially, the RISKIND analyses are meant to address "What if" questions, such as "What if I live next to a site access road?" or "What if an accident happens near my town?"

E.4.1 Transportation Routes

To assess incident-free and transportation accident impacts, route characteristics were determined for the following offsite shipments that would occur as part of routine operations:

- Pits and associated materials from the Pantex Plant (Pantex) in Texas to the Savannah River Site (SRS) and/or Los Alamos National Laboratory (LANL)
- Plutonium materials from LANL to SRS
- Transuranic waste from SRS and LANL to the Waste Isolation Pilot Plant (WIPP)
- Unirradiated MOX fuel from SRS to the Browns Ferry Nuclear Plant in Alabama, Sequoyah Nuclear Plant in Tennessee, and a generic commercial nuclear power reactor location in the northwest United States that would envelope impacts related to shipping to other possible commercial nuclear power reactor sites in the country.

- Highly enriched uranium from SRS and LANL to the Y-12 National Security Complex (Y-12) at the Oak Ridge Reservation in Tennessee
- Pieces and parts of pits from SRS to LANL in New Mexico
- Low-level and mixed low-level radioactive waste from SRS and LANL to the Nevada National Security Site (NNSS) for disposal
- Depleted uranium hexafluoride from the Portsmouth Gaseous Diffusion Plant at Piketon, Ohio, to AREVA fuel fabrication plant (AREVA) at Richland, Washington³
- Depleted uranium oxide and uranyl nitrate hexahydrate from AREVA to SRS³
- Hazardous waste from SRS and LANL to an offsite treatment, storage, and disposal facility (nonradiological impacts only)

These sites would constitute the locations where the majority of shipments would be transported.

For offsite transport, highway routes were determined using the routing computer program TRAGIS (Johnson and Michelhaugh 2003). The TRAGIS computer program is a geographic information system-based transportation analysis computer program used to identify the highway, rail, and waterway routes for transporting radioactive materials within the United States that were used in the analysis. Both the road and rail network are 1:100,000-scale databases, which were developed from the U.S. Geological Survey digital line graphs and the U.S. Bureau of the Census Topological Integrated Geographic Encoding and Referencing System. The population densities along each route were derived from 2000 Census Bureau data (Johnson and Michelhaugh 2003). The features in TRAGIS allow users to determine routes for shipment of radioactive materials that conform to DOT regulations as specified in 49 CFR Part 397. State-level U.S. Census data for 2010 (Census 2010) was used in relation to the 2000 census data to project the population densities to 2020 levels.

Offsite Route Characteristics

Route characteristics that are important to the radiological risk assessment include the total shipment distance and population distribution along the route. The specific route selected determines both the total potentially exposed population and the expected frequency of transportation-related accidents. Route characteristics for routes analyzed in this EIS are summarized in **Table E-1**. Rural, suburban, and urban areas are characterized according to the following breakdown (Johnson and Michelhaugh 2003):

- Rural population densities range from 0 to 54 persons per square kilometer (0 to 140 persons per square mile)
- Suburban population densities range from 55 to 1,284 persons per square kilometer (140 to 3,326 persons per square mile)
- Urban population densities include all population densities greater than 1,284 persons per square kilometer (3,326 persons per square mile)

³ The transport of depleted uranium is analyzed because it is one of the materials used to produce mixed oxide fuel in MFFF.

Table E-1 Offsite Transport Truck Route Characteristics

Origin	Destination	Nominal Distance (kilometers)	Distance Traveled in Zones (kilometers)			Population Density in Zone ^a (number per square kilometer)			Number of Affected Persons ^b
			Rural	Suburban	Urban	Rural	Suburban	Urban	
Pantex, TX	SRS	2,184	1,482	621	81	16.7	427.4	2,946.6	844,147
Pantex, TX	LANL	574	526	40	8	8.0	452.1	3,060.7	76,539
SRS	Y-12	633	304	292	37	25.7	481.5	3,154.8	425,642
LANL	Y-12	2,372	1,848	465	59	13.5	370.6	2,866.5	587,874
SRS	LANL	2,798	2,015	683	100	14.6	429.2	2,974.9	992,627
SRS	WIPP	2,448	1,732	651	65	17.1	409.7	2,943.4	777,585
LANL	WIPP	597	554	38	5	7.4	378.2	2,582.5	49,414
SRS	NNSS	3,879	3,003	769	107	13.3	436.6	3,007.3	1,113,816
LANL	NNSS	1,250	1,082	132	36	11.4	516.8	4,502.9	387,356
Piketon, OH ^c	Richland, WA ^d	3,768	3,053	648	67	12.9	369.3	2,611.3	726,407
Richland, WA ^d	SRS	4,256	3,253	885	118	13.6	424.9	2,888.7	1,218,892
SRS	Sequoyah Nuclear Plant	508	231	240	37	26.3	523.4	3,161.5	396,561
SRS	Browns Ferry Nuclear Plant	724	389	298	37	24.3	428.1	2,885.8	388,475
SRS	Generic reactor ^e	4,405	3,372	919	114	13.3	419.1	2,897.6	1,216,999

LANL = Los Alamos National Laboratory; NNSS = Nevada National Security Site; OH = Ohio; Pantex = Pantex Plant; SRS = Savannah River Site; TX = Texas; WA = Washington; WIPP = Waste Isolation Pilot Plant; Y-12 = Y-12 National Security Complex.

^a Population densities have been projected to 2020 using state-level data from the 2010 census (Census 2010) and assuming state population growth rates from 2000 to 2010 continue to 2020.

^b For offsite shipments, the estimated number of persons residing within 800 meters (0.5 miles) along the transportation route, projected to 2020.

^c Shipments of depleted uranium hexafluoride may also be made from the Paducah Gaseous Diffusion Plant at Paducah, Kentucky, but only travel from the Portsmouth Gaseous Diffusion Plant at Piketon, Ohio, was analyzed because this would conservatively estimate the transportation impacts associated with this material.

^d The AREVA fuel fabrication plant that would convert depleted uranium hexafluoride to depleted uranium oxide is located at Richland, Washington.

^e For purposes of analysis, it was assumed that the generic commercial nuclear power reactor would be located at the Hanford Reservation, Washington, to maximize the distance traveled in order to envelope impacts related to shipping to other possible commercial nuclear power reactor sites.

Note: To convert from kilometers to miles, multiply by 0.6214; to convert from number per square kilometer to number per square mile, multiply by 2.59. Rounded to nearest kilometer.

The affected population for route characterization and incident-free dose calculation includes all persons living within 800 meters (0.5 miles) of each side of the transportation route.

Analyzed truck routes for offsite shipments of radioactive waste and materials to and from SRS, and from the Portsmouth Gaseous Diffusion Plant to AREVA in Richland, Washington are shown in **Figure E-2**; analyzed truck routes to and from LANL are shown in **Figure E-3**.

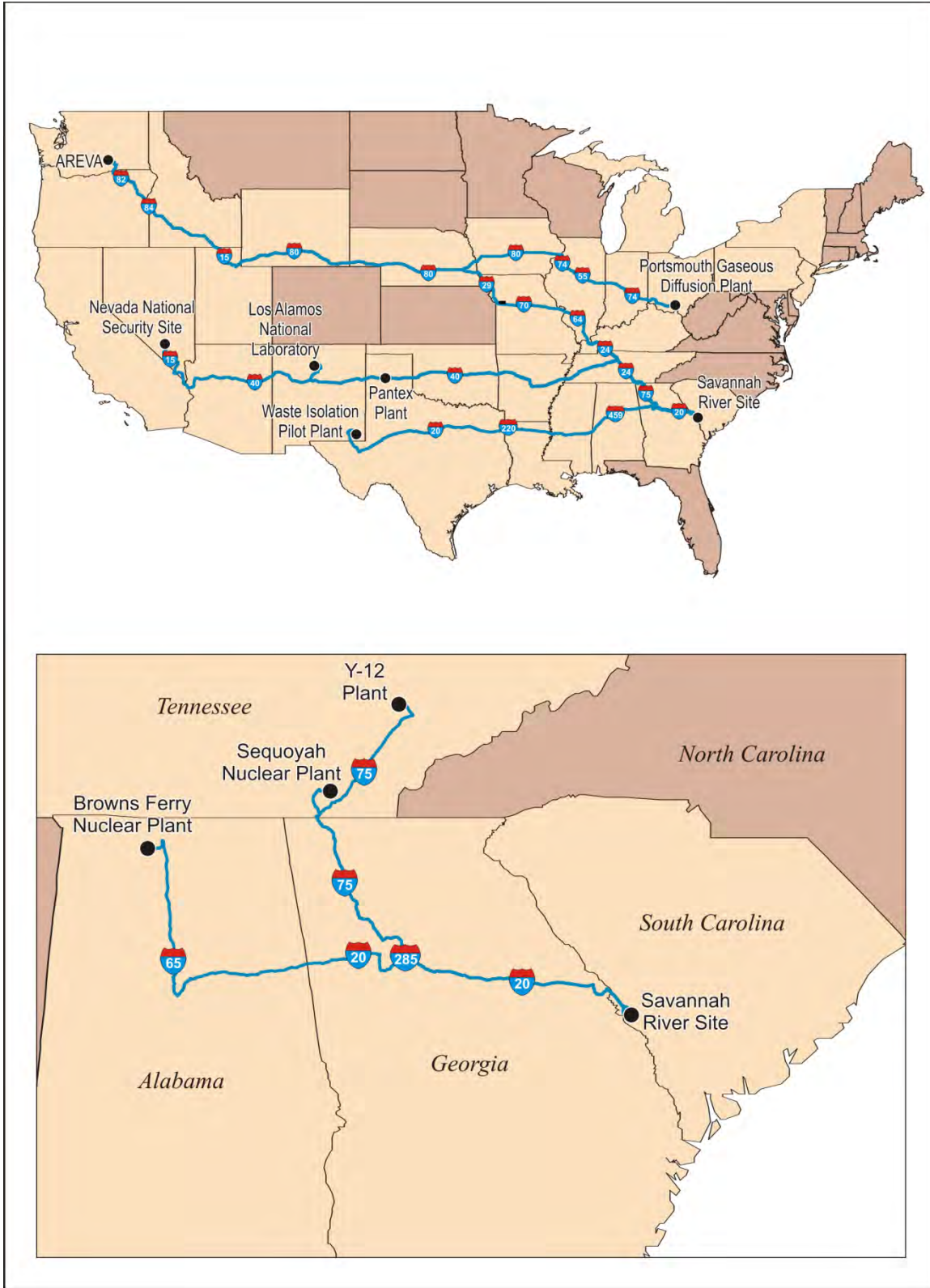

Figure E-2 Analyzed National and Regional Truck Routes from Savannah River Site



Figure E-3 Analyzed National and Regional Truck Routes from Los Alamos National Laboratory

E.4.2 Radioactive Material Shipments

Transportation of all material and waste types is assumed to occur in certified or certified-equivalent packaging on exclusive-use vehicles. Use of legal-weight heavy combination trucks is assumed in this appendix for highway transportation. Type A packages are transported on common flatbed or covered trailers; Type B packages are generally shipped on trailers designed specifically for the packaging being used. For transportation by truck, the maximum payload weight is considered to be about 22,000 kilograms (about 48,000 pounds), based on the Federal gross vehicle weight limit of 36,288 kilograms (80,000 pounds) (23 CFR 658.17). While there are large numbers of multi-trailer combinations (known as longer combination vehicles) with gross weights in excess of the Federal limit in operation on rural roads and turnpikes in some states (DOT 2000), for evaluation purposes, the load limit for the legal truck was based on the Federal gross vehicle weight. The width restriction is about 259 centimeters (102 inches) (23 CFR 658.15). Length restrictions vary by state, but are assumed for purposes of analysis to be no more than 14.6 meters (48 feet).

Several types of containers would be used to transport radioactive materials and waste. The various wastes that would be transported under the alternatives in this EIS include demolition and construction debris and hazardous waste, low-level and mixed low-level radioactive waste, and transuranic waste. **Table E–2** lists the types of containers assumed for the analysis along with their volumes and the number of containers in a shipment. A shipment is defined as the amount of waste transported on a single truck.

In general, the number of shipping containers per shipment was estimated on the basis of the dimensions and weight of the shipping containers, the Transport Index,⁴ which is the dose rate at 1 meter (3.3 feet) from the container, and the transport vehicle dimensions and weight limits. The various materials and wastes were assumed to be transported on standard truck semi-trailers in a single stack.

Special nuclear material would be transported using STAs. Special nuclear material transports include plutonium pits, plutonium oxides, enriched uranium, pieces and parts from pit disassembly, and MOX fuel. These shipments would occur to support production of MOX fuel or to accomplish disposition. These materials would be transported among SRS and the DOE facilities at LANL, Pantex, and Y-12. The numbers of shipments associated with the transport of pits, plutonium oxide, highly enriched uranium, and pieces and parts of pits are determined using up-to-date information regarding the types of transport packages to be used and forecasted generation rates. These materials would be transported in Type B packages. While it is assumed that a specific Type B package would be used for each type of nuclear material being transported for purposes of analysis, more than one particular package design could be used. Use of different Type B packages that are applicable to a particular cargo would not significantly change the impacts presented in this analysis because the designs and shipping configurations of the Type B packages are similar. For unirradiated MOX fuel, the number of shipments is based on two assemblies per transport package, one transport package per shipment; however, alternative shipment configurations are considered, as described in Appendix I, Section I.1.2.5.

Other radioactive materials would be transported by commercial carrier between the Portsmouth Gaseous Diffusion Plant at Piketon, Ohio, and the AREVA fuel fabrication facility at Richland, Washington, and from AREVA to SRS. These materials include depleted uranium hexafluoride, depleted uranium dioxide, and depleted uranium nitrate hexahydrate, respectively. Shipments of depleted uranium hexafluoride may also be made from the Paducah Gaseous Diffusion Plant at Paducah, Kentucky, but only travel from the Portsmouth Gaseous Diffusion Plant at Piketon, Ohio, was analyzed because this would conservatively

⁴ The Transport Index is a dimensionless number (rounded up to the next tenth) placed on label of a package, to designate the degree of control to be exercised by the carrier. Its value is equivalent to the maximum radiation level in millirem per hour at 1 meter (3.3 feet) from the package (10 CFR 71.4 and 49 CFR 173.403).

estimate the transportation impacts associated with this material (the total distance traveled and total population exposed along the route from the Paducah Gaseous Diffusion Plant would be less than the distance traveled and population along the route from the Portsmouth Gaseous Diffusion Plant).

Table E–2 Material or Waste Type and Associated Container Characteristics^a

<i>Material or Waste Type</i>	<i>Container</i>	<i>Container Volume (cubic meters)^b</i>	<i>Container Mass (kilograms)^c</i>	<i>Shipment Description</i>
Mixed low-level radioactive waste	208-liter drum	0.2	399	80 per truck
Low-level radioactive waste	B-25 Box	2.55	4,536	5 per truck
Transuranic waste (contact-handled)	208-liter drum ^d	0.2	399	14 per TRUPACT-II or 7 per HalfPACT; with any combination of 3 TRUPACT-IIs or HalfPACTs per truck
Special nuclear material	Type B package	0.13 to 0.30	183-318	1 to 30 per STA
Unirradiated MOX fuel	Type B package ^e	7.2 to 8.5	2,867 and 4,291	1 transport cask per STA
Fast Flux Test Facility unirradiated fuel	HUFP	9.3	6,350	1 package per truck
Transuranic waste associated with processing non-pit plutonium	Criticality control container	0.2	160	14 per TRUPACT-II
Depleted uranium hexafluoride	30B and 48G, in overpack	2.34 and 4.04	3,751 and 13,800	5 per truck and 1 per truck, respectively
Depleted uranium oxide/uranyl nitrate, hexahydrate	208-liter drum	0.2	399	72 per truck
Construction/demolition debris	Roll-on/Roll-off	15.30	Not applicable	1 per truck
Hazardous waste	208-liter drum	0.2	399	40 per truck

HUFP = Hanford Unirradiated Fuel Package; MOX = mixed oxide; STA = secure transportation asset;

TRUPACT-II = Transuranic Package Transporter Model 2.

^a Containers and transport packages identified in this table were used to determine the transportation impacts for purposes of analysis. Specific Type B packages, while not identified in this table, were assumed for specific material or waste types to conduct the analysis. Other containers and transport packages may be used in addition to, or in lieu of, those shown.

^b Container exterior volume. To convert from cubic meters to cubic feet, multiply by 35.315; from liters to gallons, by 0.26417.

^c Filled container maximum mass. Container mass includes the mass of the container shell, its internal packaging, and the materials within. To convert from kilograms to pounds, multiply by 2.2046.

^d Transuranic waste would also be packaged in pipe overpack containers, which would be the same size as a 208-liter drum.

^e Packages for transporting unirradiated MOX fuel assemblies have yet to be designed and certified. For purposes of analysis, a pressurized water reactor package and boiling water reactor package would each contain two fuel assemblies.

For radioactive waste to be transported to a DOE radioactive waste disposal site, (e.g., NNSS), it was assumed that the wastes would meet the disposal facility’s waste acceptance criteria. For purposes of analysis, it was assumed that some of the low-level radioactive waste generated at the Waste Solidification Building (WSB) would be transported to NNSS for disposal, along with all mixed low-level radioactive waste generated by plutonium disposition activities at SRS. In addition, it was assumed that all low-level radioactive waste and mixed low-level radioactive waste generated at LANL would be transported to NNSS.

Transuranic waste would be transported to WIPP for disposal. This analysis also considers options for transporting transuranic waste associated with non-pit plutonium that is unsuitable for processing at the Mixed Oxide Fuel Fabrication Facility (MFFF) to WIPP for disposal. These options include (1) rather than repackaging unirradiated Fast Flux Test Facility (FFTF) fuel and non-pit plutonium into pipe overpack containers (POCs), repackaging non-pit plutonium in criticality control containers (CCCs) at a higher concentration, thereby reducing the number of shipments and disposal volume; and

(2) transporting unirradiated FFTF fuel to WIPP in its current transport packaging (Hanford Unirradiated Fuel Package [HUFPS]).

E.4.3 Radionuclide Inventories

Radionuclide inventories are used to determine accident risks associated with a release of the radioactive or contaminated cargo. **Table E–3** provides the container radionuclide inventory concentration assumed for low-level and mixed low-level radioactive waste. It is assumed that these two waste types would have the same radioisotopic composition, with the mixed low-level radioactive waste having a hazardous component. The list of radionuclides in these tables is limited to those that would be expected from disassembly and conversion operations. The composition of the waste is the average curie concentration per radioisotope as measured in the year 2010 and received at E-Area, and this composition is assumed to be representative of the low-level and mixed low-level radioactive waste streams generated by surplus plutonium disposition activities.

Table E–3 Low-Level and Mixed Low-Level Radioactive Waste Radionuclide Concentrations^a

<i>Nuclide</i>	<i>Curies per Cubic Meter</i>
Americium-241	0.000050
Plutonium-238	0.00038
Plutonium-239	0.00011
Plutonium-240	0.000049
Plutonium-241	0.00048
Technetium-99	0.000052

^a These isotopes are the primary isotopes to be expected in offsite shipments of low-level and mixed low-level radioactive waste. The concentrations are representative of what historically has been generated at SRS. Source: SRNS 2012.

For both depleted uranium hexafluoride and depleted uranyl nitrate hexahydrate shipments, the percent concentration of uranium-235 can vary; however, for purposes of analysis, it is assumed that the concentration of uranium-235 is 0.25 percent by mass. For transport of pits from Pantex, Texas, to SRS and LANL; pieces and parts of plutonium pits from SRS to LANL; plutonium oxide from LANL to SRS; and highly enriched uranium from SRS and LANL to Y-12, it was assumed that the contents of one Type B package would be released in the event of an accident.

Table E–4 shows the number of curies per transport package assumed for boiling water reactor (BWR) and pressurized water reactor (PWR) unirradiated MOX fuel.

For the MOX Fuel Alternative and the WIPP Alternative, for which plutonium would be repackaged and sent to WIPP for disposal, for purposes of analysis it was assumed there would be 175 plutonium-239 fissile gram equivalent (FGE)⁵ of non-pit plutonium per pipe overpack container. A shipment would consist of two TRUPACT-II [Transuranic Package Transporter Model 2] packages and one HalfPACT package. DOE is determining whether the number of FGEs per POC can be increased to reduce both the volume being disposed of and the number of shipments. If the content could be increased, then the plutonium would be packaged in CCCs instead of pipe overpack containers. If CCCs were used, then it was assumed that a shipment would consist of three TRUPACT II packages, each containing 14 containers. For purposes of analysis, it was assumed that there would be 380 FGE per CCC.

⁵ Expressing the contents of a shipment in FGE allows *the analysis* to account for fissile radionuclides that may be present.

Table E-4 Radioisotopic Content of Transport Packages Containing Unirradiated Boiling Water Reactor and Pressurized Water Reactor Fuel ^a

<i>Radioisotope</i>	<i>Pressurized Water Reactor (curies per package)</i>	<i>Boiling Water Reactor (curies per package)</i>
Americium-241	14.90	3.73
Plutonium-238	86.42	21.65
Plutonium-239	2,310.27	578.86
Plutonium-240	511.99	128.28
Plutonium-241	4,364.41	1,093.54
Plutonium-242	0.040	0.0099
Uranium-235	0.0047	0.0019
Uranium-238	0.29	0.12

^a While specific transport packages have yet to be designed for transporting BWR and PWR unirradiated MOX fuel, it is assumed that the packages would each hold two assemblies.

Source: SRNS 2012.

For transuranic waste generated from processing weapons-grade plutonium, it was assumed there would be 20 plutonium-239 FGE per drum. For transuranic waste generated from processing non-pit plutonium, it was assumed there would be 10 plutonium-239 FGE per drum. A shipment of transuranic waste for either of these two cases would consist of three TRUPACT-II packages.

E.5 Incident-free Transportation Risks

E.5.1 Radiological Risk

During incident-free transportation of radioactive materials, a radiological dose results from exposure to the external radiation field that surrounds the shipping containers. The population dose is a function of the number of people exposed, their proximity to the containers, their length of time of exposure, and the intensity of the radiation field surrounding the containers.

Radiological impacts were determined for crew members and the general population during incident-free transportation. For truck shipments, the crew members are the drivers of the shipment vehicle. The general population is composed of the persons residing within 800 meters (0.50 miles) of the truck route (off-link), persons sharing the road (on-link), and persons at stops. Exposures to workers who would load and unload the shipments are not included in this analysis, but are included in the occupational estimates for plant workers (see Chapter 4, Section 4.1.2, of the *SPD Supplemental EIS*). Exposures to inspectors are evaluated and presented separately in this appendix.

Collective doses for the crew and general population were calculated by using the RADTRAN 6 computer code (SNL 2009). The radioactive material shipments were assigned an external dose rate based on their radiological characteristics. Offsite transportation of the radioactive material has a defined regulatory limit of 10 millirem per hour at 2 meters (about 6.6 feet) from the outer lateral surfaces of the vehicle (10 CFR 71.47 and 49 CFR 173.441). If a waste container showed a high external dose rate that could exceed this limit, it is categorized as an exclusive use shipment with further transport and dose rate limitations as defined in these regulations, and the cargo would be transported in a Type A or Type B shielded shipping container. The waste container dose rate at 1 meter (3.3 feet) from its surface, or its Transport Index, is dependent on the distribution and quantities of radionuclides, waste density, shielding provided by the packaging, and self-shielding provided by the waste mixture.

Dose rates for packages containing low-level and mixed low-level radioactive waste, highly enriched uranium, pieces and parts of pits, and depleted uranium materials were assigned a dose rate of 2 millirem per hour at 1 meter. The dose rate for packages containing unirradiated MOX fuel (NRC 2005) and plutonium oxide was assumed to be 5 millirem per hour at 1 meter. The dose rate for pits and contact-handled transuranic waste was assumed to be 4 millirem per hour at 1 meter (DOE 1997). In all cases, the maximum external dose rate would be less than or equal to the regulatory limit of 10 millirem per hour at 2 meters from each container.

To calculate the collective dose, a unit risk factor was developed to estimate the impact of transporting one shipment of radioactive material over a unit distance of travel in a given population density zone. The unit risk factors were combined with routing information, such as the shipment distances in various population density zones, to determine the risk for a single shipment (a shipment risk factor) between a given origin and destination. Unit risk factors were developed on the basis of travel on interstate highways and freeways, as required by 49 CFR Parts 171 to 178 for highway-route-controlled quantities of radioactive material within rural, suburban, and urban population zones by using RADTRAN 6 and its default data. In addition, it was assumed for the analysis that, for 10 percent of the time, travel through suburban and urban zones would encounter rush-hour conditions, leading to lower average speed and higher traffic density.

The radiological risks from transporting the waste are estimated in terms of the number of LCFs among the crew and the exposed population. A health risk conversion factor of 0.0006 LCFs per rem or person-rem of exposure is used for both the public and workers (DOE 2002c).

E.5.2 Nonradiological Risk

Nonradiological risks, or vehicle-related health risks, resulting from incident-free transport may be associated with the generation of air pollutants by transport vehicles during shipment and are independent of the radioactive nature of the shipment. The health risk associated with these emissions under incident-free transport conditions is the excess latent mortality due to inhalation of vehicle emissions. Unit risk factors for pollutant inhalation in terms of mortality have been developed, as described in *A Resource Handbook on DOE Transportation Risk Assessment* (DOE 2002b). This analysis was not performed for this *SPD Supplemental EIS* because the results cannot be placed into context by comparison with a standard or measured data. The amounts of vehicle emissions are estimated for each alternative in Chapter 4, Section 4.1.1.

E.5.3 Maximally Exposed Individual Exposure Scenarios

The maximum individual doses for routine offsite transportation were estimated for transportation workers, as well as for members of the general population.

For truck shipments, three hypothetical scenarios were evaluated to determine the MEI in the general population. These scenarios are as follows (DOE 2002a):

- A person caught in traffic and located 1.2 meters (4 feet) from the surface of the shipping container for 30 minutes
- A resident living 30 meters (98 feet) from the highway used to transport the shipping container
- A service station worker at a distance of 16 meters (52 feet) from the shipping container for 50 minutes

The hypothetical MEI doses were accumulated over a single year for all transportation shipments. However, for the scenario involving an individual caught in traffic next to a shipping container, the radiological exposures were calculated for only one event because it was considered unlikely that the same individual would be caught in traffic next to all containers for all shipments. For truck shipments, the maximally exposed transportation worker would be a truck crew member who could be a DOE employee or a driver for a commercial carrier. In addition to complying with DOT requirements, a DOE employee would also need to comply with 10 CFR Part 835 which limits worker radiation doses to 5 rem per year; however, DOE's goal is to maintain radiological exposure as low as reasonably achievable. DOE has therefore established the Administrative Control Level of 2 rem per year (DOE-STD-1098-2008). This limit would apply to any non-transuranic waste shipment conducted by DOE personnel. Drivers of transuranic waste shipments to WIPP have an Administrative Control Level of 1 rem per year (WIPP 2006). Commercial drivers are subject to Occupational Safety and Health Administration regulations, which limits the whole body dose to 5 rem per year (29 CFR 1910.1996(b)), and the U.S. Department of Transportation requirement of 2 millirem per hour in the truck cab (49 CFR 173.411). Commercial drivers typically do not transport radioactive materials that have high dose rates external to the package; therefore, for purposes of analysis, a maximally exposed driver would not be expected to exceed the DOE Administrative Control Level of 2 rem per year for non-transuranic waste shipments. Other workers include inspectors who would inspect the truck and its cargo along the route. One inspector was assumed to be at a distance of 1 meter (3.3 feet) from the cargo for a duration of 1 hour.

E.6 Transportation Accident Risks

E.6.1 Methodology

The offsite transportation accident analysis considers the impact of accidents during the transportation of materials. Under accident conditions, impacts on human health and the environment could result from the release and dispersal of radioactive material. Transportation accident impacts were assessed using an accident analysis methodology developed by NRC. This section provides an overview of the methodologies; detailed descriptions of various methodologies are found in the *Radioactive Material Transportation Study*, NUREG-0170, *Modal Study*, NUREG/CR-4829, and *Reexamination Study*, NUREG/CR-6672 (NRC 1977, 1987, 2000). Accidents that could potentially breach the shipping container are represented by a spectrum of accident severities and radioactive release conditions. Historically, most transportation accidents involving radioactive materials have resulted in little or no release of radioactive material from the shipping container. Consequently, the analysis of accident risks takes into account a spectrum of accidents ranging from high-probability accidents of low severity to hypothetical high-severity accidents that have a correspondingly low probability of occurrence. The accident analysis calculates the probabilities and consequences from this spectrum of accidents.

To provide DOE and the public with a reasonable assessment of radioactive waste transportation accident impacts, two types of analysis were performed. First, an accident risk assessment was performed that takes into account the probabilities and consequences of a spectrum of potential accident severities using a methodology developed by the NRC (NRC 1977, 1987, 2000). For the spectrum of accidents considered in the analysis, accident consequences in terms of collective "dose risk" to the population within 80 kilometers (50 miles) were determined using the RADTRAN 6 computer program (SNL 2009). The RADTRAN 6 code sums the product of consequences and probability over all accident severity categories to obtain a probability-weighted risk value referred to in this appendix as "dose risk," which is expressed in units of person-rem. Second, to represent the maximum reasonably foreseeable impacts to individuals and populations should an accident occur, maximum radiological consequences were calculated in an urban or suburban population zone for an accidental release with a likelihood of

occurrence greater than 1-in-10 million per year using the RISKIND computer program (Yuan et al. 1995).

For accidents where a waste container or the cask shielding was undamaged, population and individual radiation exposure from the waste package was evaluated for the duration that would be needed to recover and resume shipment. The collective dose over all segments of transportation routes was evaluated for an affected population up to a distance of 800 meters (0.5 miles) from the accident location. This dose is an external dose, and is approximately inversely proportional to the square of the distance of the affected population from accident. Any additional dose to those residing beyond 800 meters (0.5 miles) from the accident would be negligible. The dose to an individual (first responder) was calculated assuming that the individual would be located at 2 to 10 meters (6.6 to 33 feet) from the package.

E.6.2 Accident Rates

Whenever material is shipped, the possibility exists of a traffic accident that could result in vehicular damage, injury, or death. Even when drivers are trained in defensive driving and take great care, there is a risk of a traffic accident. DOE and its predecessor agencies have a successful 50-year history of transporting radioactive materials. In the years of moving radioactive and hazardous materials, DOE has not had a single fatality related to transportation of hazardous or radioactive material cargo (DOE 2009).

To calculate accident risks, vehicle accident and fatality rates were taken from data provided in *State-Level Accident Rates for Surface Freight Transportation: A Reexamination*, ANL/ESD/TM-150 (Saricks and Tompkins 1999). Accident rates are generically defined as the number of accident involvements (or fatalities) in a given year per unit of travel in that same year. Therefore, the rate is a fractional value, with accident involvement count as the numerator of the fraction and vehicular activity (total travel distance in truck kilometers) as its denominator. Accident rates were generally determined for a multi-year period. For assessment purposes, the total number of expected accidents or fatalities was calculated by multiplying the total shipment distance for a specific case by the appropriate accident or fatality rate. No reduction in accident or fatality rates was assumed, even though radioactive material carrier drivers are better trained and have better maintained equipment.

For truck transportation, the rates presented are specifically for heavy combination trucks involved in interstate commerce (Saricks and Tompkins 1999). Heavy combination trucks are rigs composed of a separable tractor unit containing the engine and one to three freight trailers connected to each other. Heavy combination trucks are typically used for radioactive material shipments. Truck accident rates were computed for each state based on statistics compiled by the Federal Highway Administration, Office of Motor Carriers, from 1994 to 1996. A fatality caused by an accident is the death of a member of the public who is killed instantly or dies within 30 days due to the injuries sustained in the accident.

For offsite transportation of radioactive materials and wastes, separate accident rates and accident fatality risks were used for rural, suburban, and urban population zones. The values selected were the state-level accident and fatality rates provided in ANL/ESD/TM-150 (Saricks and Tompkins 1999) under interstate, primary, and total categories for rural, suburban, and urban population zones along the analyzed routes, respectively. The state-level rates were adjusted based on the distance traveled in each population zone in each state to derive a route-specific accident and fatality rate per car-kilometer.

Review of the truck accidents and fatalities reports by the Federal Carrier Safety Administration indicated that state-level accidents and fatalities were underreported. For the years 1994 through 1996, which formed the bases for the analysis in the Saricks and Tompkins report, the review identified that accidents were underreported by about 39 percent and fatalities were underreported by about 36 percent

(UMTRI 2003). Therefore, state-level truck accident and fatality rates in the Saricks and Tompkins report were increased by factors of 1.64 and 1.57, respectively, to account for the underreporting.

For transport by STA, the DOE operational experience between 1975 and 1998 was used to determine an accident rate of 2.7×10^{-7} accident per kilometer (4.4×10^{-7} accident per mile) (DOE 2002a). The route-specific commercial truck accident rates were adjusted to reflect the STA accident rate. Accident fatalities for STAs were estimated using the commercial truck transport fatality per accident ratios within each zone.

E.6.3 Accident Severity Categories and Conditional Probabilities

Accident severity categories for potential radioactive waste transportation accidents are described in the *Radioactive Material Transportation Study* (NRC 1977) for radioactive waste in general, the *Modal Study* (NRC 1987), and the *Reexamination Study* (NRC 2000) for used nuclear fuel. The methods described in the *Modal Study* and the *Reexamination Study* are applicable to transportation of radioactive materials in a Type B spent fuel cask. The accident severity categories presented in the *Radioactive Material Transportation Study* would be applicable to all other waste transported off site.

The *Radioactive Material Transportation Study* (NRC 1977) originally was used to estimate conditional probabilities associated with accidents involving transportation of radioactive materials. The *Modal Study* and the *Reexamination Study* (NRC 1987, 2000) are initiatives taken by NRC to refine more precisely the analysis presented in the *Radioactive Material Transportation Study* for used nuclear fuel shipment casks.

Whereas the *Radioactive Material Transportation Study* (NRC 1977) analysis was primarily performed using best engineering judgments and presumptions concerning cask response, the later studies rely on sophisticated structural and thermal engineering analysis and a probabilistic assessment of the conditions that could be experienced in severe transportation accidents. The latter results are based on representative used nuclear fuel casks assumed to have been designed, manufactured, operated, and maintained according to national codes and standards. Design parameters of the representative casks were chosen to meet the minimum test criteria specified in 10 CFR Part 71. The study is believed to provide realistic, yet conservative, results for radiological releases under transport accident conditions.

In the *Modal Study* and the *Reexamination Study*, potential accident damage to a cask is categorized according to the magnitude of the mechanical forces (impact) and thermal forces (fire) to which a cask may be subjected during an accident. Because all accidents can be described in these terms, severity is independent of the specific accident sequence. In other words, any sequence of events that results in an accident in which a cask is subjected to forces within a certain range of values is assigned to the accident severity region associated with that range. The accident severity scheme is designed to take into account all potential foreseeable transportation accidents, including accidents with low probabilities but high consequences, and those with high probabilities but low consequences.

As discussed earlier, the accident consequence assessment considers the potential impacts of severe transportation accidents. In terms of risk, the severity of an accident must be viewed in terms of potential radiological consequences, which are directly proportional to the fraction of the radioactive material within a cask that is released to the environment during the accident. Although accident severity regions span the entire range of mechanical and thermal accident loads, they are grouped into accident categories that can be characterized by a single set of release fractions and are, therefore, considered together in the accident consequence assessment. The accident category severity fraction is the sum of all conditional probabilities in that accident category.

For the accident risk assessment, accident “dose risk” was generically defined as the product of the consequences of an accident and the probability of occurrence of that accident, an approach consistent with the methodology used by RADTRAN 6 computer code. The RADTRAN 6 code sums the product of consequences and probabilities over all accident categories to obtain a probability-weighted risk value referred to in this appendix as “dose risk,” which is expressed in units of person-rem.

E.6.4 Atmospheric Conditions

Because it is impossible to predict the specific location of an offsite transportation accident, generic atmospheric conditions were selected for the risk and consequence assessments. On the basis of observations from National Weather Service surface meteorological stations at over 177 locations in the United States, on an annual average, neutral conditions (Pasquill Stability Classes C and D) occur 58.5 percent of the time, and stable (Pasquill Stability Classes E, F, and G) and unstable (Pasquill Stability Classes A and B) conditions occur 33.5 percent and 8 percent of the time, respectively (DOE 2002a). The neutral weather conditions predominate in each season, but most frequently in the winter (nearly 60 percent of the observations).

Neutral weather conditions (Pasquill Stability Class D) compose the most frequently occurring atmospheric stability condition in the United States and are thus most likely to be present in the event of an accident involving a radioactive waste shipment. Neutral weather conditions are typified by moderate windspeeds, vertical mixing within the atmosphere, and good dispersion of atmospheric contaminants. Stable weather conditions are typified by low windspeeds, very little vertical mixing within the atmosphere, and poor dispersion of atmospheric contaminants. The atmospheric condition used in RADTRAN 6 is an average weather condition that corresponds to a stability class spread between Class D (for near distance) and Class E (for farther distance).

The accident consequences for the maximum reasonably foreseeable accident (an accident with a likelihood of occurrence greater than 1 in 10 million per year) were assessed for both stable (Class F with a wind speed of 1 meter [3.3 feet] per second) and neutral (Class D with a wind speed of 4 meters [13 feet] per second) atmospheric conditions. The population dose was evaluated under neutral atmospheric conditions and the MEI dose under stable atmospheric conditions. The MEI dose would represent an accident under weather conditions that result in a conservative dose (i.e., a stable weather condition, with minimum diffusion and dilution). The population dose would represent an average weather condition.

Radioactive Release Characteristics

Radiological consequences were calculated by assigning radionuclide release fractions on the basis of the type of waste, the type of shipping container, and the accident severity category. The release fraction is defined as the fraction of the radioactivity in the container that could be released to the atmosphere in a given severity of accident. Release fractions vary according to the waste type and the physical or chemical properties of the radioisotopes. Most solid radionuclides are nonvolatile and are, therefore, relatively nondispersible.

Representative release fractions were developed for each waste and container type on the basis of DOE and NRC reports (DOE 1994, 2002b, 2003; NRC 1977, 2000, 2005). The severity categories and corresponding release fractions provided in these documents cover a range of accidents from no impact (zero speed) to impacts with speed in excess of 193 kilometers (120 miles) per hour onto an unyielding surface. Traffic accidents that could occur at the facility would be of minor impact due to lower local speed, with no release potential.

For radioactive wastes transported in a Type B cask, the particulate release fractions were developed consistent with the models in the *Reexamination Study* (NRC 2000) and adapted in the *West Valley Demonstration Project Waste Management Environmental Impact Statement* (DOE 2003). For wastes transported in Type A containers (e.g., 208-liter [55-gallon] drums and boxes), the fractions of radioactive material released from the shipping container were based on recommended values from the *Radioactive Material Transportation Study* and *DOE Handbook on Airborne Release Fractions/Rates and Respirable Fractions for Nonreactor Nuclear Facility* (NRC 1977, DOE 1994). For contact-handled and remote-handled transuranic waste, the release fractions corresponding to the *Radioactive Material Transportation Study* severity categories as adapted in the *Waste Isolation Pilot Plant Disposal Phase Final Supplemental Environmental Impact Statement* were used (DOE 1997).

For those accidents where the waste container or cask shielding were undamaged and no radioactive material was released, it was assumed that it would take 12 hours to recover from the accident and resume shipment. During this period, no individual would remain close to the cask. A first responder was assumed to stay at a location 2 to 10 meters (6.6 to 33 feet) from the package for 1 hour (DOE 2002b).

E.6.5 Acts of Sabotage or Terrorism

In the aftermath of the tragic events of September 11, 2001, DOE is continuing to assess measures to minimize the risk or potential consequences of radiological sabotage. While it is not possible to determine terrorists' motives and targets with certainty, DOE considers the threat of terrorist attack to be real, and makes all efforts to reduce any vulnerability to this threat.

Nevertheless, DOE has evaluated the impacts of acts of sabotage and terrorism on transportation of used nuclear fuel and high-level radioactive waste shipments (DOE 1996, 2002a). The sabotage event evaluated in the *Final Environmental Impact Statement for a Geologic Repository for the Disposal of Spent Nuclear Fuel and High-Level Radioactive Waste at Yucca Mountain, Nye County, Nevada (Yucca Mountain EIS)* was considered as the enveloping analysis for this EIS. The event was assumed to involve either a truck or rail cask containing light water reactor used nuclear fuel. The consequences of such an act were calculated to result in an MEI dose (at 140 meters [460 feet]) of 40 to 110 rem for events involving a rail- or truck-sized cask, respectively. These events would lead to an increase in risk of fatal cancer to the MEI by 2 to 7 percent (DOE 2002a). The quantity of radioactive materials transported under all alternatives considered in the *SPD Supplemental EIS* would be less than that considered in the *Yucca Mountain EIS* analysis. Therefore, estimates of risk in the *Yucca Mountain EIS* envelop the risks from an act of sabotage or terrorism involving the radioactive material transported under all alternatives considered in this EIS.

E.7 Risk Analysis Results

Per-shipment risk factors have been calculated for the collective populations of exposed persons and for the crew for all anticipated routes and shipment configurations. Radiological risks are presented in doses per-shipment for each unique route, material, and container combination. Radiological risk factors per-shipment for incident-free transportation and accident conditions are presented in **Table E-5**. These factors have been adjusted to reflect the projected population in 2020. For incident-free transportation, both dose and LCF risk factors are provided for the crew and exposed population. The radiological risks would result from potential exposure of people to external radiation emanating from the packaged waste. The exposed population includes the off-link public (people living along the route), on-link public (pedestrian and car occupants along the route) and public at rest and fuel stops. LCF risk factors were calculated by multiplying the accident dose risks by a health risk conversion factor of 0.0006 cancer fatalities per person-rem of exposure (DOE 2002c).

Table E-5 Risk Factors per Shipment of Radioactive Material and Waste

Material or Wastes	Origin	Transport Destination	Incident-Free				Accident	
			Crew Dose (person-rem)	Crew Risk (LCF)	Population Dose (person-rem)	Population Risk (LCF)	Radiological Risk (LCF)	Non-radiological Risk (traffic fatalities)
Pits ^a	Pantex, TX	SRS	0.051	3.1×10^{-5}	0.061	3.6×10^{-5}	1.3×10^{-9}	0.000059
Pits ^a	Pantex, TX	LANL	0.013	7.9×10^{-6}	0.018	1.1×10^{-5}	1.4×10^{-10}	0.000017
HEU ^a	SRS	Y-12	0.0037	2.2×10^{-6}	0.0057	3.4×10^{-6}	7.5×10^{-11}	0.000011
HEU ^a	LANL	Y-12	0.014	8.1×10^{-6}	0.024	1.5×10^{-5}	1.0×10^{-10}	0.000083
Pieces-parts ^a	SRS	LANL	0.014	8.4×10^{-6}	0.029	1.7×10^{-5}	8.9×10^{-10}	0.000078
plutonium oxide powder ^a	LANL	SRS	0.028	1.7×10^{-5}	0.061	3.7×10^{-5}	7.3×10^{-8}	0.000078
TRU waste with 175 grams non-pit FGE per POC ^b	SRS	WIPP	0.094	5.7×10^{-5}	0.046	2.7×10^{-5}	8.4×10^{-10}	0.00015
TRU Waste with 10 grams non-pit FGE per drum ^c	SRS	WIPP	0.094	5.7×10^{-5}	0.046	2.7×10^{-5}	8.4×10^{-10}	0.00015
TRU Waste with 20 grams weapons-grade FGE per drum ^c	SRS	WIPP	0.094	5.7×10^{-5}	0.046	2.7×10^{-5}	8.4×10^{-10}	0.00015
TRU Waste with 20 grams weapons-grade FGE per drum ^c	LANL	WIPP	0.023	1.4×10^{-5}	0.012	7.5×10^{-6}	3.0×10^{-11}	0.000021
TRU waste in CCCs from processing non-pit plutonium ^d	SRS	WIPP	0.094	5.7×10^{-5}	0.046	2.7×10^{-5}	8.4×10^{-10}	0.00015
HUFP	SRS	WIPP	0.013	7.7×10^{-6}	0.026	1.6×10^{-5}	4.3×10^{-8}	0.00015
LLW ^e	SRS	NNSS	0.078	4.7×10^{-5}	0.031	1.9×10^{-5}	2.6×10^{-10}	0.00018
LLW ^e	LANL	NNSS	0.025	1.5×10^{-5}	0.011	6.3×10^{-6}	2.2×10^{-11}	0.000024
MLLW ^f	SRS	NNSS	0.093	5.6×10^{-5}	0.062	3.7×10^{-5}	5.1×10^{-10}	0.00018
MLLW ^f	LANL	NNSS	0.030	1.8×10^{-5}	0.021	1.3×10^{-5}	4.3×10^{-11}	0.000024
DUF ₆ (48G container)	Piketon, OH ^g	Richland, WA ^h	0.0089	5.3×10^{-6}	0.019	1.2×10^{-5}	1.0×10^{-7}	0.00020
DUF ₆ (30B container)	Piketon, OH ^g	Richland, WA ^h	0.041	2.5×10^{-5}	0.061	3.7×10^{-5}	8.8×10^{-8}	0.00020
DUO ₂ ^h	Richland, WA ^h	SRS	0.10	6.2×10^{-5}	0.061	3.6×10^{-5}	6.3×10^{-7}	0.00023
DUNH ^h	Richland, WA ^h	SRS	0.10	6.2×10^{-5}	0.061	3.6×10^{-5}	3.4×10^{-6}	0.00023
BWR MOX fuel assemblies ^j	SRS	BFN	0.0073	4.4×10^{-6}	0.012	7.2×10^{-6}	1.5×10^{-10}	0.000014
PWR MOX fuel assemblies ⁱ	SRS	SQN	0.0058	3.5×10^{-6}	0.0080	4.8×10^{-6}	1.9×10^{-10}	0.0000080
BWR MOX fuel assemblies ⁱ	SRS	Generic Reactor	0.043	2.6×10^{-5}	0.082	4.9×10^{-5}	4.7×10^{-10}	0.000091

BFN = Browns Ferry Nuclear Plant; BWR = boiling water reactor; CCC = criticality control container; DUF₆ = depleted uranium hexafluoride; DUNH = depleted uranyl nitrate, hexahydrate; DUO₂ = depleted uranium oxide; FGE = fissile gram equivalent; HEU = highly enriched uranium; HUFP = Hanford Unirradiated Fuel Package; LANL = Los Alamos National Laboratory; LCF = latent cancer fatality; LLW = low-level radioactive waste; MLLW = mixed low-level radioactive waste; MOX = mixed oxide; NNSS = Nevada National Security Site; Pantex = Pantex Plant; POC = pipe overpack container; PWR = pressurized water reactor; SQN = Sequoyah Nuclear Plant; SRS = Savannah River Site; TRU = transuranic; WIPP = Waste Isolation Pilot Plant; Y-12 = Y-12 National Security complex.

^a Transported in Type B packages.

^b Transported in 208-liter (55-gallon) drums in 2 TRUPACT-II's and 1 HalfPACT per shipment.

^c Transported in 208-liter (55-gallon) drums in 3 TRUPACT-II's per shipment.

^d Transported in 3 TRUPACT-II's per shipment.

^e Transported in Type A B-25 boxes.

^f Transported in 208-liter (55-gallon) drums.

^g Location of the Portsmouth Gaseous Diffusion Plant.

^h Location of the AREVA fuel fabrication facility.

ⁱ Assumed to be transported in an as-yet designed transport package that can hold two assemblies.

For transportation accidents, the risk factors are given for both radiological impacts, in terms of potential LCFs in the exposed population, and nonradiological impacts, in terms of number of traffic fatalities. LCFs represent the number of additional latent fatal cancers among the exposed population. Under accident conditions, the population would be exposed to radiation from released radioactivity if the package were damaged and would receive a direct dose if the package is unbreached. For accidents that had no release, the analysis conservatively assumed that it would take about 12 hours to remove the package and/or vehicle from the accident area (DOE 2002a). The nonradiological risk factors are nonoccupational traffic fatalities resulting from transportation accidents.

As stated earlier (see Section E.6.3), the accident dose is called “dose risk” because the values incorporate the spectrum of accident severity probabilities and associated consequences (e.g., dose). The accident dose risks are very low because accident severity probabilities (i.e., the likelihood of accidents leading to confinement breach of a package or shipping cask and release of its contents) are small, and the content and form of the wastes (i.e., solids) are such that a breach would lead to a nondispersible and mostly noncombustible release. Although persons are residing within an 80-kilometer (50-mile) radius along the transportation route, they are generally quite far from the route. Because RADTRAN 6 uses an assumption of homogeneous population, it would greatly overestimate the actual doses because this assumption theoretically places people directly adjacent to the route where the highest doses would be present.

As indicated in Table E-5, all per-shipment risk factors are less than one. This means that no LCF or traffic fatalities are expected to occur during each transport. For example, the risk factors to truck crew and population for transporting one shipment of pits from Pantex to SRS are given as 3.1×10^{-5} and 3.6×10^{-5} LCFs, respectively. This risk can also be interpreted as meaning that there is a chance of 3 in 100,000 that an additional latent fatal cancer could be experienced among the exposed workers from exposure to radiation during one shipment of this waste. Similarly, there is a chance of 4 in 100,000 that an additional latent fatal cancer could be experienced among the exposed population residing along the transport route due to one shipment. These chances are essentially equivalent to zero risk. It should be noted that the maximum allowable dose rate in the truck cab is less than or equal to 2 millirem per hour.

To provide flexibility for potential disposition of surplus plutonium that cannot be converted into MOX fuel, per-shipment and total transportation impacts for shipment of up to 6 metric tons (6.6 tons) of plutonium to WIPP for disposal are provided in this appendix. This surplus material is assumed to be packaged in POCs and shipped as contact-handled transuranic waste. For purposes of analysis, it is assumed that a shipment of pipe POCs would consist of 2 TRUPACT II packages and a HalfPACT, with the shipment containing a total of 35 pipe overpack containers. If CCCs are used, then a shipment would be comprised of 3 TRUPACT II packages containing a total of 42 containers.

Tables E-6 through E-10 show the risks of transporting radioactive materials and wastes under each alternative. The risks are calculated by multiplying the previously given per-shipment factors by the number of shipments over the duration of the program and, for radiological doses, by the health risk conversion factors. The risks are for the entire period under each alternative and include both construction and operations. The number of shipments for the different waste types was calculated using the estimated waste volumes for each waste type as given in Chapter 4, Section 4.1.4, of the *SPD Supplemental EIS*, the waste container and shipment characteristics provided in Section E.4.2 and Table E-2, and the projected operational duration for each facility (see Appendix B, Table B-2).

Table E-6 Risks of Transporting Radioactive Material and Waste – No Action Alternative ^a

Route	Transport Mode	Number of Shipments	One-way Kilometers Traveled (million)	Incident-Free				Accident	
				Crew		Population		Radiological Risk ^b	Nonradiological Risk ^b
				Dose (person-rem)	Risk ^b	Dose (person-rem)	Risk ^b		
PDCF at F-Area at SRS ^c									
All STA routes	STA	1,100	2.3	52	0.03	62	0.04	1×10^{-6}	0.06
SRS to WIPP	Truck	1,400	3.4	130	0.08	63	0.04	1×10^{-6}	0.2
SRS to NNSS - LLW	Truck	440	1.7	34	0.02	14	0.008	1×10^{-7}	0.08
PF-4 at LANL (2 Metric Tons [2.2 tons] Processing)									
All STA routes	STA	26	0.060	0.58	0.0003	1.3	0.0008	1×10^{-6}	0.002
LANL to WIPP	Truck	9	0.0054	0.20	0.0001	0.11	0.00007	3×10^{-10}	0.0002
LANL to NNSS - LLW	Truck	16	0.0020	0.40	0.0002	0.17	0.0001	4×10^{-10}	0.0004
Other Transports									
Portsmouth to AREVA (48G containers)	Truck	140	0.52	1.2	0.0007	2.7	0.002	1×10^{-5}	0.03
Portsmouth to AREVA (30B containers)	Truck	160	0.59	6.4	0.004	9.5	0.006	1×10^{-5}	0.03
AREVA to SRS (DUO ₂)	Truck	34	0.15	3.5	0.002	2.1	0.001	2×10^{-5}	0.008
AREVA to SRS (DUNH)	Truck	4	0.017	0.41	0.0002	0.24	0.0001	1×10^{-5}	0.0009
SRS to Generic Reactor ^d	Truck	3,400	15	150	0.09	280	0.2	2×10^{-6}	0.3
Totals									
With fresh MOX Fuel Shipments to a generic reactor ^d	–	6,700	24	380	0.2	430	0.3	0.00007	0.7
Without fresh MOX Fuel Shipments	–	3,300	8.8	230	0.1	150	0.09	0.00007	0.4

AREVA = AREVA fuel fabrication facility; DUNH = depleted uranyl nitrate, hexahydrate; DUO₂ = depleted uranium oxide; LANL = Los Alamos National Laboratory; LLW = low-level radioactive waste; MOX = mixed oxide; NNSS = Nevada National Security Site; PDCF = Pit Disassembly and Conversion Facility; PF-4 = Plutonium Facility; SRS = Savannah River Site; STA = secure transportation asset; WIPP = Waste Isolation Pilot Plant.

^a For waste shipments, the totals include construction and operations activities.

^b Risk is expressed in terms of LCFs, except for the nonradiological risk, where it refers to the number of traffic accident fatalities. Radiological risk is calculated for one-way travel while nonradiological risk is calculated for two-way travel. Accident dose-risk can be calculated by dividing the risk values by 0.0006 (DOE 2002c). The values are rounded to one non-zero digit.

^c Includes impacts from MFFF operations.

^d For purposes of analysis, it was assumed that the generic commercial nuclear power reactor would be located at the Hanford Reservation, Washington, to maximize the distance traveled in order to envelope impacts related to shipping to other possible commercial nuclear power reactor sites. Only shipments of BWR fuel are analyzed because there would be a greater number of shipments to a BWR reactor than a PWR reactor, thus providing a conservative analysis of the distance traveled per alternative that would cover a smaller number of PWR shipments to a generic commercial nuclear power reactor for the same amount of unirradiated MOX fuel, should shipments be made to a PWR.

Note: To convert kilometers to miles, multiply by 0.62137.

Table E-7 Risks of Transporting Radioactive Material and Waste – Immobilization to DWPF Alternative ^a

Route	Transport Mode	Number of Shipments	One-way Kilometers Traveled (million)	Incident-Free				Accident	
				Crew		Population		Radiological Risk ^b	Non-radiological Risk ^b
				Dose (person-rem)	Risk ^b	Dose (person-rem)	Risk ^b		
Immobilization Capability									
SRS to WIPP	Truck	550	1.3	52	0.03	25	0.02	5×10^{-7}	0.08
SRS to NNSS – MLLW	Truck	58	0.23	5.4	0.003	3.6	0.002	3×10^{-8}	0.01
PDCF at F-Area at SRS ^c									
All STA routes	STA	1,400	2.9	65	0.04	78	0.05	2×10^{-6}	0.08
SRS to WIPP	Truck	1,500	3.6	140	0.08	67	0.04	1×10^{-6}	0.2
SRS to NNSS – LLW	Truck	440	1.7	34	0.02	14	0.008	1×10^{-7}	0.08
PF-4 at LANL and MFFF at SRS ^d									
All STA routes	STA	1,700	2.0	28	0.02	47	0.03	3×10^{-5}	0.06
LANL to WIPP	Truck	150	0.087	3.3	0.002	1.8	0.001	4×10^{-9}	0.003
LANL to NNSS – LLW	Truck	320	0.40	7.9	0.005	3.3	0.002	7×10^{-9}	0.008
SRS to WIPP	Truck	1,200	3.0	120	0.07	56	0.03	1×10^{-6}	0.2
SRS to NNSS – LLW	Truck	440	1.7	34	0.02	14	0.008	1×10^{-7}	0.08
PF-4 at LANL, and H-Canyon/HB-Line and MFFF at SRS ^e									
All STA routes	STA	1,600	2.1	34	0.02	50	0.03	2×10^{-5}	0.06
LANL to WIPP	Truck	120	0.072	2.7	0.002	1.5	0.0009	4×10^{-9}	0.002
LANL to NNSS – LLW	Truck	260	0.33	6.5	0.004	2.7	0.002	6×10^{-9}	0.006
SRS to WIPP	Truck	1,300	3.2	120	0.07	60	0.04	1×10^{-6}	0.2
SRS to NNSS – LLW	Truck	440	1.7	34	0.02	14	0.008	1×10^{-7}	0.08
SRS to NNSS – MLLW	Truck	1	0.0039	0.094	0.00006	0.062	0.00004	5×10^{-10}	0.0002
PF-4 at LANL (2 Metric Tons Processing)									
All STA routes	STA	26	0.060	0.58	0.0003	1.3	0.0008	1×10^{-6}	0.002
LANL to WIPP	Truck	9	0.0054	0.20	0.0001	0.11	0.00007	3×10^{-10}	0.0002
LANL to NNSS – LLW	Truck	16	0.0020	0.40	0.0002	0.17	0.0001	4×10^{-10}	0.0004
Other Transports									
Portsmouth to AREVA (48G containers)	Truck	140	0.52	1.2	0.0007	2.7	0.002	1×10^{-5}	0.03
Portsmouth to AREVA (30B containers)	Truck	160	0.59	6.4	0.004	9.5	0.006	1×10^{-5}	0.03
AREVA to SRS (DUO ₂)	Truck	34	0.15	3.5	0.002	2.1	0.001	2×10^{-5}	0.008
AREVA to SRS (DUNH)	Truck	4	0.017	0.41	0.0002	0.24	0.0001	1×10^{-5}	0.0009
SRS to SQN	STA	430	0.22	2.5	0.001	3.4	0.002	8×10^{-8}	0.003
SRS to BFN	STA	1,700	1.2	12	0.007	20	0.01	2×10^{-7}	0.02
SRS to Generic Reactor ^f	STA	3,400	15	150	0.09	280	0.2	2×10^{-6}	0.3

Route	Transport Mode	Number of Shipments	One-way Kilometers Traveled (million)	Incident-Free				Accident	
				Crew		Population		Radiological Risk ^b	Non-radiological Risk ^b
				Dose (person-rem)	Risk ^b	Dose (person-rem)	Risk ^b		
Totals									
Immobilization/PDCF with TVA Reactors	-	6,400	13	320	0.2	230	0.1	0.00007	0.6
Immobilization/PDCF with Generic Reactor	-	7,700	26	450	0.3	480	0.3	0.00007	0.8
Immobilization/PF-4/MFFF with TVA Reactors	-	6,900	11	270	0.2	190	0.1	0.00009	0.5
Immobilization/PF-4/MFFF with Generic Reactor	-	8,200	25	400	0.2	440	0.3	0.00009	0.8
Immobilization/PF-4/H-Canyon/ HB-Line/MFFF with TVA Reactors	-	6,900	12	280	0.2	200	0.1	0.00008	0.5
Immobilization/PF-4/H-Canyon/ HB-Line/MFFF with Generic Reactor	-	8,100	25	420	0.3	450	0.3	0.00008	0.8
Immobilization/PDCF	-	4,300	11	300	0.2	200	0.1	0.00007	0.5
Immobilization/PF-4/MFFF	-	4,800	10	250	0.2	160	0.1	0.00009	0.5
Immobilization/PF-4/H-Canyon/ HB-Line/MFFF	-	4,700	10	270	0.2	170	0.1	0.00008	0.5

AREVA = AREVA fuel fabrication facility; BFN = Browns Ferry Nuclear Plant; DUNH = depleted uranyl nitrate, hexahydrate; DUO₂ = depleted uranium oxide; DWPF = Defense Waste Processing Facility; LANL = Los Alamos National Laboratory; LLW = low-level radioactive waste; MFFF = Mixed Oxide Fabrication Facility; MLLW = mixed low-level radioactive waste; NNSS = Nevada National Security Site; PDCF = Pit Disassembly Conversion Facility; PF-4 = Plutonium Facility; SQN = Sequoyah Nuclear Plant; SRS = Savannah River Site; STA = secure transportation asset; WIPP = Waste Isolation Pilot Plant.

^a For waste shipments, the totals include construction and operations activities.

^b Risk is expressed in terms of LCFs, except for the nonradiological risk, where it refers to the number of traffic accident fatalities. Radiological risk is calculated for one-way travel while nonradiological risk is calculated for two-way travel. Accident dose-risk can be calculated by dividing the risk values by 0.0006 (DOE 2002c). The values are rounded to one non-zero digit.

^c Includes impacts from WSB and MFFF operations.

^d Includes impacts from further processing at the WSB, metal oxidation at MFFF, and MFFF.

^e Includes impacts from further processing at K-Area, H-Canyon/HB-Line, WSB, metal oxidation at MFFF, and MFFF.

^f For purposes of analysis, it was assumed that the generic commercial nuclear power reactor would be located at the Hanford Reservation, Washington to maximize the distance traveled in order to envelope impacts related to shipping to other possible commercial nuclear power reactor sites. Only shipments of BWR fuel are analyzed because there would be a greater number of shipments to a BWR reactor than a PWR reactor, thus providing a conservative analysis of the distance traveled per alternative that would cover a smaller number of PWR shipments to a generic commercial nuclear power reactor for the same amount of unirradiated MOX fuel, should shipments be made to a PWR.

Note: To convert kilometers to miles, multiply by 0.62137.

Table E-8 Risks of Transporting Radioactive Material and Waste – MOX Fuel Alternative ^a

Route	Transport Mode	Number of Shipments	One-way Kilometers Traveled (million)	Incident-Free				Accident	
				Crew		Population		Radiological Risk ^b	Non-radiological Risk ^b
				Dose (person-rem)	Risk ^b	Dose (person-rem)	Risk ^b		
PDCF at F-Area at SRS ^c									
All STA routes	STA	1,400	2.9	65	0.04	78	0.05	2×10^{-6}	0.08
SRS to WIPP	Truck	1,600	3.9	150	0.09	72	0.04	1×10^{-6}	0.2
SRS to NNSS – LLW	Truck	430	1.7	34	0.02	13	0.008	1×10^{-7}	0.08
PDC ^c									
All STA routes	STA	1,400	2.9	65	0.04	78	0.05	2×10^{-6}	0.08
SRS to WIPP	Truck	1,600	3.9	150	0.09	73	0.04	1×10^{-6}	0.2
SRS to NNSS – LLW	Truck	430	1.7	34	0.02	13	0.008	1×10^{-7}	0.08
SRS to NNSS – MLLW	Truck	13	0.050	1.2	0.0007	0.81	0.0005	7×10^{-9}	0.002
PF-4 at LANL and MFFF at SRS ^d									
All STA routes	STA	1,700	2.0	28	0.02	47	0.03	3×10^{-5}	0.06
LANL to WIPP	Truck	150	0.087	3.3	0.002	1.8	0.001	4×10^{-9}	0.003
LANL to NNSS – LLW	Truck	320	0.40	7.9	0.005	3.3	0.002	7×10^{-9}	0.008
SRS to WIPP	Truck	1,400	3.3	130	0.08	62	0.04	1×10^{-6}	0.2
SRS to NNSS – LLW	Truck	430	1.7	34	0.02	13	0.008	1×10^{-7}	0.08
PF-4 at LANL, and H-Canyon/HB-Line and MFFF at SRS ^e									
All STA routes	STA	1,600	2.1	34	0.02	50	0.03	2×10^{-5}	0.06
LANL to WIPP	Truck	120	0.072	2.7	0.002	1.5	0.0009	4×10^{-9}	0.002
LANL to NNSS – LLW	Truck	260	0.33	6.5	0.004	2.7	0.002	6×10^{-9}	0.006
SRS to WIPP	Truck	1,400	3.5	140	0.08	66	0.04	1×10^{-6}	0.2
SRS to NNSS – LLW	Truck	430	1.7	34	0.02	13	0.008	1×10^{-7}	0.08
SRS to NNSS – MLLW	Truck	1	0.0039	0.094	0.00006	0.062	0.00004	5×10^{-10}	0.0002
H-Canyon/HB-Line to WIPP – 2 Metric Tons (2.2 Tons)									
SRS to WIPP, including use of POCs	Truck	430	1.0	40	0.02	19	0.01	4×10^{-7}	0.06
SRS to WIPP, including use of CCCs and HUFPS ^f	Truck	170	0.42	15	0.009	7.5	0.005	7×10^{-7}	0.03
PF-4 at LANL (2 Metric Tons [2.2 Tons] Processing)									
All STA routes	STA	26	0.060	0.58	0.0003	1.3	0.0008	1×10^{-6}	0.002
LANL to WIPP	Truck	9	0.0054	0.20	0.0001	0.11	0.00007	3×10^{-10}	0.0002
LANL to NNSS – LLW	Truck	16	0.0020	0.40	0.0002	0.17	0.0001	4×10^{-10}	0.0004

Route	Transport Mode	Number of Shipments	One-way Kilometers Traveled (million)	Incident-Free				Accident	
				Crew		Population		Radiological Risk ^b	Non-radiological Risk ^b
				Dose (person-rem)	Risk ^b	Dose (person-rem)	Risk ^b		
Other Transports									
Portsmouth to AREVA (48G containers)	Truck	180	0.69	1.6	0.001	3.5	0.002	2×10^{-5}	0.04
Portsmouth to AREVA (30B containers)	Truck	210	0.78	8.5	0.005	13	0.008	2×10^{-5}	0.04
AREVA to SRS (DUO ₂)	Truck	45	0.19	4.6	0.003	2.7	0.002	3×10^{-5}	0.01
AREVA to SRS (DUNH)	Truck	6	0.026	0.62	0.0004	0.36	0.0002	2×10^{-5}	0.001
SRS to SQN	STA	570	0.29	3.3	0.002	4.6	0.003	1×10^{-7}	0.005
SRS to BFN	STA	2,300	1.7	17	0.01	28	0.02	3×10^{-7}	0.03
SRS to Generic Reactor ^g	STA	4,500	20	190	0.1	370	0.2	2×10^{-6}	0.4
Totals									
PDCF with TVA Reactors	-	7,200	13	320	0.2	240	0.1	0.00009	0.6
PDCF/CCC option with TVA Reactors	-	7,000	13	300	0.2	220	0.1	0.00009	0.5
PDC with TVA Reactors	-	7,200	13	330	0.2	240	0.1	0.00009	0.6
PDC/CCC option with TVA Reactors	-	7,000	13	300	0.2	230	0.1	0.00009	0.6
PF-4/MFFF with TVA Reactors	-	7,700	12	280	0.2	200	0.1	0.0001	0.5
PF-4/MFFF/CCC option with TVA Reactors	-	7,400	12	250	0.2	190	0.1	0.0001	0.5
PF-4/H-Canyon/HB-Line/MFFF with TVA Reactors	-	7,600	12	290	0.2	200	0.1	0.0001	0.6
PF-4/H-Canyon/HB-Line/MFFF/CCC option with TVA Reactors	-	7,400	12	260	0.2	190	0.1	0.0001	0.5
PDCF with Generic Reactor	-	8,800	31	500	0.3	570	0.3	0.00009	1
PDCF/CCC option with Generic Reactor	-	8,600	30	470	0.3	560	0.3	0.00009	0.9
PDC with Generic Reactor	-	8,900	31	500	0.3	580	0.3	0.00009	1
PDC/CCC option with Generic Reactor	-	8,600	31	480	0.3	560	0.3	0.00009	0.9
PF-4/MFFF with Generic Reactor	-	9,300	30	450	0.3	540	0.3	0.0001	0.9
PF-4/MFFF/CCC option with Generic Reactor	-	9,100	29	420	0.3	520	0.3	0.0001	0.9
PF-4/H-Canyon/HB-Line/MFFF with Generic Reactor	-	9,300	30	460	0.3	540	0.3	0.0001	0.9
PF-4/H-Canyon/HB-Line/MFFF/CCC option with Generic Reactor	-	9,000	30	440	0.3	530	0.3	0.0001	0.9
PDCF	-	4,300	11	310	0.2	200	0.1	0.00009	0.6
PDCF/CCC option	-	4,100	11	280	0.2	190	0.1	0.00009	0.5
PDC	-	4,400	11	310	0.2	210	0.1	0.00009	0.6
PDC/CCC option	-	4,100	11	290	0.2	190	0.1	0.00009	0.5
PF-4/MFFF	-	4,800	10	260	0.2	170	0.1	0.0001	0.5
PF-4/MFFF/CCC option	-	4,600	9.6	230	0.1	150	0.09	0.0001	0.5
PF-4/H-Canyon/HB-Line/MFFF	-	4,800	10	270	0.2	170	0.1	0.0001	0.5
PF-4/H-Canyon/HB-Line/MFFF/CCC option	-	4,500	9.8	250	0.1	160	0.1	0.0001	0.5

Route	Transport Mode	Number of Shipments	One-way Kilometers Traveled (million)	Incident-Free				Accident	
				Crew		Population		Radiological Risk ^b	Non-radiological Risk ^b
				Dose (person-rem)	Risk ^b	Dose (person-rem)	Risk ^b		

AREVA = AREVA fuel fabrication facility; BFN = Browns Ferry Nuclear Plant; CCC = criticality control container; DUNH = depleted uranyl nitrate, hexahydrate; DUO₂ = depleted uranium oxide; HUFPP = Hanford Unirradiated Fuel Package; LANL = Los Alamos National Laboratory; LLW = low-level radioactive waste; MFFF = Mixed Oxide Fabrication Facility; MLLW = mixed low-level radioactive waste; MOX = mixed oxide; NNSS = Nevada National Security Site; PDC = Pit Disassembly and Conversion Project; PDCF = Pit Disassembly Conversion Facility; PF-4 = Plutonium Facility; POCs = pipe overpack containers; SQN = Sequoyah Nuclear Plant; SRS = Savannah River Site; STA = secure transportation asset; TVA = Tennessee Valley Authority; WIPP = Waste Isolation Pilot Plant.

^a For waste shipments, the totals include construction and operations activities.

^b Risk is expressed in terms of LCFs, except for the nonradiological risk, where it refers to the number of traffic accident fatalities. Radiological risk is calculated for one-way travel while nonradiological risk is calculated for two-way travel. Accident dose-risk can be calculated by dividing the risk values by 0.0006 (DOE 2002c). The values are rounded to one non-zero digit.

^c Includes impacts from WSB and MFFF operations.

^d Includes impacts from further processing at the WSB, Metal oxidation at MFFF, and MFFF.

^e Includes impacts from further processing at K-Area, H-Canyon/HB-Line, WSB, metal oxidation at MFFF, and MFFF.

^f For the use of CCCs and HUFPPs, non-pit plutonium waste would be packaged in CCCs and not in POCs, reducing the number of shipments. HUFPPs would be used to transport FFTF unirradiated fuel instead of repackaging the fuel in POCs. This option is only applicable to the MOX Fuel Alternative, WIPP disposal option, and the WIPP Alternative.

^g For purposes of analysis, it was assumed that the generic commercial nuclear power reactor would be located at the Hanford Reservation, Washington to maximize the distance traveled in order to envelope impacts related to shipping to other possible commercial nuclear power reactor sites. Only shipments of BWR fuel are analyzed because there would be a greater number of shipments to a BWR reactor than a PWR reactor, thus providing a conservative analysis of the distance traveled per alternative that would cover a smaller number of PWR shipments to a generic commercial nuclear power reactor for the same amount of unirradiated MOX fuel, should shipments be made to a PWR.

Note: To convert kilometers to miles, multiply by 0.62137.

Table E-9 Risks of Transporting Radioactive Material and Waste – H-Canyon/HB-Line to DWPF Alternative ^a

Route	Transport Mode	Number of Shipments	One-way Kilometers Traveled (million)	Incident-Free				Accident	
				Crew		Population		Radiological Risk ^b	Non-radiological Risk ^b
				Dose (person-rem)	Risk ^b	Dose (person-rem)	Risk ^b		
PDCF at F-Area at SRS ^c									
All STA routes	STA	1,400	2.9	65	0.04	78	0.05	2×10^{-6}	0.08
SRS to WIPP	Truck	1,500	3.7	140	0.09	70	0.04	1×10^{-6}	0.2
SRS to NNSS – LLW	Truck	440	1.7	34	0.02	14	0.008	1×10^{-7}	0.08
PDC ^c									
All STA routes	STA	1,400	2.9	65	0.04	78	0.05	2×10^{-6}	0.08
SRS to WIPP	Truck	1,500	3.8	150	0.09	71	0.04	1×10^{-6}	0.2
SRS to NNSS – LLW	Truck	440	1.7	34	0.02	14	0.008	1×10^{-7}	0.08
SRS to NNSS – MLLW	Truck	13	0.050	1.2	0.0007	0.81	0.0005	7×10^{-9}	0.002
PF-4 at LANL and MFFF at SRS ^d									
All STA routes	STA	1,700	2.0	28	0.02	47	0.03	3×10^{-5}	0.06
LANL to WIPP	Truck	150	0.087	3.3	0.002	1.8	0.001	4×10^{-9}	0.003
LANL to NNSS – LLW	Truck	320	0.40	7.9	0.005	3.3	0.002	7×10^{-9}	0.008
SRS to WIPP	Truck	1,300	3.2	120	0.07	59	0.04	1×10^{-6}	0.2
SRS to NNSS – LLW	Truck	440	1.7	34	0.02	14	0.008	1×10^{-7}	0.08
PF-4 at LANL, and H-Canyon/HB-Line and MFFF at SRS ^e									
All STA routes	STA	1,600	2.1	34	0.02	50	0.03	2×10^{-5}	0.06
LANL to WIPP	Truck	120	0.072	2.7	0.002	1.5	0.0009	4×10^{-9}	0.002
LANL to NNSS – LLW	Truck	260	0.33	6.5	0.004	2.7	0.002	6×10^{-9}	0.006
SRS to WIPP	Truck	1,400	3.5	130	0.08	65	0.04	1×10^{-6}	0.2
SRS to NNSS – LLW	Truck	440	1.7	34	0.02	14	0.008	1×10^{-7}	0.08
SRS to NNSS – MLLW	Truck	1	0.0039	0.094	0.00006	0.062	0.00004	5×10^{-10}	0.0002
PF-4 at LANL (2 Metric Tons Processing)									
All STA routes	STA	26	0.060	0.58	0.0003	1.3	0.0008	1×10^{-6}	0.002
LANL to WIPP	Truck	9	0.0054	0.20	0.0001	0.11	0.00007	3×10^{-10}	0.0002
LANL to NNSS – LLW	Truck	16	0.0020	0.40	0.0002	0.17	0.0001	4×10^{-10}	0.0004
H-Canyon/HB-Line and DWPF									
SRS to WIPP	Truck	87	0.21	8.2	0.005	4.0	0.002	7×10^{-8}	0.01
SRS to NNSS – MLLW	Truck	2	0.0078	0.19	0.0001	0.13	0.00007	1×10^{-9}	0.0004

Route	Transport Mode	Number of Shipments	One-way Kilometers Traveled (million)	Incident-Free				Accident	
				Crew		Population		Radiological Risk ^b	Non-radiological Risk ^b
				Dose (person-rem)	Risk ^b	Dose (person-rem)	Risk ^b		
Other Transports									
Portsmouth to AREVA (48G containers)	Truck	170	0.63	1.5	0.0009	3.2	0.002	2×10^{-5}	0.03
Portsmouth to AREVA (30B containers)	Truck	190	0.71	7.8	0.005	12	0.007	2×10^{-5}	0.04
AREVA to SRS (DUO ₂)	Truck	41	0.17	4.2	0.003	2.5	0.001	3×10^{-5}	0.01
AREVA to SRS (DUNH)	Truck	5	0.021	0.51	0.0003	0.30	0.0002	2×10^{-5}	0.001
SRS to Sequoyah Nuclear Plant	STA	500	0.25	2.9	0.002	4.0	0.002	1×10^{-7}	0.004
SRS to Browns Ferry Nuclear Plant	STA	2,100	1.5	15	0.009	25	0.02	3×10^{-7}	0.03
SRS to Generic Reactor ^f	STA	4,100	18	180	0.1	340	0.2	2×10^{-6}	0.4
Totals									
PDCF with TVA Reactors	-	6,500	12	280	0.2	210	0.1	0.00008	0.5
PDC with TVA Reactors	-	6,600	12	290	0.2	220	0.1	0.00008	0.5
PF-4/MFFF with TVA Reactors	-	7,000	11	240	0.1	180	0.1	0.0001	0.5
PF-4/H-Canyon/HB-Line/MFFF with TVA Reactors	-	7,000	11	250	0.1	180	0.1	0.0001	0.5
PDCF with Generic Reactor	-	8,000	28	440	0.3	520	0.3	0.00008	0.9
PDC with Generic Reactor	-	8,000	28	450	0.3	520	0.3	0.00008	0.9
PF-4/MFFF with Generic Reactor	-	8,500	27	390	0.2	480	0.3	0.0001	0.8
PF-4/H-Canyon/HB-Line/MFFF with Generic Reactor	-	8,500	27	410	0.2	490	0.3	0.0001	0.8
PDCF	-	3,900	10	260	0.2	180	0.1	0.00008	0.5
PDC	-	3,900	10	270	0.2	180	0.1	0.00008	0.5
PF-4/MFFF	-	4,400	9.1	210	0.1	140	0.09	0.0001	0.4
PF-4/H-Canyon/HB-Line/MFFF	-	4,400	9.4	230	0.1	150	0.09	0.0001	0.5

AREVA = AREVA fuel fabrication plant; DUNH = depleted uranyl nitrate, hexahydrate; DUO₂ = depleted uranium oxide; DWPF = Defense Waste Processing Facility; LANL = Los Alamos National Laboratory; LLW = low-level radioactive waste; MFFF = Mixed Oxide Fabrication Facility; MLLW = mixed low-level radioactive waste; NNSS = Nevada National Security Site; PDC = Pit Disassembly and Conversion Project; PDCF = Pit Disassembly Conversion Facility; PF-4 = Plutonium Facility; SRS = Savannah River Site; STA = secure transportation asset; TVA = Tennessee Valley Authority; WIPP = Waste Isolation Pilot Plant.

^a For waste shipments, the totals include construction and operations activities.

^b Risk is expressed in terms of LCFs, except for the nonradiological risk, where it refers to the number of traffic accident fatalities. Radiological risk is calculated for one-way travel while nonradiological risk is calculated for two-way travel. Accident dose-risk can be calculated by dividing the risk values by 0.0006 (DOE 2002c). The values are rounded to one non-zero digit.

^c Includes impacts from WSB and MFFF operations.

^d Includes impacts from further processing at the WSB, metal oxidation at MFFF, and MFFF.

^e Includes impacts from further processing at K-Area, H-Canyon/HB-Line, WSB, metal oxidation at MFFF, and MFFF.

^f For purposes of analysis, it was assumed that the generic commercial nuclear power reactor would be located at the Hanford Reservation, Washington to maximize the distance traveled in order to envelope impacts related to shipping to other possible commercial nuclear power reactor sites. Only shipments of BWR fuel are analyzed because there would be a greater number of shipments to a BWR reactor than a PWR reactor, thus providing a conservative analysis of the distance traveled per alternative that would cover a smaller number of PWR shipments to a generic commercial nuclear power reactor for the same amount of unirradiated MOX fuel, should shipments be made to a PWR.

Note: To convert kilometers to miles, multiply by 0.62137.

Table E-10 Risks of Transporting Radioactive Material and Waste – WIPP Alternative ^a

Route	Transport Mode	Number of Shipments	One-way Kilometers Traveled (million)	Incident-Free				Accident	
				Crew		Population		Radiological Risk ^b	Non-radiological Risk ^b
				Dose (person-rem)	Risk ^b	Dose (person-rem)	Risk ^b		
PDCF at F-Area at SRS ^c									
All STA routes	STA	1,400	2.9	65	0.04	78	0.05	2×10^{-6}	0.08
SRS to WIPP	Truck	1,500	3.7	140	0.09	70	0.04	1×10^{-6}	0.2
SRS to NNSS – LLW	Truck	440	1.7	34	0.02	14	0.008	1×10^{-7}	0.08
PDC ^c									
All STA routes	STA	1,400	2.9	65	0.04	78	0.05	2×10^{-6}	0.08
SRS to WIPP	Truck	1,500	3.8	150	0.09	71	0.04	1×10^{-6}	0.2
SRS to NNSS – LLW	Truck	440	1.7	34	0.02	14	0.008	1×10^{-7}	0.08
SRS to NNSS – MLLW	Truck	13	0.050	1.2	0.0007	0.81	0.0005	7×10^{-9}	0.002
PF-4 at LANL and MFFF at SRS ^d									
All STA routes	STA	1,700	2.0	28	0.02	47	0.03	3×10^{-5}	0.06
LANL to WIPP	Truck	150	0.087	3.3	0.002	1.8	0.001	4×10^{-9}	0.003
LANL to NNSS – LLW	Truck	320	0.40	7.9	0.005	3.3	0.002	7×10^{-9}	0.008
SRS to WIPP	Truck	1,400	3.5	130	0.08	65	0.04	1×10^{-6}	0.2
SRS to NNSS – LLW	Truck	440	1.7	34	0.02	14	0.008	1×10^{-7}	0.08
PF-4 at LANL, and H-Canyon/HB-Line and MFFF at SRS ^e									
All STA routes	STA	1,600	2.1	34	0.02	50	0.03	2×10^{-5}	0.06
LANL to WIPP	Truck	120	0.072	2.7	0.002	1.5	0.0009	4×10^{-9}	0.002
LANL to NNSS – LLW	Truck	260	0.33	6.5	0.004	2.7	0.002	6×10^{-9}	0.006
SRS to WIPP	Truck	1,400	3.4	130	0.08	63	0.04	1×10^{-6}	0.2
SRS to NNSS – LLW	Truck	440	1.7	34	0.02	14	0.008	1×10^{-7}	0.08
SRS to NNSS – MLLW	Truck	2	0.0078	0.19	0.0001	0.13	0.00007	1×10^{-9}	0.0004
H-Canyon/HB-Line to WIPP – 6 Metric Tons									
SRS to WIPP, including use of POCs	Truck	1,200	3.0	120	0.07	57	0.03	1×10^{-6}	0.2
SRS to WIPP, including use of CCCs and HUFPS ^f	Truck	560	1.4	52	0.03	25	0.02	1×10^{-6}	0.08
PF-4 at LANL (2 Metric Tons Processing)									
All STA routes	STA	26	0.060	0.58	0.0003	1.3	0.0008	1×10^{-6}	0.002
LANL to WIPP	Truck	9	0.0054	0.20	0.0001	0.11	0.00007	3×10^{-10}	0.0002
LANL to NNSS – LLW	Truck	16	0.0020	0.40	0.0002	0.17	0.0001	4×10^{-10}	0.0004

Route	Transport Mode	Number of Shipments	One-way Kilometers Traveled (million)	Incident-Free				Accident	
				Crew		Population		Radiological Risk ^b	Non-radiological Risk ^b
				Dose (person-rem)	Risk ^b	Dose (person-rem)	Risk ^b		
Other Transports									
Portsmouth to AREVA (48G containers)	Truck	170	0.63	1.5	0.0009	3.2	0.002	2×10^{-5}	0.03
Portsmouth to AREVA (30B containers)	Truck	190	0.71	7.8	0.005	12	0.007	2×10^{-5}	0.04
AREVA to SRS (DUO ₂)	Truck	41	0.17	4.2	0.003	2.5	0.001	3×10^{-5}	0.01
AREVA to SRS (DUNH)	Truck	5	0.021	0.51	0.0003	0.30	0.0002	2×10^{-5}	0.001
SRS to BFN	STA	2,100	1.5	15	0.009	25	0.02	3×10^{-7}	0.03
SRS to Generic Reactor ^g	STA	4,100	18	180	0.1	340	0.2	2×10^{-6}	0.4
Totals									
PDCF with TVA Reactors	-	7,700	15	390	0.2	270	0.2	0.00008	0.7
PDCF/CCC option with TVA Reactors	-	7,000	13	330	0.2	230	0.1	0.00008	0.6
PDC with TVA Reactors	-	7,700	15	400	0.2	270	0.2	0.00008	0.7
PDC/CCC option with TVA Reactors	-	7,000	13	330	0.2	240	0.1	0.00008	0.6
PF-4/MFFF with TVA Reactors	-	8,300	14	360	0.2	230	0.1	0.0001	0.7
PF-4/MFFF/CCC option with TVA Reactors	-	7,600	12	290	0.2	200	0.1	0.0001	0.6
PF-4/H-Canyon/HB-Line/MFFF with TVA Reactors	-	8,100	14	360	0.2	230	0.1	0.0001	0.7
PF-4/H-Canyon/HB-Line/MFFF/CCC option with TVA Reactors	-	7,400	12	290	0.2	200	0.1	0.0001	0.6
PDCF with Generic Reactor	-	9,200	31	550	0.3	570	0.3	0.00008	1
PDCF/CCC option with Generic Reactor	-	8,500	29	490	0.3	540	0.3	0.00008	0.9
PDC with Generic Reactor	-	9,200	31	560	0.3	580	0.3	0.00008	1
PDC/CCC option with Generic Reactor	-	8,500	30	490	0.3	540	0.3	0.00008	0.9
PF-4/MFFF with Generic Reactor	-	9,800	30	510	0.3	540	0.3	0.0001	1
PF-4/MFFF/CCC option with Generic Reactor	-	9,100	29	450	0.3	510	0.3	0.0001	0.9
PF-4/H-Canyon/HB-Line/MFFF with Generic Reactor	-	9,600	30	520	0.3	540	0.3	0.0001	1
PF-4/H-Canyon/HB-Line/MFFF/CCC option with Generic Reactor	-	8,900	29	450	0.3	510	0.3	0.0001	0.9
PDCF	-	5,100	13	370	0.2	230	0.1	0.00008	0.7
PDCF/CCC option	-	4,400	11	310	0.2	200	0.1	0.00008	0.6
PDC	-	5,100	13	380	0.2	240	0.1	0.00008	0.7
PDC/CCC option	-	4,400	11	310	0.2	200	0.1	0.00008	0.6
PF-4/MFFF	-	5,700	12	330	0.2	200	0.1	0.0001	0.6
PF-4/MFFF/CCC option	-	5,000	11	270	0.2	170	0.1	0.0001	0.5
PF-4/H-Canyon/HB-Line/MFFF	-	5,500	12	340	0.2	200	0.1	0.0001	0.6
PF-4/H-Canyon/HB-Line/MFFF/CCC option	-	4,800	11	270	0.2	170	0.1	0.0001	0.5

Route	Transport Mode	Number of Shipments	One-way Kilometers Traveled (million)	Incident-Free				Accident	
				Crew		Population		Radiological Risk ^b	Non-radiological Risk ^b
				Dose (person-rem)	Risk ^b	Dose (person-rem)	Risk ^b		

AREVA = AREVA fuel fabrication facility; BFN = Browns Ferry Nuclear Plant; CCC = criticality control container; DUNH = depleted uranyl nitrate, hexahydrate; DUO₂ = depleted uranium oxide; HUFPP = Hanford Unirradiated Fuel Package; LANL = Los Alamos National Laboratory; LLW = low-level radioactive waste; MFFF = Mixed Oxide Fabrication Facility; MLLW = mixed low-level radioactive waste; NNSS = Nevada National Security Site; PDC = Pit Disassembly and Conversion Project; PDCF = Pit Disassembly and Conversion Facility; PF-4 = Plutonium Facility; POC = pipe overpack container; SRS = Savannah River Site; STA = secure transportation asset; TVA = Tennessee Valley Authority; WIPP = Waste Isolation Pilot Plant.

^a For waste shipments, the totals include construction and operations activities.

^b Risk is expressed in terms of LCFs, except for the nonradiological risk, where it refers to the number of traffic accident fatalities. Radiological risk is calculated for one-way travel while nonradiological risk is calculated for two-way travel. Accident dose-risk can be calculated by dividing the risk values by 0.0006 (DOE 2002c). The values are rounded to one non-zero digit.

^c Includes impacts from WSB and MFFF operations.

^d Includes impacts from further processing at the WSB, metal oxidation at MFFF, and MFFF.

^e Includes impacts from further processing at K-Area, H-Canyon/HB-Line, WSB, metal oxidation at MFFF, and MFFF.

^f For the use of CCCs and HUFPPs, non-pit plutonium waste would be packaged in CCCs and not in POCs, reducing the number of shipments. HUFPPs would be used to transport FFTF unirradiated fuel instead of repackaging the fuel in POCs. This option is only applicable to the MOX Fuel Alternative, WIPP disposal option, and the WIPP Alternative.

^g For purposes of analysis, it was assumed that the generic commercial nuclear power reactor would be located at the Hanford Reservation, Washington to maximize the distance traveled in order to envelope impacts related to shipping to other possible commercial nuclear power reactor sites. Only shipments of BWR fuel are analyzed because there would be a greater number of shipments to a BWR reactor than a PWR reactor, thus providing a conservative analysis of the distance traveled per alternative that would cover a smaller number of PWR shipments to a generic commercial nuclear power reactor for the same amount of unirradiated MOX fuel, should shipments be made to a PWR.

Note: To convert kilometers to miles, multiply by 0.62137.

Comparison of Tables E-6 through E-10 indicates that the WIPP Alternative would have a higher radiological risk to the population during incident-free transportation than the other alternatives due to the greater number of shipments if transport of unirradiated MOX fuel is not considered. For all alternatives, if transport of unirradiated MOX fuel to TVA reactors is considered, the incident-free radiological risks would only slightly increase. If unirradiated MOX fuel is transported to other commercial nuclear power reactors in the United States, then these shipments would comprise up to about 30 percent of the total incident-free radiological risk to the population from all transports under each alternative, although there likely would not be an LCF.

The MOX Fuel Alternative would have the greatest radiological accident risk among the alternatives because this alternative would require the largest number of shipments of depleted uranium from the Portsmouth Gaseous Diffusion Plant to AREVA, and from AREVA to SRS, assuming no transport of unirradiated MOX fuel. The transport of unirradiated MOX fuel would have about the same radiological accident risk for all of the alternatives.

Nonradiological accident risks (the potential for fatalities as a direct result of traffic accidents) present the greatest risks, with an estimate of up to 1 fatality if transport of unirradiated MOX fuel to reactors somewhere in the United States is included. Considering the transportation activities analyzed in this EIS would occur over a 40-year period and the average number of traffic fatalities in the United States is about 40,000 per year (DOT 2006), the traffic fatality risk under all alternatives would be very small. See Section E.13.5 for further discussion of accident fatality rates.

If HUFs were used to transport unirradiated FFTF fuel and CCCs were used to transport non-pit plutonium to WIPP as transuranic waste, there would be a reduction in transportation risks for incident-free transport. There would be a negligible increase in radiological accident risks, with the accident risks for either option being about 1×10^{-6} LCFs, or about 1 chance in 1 million under the WIPP Alternative.

DOE is pursuing approval of applications for two different types of Type B packages that would allow doubling of the plutonium content in each of the packages. If approved, then the number of shipments of plutonium materials to WIPP in POCs could be reduced by half. This reduction in the number of shipments would reduce the risks associated with incident-free transport by half. The total radiological accident risk over all shipments of this type would remain the same. The maximum reasonably foreseeable accident consequences shown in Table E-12 would double for shipments to WIPP, assuming the full inventory in a Type B package is released, but the likelihood shown in Table E-12 would be reduced by half.

If highly enriched uranium metal were transported back to SRS from LANL for processing in the H-Canyon/HB-Line, then the per-shipment risks for this material would be enveloped by the per-shipment risks associated with the transport of pieces/parts from SRS to LANL and the transport of plutonium oxide from LANL to SRS.

The risks to various exposed individuals under incident-free transportation conditions have been estimated for the hypothetical exposure scenarios identified in Section E.5.3. The maximum estimated doses to workers and the public MEIs are presented in **Table E-11**, considering all shipment types. Doses are presented on a per-event basis (person-rem per event, per exposure, or per shipment), because it is generally unlikely that the same person would be exposed to multiple events. For those individuals that could have multiple exposures, the cumulative dose could be calculated. The maximum dose to a crew member is based on the assumption that the same individual is responsible for driving every shipment for the duration of the campaign. Note that the potential exists for larger individual exposures under one-time events of a longer duration. For example, the maximum dose to a person stuck in traffic next to a shipment of low-level radioactive waste for 1 hour is calculated to be 0.015 rem (15 millirem). This is generally considered a one-time event for that individual, although this individual may encounter another exposure of a similar or longer duration in his/her lifetime. An inspector inspecting the conveyance and

its cargo would be exposed to a maximum dose rate of 0.018 rem (or 18 millirem) per hour if the inspector stood within 1 meter of the cargo for the duration of the inspection.

Table E–11 Estimated Dose to Maximally Exposed Individuals Under Incident-Free Transportation Conditions

<i>Receptor</i>	<i>Dose to Maximally Exposed Individual</i>
Workers	
Crew member (truck driver)	2 rem per year ^a
Inspector	0.019 rem per event per hour of inspection
Public	
Resident (along the truck route)	2.6×10^{-7} rem per event
Person in traffic congestion	0.0081 rem per event per one hour stop
Person at a rest stop/gas station	0.00024 rem per event per hour of stop
Gas station attendant	0.00053 rem per event

^a In addition to complying with DOT requirements, a DOE employee would also need to comply with 10 CFR Part 835 that limits worker radiation doses to 5 rem per year; however, DOE’s goal is to maintain radiological exposure as low as reasonably achievable. DOE has therefore established the Administrative Control Level of 2 rem per year (DOE-STD-1098-2008). Based on the number of commercial shipments and the total crew dose to 2 drivers in Tables E–6 to E–10, a commercial driver would not exceed this administrative control limit; therefore, the administrative control limit is reflected in Table E–11 for the maximally exposed truck crew member.

A member of the public residing along the route would likely receive multiple exposures from passing shipments. The cumulative dose to this resident is calculated by assuming all shipments pass his or her home. The cumulative dose is calculated assuming that the resident is present for every shipment and is unshielded at a distance of 30 meters (about 98 feet) from the route. Therefore, the cumulative dose depends on the number of shipments passing a particular point and is independent of the actual route being considered. If one assumes the maximum resident dose provided in Table E–11 for all waste transport types, then the maximum dose to this resident, if all the materials were shipped via this route, would be about 2 millirem, with a risk of developing an LCF of about 1.3×10^{-6} . This dose corresponds to that for truck shipments under the WIPP Alternative, which includes up to an estimated 9,800 shipments over about a 40-year period.

The accident risk assessment and the impacts shown in Tables E–6 through E–10 takes into account the entire spectrum of potential accidents, from the fender-bender to the extremely severe. To provide additional insight into the severity of accidents in terms of the potential dose to a MEI and the public, an accident consequence assessment has been performed for a maximum reasonably foreseeable hypothetical transportation accident with a likelihood of occurrence greater than 1 in 10 million per year.

The following assumptions were used to estimate the consequences of maximum reasonably foreseeable offsite transportation accidents:

- The accident is the most severe with the highest release fraction (high-impact and high-temperature fire accident [highest severity category]).
- The individual is 100 meters (330 feet) downwind from a ground release accident.
- The individual is exposed to airborne contamination for 2 hours and ground contamination for 24 hours with no interdiction or cleanup. A stable weather condition (Pasquill Stability Class F) with a wind speed of 1 meter per second (2.2 miles per hour) is assumed.
- The population is assumed to have a uniform density to a radius 80 kilometers (50 miles) and to be exposed to the entire plume passage and 7 days of ground exposure without interdiction and cleanup. A neutral weather condition (Pasquill Stability Class D) with a wind speed of 4 meters per second (8.8 miles per hour) is assumed. Because the consequence is proportional to the

population density, the accident is assumed to occur in an urban⁶ area with the highest density (see Table E-1).

- The type and number of containers involved in the accident is listed in Table E-2. When multiple Type B or shielded Type A shipping casks are transported in a shipment, a single cask is assumed to have failed in the accident. It is unlikely that a severe accident would breach multiple casks.

Table E-12 provides the estimated dose and potential LCFs that could result for an individual and population from a maximum foreseeable truck transportation accident with the highest consequences under each alternative. (Only those accidents with a probability greater than 1×10^{-7} per year are analyzed.) The accident is assumed to be a severe impact in conjunction with a long fire duration. The highest consequences for the maximum foreseeable accident based on population dose are from accidents occurring in a suburban area involving the transport of plutonium oxide powder from LANL to SRS.

Table E-12 Estimated Dose to the Population and to Maximally Exposed Individuals Under the Maximum Reasonably Foreseeable Accident

Transport Mode	Material or Waste in the Accident With the Highest Consequences	Applicable Alternatives	Range of Likelihood of the Accident (per year) ^a	Population Zone	Population ^b		MEI ^c	
					Dose (person-rem)	LCF	Dose (rem)	LCF
STA transport from Pantex	Pits	All	5.6×10^{-7} to 7.0×10^{-7}	suburban	83	0.05	0.070	4×10^{-5}
Truck transport to WIPP	Pit weapons-grade TRU waste in a TRUPACT II	All	3.2×10^{-7} to 3.3×10^{-7}	urban	8.7	0.005	0.0011	6×10^{-7}
Truck transport to WIPP	Non-pit KIS TRU waste in a TRUPACT II	H-Canyon/ HB-Line to DWPF, WIPP ^d	8.3×10^{-8} to 1.9×10^{-7}	suburban	1.6	0.001	0.0014	9×10^{-7}
Truck transport to WIPP	Processed non-pit plutonium as TRU waste in POCs	MOX Fuel, WIPP	3.2×10^{-7} to 4.5×10^{-7}	urban	210	0.1	0.025	2×10^{-5}
Truck transport to Browns Ferry	BWR MOX Fuel	All except No Action ^e	4.6×10^{-7} to 5.4×10^{-7}	suburban	4.1	0.002	0.0035	2×10^{-6}
Truck transport to Generic Reactors	BWR MOX Fuel	All	2.8×10^{-6} to 3.3×10^{-6}	suburban	4.0	0.002	0.0035	2×10^{-6}
Truck transport to NNSS	LLW in B-25s	All	4.3×10^{-7} to 5.0×10^{-7}	suburban	0.015	9×10^{-6}	0.000012	7×10^{-9}
Truck transport to AREVA	Depleted uranium hexafluoride in 30B containers	All	2.1×10^{-7} to 2.4×10^{-7}	suburban	620	0.4	0.64	4×10^{-4}
Truck transport to AREVA	Depleted uranium hexafluoride in 48G containers	All	1.8×10^{-7} to 2.1×10^{-7}	suburban	750	0.4	0.78	5×10^{-4}
Truck transport to WIPP	Processed non-pit TRU waste in criticality control containers	MOX Fuel, WIPP	9.9×10^{-8} to 1.8×10^{-7}	urban	450	0.3	0.055	4×10^{-5}
STA transport to SRS	Plutonium oxide powder in a Type B package	All except No Action ^e	4.3×10^{-8} to 2.0×10^{-7}	suburban	6,300	4	4.3	3×10^{-3}

AREVA = AREVA fuel fabrication facility; BWR = boiling water reactor; DWPF = Defense Waste Processing Facility; LCF = latent cancer fatality; LLW = low-level radioactive waste; MEI = maximally exposed individual; MOX = mixed oxide fuel; NNSS = Nevada National Security Site; Pantex = Pantex Plant; POC = pipe overpack container; SRS = Savannah River Site; STA = safeguards transporter; TRU = transuranic; TRUPACT-II = Transuranic Package Transporter Model 2; WIPP = Waste Isolation Pilot Plant.

^a The likelihood shown is the range of likelihood estimated among the alternatives given the number of shipments over a specific time period.

^b Population extends at a uniform density to a radius of 80 kilometers (50 miles). The weather condition was assumed to be Pasquill Stability Class D with a wind speed of 4 meters per second (8.8 miles per hour).

^c The MEI is assumed to be 100 meters (330 feet) downwind from the accident and exposed to the entire plume of the radioactive release. The weather condition is assumed to be Pasquill Stability Class F with a wind speed of 1 meter per second (2.2 miles per hour).

^d While these shipments would occur under the MOX Fuel Alternative, the likelihood of an accident in a suburban area would be less than 1 in 10 million per year.

^e For the No Action Alternative, the likelihood of an accident in a suburban area would be less than 1 in 10 million per year.

⁶ If the likelihood of an accident in an urban area is less than 1-in-10 million per year, then the accident is evaluated for a suburban area.

E.8 Impact of Hazardous Waste and Construction and Operational Material Transport

This section evaluates the impacts of transporting hazardous wastes, as well as materials required to construct new facilities. For construction materials, it was assumed that these materials would be transported 50 kilometers (31 miles) one way. Hazardous wastes were assumed to be transported about 2,000 kilometers (1,240 miles). The truck accident and fatality rates that were assumed for construction materials were 7.69 accidents per 10 million truck-kilometers travelled and 4.08 fatalities per 100 million truck-kilometers travelled (Saricks and Tompkins 1999; UMTRI 2003), which is reflective of transportation in South Carolina. The truck accident and fatality rates that were assumed for transport of hazardous materials were 5.77 accidents per 10 million truck-kilometers travelled and 2.34 fatalities per 100 million truck-kilometers travelled (Saricks and Tompkins 1999; UMTRI 2003), which is reflective of the national mean. **Tables E–13 and E–14** summarize the impacts in terms of total number of kilometers, accidents, and fatalities for all alternatives. The results indicate that there would be a smaller risk of traffic accidents and fatalities for the disassembly and conversion options that maximize use of current facilities.

Table E–13 Estimated Impacts of Construction Material Transport

<i>Alternative</i>	<i>Disassembly and Conversion Option</i>	<i>Number of Shipments</i>	<i>Total Distance Traveled (kilometers; two-way)</i>	<i>Number of Accidents</i>	<i>Number of Fatalities</i>
No Action	PDCF	42,000	4,200,000	3.2	0.2
Immobilization to DWPF	PDCF	43,000	4,300,000	3.3	0.2
	PF-4 and MFFF ^a	1,200	120,000	0.09	0.005
	PF-4, H-Canyon/HB-Line, and MFFF ^b	1,200	120,000	0.09	0.005
MOX Fuel	PDCF	42,000	4,200,000	3.2	0.2
	PDC	43,000	4,300,000	3.3	0.2
	PF-4 and MFFF ^a	0	0	0	0
	PF-4, H-Canyon/HB-Line, and MFFF ^b	0	0	0	0
H-Canyon/HB-Line to DWPF	PDCF	42,000	4,200,000	3.2	0.2
	PDC	43,000	4,300,000	3.3	0.2
	PF-4 and MFFF ^a	0	0	0	0
	PF-4, H-Canyon/HB-Line, and MFFF ^b	0	0	0	0
WIPP	PDCF	42,000	4,200,000	3.2	0.2
	PDC	43,000	4,300,000	3.3	0.2
	PF-4 and MFFF ^a	0	0	0	0
	PF-4, H-Canyon/HB-Line, and MFFF ^b	0	0	0	0

DWPF = Defense Waste Processing Facility; MFFF = Mixed Oxide Fabrication Facility; MOX = mixed oxide; PDC = Pit Disassembly and Conversion Project; PDCF = Pit Disassembly and Conversion Facility; PF-4 = Plutonium Facility; WIPP = Waste Isolation Pilot Plant.

^a Under this option, pits would be disassembled at PF-4 at LANL. Pits disassembled at LANL would be converted to an oxide at LANL or using H-Canyon/HB-Line or oxidation furnaces installed at MFFF at SRS.

^b Under this option, pits could be disassembled at PF-4 at LANL or at K-Area at SRS. Pits disassembled at LANL would be converted to an oxide at LANL or SRS. Pits disassembled at K-Area at SRS would be converted to an oxide at SRS at H-Canyon/HB-Line or using oxidation furnaces installed at MFFF at SRS.

Note: To convert from kilometers to miles, multiply by 0.6214.

Table E-14 Estimated Impacts of Hazardous Waste Transport

<i>Alternative</i>	<i>Disassembly and Conversion Option</i>	<i>Number of Shipments</i>	<i>Total Distance Traveled (kilometers; two-way)</i>	<i>Number of Accidents</i>	<i>Number of Fatalities</i>
No Action	PDCF	11	44,000	0.026	0.001
Immobilization to DWPF	PDCF	66	270,000	0.15	0.006
	PF-4 and MFFF ^a	61	250,000	0.14	0.006
	PF-4, H-Canyon/HB-Line, and MFFF ^b	67	270,000	0.16	0.006
MOX Fuel	PDCF	9	40,000	0.021	0.0009
	PDC	440	1,800,000	1.0	0.04
	PF-4 and MFFF ^a	4	16,000	0.009	0.0004
	PF-4, H-Canyon/HB-Line, and MFFF ^b	5	20,000	0.011	0.0005
H-Canyon/ HB-Line to DWPF	PDCF	9	36,000	0.021	0.0009
	PDC	450	1,800,000	1.0	0.04
	PF-4 and MFFF ^a	4	16,000	0.009	0.0004
	PF-4, H-Canyon/HB-Line, and MFFF ^b	5	20,000	0.011	0.0005
WIPP	PDCF	9	36,000	0.021	0.0009
	PDC	450	1,800,000	1.0	0.04
	PF-4 and MFFF ^a	4	16,000	0.009	0.0004
	PF-4, H-Canyon/HB-Line, and MFFF ^b	4	16,000	0.009	0.0004

DWPF = Defense Waste Processing Facility; MFFF = Mixed Oxide Fabrication Facility; MOX = mixed oxide; PDC = Pit Disassembly and Conversion Project; PDCF = Pit Disassembly and Conversion Facility; PF-4 = Plutonium Facility; WIPP = Waste Isolation Pilot Plant.

^a Under this option, pits would be disassembled at PF-4 at LANL. Pits disassembled at LANL would be converted to an oxide at LANL or using H-Canyon/HB-Line or oxidation furnaces installed at MFFF at SRS.

^b Under this option, pits could be disassembled at PF-4 at LANL or at K-Area at SRS. Pits disassembled at LANL would be converted to an oxide at LANL or SRS. Pits disassembled at K-Area at SRS would be converted to an oxide at SRS at H-Canyon/HB-Line or using oxidation furnaces installed at MFFF at SRS.

Note: To convert from kilometers to miles, multiply by 0.6214.

E.9 Chemical Impacts

The chemical nature of depleted uranium and other hazardous chemicals does not pose cargo-related risks to humans during routine transportation-related operations. Transportation operations are generally well regulated with respect to packaging, such that small spills or seepages during routine transport are kept to a minimum and do not result in exposures. Potential cargo-related health risks to humans can occur only if the integrity of a container is compromised during an accident (i.e., if a container is breached). Under such conditions, some chemicals may cause an immediate health threat to exposed individuals, primarily through inhalation exposure (DOE 2004).

The risks from exposure to hazardous chemicals during transportation-related accidents can be either acute (resulting in immediate injury or fatality) or latent (resulting in cancer that would present itself after a latency period of several years). Acute health impacts were evaluated for the accidental release of uranium hexafluoride and uranium dioxide in the *Environmental Impact Statement on the Construction and Operation of a Proposed Mixed Oxide Fuel Fabrication Facility at the Savannah River Site, South Carolina* (NRC 2005:C-7). Latent health impacts from accidental chemical releases were not evaluated because these two chemicals are not considered carcinogenic. The primary exposure route of concern with respect to accidental release of hazardous chemicals would be inhalation. The results indicated that the potential for irreversible adverse effects from chemical exposures would be about 1 in 830 million as a result of MFFF operations. These results would be comparable to the impacts associated with transportation activities in this *SPD Supplemental EIS* because the transport of depleted uranium hexafluoride and uranium dioxide would only be associated with MFFF operations.

Depleted uranyl nitrate hexahydrate (DUNH) would be transported in the form of a liquid in drums from AREVA at Richland, Washington, to SRS for use in MFFF operations. DUNH contains nitric acid and is noncombustible and mildly chemically toxic. DUNH will accelerate the burning of other combustible materials if concentrated or if the water in the liquid evaporates. If involved in a fire, DUNH produces toxic oxides of nitrogen and large quantities of DUNH may explode (ChemicalBook 2010); however, this hazard would be minimized in activities related to the *SPD Supplemental EIS* because this chemical would be transported in small quantities in drums.

E.10 Onsite Transports

Onsite shipment of radioactive materials and wastes at SRS would not affect any members of the public because roads between SRS processing areas are closed to the public; therefore, shipments would only affect onsite workers. Shipments of transuranic waste and low-level and mixed low-level radioactive waste to E-Area are currently conducted as part of site operations with no discernable impact on noninvolved workers. The transport of radioactive materials and wastes under the alternatives is not expected to significantly increase the risk to these workers. As shown in this appendix, the risks from incident-free transport of radioactive waste and materials off site over long distances (hundreds to thousands of kilometers) are very small; therefore, the risks from transporting radioactive waste and materials on site, where distances would be less than 20 kilometers (12 miles) and sometimes less than 5 kilometers (3 miles), would be even smaller. For NNSA STA shipments, onsite roads would be closed during transport, further limiting the risk of noninvolved worker exposure. All involved workers (drivers and escorts) are monitored, and the maximum annual dose to a transportation worker would be administratively limited to 2 rem (10 CFR Part 835, DOE-STD-1098-2008). The potential for a trained radiation worker to develop a fatal latent cancer from the maximum annual exposure is 0.0012 LCFs; therefore, an individual transportation worker is not expected to develop a lifetime latent fatal cancer from exposure during these activities. Impacts associated with accidents during onsite transport of radioactive materials and wastes would be less than the impacts assessed for the bounding accident analyses for the plutonium disposition facilities (see Section 4.1.2.2), as well as the impacts for offsite transports, because of the much shorter distances traveled, onsite security measures, and lower onsite vehicle speeds. Because of these reasons, the impacts of onsite transport of radioactive materials and wastes are not analyzed further in this *SPD Supplemental EIS*.

The number of onsite shipments of materials and wastes is incorporated into the air quality impacts analysis described in Chapter 4, Section 4.1.1. Onsite shipments include transports of pits, metal, and oxides between the storage facility at K-Area and the proposed Pit Disassembly and Conversion Facility (PDCF), Pit Disassembly and Conversion Project (PDC), H-Canyon/HB-Line, and MFFF. SRS resources are assumed to be used to ship materials to MFFF and to and from the Analytical Laboratories in F- and H- Areas. Material is shipped in several possible types of Type B shipping containers loaded onto shipping pallets called either cargo pallet assemblies (CPAs) or Cargo Restraint Transporters (CRTs).

Non-pit plutonium material is packaged in a Type B package for storage. The Type B packages are stored in K-Area storage vaults until enough packages are accumulated for shipment to MFFF. It is assumed that each MFFF shipment consists of 25 packages. Pit disassembly byproducts (pieces/parts) are transported back from the disassembly facility to K-Area for storage until enough packages are accumulated for shipment off site (assumed to be sent to LANL). It is assumed that byproducts are shipped every time 16 packages are accumulated. Highly enriched uranium oxide is placed in a Type B package and transported to K-Area for storage until enough containers are accumulated for shipment off site to the Highly Enriched Uranium Disposition Program (assumed to be at Y-12). This analysis assumes that each highly enriched uranium shipment consists of 25 containers.

In addition to transport of plutonium, pit disassembly and conversion would produce radioactive wastes that would be transported on site to E-Area for further management (the majority of low-level radioactive

waste would be disposed of at E-Area, while transuranic waste, mixed low-level radioactive waste, and hazardous waste would be stored at E-Area prior to offsite transport). Nonradioactive hazardous waste would be disposed of at the Three Rivers Regional Landfill, located at SRS. Transuranic waste, mixed low-level radioactive waste, and hazardous waste are assumed to be transported in 55-gallon drums, with 20 drums per onsite shipment. Low-level radioactive waste is assumed to be transported in B-25 boxes, with 5 boxes per onsite shipment. Solid nonhazardous waste is assumed to be transported in roll-off containers, with 1 container per onsite shipment. The number of offsite shipments is presented in Tables E-6 through E-10.

The following subsections summarize the number of onsite shipments of materials and wastes.

E.10.1 Onsite Shipments Related to Pit Disassembly and Conversion Options

The number of onsite shipments of solid waste related to construction and operation impacts from Disassembly and Conversion Options are presented for all applicable facilities in Tables E-15 and E-16, while the number of shipments associated with transporting plutonium materials are presented below.

Table E-15 Average Annual Number of Onsite Waste Shipments due to Construction and Modifications from Disassembly and Conversion Options^a

Facility	TRU Waste to E-Area	LLW to E-Area	MLLW to E-Area	Hazardous Waste to E-Area	Solid Nonhazardous Waste to Three Rivers Landfill
PDCF	0	0	0	2	8
PDC	1	85	5	160	41
Metal oxidation at MFFF	0	0	0	0	0
H-Canyon/HB-Line	1	1	0	0	0
PF-4 to TA-54, LANL ^b	1	1	1	0	0 ^c

LANL = Los Alamos National Laboratory; LLW = low-level radioactive waste; MFFF = Mixed Oxide Fuel Fabrication Facility; MLLW = mixed low-level radioactive waste; PDC = Pit Disassembly and Conversion Project; PDCF = Pit Disassembly and Conversion Facility; PF-4 = Plutonium Facility; TA = technical area; TRU = transuranic.

^a TRU waste, MLLW, and hazardous waste are assumed to be transported in 55-gallon drums, with 20 drums per shipment.

LLW is assumed to be transported in B-25 boxes, with 5 boxes per shipment. Solid nonhazardous waste is assumed to be transported in a roll-off container, with 1 container per shipment.

^b Radioactive wastes would be transported to TA-54, not to E-Area at SRS. Solid nonhazardous would be transported off site to a solid waste landfill located near LANL.

^c Nonhazardous waste is not tracked at the facility level. Nonhazardous waste would be transported off site from the generating facility.

Table E-16 Pit Disassembly and Conversion Facility Average Annual Number of Onsite Waste Shipments due to Operations from Disassembly and Conversion Options^a

Facility	TRU Waste to E-Area	LLW to E-Area	MLLW to E-Area	Hazardous Waste to E-Area	Solid Nonhazardous Waste to Three Rivers Landfill
PDCF	44	77	0	0	130
PDC	45	78	0	0	130
Metal Oxidation at MFFF	2	1	0	0	0
H-Canyon/HB-Line	28	110	1	0	13,000
PF-4 to TA-54, LANL ^b	14	14	1	0	0

LANL = Los Alamos National Laboratory; LLW = low-level radioactive waste; MFFF = Mixed Oxide Fuel Fabrication Facility; MLLW = mixed low-level radioactive waste; PDC = Pit Disassembly and Conversion Project; PDCF = Pit Disassembly and Conversion Facility; PF-4 = Plutonium Facility; TA = technical area; TRU = transuranic.

^a TRU waste, MLLW, and hazardous waste are assumed to be transported in 55-gallon drums, with 20 drums per shipment.

LLW is assumed to be transported in B-25 boxes, with 5 boxes per shipment. Solid nonhazardous waste is assumed to be transported in a roll-off container, with 1 container per shipment.

^b Transuranic wastes would be transported to TA-54 and not to E-Area at SRS. All other waste streams would be transported off site for disposition.

PDCF in F-Area at SRS

Construction—PDCF would be constructed over an 11-year period. Construction of PDCF would generate hazardous waste and solid nonhazardous waste. Based on Table E–15, there would be no radioactive waste shipments and the majority of the waste would be nonhazardous (sanitary) because the facility would be constructed on a new site.

Operations—The materials processed in PDCF at F-Area include plutonium pits, metals, and certain alternate feedstock materials. All of these materials are stored within a Type B package. The plutonium would be transported to PDCF, where it would be converted to oxide, packaged in Type B packages, and transported back to K-Area for storage. Byproducts and highly enriched uranium would also be returned to K-Area prior to being transported off site for disposition. The resulting plutonium oxide, including alternate feedstock materials that do not require processing in PDCF, would then be transported back to MFFF in F-Area.

There would be a total of about 280 to 350 shipments of plutonium from K-Area to PDCF in F-Area for disassembly and conversion, depending on the alternative. About the same number of plutonium oxide shipments would be made back to K-Area to store the plutonium oxide prior to shipment to MFFF, along with about 25 to 30 shipments of byproducts and 130 to 170 shipments of highly enriched uranium. About 340 to 410 shipments would subsequently be made from K-Area to MFFF in F-Area (including all alternate feedstock materials).

Based on Table E–16, there would be annual onsite shipments of transuranic waste and low-level radioactive waste to E-Area, as well as nonhazardous waste to the Three Rivers Landfill.

PDC

Construction—PDC modifications would be accomplished over a 12-year period. Modification of PDC would generate low-level radioactive waste, mixed low-level radioactive waste, and hazardous waste, which would be sent to E-Area, as well as solid nonhazardous waste, which would be transported to the Three Rivers Landfill.

Operations—Modification and operation of a new PDC at K-Area would only occur under the MOX Fuel Alternative, H-Canyon/HB-Line to DWPF Alternative, and WIPP Alternative. The plutonium pits and metals would be transported to PDC for conversion. There would be no intrasite shipments required between PDC and K-Area storage because these facilities would be collocated within K-Area. There would be about 410 plutonium oxide shipments made from K-Area Storage to MFFF in F-Area (including alternate feedstock materials).

Based on Table E–16, there would be annual onsite shipments of transuranic waste, low-level radioactive waste, and nonhazardous waste to the Three Rivers Landfill. Because PDC in K-Area would operate in a similar manner as PDCF in F-Area, it can be assumed that the number of waste shipments would be the same regardless of which facility is used.

Pit Disassembly at LANL TA-55 Area (PF-4)

Construction—Modification activities at the Plutonium Facility (PF-4) would be minor in nature and would cause some transports on site at LANL of transuranic, low-level radioactive, and mixed low-level radioactive waste to Technical Area-54 (TA-54) for storage and eventual shipment off site.

Operations—Pit disassembly at LANL’s PF-4 is another option that could occur under all alternatives, except the No Action Alternative. There would be no onsite shipments of plutonium materials at LANL. Tables E-6 through E-10 show the number of intersite transports that would occur from Pantex to LANL, LANL to SRS, and LANL to Y-12. It is assumed that plutonium shipments from LANL would arrive at K-Area for storage prior to transport to MFFF. The same number of transports from K-Area storage to MFFF would occur under this option as presented for the PDC Option discussed above.

Onsite waste shipments at LANL would be limited to transuranic waste, low-level radioactive waste, and hazardous waste. The number of onsite transuranic waste shipments at LANL would be about a third of the number of the same shipments that would occur at SRS if PDC or PDCF were used.

Pit Disassembly at LANL PF-4 in Combination with H-Canyon/HB-Line at SRS and MFFF at SRS

Construction—The number of onsite shipments at LANL related to modifying PF-4 would be the same as that identified under “Pit Disassembly at LANL TA-55 Area (PF-4)” above. If plutonium materials are dissolved in H-Canyon/HB-Line, existing process lines could be used with few modifications. The number of onsite shipments of waste from these modification activities would be expected to fall within the number of onsite shipments from H-Canyon/HB-Line that currently occur. Similarly, the number of onsite shipments from MFFF due to the addition of oxidation furnaces would not measurably increase above what would currently be expected from construction of MFFF.

Operations—Under this option, plutonium metals would be transported to H-Canyon/HB-Line for processing and oxidation. Pits would be disassembled and converted at LANL PF-4 and at K-Area. Under this option, it is possible to produce highly enriched uranium oxides as the final products in the H-Canyon/HB-Line. If the plutonium products from LANL are in metal forms, then they would be sent to SRS for oxidation; otherwise, they would be directly sent to the K-Area storage facility prior to being transported to MFFF. Oxidation could occur at H-Canyon/HB-Line or in furnaces at MFFF.

No intrasite transport of plutonium materials would occur at LANL. At SRS, up to about 410 shipments of plutonium materials (including certain feedstock materials) would occur from K-Area storage to MFFF. Up to about 60 shipments of plutonium material could be transported to H-Canyon/HB-Line for processing.

For onsite waste shipments, the total number of annual shipments can be obtained from Table E-16, including the shipments related to metal oxidation at MFFF, H-Canyon/HB-Line, and PF-4.

E.10.2 Onsite Shipments Related to Disposition Options

The number of onsite shipments of solid waste related to construction and operation impacts are presented for all applicable facilities in **Tables E-17** and **E-18**, while the number of shipments associated with transporting plutonium materials are presented in Section E.10.1.

Table E–17 Average Annual Number of Onsite Waste Shipments due to Construction and Modifications for Disposition Options ^a

<i>Facility</i>	<i>TRU Waste to E-Area</i>	<i>LLW to E Area</i>	<i>MLLW to E-Area</i>	<i>Hazardous Waste to E-Area</i>	<i>Solid Nonhazardous Waste to Three Rivers Landfill</i>
Immobilization Capability to E-Area	0	33	5	5	28
DWPF to E-Area	0	0	0	0	0
MFFF to E-Area	0	0	0	0	0
H-Canyon/HB-Line to E-Area	0	0	0	0	0
H-Canyon/HB-Line to E-Area (WIPP)	1	0	0	0	0

DWPF = Defense Waste Processing Facility; LLW = low-level radioactive waste; MFFF = Mixed Oxide Fuel Fabrication Facility; MLLW = mixed low-level radioactive waste; TRU = transuranic; WIPP = Waste Isolation Pilot Plant.

^a TRU waste, MLLW, and hazardous waste are assumed to be transported in 55-gallon drums, with 20 drums per shipment. LLW is assumed to be transported in B-25 boxes, with 5 boxes per shipment. Solid nonhazardous waste is assumed to be transported in a roll-off container, with 1 container per shipment.

Table E–18 Average Annual Number of Onsite Waste Shipments due to Operations for Disposition Options ^a

<i>Facility</i>	<i>TRU Waste to E-Area</i>	<i>LLW to E-Area</i>	<i>MLLW to E-Area</i>	<i>Hazardous Waste to E-Area</i>	<i>Solid Nonhazardous Waste to Three Rivers Landfill</i>
Immobilization Capability to E-Area	120	20	20	20	3
DWPF to E-Area	0	1	0	0	0
MFFF to E-Area	66	35	0	1	66
H-Canyon/HB-Line to E-Area	0	0	0	0	0
H-Canyon/HB-Line to E-Area (WIPP)	170	8	0	0	0

DWPF = Defense Waste Processing Facility; LLW = low-level radioactive waste; MFFF = Mixed Oxide Fuel Fabrication Facility; MLLW = mixed low-level radioactive waste; TRU = transuranic; WIPP = Waste Isolation Pilot Plant.

^a TRU waste, MLLW, and hazardous waste are assumed to be transported in 55-gallon drums, with 20 drums per shipment. LLW is assumed to be transported in B-25 boxes, with 5 boxes per shipment. Solid nonhazardous waste is assumed to be transported in a roll-off container, with 1 container per shipment.

Immobilization and DWPF

Construction—Low-level and mixed low-level radioactive waste and hazardous waste shipments would be required from K-Area to E-Area. In addition, there would be shipments of nonhazardous waste to the Three Rivers Landfill. Facility modifications at DWPF would be expected to be minimal to process can-in-canisters; therefore, no transport of waste materials would be expected.

Operation—If up to 13.1 metric tons (14.4 tons) of surplus plutonium is immobilized, then a total of up to about 95 can-in-canisters would be generated, requiring an equal number of shipments from K-Area to DWPF.

For immobilization capability operations, transuranic waste, low-level and mixed low-level radioactive waste, and hazardous waste would require transport from K-Area to E-Area, as shown in Table E–18, while nonhazardous waste would require shipments from K-Area to the Three Rivers Landfill. There would be an annual shipment of low-level radioactive waste from DWPF to E-Area.

MOX Fuel Fabrication with Use in Commercial Nuclear Power Reactors

Construction—Construction of MFFF is not considered in this *SPD Supplemental EIS*. Modifications in H-Canyon/HB-Line to process plutonium material for conversion to MOX fuel at MFFF would not be extensive and would not be expected to generate enough wastes to increase the overall number of waste shipments from H-Canyon/HB-Line.

Operation—Annual transports of transuranic and low-level radioactive waste would be required from MFFF in F-Area to E-Area. Nonhazardous waste also would be annually transported from F-Area to the Three Rivers Landfill.

H-Canyon/HB-Line and DWPF

Construction—There would be no construction or facility modification activities required at H-Canyon/HB-Line and DWPF that would generate any waste types above what is currently generated.

Operation—In performing these operations under the H-Canyon/HB-Line to DWPF Alternative, additional waste generation would be minimal and can be assumed to fall within the quantities normally generated by operations at H-Canyon/HB-Line and DWPF. However, H-Canyon/HB-Line operations may need to be extended beyond 2019 to support conversion of plutonium material to an oxide; therefore, annually, there would be waste shipments beyond 2019 that would be equal to current practices.

WIPP Disposal

Construction—A transuranic waste shipment would be required annually from H-Area to E-Area due to modifications made in H-Canyon/HB-Line to prepare plutonium material for transport to WIPP.

Operation—Use of H-Canyon/HB-Line for preparing plutonium material would generate transuranic and low-level radioactive waste.

E.10.3 Onsite Shipments Related to Support Activities

Support facilities include K-Area storage, K-Area Interim Surveillance, WSB, and E-Area. Transport of plutonium materials from K-Area storage is described in Section E.10.1. No construction or modification activities are considered in this *SPD Supplemental EIS* for the support facilities. Radioactive waste would be generated by K-Area Interim Surveillance and WSB operations, as shown in **Table E-19**. There would be no waste shipments associated with K-Area storage or E-Area.

Table E-19 Average Annual Number of Onsite Waste Shipments due to Operations of Support Facilities^a

Facility	TRU Waste to E-Area	LLW to E-Area	MLLW to E-Area	Hazardous Waste to E-Area	Solid Nonhazardous Waste to Three Rivers Landfill
KIS to E-Area	0	2	0	0	1
WSB to E-Area	50	25	0	0	18

KIS = K-Area Interim Surveillance; LLW = low-level radioactive waste; MLLW = mixed low-level radioactive waste; TRU = transuranic; WSB = Waste Solidification Building.

^a TRU waste, MLLW, and hazardous waste are assumed to be transported in 55-gallon drums, 20 drums per shipment. LLW is assumed to be transported in B-25 boxes, 5 boxes per shipment. Solid nonhazardous waste is assumed to be transported in a roll-off container, 1 container per shipment.

E.11 Conclusions

Based on the results presented in the previous sections, the following conclusions have been reached (see Tables E–6 to E–10):

- For all alternatives, it is unlikely that the transportation of radioactive material and waste would cause an additional fatality as a result of radiation, either from incident-free operation or postulated transportation accidents.
- The highest risk to the public due to incident-free transportation would be under the WIPP Alternative, where up to 9,800 truck shipments of radioactive materials, wastes, and unirradiated MOX fuel would be transported to and/or from SRS (see Table E–10).
- Transporting unirradiated FFTF fuel in HUFPS and using criticality control containers to transport non-pit plutonium as transuranic waste to WIPP would not significantly change transportation risks.
- The nonradiological accident risks (the potential for fatalities as a direct result of traffic accidents) present greater risks than the radiological accident risks. Implementation of any of the alternatives could result in a traffic fatality, if shipment of unirradiated MOX fuel is included. Considering the transportation activities would occur over a period of about 40 years and the average number of traffic fatalities in the United States is about 40,000 per year, the traffic fatality risks under all alternatives are very small.

E.12 Long-term Impacts of Transportation

The *Yucca Mountain EIS* (DOE 2002a, 2008) analyzed the cumulative impacts of the transportation of radioactive material, consisting of impacts of historical shipments of radioactive waste and used nuclear fuel, reasonably foreseeable actions that include transportation of radioactive material, and general radioactive material transportation that is not related to a particular action. The collective dose to the general population and workers was the measure used to quantify cumulative transportation impacts. This measure of impact was chosen because it may be directly related to the LCFs, using a cancer risk coefficient. **Table E–20** provides a summary of the total worker and general population collective doses from various transportation activities. The table shows that the impacts of this program are small compared with the overall transportation impacts. The total collective worker dose from all types of shipments (the alternatives in this *SPD Supplemental EIS*; historical, reasonably foreseeable actions; and general transportation) was estimated to be about 420,000 person-rem (252 LCFs) for the period from 1943 through 2073 (131 years). The total general population collective dose was estimated to be about 436,000 person-rem (262 LCFs). The majority of the collective dose for workers and the general population is due to the general transportation of radioactive material. Examples of these activities are shipments of radiopharmaceuticals to nuclear medicine laboratories and shipments of commercial low-level radioactive waste to commercial disposal facilities. The total number of LCFs (among the workers and the general population) estimated to result from radioactive material transportation over the period between 1943 and 2073 is about 514, or an average of about 4 LCFs per year. Over this same period (131 years), approximately 73 million people would die from cancer, based on National Center for Health Statistics data. The average annual number of cancer deaths in the United States from 2004 through 2008 is about 560,000, with less than 1 percent fluctuation in the number of cancer fatalities from one year to the next (CDC 2012). The transportation-related LCFs would be 0.0007 percent of the total annual number of LCFs; therefore, this number is indistinguishable from the natural fluctuation in the total annual death rate from cancer.

Table E-20 Cumulative Transportation-Related Radiological Collective Doses and Latent Cancer Fatalities (1943 to 2073)

<i>Category</i>	<i>Collective Worker Dose (person-rem)</i>	<i>Collective General Population Dose (person-rem)</i>
Transportation Impacts in this SEIS^a	240 – 560	180 – 580
Other Nuclear Material Shipments^b		
Site-Specific Historical	49	25
Past, Present, and Reasonably Foreseeable DOE Actions	30,900	36,200
Past, Present, and Reasonably Foreseeable non-DOE Actions ^c	5,480	61,330
General Radioactive Material Transport (1943 to 2073)	384,000	338,000
Total Collective Dose (up to 2073)	420,000	436,000
Total Latent Cancer Fatalities^d	252	262

SEIS = supplemental environmental impact statement.

^a Range of values from Tables E-6 to E-10.

^b The values are rounded. See Chapter 4, Section 4.5.3.7, for more detail regarding how these impacts were derived.

^c Non-DOE activities include operation of four new nuclear fuel manufacturing facilities and operations at two new nuclear power reactors at the Vogtle Electric Generating Plant.

^d Total LCFs are calculated assuming 0.0006 LCFs per rem of exposure (DOE 2002c).

E.13 Uncertainty and Conservatism in Estimated Impacts

The sequence of analyses performed to generate the estimates of radiological risk for transportation includes: (1) determination of the inventory and characteristics, (2) estimation of shipment requirements, (3) determination of route characteristics, (4) calculation of radiation doses to exposed individuals (including estimating of environmental transport and uptake of radionuclides), and (5) estimation of health effects. Uncertainties are associated with each of these steps. Uncertainties exist in the way that the physical systems being analyzed are represented by the computational models; in the data required to exercise the models (due to measurement errors, sampling errors, natural variability, or unknowns caused simply by the future nature of the actions being analyzed); and in the calculations themselves (e.g., approximate algorithms used within the computer codes).

In principle, one can estimate the uncertainty associated with each input or computational source and predict the resultant uncertainty in each set of calculations. Thus, one can propagate the uncertainties from one set of calculations to the next and estimate the uncertainty in the final, or absolute, result; however, conducting such a full-scale quantitative uncertainty analysis is often impractical and sometimes impossible, especially for actions to be initiated at an unspecified time in the future. Instead, the risk analysis is designed to ensure, through uniform and judicious selection of scenarios, models, and input parameters, that relative comparisons of risk among the various alternatives are meaningful. In the transportation risk assessment, this design is accomplished by uniformly applying common input parameters and assumptions to each alternative. Therefore, although considerable uncertainty is inherent in the absolute magnitude of the transportation risk for each alternative, much less uncertainty is associated with the relative differences among the alternatives in a given measure of risk.

In the following sections, areas of uncertainty are discussed for the assessment steps enumerated above. Special emphasis is placed on identifying whether the uncertainties affect relative or absolute measures of risk. The reality and conservatism of the assumptions are addressed. Where practical, the parameters that most significantly affect the risk assessment results are identified.

E.13.1 Uncertainties in Material Inventory and Characterization

The inventories and the physical and radiological characteristics are important input parameters to the transportation risk assessment. The potential number of shipments for all alternatives is primarily based on the projected dimensions of package contents, the strength of the radiation field, and assumptions concerning shipment capacities. The physical and radiological characteristics are important in determining the material released during accidents and the subsequent doses to exposed individuals through multiple environmental exposure pathways.

Uncertainties in the inventory and characterization are reflected in the transportation risk results. If the inventory is overestimated (or underestimated), the resulting transportation risk estimates are also overestimated (or underestimated) by roughly the same factor. However, the same inventory estimates are used to analyze the transportation impacts of each of the alternatives. Therefore, for comparative purposes, the observed differences in transportation risks among the alternatives, as given in Tables E-6 through E-10, are believed to represent unbiased, reasonably accurate estimates from current information in terms of relative risk comparisons.

E.13.2 Uncertainties in Containers, Shipment Capacities, and Number of Shipments

The transportation required for each alternative is based in part on assumptions concerning the packaging characteristics and shipment capacities for commercial trucks. Representative shipment capacities have been defined for assessment purposes based on probable future shipment capacities. In reality, the actual shipment capacities may differ from the predicted capacities such that the projected number of shipments and, consequently, the total transportation risk, would change. However, although the predicted transportation risks would increase or decrease accordingly, the relative differences in risks among alternatives would remain about the same.

E.13.3 Uncertainties in Route Determination

Analyzed routes have been determined between all origin and destination sites considered in this *SPD Supplemental EIS*. The routes have been determined to be consistent with current guidelines, regulations, and practices, but may not be the actual routes that would be used in the future. In reality, the actual routes could differ from the ones that are analyzed with regard to distances and total population along the routes. Moreover, because materials could be transported over an extended time starting at some time in the future, the highway infrastructure and the demographics along routes could change. These effects have not been accounted for in the transportation assessment; however, it is not anticipated that these changes would significantly affect relative comparisons of risk among the alternatives considered in this *SPD Supplemental EIS*.

E.13.4 Uncertainties in the Calculation of Radiation Doses

The models used to calculate radiation doses from transportation activities introduce a further uncertainty in the risk assessment process. Estimating the accuracy or absolute uncertainty of the risk assessment results is generally difficult. The accuracy of the calculated results is closely related to the limitations of the computational models and to the uncertainties in each of the input parameters that the model requires. The single greatest limitation facing users of RADTRAN, or any computer code of this type, is the scarcity of data for certain input parameters. Populations (off-link and on-link) along the transportation routes, shipment surface dose rates, and individuals residing near the routes are the most uncertain data in dose calculations. In preparing these data, one makes assumptions that the off-link population is uniformly distributed; the on-link population is proportional to the traffic density, with an assumed occupancy of two persons per car; the shipment surface dose rate is the maximum allowed dose rate; and a potential exists for an individual to be residing at the edge of the highway. It is clear that not all

assumptions are accurate. For example, the off-link population is mostly heterogeneous, and the on-link traffic density varies widely within a geographic zone (i.e., urban, suburban, or rural). Finally, added to this complexity are the assumptions regarding the expected distance between the public and the shipment at a traffic stop, rest stop, or traffic jam and the afforded shielding.

Uncertainties associated with the computational models are reduced by using state-of-the-art computer codes that have undergone extensive review. Because many uncertainties are recognized but difficult to quantify, assumptions are made at each step of the risk assessment process intended to produce conservative results (i.e., overestimate the calculated dose and radiological risk). Because parameters and assumptions are applied consistently to all alternatives, this model bias is not expected to affect the meaningfulness of relative comparisons of risk; however, the results may not represent risks in an absolute sense.

E.13.5 Uncertainties in Traffic Fatality Rates

Vehicle accident and fatality rates were taken from data provided in *State-Level Accident Rates for Surface Freight Transportation: A Reexamination*, ANL/ESD/TM-150 (Saricks and Tompkins 1999). Truck and rail accident rates were computed for each state based on statistics compiled by the Federal Highway Administration, Office of Motor Carriers and Federal Railroad Administration, from 1994 to 1996. The rates are provided per unit car-kilometers for each state, as well as national average and mean values. In this analysis, route-specific (origin-destination) rates were used.

Finally, it should be emphasized that the analysis was based on accident data for the years 1994 through 1996. While this data may be the best available data, future accident and fatality rates may change as a result of vehicle and highway improvements. The recent U.S. DOT national accident and fatality statistics for large trucks and buses indicates lower accident and fatality rates for recent years compared to those of 1994 through 1996 and earlier statistical data (DOT 2009).

E.14 References

CDC (Center for Disease Control and Prevention), 2012, *Deaths, Percent of Total Deaths, and Death Rates for the 15 Leading Causes of Death in 5-Year Age Groups, by Race and Sex, United States, 1999–2008*, National Center for Health Studies (accessed June 4, 2012, <http://www.cdc.gov/nchs/mortality/lcwk1.htm>), March 30.

Census (U.S. Census Bureau), 2010, *Resident Population Data, Population Change 1910-2010* (accessed on December 21, 2010, <http://2010.census.gov/2010census/data/apportionment-pop-text.php>).

ChemicalBook, 2010, *Uranyl Nitrate Hexahydrate*, CAS Number 13520-83-7 (available at <http://www.chemicalbook.com/>).

DOE (U.S. Department of Energy), 1994, *Airborne Release Fractions/Rates and Respirable Fractions for Nonreactor Nuclear Facility*, DOE-HDBK-3010-94, (Change Notice No. 1, March 2000), Washington, DC, December.

DOE (U.S. Department of Energy), 1996, *Final Environmental Impact Statement on a Proposed Nuclear Weapons Nonproliferation Policy Concerning Foreign Research Reactor Spent Nuclear Fuel*, DOE/EIS-0218, Office of Environmental Management, Washington, DC, February.

DOE (U.S. Department of Energy), 1997, *Waste Isolation Pilot Plant Disposal Phase Final Supplemental Environmental Impact Statement*, DOE/EIS-0026-S-2, Carlsbad Area Office, Carlsbad, New Mexico, September.

DOE (U.S. Department of Energy), 1999, *Surplus Plutonium Disposition Final Environmental Impact Statement*, DOE/EIS-0283, Office of Fissile Materials Disposition, Washington, DC.

DOE (U.S. Department of Energy), 2002a, *Final Environmental Impact Statement for a Geological Repository for the Disposal of Spent Nuclear Fuel and High-Level Radioactive Waste at Yucca Mountain, Nye County, Nevada*, DOE/EIS-0250, Office of Civilian Radioactive Waste Management, Yucca Mountain Site Characterization Office, North Las Vegas, Nevada, February.

DOE (U.S. Department of Energy), 2002b, *A Resource Handbook on DOE Transportation Risk Assessment*, DOE/EM/NTP/HB-01, Office of Environmental Management, National Transportation Program, Albuquerque, New Mexico, July.

DOE (U.S. Department of Energy), 2002c, *Memorandum: Radiation Risk Estimation from Total Effective Dose Equivalents (TEDEs)*, Office of Environmental Policy and Guidance: EH-412 Peterson 6-9640, August 9.

DOE (U.S. Department of Energy), 2003, *Final West Valley Demonstration Project Waste Management Environmental Impact Statement*, DOE/EIS-0337F, West Valley Area Office, West Valley, New York, December.

DOE (U.S. Department of Energy), 2004, *Final Environmental Impact Statement for Construction and Operation of a Depleted Uranium Hexafluoride Conversion Facility at Portsmouth, Ohio, Site*, DOE/EIS-0360, Office of Environmental Management, June.

DOE (U.S. Department of Energy), 2008, *Final Supplemental Environmental Impact Statement for a Geologic Repository for the Disposal of Spent Nuclear Fuel and High-Level Radioactive Waste at Yucca Mountain, Nye County, Nevada*, DOE/EIS-0250F-S1, Office of Civilian Radioactive Waste Management, Las Vegas, Nevada, June.

DOE (U.S. Department of Energy), 2009, Environmental Management Packaging and Transportation, Office of Environmental Management (available at <http://www.doe.gov/pages/transpotation.aspx?>), May 15.

DOT (U.S. Department of Transportation), 2000, *Comprehensive Truck Size and Weight Study – Volume I, Summary Report*, FHWA-PL-00-029, Federal Highway Administration, August 19.

DOT (U.S. Department of Transportation), 2006, *Traffic Safety Facts 2004, Young Drivers*, DOT HS 809 919, National Highway Traffic Safety Administration, National Center for Statistics and Analysis, Washington, DC, January.

DOT (U.S. Department of Transportation), 2008, *Radioactive Material Regulations Review*, Pipeline and Hazardous Materials Safety Administration, December.

DOT (U.S. Department of Transportation), 2009, *Large Truck and Bus Crash Facts 2007*, FMCSA-RRA-09-029, Analysis Division Federal Motor Carrier Safety Administration, January.

DHS (U.S. Department of Homeland Security), 2008a, *National Response Framework*, January.

DHS (U.S. Department of Homeland Security), 2008b, *Nuclear/Radiological Incident Annex*, June.

Johnson, P. E., and R. D. Michelhaugh, 2003, *Transportation Routing Analysis Geographic Information System (TRAGIS) – User’s Manual*, ORNL/NTRC-006, Rev. 0, Oak Ridge National Laboratory, National Transportation Research Center, Oak Ridge, Tennessee, June.

NRC (U.S. Nuclear Regulatory Commission), 1977, *Final Environmental Impact Statement on the Transportation of Radioactive Materials by Air and Other Modes*, NUREG-0170, Office of Standards Development, Washington, DC, December.

NRC (U.S. Nuclear Regulatory Commission), 1987, *Shipping Container Response to Severe Highway and Railway Accident Conditions*, NUREG/CR-4829, Office of Nuclear Regulatory Research, Washington, DC, February.

NRC (U.S. Nuclear Regulatory Commission), 2000, *Reexamination of Spent Fuel Shipping Risk Estimates*, NUREG/CR-6672, Office of Nuclear Material Safety and Safeguards, Washington, DC, March.

NRC (U.S. Nuclear Regulatory Commission), 2005, *Environmental Impact Statement on the Construction and Operation of a Proposed Mixed Oxide Fuel Fabrication Facility at the Savannah River Site, South Carolina*, NUREG-1767, Office of Nuclear Material Safety and Safeguards, Washington, DC, January.

Saricks, C., and M. M. Tompkins, 1999, *State-Level Accident Rates for Surface Freight Transportation: A Reexamination*, ANL/ESD/TM-150, Argonne National Laboratory, Energy Systems Division, Center for Transportation Research, Argonne, Illinois, April.

SNL (Sandia National Laboratories), 2009, *RadCat 3.0 Users Guide*, SAND2009-5129P, Albuquerque, New Mexico and Livermore, California, May.

SRNS (Savannah River Nuclear Solutions, LLC), 2012, *Surplus Plutonium Disposition Supplemental Environmental Impact Statement* Data Call Response, Aiken, South Carolina.

UMTRI (University of Michigan Transportation Research Institute), 2003, “Evaluation of the Motor Carrier Management Information System Crash File, Phase One,” UMTRI-2003-6, Center for National Truck Statistics, Ann Arbor, Michigan, March.

WIPP (Waste Isolation Pilot Plant) 2006, *Waste Isolation Pilot Plant Radiation Safety Manual*, WP 12-5 Rev. 10, Carlsbad, New Mexico, May 22.

Yuan, Y. C., S. Y. Chen, B. M. Biwer, and D. J. LePoire, 1995, *RISKIND - A Computer Program for Calculating Radiological Consequences and Health Risks from Transportation of Spent Nuclear Fuel*, ANL/EAD-1, Argonne National Laboratory, Argonne, Illinois, November.

APPENDIX F
IMPACTS OF PIT DISASSEMBLY AND
CONVERSION OPTIONS

APPENDIX F

IMPACTS OF PIT DISASSEMBLY AND CONVERSION OPTIONS

This appendix to this *Draft Surplus Plutonium Disposition Supplemental Environmental Impact Statement (SPD Supplemental EIS)* addresses impacts from the construction and annual operation of specific facilities at the Savannah River Site (SRS) and Los Alamos National Laboratory (LANL) that may be used for pit disassembly and conversion. The options for pit disassembly and conversion addressed in this appendix may involve the use of multiple facilities at SRS and LANL, and are as follows:

- *PDCF at F-Area at SRS (PDCF Option)* – Pit disassembly and conversion would principally occur at a newly constructed Pit Disassembly and Conversion Facility (PDCF) in F-Area at SRS. In accordance with previous U.S. Department of Energy (DOE) decisions (see below), 2 metric tons (2.2 tons) of plutonium would be disassembled and converted to plutonium oxide at the Plutonium Facility (PF-4) at LANL, and shipped to SRS.
- *PDC at K-Area at SRS (PDC Option)* – Pit disassembly and conversion would principally occur at a newly constructed Pit Disassembly and Conversion Project (PDC) that would be installed in existing buildings in K-Area at SRS. As under the PDCF Option, 2 metric tons (2.2 tons) of plutonium would be disassembled and converted to plutonium oxide at PF-4 at LANL, and shipped to SRS.
- *PF-4 at LANL and MFFF at SRS (PF-4 and MFFF Option)* – Pit disassembly would occur at PF-4 at LANL, with some conversion of plutonium metal to plutonium oxide. Plutonium metal and oxide would be shipped from LANL to the Mixed Oxide Fuel Fabrication Facility (MFFF) at SRS, where the plutonium metal would be oxidized in furnaces installed in MFFF. All plutonium sent to MFFF would be fabricated into mixed oxide (MOX) fuel.
- *PF-4 at LANL and H-Canyon/HB-Line and MFFF at SRS (PF-4, H-Canyon/HB-Line, and MFFF Option)* – Pit disassembly would occur at PF-4 at LANL and at K-Area at SRS. Pits disassembled at LANL would be oxidized at PF-4 and sent to SRS, or sent to SRS in metallic form to be converted to plutonium oxide in metal oxidation furnaces installed in MFFF or at H-Canyon/HB-Line. Pits disassembled at K-Area would be sent to H-Canyon/HB-Line for dissolution in H-Canyon or HB-Line, with plutonium recovery as plutonium oxide at HB-Line and thence to MFFF.¹ All plutonium sent to MFFF would be fabricated into MOX fuel.

Under both the PF-4 and MFFF Option and the PF-4, H-Canyon/HB-Line, and MFFF Option, metal oxidation furnaces could be installed at MFFF during MFFF construction or during MFFF operation.

Under the PF-4, H-Canyon/HB-Line, and MFFF Option, the precise quantities of plutonium that may be addressed among the plutonium facilities at SRS and LANL are not known. Therefore, the analyses for this option are conservatively conducted assuming maximum plutonium throughputs through each SRS and LANL plutonium facility. This assumption results in a conservative level of impacts assessed under this option. Appendix B, Table B-3, provides the plutonium throughputs for each facility.

Details of these pit disassembly and conversion options are provided in Chapter 2, Section 2.1. Appendix B provides descriptions of the facilities that may be used for pit disassembly and conversion. Appendix G addresses impacts from options for plutonium disposition; Appendix H, impacts from the principal support facilities needed for pit disassembly and conversion and plutonium disposition, and

¹ Conversion to plutonium oxide at H-Canyon/HB-Line may include vacuum salt distillation pretreatment in HB-Line to separate plutonium from chloride and fluoride.

Appendix I, impacts from the use of MOX fuel in commercial nuclear power reactors. Chapter 4 addresses the environmental impacts of the *SPD Supplemental EIS* alternatives.

Pit disassembly and conversion of 2 metric tons (2.2 tons) of plutonium at PF-4 at LANL is ongoing, in accordance with previous National Environmental Policy Act (NEPA) decisions reached through the *Final Site-Wide Environmental Impact Statement for Continued Operation of Los Alamos National Laboratory, Los Alamos, New Mexico (DOE/EIS-0380) (LANL SWEIS)* (DOE 2008a) and its Record of Decision (ROD) (75 *Federal Register* [FR] 55833). The minor upgrades to PF-4 to support this activity, currently underway, are summarized in Appendix B, Section B.2.1, and were assessed as part of the *LANL SWEIS* analysis. Impacts from these upgrades are therefore not addressed further in this appendix. Modifications to PF-4 to enable an enhanced pit disassembly and conversion capability (applicable to the PF-4 and MFFF and PF-4, H-Canyon/HB-Line, and MFFF Options), however, could involve modification to or decontamination and decommissioning of several existing gloveboxes, as well as installation of additional gloveboxes (LANL 2012). These modifications are expected to result in minor environmental impacts and are addressed in this appendix. Impacts from operation of PF-4 under all pit disassembly and conversion options are also addressed in this appendix.

F.1 Air Quality

Nonradioactive air pollutant impacts under each pit disassembly and conversion option are evaluated in this section. Radioactive air pollutant impacts are evaluated in Section F.2.

Activities under the pit disassembly and conversion options could result in criteria, hazardous, and toxic air pollutant emissions from facility construction and operation. **Table F-1** shows estimated air pollutant concentrations at site boundaries from construction of, or modifications to, optional pit disassembly and conversion facilities, and compares the concentrations to applicable standards and significance levels. In this table, columns on the left provide impacts on a facility-specific basis, while columns on the right provide combined impacts for one or more facilities as appropriate for each pit disassembly and conversion option.²

Significance levels are concentrations below which no further analysis is necessary for that pollutant for the purpose of permitting. Concentrations above significance levels would need to undergo further analysis to consider the cumulative impacts from other sources within the impact area (EPA 1990:C28; Page 2010a, 2010b; 40 CFR 51.165(b) (2)). Where modeling was performed for this *SPD Supplemental EIS*, current U.S. Environmental Protection Agency (EPA) models were used. For example, the EPA AERMOD dispersion model (EPA 2004) was used unless stated otherwise. As required, updated emissions and concentrations were determined based on information provided in cited references.

The maximum concentration values presented in the tables of this section are the highest 1st-high concentration calculated at a specific receptor, except for the nitrogen dioxide 1-hour values. Use of the highest 1st-high concentration is appropriate for comparison with significance levels. However, use of the highest 1st-high concentration is not appropriate for use with all ambient air quality standards. Ambient air quality standards use different methods for evaluating the number of exceedances allowed before the standard is considered not to be met. The basis for compliance with the 1-hour nitrogen dioxide standard is a 3-year average of the 98th percentile of the daily maximum 1-hour average. EPA guidance (EPA 2011) on demonstrating compliance with the 1-hour nitrogen dioxide National Ambient Air Quality Standards (NAAQS) is to use the eighth-highest of the daily maximum 1-hour value (not the highest 1-hour value) as an unbiased surrogate for the 98th percentile.

² This format is used to present information in several tables throughout this appendix.

Table F-1 Estimated Air Pollutant Concentrations at Site Boundary from Construction of, or Modifications to, Pit Disassembly and Conversion Facilities

Pollutant	Averaging Period	More Stringent Standard for SRS ^a	More Stringent Standard for LANL ^a	Significance Level ^b (micrograms per cubic meter)	Facilities					Pit Disassembly and Conversion Options			
					SRS				LANL	PDCF	PDC	PF-4 and MFFF (SRS/LANL)	PF-4, HC/HBL, and MFFF (SRS/LANL)
					PDCF	PDC	HC/HBL ^c	MFFF ^d	PF-4 ^e				
Criteria Pollutants (micrograms per cubic meter)													
Carbon monoxide	8 hour	10,000	7,900	500	120	73	NC	NC	23	120	73	NC / 23	NC / 23
	1 hour	40,000	11,900	2,000	170	104	NC	NC	33	170	104	NC / 33	NC / 33
Nitrogen dioxide	Annual	100	75	1	0.19	0.01	NC	NC	3.4	0.19	0.01	NC / 3.4	NC / 3.4
	1 hour	188	150	7.5	110	44	NC	NC	69	110	44	NC / 69	NC / 69
PM ₁₀	24 hour	150	150	5	14	0.17	NC	NC	1.6	14	0.17	NC / 1.6	NC / 1.6
PM _{2.5} ^f	Annual	15	15	0.3	0.17	0.0015	NC	NC	0.2	0.17	0.0015	NC / 0.2	NC / 0.2
	24 hour	35	35	1.2	14	0.17	NC	NC	1.6	14	0.17	NC / 1.6	NC / 1.6
Sulfur dioxide	Annual	80	42	1	0.0002	0.001	NC	NC	0.0037	0.0002	0.001	NC / 0.0037	NC / 0.0037
	24 hour	365	209	5	0.02	0.01	NC	NC	0.03	0.02	0.01	NC / 0.03	NC / 0.03
	3 hour	1,300	1,050	25	NR	NR	NC	NC	0.066	NR	NR	NC / 0.066	NC / 0.066
	1 hour	197	152	7.8	0.3	0.2	NC	NC	0.074	0.3	0.2	NC / 0.074	NC / 0.074

HC/HBL = H-Canyon/HB-Line; LANL = Los Alamos National Laboratory; MFFF = Mixed Oxide Fuel Fabrication Facility; NC = no change; PM_n = particulate matter less than or equal to *n* microns in aerodynamic diameter; PDC = Pit Disassembly and Conversion Project; PDCF = Pit Disassembly and Conversion Facility; PF-4 = Plutonium Facility; SRS = Savannah River Site.

^a The more stringent of the Federal and state standards is presented if both exist for the averaging period.

^b EPA 1990; Page 2010a, 2010b; 40 CFR 51.165(b) (2).

^c Optional modifications to H-Canyon/HB-Line to support plutonium conversion to an oxide form, and to the K-Area Complex to install pit disassembly equipment within a glovebox, are expected to result in minimal additional emissions of air pollutants from these operational facilities.

^d Optional installation of metal oxidation furnaces at MFFF is expected to result in minimal air emissions.

^e The listed values are for minor modifications to PF-4 to support pit disassembly and conversion of up to 35 metric tons (38.6 tons) of plutonium.

^f Emissions of PM₁₀ were used to represent PM_{2.5} emissions when PM_{2.5} emission factors were not available (SRNS 2012).

Note: Diesel construction equipment would also emit various hazardous air pollutants and lead. These emissions and resulting concentrations would be small and have not been quantified.

Source: LANL 2012; SRNS 2012; NMAC 20.2.3; 40 CFR Part 50.

Peak year air pollutant emissions from construction of or modification to pit disassembly and conversion facilities at SRS are presented in **Table F–2**, where tabulated concentrations for PDCF are applicable under the PDCF Option; PDC under the PDC Option; PF-4 and MFFF under the PF-4 and MFFF Option; and PF-4, H-Canyon/HB-Line, and MFFF under the PF-4, H-Canyon/HB-Line, and MFFF Option.

Table F–2 Peak Year Air Pollutant Emissions from Construction of, or Modifications to, Pit Disassembly and Conversion Facilities

<i>Pollutant</i>	<i>Facilities (metric tons per year)</i>				
	<i>SRS</i>				<i>LANL</i>
	<i>PDCF</i>	<i>PDC</i>	<i>H-Canyon/HB-Line</i> ^a	<i>MFFF</i> ^b	<i>PF-4 at LANL</i> ^c
Carbon monoxide	35	26	NC	NC	0.12
Nitrogen dioxide	37	20	NC	NC	0.25
PM ₁₀	32	5	NC	NC	0.015
PM _{2.5} ^d	31	4.5	NC	NC	0.015
Sulfur dioxide	0.072	0.044	NC	NC	<0.001
Volatile organic compounds	7.1	4.3	NC	NC	0.034

LANL = Los Alamos National Laboratory; MFFF = Mixed Oxide Fuel Fabrication Facility; NC = no change; N/R = not reported; PM_n = particulate matter less than or equal to *n* microns in aerodynamic diameter; PDC = Pit Disassembly and Conversion Project; PDCF = Pit Disassembly and Conversion Facility; PF-4 = Plutonium Facility; SRS = Savannah River Site.

^a Optional modifications to H-Canyon/HB-Line, and to the K-Area Complex to install pit disassembly equipment within a glovebox, are expected to result in minimal additional emissions of air pollutants from these operational facilities.

^b Optional installation of metal oxidation furnaces at MFFF is expected to result in minimal air emissions.

^c The listed values are based on fuel use data provided in LANL 2012, associated with minor modifications to PF-4 needed to support pit disassembly and conversion of up to 35 metric tons (38.6 tons) of plutonium

^d Emissions of PM₁₀ were used to represent PM_{2.5} emissions when PM_{2.5} emission factors were not available (SRNS 2012).

Source: LANL 2012; SRNS 2012.

The emissions presented in Table F–2 account for fugitive emissions from earth-moving activities, emissions from construction equipment exhaust, and onsite vehicle emissions. Emissions from installation of metal oxidation furnaces in MFFF and modifications to H-Canyon/HB-Line are expected to be minimal and would consist primarily of fugitive dust and nitrogen oxides from portable generators (SRNS 2012). Emissions at LANL from preparing a 2-acre (0.8 hectare) area for a construction trailer and additional parking are also shown in Table F–2 (LANL 2012).

Estimated air pollutant contributions to concentrations at the site boundary from facility operations are presented in **Table F–3**. Sources of air pollutants associated with operations include boilers that provide heating for plutonium management activities. The table includes the most recent estimates of concentrations from operation of PDCF.

Table F-3 Estimated Air Pollutant Concentrations at Site Boundary from Operation of Pit Disassembly and Conversion Facilities

Pollutant	Averaging Period	More Stringent Standard for SRS ^a	More Stringent Standard for LANL ^a	Significance Level ^b (micrograms per cubic meter)	Facilities					Pit Disassembly and Conversion Options			
					SRS				LANL	PDCF	PDC	PF-4 and MFFF (SRS/LANL)	PF-4, HC/HBL and MFFF (SRS/LANL)
					PDCF	PDC	HC/HBL ^c	MFFF ^d	PF-4				
Criteria Pollutants (micrograms per cubic meter)													
Carbon monoxide	8 hour	10,000	7,900	500	14	12.6	NC	NC	NC	14	12.6	NC / NC	NC / NC
	1 hour	40,000	11,900	2,000	67	44.7	NC	NC	NC	67	44.7	NC / NC	NC / NC
Nitrogen dioxide	Annual	100	75	1	0.041	0.042	NC	NC	NC	0.041	0.042	NC / NC	NC / NC
	1 hour	188	150	7.5	116 ^e	73 ^e	NC	NC	NC	250	170	NC / NC	NC / NC
PM ₁₀ ^f	24 hour	150	150	5	0.49	0.61	NC	NC	NC	0.49	0.61	NC / NC	NC / NC
PM _{2.5} ^g	Annual	15	15	0.3	0.001	0.001	NC	NC	NC	0.001	0.001	NC / NC	NC / NC
	24 hour	35	35	1.2	0.33	0.47	NC	NC	NC	0.33	0.47	NC / NC	NC / NC
Sulfur dioxide	Annual	80	42	1	0.0001	0.001	NC	NC	NC	0.0001	0.001	NC / NC	NC / NC
	24 hour	365	209	5	0.009	0.23	NC	NC	NC	0.009	0.23	NC / NC	NC / NC
	3 hour	1,300	1,050	25	NR	NR	NC	NC	NC	NR	NR	NC / NC	NC / NC
	1 hour	197	152	7.8	0.12	3.6	NC	NC	NC	0.12	3.6	NC / NC	NC / NC

HC/HBL = H-Canyon/HB-Line; LANL = Los Alamos National Laboratory; MFFF = Mixed Oxide Fuel Fabrication Facility; NC = no change, NR = not reported; PM_n = particulate matter less than or equal to n microns in aerodynamic diameter; PDC = Pit Disassembly and Conversion Project; PDCF = Pit Disassembly and Conversion Facility; PF-4 = Plutonium Facility; SRS = Savannah River Site.

^a The more stringent of the Federal and state standards is presented if both exist for the averaging period.

^b EPA 1990; Page 2010a, 2010b; 40 CFR 51.165(b) (2).

^c Negligible change in emissions would occur from pit disassembly at the K-Area Complex, or from conversion of plutonium at HC/HBL, from those from current operation of either facility.

^d Plutonium metal would be converted to plutonium oxide using oxidation furnaces installed at MFFF. Emissions from operation of the furnaces would result in negligible change in emissions from the entire MFFF which are presented in Appendix G, Table G-1.

^e 8th-highest maximum 1-hour nitrogen dioxide concentration is presented for comparison to the ambient standard.

^f The PM₁₀ annual standard was revoked by the EPA.

^g Emissions of PM₁₀ were used to represent PM_{2.5} emissions when PM_{2.5} emission factors were not available (SRNS 2012).

Source: SRNS 2012, LANL 2012.

F.1.1 PDCF at F-Area at SRS

Construction—At SRS, construction-related impacts could result from nonradioactive air pollutant emissions from construction of PDCF. PDCF construction activities would emit particulate matter and other pollutants from operation of diesel-powered construction equipment and a concrete batch plant, as well as vehicles. PDCF, as currently designed, would require more land for construction than that analyzed in the *Surplus Plutonium Disposition Final Environmental Impact Statement (SPD EIS)* (DOE 1999). Earthmoving and other construction activities are expected to result in emissions higher than those estimated in the *SPD EIS*. Estimated maximum nonradioactive air pollutant concentrations at the SRS site boundary from construction of PDCF are presented in Table F-1. Exterior activities would result in small quantities of fugitive dust and other emissions from activities such as excavation and paving (SRNS 2012). As shown in Table F-1, the calculated 1-hour nitrogen dioxide, PM₁₀ [particulate matter less than or equal to *n* microns in aerodynamic diameter] 24-hour, and PM_{2.5} 24-hour concentrations for PDCF construction would be greater than the significance levels. Because these concentrations exceed the significance levels, before construction of PDCF could be permitted, additional analysis would be required. At LANL, there would be no new construction at PF-4 that could result in additional nonradioactive air pollutant emissions.

Operations—At SRS, Table F-3 indicates that, except for nitrogen dioxide 1-hour average concentrations, the contributions of PDCF to concentrations of criteria pollutants are below significance levels.

Emissions from diesel generators were included in the air quality impact analyses, and are represented in the results for PDCF in Table F-3. Generators operating less than 250 hours per year are considered insignificant sources and are exempt from Title V permitting (SRNS 2010).

At LANL, there would be no additional emissions of criteria or nonradioactive toxic air pollutants from PF-4 pit disassembly and conversion activities (LANL 2012). This is because operational emissions would be linked primarily to testing of diesel generators for the entire PF-4; this testing would occur essentially independent of pit disassembly and conversion activities at PF-4.

F.1.2 PDC at K-Area at SRS

Construction—At SRS, construction-related impacts could result from nonradioactive air pollutant emissions from construction of PDC. Estimated maximum nonradioactive air pollutant concentrations at the SRS site boundary from PDC construction are presented in Table F-1. With the exception of a 30-acre (12-hectare) construction site, construction of PDC would occur mostly inside the K-Area reactor building. Exterior activities would result in small quantities of fugitive dust and other emissions from activities such as excavation and paving (SRNS 2012). As shown in Table F-1, the calculated 1-hour nitrogen dioxide concentration for PDC construction is greater than the nitrogen dioxide significance level (7.5 micrograms per cubic meter) but less than the ambient air quality standard for SRS (188 micrograms per cubic meter). Because this concentration exceeds the nitrogen dioxide significance level, additional analysis could be required before construction of PDC could be permitted. At LANL, there would be no new construction at PF-4 that could result in additional nonradioactive air pollutant emissions.

Operations—At SRS, Table F-3 indicates that, except for nitrogen dioxide 1-hour average concentrations, the contributions of PDC operations to concentrations of criteria pollutants are below significance levels. Because the 1-hour nitrogen dioxide concentration exceeds the nitrogen dioxide significance level, before operation of PDC could be permitted, additional analysis could be required.

Emissions from diesel generators were included in the air quality impact analyses, and are represented in the results for PDC in Table F-3. An existing emergency diesel generator for the K-Area Complex emits air pollutants. Generators operating less than 250 hours per year are considered insignificant sources and are exempt from Title V permitting (SRNS 2010). Other than emissions from diesel generators, there would be minimal emissions of other nonradioactive air pollutants from operation of PDC. These would include small amounts of fluorides, hydrochloric acid, nickel and nickel oxide, and beryllium and

beryllium oxide (WSRC 2008a; SRNS 2012). Mitigation of air pollutants and protection of workers are discussed in Chapter 4, Sections 4.9.4 and 4.9.6, respectively.

At LANL, as under the PDCF Option (Section F.1.1), there would be no additional emissions of criteria or nonradioactive toxic air pollutants from PF-4 pit disassembly and conversion activities (LANL 2012).

F.1.3 PF-4 at LANL and MFFF at SRS

Construction—At SRS, emissions of nonradioactive air pollutant emissions from installation of metal oxidation furnaces at MFFF are expected to be minimal. At LANL, emissions from preparing a 2-acre (0.8 hectare) area for a construction trailer and additional parking are also shown in Table F–1 and are expected to be minimal with the exception of the 1-hour and annual nitrogen dioxide and 24 hour PM_{2.5} concentrations which are lower than the standards but higher than the significance levels (LANL 2012). Because these concentrations exceed the significance levels, before construction at PF-4 could be permitted, additional analysis could be required.

Operations—At SRS, it is expected that operation of metal oxidation furnaces at MFFF would not contribute incrementally to air pollutant emissions from MFFF; this is because emissions from MFFF are dominated by emissions from periodic testing of diesel generators at MFFF, which would occur regardless of the presence or absence of metal oxidation furnaces at the facility. At LANL, there would be no additional emissions of criteria or nonradioactive toxic air pollutants from PF-4 pit disassembly and conversion activities (LANL 2012). This is because operational emissions would be linked primarily to testing of diesel generators for the entire PF-4; and the test schedule and frequency is not expected to increase with the larger pit disassembly and conversion throughput at PF-4 addressed under this option.

F.1.4 PF-4 at LANL and H-Canyon/HB-Line and MFFF at SRS

Construction—At SRS, emissions from installation of metal oxidation furnaces at MFFF would be the same as those in Section F.1.3 under the PF-4 and MFFF Option. No changes in emissions are projected from the K-Area Complex from installation of pit disassembly equipment, or from modifications to H-Canyon/HB-Line to support pit plutonium conversion to plutonium oxide. At LANL, emissions from modifications to PF-4 would be the same as those in Section F.1.3 under the PF-4 and MFFF Option.

Operations—At SRS, emissions from the K-Area Complex and H-Canyon/HB-Line operations are not expected to change from current levels as a result of the proposed pit disassembly and conversion activities. Emissions from operation of metal oxidation at MFFF would be the same as those in Section F.1.3 under the PF-4 and MFFF Option. At LANL, emissions from pit disassembly and conversion activities would be the same as those in Section F.1.3 under the PF-4 and MFFF Option.

F.2 Human Health

F.2.1 Normal Operations

The following subsections present the potential incident-free radiological impacts on workers and the general public that could occur from each of the pit disassembly and conversion options at SRS and LANL. Human health risks from construction and normal operations are evaluated for individual and population groups, including onsite involved workers, a hypothetical maximally exposed individual (MEI) at the site boundary, and the regional population. Appendix C contains the detailed analysis of human health effects from normal operations.

Tables F–4 and F–5 summarize the potential radiological impacts from operations on involved workers and the general public, respectively, under the pit disassembly and conversion options evaluated in this *SPD Supplemental EIS*. To facilitate a comparison of impacts between these options, the estimated annual doses and latent cancer fatality (LCF) risks over the life of the facilities are presented. Total impacts on workforces and the public over a given facility's operating time frame are presented by multiplying the annual impacts by the projected operating period of the given facility that may be used to support pit disassembly and conversion (See Appendix B, Table B–2). At both SRS and LANL, doses to

actual workers would be monitored and maintained below administrative control levels through the implementation of engineered controls, administrative limits, and ALARA (as low as reasonably achievable) programs.

Table F-4 Potential Radiological Impacts on Involved Workers from Pit Disassembly and Conversion Options

Impact	Facilities					Pit Disassembly and Conversion Options			
	SRS				LANL	PDCF ^d	PDC ^d	PF-4 and MFFF ^d	PF-4, HC/HBL, and MFFF ^d
	PDCF	PDC	HC/HBL ^a	MFFF ^b	PF-4 ^c				
Total Workforce									
Number of radiation workers									
at SRS	383	383	100 / 50	35	–	383	383	35	185
at LANL	–	–	–	–	85 / 253	85	85	253	253
Annual collective dose (person-rem per year)									
at SRS	190	190	29 / 38	2.3	–	190	190	2.3	69
at LANL	–	–	–	–	29 / 190	29	29	190	190
Annual latent cancer fatalities									
at SRS	0 (1 × 10 ⁻¹)	0 (1 × 10 ⁻¹)	0 (2 × 10 ⁻²) / 0 (2 × 10 ⁻²)	0 (1 × 10 ⁻³)	–	0 (1 × 10 ⁻¹)	0 (1 × 10 ⁻¹)	0 (1 × 10 ⁻³)	0 (4 × 10 ⁻²)
at LANL	–	–	–	–	0 (2 × 10 ⁻²) / 0 (1 × 10 ⁻¹)	0 (2 × 10 ⁻²)	0 (2 × 10 ⁻²)	0 (1 × 10 ⁻¹)	0 (1 × 10 ⁻¹)
Life-of-project latent cancer fatalities^e									
at SRS	1 (1.4)	1 (1.4)	0 (0.2) / 0 (0.3)	0 (0.03)	–	1 (1.4)	1 (1.4)	0 (0.03)	1 (0.6)
at LANL	–	–	–	–	0 (0.1) / 3 (2.5)	0 (0.1)	0 (0.1)	3 (2.5)	3 (2.5)
Average Worker									
Annual dose (millirem per year)^f									
at SRS	500	500	290 / 760	65	–	500	500	65	370
at LANL	–	–	–	–	340 / 760	340	340	760	760
Annual latent cancer fatality risk									
at SRS	3 × 10 ⁻⁴	3 × 10 ⁻⁴	2 × 10 ⁻⁴ / 5 × 10 ⁻⁴	4 × 10 ⁻⁵	–	3 × 10 ⁻⁴	3 × 10 ⁻⁴	4 × 10 ⁻⁵	2 × 10 ⁻⁴
at LANL	–	–	–	–	2 × 10 ⁻⁴ / 5 × 10 ⁻⁴	2 × 10 ⁻⁴	2 × 10 ⁻⁴	5 × 10 ⁻⁴	5 × 10 ⁻⁴
Life-of-project latent cancer fatality risk									
at SRS	4 × 10 ⁻³	4 × 10 ⁻³	2 × 10 ⁻³ / 6 × 10 ⁻³	8 × 10 ⁻⁴	–	4 × 10 ⁻³	4 × 10 ⁻³	8 × 10 ⁻⁴	4 × 10 ⁻³
at LANL	–	–	–	–	1 × 10 ⁻³ / 1 × 10 ⁻²	1 × 10 ⁻³	1 × 10 ⁻³	1 × 10 ⁻²	1 × 10 ⁻²

HC/HBL = H-Canyon/HB-Line; LANL = Los Alamos National Laboratory; MFFF = MOX Fuel Fabrication Facility; PDC = Pit Disassembly and Conversion Project; PDCF = Pit Disassembly and Conversion Facility; PF-4 = Plutonium Facility; SRS = Savannah River Site; WIPP = Waste Isolation Pilot Plant.

- ^a Pit disassembly would occur in a K-Area glovebox and dissolution and oxidation would occur at H-Canyon/HB-Line. In the column, the first value addresses impacts at H-Canyon/HB-Line while the second value addresses impacts at the K-Area glovebox.
- ^b Pit conversion would occur in MFFF using metal oxidation furnaces; all plutonium sent to MFFF would be made into MOX fuel.
- ^c The first value is for pit disassembly and conversion of 2 metric tons (2.2 tons) of plutonium at LANL; the second value is for pit disassembly and conversion of 35 metric tons (38.6 tons) of plutonium at LANL.
- ^d The values listed for the PDCF Option are applicable to all alternatives in this *SPD Supplemental EIS*; the values listed for the PDC Option are applicable under the MOX Fuel, H-Canyon/HB-Line to DWPF, and WIPP Alternatives; the values listed for the PF-4 and MFFF and PF-4, H-Canyon/HB-Line, and MFFF Options are applicable under all action alternatives.
- ^e The integer indicates the number of excess latent cancer fatalities expected in the population based on a risk factor of 0.0006 latent cancer fatalities per rem or person-rem (DOE 2003); the values in parentheses are the values calculated using the risk factor.
- ^f Engineering and administrative controls would be implemented to maintain individual worker doses below 2,000 millirem per year, and as low as reasonably achievable (10 CFR Part 835).

Note: Risks are rounded to one significant figure, except that two significant figures are provided for information when the calculated value exceeds one.

– A dash indicates that the facility or option is not relevant at the indicated DOE site.

Source: DOE/NNSA 2012; LANL 2012; SRNS 2012; WSRC 2008a.

Table F-5 Potential Radiological Impacts on the Public from Pit Disassembly and Conversion Options

Impact	Facilities					Pit Disassembly and Conversion Options			
	SRS				LANL	PDCF ^d	PDC ^d	PF-4 and MFFF ^d	PF-4, HC/HBL, and MFFF ^d
	PDCF	PDC	HC/HBL ^a	MFFF ^b	PF-4 ^c				
Population Within 50 Miles (80 Kilometers)									
Annual dose (person-rem)									
at SRS	0.46	0.44	0.26	0.37	–	0.46	0.44	0.37	0.63
at LANL	–	–	–	–	0.025/0.21	0.025	0.025	0.21	0.21
Annual latent cancer fatalities									
at SRS	0 (3 × 10 ⁻⁴)	0 (3 × 10 ⁻⁴)	0 (2 × 10 ⁻⁴)	0 (2 × 10 ⁻⁴)	–	0 (3 × 10 ⁻⁴)	0 (3 × 10 ⁻⁴)	0 (2 × 10 ⁻⁴)	0 (4 × 10 ⁻⁴)
at LANL	–	–	–	–	0 (2 × 10 ⁻⁵) / 0 (1 × 10 ⁻⁴)	0 (2 × 10 ⁻⁵)	0 (2 × 10 ⁻⁵)	0 (1 × 10 ⁻⁴)	0 (1 × 10 ⁻⁴)
Life-of-project latent cancer fatalities^e									
at SRS	0 (3 × 10 ⁻³)	0 (3 × 10 ⁻³)	0 (2 × 10 ⁻³)	0 (4 × 10 ⁻³)	–	0 (3 × 10 ⁻³)	0 (3 × 10 ⁻³)	0 (4 × 10 ⁻³)	0 (6 × 10 ⁻³)
at LANL	–	–	–	–	0 (1 × 10 ⁻⁴) / 0 (3 × 10 ⁻³)	0 (1 × 10 ⁻⁴)	0 (1 × 10 ⁻⁴)	0 (3 × 10 ⁻³)	0 (3 × 10 ⁻³)
Maximally Exposed Individual									
Annual dose (millirem)									
at SRS	0.0055	0.0061	0.0024	0.0041	–	0.0055	0.0061	0.0041	0.0065
at LANL	–	–	–	–	0.0097 / 0.081	0.0097	0.0097	0.081	0.081
Annual latent cancer fatality risk									
at SRS	3 × 10 ⁻⁹	4 × 10 ⁻⁹	1 × 10 ⁻⁹	2 × 10 ⁻⁹	–	3 × 10 ⁻⁹	4 × 10 ⁻⁹	2 × 10 ⁻⁹	4 × 10 ⁻⁹
at LANL	–	–	–	–	6 × 10 ⁻⁹ / 5 × 10 ⁻⁸	6 × 10 ⁻⁹	6 × 10 ⁻⁹	5 × 10 ⁻⁸	5 × 10 ⁻⁸
Life-of-project latent cancer fatality risk									
at SRS	3 × 10 ⁻⁸	4 × 10 ⁻⁸	2 × 10 ⁻⁸	5 × 10 ⁻⁸	–	3 × 10 ⁻⁸	4 × 10 ⁻⁸	5 × 10 ⁻⁸	7 × 10 ⁻⁸
at LANL	–	–	–	–	4 × 10 ⁻⁸ / 1 × 10 ⁻⁶	4 × 10 ⁻⁸	4 × 10 ⁻⁸	1 × 10 ⁻⁶	1 × 10 ⁻⁶
Average Exposed Individual									
Annual dose (millirem)									
at SRS	0.00053	0.00055	0.00029	0.00043	–	0.00053	0.00055	0.00043	0.00072
at LANL	–	–	–	–	5.6 × 10 ⁻⁵ / 4.7 × 10 ⁻⁴	5.6 × 10 ⁻⁵	5.6 × 10 ⁻⁵	4.7 × 10 ⁻⁴	4.7 × 10 ⁻⁴
Annual latent cancer fatality risk									
at SRS	3 × 10 ⁻¹⁰	3 × 10 ⁻¹⁰	2 × 10 ⁻¹⁰	3 × 10 ⁻¹⁰	–	3 × 10 ⁻¹⁰	3 × 10 ⁻¹⁰	3 × 10 ⁻¹⁰	4 × 10 ⁻¹⁰
at LANL	–	–	–	–	3 × 10 ⁻¹¹ / 3 × 10 ⁻¹⁰	3 × 10 ⁻¹¹	3 × 10 ⁻¹¹	3 × 10 ⁻¹⁰	3 × 10 ⁻¹⁰
Life-of-project latent cancer fatality risk									
at SRS	3 × 10 ⁻⁹ to 4 × 10 ⁻⁹	4 × 10 ⁻⁹	2 × 10 ⁻⁹	5 × 10 ⁻⁹	–	3 × 10 ⁻⁹ to 4 × 10 ⁻⁹	4 × 10 ⁻⁹	5 × 10 ⁻⁹	7 × 10 ⁻⁹
at LANL	–	–	–	–	2 × 10 ⁻¹⁰ / 6 × 10 ⁻⁹	2 × 10 ⁻¹⁰	2 × 10 ⁻¹⁰	6 × 10 ⁻⁹	6 × 10 ⁻⁹

HC/HBL = H-Canyon/HB-Line; LANL = Los Alamos National Laboratory; MFFF = Mixed Oxide Fuel Fabrication Facility; PDC = Pit Disassembly and Conversion Project; PDCF = Pit Disassembly and Conversion Facility; PF-4 = Plutonium Facility; SRS = Savannah River Site.

- ^a Pit disassembly would occur in a K-Area glovebox and dissolution and oxidation would occur at H-Canyon/HB-Line. The dominant emissions would be from activities at H-Canyon/HB-Line. Negligible incremental offsite impacts are expected from activities at the K-Area glovebox.
- ^b Pit conversion would occur in MFFF using metal oxidation furnaces; all plutonium sent to MFFF would be made into MOX fuel.
- ^c The first value is for pit disassembly and conversion of 2 metric tons (2.2 tons) of plutonium at LANL; the second value is for pit disassembly and conversion of 35 metric tons (38.6 tons) of plutonium at LANL.
- ^d The values listed in the column for the PDCF Option are applicable to all alternatives in this *SPD Supplemental EIS*; the values listed in the column for the PDC Option are applicable under the MOX Fuel, H-Canyon/HB-Line to DWPF, and WIPP Alternatives; the values listed in the columns for the PF-4 and MFFF and PF-4, H-Canyon/HB-Line, and MFFF Options are applicable under all action alternatives.
- ^e The integer indicates the number of excess latent cancer fatalities that is expected in the population based on the risk factor of 0.0006 latent cancer fatalities per rem or person-rem (DOE 2003); the values in parentheses are the values calculated using the risk factor.

Note: Risks are rounded to one significant figure.
 – A dash indicates that the facility or option is not relevant at DOE or NNSA site.
 Source: DOE/NNSA 2012; LANL 2012; SRNS 2012; WSRC 2008a.

F.2.1.1 PDCF at F-Area at SRS

Construction—At SRS, an annual average of 341 construction workers are estimated for construction of PDCF. These workers are not expected to receive any incremental exposures above those of the general SRS population.

Construction of PDCF would not result in radiological impacts on the general population at the site boundary and beyond.

At LANL, there would be no new construction under this option and therefore no additional radiological impacts on workers or the public.

Operations—At SRS, the collective worker dose under the PDCF Option would be about 190 person-rem per year, with no additional LCFs. Over the life of the project the collective dose to workers would result in 1 (1.4) LCF. The average annual dose per full-time-equivalent worker under this option would be approximately 500 millirem, with a corresponding risk of the worker developing a latent fatal cancer of 3×10^{-4} , or 1 chance in about 3,300. The total LCF risk per full-time-equivalent worker over the life of this option would be about 4×10^{-3} , or 1 chance in 250 of an LCF.

For normal operation of PDCF, the annual population dose would be about 0.46 person-rem. This dose is a small fraction (less than 0.0002 percent) of the dose the same population would receive from natural background radiation. Radiological emissions over the duration of this option are estimated to result in no LCFs in the population surrounding SRS.

The dose for a hypothetical MEI residing at the closest point accessible to the public outside the SRS boundary from 1 year of pit disassembly and conversion operations under this option would be 0.0055 millirem, or about 0.002 percent of the dose from natural background radiation. The annual risk of a latent fatal cancer associated with this dose would be about 3×10^{-9} , or about 1 chance in 330 million. The total risk of a latent fatal cancer to the MEI from the dose received over the life of this option would be up to 3×10^{-8} . In other words, there is less than 1 chance in about 33 million that the MEI would develop a latent fatal cancer from exposures received over the life of the project under this option.

At LANL, the collective worker dose under the PDCF Option would be about 29 person-rem per year, with no additional LCFs. Over the life of the project the collective dose to workers would result in no additional LCFs. The average annual dose per full-time-equivalent worker under this option would be approximately 340 millirem, with a corresponding risk of the worker developing a latent fatal cancer of 2×10^{-4} , or 1 chance in 5,000. The total LCF risk per full-time-equivalent worker over the life of this option would be about 1×10^{-3} , or 1 chance in 1,000 of an LCF.

For normal operation of PF-4, the annual population dose would be about 0.025 person-rem. This dose is a small fraction (less than 0.0001 percent) of the dose the same population would receive from natural background radiation. Radiological emissions over the duration of this option are estimated to result in no LCFs in the population surrounding LANL.

The dose for a hypothetical MEI residing at the closest point accessible to the public outside the LANL boundary from 1 year of pit disassembly and conversion operations under this option would be 0.0097 millirem, or about 0.003 percent of the dose from natural background radiation. The annual risk of a latent fatal cancer associated with this dose would be about 6×10^{-9} , or less than 1 chance in about 170 million. The total risk of a latent fatal cancer to the MEI from the dose received over the life of this option would be 4×10^{-8} . In other words, there is 1 chance in 25 million that the MEI would develop a latent fatal cancer from exposures received over the life of the project under this option.

F.2.1.2 PDC at K-Area at SRS

Construction—At SRS, it is possible that construction of PDC at K-Area could take place within areas that exhibit residual levels of contamination (limited demolition, removal, and decontamination actions

were completed at K-Area in January 2008). PDC construction activities would include 2 years of decontamination and equipment removal from K-Area. The 28 PDC workers involved in decontamination and equipment removal would receive an average annual dose of 18 millirem. This would result in a collective worker dose of 0.5 person-rem per year and a total dose of 1.0 person-rem over 2 years of decontamination and removal. No LCFs among the worker population are expected (calculated value: 6×10^{-4} LCFs).

K-Area construction activities are not expected to result in any radiological impacts on the public.

At LANL, there would be no new construction under this option and therefore no additional radiological impacts on workers or the public.

Operations—At SRS, the collective worker dose under this option would be the same as those in Section F.2.1.1 under the PDCF Option.

For normal operation of PDC, the annual population dose would be about 0.44 person-rem. This dose is a small fraction (about 0.0002 percent) of the dose the same population would receive from natural background radiation. Radiological emissions over the duration of this option are estimated to result in no LCFs in the population surrounding SRS.

The dose for a hypothetical MEI residing at the closest point accessible to the public outside the SRS boundary from 1 year of pit disassembly and conversion operations would be 0.0061 millirem, or about 0.002 percent of the dose from natural background radiation. The annual risk of a latent fatal cancer associated with this dose would be about 4×10^{-9} , or 1 chance in 250 million. The total risk of a latent fatal cancer to the MEI from the dose received over the life of this option would be 4×10^{-8} . In other words, there is 1 chance in 25 million that the MEI would develop a latent fatal cancer from exposures received over the life of the project under this option.

At LANL, doses and risks to workers and the public would be the same as those in Section F.2.1.1 under the PDCF Option.

F.2.1.3 PF-4 at LANL and MFFF at SRS

Construction—At SRS, MFFF would be modified under this option to install metal oxidation furnaces. Approximately 140 construction workers would be involved over an estimated 2.5-year timeframe. Metal oxidation furnaces would be installed in an area set aside in MFFF (i.e., separate from the fuel fabrication operations), so construction workers would not be expected to receive any occupational radiation doses.

At LANL, potential construction activities at PF-4 (e.g., glovebox installations/modifications decontamination and decommissioning, and installation of equipment) are not expected to exceed an annual construction workforce dose of 18 person-rem per year to 60 workers, which equates to an average construction worker dose of 300 millirem per year. The annual risk of a latent fatal cancer associated with this average worker dose would be about 2×10^{-4} , or 1 chance in about 5,000. Over the life of the construction project, the collective worker dose could be up to 140 person-rem. These exposures are not expected to result in any additional LCFs (calculated value: 8×10^{-2} LCFs).

Construction activities at SRS, such as the installation of metal oxidation furnaces at MFFF, would not result in radiological impacts on the public. At LANL, construction activities at PF-4 (e.g., glovebox installations/modifications, decontamination and decommissioning, and installation of equipment) would similarly not result in radiological impacts on the public.

Operations—At SRS, the collective worker dose under this option would be 2.3 person-rem per year, which would result in no annual LCFs among workers. Over the life of the project the collective dose to workers would also result in no LCFs. The average annual dose per full-time-equivalent worker under this option would be approximately 65 millirem at SRS, with a corresponding risk of the worker developing a latent fatal cancer of 4×10^{-5} , or 1 chance in 25,000. The total average LCF risk at SRS per

full-time-equivalent worker over the life of this pit disassembly and conversion option would be about 8×10^{-4} , or 1 chance in 1,250 of an LCF.

For normal operation of metal oxidation furnaces at MFFF, the additional annual population dose would be about 0.37 person-rem. This dose is a small fraction (0.0001 percent) of the dose the same population would receive from natural background radiation. Radiological emissions at SRS over the duration of this pit disassembly and conversion option are estimated to result in no LCFs in the population surrounding SRS.

The dose for a hypothetical MEI residing at the closest point accessible to the public outside the SRS boundary from 1 year of pit disassembly and conversion operations under this option would be 0.0041 millirem, or less than 0.001 percent of the dose from natural background radiation. The annual risk of a latent fatal cancer associated with this dose would be about 2×10^{-9} , or 1 chance in 500 million. The total risk of a latent fatal cancer to the MEI from the dose received over the life of this option would be 5×10^{-8} . In other words, there is 1 chance in 20 million that the MEI would develop a latent fatal cancer from exposures received over the life of the project under this option.

At LANL, the collective worker dose under this option would be about 190 person-rem per year, which would result in no annual LCFs among workers. Over the life of the project the collective dose to workers could result in 3 LCFs. The average annual dose per full-time-equivalent worker under this option would be approximately 760 millirem, with associated corresponding annual risks of the worker developing a latent fatal cancer of about 5×10^{-4} (1 chance in 2,000). The total average LCF risk per full-time-equivalent worker over the life of this pit disassembly and conversion option would be about 1×10^{-2} (1 chance in 100).

For normal operation of PF-4 at LANL, the additional annual population dose under this option would be about 0.21 person-rem. This dose is a small fraction (about 0.00009 percent) of the dose the same population would receive from natural background radiation. Radiological emissions at LANL over the duration of this pit disassembly and conversion option are estimated to result in no LCFs in the population surrounding LANL.

The dose for a hypothetical MEI residing at the closest point accessible to the public outside the LANL boundary from 1 year of pit disassembly and conversion operations under this option would be about 0.081 millirem, or about 0.02 percent of the dose from natural background radiation. The annual risk of a latent fatal cancer associated with this dose would be about 5×10^{-8} , or 1 chance in 20 million. The total risk of a latent fatal cancer to the MEI at LANL from the dose received over the life of this option would be 1×10^{-6} . In other words, there is 1 chance in 1 million that the MEI would develop a latent fatal cancer from exposures received over the life of the project under this option.

F.2.1.4 PF-4 at LANL and H-Canyon/HB-Line and MFFF at SRS

Construction—At SRS, construction workforce doses would result from modifications of gloveboxes at K-Area to enable pit disassembly and at H-Canyon/HB-Line to enhance its existing capability to dissolve and oxidize plutonium for feed to MFFF. Glovebox modification activities at K-Area would result in a collective dose of 2.0 person-rem per year to a construction workforce of 20 workers. Assuming 2 years for glovebox modifications, the collective dose would be about 4.0 person-rem. Doses are not expected to exceed 0.25 person-rem per year to 10 construction workers engaged in activities at H-Canyon/HB-Line (an average dose of 25 millirem per year). Over the 2 years of construction activities at H-Canyon/HB-Line the workforce would receive a collective dose of 0.5 person-rem. The total dose from modification activities at both facilities would be about 4.5 person-rem. No LCFs would be expected (calculated value: 3×10^{-3} LCFs).

Construction efforts in support of adding the metal oxidation furnaces to MFFF would be the same as those discussed in Section F.2.1.3 under the PF-4 and MFFF Option.

At LANL, construction activities at PF-4 in support of proposed pit disassembly and conversion activities would be the same as those in Section F.2.1.3 under the PF-4 and MFFF Option.

At SRS, any potential construction activities, such as the installation of metal oxidation furnaces in MFFF or modification activities at the H-Canyon/HB-Line, would not result in radiological impacts on the public. At LANL, construction activities at PF-4 (e.g., glovebox installations/modifications/decontamination and decommissioning, and installation of equipment) would similarly not result in radiological impacts on the public.

Operations—At SRS, the collective worker dose at SRS for pit disassembly in K-Area gloveboxes, activities in H-Canyon/HB-Line, and operation of the metal oxidation furnaces at MFFF would add 69 person-rem per year. This annual dose would result in no additional LCFs. Over the life of the project the collective dose to workers would also result in no additional LCFs.

The average annual dose per full-time-equivalent worker under this option would be approximately 370 millirem, with a corresponding risk of the worker developing a latent fatal cancer of about 2×10^{-4} , or 1 chance in 5,000. The total LCF risk at SRS per full-time-equivalent worker over the life of this option would be about 4×10^{-3} , or 1 chance in 250 of an LCF.

For normal activities at H-Canyon/HB-Line associated with this option and operation of metal oxidation furnaces at MFFF at SRS, the additional annual population dose would be about 0.63 person-rem. This dose is a small fraction (approximately 0.0002 percent) of the dose the same population would receive from natural background radiation. Radiological emissions at SRS over the duration of this option are estimated to result in no LCFs in the population surrounding SRS.

The dose for a hypothetical MEI residing at the closest point accessible to the public outside the SRS boundary from 1 year of pit disassembly and conversion operations under this option would be 0.0065 millirem, or about 0.002 percent of the dose from natural background radiation. The annual risk of a latent fatal cancer associated with this dose would be about 4×10^{-9} , or 1 chance in 250 million. The total risk of a latent fatal cancer to the MEI at SRS from the dose received over the life of this option would be about 7×10^{-8} . In other words, there is about 1 chance in 14 million that the MEI would develop a latent fatal cancer from exposures received over the life of the project under this option.

At LANL, doses and risks to workers and the public would be the same as those in Section F.2.1.3 under the PF-4 and MFFF Option.

F.2.2 Accidents

The following subsections present the potential impacts on workers and the general public at SRS and LANL associated with possible accidents involving the pit disassembly and conversion options. Human health risks from these accidents are evaluated for several individual and population groups, including noninvolved workers, a hypothetical MEI at the site boundary, and the regional population. **Table F-6** summarizes the potential radiological impacts on the regional population, while **Table F-7** summarizes the potential radiological impacts on the MEI and a noninvolved worker. These impacts are associated with the facilities and processes that would be used under each of the four pit disassembly and conversion options. Impacts are presented as estimated doses and LCF risks from the accidents under consideration (see Appendix D for further details on the accident analysis). Both tables present impacts at PF-4 at LANL assuming pit disassembly and conversion of 35 metric tons (38.6 tons) of plutonium, which would encompass those for pit disassembly and conversion of 2 metric tons (2.2 tons) of plutonium.

Table F-6 Risks to the General Public within 50 Miles (80 kilometers) from Limiting Accidents Associated with Pit Disassembly and Conversion Options

Accident	SRS Facilities								LANL		Pit Disassembly and Conversion Options							
	PDCF		PDC		Metal Oxidation Furnaces at MFFF		H-Canyon/ HB-Line		PF-4 ^a		PDCF		PDC		PF-4 and MFFF		PF-4, H-Canyon/HB-Line, and MFFF	
	Dose (person-rem)	LCFs	Dose (person-rem)	LCFs	Dose (person-rem)	LCFs	Dose (person-rem)	LCFs	Dose (person-rem)	LCFs	Dose (person-rem)	LCFs	Dose (person-rem)	LCFs	Dose SRS/LANL (person-rem)	LCFs SRS/LANL	Dose SRS/LANL (person-rem)	LCFs SRS/LANL
Limiting design-basis accident	240	0.1	110	0.06	0.067	4×10 ⁻⁵	280	0.2	34	0.02	240	0.1	110	0.06	0.067 / 34	0.00004/ 0.02	280 / 34	0.2 / 0.02
Design-basis earthquake with fire (SRS) or with spill plus fire (LANL) ^{b, c}	91	0.05	58	0.03	0.0020	1×10 ⁻⁶	280	0.2	900	0.5	91	0.05	58	.03	0.0020 / 900	0.000001 / 0.5	280 / 900	0.2 / 0.5
Beyond-design-basis earthquake with fire (SRS) or with spill plus fire (LANL) ^{b, c}	7,900	5	6,300	4	670	0.4	15,000	9	3,500	2	7,900	5	6,300	4	670 / 3,500	0.4/ 2	15,000/ 3,500	9 / 2

LANL = Los Alamos National Laboratory; LCF = latent cancer fatality; MFFF = Mixed Oxide Fuel Fabrication Facility; PDC = pit disassembly and conversion Project; PDCF = Pit Disassembly and Conversion Facility; PF-4 = Plutonium Facility; SRS = Savannah River Site.

^a Impacts are assessed for PF-4 assuming pit disassembly and conversion of 35 metric tons (38.6 tons) of plutonium.

^b Doses and risks to the public from design-basis and beyond-design-basis earthquakes with fire are added for the pit disassembly and conversion options across the SRS facilities that may be involved in pit disassembly and conversion.

^c Except for metal oxidation furnaces at MFFF, the bounding design-basis earthquakes at SRS are postulated to initiate fires within the affected facilities. The bounding beyond-design-basis earthquakes at SRS are postulated to initiate fires within all affected facilities. The bounding design-basis and beyond-design-basis earthquakes at LANL are postulated to result in spills of nuclear material at PF-4 followed by fires.

Source: SRNS 2012; LANL 2012.

Table F-7 Risks to the MEI and Noninvolved Worker from Limiting Accidents Associated with Pit Disassembly and Conversion Options

Accident	SRS Facilities									Pit Disassembly and Conversion Options								
	PDCF		PDC		Metal Oxidation Furnaces at MFFF		H-Canyon/ HB-Line		LANL PF-4 ^a		PDCF		PDC		PF-4 and MFFF		PF-4, H-Canyon/ HB-Line, and MFFF	
	Dose (rem)	LCF Risk	Dose (rem)	LCF Risk	Dose (rem)	LCF Risk	Dose (rem)	LCF Risk	Dose (rem)	LCF Risk	Dose (rem)	LCF Risk	Dose (rem)	LCF Risk	Dose SRS/ LANL (rem)	LCF Risk SRS/ LANL	Dose SRS/ LANL (rem)	LCF Risk SRS/ LANL
Maximally Exposed Individual																		
Limiting design-basis accident	0.52	3×10 ⁻⁴	0.33	2×10 ⁻⁴	2.4×10 ⁻⁴	1×10 ⁻⁷	0.41	2×10 ⁻⁴	0.11	7×10 ⁻⁵	0.52	3×10 ⁻⁴	0.33	2×10 ⁻⁴	2.4×10 ⁻⁴ / 0.11	1×10 ⁻⁷ / 7×10 ⁻⁵	0.41/ 0.11	2×10 ⁻⁴ / 7×10 ⁻⁵
DBE with fire (SRS) or with spill plus fire (LANL) ^{b,d}	0.20	1×10 ⁻⁴	0.18	1×10 ⁻⁴	7.2×10 ⁻⁶	4×10 ⁻⁹	0.41	2×10 ⁻⁴	3.8	2×10 ⁻³	0.20	1×10 ⁻⁴	0.18	1×10 ⁻⁴	7.2×10 ⁻⁶ / 3.8	4×10 ⁻⁹ / 2×10 ⁻³	0.41/ 3.8	2×10 ⁻⁴ / 2×10 ⁻³
BDBE with fire (SRS) or with spill plus fire (LANL) ^{b,d}	19	1×10 ⁻²	22	3×10 ⁻²	2.4	1×10 ⁻³	26	3×10 ⁻²	15	9×10 ⁻³	19	1×10 ⁻²	22	3×10 ⁻²	2.4 / 15	1×10 ⁻³ / 9×10 ⁻³	28 / 15	3×10 ⁻² / 9×10 ⁻³
Noninvolved Worker																		
Limiting design-basis Accident	4.5	3×10 ⁻³	2.3	1×10 ⁻³	0.0054	3×10 ⁻⁶	1.6	9×10 ⁻⁴	3.7	2×10 ⁻³	4.5	3×10 ⁻³	2.3	1×10 ⁻³	0.0054 / 3.7	3×10 ⁻⁶ / 2×10 ⁻³	1.6 / 3.7	9×10 ⁻⁴ / 2×10 ⁻³
DBE with fire (SRS) or with spill plus fire (LANL) ^{c,d}	1.7	1×10 ⁻³	1.2	7×10 ⁻⁴	1.6×10 ⁻⁴	1×10 ⁻⁷	1.6	9×10 ⁻⁴	130	2×10 ⁻¹	1.7	1×10 ⁻³	1.2	7×10 ⁻⁴	1.6×10 ⁻⁴ / 130	1×10 ⁻⁷ / 2×10 ⁻¹	1.6 / 130	9×10 ⁻⁴ / 2×10 ⁻¹
BDBE with fire (SRS) or with spill plus fire (LANL) ^{c,d}	720	9 ×10 ⁻¹	770	1	61	7×10 ⁻²	1,400	1	500	0.6	720	9 ×10 ⁻¹	770	1	61/ 500	7×10 ⁻² / 6×10 ⁻¹	1,400 / 500	1 / 6×10 ⁻¹

BDBE = beyond-design-basis earthquake; DBE = design-basis-earthquake LANL= Los Alamos National Laboratory; LCF = latent cancer fatality; MFFF = Mixed Oxide Fuel Fabrication Facility; PDC = Pit Disassembly and Conversion Project; PDCF = Pit Disassembly and Conversion Facility; PF-4 = Plutonium Facility; SRS = Savannah River Site.

^a Impacts are assessed for PF-4 assuming pit disassembly and conversion of 35 metric tons (38.6 tons) of plutonium.

^b Doses and risks to the MEI from the design-basis and beyond-design-basis earthquakes with fire are added for the pit disassembly and conversion options for the SRS facilities that may be involved in surplus plutonium disposition for the purposes of this analysis even though the MEI for accidents in K-Area would be different than the MEI near H-Area, for example.

^c Doses and risks to noninvolved workers from the design-basis and beyond-design-basis earthquakes with fire are presented for the pit disassembly and conversion options for the highest dose to such an individual at a specific area since a noninvolved worker at K-Area would not be near H-Area should an accident occur there and vice versa.

^d Except for metal oxidation furnaces at MFFF, the bounding design-basis earthquakes at SRS are postulated to initiate fires within the affected facilities. The bounding beyond-design-basis earthquakes at SRS are postulated to initiate fires within all affected facilities. The bounding design-basis and beyond-design-basis earthquakes at LANL are postulated to result in spills of nuclear material at PF-4 followed by fires.

Source: SRNS 2012; LANL 2012.

F.2.2.1 PDCF at F-Area at SRS

The limiting design-basis accident at PDCF would be an over-pressurization of an oxide storage can in the facility. If this accident were to occur, the public residing within 50 miles (80 kilometers) of SRS would receive an estimated dose of 240 person-rem. This dose would result in no additional LCFs among the general public. The MEI would receive a dose of 0.52 rem which represents an increased risk to the MEI of developing a latent fatal cancer of 3×10^{-4} , or about 1 chance in 3,300. A noninvolved worker located 1,000 meters (3,280 feet) from the accident source at the time of the accident and who was unaware of the accident and failed to take any emergency actions would receive a dose of 4.5 rem with an increased risk of developing a latent fatal cancer of 3×10^{-3} , or about 1 chance in 330.

A design-basis earthquake with fire, involving F-Area when PDCF was operational, would expose the public residing within 50 miles (80 kilometers) of SRS to an estimated dose of 91 person-rem. This dose would result in no additional LCFs among the general public. The MEI would receive a dose of 0.20 rem which represents an increased risk to the MEI of developing a latent fatal cancer of 1×10^{-4} , or 1 chance in 10,000. A noninvolved worker would receive a dose of 1.7 rem with an increased risk of developing a latent fatal cancer of 1×10^{-3} , or 1 chance in 1,000.

A beyond-design-basis earthquake with fire, involving F-Area when PDCF was operational, would expose the public residing within 50 miles (80 kilometers) of SRS to an estimated dose of 7,900 person-rem. This dose could result in 5 additional LCFs among the general public. The MEI would receive a dose of 19 rem which represents an increased risk to the MEI of developing a latent fatal cancer of 1×10^{-2} , or 1 chance in 100. A noninvolved worker would receive a dose of 720 rem, which would likely result in a near-term fatality.

F.2.2.2 PDC at K-Area at SRS

The limiting design-basis accident at PDC would be an over-pressurization of an oxide storage can due to out-of-specification conditions that lead to a rupture resulting in a pressurized release of radioactive material. If this accident were to occur, the public residing within 50 miles (80 kilometers) of SRS would receive an estimated dose of 110 person-rem. This dose would result in no additional LCFs among the general public. The MEI would receive a dose of 0.33 rem which represents an increased risk to the MEI of developing a latent fatal cancer of 2×10^{-4} , or 1 chance in 5,000. A noninvolved worker would receive a dose of 2.3 rem with an increased risk of developing a latent fatal cancer of 1×10^{-3} , or 1 chance in 1,000.

A design-basis earthquake with fire, involving K-Area when PDC was operational, would expose the public residing within 50 miles (80 kilometers) of SRS to an estimated dose of 58 person-rem. This dose would result in no additional LCFs among the general public. The MEI would receive a dose of 0.18 rem which represents an increased risk to the MEI of developing an LCF of 1×10^{-4} , or 1 chance in 10,000. A noninvolved worker would receive a dose of 1.2 rem with an increased risk of developing a latent fatal cancer of 7×10^{-4} , or about 1 chance in 1,400.

A beyond-design-basis earthquake with fire, involving K-Area when PDC was operational, would expose the public residing within 50 miles (80 kilometers) of SRS to an estimated dose of 6,300 person-rem. This dose could result in 4 additional LCFs among the general public. The MEI would receive a dose of 22 rem which represents an increased risk to the MEI of developing a latent fatal cancer of 3×10^{-2} , or about 1 chance in 33. A noninvolved worker would receive a dose of 770 rem, which would likely result in a near-term fatality.

F.2.2.3 PF-4 at LANL and MFFF at SRS

The limiting design-basis accident involving metal oxidation furnaces at MFFF at SRS would be a fire in a glovebox resulting in the pressurized release of radioactive material. If this accident were to occur, the public residing within 50 miles (80 kilometers) of SRS would receive an estimated dose of 0.067 person-rem. This dose would result in no additional LCFs among the general public. The MEI would receive a

dose of 0.00024 rem which represents an increased risk to the MEI of developing a latent fatal cancer of 1×10^{-7} , or 1 chance in 10 million. A noninvolved worker would receive a dose of 0.0054 rem with an increased risk of developing a latent fatal cancer of 3×10^{-6} , or about 1 chance in 330,000.

A design-basis earthquake involving metal oxidation furnaces at MFFF would expose the public residing within 50 miles (80 kilometers) of SRS to an estimated dose of 0.0020 person-rem. This dose would result in no additional LCFs among the general public. The MEI would receive a dose of 0.0000072 rem which represents an increased risk to the MEI of developing a latent fatal cancer of 4×10^{-9} , or 1 chance in 250 million. A noninvolved worker would receive a dose of 0.00016 rem with an increased risk of developing a latent fatal cancer of 1×10^{-7} , or 1 chance in 10 million.

A beyond-design-basis earthquake with fire involving metal oxidation furnaces at MFFF would expose the public residing within 50 miles (80 kilometers) of SRS to an estimated dose of 670 person-rem. This dose would result in no additional LCFs among the general public. The MEI would receive a dose of 2.4 rem which represents an increased risk to the MEI of developing a latent fatal cancer of 1×10^{-3} , or 1 chance in 1,000. A noninvolved worker would receive a dose of 61 rem with an increased risk of developing a latent fatal cancer of 0.07, or about 1 chance in 14.

The limiting design-basis accident at PF-4 at LANL with respect to impacts on the population from the proposed pit disassembly and conversion activities would be a fire in the vault resulting in the pressurized release of radioactive material. If this accident were to occur, the public residing within 50 miles (80 kilometers) of LANL would receive an estimated dose of 34 person-rem. This dose would result in no additional LCFs among the general public. The limiting design-basis accident with respect to the MEI and a noninvolved worker would be a hydrogen deflagration associated with dissolution of plutonium metal. The MEI would receive a dose of 0.11 rem which represents an increased risk to the MEI of developing latent fatal cancer of 7×10^{-5} , or about 1 chance in 14,000. A noninvolved worker at the Technical Area 55 (TA-55) boundary would receive a dose of 3.7 rem with an increased risk of developing a latent fatal cancer of 2×10^{-3} , or 1 chance in 500.

A design-basis earthquake with spill plus fire involving PF-4 would expose the public residing within 50 miles (80 kilometers) of LANL to an estimated dose of 900 person-rem. This dose would result in 1 additional LCF among the general public. The MEI would receive a dose of 3.8 rem which represents an increased risk to the MEI of developing a latent fatal cancer of 2×10^{-3} , or about 1 chance in 500. A noninvolved worker would receive a dose of 130 rem with an increased risk of developing a latent fatal cancer of 0.2, or 1 chance in 5.

A beyond-design-basis earthquake with spill plus fire involving PF-4 would expose the public residing within 50 miles (80 kilometers) of LANL to an estimated dose of 3,500 person-rem. This dose would result in 2 additional LCFs among the general public. The MEI would receive a dose of 15 rem which represents an increased risk to the MEI of developing a latent fatal cancer of 9×10^{-3} , or 1 chance in a about 110. A noninvolved worker would receive a dose of 500 rem with an increased risk of developing a latent fatal cancer of 0.6, or about 1 chance in 1.7.

F.2.2.4 PF-4 at LANL and H-Canyon/HB-Line and MFFF at SRS

Risks involving metal oxidation furnaces at MFFF would be the same under this pit disassembly and conversion option as those under the PF-4 and MFFF Option (Section F.2.2.3). However, because there are other pit disassembly and conversion activities proposed at H-Canyon/HB-Line under this option, the doses associated with a design basis and beyond design-basis earthquake will include both facilities for the purposes of this accident analysis with respect to the public residing within 50 miles (80 kilometers) of SRS and the MEI. Noninvolved worker doses are presented for the highest dose to such an individual at a specific area since a noninvolved worker at F-Area would not be near H-Area should an accident occur there and vice versa.

The limiting design-basis accident involving pit disassembly activities at the K-Area Complex and conversion activities at H-Canyon/HB-Line at SRS would be a level-wide fire in HB-Line involving

plutonium oxides and solutions. (Accidents involving K-Area disassembly operations would result in much lower source terms.) If this accident were to occur, the public residing within 50 miles (80 kilometers) of SRS would receive an estimated dose of 280 person-rem. This dose would result in no additional LCFs among the general public. The MEI would receive a dose of 0.41 rem which represents an increased risk to the MEI of developing a latent fatal cancer of 2×10^{-4} , or 1 chance in 5,000. A noninvolved worker would receive a dose of 1.6 rem with an increased risk of developing a latent fatal cancer of 9×10^{-4} , or about 1 chance in 1,100.

A design-basis earthquake with fire involving both F-Area with metal oxidation furnaces at MFFF and H-Canyon/HB-Line would expose the public residing within 50 miles (80 kilometers) of SRS to an estimated dose of 280 person-rem. This dose would result in no additional LCFs among the general public. The MEI would receive a dose of 0.41 rem which represents an increased risk to the MEI of developing a latent fatal cancer of 2×10^{-4} , or 1 chance in 5,000. A noninvolved worker at H-Canyon/HB-Line would receive a dose of 1.6 rem with an increased risk of developing a latent fatal cancer of 9×10^{-4} , or about 1 chance in 1,100.

A beyond-design-basis earthquake with fire involving both F-Area with metal oxidation furnaces at MFFF and H-Canyon/HB-Line would expose the public residing within 50 miles (80 kilometers) of SRS to an estimated dose of 15,000 person-rem. This dose would result in 9 additional LCFs among the general public. The MEI would receive a dose of 16rem which represents an increased risk to the MEI of developing latent fatal cancer of 0.02, or 1 chance in 50. A noninvolved worker at H-Canyon/HB-Line would receive a dose of 1,400 rem, which would likely result in a near-term fatality.

The risks at PF-4 at LANL with respect to the proposed pit disassembly and conversion activities would be the same under this option as those under the PF-4 and MFFF Option (Section F.2.2.3).

F.3 Socioeconomics

This section analyzes the potential socioeconomic impacts of different pit disassembly and conversion options. Impacts on direct and indirect employment, economic output, value added and earnings are presented for the peak years of construction for these facilities and for the surplus plutonium activities at these facilities during their peak years of operations. The area that would experience the impacts presented in this section is the region of influence (ROI) surrounding each facility. The socioeconomic ROI for the facilities at SRS is defined as the four-county area of Columbia and Richmond Counties in Georgia, and Aiken and Barnwell Counties in South Carolina. The socioeconomic ROI for PF-4 at LANL is defined as the four-county area of Los Alamos, Rio Arriba, Sandoval, and Santa Fe Counties in New Mexico. All values are presented in 2010 dollars. **Table F-8** presents the socioeconomic impacts that would be generated during the peak year of construction. **Table F-9** presents the socioeconomic impacts that would be generated during the peak year of operations.

Table F-8 Peak Annual Socioeconomic Impacts associated with Construction of Pit Disassembly and Conversion Options

Impact	Facilities					Pit Disassembly and Conversion Options			
	SRS				LANL	PDCF	PDC	PF-4 and MFFF	PF-4, H-Canyon/ HB-Line, and MFFF
	PDCF	PDC	H-Canyon/ HB-Line ^a	MFFF	PF-4				
Direct Employment	722	741	10	275	46	722	741	321	331
Indirect Employment	455	467	6	173	26	455	467	199	205
Output (\$ in millions)	\$71	\$72	\$1.0	\$27	\$4.4	\$71	\$72	\$31	\$32
Value Added (\$ in millions)	\$67	\$68	\$0.9	\$25	\$3.8	\$67	\$68	\$29	\$30
Earnings (\$ in millions)	\$45	\$46	\$0.6	\$17	\$2.7	\$45	\$46	\$20	\$20

LANL = Los Alamos National Laboratory; MFFF = Mixed Oxide Fuel Fabrication Facility; PDC = Pit Disassembly and Conversion Project; PDCF = Pit Disassembly and Conversion Facility; PF-4 = Plutonium Facility; SRS = Savannah River Site.

^a Modifications at the K-Area Complex to support pit disassembly for subsequent conversion at H-Canyon/HB-Line or elsewhere is not expected to require additional employment; existing maintenance and construction staff would be used for the modifications.

Table F-9 Peak Annual Socioeconomic Impacts associated with Operation of Pit Disassembly and Conversion Options

Resource	Facilities						Pit Disassembly and Conversion Options			
	SRS			LANL			PDCF	PDC	PF-4 and MFFF	PF-4, H-Canyon/ HB-Line, and MFFF
	PDCF	PDC	H-Canyon/ HB-Line ^a	MFFF	PF-4 (2 MT)	PF-4 (35 MT)				
Direct Employment	550	500	140	35	85	253	635	585	288	428
Indirect Employment	654	595	167	42	86	256	740	681	298	465
Output (\$ in millions)	\$98	\$89	\$25	\$6.2	\$11	\$33	\$109	\$100	\$39	\$64
Value Added (\$ in millions)	\$83	\$75	\$21	\$5.3	\$11	\$32	\$94	\$86	\$37	\$58
Earnings (\$ in millions)	\$48	\$44	\$12	\$3.1	\$8.2	\$24	\$56	\$52	\$27	\$39

LANL = Los Alamos National Laboratory; MFFF = Mixed Oxide Fuel Fabrication Facility; MT = metric tons; PDC = Pit Disassembly and Conversion Project; PDCF = Pit Disassembly and Conversion Facility; PF-4 = Plutonium Facility; SRS = Savannah River Site.

^a This column provides the combined impacts for pit disassembly at K-Area and conversion to plutonium oxide at H-Canyon/HB-Line.

Note: To convert metric tons to tons, multiply by 1.1023.

F.3.1 PDCF at F-Area at SRS

Construction—At SRS, direct employment during construction of PDCF is expected to peak at 722 workers. The direct construction employment would generate an estimated 455 indirect jobs in the ROI. The direct economic output during the peak year of construction is estimated to be approximately \$71 million. Approximately \$67 million of the direct economic output would be value added to the local economy in the form of final goods and services directly comparable to Gross Domestic Product (GDP). Approximately \$45 million of the value added would be in the form of direct earnings of construction workers. At LANL, no construction would be required at PF-4 to support pit disassembly and conversion of 2 metric tons (2.2 tons) of plutonium.

Operations—At SRS, direct employment at PDCF is expected to peak at 550 workers. The direct employment would generate an estimated 654 indirect jobs in the ROI. The direct economic output during the peak year of operations is estimated to be \$98 million, of which \$83 million is estimated to be value added to the local economy in the form of final goods and services directly comparable to GDP. Approximately \$48 million of the value added would be in the form of direct earnings of those employed at PDCF.

At LANL, direct employment at PF-4 to support pit disassembly and conversion of 2 metric tons (2.2 tons) of plutonium would peak at 85 workers. The direct employment would generate an estimated 86 indirect jobs in the ROI. The direct economic output during operations of PF-4 at LANL is estimated to be \$11 million. The value added to the local economy in the form of final goods and services directly comparable to GDP is estimated to be approximately \$11 million. Approximately \$8.2 million of the value added would be in the form of direct earnings of workers at PF-4.

F.3.2 PDC in K-Area at SRS

Construction—At SRS, direct employment during construction of PDC is expected to peak at 741 workers. The direct construction employment would generate an estimated 467 indirect jobs in the ROI. The direct economic output during the peak year of construction is estimated to be approximately \$72 million. Approximately \$68 million of the direct economic output would be value added to the local economy in the form of final goods and services directly comparable to GDP. Approximately \$46 million of the value added would be in the form of direct earnings of construction workers. At LANL, similar to the PDCF Option (see Section F.3.1), no construction would be required at PF-4 to support pit disassembly and conversion of 2 metric tons (2.2 tons) of plutonium.

Operations—At SRS, direct employment at PDC is expected to peak at 500 workers. The direct employment would generate an estimated 595 indirect jobs in the ROI. The direct economic output during the peak year of operations is estimated to be \$89 million, of which \$75 million is estimated to be value added to the local economy in the form of final goods and services directly comparable to GDP. Approximately \$44 million of the value added would be in the form of direct earnings of those employed at PDC. At LANL, impacts during the peak year of operation of PF-4 would be the same as those in Section F.3.1 under the PDCF Option.

F.3.3 PF-4 at LANL and MFFF at SRS

Construction—At SRS, direct employment during installation of metal oxide furnaces in MFFF to provide a pit conversion capability would be expected to peak at 275 workers. The direct construction employment would generate an estimated 173 indirect jobs in the SRS ROI. The direct economic output during the peak year of construction is estimated to be approximately \$27 million. Approximately \$25 million of the direct output would be value added to the local economy in the form of final goods and services directly comparable to GDP. Approximately \$17 million of the value added would be in the form of direct earnings to construction workers.

At LANL, direct employment during modifications at PF-4 would be expected to peak at 46 workers. The direct employment during modifications would generate an estimated 26 indirect jobs within the LANL ROI. The direct economic output during the peak year of modification activities is estimated to be approximately \$4.4 million. Approximately \$3.8 million of the direct economic output would be value added to the local economy in the form of final goods and services directly comparable to GDP. Approximately \$2.7 million of the value added would be in the form of direct earnings of construction workers.

Operations— At SRS, direct employment due to operation of the metal oxidation furnaces at MFFF is expected to require 35 workers. The direct employment would generate an estimated 42 indirect jobs in the SRS ROI. The direct economic output during operation of the metal oxidation furnaces at MFFF is estimated to be approximately \$6.2 million, of which \$5.3 million is estimated to be value added to the local economy in the form of final goods and services directly comparable to GDP. Approximately \$3.1 million of the value added would be in the form of direct earnings of MFFF employees engaged in operation of the metal oxidation furnaces. The direct employment required for MFFF operations under this option would be drawn from the existing SRS workforce and is not expected to result in additional employment.

At LANL, direct employment at PF-4 is expected to increase to 253 workers during peak operations. The direct employment would generate an estimated 256 indirect jobs in the ROI. The direct economic output attributable to pit disassembly and conversion activities at PF-4 is estimated to be \$33 million, of which \$32 million is estimated to be value added to the local economy in the form of final goods and services directly comparable to GDP. Approximately \$24 million of the value added would be in the form of direct earnings of PF-4 workers.

F.3.4 PF-4 at LANL and H-Canyon/HB-Line and MFFF at SRS

Construction—At SRS, the socioeconomic impacts from installation of metal oxide furnaces in MFFF to provide a pit conversion capability would be to the same as those in Section F.3.3 under the PF-4, H-Canyon/HB-Line, and Metal MFFF Option.

Modification activities at K-Area to upgrade an existing glove box to support pit disassembly would not be expected to require any additional employment.

Modifications at H-Canyon/HB-Line to support pit conversion would require an estimated 10 direct workers. The direct employment is expected to generate approximately 6 indirect workers. The direct economic output attributable to H-Canyon/HB-Line modifications would be approximately \$1.0 million, of which \$0.9 million would be value added to the local economy in the form of final goods and services

directly comparable to GDP. Approximately \$0.6 million would be in the form of direct earnings to construction workers. The direct employment required for H-Canyon/HB-Line operations under this option would be drawn from the existing SRS workforce and is not expected to result in additional employment.

At LANL, facility modification activities at PF-4 would be the same as those in Section F.3.3 under the PF-4 and MFFF Option.

Operations—At SRS, operation of a pit disassembly glovebox in K-Area is expected to require direct employment of 40 workers. Pit conversion activities at H-Canyon/HB-Line would require direct employment of 100 workers. The combined direct employment of 140 workers at K-Area and H-Canyon/HB-Line would generate approximately 167 indirect jobs in the SRS ROI. The direct economic output attributable to K-Area and H-Canyon/HB-Line operations is estimated to be approximately \$25 million, of which approximately \$21 million would be value added to the local economy in the form of final goods and services directly comparable to GDP. Approximately \$12 million of the value added would be in the form of earnings to K-Area and H-Canyon/HB-Line workers.

The socioeconomic impacts from operation of the metal oxidation furnaces at MFFF would be the same as those in Section F.3.3 under the PF-4 and MFFF Option.

At LANL, the socioeconomic impacts during the peak year of operations of PF-4 would be the same as those in Section F.3.3 under the PF-4 and MFFF Option.

F.4 Waste Management

This section analyzes impacts of pit disassembly and conversion options on waste management facilities. The waste types addressed include transuranic (TRU) and mixed TRU waste (analyzed collectively), solid low-level radioactive waste (LLW), solid mixed low-level radioactive waste (MLLW), solid hazardous waste, solid nonhazardous waste, liquid LLW, and liquid nonhazardous waste. The generation of these waste streams is the result of construction, modifications, and operations associated with the facilities being analyzed for pit disassembly and conversion. Years of operation would vary depending on the combination of pit disassembly and conversion and pit disposition options that might be implemented under the *SPD Supplemental EIS* alternatives.

Waste management facilities are described in Chapter 3, Sections 3.1.10 and 3.2.10. Waste management impacts are evaluated as a percentage of treatment, storage, or disposal capacity, depending on a particular waste type's onsite disposition. For LANL, if a waste type is shipped off site for disposal, its impacts are evaluated as a percentage increase in projected quantities that would be generated as a result of an action alternative over existing waste generation rates as reported for 2009. These capacities or current generation rates are discussed in detail in Chapter 3 and are summarized in **Table F-10** and **F-11** for SRS and LANL, respectively.

F.4.1 PDCF in F-Area at SRS

Construction—**Table F-12** summarizes the average annual amount of waste that would be generated at SRS from construction of PDCF under this option. Construction of PDCF would generate solid hazardous waste, solid nonhazardous waste, and liquid nonhazardous waste. **Table F-13** summarizes the total amount of waste that would be generated under this option. At LANL, there would be no construction or facility modification activities at PF-4 that would generate any waste types above what is currently generated.

Table F-10 Summary of Waste Management Capacities at the Savannah River Site

<i>Waste Type</i>	<i>Annual Capacity</i>	<i>Disposition Method</i>	<i>Impact Criteria</i>
Transuranic	13,200 cubic meters	Onsite storage pads	As a percent of storage capacity
Solid LLW	37,000 cubic meters ^a	Onsite disposal slits or engineered trenches	As a percent of disposal capacity
Solid MLLW	296 cubic meters ^b	Onsite storage pads	As a percent of storage capacity
Solid hazardous	296 cubic meters ^b	Onsite storage pads	As a percent of storage capacity
Solid nonhazardous	4,200,000 cubic meters per year	Regional municipal landfill disposal	As a percent of permitted disposal capacity
Liquid LLW	590,000,000 liters	Onsite F/H Effluent Treatment Project	As a percent of treatment capacity
Liquid nonhazardous	1,500,000,000 liters	Onsite Central Sanitary Wastewater Treatment Facility	As a percent of treatment capacity

LLW = low-level radioactive waste; MLLW = mixed low-level radioactive waste.

^a As of February 2012, the estimated unused disposal capacity remaining is approximately 23,000 cubic meters for the slit trenches and 14,000 cubic meters for the engineered trenches.

^b Pad 26-E is permitted to store a maximum of 296 cubic meters in aggregate for solid MLLW and solid hazardous waste.

Note: To convert cubic meters to cubic feet, multiply by 35.314; liters to gallons, multiply by 0.26418.

Source: Chapter 3, Section 3.1.10.

Table F-11 Summary of Waste Management Capacities at Los Alamos National Laboratory

<i>Waste Type</i>	<i>Annual Capacity or Generation Rate</i>	<i>Disposition Method</i>	<i>Impact Criteria</i> ^a
Transuranic	79,900 drum equivalents (16,000 cubic meters) ^b	Onsite storage pads	As a percent of storage capacity
Solid LLW	3,772 cubic meters	Offsite disposal at NNSS	As a percent increase of existing generation rates
Solid MLLW	13.5 cubic meters	Offsite commercial disposal	As a percent increase of existing generation rates
Solid hazardous	1,723 metric tons	Offsite commercial disposal	As a percent increase of existing generation rates
Solid nonhazardous	2,562 metric tons	Offsite commercial landfill disposal	As a percent increase of existing generation rates
Liquid LLW	4,000,000 liters	Onsite Radioactive Liquid Waste Treatment Facility	As a percent of treatment capacity
Liquid nonhazardous	840,000,000 liters	Onsite Sanitary Wastewater System	As a percent of treatment capacity

LLW = low-level radioactive waste; MLLW = mixed low-level radioactive waste; drum equivalent = one 55-gallon drum; NNSS = Nevada National Security Site.

^a Impact criteria for solid LLW, solid MLLW, solid hazardous waste, and solid nonhazardous waste are calculated as a percent increase over generation rates reported in 2009; impact criteria for other wastes are calculated as a percent of onsite storage or treatment capacity.

^b One 55-gallon drum contains approximately 0.2 cubic meters of waste.

Note: To convert cubic meters to cubic feet, multiply by 35.314; liters to gallons, multiply by 0.26418.

Source: Chapter 3, Section 3.2.10.

Table F–12 Average Annual Construction Waste Generation from PDCF at the Savannah River Site

Facility	TRU Waste (m ³ /yr)	Solid LLW (m ³ /yr)	Solid MLLW (m ³ /yr)	Solid HW (m ³ /yr)	Solid Non-HW (m ³ /yr)	Liquid LLW (liters/yr)	Liquid Non-HW (liters/yr)
PDCF	negligible	negligible	negligible	5.6	130	negligible	1,500,000
Percent of SRS Capacity	negligible	negligible	negligible	1.9	<0.1	negligible	0.1

HW = hazardous waste; LLW = low-level radioactive waste; MLLW = mixed low-level radioactive waste; m³ = cubic meters; PDCF = Pit Disassembly and Conversion Facility; SRS = Savannah River Site; TRU = transuranic; yr = year.

Note: To convert cubic meters to cubic feet, multiply by 35.314; liters to gallons, multiply by 0.26418.

Source: DOE/NNSA 2012.

Table F–13 Total Construction Waste Generation from PDCF at the Savannah River Site

Facility	TRU Waste (m ³)	Solid LLW (m ³)	Solid MLLW (m ³)	Solid HW (m ³)	Solid Non-HW (m ³)	Liquid LLW (liters)	Liquid Non-HW (liters)
PDCF	negligible	negligible	negligible	56	1,300	negligible	15,000,000

HW = hazardous waste; LLW = low-level radioactive waste; MLLW = mixed low-level radioactive waste; m³ = cubic meters; PDCF = Pit Disassembly and Conversion Facility; TRU = transuranic.

Note: To convert cubic meters to cubic feet, multiply by 35.314; liters to gallons, multiply by 0.26418.

Source: DOE/NNSA 2012.

Operations—Table F–14 summarizes the peak annual amount of waste that would be generated from pit disassembly and conversion activities at SRS and LANL under this option. Operation of PDCF and PF-4 would generate TRU waste, solid LLW, solid MLLW, solid hazardous waste, solid nonhazardous waste, liquid LLW, and liquid nonhazardous waste. Table F–14 does not include liquid high-activity waste that would be sent to the Waste Solidification Building (WSB) for further processing; waste generated from WSB operations is addressed in Appendix H.

Table F–14 Peak Annual Operations Waste Generation from PDCF at the Savannah River Site and PF-4 at Los Alamos National Laboratory

Facility	TRU Waste (m ³ /yr)	Solid LLW (m ³ /yr)	Solid MLLW (m ³ /yr)	Solid HW (m ³ /yr)	Solid Non-HW (m ³ /yr)	Liquid LLW (liters/yr)	Liquid Non-HW (liters/yr)
PDCF	180	970	negligible	0.1	2,000	91,000	31,000,000
Percent of SRS Capacity	1.4	2.6	negligible	<0.1	<0.1	<0.1	2.1
PF-4	10	29	0.3	negligible	negligible	570	negligible
Percent of LANL Capacity ^a	<0.1	0.8	2.2	negligible	negligible	<0.1	negligible

HW = hazardous waste; LANL = Los Alamos National Laboratory; LLW = low-level radioactive waste; MLLW = mixed low-level radioactive waste; m³ = cubic meters; PDCF = Pit Disassembly and Conversion Facility; PF-4 = Plutonium Facility; SRS = Savannah River Site; TRU = transuranic; yr = year.

^a Impact criteria for solid LLW, solid MLLW, solid hazardous waste, and solid nonhazardous waste are calculated as a percent increase over generation rates reported in 2009; impact criteria for other wastes are calculated as a percent of onsite storage or treatment capacity.

Note: To convert cubic meters to cubic feet, multiply by 35.314; liters to gallons, multiply by 0.26418.

Source: DOE/NNSA 2012; LANL 2012.

F.4.2 PDC at K-Area at SRS

Construction—**Table F–15** summarizes the average annual amount of waste that would be generated at SRS from construction of PDC under this option. Construction of PDC would generate solid LLW, solid MLLW, solid hazardous waste, and solid nonhazardous waste. Equipment and piping would be installed and structural changes would be made to existing K-Area facilities. The removal of equipment and piping would increase the generation of radioactive and nonradioactive polychlorinated biphenyl-contaminated waste, which would be managed as solid MLLW and solid hazardous waste (WSRC 2008a, 2008b:7). At LANL, there would be no construction or facility modification activities required at PF-4 that would generate any waste types above what is currently generated. **Table F–16** summarizes the total amount of waste that would be generated.

Together, the average annual generation of solid MLLW and solid hazardous waste would occupy about 290 percent of the available onsite storage capacity at SRS, assuming this waste was not transported offsite for disposition. However, these wastes are routinely transported offsite to a treatment, storage, or disposal facility. To mitigate these impacts, shipments could be scheduled to occur more frequently or the available storage capacity could be increased, if adequate shipments could not be scheduled to accommodate the annual generation of this waste.

Table F–15 Average Annual Construction Waste Generation from PDC at the Savannah River Site

<i>Facility</i>	<i>TRU Waste (m³/yr)</i>	<i>Solid LLW (m³/yr)</i>	<i>Solid MLLW (m³/yr)</i>	<i>Solid HW (m³/yr)</i>	<i>Solid Non-HW (m³/yr)</i>	<i>Liquid LLW (liters/yr)</i>	<i>Liquid Non-HW (liters/yr)</i>
PDC	negligible	1,300	19	820	860	negligible	negligible
<i>Percent of SRS Capacity</i>	<i>negligible</i>	<i>3.5</i>	<i>6.4</i>	<i>280</i>	<i><0.1</i>	<i>negligible</i>	<i>negligible</i>

HW = hazardous waste; LLW = low-level radioactive waste; MLLW = mixed low-level radioactive waste; m³ = cubic meters; PDC = Pit Disassembly and Conversion Project; SRS = Savannah River Site; TRU = transuranic; yr = year.

Note: To convert cubic meters to cubic feet, multiply by 35.314; liters to gallons, multiply by 0.26418.

Source: DOE/NNSA 2012.

Table F–16 Total Construction Waste Generation from PDC at the Savannah River Site

<i>Facility</i>	<i>TRU Waste (m³)</i>	<i>Solid LLW (m³)</i>	<i>Solid MLLW (m³)</i>	<i>Solid HW (m³)</i>	<i>Solid Non-HW (m³)</i>	<i>Liquid LLW (liters)</i>	<i>Liquid Non-HW (liters)</i>
PDC	negligible	12,000	210	7,000	6,800	negligible	negligible

HW = hazardous waste; LLW = low-level radioactive waste; MLLW = mixed low-level radioactive waste; m³ = cubic meters; PDC = Pit Disassembly and Conversion Project; TRU = transuranic.

Note: To convert cubic meters to cubic feet, multiply by 35.314; liters to gallons, multiply by 0.26418.

Source: DOE/NNSA 2012.

Operations—**Table F–17** summarizes the peak annual amount of waste that would be generated from pit disassembly and conversion activities at SRS and LANL under this option. Operation of PDC and PF-4 would generate TRU waste, solid LLW, solid MLLW, solid hazardous waste, solid nonhazardous waste, liquid LLW, and liquid nonhazardous waste. Not shown in Table F–17 is liquid high-activity waste that would be sent to the WSB for further processing; waste generated from WSB operations is addressed in Appendix H.

Table F–17 Peak Annual Operations Waste Generation from PDC at the Savannah River Site and PF-4 at Los Alamos National Laboratory

Facility	TRU Waste (m ³ /yr)	Solid LLW (m ³ /yr)	Solid MLLW (m ³ /yr)	Solid HW (m ³ /yr)	Solid Non-HW (m ³ /yr)	Liquid LLW (liters/yr)	Liquid Non-HW (liters/yr)
PDC	180	970	negligible	0.1	2,000	28,000	31,000,000
Percent of SRS Capacity	1.4	2.6	negligible	<0.1	<0.1	<0.1	2.1
PF-4	10	29	0.3	negligible	negligible	570	negligible
Percent of LANL Capacity ^a	<0.1	0.8	2.2	negligible	negligible	<0.1	negligible

HW = hazardous waste; LANL = Los Alamos National Laboratory; LLW = low-level radioactive waste; MLLW = mixed low-level radioactive waste; m³ = cubic meters; PDC = Pit Disassembly and Conversion Project; PF-4 = Plutonium Facility; SRS = Savannah River Site; TRU = transuranic; yr = year.

^a Impact criteria for solid LLW, solid MLLW, solid hazardous waste, and solid nonhazardous waste are calculated as a percent increase over generation rates reported in 2009; impact criteria for other wastes are calculated as a percent of onsite storage or treatment capacity.

Note: To convert cubic meters to cubic feet, multiply by 35.314; liters to gallons, multiply by 0.26418.

Source: DOE/NNSA 2012; LANL 2012.

F.4.3 PF-4 at LANL and MFFF at SRS

Construction—Table F–18 summarizes the average annual amount of waste that would be generated from facility modification activities at SRS and LANL under this option. At SRS, metal oxidation furnaces would be installed in MFFF during its construction or operation to provide a pit conversion capability; however, negligible amounts of wastes in addition to those anticipated for construction of MFFF would be generated. At LANL, modification of PF-4 would generate TRU waste, solid LLW, and solid MLLW. Modification of PF-4 could result in up to a 52 percent increase in the annual amount of LANL-generated solid MLLW as reported in 2009; this is not expected to have significant impacts on the offsite commercial disposal of this waste stream. Table F–19 summarizes the total amount of waste that would be generated.

Table F–18 Average Annual Construction Waste Generation from MFFF at the Savannah River Site and PF-4 at Los Alamos National Laboratory

Facility	TRU Waste (m ³ /yr)	Solid LLW (m ³ /yr)	Solid MLLW (m ³ /yr)	Solid HW (m ³ /yr)	Solid Non-HW (m ³ /yr)	Liquid LLW (liters/yr)	Liquid Non-HW (liters/yr)
Metal oxidation furnaces at MFFF	0	negligible	negligible	negligible	negligible	negligible	negligible
Percent of SRS Capacity	N/A	negligible	negligible	negligible	negligible	negligible	negligible
PF-4	2.4	4.6	7.0	negligible	negligible	negligible	negligible
Percent of LANL Capacity ^a	<0.1	0.1	52	negligible	negligible	negligible	negligible

HW = hazardous waste; LANL = Los Alamos National Laboratory; LLW = low-level radioactive waste; MFFF = Mixed Oxide Fuel Fabrication Facility; MLLW = mixed low-level radioactive waste; m³ = cubic meters; N/A = not applicable; PF-4 = Plutonium Facility; SRS = Savannah River Site; TRU = transuranic; yr = year.

^a Impact criteria for solid LLW, solid MLLW, solid hazardous waste, and solid nonhazardous waste are calculated as a percent increase over generation rates reported in 2009; impact criteria for other wastes are calculated as a percent of onsite storage or treatment capacity.

Note: To convert cubic meters to cubic feet, multiply by 35.314; liters to gallons, multiply by 0.26418.

Source: LANL 2012; SRNS 2012.

Table F-19 Total Construction Waste Generation from MFFF at the Savannah River Site and PF-4 at Los Alamos National Laboratory

<i>Facility</i>	<i>TRU Waste (m³)</i>	<i>Solid LLW (m³)</i>	<i>Solid MLLW (m³)</i>	<i>Solid HW (m³)</i>	<i>Solid Non-HW (m³)</i>	<i>Liquid LLW (liters)</i>	<i>Liquid Non-HW (liters)</i>
Metal oxidation furnaces at MFFF	0	negligible	negligible	negligible	negligible	negligible	negligible
PF-4	19	37	56	negligible	negligible	negligible	negligible

HW = hazardous waste; LLW = low-level radioactive waste; MLLW = mixed low-level radioactive waste; MFFF = Mixed Oxide Fuel Fabrication Facility; m³ = cubic meters; PF-4 = Plutonium Facility; TRU = transuranic.

Note: To convert cubic meters to cubic feet, multiply by 35.314; liters to gallons, multiply by 0.26418.

Source: LANL 2012; SRNS 2012.

Operations—**Table F-20** summarizes the peak annual amount of waste that would be generated from pit disassembly and conversion activities under this option. Operation of metal oxidation furnaces at MFFF would generate TRU waste and solid LLW. Operation of PF-4 at LANL would generate TRU waste, solid LLW, solid MLLW, solid hazardous waste, and liquid LLW.

Table F-20 Peak Annual Operations Waste Generation from MFFF at the Savannah River Site and PF-4 at Los Alamos National Laboratory

<i>Facility</i>	<i>TRU Waste (m³/yr)</i>	<i>Solid LLW (m³/yr)</i>	<i>Solid MLLW (m³/yr)</i>	<i>Solid HW (m³/yr)</i>	<i>Solid Non-HW (m³/yr)</i>	<i>Liquid LLW (liters/yr)</i>	<i>Liquid Non-HW (liters/yr)</i>
Metal oxidation furnaces at MFFF	9.2	16	negligible	negligible	negligible	negligible	negligible
<i>Percent of SRS Capacity</i>	<i><0.1</i>	<i><0.1</i>	<i>negligible</i>	<i>negligible</i>	<i>negligible</i>	<i>negligible</i>	<i>negligible</i>
PF-4	55	180	1.4	0.2	negligible	3,200	negligible
<i>Percent of LANL Capacity^a</i>	<i>0.3</i>	<i>4.8</i>	<i>10</i>	<i><0.1</i>	<i>negligible</i>	<i><0.1</i>	<i>negligible</i>

HW = hazardous waste; LANL = Los Alamos National Laboratory; LLW = low-level radioactive waste; MFFF = Mixed Oxide Fuel Fabrication Facility; MLLW = mixed low-level radioactive waste; m³ = cubic meters; PF-4 = Plutonium Facility;

SRS = Savannah River Site; TRU = transuranic; yr = year.

^a Impact criteria for solid LLW, solid MLLW, solid hazardous waste, and solid nonhazardous waste are calculated as a percent increase over generation rates reported in 2009; impact criteria for other wastes are calculated as a percent of onsite storage or treatment capacity.

Note: To convert cubic meters to cubic feet, multiply by 35.314; liters to gallons, multiply by 0.26418.

Source: LANL 2012; SRNS 2012.

F.4.4 PF-4 at LANL and H-Canyon/HB-Line and MFFF at SRS

Construction—**Table F-21** summarizes the average annual amount of waste that would be generated from facility modifications under this option. Modification of SRS and LANL facilities would generate TRU waste, solid LLW, and solid MLLW. At SRS, minor quantities of wastes would result from modification of a glovebox at K-Area to allow for pit disassembly, and from modifications to H-Canyon/HB-Line to enhance the facility’s pit conversion capability. In addition, metal oxidation furnaces would be installed in MFFF to provide a pit conversion capability, although negligible amounts of wastes in addition to those anticipated for construction of MFFF would be generated. At LANL, modification of PF-4 could result in up to a 52 percent increase in the annual amount of LANL-generated solid MLLW as reported in 2009; this is not expected to have significant impacts on the offsite commercial disposal of this waste stream. **Table F-22** summarizes the total amount of waste that would be generated.

Table F–21 Average Annual Construction Waste Generation from K-Area, H-Canyon/HB-Line, and MFFF at the Savannah River Site, and PF-4 at Los Alamos National Laboratory

<i>Facility</i>	<i>TRU Waste (m³/yr)</i>	<i>Solid LLW (m³/yr)</i>	<i>Solid MLLW (m³/yr)</i>	<i>Solid HW (m³/yr)</i>	<i>Solid Non- HW (m³/yr)</i>	<i>Liquid LLW (liters/yr)</i>	<i>Liquid Non-HW (liters/yr)</i>
Pit disassembly at K-Area	1.5	2.5	negligible	negligible	negligible	negligible	negligible
H-Canyon/ HB-Line	10	18	negligible	negligible	negligible	negligible	negligible
Metal oxidation furnaces at MFFF	0	negligible	negligible	negligible	negligible	negligible	negligible
<i>Percent of SRS Capacity</i>	<i><0.1</i>	<i><0.1</i>	<i>negligible</i>	<i>negligible</i>	<i>negligible</i>	<i>negligible</i>	<i>negligible</i>
PF-4	2.4	4.6	7.0	negligible	negligible	negligible	negligible
<i>Percent of LANL Capacity^a</i>	<i><0.1</i>	<i>0.1</i>	<i>52</i>	<i>negligible</i>	<i>negligible</i>	<i>negligible</i>	<i>negligible</i>

HW = hazardous waste; LANL = Los Alamos National Laboratory; LLW = low-level radioactive waste; MFFF = Mixed Oxide Fuel Fabrication Facility; MLLW = mixed low-level radioactive waste; m³ = cubic meters; PF-4 = Plutonium Facility; SRS = Savannah River Site; TRU = transuranic; yr = year.

^a Impact criteria for solid LLW, solid MLLW, solid hazardous waste, and solid nonhazardous waste are calculated as a percent increase over generation rates reported in 2009; impact criteria for other wastes are calculated as a percent of onsite storage or treatment capacity.

Note: To convert cubic meters to cubic feet, multiply by 35.314; liters to gallons, multiply by 0.26418.

Source: LANL 2012; SRNS 2012.

Table F–22 Total Construction Waste Generation from K-Area, H-Canyon/HB-Line, and MFFF at the Savannah River Site, and PF-4 at Los Alamos National Laboratory

<i>Facility</i>	<i>TRU Waste (m³)</i>	<i>Solid LLW (m³)</i>	<i>Solid MLLW (m³)</i>	<i>Solid HW (m³)</i>	<i>Solid Non-HW (m³)</i>	<i>Liquid LLW (liters)</i>	<i>Liquid Non-HW (liters)</i>
Pit disassembly at K-Area	3	5	negligible	negligible	negligible	negligible	negligible
H-Canyon/ HB-Line	20	36	negligible	negligible	negligible	negligible	negligible
Metal oxidation furnaces at MFFF	0	negligible	negligible	negligible	negligible	negligible	negligible
PF-4	19	37	56	negligible	negligible	negligible	negligible

HW = hazardous waste; LLW = low-level radioactive waste; MFFF = Mixed Oxide Fuel Fabrication Facility;

MLLW = mixed low-level radioactive waste; m³ = cubic meters; PF-4 = Plutonium Facility; TRU = transuranic.

Note: To convert cubic meters to cubic feet, multiply by 35.314; liters to gallons, multiply by 0.26418.

Source: LANL 2012; SRNS 2012.

Operations—Table F–23 summarizes the peak annual amount of waste that would be generated from operations under this option. Operations at the listed facilities would generate TRU waste, solid LLW, solid MLLW, solid hazardous waste, solid nonhazardous waste, and liquid LLW.

Table F–23 Peak Annual Operations Waste Generation from K-Area, H-Canyon/HB-Line, and MFFF at the Savannah River Site, and PF-4 at Los Alamos National Laboratory

Facility	TRU Waste (m ³ /yr)	Solid LLW (m ³ /yr)	Solid MLLW (m ³ /yr)	Solid HW (m ³ /yr)	Solid Non-HW (m ³ /yr)	Liquid LLW (liters/yr)	Liquid Non-HW (liters/yr)
Pit disassembly at K-Area	20	80	negligible	negligible	negligible	negligible	negligible
H-Canyon/ HB-Line	110	1,400	2.4	negligible	200,000	negligible	negligible
Metal oxidation furnaces at MFFF	9.2	16	negligible	negligible	negligible	negligible	negligible
Percent of SRS Capacity	1.1	4.0	0.8	negligible	4.8	negligible	negligible
PF-4	55	180	1.4	0.2	negligible	3,200	negligible
Percent of LANL Capacity ^a	0.3	4.8	10	<0.1	negligible	<0.1	negligible

HW = hazardous waste; LANL = Los Alamos National Laboratory; LLW = low-level radioactive waste; MFFF = Mixed Oxide Fuel Fabrication Facility; MLLW = mixed low-level radioactive waste; m³ = cubic meters; PF-4 = Plutonium Facility; SRS = Savannah River Site; TRU = transuranic; yr = year.

^a Impact criteria for solid LLW, solid MLLW, solid hazardous waste, and solid nonhazardous waste are calculated as a percent increase over generation rates reported in 2009; impact criteria for other wastes are calculated as a percent of onsite storage or treatment capacity.

Note: To convert cubic meters to cubic feet, multiply by 35.314; liters to gallons, multiply by 0.26418.

Source: LANL 2012; SRNS 2012.

F.5 Transportation

Transportation involves the movement of materials and wastes between facilities involved in the Surplus Plutonium Disposition program including pit disassembly and conversion facilities, plutonium disposition facilities, support facilities, and domestic commercial nuclear power reactors. This type of system-wide analysis does not lend itself to analysis of a portion of the system (e.g., just pit disassembly and conversion) when evaluating impacts from transportation of materials and wastes. See Appendix E, “Evaluation of Human Health Effects from Transportation,” for a detailed description of the transportation impacts associated with the alternatives being evaluated in this *SPD Supplemental EIS*, including impacts associated with the pit disassembly and conversion options. Appendix E, Section E.10, provides a discussion of the impacts associated with onsite shipments at SRS and LANL.

F.6 Environmental Justice

Executive Order 12898, *Federal Actions to Address Environmental Justice in Minority Populations and Low-Income Populations*, directs federal agencies to identify and address, as appropriate, disproportionately high and adverse human health and environmental effects of their programs, policies, and activities on minority and low-income populations. The alternatives considered in this *SPD Supplemental EIS* involve construction and operation of several facilities in various combinations, with different levels of efforts and operational timeframes. This type of system-wide analysis does not lend itself to analysis of a portion of the system (e.g., just pit disassembly and conversion). Chapter 4, Section 4.1.6, presents the potential impacts on populations surrounding the facilities at SRS and LANL that would be involved in surplus plutonium activities under the *SPD Supplemental EIS* alternatives. Included are the impacts associated with pit disassembly and conversion facilities.

F.7 Other Resource Areas

F.7.1 Land Resources

This section describes impacts on land resources from construction and operations of pit disassembly and conversion options. Land resources include land use and visual resources. Only construction of PDCF or PDC at SRS, or enhancement of the existing pit disassembly and conversion capability in PF-4 at LANL, have the potential to affect land resources. No impacts on land resources are expected at SRS for pit disassembly at the K-Area Complex or for plutonium conversion using H-Canyon/HB-Line or metal oxidation furnaces installed at MFFF. Similarly, no impacts on land resources are expected at LANL for pit disassembly and conversion at PF-4 under any pit disassembly and conversion option.

F.7.1.1 PDCF at F-Area at SRS

Construction—This section only addresses construction of facilities at SRS. There would be no new construction at LANL that would impact land use or visual resources.

Land use. PDCF would be located within F-Area in the same general area as that originally analyzed in the *SPD EIS* (DOE 1999). The area required to construct this facility, which has been cleared in expectation of construction, would be about 50 acres (20 hectares), including a laydown area. Once completed, PDCF would encompass less than 23 acres (9.3 hectares). It was assumed for the *SPD EIS* that three facilities (i.e., immobilization, PDCF, and MFFF) would be built within the same location and require a total of 79 acres (32 hectares) for construction (DOE 1999:2-49, 4-287). However, MFFF was subsequently moved to an 87-acre (35-hectare) site situated to the northwest of its original location (NRC 2005:1-8; SRNS 2012), and is currently under construction. WSB is currently under construction on a 15-acre (6.1-hectare) site at F-Area (SRNS 2012). Because the use of land for construction of PDCF would be consistent with the present heavy industrial nature of F-Area and would be consistent with the goals of the Industrial Core (see Chapter 3, Section 3.1.1.1), there would be minimal impacts on existing land use.

Visual resources. PDCF would be built within F-Area with construction occurring within a cleared area immediately adjacent to existing industrial facilities. Thus, the appearance of new facilities would be consistent with the industrialized character of the area. Also, the Visual Resource Management (VRM) Class IV designation applicable to F-Area would not change.

Operations—There would be no impacts on land use or visual resources from operation of PDCF at SRS or PF-4 at LANL.

F.7.1.2 PDC at K-Area at SRS

Construction—This section only addresses construction of facilities at SRS. There would be no new construction at LANL that would impact land use or visual resources.

Land use. Construction of PDC would take place within K-Area. In total construction would require about 30 acres (12 hectares) of land of which 25 acres (10 hectares) are presently disturbed by existing facilities or are cleared. The remaining 5 acres (2 hectares) needed for construction is wooded. This area could be cleared for a warehouse and/or parking (SRNS 2012). The total project footprint following construction would be about 18 acres (7.3 hectares). The impacts of clearing 210 acres (85 hectares) around the K-Area Complex, including the 5 acres (2 hectares) proposed under this option, were addressed in the *Environmental Assessment for the Safeguards and Security Upgrades for Storage of Plutonium Materials at the Savannah River Site* (DOE 2005d). That assessment resulted in a Finding of No Significant Impact (DOE 2005e). An additional activity planned under this option is construction of a 2-mile (3.2-kilometer) sanitary tie-in connecting K-Area to a lift station at C-Area. Although the exact route is undetermined at this time, it would likely use existing easements; thus, it is not expected to alter current land use. This would be verified prior to construction through the SRS Site Use Review Process (Reddick 2010).

Visual resources. As noted above, construction of PDC would take place at K-Area. With the exception of a new parking lot, construction would take place within the developed portion of K-Area and would be compatible with its industrial appearance. The new parking lot would remove 5 acres (2 hectares) of woodland located on the east side of the complex. However, this acreage is part of the 210 acres (85 hectares) of woodland to be removed as part of the safeguards and security measures to be implemented at K-Area. The removal of this acreage was evaluated under the *Environmental Assessment for the Safeguards and Security Upgrades for Storage of Plutonium Materials at the Savannah River Site* (DOE 2005d) for which a Finding of No Significant Impact was issued (DOE 2005e).

Operations—There would be no impacts on land use or visual resources from operation of PDC at SRS or PF-4 at LANL.

F.7.1.3 PF-4 at LANL and MFFF at SRS

Construction—Land use. At SRS, modification of capabilities in MFFF to support plutonium conversion using metal oxidation furnaces would be internal to the structure. Because installation of the metal oxidation furnaces in MFFF would require no additional ground disturbance there would be no impacts on land use at SRS. At LANL modifications to PF-4 to support an enhanced pit disassembly and conversion capability would occur within the existing building. However, to support these modifications, less than 2 acres (0.8 hectares) would be needed for a temporary trailer and construction parking. While a site has not been identified, preference would be given to previously-disturbed land and appropriate site permits would be acquired through the Permit Requirements Identification process to ensure that no cultural or natural resources would be impacted (LANL 2012).

Visual resources. At SRS, because modifications of capabilities in MFFF to support plutonium conversion using metal oxidation furnaces would be internal to the structure, there would be no additional visual impacts associated with this activity. At LANL, visual impacts would be minimal because most activities associated with PF-4 modifications would take place within the existing structure. While a temporary trailer and construction parking lot could disturb less than 2 acres (0.8 hectares), this would have minimal impacts on visual resources due to the limited area involved. Further, preference would be given to locating these features on previously disturbed land. There would be no impacts on visual resources from operations at either site.

Operations— There would be no impacts on land use or visual resources at SRS or LANL.

F.7.1.4 PF-4 at LANL and H-Canyon/HB-Line and MFFF at SRS

Construction—Land use. At SRS impacts from facility modifications to support pit disassembly and conversion would take place within metal oxidation furnaces in MFFF, within H-Canyon/HB-Line, and within the K-Area Complex. At LANL, there would be no impacts on land use from PF-4 modifications as described in Section F.7.1.3. Thus, there would be no impacts on land use at either site.

Visual resources. At SRS all activities associated facility modifications to support pit disassembly and conversion would take place within structures that either already exist or are already under construction. At LANL, there would be no impacts on visual resources from PF-4 modifications as described in Section F.7.1.3. Thus, there would be no impacts on visual resources at either site.

Operations—There would be no impacts on land use or visual resources at SRS or LANL.

F.7.2 Geology and Soils

Impacts on geology and soils can occur from disturbance of geologic and soil materials during land clearing, grading, and excavation activities, and the use of geologic and soils materials during facility construction and operations. Disturbance of geologic and soil materials includes excavating rock and soil, soil mixing, soil compaction, and covering building foundations, parking lots, roadways, and fill materials. Geologic and soils materials during facility construction and operations includes crushed stone, sand, gravel, and soil used for road and building construction, as fill during construction, and as feed for processing activities during operations.

Only construction of PDCF or PDC at SRS, or enhancement of the existing pit disassembly and conversion capability in PF-4 at LANL, have the potential to affect geology and soils through disturbance of the land surface and by the use of geologic and soils materials. No land disturbance or use of geologic and soils materials is expected at SRS for optional installation of a pit disassembly capability at the K-Area Complex, for enhancing the plutonium conversion capability at H-Canyon/HB-Line, or for installation of metal oxidation furnaces in MFFF. No land disturbance or use of geologic materials is expected at LANL for pit disassembly and conversion at PF-4 under the PDC and PDCF Options and minimal land disturbance under the PF-4 and MFFF and PF-4, H-Canyon/HB-Line, and MFFF Options. **Table F–24** presents the use of geologic and soils materials during construction for each pit disassembly and conversion option.

Table F–24 Use of Geologic and Soils Materials during Construction under the Pit Disassembly and Conversion Options

Geologic and Soil Materials	Facilities					Pit Disassembly and Conversion Options			
	SRS				LANL	PDCF	PDC	PF-4 and MFFF	PF-4, HC/HBL, and MFFF
	PDCF	PDC	HC/HBL ^a	MFFF ^b	PF-4				
Crushed stone, sand, and gravel (tons)	190,000	530,000	0	0	0 to minimal	190,000	530,000	minimal	minimal
Soil (cubic yards)	130,000	13,000	0	0	0 to minimal	130,000	13,000	minimal	minimal

HC/HBL = H-Canyon/HB-Line; LANL = Los Alamos National Laboratory; MFFF = Mixed Oxide Fuel Fabrication Facility; PDC = Pit Disassembly and Conversion Project; PDCF = Pit Disassembly and Conversion Facility; PF-4 = Plutonium Facility; SRS = Savannah River Site.

^a Pit disassembly would take place at the K-Area Complex; plutonium conversion would take place at HC/HBL. Installation of the pit disassembly capability at the K-Area Complex would involve no land disturbance and would not use geologic and soils materials.

^b Pit conversion would take place in MFFF using metal oxidation furnaces.

Note: Values are rounded to two significant figures. To convert tons to metric tons, multiply by 0.90718; cubic yards to cubic meters, multiply by 0.76456.

Source: DOE/NNSA 2012; LANL 2012; SRNS 2012; WSRC 2008a.

F.7.2.1 PDCF at F-Area at SRS

Construction—As described in Section F.7.1.1, construction of PDCF at SRS would disturb a total of 50 acres (20 hectares) of previously disturbed land at F-Area. During construction, best management practices (BMPs) such as silt fences, straw bales, geotextile fabrics, and revegetation would be used to control erosion. The South Carolina Department of Health and Environmental Control (SCDHEC) requires a Stormwater Pollution Prevention Plan (SWPPP) under the South Carolina National Pollutant Discharge Elimination System (NPDES) General Permit for stormwater discharges from construction activities (Permit Number SCR100000) (NRC 2005:4-24, 5-2). Because this area has already been disturbed, a limited area of soils would be disturbed at any one time, and BMPs would be used to limit soil erosion. Minimal impacts on geology and soils are expected.

The total quantities of geologic and soils materials (see Table F–24) would represent small percentages of regionally plentiful resources and are unlikely to have adverse impacts on SRS geology and soils.

Operations—Operation of PDCF would involve no ground-disturbing activities, and little or no use of geologic and soils materials, and therefore, would result in minimal impacts on SRS geology and soils.

F.7.2.2 PDC at K-Area at SRS

Construction—As described in Section F.7.1.2, construction of PDC at SRS would disturb a total of about 30 acres (12 hectares) of land At K-Area. The use of construction BMPs similar to those described in Section F.7.2.1 would likely result in minimal impacts on SRS geology and soils.

As described in Section F.7.2.1, the use of geologic and soil materials is unlikely to have adverse impacts on SRS geology and soils.

Operations—Operation of PDC would involve no ground-disturbing activities and little or no use of geologic and soils materials and, therefore, would result in minimal impacts on SRS geology and soils.

F.7.2.3 PF-4 at LANL and MFFF at SRS

Construction—At SRS, modification of capabilities in MFFF to support plutonium conversion using metal oxidation furnaces would be internal to the structure. Because installation of metal oxidation furnaces at MFFF would require no additional ground disturbance and no use of geologic materials, there would be no impacts on SRS geology and soils.

At LANL, as described in Section F.7.1.3, modification of PF-4 would temporarily disturb less than 2 acres (0.8 hectares) of land. The use of construction BMPs similar to those described in Section F.7.2.1 would likely result in minimal impacts on LANL geology and soils. This option would involve little or no use of geologic and soils materials and, therefore, would result in minimal impacts on LANL geology and soils.

Operations—Operation of facilities involved in this option would involve no ground-disturbing activities and little or no use of geologic and soils materials and, therefore, would result in minimal impacts on SRS and LANL geology and soils.

F.7.2.4 PF-4 at LANL and H-Canyon/HB-Line and MFFF at SRS

Construction—At SRS, modifications to capabilities in MFFF to support plutonium conversion using metal oxidation furnaces would be internal to the structure (see Section F.7.2.3). The minor modifications needed at the K-Area Complex and H-Canyon/HB-Line to support pit disassembly and conversion would only involve activities such as equipment replacement. Therefore, the facility modifications proposed at F- and H-Areas under this option would neither disturb additional ground nor cause impacts on SRS soil and geology.

At LANL, as described in Section F.7.1.3, modification of PF-4 at LANL would disturb less than 2 acres (0.8 hectares) of land. The use of construction BMPs similar to those described in Section F.7.2.1 would likely result in minimal impacts on LANL geology and soils. This option would require minimal use of geologic and soils materials and, therefore, would have minimal impacts on LANL geology and soils.

Operations—Operation of facilities involved in this option would involve no ground-disturbing activities and little or no use of geologic and soils materials and, therefore, would result in minimal impacts on SRS and LANL geology and soils.

F.7.3 Water Resources

This section analyzes impacts on water resources (surface water and groundwater) for each of the pit disassembly and conversion options. Because none of the projected construction or operational requirements for any of the options is expected to require more than about 1 percent of the available water capacity at SRS or LANL (see Section F.7.7), no impacts on groundwater quality are expected under any option at either site.

F.7.3.1 PDCF at F-Area at SRS

F.7.3.1.1 Surface Water

Construction—PDCF would be constructed within F-Area between MFFF and WSB (SRNS 2012). SCDHEC requires an SWPPP that would minimize the amount of sediment in runoff to surface waters (NRC 2005).³ As required by SCDHEC, proven construction techniques and BMPs, such as silt fences, straw bales, and sediment basins, would be installed at strategic locations to control the discharge of sediment and runoff. Detention ponds would be designed to control the release of stormwater runoff at a rate equal to or slightly less than that of the predevelopment stage. Runoff would be routed to detention ponds during earthmoving and excavation activities to minimize the potential for sediment migration to streams (NRC 2005:4-24).

Sedimentation resulting from PDCF construction would likely have minimal impacts on Upper Three Runs, which receives runoff from tributaries adjacent to the proposed construction area and discharges into the Savannah River. Ground-disturbing activities would be confined to construction areas and discharges would be in compliance with existing stormwater permits. Because surface waters would not be used to supply construction water needs, no impacts on SRS surface water quantity or availability to downstream users were identified. Subsequently, no long-term changes to stream channel morphology, aquatic habitats, or flow regimes are expected.

Accidental spills of oil, gas or diesel fuels, paint, or hydrologic fluids could affect stormwater runoff water quality. In accordance with a Spill Prevention Control and Countermeasures Plan pursuant to Title 40 of the *Code of Federal Regulations*, Part 112 (40 CFR Part 112), all spill events would be immediately reported, and for each spill event the material would be contained and remediated to the degree possible and properly disposed (NRC 2005:4-24). Impacts from localized spills on surface water quality are expected to be minimal. SRS surface runoff flows into existing storm sewer systems that provide the capability to block, divert, reroute, or temporarily contain water flows. During periods of construction when there would be the potential for spills or sediment loading, affected storm sewer zone flow paths would be secured. In the event of a chemical spill or contamination of runoff, the water could be rerouted by paved ditches and underground drainage lines from the secured storm sewer to a lined retention basin, thus averting a release of contaminants into receiving streams.

There would be no direct release of contaminated effluent during PDCF construction. Nonhazardous sanitary wastewater (sewage) would be managed using appropriate sanitary wastewater collection and treatment systems. Although it is likely that much liquid sanitary waste would be managed using portable toilets, it was conservatively assumed that all nonhazardous liquid wastes generated during PDCF construction would be managed at the Central Sanitary Waste Water Treatment Facility (CSWTF). CSWTF has sufficient hydraulic and organic capacity to treat the expected discharges from construction activities (NRC 2005:4-24); therefore, no impacts on surface water quantity or quality are expected.

At LANL, because there would be no modifications to PF-4 beyond those analyzed in the *LANL SWEIS* (DOE 2008a), there would be no potential for impacts on surface water quantity and quality.

Operations—At SRS, nonhazardous facility wastewater, stormwater runoff, and other industrial waste streams from PDCF operations (see **Table F-25**) would be managed and disposed in compliance with NPDES permit limits and requirements. Concentrations of regulated pollutants in the discharge would be well below NPDES permit limits (WGI 2005:129-149). Assuming the volume of effluent discharge from the treatment facilities would equal the volume of incoming wastewater, minimal impacts on surface water quality or flow are expected in Upper Three Runs, Fourmile Branch, and the Savannah River.

³ SRS hazardous facility structures are designed to engineering standards that quantify rainfall events having 10,000-year return periods for Performance Category 3 structures and 100,000-year return periods for Performance Category 4 structures. For performance category structures, the minimum drainage system design is for a 25-year, 6-hour rainfall event (SRS 2010:8, 11).

Table F-25 Nonhazardous Wastewater Generated During Pit Disassembly and Conversion Facility Operations

<i>Facility Wastewater Source</i>	<i>Estimated Wastewater Volumes (gallons per year)</i>	<i>Management and Disposal</i>
Blowdown	Process Cooling Tower – 520,000 HVAC Cooling Tower – 1,100,000 Process Chilled Water System – 1,200 Total – 1,600,000	Blowdown and condensate wastewater would be routed directly to CSWTF. The majority of sanitary wastewater would be clean HVAC condensate.
Condensates	HVAC – 1,900,000 Breathing Air – 42,000 Plant and Instrument Air – 14,000 Total – 2,000,000	
Sanitary wastewater	4,700,000	The wastewater would be delivered to CSWTF, which is capable of managing the expected volume of PDCF sanitary wastewater. ^a
Fire suppression system testing	1,400	Discharged over graded natural ground.
Vehicle wash rack	2,400	Wash water from the truck bay would be collected in an underground tank, pumped about once a month into a transport truck, and discharged through a permitted outfall.
Total:	8,200,000	

CSWTF = Central Sanitary Waste Water Treatment Facility; HVAC = heating, ventilation, and air conditioning; PDCF = Pit Disassembly and Conversion Facility.

^a CSWTF has a capacity of 383,000,000 gallons per year (SRNS 2012).

Note: Values have been rounded to two significant figures. To convert gallons to liters, multiply by 3.7854.

Source: WGI 2005:5, 32, 33; SRNS 2012.

PDCF stormwater runoff would be managed using two stormwater retention basins. The north and southeast basins would have an estimated volume (for a 100-year storm) of 9.9 acre-feet (12,000 cubic meters) and 6.4 acre-feet (7,900 cubic meters), respectively, and would discharge into an unnamed stream tributary that drains into Fourmile Branch (WGI 2005:32). Management options for runoff collected within the basins include: (1) release uncontaminated water into the receiving stream, (2) reroute contaminated water to the Effluent Treatment Project (ETP) for treatment, and (3) reroute contaminated water to tanks for storage and treatment. The latter two options are not expected because contamination is not expected in stormwater runoff. Basin discharges are expected to be well below permit limits (WGI 2005:146).

Uncontaminated heating, ventilation, and air conditioning (HVAC) condensate wastewater and stormwater runoff from MFFF and WSB would be discharged into Upper Three Runs and ultimately into the Savannah River at NPDES outfall H-16 under the conditions of SCDHEC Permit SC0000175. Contamination of surface water from this outfall would be minimal because under the conditions of the permit, pollutant concentrations would be limited to safe levels (WSRC 2008a).

Surface water sources would not be used to supply water for facility operations; therefore, no decrease in surface water levels or flows is expected. Likewise, plutonium disposition actions would not limit the availability of surface water to downstream users. Uncontaminated stormwater runoff would be discharged into NPDES-permitted discharge outfalls and sanitary wastewater routed to CSWTF. Effluent from treatment of wastewater at CSWTF would be discharged to Fourmile Branch (WSRC 2006:4-66); no impacts on surface water quantity or quality are expected.

At LANL, pit disassembly and conversion of 2 metric tons (2.2 tons) of surplus plutonium material has been analyzed (DOE 2008a) and is underway. Because stormwater runoff variables, NPDES permit requirements, and effluent discharge would not be affected, and surface water sources would not be used to supply water for facility operation, no impacts on surface water quantity or quality are expected.

F.7.3.1.2 Groundwater

Construction—At SRS, no direct releases of contaminated effluent to groundwater are planned (NRC 2005:4-24). The principal potential for water contamination and infiltration would arise from construction site runoff stored in stormwater retention basins (WGI 2005:32). Regarding potential releases of contaminated runoff, adherence to SWPPPs and implementation of spill prevention and control measures meeting EPA and SCDHEC regulations would limit the likelihood of groundwater contamination. Impacts on existing groundwater contamination underlying F-Area from construction of PDCF would not be measurable because the deepest construction activities would occur approximately 60 to 80 feet (18 to 24 meters) above the groundwater contamination (SRNS 2012). Existing groundwater monitoring wells would be moved to allow for continued monitoring before the start of PDCF construction (WGI 2005:140). No direct or indirect impacts on groundwater quality are expected (NRC 2005:4-24).

At LANL, because no modifications to PF-4 are planned beyond those previously assessed (DOE 2008a), there would be no potential for impacts on groundwater resources.

Operations—At SRS, PDCF is designed with the capability to monitor liquid effluents and control discharges (WGI 2005:140; WSRC 2008a). No direct discharge of liquid effluents to groundwater during facility operation is expected. Retention or detention basins would not be used as a component of facility wastewater treatment systems. Groundwater contamination could occur, however, resulting from groundwater recharge from contaminated surface water sources or from infiltration of accidental spills. Yet it is unlikely that groundwater quality would be affected by these indirect sources because adherence to NPDES requirements and Spill Prevention and Countermeasures Control Plans would require prompt and thorough cleanup which would limit groundwater contamination (NRC 2005:4-26). No impacts on groundwater quality are expected.

At LANL, there would be no direct discharge of liquid effluents to groundwater during operation of PF-4. As at SRS (see above), the potential for impacts on groundwater from contaminated surface water sources would be minimized through adherence to NPDES requirements and implementation of spill prevention and control measures. Pit disassembly and conversion of 2 metric tons (2.2 tons) of plutonium is underway at PF-4 and would not result in additional impacts on groundwater resources.

F.7.3.2 PDC at K-Area at SRS

F.7.3.2.1 Surface Water

Construction—At SRS, surface waters would not be used to support construction of PDC in K-Area. Construction-induced stormwater runoff would be discharged from permitted outfalls (WSRC 2008a). To meet SCDHEC requirements, the site would be divided into four drainage areas with four stormwater retention basins and the outfalls K-01, K-02, K-04, and K-New (see Chapter 3, Table 3–2). The K-New outfall would drain approximately 1.24 acres (0.50 hectares) that would contain a new substation, switchgear building, diesel storage, utility building, cooling tower, and roads (SRNS 2012).

Because BMPs would be used to control stormwater runoff and soil erosion (see Section F.7.3.1.1), construction is not expected to significantly augment liquid effluents from K-Area (SRNS 2012). Construction-induced sedimentation is also expected to have minimal water quality impacts on Indian Grave Branch or Pen Branch. No long-term changes to stream channel morphology, aquatic habitats, or flow regimes are expected, and the availability of surface water for downstream users would not be limited (WSRC 2008a).

At LANL, there would be no potential for impacts on surface water resources as discussed under the PDCF Option (see Section F.7.3.1.1).

Operations—PDC water and wastewater requirements would be supported by existing infrastructure at the K-Area Complex, which includes a domestic water system, sanitary sewer system, stormwater system, fire protection system, and process sewer system. PDC operation would increase the volumes of liquid

effluents from the K-Area Complex, particularly cooling tower blowdown and, to a lesser extent, noncontact cooling water. Other minor noncontact condensate sources would be piped to building drains (SRNS 2012). Water used to cool process equipment and gloveboxes would be contained within a closed loop system and separated by a heat exchanger from clean processes such as HVAC. If it becomes contaminated, this water would be trucked to the ETP for treatment (Goel 2010:133). Any fire fighting water used in process areas would be collected and sent to ETP for treatment prior to discharge (SRNS 2012).

PDC is expected to annually discharge about 2,300 gallons (8,700 liters) of process service water and about 8.2 million gallons (31 million liters) of sanitary sewer wastewater to CSWTF. Non-contaminated wastewater and stormwater would be discharged at one of the permitted K-Area drainage area outfalls (SRNS 2012). Surface water sources would not be used to supply water for facility operations; therefore, no decrease in surface water levels or flows is expected. No impacts on surface water quality are expected.

At LANL, impacts from pit disassembly and conversion activities at PF-4 would be minimal as discussed under the PDCF Option (see Section F.7.3.1.1).

F.7.3.2.2 Groundwater

Construction—At SRS, no liquid effluents would be directly discharged to the groundwater during construction of PDC (WSRC 2008a). As under the PDCF Option (see Section F.7.3.1.2), it is unlikely that groundwater quality would be affected by contaminated surface water sources because adherence to SWPPPs and implementation of spill prevention and control measures would minimize the potential for impacts on groundwater quality. At LANL, there would be minimal impacts on groundwater quality for the same reasons as those discussed under the PDCF Option (see Section F.7.3.1.2).

Operations—At SRS, water and wastewater treatment requirements would be met using existing K-Area and SRS infrastructure, with no projected discharge to groundwater. Groundwater would be protected from contaminated surface water sources using the same measures as those discussed under the PDCF Option (see Section F.7.3.1.2). Therefore, no impacts on groundwater quality are expected.

At LANL, there would be no additional impacts on groundwater resources as discussed under the PDCF Option (see Section F.7.3.1.2).

F.7.3.3 PF-4 at LANL and MFFF at SRS

F.7.3.3.1 Surface Water

Construction—At SRS, modification of capabilities in MFFF to support plutonium conversion using metal oxidation furnaces would be internal to the structure (SRNS 2012). Because there would be no potential for erosion or sediment loss, there would be no impacts on surface water quality.

At LANL, although modification of the existing PF-4 at TA-55 to support an enhanced pit disassembly and conversion capability would occur within an existing structure, up to 2 acres (0.8 hectares) of land could be temporarily disturbed to provide for a construction trailer and parking for construction workers. Ground disturbance associated with installing this temporary trailer could lead to a short-term increase in stormwater runoff, erosion, and/or sedimentation, but potential impacts on surface-water quality would be mitigated as at SRS (see Section F.7.3.1.1) through implementation of an SWPPP. The SWPPP would be prepared, prior to commencement of construction, to implement requirements and guidance from Federal and state regulations under the Clean Water Act, including the NPDES Construction General Permit and Clean Water Act Section 401 and 404 permits. Stormwater management controls, including BMPs for increased stormwater flows and sediment loads, would be included in the construction design specifications (DOE 2008a). To monitor the effectiveness of erosion and sediment control measures, the SWPPP would include a mitigation monitoring program, such as consistent and continual inspection and maintenance, to ensure that an adequate schedule and procedures are in place and implemented. If oil, gasoline, diesel fuel, or other petroleum products spill onto the ground, they would be cleaned up,

containerized, characterized, and disposed of (DOE 2011). Therefore, only minimal short-term impacts and no long-term impacts on surface water quantity and quality are expected.

Operations—At SRS, uncontaminated HVAC condensate wastewater and stormwater runoff from all MFFF operations, including pit conversion using metal oxidation furnaces, would be discharged into Upper Three Runs and ultimately into the Savannah River at NPDES outfall H-16 under the conditions of SCDHEC Permit SC0000175. Contamination of surface water from this outfall would be minimal because under the conditions of the permit, pollutant concentrations would be limited to safe levels (WSRC 2008a). Sanitary wastewater would be routed directly to CSWTF. Because surface water sources would not be used to supply water for MFFF operations, no decrease in surface water flows or impacts on surface water quality would be expected from pit conversion activities in MFFF.

At LANL, TA-55 where PF-4 is located is not in an area prone to flooding. TA-55 is dominated by sheet flow runoff conditions and does not contain natural runoff drainage features. There would be no direct discharge of industrial effluent and sanitary wastewater would be directed to the appropriate treatment facility for disposal (DOE 2011). Because surface water sources would not be used to supply water for PF-4 operations, no decrease in surface water levels or flows would be expected, nor impacts on surface water quality.

F.7.3.3.2 Groundwater

Construction—At SRS, there would be no discharge to groundwater during installation of metal oxidation furnaces at MFFF, and no potential for surface water sources during construction to affect groundwater resources. Therefore, there would be no impacts on groundwater quality.

At LANL, there would be no direct discharge to groundwater during modifications to PF-4. Because impacts on surface water quality would be protected as addressed in Section F.7.3.3.1, there would be minimal potential for contaminated surface water sources to impact groundwater. Therefore, modifications to PF-4 are expected to result in minimal impacts on groundwater quality.

Operations—At SRS, although operation of metal oxidation furnaces would slightly increase water and wastewater management requirements for MFFF, these requirements would be met by existing permits and facility and site infrastructure. No impacts on groundwater quality are expected. At LANL, augmented pit disassembly and conversion activities would similarly slightly increase water and wastewater management requirements, although these requirements would similarly be met by existing permits and facility and site infrastructure, with no expected impacts on groundwater quality.

F.7.3.4 PF-4 at LANL and H-Canyon/HB-Line and MFFF at SRS

F.7.3.4.1 Surface Water

Construction—At SRS, there would be no potential for impacts on surface water due to installation of metal oxidation furnaces in MFFF (see Section F.7.3.3.1). Modification of a glovebox at the K-Area Complex to support pit disassembly activities, and modification of the existing plutonium processing capability at H-Canyon/HB-Line to support pit conversion activities, would occur within existing structures with no potential for erosion or sediment loss that could affect surface water quality.

At LANL and as addressed in Section F.7.3.3.1, modification of PF-4 to enhance its pit disassembly and conversion capability is expected to have only minimal short-term impacts and no long-term impacts on surface water quality.

Operations—At SRS, contamination of surface water from MFFF (including plutonium oxidation) operations would be minimal, and no decrease in surface water flows or impacts on surface water quality would be expected from pit conversion activities (see Section F.7.3.3.1). Pit disassembly at the K-Area Complex would be conducted using existing infrastructure. Pit disassembly would only negligibly increase the annual volumes of liquid effluents from the K-Area Complex, including cooling tower blowdown and noncontact cooling water (see Section F.7.3.2.1). H-Canyon/HB-Line wastewater and

storm water runoff would be managed and discharged in compliance with existing regulations and facility permits that require pollutant concentrations to be limited to safe levels. Uncontaminated HVAC condensate and stormwater runoff would be discharged through permitted outfalls into Upper Three Runs. Operation of H-Canyon/HB-Line for pit conversion would not significantly affect these discharges and thus would not significantly affect surface water quality.

At LANL, impacts on surface water quality are expected to be the same (minimal) as those discussed in Section F.7.3.3.1 for the PF-4 and MFFF Option.

F.7.3.4.2 Groundwater

Construction—At SRS, installation of metal oxidation furnaces at MFFF would have negligible impacts on groundwater resources (see Section F.7.3.3.2). Only minor modifications would be needed at K-Area to install a pit disassembly capability and at H-Canyon/HB-Line to provide an enhanced pit conversion capability. These modifications would require only minor usages of water and other utilities with no potential for releases to surface water that could infiltrate into and contaminate groundwater resources. Hence, there would be no impacts on groundwater quality.

At LANL, minimal impacts on groundwater quality are expected as discussed in Section F.7.3.3.2 under the PF-4 and MFFF Option.

Operations—At SRS, there would be no discharge to groundwater from operation of K-Area, H-Canyon/HB-Line, and MFFF in support of pit disassembly and conversion. Water and wastewater management requirements would be met using existing facility and site infrastructure. No impacts on groundwater quality are expected.

At LANL, no impacts on groundwater quality are expected as discussed in Section F.7.3.3.2 under the PF-4 and MFFF Option.

F.7.4 Noise

Activities under the pit disassembly and conversion options would result in noise from vehicles, construction equipment, and facility operations. The change in noise levels was considered for construction and operation of the pit disassembly and conversion options.

F.7.4.1 PDCF at F-Area at SRS

Construction—At SRS, noise associated with PDCF construction would be similar to that described in the *SPD EIS* (DOE 1999). Impacts from onsite noise sources would be small, and construction traffic noise impacts would be unlikely to result in increased annoyance of the public (DOE 1999:4-52). Any change in traffic noise associated with construction would occur onsite and along offsite local and regional transportation routes. At LANL, there would be no new construction that would increase noise levels at the site.

Operations—At SRS, noise impacts from operating PDCF would be similar to those described for existing conditions at SRS in Chapter 3, Section 3.1.4.3. Noise sources during operations could include emergency generators, cooling systems, vents, motors, material-handling equipment, and employee vehicles and trucks. Given the distances to the site boundary, noise from facility operations is not expected to result in annoyance to the public. Non-traffic noise sources are far enough away from offsite areas that the contribution to offsite noise levels would continue to be small. Noise from traffic associated with the operation of facilities is expected to increase by less than 1 decibel as a result of the increase in staffing. Some noise sources could have onsite noise impacts, such as the disturbance of wildlife. However, noise would be unlikely to affect federally listed threatened or endangered species or their critical habitats. Some change in the noise levels to which noninvolved workers are exposed could occur. Appropriate noise control measures would be implemented under DOE Order 440.1B, *Worker Protection Program for DOE (Including the National Nuclear Security Administration) Federal Employees*, to protect worker hearing.

At LANL, noise impacts from operating PF-4 would be similar to those described for existing conditions at LANL in Chapter 3, Section 3.2.4.3. Noise sources during operations could include emergency generators, cooling systems, vents, motors, material-handling equipment, and employee vehicles and trucks. Given the distances to site boundaries (about 0.6 miles [1 kilometer] from TA-55), noise from facility operations is not expected to result in annoyance to the public. Non-traffic noise sources are far enough away from offsite areas that the contribution to offsite noise levels would continue to be small (LANL 2012).

F.7.4.2 PDC at K-Area at SRS

Construction—At SRS, noise impacts from construction of PDC at K-Area would be small and construction traffic noise impacts would be unlikely to result in increased annoyance of the public. At LANL, there would be no new construction that would increase noise levels at the site.

Operations—Noise impacts from operation of PDC at SRS and PF-4 at LANL are expected to be similar to those in Section F.7.4.1 under the PDCF Option.

F.7.4.3 PF-4 at LANL and MFFF at SRS

Construction—At SRS, noise impacts from installation of metal oxidation furnaces at MFFF would be minor. At LANL, noise impacts from modifications to PF-4 would be minor also.

Operations—Noise impacts from pit conversion activities at MFFF at SRS are expected to be minor, representing a negligible addition to those resulting from operation of MFFF for MOX fuel fabrication (see Appendix G, Section G.7.4). Noise impacts from operation of PF-4 at LANL are expected to be similar to those in Section F.7.4.1 under the PDCF Option, although there would be some minor additional sources of traffic noise due to the increased level of pit disassembly and conversion activity.

F.7.4.4 PF-4 at LANL and H-Canyon/HB-Line and MFFF at SRS

Construction—At SRS, noise impacts from installation of metal oxidation furnaces at MFFF and modifications to the K-Area Complex and H-Canyon/HB-Line would be minor. At LANL, noise impacts from modifications to PF-4 would be minor also.

Operations—At SRS, noise impacts from pit disassembly and conversion activities at the K-Area Complex, H-Canyon/HB-Line, and MFFF are expected to be similar to those discussed in Section F.7.4.1 under the PDCF Option. At LANL, noise impacts from pit disassembly and conversion activities at PF-4 are expected to be similar to those discussed in Section F.7.4.3 under the PF-4 and MFFF Option.

F.7.5 Ecological Resources

This section analyzes impacts on ecological resources—including terrestrial, aquatic, and wetland resources, and threatened and endangered species—resulting from construction or modification of facilities for pit disassembly and conversion. Operation of these facilities would not further affect ecological resources. Terrestrial resources would not be further affected because additional land would not be disturbed during facility operations, and any artificial lighting and noise-producing activities would occur in areas that are already in industrial use. Aquatic and wetland resources, and threatened and endangered species, would not be further affected because additional land would not be disturbed during facility operations.

Only construction of PDCF or PDC at SRS, or enhancement of the existing pit disassembly and conversion capability in PF-4 at LANL, have the potential to affect ecological resources through disturbance of the land surface. No land disturbance is expected at SRS for pit disassembly at the K-Area Complex, for plutonium conversion using H-Canyon/HB-Line, or for metal oxidation furnaces installed at MFFF. The majority of land needed to support construction activities has already been disturbed; thus, only minimal impacts on ecological resources at SRS and LANL are expected. Section F.7.1 presents the land disturbed for each pit disassembly and conversion option.

F.7.5.1 PDCF at F-Area at SRS

Construction—Only construction at SRS is considered in this section; there would be no construction at LANL PF-4 that could result in impacts on ecological resources.

Terrestrial resources. PDCF would be constructed on about 50 acres (20 hectares) of land at F-Area. Because this area has already been disturbed, and BMPs would be used to limit soil erosion, minimal impacts on ecological resources are expected.

Aquatic resources. No aquatic resources exist within the disturbed area required for the construction and operation of PDCF at F-Area (WSRC 2008a). An SWPPP would be implemented during construction to minimize the amount of soil erosion and sedimentation that could be transported into nearby water bodies. Control measures could include sediment fences and minimizing the amount of time bare soil would be exposed. Therefore, any impacts on aquatic resources including streams, lakes, or ponds, would be minimized.

Wetlands. No wetlands exist within the disturbed area required for construction of PDCF at F-Area (WSRC 2008a). As addressed above, during construction of PDCF an SWPPP would be implemented during construction to minimize the amount of soil lost or transported into nearby water wetlands. Measures could include sediment fences and minimizing the amount of time bare soil is exposed. Therefore, any impacts on wetlands would be minimized.

Threatened and endangered species. Construction of PDCF at F-Area would take place on already disturbed land where no threatened or endangered species are known to forage, breed, nest, or occur. Therefore, no impacts on threatened or endangered species are expected (WSRC 2008a; NRC 2005:4-105).

Operations—Operation of facilities under this option would involve no ground-disturbing activities, and, therefore, would result in minimal impacts on SRS and LANL ecological resources.

F.7.5.2 PDC at K-Area at SRS

Construction— Only construction at SRS is considered in this section; there would be no construction at LANL PF-4 that could result in impacts on ecological resources.

Terrestrial resources. Up to 30 acres (12 hectares) of land within K-Area would be required to support construction of PDC. Of the 30 acres, approximately 5 acres (2 hectares) of undisturbed wooded land would be developed for construction of a warehouse and/or parking lot to support PDC operations (SRNS 2012). Impacts related to the clearing of 210 acres (85 hectares) of land surrounding the K-Area Complex, including the 5 acres (2 hectares) of undisturbed land that could be disturbed by this action, would include loss of upland forest and other habitat types. These impacts were addressed in the *Environmental Assessment for the Safeguards and Security Upgrades for Storage of Plutonium Materials at the Savannah River Site* (DOE 2005d). The accompanying Finding of No Significant Impact concluded that the proposed action is not expected to have measurable impacts on the human environment including threatened and endangered species, wetlands, and migratory avian species (DOE 2005e).

It is expected that a planned sanitary tie-in connecting K-Area to a lift station at C-Area would be constructed on previously disturbed land, resulting in no additional impacts on terrestrial resources (Reddick 2010). If portions of the sanitary tie-in are routed through previously undisturbed land, however, impacts could include loss of upland forest and other habitat, and temporary disturbance of wildlife. Preconstruction surveys and consultations with the U.S. Fish and Wildlife Service and the South Carolina Department of Natural Resources would be conducted, if appropriate, and impacts on sensitive animal and plant species would be minimized with as-necessary implementation of mitigation actions.

Aquatic resources. Although new construction would be required in both undisturbed and disturbed areas of K-Area to support PDC operations, no substantial aquatic resources exist within either of these areas. Control measures to minimize erosion and sediment loss would be implemented similar to those

discussed in Section F.7.5.1, and minimal impacts on aquatic resources are expected. No impacts on aquatic resources are expected resulting from construction of a sanitary tie-in connecting K-Area to a lift station at C-Area.

Wetlands. As discussed above, no wetlands exist within the area required for the structures to be constructed at K-Area for PDC. Because measures would be taken to minimize erosion and sediment loss during construction (similar to those discussed in Section F.7.5.1), minimal impacts on wetlands are expected. No impacts on wetlands are expected to result from construction of a sanitary tie-in connecting K-Area to a lift station at C-Area.

Threatened and endangered species. No threatened or endangered species are known to forage, breed, nest, or occur on any of the land required for the structures to be constructed at K-Area for PDC. Therefore, no impacts are expected (DOE 2005d; WSRC 2006). In addition, because no threatened or endangered species occur within or nearby the area surrounding the proposed construction sites, they would not be affected by noise produced by construction activities. No impacts on threatened or endangered species are expected resulting from construction of a sanitary tie-in connecting K-Area to a lift station at C-Area.

Operations—Operation of facilities under this option would involve no ground-disturbing activities, and, therefore, would result in minimal impacts on SRS and LANL ecological resources.

F.7.5.3 PF-4 at LANL and MFFF at SRS

Construction—At SRS, construction or modification of facilities used for pit disassembly and conversion would take place within existing structures on already disturbed land. There would be no potential for erosion and sediment loss during construction to impact aquatic resources or wetlands, and no potential for impacts on threatened and endangered species. Therefore, facility construction or modification would not cause impacts on terrestrial, aquatic, and wetland resources, or threatened and endangered species.

At LANL, as described in Section F.7.1.3, modification of PF-4 at LANL would disturb less than 2 acres (0.8 hectares) of land for a temporary trailer and construction parking. While a site has not yet been identified, preference would be given to disturbed land and appropriate site permits would be acquired through the Permit Requirements Identification Process to ensure that no ecological resources would be impacted (LANL 2012).

Operations—Operation of facilities under this option would involve no ground-disturbing activities and thus would result in minimal impacts on SRS and LANL ecological resources.

F.7.5.4 PF-4 at LANL and H-Canyon/HB-Line and MFFF at SRS

Construction—At SRS, construction or modification of facilities used for pit disassembly and conversion would take place within existing structures on already disturbed land. There would be no potential for erosion and sediment loss during construction to impact aquatic resources or wetlands, and no potential for impacts on threatened and endangered species. Therefore, facility construction or modification activities would not cause impacts on terrestrial, aquatic, and wetland resources, or threatened and endangered species.

At LANL, as described in Section F.7.1.3, modification of PF-4 at LANL would disturb less than 2 acres (0.8 hectares) of land for a temporary trailer and construction parking. While a site has not yet been identified, preference would be given to disturbed land and appropriate site permits would be acquired through the Permit Requirements Identification Process to ensure that no ecological resources would be impacted (LANL 2012).

Operations—Operation of facilities under this option would involve no ground-disturbing activities and, thus, would result in minimal impacts on SRS and LANL ecological resources.

F.7.6 Cultural Resources

SRS manages and protects its cultural resources, including prehistoric, historic, American Indian, and paleontological resources, under the terms of agreements and through a Site use Review Process to evaluate potential impacts imposed by the scope of work intended prior to taking any action. The Savannah River Archaeological Research Program (SRARP) of the South Carolina Institute of Archeology and Anthropology at the University of South Carolina assists DOE in determining how the project can proceed to minimize or mitigate potential impacts on cultural resources (Wingard 2010).

LANL manages and protects its cultural resources as detailed in *A Plan for the Management of the Cultural Heritage at Los Alamos National Laboratory, New Mexico* (LANL 2006) and governed by the *Programmatic Agreement Between the U.S. Department of Energy, National Nuclear Security Administration, Los Alamos Site Office, the New Mexico State Historic Preservation Office and the Advisory Council on Historic Preservation Concerning the Management of the Historic Properties of Los Alamos National Laboratory, New Mexico* (DOE 2006).

The land area required for construction or modification of facilities at SRS and LANL for pit disassembly and conversion is relatively small; would take place primarily in previously disturbed or developed areas; and would be surveyed and monitored, as appropriate, in compliance with existing agreements and procedures. Impacts from operations would be negligible at either site, and are not further addressed, because security measures at the sites would restrict access to any nearby prehistoric, historic, American Indian, and paleontological resources.

F.7.6.1 PDCF at F-Area at SRS

This section only addresses construction impacts at SRS. There would be no new construction at LANL that would result in impacts on cultural resources.

Prehistoric Resources. PDCF would be constructed in F-Area adjacent to MFFF and WSB, which are currently under construction. F-Area is classified as site industrial and is within the Industrial Core Management Area (DOE 2005b:4, 2005c:56). Prior to MFFF construction activities, this entire area was surveyed for cultural resources and 15 prehistoric sites were identified; 7 have been deemed eligible for listing on the National Register of Historic Places (NRHP). Because two of these sites would be directly affected by construction activities, a data recovery plan was submitted and approved by the South Carolina State Historic Preservation Office (SHPO). Subsequently, prior to the commencement of construction activities, SRARP excavated the sites to mitigate impacts caused by the construction of the MFFF and potential construction of PDCF (NRC 2005:3-38, 5-14). Data recovery of these sites was completed, as well as appropriate monitoring, which ensures that DOE, through SRARP, exceeded the recommendations in the data recovery plans (NRC 2005:App. B) and met the terms of the Memorandum of Agreement (SRARP 1989:App. C) regarding mitigation of impacts on archaeological sites within the surplus plutonium disposition facilities project area (King 2010).

In 2008 and 2009, 75 acres (30 hectares) in F-Area were surveyed for the purpose of constructing a laydown yard for PDCF. This fieldwork located four of five previously recorded sites and identified a new site, as well as five artifacts. Because the artifacts have no research potential there would be no adverse impact; however, two sites are potentially eligible for nomination to the NRHP so it is recommended that they be avoided. SRARP expects an amended site use permit to facilitate this recommendation (SRARP 2009:10-12).

Historic Resources. There would be no impacts on historic resources associated with the Cold War era in F-Area because the proposed alternative action involves new construction and does not affect existing facilities.

American Indian Resources. Due to the developed nature of F-Area, it is highly unlikely that either vegetation important to American Indians, or other resources of concern, would be found within the area.

Thus, impacts on American Indian resources resulting from actions necessary to implement pit disassembly and conversion would be unlikely.

Paleontological Resources. Paleontological resources are unlikely to be found within F-Area due to the highly disturbed nature of the area. Thus, impacts on paleontological resources resulting from implementing pit disassembly and conversion would be unlikely.

F.7.6.2 PDC at K-Area at SRS

This section only addresses construction impacts at SRS. There would be no new construction at LANL that would result in impacts on cultural resources.

Prehistoric Resources. PDC would be constructed at K-Area, which is classified as site industrial (DOE 2005b:4, 2005c:62). The majority of the land required for PDC construction has been previously disturbed with the exception of approximately 5 acres (2 hectares), which are currently wooded. Because construction would take place within the built-up portion of K-Area and previous archeological reviews did not reveal any identified sites where land disturbance would occur, impacts on prehistoric resources are unlikely. Although six archeological sites have been identified in the vicinity of the project boundary, none would be disturbed (Blunt 2010; DOE 2005d:13-14; SRARP 2006:10).

Associated with establishing pit disassembly and conversion capabilities in K-Area would be construction of a 2-mile (3.2-kilometer) sanitary tie-in connecting K-Area to a lift station in C-Area. Although the exact route is undetermined at this time, it would likely use existing easements; thus, it is not expected to impact prehistoric resources. This would be verified prior to construction through the SRS site use clearance process and, if necessary, cultural resource surveys would be conducted (Reddick 2010; SRARP 1989:App. C).

Historic Resources. The K-Area reactor building is an NRHP-eligible structure itself and within the context of the Cold War Historic District. This facility is considered highly significant because it was primary to SRS's mission and housed a part or all of one of the site's nuclear production processes and is valued for its good integrity in that the building contains parts of its original equipment and can still provide information about its past. As such, proposed changes that may impact the historic fabric of this building, or to any intact historically significant equipment, would be studied, discussed with the South Carolina SHPO, and avoided, mitigated, or minimized (DOE 2005a:16, 44, 61, 67).

American Indian Resources. Due to the developed nature of K-Area, it is highly unlikely that either vegetation important to American Indians, or other resources of concern, would be found within the area. Thus, impacts on American Indian resources resulting from actions necessary to implement pit disassembly and conversion would be unlikely.

Paleontological Resources. Paleontological resources are unlikely to be found within K-Area due to the highly disturbed nature of the area. Thus, impacts on paleontological resources resulting from implementing pit disassembly and conversion would be unlikely.

F.7.6.3 PF-4 at LANL and MFFF at SRS

Prehistoric Resources. At SRS, metal oxidation furnaces would be installed in MFFF at F-Area. Because construction would be internal to the MFFF structure, there would be no impacts on prehistoric resources.

At LANL, modification of PF-4 could require up to 2 acres (0.8 hectares) for a temporary trailer and construction parking. Although a site has not been identified, preference would be given to previously disturbed land and appropriate permits would be acquired including adherence to provisions set forth in the *Programmatic Agreement Between the U.S. Department of Energy, National Nuclear Security Administration, Los Alamos Site Office, the New Mexico State Historic Preservation Office and the Advisory Council for Historic Preservation Concerning the Management of the Historic Properties of Los Alamos National Laboratory, New Mexico* (DOE 2006). A rock shelter has been identified in TA-55

as eligible or potentially eligible for listing on the NRHP which would be taken into consideration in siting the temporary construction site.

Historic Resources. There would be no impacts on historic resources associated with the Cold War era at SRS or LANL because the option involves relatively modern or new facilities. Modifications to PF-4 would conform to requirements in *A Plan for the Management of the Cultural Heritage at the Los Alamos National Laboratory, New Mexico* (LANL 2006).

American Indian Resources. Due to the developed nature of F-Area at SRS and TA-55 at LANL, it is highly unlikely that either vegetation important to American Indians, or other resources of concern, would be found within the area. Thus, impacts on American Indian resources resulting from actions necessary to implement pit disassembly and conversion would be unlikely.

Paleontological Resources. Paleontological resources are unlikely to be found within F-Area at SRS or TA-55 at LANL due to the highly disturbed nature of the area. Thus, impacts on paleontological resources resulting from implementing pit disassembly and conversion would be unlikely.

F.7.6.4 PF-4 at LANL and H-Canyon/HB-Line and MFFF at SRS

Prehistoric Resources. At SRS and as discussed in Section F.7.6.3, there would be no impacts on prehistoric resources from installation of metal oxidation furnaces in MFFF. Although H-Canyon/HB-Line in H-Area and a glovebox within the K-Area Complex could be modified to support pit disassembly and conversion, the modifications would occur inside an existing structure so there would be no impacts on prehistoric resources at H- or K-Area. At LANL, there would be no impacts on prehistoric resources from modification of PF-4.

Historic Resources. At SRS, the H-Canyon building, including HB-Line, and any other attached auxiliaries have been identified as NRHP-eligible individually, as well as collectively within the context of the Cold War Historic District. The H-Canyon building and its auxiliary facilities are considered highly significant given that these structures were primary to SRS's mission and housed part or all of the site's nuclear production processes (DOE 2005a:39, 58, 61, 66). Photographic mitigation and oral histories have been initiated and, when completed, will be distributed to the South Carolina SHPO to determine what, if any, further action is required in order to preserve the historical integrity of these facilities (DOE 2008b:4). The proposed facility modifications would be assessed in accordance with the *Cold War Historic Preservation Program* (Sauerborn 2011). There would be no impacts on historic resources at MFFF because the facility is under construction, and no impacts on historic resources at the K-Area Complex because of the limited scope of the modifications that mostly entail replacement of equipment with an existing glovebox.

At LANL, no impacts are expected on historic resources associated with the Cold War era as discussed in Section F.7.6.3.

American Indian Resources. Due to the developed nature of F-, H-, and K-Areas at SRS and TA-55 at LANL, it is highly unlikely that either vegetation important to American Indians, or other resources of concern, would be found within the area. Thus, impacts on American Indian resources resulting from actions necessary to implement pit disassembly and conversion would be unlikely.

Paleontological Resources. Paleontological resources are unlikely to be found within F-, H-, and K-Areas at SRS and TA-55 at LANL due to the highly disturbed nature of the area. Thus, impacts on paleontological resources resulting from implementing pit disassembly and conversion would be unlikely.

F.7.7 Infrastructure

This section analyzes impacts of different pit disassembly and conversion options on infrastructure resources. The resources being analyzed are electricity, fuel oil, and water. **Table F–26** summarizes the peak annual resource requirements that would be required for construction under the pit disassembly and conversion options. **Table F–27** summarizes the peak annual resource requirements that would be required for operations under the pit disassembly and conversion options.

F.7.7.1 PDCF at F-Area at SRS

Construction—At SRS, construction of PDCF would annually use less than 1 percent of SRS’s available electrical capacity (about 4.1 million megawatt-hours) and available water capacity (about 2.63 billion gallons [9.96 billion liters]). Fuel oil usage is not limited by site capacity because oil fuel is delivered to the site as needed. However, construction of PDCF is estimated to require 390,000 gallons (1,500,000 liters) of fuel oil per year, approximately 95 percent of SRS’s current annual fuel usage (about 410,000 gallons [1,600,000 liters] per year—see Chapter 3, Section 3.1.9). At LANL, there would be no additional construction that would impact infrastructure resources.

Operations—At SRS, operation of PDCF would annually use approximately 2 percent of SRS’s available electrical capacity, and water usage at PDCF would annually use less than 1 percent of the site’s available capacity. Fuel oil usage is estimated at approximately 9 percent of SRS’s current annual fuel usage. At LANL, pit disassembly and conversion activities at PF-4 would annually use about 0.3 and 0.4 percent, respectively, of LANL’s available electrical and water capacity (conservatively, about 352,000 megawatt-hours of electricity and 114 million gallons [430 million liters] of water). No additional fuel oil would be needed at PF-4 to support pit disassembly and conversion.

F.7.7.2 PDC at K-Area at SRS

Construction—At SRS, construction of PDC would use less than 1 percent of SRS’s available electrical capacity and available water capacity, but require about 300,000 gallons (1,100,000 liters) of fuel oil, approximately 73 percent of SRS’s current annual fuel usage. At LANL, there would be no additional construction that would impact infrastructure resources.

Operations—At SRS, operations would use approximately 1 percent of SRS’s available electrical capacity, and less than 1 percent of the site’s available water capacity. Fuel oil is not expected to be required beyond the fuel oil already required associated with other ongoing operations at K-Area. At LANL, resource use for pit disassembly and conversion would be the same as that for the PDCF Option.

F.7.7.3 PF-4 at LANL and MFFF at SRS

Construction—At SRS, installation of metal oxidation furnaces at MFFF to provide a pit conversion capability would be performed during construction of the overall MFFF or during its operation. In either event, resource use would be minimal. At LANL, modifications to PF-4 would conservatively use less than 1 percent of the available LANL electrical capacity, and less than 1 percent of the available LANL water capacity. Fuel oil use is estimated at 2,800 gallons (11,000 liters) per year at PF-4.

Operations—At SRS, operation of metal oxidation furnaces at MFFF would have minimal impacts on available SRS capacities. No additional fuel oil would be required to support metal oxidation furnace operations at MFFF. At LANL, annual operations at PF-4 related to pit disassembly and conversion would conservatively require less than 1 percent of LANL’s available electrical capacity and about 1 percent of LANL’s available water capacity. No additional fuel oil would be required to support operations as a result of pit disassembly and conversion activities at PF-4.

Table F-26 Peak Annual Construction Infrastructure Requirements Associated with Pit Disassembly and Conversion Options

Resource	Facilities					Pit Disassembly and Conversion Options			
	SRS				LANL	PDCF	PDC	PF-4 and MFFF	PF-4, H-Canyon/HB-Line, and MFFF
	PDCF	PDC	H-Canyon/ HB-Line ^a	MFFF ^a	PF-4 ^b				
Electricity (megawatt-hours)	15,000	9,400	minimal	minimal	83	15,000	9,400	83	83
Water (gallons)	2,600,000	1,100,000	minimal	minimal	340,000	2,600,000	1,100,000	340,000	340,000
Fuel oil (gallons) ^c	390,000	300,000	minimal	minimal	2,800	390,000	300,000	2,800	2,800

LANL = Los Alamos National Laboratory; MFFF = Mixed Oxide Fuel Fabrication Facility; PDC = Pit Disassembly and Conversion Project; PDCF = Pit Disassembly and Conversion Facility; PF-4 = Plutonium Facility; SRS = Savannah River Site.

^a Modifications to K-Area, H-Canyon/HB-Line, and MFFF to support pit disassembly and conversion activities are expected to result in minimal additional infrastructure requirements and to fall within SRS's current infrastructure requirements.

^b The values reflect resource use for modifications to PF-4 to support an enhanced pit disassembly and conversion capability under the PF-4 and MFFF and PF-4, H-Canyon/HB-Line, and MFFF Options. No additional construction resource use is expected at PF-4 under the PDCF and PDC Options.

^c Construction fuel oil includes gasoline.

Note: Values are rounded to two significant figures. To convert gallons to liters, multiply by 3.7854.

Source: LANL 2012; SRNS 2012; WSRC 2008a.

Table F-27 Peak Annual Operational Infrastructure Requirements Associated with Pit Disassembly and Conversion Options

Resource	Facilities					Pit Disassembly and Conversion Options			
	SRS				LANL	PDCF	PDC	PF-4 and MFFF	PF-4, H-Canyon/HB-Line, and MFFF
	PDCF	PDC	H-Canyon/ HB-Line ^a	MFFF ^b	PF-4 ^c				
Electricity (megawatt-hours)	92,000	41,000	minimal	150	960 / 1,900	93,000	42,000	2,100	2,100
Water (gallons)	16,000,000	16,000,000	minimal	minimal	480,000 / 1,200,000	16,000,000	16,000,000	1,200,000	1,200,000
Fuel oil (gallons)	35,000	170,000	minimal	0	0 / 0	35,000	170,000	0	minimal

LANL = Los Alamos National Laboratory; MFFF = Mixed Oxide Fuel Fabrication Facility; PDC = Pit Disassembly and Conversion Project; PDCF = Pit Disassembly and Conversion Facility; PF-4 = Plutonium Facility; SRS = Savannah River Site.

^a Annual operations at K-Area and H-Canyon/HB-Line to support pit disassembly and conversion activities are expected to result in minimal additional infrastructure requirements beyond those already included in SRS's current infrastructure requirements. About 41 megawatt hours of electricity and 31,000 gallons of water at DWPF could be annually attributable to vitrification of waste resulting from pit conversion activities at H-Canyon/HB-Line.

^b Annual operation of metal oxidation furnaces at MFFF to support pit disassembly and conversion activities is expected to result in minimal additional requirements for water and no additional requirements for fuel oil at MFFF beyond those already included in MFFF's current infrastructure requirements (see Appendix G).

^c The first value reflects pit disassembly and conversion activities at PF-4 under the PDCF and PDC Options. The second value reflects pit disassembly and conversion activities at PF-4 under the PF-4 and MFFF and PF-4, H-Canyon/HB-Line, and MFFF Options. Pit disassembly and conversion at PF-4 is not expected to result in increased use of fuel oil under any option.

Note: Values are rounded to two significant figures. To convert gallons to liters, multiply by 3.7854.

Source: LANL 2012; SRNS 2012; WSRC 2008a.

F.7.7.4 PF-4 at LANL and H-Canyon/HB-Line and MFFF at SRS

Construction—At SRS, modifications to K-Area to upgrade an existing glovebox to support pit disassembly, and at H-Canyon/HB-Line to support pit conversion, would have minimal impacts on SRS infrastructure. Similarly and as discussed in Section F.7.7.3, installation of metal oxidation furnaces at MFFF would have a minimal effect on SRS infrastructure. At LANL, resource use from modifications to PF-4 would be the same as that under the PF-4 and MFFF Option (see Section F.7.7.3).

Operations—At SRS, the additional infrastructure requirements associated with operating a pit disassembly glovebox in K-Area and metal oxidation furnaces at MFFF would be minimal compared to the other infrastructure requirements at these facilities. Pit conversion operations at the H-Canyon/HB-Line would require minimal additional electricity, water or fuel oil compared to current infrastructure requirements associated with continued operation of this facility. These requirements are already reflected in SRS's baseline operations so there would not be any additional impacts on SRS's available electrical or water capacity. At LANL, resource use from pit disassembly and conversion activities at PF-4 would be the same as that under the PF-4 and MFFF Option (see Section F.7.7.3).

F.8 References

Blunt, B., 2010, Savannah River Site, Aiken, South Carolina, personal communication (email) to J. DiMarzio, Science Applications International Corporation, Germantown, Maryland, "Item #42 Cultural Sites," December 21.

DOE (U.S. Department of Energy), 1999, *Surplus Plutonium Disposition Final Environmental Impact Statement*, DOE/EIS-0283, Office of Fissile Materials Disposition, Washington, DC, November.

DOE (U.S. Department of Energy), 2003, *Estimating Radiation Risk from Total Effective Dose Equivalent (TEDE), ISCORS Technical Report No. 1*, DOE/EH-412/0015/0802, Rev. 1, Office of Environmental Policy and Guidance, January.

DOE (U.S. Department of Energy), 2005a, *Savannah River Site's Cold War Built Environment Cultural Resources Management Plan*, Savannah River Operations Office, Aiken, South Carolina, January 26.

DOE (U.S. Department of Energy), 2005b, *Natural Resources Management Plan for the Savannah River Site*, Aiken, South Carolina, May.

DOE (U.S. Department of Energy), 2005c, *Savannah River Site End State Vision*, Aiken, South Carolina, July 26.

DOE (U.S. Department of Energy), 2005d, *Environmental Assessment for the Safeguards and Security Upgrades for Storage of Plutonium Materials at the Savannah River Site*, DOE/EA-1538, Savannah River Operations Office, Aiken, South Carolina, December.

DOE (U.S. Department of Energy), 2005e, *Finding of No Significant Impact for the Safeguards and Security Upgrades for Storage of Plutonium Materials at the Savannah River Site*, Savannah River Operations Office, Aiken, South Carolina, December 16.

DOE (U.S. Department of Energy), 2006, *Programmatic Agreement Between the U.S. Department of Energy, National Nuclear Security Administration, Los Alamos Site Office, the New Mexico State Historic Preservation Office and the Advisory Council for Historic Preservation Concerning the Management of the Historic Properties of Los Alamos National Laboratory, New Mexico*, LA-UR-06-1975, Los Alamos Site Office, Los Alamos, New Mexico, June 15.

DOE (U.S. Department of Energy), 2008a, *Final Site-Wide Environmental Impact Statement for Continued Operation of Los Alamos National Laboratory, Los Alamos, New Mexico*, DOE/EIS-0380, National Nuclear Security Administration, Los Alamos Site Office, Los Alamos, New Mexico, May.

DOE (U.S. Department of Energy), 2008b, *Savannah River Site (SRS) Cold War Built Environment Historic Preservation Annual Summary Report Fiscal Year (FY) 2008*, Savannah River Operations Office, Aiken, South Carolina, October.

DOE (U.S. Department of Energy), 2011, *Final Supplemental Environmental Impact Statement for the Nuclear Facility Portion of the Chemistry and Metallurgy Research Building Replacement Project at Los Alamos National Laboratory, Los Alamos, New Mexico*, DOE/EIS-0350-S1, National Nuclear Security Administration, Los Alamos Site Office, Los Alamos, New Mexico, August.

DOE/NNSA (U.S. Department of Energy/National Nuclear Security Administration), 2012, *NEPA Source Document for Pit Disassembly and Conversion (PDC) Project*, SRNS-RP-2011-01168, Rev. 0, Office of Defense Nuclear Nonproliferation, Denver, Colorado, April 25.

EPA (U.S. Environmental Protection Agency), 1990, *New Source Review Workshop Manual – Prevention of Significant Deterioration and Nonattainment Area Permitting*, Draft, October.

EPA (U.S. Environmental Protection Agency), 2004, *User’s Guide for the AMS/EPA Regulatory Model – AERMOD*, EPA-454/B-03-001, Office of Air Quality Planning and Standards, Emissions Monitoring and Analysis Division, Research Triangle Park, North Carolina, September.

EPA (U.S. Environmental Protection Agency), 2011, Memorandum to Regional Air Division Directors, “Additional Clarification Regarding Application of Appendix W Modeling Guidance for the 1-hour NO₂ National Ambient Air Quality Standard,” Office of Air Quality Planning and Standards, March 1.

Goel, V., 2010, *Facility Design Description for the Pit Disassembly and Conversion Project in the K-Area Complex*, Y-FDD-K-00001, Rev. 0, September 23.

King, A., 2010, South Carolina Institute of Archaeology and Anthropology, University of South Carolina, Columbia, South Carolina, personal communication (email) to S. Pietzyk, Science Applications International Corporation, McLean, Virginia, “RE: EIS,” October 4.

LANL (Los Alamos National Laboratory), 2006, *A Plan for the Management of the Cultural Heritage at Los Alamos National Laboratory, New Mexico*, LA-UR-04-8964, Los Alamos, New Mexico, March.

LANL (Los Alamos National Laboratory), 2012, *Surplus Plutonium Disposition Supplemental Environmental Impact Statement Data Call Response*, Los Alamos, New Mexico.

NRC (U.S. Nuclear Regulatory Commission), 2005, *Environmental Impact Statement on the Construction and Operation of a Proposed Mixed Oxide Fuel Fabrication Facility at the Savannah River Site, South Carolina*, NUREG-1767, Office of Nuclear Material Safety and Safeguards, Washington, DC, January.

Page, S. D., 2010a, U.S. Environmental Protection Agency, Office of Air Quality Planning and Standards, Research Triangle Park, North Carolina, personal communication (memorandum) to Regional Air Division Directors, “Guidance Concerning the Implementation of the 1-hour SO₂ NAAQS for the Prevention of Significant Deterioration Program,” August 23.

Page, S. D., 2010b, U.S. Environmental Protection Agency, Office of Air Quality Planning and Standards, Research Triangle Park, North Carolina, personal communication (memorandum) to Regional Air Division Directors, “Guidance Concerning the Implementation of the 1-hour NO₂ NAAQS for the Prevention of Significant Deterioration Program,” June 29.

Reddick, R., Battelle Memorial Institute, Aiken, South Carolina, 2010, personal communication (email) to J. Dimarzio, Science Applications International Corporation, Germantown, Maryland, “Land Use,” December 13.

Sauerborn, P., 2011, *Cold War Historic Preservation Program*, Savannah River Nuclear Solutions, LLC, June 14.

SRARP (Savannah River Archaeological Research Program), 1989, *Archaeological Resource Management Plan of the Savannah River Site Archaeological Research Program*, South Carolina Institute of Archaeology and Anthropology, University of South Carolina, December.

SRARP (Savannah River Archaeological Research Program), 2006, *Annual Review of Cultural Resource Investigations by the Savannah River Archaeological Research Program, Fiscal Year 2006*, South Carolina Institute of Archaeology and Anthropology, University of South Carolina, October.

SRARP (Savannah River Archaeological Research Program), 2009, *Annual Review of Cultural Resource Investigations by the Savannah River Archaeological Research Program, Fiscal Year 2009*, South Carolina Institute of Archaeology and Anthropology, University of South Carolina, October.

SRNS (Savannah River Nuclear Solutions, LLC), 2010, *SRS Part 70 Air Quality Permit TV-0080-0041: Revision to Renewal Application*, SRNS-J2220-2010-00217, Aiken, South Carolina, December 17.

SRNS (Savannah River Nuclear Solutions, LLC), 2012, *Surplus Plutonium Disposition Supplemental Environmental Impact Statement Data Call Response*, Aiken, South Carolina.

SRS (Savannah River Site), 2010, *Structural Design Criteria*, WSRC-TM-95-1, Rev. 10, Aiken, South Carolina, August 12.

WGI (Washington Group International), 2005, *Pit Disassembly and Conversion Facility Waste Management Plan, Rev. 1*, Q-PRP-F-0001, Denver, Colorado, June 30.

Wingard, G. L., 2010, Savannah River Archaeological Research Program, South Carolina Institute of Archaeology and Anthropology, University of South Carolina, New Ellenton, South Carolina, personal communication (email) to S. Pietzyk, Science Applications International Corporation, McLean, Virginia, "RE: SPD SEIS additional data request re: archeology," September 14.

WSRC (Washington Savannah River Company), 2006, *SRS Ecology Environmental Information Document*, WSRC-TR-2005-00201, Aiken, South Carolina, July.

WSRC (Washington Savannah River Company), 2008a, *Surplus Plutonium Disposition Supplemental Environmental Impact Statement Data Call Response*, Aiken, South Carolina.

WSRC (Washington Savannah River Company, LLC), 2008b, *Waste Management Strategy for the Plutonium Preparation Project in the K-Area Complex*, Rev. A, SK-DA-WM-007, Aiden, South Carolina, July.

APPENDIX G
IMPACTS OF PLUTONIUM DISPOSITION OPTIONS

APPENDIX G

IMPACTS OF PLUTONIUM DISPOSITION OPTIONS

This appendix to this *Draft Surplus Plutonium Disposition Supplemental Environmental Impact Statement (SPD Supplemental EIS)* addresses impacts from the construction and annual operation of specific facilities at the Savannah River Site (SRS) that may be used for plutonium disposition. The options for plutonium disposition addressed in this appendix may involve the use of multiple facilities at SRS, and are as follows:

- *Immobilization and DWPF Option* – Surplus plutonium would be immobilized at an immobilization capability constructed at the K-Area Complex, and can-in-canisters containing immobilized plutonium would be transferred to the Defense Waste Processing Facility (DWPF) at S-Area to be filled with vitrified high-level radioactive waste (HLW) and stored within Glass Waste Storage Buildings (GWSBs).
- *MOX Fuel Option* – Surplus plutonium would be fabricated into mixed oxide (MOX) fuel at the Mixed Oxide Fuel Fabrication Facility (MFFF) at F-Area.¹
- *H-Canyon/HB-Line and DWPF Option* – Surplus non-pit plutonium would be dissolved at H-Canyon/HB-Line in H-Area, with the resulting plutonium solution transferred to DWPF in S-Area for vitrification with HLW within canisters that would be stored within the GWSBs.
- *WIPP Disposal Option* – Surplus non-pit plutonium would be prepared at H-Canyon/HB-Line for disposal as transuranic (TRU) waste at the Waste Isolation Pilot Plant (WIPP) near Carlsbad, New Mexico. At H-Canyon/HB-Line, surplus plutonium would be oxidized as necessary, mixed with inert materials, placed in appropriate containers, and transferred to E-Area at SRS for staging pending shipment to WIPP for disposal as TRU waste.²

The analysis in this appendix for the MOX Fuel Option for plutonium disposition conservatively includes the impacts from fabricating MOX fuel at MFFF as well as from a preceding step in which 4 metric tons (4.4 tons) of non-pit plutonium would be converted to an oxide form at H-Canyon/HB-Line prior to transfer to MFFF for MOX fuel fabrication. This additional processing step for 4 metric tons (4.4 tons) of non-pit plutonium is applicable under the MOX Fuel Alternative; for all other alternatives the impacts under the MOX Fuel Option for plutonium disposition would be those from operation of MFFF alone.

Details of these plutonium disposition options are provided in Chapter 2, Section 2.2, while details about the *SPD Supplemental EIS* alternatives are provided in Section 2.3. Appendix B provides descriptions of the SRS facilities that may be used for plutonium disposition. Appendix F addresses impacts from options for pit disassembly and conversion; Appendix H, impacts from the principal support facilities needed for pit disassembly and conversion and plutonium disposition; and Appendix I, impacts from the use of MOX fuel in commercial nuclear power reactors. Chapter 4 describes the environmental impacts of the *SPD Supplemental EIS* alternatives.

This appendix does not address the environmental consequences from disposal of TRU waste at WIPP or disposal of used fuel (also known as spent fuel or spent nuclear fuel) from commercial nuclear power reactors containing MOX fuel. Impacts from TRU waste disposal at WIPP are addressed in the *Waste Isolation Pilot Plant Disposal Phase Final Supplemental Environmental Impact Statement* (DOE 1997),

¹ *MOX fuel would be subsequently shipped to commercial nuclear power reactors for irradiation.*

² *Impacts from staging TRU waste at E-Area for WIPP disposal, including surplus plutonium prepared for WIPP disposal, are addressed in Appendix H.*

which is incorporated by reference (see Appendix A, Section A.2.2). All TRU waste that would be disposed at WIPP would be certified for disposal in accordance with the WIPP waste acceptance criteria.

G.1 Air Quality

Nonradioactive air pollutant impacts under each plutonium disposition option are evaluated in this section. Radioactive air pollutant impacts are evaluated in Section G.2, Human Health.

Activities under the various options could result in criteria, hazardous, and toxic air pollutant emissions from facility construction and operation. **Table G-1** shows air pollutant concentrations that were evaluated for operational activities at plutonium disposition facilities and compared to applicable standards and significance levels. In this table, columns on the left provide impacts on a facility-specific basis, while columns on the right provide combined impacts for one or more facilities as appropriate for each plutonium disposition option.³

Significance levels are concentrations below which no further analysis is necessary for that pollutant for the purpose of permitting. Concentrations above the significance levels could need to undergo further analysis to consider the cumulative impacts from other sources within the impact area (EPA 1990:C28; Page 2010a, 2010b; 40 CFR 51.165(b) (2)). Where new modeling was performed for this *SPD Supplemental EIS*, current U.S. Environmental Protection Agency (EPA) models were used. For example, the EPA AERMOD dispersion model (EPA 2004) was used unless stated otherwise. As required, updated emissions and concentrations were determined based on information provided in cited references.

G.1.1 Immobilization and DWPF

Construction—With the exception of a 2-acre (0.8-hectare) construction site at K-Area at SRS, construction of the K-Area immobilization capability would occur mostly inside existing buildings. Exterior activities, such as excavation and paving, would generate small quantities of fugitive dust and other emissions (SRNS 2012). Minimal emissions of pollutants would result from modifications to DWPF to support receipt and handling of canisters containing plutonium immobilized at K-Area.

Operations—Nonradioactive air pollutant emissions from the K-Area immobilization capability could result from operation and testing of additional diesel generators. Estimated air pollutant emissions from testing and operation of diesel generators at the K-Area immobilization capability are summarized in **Table G-2**. Generators would be tested intermittently. Generators operating less than 250 hours per year are considered insignificant sources and are exempt from Title V permitting (SRNS 2010). Other than emissions from diesel generators, there would be minimal emissions of other nonradioactive air pollutants from the immobilization capability. These would include small amounts of fluorides, hydrochloric acid, nickel and nickel oxide, and beryllium and beryllium oxide (WSRC 2008; SRNS 2012).

During the period when immobilized plutonium would be combined with vitrified HLW at DWPF, as much as 5 percent of DWPF emissions would be attributed to vitrification of HLW used to encase can-in-canisters of immobilized plutonium.

³ This format is used to present information in several tables throughout this appendix.

Table G-1 Estimated Air Pollutant Concentrations at the Site Boundary from Operations at Plutonium Disposition Facilities

Pollutant	Averaging Period	More Stringent Standard or Guideline ^a	Significance Level ^b (µg/m ³)	SRS Facilities								Plutonium Disposition Options			
				MFFF	K-Area Immobilization Capability ^c	H-Canyon/HB-Line			DWPF ^d			Immobilization and DWPF	MOX Fuel ^e	H-Canyon/HB-Line and DWPF	WIPP Disposal
						Prepare Pu for MFFF	Prepare Pu for DWPF Vitrification	Prepare Pu for WIPP Disposal	Immobilized Pu	Waste from Pu Prepared for MFFF	Pu Prepared for Vitrification				
Criteria Pollutants (micrograms per cubic meter)															
Carbon monoxide	8 hours	10,000	500	23	18	N/C	N/C	N/C	N/C	N/C	N/C	18	23	N/C	N/C
	1 hour	40,000	2,000	79	140	N/C	N/C	N/C	N/C	N/C	N/C	140	79	N/C	N/C
Nitrogen dioxide	Annual	100	1	0.05	0.024	N/C	N/C	N/C	N/C	N/C	N/C	0.024	0.05	N/C	N/C
	1 hour	188	7.5	NR	39	N/C	N/C	N/C	N/C	N/C	N/C	39	NR	N/C	N/C
PM ₁₀	24 hours	150	5	0.78	1	N/C	N/C	N/C	N/C	N/C	N/C	1	0.78	N/C	N/C
PM _{2.5}	Annual	15	0.3	0.0004	0.0008	N/C	N/C	N/C	N/C	N/C	N/C	0.0008	0.0004	N/C	N/C
	24 hours	35	1.2	0.78	1	N/C	N/C	N/C	N/C	N/C	N/C	1	0.78	N/C	N/C
Sulfur dioxide	Annual	80	1	0.003	0.0072	N/C	N/C	N/C	N/C	N/C	N/C	0.0072	0.003	N/C	N/C
	24 hours	365	5	4.8	7.9	N/C	N/C	N/C	N/C	N/C	N/C	7.9	4.8	N/C	N/C
	3 hours	1,300	25	22	59	N/C	N/C	N/C	N/C	N/C	N/C	59	22	N/C	N/C
	1 hour	197	7.8	N/R	65	N/C	N/C	N/C	N/C	N/C	N/C	65	N/R	N/C	N/C

DWPF = Defense Waste Processing Facility; µg/m³ = micrograms per cubic meter; MFFF = Mixed Oxide Fuel Fabrication Facility; MOX = mixed oxide; N/C = no change from existing emissions; NR = not reported; PM_n = particulate matter less than or equal to *n* microns in aerodynamic diameter; Pu = plutonium; WIPP = Waste Isolation Pilot Plant.

^a The more stringent of the Federal and state standards is presented if both exist for the averaging period.

^b EPA 1990; Page 2010a, 2010b; 40 CFR 51.165(b)(2).

^c Concentrations from the K-Area immobilization capability were estimated based on projected emissions from the K-Area Pit Disassembly and Conversion Project addressed in Appendix F, Section F.1.

^d Contributions from DWPF are included in the concentrations from sources at SRS as presented in Chapter 3, Table 3-7. A fraction of those emissions could be attributed to plutonium disposition activities as discussed in Section G.1.1.

^e Listed impacts for the MOX Fuel Option for plutonium disposition conservatively include those from processing 4 metric tons (4.4 tons) of non-pit plutonium at H-Canyon/HB-Line (and vitrification of waste resulting from this processing at DWPF) as a precursor for fabrication of the plutonium into MOX fuel at MFFF. This processing step for non-pit plutonium is applicable under the MOX Fuel Alternative; for all other alternatives the impacts under the MOX Fuel Option would be those from operation of MFFF alone.

Note: Values have been rounded where appropriate.

Source: DCS 2004:5-91; DOE/NNSA 2012; EPA 1990, 2009; Page 2010a, 2010b; SCDHEC 2011; 40 CFR 51.165.

Table G–2 Estimated Air Pollutant Emissions from Testing and Operation of Diesel Generators for the K-Area Immobilization Capability

<i>Pollutant</i> ^a	<i>250-Kilowatt (metric tons per year)</i> ^b	<i>810-Kilowatt (metric tons per year)</i> ^b	<i>Total (metric tons per year)</i>
Carbon monoxide	0.51	2.7	3.2
Nitrogen dioxide	2.4	12	14
PM ₁₀	0.16	0.34	0.51
Sulfur dioxide	0.15	4.0	4.1
Carbon dioxide	87	570	660
Total organic compounds	0.19	0.34	0.54

PM₁₀ = particulate matter less than or equal to 10 microns in aerodynamic diameter.

^a Emissions data for PM_{2.5} were not available. Emissions data were available for total organic compounds but not for volatile organic compounds. Total organic compounds include volatile organic compounds.

^b The 250-kilowatt unit consists of one diesel generator; the 810-kilowatt unit consists of 2 diesel generators.

Note: To convert metric tons to tons, multiply by 1.1023.

Source: WSRC 2008.

G.1.2 MOX Fuel

Construction—MFFF is already under construction and impacts from its construction have been previously assessed (DOE 1999; NRC 2005). Emissions from MFFF construction are included with the site baseline (see Chapter 3, Section 3.1.4.2).

Operations—Nonradioactive air pollutant emissions would result from operation of the MFFF. Site boundary concentrations based on the latest projected emissions for operation of MFFF (currently under construction) are summarized in Table G–1. Under the MOX Fuel Alternative, 4 metric tons (4.4 tons) of non-pit plutonium would be converted to plutonium oxide at H-Canyon/HB-Line, but no changes are expected in operational air emissions from H-Canyon/HB-Line.

G.1.3 H-Canyon/HB-Line and DWPF

Construction—Internal modifications to H-Canyon/HB-Line would result in only minor emissions of criteria and toxic air pollutants (SRNS 2012).

Operations—No changes are expected in air pollutant emissions from H-Canyon/HB-Line. Disposition of surplus plutonium into sludge batches at DWPF is expected to result in no additional nonradioactive emissions from DWPF.

Additional steam required for dissolution processes at H-Canyon/HB-Line would result in additional air pollutant emissions from the steam-producing facilities at SRS. Estimated annual emissions of air pollutants from steam production are expected to increase by about 3 percent (SRNS 2012; WSRC 2008). The expected concentrations at the site boundary would be less than those presented for the SRS baseline in Chapter 3, Section 3.1.4.2, which are based on permitted emissions associated with the SRS Title V permit. H-Canyon/HB-Line emissions are primarily particulate matter and sulfur dioxide (SCDHEC 2003).

G.1.4 WIPP Disposal

Construction—Only minor modifications to H-Canyon/HB-Line would be required under this option, with correspondingly minor emissions of criteria and toxic air pollutants.

Operations—No changes are expected in nonradioactive air pollutant emissions from H-Canyon/HB-Line.

G.2 Human Health

The following subsections present the potential incident-free radiological impacts on workers and the general public at SRS associated with the plutonium disposition options. Human health risks from construction and normal operations are evaluated for several individual and population groups, including involved workers, a hypothetical maximally exposed individual (MEI) at the site boundary, and the regional population. **Tables G-3** and **G-4** summarize the potential radiological impacts on involved workers and the general public, respectively, associated with the facilities and processes that would be used under each of the four disposition options. Impacts are presented as estimated doses and latent cancer fatality (LCF) risks from 1 year of operation and as LCF risks for the life of the project. (LCFs are determined using a risk factor of 0.0006 LCFs per rem or person-rem [DOE 2003].) Life-of-project risks were determined by multiplying the annual impacts of a facility by the number of years the facility is projected to operate (see Appendix B, Table B-2).

G.2.1 Normal Operations

G.2.1.1 Immobilization and DWPF

Construction—Construction of a K-Area immobilization capability and minor modifications to DWPF to accommodate receipt of can-in-canisters from the immobilization capability would be required. The majority of the construction activities would occur in areas having dose rates close to background levels, although there would be existing equipment that would require decontamination and removal. Due to the nature of the contamination, the external dose rates from this equipment would be low. The activities to decontaminate and remove contaminated equipment would result in small additional occupational exposures to the workers performing these activities. The 72 construction workers involved in decontamination and removal would receive a collective dose of about 3.3 person-rem per year. The workforce dose for this 2-year activity would be 6.6 person-rem, resulting in no additional LCFs (calculated value: 4×10^{-3} LCFs). No additional construction worker dose is expected for the balance of the construction period.

No radiological impacts on the public are expected from construction activities. All immobilization capability construction activities involving radioactive materials would occur within an existing structure and would be subject to strict controls (WSRC 2008). Releases of radioactive materials to the environment caused by modifications to DWPF to accommodate the can-in-canisters are not expected.

Operations—Table G-3 presents the potential radiological impacts on involved workers associated with this option. Doses to workers would result from operations at the K-Area immobilization capability and DWPF. This disposition option is projected to result in the highest radiological impacts on the workforce. Over the life of the project, the collective dose received by workers could result in 1 to 2 LCFs.

Table G-4 presents the potential radiological impacts on the general public associated with this option. Doses to public receptors would result from emissions from the K-Area immobilization capability. Because activities at DWPF involving surplus plutonium are not expected to result in additional releases to the atmosphere (beyond those associated with vitrifying HLW alone), there would be no incremental radiological impacts on the public from this facility. Table G-4 shows that potential doses to all public receptors would be a small fraction of the 311-millirem-per-year dose each member of the public is assumed to receive from natural background radiation (see Chapter 3, Section 3.1.6.1).

Table G-3 Potential Radiological Impacts on Involved Workers from Plutonium Disposition Options at the Savannah River Site

	SRS Facilities								Plutonium Disposition Options			
	MFFF	K-Area Immobilization Capability	H-Canyon/ HB-Line			DWPF						
			Prepare Pu for MFFF	Prepare Pu for DWPF Vitrification	Prepare Pu for WIPP Disposal	Immobilized Pu	Waste from Pu Prepared for MFFF	Pu Prepared for Vitrification	Immobilization and DWPF	MOX Fuel ^a	H-Canyon/ HB-Line and DWPF	WIPP Disposal
Total Workforce												
Number of radiation workers	450	314	100	14	130	25	5	8	339	555	22	130
Annual Collective worker dose (person-rem)	51	310	29	7.0	20 to 60	5.9	1.2	1.9	320	80	8.9	60
Annual LCFs ^b	0 (3×10^{-2})	0 (2×10^{-1})	0 (2×10^{-2})	0 (4×10^{-3})	0 (1×10^{-2} to 4×10^{-2})	0 (4×10^{-3})	0 (7×10^{-4})	0 (1×10^{-3})	0 (2×10^{-1})	0 (5×10^{-2})	0 (5×10^{-3})	0 (4×10^{-2})
Life-of-project LCFs ^{b, c}	1 (0.6 to 0.7)	2 (1.9)	0 (0.2)	0 (0.05)	0 (0.1 to 0.5)	0 (0.04)	0 (4×10^{-3})	0 (1×10^{-2})	2 (1.9)	1 (0.9 to 1)	0 (0.07)	0 (0.5)
Average Worker												
Annual dose (millirem) ^d	110	1,000 ^e	290	500	150 to 460	240	240	240	930	140	400	460
Annual LCF risk	7×10^{-5}	6×10^{-4}	2×10^{-4}	3×10^{-4}	9×10^{-5} to 3×10^{-4}	1×10^{-4}	1×10^{-4}	1×10^{-4}	6×10^{-4}	8×10^{-5}	3×10^{-4}	3×10^{-4}
Life-of-project LCF risk ^e	1×10^{-3} to 2×10^{-3}	6×10^{-3}	2×10^{-3}	4×10^{-3}	9×10^{-4} to 4×10^{-3}	1×10^{-3}	9×10^{-4}	2×10^{-3}	6×10^{-3}	2×10^{-3}	3×10^{-3}	4×10^{-3}

DWPF = Defense Waste Processing Facility; LCF = latent cancer fatality; MFFF = Mixed Oxide Fuel Fabrication Facility; MOX = mixed oxide; Pu = plutonium; SRS = Savannah River Site; WIPP = Waste Isolation Pilot Plant

^a Listed impacts for the MOX Fuel Option for plutonium disposition conservatively include those from processing 4 metric tons (4.4 tons) of non-pit plutonium at H-Canyon/HB-Line (and vitrification of waste resulting from this processing at DWPF) as a precursor for fabrication of the plutonium into MOX fuel at MFFF. This processing step for non-pit plutonium is applicable under the MOX Fuel Alternative; for all other alternatives the impacts under the MOX Fuel Option would be those from operation of MFFF alone.

^b The integer indicates the number of excess LCFs that are expected in the population based on a risk factor of 0.0006 LCFs per rem or person-rem (DOE 2003); the values in parentheses are the values calculated from the dose and risk factor.

^c Ranges in impacts are due to differences in the quantities of material processed for different plutonium disposition options or the number of years that facilities would operate under the different alternatives.

^d Dose to an average worker reflects the collective worker dose divided by the number of workers. Engineering and administrative controls would be implemented to maintain individual worker doses below 2,000 millirem per year, and as low as reasonably achievable.

^e This estimate is based on a conceptual design. If the K-Area immobilization capability were implemented, engineering and administrative controls would be implemented as discussed in table note c to maintain individual worker doses to levels as low as reasonably achievable.

Note: Doses are rounded to two significant figures; LCF risks are rounded to one significant figure. Values presented in the table may differ slightly from those presented in Appendix C due to rounding. Values are derived from analyses presented in Appendix C.

Table G-4 Potential Radiological Impacts on the Public from Plutonium Disposition Options at the Savannah River Site

	SRS Facilities								Plutonium Disposition Options			
	MFFF	K-Area Immobilization Capability	H-Canyon/HB-Line			DWPF ^a			Immobilization and DWPF	MOX Fuel ^b	H-Canyon/HB-Line and DWPF	WIPP Disposal
			Prepare Pu for MFFF	Prepare Pu for DWPF Vitrification	Prepare Pu for WIPP Disposal	Immobilized Pu	Waste from Pu Prepared for MFFF	Pu Prepared for Vitrification				
Population within 50 Miles												
Annual dose (person-rem per year)	0.045	0.00062	0.26	0.0060	0.26	–	–	–	0.00062	0.31	0.0060	0.26
Annual LCFs ^c	0 (3 × 10 ⁻⁵)	0 (4 × 10 ⁻⁷)	0 (2 × 10 ⁻⁴)	0 (4 × 10 ⁻⁶)	0 (2 × 10 ⁻⁴)	–	–	–	0 (4 × 10 ⁻⁷)	0 (2 × 10 ⁻⁴)	0 (4 × 10 ⁻⁶)	0 (2 × 10 ⁻⁴)
Life-of-project LCFs ^c	0 (6 × 10 ⁻⁴)	0 (4 × 10 ⁻⁶)	0 (2 × 10 ⁻³)	0 (5 × 10 ⁻⁵)	0 (2 × 10 ⁻³)	–	–	–	0 (4 × 10 ⁻⁶)	0 (3 × 10 ⁻³)	0 (5 × 10 ⁻⁵)	0 (2 × 10 ⁻³)
Maximally Exposed Individual												
Annual dose (millirem)	0.00050	0.0000075	0.0024	0.000043	0.0024	–	–	–	0.0000076	0.0029	0.000043	0.0024
Annual LCFs ^c	3 × 10 ⁻¹⁰	5 × 10 ⁻¹²	1 × 10 ⁻⁹	3 × 10 ⁻¹¹	1 × 10 ⁻⁹	–	–	–	5 × 10 ⁻¹²	1 × 10 ⁻⁹	3 × 10 ⁻¹¹	1 × 10 ⁻⁹
Life-of-project LCF risk ^{c,d}	6 × 10 ⁻⁹ to 8 × 10 ⁻⁹	5 × 10 ⁻¹¹	2 × 10 ⁻⁸	3 × 10 ⁻¹⁰	1 × 10 ⁻⁸	–	–	–	5 × 10 ⁻¹¹	3 × 10 ⁻⁸	3 × 10 ⁻¹⁰	1 × 10 ⁻⁸
Average Exposed Individual^d												
Annual dose (millirem per year) ^e	0.000052	0.00000077	0.00029	0.0000068	0.00029	–	–	–	0.0000077	0.00034	0.0000068	0.00029
Annual LCF risk	3 × 10 ⁻¹¹	5 × 10 ⁻¹³	2 × 10 ⁻¹⁰	4 × 10 ⁻¹²	2 × 10 ⁻¹⁰	–	–	–	5 × 10 ⁻¹³	2 × 10 ⁻¹⁰	4 × 10 ⁻¹²	2 × 10 ⁻¹⁰
Life-of-project LCF risk ^d	7 × 10 ⁻¹⁰ to 9 × 10 ⁻¹⁰	5 × 10 ⁻¹²	2 × 10 ⁻⁹	5 × 10 ⁻¹¹	2 × 10 ⁻⁹	–	–	–	5 × 10 ⁻¹²	3 × 10 ⁻⁹	5 × 10 ⁻¹¹	2 × 10 ⁻⁹

DWPF = Defense Waste Processing Facility; LCF = latent cancer fatality; MFFF = Mixed Oxide Fuel Fabrication Facility; MOX = mixed oxide; Pu = plutonium; SRS = Savannah River Site; WIPP = Waste Isolation Pilot Plant

^a DWPF operations involving surplus plutonium are not expected to result in any incremental emissions; therefore, no impacts on the public are expected.

^b Listed impacts for the MOX Fuel Option for plutonium disposition conservatively include those from processing 4 metric tons (4.4 tons) of non-pit plutonium at H-Canyon/HB-Line (and vitrification of waste resulting from this processing at DWPF) as a precursor for fabrication of the plutonium into MOX fuel at MFFF. This processing step for non-pit plutonium is applicable under the MOX Fuel Alternative; for all other alternatives the impacts under the MOX Fuel Option would be those from operation of MFFF alone.

^c The integer indicates the number of excess LCFs that are expected in the population based on a risk factor of 0.0006 LCFs per rem or person-rem (DOE 2003); the values in parentheses are the values calculated from the dose and risk factor.

^d Ranges in impacts are due to differences in the number of years that facilities would operate under the different alternatives.

^e Dose to an average member of the offsite population is obtained by dividing the population dose by the number of people projected to live within 50 miles (80 kilometers) of the SRS facilities in 2020 (approximately 809,000 for K-Area, 869,000 for F-Area, and 886,000 for H-Area).

Note: Doses are rounded to two significant figures; LCF risks are rounded to one significant figure. Values presented in the table may differ slightly from those presented in Appendix C due to rounding. Values are derived from analyses presented in Appendix C. To convert miles to kilometers, multiply by 1.6093.

G.2.1.2 MOX Fuel

Construction—MFFF is already under construction and impacts from its construction have been previously assessed (DOE 1999; NRC 2005). No additional construction would be required.

Operations—Table G-3 presents the potential radiological impacts on involved workers associated with this option. Doses to workers would result from operations at MFFF. Under the MOX Fuel Alternative, doses would also result from operations at H-Canyon/HB-Line (and, to a much lesser extent, DWPF), assuming 4 metric tons (4.4 tons) of non-pit plutonium are processed at H-Canyon/HB-Line and fabricated into MOX fuel. The collective dose received by the workforce over the life of the project is not expected to result in any LCFs.

Table G-4 presents the potential radiological impacts on the general public associated with this option. Doses to public receptors would result from emissions MFFF, and under the MOX Fuel Alternative, also from H-Canyon/HB-Line, assuming 4 metric tons (4.4 tons) of non-pit plutonium are processed at H-Canyon/HB-Line and fabricated into MOX fuel. Potential activities at DWPF (to vitrify waste from plutonium processed at H-Canyon/HB-Line) are not expected to result in additional releases to the atmosphere, so there would be no incremental radiological impacts on the public from this facility. Table G-4 shows that potential doses to all public receptors would be a small fraction of the 311-millirem-per-year dose each member of the public is assumed to receive from natural background radiation (see Chapter 3, Section 3.1.6.1).

G.2.1.3 H-Canyon/HB-Line and DWPF

Construction—At H-Canyon, some tanks and/or piping may be changed out or reconfigured to increase plutonium storage volume and capacity, and some equipment may be changed or added at HB-Line. These types of activities are part of normal operations and does are accounted for in workers' operational doses. No construction or modification activities are expected at DWPF. Therefore, minimal impacts on construction workers are expected, and no impacts on the general public are expected.

Operations—Table G-3 presents the potential radiological impacts on involved workers associated with this option. Doses to workers would result from operations at H-Canyon/HB-Line and DWPF. The collective dose received by the workforce over the life of the project is not expected to result in any LCFs. Table G-4 presents the potential radiological impacts on the general public associated with this option. Doses to public receptors would result from emissions from H-Canyon/HB-Line. Impacts on the public from this option and the WIPP Disposal Option are comparable and are higher than those of the other two disposition options. At DWPF, vitrification of HLW containing dissolved plutonium is not expected to result in additional releases to the atmosphere, so there would be no incremental radiological impacts on the public from this facility. Table G-4 shows that potential doses to all public receptors would be a small fraction of the 311-millirem-per-year dose each member of the public is assumed to receive from natural background radiation (see Chapter 3, Section 3.1.6.1).

G.2.1.4 WIPP Disposal

Construction—Glovebox installation and modifications at the H-Canyon/HB-Line to support preparation of 6 metric tons (6.6 tons) of non-pit plutonium for WIPP disposal would result in a collective dose of 0.58 person-rem per year to a construction workforce of 10 (average dose of 58 millirem per worker per year). These modifications would occur over a 2-year period, resulting in a total dose of 1.2 person-rem, resulting in no additional LCFs (calculated value: 7×10^{-4} LCFs). None of these exposures is expected to result in any additional LCFs to construction workforces. No impacts on the public would result from construction activities at H-Canyon/HB-Line.

Operations—Table G-3 presents the potential radiological impacts on involved workers associated with this option. Doses to workers would result from operations at H-Canyon/HB-Line. The collective dose received by the workforce over the life of the project is not expected to result in any LCFs. Activities at

E-Area in support of this option are expected to result in negligible incremental impacts to both workers and the public from the staging of TRU waste awaiting shipment to WIPP, from the staging of mixed low-level radioactive waste (MLLW) pending offsite shipment, or from storage or disposal of low-level radioactive waste (LLW).

Table G-4 presents the potential radiological impacts on the general public associated with this option. Doses to public receptors would result from emissions from H-Canyon/HB-Line. Impacts on the public from this option and the H-Canyon/HB-Line and DWPF Option are comparable and are higher than those of the other two disposition options. Table G-4 shows that potential doses to all public receptors would be a small fraction of the 311-millirem-per-year dose each member of the public is assumed to receive from natural background radiation (see Chapter 3, Section 3.1.6.1).

G.2.2 Accidents

The following subsections present the potential impacts on workers and the general public at SRS associated with possible accidents involving the plutonium disposition options. Human health risks from these accidents are evaluated for several individual and population groups, including noninvolved workers, a hypothetical MEI at the site boundary, and the regional population. **Table G-5** summarizes potential radiological impacts on the general public associated with the facilities and processes that would be used under each of the four disposition options, while **Table G-6** summarizes the potential radiological impacts on the MEI and noninvolved workers. Impacts are presented as estimated doses and LCF risks from the accidents under consideration (see Appendix D for further details on these accidents). Activities at DWPF or the GWSBs involving surplus plutonium disposition are not expected to result in additional risks above those for operation of these facilities for HLW alone.

G.2.2.1 Immobilization and DWPF

The limiting design-basis accident at the K-Area immobilization capability would be an explosion in a metal oxidation furnace. If this accident were to occur, the public residing within 50 miles (80 kilometers) of SRS would receive an estimated dose of 630 person-rem. This dose would result in no additional LCFs among the general public. The MEI would receive a dose of 2.1 rem which represents an increased risk to the MEI of developing a latent fatal cancer of 1×10^{-3} , or 1 chance in 1,000. A noninvolved worker located 1,000 meters (3,280 feet) from the accident source at the time of the accident, who was unaware of the accident and failed to take any emergency actions, would receive a dose of 27 rem with an increased risk of developing a latent fatal cancer of 3×10^{-2} , or about 1 chance in 33.

A design-basis earthquake involving K-Area when the immobilization capability was operational would expose the public residing within 50 miles (80 kilometers) of SRS to an estimated dose of 9.9 person-rem. This dose would result in no additional LCFs among the general public. The MEI would receive a dose of 0.033 rem which represents an increased risk to the MEI of developing a latent fatal cancer of 2×10^{-5} , or 1 chance in 50,000. A noninvolved worker would receive a dose of 0.43 rem with an increased risk of developing a latent fatal cancer of 3×10^{-4} , or about 1 chance in 3,300.

A beyond-design-basis earthquake involving K-Area when the immobilization capability was operational would expose the public residing within 50 miles (80 kilometers) of SRS to an estimated dose of 100 person-rem. This dose could result in no additional LCFs among the general public. The MEI would receive a dose of 0.36 rem which represents an increased risk to the MEI of developing a latent fatal cancer of 2×10^{-4} , or 1 chance in 5,000. A noninvolved worker would receive a dose of 12 rem with an increased risk of developing a latent fatal cancer of 7×10^{-3} , or about 1 chance in 140.

Table G-5 Risks to the Public within 50 Miles (80 kilometers) from Limiting Accidents Associated with Plutonium Disposition Options at the Savannah River Site

Accident	SRS Facilities						Plutonium Disposition Options							
	MFFF		K-Area Immobilization Capability		H-Canyon/ HB-Line		Immobilization and DWPF		MOX Fuel ^a		H-Canyon/ HB-Line and DWPF		WIPP Disposal	
	Dose (person-rem)	LCFs	Dose (person-rem)	LCFs	Dose (person-rem)	LCFs	Dose (person-rem)	LCFs	Dose (person-rem)	LCFs	Dose (person-rem)	LCFs	Dose (person-rem)	LCFs
Limiting design-basis-accident	1.6	0 (0.0009)	630	0 (0.4)	280	0 (0.2)	630	0 (0.4)	280	0 (0.2)	280	0 (0.2)	280	0 (0.2)
Design-basis-earthquake ^{b,c}	0.0020	0 (1×10^{-6})	9.9	0 (0.006)	280	0 (0.2)	9.9	0 (0.006)	280	0 (0.2)	280	0 (0.2)	280	0 (0.2)
Beyond-design-basis-earthquake ^{b,c}	240	0 (0.1)	100	0 (6×10^{-2})	15,000	9	100	0 (6×10^{-2})	15,000	9	15,000	9	15,000	9

DWPF = Defense Waste Processing Facility; LCF = latent cancer fatality; MFFF = Mixed Oxide Fuel Fabrication Facility; MOX = mixed oxide; SRS = Savannah River Site; WIPP = Waste Isolation Pilot Plant.

^a Listed impacts for the MOX Fuel Option for plutonium disposition conservatively include those from processing 4 metric tons (4.4 tons) of non-pit plutonium at H-Canyon/HB-Line (and vitrification of waste resulting from this processing at DWPF) as a precursor for fabrication of the plutonium into MOX fuel at MFFF. This processing step for non-pit plutonium is applicable under the MOX Fuel Alternative; for all other alternatives the impacts under the MOX Fuel Option would be those from operation of MFFF alone.

^b Doses and risks to the public for the design-basis earthquake and beyond-design-basis earthquake are added for all SRS facilities that may be involved in a particular plutonium disposition option. Note that the impacts for the design-basis earthquake and the beyond-design-basis earthquake for H-Canyon/HB-Line include a seismically-induced fire.

^c Impacts from design-basis and beyond-design-basis earthquakes involving H-Canyon/HB-Line include impacts from seismically induced fires.

Note: Values are derived from analyses presented in Appendix D.

Table G-6 Risk to the Maximally Exposed Individual and Noninvolved Worker from Limiting Accidents Associated with Plutonium Disposition Options at the Savannah River Site

Accident	SRS Facilities						Plutonium Disposition Options							
	MFFF		K-Area Immobilization Capability		H-Canyon/HB-Line		Immobilization and DWPF		MOX Fuel ^a		H-Canyon/HB-Line and DWPF		WIPP Disposal	
	Dose (rem)	LCF Risk	Dose (rem)	LCF Risk	Dose (rem)	LCF Risk	Dose (rem)	LCF Risk	Dose (rem)	LCF Risk	Dose (rem)	LCF Risk	Dose (rem)	LCF Risk
Maximally Exposed Individual														
Limiting design-basis accident	0.0094	6 × 10 ⁻⁶	2.1	1 × 10 ⁻³	0.41	2 × 10 ⁻⁴	2.1	1 × 10 ⁻³	0.41	2 × 10 ⁻⁴	0.41	2 × 10 ⁻⁴	0.41	2 × 10 ⁻⁴
Design-basis-earthquake ^{b, d}	7.2 × 10 ⁻⁶	4 × 10 ⁻⁹	0.033	2 × 10 ⁻⁵	0.41	2 × 10 ⁻⁴	0.033	2 × 10 ⁻⁵	0.41	2 × 10 ⁻⁴	0.41	2 × 10 ⁻⁴	0.41	2 × 10 ⁻⁴
Beyond-design-basis earthquake ^{b, d}	0.86	5 × 10 ⁻⁴	0.36	2 × 10 ⁻⁴	26	3 × 10 ⁻²	0.36	2 × 10 ⁻⁴	27	3 × 10 ⁻²	26	3 × 10 ⁻²	26	3 × 10 ⁻²
Noninvolved Worker														
Limiting design-basis accident	0.22	1 × 10 ⁻⁴	27	3 × 10 ⁻²	1.6	9 × 10 ⁻⁴	27	3 × 10 ⁻²	1.6	9 × 10 ⁻⁴	1.6	9 × 10 ⁻⁴	1.6	9 × 10 ⁻⁴
Design-basis-earthquake ^{c, d}	0.00016	1 × 10 ⁻⁷	0.43	3 × 10 ⁻⁴	1.6	9 × 10 ⁻⁴	0.43	3 × 10 ⁻⁴	1.6	9 × 10 ⁻⁴	1.6	9 × 10 ⁻⁴	1.6	9 × 10 ⁻⁴
Beyond-design-basis earthquake ^{c, d}	22	3 × 10 ⁻²	12	7 × 10 ⁻³	1,400	1	12	7 × 10 ⁻³	1,400	1	1,400	1	1,400	1

DWPF = Defense Waste Processing Facility; LCF = latent cancer fatality; MFFF = Mixed Oxide Fuel Fabrication Facility; MOX = mixed oxide; SRS = Savannah River Site; WIPP = Waste Isolation Pilot Plant.

^a Listed impacts for the MOX Fuel Option for plutonium disposition conservatively include those from processing 4 metric tons (4.4 tons) of non-pit plutonium at H-Canyon/HB-Line (and vitrification of waste resulting from this processing at DWPF) as a precursor for fabrication of the plutonium into MOX fuel at MFFF. This processing step for non-pit plutonium is applicable under the MOX Fuel Alternative; for all other alternatives the impacts under the MOX Fuel Option would be those from operation of MFFF alone.

^b For the purposes of this analysis, doses and risks to the maximally exposed individual for the design-basis earthquake and beyond-design-basis earthquake accidents are added across all SRS facilities that may be involved in a particular plutonium disposition option even though the maximally exposed individual for accidents in K-Area would be different than the maximally exposed individual near H-Area, for example.

^c Doses and risks to noninvolved workers for the design-basis and beyond-design-basis earthquake accidents are presented for the highest dose to such an individual at a specific area since a noninvolved worker at K-Area would not be near H-Area should an accident occur there and vice versa. Note that the impacts for the design-basis earthquake and the beyond-design-basis earthquake for H-Canyon/HB-Line include a seismically-induced fire.

^d Impacts from design-basis and beyond-design-basis earthquakes involving H-Canyon/HB-Line include impacts from seismically induced fires.

Note: Values are derived from analyses presented in Appendix D.

G.2.2.2 MOX Fuel

The limiting design-basis accident during operation of MFFF in F-Area would be a criticality incident. If this accident were to occur, the public residing within 50 miles (80 kilometers) of SRS would receive an estimated dose of 1.6 person-rem. This dose would result in no additional LCFs among the general public. The MEI would receive a dose of 0.0094 rem which represents an increased risk to the MEI of developing an LCF of 6×10^{-6} , or about 1 chance in 170,000. A noninvolved worker would receive a dose of 0.22 rem with an increased risk of developing a latent fatal cancer of 1×10^{-4} , or 1 chance in 10,000.

A design-basis earthquake involving F-Area when the MFFF was operational would expose the public residing within 50 miles (80 kilometers) of SRS to an estimated dose of 0.0020 person-rem. This dose would result in no additional LCFs among the general public. The MEI would receive a dose of 7.2×10^{-6} rem which represents an increased risk to the MEI of developing a latent fatal cancer of 4×10^{-9} , or 1 chance in 250 million. A noninvolved worker would receive a dose of 0.00016 rem with an increased risk of developing a latent fatal cancer of 1×10^{-7} , or 1 chance in 10 million.

A beyond-design-basis earthquake involving F-Area when the MFFF was operational would expose the public residing within 50 miles (80 kilometers) of SRS to an estimated dose of 240 person-rem. This dose would result in no additional LCFs among the general public. The MEI would receive a dose of 0.86 rem which represents an increased risk to the MEI of developing a latent fatal cancer of 5×10^{-4} , or 1 chance in 2,000. A noninvolved worker would receive a dose of 22 rem with an increased risk of developing a latent fatal cancer of 3×10^{-2} , or about 1 chance in 33.

The impacts listed in Tables G-5 and G-6 under the MOX Fuel Option for plutonium disposition include those for operation of H-Canyon/HB-Line to process 4 metric tons (4.4 tons) of non-pit plutonium as a precursor to fabrication of this non-pit plutonium into MOX fuel at MFFF. The impacts from postulated accidents at H-Canyon/HB-Line would be the same as those addressed below in Section G.2.2.3. These combined accident impacts would be applicable under the MOX Fuel Alternative; under all other alternatives the accident impacts for the MOX Fuel Option for plutonium disposition would be those for the MFFF alone.

G.2.2.3 H-Canyon/HB-Line and DWPF

The limiting design-basis accident involving plutonium dissolution activities at H-Canyon/HB-Line (and conversion of non-pit plutonium to plutonium oxide under the MOX Fuel Alternative) at SRS would be a level-wide fire in HB-Line involving plutonium oxides and solutions. (Accidents involving K-Area disassembly operations would result in much lower source terms.) If this accident were to occur, the public residing within 50 miles (80 kilometers) of SRS would receive an estimated dose of 280 person-rem. This dose would result in no additional LCFs among the general public. The MEI would receive a dose of 0.41 rem which represents an increased risk to the MEI of developing a latent fatal cancer of 2×10^{-4} , or 1 chance in 5,000. A noninvolved worker would receive a dose of 1.6 rem with an increased risk of developing a latent fatal cancer of 9×10^{-4} , or about 1 chance in 1,100.

A design-basis earthquake with fire involving H-Canyon/HB-Line would expose the public residing within 50 miles (80 kilometers) of SRS to an estimated dose of 280 person-rem. This dose would result in no additional LCFs among the general public. The MEI would receive a dose of 0.41 rem which represents an increased risk to the MEI of developing a latent fatal cancer of 2×10^{-4} , or 1 chance in 5,000. A noninvolved worker would receive a dose of 1.6 rem with an increased risk of developing a latent fatal cancer of 9×10^{-4} , or about 1 chance in 1,100.

A beyond-design-basis earthquake with fire involving H-Canyon/HB-Line would expose the public residing within 50 miles (80 kilometers) of SRS to an estimated dose of 15,000 person-rem. This dose would result in 9 additional LCFs among the general public. The MEI would receive a dose of 26 rem, which represents an increased risk to the MEI of developing a latent fatal cancer of 3×10^{-2} , or about

1 chance in 33. A noninvolved worker would receive a dose of 1,400 rem, which would likely result in a near-term fatality.

G.2.2.4 WIPP Disposal

The results of the accident analysis of the plutonium disposition options indicate that the accidents discussed in Section G.2.2.3 involving H-Canyon/HB-Line represent the limiting risks under the WIPP Disposal Option as well. This is because H-Canyon/HB-Line would be used to prepare the surplus plutonium for WIPP disposal and the same accidents could occur.

G.3 Socioeconomics

This section analyzes the potential annual socioeconomic impacts of different plutonium disposition options. Impacts on direct and indirect employment, economic output, value added and earnings are presented for the peak years of construction for these facilities and for the surplus plutonium activities at these facilities during their peak years of operations. The area that would experience the impacts presented in this section is the region of influence (ROI) surrounding each facility. The socioeconomic ROI for the facilities at SRS is defined as the four-county area of Columbia and Richmond Counties in Georgia, and Aiken and Barnwell Counties in South Carolina. All values are presented in 2010 dollars.

G.3.1 Immobilization and DWPF

Construction—**Table G-7** summarizes the socioeconomic impacts that would be generated during the peak year of construction of the K-Area immobilization capability. This capability would be constructed over a 6-year period. Direct employment during construction of the immobilization capability is expected to peak at 252 workers. The direct construction employment would generate an estimated 159 indirect jobs in the ROI. The direct economic output during the peak year of construction is estimated to be approximately \$25 million. Approximately \$23 million of the direct economic output would be value added to the local economy in the form of final goods and services directly comparable to gross domestic product (GDP). Approximately \$16 million of the value added would be in the form of direct earnings of construction workers.

There would be some minor modifications to DWPF to receive the can-in-canisters. However, no additional employment would be required to support these modifications. Therefore, no socioeconomic impacts are expected to result from modifications at DWPF.

Operations—**Table G-8** summarizes the socioeconomic impacts generated by the K-Area immobilization capability and DWPF operations associated with immobilized plutonium. Direct employment at the K-Area immobilization capability is expected to peak at 434 workers. The direct employment would generate an estimated 516 indirect jobs in the ROI. The direct economic output during the peak year of operations is estimated to be \$77 million, of which \$65 million is estimated to be value added to the local economy in the form of final goods and services directly comparable to GDP. Approximately \$38 million of the value added would be in the form of direct earnings of those employed at the K-Area immobilization capability.

Operations at DWPF would continue at their current rate and are not expected to require any additional employment. Therefore, no socioeconomic impacts are expected to result from DWPF operations associated with immobilized plutonium.

Table G-7 Peak Annual Socioeconomic Impacts from Construction in Support of Plutonium Disposition Options at the Savannah River Site

Resource	SRS Facilities								Plutonium Disposition Options			
	MFFF ^a	K-Area Immobilization Capability	H-Canyon/HB-Line			DWPF ^c			Immobilization and DWPF	MOX Fuel	H-Canyon/HB-Line and DWPF	WIPP Disposal
			Prepare Pu for WIPP Disposal	Prepare Non-Pit Pu for MFFF ^b	Prepare Pu for DWPF Vitrification ^b	Immobilized Pu	Waste from Non-Pit Pu Prepared for MFFF	Pu Prepared for Vitrification				
Direct employment	N/A	252	10	0	0	negligible	0	0	252	0	0	10
Indirect employment	N/A	159	6	0	0	negligible	0	0	159	0	0	6
Output (\$ in millions)	N/A	\$25	\$1.0	0	0	negligible	0	0	\$25	0	0	\$1.0
Value added (\$ in millions)	N/A	\$23	\$0.9	0	0	negligible	0	0	\$23	0	0	\$0.9
Earnings (\$ in millions)	N/A	\$16	\$0.6	0	0	negligible	0	0	\$16	0	0	\$0.6

DWPF = Defense Waste Processing Facility; MFFF = Mixed Oxide Fuel Fabrication Facility; MOX = mixed oxide; N/A = not applicable; Pu = plutonium; SRS = Savannah River Site; WIPP = Waste Isolation Pilot Plant.

^a Construction requirements associated with MFFF are not included in this *SPD Supplemental EIS* because the building is already under construction in accordance with decisions reached through previous National Environmental Policy Act analyses (DOE 1999; NRC 2005) and its workforce requirements fall within SRS's current workforce requirements.

^b Modifications to H-Canyon/HB-Line to support preparation of non-pit plutonium for MFFF (applicable under the MOX Fuel Alternative) or to support dissolution of non-pit plutonium for vitrification at DWPF are not expected to require additional employment and would fall within SRS's current workforce requirements.

^c Minor modifications would be made to DWPF to accommodate can-in-canisters received from K-Area, with no additional employment expected to be needed. There would be no need for modification of DWPF to support vitrification of waste generated from processing non-pit plutonium for MOX fuel fabrication (applicable under the MOX Fuel Alternative) or for vitrifying plutonium dissolved at H-Canyon/HB-Line.

Table G–8 Peak Annual Socioeconomic Impacts from Facility Operations in Support of Plutonium Disposition Options at the Savannah River Site

<i>Resource</i>	<i>SRS Facilities</i>								<i>Plutonium Disposition Options</i>			
	<i>MFFF</i>	<i>K-Area Immobilization Capability</i>	<i>H-Canyon/HB-Line^a</i>			<i>DWPF^b</i>			<i>Immobilization and DWPF</i>	<i>MOX Fuel^c</i>	<i>H-Canyon/HB-Line and DWPF</i>	<i>WIPP Disposal</i>
			<i>Prepare Pu for WIPP Disposal</i>	<i>Prepare Pu for MFFF</i>	<i>Prepare Pu for DWPF Vitrification</i>	<i>Immobilized Pu</i>	<i>Waste from Pu Prepared for MFFF</i>	<i>Pu Prepared for Vitrification</i>				
Direct employment	1,000	434	130	100	40	0	0	0	434	1,100	40	130
Indirect employment	1,189	516	155	119	48	0	0	0	516	1,308	48	155
Output (\$ in millions)	\$178	\$77	\$23	\$18	\$7.1	0	0	0	\$77	\$196	\$7.1	\$23
Value added (\$ in millions)	\$150	\$65	\$20	\$15	\$6.0	0	0	0	\$65	\$165	\$6.0	\$20
Earnings (\$ in millions)	\$88	\$38	\$11	\$8.8	\$3.5	0	0	0	\$38	\$97	\$3.5	\$11

DWPF = Defense Waste Processing Facility; MFFF = MOX Fuel Fabrication Facility; MOX = mixed oxide; Pu = plutonium; SRS = Savannah River Site; WIPP = Waste Isolation Pilot Plant.

^a Annual operations at H-Canyon/HB-Line to support plutonium disposition are not expected to result in any additional employment beyond those already included in SRS’s current workforce requirements. The listed values reflect those workers who would be engaged in plutonium conversion operations.

^b Annual operations at DWPF to support plutonium disposition activities are not expected to result in additional employment beyond those already included in SRS’s current workforce requirements.

^c Listed impacts for the MOX Fuel Option for plutonium disposition conservatively include those from processing 4 metric tons (4.4 tons) of non-pit plutonium at H-Canyon/HB-Line (and vitrification of waste resulting from this processing at DWPF) as a precursor for fabrication of the plutonium into MOX fuel at MFFF. This processing step for non-pit plutonium is applicable under the MOX Fuel Alternative; for all other alternatives the impacts under the MOX Fuel Option would be those from operation of MFFF alone.

G.3.2 MOX Fuel

Construction—MFFF is already under construction and impacts from its construction have been previously assessed (DOE 1999; NRC 2005). No modifications would be required at MFFF as it is currently being constructed to support this plutonium disposition option, and no modifications are expected at H-Canyon/HB-Line. Therefore, no socioeconomic impacts are expected above those previously analyzed.

Operations—Table G-8 summarizes the socioeconomic impacts that would be generated during the peak year of disposition activities. While most disposition activities would occur at MFFF, conversion of 4 metric tons (4.4 tons) of non-pit plutonium to an oxide could occur at H-Canyon/HB-Line as part of the MOX Fuel Alternative and would result in a small amount of waste needing to be sent to DWPF annually, with no change in employment at DWPF. Table G-8 conservatively includes the impacts from this potential activity with the values listed for the MOX Fuel Option.

Direct employment at MFFF is expected to peak at 1,000 workers. The direct employment would generate an estimated 1,189 indirect jobs in the ROI. The direct economic output during the peak year of operations is estimated to be \$178 million, of which \$150 million is estimated to be value added to the local economy in the form of final goods and services directly comparable to GDP. Approximately \$88 million of the value added would be in the form of direct earnings of those employed at MFFF.

Direct employment required for conversion of plutonium material to plutonium oxide at H-Canyon/HB-Line for use at MFFF is estimated to peak at 100 workers. The direct employment would generate an estimated 119 indirect jobs in the ROI. The direct economic output during the peak year of H-Canyon/HB-Line operations is estimated to be approximately \$18 million, of which \$15 million would be value added to the local economy in the form of final goods and services directly comparable to GDP. Approximately \$8.8 million of the value added would be in the form of earnings of H-Canyon/HB-Line workers engaged in plutonium conversion activities. The direct employment required for H-Canyon/HB-Line operations would be drawn from the existing SRS workforce and is not expected to result in additional employment.

Operations at DWPF would continue at their current rate and would not be expected to require any additional employment. Therefore, no socioeconomic impacts would be expected to result from DWPF operations associated with MOX fuel fabrication.

G.3.3 H-Canyon/HB-Line and DWPF

Construction—Modifications that may be needed at H-Canyon/HB-Line to support disposition of surplus plutonium through H-Canyon/HB-Line and DWPF would be minor and are not expected to require additional employment. No facility construction or modification is expected at DWPF.

Operations—Table G-8 summarizes the peak socioeconomic impacts that would be generated by operation of H-Canyon/HB-Line and DWPF for plutonium disposition. Under this disposition option, 6 metric tons (6.6 tons) of plutonium would be processed through H-Canyon/HB-Line so that it could be sent to DWPF for vitrification. Direct employment during peak operations at H-Canyon/HB-Line is estimated to be 40 workers. The direct employment would generate an estimated 48 indirect jobs in the ROI. The direct economic output during the peak year of H-Canyon/HB-Line operations is estimated to be approximately \$7.1 million, of which \$6.0 million would be value added to the local economy in the form of final goods and services directly comparable to GDP. Approximately \$3.5 million of the value added would be in the form of earnings of H-Canyon/HB-Line workers engaged in plutonium preparation activities. The direct employment required for H-Canyon/HB-Line operations would be drawn from the existing SRS workforce and is not expected to result in additional employment.

Operations at DWPF to prepare plutonium for disposition through DWPF would continue at their current rate and would not require any additional employment. Therefore, no socioeconomic impacts are expected from DWPF operations associated with plutonium disposition.

G.3.4 WIPP Disposal

Construction—Table G-7 summarizes the socioeconomic impacts that would be generated by the modifications to H-Canyon/HB-Line needed to support plutonium disposition at WIPP. H-Canyon/HB-Line modifications are not expected to require additional employment. Direct employment during the peak year of H-Canyon/HB-Line modifications is estimated to require 10 workers. The direct employment would generate 6 indirect jobs in the ROI. The direct economic output during the peak year of modifications is estimated to be approximately \$1.0 million, of which \$0.9 million would be value added to the local economy in the form of final goods and services directly comparable to GDP. Approximately \$0.6 million of the value added would be in the form of earnings of construction workers. The direct employment required for H-Canyon/HB-Line operations would be drawn from the existing SRS workforce and is not expected to result in additional employment.

Operations—Table G-8 summarizes the socioeconomic impacts that would be generated by H-Canyon/HB-Line operations in support of plutonium disposition at WIPP. Direct employment during the peak year of H-Canyon/HB-Line operations related to this plutonium disposition option is estimated to be 130 workers. The direct employment would generate an estimated 155 indirect jobs in the ROI. The direct economic output generated during the peak year of operations is estimated to be approximately \$23 million, of which \$20 million would be value added to the local economy in the form of final goods and services directly comparable to GDP. Approximately \$11 million of the value added would be in the form of earnings of H-Canyon/HB-line workers engaged in plutonium preparation activities. The direct employment required for H-Canyon/HB-Line operations would be drawn from the existing SRS workforce and is not expected to result in additional employment.

G.4 Waste Management

This section analyzes impacts of plutonium disposition options on waste management facilities. The waste types addressed include TRU and mixed TRU waste (analyzed collectively), solid LLW, solid MLLW, solid hazardous waste, solid non-hazardous waste, liquid LLW, and liquid non-hazardous waste. The generation of these waste streams is the result of construction, modifications and operations associated with the facilities being analyzed for plutonium disposition activities. Years of operation would vary depending on the combination of pit disassembly and conversion and plutonium disposition options that might be implemented under the *SPD Supplemental EIS* alternatives.

Waste management facilities and their associated capacities at SRS are described in Chapter 3, Section 3.1.10. Waste management impacts are evaluated as a percentage of treatment, storage, or disposal capacity, depending on a particular waste type's onsite disposition. Appendix F, Table F-10, provides a summary of capacities for SRS waste management facilities and the evaluation criteria used to assess impacts.

G.4.1 Immobilization and DWPF

Construction—Table G-9 summarizes the average annual amount of waste that would be generated from facility construction or modification. The K-Area immobilization capability would be constructed over a 6-year period. Construction would generate solid LLW, solid MLLW, solid hazardous waste, and solid non-hazardous waste. There would be a few minor modifications at DWPF to accommodate the receipt of the can-in-canisters from the immobilization capability, but the waste generated from these modifications is expected to be negligible. Construction of the GWSBs is not analyzed in this *SPD Supplemental EIS* because the impacts associated with storage of up to 10,000 canisters containing vitrified HLW have been previously analyzed (DOE 1982). Table G-10 summarizes the total amount of waste that would be generated.

Table G–9 Immobilization and DWPF Option Average Annual Construction Waste Generation

<i>Facility</i>	<i>TRU Waste (m³/yr)</i>	<i>Solid LLW (m³/yr)</i>	<i>Solid MLLW (m³/yr)</i>	<i>Solid Hazardous Waste (m³/yr)</i>	<i>Solid Nonhazardous Waste (m³/yr)</i>	<i>Liquid LLW (liters per year)</i>	<i>Liquid Nonhazardous Waste (liters per year)</i>
K-Area immobilization capability	negligible	420	17	17	420	negligible	negligible
DWPF	negligible	negligible	negligible	negligible	negligible	negligible	negligible
<i>Percent of SRS Capacity</i>	<i>negligible</i>	<i>1.1</i>	<i>5.7</i>	<i>5.7</i>	<i><0.1</i>	<i>negligible</i>	<i>negligible</i>

DWPF = Defense Waste Processing Facility; LLW = low-level radioactive waste; m³/yr = cubic meters per year; MLLW = mixed low-level radioactive waste; SRS = Savannah River Site; TRU = transuranic.

Note: To convert cubic meters to cubic feet, multiply by 35.314; liters to gallons, multiply by 0.26418.

Source: SRNS 2012.

Table G–10 Immobilization and DWPF Option Total Construction Waste Generation

<i>Facility</i>	<i>TRU Waste (m³)</i>	<i>Solid LLW (m³)</i>	<i>Solid MLLW (m³)</i>	<i>Solid Hazardous Waste (m³)</i>	<i>Solid Nonhazardous Waste (m³)</i>	<i>Liquid LLW (liters)</i>	<i>Liquid Nonhazardous Waste (liters)</i>
K-Area immobilization capability	negligible	2,500	100	100	2,500	negligible	negligible
DWPF	negligible	negligible	negligible	negligible	negligible	negligible	negligible

DWPF = Defense Waste Processing Facility; LLW = low-level radioactive waste; MLLW = mixed low-level radioactive waste; m³ = cubic meters; TRU = transuranic.

Note: To convert cubic meters to cubic feet, multiply by 35.314; liters to gallons, multiply by 0.26418.

Source: SRNS 2012.

Operations—**Table G–11** summarizes the peak annual amount of waste that would be generated from immobilization operations. Operations from the facilities cited in the table would generate transuranic waste, solid LLW, solid MLLW, solid hazardous waste, solid non-hazardous waste, and liquid LLW.

The K-Area immobilization capability would operate for 10 years to immobilize 13.1 metric tons (14.4 tons) of plutonium. In support of the Immobilization and DWPF Option, DWPF would also operate for 10 years. Approximately 790 can-in-canisters would be sent from the K-Area immobilization capability to DWPF. Due to displaced HLW from the can-in-canisters, approximately 95 additional canisters of vitrified HLW would be generated. The GWSBs currently have the capacity to store up to 4,590 canisters and additional buildings could be constructed to expand the storage capacity to up to 10,000 canisters (SRNS 2012; SRR 2009, DOE 1982:3-43); therefore, there would be no waste management impacts from storage of these additional HLW canisters. DWPF would need to remain operational for an additional 6 years, from 2026 to 2031, to accommodate the timing of can-in-canisters transfer from the K-Area immobilization capability to DWPF. DWPF operations from 2026 to 2031, and likewise the annual waste generation as shown in Chapter 3, Table 3–21, would represent approximately 30 percent of normal full-scale operations. However, the total amount of waste that would be generated at DWPF during its operational lifecycle would not change, with the exception of that incremental waste associated with the processing of approximately 95 additional canisters.

Table G–11 Immobilization and DWPF Option Peak Annual Operations Waste Generation

Facility	TRU Waste (m ³ /yr)	Solid LLW (m ³ /yr)	Solid MLLW (m ³ /yr)	Solid Hazardous Waste (m ³ /yr)	Solid Nonhazardous Waste (m ³ /yr)	Liquid LLW (liters per year)	Liquid Nonhazardous Waste (liters per year)
K-Area immobilization capability	460	250	80	80	50	negligible	negligible
DWPF ^a	negligible	7.9	0.1	negligible	negligible	6.3	negligible
Percent of SRS Capacity	3.5	0.7	27	27	<0.1	<0.1	negligible

DWPF = Defense Waste Processing Facility; LLW = low-level radioactive waste; MLLW = mixed low-level radioactive waste; m³/yr = cubic meters per year; SRS = Savannah River Site; TRU = transuranic.

^a DWPF waste is the incremental annual volumes that would be generated over that generated from normal DWPF operations for the additional canisters that would be processed annually to support the Immobilization and DWPF Option. For example, 95 canisters over 10 years of immobilization activities yields approximately an additional 10 canisters that would be annually processed at DWPF. Note: To convert cubic meters to cubic feet, multiply by 35.314; liters to gallons, multiply by 0.26418.

Source: SRNS 2012.

G.4.2 MOX Fuel

Construction and Modifications— MFFF is already under construction and impacts from its construction have been previously assessed (DOE 1999; NRC 2005). Wastes from MFFF construction are included with current SRS waste generation rates (see Chapter 3, Section 3.1.10).

Operations—**Table G–12** summarizes the peak annual volumes of waste that would be generated from operations under the MOX Fuel Option. Operations from the facilities cited in the table would generate TRU waste, solid LLW, solid MLLW, solid hazardous waste, solid non-hazardous waste, liquid LLW, and liquid non-hazardous waste.

Conversion of 4 metric tons (4.4 tons) of non-pit plutonium materials to plutonium oxide would occur at H-Canyon/HB-Line under the MOX Fuel Alternative. Conversion of non-pit plutonium materials to plutonium dioxide at H-Canyon/HB-Line is assumed to take 6 years. In addition, processing of additional feed material at DWPF associated with non-pit plutonium conversion activities at H-Canyon/HB-Line would increase by less than 1 percent; therefore, any increase in waste generation at DWPF is expected to be negligible. It is estimated that no more than approximately 2 additional HLW canisters would be produced at DWPF (i.e., approximately 1 canister for every 2 metric tons (2.2 tons) of plutonium processed in H-Canyon/HB-Line). GWSB operations would not be impacted by these additional HLW canisters. MFFF would operate for 21 to 24 years, depending on the alternative.

Table G–12 MOX Fuel Option Peak Annual Operations Waste Generation

Facility	TRU Waste (m ³ /yr)	Solid LLW (m ³ /yr)	Solid MLLW (m ³ /yr)	Solid Hazardous Waste (m ³ /yr)	Solid Nonhazardous Waste (m ³ /yr)	Liquid LLW (liters per year)	Liquid Nonhazardous Waste (liters per year)
H-Canyon/HB-Line ^a	110	1,400	2.4	negligible	200,000	negligible	negligible
DWPF ^a	negligible	negligible	negligible	negligible	negligible	negligible	negligible
MFFF	260	450	negligible	0.3	1,000	1,200,000	340,000,000
Percent of SRS Capacity	2.8	5.0	0.8	<0.1	4.8	0.2	23

DWPF = Defense Waste Processing Facility; LLW = low-level radioactive waste; MFFF = Mixed Oxide Fuel Fabrication Facility; MLLW = mixed low-level radioactive waste; MOX = mixed oxide; m³/yr = cubic meters per year; SRS = Savannah River Site; TRU = transuranic.

^a Waste volumes associated with conversion activities for 4 metric tons (4.4 tons) of non-pit plutonium for transfer to MFFF; these wastes are applicable under the MOX Fuel Alternative; for all other alternatives the waste volumes under the MOX Fuel Option for plutonium disposition would be those from operation of MFFF alone.

Note: To convert cubic meters to cubic feet, multiply by 35.314; liters to gallons, multiply by 0.26418.

Source: SRNS 2012.

G.4.3 H-Canyon/HB-Line and DWPF

Construction—Minor modifications to H-Canyon/HB-Line are expected under the H-Canyon/HB-Line and DWPF Option, with no construction or modification expected at DWPF; therefore, no waste would be generated.

Operations—**Table G–13** summarizes the peak annual amount of waste that would be generated from operations under the H-Canyon/HB-Line and DWPF Option. Operations from the facilities cited in the table would principally generate TRU waste, solid LLW, solid MLLW, solid hazardous waste, and solid non-hazardous waste. H-Canyon/HB-Line would operate for 13 years to process 6 metric tons (6.6 tons) of non-pit plutonium materials for shipment to DWPF.

Up to 48 additional vitrified glass canisters would be generated from disposition of 6 metric tons (6.6 tons) of surplus plutonium at H-Canyon/HB-Line with vitrification at DWPF, assuming no credit for using gadolinium as a neutron poison (see Appendix B, Section B.1.4.1). These additional canisters would not be significant to the existing operation of DWPF. If gadolinium is credited, then approximately 20 additional canisters would be generated (SRNS 2012). For the reasons discussed in Section G.4.1, the additional canisters would have no impacts on HLW storage capacity at the GWSBs.

Table G–13 H-Canyon/HB-Line and DWPF Option Peak Annual Operations Waste Generation

<i>Facility</i>	<i>TRU Waste (m³/yr)</i>	<i>Solid LLW (m³/yr)</i>	<i>Solid MLLW (m³/yr)</i>	<i>Solid Hazardous Waste (m³/yr)</i>	<i>Solid Nonhazardous Waste (m³/yr)</i>	<i>Liquid LLW (liters per year)</i>	<i>Liquid Nonhazardous Waste (liters per year)</i>
H-Canyon/HB-Line ^a	110	1,400	2.4	negligible	200,000	negligible	negligible
DWPF	negligible	negligible	negligible	negligible	negligible	negligible	negligible
<i>Percent of SRS Capacity</i>	<i>0.80</i>	<i>3.8</i>	<i>0.8</i>	<i><0.1</i>	<i>4.8</i>	<i>negligible</i>	<i>negligible</i>

DWPF = Defense Waste Processing Facility; LLW = low-level radioactive waste; MLLW = mixed low-level radioactive waste; m³/yr = cubic meters per year; SRS = Savannah River Site; TRU = transuranic.

^a Waste associated with dissolution of 6 metric tons (6.6 tons) of non-pit plutonium for transfer to DWPF.

Note: To convert cubic meters to cubic feet, multiply by 35.314; liters to gallons, multiply by 0.26418.

Source: SRNS 2012.

G.4.4 WIPP Disposal

Construction—**Table G–14** summarizes the average annual quantities of waste that would be generated from construction or modifications under the WIPP Disposal Option. Minor modifications to H-Canyon/HB-Line would be required and would occur over a 2-year period. Modification of H-Canyon/HB-Line would generate TRU waste. **Table G–15** summarizes the total quantities of waste that would be generated during construction.

Table G–14 WIPP Disposal Option Average Annual Construction Waste Generation

<i>Facility</i>	<i>TRU Waste (m³/yr)</i>	<i>Solid LLW (m³/yr)</i>	<i>Solid MLLW (m³/yr)</i>	<i>Solid Hazardous Waste (m³/yr)</i>	<i>Solid Nonhazardous Waste (m³/yr)</i>	<i>Liquid LLW (liters per year)</i>	<i>Liquid Nonhazardous Waste (liters per year)</i>
H-Canyon/HB-Line	5	negligible	negligible	negligible	negligible	negligible	negligible
<i>Percent of SRS Capacity</i>	<i><0.1</i>	<i>negligible</i>	<i>negligible</i>	<i>negligible</i>	<i>negligible</i>	<i>negligible</i>	<i>negligible</i>

LLW = low-level radioactive waste; MLLW = mixed low-level radioactive waste; m³/yr = cubic meters per year;

SRS = Savannah River Site; TRU = transuranic; WIPP = Waste Isolation Pilot Plant.

Note: To convert cubic meters to cubic feet, multiply by 35.314; liters to gallons, multiply by 0.26418.

Source: SRNS 2012.

Table G–15 WIPP Disposal Option Total Construction Waste Generation

<i>Facility</i>	<i>TRU Waste (m³)</i>	<i>Solid LLW (m³)</i>	<i>Solid MLLW (m³)</i>	<i>Solid Hazardous Waste (m³)</i>	<i>Solid Nonhazardous Waste (m³)</i>	<i>Liquid LLW (liters)</i>	<i>Liquid Nonhazardous Waste (liters)</i>
H-Canyon/ HB-Line	10	negligible	negligible	negligible	negligible	negligible	negligible

LLW = low-level radioactive waste; MLLW = mixed low-level radioactive waste; m³ = cubic meters; TRU = transuranic; WIPP = Waste Isolation Pilot Plant.

Note: To convert cubic meters to cubic feet, multiply by 35.314; liters to gallons, multiply by 0.26418.

Source: SRNS 2012.

Operations—**Table G–16** summarizes the peak annual amount of waste that would be generated from operations under the WIPP Disposal Option. Operations would principally generate TRU waste and solid LLW. Two metric tons (2.2 tons) of non-pit plutonium materials would be packaged for shipment to WIPP under the MOX Fuel Alternative. It is assumed that two processing lines would be used at HB-Line to prepare the plutonium for shipment to WIPP, requiring 10 years to complete. Under the WIPP Alternative, it is assumed that three processing lines would be used at HB-Line to prepare 6 metric tons (6.6 tons) of plutonium for shipment to WIPP, requiring 12 years to complete (SRNS 2012).

Table G–16 WIPP Disposal Option Peak Annual Operations Waste Generation

<i>Facility</i>	<i>TRU Waste (m³/yr)</i>	<i>Solid LLW (m³/yr)</i>	<i>Solid MLLW (m³/yr)</i>	<i>Solid Hazardous Waste (m³/yr)</i>	<i>Solid Nonhazardous Waste (m³/yr)</i>	<i>Liquid LLW (liters per year)</i>	<i>Liquid Nonhazardous Waste (liters per year)</i>
H-Canyon/ HB-Line ^a	310	100	negligible	negligible	negligible	negligible	negligible
H-Canyon/ HB-Line ^b	664	100	negligible	negligible	negligible	negligible	negligible
<i>Percent of SRS Capacity^c</i>	<i>7.4</i>	<i>0.5</i>	<i>negligible</i>	<i>negligible</i>	<i>negligible</i>	<i>negligible</i>	<i>negligible</i>

LLW = low-level radioactive waste; MLLW = mixed low-level radioactive waste; m³/yr = cubic meters per year; SRS = Savannah River Site; TRU = transuranic; WIPP = Waste Isolation Pilot Plant.

^a Waste associated with packaging 2 metric tons (2.2 tons) of plutonium materials for shipment to WIPP under the MOX Fuel Alternative.

^b Waste associated with packaging 6 metric tons (6.6 tons) of plutonium materials for shipment to WIPP under the WIPP Alternative.

^c Percent of SRS capacity represents the amount of TRU waste under the MOX Fuel Alternative and the WIPP alternative combined, although these actions would be mutually exclusive.

Note: To convert cubic meters to cubic feet, multiply by 35.314; liters to gallons, multiply by 0.26418.

Source: SRNS 2012.

G.5 Transportation

Transportation involves the movement of materials and wastes between facilities involved in the surplus Plutonium Disposition Program including pit disassembly and conversion facilities, plutonium disposition facilities, support facilities, and domestic commercial nuclear power reactors. This type of system-wide analysis does not lend itself to analysis of a portion of the system (e.g., just the plutonium disposition options) when evaluating impacts from transportation of materials and wastes. See Appendix E, “Evaluation of Human Health Effects from Transportation,” for a detailed description of the transportation impacts associated with the alternatives being evaluated in this *SPD Supplemental EIS*. Included are the effects associated with the plutonium disposition options addressed for each alternative. Appendix E, Section E.10, provides a discussion of the impacts associated with onsite shipments at SRS.

G.6 Environmental Justice

Executive Order 12898, *Federal Actions to Address Environmental Justice in Minority Populations and Low-Income Populations*, directs Federal agencies to identify and address, as appropriate, disproportionately high and adverse human health and environmental effects of their programs, policies, and activities on minority and low-income populations. The alternatives considered in this *SPD Supplemental EIS* involve construction and operation of several facilities in various combinations, with different levels of efforts and operational timeframes. This type of system-wide analysis does not lend itself to analysis of a portion of the system (e.g., just the plutonium disposition options). Chapter 4, Section 4.1.6, presents the potential impacts on populations surrounding the facilities at SRS that would be involved in surplus plutonium activities under the *SPD Supplemental EIS* alternatives. Included are the impacts associated with the plutonium disposition facilities.

G.7 Other Resource Areas

G.7.1 Land Resources

This section describes impacts that the plutonium disposition options would have on land resources. Land resources include land use and visual resources. Construction of the K-Area immobilization capability under the Immobilization and DWPF Option has the most potential to affect land resources. The other plutonium disposition options evaluated in this appendix would have no to minimal potential for impacting land resources.

G.7.1.1 Immobilization and DWPF

Gloveboxes and other equipment required for safe plutonium preparation would be installed within the K-Area Complex; however, construction of new support systems would be needed, such as a chiller building, cooling towers, office space, sand filter, fan house, and exhaust tunnel and stack. Approximately 2 acres (0.8 hectares) of previously disturbed land at K-Area would be required during construction of these support systems. Because K-Area is an industrialized area, this would not represent a change in land use. Minor modifications to DWPF at S-Area to support filling can-in-canisters received from K-Area with vitrified HLW would occur within the existing DWPF structure, resulting in no impacts on land use. Operation of the facilities involved in this option would involve no ground-disturbing activities and, therefore, would not result in impacts on land use at SRS.

Installation of gloveboxes and other equipment within an existing structure at the K-Area Complex would not impact visual resources, although a number of new structures would be constructed at K-Area including the previously-mentioned support systems. Because each of these structures would be constructed within the built-up portion of K-Area, there would be no change in its overall industrial appearance or its current Visual Resource Management Class IV designation. Because modifications to DWPF would occur within the existing structure there would be no change to visual resources at S-Area. Operation of the facilities involved in this option would not impact visual resources at SRS.

G.7.1.2 MOX Fuel

No additional construction would be required at MFFF to fabricate plutonium oxide into MOX fuel beyond that analyzed in previous National Environmental Policy Act analyses (DOE 1999; NRC 2005). Therefore, there would be no impacts on existing land use or visual resources under this option. Operation of any of the facilities potentially involved in this option would involve no ground-disturbing activities and, therefore, would not result in impacts on land use or visual resources at SRS.

G.7.1.3 H-Canyon/HB-Line and DWPF

Facility modifications to H-Canyon include changing out or reconfiguring some tanks and/or piping to increase plutonium storage volume and capacity, and changes to or adding some equipment at HB-Line. Because all such modifications would be within the existing structure, there would be no change in land use or visual resources at H-Area. A transfer bypass line may be installed around a diversion box at the

H-Area tank farm on land that is already disturbed and used for industrial purposes; thus, if this line is installed, it would not impact land resources at H-Area. No additional features would be required at DWPF. Operation of the facilities involved in this option would involve no ground-disturbing activities and, therefore, would not result in impacts on land use or visual resources at SRS.

G.7.1.4 WIPP Disposal

As discussed under Section G.7.1.3, because implementing this option would involve minor modifications to equipment within the existing H-Canyon/HB-Line structure, there would be no potential for impacts on land use or visual resources at SRS. Also, because operation of the facilities under this option would involve no ground-disturbing activities, there would be no impacts on land use or visual resources at SRS.

G.7.2 Geology and Soils

Impacts on geology and soils can occur from disturbance of geologic and soil materials during land clearing, grading, and excavation activities, and the use of geologic and soils materials during facility construction and operations. Disturbance of geologic and soil materials includes excavating rock and soil, soil mixing, soil compaction, and covering with building foundations, parking lots, roadways, and fill materials. The use of geologic and soils materials during facility construction and operations includes using crushed stone, sand, gravel, and soil in road and building construction, as fill during construction, and as feed for processing activities during operations.

Construction of the K-Area immobilization capability under the Immobilization and DWPF Option has the most potential to affect geology and soils by disturbance of the land surface and the use of geologic and soils materials. The other plutonium disposition options evaluated in this appendix would have no to minimal potential for land disturbance and use of geologic and soils materials.

G.7.2.1 Immobilization and DWPF

Construction—As described in Section G.7.1.1, construction of the K-Area immobilization capability would disturb a total of 2 acres (0.8 hectares) of previously disturbed land. During construction, best management practices (BMPs) such as silt fences, straw bales, geotextile fabrics, and revegetation would be used to control erosion. The South Carolina Department of Health and Environmental Control (SCDHEC) requires a Stormwater Pollution Prevention Plan (SWPPP) under the South Carolina National Pollutant Discharge Elimination System (NPDES) General Permit for stormwater discharges from construction activities (Permit Number SCR100000) (NRC 2005:4-24, 5-2). Because this area has already been disturbed, a limited area of soils would be disturbed at any time, and BMPs would be used to limit soil erosion, minimal impacts on geology and soils at SRS are expected.

It is estimated that 1,200 tons (1,100 metric tons) of crushed stone, sand, and gravel, and 9,500 cubic yards (7,300 cubic meters) of soil would be used during construction of the K-Area immobilization capability (WSRC 2008). The crushed stone, sand, and gravel would be supplied from offsite commercial sources, and the soils would be supplied from onsite resources and from soils stockpiled at the construction site during excavation. The total quantities of these materials would represent small percentages of regionally plentiful resources and are unlikely to have adverse impacts on geology and soils at SRS. It is expected that no geologic and soil materials would be needed at DWPF to support facility modifications under this option.

Operations—Operation of the facilities involved in this option would involve no ground-disturbing activities and little or no use of geologic and soils materials and, therefore, would result in minimal impacts on SRS geology and soils.

G.7.2.2 MOX Fuel

Construction— MFFF is already under construction and impacts from its construction have been previously assessed (DOE 1999; NRC 2005); no additional impacts on SRS geology and soils are expected.

Operations—Operation of the facilities potentially involved in this option would involve no ground-disturbing activities and little or no use of geologic and soils materials and, therefore, would have minimal impacts on SRS geology and soils.

G.7.2.3 H-Canyon/HB-Line and DWPF

Construction—Although there would be some minor modifications to equipment at H-Canyon/HB-Line to prepare and dissolve plutonium for subsequent vitrification with HLW at DWPF, these modifications would take place within an existing structure. There would be no additional ground disturbance at H-Area and no impacts on SRS geology and soils. A transfer bypass line may be installed around a diversion box at the H-Area tank farm on land that is already disturbed and used for industrial purposes. If this bypass line is installed, control measures would be implemented similar to those discussed in Section G.7.2.1 to minimize the potential for erosion and sediment loss. Therefore, implementing this option would require little or no use of geologic and soils materials and have minimal impacts on SRS geology and soils.

Operations—Operation of the facilities involved in this option would involve no ground-disturbing activities and little or no use of geologic and soils materials and, therefore, would result in minimal impacts on SRS geology and soils.

G.7.2.4 WIPP Disposal

Construction—As discussed under Section G.7.2.3, because implementing this option would involve minor modifications to equipment within the existing H-Canyon/HB-Line structure, there would be no potential for erosion and sediment loss. Thus, this option would require little or no use of local geologic and soils materials and would have minimal impacts on SRS geology and soils.

Operations—Operation of the facilities involved in this option would involve no ground-disturbing activities and little or no use of local geologic and soils materials and, therefore, would result in minimal impacts on SRS geology and soils.

G.7.3 Water Resources

This section analyzes impacts on water resources (surface water and groundwater).

G.7.3.1 Immobilization and DWPF

G.7.3.1.1 Surface Water

Construction—The K-Area Complex would be modified to support plutonium immobilization. The estimated area of land disturbance is 2 acres (0.8 hectares). Site work would include temporary and permanent erosion controls; site preparation, excavation, and backfill; installation of access walkways, driveways, and parking areas; installation of utilities (water, sanitary sewer, electrical); and final grading and provision of storm drainage and ground cover. The management and discharge of construction site runoff would be in compliance with stormwater permits. Some existing utility lines would be removed or relocated (WSRC 2008). Existing K-Area systems would be used to support new domestic, process, cooling water, and sanitary sewer lines. New structures would include a sand filter, fan house, exhaust tunnel, and stack. Surface water would not be used to support construction activities (SRNS 2012).

Surface water quality would be protected during construction using methods similar to those that would be implemented for optional construction of the Pit Disassembly and Conversion Facility in F-Area at SRS (see Appendix F, Section F.7.3.1.1). In accordance with the requirements of the SCDHEC, an

SWPPP would be implemented during construction to minimize the amount of sediment in runoff to surface waters. Because BMPs would be used to control stormwater runoff and soil erosion, K-Area construction-induced sedimentation is expected to have minimal, short-term impacts on water quality in Indian Grave Branch and Pen Branch. Any accidental spills of oil, gas, or diesel fuels, paint, or hydraulic fluids that could affect stormwater runoff water quality would be contained and remediated. No long-term impacts on water quality or changes to stream channel morphology, aquatic habitats, or flow regimes are expected, and the availability of surface water for downstream users would not be limited (WSRC 2008).

Modifications to DWPF at S-Area to facilitate vitrification of HLW canisters containing immobilized plutonium would occur within an existing structure with no potential for erosion or sediment loss that could impact surface water quality. There would be no need for construction of additional GWSBs.

Operations—Impacts on surface water from operation of the K-Area immobilization capability are expected to be minimal. K-Area Complex heating, ventilating, and air conditioning (HVAC) condensate (SCDHEC Permit SC0000175) and stormwater (SCDHEC Permit SCR000000) are discharged at NPDES outfall K-18 into Indian Grave Branch via the K-Reactor Discharge Canal, which merges with Pen Branch prior to discharging into the Savannah River (WSRC 2008). Discharges from the outfall are limited for pH, total suspended solids, and flow, and potential contaminants are limited to safe concentrations; this ensures minimal impacts on receiving streams. Typically, tritium concentrations in the discharge are at or below background levels and flow rates generally range from 200 to 400 gallons (760 to 1,500 liters) per minute. Sanitary wastewater from K-Area would be routed to the Central Sanitary Wastewater Treatment Facility (CSWTF) for processing before discharge from a permitted outfall (SRNS 2012). Some process-generated wastewater may also be routed to CSWTF depending on the content of metals such as zinc or copper in the wastewater.

DWPF and the GWSBs at S-Area would operate in accordance with existing permits; discharges from these facilities are expected to have negligible impacts on receiving streams (WSRC 2008). Surface water sources would not be used to supply water for facility operations; therefore, no decrease in surface water levels or flows is expected. Plutonium disposition activities would not limit the availability of surface water availability to downstream users.

G.7.3.1.2 Groundwater

Construction—No liquid effluents would be directly discharged to groundwater during construction (WSRC 2008). Modification of DWPF at S-Area to facilitate vitrification of HLW canisters containing immobilized plutonium would require minimal additional use of groundwater. No long-term impacts on local or available SRS capacity or groundwater quality are expected.

Operations—No direct discharge of liquid effluents to groundwater would be expected, retention or detention basins would not be used as components of wastewater treatment systems, and NPDES guidelines and Spill Prevention Control and Countermeasures Plans would be used to minimize impacts. DWPF is designed with the capability to monitor water effluents and control discharges, and there would be no direct discharge of liquid effluents to groundwater during facility operation. Water use would be minimal for GWSB storage of HLW canisters containing surplus plutonium; therefore, no impacts on groundwater resources are expected.

No long-term impacts on available SRS capacity or groundwater quality are expected.

G.7.3.2 MOX Fuel

G.7.3.2.1 Surface Water

Construction—No additional construction would be required to fabricate plutonium oxide into MOX fuel at MFFF beyond that previously analyzed (DOE 1999; NRC 2005). Therefore, no impacts on surface waters are expected.

Operations—Stormwater associated with MFFF operations would be discharged to Upper Three Runs at NPDES-permitted outfalls, and noncontact HVAC condensate would be routed directly to CSWTF. Uncontaminated HVAC condensate and stormwater runoff from H-Canyon/HB-Line would be discharged into Upper Three Runs at permitted outfalls (WSRC 2008). Impacts on surface water quality and downstream flow regimes from activities at MFFF or H-Canyon/HB-Line are expected to be minimal.

G.7.3.2.2 Groundwater

Construction—Because no additional facility construction would be required for MOX fuel fabrication at MFFF, no facility construction-related impacts on groundwater are expected.

Operations—The MFFF water supply needs include potable water, fire fighting water (hydrants and fire protection systems), utility cooling water, utility and process chilled water, and cooling water. MFFF is designed with the capability to monitor liquid effluents and control discharges (WGI 2005:140; WSRC 2008). No direct discharge of liquid effluents to groundwater during facility operation is expected. Retention or detention basins would not be used as a component of facility wastewater treatment systems. Groundwater contamination could occur from groundwater recharge from indirectly contaminated surface water sources or from infiltration of accidental spills. It is unlikely that groundwater quality would be affected by indirect sources because NPDES guidelines and Spill Prevention Control and Countermeasures Plans would require prompt and thorough cleanup which would limit groundwater contamination (NRC 2005:4-26).

Use of water at H-Canyon/HB-Line (applicable under the MOX Fuel Alternative) is relatively independent of the types of activities conducted. H-Canyon/HB-Line is designed with the capability to monitor liquid effluents and control discharges, and there would be no direct discharge of liquid effluents to groundwater during facility operation.

Processing surplus plutonium at H-Canyon/HB-Line would result in generation of small quantities of waste that would be vitrified with other HLW at DWPF. DWPF is designed with the capability to monitor water effluents and control discharges; there would be no direct discharge of liquid effluents to groundwater during facility operation. Water use would be minimal for GWSB storage of HLW canisters containing surplus plutonium; therefore, no impacts on groundwater resources are expected.

No impacts on groundwater quality or long term impacts on SRS available capacity are expected.

G.7.3.3 H-Canyon/HB-Line and DWPF

G.7.3.3.1 Surface Water

Construction—For this option, minor modifications to existing H-Canyon/HB-Line facilities would be required. Because these modifications would take place within an existing structure, there would be no potential for erosion or sediment loss that could impact surface water quality. No additional construction activities are expected at DWPF to vitrify the dissolved plutonium sent to DWPF from H-Canyon/HB-Line. There would be no need for construction of additional GWSBs. Because of the larger quantity of surplus plutonium that would be processed through H-Canyon/HB-Line and DWPF, a buried transfer line may be constructed at the H-Area tank farm, which would cause limited ground disturbance. However, surface water resources would be protected using standard techniques such as BMPS and minimal impacts on surface water are expected (SRNS 2012).

Operations—During operations, the potential for surface water resource impacts would be minimal for H-Canyon/HB-Line (see Section G.7.3.2.1) and for DWPF and the GWSBs (see Section G.7.3.1.1).

G.7.3.3.2 Groundwater

Construction—The minor expected modifications to existing H-Canyon/HB-Line facilities would require a negligibly small quantity of water. No impacts on groundwater resources are expected from the possible construction of a buried transfer line at the H-Area tank farm. No impacts on groundwater quality or long term impacts on SRS available capacity are expected.

Operations—Use of water at H-Canyon/HB-Line is relatively independent of the types of activities conducted. H-Canyon/HB-Line is designed with the capability to monitor liquid effluents and control discharges, and there would be no direct discharge of liquid effluents to groundwater during facility operation.

The surplus plutonium processed at H-Canyon/HB-Line would be vitrified with other HLW at DWPF. Only a fraction of the water use at DWPF would be attributable to vitrification of immobilized plutonium. DWPF is designed with the capability to monitor water effluents and control discharges, and there would be no direct discharge of liquid effluents to groundwater during facility operation. Water use would be minimal for GWSB storage of HLW canisters containing surplus plutonium.

No impacts on groundwater quality or long-term impacts on SRS available capacity are expected.

G.7.3.4 WIPP Disposal

G.7.3.4.1 Surface Water

Construction—Existing H-Canyon/HB-Line structures may undergo minor modifications to facilitate preparation of surplus plutonium for shipment to WIPP for disposal as TRU waste. These facility modifications, however, would take place within an existing structure, with no potential for erosion or sediment loss that could impact surface water quality. No construction would be required at E-Area at SRS to facilitate staging of TRU waste pending shipment to WIPP. No impacts on surface waters are expected.

Operations—Uncontaminated HVAC condensate wastewater and stormwater runoff from H-Canyon/HB-Line would be discharged at permitted outfalls (see Section G.7.3.2.1) and sanitary wastewater would be routed to CSWTF. No impacts on surface water resources are expected from activities at E-Area. Therefore, no impacts on surface water quality or downstream flows are expected for SRS

G.7.3.4.2 Groundwater

Construction—Minor modifications of existing H-Canyon/HB-Line structures as necessary for surplus plutonium preparation for WIPP disposal would result in a negligible increase in water consumption and would have negligible impacts on groundwater resources. No long-term impacts on SRS available capacity or groundwater quality are expected.

Operations—Use of water at H-Canyon/HB-Line is relatively independent of the types of activities conducted. H-Canyon/HB-Line is designed with the capability to monitor liquid effluents and control discharges, and there would be no direct discharge of liquid effluents to groundwater during facility operation. No long-term impacts on SRS available capacity or groundwater quality are expected.

G.7.4 Noise

Activities under the plutonium disposition options would result in noise from vehicles, construction equipment, and facility operations. The change in noise levels was considered for modification and operation of the plutonium disposition facilities.

Construction—Noise during the optional construction of the K-Area immobilization capability would include bulldozers, graders, dump trucks, and other vehicles. Impacts would be small, and construction traffic noise impacts would be unlikely to result in increased public annoyance. Any change in traffic

noise associated with construction would occur onsite and along offsite local and regional transportation routes. Noise sources during optional modifications to H-Canyon/HB-Line or MFFF (to add metal oxidation furnaces) would be primarily indoors and would have minor impacts on the public and wildlife. There would be no noise impacts from optional modifications to DWPF. Construction noise impacts from MFFF were addressed previously (DOE 1999; NRC 2005).

Operations—Noise impacts due to operation of the K-Area immobilization capability, MFFF, DWPF, and/or H-Canyon/HB-Line would be similar to those described for existing conditions at SRS in Chapter 3, Section 3.1.4.3. Noise sources during operations could include emergency generators, cooling systems, vents, motors, material-handling equipment, and employee vehicles and trucks. Given the distances to site boundaries (about 5.4 miles [8.7 kilometers] from F-Area, for example), noise from facility operations is not expected to result in annoyance to the public. Non-traffic noise sources are far enough away from offsite areas that the contribution to offsite noise levels would continue to be small. Noise from traffic associated with the operation of facilities is expected to increase by less than 1 decibel as a result of the increase in staffing. Some noise sources could have onsite noise impacts, such as the disturbance of wildlife. However, noise would be unlikely to affect federally listed threatened or endangered species or their critical habitats. Some change in the noise levels to which noninvolved workers are exposed could occur. Appropriate noise control measures would be implemented under DOE Order 440.1B, *Worker Protection Program for DOE (Including the National Nuclear Security Administration) Federal Employees*, to protect worker hearing.

G.7.5 Ecological Resources

This section analyzes impacts on ecological resources—including terrestrial, aquatic, and wetland resources, and threatened and endangered species—resulting from construction or modification of facilities at SRS for plutonium disposition. Operational activities at these facilities would not further affect ecological resources. Terrestrial resources would not be further affected because additional land would not be disturbed during facility operations, and any artificial lighting and noise-producing activities would occur in areas that are already in industrial use. Aquatic and wetland resources, and threatened and endangered species, would not be further affected because additional land would not be disturbed during facility operations.

Construction of the K-Area immobilization capability under the Immobilization and DWPF Option has the most potential to affect ecological resources by disturbance of the land surface. The other plutonium disposition options evaluated in this appendix would have no to minimal potential for land disturbance.

G.7.5.1 Immobilization and DWPF

Construction—

Terrestrial resources. Several structures would be constructed to support the K-Area immobilization capability. These structures would be built on 2 acres (0.8 hectares) of land already classified as disturbed or developed, and would not result in impacts on terrestrial resources (WSRC 2008). Minor modifications to DWPF at S-Area to support filling can-in-canisters received from K-Area with vitrified HLW would occur within the existing DWPF structure, resulting in no impacts on terrestrial resources. No additional GWSBs would be required. Therefore, implementing this plutonium disposition option would not impact terrestrial resources at SRS.

Aquatic resources. No aquatic resources exist within the area required for the construction of new structures supporting the K-Area immobilization capability. An SWPPP would be implemented during construction to minimize the amount of soil erosion and sedimentation that could be transported into nearby water bodies. Control measures could include sediment fences and minimizing the amount of time that bare soil would be exposed. Therefore, any impacts on aquatic resources, including streams, lakes, or ponds, would be minimized. As with terrestrial resources, there would be no impacts on aquatic resources from modifying DWPF to accommodate can-in-canisters received from K-Area, because all

construction would be internal to the structure, with no potential for erosion and sediment loss that could impact aquatic resources. No additional GWSBs would be required. Therefore, implementing this plutonium disposition option would have no to minimal impacts on aquatic resources.

Wetlands. No wetlands exist within the portion of K-Area required for the construction of the structures supporting the immobilization capability; as discussed above, measures would be taken at K-Area to minimize erosion and sediment loss, with consequently minimal impacts on wetlands. As with aquatic resources, there would be no impacts on wetlands due to minor modifications to DWPF, and there would be no need for additional GWSBs. Therefore, implementing this plutonium disposition option would have no to minimal impact on wetlands.

Threatened and endangered species. No impacts on threatened and endangered species are expected from construction of support structures for the immobilization capability, which would occur in an industrial area of K-Area. No impacts are expected from minor modifications to DWPF, because the modifications would occur within an existing structure, with no potential for impacts on threatened and endangered species, and there would be no need to construct additional GWSBs. Therefore, implementing this plutonium disposition option would have no impacts on threatened or endangered species.

Operations—Operation of the facilities involved in this option would involve no ground-disturbing activities and, thus, would result in minimal impacts on ecological resources.

G.7.5.2 MOX Fuel

Construction—This option would involve no new construction at MFFF beyond that previously analyzed (DOE 1999; NRC 2005), with no additional land disturbance, and, therefore, no impacts on ecological resources.

Operations—Operation of the facilities potentially involved in this option would involve no ground-disturbing activities and therefore would have no impacts on ecological resources.

G.7.5.3 H-Canyon/HB-Line and DWPF

Construction—As addressed in Appendix B, minor modification of H-Canyon could be required (SRNS 2012). Some tanks and/or piping may be changed out or reconfigured to increase plutonium storage volume and capacity, and some equipment may be changed or added at HB-Line. These facility modifications, however, would occur within existing structures, so that there would be no potential for erosion and sediment loss that could impact aquatic resources or wetlands, and no potential for impacts on threatened and endangered species. A transfer bypass line may be installed around a diversion box at the H-Area tank farm, on land that is already disturbed and used for industrial purposes; if this bypass line is installed, control measures would be implemented similar to those discussed in Section G.7.5.1 to minimize the potential for erosion and sediment loss that could impact aquatic resources or wetlands outside the construction area. As discussed in Section G.7.5.1, there would be no need for additional GWSBs. Therefore, implementing this plutonium disposition option would have no to minimal impacts on terrestrial, aquatic, and wetlands resources, and threatened and endangered species.

Operations—Operation of the facilities involved in this option would involve no ground-disturbing activities and therefore would result in no impacts on SRS ecological resources.

G.7.5.4 WIPP Disposal

Construction—Under this plutonium disposition option, surplus plutonium would be prepared for disposal as TRU waste. Minor facility modifications to H-Canyon/HB-Line needed to support plutonium preparation for WIPP disposal would occur within existing structures. Thus, there would be no impact on terrestrial resources, no potential for erosion and sediment loss that could impact aquatic resources and wetlands, and no potential for impacts on threatened and endangered species. Therefore, implementing this plutonium disposition option would have no impacts on terrestrial, aquatic, and wetlands resources, and threatened and endangered species.

Operations—Operation of the facilities involved in this option would involve no ground-disturbing activities and, thus, would result in no impacts on ecological resources.

G.7.6 Cultural Resources

SRS manages and protects its cultural resources, including prehistoric, historic, American Indian, and paleontological, under the terms of agreements and through a Site Use Review Process, to evaluate potential impacts imposed by a scope of work prior to taking action. The Savannah River Archaeological Research Program (SRARP) of the South Carolina Institute of Archeology and Anthropology at the University of South Carolina assists DOE in determining how the project can proceed to minimize or mitigate potential impacts on cultural resources (Wingard 2010).

For the proposed plutonium disposition options, the land area required for construction or modification of facilities at SRS is relatively small; would take place primarily in previously disturbed or developed areas; and would be surveyed and monitored, as appropriate, in compliance with existing agreements and procedures. Impacts from operations would be negligible, and are not further addressed, because security measures at both sites would restrict access to any nearby prehistoric, historic, American Indian, or paleontological resources.

G.7.6.1 Immobilization and DWPF

Prehistoric Resources. While some capabilities would be installed in existing facilities with no impact on prehistoric resources, a number of new facilities would be constructed within the industrial portion of K-Area in support of the immobilization capability. K-Area is classified as site industrial (DOE 2005c:62). These facilities would occupy approximately 2 acres (0.8 hectares) of previously disturbed land. Because construction would take place within the built-up portion of K-Area and previous archeological reviews did not reveal any identified sites where land disturbance would occur, impacts on prehistoric resources are unlikely. Although six archeological sites have been identified in the vicinity of the K-Area boundary, none would be disturbed (DOE 2005d:13-14; SRARP 2006:10; Blunt 2010).

DWPF is located in S-Area, which is classified as site industrial within the Industrial Core Management Area (DOE 2005b:4, 2005c:75). Minor modifications to DWPF would be needed to support filling can-in-canisters received from K-Area with vitrified HLW. Because construction would be within DWPF there would be no impacts on prehistoric resources.

Historic Resources. The K-Area reactor building is a National Register of Historic Places (NRHP)-eligible structure itself and within the context of the Cold War Historic District. The K-Area reactor building is considered highly significant because it was primary to SRS's mission and housed a part or all of one of the site's nuclear production processes and is valued for its good integrity in that the building contains parts of its original equipment and can still provide information about its past.

To accommodate new facilities, the Cooling Water Pump House in K-Area would be removed in accordance with applicable procedures and regulations; in addition, the adjacent Cooling Water Reservoir could be affected, as well as the Filter and Softener Plant (Blunt 2010). These structures were determined to be eligible for listing on the NRHP as contributing members of the Cold War Historic District and were determined to be valued for their good integrity (fair in the case of the Filter and Softener Plant) in that they contain parts of their original equipment and can still provide information about their past, even

though they support a process that, in itself, is not unique and could be found in other industrial contexts. As such, proposed changes to the historic fabric of these buildings and structure, or to any intact historically significant equipment, would be studied, discussed with the South Carolina State Historic Preservation Office (SHPO), and avoided, mitigated, or minimized (DOE 2005a:16, 59, 61, 67).

There would be no impacts on historic resources associated with the Cold War era at S-Area because construction of DWPF began in 1983 and operations began in 1996 (SRR 2009).

American Indian Resources. Due to the developed nature of K- and S-Areas, it is highly unlikely that either vegetation important to American Indians, or other resources of concern, would be found within these areas. Thus, impacts on American Indian resources resulting from actions necessary to implement plutonium disposition would be unlikely.

Paleontological Resources. Paleontological resources are unlikely to be found within K- and S-Areas due to the highly disturbed nature of these areas. Thus, impacts on paleontological resources resulting from implementing plutonium disposition would be unlikely.

G.7.6.2 MOX Fuel

No modifications to MFFF would be required to fabricate plutonium oxide into MOX fuel beyond that analyzed in previous National Environmental Policy Act analyses (DOE 1999; NRC 2005); therefore no impacts on cultural resources are expected.

G.7.6.3 H-Canyon/HB-Line and DWPF

Prehistoric Resources. Minor modifications to H-Canyon/HB-Line would be required to support plutonium disposition. In addition, a transfer bypass line may be installed around a diversion box at the H-Area tank farm; however, it would be located on land that is already disturbed and used for industrial purposes. Because these actions would take place within an existing facility and industrial zone, no impacts on prehistoric resources are expected.

Historic Resources. The H-Canyon building, including HB-Line, and any other attached auxiliaries have been identified as NRHP-eligible individually, as well as collectively within the context of the Cold War Historic District. The H-Canyon building and its auxiliary facilities are considered highly significant given that these structures were primary to SRS's mission and housed a part or all of one of the site's nuclear production processes (DOE 2005a:39, 58, 61, 66). Photographic mitigation and oral histories have been initiated and, when completed, will be distributed to the South Carolina SHPO to determine what, if any, further action is required in order to preserve the historical integrity of these facilities (DOE 2008:4). The proposed facility modifications would be assessed in accordance with the Cold War Historic Preservation Program (Sauerborn 2011).

American Indian Resources. There would be no impacts on American Indian resources associated with modifications to H-Canyon/HB-Line.

Paleontological Resources. There would be no impacts on paleontological resources associated with modifications to H-Canyon/HB-Line.

G.7.6.4 WIPP Disposal

Minor modifications to H-Canyon/HB-Line would be required to support plutonium preparation for WIPP disposal. Impacts on prehistoric, historic, American Indian, and paleontological resources would be the same as those in Section G.7.6.3. Although there would be temporary staging of TRU waste at E-Area, no modifications would be required that would have impacts on cultural resources.

G.7.7 Infrastructure

This section analyzes impacts of plutonium disposition options on infrastructure resources, including electricity, fuel oil and water.

G.7.7.1 Immobilization and DWPF

Construction—**Table G–17** summarizes the peak infrastructure requirements that would be generated by construction of the K-Area immobilization capability. This capability would be constructed over a 6-year period. Construction of the immobilization capability would use less than 1 percent of SRS’s available electrical and water capacity (annually about 4.1 million megawatt-hours and 2.63 billion gallons [9.96 billion liters], respectively). Fuel oil usage is not limited by site capacity because fuel oil is delivered to the site as needed. However, construction of the K-Area immobilization capability is estimated to require 5,000 gallons (19,000 liters) per year, representing about 1 percent of SRS’s current annual fuel usage of about 410,000 gallons (1,600,000 liters) (see Chapter 3, Section 3.1.9).

There would be some minor modifications at DWPF to receive the can-in-canisters, but minimal additional infrastructure resources would be required to support these modifications.

Operations—**Table G–18** summarizes the annual operational infrastructure requirements generated by the K-Area immobilization capability and DWPF operations associated with immobilized plutonium. The K-Area immobilization capability would operate for 5 years to process 6 metric tons (6.6 tons) of plutonium and for 10 years to process 13.1 metric tons (14.4 tons) of plutonium. Peak annual operations would use approximately 1 percent of SRS’s available electrical capacity, and less than 1 percent of the site’s available water capacity. Fuel oil use is estimated at 18,000 gallons (68,000 liters) per year, approximately 4 percent of SRS’s current annual fuel usage.

Operations at DWPF would continue at their current rate and would have a minimal impact on infrastructure resources related to SRS’s available capacity because DWPF’s annual infrastructure requirements would not change as a result of immobilization activities. Only about 3 percent of the annual electricity and water use at DWPF would be attributable to plutonium disposition activities. If all 13.1 metric tons (14.4 tons) of plutonium materials were immobilized, DWPF would need to remain operational an additional 6 years, from 2026 to 2031, to accommodate the timing of can-in-canister transfers from the K-Area immobilization capability to DWPF. In this case, infrastructure requirements associated with DWPF operations from 2026 to 2031 would represent approximately 30 percent of normal full-scale operations because a smaller number of canisters would be filled at DWPF each year (approximately 80 compared to approximately 300).

G.7.7.2 MOX Fuel

Construction—No modifications would be required at MFFF, as it is currently being constructed to support this disposition option, and no modifications would be needed at H-Canyon/HB-Line or DWPF to support conversion of some non-pit plutonium to plutonium oxide; therefore, there would be no impacts on current infrastructure requirements.

Operations—**Table G–18** summarizes the annual infrastructure requirements that would be generated by disposition activities. While most disposition activities would occur at MFFF, conversion of 4 metric tons (4.4 tons) of non-pit plutonium to plutonium oxide would occur at H-Canyon/HB-Line as part of the MOX Fuel Alternative and would result in a small amount of waste needing to be sent to DWPF annually. Infrastructure requirements from these possible activities are conservatively included in the values in the table under the MOX Fuel Option.

Annual operations at MFFF would use approximately 3 percent of SRS’s available electrical capacity. Annual water usage would be less than 1 percent of the site’s available capacity. Fuel oil use is estimated at 110,000 gallons (420,000 liters) per year, approximately 27 percent of SRS’s current annual fuel usage of about 410,000 gallons (1.6 million liters).

Table G–17 Peak Annual Construction Infrastructure Requirements from Plutonium Disposition Options at the Savannah River Site

Resource	SRS Facilities								Plutonium Disposition Options			
	MFFF ^a	K-Area Immobilization Capability	H-Canyon/HB-Line ^b			DWPF ^b			Immobilization and DWPF	MOX Fuel	H-Canyon/HB-Line and DWPF	WIPP Disposal
			Prepare Pu for WIPP Disposal	Prepare Pu for MFFF	Prepare Pu for DWPF Vitrification	Immobilized Pu	Waste from Pu Prepared for MFFF	Pu Prepared for Vitrification				
Electricity (MWh)	N/A	9,000	minimal	0	minimal	minimal	0	0	9,000	minimal	minimal	minimal
Water (gallons)	N/A	2,000	minimal	0	minimal	minimal	0	0	2,000	minimal	minimal	minimal
Fuel Oil (gallons) ^c	N/A	5,000	minimal	0	minimal	minimal	0	0	5,000	minimal	minimal	minimal

DWPF = Defense Waste Processing Facility; MFFF = Mixed Oxide Fuel Fabrication Facility; MOX = mixed oxide; MWh = megawatt-hours; N/A = not applicable; Pu = plutonium; SRS = Savannah River Site; WIPP = Waste Isolation Pilot Plant.

^a Construction requirements associated with MFFF are not included in this *SPD Supplemental EIS* because the building is already under construction and its infrastructure requirements fall within SRS’s current infrastructure requirements.

^b Possible modifications to H-Canyon/HB-Line and DWPF to support plutonium disposition activities are expected to result in no to minimal additional infrastructure requirements and to fall within SRS’s current infrastructure requirements.

^c Construction fuel oil includes gasoline.

Note: To convert gallons to liters, multiply by 3.7854.

Source: SRNS 2012.

Table G–18 Peak Annual Operational Infrastructure Requirements from Plutonium Disposition Options at the Savannah River Site

Resource	SRS Facilities								Plutonium Disposition Options			
	MFFF	K-Area Immobilization Capability	H-Canyon/HB-Line ^a			DWPF ^b			Immobilization and DWPF	MOX Fuel ^c	H-Canyon/HB-Line and DWPF ^b	WIPP Disposal
			Prepare Pu for WIPP Disposal	Prepare Pu for MFFF	Prepare Pu for DWPF Vitrification	Immobilized Pu	Waste from Pu Prepared for MFFF	Pu Prepared for Vitrification				
Electricity (MWh)	130,000	44,000	minimal	minimal	minimal	960	46	390	45,000	130,000	390	minimal
Water (gallons)	8,900,000	16,000,000	minimal	minimal	minimal	720,000	35,000	300,000	17,000,000	8,900,000	300,000	minimal
Fuel Oil (gallons)	110,000	18,000	minimal	minimal	minimal	0	0	0	18,000	110,000	minimal	minimal

DWPF = Defense Waste Processing Facility; MFFF = Mixed Oxide Fuel Fabrication Facility; MOX = mixed oxide; MWh = megawatt hours; Pu = plutonium; SRS = Savannah River Site; WIPP = Waste Isolation Pilot Plant.

^a Annual operations at H-Canyon/HB-Line to support plutonium disposition activities are expected to result in minimal additional infrastructure requirements beyond those already included in SRS’s current infrastructure requirements as described in Chapter 3, Section 3.1.9.

^b The values represent the annual infrastructure requirements for DWPF that can be attributed to plutonium processing activities, and not the annual infrastructure requirements for processing all waste at DWPF. Processing plutonium at DWPF, or waste associated with plutonium conversion at H-Canyon/HB-Line, is not expected to increase annual infrastructure requirements for DWPF operation, which are already included in SRS’s current infrastructure requirements. Fuel oil is not used to support DWPF operations.

^c Listed impacts for the MOX Fuel Option for plutonium disposition conservatively include those from processing 4 metric tons (4.4 tons) of non-pit plutonium at H-Canyon/HB-Line (and vitrification of waste resulting from this processing at DWPF) as a precursor for fabrication of the plutonium into MOX fuel at MFFF. This processing step for non-pit plutonium is applicable under the MOX Fuel Alternative; for all other alternatives the impacts under the MOX Fuel Option would be those from operation of MFFF alone.

Note: To convert gallons to liters, multiply by 3.7854.

Source: SRNS 2012.

Conversion of plutonium material to an oxide at H-Canyon/HB-Line for use at MFFF would require minimal additional electricity, water, and fuel oil beyond current infrastructure requirements associated with continued operation of H-Canyon/HB-Line. These requirements are already reflected in SRS's baseline operations so there would not be any additional impact on SRS's available electrical or water capacity.

Operations at DWPF would continue at their current rate and would have no impacts on resources related to SRS's available capacity because DWPF operations are already accounted for in site infrastructure requirements. Less than 1 percent of the annual electricity and water use at DWPF would be attributable to plutonium disposition activities.

G.7.7.3 H-Canyon/HB-Line and DWPF

Construction—Only minor facility modifications would be needed at H-Canyon/HB-Line to support disposition of surplus plutonium, and no modifications would be needed at DWPF. Therefore, construction infrastructure use under this option would be minimal.

Operations—Table G-18 summarizes the annual infrastructure requirements generated by operation of H-Canyon/HB-Line and DWPF for plutonium disposition. Under this disposition option, 6 metric tons (6.6 tons) of plutonium would be processed through H-Canyon/HB-Line so that it could be sent to DWPF for vitrification. Operations at H-Canyon/HB-Line would require minimal additional electricity, water, and fuel oil beyond current infrastructure requirements associated with continued operation of H-Canyon/HB-Line. Operations at DWPF would not require any additional electricity, water or fuel oil beyond current infrastructure requirements associated with continued operation of this facility. About 1 percent of the annual electricity and water use at DWPF would be attributable to plutonium disposition activities. Therefore, implementation of this option would not impact SRS's available electrical and water capacities.

G.7.7.4 WIPP Disposal

Construction—Table G-17 summarizes the peak resource requirements that would be generated by process modification activities in H-Canyon/HB-Line to support plutonium disposition via WIPP disposal. Infrastructure requirements related to the required process modifications at H-Canyon/HB-Line to support plutonium disposition at WIPP would be minimal.

Operations—Table G-18 summarizes the annual infrastructure requirements that would be generated by H-Canyon/HB-Line operations in support of plutonium disposition via WIPP disposal. H-Canyon/HB-Line operations related to this plutonium disposition option would require minimal additional electricity, water, or fuel oil beyond current infrastructure requirements associated with continued operation of this facility. These requirements are already reflected in SRS's baseline operations so there would not be any additional impacts on SRS's available electrical and water capacities.

G.8 References

Blunt, B., 2010, Savannah River Site, Aiken, South Carolina, personal communication (email) to J. DiMarzio, Science Applications International Corporation, Germantown, Maryland, “Item #42 Cultural Sites,” December 21.

DCS (Duke Cogema Stone & Webster), 2004, *Mixed Oxide Fuel Fabrication Facility Environmental Report Revision 5, Docket Number 070-03098*, Charlotte, North Carolina, June 10.

DOE (U.S. Department of Energy), 1982, *Final Environmental Impact Statement, Defense Waste Processing Facility, Savannah River Plant, Aiken, S.C.*, DOE/EIS-0082, Office of Defense Waste and Byproducts Management, Washington, DC, February.

DOE (U.S. Department of Energy), 1997, *Waste Isolation Pilot Plant Disposal Phase Final Supplemental Environmental Impact Statement*, DOE/EIS-0026-S-2, Carlsbad Area Office, Carlsbad, New Mexico, September.

DOE (U.S. Department of Energy), 1999, *Surplus Plutonium Disposition Final Environmental Impact Statement*, DOE/EIS-0283, Office of Fissile Materials Disposition, Washington, DC, November.

DOE (U.S. Department of Energy), 2003, *Estimating Radiation Risk from Total Effective Dose Equivalent (TEDE), ISCORS Technical Report No. 1*, DOE/EH-412/0015/0802, Rev. 1, Office of Environmental Policy and Guidance, January.

DOE (U.S. Department of Energy), 2005a, *Savannah River Site’s Cold War Built Environment Cultural Resources Management Plan*, Savannah River Operations Office, Aiken, South Carolina, January 26.

DOE (U.S. Department of Energy), 2005b, *Natural Resources Management Plan for the Savannah River Site*, Aiken, South Carolina, May.

DOE (U.S. Department of Energy), 2005c, *Savannah River Site End State Vision*, Office of Environmental Management, Aiken, South Carolina, July 26.

DOE (U.S. Department of Energy), 2005d, *Environmental Assessment for the Safeguards and Security Upgrades for Storage of Plutonium Materials at the Savannah River Site*, DOE/EA-1538, Savannah River Operations Office, Aiken, South Carolina, December.

DOE (U.S. Department of Energy), 2008, *Savannah River Site (SRS) Cold War Built Environment Historic Preservation Annual Summary Report, Fiscal Year (FY) 2008*, Savannah River Operations Office, Aiken, South Carolina, October.

DOE/NNSA (U.S. Department of Energy/National Nuclear Security Administration), 2012, *NEPA Source Document for Pit Disassembly and Conversion (PDC) Project*, SRB-25.02-10-0014, Rev. 0, Office of Defense Nuclear Nonproliferation, Denver, Colorado, June 18.

EPA (U.S. Environmental Protection Agency), 1990, *New Source Review Workshop Manual – Prevention of Significant Deterioration and Nonattainment Area Permitting*, Draft, October.

EPA (U.S. Environmental Protection Agency), 2004, *User’s Guide for the AMS/EPA Regulatory Model – AERMOD*, EPA-454/B-03-001, Office of Air Quality Planning and Standards, Emissions Monitoring and Analysis Division, Research Triangle Park, North Carolina, September.

EPA (U.S. Environmental Protection Agency), 2009, *National Primary and Secondary Ambient Air Quality Standards*, 40 CFR 50, July.

NRC (U.S. Nuclear Regulatory Commission), 2005, *Environmental Impact Statement on the Construction and Operation of a Proposed Mixed Oxide Fuel Fabrication Facility at the Savannah River Site, South Carolina*, NUREG-1767, Office of Nuclear Material Safety and Safeguards, Washington, DC, January.

Page, S. D., 2010a, U.S. Environmental Protection Agency, Office of Air Quality Planning and Standards, Research Triangle Park, North Carolina, personal communication (memorandum) to Regional Air Division Directors, "Guidance Concerning the Implementation of the 1-hour SO₂ NAAQS for the Prevention of Significant Deterioration Program," August 23.

Page, S. D., 2010b, U.S. Environmental Protection Agency, Office of Air Quality Planning and Standards, Research Triangle Park, North Carolina, personal communication (memorandum) to Regional Air Division Directors, "Guidance Concerning the Implementation of the 1-hour NO₂ NAAQS for the Prevention of Significant Deterioration Program," June 29.

Sauerborn, P., 2011, *Cold War Historic Preservation Program*, Savannah River Nuclear Solutions, LLC, June 14.

SCDHEC (South Carolina Department of Health and Environmental Control), 2003, *Part 70 Air Quality Permit, U.S. Department of Energy, Washington Savannah River Company, LLC – Savannah River Site*, Permit Number TV-0080-0041, February 19.

SCDHEC (South Carolina Department of Health and Environmental Control), 2011, *Chapter 61-62.5, Air Pollution Control Standards*, Standard No. 2, "Ambient Air Quality Standards;" Standard No. 8, "Toxic Air Pollutants," Air Pollution Control, Columbia, South Carolina.

SRARP (Savannah River Archaeological Research Program), 2006, *Annual Review of Cultural Resource Investigations by the Savannah River Archaeological Research Program: Fiscal Year 2006*, South Carolina Institute of Archaeology and Anthropology, University of South Carolina, October.

SRNS (Savannah River Nuclear Solutions, LLC), 2010, *SRS Part 70 Air Quality Permit TV-0080-0041: Revision to Renewal Application*, SRNS-J2220-2010-00217, Aiken, South Carolina, December 17.

SRNS (Savannah River Nuclear Solutions, LLC), 2012, *Surplus Plutonium Disposition Supplemental Environmental Impact Statement*, Data Call Response, Aiken, South Carolina.

SRR (Savannah River Remediation, LLC), 2009, *Defense Waste Processing Facility*, Aiken, South Carolina, November.

WGI (Washington Group International), 2005, *Pit Disassembly and Conversion Facility Waste Management Plan, Rev. 1*, Q-PRP-F-0001, Denver, Colorado, June 30.

Wingard, G. L., 2010, Savannah River Archaeological Research Program, South Carolina Institute of Archaeology and Anthropology, University of South Carolina, New Ellenton, South Carolina, personal communication (email) to S. Pietzyk, Science Applications International Corporation, McLean, Virginia, "RE: SPD SEIS additional data request re: archeology," September 14.

WSRC (Washington Savannah River Company), 2008, *Surplus Plutonium Disposition Supplemental Environmental Impact Statement* Data Call Response, Aiken, South Carolina.

APPENDIX H
IMPACTS OF PRINCIPAL PLUTONIUM
SUPPORT FACILITIES

APPENDIX H

IMPACTS OF PRINCIPAL PLUTONIUM SUPPORT FACILITIES

This appendix addresses the impacts associated with operation of the principal facilities at the Savannah River Site (SRS) and Los Alamos National Laboratory (LANL) supporting the pit disassembly and conversion and plutonium disposition options analyzed in this *Draft Surplus Plutonium Disposition Supplemental Environmental Impact Statement (SPD Supplemental EIS)*. The principal SRS plutonium support facilities are as follows:

- *K-Area storage* – Provides a capability at the K-Area Complex to store surplus plutonium, principally at the K-Area Material Storage Area.
- *K-Area Interim Surveillance (KIS)* – Provides a capability at the K-Area Complex to perform surveillance of stored, surplus plutonium in accordance with the requirements of DOE-STD-3013-2012 (DOE 2012).
- *Waste Solidification Building (WSB)* – Provides a capability at F-Area to treat liquid radioactive wastes generated from pit disassembly and conversion and plutonium disposition activities.
- *E-Area* – Provides waste management capabilities, including the capability to store, stage, and certify transuranic (TRU) waste for shipment to the Waste Isolation Pilot Plant (WIPP) near Carlsbad, New Mexico, for disposal. E-Area also provides management capabilities for other types of waste, including storage of radioactive and hazardous wastes before shipment to offsite facilities and disposal of low-level radioactive waste (LLW).

The principal LANL facilities supporting pit disassembly and conversion are currently located in Technical Area 54 (TA-54) and provide capabilities for TRU waste characterization, packaging, certification, and storage pending shipment to WIPP for disposal. Among other capabilities, TA-54 also provides management capabilities for other types of waste, including characterization of radioactive and chemical wastes; storage of radioactive and chemical wastes, pending shipment to offsite facilities; and disposal of LLW.

Appendix B provides descriptions of these support facilities. Appendix F addresses impacts from the options for pit disassembly and conversion; Appendix G, impacts from options for plutonium disposition; and Appendix I, impacts from the use of mixed oxide (MOX) fuel in commercial nuclear power reactors. Chapter 4 describes the environmental consequences of implementing the *SPD Supplemental EIS* alternatives, including the impacts from operating the SRS and LANL plutonium support facilities.

Impacts from construction of these support facilities are not addressed in this appendix because no new construction is expected. The K-Area storage, KIS, and E-Area waste management capabilities are already operational at SRS, as are the waste management capabilities at LANL. The WSB is under construction, and the impacts from WSB construction have been addressed in previous National Environmental Policy Act (NEPA) analyses (e.g., the *Supplement Analysis for Construction and Operation of a Waste Solidification Building at the Savannah River Site* [DOE 2008a]).

The K-Area storage and KIS capabilities are specifically addressed in this appendix because their principal activities pertain to plutonium management, while WSB is addressed because it is intended to process liquid waste from several plutonium facilities. E-Area at SRS and TA-54 at LANL are addressed because of the quantities of waste that could be generated under some *SPD Supplemental EIS* alternatives

and would be managed at these areas. Other facilities at SRS and LANL provide analytical or waste management support to sitewide activities rather than primarily focusing on surplus plutonium management, with the result that the incremental impacts that could be attributed to surplus plutonium activities would be very small, with little or no change in annual impacts such as worker exposures, releases of radioactive and nonradioactive material to the air, or resource use. These facilities are addressed as needed in the context of the analyses in this and other appendices and Chapter 4 of this *SPD Supplemental EIS*.

For example, the F/H-Laboratory at SRS is a large complex designed to accommodate a variety of missions, and it would also provide an analytical support capability for new facilities such as the K-Area Pit Disassembly and Conversion Project (PDC) if it is constructed, as well as continue to provide analytical support services for currently operating SRS facilities such as H-Canyon/HB-Line. Minor modifications may be needed at F/H-Laboratory if PDC is constructed and operated at K-Area, or if H-Canyon/HB-Line is used to support conversion of pit plutonium to plutonium oxide (see Appendix F). These minor modifications are not expected to result in environmental impacts on workers or the public. Samples analyzed at the F/H-Laboratory in support of plutonium management activities would account for only a small fraction of the overall activities performed there and are not expected to add to the annual environmental impacts associated with operation of this facility. Similar laboratory analysis would also be performed at LANL if pit disassembly and conversion activities were done there. This analysis would be done at the Chemistry and Metallurgy Research Building and the Radiological Laboratory/Utility/Office Building (RLUOB). No new construction at the Chemistry and Metallurgy Research Building or RLUOB is expected to support activities under any pit disassembly and conversion option addressed in this *SPD Supplemental EIS*. Impacts from sample analysis at these facilities are not expected to add to their annual environmental impacts.

H.1 Principal Savannah River Site Plutonium Support Facilities

The following sections address impacts from operation of K-Area storage, KIS, and WSB for the following resource areas: air quality, human health, socioeconomic, waste management, transportation, environmental justice, water resources, noise, and infrastructure. Operation of these three support facilities is expected to have no impacts on land resources (land use and visual resources), geology and soils, and ecological and cultural resources because there would be no new land-disturbing construction activities. Therefore, these resource areas for these three support facilities are not addressed further in this appendix.

Section H.1.4.4 addresses the impacts associated with operation of E-Area to support radioactive and nonradioactive waste management activities at the plutonium facilities. Impacts associated with other resource areas are expected to result in no or negligible incremental impacts or are better addressed on a system-wide rather than a facility-specific basis. Because there would be no new land-disturbing construction activities at E-Area, operation of E-Area in support of the other SRS plutonium facilities is expected to have no impacts on land resources, geology and soils, and ecological and cultural resources. Operation of E-Area is expected to result in negligible incremental radiological impacts on workers and the public and present no additional risks from potential accidents. Because no additional employment is projected for E-Area, there would be no socioeconomic impacts. Noise levels from E-Area operations would be similar to existing conditions (see Chapter 3, Section 3.1.4.3). E-Area operates in accordance with existing National Pollutant Discharge Elimination System (NPDES) permits (see Chapter 3, Section 3.1.3.1). There would be no additional withdrawals of groundwater to support E-Area activities, and staging activities are expected to have negligible impacts on surface water resources and no impact on groundwater quality or SRS available capacity. Water and utility use at E-Area is not expected to be

significantly affected by the particular mix of waste management activities that may take place at E-Area under each of the *SPD Supplemental EIS* alternatives.¹

Two resource areas, transportation and environmental justice, are meant for system-wide analysis rather than analysis of just a portion of the system (e.g., just the principal SRS plutonium support facilities). Therefore, for the same reasons discussed in Section H.1.5 for K-Area storage, KIS, and WSB, the analysis of transportation impacts associated with E-Area operations is deferred to Appendix E, which provides a detailed analysis of the transportation impacts associated with the alternatives being evaluated in this *SPD Supplemental EIS*, including the impacts associated with the principal plutonium support facilities. Similarly the analysis of environmental justice impacts associated with E-Area operations (Section H.1.6) is deferred to Chapter 4, Section 4.1.6, which presents the potential impacts on populations surrounding the facilities that would be involved in surplus plutonium activities, including the impacts associated with the principal plutonium support facilities.

H.1.1 Air Quality

Nonradioactive air pollutant impacts are evaluated in this section. Radioactive air pollutant impacts are evaluated in Section H.1.2.

Operation of the principal SRS plutonium support facilities could result in emissions of criteria, hazardous, and toxic air pollutants.

Concentrations resulting from existing sources at SRS (see Chapter 3, Section 3.1.4.2, Table 3–7) include contributions from currently operating facilities such as K-Area storage and KIS, from which the contributions are expected to be essentially unchanged. Maximum concentrations resulting from WSB operations, as determined using worst-case meteorology at the distance of the nearest site boundary, were estimated using the EPA SCREEN3 model (EPA 1995). As shown in **Table H–1**, contributions of criteria pollutants and particulates from WSB operations would be minor. Concentrations of toxic pollutants from WSB were estimated to represent less than 0.0001 percent of the acceptable source impact levels for all the toxic pollutants except nitric acid, which was estimated at 0.12 percent.

H.1.2 Human Health

H.1.2.1 Incident-Free Operations

The following section presents the potential incident-free radiological impacts on workers and the general public associated with the principal plutonium support facilities at SRS. Human health risks from normal operations are evaluated for several individual and population groups, including onsite involved workers, a hypothetical maximally exposed individual (MEI) at the site boundary, and the regional population.

Tables H–2 and **H–3** summarize the potential radiological impacts on involved workers and the general public, respectively, which are associated with the support facilities. Activities at K-Area storage are not expected to result in radioactive emissions, so there would be no radiological impacts on the public.

Tables H–2 and H–3 present the estimated doses and latent cancer fatality (LCF) risks from 1 year of operations and the life-of-project risks for each support facility. Life-of-project risks were determined by multiplying the annual impacts of a facility by the number of years the facility is projected to operate (see Appendix B, Table B–2). Table H–2 shows that up to 1 LCF may be projected among workers over all years of the project. Table H–3 shows that potential doses to all public receptors would represent a small fraction of the 311 millirem dose these receptors are each assumed to receive from natural background radiation (see Chapter 3, Section 3.1.6.1).

¹ From Chapter 3, Section 3.1.9: E-Area annually requires about 2,900 megawatt-hours of electricity and 20,000,000 gallons (76,000,000 liters) of water. Each requirement represents less than 1 percent of SRS's available electrical and water capacity. Fuel oil is not used at E-Area.

Table H-1 Estimated Air Pollutant Concentrations from Operation of the Waste Solidification Building

<i>Pollutant</i>	<i>Averaging Period</i>	<i>More Stringent Standard or Guideline^a</i>	<i>Significance Level^b</i>	<i>Contribution From WSB^c</i>
Criteria Pollutants (micrograms per cubic meter)				
Carbon monoxide	8 hours	10,000	500	Not applicable
	1 hour	40,000	2,000	Not applicable
Nitrogen dioxide	Annual	100	1	Not applicable
	1 hour	188	7.5	Not applicable
PM ₁₀	24 hours	150	5	0.000061
PM _{2.5}	Annual	15	0.3	0.000012
	24 hours	35	1.2	0.000061
Sulfur dioxide	Annual	80	1	Not applicable
	24 hours	365	5	Not applicable
	3 hours	1,300	25	Not applicable
	1 hour	197	7.8	Not applicable

PM_n = particulate matter with an aerodynamic diameter less than or equal to *n* micrometers; WSB = Waste Solidification Building.

^a The more stringent of the Federal and state standards is presented if both exist for the averaging period.

^b EPA 1990; Page 2010a, 2010b; 40 CFR 51.165(b)(2).

^c WSRC 2008.

Table H-2 Potential Radiological Impacts on Involved Workers from Operation of K-Area Storage, K-Area Interim Surveillance, and the Waste Solidification Building^a

<i>Receptor Impacts</i>	<i>Facilities</i>			<i>Total</i>
	<i>K-Area Storage</i>	<i>KIS</i>	<i>WSB</i>	
Number of radiation workers	24	40	50	114
Collective workforce dose (person-rem per year)	8.9	25	25	59
Annual LCFs ^b	0 (5×10 ⁻³)	0 (2×10 ⁻²)	0 (2×10 ⁻²)	0 (4×10 ⁻²)
Life-of-project LCFs ^{b, c}	0 (0.1 to 0.2)	0 to 1 (0.1 to 0.6)	0 (0.3 to 0.4)	1 (0.6 to 1)
Average worker dose (millirem per year) ^d	370	630	500	520
Average annual LCF risk	2×10 ⁻⁴	4×10 ⁻⁴	3×10 ⁻⁴	3×10 ⁻⁴
Life-of-project average LCF risk ^c	4×10 ⁻³ to 9×10 ⁻³	3×10 ⁻³ to 2×10 ⁻²	6×10 ⁻³ to 7×10 ⁻³	5×10 ⁻³ to 1×10 ⁻²

KIS = K-Area Interim Surveillance capability; LCF = latent cancer fatality; WSB = Waste Solidification Building.

^a LCF risks were determined using a risk factor of 0.0006 LCFs per rem or person-rem (DOE 2003).

^b The first value is the projected number of LCFs over the life of the project; the second set of values, in parentheses, is the calculated product of the dose and risk factor.

^c Ranges in impacts are due to differences in the number of years that facilities would operate under the *SPD Supplemental EIS* alternatives.

^d Engineering and administrative controls would be implemented to maintain individual worker doses below 2,000 millirem per year and as low as reasonably achievable.

Note: Doses are rounded to two significant figures; LCF risks are rounded to one significant figure. Sums and products presented in the table may differ slightly from those presented in Appendix C due to rounding. Values are derived from analyses presented in Appendix C.

Table H–3 Potential Radiological Impacts on the Public from Operation of K-Area Storage, K-Area Interim Surveillance, and the Waste Solidification Building^a

Receptor Impacts	Facilities			Total
	K-Area Storage ^b	KIS	WSB	
Population within 50 miles				
Annual dose (person-rem)	0	4.3×10^{-5}	0.031	0.031
Annual LCFs ^c	0	$0 (3 \times 10^{-8})$	$0 (2 \times 10^{-5})$	$0 (2 \times 10^{-5})$
Life-of-project LCFs ^{c, d}	0	$0 (2 \times 10^{-7} \text{ to } 1 \times 10^{-6})$	$0 (4 \times 10^{-4})$	$0 (4 \times 10^{-4})$
Maximally exposed individual^e				
Annual dose (millirem)	0	8.5×10^{-7}	0.00063	0.00063
Annual LCF risk	0	5×10^{-13}	4×10^{-10}	4×10^{-10}
Life-of-project LCF risk ^d	0	$4 \times 10^{-12} \text{ to } 2 \times 10^{-11}$	$8 \times 10^{-9} \text{ to } 9 \times 10^{-9}$	$8 \times 10^{-9} \text{ to } 9 \times 10^{-9}$
Average exposed individual^f				
Annual dose (millirem)	0	5.3×10^{-8}	3.6×10^{-5}	3.6×10^{-5}
Annual LCF risk	0	3×10^{-14}	2×10^{-11}	2×10^{-11}
Life-of-project LCF risk ^d	0	$2 \times 10^{-13} \text{ to } 1 \times 10^{-12}$	5×10^{-10}	5×10^{-10}

KIS = K-Area Interim Surveillance capability; LCF = latent cancer fatality; WSB = Waste Solidification Building.

^a LCF risks were determined using a risk factor of 0.0006 LCFs per rem or person-rem (DOE 2003).

^b Storage operations are not expected to result in radiological emissions; therefore, no impacts on the public are expected.

^c The first value is the projected number of LCFs over the life of the project; the second set of values, in parentheses, is the calculated product of the dose and risk factor.

^d Ranges in impacts are due to differences in the number of years that facilities would operate under the *SPD Supplemental EIS* alternatives.

^e The dose to the maximally exposed individual is conservatively estimated by summing the highest dose to an offsite individual for each facility, even though the hypothetical individual receiving that dose would be in different locations.

^f Impacts to the average individual are determined by dividing the population dose by the number of people in the offsite population within a 50-mile (80-kilometer) radius (approximately 869,000 persons for F-Area and 809,000 for K-Area).

Note: Doses are rounded to two significant figures; LCF risks are rounded to one significant figure. Sums and products presented in the table may differ slightly from those presented in Appendix C due to rounding. Values are derived from the analyses presented in Appendix C.

H.1.2.2 Accidents

The following subsections present the potential impacts on workers and the general public at SRS that are associated with possible accidents involving the principal plutonium support facilities. Human health risks from these accidents are evaluated in **Table H–4** for several individual and population groups, including noninvolved workers, a hypothetical MEI at the site boundary, and the regional population. Impacts are presented as estimated doses and LCF risks from the accidents under consideration (see Appendix D for further details on these accidents).

H.1.2.2.1 K-Area Storage and K-Area Interim Surveillance

The limiting design-basis accident for K-Area plutonium activities would be a fire in the KIS vault leading to a rupture of a plutonium storage container and a pressurized release of radioactive material. If this accident were to occur, the public residing within 50 miles (80 kilometers) of SRS would receive an estimated dose of 52 person-rem. This dose would result in no additional LCFs among the general public. The MEI would receive a dose of 0.18 rem, which represents an increased risk to the MEI of developing a latent fatal cancer of 1×10^{-4} , or 1 chance in 10,000. A noninvolved worker located 1,000 meters (3,281 feet) from the accident source at the time of the accident, who was unaware of the accident and failed to take any emergency actions, would receive a dose of 4.5 rem, with an increased risk of developing a latent fatal cancer of 3×10^{-3} , or about 1 chance in 330.

Table H-4 Limiting Accidents Associated with K-Area Storage, K-Area Interim Surveillance, and the Waste Solidification Building

Accident	Facilities				Total	
	K-Area Storage and KIS		WSB			
	Dose	LCFs	Dose	LCFs	Dose	LCFs
Population within 50 miles (80 kilometers) (dose in person-rem)						
Limiting design-basis accident	52	0 (0.03)	0.13	0 (8×10^{-5})	52	0 (0.03)
Design-basis earthquake ^a	1.8	0 (0.001)	0.13	0 (8×10^{-5})	1.9	0 (0.001)
Beyond-design-basis earthquake ^{a, c}	2,500	2	180	0.1	2,700	2
Maximally Exposed Individual (dose in rem and risk of an LCF if the accident were to occur)						
Limiting design-basis accident	0.18	1×10^{-4}	0.00046	3×10^{-7}	0.18	1×10^{-4}
Design-basis earthquake ^a	0.0063	4×10^{-6}	0.00046	3×10^{-7}	0.0068	4×10^{-6}
Beyond-design-basis earthquake ^{a, c}	9.1	0.005	0.62	4×10^{-4}	9.7	0.006
Noninvolved Worker (dose in rem and risk of an LCF if the accident were to occur)						
Limiting-design-basis accident	4.5	3×10^{-3}	0.010	6×10^{-6}	4.5	3×10^{-3}
Design-basis earthquake ^b	0.16	9×10^{-5}	0.010	6×10^{-6}	0.16	9×10^{-5}
Beyond-design-basis earthquake ^{b, c}	310	0.4	16	0.01	310	0.4

KIS = K-Area Interim Surveillance capability; LCF = latent cancer fatality; WSB = Waste Solidification Building.

^a Design-basis and beyond-design-basis earthquake doses and risks are added across for multiple SRS plutonium support facilities.

^b Design-basis and beyond-design-basis earthquake doses and risks to noninvolved workers are presented for the highest dose to such an individual at a specific area because a noninvolved worker at K-Area would not be near H-Area should an accident occur there and vice versa.

^c Impacts from a beyond-design-basis earthquake involving K-Area storage and KIS include those from a seismically induced fire.

Source: SRNS 2012.

A design-basis earthquake involving K-Area plutonium storage and KIS would expose the public residing within 50 miles (80 kilometers) of SRS to an estimated dose of 1.8 person-rem. This dose would result in no additional LCFs among the general public. The MEI would receive a dose of 0.0063 rem, which represents an increased risk to the MEI of developing a latent fatal cancer of 4×10^{-6} , or 1 chance in 250,000. A noninvolved worker would receive a dose of 0.16 rem, with an increased risk of developing a latent fatal cancer of 9×10^{-5} , or about 1 chance in 11,000.

A beyond-design-basis earthquake with fire involving K-Area plutonium storage and KIS would expose the public residing within 50 miles (80 kilometers) of SRS to an estimated dose of 2,500 person-rem. This dose would result in 2 additional LCFs among the general public. The MEI would receive a dose of 9.1 rem, representing an increased risk to the MEI of developing a latent fatal cancer of 0.005, or 1 chance in 200. A noninvolved worker would receive a dose of 310 rem, with an increased risk of developing a latent fatal cancer of 0.4, or 1 chance in 2.5.

H.1.2.2.2 Waste Solidification Building

The limiting design-basis accident at WSB in F-Area would be an explosion resulting in the release of radioactive material. If this accident were to occur, the public residing within 50 miles (80 kilometers) of SRS would receive an estimated dose of 0.13 person-rem. This dose would result in no additional LCFs among the general public. The MEI would receive a dose of 0.00046 rem, which represents an increased risk to the MEI of developing a latent fatal cancer of 3×10^{-7} , or about 1 chance in 3.3 million. A noninvolved worker located 1,000 meters (3,300 feet) from the accident source at the time of the accident, who was unaware of the accident and failed to take any emergency actions, would receive a dose of 0.010 rem, with an increased risk of developing a latent fatal cancer of 6×10^{-6} , or about 1 chance in 170,000.

A design-basis-earthquake involving WSB would expose the public residing within 50 miles (80 kilometers) of SRS and noninvolved workers to doses and risks similar to those cited for the limiting design-basis accident.

A beyond-design-basis earthquake involving WSB would expose the public residing within 50 miles (80 kilometers) of SRS to an estimated dose of 180 person-rem. This dose would result in no additional LCFs among the general public. The MEI would receive a dose of 0.62 rem, representing an increased risk to the MEI of developing a latent fatal cancer of 4×10^{-4} , or 1 chance in 2,500. A noninvolved worker would receive a dose of 16 rem, with an increased risk of developing a latent fatal cancer of 0.01, or 1 chance in 100.

H.1.2.2.3 Accidents Involving K-Area Support Activities and WSB

A design-basis earthquake involving K-Area storage, KIS, and WSB would expose the public residing within 50 miles (80 kilometers) of SRS to an estimated dose of 1.9 person-rem. This dose would result in no additional LCFs among the general public. The MEI would receive a dose of 0.0068 rem, which represents an increased risk of developing a latent fatal cancer of 4×10^{-6} , or 1 chance in 250,000. A noninvolved worker would receive a dose of 0.17 rem with an increased risk of developing a latent fatal cancer of 1×10^{-4} , or 1 chance in 10,000.

A beyond-design-basis earthquake involving K-Area storage, KIS, and WSB would include a seismically induced fire in the case of K-Area storage and KIS. This combined event would expose the public residing within 50 miles (80 kilometers) of SRS to an estimated dose of about 2,700 person-rem. This dose would result in 2 additional LCFs among the general public. The MEI would receive a dose of about 9.7 rem, which represents an increased risk of developing a latent fatal cancer of 0.006, or about 1 chance in 170. A noninvolved worker would receive a dose of 310 rem, resulting in an increased risk of an LCF of 0.4, or 1 chance in 2.5.

H.1.3 Socioeconomics

This section analyzes the potential socioeconomic impacts associated with operation of plutonium support facilities at SRS. Impacts on direct and indirect employment, economic output, value added, and earnings are presented for the surplus plutonium activities at these facilities during the peak years of operations. The area that would experience the impacts presented in this section is the region of influence (ROI) surrounding each facility. The socioeconomic ROI for the facilities at SRS is defined as the four-county area of Columbia and Richland Counties in Georgia, and Aiken and Barnwell Counties in South Carolina. All values are presented in 2010 dollars.

H.1.3.1 K-Area Storage

Table H-5 summarizes the annual socioeconomic impacts that would be generated by K-Area plutonium storage operations. Annual direct employment at K-Area storage is expected to peak at 26 workers. The direct employment would generate an estimated 31 indirect jobs in the ROI. The direct economic output during peak operations is estimated to be \$4.6 million annually, of which \$3.9 million is estimated to be value added to the local economy in the form of final goods and services directly comparable to gross domestic product (GDP). Approximately \$2.3 million of the value added would be in the form of direct earnings of those employed at K-Area storage.

H.1.3.2 K-Area Interim Surveillance

Table H-5 summarizes the annual socioeconomic impacts that would be generated by operations at KIS. Annual direct employment at KIS is expected to peak at 41 workers. The direct employment would generate an estimated 49 indirect jobs in the ROI. The direct economic output during peak operations is estimated to be \$7.3 million annually, of which \$6.2 million is estimated to be value added to the local economy in the form of final goods and services directly comparable to the gross domestic product.

Approximately \$3.6 million of the value added would be in the form of direct earnings of those employed at KIS.

Table H–5 Annual Socioeconomic Impacts from Operation of K-Area Storage, K-Area Interim Surveillance, and the Waste Solidification Building

<i>Resource</i>	<i>Facilities</i>			<i>Total</i>
	<i>K-Area Storage</i>	<i>KIS</i>	<i>WSB</i>	
Direct Employment	26	41	60	127
Indirect Employment	31	49	71	151
Output (\$ in millions)	\$4.6	\$7.3	\$11	\$23
Value Added (\$ in millions)	\$3.9	\$6.2	\$9.0	\$19
Earnings (\$ in millions)	\$2.3	\$3.6	\$5.3	\$11

KIS = K-Area Interim Surveillance capability; WSB = Waste Solidification Building.

H.1.3.3 Waste Solidification Building

Table H–5 summarizes the annual socioeconomic impacts that would be generated by operations at WSB. Annual direct employment at WSB is expected to peak at 60 workers. The direct employment would generate an estimated 71 indirect jobs in the ROI. The direct economic output during peak operations is estimated to be \$11 million annually, of which \$9.0 million is estimated to be value added to the local economy in the form of final goods and services directly comparable to GDP. Approximately \$5.3 million of the value added would be in the form of direct earnings of those employed at WSB.

H.1.4 Waste Management

This section analyzes the waste management impacts associated with operation of the principal SRS support facilities associated with pit disassembly and conversion and plutonium disposition. The waste types addressed include TRU and mixed TRU waste (analyzed collectively), solid LLW, solid mixed low-level radioactive waste (MLLW), solid hazardous waste, solid nonhazardous waste, liquid LLW, and liquid nonhazardous waste.

Waste management facilities and their associated capacities at SRS are described in Chapter 3, Section 3.1.10. Waste management impacts are evaluated as a percentage of treatment, storage, or disposal capacity, depending on a particular waste type’s onsite disposition. Appendix F, Table F–10, provides a summary of capacities for SRS waste management facilities and the evaluation criteria used to assess impacts.

H.1.4.1 K-Area Storage

Negligible quantities of waste would be generated from plutonium storage operations at K-Area. Years of operation would vary depending on the combination of pit disassembly and conversion options that might be implemented under the *SPD Supplemental EIS* alternatives.

H.1.4.2 K-Area Interim Surveillance

Table H–6 summarizes the peak annual quantities of waste that would be generated from KIS operations. Years of operation would vary, depending on the combination of pit disassembly and conversion options that might be implemented under the *SPD Supplemental EIS* alternatives. Operations would generate TRU waste, solid LLW, solid hazardous waste, and solid nonhazardous waste. The quantities of waste generated would represent small percentages of the capacities of SRS waste management facilities.

Table H–6 Waste Management Impacts for the K-Area Interim Surveillance Capability

<i>Peak Annual Operations Waste Generation</i>							
<i>Facility</i>	<i>TRU Waste</i>	<i>Solid LLW</i>	<i>Solid MLLW</i>	<i>Solid Hazardous Waste</i>	<i>Solid Nonhazardous Waste</i>	<i>Liquid LLW</i>	<i>Liquid Nonhazardous Waste</i>
	<i>(cubic meters per year)</i>					<i>(liters per year)</i>	
KIS	0.4	20	negligible	0.1	21	negligible	negligible
<i>Percent of SRS Capacity</i>	<i><0.1</i>	<i><0.1</i>	<i>negligible</i>	<i><0.1</i>	<i><0.1</i>	<i>negligible</i>	<i>negligible</i>

KIS = K-Area Interim Surveillance capability; LLW = low-level radioactive waste; MLLW = mixed low-level radioactive waste; SRS = Savannah River Site, TRU = transuranic.

Note: To convert cubic meters to cubic feet, multiply by 35.314; liters to gallons, multiply by 0.26418.

Source: SRNS 2012.

H.1.4.3 Waste Solidification Building

Table H–7 summarizes the peak annual quantities of waste that would be generated from WSB operations. Table H–7 includes waste generated from treatment of liquid high-activity waste that would come from activities that could occur under the PDCF or PDC Options for pit disassembly and conversion, as discussed in Appendix F, Sections F.4.1 and F.4.2. Operations would generate TRU waste, solid LLW, solid hazardous waste, solid nonhazardous waste, liquid LLW, and liquid nonhazardous waste. The quantities of waste generated would represent small percentages of the capacities of SRS waste management facilities.

Table H–7 Waste Management Impacts for the Waste Solidification Building

<i>Peak Annual Operations Waste Generation</i>							
<i>Facility</i>	<i>TRU Waste</i>	<i>Solid LLW</i>	<i>Solid MLLW</i>	<i>Solid Hazardous Waste</i>	<i>Solid Nonhazardous Waste</i>	<i>Liquid LLW</i>	<i>Liquid Nonhazardous Waste</i>
	<i>(cubic meters per year)</i>					<i>(liters per year)</i>	
WSB	200	320	negligible	0.2	280	8,500,000	10,200,000
<i>Percent of SRS Capacity</i>	<i>1.5</i>	<i>0.9</i>	<i>negligible</i>	<i>0.1</i>	<i><0.1</i>	<i>1.4</i>	<i>0.7</i>

LLW = low-level radioactive waste; MLLW = mixed low-level radioactive waste; SRS = Savannah River Site; TRU = transuranic; WSB = Waste Solidification Building.

Note: To convert cubic meters to cubic feet, multiply by 35.314; liters to gallons, multiply by 0.26418.

Source: SRNS 2012.

H.1.4.4 E-Area

Waste management in E-Area would generate negligible quantities of additional waste that would require treatment, storage, or disposal. The annual quantities of wastes that would be managed at E-Area, which would generally entail temporary storage or staging of TRU and other wastes for offsite shipment, would depend on the *SPD Supplemental EIS* alternative selected. Yet even with the largest quantities of wastes projected for E-Area management under any of the alternatives, it is not expected that E-Area waste treatment, storage or staging, or disposal capacities would be exceeded. (These capacities are discussed in Chapter 3, Section 3.1.10.) Years of E-Area operation attributable to surplus plutonium management and disposition would vary depending on the *SPD Supplemental EIS* alternative selected, but would generally coincide with the need to ship TRU waste to WIPP or another authorized disposition facility.

H.1.5 Transportation

Transportation involves the movement of materials and wastes between facilities involved in the Surplus Plutonium Disposition Program, including pit disassembly and conversion facilities, plutonium

disposition facilities, principal plutonium support facilities, and domestic commercial nuclear power reactors. This type of system-wide analysis does not lend itself to analysis of a portion of the system (e.g., just the principal plutonium support facilities) when evaluating impacts from transportation of materials and wastes. See Appendix E for a detailed description of the transportation impacts associated with the alternatives being evaluated in this *SPD Supplemental EIS*, which includes impacts associated with the principal plutonium support facilities. Appendix E, Section E.10, provides a discussion of the impacts associated with onsite shipments at SRS.

H.1.6 Environmental Justice

Executive Order 12898, *Federal Actions to Address Environmental Justice in Minority Populations and Low-Income Populations*, directs Federal agencies to identify and address, as appropriate, disproportionately high and adverse human health and environmental effects of their programs, policies, and activities on minority and low-income populations. The alternatives considered in this *SPD Supplemental EIS* involve construction and operation of several facilities in various combinations, with different levels of efforts and operational timeframes. This type of system-wide analysis does not lend itself to analysis of a portion of the system (e.g., just the principal plutonium support facilities). Chapter 4, Section 4.1.6, presents the potential impacts on populations surrounding the facilities at SRS and LANL that could result from surplus plutonium activities under the *SPD Supplemental EIS* alternatives. Included are the impacts associated with the principal plutonium support facilities.

H.1.7 Other Resource Areas

H.1.7.1 Water Resources

This section analyzes impacts on water resources (surface water and groundwater) resulting from the principal plutonium support facilities at SRS.

H.1.7.1.1 K-Area Storage and K-Area Interim Surveillance

Annual water use at K-Area is estimated to be about 3.6 million gallons (14 million liters) per year (see Table H-8). Most activities at the K-Area Complex are associated with continued storage and surveillance of surplus plutonium. No impacts on surface water, groundwater quality, or SRS available capacity are expected from plutonium storage or surveillance activities at the K-Area Complex.

H.1.7.1.2 Waste Solidification Building

WSB is projected to annually use approximately 12 million gallons (45 million liters) of water (see Table H-8). Uncontaminated heating, ventilating, and air-conditioning condensate wastewater from WSB would be discharged into the sanitary sewer, while facility stormwater runoff would be discharged into Upper Three Runs and ultimately into the Savannah River at NPDES outfall H-16 under the conditions of South Carolina Department of Health and Environmental Control Permit SC0000175 (SRNS 2012; WSRC 2008). Contamination of surface water from this outfall would be minimal because, under the conditions of the permit, pollutant concentrations would be limited to safe levels. Impacts on surface water from WSB operations are expected to be minimal. No impacts on surface water, groundwater quality, or SRS available capacity are expected.

H.1.7.2 Noise

Noise impacts due to K-Area storage, KIS, and WSB operations would be similar to those described for existing conditions at SRS in Chapter 3, Section 3.1.4.3. Noise sources during operations could include diesel generators, cooling systems, vents, motors, material-handling equipment, and employee vehicles and trucks. Traffic noise associated with operation of these facilities would occur on site and along offsite local and regional transportation routes used to bring materials and workers to the site. Noise from traffic associated with the operation of facilities is expected to increase by less than 1 decibel as a result of the increase in staffing.

Given the distances to site boundaries, noise from facility operations is not expected to result in public annoyance. Non-traffic noise sources are far enough away from offsite areas that the contribution to offsite noise levels would be small. Some noise sources could have onsite noise impacts, such as the disturbance of wildlife. However, noise would be unlikely to affect federally listed threatened or endangered species or their critical habitats. Some change in the noise levels to which noninvolved workers are exposed could occur. Appropriate noise control measures would be implemented under U.S. Department of Energy (DOE) Order 440.1B, *Worker Protection Program for DOE (Including the National Nuclear Security Administration) Federal Employees*, to protect worker hearing.

H.1.7.3 Infrastructure

This section analyzes the infrastructure impacts associated with operation of plutonium support facilities at SRS. The resource types addressed include electricity, water, and fuel oil.

H.1.7.3.1 K-Area Storage and K-Area Interim Surveillance

Table H–8 summarizes the annual resources that would be used by K-Area storage and KIS operations. Combined operations would use about 1 percent or less of SRS’s available electrical and water capacity (4.1 million megawatt-hours and 2.63 billion gallons [9.96 billion liters], respectively), annually. Fuel oil usage is not limited by site capacity because fuel oil is delivered to the site as needed. However, fuel oil use for K-Area storage and KIS operations is estimated at 170,000 gallons (640,000 liters) per year, representing approximately 41 percent of SRS’s current annual fuel usage (410,000 gallons [1,600,000 liters] – see Chapter 3, Section 3.1.9).

Table H–8 Annual Infrastructure Requirements from Operation of K-Area Storage, K-Area Interim Surveillance, and the Waste Solidification Building

Resource	Facility		Total
	K-Area Storage ^a and KIS	WSB	
Electricity (megawatt-hours)	9,200	35,000	44,000
Water (gallons)	3,600,000	12,000,000	16,000,000
Fuel oil (gallons)	170,000	2,500	170,000

KIS = K-Area Interim Surveillance capability; WSB = Waste Solidification Building.

^a Values for K-Area are for operation of the entire K-Area Complex, rather than solely plutonium storage and KIS operations; plutonium storage with associated examination at KIS are the main activities at K-Area.

Note: To convert gallons to liters, multiply by 3.7854.

Source: DOE 2008a; WSRC 2008.

H.1.7.3.2 Waste Solidification Building

Table H–8 summarizes the annual resources that would be used by WSB. Operations would use less than 1 percent of SRS’s available electrical and water capacity. Fuel oil use is estimated at 2,500 gallons (9,500 liters) per year, representing less than 1 percent of SRS’s current annual fuel usage.

H.2 Principal Los Alamos National Laboratory Plutonium Support Facilities

Negligible quantities of waste would be generated from TRU waste characterization and staging, or from onsite disposal of LLW or from characterization or temporary staging of LLW, MLLW, or hazardous waste pending offsite shipment. TRU waste generated from pit disassembly and conversion activities at the Plutonium Facility (PF-4) would be transferred to Area G in TA-54 for WIPP characterization, including the use of real-time radiography, assay, and head-space gas analysis. TRU waste would then be transferred to the Radioassay and Nondestructive Testing Facility (RANT), also located in TA-54, for final packaging in Transuranic Package Transporter (TRUPACT) containers for shipment to WIPP. If some LLW, MLLW, and hazardous waste could not be shipped directly from PF-4 to an offsite disposal facility, some of this waste may be characterized and temporarily staged at TA-54 prior to shipment for offsite disposal.

Because of the requirements in a 2005 Compliance Order on Consent between DOE/National Nuclear Security Administration (NNSA) and the New Mexico Environmental Department, the waste management capabilities in Area G are being transitioned to other locations along the Pajarito Road corridor (i.e., other locations on the same mesa as TA-54).² Because of this, it is expected that after packaging to meet WIPP specifications, characterization of TRU waste from pit disassembly and conversion activities at PF-4 would shift to the RANT facility where TRUPACT-loading would also occur. After it becomes operational, management of TRU waste from pit disassembly and conversion activities could also occur at the new TRU Waste Facility planned for construction in TA-63. LLW, MLLW, and hazardous waste management capabilities would be transitioned to other locations in TA-54.

The annual quantities of wastes that would be managed would depend on the pit disassembly and conversion option selected. Yet even with the largest quantities of wastes projected for management at the LANL support facilities under any of the options (see Appendix F, Section F.4), it is not expected that the waste characterization, storage or staging, or authorized disposal capacities at LANL (presented in Appendix F, Table F-11) would be exceeded. Years of support facility operation attributable to surplus plutonium management and disposition would vary depending on the *SPD Supplemental EIS* alternative selected, but would generally coincide with the need to ship TRU waste to WIPP or another authorized disposition facility.

Impacts associated with other resource areas are expected to result in no or negligible incremental impacts resulting from pit disassembly and conversion activities at LANL, or are better addressed on a system-wide rather than facility-specific basis. Because there would be no new land-disturbing construction activities, operation of the principal facilities in support of PF-4 is expected to have no impacts on land resources, geology and soils, and ecological and cultural resources. Operation of these facilities is expected to result in negligible incremental radiological impacts on workers and the public and present no additional risks from potential accidents. Because no additional employment is projected, there would be no socioeconomic impacts. Noise levels from operations would be similar to existing conditions (see Chapter 3, Section 3.2.4.3). TA-54 operates in accordance with existing NPDES permits (see Chapter 3, Section 3.2.3.1), as would the new TRU Waste Facility proposed for TA-63. There would be no additional withdrawals of groundwater, and staging activities are expected to have negligible impacts on surface water resources and no impact on groundwater quality or LANL available capacity. Water and utility use at the principal support facilities is not expected to be significantly affected by the particular combinations of waste management activities that may take place under each of the *SPD Supplemental EIS* alternatives.

Two resource areas, transportation and environmental justice, are meant for system-wide analysis rather than analysis of just a portion of the system (e.g., just LANL waste management capabilities). Therefore, for the same reasons discussed in Section H.1.5 for K-Area storage, KIS, and WSB at SRS, the analysis of transportation impacts associated with support facility operations is deferred to Appendix E, which provides a detailed analysis of the transportation impacts associated with the alternatives being evaluated in this *SPD Supplemental EIS*, including the impacts associated with the principal plutonium support facilities. Appendix E, Section E.10, provides a discussion of the impacts associated with onsite shipments at LANL. Similarly, the analysis of environmental justice impacts associated with support facility operations is presented in Chapter 4, Section 4.1.6, which presents the potential impacts on populations surrounding the LANL facilities that would be involved in surplus plutonium activities, including the impacts associated with the principal plutonium support facilities. This approach is consistent with that taken for SRS support facilities (see Section H.1.6).

² DOE decided to transition the waste management capabilities at LANL (73 FR 55833), including construction of the new TRU Waste Facility in TA-63, based on the analysis of environmental impacts in the 2008 LANL SWEIS (DOE 2008b).

H.3 References

DOE (U.S. Department of Energy), 2003, *Estimating Radiation Risk from Total Effective Dose Equivalent (TEDE)*, ISCORs Technical Report No. 1, DOE/EH-412/0015/0802, Rev. 1, Office of Environmental Policy and Guidance, Washington, DC, January.

DOE (U.S. Department of Energy), 2008a, *Supplement Analysis for Construction and Operation of a Waste Solidification Building at the Savannah River Site*, DOE/EIS-0283-SA-2, Savannah River Operations Office, Aiken, South Carolina, November.

DOE (U.S. Department of Energy), 2008b, *Final Site-Wide Environmental Impact Statement for Continued Operation of Los Alamos National Laboratory, Los Alamos, New Mexico*, DOE/EIS-0380, National Nuclear Security Administration, Los Alamos Site Office, Los Alamos, New Mexico, May.

DOE (U.S. Department of Energy), 2012, *Stabilization, Packaging, and Storage of Plutonium-Bearing Materials*, DOE-STD-3013-2012, Washington, DC, March 1.

EPA (U.S. Environmental Protection Agency), 1990, *New Source Review Workshop Manual – Prevention of Significant Deterioration and Nonattainment Area Permitting*, Draft, October.

EPA (U.S. Environmental Protection Agency), 1995, *SCREEN3 Model User's Guide*, EPA-454/B-95-004, Office of Air Quality Planning and Standards, Research Triangle Park, North Carolina, September.

Page, S. D., 2010a, U.S. Environmental Protection Agency, Office of Air Quality Planning and Standards, Research Triangle Park, North Carolina, personal communication (memorandum) to Regional Air Division Directors, “Guidance Concerning the Implementation of the 1-hour SO₂ NAAQS for the Prevention of Significant Deterioration Program,” August 23.

Page, S. D., 2010b, U.S. Environmental Protection Agency, Office of Air Quality Planning and Standards, Research Triangle Park, North Carolina, personal communication (memorandum) to Regional Air Division Directors, “Guidance Concerning the Implantation of the 1-hour NO₂ NAAQS for the Prevention of Significant Deterioration Program,” June 29.

SRNS (Savannah River Nuclear Solutions, LLC), 2012, *Surplus Plutonium Disposition Supplemental Environmental Impact Statement Data Call Response*, Aiken, South Carolina.

WSRC (Washington Savannah River Company), 2008, *Surplus Plutonium Disposition Supplemental Environmental Impact Statement Data Call Response*, Aiken, South Carolina.

APPENDIX I
IMPACTS OF MIXED OXIDE FUEL USE IN
DOMESTIC COMMERCIAL NUCLEAR POWER REACTORS

APPENDIX I

IMPACTS OF MIXED OXIDE FUEL USE IN DOMESTIC COMMERCIAL NUCLEAR POWER REACTORS

This appendix to this *Draft Surplus Plutonium Disposition Supplemental Environmental Impact Statement (SPD Supplemental EIS)* provides an assessment of the environmental impacts from the use of a partial mixed oxide (MOX) fuel core (i.e., up to 40 percent MOX fuel), rather than a 100-percent low-enriched uranium (LEU) core in commercial nuclear power reactors. Section I.1 addresses impacts of use of MOX fuel in two multiple-unit nuclear reactor facilities operated by the Tennessee Valley Authority (TVA) – namely, the Browns Ferry Nuclear Plant (Browns Ferry) near Athens, Alabama, and the Sequoyah Nuclear Power Plant (Sequoyah) near Soddy-Daisy, Tennessee. Section I.2 addresses impacts of use of MOX fuel within generic commercial nuclear reactors potentially located anywhere within the United States.

I.1 Impacts of Irradiating Mixed Oxide Fuel at Tennessee Valley Authority Reactor Sites

As discussed in Chapter 2, Section 2.3.3, of this *SPD Supplemental EIS*, use of MOX fuel within commercial nuclear reactors is evaluated for TVA’s Browns Ferry and Sequoyah Nuclear Plants. Browns Ferry has three operating boiling water reactors (BWRs) and Sequoyah has two operating pressurized water reactors (PWRs) that could be used to irradiate MOX fuel assemblies. The U.S. Nuclear Regulatory Commission (NRC) licenses and regulates all commercial nuclear power plants that generate electricity in the United States, including the TVA reactors at Browns Ferry and Sequoyah. (For more information on NRC’s power reactor regulatory program, see <http://www.nrc.gov/reactors/power.html>.) **Table I–1** summarizes the operating power level for each of the Browns Ferry and Sequoyah reactors.

Fukushima Accident

The March 11, 2011 earthquake and subsequent tsunami in Japan caused significant damage to reactors at the Fukushima Daiichi Nuclear Power Station. At the time of the accident, Unit 3 was operating with a partial mixed oxide fuel core. The U.S. Nuclear Regulatory Commission (NRC) has studied the accident at the Fukushima Daiichi Nuclear Power Station and issued recommendations and new requirements for U.S. nuclear power stations (NRC 2011, 2012). The Tennessee Valley Authority (TVA) has been proactive in taking steps to ensure adequate cooling during the unlikely event of an extended loss of offsite power (station blackout). Appendix J, Section J.3.3.3, describes the NRC process and actions taken by TVA.

Table I–1 Reactor Operating Power Level

<i>Reactor</i>	<i>Operator</i>	<i>Installed Power Level (megawatts electric)</i>
Browns Ferry 1	TVA	1,158 ^a
Browns Ferry 2	TVA	1,161 ^a
Browns Ferry 3	TVA	1,161 ^a
Sequoyah 1	TVA	1,216
Sequoyah 2	TVA	1,194

TVA = Tennessee Valley Authority.

^a TVA plans to increase the generating capacity of each Browns Ferry unit to approximately 1,295 megawatts electric with an extended power uprate following approval from the NRC.

Source: TVA 2012.

In accordance with the alternatives presented in Chapter 2, Section 2.3, of this *SPD Supplemental EIS*, these reactors could use MOX fuel to partially fuel their reactor cores. Depending on the alternative chosen, between 34 metric tons (37 tons) and 45.1 metric tons (49.7 tons) of surplus plutonium could be fabricated into MOX fuel. The impact analyses presented in this section are based on publically available information and information provided by TVA. Data were also developed independently to support these

analyses; this included projecting the population around the reactor sites out to 2020¹ and compiling information related to the topography surrounding the reactor sites for evaluating air dispersal patterns. Standard models for estimating radiation doses from normal operations and accident scenarios, and estimating air pollutant concentrations at the reactor sites, were run using this information. In addition, expected ratios of radionuclide activities in MOX fuel versus those in LEU fuel as it would be used in the reactors were calculated using the ORIGEN computer code and used to estimate the consequences in the event of a number of reactor accidents (ORNL 2012).

Under the MOX fuel approach, both MOX and LEU fuel assemblies would be loaded into the reactors. When the MOX fuel completes its time in the reactor core, it would be withdrawn from the reactor in accordance with the plant's refueling procedures and placed in the plant's used fuel (also known as spent fuel) pool for cooling among other used fuel. The used fuel may be subsequently transferred to dry storage casks. No major changes are expected in the plant's used fuel storage plans to accommodate the MOX used fuel. Although the amount of fissile material would be higher in MOX used fuel rods than in LEU used fuel rods, the fuel assembly numbers and spacing in the used fuel pool and/or dry storage casks would be adjusted as necessary to maintain criticality and thermal safety margins.

Before MOX fuel could be used, the utility operating the reactor would be required to obtain a license amendment from NRC in accordance with 10 CFR Parts 50 or 52. NRC would determine whether to issue license amendments that would allow the reactor(s) to use MOX fuel. The NRC licensing process is described in Chapter 5, Section 5.3.3.

I.1.1 Construction Impacts

No new construction would likely be needed on undeveloped areas of the reactor sites to support the irradiation of MOX fuel (TVA 2012). Although the use of MOX fuel may require some changes to safety systems such as the number of control rods, the use of MOX fuel is expected to require only minor modifications at the reactor site itself. Minor changes may be needed to existing facilities for security upgrades and to provide adequate room to receive MOX fuel assemblies. As a result, there would be only minimal impacts on all resource areas.

I.1.2 Operational Impacts

This section describes and compares the impacts from the operation of the TVA reactors using a partial MOX fuel core versus a full LEU core. The No Action Alternative does not include the use of TVA reactors for this purpose but any of the other alternatives considered in this *SPD Supplemental EIS* could potentially result in MOX fuel becoming available for use in TVA reactors.

I.1.2.1 Air Quality

Continued operation of the reactors would result in small amounts of nonradiological air pollutants being released to the atmosphere, mainly due to the requirement to periodically test diesel generators and from the operation of auxiliary steam boilers. As shown in Chapter 3, Sections 3.3.1.1 and 3.3.2.1, of this *SPD Supplemental EIS*, all of the reactors operate within Federal, state, and local air quality regulations or guidelines. Release of air pollutants resulting from operation of the reactors is not expected to increase due to the use of MOX fuel (TVA 2012).

Estimated total emissions from shipping unirradiated MOX fuel to TVA reactors are presented in **Table I-2** conservatively assuming one Type B cask per shipment. Similar emissions would occur even if MOX fuel is not used in TVA reactors, because the MOX fuel is replacing LEU fuel that would be shipped to the reactors under the No Action Alternative.

¹ Population projections for the area within a 50-mile (80-kilometer) radius around the proposed reactor sites were projected to 2020. By 2020, the MOX program should be firmly established and is expected to remain stable through the end of the program. Using 1990, 2000, and 2010 census data a linear trend was developed and the population around the sites was projected to 2020.

Table I–2 Criteria Pollutant Emissions from Shipping Unirradiated MOX Fuel to the Browns Ferry and Sequoyah Nuclear Plants

Pollutant	Total Emissions by Alternative (metric tons)				
	No Action ^a	Immobilization	MOX Fuel	H-Canyon/HB-Line	WIPP
Carbon monoxide	N/A	6.7	9	8.2	8.2
Nitrogen dioxide	N/A	23	31	28	28
PM ₁₀	N/A	0.66	0.89	0.81	0.81
PM _{2.5}	N/A	0.55	0.75	0.68	0.68
Sulfur dioxide	N/A	0.028	0.037	0.034	0.034
Volatile organic compounds	N/A	1.1	1.4	1.3	1.3

MOX = mixed oxide; N/A = not applicable; PM_n = particulate matter less than or equal to *n* microns in aerodynamic diameter; WIPP = Waste Isolation Pilot Plant.

^a No MOX fuel would be shipped to Sequoyah Nuclear Plant and Browns Ferry Nuclear Plant under the No Action Alternative.

Note: To convert metric tons to tons, multiply by 1.1023.

Estimated carbon dioxide emissions from shipping unirradiated MOX fuel to TVA reactors would be less than 190 tons per year (170 metric tons per year).

I.1.2.2 Human Health Risk

This section describes the impacts from operation of the TVA reactors with the partial MOX fuel core on human health from normal reactor operations, facility accidents, and intentional destructive acts.

I.1.2.2.1 Human Health Risk from Normal Operations

Doses to workers – Under all alternatives, occupational doses to plant workers during periods of MOX fuel loading and irradiation are expected to be similar to those for LEU fuel (TVA 2012). Unirradiated MOX fuel could present a risk of higher radiation doses to reactor workers due to the presence of additional plutonium and other actinides compared to LEU fuel. However, worker doses would continue to meet Federal regulatory dose limits as required by NRC, and TVA would be required by NRC to take steps within its ALARA [as low as reasonably achievable] program to limit any increase in doses to workers that may occur from use of MOX fuel. The only time any increase in dose is likely to occur would be during acceptance inspections at the reactor when the fuel assemblies are first delivered to the plant and workers are required to inspect the fuel assemblies to ensure that they meet design specifications. After inspection, worker doses would be limited because the assemblies would be handled remotely as they are loaded into the reactor and subsequently removed from the reactor and transferred into the used fuel pool. For MOX fuel use at the Browns Ferry and Sequoyah Nuclear Plants, however, TVA personnel have indicated that any potential increases in worker dose would be prevented through the continued implementation of aggressive ALARA programs. If needed, additional shielding and remote handling equipment would be used to prevent an increase in worker dose (TVA 2012). Worker doses at the reactors would continue to meet Federal regulatory dose limits as required by NRC in 10 CFR Part 20, and steps would be taken at the reactor sites to limit any increase in dose to workers that could result from use of MOX fuel.

As discussed in Chapter 3, Sections 3.3.1.2 and 3.3.2.2, of this *SPD Supplemental EIS*, Browns Ferry workers received an average annual dose of 175 millirem from plant operations during the period from 2005 through 2009, while Sequoyah workers received an average annual dose of 110 millirem (TVA 2012). Over the same period, the average annual total worker dose at Browns Ferry was 532 person-rem, while the average annual total worker dose at Sequoyah was 142 person-rem (TVA 2012). Using a risk estimator of 600 cancer deaths per 1 million person-rem (DOE 2003), the risk of a latent cancer fatality (LCF) for the average worker would be 0.0001 and 0.00007 annually at Browns Ferry and Sequoyah, respectively. No LCFs are expected in the plant worker population at either reactor site from normal operations using either a partial MOX fuel core or a full LEU core.

Doses to members of the public – **Table I-3** shows the projected radiological doses that would be received by the offsite maximally exposed individual (MEI) and the general population. No change in radiation dose to the public is expected from normal operation of the reactors assuming a partial MOX fuel core versus a full LEU fuel core. This is consistent with findings in the *SPD EIS* (DOE 1999).

Table I-3 Estimated Dose to the Public from Continued Operation of the Browns Ferry and Sequoyah Nuclear Plants in the Year 2020 (partial mixed oxide or low-enriched uranium core)

<i>Impact</i>	<i>Sequoyah</i> ^a	<i>Browns Ferry</i> ^b
Population within 50 miles (80 kilometers) for year 2020		
Dose (person-rem)	3	0.2
Percent of natural background ^c	0.00077	0.000058
Latent fatal cancers ^d	0 (0.002)	0 (0.0001)
Maximally exposed individual (millirem per year)		
Annual dose (millirem)	0.15	0.043
Percent of natural background ^c	0.047	0.013
Latent fatal cancer risk	9×10^{-8}	3×10^{-8}
Average exposed individual within 50 miles (80 kilometers)		
Annual dose (millirem)	0.0025	0.00018
Latent fatal cancer risk	2×10^{-9}	1×10^{-10}

^a The population within 50 miles (80 kilometers) for the year 2020 is estimated to be approximately 1.2 million.

^b The population within 50 miles (80 kilometers) for the year 2020 is estimated to be approximately 1.1 million.

^c The natural background dose is 318 millirem per year (Chapter 3, Table 3-46).

^d Estimated number of latent cancer fatalities in the entire offsite population out to a distance of 50 miles given exposure to the indicated dose. The number of latent cancer fatalities is calculated by multiplying the dose by the risk factor of 0.0006 LCFs per person-rem (DOE 2003). Because the risk factor is only calculated to one significant figure, the number of latent cancer fatalities is reported to one significant figure.

As discussed in Chapter 3, Section 3.3.1.2, of this *SPD Supplemental EIS*, the Browns Ferry MEI was calculated to receive an annual dose of 0.043 millirem from typical (representative) plant operations (TVA 2012). Using a risk estimator of 600 cancer deaths per 1 million person-rem (DOE 2003), the annual fatal cancer risk to the MEI from Browns Ferry operations using a partial MOX fuel core is estimated to be 3×10^{-8} , the same as would occur from using a full LEU core. That is, the estimated probability of this person developing a fatal cancer sometime in the future from 1 year of plant operations would be approximately 1 in 33 million. As also discussed in Section 3.3.1.2, the annual dose to the population residing within 50 miles (80 kilometers) of Browns Ferry was calculated to be 0.15 person-rem from typical recent plant operations. For the year 2020, the subject population is expected to be approximately 30 percent higher (see Appendix J); therefore, it was conservatively assumed that the population dose would also be 30 percent higher (0.20 person-rem) in 2020. Employing the same risk estimator as above, a calculated value of 0.00012 fatal cancers indicates that no fatal cancers are projected for the Browns Ferry general population from normal operations using a partial MOX fuel core or a full LEU fuel core.

As discussed in Chapter 3, Section 3.3.2.2, of this *SPD Supplemental EIS*, the Sequoyah MEI was calculated to receive an annual dose of 0.15 millirem from typical (representative) plant operations. Using a risk estimator of 600 cancer deaths per 1 million person-rem (DOE 2003), the annual fatal cancer risk to the MEI from Sequoyah operations using a partial MOX fuel core is estimated to be 9×10^{-8} , the same as would occur from using a full LEU core. That is, the estimated probability of this person developing a fatal cancer sometime in the future from 1 year of plant operations would be 1 in 11 million. As also discussed in Section 3.3.2.2, the annual dose to the population residing within 50 miles (80 kilometers) of Sequoyah was calculated to be 2.5 person-rem from typical recent plant operations. For the year 2020, the subject population is expected to be approximately 20 percent higher than in 2007 (see Appendix J); therefore, it was conservatively assumed that the population dose would also be 20 percent higher (3.0 person-rem) in 2020. Employing the same risk estimator as above, a calculated

value of 0.002 fatal cancers indicates that no fatal cancers are projected for the Sequoyah general population from normal operations using a partial MOX fuel core or a full LEU fuel core.

For either reactor site, the average individual living within 50 miles (80 kilometers) of the reactor sites could expect to receive an annual dose of 0.00018 to 0.0025 millirem from normal operations regardless of whether the reactors were using MOX fuel or LEU fuel. This is a small dose compared with the average annual dose an individual would receive from natural background radiation near these sites (about 318 millirem as shown in Chapter 3, Table 3–46, of this *SPD Supplemental EIS*).

I.1.2.2.2 Reactor Accidents

Under all alternatives, the potential impacts of accidents at either TVA reactor would be similar. The focus of the analysis was an examination of the potential differences in the accidents' impacts if a partial MOX fuel core were used in commercial nuclear power plants. This question was addressed in the *SPD EIS* (DOE 1999) for use of MOX fuel in PWRs and is being reexamined and updated in this *SPD Supplemental EIS* for both PWRs and BWRs. This section summarizes the more detailed analyses of postulated reactor accidents presented in Appendix J.

The approach is straightforward. Sequoyah, which has PWRs, and Browns Ferry, which has BWRs, were used to represent typical commercial nuclear power reactors in the United States as well as being the specific reactors under consideration for use of MOX fuel.

Since Sequoyah and Browns Ferry are currently licensed by NRC to operate with LEU fuel, representative accidents were selected from current TVA licensing documents for comparison of the impacts if a partial MOX fuel core were substituted for the licensed full LEU fuel core. For this comparison, representative design-basis accidents and beyond-design-basis accidents were selected from TVA safety analyses. It should be noted that before MOX fuel could be used in these reactors or any commercial reactors in the United States, detailed safety analyses in support of licensing amendment requests would evaluate the probability of occurrence and consequences of all accident possibilities while using MOX fuel. These analyses would be reviewed and approved by the NRC prior to granting licensing amendments to use MOX fuel.

Depending on the accident being analyzed, the presence of MOX fuel would decrease or increase the consequences of the accident because it would result in different amounts of radiation being released due to the different isotopic distributions and quantities of radioactive isotopes being generated. Models currently accepted by NRC to estimate potential radiological impacts from reactor accidents were used to evaluate a selected suite of design-basis and beyond-design-basis accidents. Additional modeling will likely be required by NRC as part of the license amendment process should TVA decide to move forward with the proposal to use MOX fuel in its reactors. The methodology used is consistent with current DOE and industry practice (see Appendix J of this *SPD Supplemental EIS*).

TVA Reactor Design-basis Accidents. Design-basis accidents are not expected to take place, but are postulated because their consequences would include the potential release of radioactive material. They are the most drastic events that must be designed against and represent limiting design cases. The design-basis accidents evaluated in this *SPD Supplemental EIS* include a large-break loss-of-coolant accident and a used fuel-handling accident.

As shown in **Table I–4**, the design-basis accident with the greatest dose at the exclusion area boundary would be a loss-of-coolant accident. As also shown in Table I–4, the dose to a person at the exclusion area boundary for these accidents is well below regulatory limits (25 rem) and would not be significantly different if the TVA reactor were partially fueled with MOX fuel.

Table I-4 Summary of Environmental Consequences from Design-Basis Accidents at the Browns Ferry and Sequoyah Nuclear Plants

Accident	Full LEU or Partial MOX Fuel Core	Impacts on the MEI at the Exclusion Area Boundary		Impacts on the Population within 50 Miles	
		Dose (rem) ^a	NRC Regulatory Limit (rem) ^b	Dose (person-rem) ^a	Average Individual Dose (rem) ^c
Browns Ferry Nuclear Plant					
Loss-of-coolant accident ^d	LEU	0.026	25	150	1.4×10^{-4}
	MOX	0.023	25	150	1.4×10^{-4}
Used-fuel-handling accident ^e	LEU	0.00014	25	0.086	7.9×10^{-8}
	MOX	0.00014	25	0.086	7.9×10^{-8}
Sequoyah Nuclear Plant					
Loss-of-coolant accident ^f	LEU	0.0023	25	0.75	6.2×10^{-7}
	MOX	0.0020	25	0.72	5.9×10^{-7}
Used-fuel-handling accident ^f	LEU	0.000036	25	0.018	1.5×10^{-8}
	MOX	0.000036	25	0.018	1.5×10^{-8}

LEU = low-enriched uranium; MEI = maximally exposed individual; MOX = mixed oxide; NRC = U.S. Nuclear Regulatory Commission.

^a The reactor accident doses were calculated over a 80-year period using the MACCS2 computer code. Eighty years was chosen to represent a typical person's lifetime.

^b From 10 CFR 50.34 for design basis accidents.

^c Average individual dose to the entire offsite projected population in 2020 (approximately 1,100,000 for Browns Ferry and 1,200,000 for Sequoyah) out to a distance of 50 miles for the indicated accident.

^d Release would be through a 604-foot stack.

^e Release was assumed to be through the top of the containment building at 173 feet.

^f Release was assumed to be through the top of the containment building at 171 feet.

To convert feet to meters, multiply by 0.3048; miles to kilometers by 1.6093.

Source: Appendix J, Tables J-4 and J-5.

TVA Reactor Beyond-design-basis Accidents. Risk is determined by multiplying two factors, frequency and consequence. In the case of the beyond-design-basis reactor accidents evaluated in this SPD Supplemental EIS, no change is expected in the estimated frequency of the accident based on the presence of a partial MOX fuel core. The frequencies used in the analysis are the same as those used in each reactor's probabilistic risk assessment, which was prepared for NRC for the reactor's current LEU core. A recent analysis of severe accidents for reactors using partial MOX fuel cores determined them to have a similar accident progression as those for a full LEU fuel core in a number of scenarios including early and late containment failures (SNL 2010). These frequencies are event-based (e.g., frequency of an initiating event such as loss of offsite power) and depend on systems- and operational-response-related events (mitigation activities with probabilities to accomplish the required actions). They are not dependent on the type of the fuel in use in the reactor at the start of the accident.

Beyond-design-basis accident scenarios that would lead to containment bypass or failure were evaluated because these are the accidents that have the greatest potential consequences. The public health and environmental consequences would be significantly less for accident scenarios that do not lead to containment bypass or failure. A steam generator tube rupture, early containment failure, late containment failure, and an interfacing systems loss-of-coolant accident were chosen as the representative set of beyond-design-basis accidents (see Appendix J).

As shown in **Table I-5**, of the beyond-design-basis accidents evaluated for Sequoyah, the late containment failure accident represents the highest risk to the MEI, with an estimated frequency of approximately 1 chance in 330,000 of the accident occurring per year of operation. Of the beyond-design-basis accidents evaluated for Browns Ferry, the early containment failure accident represents the highest risk to the MEI, with an estimated frequency of approximately 1 chance in 9 million of the accident occurring per year of operation.

Table I-5 Summary of Environmental Consequences from Beyond Design-Basis Accidents at the Browns Ferry and Sequoyah Nuclear Plants

Accident	Frequency (per year)	LEU or MOX Fuel Core	Impacts on the MEI at the Exclusion Area Boundary			Impacts on the Population within 50 Miles		
			Dose (rem) ^a	Dose Risk (rem/year) ^b	Annual Risk of Fatal Cancer ^c	Dose (person-rem) ^a	Average Individual Dose Risk (rem/year) ^d	Risk of Fatal Cancer to Average Individual ^e
Browns Ferry Nuclear Plant								
Early containment failure	1.1 × 10 ⁻⁷	LEU	11,000	1.2 × 10 ⁻³	1 × 10 ⁻⁷	5.6 × 10 ⁶	5.7 × 10 ⁻⁷	3 × 10 ⁻¹⁰
		MOX	11,000	1.2 × 10 ⁻³	1 × 10 ⁻⁷	5.4 × 10 ⁶	5.5 × 10 ⁻⁷	3 × 10 ⁻¹⁰
Late containment failure	3.0 × 10 ⁻⁷	LEU	190	5.7 × 10 ⁻⁵	7 × 10 ⁻⁸	420,000	1.2 × 10 ⁻⁷	7 × 10 ⁻¹¹
		MOX	200	6.0 × 10 ⁻⁵	7 × 10 ⁻⁸	400,000	1.1 × 10 ⁻⁷	7 × 10 ⁻¹¹
ISLOCA	4.6 × 10 ⁻⁸	LEU	41	1.9 × 10 ⁻⁶	2 × 10 ⁻⁹	220,000	9.3 × 10 ⁻⁹	6 × 10 ⁻¹²
		MOX	38	1.7 × 10 ⁻⁶	2 × 10 ⁻⁹	210,000	8.9 × 10 ⁻⁹	5 × 10 ⁻¹²
Sequoyah Nuclear Plant								
Early containment failure	3.4 × 10 ⁻⁷	LEU	27,000	0.0092	3 × 10 ⁻⁷	2.3 × 10 ⁶	6.5 × 10 ⁻⁷	4 × 10 ⁻¹⁰
		MOX	33,000	0.011	3 × 10 ⁻⁷	2.4 × 10 ⁶	6.7 × 10 ⁻⁷	4 × 10 ⁻¹⁰
Late containment failure	3.0 × 10 ⁻⁶	LEU	790	0.0024	3 × 10 ⁻⁶	1.5 × 10 ⁶	3.7 × 10 ⁻⁶	2 × 10 ⁻⁹
		MOX	870	0.0026	3 × 10 ⁻⁶	1.5 × 10 ⁶	3.7 × 10 ⁻⁶	2 × 10 ⁻⁹
Steam generator tube rupture accident	1.4 × 10 ⁻⁶	LEU	45,000	0.063	1 × 10 ⁻⁶	4.0 × 10 ⁶	4.6 × 10 ⁻⁶	3 × 10 ⁻⁹
		MOX	56,000	0.078	1 × 10 ⁻⁶	4.2 × 10 ⁶	4.9 × 10 ⁻⁶	3 × 10 ⁻⁹

ISLOCA = interfacing systems loss-of-coolant accident; LEU = low-enriched uranium; MEI = maximally exposed individual; MOX = mixed oxide.

- ^a The reactor accident doses were calculated over a 80-year period using the MACCS2 computer code. Eighty years was chosen to represent a typical person’s lifetime.
- ^b Annual dose risk to a hypothetical MEI at the exclusion area boundary (4,806 feet at Browns Ferry and 1,824 feet at Sequoyah) accounting for the probability of the accident occurring.
- ^c Annual risk of a fatality or fatal latent cancer to a hypothetical MEI at the exclusion area boundary (4,806 feet at Browns Ferry and 1,824 feet at Sequoyah) accounting for the probability of the accident occurring.
- ^d Average individual dose risk per year for the entire offsite projected population in 2020 (approximately 1,100,000 at Browns Ferry and 1,200,000 at Sequoyah) out to a distance of 50 miles, given exposure to the indicated dose and accounting for the probability of the accident occurring.
- ^e Annual risk of a cancer fatality in to the average individual in the entire offsite projected population in 2020 out to a distance of 50 miles accounting for the probability of the accident occurring.

Note: To convert feet to meters, multiply by 0.3048; miles to kilometers by 1.6093.

Source: Appendix J, Tables J-7 and J-8.

In terms of risks to the surrounding population, the maximum evaluated beyond-design-basis accident at Sequoyah would be a steam generator tube rupture accident. Taking into account the frequency of this accident, the average individual’s probability of developing a fatal cancer would increase by about 1 chance in 330 million, regardless of whether the plant was operating with a partial MOX fuel core or a full LEU fuel core. The maximum evaluated beyond-design-basis accident at Browns Ferry would be an early containment failure accident. Taking into account the frequency of this accident, the average individual’s probability of developing a fatal cancer would increase by about 1 chance in 3.3 billion, regardless of whether the plant was operating with a partial MOX fuel core or a full LEU fuel core. For comparison, using the risk factor of 0.0006 LCFs per rem, the dose from natural background radiation would increase the risk of a cancer by 1 chance in 5,200 for each year of exposure.

As discussed in Appendix J, Section J.3.4 and illustrated in Tables I-6 and I-7 of this SPD Supplemental EIS, accident risks projected for a member of the general public near the reactor, or for the general population for either reactor using a partial MOX fuel core are comparable. Table I-6 presents a comparison of projected radiological impacts from a series of design-basis accidents that were

analyzed in this *SPD Supplemental EIS*. The comparison is presented as the ratio of the accident impacts involving partial MOX fuel cores to those involving full LEU fuel cores. Impacts were estimated for a member of the general public at the exclusion area boundary at the time of the accident (i.e., the MEI) and the general population residing within 50 miles (80 kilometers) of the reactor. The numbers in parentheses are the calculated ratios (impacts for a partial MOX core divided by impacts for an LEU core). A ratio less than 1 indicates that the MOX fuel core could result in smaller impacts than the same accident with an LEU fuel core. A value of 1 indicates that the estimated impacts are the same for both fuel core types. A ratio larger than 1 indicates that the MOX fuel core could result in larger impacts than the same accident with an LEU fuel core. Outside the parentheses, the table shows a ratio of 1 for all accident scenarios. This is a rounded value because, when modeling and analytical uncertainties are considered, the precision of the results is no more than one significant figure.

Table I-6 Ratio of Design-Basis Accident Impacts for a Partial Mixed Oxide Fuel Core Compared to a Full Uranium Fuel Core Reactor (partial mixed oxide fuel core doses/full low-enriched uranium fuel core doses) ^{a, b}

<i>Accident</i>	<i>Browns Ferry Nuclear Plant</i>		<i>Sequoyah Nuclear Plant</i>	
	<i>MEI at the Exclusion Area Boundary</i>	<i>Population Within 50 Miles (80 kilometers)</i>	<i>MEI at the Exclusion Area Boundary</i>	<i>Population Within 50 Miles (80 kilometers)</i>
LOCA	1 (0.88)	1 (1.00)	1 (0.87)	1 (0.96)
Used-fuel-handling accident	1 (1.00)	1 (1.00)	1 (1.00)	1 (1.00)

LOCA = loss-of-coolant accident; MEI = maximally exposed individual.

^a Reactor accidents involving the use of partial MOX fuel cores were assumed to involve reactor cores with approximately 40 percent MOX fuel and 60 percent LEU fuel.

^b The values in parentheses reflect the ratio calculated by dividing the accident analysis results for a partial MOX fuel core by the results for a full LEU core. When modeling and analytical uncertainties are considered, the precision of the results is no more than one significant figure.

Source: Appendix J, Table J-9.

Table I-7 Ratio of Beyond Design-Basis Accident Impacts for a Partial Mixed Oxide Fuel Core Compared to a Full Uranium Fuel Core Reactor (partial mixed oxide fuel core doses/full low-enriched uranium fuel core doses) ^{a, b}

<i>Accident</i>	<i>Browns Ferry Nuclear Plant</i>		<i>Sequoyah Nuclear Plant</i>	
	<i>MEI at the Exclusion Area Boundary</i>	<i>Population Within 50 Miles (80 kilometers)</i>	<i>MEI at the Exclusion Area Boundary</i>	<i>Population Within 50 Miles (80 kilometers)</i>
Early containment failure	1 (1.00)	1 (0.96)	1 (1.22)	1 (1.04)
Late containment failure	1 (1.05)	1 (0.95)	1 (1.10)	1 (1.00)
Steam generator tube rupture ^c	Not applicable	Not applicable	1 (1.24)	1 (1.05)
ISLOCA ^d	1 (0.93)	1 (0.95)	See SGTR	See SGTR

ISLOCA = interfacing systems loss-of-coolant accident; MEI = maximally exposed individual; SGTR = steam generator tube rupture.

^a Reactor accidents involving the use of partial MOX fuel cores were assumed to involve reactor cores with approximately 40 percent MOX fuel and 60 percent LEU fuel.

^b The values in parentheses reflect the ratio calculated by dividing the accident analysis results for a partial MOX fuel core by the results for a full LEU core. When modeling and analytical uncertainties are considered, the precision of the results is no more than one significant figure.

^c Steam generator tube rupture is not applicable for boiling water reactors since they do not use steam generators.

^d An ISLOCA was not analyzed in the *Watts Bar Nuclear Plant Severe Reactor Accident Analysis* (SAIC 2007), on which the analysis in this appendix is based, because the impacts were bounded by the SGTR accident.

Source: Appendix J, Table J-9.

Table I-7 presents a comparison of projected radiological impacts from a series of beyond-design-basis accidents that were analyzed in this *SPD Supplemental EIS*. As with the design-basis accidents, numbers in parentheses are the calculated ratios (impacts for a partial MOX core divided by impacts for an LEU

core). Outside the parentheses, the table shows a ratio of 1 for all accident scenarios. This is a rounded value because, when modeling and analytical uncertainties are considered, the precision of the results is no more than one significant figure.

Based on this evaluation the potential risks of accidents involving the two types of cores are projected to be comparable for the MEI or the general population from these design-basis and beyond-design-basis accidents for both a PWR (Sequoyah) and a BWR (Browns Ferry). These results are similar to those in the *SPD EIS* (DOE 1999) for use of MOX fuel in PWRs.

I.1.2.2.3 Intentional Destructive Acts

Similar to the use of duplicate backup systems to ensure safety, TVA implements a layered approach to physical security at the reactor sites in accordance with NRC regulations and guidance. Nuclear power plants are inherently secure, robust structures built to withstand extreme natural phenomena such as hurricanes, tornadoes, and earthquakes. Additional security measures are in place including physical barriers; intrusion detection and surveillance systems; access controls; and coordination of threat information and response with Federal, state, and local agencies (NRC 2008).

Since September 11, 2001, NRC has strengthened requirements at nuclear power plants and enhanced coordination with Federal, state, and local organizations. Additional requirements (NRC 2005) address:

- Increased physical security programs to defend against a more challenging adversarial threat
- More restrictive site access controls for all personnel
- Enhanced communication and liaison with the intelligence community
- Improved capability for events involving explosions or fires
- Enhanced readiness of security organizations by strengthening training and qualifications programs for plant security forces
- Required vehicle checks at greater stand-off distances
- Enhanced force-on-force exercises to provide a more realistic test of plant capabilities to defend against an adversarial force
- Improved liaison with Federal, state, and local agencies responsible for protection of the national critical infrastructure through integrated response training

NRC has also performed comprehensive safety and security studies showing that a radiological release affecting public health and safety is unlikely from a terrorist attack, including one involving a large commercial aircraft. Factors supporting this conclusion included the hardened condition of power plants which are designed to withstand extreme events such as hurricanes, tornadoes, and earthquakes (e.g., thick concrete walls with heavy reinforcing steel); redundant safety systems operated by trained staff; multiple barriers protecting the reactor or serving to prevent or minimize offsite releases; and in-place mitigation strategies and measures. In addition, security measures at nuclear plants have been complemented by measures taken throughout the United States to improve security and reduce the risk of successful terrorist attacks, including measures designed to respond to and reduce the threats posed by hijacking large jet airplanes (e.g., reinforced cockpit doors, Federal Air Marshals) (NRC 2005, 2009).

An analysis of the consequences of the crash of a large aircraft at a nuclear power reactor site has been performed by the Electric Power Research Institute (EPRI) for the Nuclear Energy Institute. The analysis addressed the consequences of a large jet airline being purposefully crashed into sensitive nuclear facilities or containers including nuclear reactor containment buildings, used fuel storage pools, used fuel dry storage facilities, and used fuel transportation containers. Using conservative analyses, EPRI concluded that there would be no release of radionuclides from any of these facilities or containers because they are already designed to withstand potentially destructive events. The EPRI analysis used

computer models in which a Boeing 767-400 was crashed into containment structures that were representative of reactor containment designs for U.S. nuclear power plants. The containment structures suffered some crushing and chipping at the maximum impact point but were not breached (EPRI 2002).

Notwithstanding the remote risk of a terrorist attack affecting operations at a nuclear power plant, in the very remote likelihood that a terrorist attack would successfully breach the physical and other safeguards at Browns Ferry or Sequoyah resulting in the release of radionuclides, the risks of such a release are reasonably captured by the consideration of the impacts of severe accidents discussed previously in this section.

I.1.2.3 Socioeconomics

Neither Browns Ferry nor Sequoyah would need to employ additional workers to support MOX fuel use in the reactors (TVA 2012). This is consistent with information presented in the *SPD EIS*, which concluded that MOX fuel use would not result in increases in worker populations at reactor sites (DOE 1999). Therefore, as compared to the current use of full LEU fuel cores, use of a partial MOX fuel core in these reactors is expected to have no impact on socioeconomics in the communities surrounding the reactors.

I.1.2.4 Waste Management and Used Nuclear Fuel

Radioactive and Nonradioactive Waste Generation – Browns Ferry and Sequoyah are expected to continue to produce LLW, MLLW, hazardous waste, and nonhazardous waste as part of normal operations. As compared to the current use of full LEU fuel cores, use of MOX fuel is not expected to increase the annual volumes of these wastes (TVA 2012). This is consistent with information presented in the *SPD EIS* that stated that MOX fuel use is not expected to increase the amount or change the content of the waste being generated (DOE 1999).

Used Nuclear Fuel – As shown in **Table I-8**, it is likely that some additional used (irradiated) nuclear fuel would be generated from use of a partial MOX core in the TVA reactors compared to the current use of full LEU fuel cores. The amount of additional used nuclear fuel is estimated to range from approximately 8 to 10 percent of the total amount of used nuclear fuel that would be generated by the TVA reactors during the time period that MOX fuel would be used. Used MOX fuel will be managed in the same manner as LEU used fuel, by storing it in the reactor’s used fuel pool or placing it in dry storage. The amount of additional used fuel is not expected to affect used fuel management at the reactor sites (TVA 2012).

Table I-8 Additional Used Nuclear Fuel Assemblies Generated by Mixed Oxide Fuel Irradiation

<i>Reactor</i>	<i>Number of Used Fuel Assemblies Generated With No MOX Fuel over a Typical Fuel Cycle</i>	<i>Number of Additional Used Fuel Assemblies With MOX Fuel</i>	<i>Percent Increase</i>
Sequoyah 1	81	8	9.9
Sequoyah 2	81	8	9.9
Browns Ferry 1	312 ^a	24 ^a	7.7
Browns Ferry 2	312 ^a	24 ^a	7.7
Browns Ferry 3	312 ^a	24 ^a	7.7

MOX = mixed oxide.

^a The Browns Ferry Nuclear Plant is a BWR and the Sequoyah Nuclear Plant is a PWR. Fuel assemblies for boiling water reactors are smaller than for pressurized water reactors, therefore, more assemblies are needed to power the reactor.

Source: TVA 2012.

I.1.2.5 Transportation

Transportation requirements would include shipments of MOX fuel from the Savannah River Site (SRS) to the reactor sites for irradiation, using the National Nuclear Security Administration’s Secure Transportation Assets. It is estimated (see Appendix E, Section E.7) that between approximately 2,100 and 2,900 shipments of unirradiated MOX fuel could be shipped from SRS to the reactor sites

under the alternatives being considered in this *SPD Supplemental EIS*.² This range of number of shipments was determined assuming one Type B cask containing 2 unirradiated BWR or PWR MOX fuel assemblies per shipment to maximize the number of shipments for the analysis. Alternatively, DOE is considering the shipment of up to seven casks containing BWR fuel assemblies and up to five casks containing PWR fuel assemblies per shipment if escorted commercial trucks are used (under DOE/NNSA’s Secure Transportation Asset Program), reducing the total number of shipments to approximately 330 to 440 shipments.

As analyzed in Appendix E of this *SPD Supplemental EIS* and shown in **Table I-9**, the estimated dose to the transportation crew from the incident-free transport of unirradiated MOX fuel to the TVA reactors is estimated to range from 15 person-rem (for 2,100 shipments containing one Type B cask per shipment for a combination of PWR and BWR shipments) to 20 person-rem (for 2,900 shipments containing one Type B cask per shipment for a combination of PWR and BWR shipments), depending on the alternative being analyzed. In terms of the number of LCFs related to the crew from this transportation, the crew risk would range from 0.009 to 0.01. If escorted commercial trucks carrying up to 7 casks of BWR fuel or 5 casks of PWR fuel are used, the impacts to workers could increase about 2 times, with the risk of an LCF still less than 1 (about 0.02).

Table I-9 Transportation Impacts Associated with the Shipment of Unirradiated Mixed Oxide Fuel to the Browns Ferry and Sequoyah Nuclear Plants (assuming one Type B Cask per shipment)

Alternative	Number of Shipments	Incident Free Dose person-(rem)		Number of Radiological LCFs ^a		Accident	
		Crew	Population	Crew	Population	Radiological LCF ^a	Traffic Fatality
No Action ^b	N/A	N/A	N/A	N/A	N/A	N/A	N/A
Immobilization	2,100	15	24	0.009	0.01	0.0000003	0.03
MOX Fuel	2,900	20	32	0.01	0.02	0.0000004	0.04
H-Canyon/HB-Line	2,600	18	29	0.01	0.02	0.0000004	0.03
WIPP	2,600	18	29	0.01	0.02	0.0000004	0.03

LCF = latent cancer fatality; MOX = mixed oxide; N/A = not applicable; WIPP = Waste Isolation Pilot Plant.

^a Estimated number of latent cancer fatalities in the affected population along the potential transportation routes given exposure to the indicated dose. The number of latent cancer fatalities is calculated by multiplying the dose by the risk factor of 0.0006 LCFs per person-rem (DOE 2003). Because the risk factor is only calculated to one significant figure, the number of latent cancer fatalities is reported to one significant figure.

^b No MOX fuel would be shipped to Sequoyah Nuclear Plant and Browns Ferry Nuclear Plant reactors under the No Action Alternative.

Note: To convert metric tons to tons, multiply by 1.1023.

The estimated dose to the public from the incident-free transportation of this material is estimated to range from 24 to 32 person-rem assuming shipments with one Type B cask per shipment. The number of LCFs expected to develop in the public from this transportation range from 0.01 to 0.02. Thus, no fatalities are expected as a result of incident-free transportation of unirradiated MOX fuel. If a larger number of casks are carried on each escorted commercial truck, as discussed above, the incident-free impacts to the population could decrease about 25 to 40 percent for PWR and BWR shipments, respectively. This reduction is due to an 85 percent decrease in the number of shipments. The risk of a traffic fatality ranges from 0.03 to 0.04 when single cask shipments are assumed; this risk would proportionally decrease with a decrease in the number of shipments if a larger number of casks are carried on each escorted commercial truck.

The estimated total risk in terms of the number of LCFs in the public from all projected accidents involving MOX fuel shipments is projected to range from 0.0000003 to 0.0000004. These total accident

² The shipments of MOX fuel to the reactors would largely be replacing shipments of LEU fuel that would have occurred for a full LEU core. Therefore, much of the transportation impacts would occur regardless of using a partial MOX fuel core. There is no discernible radiological impact difference for the transportation crew between LEU fuel and MOX fuel.

risks were determined taking into account a spectrum of accident severities ranging from high-probability accidents of low severity (e.g., a fender bender) to hypothetical high-severity accidents having low probabilities of occurrence. The per-shipment radiological accident risk would not change if a larger number of casks were assumed per shipment as discussed above because it is assumed only one Type B cask would release its contents in the event of a severe accident regardless of the number of casks in a shipment³. However, the total radiological accident risk, taking into account the total number of shipments, would proportionally decrease with the decrease in the number of shipments. The risk of a traffic fatality ranges from 0.03 to 0.04; this risk would also proportionally decrease with a decrease in the number of shipments. In terms of a fatality from traffic accidents, it is estimated that the analyzed shipments would result in no fatalities under any of the alternatives being considered. The radiological and traffic fatality accident risks would decrease by about an order of magnitude if escorted commercial trucks are used due to the decrease in number of shipments.

The maximum reasonably foreseeable offsite truck transportation accident having the highest consequence was also determined. This accident would involve truck transport of BWR MOX fuel to Browns Ferry (see Appendix E, Table E-13). These shipments would occur over about 23 years. Transportation accident probabilities were calculated for all route segments (i.e., rural, suburban, and urban), and maximum consequences were determined for those route segments having a likelihood of release frequency exceeding 1 in 10 million (1×10^{-7}) per year. The maximum reasonably foreseeable probability of a truck accident involving this material would be approximately 5×10^{-7} per year in a suburban area, or approximately 1 chance in 2 million each year. The consequences of the truck transport accident in terms of population dose would be about 4.1 person-rem. Such exposures would not likely result in an additional LCF among the exposed population. The likelihood of release frequency for a maximum reasonably foreseeable offsite truck accident involving PWR MOX fuel shipped to Sequoyah would be less than 1-in-10 million (1×10^{-7}) per year; transport of PWR MOX fuel was therefore not analyzed. For shipments potentially involving more than one Type B cask, the consequences would remain the same with the likelihood decreasing proportionally with the decrease in number of shipments.

I.1.2.6 Environmental Justice

As demonstrated throughout the analyses presented in Section I.1.2.2.1, normal irradiation of MOX fuel in commercial nuclear reactors would pose no significant health risks to the public. The expected number of LCFs would not increase as a result of radiation released during normal operations because there would be essentially no increase in radiation doses received by the general population from the use of MOX fuel compared to the current use of full LEU fuel cores.

No LCFs are expected among the public assuming design-basis accidents (loss-of-cooling and used-fuel-handling accidents) at Browns Ferry or Sequoyah regardless of whether a full LEU fuel core or partial MOX fuel core were used in the reactors (see Table I-4). Beyond-design-basis accidents, if they were to occur, are expected to result in major impacts on the surrounding communities and environment regardless of whether the reactors used a partial MOX core or a full LEU fuel core (Table I-5). However, because the probability of a beyond-design-basis accident actually happening is extremely unlikely, the risk to an individual living within 50 miles (80 kilometers) of the reactors from these accidents is estimated to be low.

As shown in Section I.1.2.5 and Appendix E, no radiological or nonradiological fatalities are expected to result from incident-free transportation of MOX fuel to the reactor sites. Nor are radiological or nonradiological fatalities expected to result from transportation accidents.

³ Type B packages must meet the general packaging and performance standards for Type A packages and additionally must have the ability to survive serious accident damage tests (hypothetical accident conditions). After testing, there may be only a very limited loss of shielding capability and no loss of containment, as measured by leak-rate testing of the containment system of the package (DOT 2008). Specific requirements are summarized in Appendix E, Section E.3.1. Because of these stringent testing requirements, no more than one cask is assumed to fail in the accident analysis.

The implementation of the MOX fuel irradiation program at either of the TVA reactor sites would not pose significant risks (when probability is considered) to the public, nor would implementation of this program pose significant risks to particular groups within the public. Therefore, because risks are low, there would be no disproportionately high and adverse effects on minority and low-income populations.

I.1.2.7 Other Resource Areas

This section of this appendix addresses resource areas having a lesser potential for environmental impacts than the resource areas addressed in Sections I.1.2.1 through I.1.2.6.

I.1.2.7.1 Land Resources

Additional land would not be required at the Browns Ferry or Sequoyah Nuclear Plants to support the use of MOX fuel. Nor would the use of MOX fuel at either reactor site affect the use of other onsite lands (e.g., buffer zones and undeveloped land areas) (TVA 2012). Prime farmland would not be affected and, because the use of MOX fuel would not result in an in-migration of workers, as discussed in Section I.1.2.3, Socioeconomics, no indirect impacts on offsite lands are expected.

I.1.2.7.2 Geology and Soils

No ground-disturbing activities related to the use of a partial MOX fuel core rather than a full LEU fuel core are expected at either of the reactor sites (TVA 2012). Therefore, there would be no impact on geology or soils resulting from the use of MOX fuel compared to the current use of full LEU fuel cores.

I.1.2.7.3 Water Resources

There would be no change in water usage or discharge of pollutants, including thermal discharges, resulting from use of a partial MOX fuel core compared to the current use of full LEU fuel cores at Browns Ferry and Sequoyah. Each of the TVA reactor sites discharges wastewater in accordance with a National Pollutant Discharge Elimination System permit, or an analogous state-issued permit (TVA 2012). Therefore, there would be no additional impacts on water resources.

I.1.2.7.4 Noise

No increase in operational noise levels is expected from the operation of the Browns Ferry and Sequoyah due to use of a partial MOX fuel core rather than a full LEU fuel core (TVA 2012).

I.1.2.7.5 Ecological Resources

There would be no activities in undeveloped areas of the sites, and operational emissions of effluents from the reactors are not expected to change. Also, there would be no additional thermal releases to the environment as a result of using MOX fuel (TVA 2012). Therefore, as compared to the current use of full LEU fuel cores use of a partial MOX fuel core at Browns Ferry and Sequoyah is not expected to result in any impacts on ecological resources at the reactor sites.

I.1.2.7.6 Cultural Resources

No operational ground-disturbing activities are expected at Browns Ferry and Sequoyah related to the use of MOX fuel (TVA 2012). Therefore, the use of either a partial MOX fuel core or a full LEU fuel core in these reactors is not expected to affect cultural and paleontological resources at the reactor sites. Similarly, no impacts on American Indian resources in the areas surrounding the reactor sites are expected.

I.1.2.7.7 Infrastructure

The existing site infrastructure would continue to serve Browns Ferry and Sequoyah. Each reactor site is equipped with a water supply, wastewater, and power distribution system that would adequately support the demands of the reactors should MOX fuel be used (TVA 2012). Therefore, additional infrastructure would not be required at the reactor sites to support operations using a partial MOX fuel core rather than a full LEU core.

I.2 Impacts of Irradiating Mixed Oxide Fuel at Generic Commercial Nuclear Power Reactor Sites

While Section I.1 includes an analysis of using MOX fuel in TVA's Browns Ferry and Sequoyah Nuclear Plants, and Chapter 4, Section 4.28, of the *SPD EIS* included an analysis of using MOX fuel in Duke Power's McGuire and Catawba Nuclear Plants and Virginia Power's (now Dominion Power) North Anna nuclear reactors (DOE 1999), it is possible that the MOX fuel being produced at SRS could be used in any of the nation's nuclear power plants. Therefore, this section addresses the potential impacts of using MOX fuel in commercial nuclear reactors located anywhere in the United States. As discussed earlier in this Appendix, before MOX fuel could be used, the utilities operating the reactors would be required to obtain a license amendment from NRC in accordance with 10 CFR Parts 50 or 52. NRC would determine whether to issue license amendments that would allow the reactors to use MOX fuel.

As described in this *SPD Supplemental EIS* and the *SPD EIS* (DOE 1999), both MOX and LEU fuel assemblies would be loaded into the reactors. For the purposes of these analyses, it was assumed that the reactors would include a 40 percent MOX fuel core. As with LEU fuel assemblies, MOX assemblies would remain in the reactors for a set number of fuel cycles. When the MOX fuel completes its normal number of cycles, it would be withdrawn from the reactors in accordance with standard refueling procedures and placed in the reactors' used fuel storage pools for cooling among other used fuel. The used nuclear fuel may be subsequently transferred to dry storage casks. No changes are expected in the reactors' used fuel storage plans to accommodate the MOX used fuel. Although the amount of fissile material would be somewhat higher in MOX used fuel rods than in LEU used fuel rods, the fuel assembly number and spacing in the used fuel pools and/or dry storage casks could be adjusted as necessary to maintain the necessary criticality and thermal safety margins.

I.2.1 Construction Impacts

As discussed in Section I.1.1 and Chapter 4, Section 4.28, of the *SPD EIS* (DOE 1999), it is not expected that significant new construction would be required at commercial nuclear reactor sites to support the use of MOX fuel. The same is expected at any generic reactor considering the use of MOX fuel. As discussed earlier in this Appendix, the use of MOX fuel may require some changes to safety systems such as the number of control rods, however, the use of MOX fuel is expected to require only minor modifications at the reactor sites themselves, regardless of where they may be located in the United States. Therefore, minimal impacts on all resource areas are expected.

I.2.2 Operational Impacts

Based on the information presented in Section I.1.2 of this *SPD Supplemental EIS* and the *SPD EIS* (DOE 1999), from an operational standpoint the use of MOX fuel is not expected to require significant changes in the environmental impacts that may result from normal operations of a reactor.

I.2.2.1 Air Quality

Operation of a generic reactor within the United States would result in small amounts of nonradiological air pollutants being released to the atmosphere, because of activities such as periodic testing of diesel generators. Use of MOX fuel at a generic reactor, however, is not expected to result in an increase in these emissions.

Estimated total emissions from shipping unirradiated MOX fuel to a generic commercial nuclear reactor hypothetically located in the northwestern United States are presented in **Table I-10** assuming one Type B cask per shipment. (For purposes of this *SPD Supplemental EIS*, a generic transportation route was analyzed from SRS to the northwestern United States that is intended to envelop all of the transportation routes to currently operating commercial nuclear reactors in the country.) Similar emissions would occur even if MOX fuel is not used in generic reactors since the MOX fuel is replacing LEU fuel that would be shipped to the reactors.

Table I–10 Criteria Pollutant Emissions from Shipping Unirradiated MOX Fuel to a Generic Commercial Nuclear Reactor ^a

<i>Pollutant</i>	<i>Total Emissions by Alternative (metric tons)</i>				
	<i>No Action</i>	<i>Immobilization</i>	<i>MOX Fuel</i>	<i>H-Canyon/HB-Line</i>	<i>WIPP</i>
Carbon monoxide	69	69	91	83	83
Nitrogen dioxide	240	240	310	280	280
PM ₁₀	6.8	6.8	9.0	8.2	8.2
PM _{2.5}	5.7	5.7	7.6	6.9	6.9
Sulfur dioxide	0.28	0.28	0.38	0.34	0.34
Volatile organic compounds	11	11	14	13	13

MOX = mixed oxide; PM_n = particulate matter less than or equal to *n* microns in aerodynamic diameter; WIPP = Waste Isolation Pilot Plant.

^a For purpose of analysis, it was assumed that the generic commercial nuclear power reactor would be located at the Hanford Reservation, Washington, to maximize the distance traveled in order to envelope impacts related to shipping to other possible commercial nuclear power reactor sites. Only shipments of BWR fuel are analyzed because there would be a greater number of shipments to a BWR reactor than a PWR reactor, thus providing a conservative analysis of the distance traveled per alternative that would cover a smaller number of PWR shipments to a generic commercial nuclear power reactor for the same amount of unirradiated MOX fuel, should shipments be made to a PWR.

Note: To convert metric tons to tons, multiply by 1.1023.

Estimated carbon dioxide emissions from shipping unirradiated MOX fuel to generic reactors would be less than 1,900 tons per year (1,700 metric tons per year). (The greatest impacts would be associated with shipments to a BWR because more shipments would be required [up to 4,500 shipments, if one Type B cask per shipment is assumed, see Section I.2.2.5], emissions would be lower if the reactor were a PWR because there would be fewer shipments.)

I.2.2.2 Human Health Risk

I.2.2.2.1 Human Health Risk from Normal Operations

Doses to workers – Unirradiated MOX fuel could present a risk of higher radiation doses to reactor workers due to the presence of additional plutonium and other actinides compared to LEU fuel. However, worker doses would continue to meet Federal regulatory dose limits as required by NRC, and any reactor proposing to use MOX fuel would be required by NRC to take steps within its ALARA program to limit any increase in doses to workers that may occur from use of MOX fuel. The only time this difference is likely to cause an increased dose would be during acceptance inspections at the reactor, when the fuel assemblies are first delivered to the plant. Workers are required to inspect the fuel assemblies to ensure that they meet design specifications and they could receive a higher dose compared to LEU fuel assembly inspections. After the fuel rods are inspected, doses to workers would be limited because the assemblies would be handled remotely as they are loaded into the reactor and subsequently removed from the reactor and transferred into the used fuel pool.

Doses to members of the public – As addressed in Section I.1.2.2.1, no change in the radiation dose to the public is expected from normal operation of a TVA reactor operating with a partial MOX fuel core rather than a full LEU fuel core. Consistent with this assessment and Chapter 4, Section 4.28.2.4, of the *SPD EIS* (DOE 1999), no change in the radiation dose to the public is expected from normal operation of generic commercial nuclear reactors using a partial MOX fuel core rather than a full LEU core.

I.2.2.2.2 Reactor Accidents and Intentional Destructive Acts

Reactor accidents – The reactor accident analyses included in Section I.1.2.2.2 of this appendix and Chapter 4, Section 4.28.2.5, of the *SPD EIS* (DOE 1999) indicate that, in the event of a postulated reactor accident, the doses to the public would be somewhat different for different reactors. The results of these accident analyses differ for each reactor based on a number of factors, including the size of the population

surrounding the reactor, the distance from the reactor to the surrounding population, and site-specific meteorological conditions. The five sets of reactors analyzed in these documents include reactors located near large cities such as Charlotte, North Carolina, as well as reactors located in relatively less-populated areas. The reactors included both BWRs and PWRs.

Table I-11 presents a comparison of projected radiological impacts from a series of design-basis and beyond-design-basis accidents that were analyzed in this *SPD Supplemental EIS* and the *SPD EIS*. The comparison is presented as the ratio of the accident impacts involving partial MOX fuel cores to those using full LEU fuel cores. Impacts were estimated for a member of the general public at the exclusion area boundary at the time of the accident (i.e., the MEI) and the general population residing within 50 miles (80 kilometers) of the reactor. The numbers in parentheses are the calculated ratios (impacts for a partial MOX core divided by impacts for an LEU core); the range of numbers reflects the results for the five sets of reactors that were evaluated. A ratio less than 1 indicates that the MOX fuel core could result in smaller impacts than the same accident with an LEU fuel core. A value of 1 indicates that the estimated impacts are the same for both fuel core types. A ratio larger than 1 indicates that the MOX fuel core could result in larger impacts than the same accident with an LEU fuel core. Outside the parentheses, the table shows a ratio of 1 for all accident scenarios. This is a rounded value because, when modeling and analytical uncertainties are considered, the precision of the results is no more than one significant figure.

Table I-11 Ratio of Doses from Reactor Accidents for a Partial Mixed Oxide Fuel Core Compared to a Full Low-Enriched Uranium Fuel Core (partial mixed oxide fuel core dose/full low-enriched uranium fuel core dose) ^{a,b}

<i>Accident</i>	<i>MEI</i>	<i>Population</i>
Design-Basis Accidents		
Loss-of-coolant accident	1 (0.87 to 1.03)	1 (0.96 to 1.03)
Used-fuel-handling accident	1 (0.90 to 1.00)	1 (0.94 to 1.00)
Beyond-Design-Basis Accidents		
Steam generator tube rupture ^c	1 (1.06 to 1.24)	1 (1.04 to 1.09)
Early containment failure	1 (1.00 to 1.22)	1 (0.96 to 1.05)
Late containment failure	1 (1.01 to 1.10)	1 (0.95 to 1.09)
ISLOCA	1 (0.93 to 1.22)	1 (0.95 to 1.14)

ISLOCA = interfacing systems loss-of-coolant accident; MEI = maximally exposed individual.

^a Reactor accidents involving the use of partial MOX fuel cores were assumed to involve reactor cores with approximately 40 percent MOX fuel and 60 percent LEU fuel.

^b The values in parentheses reflect the range of results from analyses at 5 different reactors; they are the ratios calculated by dividing the accident analysis results for a partial MOX fuel core by the results for a full LEU core.

^c Steam generator tube rupture is not applicable for boiling water reactors since they do not use steam generators.

Source: *SPD Supplemental EIS* Tables I-6 and I-7 and Table 4-217 of the *SPD EIS* (DOE 1999).

Intentional destructive acts – As addressed in Section I.1.2.2.3, operators of generic reactors using MOX fuel would implement a layered approach to physical security at the reactor site in accordance with NRC regulations and guidance. Nuclear power plants are inherently secure, robust structures built to withstand extreme natural phenomena such as hurricanes, tornadoes, and earthquakes. Additional security measures are in place, including physical barriers; intrusion detection and surveillance systems; access controls; and coordination of threat information and response with federal, state, and local agencies. Since September 11, 2001, physical security requirements at nuclear power plants have been strengthened, and security measures at nuclear plants have been complemented by measures taken throughout the United States to improve security and reduce the risk of successful terrorist attacks. NRC and others have performed comprehensive safety and security studies showing that a radiological release affecting public health and safety is unlikely from a terrorist attack, including one involving a large commercial aircraft.

I.2.2.3 Socioeconomics

Because it is expected that operators of a generic commercial nuclear would not need to employ additional workers to operate the reactor using a partial MOX fuel core rather than a full LEU core, use of a partial MOX fuel core rather than a full LEU core is expected to have no impact on socioeconomics in the communities surrounding the commercial nuclear reactor.

I.2.2.4 Waste Management and Used Nuclear Fuel

Radioactive and Nonradioactive Waste Generation – No change is expected in the type or amount of radioactive and nonradioactive waste generated at a generic commercial nuclear reactor using a partial MOX fuel core rather than a full LEU core.

Used Nuclear Fuel – Some additional used nuclear fuel would likely be generated from use of a partial MOX core in a commercial nuclear reactor. Based on the analyses in Section I.1.2.4 and Chapter 4, Section 4.28.2.8, of the *SPD EIS* (DOE 1999), the amount of additional used nuclear fuel generated during the period when MOX fuel would be used in a reactor is estimated to increase by approximately 2 to 16 percent compared to the reactor continuing to use only LEU fuel. It is expected that increases of this magnitude would be managed within the reactor’s normal planning for storage in its used fuel storage pool or dry storage casks.

I.2.2.5 Transportation

It is estimated (see Appendix E, Section E.7) that between approximately 3,400 and 4,500 shipments of unirradiated MOX fuel could occur from SRS to a generic BWR reactor under the various alternatives assuming one Type B cask per shipment (transport of unirradiated BWR MOX fuel was analyzed to maximize the number of shipments; if the shipments were of PWR MOX fuel, the number of shipments would be lower as discussed in Section I.2.2.1). These shipments would likely replace similar shipments of unirradiated LEU fuel to the reactor sites, thereby reducing transportation risks associated with LEU fuel, while adding risks from the MOX fuel shipments. Although the risks associated with incident-free transport and accident conditions would be somewhat larger for shipment of unirradiated MOX fuel than for LEU fuel, the overall risks associated with MOX fuel shipments would be low, as shown in **Table I–12** and discussed below. Alternatively, up to seven casks containing BWR fuel assemblies could be transported in one shipment if escorted commercial trucks are used (under the Secure Transportation Asset Program), for a total of between approximately 490 to 640 shipments.

Table I–12 Transportation Impacts Associated with the Shipment of Unirradiated Mixed Oxide Fuel to a Generic Commercial Nuclear Reactor (assuming one Type B Cask per shipment)

Alternative	Number of Shipments	Incident Free Dose (person-rem)		Number of Radiological LCFs ^a		Accident Risk	
		Crew	Population	Crew	Population	Radiological LCF ^a	Traffic Fatality
Immobilization	3,400	150	280	0.09	0.2	0.000002	0.3
MOX Fuel	4,500	190	370	0.1	0.2	0.000002	0.4
H-Canyon/HB-Line	4,100	180	340	0.1	0.2	0.000002	0.4
WIPP	4,100	180	340	0.1	0.2	0.000002	0.4

LCF = latent cancer fatality; MOX = mixed oxide; WIPP = Waste Isolation Pilot Plant.

^a Estimated number of latent cancer fatalities in the affected population along the potential transportation routes given exposure to the indicated dose. The number of latent cancer fatalities is calculated by multiplying the dose by the risk factor of 0.0006 LCFs per person-rem (DOE 2003). Because the risk factor is only calculated to one significant figure, the number of latent cancer fatalities is reported to one significant figure.

For purposes of this *SPD Supplemental EIS*, a generic transportation route was analyzed from SRS to the northwestern United States that is intended to envelop all of the currently operating commercial nuclear reactors in the country. The distance analyzed was approximately 4,400 kilometers (2,730 miles). The estimated dose to the transport crew from incident-free transport of unirradiated MOX fuel to a generic commercial nuclear reactor in the northwestern United States is estimated to range from 150 person-rem (for 3,400 shipments) to 190 person-rem (for 4,500 shipments), depending on the alternative being analyzed. The corresponding number of LCFs in the crew would range from 0.09 to 0.1. If a larger number of casks are carried on each escorted commercial truck as discussed in Section I.1.2.5, the impacts to workers could increase about 2 times, with the risk of an LCF still less than 1 (about 0.2).

The estimated dose to the public from incident-free transport of this material is estimated to range from 280 person-rem to 370 person-rem assuming shipments with one Type B cask per shipment. The corresponding number of LCFs in the public would be about 0.2. If a larger number of casks are carried on each escorted commercial truck, as discussed in Section I.1.2.5, the incident-free impacts to the population could decrease about 40 percent. This reduction would be due to a decrease of up to 85 percent in the total number of shipments of unirradiated MOX fuel. Thus, no fatalities are expected from incident-free transport of unirradiated MOX fuel to a generic commercial nuclear reactor site regardless of the number of Type B casks included per shipment.

The number of LCFs expected from transportation accidents is also projected to be small. The estimated total risk in terms of the number of LCFs in the public from all projected radiological accidents involving MOX fuel shipments is projected to be about 0.000002. These total accident risks were determined taking into account a spectrum of accident severities ranging from high-probability accidents of low severity (e.g., a fender bender) to hypothetical high-severity accidents having low probabilities of occurrence. As discussed in Section I.1.2.5, the per-shipment radiological accident risk would not change because it is assumed only one Type B cask would release its contents in the event of a severe accident regardless of the number of casks in a shipment. The radiological and traffic fatality accident risks would decrease by about an order of magnitude if escorted commercial trucks are used due to the decrease in number of shipments.

The maximum reasonably foreseeable offsite truck transportation accident having the highest consequence was also determined. This accident would involve truck transport of BWR MOX fuel to a generic commercial nuclear reactor located in the northwestern United States (see Appendix E, Table E-12). These shipments would occur over about 23 years. Transportation accident probabilities were calculated for all route segments (i.e., rural, suburban, and urban), and maximum consequences were determined for those route segments having a likelihood of release frequency exceeding 1-in-10 million per year. The maximum reasonably foreseeable probability of a truck accident involving this material would be up to 3.3×10^{-6} per year in a suburban area, or approximately 1 chance in 300,000 each year. The consequences of the truck transport accident in terms of population dose would be about 4.0 person-rem. If the accident were to occur, such an exposure would not likely result in an additional LCF among the exposed population. For shipments potentially involving more than one Type B cask, the consequences would remain the same with the likelihood decreasing proportionally with the decrease in number of shipments.

I.2.2.6 Environmental Justice

As discussed in Section I.2.2.2.1, normal irradiation of MOX fuel in a nuclear reactor is not expected to pose significant health risks to the public, because there would be essentially no increase in radiation doses received by the general population from the use of MOX fuel. In addition, as addressed in Section I.2.2.2.2, for all practical purposes, the results indicate that there is no difference in the potential impacts on the public from either a design-basis or beyond-design-basis accident between the use of a partial MOX fuel core or a full LEU fuel core. It may also be noted that the probability of a beyond-design-basis accident actually happening is extremely unlikely, so that the risk to any individual living within 50 miles (80 kilometers) of the reactor would be low. In addition, as addressed in Section I.2.2.5,

no radiological or nonradiological fatalities are expected to result from incident-free transport of MOX fuel to a generic commercial nuclear reactor site, which for purposes of this *SPD Supplemental EIS* is conservatively assumed to be located within the northwestern United States. In terms of nonradiological fatalities resulting from possible traffic accidents, it is estimated that the analyzed shipments would result in no fatalities under the MOX Fuel Alternative.

Because the implementation of a MOX fuel irradiation program at a generic commercial nuclear reactor would not pose significant risks (when probability is considered) to the public, it is not expected that implementation of this program would pose significant risks to particular groups within the public. Therefore, because risks are low, there would be no disproportionately high and adverse effects on minority and low-income populations.

I.2.2.7 Other Resource Areas

This section of this appendix addresses resource areas having a lesser potential for environmental impacts than the resource areas addressed in Sections I.2.2.1 through I.2.2.6.

I.2.2.7.1 Land Resources

It is not expected that additional land would be needed at a generic commercial nuclear reactor site for operational use of a partial MOX fuel core rather than a full LEU fuel core; nor would other onsite lands such as buffer zones be affected. Operation of a generic commercial nuclear reactor using a partial MOX fuel core rather than a full LEU core would not change the designated land uses for the reactor and the areas within the vicinity of the reactor site; thus, it is not expected that prime farm land would be affected.

I.2.2.7.2 Geology and Soils

Operation of a generic commercial nuclear reactor using a partial MOX fuel core rather than a full LEU core would not require any excavation or any use of geological resources such as sand, gravel, stone, or cement.

I.2.2.7.3 Water Resources

No change is expected in water usage at a generic commercial nuclear reactor site or in the waterborne discharge of pollutants resulting from the use of a partial MOX fuel core rather than a full LEU fuel core.

I.2.2.7.4 Noise

No change is expected in the noise generated at a generic commercial nuclear reactor site from the use of a partial MOX fuel core rather than a full LEU fuel core.

I.2.2.7.5 Ecological Resources

Use of a partial MOX fuel core rather than a full LEU core at a generic commercial reactor site is not expected to result in any additional impacts on ecological resources at the reactor site because land use and emissions of effluents from the reactor are not expected to change.

I.2.2.7.6 Cultural Resources

Operation of a generic commercial nuclear reactor using a partial MOX fuel core rather than a full LEU core would not require any excavation or other activities at the reactor site that could disturb cultural resources.

I.2.2.7.7 Infrastructure

Use of a partial MOX fuel core rather than a full LEU core at a generic commercial nuclear reactor site is not expected to require additional use of utilities; thus, there would be no impact on the existing infrastructure at the reactor site.

I.3 References

DOE (U.S. Department of Energy), 1999, *Surplus Plutonium Disposition Final Environmental Impact Statement*, DOE/EIS-0283, Office of Fissile Materials Disposition, Washington, DC, November.

DOE (U.S. Department of Energy), 2003, *Estimating Radiation Risk from Total Effective Dose Equivalent (TEDE), ISCORS Technical Report No. 1*, DOE/EH-412/0015/0802, Rev. 1, Office of Environmental Policy and Guidance, Washington, DC, January.

DOT (U.S. Department of Transportation), 2008, *Radioactive Material Regulations Review*, RAMREG-12-2008, Pipeline and Hazardous Materials Safety Administration, December.

EPRI (Electric Power Research Institute), 2002, *Deterring Terrorism: Aircraft Crash Impact Analyses Demonstrate Nuclear Power Plant's Structural Strength*, December.

NRC (U.S. Nuclear Regulatory Commission), 2005, Fact Sheet – Safety and Security Improvements at Nuclear Plants, February.

NRC (U.S. Nuclear Regulatory Commission), 2008, *Backgrounder – Nuclear Security*, Office of Public Affairs, February 4.

NRC (U.S. Nuclear Regulatory Commission), 2009, *Protecting Our Nation, A Report of the U.S. Nuclear Regulatory Commission*, NUREG/BR-0314, Rev. 1, Office of Nuclear Security and Incident Response, September.

NRC (U.S. Nuclear Regulatory Commission), 2011, *Enhancing Reactor Safety in the 21st Century, The Near-Term Task Force Review of Insights from the Fukushima Dai-Ichi Accident*, July 12.

ORNL (Oak Ridge National Laboratory), 2012, *Core Average (MOX/LEU) Nuclide Ratios for Sequoyah and Browns Ferry Reactors*, ORNL/TM-2012/93, Oak Ridge, Tennessee, March 20. (Proprietary)

SAIC (Science Applications International Corporation), 2007, *Watts Bar Nuclear Plant Severe Reactor Accident Analysis*, Germantown, Maryland, May 30.

SNL (Sandia National Laboratories), 2010, *Assessment of Severe Accident Source Terms in Pressurized-Water Reactors with a 40% Mixed-Oxide and 60% Low-Enriched Uranium Core Using MELCOR 1.8.5*, SAND2008-6665, Albuquerque, New Mexico.

TVA (Tennessee Valley Authority), 2012, *Surplus Plutonium Disposition Supplemental Environmental Impact Statement Data Call Response*, Chattanooga, Tennessee.

APPENDIX J
EVALUATION OF SELECT REACTOR ACCIDENTS
WITH MIXED OXIDE FUEL USE AT THE
BROWNS FERRY AND SEQUOYAH NUCLEAR PLANTS

APPENDIX J

EVALUATION OF SELECT REACTOR ACCIDENTS WITH MIXED OXIDE FUEL USE AT THE BROWNS FERRY AND SEQUOYAH NUCLEAR PLANTS

J.1 Introduction

This appendix examines the potential differences in accident impacts if mixed oxide (MOX) fuel were used to partially fuel domestic, commercial nuclear power plants. This appendix provides an assessment of the human health effects related to postulated reactor accidents involving MOX fuel use in the Browns Ferry and Sequoyah Nuclear Plants (Browns Ferry and Sequoyah). The analyses provide a basic comparison of potential safety impacts posed by reactor operations using a partial MOX fuel core (approximately 40 percent MOX fuel and 60 percent low-enriched uranium [LEU] fuel) versus operations using a full LEU fuel core. As part of the licensing process for certifying the use of MOX fuel in any domestic commercial nuclear power facility, the U.S. Nuclear Regulatory Commission (NRC) would also conduct rigorous, independent analyses of the effects of MOX fuel use on reactor safety.

In support of this *SPD Supplemental EIS*, reactor fuel experts at Oak Ridge National Laboratory (ORNL), with input from Tennessee Valley Authority (TVA) nuclear engineers, ran state-of-the-art computer codes to model reactor fuel cores to develop inventories of radioactive materials that would be in the reactor cores at the end of a core's life (ORNL 2012), commensurate with the highest inventory of fission products. These models used actual plant parameters and fuel types for both the Sequoyah and Browns Ferry reactors. Models were run for both typical 100 percent LEU reactor cores and for reactor cores using partial MOX fuel (approximately 40 percent MOX fuel and 60 percent LEU fuel), as is currently anticipated for the potential use of MOX fuel to disposition surplus plutonium.

As these reactors are currently licensed by NRC to operate with LEU fuel, representative accidents were selected from current TVA licensing documents for comparison of the impacts if partial-MOX fuel cores were substituted for the licensed full-LEU fuel cores. It should be noted that, before MOX fuel could be used in these reactors or any commercial reactors in the United States, detailed safety analyses in support of licensing amendment requests would evaluate the probability of the occurrence and consequences of all accident possibilities while using MOX fuel. These analyses would be reviewed by NRC prior to granting licensing amendments to use MOX fuel.

For the purposes of comparison in this *SPD Supplemental EIS*, representative design-basis accidents and beyond-design-basis accidents were selected from TVA safety analyses. Impacts from the potential releases associated with these accidents were examined for both full-LEU and partial-MOX fuel cores for both the Sequoyah and Browns Ferry reactors to see whether the use of MOX fuel made a substantial difference in the projected impacts of design-basis or beyond-design-basis accidents.

J.2 Background

MOX fuel was first used in a thermal reactor in 1963, but did not come into widespread commercial use until the 1980s. From the 1960s to the 1980s, significant amounts of MOX fuel testing were performed at various reactors in the United States. Plutonium was fabricated into MOX fuel, irradiated, and tested in numerous test and commercial reactors in the 1960s and 1970s. In the Saxton Plutonium Program, nuclear fuel was irradiated in a test reactor at the Westinghouse Reactor Evaluation Center (Waltz Mill, Pennsylvania) in 1965 (ORNL 2000). MOX fuel was also tested in Quad Cities Nuclear Power Station (Cordova, Illinois) in the 1970s, and a 1998 report summarized a more recent examination of the Quad Cities Nuclear Power Station irradiations (ORNL 1998). From 1969 to 1976, MOX fuel was used in the Big Rock Point Nuclear Power Plant (Charlevoix, Michigan). Much of the U.S. work ultimately

culminated in the *Final Generic Environmental Statement on the Use of Recycle Plutonium in Mixed Oxide Fuel in Light Water Cooled Reactors (NUREG-0002)* (NRC 1976).

Beginning in the 1970s, commercial use of reactor-grade MOX fuel occurred in several European countries, as well as in Japan. Introduction of MOX fuel into the fuel cycle has had its own challenges with regards to plutonium feed, production and handling, fabrication and assembly design, and operation and performance (IAEA 2003). Nevertheless, through the years, the use of MOX fuel became a routine part of nuclear reactor operations and much operational experience with this fuel has been gathered. About 40 reactors in Europe (in Belgium, Switzerland, Germany and France) were licensed to use MOX fuel, and over 30 used it regularly. France plans to have all of its 900 megawatt-electric series of reactors running with cores that are at least one-third MOX fuel (WNA 2011). In Japan, about 10 reactors were licensed to use or were planned to use MOX fuel. These reactors generally used cores that were about one-third MOX fuel.

The overall widespread success of the use of MOX fuel in power reactors greatly reduced technical uncertainties regarding the decision to proceed with MOX fuel as a major disposition option for surplus plutonium. Activities involving the use of MOX fuel were restarted in the United States in the mid-1990s, when the feasibility of dispositioning surplus plutonium as MOX fuel was explored by the U.S. Department of Energy (DOE) and the National Academy of Sciences (NAS 1995). A number of evaluations, analyses, and tests involving a wide variety of reactors (pressurized water reactors [PWRs], boiling water reactors [BWRs], and heavy water reactors [HWRs]) were conducted to determine how MOX fuel fabricated with surplus weapons-usable plutonium performs and how it differs from MOX fuel fabricated with reactor-grade plutonium and LEU fuel. Numerous government-, vendor-, and utility-sponsored scoping studies and comprehensive assessments covering the in-core performance of weapons-usable plutonium-based MOX fuel, as well as the reactor operational and accident responses, have been performed in the United States and internationally. Descriptions of U.S. MOX fuel demonstrations and of international experience in the use of MOX fuel have been prepared by NRC and the Electric Power Research Institute (NRC 1999, EPRI 2009).

Recent evaluations included the completion of testing of weapons-usable plutonium-based MOX fuel test rods in the Advanced Test Reactor in Idaho from 1998 to 2004, with subsequent postirradiation examinations of the test rods at ORNL (ORNL 2005; ORNL 2006). That evaluation was performed primarily as a generic test for gallium impurities in the plutonium, which could be a difference between the use of weapons-derived material and the historical and worldwide experience with MOX fuel. After down-selection of a MOX fuel fabricator/utility consortia by DOE (at the time, Duke Power, Inc; Cogema; and Stone & Webster, Inc.), the irradiation of MOX fuel lead test assemblies (LTAs) was approved by NRC and took place in Duke Power's Catawba Nuclear Station Unit 1 PWR (York, South Carolina) beginning in May 2005, as discussed below. Prior to this LTA testing, the last MOX fuel assemblies irradiated in a commercial U.S. nuclear power plant were irradiated in the R.E. Ginna Nuclear Power Plant (Ontario, New York) in 1985.

As part of the DOE SPD MOX Fuel Qualification Program, four PWR LTAs using weapons-usable plutonium MOX fuel were irradiated in the Duke Energy Catawba Nuclear Station Unit 1 between 2005 and 2008. These LTAs were 17×17 fuel assemblies that were similar in design to those used at the TVA Sequoyah reactors. At the end of two cycles, these LTAs had an average assembly and peak fuel rod burnup of 41.8 and 47.3 gigawatt-days per metric ton heavy metal, respectively. Poolside nondestructive examinations were performed on the four LTAs after each cycle of irradiation. After the second cycle, five fuel rods were removed from one of the LTAs and sent to ORNL for hot cell post-irradiation examination. The purpose of this program was to compare post-irradiation examination measurements to computer code predictions and the accumulated experience with reactor-grade MOX fuel and LEU fuel at similar burnup levels (AREVA 2012).

The poolside nondestructive examinations and hot cell fuel rod post-irradiation examination measured the following MOX fuel irradiation thermal, mechanical, and chemical performance behavior and

mechanisms: (1) fuel assembly axial growth, bowing, hold-down spring relaxation, and visual appearance; (2) fuel rod external axial growth, oxidation, hydride formation, surface fretting, ridging, crud formation, and integrity; (3) fuel rod internal pressure, void volume, gas analysis, burnup distribution, fuel pellet microstructure, density, and stack height; (4) cladding microstructure; (5) guide tube oxidation; (6) spacer grid width; and (7) migration and impact of fuel pellet gallium on cladding (AREVA 2012).

Measured values were compared to predictions made using the AREVA COPERNIC2 fuel rod design computer code, as well as post-irradiation data from other MOX fuel tests. Most measured parameters were found to be bounded by or similar to the COPERNIC2 calculations and comparable to AREVA's extensive irradiation experience with MOX fuel. The measured maximum fuel assembly axial growth exceeded predicted values by less than 0.05 inches (0.13 centimeters) as compared to the fabricated assembly total axial length of 159.8 inches (406 centimeters), but remained within a range that does not impact safety. This axial growth is due to a change in dimension of the control rod guide tubes and not the MOX fuel rods in the fuel assembly. Similar behavior has been observed in the same design fuel assembly using LEU fuel and is therefore not related to the use of MOX fuel. However, because the axial growth of three of the four LTAs exceeded the criterion for reinsertion for a third cycle of irradiation, the LTAs were discharged to the used fuel pool after the second cycle. In summary, extensive poolside nondestructive examinations and hot cell post-irradiation examination of the four weapons-grade plutonium MOX LTAs showed close agreement with computer code predictions and other MOX fuel experience for most performance behavior. No issues that would affect the safe operation of the core were found, although higher than predicted axial fuel assembly growth in three LTAs prevented a third cycle of irradiation (AREVA 2012).

The principal technical challenges associated with MOX fuel use include reactivity control and maintenance of adequate shutdown margins due to reduced effectiveness of neutron absorber materials (control rods and soluble boron) in the hardened neutron spectrum (i.e., higher-energy neutrons than in an LEU fuel core) resulting from the presence of plutonium (EPRI 2009). In addition, several facility design and operational issues must be addressed for receipt, handling, and storage of fresh MOX fuel and for the management of used MOX fuel due to higher heat loads, increased neutron dose rates, and reduced effectiveness of reactivity control materials in the used fuel pool and in dry storage systems. Experience at reactors in Europe and with the use of LTAs at the Catawba Nuclear Station in the United States have shown how these technical challenges can be met, and how MOX fuel performance and reliability is comparable to those of standard LEU fuel (AREVA 2012; EPRI 2009).

Given the safety margins incorporated into light water reactor designs, most existing U.S. reactor designs could accommodate partial (30 to 40 percent) MOX fuel cores with relatively minor plant modifications and operational changes (EPRI 2009). This mix of MOX and LEU fuel has already been in use in Europe and Japan and has been analyzed by U.S. national laboratories and NRC (INEL 2009; NRC 2005).

U.S. light water reactors using MOX fuel would need to comply with NRC requirements, and would require amendment of the reactor operating license. MOX fuel would be transported in NRC-certified packages using DOE's Secure Transportation Assets or escorted commercial trucks as discussed in Appendix E.

J.2.1 Operation with Mixed Oxide Fuel

There are differences in the design and performance of MOX fuel compared to LEU fuel. The differences in nuclear reactor core physics for plutonium and uranium result in important issues for core reactivity due to (1) overall decreased effectiveness of materials that serve to reduce or suppress reactivity (control/shutdown rods, soluble boron, gadolinium, xenon) and (2) changes in fuel and moderator temperature responses that reduce shutdown margins (EPRI 2009). The reduced effectiveness of reactivity control materials for MOX fuel, notably control/shutdown rods and soluble boron, means that MOX fuel use would likely require one or more of the available options to enhance reactivity control.

For PWRs with partial-MOX fuel cores, reactivity control modifications could include increasing soluble boron concentrations, using enriched boron in coolant systems, replacing partial-length control rods with full-length rods, employing integral burnable absorbers, and/or using higher-worth control rods. It is worth noting that burnable absorber materials and applications were primarily developed for LEU fuel cores. Further development of burnable absorber technology optimized for the MOX fuel core environment could improve core design flexibility, fuel utilization, and overall commercial viability of MOX fuel use in PWRs. Another method to control the reactivity effect of MOX fuel is to locate MOX fuel assemblies away from rod control cluster assembly positions in PWR cores to preserve control rod worth (ORNL 1997). The current analysis assumed the use of 17×17 PWR fuel with 20 gadolinia (uranium and gadolinium) burnable poison rods (with 2 weight-percent gadolinium oxide) in each fuel assembly and a fuel-cycle, time-averaged concentration of natural boron of 867 parts per million.

For BWRs, the impact of MOX fuel on control rod worth is less pronounced due to relatively large water gaps between bundles, which allow for recovery of thermal neutron fluxes. Accordingly, BWR cores offer the flexibility of scattering MOX fuel assemblies throughout the core and limiting the number of MOX fuel assemblies assigned to a control blade location to one or two (IAEA 2003). Other reactivity control measures for use in BWRs with partial-MOX fuel cores include incorporation of burnable absorbers or poisons such as gadolinium to provide additional reactivity control early in the irradiation cycle to counteract the effects of fresh fuel, including power peaking. Burnable absorbers can be inserted into the fuel assembly as discrete elements/rods or incorporated into the fuel itself as integral burnable absorbers applied as coatings on fuel pellet surfaces. Integral burnable absorbers in partial-MOX fuel cores provide flexibility for controlling early cycle reactivity. General Electric highlighted its gadolinium-based integral burnable absorber technology as a promising application under active commercial development for use in its international BWR designs (EPRI 2009; ORNL 1997). The current analysis assumed the use of 10 × 10 BWR fuel with individual fuel assemblies comprised of 13 to 28 fuel rods containing 2.2 to 8 weight-percent gadolinium oxide.

The current understanding of MOX and LEU fuel is such that implementing a partial-MOX fuel core is technically reasonable and has been previously accomplished in a number of reactors around the world. It is acknowledged that MOX fuel loadings above certain levels in the reactor core would likely result in modifications to reactivity control systems, worker radiation protection, core fuel management design, technical specifications, and transient behavior. In future NRC licensing applications, licensees would be required to provide the technical bases for remaining within the plant safety envelope, which may involve fuel management, operations, technical specifications, and design modifications. There is ample evidence from the use of MOX fuel in foreign nuclear power reactors that this can be safely accomplished.

The analysis presented in this *SPD Supplemental EIS* is provided to update the analysis presented in the *SPD EIS*. Before MOX fuel can be used in any domestic, commercial nuclear power plant, NRC's approval of its use would be required. The NRC decisionmaking process is based on a set of submittals by the licensee, which would provide detailed safety analyses and include relevant design and operational plant modifications that would allow the licensee to continue to operate its plant safely with partial-MOX fuel cores.

J.2.2 Sequoyah and Browns Ferry Nuclear Plant Low-Enriched Uranium and Partial Mixed Oxide Core Inventory Development

Representative core inventories for both full-LEU and partial-MOX fuel cores were developed for the Sequoyah and Browns Ferry reactors to support the accident analysis presented in this *SPD Supplemental EIS* (ORNL 2012). Models were developed for full-LEU and partial-MOX fuel cores in the Sequoyah and Browns Ferry reactors

Sequoyah. The Sequoyah fuel and reactor parameters were used to develop the new reactor core inventories. The Sequoyah data reflect three different plutonium enrichments in the partial MOX fuel assembly, with an average enrichment of 4.35 weight-percent plutonium. The Sequoyah models for each

type of assembly contain 20 gadolium (uranium and gadolinium) rods with 3 weight-percent uranium-235 and 2 weight-percent gadolinium oxide.

To simulate a normal plant refueling cycle at Sequoyah, the MOX fuel portion of the partial-MOX fuel core was assumed to include approximately 50 percent once-burned (i.e., gone through one irradiation cycle), and 50 percent twice-burned (i.e., gone through two irradiation cycles) assemblies with an average enrichment value of approximately 4.35 percent. Approximately 37 percent of the partial-MOX fuel core would include MOX fuel. The LEU portion of the partial-MOX fuel core was assumed to include approximately 40 percent once-burned, 40 percent twice-burned, and 20 percent thrice-burned (i.e., gone through three irradiation cycles) assemblies, with an average enrichment value of 4.39 percent. The full-LEU fuel core was assumed to include approximately 42 percent once-burned, 42 percent twice-burned, and 16 percent thrice-burned assemblies, with an average enrichment value of 4.43 percent. All analyses assumed end-of-cycle inventories to produce the highest consequences. Fuel cycles were based on an 18-month refueling schedule, with about a 40-day downtime period between cycles.

For the Sequoyah MOX fuel core, assembly models for each enrichment in the core were run up to 60 gigawatt-days per metric ton heavy metal to cover expected burnup ranges. The average burnup of the MOX fuel portion of the partial-MOX fuel core was approximately 34 gigawatt-days per metric ton heavy metal. The average burnup of the LEU fuel portion of the partial-MOX fuel core was approximately 39 gigawatt-days per metric ton heavy metal. The average burnup of the full-LEU fuel core was approximately 38 gigawatt-days per metric ton heavy metal (ORNL 2012).

Browns Ferry. For the Browns Ferry case, the analysis used the ATRIUM 10 design. This assembly is heterogeneous and may come in many variations that incorporate rods with gadolium in different percentages and with different numbers of uranium and gadolinium rods in different locations.

To simulate a normal plant refueling cycle at Browns Ferry, the MOX fuel portion of the partial-MOX fuel core was assumed to include approximately 39 percent once-burned, 39 percent twice-burned, and 22 percent thrice-burned assemblies, with an average enrichment value of approximately 4.17 percent. Approximately 45 percent of the partial-MOX fuel core would include MOX fuel. The LEU portion of the partial-MOX fuel core was assumed to include approximately 48 percent once-burned, 48 percent twice-burned, and 4 percent thrice-burned assemblies, with an average enrichment value of 4.12 percent. The full-LEU fuel core was assumed to include approximately 41 percent once-burned, 41 percent twice-burned, and 18 percent thrice-burned assemblies, with an average enrichment value of 4.11 percent. All analyses assumed end-of-cycle inventories to produce the highest consequences. Fuel cycles were based on a 24-month refueling schedule, with about a 40-day downtime period between cycles.

For the Browns Ferry MOX fuel core, the assemblies have up to 5 axial regions with different average enrichments and lattices to provide a specific average enrichment for the assembly. For each BWR MOX and LEU fuel assembly, two lattices were modeled to represent the assemblies. The average burnup of the MOX fuel portion of the partial-MOX fuel core was approximately 31 gigawatt-days per metric ton heavy metal. The average burnup of the LEU fuel portion of the partial-MOX fuel core was approximately 34 gigawatt-days per metric ton heavy metal. The average burnup of the full-LEU fuel core was approximately 35 gigawatt-days per metric ton heavy metal (ORNL 2012).

Table J-1 presents the results of these core inventory calculations (ORNL 2012). For both Sequoyah and Browns Ferry, the MOX fuel would be fabricated using depleted uranium (approximately 0.25 weight-percent uranium-235). The isotopes used in the accident analysis are also listed in the table.

Table J-1 Partial Mixed Oxide and Full Low-Enriched Uranium Core Inventories for the Sequoyah and Browns Ferry Nuclear Power Plants

<i>Isotope</i> ^a	<i>Sequoyah Nuclear Plant</i>		<i>Browns Ferry Nuclear Plant</i>	
	<i>Partial-MOX Fuel Core (curies)</i>	<i>Full-LEU Fuel Core (curies)</i>	<i>Partial-MOX Fuel Core (curies)</i>	<i>Full-LEU Fuel Core (curies)</i>
Americium-241	2.79×10^4	1.35×10^4	3.48×10^4	1.95×10^4
Americium-242	1.42×10^7	8.25×10^6	1.48×10^7	9.78×10^6
Americium-242m	1.39×10^3	6.20×10^2	1.41×10^3	7.75×10^2
Americium-243	3.60×10^3	2.28×10^3	3.53×10^3	2.82×10^3
Americium-244	1.42×10^6	9.20×10^5	9.63×10^5	8.15×10^5
Americium-245	2.30×10^3	1.57×10^3	1.43×10^3	1.34×10^3
Barium-137m	1.08×10^7	1.05×10^7	1.41×10^7	1.53×10^7
Barium-139	1.61×10^8	1.66×10^8	1.91×10^8	1.97×10^8
Barium-140	1.54×10^8	1.60×10^8	1.84×10^8	1.90×10^8
Barium-141	1.44×10^8	1.50×10^8	1.72×10^8	1.77×10^8
Barium-142	1.33×10^8	1.40×10^8	1.60×10^8	1.67×10^8
Bromine-83	9.58×10^6	1.09×10^7	1.21×10^7	1.33×10^7
Bromine-84	1.57×10^7	1.84×10^7	2.03×10^7	2.26×10^7
Cerium-141	1.45×10^8	1.50×10^8	1.73×10^8	1.79×10^8
Cerium-143	1.31×10^8	1.40×10^8	1.59×10^8	1.67×10^8
Cerium-144	1.09×10^8	1.19×10^8	1.35×10^8	1.47×10^8
Curium-242	8.16×10^6	4.53×10^6	9.02×10^6	5.95×10^6
Curium-243	3.48×10^3	1.78×10^3	3.28×10^3	2.18×10^3
Curium-244	6.44×10^5	3.72×10^5	5.07×10^5	4.29×10^5
Curium-245	1.15×10^2	5.45×10^1	6.28×10^1	4.82×10^1
Curium-246	2.45×10^1	1.04×10^1	1.41×10^1	1.22×10^1
Cobalt-58	2.56×10^{-11}	1.95×10^{-11}	3.03×10^{-11}	2.56×10^{-11}
Cobalt-60	1.17×10^{-9}	1.19×10^{-9}	1.52×10^{-9}	1.71×10^{-9}
Cesium-134	1.98×10^7	1.86×10^7	1.94×10^7	2.23×10^7
Cesium-135	5.95×10^1	5.01×10^1	8.34×10^1	8.27×10^1
Cesium-136	5.43×10^6	4.60×10^6	5.27×10^6	5.34×10^6
Cesium-137	1.14×10^7	1.11×10^7	1.48×10^7	1.62×10^7
Cesium-138	1.69×10^8	1.75×10^8	2.01×10^8	2.06×10^8
Europium-154	9.18×10^5	7.39×10^5	9.32×10^5	9.05×10^5
Europium-155	4.85×10^5	4.08×10^5	5.84×10^5	5.73×10^5
Iodine-129	3.36×10^0	2.80×10^0	4.26×10^0	4.03×10^0
Iodine-130	2.00×10^6	1.79×10^6	2.18×10^6	2.24×10^6
Iodine-131	9.43×10^7	9.26×10^7	1.09×10^8	1.08×10^8
Iodine-132	1.37×10^8	1.35×10^8	1.58×10^8	1.58×10^8
Iodine-133	1.87×10^8	1.89×10^8	2.18×10^8	2.22×10^8
Iodine-134	2.07×10^8	2.11×10^8	2.43×10^8	2.49×10^8
Iodine-135	1.79×10^8	1.80×10^8	2.09×10^8	2.11×10^8
Krypton-83m	9.54×10^6	1.09×10^7	1.20×10^7	1.32×10^7
Krypton-85	1.09×10^6	1.29×10^6	1.49×10^6	1.89×10^6
Krypton-85m	1.97×10^7	2.36×10^7	2.59×10^7	2.93×10^7
Krypton-87	3.75×10^7	4.53×10^7	4.96×10^7	5.64×10^7
Krypton-88	4.91×10^7	5.99×10^7	6.54×10^7	7.48×10^7
Lanthanum-140	1.68×10^8	1.74×10^8	1.91×10^8	1.98×10^8
Lanthanum-141	1.45×10^8	1.51×10^8	1.73×10^8	1.78×10^8
Lanthanum-142	1.38×10^8	1.45×10^8	1.66×10^8	1.72×10^8
Lanthanum-143	1.30×10^8	1.39×10^8	1.58×10^8	1.66×10^8
Molybdenum-99	1.69×10^8	1.71×10^8	1.97×10^8	2.01×10^8
Niobium-95	1.41×10^8	1.53×10^8	1.73×10^8	1.84×10^8

Isotope ^a	Sequoyah Nuclear Plant		Browns Ferry Nuclear Plant	
	Partial-MOX Fuel Core (curies)	Full-LEU Fuel Core (curies)	Partial-MOX Fuel Core (curies)	Full-LEU Fuel Core (curies)
Niobium-97	1.51×10^8	1.57×10^8	1.80×10^8	1.86×10^8
Niobium-97m	2.38×10^5	2.07×10^5	2.52×10^5	2.26×10^5
Neodymium-147	5.84×10^7	5.99×10^7	6.91×10^7	7.10×10^7
Neptunium-237	2.79×10^1	3.47×10^1	3.15×10^1	4.41×10^1
Neptunium-238	3.24×10^7	3.97×10^7	2.63×10^7	3.84×10^7
Neptunium-239	1.91×10^9	1.90×10^9	1.88×10^9	1.95×10^9
Neptunium-240	1.31×10^6	1.31×10^6	9.13×10^5	9.82×10^5
Palladium-107	1.65×10^1	1.10×10^1	2.00×10^1	1.52×10^1
Promethium-147	1.66×10^7	1.74×10^7	2.43×10^7	2.59×10^7
Praseodymium-143	1.27×10^8	1.35×10^8	1.57×10^8	1.65×10^8
Praseodymium-144	1.10×10^8	1.20×10^8	1.36×10^8	1.48×10^8
Praseodymium-145	9.05×10^7	9.56×10^7	1.09×10^8	1.14×10^8
Plutonium-237	7.30×10^2	6.49×10^2	4.96×10^2	5.83×10^2
Plutonium-238	3.09×10^5	3.14×10^5	3.02×10^5	3.87×10^5
Plutonium-239	5.50×10^4	3.46×10^4	6.26×10^4	4.26×10^4
Plutonium-240	8.95×10^4	4.67×10^4	1.19×10^5	6.77×10^4
Plutonium-241	2.30×10^7	1.35×10^7	2.35×10^7	1.53×10^7
Plutonium-242	2.81×10^2	1.84×10^2	3.39×10^2	2.53×10^2
Plutonium-243	5.38×10^7	3.75×10^7	4.27×10^7	3.50×10^7
Plutonium-244	1.09×10^{-4}	6.46×10^{-5}	8.02×10^{-5}	6.87×10^{-5}
Plutonium-245	5.24×10^2	3.01×10^2	2.40×10^2	2.17×10^2
Rubidium-86	2.34×10^5	2.64×10^5	2.13×10^5	2.80×10^5
Rubidium-88	5.03×10^7	6.11×10^7	6.67×10^7	7.61×10^7
Rubidium-89	6.58×10^7	8.03×10^7	8.76×10^7	1.00×10^8
Rhodium-103m	1.62×10^8	1.47×10^8	1.78×10^8	1.66×10^8
Rhodium-105	1.16×10^8	9.77×10^7	1.20×10^8	1.06×10^8
Rhodium-106	7.85×10^7	5.94×10^7	8.41×10^7	6.88×10^7
Rhodium-107	7.35×10^7	5.92×10^7	7.42×10^7	6.28×10^7
Ruthenium-103	1.64×10^8	1.49×10^8	1.80×10^8	1.68×10^8
Ruthenium-105	1.24×10^8	1.06×10^8	1.29×10^8	1.15×10^8
Ruthenium-106	7.08×10^7	5.22×10^7	7.71×10^7	6.19×10^7
Antimony-125	1.13×10^6	9.36×10^5	1.36×10^6	1.24×10^6
Antimony-127	1.00×10^7	9.00×10^6	1.08×10^7	1.00×10^7
Antimony-129	2.95×10^7	2.72×10^7	3.23×10^7	3.05×10^7
Antimony-130	2.70×10^7	2.65×10^7	3.09×10^7	3.06×10^7
Samarium-147	1.59×10^{-4}	1.62×10^{-4}	2.75×10^{-4}	3.16×10^{-4}
Samarium-151	4.20×10^4	3.39×10^4	4.89×10^4	4.38×10^4
Strontium-89	6.80×10^7	8.36×10^7	9.04×10^7	1.04×10^8
Strontium-90	6.69×10^6	7.93×10^6	9.20×10^6	1.19×10^7
Strontium-91	8.93×10^7	1.06×10^8	1.16×10^8	1.31×10^8
Strontium-92	9.98×10^7	1.15×10^8	1.27×10^8	1.41×10^8
Technetium-99	1.42×10^3	1.40×10^3	1.92×10^3	2.11×10^3
Technetium-99m	1.49×10^8	1.52×10^8	1.75×10^8	1.78×10^8
Technetium-101	1.61×10^8	1.60×10^8	1.86×10^8	1.86×10^8
Tellurium-125m	2.48×10^5	2.02×10^5	3.01×10^5	2.74×10^5
Tellurium-127	9.77×10^6	8.77×10^6	1.06×10^7	9.82×10^6
Tellurium-127m	2.66×10^5	2.18×10^5	3.00×10^5	2.58×10^5
Tellurium-129	2.96×10^7	2.72×10^7	3.23×10^7	3.06×10^7
Tellurium-129m	1.44×10^4	1.22×10^4	1.44×10^4	1.32×10^4
Tellurium-131	8.32×10^7	8.28×10^7	9.61×10^7	9.64×10^7

Isotope ^a	Sequoyah Nuclear Plant		Browns Ferry Nuclear Plant	
	Partial-MOX Fuel Core (curies)	Full-LEU Fuel Core (curies)	Partial-MOX Fuel Core (curies)	Full-LEU Fuel Core (curies)
Tellurium-131m	1.49×10^7	1.33×10^7	1.60×10^7	1.48×10^7
Tellurium-132	1.33×10^8	1.32×10^8	1.53×10^8	1.54×10^8
Tellurium-133	1.05×10^8	1.08×10^8	1.24×10^8	1.28×10^8
Tellurium-133m	7.73×10^7	7.90×10^7	9.11×10^7	9.30×10^7
Tellurium-134	1.56×10^8	1.66×10^8	1.89×10^8	1.98×10^8
Uranium-234	7.38×10^1	1.23×10^2	1.49×10^2	2.08×10^2
Uranium-235	1.50×10^0	2.59×10^0	3.49×10^0	4.39×10^0
Uranium-236	2.07×10^1	3.09×10^1	3.15×10^1	4.73×10^1
Uranium-237	6.48×10^7	8.63×10^7	5.98×10^7	8.32×10^7
Uranium-238	2.72×10^1	2.74×10^1	4.31×10^1	4.35×10^1
Uranium-239	1.91×10^9	1.91×10^9	1.88×10^9	1.95×10^9
Xenon-131m	1.25×10^6	1.22×10^6	1.42×10^6	1.41×10^6
Xenon-133	1.80×10^8	1.82×10^8	2.11×10^8	2.14×10^8
Xenon-133m	2.48×10^6	2.41×10^6	2.83×10^6	2.81×10^6
Xenon-135	6.03×10^7	5.30×10^7	7.04×10^7	6.48×10^7
Xenon-135m	3.05×10^7	2.92×10^7	3.43×10^7	3.34×10^7
Xenon-138	1.53×10^8	1.59×10^8	1.83×10^8	1.89×10^8
Yttrium-90	6.92×10^6	8.21×10^6	9.49×10^6	1.23×10^7
Yttrium-91	9.17×10^7	1.09×10^8	1.19×10^8	1.35×10^8
Yttrium-91m	5.12×10^7	6.06×10^7	6.67×10^7	7.49×10^7
Yttrium-92	1.01×10^8	1.16×10^8	1.29×10^8	1.43×10^8
Yttrium-93	1.18×10^8	1.32×10^8	1.48×10^8	1.60×10^8
Yttrium-94	1.27×10^8	1.40×10^8	1.58×10^8	1.69×10^8
Yttrium-95	1.36×10^8	1.47×10^8	1.66×10^8	1.76×10^8
Zirconium-95	1.41×10^8	1.52×10^8	1.72×10^8	1.83×10^8
Zirconium-97	1.50×10^8	1.56×10^8	1.78×10^8	1.84×10^8

LEU = low-enriched uranium; MOX = mixed oxide.

^a This is a partial listing of the isotopes that would be in the core at the end of an operational cycle. These are the major isotopes that would contribute to the radiological impacts in the event of an accident.

Source: ORNL 2012.

J.2.3 Meteorological Data

Annual onsite meteorological data for each reactor site from 2005 through 2009 were evaluated. The meteorological data characteristics of the site are described by 1 year of hourly data (8,760 measurements). These data include windspeed, wind direction, atmospheric stability, and rainfall (TVA 2010a). The accident modeling was performed using each year of meteorological data. The years 2006 (Browns Ferry) and 2007 (Sequoyah) were selected for presentation because they result in the highest calculated population doses and therefore provide conservative results.

J.2.4 Population Data

The population distribution around each plant was determined using 2010 and prior decennial census data and projecting to the year 2020. The population was then allocated based on its current location into segments that correspond to a polar coordinate grid. The polar coordinate grid for this analysis consists of 10 radial intervals aligned with the 16 compass directions. For Browns Ferry, the total projected population out to 50 miles (80 kilometers) is about 1.1 million. For Sequoyah, the total projected population out to 50 miles (80 kilometers) is about 1.2 million. Projected population data for the year 2020 corresponding to the grid segments at Browns Ferry and Sequoyah are presented in **Tables J-2** and **J-3**, respectively.

Table J–2 Projected Year 2020 Population near the Browns Ferry Nuclear Plant

Direction	Distance (miles)									
	0–1	1–2	2–3	3–4	4–5	5–10	10–20	20–30	30–40	40–50
N	11	46	78	110	142	1,295	2,854	4,000	12,647	8,929
NNE	13	47	78	142	318	2,591	5,952	4,028	9,539	7,084
NE	12	44	66	105	226	6,050	18,358	13,638	8,354	14,249
ENE	8	28	38	53	121	3,333	23,025	41,312	33,507	11,693
E	8	23	38	53	69	1,049	22,441	135,888	104,444	8,163
ESE	8	23	38	53	69	841	2,951	10,851	35,557	13,832
SE	0	0	0	0	0	7,529	33,564	10,186	10,890	26,950
SSE	0	20	35	57	74	7,289	30,659	18,525	29,661	28,354
S	0	10	13	20	44	3,230	7,182	3,406	7,830	11,593
SSW	0	10	13	17	50	1,969	7,880	1,708	3,087	5,601
SW	0	10	13	17	30	810	6,310	2,843	5,047	13,104
WSW	0	10	13	17	22	379	3,411	3,832	18,479	5,861
W	0	10	13	17	22	285	2,547	11,091	30,797	4,239
WNW	0	12	13	17	22	407	3,954	16,886	55,795	7,453
NW	0	0	0	104	87	1,097	5,884	10,127	6,847	4,991
NNW	8	43	78	110	142	1,187	3,394	4,372	16,556	10,247
Total Population	1,087,041									

Population projected to 2020 using 2010 census data (Census 2011) and prior decennial census data for the area within 50 miles of the Browns Ferry Nuclear Plant.

Note: To convert miles to kilometers, multiply by 1.6093.

Table J–3 Projected Year 2020 Population near the Sequoyah Nuclear Plant

Direction	Distance (miles)									
	0–1	1–2	2–3	3–4	4–5	5–10	10–20	20–30	30–40	40–50
N	63	156	72	136	314	2,532	7,186	5,899	5,926	24,236
NNE	0	103	58	81	114	1,276	10,596	9,435	8,709	12,016
NE	0	187	170	216	128	1,226	3,584	7,479	9,536	15,844
ENE	0	227	278	257	293	1,477	6,055	11,689	28,986	28,664
E	0	217	305	347	160	2,103	24,414	8,965	7,901	5,248
ESE	51	163	305	222	135	2,759	53,322	6,896	3,436	17,554
SE	51	161	304	206	251	2,168	12,216	9,113	4,808	14,823
SSE	0	208	273	464	762	4,308	10,817	28,595	62,485	16,564
S	0	207	262	478	771	9,383	40,896	31,620	41,458	22,268
SSW	0	206	282	626	801	8,604	93,860	52,483	20,635	12,969
SW	0	207	564	714	654	10,272	96,974	30,756	14,748	11,089
WSW	50	310	997	1,394	1,387	15,749	41,190	5,527	14,994	8,548
W	51	457	859	1,259	2,019	5,307	4,856	7,445	6,763	7,889
WNW	57	210	350	625	1,092	2,434	4,427	5,214	4,986	5,537
NW	65	210	350	504	1,007	2,419	3,524	4,252	2,182	14,639
NNW	65	210	341	316	358	2,303	1,781	3,504	3,351	6,521
Total Population	1,211,956									

Population projected to 2020 using 2010 census data (Census 2011) and prior decennial census data for the area within 50 miles of the Sequoyah Nuclear Plant.

Note: To convert miles to kilometers, multiply by 1.6093.

J.3 Reactor Accident Identification and Quantification

As discussed above, the *Supplemental SPD EIS* reactor accident analysis includes an assessment of postulated accidents at TVA reactors at Sequoyah (a PWR) and Browns Ferry (a BWR). The analysis in this *SPD Supplemental EIS* compares the accident results for partial-MOX fuel and full-LEU fuel cores to determine whether the use of MOX fuel in these TVA reactors would make any substantive difference in the potential risks associated with the accidents analyzed.

The postulated accidents include design-basis and beyond-design-basis accidents at each reactor site using both partial-MOX and full-LEU fuel cores. The accidents presented were selected because of their potential to release substantial amounts of radioactive material to the environment. This assessment is patterned after the similar assessment presented in the *SPD EIS* (DOE 1999) and uses similar conventions and assumptions. In the *Final SPD EIS*, design-basis accidents and beyond-design-basis accidents were considered for six PWRs operated by Duke Power and Virginia Power (now Dominion Power). For the current assessment, both a PWR and a BWR were evaluated. Although design features make some of the accident scenarios differ between the PWRs and BWRs, the basic accidents are similar.

Only those accidents with the potential for substantial radiological releases to the environment were evaluated for the purposes of this *SPD Supplemental EIS*. Two design-basis accidents (a loss-of-coolant accident [LOCA] and a used-fuel-handling accident) and four beyond-design-basis accidents (an early containment failure, a late containment failure, a steam generator tube rupture [containment bypass in a PWR], and an interfacing-systems-loss-of-coolant accident [ISLOCA] [containment bypass in a BWR]) meet these criteria. Each of these accidents was analyzed twice: once assuming use of a full-LEU fuel core and once assuming use of a partial-MOX fuel core. As part of its license amendment process, NRC would likely require nuclear reactor plants applying to use MOX fuel to perform additional accident analyses involving other accident scenarios that would likely result in smaller radiological releases to the environment.

These accidents were chosen to highlight differences in the potential impacts to the public due to the use of a partial-MOX fuel core, in the unlikely event that an accident occurred. The LOCA represents a design-basis accident inside the containment that assumes the entire reactor core has failed, thereby releasing a large quantity of fission products to the reactor coolant system and a significant radiological source term to the environment. Similarly, the used-fuel-handling accident represents a design-basis accident outside the containment that releases a significant fraction of fission products within a used nuclear fuel assembly without the ameliorating design features of the containment and its systems. Both the LOCA and used-fuel-handling accident are design-basis accident scenarios that are prescribed by NRC regulations for licensing approval of a commercial nuclear power plant. They do not have any specified annual frequency of occurrence, but are instead used to demonstrate the safety design performance of a specific, sited nuclear power plant and its acceptability with respect to regulatory radiation dose standards. As both the LOCA and used-fuel-handling accident are design-basis accidents that are required by NRC regulations, they are equally applicable to both an LEU and a partial-MOX fuel core. Other NRC prescribed design-basis accidents that could be analyzed would not result in a larger source term than the two selected for this *SPD Supplemental EIS*.

The beyond-design-basis accidents were developed by plant-specific probabilistic risk assessments that postulated a wide spectrum of initiating events followed by different combinations of system and/or component failures, along with operator actions. Some of these events lead to a predicted failure of the reactor core, as in the case of the design-basis LOCA, but with higher release fractions to the environment, different timing of the release, and different plume energies and release heights. Several decades of probabilistic risk assessment experience on the part of the NRC, U.S. national laboratories, licensees, and their contractors have resulted in well-understood, dominant, beyond-design basis accident scenarios.

These are the accident scenarios that were selected for analysis in this *SPD Supplemental EIS*. Each of them results in failure of the entire core, but at different times after reactor shutdown, and different release fractions of groups of fission products, different plume energies, and different release heights. As a group, the selected beyond-design-basis accident scenarios encompass the range of this class of accidents that would be expected to result in the highest radiological consequences to the public. This group of beyond-design-basis accidents also demonstrates the impact and effectiveness of emergency response to ameliorate impacts to the population because differences in the timing of releases allow different emergency response actions such as sheltering and evacuation. As part of its license amendment process, NRC would likely require nuclear reactor plants applying to use MOX fuel to perform additional accident analyses involving other accident scenarios.

The frequencies associated with the accident scenarios evaluated in this *SPD Supplemental EIS* are not expected to be dependent on the fuel type inside the reactor. A recent analysis of severe accidents for reactors using partial-MOX fuel cores determined them to have a similar accident progression (i.e., source term, timing, plume energy) as those for a full-LEU fuel core in a number of scenarios including early and late containment failures (SNL 2010). These frequencies are event-based (e.g., frequency of an initiating event such as loss of offsite power) and depend on systems- and operational-response-related events (mitigation activities with probabilities to accomplish the required actions). For example, an early containment failure at these reactors due to a station blackout (e.g., loss of offsite and onsite [emergency diesel generator] power) as an initiating event and failure to provide emergency and long-term cooling in a timely manner, leading to core melt/containment failure, does not depend on whether the reactor uses a partial-MOX or full-LEU fuel core, but rather on the likelihood of a series of events occurring that are unrelated to the fuel type. The decay heat removal and other control systems that need to be operational in the event of such an accident are the same as those designed for operation with LEU fuel. TVA, as part of its license amendment submittal to NRC, would evaluate and may modify plant operations and core design to allow for the use of MOX fuel and remain within the envelope of accident response for the types of accidents that have been analyzed in the plant's probabilistic risk assessment (PRA), which was the basis for the selection of accidents analyzed in this *SPD Supplemental EIS*.

For this *SPD Supplemental EIS*, postulated design-basis and beyond-design-basis accidents were analyzed using the MACCS2 computer code¹ for each of the proposed reactor sites. Doses (consequences) and risks to the offsite maximally exposed individual (MEI) and the general public within 50 miles (80 kilometers) of each plant, using the population distributions shown in Section J.2.4 for each accident scenario, were calculated for each type of core. Impacts at the time of the accident would be from direct radiation exposure and inhalation of the passing plume. The longer-term effects from radionuclides deposited on the ground and surface waters after the accident were modeled for reactor accidents. Exposure pathways include resuspension and inhalation of plutonium and ingestion of contaminated crops. The MACCS2 code calculates the dose over a number of years, incorporating a number of factors including radioactive decay. In the case of this *SPD Supplemental EIS*, the reactor accident doses were calculated over an 80-year period to represent a typical lifetime. These results were then compared for the partial-MOX and full-LEU fuel cores, by plant, for each postulated accident.

The MEI dose was calculated at the exclusion area boundary of each plant. The exclusion area boundary is that surrounding the reactor within which the reactor licensee has the authority to determine all activities, including exclusion or removal of personnel and property from the area. This area may be traversed by a highway, railroad, or waterway, provided any one of these is not so close to the facility that it interferes with normal operation of the facility, and appropriate and effective arrangements are made to

¹ MACCS2, version 1.13.1, was used in the analysis. This version of the code is contained in the DOE Office of Health, Safety, and Security safety software "toolbox" of codes. All such codes are compliant with the DOE Safety Software Quality Assurance requirements of DOE O 414.1D and its safety software guidance, DOE G 414.1-4 (http://www.hss.doe.gov/nuclearsafety/qa/sqa/central_registry.htm). MACCS2 is also used by the NRC to calculate impacts from postulated severe accidents in nuclear power plant reactors and support decisionmaking (<http://www.nrc.gov/about-nrc/regulatory/research/comp-codes.html>).

control traffic and protect public health and safety on the highway, railroad, or waterway in an emergency. There are generally no residences within an exclusion area. However, if there were residents, they would be subject to ready removal in case of necessity. Activities unrelated to operation of the reactor may be permitted in an exclusion area under appropriate limitations, provided no significant hazards to the public health and safety would result.

Sources of information. Both design-basis accidents and beyond-design-basis accidents were identified from plant safety analysis documents developed by TVA. Design-basis accidents were selected by reviewing the Updated Final Safety Analysis Report (UFSAR) for each plant (TVA 2007, 2010b). Beyond-design-basis accidents were identified from the submittals in response to NRC's requirements for reactor licensees to perform Individual Plant Examinations (IPEs) for severe accident vulnerabilities, as well as subsequent updates and revisions developed for license renewal (TVA 2002a, 2002b, 2003). Source terms for each accident in terms of the fraction of the reactor core inventory that might be released as a function of time for the full-LEU fuel cores were identified from these documents. These specific, time-dependent release fractions were then applied to the reactor core inventories developed by ORNL for both the full-LEU and partial-MOX fuel cores for Sequoyah and Browns Ferry.

For Sequoyah, a recent Level 3 PRA that developed accident source terms and consequences was not available. However, such an analysis was available for the Watts Bar Nuclear Plant (SAIC 2007), a sister plant to Sequoyah. Sequoyah and the Watts Bar Nuclear Plant are similar plants, both with two Westinghouse PWRs with ice condenser containments. Because of these similarities, the release paths and mitigating mechanisms for the two plants were assumed to be identical.

Key modeling assumptions. It is well known that accident progression and modeling assumptions can make a substantial difference regarding the estimated impacts of an accident. For this reason, the impacts evaluated in this *SPD Supplemental EIS* use the standard accident progression assumptions included in TVA licensing activities and in the standard, NRC-sponsored MACCS2 computer code for evaluation of reactor accident impacts. The accident evaluations presented in this *SPD Supplemental EIS* are used for comparison of the relative impacts of accident scenarios. The real-world impacts associated with any of these accidents, should they occur, would likely be less than those predicted in these accident analyses. This is because conservative values were chosen for a number of the analysis parameters. For example, perpetual rain (resulting in wet deposition) was assumed in the region between 40 and 50 miles (64 and 80 kilometers) from a release point, maximizing the exposure of the population in this region; release plumes were assumed to be neutrally buoyant, resulting in higher concentrations to receptors close to the release point; and all beyond-design-basis accidents were assumed to result in ground-level release. The combined, multiplicative effect of these conservative assumptions is that the impacts shown in this *SPD Supplemental EIS* are likely overestimated.

Assumptions that can substantially influence calculations of close-in doses include how the release occurs and whether there is sufficient energy for plume rise so that close-in locations do not receive high doses. For the analyses in this *SPD Supplemental EIS*, assumptions for beyond-design-basis accidents, such as early containment failure (defined in Section J.3.2), were made that maximize the estimated close-in doses, such as those assessed at the exclusion area boundary, should a member of the public be located there at the time of the accident. More realistically, a plume would likely pass over the exclusion area boundary and, at the point the plume reached the ground, it would be more diluted and doses to individuals in the affected population would be comparatively lower than the dose to an individual at the exclusion area boundary.

For some accidents, such as late containment failure (defined in Section J.3.2), it was assumed that most radioactive material would be released a number of hours after the initial accident. This would allow time for many emergency actions to occur, including evacuation of most of the nearby population. The dose that these members of the population might receive while still located near the reactor, or during evacuation, is highly dependent on the timing of the accident sequence and the timing of evacuation. The analysis for this *SPD Supplemental EIS* used standard, site-specific assumptions used by TVA in NRC

licensing activities and local emergency planning preparations. As discussed in Section J.3.2, it was assumed that 95 percent of the affected population within the emergency planning zone would begin to be evacuated shortly after a warning was issued by emergency response officials; however, the timing of accident sequences and evacuation and certain other assumptions differed between the reactor sites. These assumptions differed because of differences in the types of reactors (PWR and BWR) operating at the two sites, as well as the assumptions TVA made to account for differences in local geography, roads, and population distributions.

For reactor accidents, the surrounding population could receive an initial radiation dose from direct radiation exposure and inhalation of the initial plume, and over the longer term, from direct radiation exposure, inhalation of resuspended material, and ingestion of contaminated foods. The MACCS2 computer code estimates not only the acute impacts from the initial cloud passage, but also the longer term, chronic impacts from direct radiation exposure, inhalation, and ingestion of contaminated food. In reality, because contamination in food is easily and relatively inexpensively monitored, most of the contaminated food is unlikely to be consumed. Nevertheless, the doses reported in this *SPD Supplemental EIS* for reactor accidents include those due to the chronic effects associated with the long-term ingestion of contaminated food.

J.3.1 Design-Basis Accidents

Design-basis accidents are identified by NRC, and their impacts are evaluated as a part of the NRC regulatory process to demonstrate that the safety features of the plant provide adequate protection of the public. They are defined by NRC as postulated accidents that a nuclear facility must be designed and built to withstand without loss of the systems, structures, and components necessary to ensure public health and safety. These are the most serious events that reactor plants must be designed against and represent limiting design cases.

The accident analyses presented in the Browns Ferry and Sequoyah UFSARs are conservative design-basis analyses and, therefore, the dose consequences are considered bounding (i.e., a more realistic analysis would result in lower doses and, thus, lower consequences). The results, however, provide a comparison of the potential consequences resulting from design-basis accidents. The consequences also provide insight into which design-basis accidents should be analyzed in this *SPD Supplemental EIS*.

After a review of the UFSAR accident analyses, the LOCA and used-fuel-handling accident were selected as design-basis accidents to be evaluated in this *SPD Supplemental EIS*. When compared to other design-basis accidents, such as a rod ejection or a main steam line break, the LOCA and used-fuel-handling accident constitute scenarios that result in source terms that are larger in magnitude and encompass the broadest spectrum of radionuclides and, therefore, are the best design-basis accidents by which to compare the consequences of a partial-MOX fuel core with a full-LEU fuel core.

The LOCA includes damage to 100 percent of the core and releases involving both the fuel gap and the balance of the fuel while coupling releases to actuation of engineered safety systems and the containment. Another design-basis accident, a rod ejection accident, does not result in failure of 100 percent of the core, but rather a smaller fraction of the fuel that is located around the control rod that was ejected. As both of these design-basis accidents involve fuel failure inside containment and the LOCA results in higher source terms and doses to the public, the LOCA was chosen as the representative design-basis accident inside containment. Furthermore, the licensee can institute plant core and control rod design modifications that ameliorate the fuel damage resulting from a rod ejection accident, whereas the LOCA source term is prescribed by regulation. The main steam line break accident source term is related to the allowable coolant activity levels and not fuel design.

Similarly, other design-basis accidents are postulated outside containment in addition to the used-fuel-handling accident (e.g., waste gas tank failure, dropped used fuel cask), but the used-fuel-handling accident was judged to be the best representative of outside-containment, design-basis accidents for the purpose of comparing the consequences of such an accident involving a partial-MOX fuel core with one

involving a full-LEU fuel core because it involves a source term directly related to the fuel design. So the differences between a used-fuel-handling accident involving MOX fuel and one involving LEU fuel can be easily compared, and this accident typically results in larger offsite doses than the other outside-containment, design-basis accidents.

The design-basis accidents evaluated in this *SPD Supplemental EIS* are associated with large source terms. Many design-basis and higher-frequency accident scenarios result in no radiological releases or releases that have no relation to the core fission product inventory and are not expected to result in significant differences in consequences due to the presence of MOX fuel. It is likely that future accident analyses that have yet to be developed would be incorporated into license amendment applications to NRC that are developed by licensees that may desire to use partial-MOX fuel cores in their reactors.

Design-basis LOCA. A design-basis large-break LOCA was chosen for evaluation because it is the limiting reactor design-basis accident at both of the TVA plants evaluated in this *SPD Supplemental EIS*. The large-break LOCA is defined as a break equivalent in size to a double-ended rupture of the largest pipe of the reactor coolant system. Following a postulated double-ended rupture of a reactor coolant pipe, the emergency core cooling system would operate as designed, keeping cladding temperatures well below melting and ensuring that the core remains intact and in a coolable geometry. As a result of the increase in cladding temperature and rapid depressurization of the core, however, some cladding failure may occur in the hottest regions of the core. Thus, a fraction of the fission products accumulated in the pellet-cladding gap may be released to the reactor coolant system and thereby to the containment. Although no core melting would occur for the design-basis LOCA, a gaseous release of fission products is evaluated.

The LOCA source terms, including the specific isotope releases in curies as a function of time after the initiation of the accident, were supplied by TVA from current safety documents for Browns Ferry and Sequoyah (TVA 2010a). These estimated releases were used to calculate the plant- and accident-specific fractions of the core released. These fractions were then applied to the current partial-MOX and full-LEU fuel core inventories developed for Browns Ferry and Sequoyah by ORNL (see Table J-1) to determine the specific releases by isotope and time.

The LOCA radiological consequence analysis for the full-LEU and partial-MOX fuel cores was performed assuming a stack release based on TVA-supplied, plant-specific radioisotope release data. The possible leak paths through containment and bypass were included.

Used-fuel-handling accident. In the postulated used-fuel-handling accident scenario, a used fuel assembly is dropped. The drop would result in a breach of the fuel rod cladding, and a portion of the volatile fission gases from the damaged fuel rods would be released. A used-fuel-handling accident would realistically result in damage to only a fraction of the fuel rods. However, consistent with NRC methodology, all the fuel rods in the dropped fuel assembly were assumed to be damaged.

The accident was assumed to occur at the earliest time that fuel-handling operations may begin after shutdown, as identified in each plant's technical specifications to maximize the potential consequences of such an accident. The accident was assumed to start 72 hours after shutdown at Browns Ferry and 100 hours at Sequoyah, based on previous submittals by TVA to NRC.

Consistent with NRC guidance, the assumption in the TVA safety analyses is that an assembly with extremely high burnup (e.g., for Browns Ferry, 50 percent higher than the average core assembly) is damaged while being removed from the reactor. The values for individual fission product inventories in the damaged assembly were calculated assuming full-power operation at the end of core life immediately preceding shutdown. All of the gap activity in the damaged rods was assumed to be released. Releases would be through the top of the containment building to the environment, but the water in the refueling pool would greatly reduce the iodine available for release to the environment. It was assumed that all of the iodine escaping from the refueling pool is released to the environment over a 2-hour time period

through the fuel-handling building ventilation system. The Browns Ferry and Sequoyah UFSARs assumed iodine filter efficiencies of 95 percent for both the inorganic and organic species.

The used-fuel-handling accident source terms, including the specific isotope releases in curies as a function of time after the initiation of the accident, were supplied by TVA from current safety documents for Browns Ferry and Sequoyah (TVA 2010a). These estimated releases were used to calculate plant- and accident-specific fractions of the core released as a function of time. These fractions were then applied to the partial-MOX and full-LEU fuel core inventories developed by ORNL for Browns Ferry and Sequoyah to determine the specific release by isotope and time (see Table J–1).

J.3.1.1 Browns Ferry Design-Basis Accident Analysis

Table J–4 presents the results of this analysis for design-basis accidents at Browns Ferry. Results are presented for a hypothetical individual at the exclusion area boundary for the entire period of release from the accident, as well as for persons in the surrounding population. For both accidents, the doses would be small relative to the NRC requirement that an individual located at any point of the boundary of the exclusion area (referred to as the MEI hereafter) for any 2-hour period following the onset of the postulated accident would not receive a total effective dose equivalent in excess of 25 rem (10 CFR 50.34). For the LOCA at Browns Ferry, the dose to the MEI would be 0.026 rem for a full-LEU fuel core and 0.023 rem for a partial-MOX fuel core. In either case, the dose would be small compared to the NRC limit of 25 rem. For the used-fuel-handling accident at Browns Ferry, the dose to the MEI would be approximately 0.00014 rem for either a partial MOX fuel assembly or an LEU fuel assembly. In either case, the used-fuel-handling accident dose would be negligible compared to the NRC limit of 25 rem.

Table J–4 Browns Ferry Nuclear Plant Design-Basis Accident Impacts

Accident	Full-LEU or Partial- MOX Fuel Core	Impacts on the MEI at the Exclusion Area Boundary		Impacts on the Population within 50 Miles	
		Dose (rem) ^a	NRC Regulatory Limit (rem) ^b	Dose (person-rem) ^a	Average Individual Dose (rem) ^c
Loss-of-coolant accident ^d	LEU	0.026	25	150	1.4×10^{-4}
	MOX	0.023	25	150	1.4×10^{-4}
Used-fuel-handling accident ^e	LEU	0.00014	25	0.086	7.9×10^{-8}
	MOX	0.00014	25	0.086	7.9×10^{-8}

LEU = low-enriched uranium; MEI = maximally exposed individual; MOX = mixed oxide; NRC = U.S. Nuclear Regulatory Commission.

^a The reactor accident doses were calculated over an 80-year period using the MACCS2 computer code. Eighty years represents a typical person’s lifetime.

^b From 10 CFR 50.34 for design-basis accidents.

^c Average individual dose to the entire offsite projected population in 2020 (approximately 1,100,000) out to a distance of 50 miles for the indicated accident.

^d Release would be through a 604-foot stack.

^e Release was assumed to be through the top of the containment building at 173 feet.

Note: To convert feet to meters, multiply by 0.3048; miles to kilometers by 1.6093.

The results also indicate that the impacts on the surrounding population for a design-basis accident with a partial-MOX fuel core or a full-LEU fuel core would be similar and within the overall analysis uncertainty. The dose to the population from the LOCA at Browns Ferry would be approximately 150 person-rem for either a partial-MOX fuel core or a full-LEU fuel core. The average dose to an individual residing within 50 miles (80 kilometers) of Browns Ferry at the time of the accident, in the unlikely event that it occurred, would be 1.4×10^{-4} rem, regardless of the fuel type in the reactor at the time of the accident. The dose to the population from the used-fuel-handling accident at Browns Ferry would be 0.086 person-rem for either a full-LEU or a partial-MOX fuel core. The average dose to an individual from this accident, in the unlikely event that it occurred, would be 7.9×10^{-8} rem, regardless of the fuel type in the dropped fuel assembly at the time of the accident. Therefore, potential risks presented

by the two types of cores are projected to be comparable for the MEI or general population surrounding the plant from these design-basis accidents.

J.3.1.2 Sequoyah Design-Basis Accident Analysis

Table J–5 presents the results of the analysis for design-basis accidents at Sequoyah. Results are presented for a hypothetical individual at the exclusion area boundary for the entire period of release from the accident, as well as for persons in the surrounding population. For a LOCA at Sequoyah, the dose to the MEI would be 0.0023 rem for a full-LEU fuel core and 0.0020 rem for a partial-MOX fuel core. In either case, the dose would be small compared to the NRC limit of 25 rem. For the used-fuel-handling accident at Sequoyah, the dose to the MEI would be approximately 0.000036 rem for either a partial MOX fuel assembly or an LEU fuel assembly. In either case, the used-fuel-handling accident dose would be negligible compared to the NRC limit of 25 rem.

Table J–5 Sequoyah Nuclear Plant Design-Basis Accident Impacts

Accident	Full-LEU or Partial-MOX Fuel Core	Impacts on the MEI at the Exclusion Area Boundary		Impacts on the Population within 50 Miles	
		Dose (rem) ^a	NRC Regulatory Limit (rem) ^b	Dose (person-rem) ^a	Average Individual Dose (rem) ^c
Loss-of-coolant accident ^d	LEU	0.0023	25	0.75	6.2×10^{-7}
	MOX	0.0020	25	0.72	5.9×10^{-7}
Used-fuel-handling accident	LEU	0.000036	25	0.018	1.5×10^{-8}
	MOX	0.000036	25	0.018	1.5×10^{-8}

LEU = low enriched uranium; MEI = maximally exposed individual; MOX = mixed oxide; NRC = U.S. Nuclear Regulatory Commission.

^a The reactor accident doses were calculated over an 80-year period using the MACCS2 computer code. Eighty years represents a typical person's lifetime.

^b From 10 CFR 50.34 for design basis accidents.

^c Average individual dose to the entire offsite projected population in 2020 (approximately 1,200,000) out to a distance of 50 miles for the indicated accident.

^d Release was assumed to be through the top of the containment building at 171 feet.

Note: To convert feet to meters, multiply by 0.3048; miles to kilometers by 1.6093.

The results also indicate that the impacts on the surrounding population for a design-basis accident with a partial-MOX fuel core or a full-LEU fuel core would be both similar and within the overall analysis uncertainty. The dose to the population from a LOCA at Sequoyah would be approximately 0.75 person-rem for a full-LEU fuel core and 0.72 person-rem for a partial-MOX fuel core. The average dose to an individual residing within 50 miles (80 kilometers) of Sequoyah at the time of the accident, in the unlikely event that it occurred, would be approximately 6.0×10^{-7} rem, regardless of the fuel type in the reactor at the time of the accident. The dose to the population from the used-fuel-handling accident at Sequoyah would be approximately 0.018 person-rem for either a partial MOX fuel assembly or an LEU fuel assembly. The average dose to an individual from this accident, in the unlikely event that it occurred, would be 1.5×10^{-8} rem, regardless of the fuel type in the dropped fuel assembly at the time of the accident. Therefore, potential risks presented by the two types of cores are projected to be comparable for the MEI or the general population surrounding the plant from these design-basis accidents.

J.3.2 Beyond-Design-Basis Accidents

Beyond-design-basis accidents (severe reactor accidents) are less likely to occur than design-basis accidents. In design-basis accidents, mitigating systems are assumed to be available. In beyond-design-basis accidents, even though the initiating event could be a design-basis event (e.g., a large-break LOCA), additional failures of mitigating systems such as the emergency core cooling system cause some degree of physical deterioration of the fuel in the reactor core and a possible breach of the containment structure, leading to the direct release of radioactive materials to the environment.

The beyond-design-basis accident evaluation in the *SPD EIS* included a review of each plant's IPE. In 1988, NRC required all licensees of operating plants to perform IPEs for severe accident vulnerabilities (NRC 1988) and indicated that a PRA would be an acceptable approach to performing the IPE. A PRA evaluates, in full detail (quantitatively), the consequences of all potential events caused by operating disturbances (known as internal initiating events) within the plant. A state-of-the-art PRA uses realistic criteria and assumptions in evaluating the accident progression and the systems required to mitigate each accident.

Beyond-design-basis accidents evaluated in this *SPD Supplemental EIS* include only those scenarios that lead to containment bypass or failure because the public and environmental consequences would be significantly less for accident scenarios that do not lead to containment bypass or failure. Accidents that lead to containment bypass or failure are expected to result in the greatest release of core fission products, which could result in different consequences for the same accident, depending on whether the reactor has a full-LEU or a partial-MOX fuel core. The accidents evaluated consist of an early containment failure, a late containment failure, a steam generator tube rupture (for a PWR), and an ISLOCA (for a BWR).

Early containment failure. This accident is defined as the failure of containment prior to or very soon (within a few hours) after breach of the reactor vessel. A variety of mechanisms, such as direct contact of core debris with the containment, rapid pressure and temperature loads, hydrogen combustion, and fuel-coolant interactions, can cause structural failure of the containment. Early containment failure can be important because it tends to result in shorter warning times for initiating public protective measures, and because radionuclide releases would generally be more severe than if the containment fails later.

Late containment failure. A late containment failure involves structural failure of the containment more than a day after accident initiation and typically a day or more after breach of the reactor vessel. A variety of mechanisms, such as gradual pressure and temperature increase, hydrogen combustion, and basemat melt-through by core debris, can cause late containment failure.

Steam generator tube rupture. A beyond-design-basis steam generator tube rupture induced by high temperatures also represents a containment bypass event. Analyses have indicated a potential for very high gas temperatures in the reactor coolant system during accidents involving core damage when the primary system is at high pressure. The high temperature could cause the steam generator tubes to fail in a PWR (BWRs do not use steam generators). As a result of a severe tube rupture, the secondary side could be exposed to full reactor coolant system pressures (approximately 2,250 pounds per square inch). These pressures would cause relief valves to lift on the secondary side as they are designed to do, resulting in pressure being transferred to the containment structure. If these valves fail to close after venting and the pressure in the containment caused it to be breached, an open pathway from the reactor vessel to the environment could result.

ISLOCA. An ISLOCA refers to a class of accidents in which the reactor coolant system pressure boundary interfacing with a supporting system of lower design pressure is breached. If this occurred, the lower pressure system would be over-pressurized and could rupture outside the containment. This failure would establish a flow path directly to the environment or, sometimes, to another building with a lesser ability to handle increased pressure compared to the containment. An ISLOCA could occur at either a PWR or BWR and has been included in this *SPD Supplemental EIS* as a representative over-pressurization accident for a BWR.

As discussed in Section J.2.2, ORNL developed an end-of-core-life inventory for both full-LEU and partial-MOX fuel cores for Browns Ferry and Sequoyah (see Table J-1). For the source term and offsite consequence analysis of beyond-design-basis accidents, the radioactive species are collected into classes of isotopes that exhibit similar chemical behavior. The following groups represent the isotopes considered to be most important to offsite consequences in the event of a beyond-design-basis accident: noble gases (including krypton and xenon); iodine (including bromine); cesium (including rubidium); tellurium (including selenium and antimony); strontium; ruthenium (including rhodium, palladium,

molybdenum, and technetium); lanthanum (including zirconium, neodymium, europium, niobium, promethium, praseodymium, samarium, and yttrium), cerium (including plutonium and neptunium); and barium.

The source term for each accident, taken from data provided for each plant (e.g., PRAs and TVA-provided data), is described by the release height, timing, duration, fraction of each isotope group released, and general emergency declaration (alarm) time (time when preparation for evacuation of persons living closest to the affected reactor is initiated, as discussed below). The PRAs included several release categories for each bypass and failure scenario. These release categories were screened for each accident scenario to determine which release category resulted in the highest risk; those accidents were included in this evaluation. The risk was determined by multiplying the consequences by the frequency for each release category. The highest risk release category source terms for each of the Browns Ferry and Sequoyah beyond-design-basis accidents are presented in **Table J-6**.

Table J-6 Beyond-Design-Basis Accident Source Term Release Fractions

Release Groups ^a	Release Fractions								
	Kr, Xe	I, Br	Cs, Rb	Te, Sb, Se	Sr	Ru, Rh, Pd, Mo, Tc	La, Zr, Nd, Eu, Nb, Pm, Pr, Sm, Y	Ce, Pu, Np	Ba
Accident: SGTR Release Fractions									
BFN ^b	Not applicable – boiling water reactors do not have steam generators								
SQN ^c	0.91	0.21	0.19	0.0004	0.0023	0.07	0.00028	0.00055	0.0025
Accident: Early Containment Failure Release Fractions									
BFN ^b	1	0.2482	0.2631	0.1711	0.0036	0.01422	0.000324	0.00130	N/A
SQN ^c	0.9	0.042	0.043	0.044	0.0027	0.0065	0.00048	0.004	0.0046
Accident: Late Containment Failure Release Fractions									
BFN ^b	0.95	0.00087	0.0012	0.0053	0.00016	0.000019	0.000015	0.000062	N/A
SQN ^c	0.94	0.0071	0.011	0.0052	0.00036	0.00051	4.2×10^{-6}	4×10^{-6}	0.0013
Accident: Interfacing Systems LOCA Release Fractions									
BFN ^b	0.73	0.0005	0.00059	0.00038	1.3×10^{-6}	4.9×10^{-7}	1.4×10^{-7}	5.8×10^{-7}	N/A
SQN ^c	Not evaluated as a significant risk contributor in the cited reference for SQN								

Ba = barium; BFN = Browns Ferry Nuclear Plant; Br = bromine; Ce = cerium, Cs = cesium, Eu = europium; I = iodine; Kr = krypton; La = lanthanum; LOCA = loss-of-coolant accident; Mo = molybdenum; N/A = not applicable; Nb = niobium; Nd = neodymium; Np = neptunium; Pd = palladium; Pm = promethium; Pr = praseodymium; Pu = plutonium; Rb = rubidium; Rh = rhodium; Ru = ruthenium; Sb = antimony; Se = selenium; SGTR = steam generator tube rupture accident; Sm = samarium; SQN = Sequoyah Nuclear Plant; Sr = strontium; Tc = technetium; Te = terbium; Xe = xenon; Y = yttrium; Zr = zirconium.

^a Groups of radionuclides with common release fractions.

^b Browns Ferry release fractions are from TVA 2003, Table II-4, Attachment E-4, page E-410.

^c Sequoyah release fractions are based on the *Watts Bar Nuclear Plant Severe Accident Analysis* (SAIC 2007).

Evacuation information. Each beyond-design-basis accident scenario has a warning time and a subsequent release time. The warning time is the time at which notification is given to offsite emergency response officials to initiate protective measures for the surrounding population. The release time is the time when the release to the environment begins. The minimum time between the warning time and the release time is one-half hour. The minimum time of one-half hour is enough time to evacuate onsite personnel that are not needed to provide emergency support (i.e., noninvolved workers). This also conservatively assumes that an onsite emergency has not been declared prior to initiating an offsite notification. Intact containment severe accident scenarios, which were not analyzed because of their insignificant offsite consequences, take place over an even longer time frame.

This beyond-design-basis accident analysis assumed that 95 percent of the population within the emergency planning zone (10 miles [16 kilometers] for Sequoyah; 20 miles [32 kilometers] for Browns Ferry) participated in an initial evacuation. It was also assumed that the 5 percent of the population that did not participate in the initial evacuation was relocated within 12 to 24 hours after plume passage, based on the measured concentrations of radioactivity in the surrounding area and the comparison of projected doses with EPA guidelines. Longer-term countermeasures (e.g., crop or land interdiction) were based on EPA Protective Action Guides built into the MACCS2 model (NRC 1998).

J.3.3 Beyond-Design-Basis Accident Analysis

Only beyond-design-basis accident scenarios that lead to containment bypass or failure were evaluated because they are the accidents with the greatest potential consequences. The public health and environmental consequences would be significantly less for accident scenarios that do not lead to containment bypass or failure. Early containment failure, late containment failure, a steam generator tube rupture, and an ISLOCA were chosen as the representative set of beyond-design-basis accidents. As with the design-basis accident, the purpose of the analysis was to compare the potential impacts of using a partial-MOX fuel to those of using a full-LEU fuel core. Differences between the projected impacts for the Browns Ferry and Sequoyah beyond-design-basis accidents are primarily due to accident assumptions and siting, not inherent differences in reactor types.

J.3.3.1 Browns Ferry Beyond-Design-Basis Accident Analysis

Table J–7 shows the potential doses and average individual risks associated with the evaluated beyond-design-basis accidents at Browns Ferry. As shown in this table, of the beyond-design-basis accidents evaluated, the one that presents the highest risk to the MEI and the surrounding population is an early containment failure with an estimated frequency of approximately 1 chance in 9 million of the accident occurring per year of operations. The risks under either accident scenario would be similar regardless of whether the plant was using a full-LEU or partial-MOX fuel core.

For the MEI, the risk of a cancer fatality from an early containment failure would be approximately 1 chance in 10 million per year of operations for either a full-LEU or partial-MOX fuel core. For the average individual residing within 50 miles (80 kilometers) of Browns Ferry, the risk of a cancer fatality from an early containment failure would be approximately 1 chance in 3.3 billion per year of operations for either a full-LEU or partial-MOX fuel core. By comparison, the risk to an individual of developing a fatal cancer from normal background radiation would be approximately 1 chance in 5,200 per year (based on an average annual natural background radiation dose of 318 millirem [see Chapter 3, Section 3.3.1.2]). The risk of a single latent fatal cancer from exposure to natural background radiation is estimated using the same factor used in the *SPD Supplemental EIS* for the evaluation of human health risk, i.e., 0.0006 latent cancer fatalities per rem.

The results of all of the beyond-design-basis accidents analyzed in this *SPD Supplemental EIS* indicate that, regardless of whether a partial-MOX fuel core or a full-LEU fuel core were used in Browns Ferry, the risk to individuals in the surrounding population would be similar and within the overall analysis uncertainty. Potential risks presented by the two types of cores are projected to be comparable for the MEI or the general population from these beyond-design-basis accidents.

Table J-7 Browns Ferry Nuclear Plant Beyond-Design-Basis Accident Impacts

Accident	Frequency (per year)	LEU or MOX Core	Impacts on the MEI at the Exclusion Area Boundary			Impacts on the Population within 50 Miles		
			Dose (rem) ^a	Dose Risk (rem/year) ^b	Annual Risk of Fatal Cancer ^c	Dose (person-rem) ^a	Average Individual Dose Risk (rem/year) ^d	Risk of Fatal Cancer to Average individual ^e
Early containment failure	1.1×10^{-7}	LEU	11,000	1.2×10^{-3}	1×10^{-7}	5.6×10^6	5.7×10^{-7}	3×10^{-10}
		MOX	11,000	1.2×10^{-3}	1×10^{-7}	5.4×10^6	5.5×10^{-7}	3×10^{-10}
Late containment failure	3.0×10^{-7}	LEU	190	5.7×10^{-5}	7×10^{-8}	420,000	1.2×10^{-7}	7×10^{-11}
		MOX	200	6.0×10^{-5}	7×10^{-8}	400,000	1.1×10^{-7}	7×10^{-11}
ISLOCA	4.6×10^{-8}	LEU	41	1.9×10^{-6}	2×10^{-9}	220,000	9.3×10^{-9}	6×10^{-12}
		MOX	38	1.7×10^{-6}	2×10^{-9}	210,000	8.9×10^{-9}	5×10^{-12}

ISLOCA = interfacing systems loss-of-coolant accident; LEU = low-enriched uranium; MEI = maximally exposed individual; MOX = mixed oxide.

^a The reactor accident doses were calculated over an 80-year period using the MACCS2 computer code. Eighty years represents a typical person's lifetime.

^b Annual dose risk to a hypothetical MEI at the exclusion area boundary (4,806 feet) accounting for the probability of the accident occurring.

^c Annual risk of a fatality or fatal latent cancer to a hypothetical MEI at the exclusion area boundary (4,806 feet) accounting for the probability of the accident occurring.

^d Average individual dose risk per year for the entire offsite projected population in 2020 (approximately 1,100,000) out to a distance of 50 miles, given exposure to the indicated dose and accounting for the probability of the accident occurring.

^e Annual risk of a cancer fatality to the average individual in the entire offsite projected population in 2020 out to a distance of 50 miles accounting for the probability of the accident occurring.

Note: To convert feet to meters, multiply by 0.3048; miles to kilometers by 1.6093.

Source: TVA 2003, Table III-3, Attachment E-4, page E-418 for accident frequencies.

J.3.3.2 Sequoyah Beyond-Design-Basis Accidents

Table J-8 shows the potential doses and risks associated with the evaluated beyond-design-basis accidents at Sequoyah. As shown in this table, of the beyond-design-basis accidents evaluated, the late containment failure accident represents the highest risk to the MEI, with an estimated frequency of approximately 1 chance in 330,000 of the accident occurring per year of operation. The steam generator tube rupture accident represents the highest risk to the population near Sequoyah, with an estimated frequency of approximately 1 chance in 710,000 of the accident occurring per year of operations. The risks under either accident scenario would be similar regardless of whether the reactor was using a full-LEU or a partial-MOX fuel core.

For the MEI, the risk of a cancer fatality from the late containment failure accident would be approximately 1 chance in 330,000 per year of operations for either a full-LEU or partial-MOX fuel core. For the average individual residing within 50 miles (80 kilometers) of Sequoyah, the risk of a latent fatal cancer from a steam generator tube rupture would be approximately 1 chance in 330 million per year of operations for either a full-LEU or partial-MOX fuel core. As discussed in Section J.3.3.1, the risk to the MEI of developing a fatal cancer from normal background radiation would be approximately 1 chance in 5,200 per year.

The results for all of the beyond-design-basis accidents analyzed in this *SPD Supplemental EIS* indicate that, regardless of whether a partial-MOX fuel core or a full-LEU fuel core were used in Sequoyah, the risk to individuals in the surrounding population would be both similar and within the overall analysis uncertainty. Potential risks presented by the two types of cores are projected to be comparable for the MEI or the general population from these beyond-design-basis accidents.

Table J-8 Sequoyah Nuclear Plant Beyond-Design-Basis Accident Impacts

Accident	Frequency (per year)	LEU or MOX Core	Impacts on the MEI at the Exclusion Area Boundary			Impacts on the Population within 50 miles		
			Dose (rem) ^a	Dose Risk (rem/year) ^b	Annual Risk of Fatal Cancer ^c	Dose (person-rem) ^a	Average Individual Dose Risk (rem/year) ^d	Annual Risk of Fatal Cancer to Average Individual ^e
Early containment failure	3.4×10^{-7}	LEU	27,000	0.0092	3×10^{-7}	2.3×10^6	6.5×10^{-7}	4×10^{-10}
		MOX	33,000	0.011	3×10^{-7}	2.4×10^6	6.7×10^{-7}	4×10^{-10}
Late containment failure	3.0×10^{-6}	LEU	790	0.0024	3×10^{-6}	1.5×10^6	3.7×10^{-6}	2×10^{-9}
		MOX	870	0.0026	3×10^{-6}	1.5×10^6	3.7×10^{-6}	2×10^{-9}
Steam generator tube rupture	1.4×10^{-6}	LEU	45,000	0.063	1×10^{-6}	4.0×10^6	4.6×10^{-6}	3×10^{-9}
		MOX	56,000	0.078	1×10^{-6}	4.2×10^6	4.9×10^{-6}	3×10^{-9}

LEU = low-enriched uranium; MEI = maximally exposed individual; MOX = mixed oxide.

^a The reactor accident doses were calculated over an 80-year period using the MACCS2 computer code. Eighty years represents a typical person’s lifetime.

^b Annual dose risk to a hypothetical MEI at the exclusion area boundary (1,824 feet) accounting for the probability of the accident occurring.

^c Annual risk of a fatality or fatal latent cancer to a hypothetical MEI at the exclusion area boundary (1,824 feet) accounting for the probability of the accident occurring.

^d Average individual dose risk per year for the entire offsite projected population in 2020 (approximately 1,200,000) out to a distance of 50 miles, given exposure to the indicated dose and accounting for the probability of the accident occurring.

^e Annual risk of a cancer fatality to the average individual to the entire offsite projected population in 2020 out to a distance of 50 miles accounting for the probability of the accident occurring.

Note: To convert feet to meters, multiply by 0.3048; miles to kilometers by 1.6093.

Source: SAIC 2007, for accident frequencies.

J.3.3.3 Consideration of Other Severe Accidents

A wide range of beyond-design-basis accidents is considered by NRC in evaluating the accident risks from the operation of commercial nuclear power reactors, including TVA reactors. Unlikely to very unlikely events are considered in the contingency planning for these plants, including dam failures, hurricanes, flooding, tornadoes, terrorism, and similar events that might cause loss of offsite power (affecting the ability of the plant to provide emergency cooling to the reactors and used fuel pools) and threaten multiple plants. While some of the details of the contingencies to prevent these types of accidents are not made public, NRC requires that the reactor licensees be able to accommodate these kinds of potential disruptions without the plants experiencing severe or beyond-design-basis accidents such as those that occurred in Japan in 2011. TVA anticipates regulatory changes as a result of events that occurred in 2011 in the United States (the East Coast earthquake near Mineral, Virginia) and the earthquake and tsunami in Japan. Regulatory changes are incorporated in the plant design and operations in accordance with implementation requirements included in the regulations (e.g., CFR, NRC order, or 10 CFR 50.54(f) letter).

On March 11, 2011, a magnitude 9.0 earthquake occurred near the northeast coast of Honshu, Japan. This earthquake caused tsunami waves as high as 29.6 meters (97.1 feet) along the coast of Japan. The 14-meter (46-foot) tsunami that occurred at the Fukushima Daiichi nuclear power plant site² resulted in extended periods of time when the plant was without emergency system power and emergency cooling water. This, in turn, resulted in significant core damage to three of the six nuclear power plants, including hydrogen explosions that breached the containment. All of the reactors at Fukushima Daiichi are now in a safe shutdown condition with continuing active cooling.

² The Fukushima Daiichi nuclear power plant includes six BWRs of the same design as those present in TVA’s Browns Ferry Nuclear Plant.

Shortly after this accident began to unfold, NRC formed a Fukushima Near-Term Task Force to conduct a systematic and methodical review of NRC processes and regulations to determine whether the agency should make additional improvements to its regulatory system and to make recommendations to NRC for its policy direction. The Near-Term Task Force issued its report in July 2011 (NRC 2011), which was followed by extensive discussions between NRC, the industry, and the public. Based on the Near-Term Task Force report and subsequent discussions, NRC directed its staff to initiate appropriate regulatory changes through issuance of orders and rulemaking processes.

The Near-Term Task Force has developed three prioritized tiers of recommended actions: Tier 1, which should be started without unnecessary delay; Tier 2, which requires further assessment and depends on Tier 1 issues and resources; and Tier 3, which requires further NRC staff study and is associated with longer-term actions. Tier 1 recommendations include: seismic, flooding, and other external hazard re-evaluations and walk downs; extended station blackout coping capability; reliable hardened vents for some early designs of BWRs; enhanced survival instrumentation for the used fuel pool, nuclear reactor, and containment; strengthening of emergency procedures, as well as severe accident management guidelines, damage mitigation guidelines; and improvements in staffing and communication during an emergency. Tier 2 and 3 recommendations involve additional improvements and enhancements to mitigate the effects of extreme seismic and flooding events in terms of used fuel pool integrity, hydrogen control, long-term station blackout, venting, training, monitoring, decisionmaking, emergency preparedness, and public education.

In February 2012, NRC issued policy guidance to implement the aforementioned actions in the form of proposed orders requiring safety enhancements of operating reactors, construction permit holders, and combined license holders (NRC 2012b). On March 12, 2012, the NRC issued three orders as well as a request for information regarding additional concerns (NRC 2012c). The orders addressed mitigation strategies for beyond-design basis external events (NRC 2012d), reliable hardened containment vents [Mark I and II BWRs] (NRC 2012e), and reliable spent fuel pool instrumentation (NRC 2012f). The request for information directed each reactor licensee to provide specific information following a re-evaluation of seismic and flooding hazards, emergency communications systems and staffing levels. Information from licensees was also requested after the licensees conduct walkdowns of reactor facilities to ensure protections against potential design basis hazards.

The NRC has issued an advance notice of proposed rulemaking for station blackout regulatory actions. It also anticipates issuing an advanced notice of proposed rulemaking on the strengthening and integration of emergency operating procedures, severe accident management guidelines, and extensive damage mitigation guidelines (NRC 2012c).

TVA will institute applicable NRC regulatory updates at Browns Ferry and Sequoyah when they are promulgated in their final approved form. TVA took proactive steps in response to the events at Fukushima, forming a review team to assess early lessons learned and determine their potential applicability to the safety of TVA's reactors, including Browns Ferry and Sequoyah. Based on this assessment, TVA has taken steps to procure additional equipment to further ensure adequate cooling during the extremely unlikely event of an extended loss of offsite power, known as a station blackout, that could affect multiple reactors at TVA sites. In addition, TVA is working with various industry groups such as the Institute for Nuclear Power Operators and the Nuclear Energy Institute to conduct a more comprehensive assessment of the Fukushima events. TVA continues, through its engagement with the Nuclear Energy Institute and the Institute for Nuclear Power Operators, to work with NRC to ensure that the regulations governing the operation of U.S. nuclear plants appropriately protect public health and safety and the environment in light of the Fukushima events.

J.3.4 Overall Modeling Results

Table J-9 shows a comparison of projected radiological impacts from a series of design-basis and beyond-design-basis accidents reactors using partial-MOX fuel cores versus those using full-LEU fuel cores in the unlikely event one of these accidents were to occur. The dose to a member of the general public at the exclusion area boundary (i.e., the MEI) and the general population doses from these accidents, if they were to occur, are expected to be approximately the same for either core as shown in Tables J-4, J-5, J-7, and J-8. The Table J-9 numbers in parentheses are the calculated ratios (impacts for a partial MOX core divided by impacts for an LEU core). A value of less than 1 indicates that the MOX fuel core could result in smaller impacts than the same accident with an LEU fuel core. A value of 1 indicates that the estimated impacts are the same for both fuel core types. A ratio larger than 1 indicates that the MOX fuel core could result in larger impacts than the same accident with an LEU fuel core. Outside the parentheses, the table shows a ratio of 1 for all accident scenarios. This is a rounded value because when modeling and analytical uncertainties are considered, the precision of the results is no more than one significant figure.

Table J-9 Ratio of Accident Impacts for Partial Mixed Oxide Fuel and Full Low-Enriched Uranium Fuel Cores (Partial Mixed Oxide Fuel Doses/Full Low-Enriched Uranium Fuel Doses)^{a,b}

<i>Accident</i>	<i>Browns Ferry Nuclear Plant</i>		<i>Sequoyah Nuclear Plant</i>	
	<i>MEI at the Exclusion Area Boundary</i>	<i>Population within 50 Miles</i>	<i>MEI at the Exclusion Area Boundary</i>	<i>Population within 50 Miles</i>
Design-basis accidents				
LOCA	1 (0.88)	1 (1.00)	1 (0.87)	1 (0.96)
Used-fuel-handling accident	1 (1.00)	1 (1.00)	1 (1.00)	1 (1.00)
Beyond-design-basis accidents				
Early containment failure	1 (1.00)	1 (0.96)	1 (1.22)	1 (1.04)
Late containment failure	1 (1.05)	1 (0.95)	1 (1.10)	1 (1.00)
SGTR ^c	Not applicable	Not applicable	1 (1.24)	1 (1.05)
ISLOCA ^d	1 (0.93)	1 (0.95)	See SGTR	See SGTR

ISLOCA = interfacing systems loss-of-coolant accident; LOCA = loss-of-coolant accident; MEI = maximally exposed individual; SGTR = steam generator tube rupture accident.

^a Reactor accidents involving the use of partial-MOX fuel cores were assumed to involve reactor cores with approximately 40 percent MOX fuel and 60 percent LEU fuel.

^b The values in parentheses reflect the ratios calculated by dividing the accident analysis results for a partial MOX fuel core by the results for a full LEU core. When modeling and analytical uncertainties are considered, the precision of the results is no more than one significant figure.

^c Steam generator tube rupture is not applicable for boiling water reactors because they do not use steam generators.

^d An ISLOCA was not analyzed in the *Watts Bar Nuclear Plant Severe Reactor Accident Analysis* (SAIC 2007) on which the analysis in this appendix is based because the impacts were bounded by the SGTR accident.

Note: To convert miles to kilometers, multiply by 1.6093.

Regardless of the core type, the estimated doses to the MEI from design-basis accidents would be small compared to the NRC limit, as discussed in Sections J.3.1.1 and J.3.1.2. The estimated doses to the MEI from beyond-design-basis accidents would present similar risks to the MEI, as discussed in Sections J.3.3.1 and J.3.3.2. Based on this evaluation of the potential impacts of accidents with either a full-LEU or a partial-MOX fuel core in either a PWR (Sequoyah) or a BWR (Browns Ferry), the projected radiological impacts of such accidents or the risks associated with the plants’ operation are comparable. This conclusion is similar to the conclusion reached in the *SPD EIS* (DOE 1999). The risks to the MEI and the surrounding populations of developing a fatal cancer as a result of one of these accidents, regardless of whether the reactors are using partial-MOX fuel cores or full-LEU fuel cores are small.

J.4 Uncertainties

The purpose of the analysis in this appendix is to compare the potential impacts from accidents related to the use of MOX fuel in domestic, commercial nuclear power plants. The analyses are based on studies, data, and models that introduce levels of uncertainty into the analyses. The following paragraphs address recognized uncertainties in the analyses.

In the application of the MACCS2 v1.13.1 computer code, dose conversion factors from Federal Guidance Report 11 (EPA 1988) were used. A more recent version of dose conversion factors has been developed and is included in Federal Guidance Report 13 (EPA 1999). Using the updated dose conversion factors in Federal Guidance Report 13, the estimated doses from DOE facility accidents and reactor accidents would increase for some key isotopes and decrease for other key isotopes. Overall, these differences are expected to be well within the much larger uncertainties associated with what might actually happen during an accident; for example, the amount of radioactive material that might actually escape a facility, the amount of time the fuel in a reactor may have been irradiated before the accident occurred, or the weather conditions at the time of the accident.

The accident analysis estimated the individual risk of a latent cancer fatality as a result of exposure to radiation by applying a constant factor of 0.0006 LCFs per rem or person-rem to all doses less than 20 rem (the risk factor is doubled for doses equaling or exceeding 20 rem). This linear no-threshold extrapolation is the standard method for estimating health risks. In the unlikely event of an accident, many of the individuals in the affected population could receive such a small dose of radiation that they would not suffer any health effects from the radiation. As discussed in Appendix C (see text box in Section C.3), a number of radiation health scientists and organizations have expressed reservations that the currently used cancer risk conversion factors, which are based on epidemiological studies of high doses (doses exceeding 5 to 10 rem), may not apply at low doses. In addition, because the affected population would receive increased health monitoring in the event of the accidents considered in this *SPD Supplemental EIS*, early detection of cancers may result in a lower number of cancer fatalities in the affected population than in a similar, unmonitored population. Nevertheless, the human health risk analysis in this appendix uses the linear no-threshold dose risk assumption.

A recent beyond-design-basis accident analysis by Sandia National Laboratories (SNL 2011) indicates that release fractions from a 40 percent MOX fuel core are similar to those of a full-LEU fuel core. Differences between the partial-MOX fuel core and full-LEU fuel core release times and source terms for each accident phase and class of radionuclide are within the uncertainty of the calculation methodology. In some cases, full-LEU fuel core release fractions were slightly larger, while in other cases partial-MOX fuel core release fractions were larger. Therefore, the release fractions given in Table J-6 of this appendix are appropriate for accidents involving either a partial-MOX or full-LEU fuel core.

The Sandia National Laboratories beyond-design-basis accident analysis (SNL 2011) was developed as part of an NRC research program to evaluate the impact of using MOX fuel in commercial nuclear power plants. This study was undertaken to evaluate the impact of the usage of a 40 percent MOX fuel core on the consequences of postulated severe or beyond-design-basis accidents. A series of severe accident calculations were performed using MELCOR 1.8.5 for a four-loop Westinghouse reactor with an ice condenser containment (similar to that in Sequoyah). The calculations covered the risk- and consequence-dominant accident sequences in plant-specific PRAs, including early and late containment failures.

The results indicated that the accident progression and source terms for the full-LEU and partial-MOX fuel cores were similar. This was initially unexpected because the experimental data for fission product releases from MOX fuel suggested higher releases than LEU fuel. However, the calculations show that at severe accident fuel temperatures, the volatile fission product releases occur at a very high release rate, regardless of the fuel type. Hence, the differences noted in the experimental results at lower temperature

were not prototypical of severe accident conditions in the long term and did not greatly impact the integral source term.

In January 2012, NRC issued draft NUREG-1935, *State-of-the-Art Reactor Consequence Analyses Report (SOARCA Report)* (NRC 2012a), for comment. The *SOARCA Report* presents the results of best-estimate severe (beyond-design-basis) accident analyses for two operating U.S. nuclear power plants, the Surry Power Station (Surry), a PWR in Surry, Virginia, and the Peach Bottom Atomic Power Station (Peach Bottom), a BWR in Delta, Pennsylvania, using current knowledge and computer codes. The *SOARCA Report* work was developed over more than 5 years and has been subject to extensive independent peer review by experts in severe accident phenomena, modeling, and assessment. Using updated and benchmarked plant risk models, the *SOARCA Report* analyzed the following severe accident scenarios: short-term and long-term station blackouts for both Surry and Peach Bottom; a thermally induced steam generator tube rupture for Surry; and an ISLOCA for Surry. Modeling of these severe accident scenarios included input from plant PRAs and senior reactor operators, as well as mitigation measures based on emergency operating procedures and severe accident management guidelines.

The *SOARCA Report* analyzed the timing and magnitude of radioisotope source terms for both mitigated and unmitigated scenarios and compared these results to earlier severe accident studies. The *SOARCA Report* severe accident source terms for risk-dominant radioisotopes of iodine and cesium were calculated to be from 3 to 225 times smaller than those calculated in the 1982 *Technical Guidance for Siting Criteria Development*, NUREG/CR-2239 (NRC 1982). The *SOARCA Report* also confirmed that severe accident and emergency operations procedures and strategies would successfully prevent core damage or large radiological releases to the environment if implemented correctly. The *SOARCA Report* conclusions show that the public risk from severe accidents at current generation nuclear power plants is very small and has benefited by improvements in severe accident management and emergency response procedures.

J.5 References

AREVA (AREVA NP, Inc.), 2012, *Summary Report on Postirradiation Examinations of MOX Fuel*,” ANP-10320NP, Rev. 0, Aiken, South Carolina, February.

Census (U.S. Census Bureau), 2011, 2010 Decennial Census, Summary File 1, Detailed tables, Table P5. Hispanic or Latino Origin by Race; Universe – Total Population, accessed through http://www2.census.gov/census_2010/04-Summary_File_1/, August 25th.

DOE (U.S. Department of Energy), 1999, *Surplus Plutonium Disposition Final Environmental Impact Statement*, DOE/EIS-0283, Office of Fissile Materials Disposition, Washington, DC, November.

EPA (U.S. Environmental Protection Agency), 1988, *Limiting Values of Radionuclide Intake And Air Concentration and Dose Conversion Factors For Inhalation, Submersion, And Ingestion*, Federal Guidance Report No. 11, EPA 520/1-88-020, Office of Radiation Programs, Washington, DC, September.

EPA (U.S. Environmental Protection Agency), 1999, *Cancer Risk Coefficients for Environmental Exposure to Radionuclides*, Federal Guidance Report No. 13, EPA 402-R-99-001, Office of Radiation and Indoor Air, Washington, DC, September.

EPRI (Electric Power Research Institute), 2009, *Program on Technology Innovation: Readiness of Existing and New U.S. Reactors for Mixed-Oxide (MOX) Fuel*, Technical Report 1018896, Palo Alto, California, May.

IAEA (International Atomic Energy Agency), 2003, *Status and Advances in MOX Fuel Technology*, Technical Report Series No. 415, Vienna, Austria.

INEL (Idaho National Laboratory), 2009, Full Core 3-D Simulation of a Partial MOX LWR Core, INL/EXT-09-15913, Idaho Falls, Idaho, May.

NAS (National Academy of Sciences and National Research Council), 1995, *Management and Disposition of Excess Weapons Plutonium: Reactor-Related Options*, ISBN: 0-309-58737-9, National Academy Press, Washington, DC.

NRC (U.S. Nuclear Regulatory Commission), 1976, *Final Generic Environmental Statement on the Use of Recycle Plutonium in Mixed Oxide Fuel in Light Water Cooled Reactors*, NUREG-0002, Rockville, Maryland, August.

NRC (U.S. Nuclear Regulatory Commission), 1982, *Technical Guidance for Siting Criteria Development*, NUREG/CR-2239, SAND81-1549, Albuquerque, New Mexico, December.

NRC (U.S. Nuclear Regulatory Commission), 1988, *Individual Plant Examination for Severe Accident Vulnerabilities—10 CFR 50.54(f)* (Generic Letter 88-20), Washington, DC, November 23.

NRC (U.S. Nuclear Regulatory Commission), 1998, *Code Manual for MACCS2: Volume 1, User's Guide*, NUREG/CR-6613, SAND97-0594, Washington, DC, May.

NRC (U.S. Nuclear Regulatory Commission), 1999, Memorandum from W.D. Travers, Executive Director for Operations, to the NRC Commissioners, Re: *Mixed-Oxide Fuel Use in Commercial Light Water Reactors*, Washington, DC, April 14.

NRC (U.S. Nuclear Regulatory Commission), 2005, *Environmental Impact Statement on the Construction and Operation of a Proposed Mixed Oxide Fuel Fabrication Facility at the Savannah River Site, South Carolina*, NUREG-1767, Office of Nuclear Material Safety and Safeguards, Washington, DC, January.

NRC (U.S. Nuclear Regulatory Commission), 2011, *Recommendations for Enhancing Reactor Safety in the 21st Century - The Near-Term Task Force Review of Insights from the Fukushima Dai-Ichi Accident*, Rockville, Maryland, July 12.

NRC (U.S. Nuclear Regulatory Commission), 2012a, *State-of-the-Art Reactor Consequence Analyses (SOARCA) Project*, Main Report (Draft), NUREG-1935, Washington, DC, January.

NRC (U.S. Nuclear Regulatory Commission), 2012b, “Proposed Orders and Requests for Information in Response to Lessons Learned from Japan’s March 11, 2011 Great Tohoku Earthquake and Tsunami,” SECY-12-0025, Rockville, Maryland, February 17.

NRC (U.S. Nuclear Regulatory Commission), 2012c, “Actions in Response to the Japan Nuclear Accident” (accessed May 9, 2012, <http://www.nrc.gov/reactors/operating/ops-experience/japan-info.html>).

NRC (U.S. Nuclear Regulatory Commission), 2012d, Order Modifying Licenses with Regard to Requirements for Mitigation Strategies for Beyond-Design-Basis External Events, EA-12-049, Washington, DC, March 12.

NRC (U.S. Nuclear Regulatory Commission), 2012e, Order Modifying Licenses with Regard to Reliable Hardened Containment Vents, EA-12-050, Washington, DC, March 12.

NRC (U.S. Nuclear Regulatory Commission), 2012f, Order to Modify Licenses with Regard to Reliable Spent Fuel Pool Instrumentation, EA-12-051, Washington, DC, March 12.

ORNL (Oak Ridge National Laboratory), 1997, *Fuel Qualification Issues and Strategies for Reactor-Based Surplus Plutonium Disposition*, ORNL/TM-13405, Rev. 0, Oak Ridge, Tennessee, August.

ORNL (Oak Ridge National Laboratory), 1998, *Neutronics Benchmark for the Quad Cities-1 (Cycle 2) Mixed-Oxide Assembly Irradiation*, ORNL/TM-13567, Oak Ridge, Tennessee, April.

ORNL (Oak Ridge National Laboratory), 2000, *Neutronic Benchmarks for the Utilization of Mixed-Oxide Fuel: Joint U.S./Russian Progress Report for Fiscal Year 1997*, Volume 4, Part 2—Saxton Plutonium Program Critical Experiments, ORNL/SUB/00-XSZ175V-2, Oak Ridge, Tennessee, September.

ORNL (Oak Ridge National Laboratory), 2005, *Weapons-Derived Mixed Oxide Fuel Test Irradiation Summary*, ORNL/TM-2005/255, Oak Ridge, Tennessee, November.

ORNL (Oak Ridge National Laboratory), 2006, *Implications of the PIE Results for the 50-GWd/MT MOX Test Capsules*, ORNL/TM-2006/83, Oak Ridge, Tennessee, May.

ORNL (Oak Ridge National Laboratory), 2012, *Core Average (MOX/LEU) Nuclide Ratios for Sequoyah and Browns Ferry Reactors*, Oak Ridge, Tennessee, April 4. [Proprietary]

SAIC (Science Applications International Corporation), 2007, *Watts Bar Nuclear Plant Severe Reactor Accident Analysis*, Germantown, Maryland, May 30.

SNL (Sandia National Laboratories), 2010, *Assessment of Severe Accident Source Terms in Pressurized-Water Reactors with a 40% Mixed-Oxide and 60% Low-Enriched Uranium Core Using MELCOR 1.8.5*, SAND2008-6665, Albuquerque, New Mexico, April.

SNL (Sandia National Laboratory), 2011, *Accident Source Terms for Light-Water Nuclear Power Plants Using High-Burnup or MOX Fuel*, SAND2011-0128, Albuquerque, New Mexico, January.

TVA (Tennessee Valley Authority), 2002a, *Final Supplemental Environmental Impact Statement for Browns Ferry Nuclear Plant Operating License Renewal Athens, Alabama*, Appendix A, "BFN Severe Accident Mitigation Alternatives Analysis," Athens, Alabama, March.

TVA (Tennessee Valley Authority), 2002b, *Level 3 Consequence Assessment for Browns Ferry Nuclear (SAMA)*, Calc No. MDN0-999-2001-0011, Rev. 0, Athens, Alabama, March 7.

TVA (Tennessee Valley Authority), 2003, *Applicant's Environmental Report, Operating License Renewal Stage, Browns Ferry Nuclear Power Plant Units, 1, 2, and 3*, Appendix E, "Environmental Report," Athens, Alabama, December.

TVA (Tennessee Valley Authority), 2007, *Browns Ferry Nuclear Plant Updated Final Safety Analysis Report*, Chapter 14, "Plant Safety Analysis," BFN-22, Athens, Alabama.

TVA (Tennessee Valley Authority), 2010a, *Surplus Plutonium Disposition Supplemental Environmental Impact Statement Data Call Response*, Chattanooga, Tennessee.

TVA (Tennessee Valley Authority), 2010b, *Sequoyah Nuclear Plant Updated Final Safety Analysis Report, Amendment 22*, Athens, Alabama, May 24.

WNA (World Nuclear Association), 2011, "Mixed Oxide Fuel," *World Nuclear Association* (accessed February 28, 2012, <http://www.world-nuclear.org/info/inf29.html>), August.

APPENDIX K
CONTRACTOR DISCLOSURE STATEMENT

**NEPA DISCLOSURE STATEMENT FOR PREPARATION OF A
SURPLUS PLUTONIUM DISPOSITION
SUPPLEMENTAL ENVIRONMENTAL IMPACT STATEMENT**

CEQ regulations at 40 CFR Part 1506.5(c), which have been adopted by DOE (10 CFR Part 1021), require contractors who will prepare an EIS to execute a disclosure specifying that they have no financial or other interest in the outcome of the project. The term "financial interest or other interest in the outcome of the project," for the purposes of this disclosure, is defined in the March 23, 1981 guidance "Forty Most Asked Questions Concerning CEQ's National Environmental Policy Act Regulations," 46 FR 18026-18038 at Question 17a and b.

"Financial or other interest in the outcome of the project 'includes' any financial benefit such as a promise of future construction or design work in the project, as well as indirect benefits the contractor is aware of (e.g., if the project would aid proposals sponsored by the firm's other clients)," 46 FR 18026-18038 at 18031.

In accordance with these requirements, the offeror and any proposed subcontractors hereby certify as follows: (check either (a) or (b) to assure consideration of your proposal)

- (a) X Offeror and any proposed subcontractor have no financial interest in the outcome of the project.
- (b) _____ Offeror and any proposed subcontractor have the following financial or other interest in the outcome of the project and hereby agree to divest themselves of such interest prior to award of this contract.

Financial or Other Interests:

- 1.
- 2.
- 3.

Certified by:



Signature

Kelly C. Russell
Name

Contracts Representative
Title

January 12, 2011
Date