

# Radiometric Testing of Germicidal UV Products, Round 1: UV-C Towers and Whole-Room Luminaires

CALiPER Full Report

September 2023

(This page intentionally left blank)

# **Radiometric Testing of Germicidal UV Products, Round 1: UV-C Towers and Whole-Room Luminaires**

CALiPER Full Report

Jason Tuenge, Gabe Arnold, Margaret Axelson, and Jianchuan Tan

Pacific Northwest National Laboratory

September 2023

Produced for the U.S. Department of Energy, Energy Efficiency and Renewable Energy, by the Pacific Northwest National Laboratory, Richland, Washington 99352

**DISCLAIMER**

This report was prepared as an account of work sponsored by an agency of the United States Government. Neither the United States Government nor any agency thereof, nor Battelle Memorial Institute, nor any of their employees, makes **any warranty, express or implied, or assumes any legal liability or responsibility for the accuracy, completeness, or usefulness of any information, apparatus, product, or process disclosed, or represents that its use would not infringe privately owned rights.** Reference herein to any specific commercial product, process, or service by trade name, trademark, manufacturer, or otherwise does not necessarily constitute or imply its endorsement, recommendation, or favoring by the United States Government or any agency thereof, or Battelle Memorial Institute. The views and opinions of authors expressed herein do not necessarily state or reflect those of the United States Government or any agency thereof.

PACIFIC NORTHWEST NATIONAL LABORATORY  
*operated by*  
BATTELLE  
*for the*  
UNITED STATES DEPARTMENT OF ENERGY  
*under Contract DE-AC05-76RL01830*

Printed in the United States of America

Available to DOE and DOE contractors from the  
Office of Scientific and Technical Information,  
P.O. Box 62, Oak Ridge, TN 37831-0062;  
ph: (865) 576-8401  
fax: (865) 576-5728  
email: [reports@adonis.osti.gov](mailto:reports@adonis.osti.gov)

Available to the public from the National Technical Information Service  
5301 Shawnee Rd., Alexandria, VA 22312  
ph: (800) 553-NTIS (6847)  
email: [orders@ntis.gov](mailto:orders@ntis.gov) <<https://www.ntis.gov/about>>  
Online ordering: <http://www.ntis.gov>

**DOE CALiPER No Commercial Use Policy**

The U.S. Department of Energy (DOE) is a federal agency working in the public interest. Published information from the DOE CALiPER program, including test reports, technical information, and summaries, is intended solely for the benefit of the public, in order to help buyers, specifiers of new products, testing laboratories, energy experts, energy program managers, regulators, and others make informed choices and decisions about germicidal ultraviolet (GUV) disinfection products and related technologies.

Such information may not be used in advertising, to promote a company's product or service, or to characterize a competitor's product or service. This policy precludes any commercial use of any DOE CALiPER Program published information in any form without DOE's express written permission.

# Preface

The U.S. Department of Energy (DOE) Lighting R&D program launched the CALiPER program<sup>1</sup> in 2006 to address a need for unbiased, trusted performance information for solid-state lighting (SSL) products that were beginning to enter the general illumination market. At the time, LED-based lighting products were often poor performers in terms of light quantity, color quality, appearance, flicker, glare, and reliability, with marketing claims significantly overstating actual performance. Further, LED-specific metrics and industry-standard test methods had not yet been developed.<sup>2</sup> CALiPER began evaluating LED products using modified and in-development test methods, comparing performance to the LED products' own claims as well as to benchmark (incandescent, fluorescent, and high-intensity discharge) products. The published results helped to encourage high-quality products and discourage inflated performance claims, while educating product developers, specifiers, and buyers on how to evaluate product performance. Early CALiPER testing also contributed fundamentally to the development of industry-standard photometric test methods specifically for SSL and the associated accreditation of testing laboratories. CALiPER testing was most active from 2007 to 2014, ramping down with maturation of LED technology and the market.

The COVID-19 pandemic has led to a similar environment for germicidal ultraviolet (GUV) products, where unsubstantiated performance claims proliferate, new technologies and test methods are in development, and the capabilities and capacity of commercial test laboratories are limited. Motivated by the national imperative to improve resilience to future pandemics while using energy resources as efficiently as possible, DOE has reactivated the CALiPER program to test, evaluate, and report the performance and photobiological safety of GUV disinfection products used to treat air and surfaces in occupiable spaces. The predominant GUV technology in such applications is the phosphorless low-pressure mercury (LPM) lamp, which has been used in health and institutional settings for many decades. Emerging alternatives include products incorporating UV-emitting LEDs or krypton-chloride based excimer lamps.<sup>3</sup>

CALiPER GUV product testing follows past CALiPER practices: testing is conducted by accredited, independent laboratories, using industry-standard test methods and metrics wherever possible and contributing to new and revised industry-standard test methods as needed. The resulting CALiPER reports assemble data from several product tests and provide comparative analyses. Each round of testing may focus on one or more types of products and/or particular performance aspects.

Buyers and specifiers can reduce risk of poor performance by learning how to compare products and consider every potential GUV purchase carefully. To this end, CALiPER test results provide data for commercially-available products as well as objective analysis and comparative insights. However, some limitations should be kept in mind:

- Random sampling is not implemented when acquiring test units, and sample sizes are relatively small, so test results may not be representative for a tested model. Similarly, the products selected for testing are not a representative sample of all available products of that type. Furthermore, some tested products may no longer be sold or may have been updated since the time of purchase. Consequently, the results should not be taken as a verdict on any product line or manufacturer.
- Radiometric testing alone cannot fully characterize a product—other facets (e.g., controls, warranty) should also be considered.

---

<sup>1</sup> CALiPER originally abbreviated “Commercially Available LED Product Evaluation and Reporting.” Only the acronym is used now.

<sup>2</sup> Industry-standard test methods are typically consensus-based documents published by standards developers accredited by ANSI, IEC, or ISO.

<sup>3</sup> An LED that only emits ultraviolet (which is not light) would be more accurately described as a UVLED, but we follow convention here.

## Acknowledgements

This work was supported by the DOE Building Technologies Office (BTO) within the Office of Energy Efficiency and Renewable Energy (EERE). For more information on GUV activities supported by the Lighting R&D Program at BTO, please visit <https://www.energy.gov/eere/ssl/germicidal-ultraviolet-disinfection>.

The authors would also like to thank the GUV team at Intertek Testing Services for their contributions to this study, as well as PNNL photographers Andrea Starr and Edward Pablo.

## Abbreviations

Standard abbreviations are used for common measurement units, such as: amperes (A), hours (h), meters (m), seconds (s), volts (V), and watts (W). Some abbreviations that may be less familiar are tabulated below.

AC	Alternating current
ACGIH	American Conference of Governmental Industrial Hygienists
ANSI	American National Standards Institute
BF	Ballast factor
CIE	International Commission on Illumination
DOE	U.S. Department of Energy
DUT	Device under test
FWHM	Full width half maximum
GUV	Germicidal ultraviolet
IEC	International Electrotechnical Commission
IES	Illuminating Engineering Society
ISO	International Organization for Standardization
IUVA	International Ultraviolet Association
LED	Light-emitting diode
LPM	Low-pressure mercury
$\mu$ W	Microwatt(s)
NIOSH	National Institute for Occupational Safety and Health
nm	Nanometer(s)
OSHA	Occupational Safety & Health Administration
PNNL	Pacific Northwest National Laboratory
RG	Risk group
RMS	Root mean square
SPD	Spectral power distribution
sr	Steradian(s)
THD	Total harmonic distortion
TLV	Threshold limit value

## Summary

This report analyzes the independently tested performance of 13 germicidal ultraviolet (GUV) products purchased between February and July 2022. The products were of three different types:

- Seven portable, consumer-oriented GUV towers designed to be placed on the floor or a desk of an unoccupied room to disinfect air and surfaces. Five of these products used LED sources and two products had low-pressure mercury (LPM) sources.
- One GUV whole-room luminaire<sup>4</sup> designed to be installed on a ceiling to disinfect air when a room is occupied. This product had LED sources.
- Five GUV troffer or high-bay style whole-room luminaires designed to be installed in or suspended from a ceiling to disinfect air and surfaces when a room is unoccupied. All five had LPM sources.

Product testing covered radiometric and electrical performance for all 13 products as well as photobiological safety evaluation if product documentation included testable claims. Measurement results enable comparison between products and against manufacturer or vendor claims.

Testing identified numerous issues related to the accuracy of claimed GUV product performance. Claims were often untestable, contradictory, ambiguous, or used incorrect units and/or terminology. When claims were testable, they often did not match test results. For example, three LED products that claimed to emit UV-C emitted only UV-A. Product claim issues were more common among consumer-oriented tower products, but all product types exhibited problems with accurate performance claims.

The UV-C radiant efficiency (calculated as UV-C output power divided by electrical input power) of the products varied widely, even among similar products using the same source technologies. For example, the UV-C radiant efficiency of LPM products varied by greater than a factor of three for the same product type, indicating a large potential energy savings opportunity for products that are better designed for efficiency. LED products had orders-of-magnitude lower UV-C radiant efficiency than LPM products.

This study also identified several testing challenges and limitations. Most significant among these is the capability to accurately test and report the performance of larger GUV products. Whereas integrating spheres are used to quickly measure total radiant flux (i.e., output power) and spectral distribution, goniometers are used to measure radiant intensity distribution (from which radiant flux can be calculated). Integrating spheres require a specialized and costly coating to test UV, and the testing laboratory for this round of products had only a 20-inch diameter hemisphere with this capability. The integrating sphere accommodated just 2 of the 10 UV-C emitting products. Goniometer testing had a different size limitation in that mirrors typically used to increase goniometer test distance to the far field reflect little to no UV. As a result, the study evaluated only 6 of 13 products in the far field. Electronic files of UV-C intensity data for the other 7 products, which would typically be imported into design software for designing GUV applications, may not be reliable for predicting irradiance at arbitrary far-field distances (IES 2022a; CIE 2020).<sup>5</sup>

Specifiers and buyers of GUV products need accurate performance claims and data to deploy GUV technology safely and effectively. This CALiPER GUV Round 1 report demonstrates the significant education and training manufacturers and vendors still require to accurately test and report the performance of their GUV products. Further industry standards and guidelines may address testing limitations and improve test methods, product performance, and the accuracy of performance claims.

---

<sup>4</sup> The term “luminaire” has traditionally applied to lighting products (IES 2022a), but has also been more broadly defined to include products that emit other kinds of optical radiation (CIE 2020). Usage of the terms “UV luminaire” and “GUV luminaire” is increasingly common (IES 2022b; IEC 2022).

<sup>5</sup> Definitions for most terms used in this report (e.g., radiant flux, radiant intensity, irradiance) can be found in industry-standard online glossaries.



# Table of Contents

Preface .....	i
Acknowledgements .....	ii
Abbreviations .....	ii
Summary .....	iii
<b>1 Introduction .....</b>	<b>1</b>
<b>2 Products acquired for testing .....</b>	<b>3</b>
2.1 Performance and safety claims .....	5
2.1.1 Electrical and radiometric performance claims .....	6
2.1.2 UV spectrum claims .....	9
2.1.3 Ozone generation claims .....	9
2.1.4 Longevity claims .....	11
2.1.5 Photobiological safety claims and safeguards .....	11
2.2 Product ordering and receipt .....	14
<b>3 Method .....</b>	<b>15</b>
3.1 Control configuration .....	18
3.2 Hemisphere testing .....	18
3.3 Gonio testing .....	20
3.4 Application-distance testing .....	22
3.5 Photobiological safety testing .....	22
<b>4 Results and analysis .....</b>	<b>23</b>
4.1 Electrical input, UV-C output, and efficiency .....	23
4.2 UV spectrum .....	27
4.3 UV-C radiant intensity distribution .....	31
4.4 Near-field UV-C irradiance .....	40
4.5 Photobiological safety .....	43
4.6 Long-term performance .....	44
<b>5 Discussion .....</b>	<b>45</b>
5.1 Claims versus test results .....	45
5.1.1 Input power .....	46
5.1.2 UV-C output power .....	47
5.1.3 UV Spectrum .....	47
5.1.4 Intensity distribution .....	48
5.1.5 Irradiance .....	48
5.1.6 Photobiological safety .....	48
5.1.7 Long-term performance .....	49
5.2 LPM versus LED .....	49
5.2.1 Output power versus intensity distribution .....	50
5.2.2 Radiant efficiency and output ratio .....	50

5.3 Measurement and calculation methods.....	50
5.4 Testing challenges and limitations.....	51
<b>6 Conclusions.....</b>	<b>52</b>
6.1 Recommendations .....	53
<b>Appendix A – Missing or damaged product components.....</b>	<b>56</b>
<b>Appendix B – Alternative measurement of LED-22-04A .....</b>	<b>58</b>
<b>References.....</b>	<b>59</b>

# 1 Introduction





The safe and effective deployment and application of any germicidal ultraviolet (GUV) technology requires accurate data about product performance, particularly related to the emission of ultraviolet radiation. Measurement of ultraviolet radiation requires specialized equipment and test methods; some industry-standard test methods are still under development. This round of CALiPER testing provides independent measurements of 13 commercially available GUV products using currently available industry-standard test methods. Product evaluations of radiometric performance, electrical performance, and photobiological safety compare independent measurements to manufacturer or seller claims about the products. These evaluations do not consider germicidal efficacy (e.g., virus inactivation rate, required UV dose), which would require biological capabilities beyond the scope of the Lighting R&D program. This report identifies important issues with product radiometric performance data that must be addressed to support the needs of buyers and specifiers seeking safe and effective deployment of GUV technology. To this end, the report provides recommendations to numerous stakeholder groups, including manufacturers and sellers, specifiers and buyers, test laboratories, and industry standards development organizations.

There are three different bands of UV including UV-C (100–280 nm), UV-B (280–315 nm), and UV-A (315–400 nm). Most GUV products emit UV-C wavelengths because they have higher germicidal effectiveness than UV-A and UV-B and can be photobiologically safe for occupants when properly applied (IES 2021).

Several GUV lamp technologies generate UV-C. The most common types for air disinfection include low-pressure mercury (LPM), Krypton-Chlorine Excimer, and LED. LPM emits UV at a peak wavelength of 254 nm, Krypton-Chlorine Excimer at 222 nm, and LED at various wavelengths, though most commonly 255–275 nm in currently available products. The wavelength of the source impacts both the safety and germicidal effectiveness in the application.

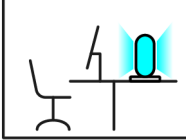
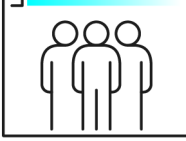
Table 1 shows a variety of GUV product types. Product designs target disinfection of air and/or surfaces. Some product designs aim to be safe in occupied spaces, while others should not operate when a room is occupied.

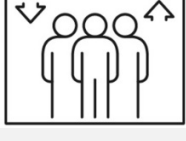
**Table 1: GUV Product Types. Round 1 of CALiPER GUV testing included towers, whole-room luminaires for vacant rooms, and whole-room luminaires for occupied rooms.**

	Product type	Description
	Wand	A handheld GUV device used to disinfect surfaces.
	Tower	A portable GUV device placed on horizontal surfaces such as floors or tables to disinfect air and surfaces; these products are generally intended for use when the room is unoccupied.
	Upper-room luminaire	A GUV device mounted to upper walls or ceilings to disinfect air in the portion of the room above occupants; this allows for safe use of the room when the device is operating, but requires sufficient air mixing between upper and lower portions of the room.
	Whole-room luminaire for vacant rooms	A GUV device mounted to ceilings to disinfect air and surfaces throughout the room; UV exposure is generally above safety limits, so safeguards are needed to prevent operation when the room is occupied.
	Whole-room luminaire for occupied rooms	A GUV device mounted to ceilings to disinfect air and surfaces throughout the room without exceeding safety limits, allowing for use in occupied rooms.
	In-duct unit	A GUV device installed in HVAC equipment, typically within or near the exit of an HVAC air-handling unit to disinfect air before it is supplied to a room; UV is contained inside the equipment, allowing for use in occupied rooms.
	Room air cleaner	A GUV device that uses a fan to draw air into a chamber and then exhausts disinfected air into a room; UV is contained inside the chamber, allowing for use in occupied rooms.

Round 1 of CALiPER GUV product testing focused on products that claimed to emit UV-C intended for air and surface disinfection within occupiable spaces. Occupiable spaces are enclosed spaces intended for human activities, excluding those spaces intended primarily for other purposes that are only occupied occasionally and for short periods of time (e.g., storage rooms, equipment rooms). For this round, CALiPER targeted direct-irradiation GUV products that had LED emitters or LPM lamps and fell into one of the following three categories:

- Products that are, or could potentially be, used as a lamp in GUV towers that are powered by cord and plug and placed on horizontal surfaces (e.g., floor, desk) indoors with no occupants present. Examples of LED products include screw-based integrated lamps provided with socketed stands for upright (base down) operation, and integrated lamps that could be used in this manner. In contrast, LPM products typically comprise a tower-style product with integral ballast and pin-based lamp(s).
- Ceiling-mounted GUV whole-room luminaires for use with occupants present.
- Ceiling-mounted GUV whole-room luminaires for use with no occupants present.

CALiPER targeted products that claimed to generate no ozone. Ozone generation begins around 242 nm and increases with decreasing UV-C wavelength (Claus 2021). The study prioritizes products with testable performance (e.g., input power, UV-C output, spectrum) or photobiological safety claims. CALiPER identified products that were available through major retailers (e.g., Amazon, Walmart) or other established purchasing channels (e.g., electrical distributors), or that had been featured in trade magazines and/or advertising campaigns.

## 2 Products acquired for testing

Figure 1 shows the LED and LPM products acquired for testing as GUV towers. CALiPER identifiers in the top left corner of each photo consist of GUV technology (e.g., LED, LPM), year of purchase (e.g., “22” denotes 2022), and a unique integer. All LED tower products included or consisted of integrated LED lamps with medium (E26) screw bases. Models LED-22-01, LED-22-02, and LED-22-05 had socketed stands. Marketing material for LED-22-04 included an image showing it installed in a socketed stand that appeared identical to the one provided with LED-22-02. Except for LED-22-03, all GUV towers had a wireless remote control with buttons for power (e.g., on, off) and timer settings (e.g., 30 minutes).

The following GUV towers were rated 110 V, with no statements in online documentation regarding frequency of input voltage waveform: LED-22-01, LED-22-03, LED-22-05, LPM-22-01, and LPM-22-02. The product labels (e.g., stickers, markings) on units received for LED-22-03 clarified the rated range is 110–130 V. Similarly, the product label on LPM-22-01 units stated 120 V and 60 Hz, and the product label on LPM-22-02 units stated 110 V and 50/60 Hz.

Figure 2 shows the LED tower lamps positioned base-up, without socketed stands, to show their relative sizes and provide a closer view of their LED emitters. All five models contained LED emitters that were white in appearance when not energized, and three of them (LED-22-01, LED-22-04, and LED-22-05) also contained LED emitters that were gold in appearance when not energized. In addition to the horizontally-directed LED emitters visible in the photo, all five models also had LED emitters located on the end of the lamp opposite the screw base. LPM-22-01 was approximately 23 inches tall, versus 20 inches for LPM-22-02, and both had one 4-pin 2G11 single-ended lamp, oriented base-down.



Figure 1. LED and LPM tower products. Photo credit: PNNL (Andrea Starr).



Figure 2. Lineup of LED tower lamps to show details and relative sizes. Measured lengths in inches were 7.0 for LED-22-01, 9.2 for LED-22-02, 3.7 for LED-22-03, 7.0 for LED-22-04, and 5.1 for LED-22-05. Photo credit: PNNL (Andrea Starr).

Figure 3 shows the LED and LPM products acquired for testing as ceiling-mounted GUV whole-room luminaires, including two subcategories of whole-room luminaires: (1) those intended for use in occupied rooms (termed *occupied-room luminaires*) and (2) those for use in vacant rooms (termed *vacant-room luminaires*). LED-22-06 has a surface-mounted design, while LPM-22-05 is typically suspended from the ceiling. The other LPM luminaires in this round of CALiPER testing were troffers designed to be recessed into the ceiling. The point of view for the LPM luminaires is up into the radiant aperture, from just beyond one end, with lamp ends visible at the other end. Whereas LED-22-06 was an occupied-room luminaire, the LPM products were all vacant-room luminaires. LPM-22-04 had 4-pin 2G11 single-ended lamps, while the other LPM luminaires all had double-ended T8 lamps with G13 bases. LPM-22-07 had an internal fan (“CE-listed Frictionless Fan Disperses UVC for a 30% Increase of Efficiency”) that is not visible from below and exhausts up into the ceiling plenum; the fan was rated 12 V and 0.18 A according to its label.

All whole-room luminaires were rated for alternating current (AC) operation at 120 V. The datasheets for some products (LED-22-06, LPM-22-04, LPM-22-05, and LPM-22-06) did not state rated frequency, but labels on units received indicated they were rated for 60 Hz.

## 2.1 Performance and safety claims

The following sections summarize claims pertaining to performance (electrical, radiometric, spectral) and photobiological safety (i.e., regarding skin and eye), which can be relatively straightforward to test. Claims pertaining to ozone generation and longevity are also shown for reference.

In contrast, evaluation of germicidal efficacy and associated claims is complex and beyond the scope of this report. Many brands and vendors made such claims (e.g., “Killing rate up to 99.99%”) but lacked critical pieces of information such as target pathogen, duration of operation, or geometries (e.g., distance from GUV source to measurement point, detector orientation). Evaluation of products, like LED-22-06, that are intended for use in occupied spaces is further complicated by the need for information regarding the occupants (e.g., count, spacing). However, evaluation of germicidal efficacy may be included in future reports as industry standards become available for use in determining the required dose. Other researchers are better able to make such efficacy measurements (characterizing treatment results), but designers need that data in combination with the kinds of measurement data addressed in this study (enabling treatment characterization) to yield safe and effective GUV systems.



Figure 3. LED and LPM whole-room luminaires, viewed from below and to one side. LED-22-06 had a 5-inch diameter and protruded 2.1 inches below ceiling. LPM-22-03 and LPM-22-04 were 2x2 troffers, measuring 2 feet on each side in plan. LPM-22-05 was a high-bay luminaire measuring 14x48 inches in plan. LPM-22-06 and LPM-22-07 were 2x4 troffers. Troffers are intended to be recessed into the ceiling but are shown surface-mounted. Photo credit: PNNL (Andrea Starr).

### 2.1.1 Electrical and radiometric performance claims

Table 2 summarizes electrical and radiometric performance claims found in online documentation or in materials included with the acquired units (e.g., product packaging, user manuals, product labels). If a claim is shown from the vendor but not from the manufacturer, then the latter made no differing claim.



**Table 2. Electrical and radiometric performance claims. Bold font denotes text pertaining to radiant output power or irradiance. Note that “uW” is sometimes used in lieu of “µW” to denote microwatts.**

Product type	Product	Claims
Tower	LED-22-01	“Rated power: 60W” * “Question: How many watts is your product? Answer: 7W” *
	LED-22-02	“Light Source Wattage 100 Watts” * “Sterilizing lamp CE ROHS 90W” * “UV Germicidal Lamp 100W” §
	LED-22-03	-
	LED-22-04	“Wattage 30 watts” * “Question: What's the uv-c power for this light bulb (hint: it's usually a very small percentage of the total power)? Answer: 30 watt power” *
	LED-22-05	“Light Source Wattage 36 Watts” *
	LPM-22-01	“Power: 55w” *
	LPM-22-02	“Wattage: 60W” † “Powerful 60Watts of UVC” † “Output Wattage: 170-180µW/cm <sup>2</sup> ” †
Occupied-room luminaire	LED-22-06	“System Power Factor (PF): >0.9” † “Total Harmonic Distortion (THD): <20%” † “Input wattage: 3.88W” † “Output Value [...] 2300uW” †
Vacant-room luminaire	LPM-22-03	“Total Watts: 60W” † “Single-lamp Watts: 20W” † “Single-lamp UV-C Output: 9.1W (27.3W Total)” †
	LPM-22-04	“Power: 110W” *† “Rated Power 2*55W UVC” ‡ “UV Strength: ≥380 µW/cm <sup>2</sup> (at 3.5 ft)” *†‡ “≥380 µW/cm <sup>2</sup> (at 3.5 ft) UV Intensity” ‡
	LPM-22-05	“Input Watts 175.2” † “Irradiance (mW) 45691.4” †
	LPM-22-06	“4 ft lamp: 40W each” † “Electrical 40W-80W” † “For line volt-amperes multiply total lamp wattage by 1.5” §
	LPM-22-07	“160W, 110V-277V; 60Hz Electrical Operation” † “(4) 20W UVC Tubes” † “Total UV Output 79.2W” * “Power: 160W” §
Notes		
* Claim from vendor website, including seller responses to questions from customers		
† Claim from manufacturer website or its downloadable product documentation		
‡ Claim from product packaging or printed product documentation received with unit		
§ Text from product label		

The seller of LED-22-01 claimed 7 W input power once in an online Q&A, versus several 60 W claims that the product webpage displays more prominently. This product had 7 LEDs that were described by the seller as UV-C (see Table 3). This study only considers the 60 W claim in later sections.

Manufacturer claims were not always clear whether power (frequently referred to as “wattage”) pertained to electrical input or radiant output. For example, the manufacturer website for LPM-22-02 claimed “60 Watts of UVC” (which could be interpreted as radiant output power), but also claimed a “wattage” of this same numerical value (which could be interpreted as electrical input power). The website further claimed an “output

wattage” of 170–180  $\mu\text{W}/\text{cm}^2$ , where the units would normally correspond to irradiance (the density of radiant flux landing on a surface), but such an irradiance claim would have little meaning because the manufacturer does not specify the geometric relationship (e.g., distance) between product and measurement point. Similarly, LPM-22-05 claimed an “irradiance” of 45,691.4 mW, but this presumably refers instead to radiant output power.

The datasheet for LPM-22-04 claimed a minimum irradiance (termed “strength” or “intensity”) value “at 3.5 ft” but it was not clear whether this distance was measured from floor (corresponding to the height of some countertops) or from luminaire, and the manufacturer did not state the assumed distance from floor to luminaire. The manufacturer datasheet for LPM-22-06 included a set of what appear to be irradiance claims at various distances directly below center of luminaire; Section 4.4 tabulates these values for comparison with measured irradiance. The manufacturer datasheet for LPM-22-07 showed an irradiance grid but did not state the corresponding geometries (e.g., distance to luminaire) or depreciation factors, precluding any testing of claims.

In some cases, it was difficult to determine whether differences in claimed power for LPM luminaires and their lamp(s) were attributable to ballast factor (BF) or something else.<sup>6</sup> For example, the manufacturer webpage and downloadable datasheet for LPM-22-03 indicated 60 W for the luminaire and 20 W for each of the three lamps (apparently referring to input power), but the instruction manual indicated 51 W using T8 LED lamps. In contrast, the build list included with the acquired units indicated the lamps were UV-C and rated 17 W, and the datasheet for the listed ballast indicated such lamps would operate at 1.04 BF for 53 W combined input power. The manufacturer’s webpage and datasheet for the luminaire claimed 4.5 W of UV-C output per lamp in one place and 9.1 W in another, and their downloadable instruction manual for the replacement lamp stated, “This 20-watt unit offers 7.5 watts of UV-C output.” Similarly, whereas the datasheet for LPM-22-06 only stated nominal power for its lamps (20 W each for 2-foot length, or 40 W each for 4-foot length), its webpage only stated a range of 40–80 W for “electrical” (apparently corresponding to 2-lamp or 4-lamp versions of its 2x2 luminaire).

The product packaging for acquired LED-22-02 units appeared to be for a general illumination product (e.g., “Saving up to 80% energy compared to traditional incandescent bulbs”). The seller’s webpage for LED-22-04 not only claimed to emit UV-C, but also claimed 3,750 lumens of light output, without clarifying whether these values correspond to different operating modes. Similarly, the manufacturer webpages for both LPM-22-03 and its replacement lamps described them as “UV-C fluorescent.”

The user manual included with acquired LED-22-05 units showed a polar plot for a half-plane of radiant intensity data, presumably pertaining to a single LED emitter, rather than all the emitters in combination; the intensity distribution appeared to be roughly Lambertian (i.e., following the cosine of the angle from center of beam) (IES 2022a; CIE 2020).<sup>7</sup> Meanwhile, the manufacturer’s online documentation for LED-22-06 included a polar plot showing two half-planes (presumably in the same vertical plane) of radiant intensity data; Section 4.3 shows this plot for comparison with the measured intensity distribution.

Occupied-room luminaire LED-22-06 was unique among the tested products in having claims for power factor or total harmonic distortion (THD) of the current waveform.

---

<sup>6</sup> BF is the fraction of flux produced by lamp(s) when powered by a commercially-available ballast, divided by the rated flux produced when powered by a reference ballast (IES 2022a). It does not enable reliable determination of ballast input power, but can enable a rough estimate if ballast efficiency is considered (e.g., three 20 W lamps on a 0.88 BF ballast with 88% efficiency might yield ~60 W ballast input power). BF is currently defined based on luminous flux (for lighting products), but has been used by manufacturers to describe ballasts marketed for use with UV lamps.

<sup>7</sup> Radiant intensity is formally defined in industry-standard glossaries. It can be thought of as the density of radiant flux emitted from a point source into the adjacent tip of a conical region of space, which is in turn termed a solid angle. After measuring radiant intensity in many directions, capturing the intensity distribution of a luminaire, this data can be used to calculate other quantities like irradiance and total radiant flux.

### 2.1.2 UV spectrum claims

Table 3 summarizes claims pertaining to UV spectrum for LED products. In addition to claiming a wavelength of 250–255 nm, the seller’s webpage for LED-22-04 included a spectral power distribution (SPD) with peak wavelength around 264 nm, and claimed a color temperature of 7200 K, without clarifying whether these values correspond to different operating modes.<sup>8</sup> Similarly, the seller’s webpage for LED-22-05 included an SPD with peak at ~278 nm, and the user manual included with acquired units showed a “Typ” peak wavelength of 275 nm. Section 4.2 shows these SPDs for comparison with measured SPDs.

**Table 3. UV spectrum claims for LED products. Some UV-C claims without mention of wavelength are instead shown in Table 2. Note that some text was identical for LED-22-01 and LED-22-02.**

Product type	Product	Claims
Tower	LED-22-01	“LED chip: 165 UV LED, 7 UVC and 158 UVA” * “240-280NM COMPREHENSIVE THOROUGH STERILIZATION” * “UVA(315-400nm) has the characteristics of killing micro pests” *
	LED-22-02	“Wavelength : 260-280 nm” * “240-280NM COMPREHENSIVE THOROUGH STERILIZATION” * “UVA(315-400nm) has the characteristics of killing” *
	LED-22-03	“Wavelength: 255 (nm)” *
	LED-22-04	“Wavelength: 250-255 nm” *
	LED-22-05	“100% ACTUAL UVC LED” * “9 pcs of 100% actual UV-C LED beads with 260-280nm spectrum” * “Lab Test report with actual 260nm-280nm UV-C spectrum” *
Occupied-room luminaire	LED-22-06	“UV Output 254nm ± 5nm” †
Notes		
* Claim from vendor website, including seller responses to questions from customers		
† Claim from manufacturer website or its downloadable product documentation		
‡ Claim from product packaging or printed product documentation received with unit		

All LPM products claimed 253.7 nm or 254 nm as the peak wavelength. Product packaging for two of three LPM-22-02 units additionally claimed “Wavelength: ~180nm.” The brand website and downloadable documentation for LPM-22-03 stated “UV Wavelength: 200nm - 280nm (254nm).”

### 2.1.3 Ozone generation claims

Some products are designed to generate ozone for disinfection purposes; however, ozone is hazardous when concentrations exceed safety thresholds, and its germicidal efficacy has been questioned (EPA 2022). UV-C begins generating some ozone through photolysis of diatomic oxygen at ~242 nm, with the rate generally increasing as UV-C wavelength decreases, and ozone is strongly generated at wavelengths shorter than 200 nm (Blatchley et al. 2022). The Occupational Safety & Health Administration (OSHA) specifies a Permissible Exposure Limit of 0.2 mg/m<sup>3</sup> (0.1 parts per million [ppm]) for ozone, measured as a time-weighted average over an 8-hour period (OSHA 2022). The National Institute for Occupational Safety and Health (NIOSH) publishes the same 0.1 ppm value as a Recommended Exposure Limit, but specifically as a “ceiling” value that should not be exceeded at any time (NIOSH 2016).

Some vendors and manufacturers appeared to make conflicting statements regarding ozone generation (e.g., claiming no ozone but recommending ventilation before returning to the treated space), as shown in Table 4.

<sup>8</sup> The term “spectral power distribution” and its abbreviation (SPD) specifically apply to measurements of spectral distribution (CIE 2020) of radiant flux (or power), with units of power divided by wavelength (e.g., W/nm), but are often generically applied to other quantities. For simplicity, CALiPER uses “SPD” in this generic manner to describe both spectral distribution of irradiance (e.g., W/m<sup>2</sup>/nm) and spectral distribution of radiant flux. There is no functional difference for the purpose of evaluating spectral distributions, but the difference matters in other contexts (e.g., integrating for total radiant flux).

This is illustrated by LPM-22-01, which was marketed as producing no ozone, but also claimed to generate less than 0.2 mg/m<sup>3</sup> of some unspecified substance. One possible explanation is that the associated odor is due to something other than ozone, such as thiol molecules (Brais and Despatis 2018; Claus 2021). However, the claimed maximum concentration for that product matches the ozone limits specified by NIOSH and OSHA.

The manufacturer of LPM-22-02 marketed the device as ozone-free, but two of the three units CALiPER received stated “ozone purification” on their packaging. Whereas product packaging for those two units both had claimed wavelengths of 253.7 nm and ~180 nm, product packaging for the third unit only claimed 253.7 nm. While the two “ozone purification” units came with “Ozone Version” user manuals dated September 2020, the other unit had a manual dated September 2021, suggesting the former may have been discontinued.

Product documentation for LED-22-06 claimed compliance with California’s ozone limit (CARB 2022).

**Table 4. Claims pertaining to ozone generation. Orange font denotes text that potentially indicates ozone is generated. Bold font denotes text that more clearly indicates ozone is generated.**

Product type	Product	Claims
Tower	LED-22-01	“ozone free” * “after disinfecting the room, wait a few minutes before entering the room, please open the window for ventilation immediately” *
	LED-22-02	-
	LED-22-03	-
	LED-22-04	“no bad Ozone smell” * “no ozone” ‡ “After the bulb finishes working, pls ventilate the scene for 20 minutes” ‡
	LED-22-05	“100% OZONE AND CHEMICAL FREE” *
	LPM-22-01	“After disinfection, you can smell a little odor. It is NOT Ozone. The smell is lower than 0.2mg/m <sup>3</sup> , so it is not harmful to human body. It is some kind of taste of decomposition of bacteria such as mites.” *
	LPM-22-02	“uses an ozone-free bulb, and creates no odor or ozone” * “Ozone Version” ‡ “After the operation cycle completes and the ozone has dissipated, the room is safe to re-enter” ‡ “After the operation cycle completes, the room is safe to re-enter” ‡
Occupied-room luminaire	LED-22-06	“A UVC device has a potential to emit ozone [...] devices meet California ozone emissions limit: CARB certified” †
Vacant-room luminaire	LPM-22-03	“This lamp DOES NOT produce ozone” *†
	LPM-22-04	-
	LPM-22-05	“Special lamp glass filters out the 185 nm ozone-forming radiation” † “Plants and/or materials that are exposed to UV-C and/or ozone for a long time may become damaged and/or discolored” †
	LPM-22-06	“Produces no ozone or other secondary contaminants” *†
	LPM-22-07	-
Notes		
* Claim from vendor website, including seller responses to questions from customers		
† Claim from manufacturer website or its downloadable product documentation		
‡ Claim from product packaging or printed product documentation received with unit		

### 2.1.4 Longevity claims

Table 5 summarizes claims pertaining to long-term performance and longevity. No explicit claim of rated life was found for LED-22-05, but its seller offered a two-year warranty, which implies a lifetime of at least 17,520 h. Product documentation for LED-22-06 claimed it would last approximately one year in continuous operation; this equates to 8,760 h for a non-leap year, similar to rated life for LPM lamps. The datasheet for the lamps used in LPM-22-05 was unique among tested products in claiming a specific value (10%) for depreciation at their “useful life” of 9,000 h. It also claimed 15.0 W of “UV-C Radiation at 100 hr” per lamp, so they would each be expected to produce 13.5 W of UV-C at 9,000 h when operated on a 1.0 BF ballast.

**Table 5. Long-term performance claims. Bold font denotes claims describing reduction of UV-C output with use, relative to initial output.**

Product type	Product	Claims
Tower	LED-22-01	“50,000H Long Working Life” *
	LED-22-02	“This LED UVC Germicidal light bulb have up to 50000 hrs lifespan.”*
	LED-22-03	“Service life: 20000 (H)” *
	LED-22-04	“Average Life 50000 Hours” *
	LED-22-05	“2 years warranty and free replacement service” *
	LPM-22-01	“Bulb Service Life: 8000 hours” *
	LPM-22-02	“Good for 9,000 hours” *†
Occupied-room luminaire	LED-22-06	“Assuming correct professional installation and 24-hour operation [...] should provide continuous air disinfection for approximately one year” †
Vacant-room luminaire	LPM-22-03	“bulbs [...] with an expected lifespan of 8,000+ hours” *†
	LPM-22-04	“Bulb Lifespan: ≥8,000 hours” *†
	LPM-22-05	“Useful Life (Nom) 9000 h” † <b>“Depreciation at Useful Lifetime 10 %” †</b>
	LPM-22-06	“For optimum results, replace UVC lamps after 9,000 hours or one year of operation” *†
	LPM-22-07	“Lamp Lifespan 8,000hrs or 9 years per recommended settings” †
Notes		
* Claim from vendor website, including seller responses to questions from customers		
† Claim from manufacturer website or its downloadable product documentation		

### 2.1.5 Photobiological safety claims and safeguards

Table 6 summarizes claims pertaining to photobiological safety and relevant safeguards. LED-22-03 provided no warnings regarding UV-C exposure online or in materials received with the acquired units. Webpages and downloadable documentation for the other tower products had clear warnings for users to leave the room with the unit in operation, but warnings on product labels and other materials received with the acquired units were often absent or more limited. LED-22-02 had no such warnings in materials received, and none of the LED towers had warnings on their product labels. LPM-22-01 had a product label that warned users to avoid looking directly at the product, but only its user manual recommended leaving the room.

**Table 6. Specific claims (bold) or guidance pertaining to photobiological safety. A dash indicates no relevant text was found. Orange font denotes claims pertaining to motion or occupancy sensors.**

Product type	Product	Text
Tower	LED-22-01	“After the germicidal lamp is turned on, people should not be in the sterilization room” * “Long-term exposure to ultraviolet rays will burn people’s skin and glasses, please do not close contact with ultraviolet rays” ‡
	LED-22-02	“People / pet / plant can’t be exposed to the UVC light, must left room when lamp work.” *
	LED-22-03	-
	LED-22-04	“You must leave your room” * “People, animals and plants must leave the scene” ‡
	LED-22-05	“humans and animals and plants must leave the room” * <b>“Stay away at least 1 meter’s distance when it’s working” ‡</b> “people and animals and plants must leave the scene” ‡
	LPM-22-01	“Leave the room now” * “Make sure to leave the room once the device is in operation” †‡
	LPM-22-02	<b>“Three (3) meter motion detection sensors” *†</b> “It is not recommended to be in the room when using” *† <b>“5-Meter Motion detection sensors” ‡</b> “people and animals must leave the room quickly” §
Occupied-room luminaire	LED-22-06	“products comply with <b>UL 8802 Outline of Investigation for UV Germicidal Equipment and Systems</b> , IEC 62471 Photobiological Safety of Lamps and Lamp Systems standards, and American Conference of Governmental Industrial Hygienists (ACGIH®) TLVs® guidelines over an 8-hour period when installed as directed” † <b>“Minimum Ceiling Height 8’0” and above” †</b> <b>“MOUNT THIS EQUIPMENT AT LEAST 10 FT ABOVE THE FLOOR (0.075 CEILING HEIGHT).” §</b>
Vacant-room luminaire	LPM-22-03	“do not operate the device in any application that allows UV-C light to be visible during operation” *†‡ “Do not expose this UVC light to human skin or eyes” §
	LPM-22-04	“Clear area of people, plants, and animals” *†‡ <b>“360° motion sensor deactivates the lamp when it detects movement within 16 feet” †</b>
	LPM-22-05	“For proper UL certified permanent installations, a controls system must be used [...] As an example, the system would consist of a control panel with optional components including checkpoint switches, door switches, warning lights, emergency stop switches, and motion detectors” † “UV-C RISK GROUP 3” ‡ <b>“HIGHEST IRRADIANCE AT 500MM 5.224 mw/cm<sup>2</sup>” §</b> “AVOID EYE AND SKIN EXPOSURE TO UNSHIELDED PRODUCT” §
	LPM-22-06	“Designed for unoccupied spaces” † “Protect eyes and skin from exposure to UV light” §
	LPM-22-07	<b>“5 safety features to ensure non-occupancy based operation” *†</b> “system is not to be used in the presence of individuals without protective gear” §

Notes

\* Text from vendor website, including seller responses to questions from customers

† Text from manufacturer website or its downloadable product documentation

‡ Text from product packaging or printed product documentation received with unit

§ Text from product label

Some product documentation included claims regarding IEC 62471 (IEC 2006) risk group (RG), minimum distance, or maximum irradiance:

- The manual for tower LED-22-05 warned users to stay at least 1 m from the product when in operation, which suggests occupants might be safe from harm at this distance.
- Occupied-room luminaire LED-22-06 was a second-generation design, with the most obvious difference from the first-generation design being the addition of a reflector suspended below the canopy via three supports. CALiPER ordered the second-generation product configured to be mounted to ceilings that are at least 8 feet above the floor, and the units received matched the physical appearance of the product in online marketing materials (e.g., with the reflector), but all product labeling and materials received with the units pertained instead to the first-generation design (which had no such reflector). For example, the product label indicated a minimum ceiling height of 10 feet, which roughly corresponded to a specifiable configuration for the first-generation product (namely for mounting heights of 10–11 feet) but not for the second-generation product. Also, the downloadable installation instructions for the second-generation product warned that installers should only turn the unit on once all personnel are located in (rather than above) the occupied space, which the document defined as the portion of a room within 7 feet of the floor. With a luminaire thickness of about 2 inches, and a ceiling height of 8 feet, the minimum distance to occupied space would then be 10 inches.
- The webpage for LPM-22-03 provided an IEC 62471:2006 test report indicating a risk group (RG) of 3 (“High-Risk”) for its lamp, based on a test distance of 200 mm, but no such report or rating was available for the luminaire.
- The instructions included with the LPM-22-05 units stated that the luminaire is RG-3. The product labels on the 4-lamp luminaires stated maximum irradiance “at 500 mm” is 5.224 mW/cm<sup>2</sup> but, as with LPM-22-04, did not clarify whether this distance is from luminaire or from floor. In addition, the instructions claimed this same irradiance value for a 1-lamp luminaire (which was not an available configuration for this model) and did not make any claim for a 4-lamp luminaire. Whereas the “at 3.5 ft” for LPM-22-04 might be interpreted as meaning 42-inch counter height, 500 mm equates to about 20 inches, which would be slightly above a typical chair seat. Furthermore, whereas a minimum height could be reasonably assumed for troffer LPM-22-04, no such assumption can be made for this “high bay” style luminaire, so the stated distance is assumed to be from the luminaire rather than from the floor.

Some products used other safeguards to help protect occupants from excessive UV-C exposure:

- Packaging for tower LPM-22-02 included a doorknob hanger, stating “For your Safety we ask you do not enter while the UV-C light is active.”
- Except for LED-22-03, all products tested as towers had timer controls to limit the duration of operation (and potential exposure). Some also claimed a delayed start, providing time for the user to leave the room: LED-22-04 (15 s), LPM-22-01 (30 s per the user manual or 60 s per the website), and LPM-22-02 (10 s).
- All tower products except LED-22-03 were provided with wireless controls to set timers remotely. Some had a power (on or off) button and buttons for timer settings of 15, 30, or 60 minutes (LED-22-01, LED-22-02, LED-22-04, LPM-22-01). The remote for LED-22-05 had two buttons for power (on and off) and two timer buttons (15 or 30 minutes) that differed from those shown on the seller’s webpage (30 or 60 minutes). The remote for LPM-22-02 had a power (on or off) button and buttons for timer settings of 15, 30, 45, or 60 minutes. Vacant-room luminaire LPM-22-04 also had a remote control, with a button for power and five buttons for timer settings (15, 30, 45, or 60 minutes, or “Max”).

- Some tower products also had built-in buttons or switches to enable direct control. Towers LED-22-01 and LED-22-05 both had a switched cord. LPM-22-01 had a power (on or off) button and a timer button to select a duration of 15, 30, or 60 minutes. LPM-22-02 had a timer button for 15, 30, 45, or 60 minutes. Vacant-room luminaire LPM-22-04 had a switch on the side of the luminaire (not visible from below) to select either the remote or a wall switch for control of the timer.
- Three products had integral motion sensors to prevent operation in occupied spaces: tower LPM-22-02, as well as vacant-room luminaires LPM-22-04 and LPM-22-07. Following interruption of a cycle due to sensed occupancy, LPM-22-02 was designed to resume operation 10 s after detecting no occupant, to complete the cycle; LPM-22-04 was similarly designed to resume after 20 s of no detected motion.

Tower products LED-22-02 and LED-22-03 did not include any printed owner’s manual, user’s guide, or instructions. LED-22-01 included “installation instructions” but only provided specifications and warnings that did not address use of remote control or timer function. LED-22-04 had similar information on its packaging, with no other instructions. LED-22-05 included instructions that did not address the timer function but did state, “Turn on the power switch.” Some product webpages provided additional guidance:

- The seller’s webpage for LED-22-01 provided instructions that addressed timer configuration, concluding with: “Leave room, turn on remote control switch ‘ON’ and time setting.”
- The seller’s webpage for LED-22-02 specified use of the remote control (“Install this light in target room and turn it on to start irradiate”) but not the timer function.
- The seller’s webpage for LED-22-04 similarly specified use of the remote control (“Screw-in the U-V bulb and press the ‘start Button’ on the remote controller, the light will start to clean”) but not the timer function.

In contrast, towers LPM-22-01 and LPM-22-02 both came with printed instructions that addressed use of remote control and timer function. Vacant-room luminaire LPM-22-04 only had brief instructions on a label on top of the luminaire, saying that after it is installed and connected to power, the remote control should be used to power it on and set the timer. Similarly, vacant-room luminaire LPM-22-07 came with no instructions.

## 2.2 Product ordering and receipt

Table 7 summarizes the months in 2022 during which products were ordered, and the number of weeks until they were received, rounded up to the nearest integer. CALiPER purchased at least three units of each model to provide spares (e.g., to replace damaged or non-functioning units) and to simplify long-term testing or enable future round-robin testing. Letters appended to CALiPER base identifiers indicate specific units of a given model. For example, the three units of model LED-22-01 were: LED-22-01A, LED-22-01B, and LED-22-01C.

Some received units did not appear to match what had been ordered. Units LPM-22-02A and LPM-22-02B had packing and user manuals indicating ozone would be generated, while LPM-22-02C had no such indication. Similarly, while the units received for LED-22-06 matched the appearance of the second-generation design ordered, all printed materials corresponded to the first-generation design that had no reflector, so the model number of units received was unclear. In addition, whereas the datasheet for LPM-22-06 showed arched white reflectors above lamps, the units received had specular (mirror-like) reflectors folded at abrupt angles.



Table 7. Product acquisition information, including month in 2022 in which products were ordered, with approximate number of weeks until products were received. Lead times are rounded up to the nearest integer. Purchasing channels are also shown for reference, without identifying electrical distributors (which CALiPER may reuse for non-retail products) or product brands.

Product type	Product	Month ordered	Approximate lead time (weeks)	Purchased from
Tower	LED-22-01	Feb	1	amazon.com
	LED-22-02	Feb	1	amazon.com
	LED-22-03	Feb	2	walmart.com
	LED-22-04	Mar	2	amazon.com
	LED-22-05	Mar	1	amazon.com
	LPM-22-01	Feb	1	amazon.com
	LPM-22-02	Feb	1	brand website
Occupied-room luminaire	LED-22-06	May	6	electrical distributor
Vacant-room luminaire	LPM-22-03	Feb	1	brand website
	LPM-22-04	Feb	2	midwesttechnology.com
	LPM-22-05	Feb	8	electrical distributor
	LPM-22-06	May	8	electrical distributor
	LPM-22-07	Feb	2	brand website

Several units were received with apparently minor flaws or damage to packaging and/or the product itself (e.g., corners of housing bent), and were deemed fit for testing. In other cases, lamps had broken in the luminaire or the product was missing a ballast, so those units were excluded from testing. Appendix A provides a summary of the damaged units with example photos.

### 3 Method

CALiPER testing of GUV luminaires evaluates products in accordance with available industry-standard test methods, to the extent possible, recognizing that they in some cases do not yet directly address UV-C measurements. LPM products were tested to ANSI/IES LM-41-20 (IES 2020a) and LED products were tested to ANSI/IES LM-79-19 (IES 2019a). Each device under test (DUT) was evaluated using one or more of the following industry-standard methods:

- Measurements via integrating sphere (referred to herein as *sphere* testing) were based on ANSI/IES LM-78-20 (IES 2020b).
- Measurements via goniometer (referred to herein as *gonio* testing) were based on ANSI/IES LM-75-19 (IES 2019b), and in the case of bare-lamp testing, ANSI/IES LM-9-20 (IES 2020c) as well.
- Application-distance irradiance measurements were based on ANSI/IES LM-91-22 (IES 2022c), enabling assessment in the near field, where the inverse-square law cannot be used reliably (IES 2022a; CIE 2020).
- Photobiological safety testing was in accordance with IEC 62471:2006 (IEC 2006).
- Measurements of long-term performance were based on the above (either sphere or gonio), with DUTs operated continuously between measurements under conditions based on ANSI/IES LM-84-20 (IES 2020d).

Use of spectroradiometers (e.g., for SPD measurements) was in accordance with ANSI/IES LM-58-20 (IES 2020e), except for photobiological safety testing. AC input voltage and frequency were 120 V and 60 Hz, respectively, with tolerances in accordance with IES LM-79 for LED and IES LM-41 for LPM.

Ambient ozone concentration was monitored to ensure personnel safety, but measurement of ozone generation rate was not included in the scope of testing (i.e., no use of a controlled environmental chamber).

CALiPER required the laboratories it used to be accredited to ISO 17025 (ISO 2017) for the relevant test methods. This inaugural round of GUV product testing was conducted by a single laboratory (Intertek Testing Services). Future rounds of GUV testing are expected to include at least one additional laboratory.

Table 8 provides an overview of the testing conducted for each unit. All products were tested for initial performance via gonio. For LED products, “initial” means at 0 h of operation (in accordance with IES LM-79). In contrast, prior to “initial” testing of LPM towers and whole-room luminaires, the lamps were operated (“seasoned”) for 100 h, in accordance with IES LM-41 and ANSI/IES LM-54-20 (IES 2020f). Seasoning was performed with lamps removed from products to avoid degradation of other components from prolonged UV exposure. For some products, additional units were used exclusively for long-term performance testing, with measurements taken after 0 h, 100 h, and 500 h of operation; sphere measurements characterized products that were sufficiently small. In contrast to units tested for initial performance, long-term testing of LPM units used unseasoned lamps.

Long-term CALiPER testing was limited but included a range of products. Tower LED-22-05 and occupied-room luminaire LED-22-06 emitted UV-C and were small enough to be installed in the integrating hemisphere without a direct line of sight to its detector or auxiliary lamp. The lamps provided with LPM-22-03 were generic (i.e., had no markings), and the upper reflector pan appeared to have a “Flat White Polyester Finish” (according to the product datasheet) that might degrade when exposed to UV-C. In contrast, LPM-22-05 had brand-name lamps and a specular (mirror-like) finish on the upper reflector.

**Table 8. Product test matrix overview.**

Product type	DUT	Sphere	Gonio	Near-field	Photobiological safety
Tower	LED-22-01A		Initial		
	LED-22-02A		Initial		
	LED-22-03A		Initial		
	LED-22-04A		Initial		
	LED-22-05A		Initial		Initial
	LED-22-05B	Long-term			
	LPM-22-01A		Initial		
	LPM-22-02C		Initial		
Occupied-room luminaire	LED-22-06B	Long-term			
	LED-22-06C	Initial	Initial	Initial	Initial
Vacant-room luminaire	LPM-22-03A		Initial		
	LPM-22-03B		Long-term		
	LPM-22-04A		Initial	Initial	
	LPM-22-05A		Initial	Initial	
	LPM-22-05B		Long-term		
	LPM-22-06A		Initial	Initial	
	LPM-22-07B		Initial		

Testing included measurement of the following electrical and radiometric quantities:

- Electrical measurement data included input voltage, input current, active power (i.e., input power), power factor, and total harmonic distortion (THD) of the input current waveform (i.e., current THD). Voltage and current were expressed as root-mean-square (RMS) values. Power factor accounts for both displacement and distortion. Active power is the real part of complex power under sinusoidal conditions. In addition, apparent power was calculated as the product of measured input voltage and current.
- Radiometric measurement data included SPD from 200–400 nm, UV-C radiant intensity distribution, UV-C radiant flux (i.e., UV-C output power), and UV-C irradiance.<sup>9</sup> With some exceptions for products tested long-term, one SPD was generated from each sphere test, and each gonio test included at least one SPD. The measurement resolution for SPDs from sphere testing was 1 nm; the measurement resolution for SPDs from gonio testing was 2 nm, with values at intermediate wavelengths subsequently interpolated using the spectroradiometer’s software.

These measurements permitted calculation of two efficiency metrics:

- UV-C radiant efficiency (IES 2022a), which could also be termed UV-C wall-plug efficiency (IEC 2020), is calculated as the ratio of a product’s UV-C output power to its electrical input power. This metric can be applied to any GUV product that is not powered by batteries.
- UV-C output ratio (CIE 2020) is calculated as the UV-C output power from a luminaire, divided by the combined UV-C output power from its lamp(s) when operated together on its ballast(s) outside the luminaire (i.e., bare-lamp); it can be thought of as the UV-C luminaire:lamp efficiency. This metric is analogous to the *luminaire efficiency* used to characterize lighting products that are suitable for relative radiometry,<sup>10</sup> and gauges the portion of lamp output that is not trapped inside the luminaire. Bare-lamp testing, in combination with whole-luminaire testing, enables determination of the UV-C output ratio for products with pin-based LPM lamps, and is discussed in Section 0. Bare-lamp testing was conducted for LPM-22-03B, LPM-22-04A, LPM-22-05B, LPM-22-06A, and LPM-22-07B.

IEC 62471 risk group (RG) classifications were based on measurements of irradiance and SPD. Notably, these classifications were only based on assessment of the Actinic UV and Near UV hazards (e.g., without consideration of the Blue Light hazard).

Products were oriented as intended by the manufacturer (i.e., towers base-down, ceiling-mounted whole-room luminaires facing floor) for all testing, except when measuring spectral irradiance from whole-room luminaires, as explained in Section 0.

Two units were removed from testing. The external power supply for LED-22-06A was damaged at the start of testing due to misinterpretation of installation instructions and replaced with LED-22-06C. Unit LPM-22-02A generated ozone in concentrations that exceeded 100 ppb and could not be safely mitigated with available room ventilation. Materials received with unit LPM-22-02B (e.g., product labels, printed manual) appeared identical to those for LPM-22-02A (which indicated ozone would be generated), but materials received with unit LPM-22-02C had no indication that it would generate ozone. Consequently, LPM-22-02A was replaced with LPM-22-02C, which did not cause ambient ozone to exceed 100 ppb.

---

<sup>9</sup> UV-C is from 100-280 nm, UV-B is from 280-315 nm, and UV-A (which overlaps the visible spectrum) is from 315-400 nm (CIE 2020).

<sup>10</sup> According to IES LM-79, products with integrated LED emitters must be tested using absolute radiometry. In contrast, luminaires with replaceable lamps (e.g., LPM) can be measured using relative or absolute radiometry.

### 3.1 Control configuration

The test laboratory explored the effect of the remote controls on the LED towers and then determined whether and how to use them as described below.

- LED-22-01 and LED-22-04: Prior to testing, the DUT was connected to power (without any use of the remote control) and no UV-C was detected. The effect of the remote control was also explored by pressing its ON button (with DUT already connected to power), and then (without pressing any other buttons) measuring DUT performance 10 minutes later to clear any automated delays. The process was then repeated, except this time pressing a timer button after pressing the ON button, and then waiting again 10 minutes before taking measurements. It was determined that the timer buttons on the remote control had no effect on the input power or the UV-C irradiance in the 200–280 nm range. Consequently, only the ON button of the remote control was used when testing the DUT.
- LED-22-02 and LED-22-05: DUT behavior was explored prior to testing by first connecting the DUT to power, and then (without pressing any remote control buttons) measuring DUT performance 10 minutes later to clear any automated delays. The effect of the remote control was then explored by pressing its ON button (with DUT already connected to power), and then (without pressing any other buttons) measuring DUT performance 10 minutes later to clear any automated delays. The process was then repeated, except this time pressing a timer button after pressing the ON button, and then waiting again 10 minutes before taking measurements. It was determined that the buttons on the remote control had no effect on the input power or the UV-C irradiance in the 200–280 nm range. Consequently, the remote control was not used when testing the DUT.

The test laboratory also explored the effect of associated controls (e.g., remote, occupancy, timer) on the LPM products, and decided to disable or simply not use them, as described below.

- LPM-22-01: DUT behavior was explored prior to testing by first connecting the DUT to power, and then (after pressing the ON button and selecting a timer setting) observing that the on-time would not be long enough for seasoning or testing. Consequently, the manual controls were not used when testing the DUT, and the timer was bypassed by taking it out of the circuit.
- LPM-22-02: DUT behavior was explored prior to testing by first connecting the DUT to power, and then (after pressing the ON button and selecting a timer setting) observing that the on-time would not be long enough for seasoning or testing. Consequently, the manual controls were not used when testing the DUT, and the timer was bypassed by taking it out of the circuit. The three occupancy sensors were removed from the circuit prior to testing for similar reasons.
- LPM-22-04: DUT behavior was explored prior to testing by first connecting the DUT to power, and then (after pressing the ON button and selecting a timer setting) observing that the on-time would not be long enough for seasoning or testing. Consequently, the manual controls were not used when testing the DUT, and the timer was bypassed by taking it out of the circuit. The occupancy sensor was for similar reasons removed from the circuit prior to testing. These modifications resulted in wires being visible on the room-facing side of the product, as can be seen in Figure 3.
- LPM-22-07: The DUT contained an occupancy sensor that would not allow for seasoning or uninterrupted testing. Consequently, the occupancy sensor was bypassed by taking it out of the circuit. The dimming ballasts were not connected to a controller.

### 3.2 Hemisphere testing

The integrating “sphere” used in this round was actually a hemisphere. Its 20-inch internal diameter precluded its use for characterizing any of the LPM products or their lamps due to physical incompatibility (i.e., those products were too large). In addition, according to section A.2 of IES LM-78, a baffle is needed to shield the

detector from direct irradiation by the DUT so that only reflected radiation is measured. Section 5.5 of the industry standard further recommends that the auxiliary lamp, which is used to correct for DUT self-absorption, be shielded from the detector and the DUT. Consequently, only products LED-22-03, LED-22-05, and LED-22-06 were deemed compatible with the hemisphere.

Figure 4 illustrates how models LED-22-05 and LED-22-06 were measured in the hemisphere. The test laboratory used its own mounting plate for both products and did not use the socketed stand for LED-22-05.

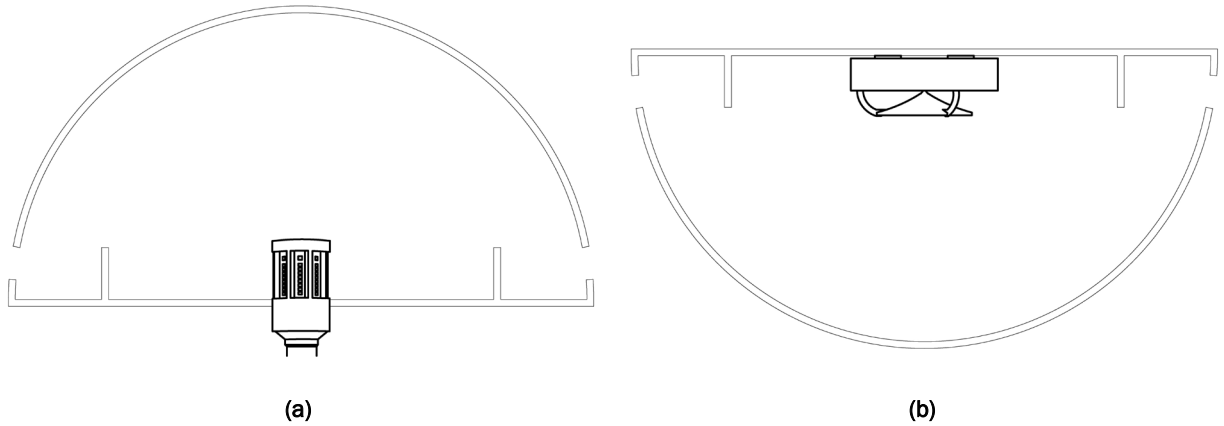

**Figure 4. Integrating hemisphere (20-inch diameter) used to measure initial performance or long-term performance, with approximate location illustrated for relevant products: LED-22-05 protruding up into hemisphere (a), and LED-22-06 protruding down into hemisphere (b). Both products protruded approximately 2 inches into the hemisphere cavity. Baffles are shown to either side of DUT, with ports for spectroradiometer and auxiliary lamp beyond.**

### 3.3 Gonio testing

All gonio testing was on a Type C goniometer and yielded IES-C radiometric webs (IES 2019b). Horizontal resolution (i.e., the interval between vertical half-planes) was  $22.5^\circ$  by default. Some products merited specialized resolution, as illustrated in Figure 5. Horizontal resolution for LED towers was chosen such that half-planes passed through LED faces and midway between them to enable evaluation of symmetry and uniformity. To enable finer horizontal resolution for the evaluation of shadowing from structural elements, reflection symmetry was assumed for LED-22-06 and LPM-22-02; this was desirable but not viable for LPM-22-01, which had a lamp that was rotated relative to its support structure.

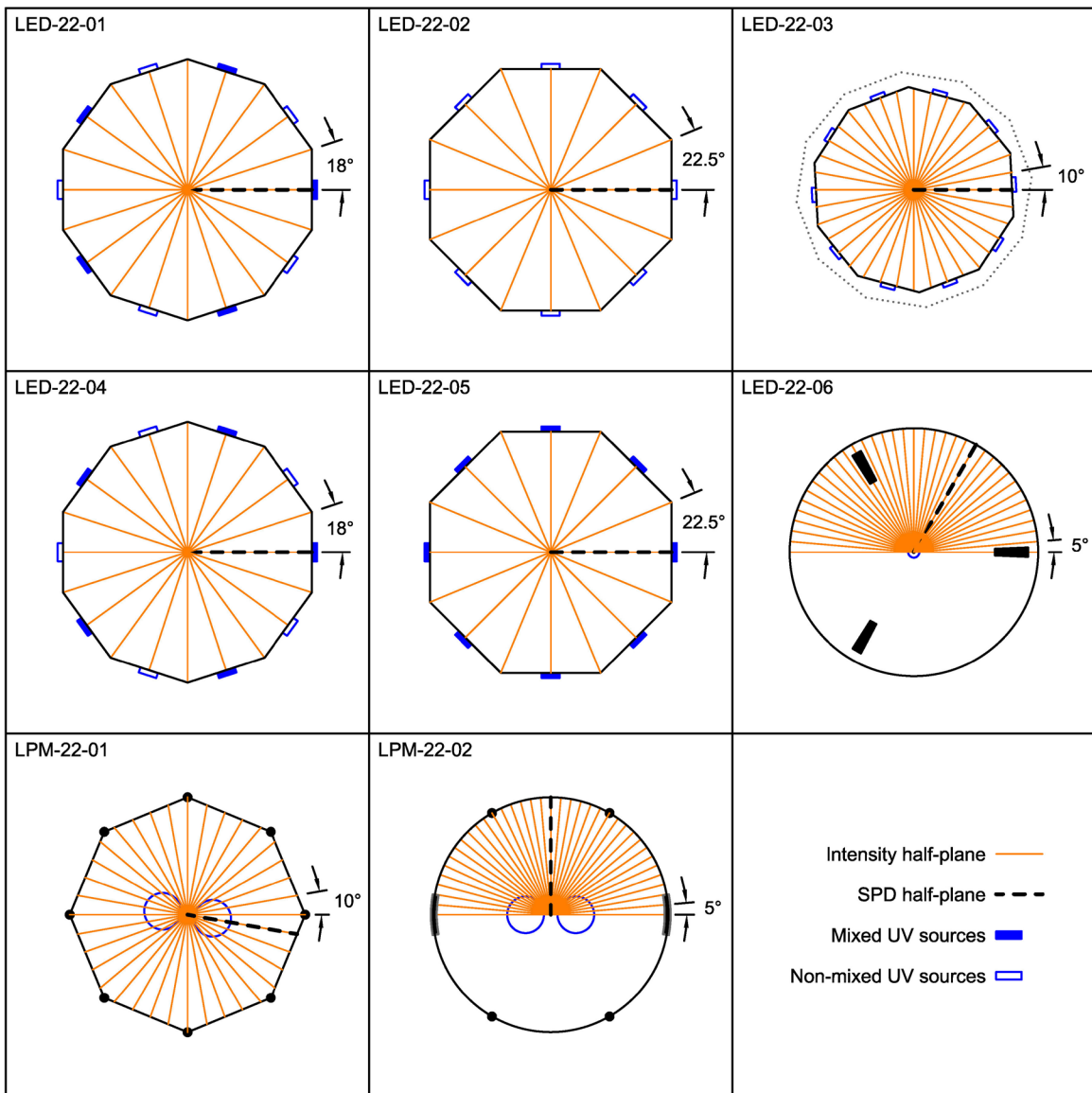

Figure 5. Sampled vertical half-planes, as viewed from above DUT, for products that merited specific treatment. Small blue rectangles represent rectangular LED arrays; those with at least one gold-colored LED emitter are solid blue, while others have white fill. Large blue circles denote LPM lamp tubes. Orange lines denote vertical half-planes for intensity measurements; lines drawn rightward from center of DUT are  $0^\circ$  half-planes. Dashed black lines denote vertical half-planes in which SPD measurements are made. Drawings are not to scale.

Measurement resolution vertically within a given half-plane was 2.5° by default. Finer 1° resolution was used for LED-22-06 (which claimed a highly-concentrated intensity distribution) and LPM-22-02 (which had closely-spaced horizontal louvers) to ensure sharp gradients would be captured.

SPD was measured in or near the expected direction of maximum UV-C intensity. For the LED tower products, SPD was measured 90° from nadir in the 0° half-plane, as shown in Figure 5. LPM-22-01 was measured 90° from nadir in the 350° half-plane, and LPM-22-02 was measured 90° from nadir in the 90° half-plane. All LPM whole-room luminaires were measured at nadir. For LED-22-06, multiple SPDs were measured in the 60° half-plane, at angles 61° to 85° from nadir in 4° increments.

Products were oriented as intended (i.e., towers base-down, ceiling-mounted luminaires facing floor) for all testing, except when measuring SPD for LED-22-06C and the LPM whole-room luminaires. SPDs for LED-22-06C were measured in multiple directions as with a Type A goniometer (i.e., the DUT was tilted while the detector remained stationary) with a DUT-detector distance of 10 inches (25.4 cm). Center-beam SPD measurement of each LPM whole-room luminaire used a DUT-detector distance of 150 cm, and lamps remained horizontal, but the plane of luminaire aperture was vertical. SPD measurement distance was 90 cm for LED-22-02, versus 60 cm for the other LED tower products; the LPM towers had distances of 260 cm for LPM-22-01 and 150 cm for LPM-22-02.

Mirrors can reduce the size of the room required for goniophotometry, but the ordinary glass typically covering such mirrors is largely opaque in the UV and is therefore problematic for UV measurements. The gonioradiometer used for this round of testing was modified to put its detector on the mirror (such that no UV is received by the detector directly from the mirror), yielding test distances shown in Table 9. Products with a maximum UV-C radiant dimension of more than 15 inches did not satisfy the five-times (i.e., 5x) rule of thumb (e.g., see section 7.1 of IES LM-41).<sup>11</sup> As a result, LED product measurements were far-field, but LPM measurements were near-field, although LPM-22-02C was almost far field. However, the detectors used were cosine-corrected, so the UV-C irradiance measurements were integrated by the test lab to yield UV-C output power. Whereas the detector used to measure the first four test units (LED-22-01A, LED-22-02A, LED-22-03A, and LED-22-05A) had a nominal  $f_2$  of 8%, the detector used for all other test units had a nominal  $f_2$  of 7% (the second detector was out for calibration during early testing).<sup>12</sup>

Bare-lamp testing enabled estimation of UV-C output ratios for LPM luminaires. The first step was to measure the total UV-C output of one bare lamp via goniometer. This was followed by “spot” measurements of UV-C irradiance from each bare lamp in isolation; for a given luminaire, each lamp was measured from the same distance and in the same direction. Assuming all lamps of a given model had intensity distributions with the same toroidal shape, the UV-C output of lamps not measured via gonio were then estimated by multiplying the measured output for the gonio-measured lamp by the ratio of irradiances measured for another lamp and the gonio-measured lamp. For example, if a lamp was found to produce 100 W via gonio, and produced an irradiance of 1 W/m<sup>2</sup> in a given direction at a certain distance, and another lamp produced an irradiance of 2 W/m<sup>2</sup> under those same conditions, the output of that other lamp could be estimated as 200 W. Measured and estimated values were then summed to estimate combined UV-C output from all the luminaire’s bare lamps. For each bare-lamp measurement, all lamps were connected to the ballast(s) for consistent BF, but the detector only received UV-C from one lamp at a time. Electrical measurements (e.g., input power) were also collected at luminaire input during bare-lamp testing.

---

<sup>11</sup> A UV-C radiant dimension is a straight-line distance measurement spanning the UV-C emitting portion of the product.

<sup>12</sup> These  $f_2$  values were stated by a representative of the detector manufacturer in a November 2022 email to the test lab. The metric is defined in ISO/CIE 19476:2014 (CIE 2014).

Table 9. Goniometer test distance for each DUT relative to its maximum UV-C radiant dimension. Values in orange did not satisfy the 5x rule of thumb; in these cases, measurements are near-field and cannot be used to calculate true (far-field) intensity, precluding use of this data to reliably calculate irradiance at other distances.

DUT	UV-C radiant dimension (ft)				Test distance	
	Length	Width	Height	Diagonal	Absolute (ft)	Relative (absolute/diagonal)
LED-22-01A	0.17	0.17	0.34	0.38	6.52	17.2
LED-22-02A	0.25	0.25	0.49	0.55	6.48	11.8
LED-22-03A	0.08	0.08	0.17	0.19	6.50	34.6
LED-22-04A	0.17	0.17	0.30	0.34	6.46	18.7
LED-22-05A	0.17	0.17	0.25	0.30	6.52	21.6
LED-22-06C	0.42	0.42	0.06	0.42	6.73	15.9
LPM-22-01A	0.31	0.31	1.58	1.61	6.51	4.0
LPM-22-02C	0.42	0.42	1.25	1.32	6.43	4.9
LPM-22-03A,B	1.88	1.88	0.00	2.66	7.10	2.7
LPM-22-04A	1.83	1.88	0.00	2.62	6.74	2.6
LPM-22-05A,B	4.00	1.08	0.00	4.14	6.73	1.6
LPM-22-06A	3.92	1.90	0.00	4.36	7.01	1.6
LPM-22-07B	3.75	1.79	0.00	4.16	6.73	1.6

### 3.4 Application-distance testing

Unlike intensity data from gonio testing, irradiance data from application-distance testing are not intended to be used for extrapolation to other distances and locations. Near-field measurements of UV-C irradiance were conducted in accordance with IES LM-91 guidance for application-distance radiometry. This testing was used to evaluate products that had associated irradiance claims, as well as to inform photobiological safety testing for units with such claims. Rectangular measurement grids were tailored to each product, as detailed in Section 4.4.

### 3.5 Photobiological safety testing

Photobiological safety testing was conducted in accordance with IEC 62471, except limited to the Actinic UV and Near UV hazards. This testing was used to determine the Risk Group (RG) for products that had associated photobiological safety claims. Measurement direction and distance were informed by other test results (e.g., goniometer, application-distance) and manufacturer instructions, as detailed in Section 4.5.



## 4 Results and analysis

Measured values in Sections 4.1 through 4.5 are for initial performance, corresponding to zero hours of service. Initial measurements for LPM products were taken after 100 hours of lamp seasoning, except for units tested long-term, which were not seasoned. LED products were not seasoned. Section 4.6 presents results of long-term testing and Section 5 provides related discussion.

### 4.1 Electrical input, UV-C output, and efficiency

Table 10 compares claimed and measured initial values for electrical input power (specifically active power) and UV-C output power (i.e., radiant flux). Measured UV-C output power was divided by measured input power to yield UV-C radiant efficiency.

**Table 10. Rated and measured initial values pertaining to input power or UV-C output power. Bold font denotes units tested long-term. In cases where more than one value was claimed (without any clarification regarding different operating modes), they are separated by the word “and.” Italicized font denotes cases where it was not clear whether claimed power was input or output, but was presumed to mean input (e.g., “wattage”). Orange font denotes cases where measured input power was greater than claimed, or measured UV-C output power was less than claimed.**

Product type	DUT	Rated power (W)		Measured power (W)		Measured UV-C radiant efficiency (%)
		Input	UV-C output	Input	UV-C output	
Tower	LED-22-01A	60	-	31.1	0.0000	0.00
	LED-22-02A	<i>90 and 100</i>	-	45.8	0.0000	0.00
	LED-22-03A	-	-	3.53	0.0000	0.00
	LED-22-04A	30	-	26.5	0.0371	0.14
	LED-22-05A	36	-	10.4	0.0224	0.22
	<b>LED-22-05B*</b>	36	-	10.5	0.0165	0.16
	LPM-22-01A	55	-	47.5	13.6	28.7
LPM-22-02C	60	-	44.3	2.88	6.50	
Occupied-room luminaire	<b>LED-22-06B*</b>	3.88	0.0023	2.67	0.0011	0.04
	LED-22-06C*	3.88	0.0023	2.62	0.0012	0.05
	LED-22-06C	3.88	0.0023	2.62	0.0016	0.06
Vacant-room luminaire	LPM-22-03A	60	13.5	62.0	7.09	11.4
	<b>LPM-22-03B</b>	60	13.5	61.9	7.41	12.0
	LPM-22-04A	110	-	92.2	17.0	18.5
	LPM-22-05A	175	45.7	176	56.6	32.2
	<b>LPM-22-05B</b>	175	45.7	177	57.3	32.3
	LPM-22-06A	160	-	140	58.2	41.7
LPM-22-07B	160	79.2	179	23.3	13.0	

\* DUT tested in integrating hemisphere rather than via goniometer.

Two LED models had units dedicated to initial or long-term testing. Whereas long-term units LED-22-05B and LED-22-06B were measured via sphere, unit LED-22-05A was measured via gonio, and LED-22-06C was measured both ways. Notably, sphere-measured UV-C output power values for a given model were 69–76% of those from gonio testing.

UV-C output power and UV-C radiant efficiency for LED products were both orders of magnitude lower than for LPM products, and there was wide variation among LPM products, as shown in Figure 6. Three LPM products (LPM-22-02, LPM-22-03, and LPM-22-07), which all had louvered designs, had less than 15% UV-C radiant efficiency. The average UV-C radiant efficiency of tested LPM products was 22%.

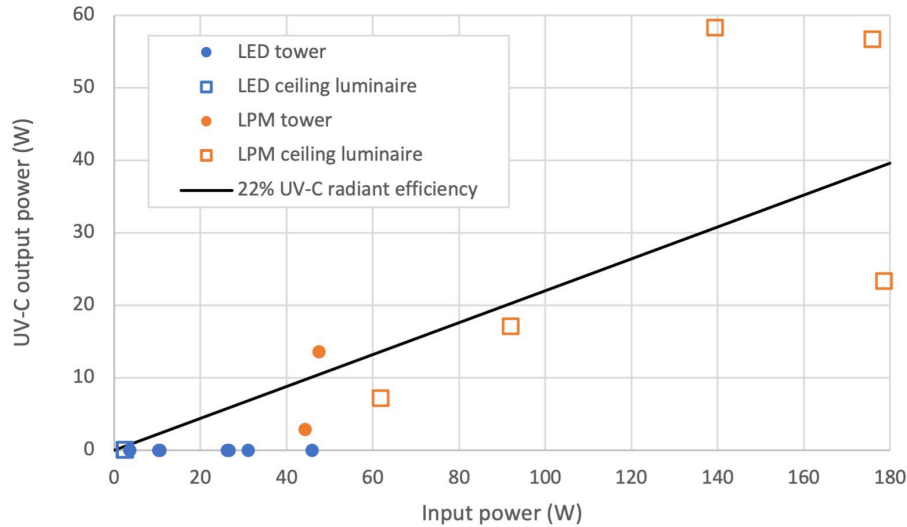

**Figure 6. Measured electrical input power and UV-C output power for all tested products. The solid black line represents the average UV-C radiant efficiency for tested LPM products (22%).**

Many LPM whole-room luminaires drew more power than claimed or produced less UV-C than claimed, and some did both (LPM-22-03 and LPM-22-07). The two LPM towers and two of the LPM whole-room luminaires had no explicitly claimed values for output power.

Although all the LED tower products claimed to emit UV-C, none explicitly claimed an output power value, and LED-22-03 further made no claim regarding input power. All the other LED products and tower products were found to draw less power than claimed. Some LED products emitted no UV-C (LED-22-01, LED-22-02, LED-22-03) or less UV-C than claimed (LED-22-06). LED-22-04 was additionally tested base-up, and in that orientation was found to produce 94% of its base-down output, as discussed in Appendix B.

Rated input power was much greater than measured active power for several products, with rated values in some cases seemingly overstated by factors of roughly two (LED-22-01 and LED-22-02) or three (LED-22-05). Table 11 shows that for products with low power factor, claimed power was much closer to measured apparent power than to measured active power:

- LED-22-01 had a rated power of 60 W, but it was found to draw 31 W of active power and 54 VA of apparent power.
- LED-22-02 had rated powers of 90 W and 100 W, but it was found to draw 46 W and 80 VA.
- LED-22-05 had a rated power of 36 W, but it was found to draw less than 11 W and 20 VA.

With the exception of LED-22-04, tower products and LED products had low power factor and high THD. Occupied-room luminaire LED-22-06 had a claimed power factor > 0.9 but measured power factor for both units was about half this value. Similarly, the model had a rated THD < 20% but measured THD for both units was 89%. No claims pertaining to power factor or THD were found for the other products tested in this round. All of the vacant-room luminaires had high power factor.

**Table 11. Measured initial values for electrical parameters other than active power. Bold font denotes units tested long-term. Orange font denotes values that disagree with claims, regardless of manufacturing tolerances.**

Product type	DUT	Input voltage (V)	Input current (mA)	Apparent power (VA)	Power factor	Current THD (%)
Tower	LED-22-01A	120.05	452.5	54.32	0.576	67.51
	LED-22-02A	120.15	669.1	80.39	0.570	74.21
	LED-22-03A	119.94	50.7	6.08	0.581	54.99
	LED-22-04A	120.06	236.4	28.38	0.935	5.69
	LED-22-05A	120.24	153.6	18.47	0.561	81.64
	<b>LED-22-05B*</b>	120.04	166.3	19.96	0.527	84.40
	LPM-22-01A	120.13	760.4	91.35	0.520	80.05
	LPM-22-02C	120.11	644.2	77.37	0.574	71.98
Occupied-room luminaire	<b>LED-22-06B*</b>	120.04	50.4	6.05	0.441	89.03
	LED-22-06C*	120.05	49.5	5.94	0.440	89.63
	LED-22-06C	120.01	48.9	5.87	0.447	89.41
Vacant-room luminaire	LPM-22-03A	120.09	523.0	62.81	0.986	6.02
	<b>LPM-22-03B</b>	120.23	521.7	62.73	0.987	5.98
	LPM-22-04A	120.14	769.5	92.45	0.997	1.97
	LPM-22-05A	120.10	1,474.4	177.08	0.994	4.76
	<b>LPM-22-05B</b>	120.05	1,485.0	178.27	0.994	4.72
	LPM-22-06A	120.10	1,167.7	140.24	0.995	4.30
	LPM-22-07B	120.08	1,498.3	179.92	0.994	9.16

\* DUT tested in integrating hemisphere rather than via goniometer.

Whereas the UV-C radiant efficiency reported in Table 10 has product input power in the denominator, the UV-C output ratio in Table 12 has combined UV-C output from bare lamps in the denominator, to provide a measure of the portion of lamp output that is not trapped inside the luminaire.

There was a strong linear relationship ( $R^2 = 0.985$ ) between UV-C output ratio and UV-C radiant efficiency (e.g., LPM-22-06 was roughly 4 times LPM-22-03 by both measures). The products with louvered designs and white reflectors above lamps (LPM-22-03 and LPM-22-07) again had the lowest values among whole-room luminaires. The next-lowest value was for LPM-22-04, which had a flat specular reflector above its lamps, white reflectors to either side of them, and a wire guard below. The highest values were for LPM-22-05 and LPM-22-06, which had specular reflectors above and to the sides of their lamps, with no louvers or wire guards below.

Lamps that were only spot-measured for irradiance were generally within 10% of lamps that were measured via gonio. LPM-22-03 had a lamp that was 12% higher, LPM-22-06 had a lamp that was 14% lower, and LPM-22-07 had one lamp that was 11% lower and another that was 12% higher.

For LPM-22-03 and LPM-22-05, measured input power was 1–2% higher during bare-lamp testing than when all lamps were operating in the luminaire, perhaps due to different temperatures inside and outside the luminaires. LPM-22-04 was 5% higher during bare-lamp testing, perhaps due to its different (single-ended) lamp design. In contrast, LPM-22-06 and LPM-22-07 both had 4% lower input power during bare-lamp testing; this may be due to different lamp design and/or the cooling action of an integral fan (in the case of LPM-22-07).

Table 12. Estimating UV-C output ratio for whole-room luminaires. The luminaire UV-C output power from Table 10 is used as the numerator. Combined UV-C output from bare lamps is used in the denominator, based on measured UV-C output power for one bare lamp and spot measurements of UV-C irradiance for all bare lamps. Spot measurements of irradiance were taken after 100 h of operation (including any seasoning), except for LPM-22-03B, which was measured after 500 h of operation. Orange font indicates lamp irradiance deviated from that of the gonio-measured lamp by more than 5%.

DUT	Lamp	Measured UV-C lamp output (mW)	Spot-measurement of bare-lamp UV-C irradiance (% of lamp 1)	Estimated combined UV-C lamp output (mW)	Estimated UV-C output ratio (%)
LPM-22-03B	1	11,253	100.0	36,062	20.5
	2	-	108.1		
	3	-	112.4		
LPM-22-04A	1	24,621	100.0	49,840	34.2
	2	-	102.4		
LPM-22-05B	1	19,479	100.0	80,882	70.8
	2	-	104.1		
	3	-	107.0		
	4	-	104.2		
LPM-22-06A	1	18,042	100.0	69,927	83.2
	2	-	103.2		
	3	-	85.8		
	4	-	98.6		
LPM-22-07B	1	21,069	100.0	84,999	27.4
	2	-	103.2		
	3	-	88.6		
	4	-	111.6		

## 4.2 UV spectrum

The LED tower products all had peak UV output at 400 nm, as shown in Figure 7. Three units had no UV-C output: LED-22-01A, LED-22-02A, and LED-22-03A. Units LED-22-04A and LED-22-05A had UV-C peaks with 1% and 2% (respectively) of the spectral irradiance found at 400 nm. The claimed SPDs for models LED-22-04 and LED-22-05 only showed energy in the UV-C portion of the spectrum; although the measured SPDs for both products showed some UV-C, most of their radiant output was UV-A.

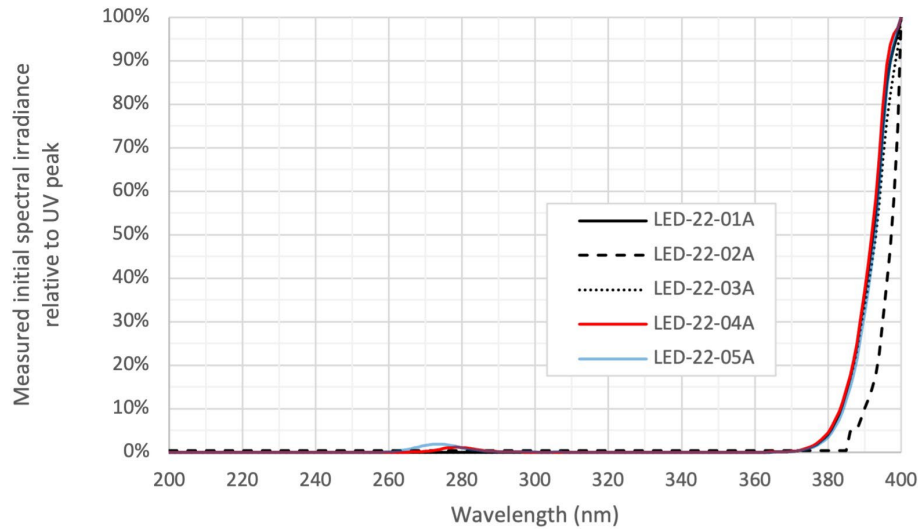

**Figure 7. Measured initial SPDs for LED tower units. UV-C is from 100-280 nm, UV-B is from 280-315 nm, and UV-A (which overlaps the visible spectrum) is from 315-400 nm (CIE 2020). Only models LED-22-04 and LED-22-05 were found to produce UV-C.**

Figure 8 compares claimed and measured SPDs for tower LED-22-04A. Although the overall UV peak (from 200–400 nm) was found to be at 400 nm, the claimed SPD only showed data at wavelengths below 286 nm. In addition, whereas the seller’s webpage claimed a “wavelength” of 250–255 nm, and its separately claimed SPD showed a peak wavelength of ~264 nm, the measured UV-C peak was at 278 nm, with a full width half maximum (FWHM) of 11 nm (IEC 2023a).

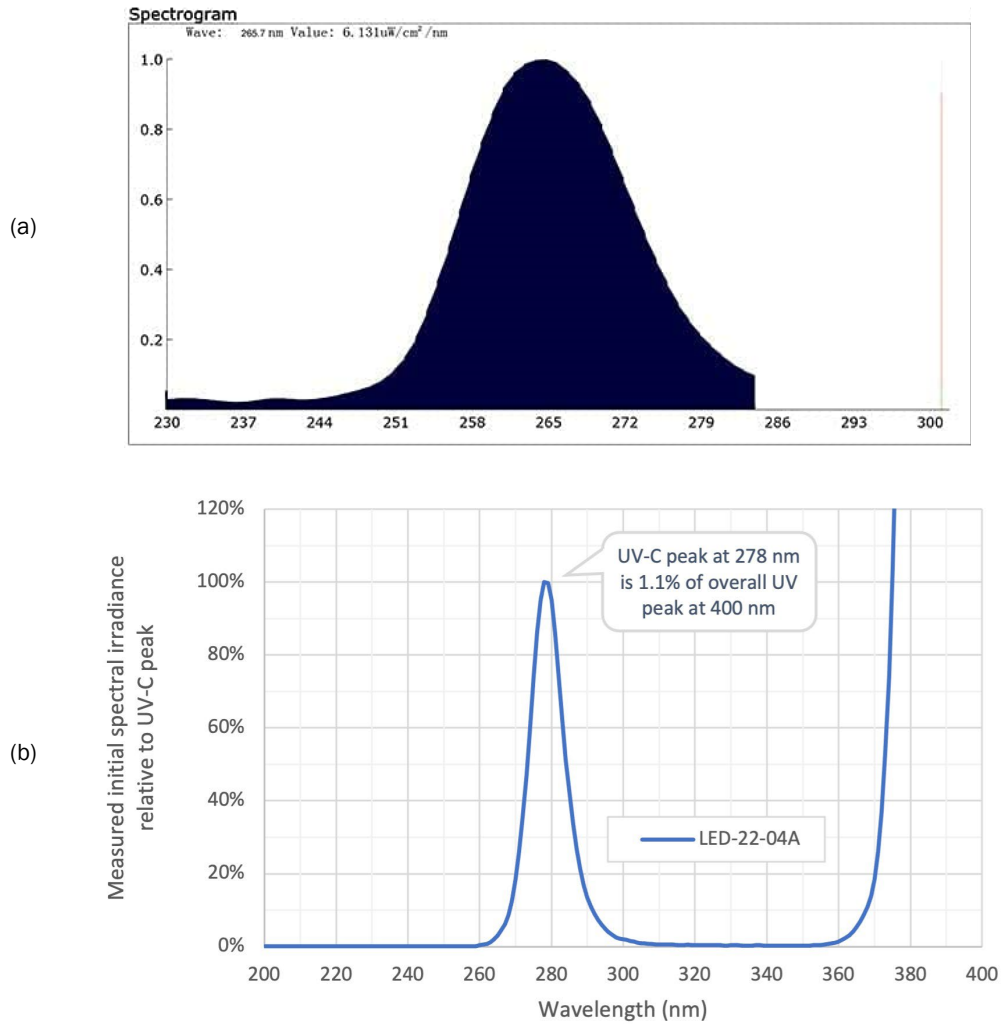

**Figure 8. Claimed (a) and measured initial (b) SPDs for unit LED-22-04A. Note the plots have differing scales for both axes; tabulated data was not available for the claimed SPD. To improve visibility of the UV-C peak in (b), without use of log scale, the much larger overall UV peak at 400 nm is not shown.**

Figure 9 compares claimed and measured SPDs for LED-22-05A (measured benchtop) and LED-22-05B (measured via integrating hemisphere). Although the overall UV peak (from 200–400 nm) was found to be at 400 nm, the claimed SPDs only showed data at wavelengths below 360 nm. In addition, one of the claimed SPDs showed substantial energy below 240 nm. The UV-C peaks of the measured SPDs were at 273 and 277 nm, agreeing well with that aspect of the two claimed SPD plots for this product, which had peaks at 277–278 nm. The claimed SPDs were similar to the measured SPDs in showing substantial energy  $\pm 20$  nm from the UV-C peak, but the seller’s webpage separately claimed a “260-280nm spectrum” (conflicting with claimed and measured SPDs). The measured FWHM of the UV-C peak was 13–14 nm.

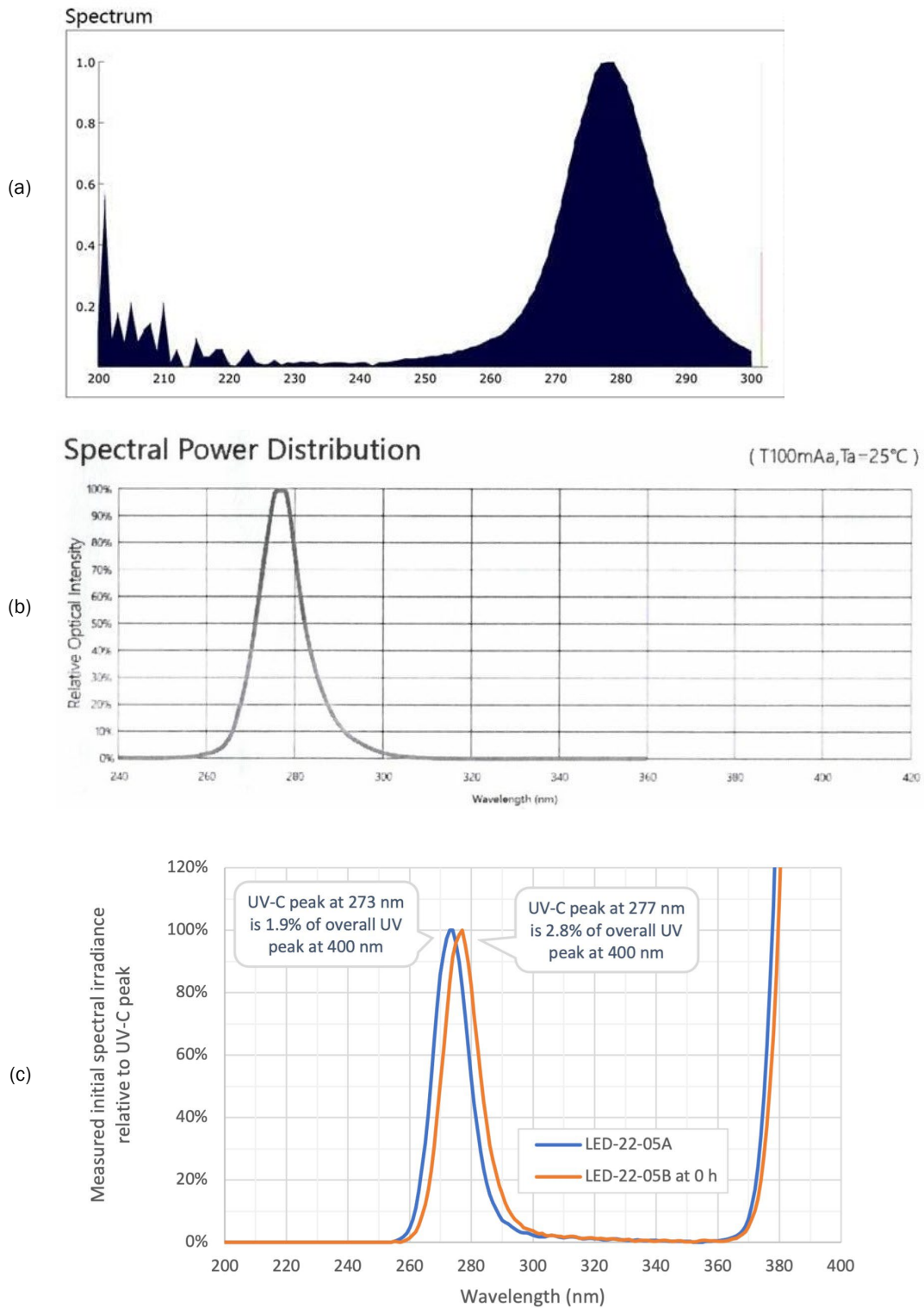

Figure 9. Claimed (a, b) and measured initial (c) SPDs for units LED-22-05A and LED-22-05B. Note the plots have differing scales for both axes; tabulated data was not available for the claimed SPDs. To improve visibility of the UV-C peak in (c), without use of log scale, the much larger overall UV peak at 400 nm is not shown.

The claimed spectrum for LED-22-06 was  $254 \text{ nm} \pm 5 \text{ nm}$ , perhaps indicating a tolerance for the peak wavelength or indicating a FWHM of 10 nm. Initial SPD was measured for LED-22-06C via gonio in the  $60^\circ$  half-plane, at a set of angles  $61\text{--}85^\circ$  from nadir in  $4^\circ$  increments, to see if there was any meaningful variation over this range near peak intensity. The peak UV wavelength in all 7 directions was found to be 260 nm, with a FWHM of 11 nm. The 0 h measurements of LED-22-06B and LED-22-06C in the integrating hemisphere yielded the same FWHM, and similar peaks of 258 nm and 260 nm, respectively. No UV-A radiation was detected for this product.

Claimed SPDs were found for two of the LPM products and are shown in Figure 10.

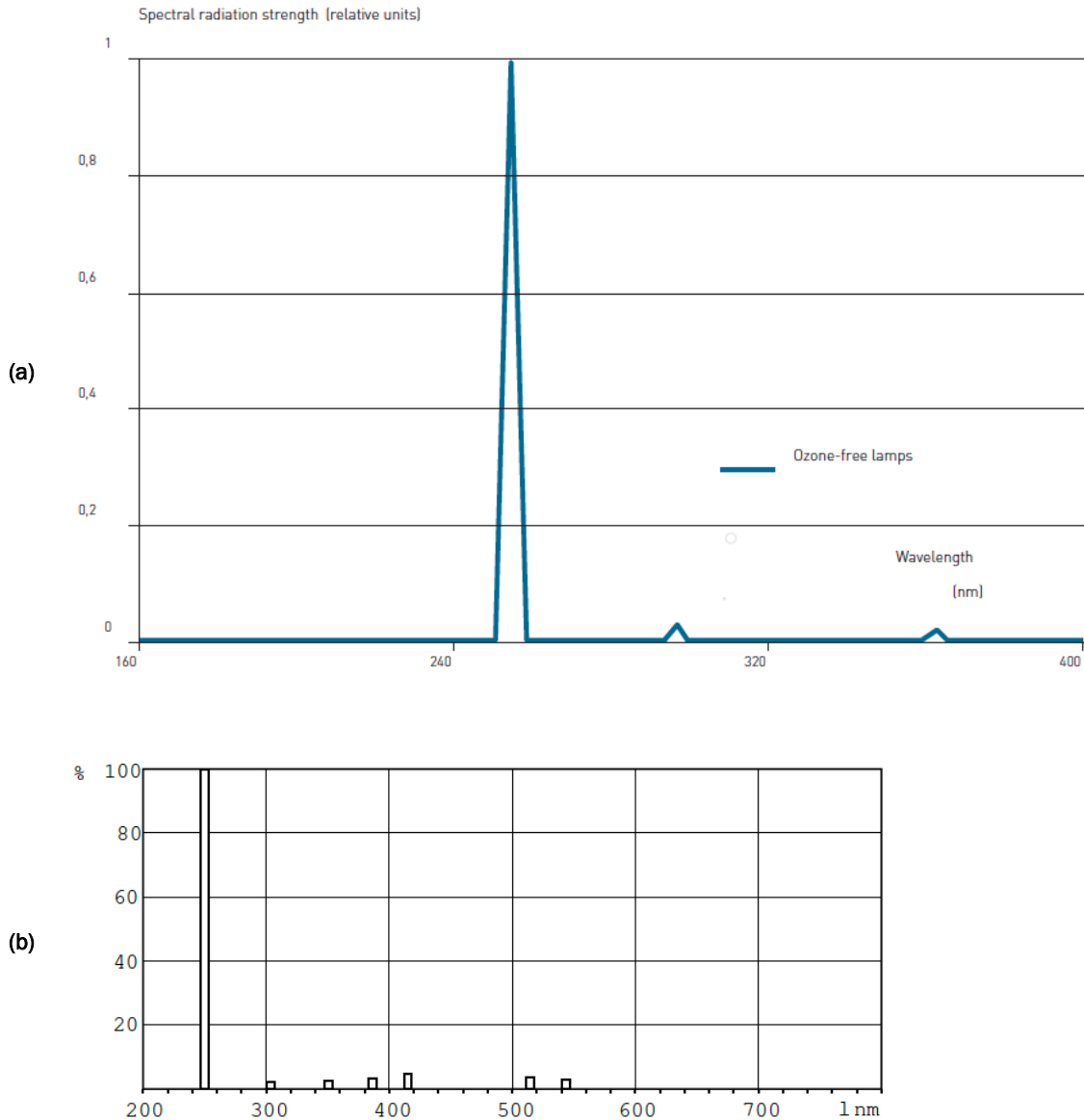

Figure 10. Claimed SPDs for LPM luminaires LPM-22-03 (a) and LPM-22-05 (b).



Documentation for LPM-22-03 showed an SPD with primary spike at 254 nm and secondary spikes at approximately 297 and 363 nm. Product documentation for the lamps provided with LPM-22-05 showed an SPD with primary spike at approximately 250 nm and secondary UV spikes at approximately 304, 351, and 387 nm. Figure 11 shows that all the tested LPM products had the expected peak wavelength at 254 nm, with secondary spikes of around 1% peak spectral irradiance at 313 nm and 365 nm.

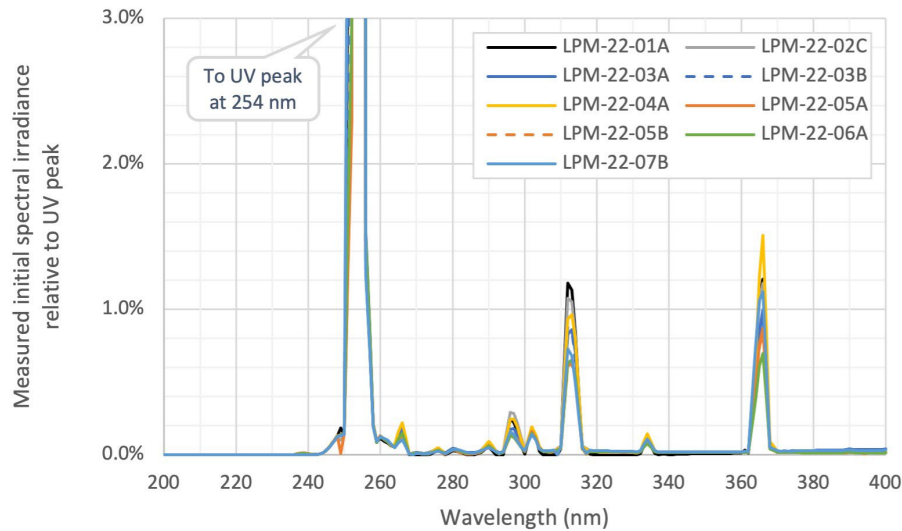

Figure 11. Measured initial SPDs for the LPM products. To improve visibility of the smaller emission lines, without use of log scale, the much larger overall UV peak at 254 nm is not shown. Dashed lines denote products tested long-term.

### 4.3 UV-C radiant intensity distribution

Only two tested products, LED-22-06 and LPM-22-05, clearly claimed an intensity distribution for the complete product (rather than for a subcomponent like an LED emitter or LPM lamp).

Figure 12 shows “UVC light output” (presumed here to mean UV-C radiant intensity) for occupied-room luminaire LED-22-06, in units of  $\mu\text{W}/\text{sr}$ . It was not clear which vertical half-planes were represented, and this product was available with a range of nominal output options (500 to 2,300  $\mu\text{W}$ ), but the option represented by the plot was not stated. Further complicating evaluation, although CALiPER ordered the maximum output version of the second-generation design and received a second-generation design product, all model numbers on the product and its packaging corresponded to the first-generation design, so the true model number(s) of the units received was unclear.

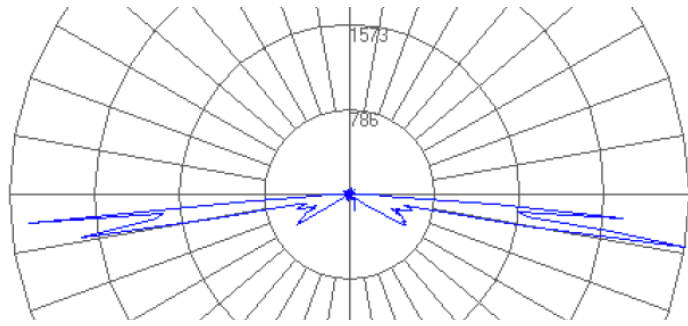

Figure 12. Photo (left) and polar plot of “UV-C light output” in units of  $\mu\text{W}/\text{sr}$  from downloadable installation instructions (right) for occupied-room luminaire LED-22-06. Top and bottom of plot are cropped to save space; the outer ring was labeled 3146, corresponding to the maximum radiant intensity for the product.

Figure 13 shows gonio measurement results for LED-22-06. Measurements were taken in  $1^\circ$  increments from nadir to zenith in vertical half-planes spaced  $5^\circ$  apart, spanning horizontal angles from  $0^\circ$  (passing through a reflector support) to  $180^\circ$  (passing between supports in the opposite direction), thereby covering one hemisphere.<sup>13</sup> Symmetry was assumed in order to enable the relatively fine horizontal resolution, aiming to capture shadowing from the three reflector supports. The radiometric center of the DUT was unclear, and may vary depending on viewing direction, but the test laboratory assumed it to be located about 0.5 inch above bottom of luminaire for gonio measurements.

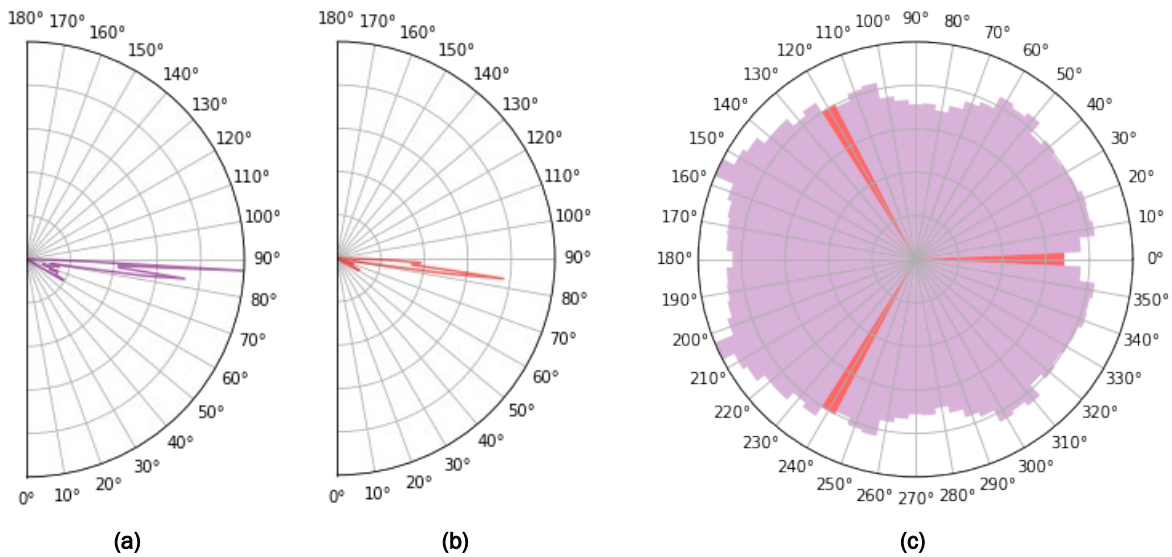

Figure 13. Initial UV-C radiant intensity for LED-22-06C. “Side view” plot (a) shows measurements in the  $155^\circ$  half-plane, which contained the direction of maximum intensity, relative to the measured maximum intensity value of  $2.6 \text{ mW}/\text{sr}$ . Plot (b) similarly shows relative data in the  $0^\circ$  half-plane, which passes through a reflector support. “Top view” plot (c) shows average intensity for each half-plane (represented by a colored slice), relative to the maximum of these averages, looking down on the DUT. The three half-planes passing through supports are colored red. Notably, whereas the data in (c) from  $0-180^\circ$  were measured, the data from  $180-360^\circ$  (i.e., the other hemisphere) were mirrored via assumed symmetry.

<sup>13</sup> Note that when dealing with intensity measurements using a goniometer, “sphere” and “hemisphere” refer to solid angles (rather than instruments).

The hemisphere from horizontal angles 180–360° in plot (c) was simply mirrored from the measured data; however, the results suggest this assumption of reflection symmetry may not be valid. Average intensity was generally lower in half-planes from horizontal angles 0–120° than from horizontal angles 125–180°. In addition, most half-planes from 0–125° had maximum intensity 83° from nadir, while half-planes from 130–180° had maximum intensity 87° from nadir. Based on the published polar plot for LED-22-06, maximum intensity was expected at an angle of about 81° or 85° from nadir, depending on the half-plane. Notably, the detector was only slightly shadowed by the mirror supports in the 0° and 120° half-planes.

Figure 14 shows the relative intensity distributions from the datasheet for 4-lamp and 6-lamp versions of LPM-22-05. Figure 15 shows that gonio measurement results for the 4-lamp high-bay luminaire more closely resemble the claimed intensity profile for the 6-lamp version. Measurements were taken in 2.5° increments from nadir to zenith in vertical half-planes spaced 22.5° apart, spanning horizontal angles from 0° (parallel to lamp axis) to 337.5°, thereby covering a full sphere with no assumed symmetry.

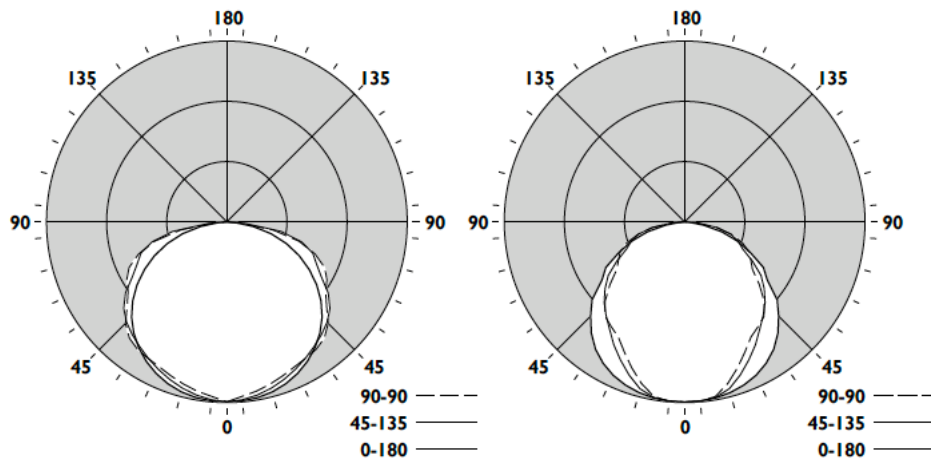
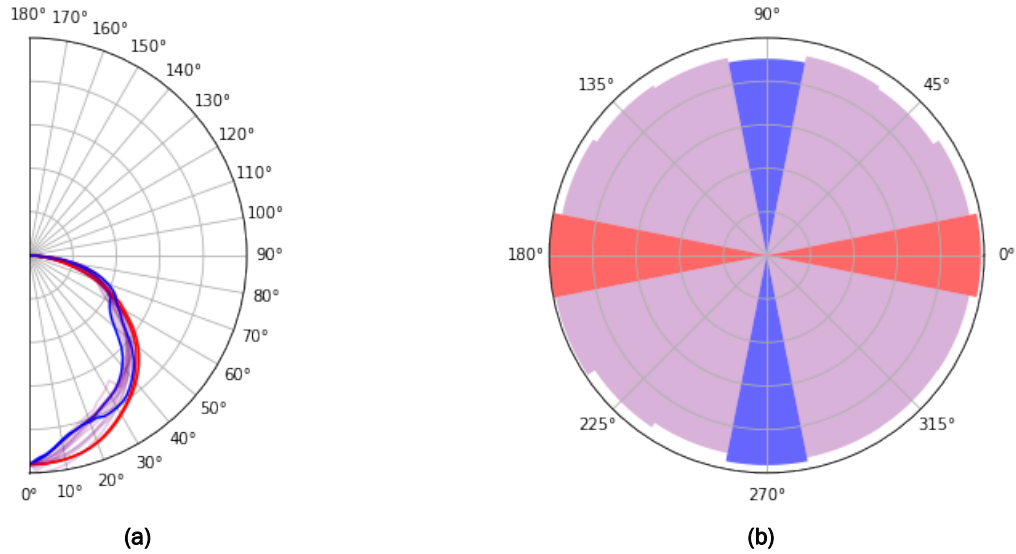

Figure 14. Polar plots of relative radiant intensity from downloadable datasheet for LPM-22-05. The plot at left is for the 4-lamp version that was ordered for testing. The plot at right is for the 6-lamp version of the product, shown for reference.



**Figure 15. UV-C radiant intensity for LPM-22-05A. In plot (a), each continuous curve shows intensity at different angles in a vertical half-plane, relative to the maximum UV-C intensity of 19,471 mW/sr. In plot (b), the radius of a colored slice represents average intensity for a half-plane, relative to the maximum of these averages. Half-planes perpendicular to lamp axis are shaded blue, while those parallel are red, and the rest are purple.**

Measured intensity distributions for other products are presented below. The following products do not have intensity data because they did not emit UV-C: LED-22-01, LED-22-02, and LED-22-03.

Figure 16 shows initial UV-C intensity for the 10-sided LED-22-04 operated base-down, with an 18° interval between 20 sampled vertical half-planes. The gold-colored LEDs were presumed to emit UV-C, and the 0° half-plane passed through a pair of them aimed in the same direction, 90° from nadir; each such pair is spaced 72° apart, and every fourth half-plane passes through a pair. Two gold-colored LEDs on the “top” face of the product, opposite the screw base, caused the asymmetry between upper and lower hemispheres. Intensities are clearly lower for half-planes passing through horizontally-aimed gold-colored LEDs than for half-planes between them.

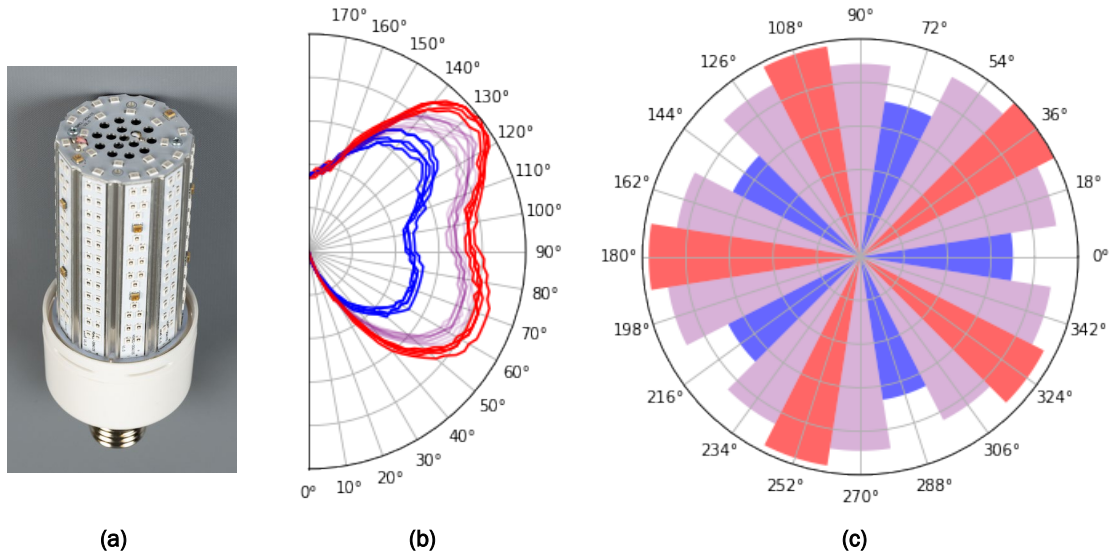

Figure 16. UV-C radiant intensity for LED-22-04A (a) operated base-down. In plot (b), each continuous curve shows intensity at different angles in a vertical half-plane, relative to the maximum UV-C intensity of 4.7 mW/sr. In plot (c), the radius of a colored slice represents average intensity for a half-plane, relative to the maximum of these averages. Half-planes passing through gold-colored LEDs are shaded blue, while those midway between are red, and the rest are purple.

Figure 17 shows the polar plot of what appears to be relative UV-C intensity shown in a pamphlet that was included with acquired LED-22-05 units. Although the document was not explicit regarding what the plot represents, it presumably describes a single LED emitter in isolation, rather than the combined output from each LED emitter in the integrated LED lamp.

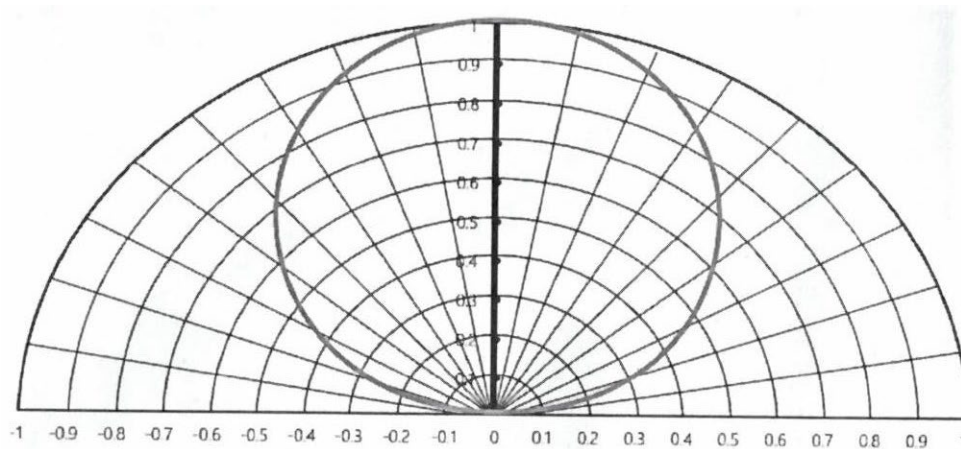

Figure 17. Polar plot of "Typical Radiation Pattern" shown in the "UV-C LED DATA SPECIFICATIONS" section of the pamphlet received with LED-22-05. The centerbeam of the roughly Lambertian emitter would be oriented toward top of page.

Figure 18 shows measured UV-C intensity for the 8-sided LED-22-05, given a 22.5° interval between sampled vertical half-planes. Tower LED-22-05 (unlike LED-22-04) has a single gold-colored LED on every face, but (like LED-22-04) those emitters appear to have maximum intensity about 20° from centerbeam. In this case, intensities are on average 10% greater for half-planes passing through horizontally aimed gold-colored LEDs than for half-planes between them.

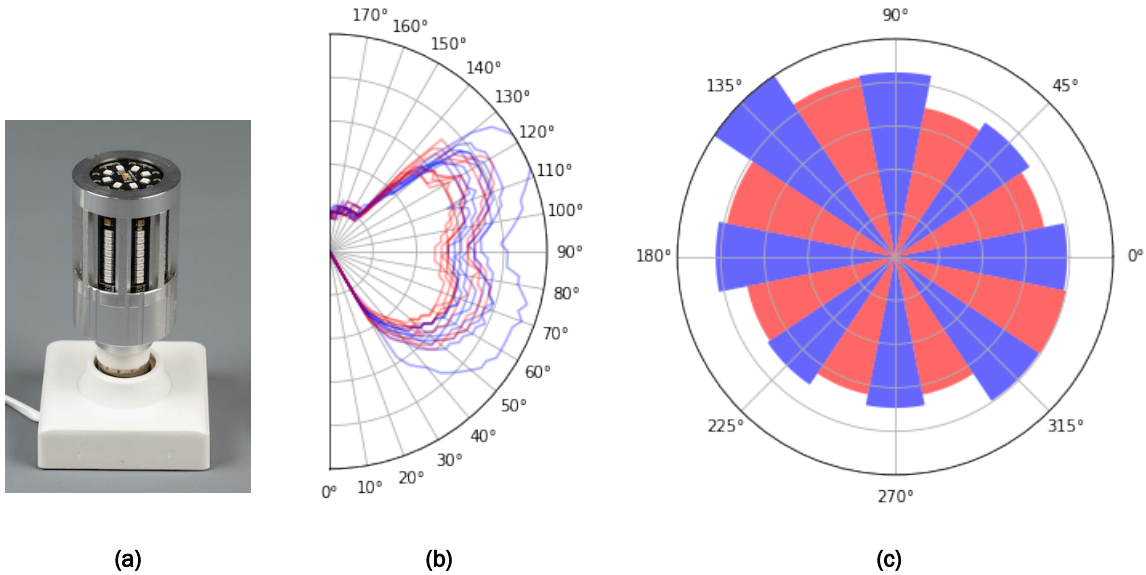

Figure 18. UV-C radiant intensity for LED-22-05A (a). In plot (b), each continuous curve shows intensity at different angles in a vertical half-plane, relative to the maximum UV-C intensity of 3.3 mW/sr. In plot (c), the radius of a colored slice represents average intensity for a half-plane, relative to the maximum of these averages. Half-planes passing through gold-colored LEDs are shaded blue, while those midway between are red.

LPM-22-01 was found to have minimum output in the 0° and 180° half-planes (where one lamp tube is behind the other) and maximum output in the 90° and 270° half-planes (where both lamp tubes are visible), as expected, and shown in Figure 19. A 10° interval was used between half-planes, and no symmetry was assumed because the wire cage was not symmetric about the vertical plane passing through both lamp tubes.

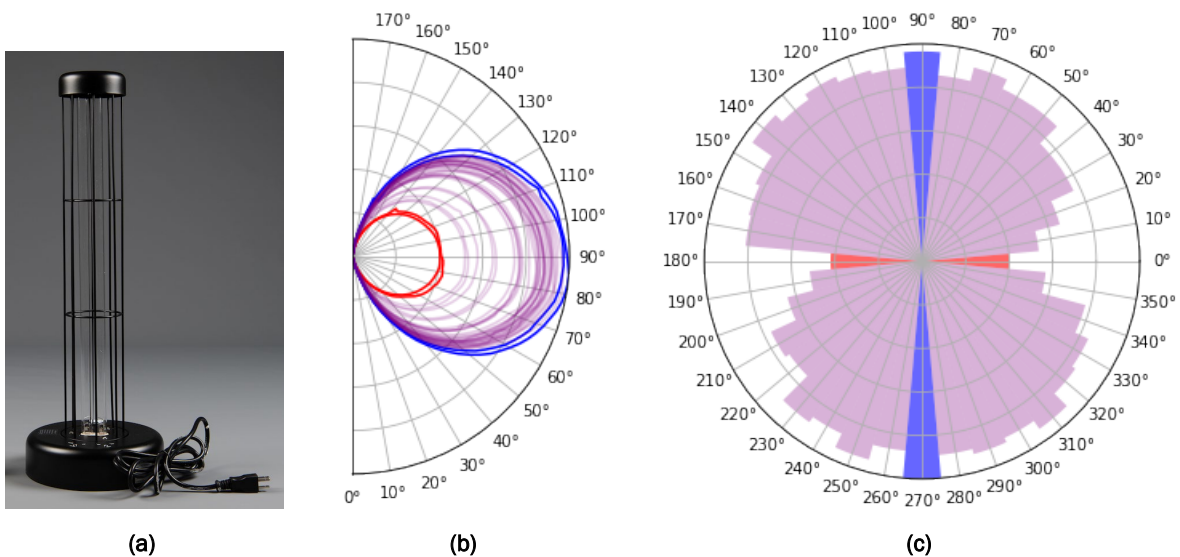
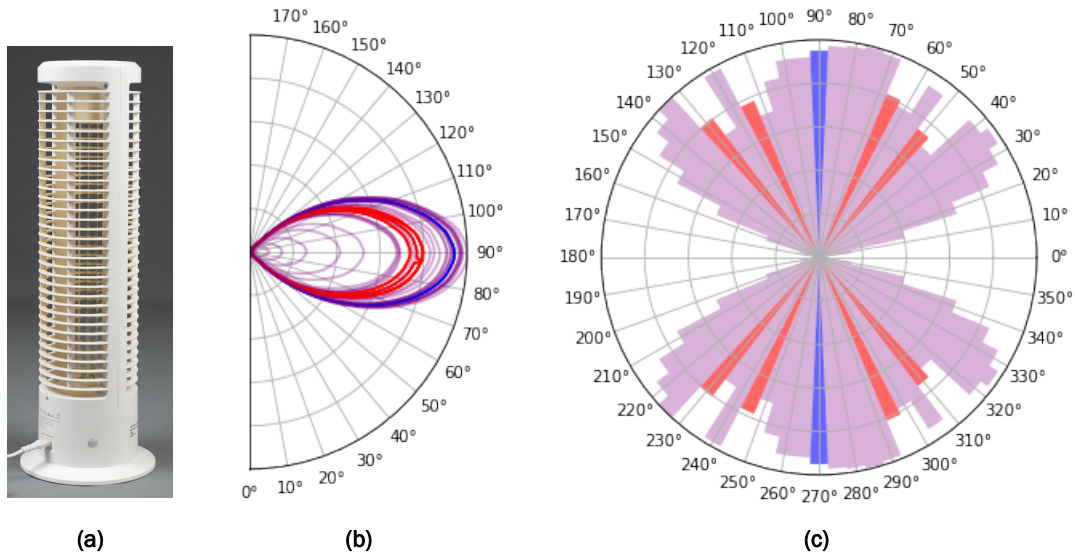

Figure 19. Initial UV-C radiant intensity from LPM-22-01A (a). In plot (b), each continuous curve shows intensity at different angles in a vertical half-plane, relative to the maximum UV-C intensity of 1,806 mW/sr. In plot (c), the radius of a colored slice represents average intensity for a half-plane, relative to the maximum of these averages. Half-planes expected to contain maximum intensity are shaded blue; those expected to contain minimum intensity are red, and others are purple.

In contrast, LPM-22-02 was designed so that its two main columns appeared to be aligned with the two tubes of its lamp, enabling enhanced resolution ( $5^\circ$  between half-planes) with the same number of measurements by only sampling in one hemisphere (assuming symmetry, as with LED-22-06). Like LPM-22-01, it was found to have minimum output in the  $0^\circ$  and  $180^\circ$  half-planes, in this case approaching zero because the lamp is not visible behind a large column. But unlike LPM-22-01, its maximum output was not found in the  $90^\circ$  and  $270^\circ$  half-planes (where both lamp tubes are visible with no occlusion by columns), as shown in Figure 20. Notably, the horizontal louvers in LPM-22-02 had the expected effect of restricting output to the region at or near horizontal, as seen in the diagram at left.



**Figure 20.** Initial UV-C radiant intensity for LPM-22-02C (a). In plot (b), each continuous curve shows intensity at different angles in a vertical half-plane, relative to the maximum UV-C intensity of 709 mW/sr. In plot (c), the radius of a colored slice represents average intensity for a half-plane, relative to the maximum of these averages. Half-planes expected to contain maximum intensity are shaded blue; those understood to be shadowed by smaller columns are red, and others are purple. Notably, whereas the data in (b) from  $0-180^\circ$  were measured, the data from  $180-360^\circ$  (i.e., the other hemisphere) were mirrored via assumed symmetry.

Figure 21 through Figure 24 show measured UV-C intensity distributions for the remaining LPM troffers. Measurements were taken in  $2.5^\circ$  increments from nadir to zenith in vertical half-planes spaced  $22.5^\circ$  apart, spanning horizontal angles from  $0^\circ$  (parallel to lamp axis) to  $337.5^\circ$ , thereby covering a full sphere with no assumed symmetry. Whereas louvered LPM-22-03 had maximum intensity almost  $40^\circ$  from nadir in the  $90-270^\circ$  plane, louvered LPM-22-07 had maximum intensity  $20^\circ$  from nadir in that plane. LPM-22-04 was unique in having higher intensity  $80^\circ$  from nadir in the  $90-270^\circ$  plane than in the  $0-180^\circ$  plane, and LPM-22-06 would have had maximum intensity  $20^\circ$  from nadir were it not for an isolated spike  $5^\circ$  from nadir.

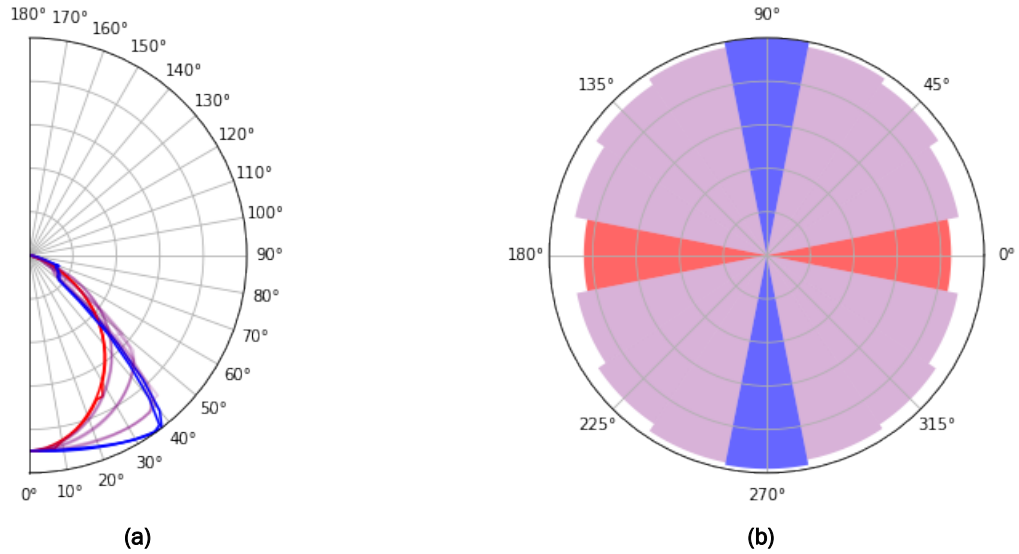

Figure 21. UV-C radiant intensity for LPM-22-03A. In plot (a), each continuous curve shows intensity at different angles in a vertical half-plane, relative to the maximum UV-C intensity of 3,464 mW/sr. In plot (b), the radius of a colored slice represents average intensity for a half-plane, relative to the maximum of these averages. Half-planes perpendicular to lamp axis are shaded blue, while those parallel are red, and the rest are purple.

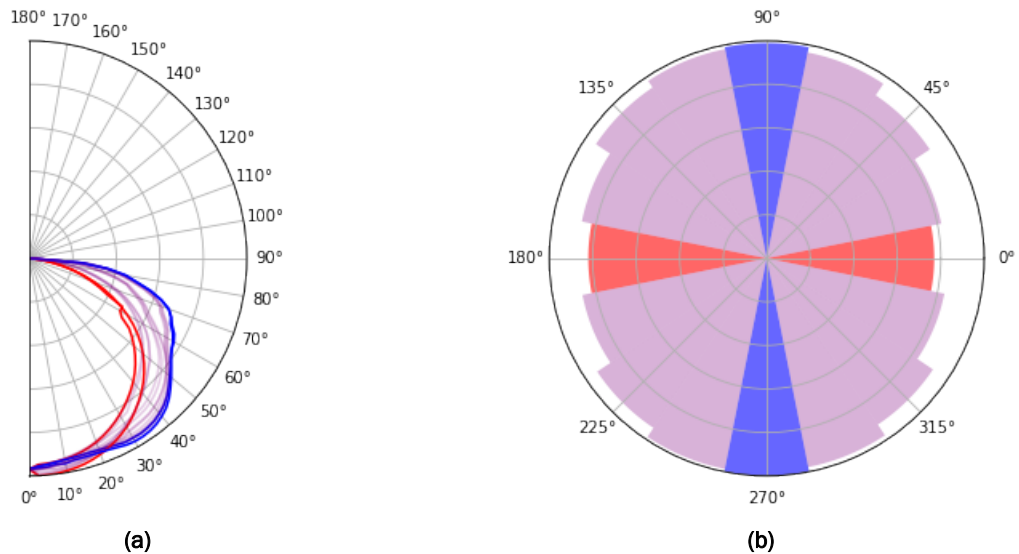

Figure 22. UV-C radiant intensity for LPM-22-04A. In plot (a), each continuous curve shows intensity at different angles in a vertical half-plane, relative to the maximum UV-C intensity of 4,480 mW/sr. In plot (b), the radius of a colored slice represents average intensity for a half-plane, relative to the maximum of these averages. Half-planes perpendicular to lamp axis are shaded blue, while those parallel are red, and the rest are purple.



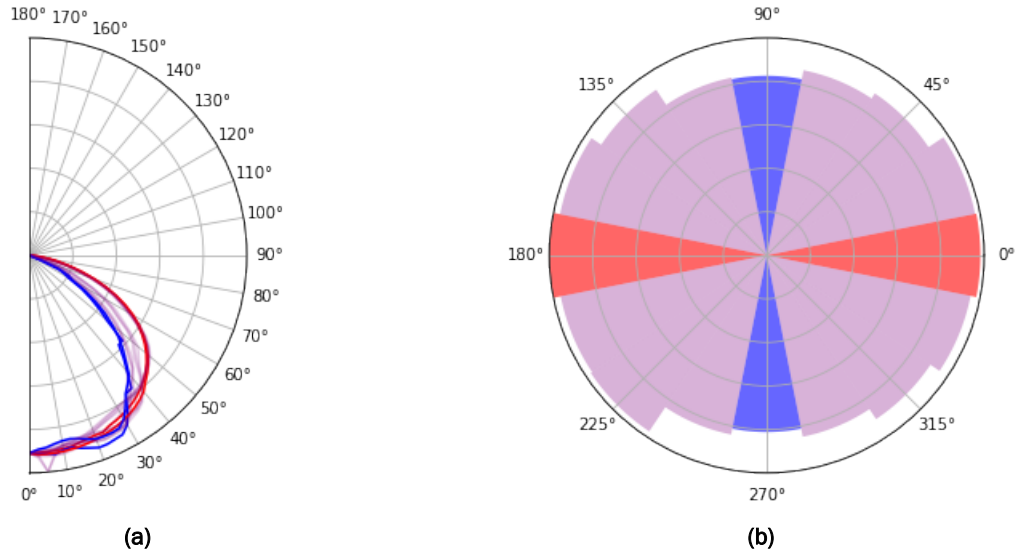

Figure 23. UV-C radiant intensity for LPM-22-06A. In plot (a), each continuous curve shows intensity at different angles in a vertical half-plane, relative to the maximum UV-C intensity of 21,889 mW/sr. In plot (b), the radius of a colored slice represents average intensity for a half-plane, relative to the maximum of these averages. Half-planes perpendicular to lamp axis are shaded blue, while those parallel are red, and the rest are purple.

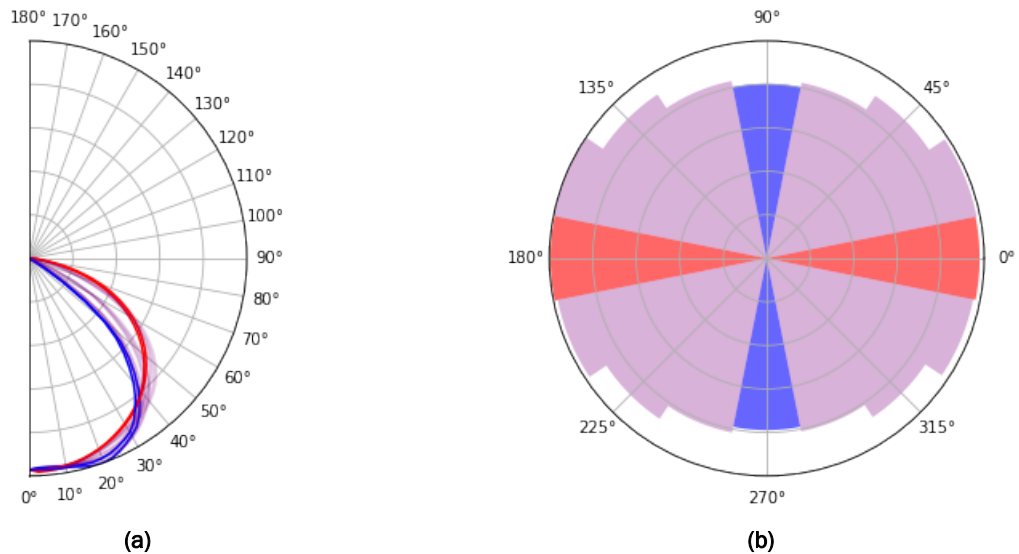

Figure 24. UV-C radiant intensity for LPM-22-07B. In plot (a), each continuous curve shows intensity at different angles in a vertical half-plane, relative to the maximum UV-C intensity of 8,982 mW/sr. In plot (b), the radius of a colored slice represents average intensity for a half-plane, relative to the maximum of these averages. Half-planes perpendicular to lamp axis are shaded blue, while those parallel are red, and the rest are purple.

#### 4.4 Near-field UV-C irradiance

LPM-22-04 claimed a “UV intensity” (assumed to mean irradiance) of at least  $380 \mu\text{W}/\text{cm}^2$  “at 3.5 ft” but did not clarify whether this distance was from floor or from luminaire. If the claim was based on distance from floor, directly beneath center of luminaire, it would not be supported by our measurement data given typical ceiling heights of at least 8 feet. A near-field intensity of  $4,342 \text{ mW}/\text{sr}$  was measured via gonio at a point 6.7 ft below center of luminaire, corresponding to an irradiance of  $103 \mu\text{W}/\text{cm}^2$  using the inverse-square law. If the luminaire was mounted 8 feet above floor (greater heights would yield lower irradiance values), the distance to a point 3.5 feet above floor would be 4.5 feet, for an estimated irradiance of  $231 \mu\text{W}/\text{cm}^2$ .

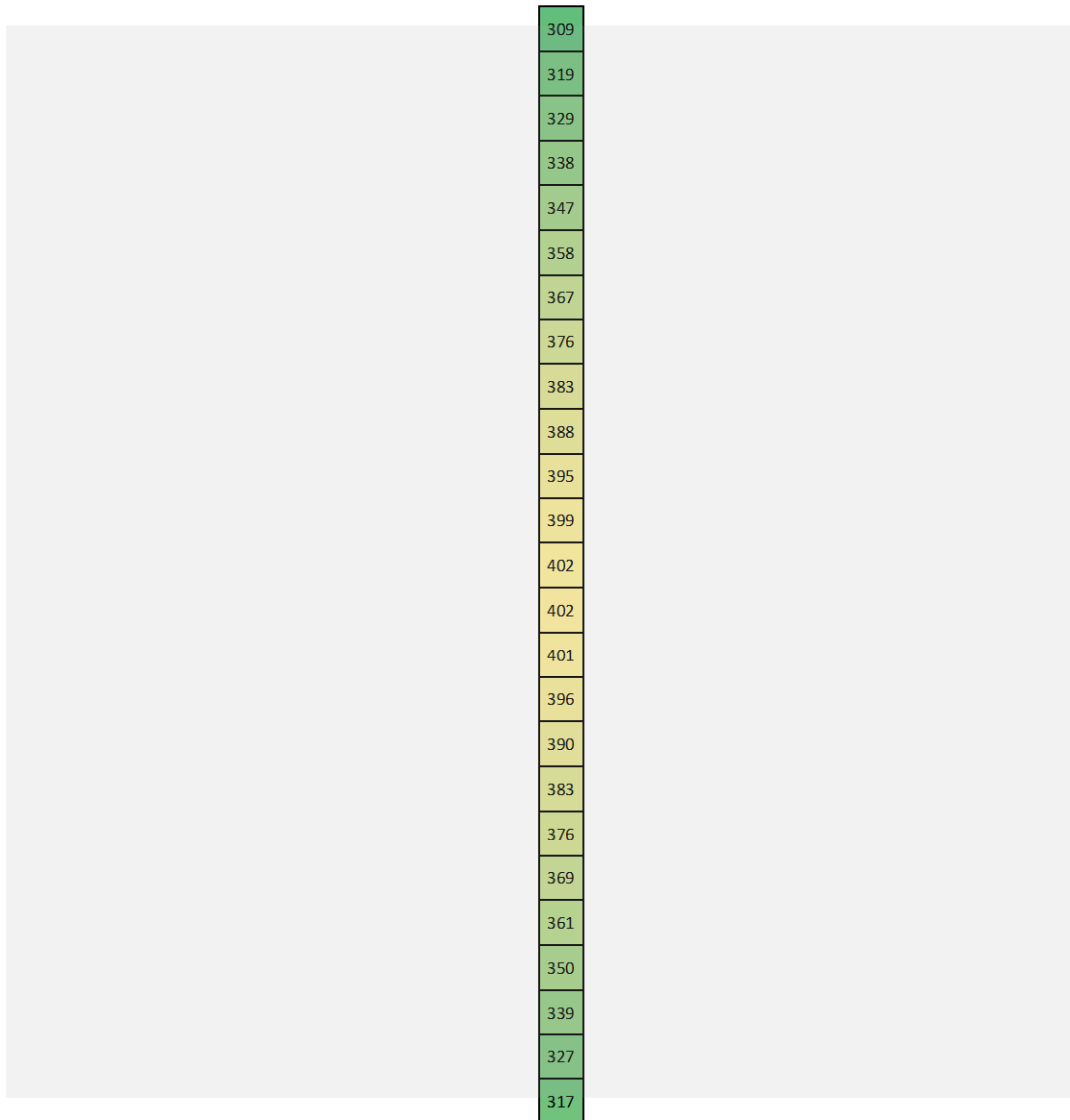

Figure 25. Measured near-field UV-C irradiance in  $\mu\text{W}/\text{cm}^2$  for LPM-22-04A. The horizontal measurement grid is 42 inches below DUT (represented by transparent gray rectangle), with detector aimed at zenith. Points are spaced 1 inch apart, with center point directly under center of DUT. Each lamp’s long axis is perpendicular to the column of measurement points.

However, if the claim is interpreted as distance directly below luminaire, the claim is supported by our measured  $402 \mu\text{W}/\text{cm}^2$  initial UV-C irradiance following IES LM-91, as shown in Figure 25. This corresponds to a near-field intensity of  $4,574 \text{ mW}/\text{sr}$ , which at 4.5 feet below luminaire would yield an estimated irradiance of  $243 \mu\text{W}/\text{cm}^2$ . In this case the error in extrapolating from near-field photometry would be relatively small.

LPM-22-05 had a claimed *maximum* irradiance of 5.224 mW/cm<sup>2</sup> at a distance of 50 cm. This claim was supported by CALiPER’s measurements across the measurement grid, shown in Figure 26, which showed a maximum initial UV-C irradiance of 4.44 mW/cm<sup>2</sup> at that distance directly beneath the center of the luminaire, with detector aimed at zenith. By way of comparison, gonio testing at a substantially greater distance of 205.1 cm showed a near-field UV-C intensity of 18,706 mW/sr in that direction, which would result in an unreliably estimated UV-C irradiance of 7.48 mW/cm<sup>2</sup> at a distance of 50 cm using the inverse-square law; this 68% higher value illustrates the potential for error when extrapolating to, from, or within the near field. The claimed “irradiance” of 45,691 mW (with no distance specified) more closely matched the measured UV-C output power of 56,632 mW.

3.43	3.46	3.46	3.50	3.51	3.44	3.36
3.87	3.85	3.86	3.89	3.85	3.85	3.75
4.12	4.17	4.23	4.26	4.21	4.19	4.11
4.27	4.33	4.35	4.44	4.37	4.33	4.26
4.26	4.33	4.37	4.38	4.36	4.34	4.26
3.99	4.06	4.20	4.06	4.16	4.10	4.00
3.54	3.62	3.66	3.67	3.57	3.60	3.50

Figure 26. Measured near-field UV-C irradiance in mW/cm<sup>2</sup> for unit LPM-22-05A, as viewed from above the horizontal measurement grid, which is 50 cm below DUT (represented here by transparent gray rectangle), with detector aimed at zenith. Points are spaced 2 inches apart, with center point directly under center of DUT. Each lamp’s long axis is parallel with a row of measurement points.

The manufacturer’s product datasheet for 2x4 troffer LPM-22-06 included a table and a diagram with what appear to be irradiance claims, which are shown in the first two columns of Table 13. Although the claimed numerical values were in agreement between table and diagram, the corresponding measurement units differed. The table used units of mJ/cm<sup>2</sup> and described the values as both “radiant exposure dosages” (which would be compatible with those units) and “irradiance values” (for which units of mW/cm<sup>2</sup> would be more appropriate). Meanwhile, the diagram gave “dosage” in units of mJ/s, which (being equal to mW) would instead correspond to radiant flux (i.e., output power). Duration of dose was not stated.

Table 13. Claimed values and measured or estimated UV-C irradiance for points directly beneath center of unit LPM-22-06A. All points are in the near field for this luminaire measuring 4 feet in length, but estimates use the inverse-square law as though data were far-field. Irradiance-based estimates use intensity calculated from irradiance measured per IES LM-91 at 2-ft distance. Intensity-based estimates use 19,891 mW/sr intensity measured at nadir from 7 ft (213.7 cm) distance via gonio. Orange font denotes estimates considered unreliable due to deviation from near-field measurement distance.

Vertical distance (ft)	Claimed value (mJ/cm <sup>2</sup> or mW)	UV-C irradiance (mW/cm <sup>2</sup> )		
		Measured value	Irradiance-based estimate	Intensity-based estimate
2	1.45	2.73	-	5.35
4	0.570	-	0.682	1.34
6	0.257	-	0.303	0.595
8	0.146	-	0.171	0.335
10	0.095	-	0.109	0.214
12	0.065	-	0.076	0.149

If measurement geometries are far field (a condition that is generally satisfied when a UV source’s maximum dimension is less than 20% of the distance to the measurement point), the luminaire can be approximated as a point source, intensity is independent of distance, and irradiance can be accurately estimated at various distances. The two rightmost columns in Table 13. Claimed values and measured or estimated UV-C irradiance for points directly beneath center of unit LPM-22-06A. All points are in the near field for this luminaire measuring 4 feet in length, but estimates use the inverse-square law as though data were far-field. Irradiance-based estimates use intensity calculated from irradiance measured per IES LM-91 at 2-ft distance. Intensity-based estimates use 19,891 mW/sr intensity measured at nadir from 7 ft (213.7 cm) distance via gonio. Orange font denotes estimates considered unreliable due to deviation from near-field measurement distance.illustrate the potential for error when extrapolating to or from the near field. The irradiance-based estimates were calculated by first estimating the intensity based on the measured irradiance (at the near-field distance of 2 feet) and then using this estimated intensity to estimate irradiance at greater distances. The intensity-based estimates were calculated in a similar way, except based on a near-field intensity measurement at a distance of 7 feet. The luminaire was approximated as a point source in all calculations.

Figure 27 shows UV-C irradiance measurements 2 feet below LPM-22-06A. The center point supports the claimed irradiance at a 2-foot distance: The claimed irradiance was 53% of the measured value. Analysis of intensity data from near-field goniometry yielded similar results for claims at distances of 6 and 8 feet, with claimed irradiance being about 43% of measured irradiance. In Table 13, orange font indicates values that have been extrapolated to distances that are relatively far from the distance at which measurements were made; these estimates should be considered unreliable and are shown here to illustrate the potential for error when extrapolating via the inverse-square law (e.g., as implemented automatically via simulation software) to, from, or within the near field. For example, the (reliable) measurement at a 2-foot distance is 51% of the (unreliable) intensity-based estimate for that distance. Meanwhile, the (unreliable) irradiance-based estimate at an 8-foot distance is 51% of the (reliable) intensity-based estimate at an 8-foot distance. And neither estimation approach would be reliable at distances of 4 or 12 feet. Luminaire discretization (i.e., subdivision) could be used in calculations to reduce uncertainty, but this would not eliminate associated error.

1.91	2.05	2.14	2.17	2.14	2.05	1.90
2.15	2.36	2.46	2.42	2.28	2.21	2.14
2.42	2.63	2.71	2.73	2.70	2.56	2.42
2.40	2.58	2.69	2.73	2.69	2.57	2.39
2.40	2.57	2.67	2.72	2.67	2.62	2.41
2.22	2.34	2.47	2.54	2.47	2.40	2.19
2.00	2.15	2.24	2.27	2.24	2.14	1.97

Figure 27. Measured near-field UV-C irradiance in mW/cm<sup>2</sup> for unit LPM-22-06A. The horizontal measurement grid is 24 inches below DUT (represented here by transparent gray rectangle), with detector aimed at zenith. Points are spaced 4 inches apart, with center point directly under center of DUT. Each lamp’s long axis is parallel with a row of points.

Higher-than-expected irradiance may be acceptable for the LPM products, given that they are intended for use in unoccupied spaces. In contrast, higher-than-expected irradiance could be problematic for LED-22-06, which is intended for use at least 10 inches above occupied spaces (e.g., the 2-inch luminaire would be rated for use on an 8-foot ceiling if occupied space is defined as up to 7 feet above floor). UV-C irradiance was measured at multiple points on a horizontal line 10 inches below LED-22-06C, as shown in Table 14, to inform determination of the distance and direction from which to evaluate the product for photobiological safety.

**Table 14. Measured near-field UV-C irradiance for unit LED-22-06C. The horizontal measurement grid was 10 inches below DUT, with detector aimed at zenith (to measure horizontal irradiance). The first measurement point was 40 cm horizontally from center of DUT in the 60° half-plane (midway between reflector supports). The remaining 13 points were spaced 1.5 cm apart, extending away from DUT in the same direction. Irradiance for measurement points 1–3 (not shown) was 0. Orange font denotes the point with greatest irradiance.**

Point	4	5	6	7	8	9	10	11	12	13	14
Distance (cm)	44.5	46.0	47.5	49.0	50.5	52.0	53.5	55.0	56.5	58.0	59.5
Irradiance ( $\mu\text{W}/\text{cm}^2$ )	0.0018	0.0243	0.0445	0.0388	0.0350	0.0341	0.0283	0.0258	0.0231	0.0200	0.0171

The locations of these points were selected to straddle the shadow cast by the reflector, at an angle of  $\sim 60^\circ$  from nadir, where maximum irradiance was expected for a detector aimed at the DUT. Point 6, at a horizontal distance of 47.5 cm from the DUT, was found to have the greatest horizontal irradiance ( $0.0445 \mu\text{W}/\text{cm}^2$ ). Using the inverse-square law and the cosine (IES 2022a), this point also had the greatest expected irradiance for a detector instead aimed at the UV-C LED ( $0.0878 \mu\text{W}/\text{cm}^2$ ), so it was selected for use in photobiological safety testing.

## 4.5 Photobiological safety

The manual received with tower LED-22-05A (and the other units acquired for that model) instructed occupants to stay at least 1 m away when in use, suggesting that would be a safe distance from the product. The direction of maximum UV-C intensity was determined via gonio testing to be  $120^\circ$  from nadir in the  $135^\circ$  half-plane. Photobiological testing was conducted with the detector aimed at the radiometric center of the DUT from 100 cm away in the direction of maximum UV-C intensity. The actinic-weighted irradiance and unweighted UV-A irradiance were found to be  $0.00329 \text{ W}/\text{m}^2$  and  $0.0683 \text{ W}/\text{m}^2$ , respectively; this indicates the product would not be safe to use at that distance for more than 2.5 h,<sup>14</sup> and corresponds to an RG-2 (Medium Risk) classification.

The downloadable instruction manual for LED-22-06C indicated a minimum distance of 10 inches below luminaire to the horizontal plane of the occupied space. For this type of product, irradiance is measured at points in this plane, where distance from a given point to the DUT varies, so it would not be appropriate to simply choose the direction of maximum intensity. Using the direction and distance determined from IES LM-91 application-distance testing, the actinic-weighted irradiance and unweighted UV-A irradiance were found to be  $0.6 \text{ mW}/\text{m}^2$  and  $9 \mu\text{W}/\text{m}^2$ , respectively. The actinic-weighted irradiance was therefore below the Actinic UV limit of  $1 \text{ mW}/\text{m}^2$  for what is commonly termed RG-0 (Exempt), indicating this product could be used safely at that distance for at least 8 hours.

For both products, unweighted UV-A irradiance was well below the Near UV limit of  $10 \text{ W}/\text{m}^2$  for RG-0 (Exempt), so that hazard did not play a role in classification.

<sup>14</sup> Maximum exposure duration was calculated as the quotient of the exposure limit (IEC 62471 Table 5.4) and the actinic-weighted irradiance.

## 4.6 Long-term performance

Figure 28 shows UV-C output power measurements for two LED products and two LPM luminaires after 0 h, 100 h, and 500 h of operation.

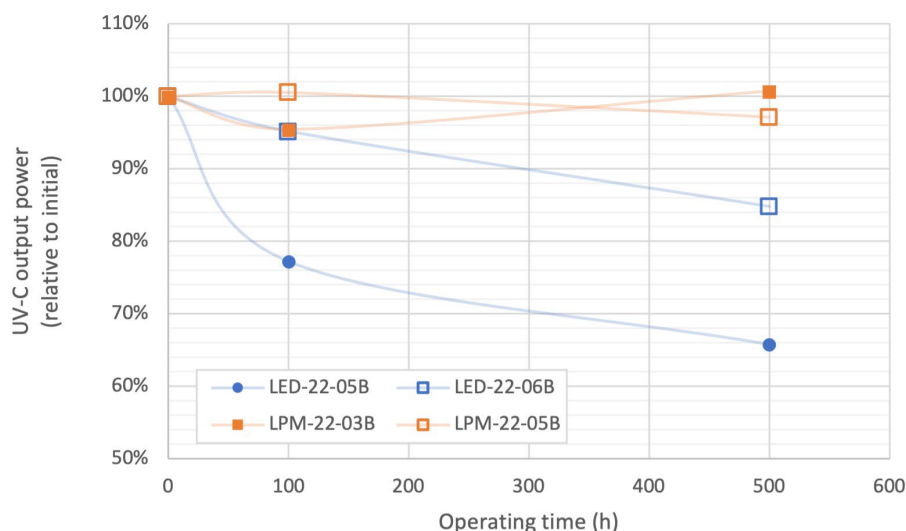

**Figure 28. Long-term performance for two LED products (tower LED-22-05B and occupied-room luminaire LED-22-06B) and two LPM vacant-room luminaires (recessed troffer LPM-22-03B and suspended high-bay LPM-22-05B) after 0, 100, and 500 h of operation. Products (including LPM lamps) were not seasoned prior to long-term testing, and operation was continuous between measurements (i.e., no cycling).**

Product LED-22-05 made no claims regarding initial UV-C output or longevity, and was found to have 77% of initial UV-C output at 100 h and 66% at 500 h. Initial UV-C output for LED-22-06 was 48% of the rated value; it had a claimed useful lifetime of almost 9,000 h and was found to have 85% of initial UV-C output at 500 h. Spectral radiant flux at the peak UV-C wavelengths diminished by these same amounts for both products. In contrast, spectral radiant flux at the much greater UV-A peak had diminished by only 3% at 100 h and 5% at 500 h for LED-22-05 (no UV-A was emitted by LED-22-06). Input power for the two LED products did not change during the first 500 h of operation.

The claimed lifetime for the lamps in LPM-22-03 was 8,000 h, and the datasheet for the lamps used in LPM-22-05 was unique among tested products in claiming a specific value (10%) for depreciation at their useful life of 9,000 h. UV-C output from LPM-22-05 diminished by 3% in the first 500 h, and LPM-22-03 increased slightly. Input power for the two LPM luminaires increased slightly, by 3% for LPM-22-03 and 2% for LPM-22-05.

In addition to gonio testing for the two LPM luminaires, one lamp from each luminaire was also measured via gonio at two points in time (0 and 100 h) to gauge the effect of lamp seasoning and provide a sense of lamp lumen depreciation. At 100 h, the sampled lamp from LPM-22-03 had diminished to 89% of initial (0 h) output, while the sampled lamp from LPM-22-05 had only dropped to 99% of initial output.

LPM-22-02C was not tested long-term, but its white “ABS plastic” housing yellowed visibly over its 24–32 h of gonio testing, as can be seen in Figure 3 and Figure 29 (its condition in both figures is post-test). It is unclear what effect continued yellowing might have on its UV-C output over time.



Figure 29. LPM-22-02C after three days of gonio testing (left) and unused LPM-22-02B (right).



## 5 Discussion

Performance claims were often absent or ambiguous. For many of the products tested, there were differences between the performance claims made by the product manufacturer or seller and the measured test results. In some cases, these differences may impact the effectiveness and/or safety of the product when installed. Additionally, the performance and UV-C radiant efficiency of the products varied widely, even among the same types of products with the same source technology. One LPM troffer-style luminaire had nearly four times the UV-C radiant efficiency of another LPM troffer, indicating large potential variations in effectiveness and energy use for a GUV installation, depending on the specific product used. Because measurement methods for GUV technology are relatively new to the industry and remain in development, testing these products uncovered several challenges and limitations. This section discusses these issues in greater detail.

### 5.1 Claims versus test results

In cases where product claims were testable, claims for input power, UV-C output power, UV spectrum, intensity distribution, irradiance, photobiological safety, and longevity were compared to test results. Table 15 summarizes test results relative to claims for all tested products. Sections 5.1.1 through 5.1.7 discuss differences in test results for each topic area and offer potential explanations for the differences.

Table 15: Test results relative to claims. Shading is explained in the table footnotes. Notably, whereas LPM-22-04 and LPM-22-06 had claims pertaining to *minimum* irradiance, the claim for LPM-22-05 pertained to *maximum* irradiance.

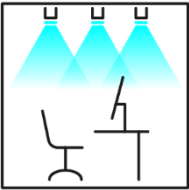
Product type	Product	Input power	UV-C output power	Peak UV wavelength	UV-C irradiance	IEC 62471 Risk Group
<p>Tower</p> 	LED-22-01	-48%	none detected	140 nm		
	LED-22-02	-49%	none detected	140 nm		
	LED-22-03		none detected	145 nm		
	LED-22-04	-12%		20 nm		
	LED-22-05	-71%		1 nm		2
	LPM-22-01	-14%		0		
	LPM-22-02	-26%		0		
<p>Occupied-room Luminaire</p> 	LED-22-06	-31%	-52%	5 nm		0
<p>Vacant-room Luminaire</p> 	LPM-22-03	3%	-47%	0		
	LPM-22-04	-16%		0	6%	
	LPM-22-05	1%	24%	0	-15%	
	LPM-22-06	-13%		0	88%	
	LPM-22-07	12%	-71%	0		
	<p>Values shown are differences from claim (e.g., -1% means measured value was 1% less than claim).</p> <ul style="list-style-type: none"> <li>Yellow shading indicates test result differed substantially from claim but would not necessarily be problematic (e.g., input power lower than rated)</li> <li>Red shading indicates test result differed substantially from claim and would likely be problematic (e.g., output power lower than rated)</li> <li>Green shading indicates test result did not differ substantially from claim (e.g., less than 10% difference)</li> <li>Empty fields indicate no claim was made or tested</li> </ul>					

### 5.1.1 Input power

Differences between measured input power and rated input power were observed across all types of products. For the remote-controllable LED tower products, the test laboratory determined that they were operating in the active mode with UV-C output as the primary function,<sup>15</sup> so the differences between claimed and measured input power might be attributable to the manufacturer or vendor: simple mistakes (e.g., typos), “conservative” estimation (e.g., to account for production tolerances), or confusion between different types of quantities (e.g., active power, apparent power) and measurement units (e.g., W, VA). Claimed power was much closer to apparent power than to active power for LED-22-01 and LED-22-02 (neither of which emitted UV-C),

<sup>15</sup> Active mode and primary function are defined in IEC 62301:2011 (IEC 2011), and the definitions can be accessed via the online IEC Glossary (IEC 2023b).



suggesting the sellers of these products may have miscalculated watts as the simple product of volts and amperes. In contrast, measured active power and apparent power for LED-22-05 (which did emit UV-C) were both well below claimed power.

Differences between measured input power and rated input power will impact the energy use of the GUV product or system, resulting in either lower or higher energy use than would be expected by the buyer or specifier. Lower measured input power than rated input power is not necessarily a problem; most buyers would appreciate lower energy use. However, it can be a sign that the product also has lower output power and therefore lower germicidal effectiveness than expected by the buyer or specifier. A case in point is LED-22-06, which had both lower measured input power and lower measured output power than the rated values of the product ordered.

Potential explanations for higher-than-rated input power for some LPM products include  $BF > 1$ , low ballast efficiency, and power draw from other components. Measured input power was 84–87% of rated power for several LPM products (LPM-22-01, LPM-22-04, LPM 22-06), and this might be expected using common non-dimming ballasts (which often have  $\sim 0.87$  BF), but only if they have high efficiency.

One product, LPM-22-07 (which had rated input power of 160 W), had dimming ballasts. Its occupancy sensor was removed from the circuit to enable lamp seasoning and product testing. Consequently, its dimming ballasts received no control signal. The expected behavior of the ballasts in this condition was not known—the ballast datasheet and label only stated, “lamp fault: 0V.” However, the four lamps were each rated 40 W (input power), the 1-lamp ballasts were rated for 85% efficiency at full load according to their datasheet, and the fan was rated 12 V and 0.18 A according to its label. Given the measured 179 W luminaire input power, it appears the lamps were operating at  $\sim 94\%$  of rated input power if the fan was operating at full power.

### 5.1.2 UV-C output power

All tested products claimed to emit UV-C, but three of the LED tower products were found to emit no UV-C. The lack of UV-C from models LED-22-02 and LED-22-03 is not altogether surprising, given that they had no gold-colored LEDs, as gold is commonly used for reflectors in UV-C LED emitters (DOE 2021; DOE 2022). In contrast, LED-22-01 had some gold-colored LEDs but emitted no UV-C. This suggests that while the lack of gold-colored LEDs can be an indicator of no UV-C, their presence does not necessarily indicate UV-C will be produced. Other possible explanations include defective units (e.g., as shown for LED-22-01 in Appendix A) or failure to capture the mode with full UV-C output via the remote control (e.g., UV-C and UV-A LEDs might be operated independently in different modes via the remote control).

One possible explanation for the observed lower-than-rated UV-C output for occupied-room luminaire LED-22-06 is that the model received (which was unclear, as discussed in Sections 2.1.5 and 2.2) was a lower-power version of the model that was ordered. As noted in Section 5.1.1, input power was also found to be lower than rated, suggesting CALiPER received a lower-power version. In any case, this product was unique among the tested products in that it was clearly rated for use in occupied spaces, so if measured output had instead been greater than claimed, it could have posed photobiological safety issues. Conversely, the fact that the product received had lower output power suggests it is less effective for germicidal disinfection than the product ordered.

### 5.1.3 UV Spectrum

Contrary to their claimed SPDs, which only showed energy at UV-C and UV-B wavelengths, LED-22-04 and LED-22-05 were found to emit mostly UV-A, with overall UV peaks at 400 nm. LED-22-04 claimed a “wavelength” of 250–255 nm and its separately claimed SPD showed a peak wavelength of  $\sim 264$  nm, while the measured UV-C peak was at 278 nm. Similarly, whereas the measured peak UV-C wavelengths for two units of LED-22-05 (273 nm and 277 nm) aligned with its claimed SPD, the stated 260–280 nm range only captured one side of the UV-C peak (thereby omitting substantial UV-B energy). It was not surprising to find that these LED tower products (which contained more white-colored LEDs than gold-colored LEDs) emitted

mostly UV-A, although it seemed possible that the two source types might be operated independently in different modes via the remote controls. Potential explanations for differences between claimed and measured SPDs in the UV-C range include use of data from LED emitter datasheets (characteristics can change once integrated into products) and failure to update product datasheets as designs change (e.g., using different LED emitters).

For tested LPM products, the measured primary spike at 254 nm, and secondary spikes of around 1% of the primary spike's spectral irradiance at 313 nm and 365 nm appear consistent with the known behavior of LPM lamps (IES 2021; NLPIP 2020). Meanwhile, only two products had SPDs in downloadable documentation; these seemed to show primary spikes at 254 nm, and one had a secondary peak near 365 nm. Other secondary peaks appeared to differ in location, but were at or near the low end of the test laboratory's measurement capability.

Differences between measured and claimed peak wavelengths or SPDs can impact the safety and effectiveness of GUV products. Threshold limit values (TLVs) established by ACGIH for exposure to ultraviolet radiation are a function of wavelength (ACGIH 2022), for example, and the same is true for risk group limits specified in IEC 62471. Thus, a product with a different measured SPD than what is claimed could be less safe than what is expected by the specifier or buyer. Similarly, the susceptibility of different pathogens to GUV also varies by wavelength, so a product with a different measured SPD than what is claimed could be less effective for disinfection than expected (IES 2021).

#### **5.1.4 Intensity distribution**

LED-22-05, LED-22-06, and LPM-22-05 had claimed intensity distributions. The polar plot of claimed intensity for LED-22-05 was Lambertian, and was presumably intended to represent a single isolated LED emitter, rather than the combined output of all such emitters in the integrated LED lamp. However, this may not be clear to buyers. In addition, the measured intensity distribution suggests the distribution of each LED emitter is not Lambertian. If maximum intensity for each LED emitter was at its centerbeam, the maximum intensity in the lower hemisphere (0–90° from nadir) would occur 90° from nadir, rather than 70–75° from nadir. Indeed, for many UV-C LED emitters, the centerbeam intensity is not the maximum intensity (Galbraith and Follett 2020; Krames 2020).

The vertical angles of maximum intensity evident in the claimed intensity plot for LED-22-06 (81° and 85° from nadir) differed by 2° from the angles identified from gonio testing (83° and 87° from nadir). The discrepancy could for example be explained by differences in the assumed location of radiometric center. The claimed and measured intensity profiles were otherwise similar, but it should be noted that for products with such concentrated beams, slight changes in angle can have a large effect on irradiance at a given point (e.g., when evaluating photobiological safety).

#### **5.1.5 Irradiance**

Although there was some ambiguity, and not all scenarios were evaluated, irradiance claims appeared to be supported by our measurements, which were based on the guidance in IES LM-91 for application-distance radiometry. However, the datasheet for LPM-22-07 showed a grid of irradiance values, but did not state distance from grid to luminaire, so its performance could not be evaluated relative to claims. For irradiance claims to be useful, they should not be missing needed information (e.g., distance from product to measurement point), communicated as other quantities (e.g., intensity, dosage), or stated with incompatible measurement units (e.g., mJ/cm<sup>2</sup>, mW). Confusion regarding irradiance can lead to installations that are inefficient, ineffective, and/or unsafe.

#### **5.1.6 Photobiological safety**

Two products had testable photobiological safety claims. Although most documentation (e.g., seller's webpage) for LED-22-05 instructed users to leave the room, the pamphlet received with the units instructed users to stay at least 1 m away. Testing to IEC 62471 for Actinic UV and Near UV hazards indicated it would

not be safe to use the product at this distance for more than 2.5 h, corresponding to an RG-2 (Medium Risk) classification. Notably, although the measured UV peak was 400 nm, testing for the Blue Light hazard (which considers wavelengths 300–700 nm) was outside the scope of this study. In addition, the test laboratory determined this product emitted UV-C when it was connected to power, without any need to be turned on via the remote control; consequently, users may be exposed to unsafe levels of UV-C when they believe the unit is off. However, this product was no longer offered via the seller's Amazon webpage as of January 11, 2023.

The actinic-weighted irradiance of 0.6 mW/m<sup>2</sup> for LED-22-06 (located 10 inches above the occupied space as recommended by the manufacturer) was below the Actinic UV limit of 1 mW/m<sup>2</sup> for what is commonly termed RG-0 (Exempt), indicating the product could be safely used at this distance for at least 8 h. However, subsequent gonio testing found higher intensities in the 155° half-plane (e.g., 0.5 mW/sr at 60° from nadir) than in the 60° half-plane used for IES LM-91 and IEC 62471 testing (e.g., 0.4 mW/sr at 60° from nadir), and intensity was not measured at horizontal angles greater than 180°, so it is possible that a greater irradiance might be found in another half-plane. Furthermore, the model number was unclear and input power was lower than rated, so the tested unit may have been a lower-power version of the model ordered. Consequently, it is unclear whether the model ordered (which was the highest-output option) would be classified RG-0 or some higher risk group. One additional consideration is that UL 8802 (UL 2022), which cites IEC 62471 and is applicable to products of this type, specifies testing such products with 1° tilt; this could also affect the RG classification.

### 5.1.7 Long-term performance

UV-C output from the two LPM luminaires tested long-term (LPM-22-03 and LPM-22-05), one of which had generic lamps and a white-painted reflector, diminished by 3% or less after 500 h of operation, and variation in the first 100 h of operation appeared to be attributable to the fact that the lamps were effectively being seasoned during this period. However, the plastic housing of tower product LPM-22-02 yellowed visibly after just 24–32 h of gonio testing, demonstrating the importance of selecting suitable materials for GUV products.

The two LED products tested long-term, LED-22-05 and LED-22-06, diminished after 500 h of operation to 66% and 85% of initial output respectively. LED-22-06 had a rated life of approximately one year of continuous use (8,760 h), but did not state the expected depreciation at the end of this period, and LED-22-05 had no such claims. By way of comparison, the lamps used in LPM-22-05 had a rated useful lamp life of 9,000 h, and claimed 90% of initial output at that point.

Results for these integrated LED products are consistent with recent findings by DOE for isolated LED emitters (DOE 2022), and raise questions regarding useful life and the expected percentage of initial output when it is reached. Buyers and specifiers need to know the expected life and depreciation of the products to equitably compare products and develop operation, maintenance, and/or replacement practices to ensure the ongoing effectiveness of the GUV installation. Longevity estimates for LED lighting products can be uncertain because expected useful lifetimes often greatly exceed the duration of available long-term test (IES 2018a), but standard extrapolation methods may be viable for GUV products due to their shorter useful lifetimes.

## 5.2 LPM versus LED

Towers were the only tested product type for which direct comparisons of LED and LPM products could be made. However, the tested LED towers generally performed below the tested LPM towers based on the metrics considered, and this was true across other product categories as well. As noted in the preceding sections, UV-C output power for LED products was orders of magnitude lower than for LPM products, and the gap grew after 500 h of operation for the two LED products and two LPM products tested long-term. Whereas nearly all the output from the LPM products and LED-22-06 in the 200–400 nm range was UV-C, most of the output from the two UV-C emitting LED towers was UV-A, and nearly half of the remainder was UV-B. Ultimately, both technologies can present photobiological safety concerns in the absence of appropriate safeguards.

### 5.2.1 Output power versus intensity distribution

It is possible for two products to have equal maximum intensities in a desired direction, and yet have very different output power, due to differences elsewhere in their intensity distributions. In such cases, the product with lower output power may be just as effective, while also using less input power, if its output is better directed to the targeted portions of the room. However, while the maximum UV-C intensity for LED products ranged from 2.6 to 4.7 mW/sr, values for LPM products ranged from 709 to 21,889 mW/sr (orders of magnitude greater). Although these products are intended for different uses, and the value of direct comparisons between product categories is limited, this does, for example, raise the question of how LED-22-06 would compare against upper-room (indirect) GUV luminaires.

### 5.2.2 Radiant efficiency and output ratio

UV-C radiant efficiency for LED products was far lower than for LPM products, and LPM values varied widely. Whereas LED-22-05A (highest among LED products) was measured at 0.22%, LPM-22-02C (lowest among LPM products) was 6.5% and LPM-22-06A (highest among LPM products) was 42%. Notably, because UV-C radiant efficiency is calculated from UV-C radiant flux, this simple metric weights all UV-C wavelengths equally and does not consider the spatial distribution of UV-C radiant intensity.

The strong linear relationship between UV-C radiant efficiency and UV-C output ratio suggests that the tested LPM luminaires varied more in terms of optical losses than in electrical losses. The three LPM products with lowest UV-C radiant efficiency and UV-C output ratio had louvered designs, and all three had at least some optical components with white rather than specular (mirror-like) or semi-specular finish. The louvers in LPM-22-02 were white plastic. The louvers in LPM-22-03 and LPM-22-07 were specular or semi-specular, but the reflectors directly above lamps were white; if the upper reflectors were instead specular or semi-specular, as in the other LPM whole-room luminaires, their performance may have been somewhat better. Notably, LPM-22-04 had no louvers, but did have a wire guard and white side reflectors, and its performance by these metrics was closer to the other LPM products than to LPM-22-05 and LPM-22-06 (which both had only specular reflectors).

The use of louvers and white reflectors can have large impacts on performance and energy use. Though the louvered troffer design (LPM-22-03, LPM-22-07) and architectural troffer design (LPM-22-04) may help GUV products blend in with nearby lighting products, the resulting reduction in efficiency can have significant cost implications. For example, whereas only 17% of lamp output was trapped inside LPM-22-06, nearly 73% was trapped inside LPM-22-07. Consequently, five units of LPM-22-07 would be needed to match the output of two units of LPM-22-06, and LPM-22-07 would use more than three times the amount of electrical energy.

## 5.3 Measurement and calculation methods

LED-22-06C was measured at 0 h both in the integrating hemisphere and via goniometer. Sphere-measured UV-C output power was 76% of the value from gonio. Similarly, the 0 h sphere measurement for LED-22-06B was 69% of the LED-22-06C gonio measurement, and the 0 h sphere measurement for LED-22-05B was 74% of the LED-22-05A gonio measurement, although manufacturing tolerances may explain some of the difference in these cases. The discrepancies suggest that the sphere and/or gonio measurements of UV-C output power were inaccurate. However, in the case of LED-22-06C, only one hemisphere was measured via gonio (i.e., vertical half-planes in horizontal angles 0–180°), so if output in the other hemisphere was lower, that might explain some of the discrepancy.

Reflection symmetry was assumed for LED-22-06 to enable finer horizontal resolution, aiming to capture shadows cast by its three reflector supports. Asymmetry in the test results indicates this may not have been a valid assumption. In addition, the detector was only slightly shadowed at the 0° and 120° horizontal angles, suggesting some imprecision in the measurement (e.g., detector was relatively large and/or those two half-planes did not pass through the supports).

For three different LPM luminaires, at least one lamp had a spot measurement of irradiance that differed by more than 10% from the lamp measured bare-lamp via gonio. For multi-lamp luminaires, this suggests UV-C output ratio should not be estimated based only on bare-lamp testing of one lamp, although imperfect repeatability could also explain some of the difference.

Section 4.4 illustrates the potential for error when extrapolating (UV-C) irradiance via the inverse-square law to, from, or within the near field. Radiant intensity values can be accurately derived from measured irradiance if the product-detector distance is at least five times the maximum radiant dimension of the product; such values can then be used to reliably extrapolate irradiance to other far-field distances via the inverse-square law. However, calculations become unreliable if intensity is derived from irradiance measured in the near field, and/or if the extrapolation is to a point in the near field. The error generally increases as the relative extrapolation distance increases, and this is easiest to see by comparing derived intensities directly:

- 402  $\mu\text{W}/\text{cm}^2$  was measured 3.5 feet below LPM-22-04, corresponding to a near-field intensity of 4,575 mW/sr. A near-field intensity of 4,342 mW/sr was separately derived via gonio measurement of irradiance at a point 6.74 feet below the luminaire (nearly twice the distance). If this value is extrapolated to the 3.5-foot distance via the inverse-square law, an unreliable estimate of 382  $\mu\text{W}/\text{cm}^2$  is obtained, with just 5% error in this case.
- 2.73 mW/cm<sup>2</sup> was measured 2 feet below LPM-22-06, corresponding to a near-field intensity of 10,145 mW/sr. A near-field intensity of 19,891 mW/sr was separately derived via gonio measurement of irradiance at a point 7.01 feet below the luminaire (nearly twice the distance). If this value is extrapolated to the 2-foot distance via the inverse-square law, an unreliable estimate of 5.35 mW/cm<sup>2</sup> is obtained, with 96% error in this case.

## 5.4 Testing challenges and limitations

CALiPER encountered a variety of challenges in the process of selecting, acquiring, and testing the products evaluated in this round. One issue recognized early on in selecting products was that performance claims were often absent, ambiguous (e.g., unclear whether applicable to lamp or whole product), conflicting (e.g., different input power ratings in different documents), or nonsensical (e.g., irradiance in mW). Consequently, some assumptions had to be made regarding the intended meaning of claims.

It should be noted that random sampling is not implemented when acquiring test units, and sample sizes are relatively small, so test results may not be representative for a tested model, and no consideration is given to manufacturing tolerances. Furthermore, the products selected for testing are not a representative sample of all available products of that type. CALiPER cannot control for the age of products in the distribution system, nor account for any differences in products that carry the same model number.

It was not always clear whether the products received were the products that had been ordered. For example, CALiPER ordered the second-generation design of LED-22-06, and received units that matched its appearance, but all printed materials received with the units were for the first-generation design. Similarly, the optical system in units received for LPM-22-06 did not resemble the appearance of the product on its datasheet, and there was no means of ordering one optical system or another.

Many products were received damaged or with apparent defects. Products with broken lamps or missing ballasts were simply not used, but products with apparently minor defects (e.g., misaligned LEDs) or damage (e.g., bent housing corners) were deemed suitable for testing. Unlike lighting products, UV products cannot be safely and easily evaluated visually (e.g., to ensure all LED emitters in an integrated LED lamp are operational).

Although input power had stabilized for all products prior to testing, UV-C output for two LED products did not fully stabilize to the 0.5% tolerance specified in IES LM-79; LED-22-04A stabilized to 1.5% and LED-22-05A stabilized to 1.1%.

Some LPM products had integral timers or motion sensors that were bypassed to enable lamp seasoning and gonio testing without interruption. These modifications may have affected performance; for example, the dimming ballasts in LPM-22-07 received no control signal from the integral occupancy sensor, so may not have been operating at maximum output.

Integrating-sphere testing was limited to the two UV-C emitting products suitable for measurement in the available 20-inch diameter hemisphere. Similarly, the maximum product-detector test distance of the goniometer was limited such that all intensity measurements for LPM products must be considered near-field intensity values, which cannot be reliably extrapolated to other distances. However, the detector was cosine-corrected, so accurate numerical integration for UV-C output power was still possible.

For bare-lamp gonio testing, LPM lamp sockets were attached to the broad face of an unpainted 2x4 (pine lumber), so UV-C output power values for lamps in Table 12 may be somewhat overstated, and UV-C output ratios may thus be somewhat understated. Lumber appears to have about 5% reflectance at 254 nm (Smith et al. 1984; Endo et al. 2021).

## 6 Conclusions

Specifiers and buyers of GUV technology need complete and accurate performance data for the safe and effective application of the technology. Product developers need industry-standard test methods and associated laboratory capabilities to provide this data. This initial round of CALiPER GUV product testing identified a host of issues to be addressed to realize both outcomes. Key findings from the first round of CALiPER GUV product testing include:

- Performance claims were often absent, untestable (e.g., irradiance without stated distance), contradictory (e.g., unexplained differences between multiple power values), or ambiguous (e.g., unclear whether input power or output power). Measurement units frequently conflicted with quantities, making the intended meaning of the claim unclear. In some cases, irradiance measurement units (e.g.,  $\mu\text{W}/\text{cm}^2$ ) were incorrectly associated with other quantities (e.g., intensity). In other cases, measurement units for other quantities (e.g.,  $\text{mJ}/\text{cm}^2$ ,  $\text{mJ}/\text{s}$ ,  $\text{mW}$ ) were incorrectly associated with irradiance.
- All five of the tested LED tower products claimed to emit UV-C but mostly or only emitted UV-A. Three only emitted UV-A, and the other two had UV-C peaks near 280 nm (thus emitting substantial UV-B) that were just 1–3% of their overall UV peaks at 400 nm.
- All tested LED products had lower-than-rated input power, and the measured UV-C radiant flux (i.e., output power) for the only one that explicitly claimed an output power value (the whole-room luminaire for occupied rooms) was lower than rated. Three of the seven LPM products had higher-than-rated input power, and of these three, the two that deviated most from claimed input power also had lower-than-rated UV-C output power.
- There was a wide variation in UV-C radiant efficiency, from 0.04% for the lowest-output UV-C emitting LED product (the whole-room luminaire for occupied rooms), to 42% for the highest-output LPM product (a 2x4 troffer for vacant rooms). LPM products with white louvers or reflectors had substantially lower UV-C radiant efficiency than those with only specular reflectors. In addition, there was a strong linear relationship between UV-C radiant efficiency and UV-C output ratio, suggesting that the tested LPM luminaires varied more in terms of optical losses than in electrical losses.

- Products with relatively little UV-C radiant intensity can still exceed photobiological safety limits at plausible distances. The user manual for one LED tower warned users to stay at least 1 m away from the product, but IEC 62471 testing for Actinic UV and Near UV hazards indicated that more than 2.5 h of exposure to the product at that distance would be unsafe, corresponding to an RG-2 (Medium Risk) classification. The same product was found to emit UV-C before its remote control was used to switch it on, potentially posing a safety hazard to room occupants who believe it is off.
- Of the two UV-C LED products tested long-term, one had a two-year warranty (implying a rated life of at least 17,520 h) but dropped to 66% of its initial output at 500 h. The other, which claimed a lifetime of about one year in continuous use (8,760 h) dropped to 85% at 500 h. These findings suggest rated lifetimes for UV-C LED products may merit close scrutiny.
- UV-C radiant intensity data was gathered for all products, but the product-detector distance of the goniometer was such that the data collected for all LPM products was near-field (i.e., not true far-field intensity), and thus cannot be reliably used to calculate irradiance via the inverse-square law as is typically accomplished through design software using electronic files with radiant intensity data.
- Integrating-sphere testing was limited to the two UV-C emitting products suitable for measurement in the available 20-inch diameter hemisphere. Larger integrating spheres suitable for GUV product testing would enable measurement of larger GUV products as well as comparisons with goniometer measurements. However, larger spheres may not be available at commercial test laboratories.
- For the limited scenarios where comparisons were possible, integrating hemisphere measurements of UV-C output power were around 25% lower than values based on goniometer testing. In one scenario, a unit tested both ways exhibited a 24% discrepancy. In another scenario, two models each had units dedicated to each kind of test (which may differ due to manufacturing tolerances), and they exhibited discrepancies of 26% and 31%.

## 6.1 Recommendations

Manufacturers and vendors of GUV products can take actionable steps to minimize the discrepancies between claimed and measured performance CALiPER testing has uncovered:

- Use industry-standard terminology and measurement units when reporting product performance and photobiological safety.
- Clearly state whether occupants can be in the room when the product is operating. Do not state a safe distance unless one has been established through IEC 62471 testing, in which case the corresponding risk group should also be stated. Consider UL 8802 (for luminaires and systems) or UL 8803 (for portable products) as appropriate.<sup>16</sup> Implement suitable safeguards (e.g., warning lights, occupancy sensors) as needed.
- Provide clear instructions for use of controls (e.g., remote, occupancy, timer) in online documentation and printed materials shipped with products. Modes with different input power and/or UV-C output power should be clearly identified and characterized.
- Consider using specular or semi-specular metallic finishes (e.g., aluminum) in lieu of white finishes (e.g., paint, plastic) for any reflector materials, such as those used in LPM products, to improve UV-C radiant efficiency and the UV-C output ratio. Select materials and finishes with long-term performance in mind.

---

<sup>16</sup> Whereas UL 8802 is now a Collaborative Standards Development System (CSDS) proposal, UL 8803 remains an outline of investigation (UL 2021).

- Consider publishing polar plots of UV-C radiant intensity for vertical half-planes covering the range of intensity profiles for the product (e.g., parallel and perpendicular to lamps for LPM luminaires). Provide downloadable standard-format radiometric data files (e.g., ANSI/IES LM-63-19 [IES 2019c], ANSI/IES TM-33-18 [IES 2018b]), containing clear descriptions of the reported quantities (e.g., UV-C radiant intensity) and measurement units, for use in simulation software. Clearly state which specific model is represented and describe the assumed location of the radiometric center.
- Clearly state whether intensity and irradiance values are based on near-field radiometry, ideally stating the product-detector test distance. Large errors can result from extrapolation via the inverse-square law to, from, or within the near field.
- Publish SPD data with adequate horizontal resolution (e.g., 1 nm) and vertical resolution (e.g., 0.1% of peak wavelength). The horizontal scale should span at least 200–400 nm, with measurement data covering this range. In cases where the peak wavelength is orders of magnitude greater than secondary peaks, consider plotting SPDs relative to peak wavelength, and cropping them just above the secondary peaks (e.g., see Figure 11 for LPM). When using a range to describe spectrum (e.g., 260–280 nm,  $270 \pm 10$  nm), clearly state whether it represents a tolerance for the peak UV-C wavelength or something else. Provide downloadable files in industry-standard format (e.g., ANSI/IES TM-27-20 [IES 2020g] or IES TM-33) or simply tabulated.
- Publish defensible claims for rated useful lifetime and the expected percentage of initial UV-C output power at its end. If lifetime is not based on continuous operation, state the assumed daily hours of use. Consider following or adapting the guidance in available industry standards for LPM lamps and LED products.<sup>17</sup> Use replaceable components where possible, considering the relatively-short rated lifetimes of currently-available GUV products (compared to those of lighting products).
- Contribute to the development of industry-standard test methods that are directly applicable to GUV products.

Specifiers and buyers of GUV products can take actionable steps to minimize discrepancies between claimed and measured performance:

- Review the above recommendations to manufacturers and sellers, and request information as needed.
- Become familiar with the relevant terminology, technologies, industry-standard test methods, and use of available data and/or seek the assistance of someone with this expertise.
- Seek clarification when it is unclear whether intensity and irradiance values are based on near-field radiometry, and request the product-detector test distance. Large errors can result from extrapolation via the inverse-square law to, from, or within the near field.
- Contribute to the development of industry-standard test methods that are directly applicable to GUV products. Monitor ongoing development and publication of such standards, which provide guidance and are often accompanied by educational webinars.

Test laboratories can take actionable steps to minimize discrepancies between claimed and measured performance:

- Have a goniometer capable of far-field measurement of UV-C radiant intensity for products measuring 4 feet in length or more.

---

<sup>17</sup> Examples for LPM lamps include ANSI/IES LM-40-20 (IES 2020h) and ANSI/IES LM-65-20 (IES 2020i). Examples for LED products include ANSI/IES TM-28-20 (IES 2020j) and IES LM-84.



- Clearly state in radiometric data files (e.g., IES LM-63 or IES TM-33 format) and test reports the product-detector test distance and whether this satisfies the 5x rule (i.e., is far field). In addition, these documents should clearly describe the reported quantities (e.g., UV-C radiant intensity) and measurement units. Product orientation with respect to gravity should also be clearly described.
- For a given diameter, consider integrating spheres in lieu of integrating hemispheres, to accommodate larger GUV products.
- Clearly state in test reports how product controls (e.g., remotes, timers, occupancy sensors) were configured or disabled for testing.
- Clearly describe in test reports how industry-standard test methods were used, including any necessary modifications for GUV.
- Contribute to the development of industry standards that are directly applicable to GUV products.

Standards-development organizations can take actionable steps to minimize discrepancies between claimed and measured performance:

- Continue developing industry-standard test methods specific to GUV technologies. For example, IES has recently published multiple relevant standards, and is currently developing a standard for electrical and UV measurement of UV-C disinfection products (Miller 2022). Specifiers and buyers need more guidance for evaluating GUV products and applying them safely and effectively.
- Consider revising existing industry standards to accommodate GUV. For example, IES LM-63 is more widely used than IES TM-33 and is already being adapted for GUV products. The standard could be revised to clarify the quantities (e.g., luminous intensity, UV-C radiant intensity) and measurement units represented, as well as an indication of the test distance and whether it was far field.
- Consider developing an industry standard for reporting GUV product radiometric performance, electrical performance, and photobiological safety. This standard could identify the metrics, units, and data that should be reported for any GUV product intended for use in occupiable spaces.
- Provide guidance on estimating and correcting the error associated with extrapolating values via inverse-square law to, from, or within the near field.
- Help to educate buyers, specifiers, and manufacturers on GUV.

## Appendix A – Missing or damaged product components

One of the many white-colored LEDs in tower LED-22-01A, which was located between two of the seven gold-colored LEDs, was securely attached but visibly misaligned, as shown in

Figure 30. This unit was not excluded from testing.

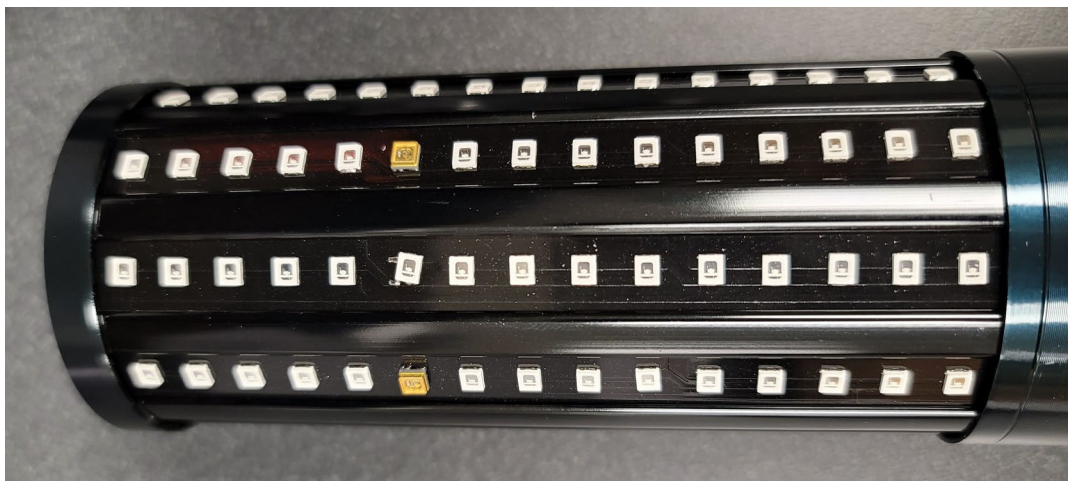

**Figure 30.** Close-up view of LED-22-01A. The white-colored LED between the two gold-colored LEDs was visibly misaligned.

The shipment for LPM-22-04 arrived with a unit in one box and the other two in a second box. Loose glass could be heard from outside the box containing two units, indicating lamps inside had been broken; these units were excluded from testing. The two lamps in the other box were intact, but one of them had popped out of its support clip and was wedged against the wire guard, as shown in Figure 31. CALiPER staff reseated the lamp in the lamp clip before sending the unit as LPM-22-04A to the test laboratory. Among the LPM whole-room luminaires selected for testing, only LPM-22-04 was shipped with lamps already installed in the luminaire. However, the two LPM towers (LPM-22-01 and LPM-22-02) were shipped with lamp securely installed and had no apparent issues with broken or unseated lamps.



**Figure 31.** Close-up view of LPM-22-04A. One of the two lamps in the unit received was still attached to its socket (at lower left) but had popped out of its support clip (at lower right).

All units received for model LPM-22-07 had damage to corners of their housings, as shown in Figure 32, but the reflectors (including louvers) and lamps appeared unharmed. Unit LPM-22-07A was also missing one of its four 1-lamp ballasts (the datasheet stated it would instead have two 2-lamp ballasts), leaving some wires unconnected, so LPM-22-07B was tested in its place.

(a)



(b)



Figure 32. Two views of LPM-22-07A. Image (a) shows damage to corners of housings typical of all units received. Image (b) shows the internal ballast compartment, where one of the four 1-lamp ballasts was missing. Notably, the internal fan for this product is visible left of center.

## Appendix B – Alternative measurement of LED-22-04A

IES LM-79 specifies that LED products be tested in their intended orientation. LED-22-04 (unlike LED-22-03) was shown in some marketing imagery being used base-down as a tower, but (like LED-22-03) was not furnished with a socketed stand for such use—and might be used in other orientations. Figure 33 shows initial UV-intensity for the same LED-22-04A unit that was tested base-down, except this time operated base-up, and with a 22.5° interval between 16 sampled vertical half-planes (which would be more appropriate for an 8-sided product). The data have been inverted with respect to gravity to facilitate comparison with Figure 16 and other tower test data. Now the only half-plane passing through a pair of gold-colored LEDs is the one at 0° (even multiple of 36° shown in blue), and the only one midway between such pairs is at 180° (odd multiple of 36° shown in red).

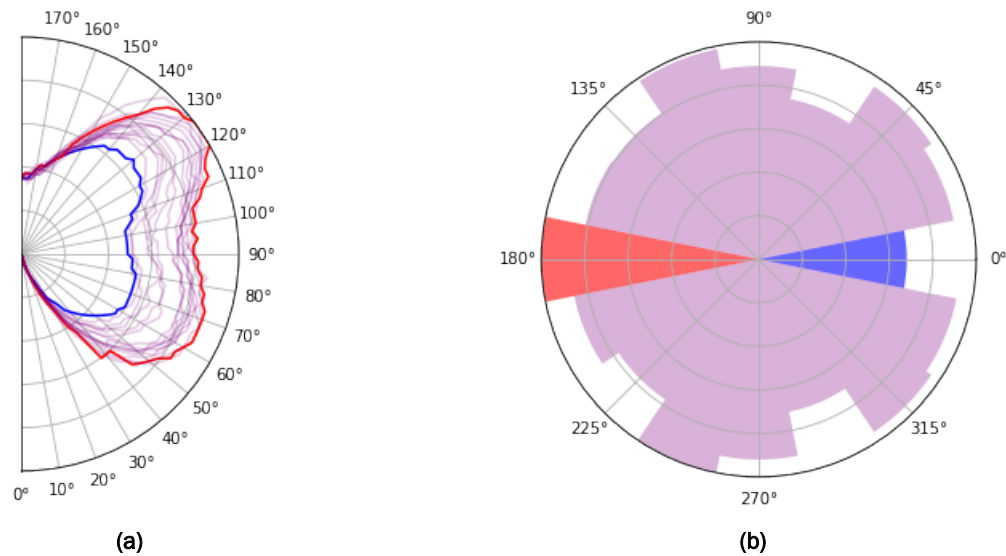

**Figure 33. UV-C radiant intensity sampled in 16 vertical half-planes for LED-22-04A operated base-up; data has been inverted with respect to gravity for comparison with other tower test data. In plot (a), each continuous curve shows intensity at different angles in a vertical half-plane, relative to the maximum UV-C intensity of 4.3 mW/sr. In plot (b), the radius of each colored slice represents average intensity for a half-plane, relative to the maximum of these averages. Half-planes passing through gold-colored LEDs are shaded blue, while those midway between are red, and the rest are purple.**

Average UV-C radiant intensity in the 0° and 180° half-planes (the only two that overlap for the two tests) when the unit was operated base-down was 7% greater than when operated base-up. Total UV-C output power when the unit was operated base-down was 6% higher than when operated base-up. These findings suggest that the difference in measured UV-C output power was in this case primarily due to lamp orientation, rather than the chosen directions for sampling UV-C radiant intensity.

## References

- ACGIH. 2022. *2022 TLVs and BEIs*. Cincinnati: The American Conference of Governmental Industrial Hygienists. <https://www.acgih.org/publications/digital-pubs/>.
- Blatchley, Ernest R III, David J Brenner, Holger Claus, Troy E Cowan, Karl G Linden, Yijing Liu, Ted Mao, et al. 2022. "Far UV-C radiation: An emerging tool for pandemic control." *Critical Reviews in Environmental Science and Technology*. doi:10.1080/10643389.2022.2084315.
- Brais, Normand, and Benoit Despatis. 2018. *Root Cause Of The Odor Generated By Germicidal UV Disinfection With Mobile Units*. October 10. <https://sanuvox.com/blog/root-cause-of-the-odor-generated-by-germicidal-uv-disinfection-with-mobile-units/>.
- CARB. 2022. *California's Air Cleaner Regulation (AB 2276)*. Sacramento: California Air Resources Board. <https://ww2.arb.ca.gov/about-indoor-air-cleaning-devices-regulation>.
- CIE. 2014. *ISO/CIE 19476:2014, Characterization of the performance of illuminance meters and luminance meters*. International Organization for Standardization/International Commission on Illumination. <https://www.iso.org/obp/ui/#iso:std:iso-cie:19476:ed-1:v1:en>.
- CIE. 2020. *CIE S 017:2020, E-ILV: International Lighting Vocabulary*. International Commission on Illumination. <https://cie.co.at/e-ilv>.
- Claus, Holger. 2021. "Ozone Generation by Ultraviolet Lamps." *Photochemistry and Photobiology* 97 (3): 471-476. doi:10.1111/php.13391.
- DOE. 2021. *Initial Benchmarks of UV LEDs and Comparisons with White LEDs*. Washington, DC: U.S. Department of Energy. <https://www.energy.gov/sites/default/files/2022-01/ssl-rti-uv-leds-nov2021.pdf>.
- DOE. 2022. *Operating Lifetime Study of Ultraviolet (UV) Light-Emitting Diode (LED) Products*. Office of Energy Efficiency and Renewable Energy, Washington, DC: U.S. Department of Energy. [https://www.energy.gov/sites/default/files/2022-09/ssl-rti\\_uv-leds-lifetime\\_apr2022.pdf](https://www.energy.gov/sites/default/files/2022-09/ssl-rti_uv-leds-lifetime_apr2022.pdf).
- Endo, Tomonori, Aki Gemma, Ryoto Mitsuyoshi, Hiroki Kodama, Daiya Asaka, Midori Kono, Takeshi Mochizuki, Hiromi Kojima, Takeo Iwamoto, and Saburo Saito. 2021. "Discussion on effect of material on UV reflection and its disinfection with focus on Japanese Stucco for interior wall." *Scientific Reports* 11. doi:10.1038/s41598-021-01315-1.
- EPA. 2022. *Ozone Generators that are Sold as Air Cleaners*. Washington, DC: United States Environmental Protection Agency. <https://www.epa.gov/indoor-air-quality-iaq/ozone-generators-are-sold-air-cleaners>.
- Galbraith, Justine, and Sharayah Follett. 2020. "Transparent Material Considerations for UV Optics in Horticultural Lighting Applications." *LED Professional*, February 5. <https://www.led-professional.com/resources-1/articles/transparent-material-considerations-for-uv-optics-in-horticultural-lighting-applications>.
- IEC. 2006. *IEC 62471, Photobiological safety of lamps and lamp systems*. International Electrotechnical Commission, July 26. [https://www.iecee.org/dyn/www/?p=106:49:0:::FSP\\_STD\\_ID:7076](https://www.iecee.org/dyn/www/?p=106:49:0:::FSP_STD_ID:7076).
- IEC. 2011. *IEC 62301:2011, Household electrical appliances - Measurement of standby power*. International Electrotechnical Commission, January 27. <https://webstore.iec.ch/publication/6789>.
- IEC. 2020. *IEC 62595-2-4:2020, Display lighting unit - Part 2-4: Electro-optical measuring methods of laser module*. International Electrotechnical Commission. <https://webstore.iec.ch/publication/63535>.

- IEC. 2022. *IEC 62471-6:2022, Photobiological safety of lamps and lamp systems - Part 6: Ultraviolet lamp products*. International Electrotechnical Commission. <https://webstore.iec.ch/publication/59543>.
- IEC. 2023a. *Electropedia: The World's Online Electrotechnical Vocabulary*. International Electrotechnical Commission. <https://www.electropedia.org/>.
- IEC. 2023b. *Glossary*. Geneva: International Electrotechnical Commission. <https://std.iec.ch/glossary>.
- IES. 2018a. *IES PS-10-18, IES Position on LED Product Lifetime Prediction*. New York: Illuminating Engineering Society. <https://www.ies.org/advocacy/position-statements/ps-10-18-ies-position-on-led-product-lifetime-prediction/>.
- IES. 2018b. *ANSI/IES TM-33-18, Standard Format for the Electronic Transfer of Luminaire Optical Data*. New York: Illuminating Engineering Society. <https://store.ies.org/product/tm-33-18-technical-memoranda-standard-format-for-the-electronic-transfer-of-luminaire-optical-data/>.
- IES. 2019a. *ANSI/IES LM-79-19, Optical and Electrical Measurements of Solid State Lighting Products*. New York: Illuminating Engineering Society. <https://store.ies.org/product/lm-79-19-approved-method-optical-and-electrical-measurements-of-solid-state-lighting-products/>.
- IES. 2019b. *ANSI/IES LM-75-19, Guide to Goniometer Measurements and Types, and Photometric Coordinate Systems*. New York: Illuminating Engineering Society. <https://store.ies.org/product/lm-75-19-approved-method-guide-to-goniometer-measurements-and-types-and-photometric-coordinate-systems/>.
- IES. 2019c. *ANSI/IES LM-63-19, IES Standard File Format for the Electronic Transfer of Photometric Data and Related Information*. New York: Illuminating Engineering Society. <https://store.ies.org/product/lm-63-19-approved-method-ies-standard-file-format-for-the-electronic-transfer-of-photometric-data-and-related-information/>.
- IES. 2020a. *ANSI/IES LM-41-20, Photometric Testing of Indoor Fluorescent Luminaires*. New York: Illuminating Engineering Society. <https://store.ies.org/product/lm-41-20-approved-method-photometric-testing-of-indoor-fluorescent-luminaires/>.
- IES. 2020b. *ANSI/IES LM-78-20, Total Luminous Flux Measurement of Lamps Using an Integrating Sphere Photometer*. New York: Illuminating Engineering Society. <https://store.ies.org/product/lm-78-20-approved-method-total-luminous-flux-measurement-of-lamps-using-an-integrating-sphere-photometer/>.
- IES. 2020c. *ANSI/IES LM-9-20, Electrical and Photometric Measurement of Fluorescent Lamps*. New York: Illumination Engineering Society. <https://store.ies.org/product/lm-9-20-approved-method-electrical-and-photometric-measurement-of-fluorescent-lamps/>.
- IES. 2020d. *ANSI/IES LM-84-20+E1, Measuring Optical Radiation Maintenance of LED Lamps, Light Engines, and Luminaires*. New York: Illuminating Engineering Society. <https://store.ies.org/product/lm-84-20-approved-method-measuring-optical-radiation-maintenance-of-led-lamps-light-engines-and-luminaires/>.
- IES. 2020e. *ANSI/IES LM-58-20+E1, Spectroradiometric Measurement Methods for Light Sources*. New York: Illuminating Engineering Society. <https://store.ies.org/product/lm-58-20-approved-method-spectroradiometric-measurement-methods-for-light-sources/>.
- IES. 2020f. *ANSI/IES LM-54-20, IES Guide to Lamp Seasoning*. New York: Illuminating Engineering Society. <https://store.ies.org/product/lm-54-20-approved-method-ies-guide-to-lamp-seasoning/>.

- IES. 2020g. *ANSI/IES TM-27-20, IES Standard Format for the Electronic Transfer of Spectral Data*. New York: Illuminating Engineering Society. <https://store.ies.org/product/tm-27-20-technical-memorandum-ies-standard-format-for-the-electronic-transfer-of-spectral-data/>.
- IES. 2020h. *ANSI/IES LM-40-20, Life Testing of Fluorescent Lamps*. New York: Illuminating Engineering Society. <https://store.ies.org/product/lm-40-20-approved-method-life-testing-of-fluorescent-lamps/>.
- IES. 2020i. *ANSI/IES LM-65-20, Life Testing of Single-Based Fluorescent Lamps*. New York: Illuminating Engineering Society. <https://store.ies.org/product/lm-65-20-approved-method-life-testing-of-single-based-fluorescent-lamps/>.
- IES. 2020j. *ANSI/IES TM-28-20, Projecting Long-Term Luminous Flux Maintenance of LED Lamps and Luminaires*. New York: Illuminating Engineering Society. <https://store.ies.org/product/tm-28-20-approved-method-projecting-long-term-luminous-flux-maintenance-of-led-lamps-and-luminaires/>.
- IES. 2021. *ANSI/IES RP-44-21, Ultraviolet Germicidal Irradiation (UVGI)*. New York: Illuminating Engineering Society. <https://store.ies.org/product/rp-44-21-recommended-practice-ultraviolet-germicidal-irradiation-uvgi/>.
- IES. 2022a. *ANSI/IES LS-1-22, Lighting Science: Nomenclature and Definitions for Illuminating Engineering*. Illuminating Engineering Society. <https://www.ies.org/standards/definitions/>.
- IES. 2022b. *ANSI/IES RP-27.1-22, Risk Group Classification and Minimization of Photobiological Hazards From Ultraviolet Lamps and Lamp Systems*. New York: Illuminating Engineering Society. <https://store.ies.org/product/rp-27-1-22-risk-group-classification-and-minimization-of-photobiological-hazards-from-ultraviolet-lamps-and-lamp-systems/>.
- IES. 2022c. *ANSI/IES LM-91-22, Application Distance Radiometry*. New York: Illuminating Engineering Society. <https://store.ies.org/product/lm-91-22-approved-method-application-distance-radiometry/>.
- ISO. 2017. *ISO/IEC 17025:2017, General requirements for the competence of testing and calibration laboratories*. International Organization for Standardization. <https://www.iso.org/standard/66912.html>.
- Krames, Mike. 2020. "The rise of UV-C LEDs." *LEDs Magazine*, July 24. <https://www.ledsmagazine.com/leds-ssl-design/article/14178371/technology-roadmap-shows-uv-c-leds-are-on-the-rise>.
- Miller, C Cameron. 2022. *UVC Measurement Methods & UVC Documentary Standard Development*. National Institute of Standards and Technology. Washington, DC: U.S. Department of Energy. [https://www.energy.gov/sites/default/files/2022-02/ssl-rd22\\_miller\\_guv.pdf](https://www.energy.gov/sites/default/files/2022-02/ssl-rd22_miller_guv.pdf).
- NIOSH. 2016. *NIOSH Pocket Guide to Chemical Hazards*. The National Institute for Occupational Safety and Health. <https://www.cdc.gov/niosh/npg/default.html>.
- NLPIP. 2020. "Lighting Answers: UV Disinfection Products." December. [https://www.lrc.rpi.edu/programs/NLPIP/lightingAnswers/pdf/view/LA\\_UVDisinfection.pdf](https://www.lrc.rpi.edu/programs/NLPIP/lightingAnswers/pdf/view/LA_UVDisinfection.pdf).
- OSHA. 2022. *Occupational Chemical Database*. Prod. Occupational Safety & Health Administration. U.S. Department of Labor, August 4. <https://www.osha.gov/chemicaldata/9>.
- Smith, Emmett M, James R Aronson, Raymond M Cornish, Bruce E Goodwin, Ivan Simon, and Peter von Thuna. 1984. *Surface Sampling Techniques Using Ultraviolet Illumination*. Arthur D. Little, Inc., 69. <https://apps.dtic.mil/sti/citations/ADA156457>.

UL. 2021. *UL 8803, Edition 1, UL LLC Outline of Investigation for Portable UV Germicidal Equipment With Uncontained UV Sources*. UL, September 2.

<https://www.shopulstandards.com/ProductDetail.aspx?UniqueKey=40554>.

UL. 2022. *UL 8802, Edition 1, Ultraviolet (UV) Germicidal Equipment and Systems*. UL, June 17.

[https://www.shopulstandards.com/ProductDetail.aspx?productId=UL8802\\_1\\_C\\_20220617](https://www.shopulstandards.com/ProductDetail.aspx?productId=UL8802_1_C_20220617).



(This page intentionally left blank)

U.S. DEPARTMENT OF  
**ENERGY**

*Office of*  
**ENERGY EFFICIENCY &  
RENEWABLE ENERGY**

For more information, visit:  
[energy.gov/eere/ssl](https://energy.gov/eere/ssl)

PNNL-33824 • September 2023