

# Spawn and Modelica Buildings Library

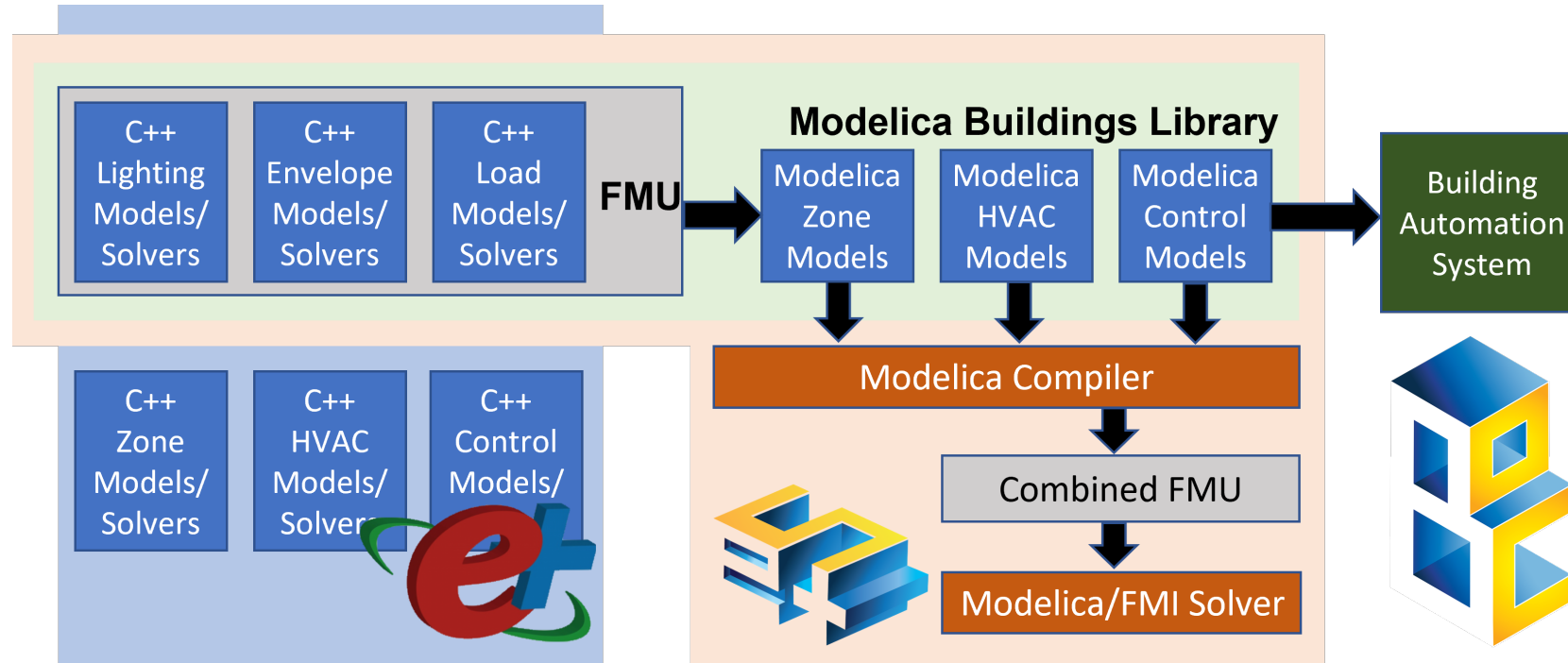

LBNL, NREL, PNNL, ORNL, Solamen, Open Source Modelica Consortium, Modelon, Objexx, Nouidui Consulting

Michael Wetter, PhD

[mwetter@lbl.gov](mailto:mwetter@lbl.gov)

WBS 3.5.5.11

# Project Summary

## Objective and outcome

Enable >1 quad/yr savings by

- Bridging BEM (mechanical engineering, HVAC design and sizing) and controls workflow
- Providing a virtual test-bed – with HIL capability – for buildings, district energy systems, and controls
- De-risking HVAC & controls deployments
- Accelerating HVAC & controls R&DD

## Team and Partners

**NREL:** Spawn development, EnergyPlus integration

**PNNL, ORNL, Solamen:** Modelica HVAC templates and components

**Objexx:** Quantized State System (QSS) solver

**Modelon:** Modelica IDE & run-time environment and QSS solver

**Open Source Modelica Consortium:** Modelica IDE & run-time environment and multi-rate solver

**Nouidui Consulting:** User support

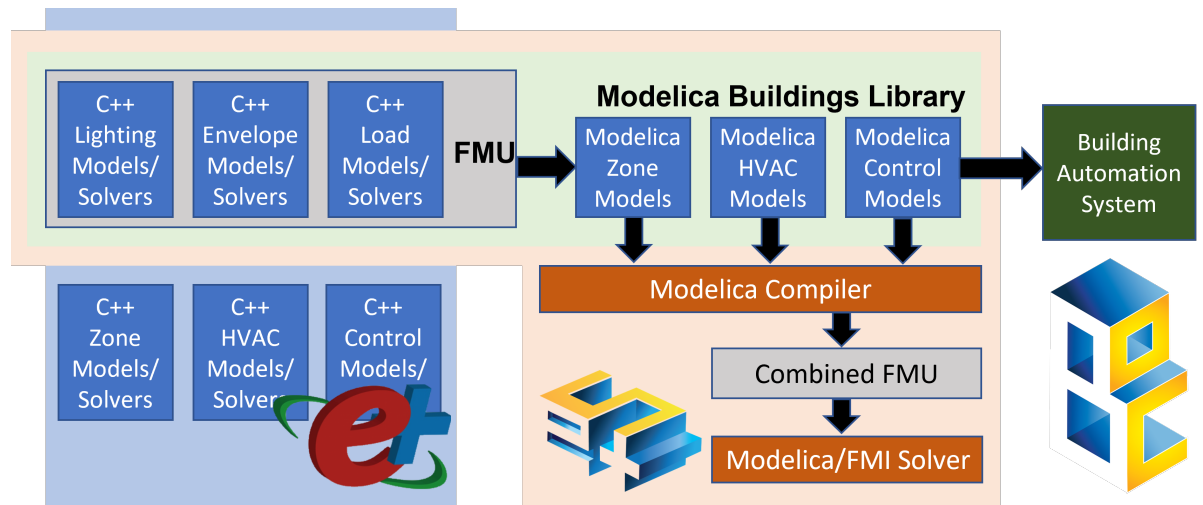

## Stats

- Performance Period: FY23-25 (Phase I FY 2017-19, Phase II: 2020-22)
- DOE budget: \$1M/yr
- Milestone 1: FY23-Q1: Released Spawn & Modelica Buildings.
- Milestone 2: FY23-Q3: Released Modelica Buildings Library with HVAC templates

# Problem: Rapid Deep Decarbonization Entails Risk

**Industry is not ready to deploy complex, untested decarbonized systems – certainly not at scale**

- High-profile failures (often requiring expensive retrofits) only make the problem worse

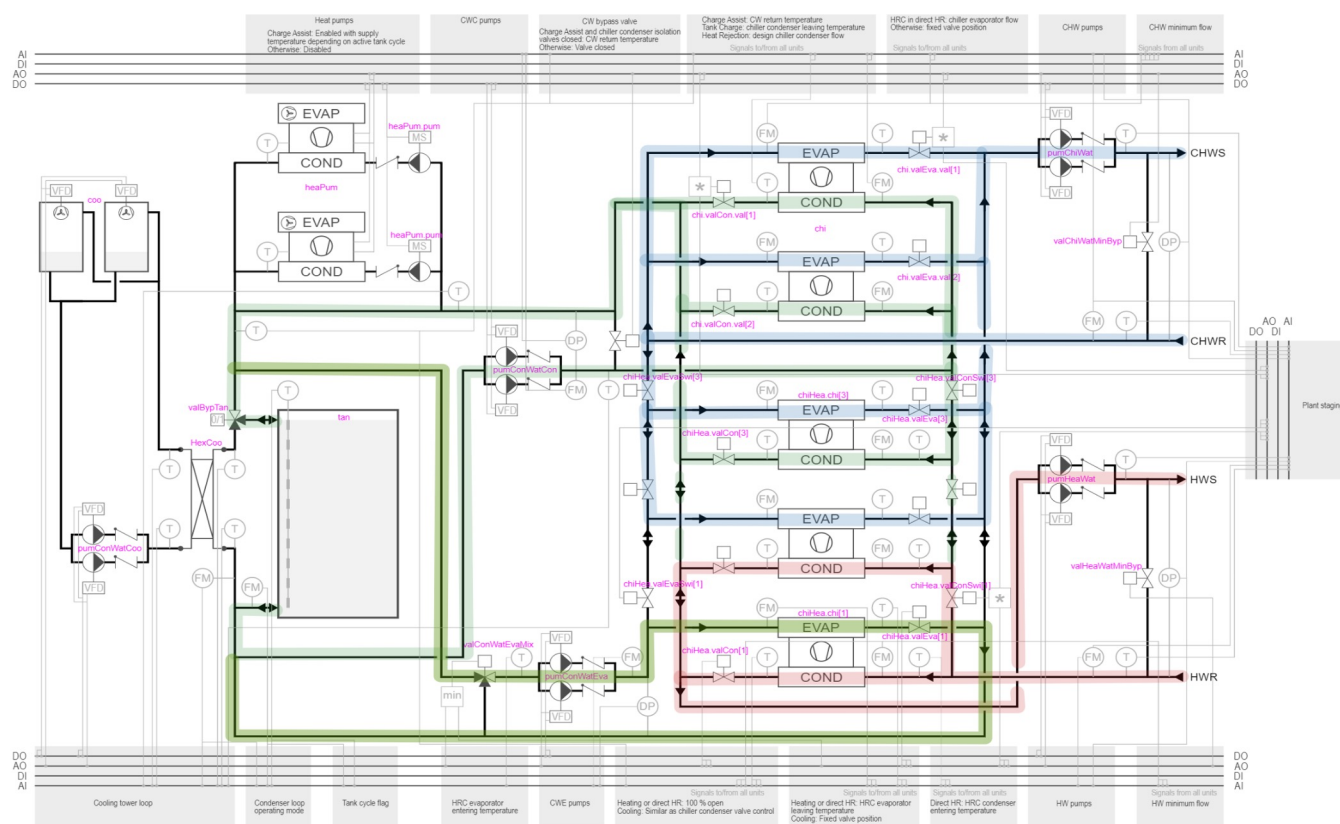

## HVAC & control complexity

- 20 modes of operation
- multiple heat pumps
- storage with 5 tuning parameters
- multiple cooling towers
- 45 pages of control sequences

See reports of failed heat pump deployment in Europe.

*Cost-effective, high-efficiency HP plant with small footprint needed for dense developments have complexities that stifle large scale deployment (<https://taylorengeers.com/news-1/new-article-in-the-ashrae-journal>)*

# Underlying Problems and The Spawn Solution

## The problem(s)

- Increased **complexity** of HVAC and controls due to tightly integrated systems
- Lack of **experience** in designing and operating these systems
- Inadequate **tools for designing, testing and implementing** these systems and their controls

## Today's BEM tools (including EnergyPlus) do not effectively support these new complex systems

- Hard-wired **primary/secondary loop** simulation approach limits system topology
- **Load-based** “retroactive” simulation approach idealizes control and HVAC behavior
- Use **idealized control**, different from controls that need to be implemented, breaking workflows

## Spawn's capabilities enable new HVAC & control design, testing, and implementation workflows that

- **Accelerate** R&DD of systems with integrated heat recovery, storage and controls
- **Can be used to develop specifications** for implementing efficient HVAC systems and their controls
- **De-risk** deployment of innovative systems

# The Spawn Approach

Spawn performs **dynamic state-based simulation** of HVAC and control.

- no fixed simulation “time step” and
- no need to “retroactively” apply state transitions within a time step

Spawn adjusts the time step based on system dynamics and activates control logic when variables cross thresholds.

## Spawn

- Allows any system topology
- Simulates HVAC operation realistically, to sub-second time scales
- Uses actual feed-back control
  - **Bridges the controls design-implementation gap**
- **Allows true high-fidelity digital prototyping of HVAC systems**

These capabilities derive from Modelica, a modeling and simulation language that is used in many industries including automotive, aerospace, robotics and power.



*7% of German power production is optimized based on Modelica*

### Reference Intraday optimization of municipal power

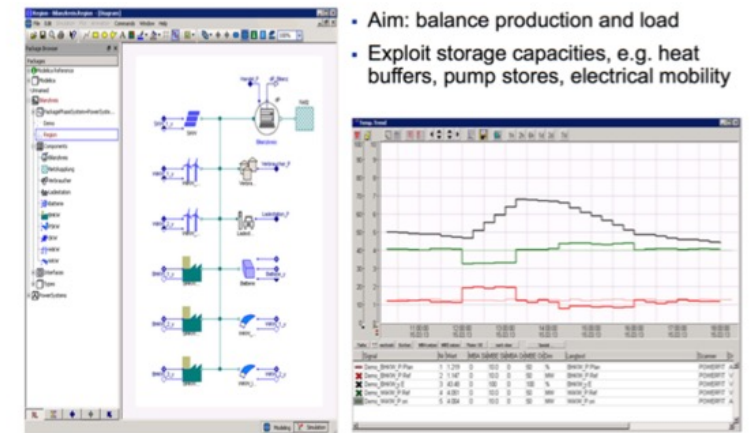

- Aim: balance production and load
- Exploit storage capacities, e.g. heat buffers, pump stores, electrical mobility

© ABB Group  
May 8, 2014 | Slide 13



Source: <http://new.abb.com/power-generation/power-plant-optimization>

# Spawn Leverages and Combines Two Large, Ongoing Investments

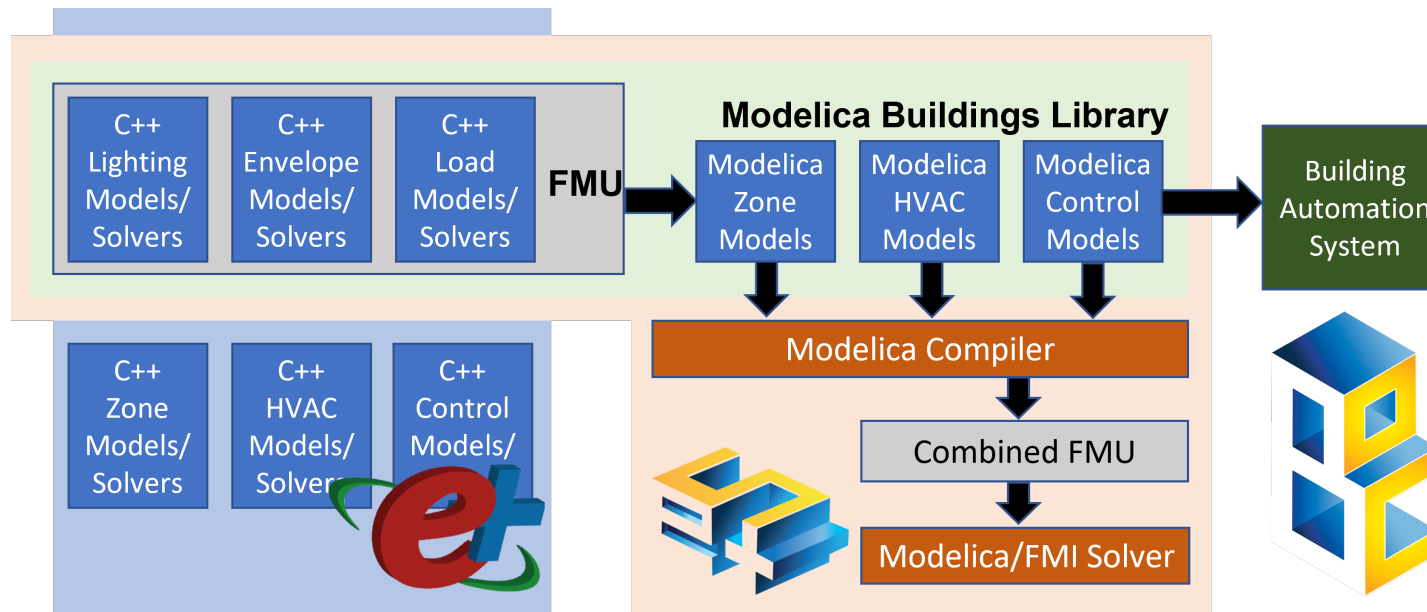

## **EnergyPlus: 26+ years of DOE funding (22 years of funding for DOE-2 before that)**

- Fast lighting, envelope, and load simulation ← dynamic state-based simulation is not important
- A mature tools ecosystem with multiple model authoring options

## **Modelica Buildings Library: 12 years of contributions from 20 organizations in 10 countries**

- 2000+ Modelica models for HVAC systems, district systems, electrical systems, controls, and more

## **The Spawn project**

- Modelica and Modelica Buildings Library leadership and management
- The glue for combining EnergyPlus with Modelica Buildings Library

# Global Leadership In Modelica Technology

## Open software standards enable effective collaboration

- Spawn relies on FMI (Functional Mockup Interface) co-simulation standard



## As part of the Spawn Project, LBNL

- Led IEA EBC Annex 60 “New generation computational tools for building and community energy systems based on the Modelica and FMI standards” (2012-17, 42 institutes)
  - <http://iea-annex60.org/>
- Led IBPSA-World Project 1 “Modelica Buildings Library” (2017-22, 60 institutes)
  - <https://ibpsa.github.io/project1/>
- Leads IBPSA Modelica Working Group (>10 institutes)
  - <https://www.ibpsa.us/introducing-the-ibpsa-modelica-working-group/>
- Act on Modelica and FMI steering committee

## Team collaborates with open source and commercial tool developers

- Such as Open Source Modelica Consortium, Modelon, Dassault Systemes

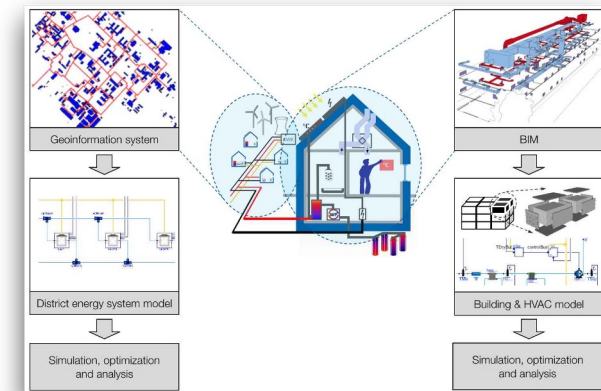

IBPSA-Project1

# Modelica Buildings Library

Open-source library for building and district energy systems and controls

- 45 contributors
- 2000+ models and functions
- 1500+ test cases

Supported by multiple compilers: OPTIMICA, OpenModelica & Dymola

Used by major HVAC and control providers

HVAC with realistic supervisory and local loop control

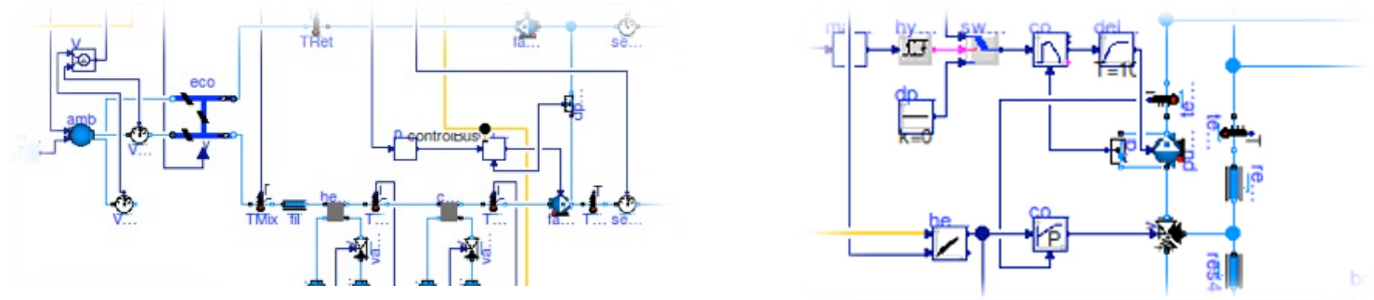

Building heat transfer, natural ventilation, and CFD

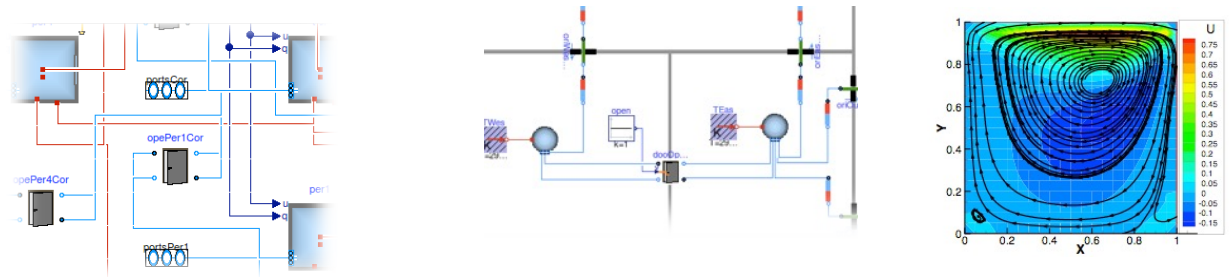

Fully coupled thermal, fluid flow, electrical and control simulation

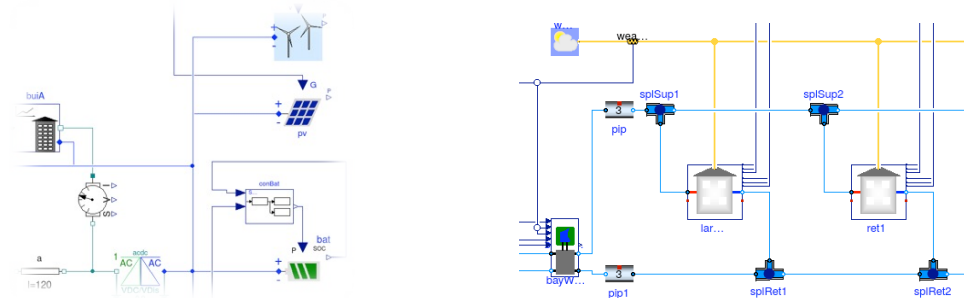



# Modelica Buildings Library – Recent Progress

## Released this FY

- Bore fields with 1000s of boreholes
- Reference implementation of ASHRAE Guideline 36 and other pre-configured controls

## Summer 2023 release

- HVAC templates
- Fan/pump based on Euler similarity law
- Templates for hydronic systems

## Fall 2023 release

- District energy systems
- PTAC, ERV, DX heating coil, auto-tuning PID

## Currently under development

- Aquifer thermal energy storage
- Detailed PV and battery
- Heat pump with customizable detail: defrost, safety if modeled outside of operation envelope
- Low order building model (ISO 13790)

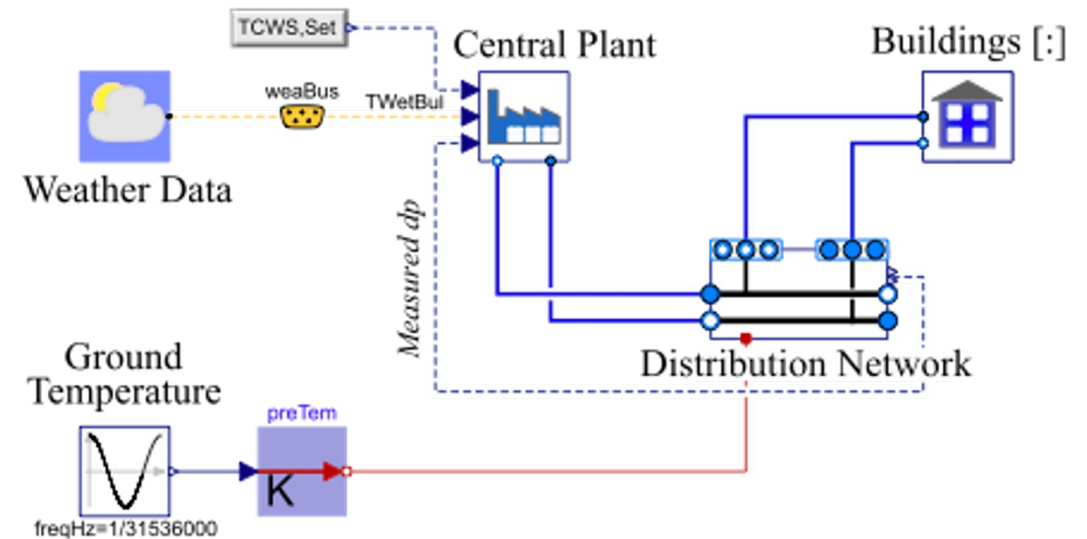

# EnergyPlus-Modelica Coupling

## This required some new EnergyPlus capabilities

- Run with native HVAC/control disabled
- Start and stop simulation on demand
- Read and write values very efficiently
- Run multiple EnergyPlus instances in the same process without interference (important for larger scale simulation of multiple buildings and district systems/DERs)
- Export an FMU (Functional Mockup Unit)

## This has all been implemented

- EnergyPlus FMU that can be combined with Modelica models
- First released in Modelica Buildings Library 8.0 (2021).

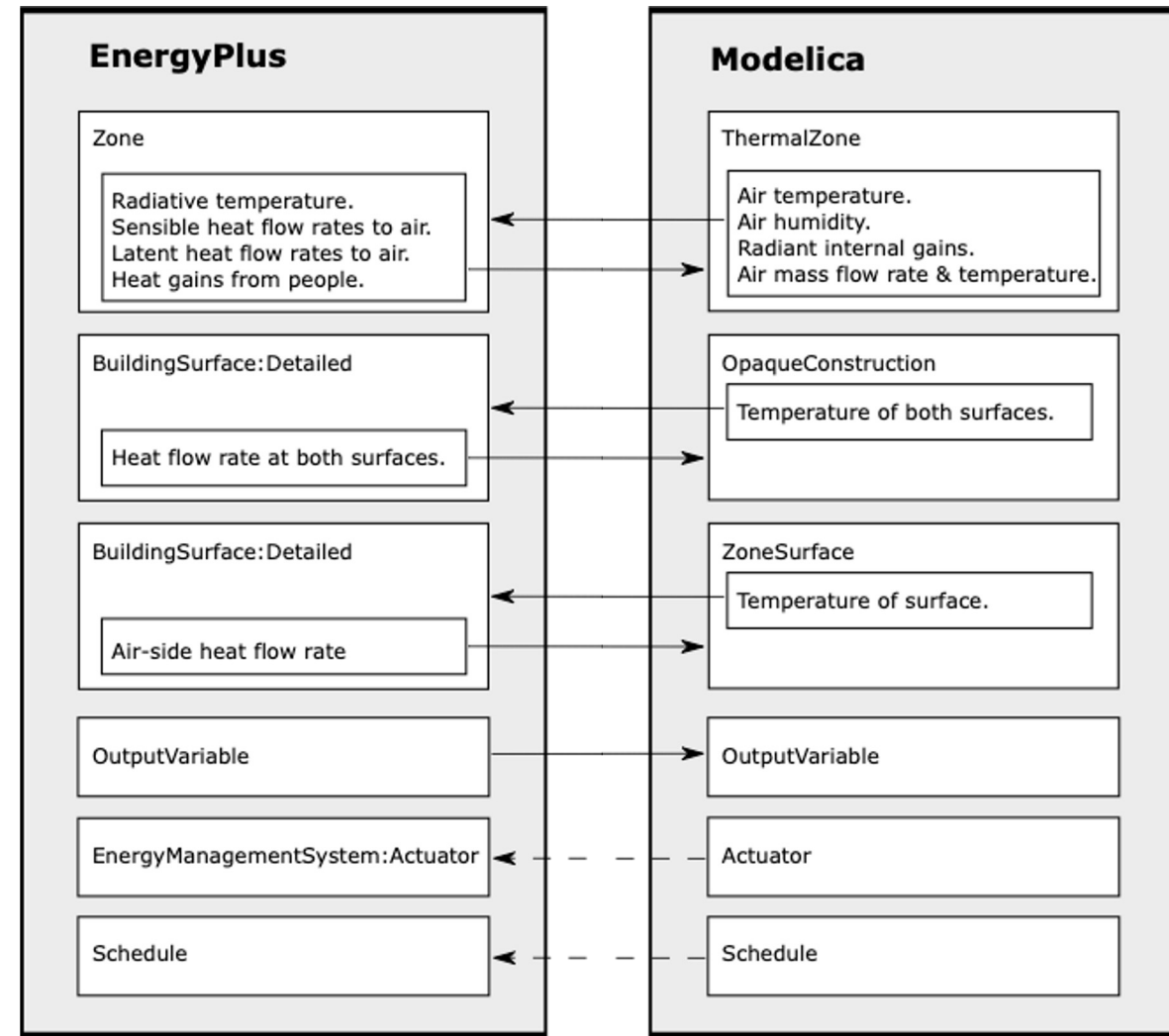

# EnergyPlus-Modelica Coupling

In a Modelica simulation environment a conventional EnergyPlus input file (.idf) can be used to create an EnergyPlus FMU with the right connections (i.e., room energy balance, sensors, and actuators) to which Modelica HVAC and control models can be attached.

Coupling of Modelica to EnergyPlus objects is done automatically.

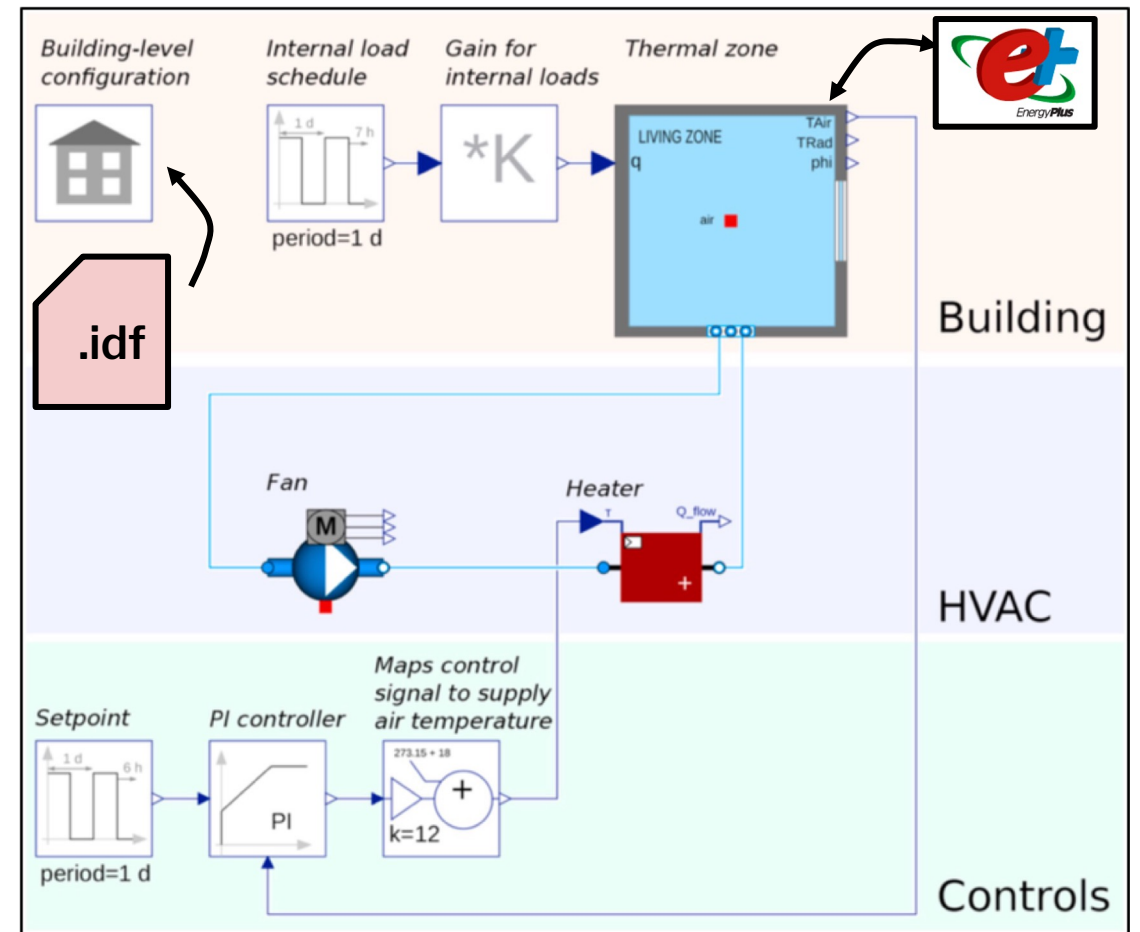

# Risks and Mitigation – Modelica IDEs

## Barrier/Risk: cost of commercial Modelica IDEs (Integrated Development Environment)

- Currently required to run complex models

## Mitigation:

- Ensure full support by free OpenModelica open-source IDE
- Provide commercial support option through Modelon's IMPACT

## Longer term:

- Release bundled EnergyPlus, Modelica Buildings Library, and Modelica compiler
- Translation and workflow automation from OpenStudio SDK
- Will allow Spawn to be used in more contexts in which EnergyPlus is used now

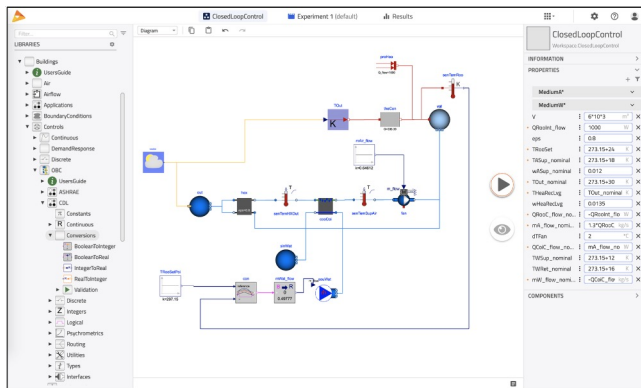

Modelon IMPACT

*Models are portable among Modelica IDEs, allowing users to choose among free and commercial tools*

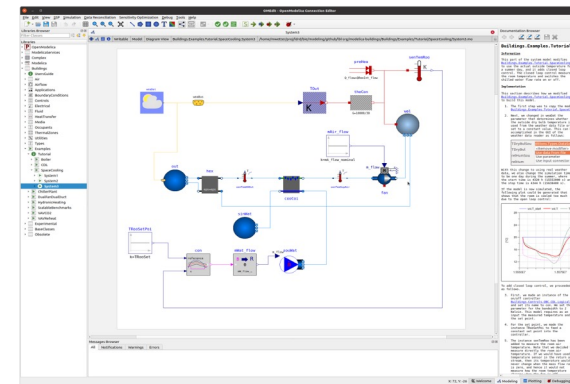

OpenModelica's OMEdit

# Risks and Mitigations – Need for HVAC and Controls Expertise

**Barrier/Risk: Spawn requires HVAC and controls expertise most mechanical engineers do not have**

**Technical mitigation: pre-configured templates for common systems**

- Distribute with HVAC and control sequence selection and configuration tool “ctrl-flow”

**Another mitigation: provide technical support, training, and outreach**

- Developed 20+ user guides
- Organized American Modelica Conferences 2018, 20, 22 (<https://namug.org/>)
- Offer training through Modelon and LBNL

**Also: commercial offering with professional support (e.g., Modelon IMPACT)**

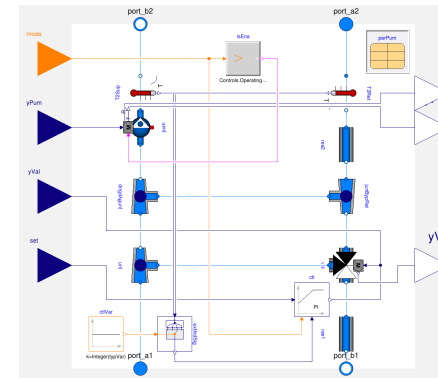
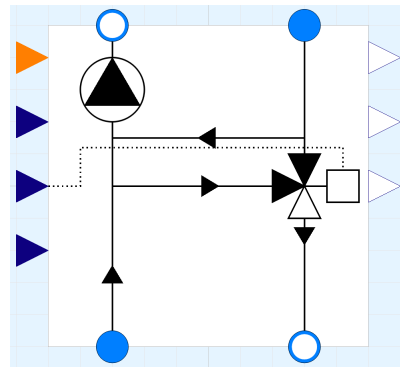
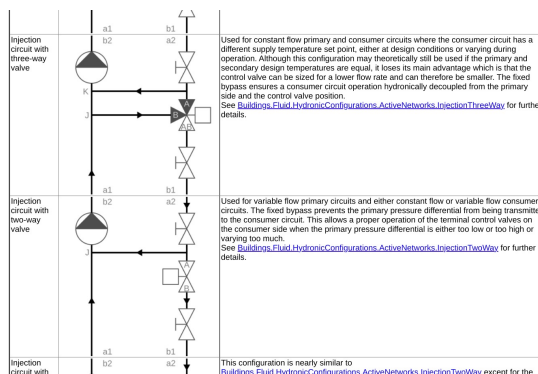

*Templates provide preconfigured best-practice hydronic configurations  
Includes valve auto-sizing and physics required for control workflows.*

# Risks and Mitigations – Simulation Time

**Barrier/risk: Traditional ODE (ordinary differential equation solvers for stiff systems) scale poorly on large models and handling state events is computationally expensive**

- CVode: State of the art ODE solver for stiff problems

## Mitigation 1: QSS (Quantized State System)

- Asynchronous integration driven by component dynamics, allows different parts of the model to proceed at different rates
- Efficient handling of state events ← have implemented this
- Faster than CVode\* on limited tests of Spawn-relevant problems

## Ongoing work

- Research trajectory “relaxation” for models with derivative sensitivity
- Implement directional derivative for state 2<sup>nd</sup> derivatives
- Performance refinements and parallelization

## Mitigation 2: multi-rate solver

- Developed by team members through other funds

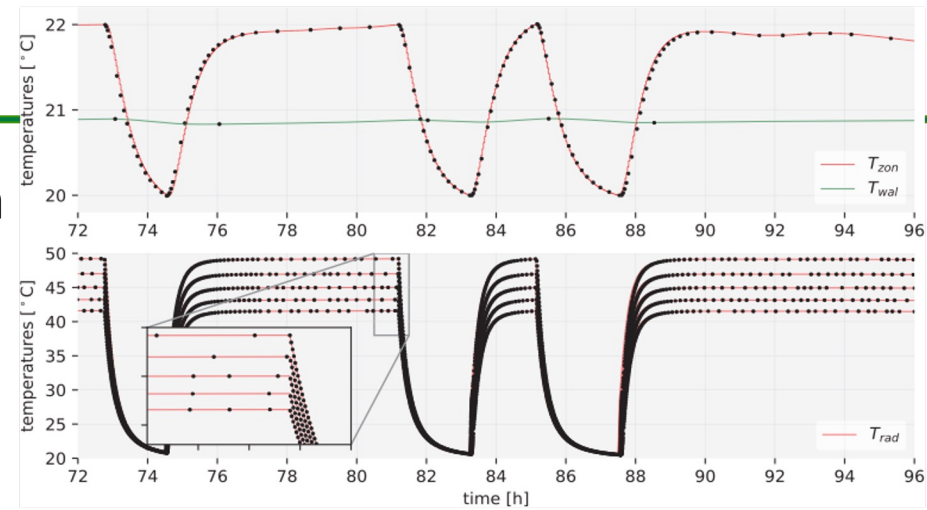

Model	CVode (s)	QSS2 (s)	CVODE /QSS2
SimpleHouseDiscreteTime	194	175	1.11
ACControl	7.59	2.94	2.58
UpstreamSampler	7.98	1.14	7.00

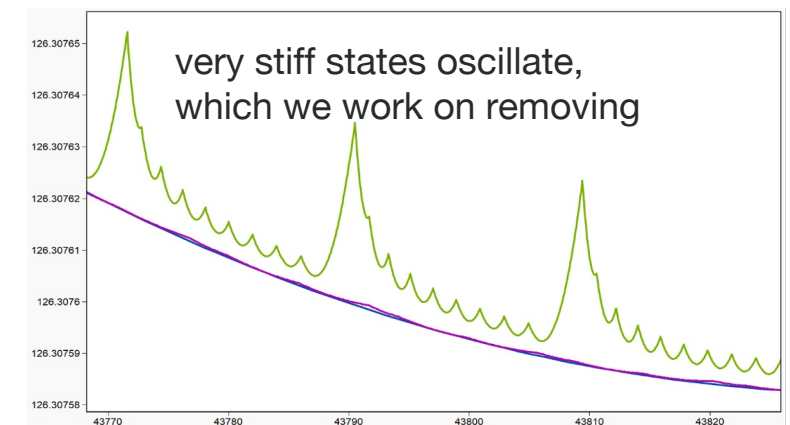

# Success Story – Reproducing and Solving Control Issues

Decarbonized systems entail increased complexity and risk

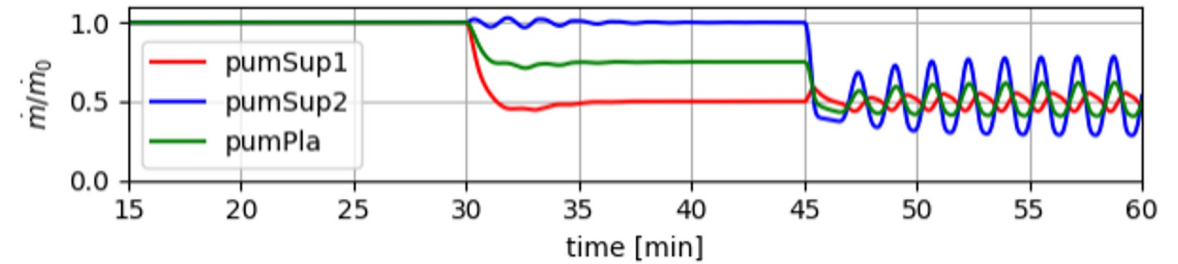
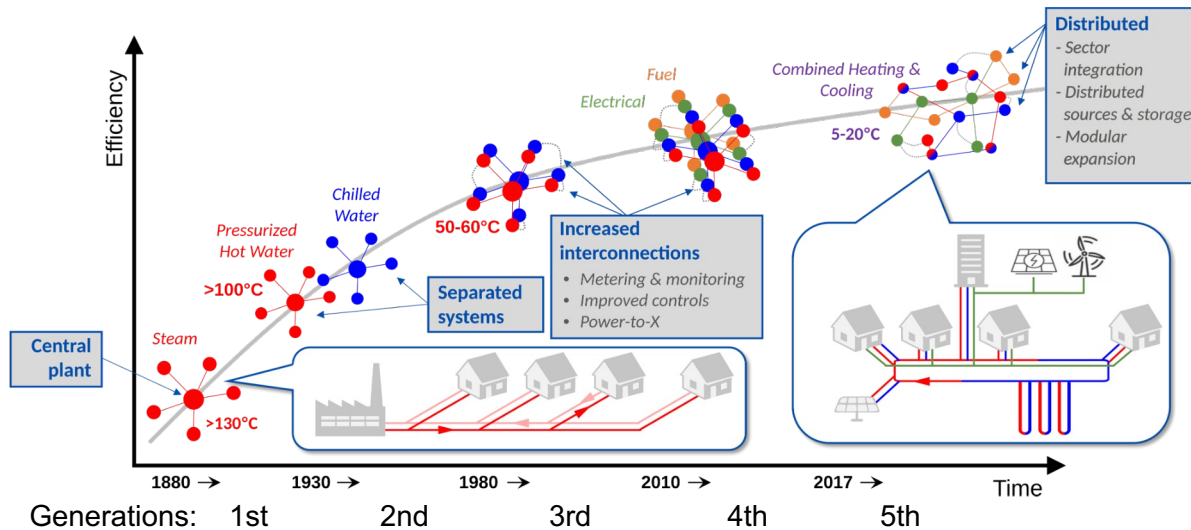

Early installations of decarbonized energy systems had control problems. We reproduced them virtually using Modelica and provided solutions for Sidewalk Labs (Toronto district energy system).

Michael Wetter, Jianjun Hu. Quayside Energy System Analysis. LBNL-2001197, 2019.

ESTCP FOA 2022 (Thermal Microgrid): ... To meet the aggressive GHG emissions reduction targets outlined in Executive Order 14057, the DoD needs to find solutions that make step-change improvements to energy efficiency and to the way buildings are heated, cooled, and powered.

This was a successful early test of our tools. It showed that the right simulation capabilities can de-risk novel systems.



# Success Story – Trane TRACE 3DPlus-Spawn Integration

## TRACE 3D Plus to Spawn

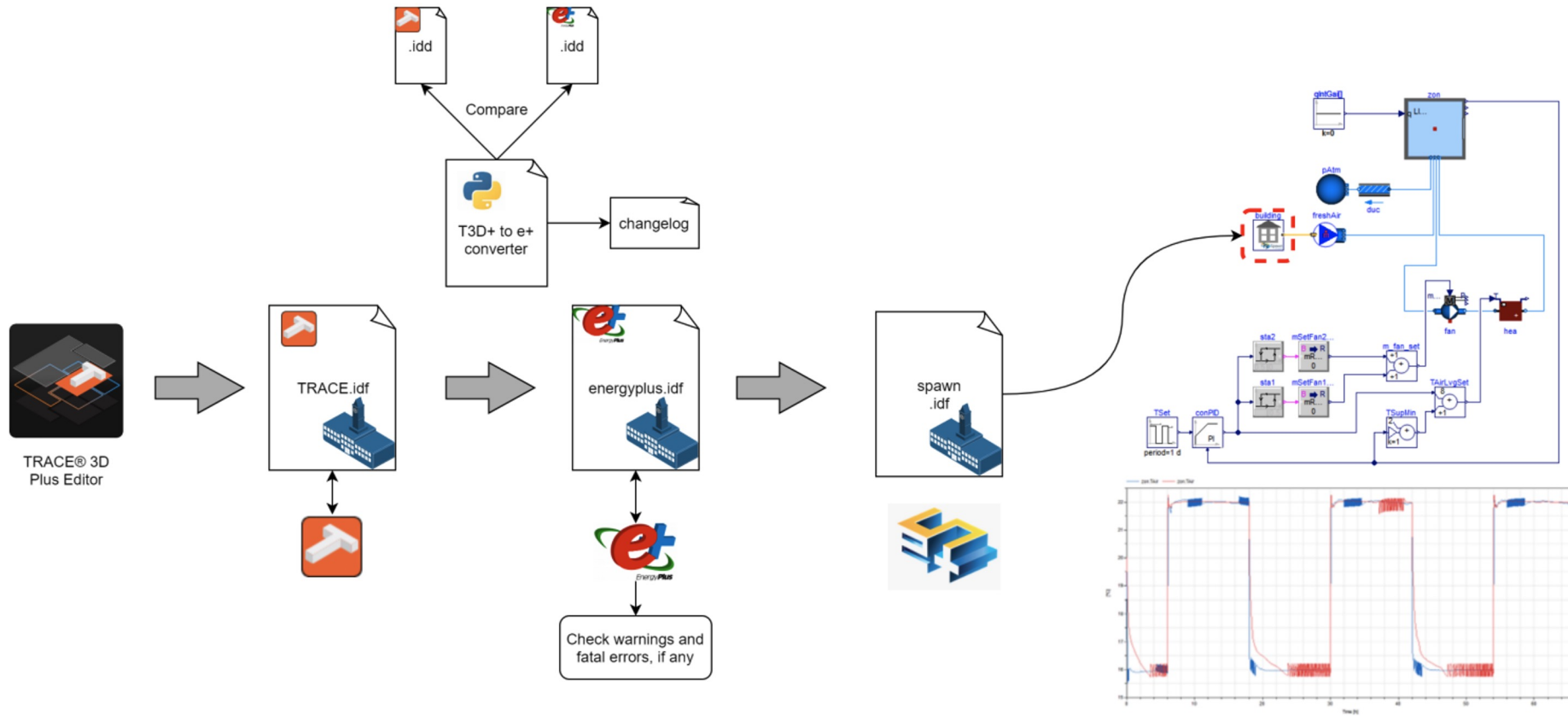

10



*Trane-developed workflow to couple Trane's TRACE with Spawn.*



# Success Story – Model-Based Heat-Pump Design at Mitsubishi Electric

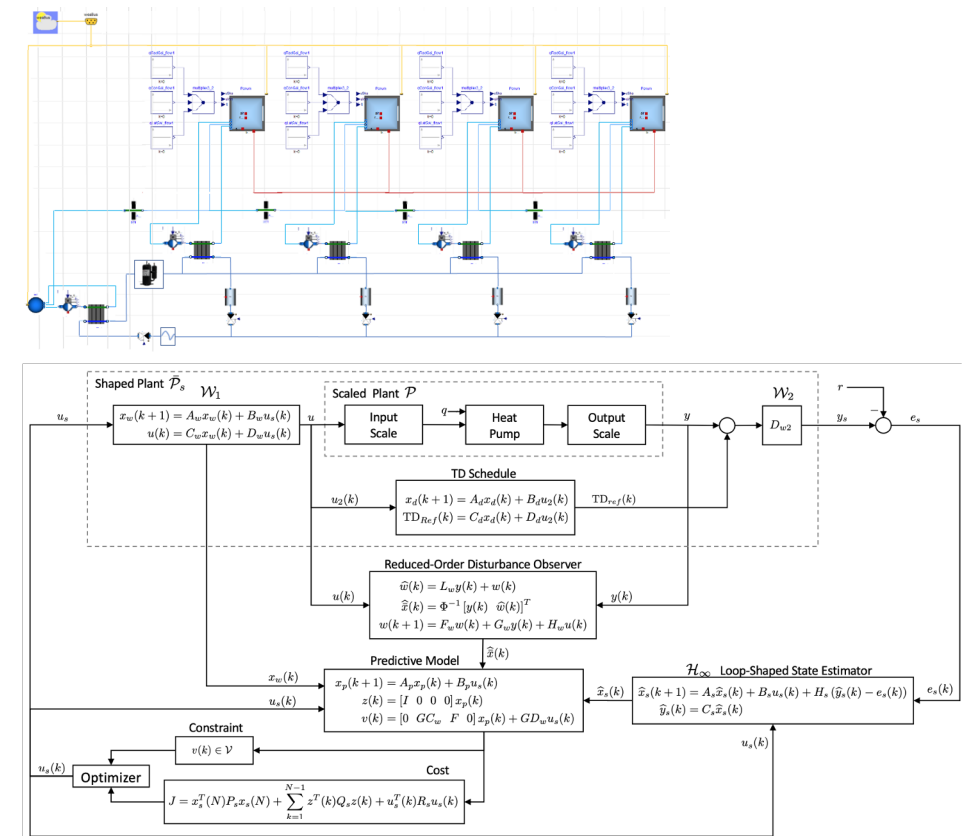
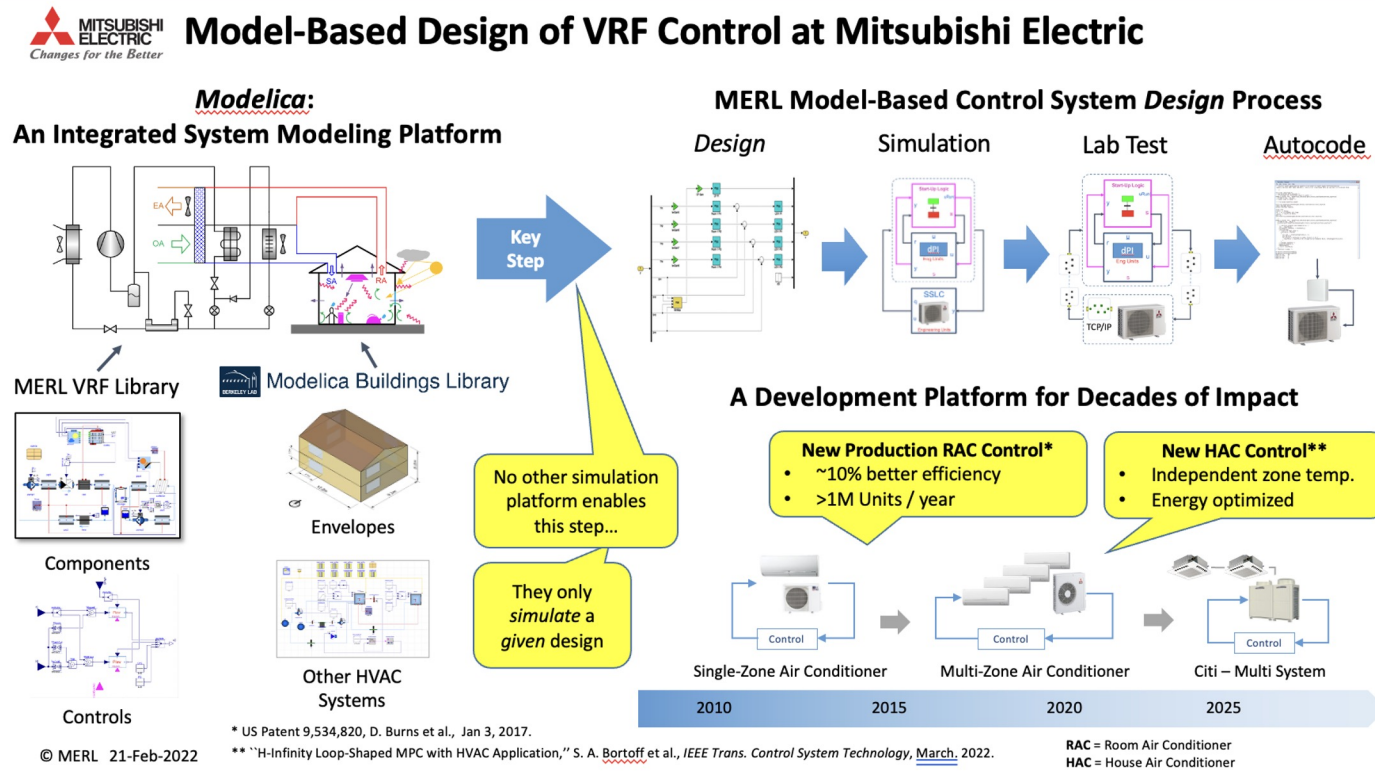

Model-based design of VRF systems using Modelica Buildings Library. The key capability is not simulation, it is that the model equations can be transformed to a form needed for development of robust and efficient controls.

Modelica Buildings Library bridges BEM with control to develop robust MPC for HPs. *IEEE Trans. on Ctrl*, doi: 10.1109/TCST.2022.3141937 <https://www.merl.com/publications/docs/TR2022-028.pdf>

# Lessons Learned

High performance systems tend to have complex hydronic configurations and controls with which industry lacks experience.

Deployment at scale requires

- Pre-configured templates including controls (few mechanical engineers know how to implement controls)
- Free solutions (OpenModelica with OMEdit) allow engineers to get started

Joint development with tool (Modelon and Open Source Modelica Consortium) and library (IBPSA Modelica Working Group) developers has shown to lead to better code at reduced costs

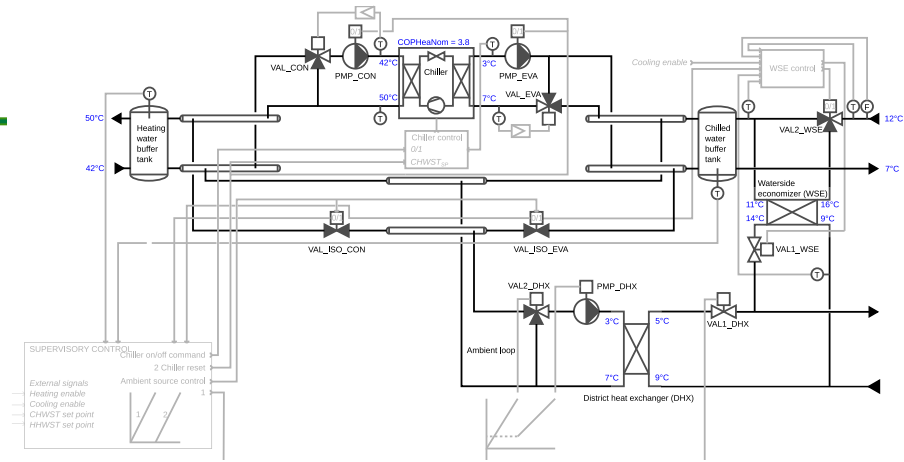

<https://doi.org/10.1016/j.apenergy.2022.119880>

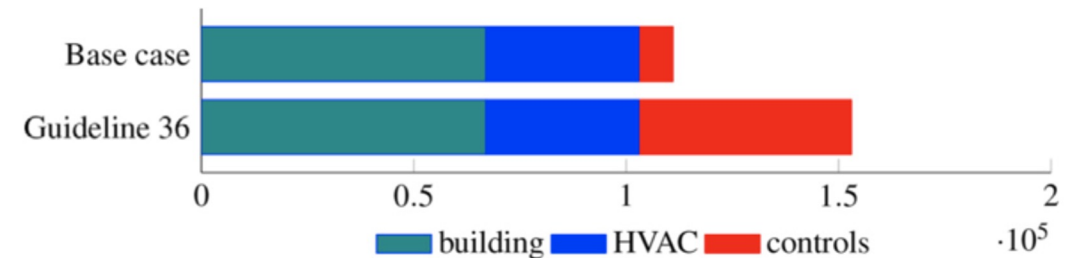

Fig. 12. Number of lines of code for building (including multi-zone air exchange and infiltration), HVAC system, and controls.

<https://doi.org/10.1016/j.energy.2021.121501>

**High performance controls can save 30% energy, but are difficult to implement. Pre-configured HVAC templates with controls put high-performance control into the hands of mechanical engineers.**

# Future plans

## EnergyPlus-Modelica coupling

- Harden current implementation
- Make EnergyPlus **load sizing** accessible to Modelica

## Modelica Buildings Library

- Expand **HVAC templates** from air-side systems and chiller/boiler plants to heat pump plants with storage

## Modeling IDE

- Make free **OpenModelica** fully compatible
- Work with open-source and commercial providers on **scalability** to large buildings and district energy systems

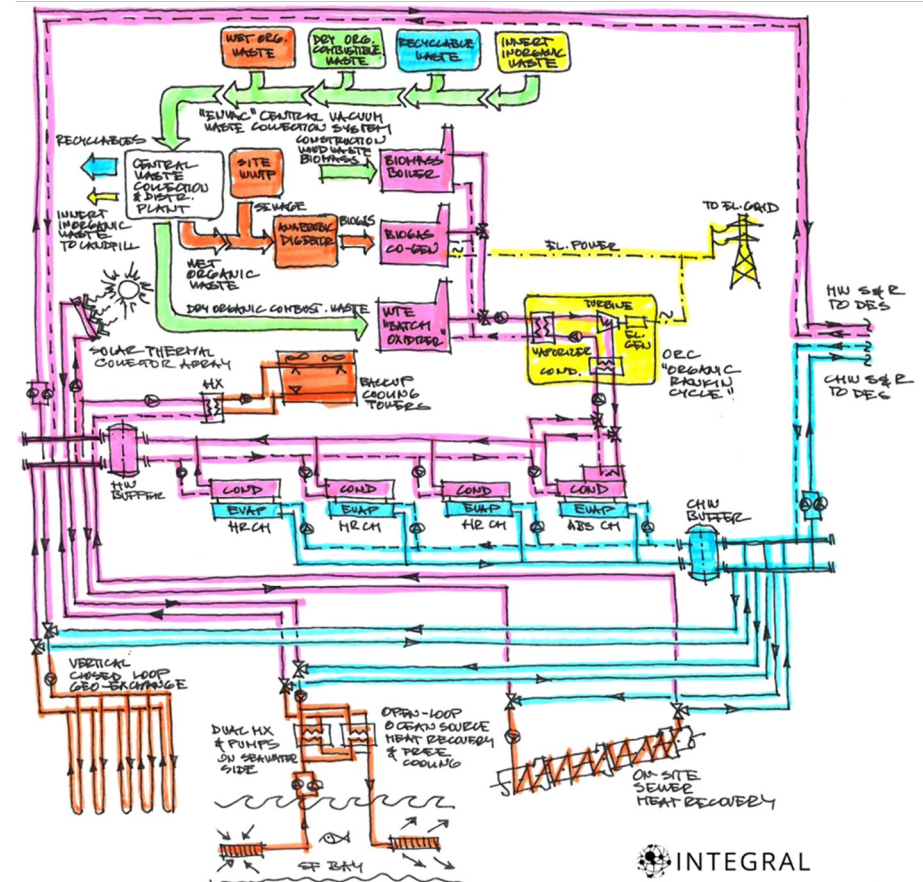

Provide digitized design and risk-reduction for decarbonized grid-responsive systems, such as for this heat recovery HP system, fully integrated with digitized building control delivery process

## De-risking and accelerating decarbonization

by providing advanced HVAC & controls simulation capabilities that support model-based design, virtual testing, and digitized deployment of controls

backed by robust open industry standards that enable collaboration, accelerate innovation, and reduce costs



---

# Thank You

LBLN, NREL, PNNL, ORNL, Solamen,  
Open Source Modelica Consortium, Modelon,  
Objexx, Nouidui Consulting

Michael Wetter, PhD  
[mwetter@lbl.gov](mailto:mwetter@lbl.gov)

WBS 3.5.5.11

---

# REFERENCE SLIDES

# Project Execution

	FY2023				FY2024				FY2025			
Spent budget	400k											
Planned budget	900k				1100k				1500k			
	Q1	Q2	Q3	Q4	Q1	Q2	Q3	Q4	Q1	Q2	Q3	Q4
<b>Past Work</b>												
Q1: Released Buildings Library with updated ASHRAE Std 231P implementation.	x											
Q1: Released Spawn.	x											
<b>Current/Future Work</b>												
Q2: Released OMEdit with support for replaceable models.		x										
Q2: Held IBPSA Modelica Working Group Meeting.		x										
Q3: Released Buildings Library with updated HVAC System Templates.			x									
Q3: Specified Buildings Library model API for OpenStudio workflow.			x									
Q4: Demonstrated 20% faster simulation with QSS across representative examles.				x								
Q4: Held IBPSA Modelica Working Group Meeting.				x								
Q5: Released Buildings Library with template for heat pump plant.					x							
Q5: Released Spawn.					x							
Q6: Posted specification for coupling Modelica CFD with E+ envelope.						x						
Q6: Held IBPSA Modelica Working Group Meeting.						x						
Q7: Released Buildings Library that gets autosizing from E+.							x					
Q8: Demonstrated OpenStudio workflow for Spawn.								x				
Q8: Demonstrated Spawn simulation with building with 100 zones.								x				
Q8: Held IBPSA Modelica Working Group Meeting.								x				
Q9: Released Buildings Library with Modelica CFD coupled to E+.									x			
Q9: Released Spawn.									x			
Q10: Integrated multi-rate solver for use with Spawn.										x		
Q10: Held IBPSA Modelica Working Group Meeting.										x		
Q11: Released Buildings Library with expanded HVAC and control template library.											x	
Q12: Demonstrated district energy system with 50 energy transfer stations.												x
Q12: Held IBPSA Modelica Working Group Meeting.												x

Red color indicates go/no-go milestones

# Team

## **LBNL**

Overall project lead, software architecture, Modelica Buildings Library development.

- Michael Wetter (PI)
- David Blum
- Jianjun Hu
- Anand Prakash
- Hongxiang “Casper” Fu

## **NREL**

EnergyPlus refactoring for Spawn coupling. Spawn run-time environment

- Kyle Benne

## **PNNL**

Modelica Buildings Library component and system development

- Yan Chen
- Karthik Devaprasad
- Xing Lu

## **ORNL**

HVAC component implementation.

- Sen Huang

## **Solamen**

HVAC template lead and implementation.

- Antoine Gautier

## **Modelon**

IMPACT model-based IDE development & Quantized State System run-time environment.

- Hubertus Tummescheit
- Christian Winther
- Robin Andersson
- Peter Meisrimel
- Hakan Lyngjo

## **Open Source Modelica Consortium**

OpenModelica model-based IDE development & multi-rate solver.

- Francesco Casella
- Peter Fritzson
- Adrian Pop
- Martin Sjoelund
- Adeel Ashgar
- Per Oestlund

## **Objexx**

Quantized State System solver.

- Stuart Mentzer

## **Nouidui Consulting**

User support.

- Thierry Nouidui

Team has tight collaboration with industry via direct user support, training, and CRADAs. Wetter is leading IBPSA’s Modelica Working Group (and led IEA Annex 60 and IBPSA Project 1).

Sjoelund is vice-chair of Modelica Association.

Casella is chair of the “Quality and Process” Working Group of the Modelica Association.

Tummescheit is on steering committee of Modelica and FMI Standards.

Tummescheit and Wetter are on Board of American Modelica Users’ Group and organized multiple Modelica Conferences in the USA.