

# Lighting for Health and Wellness Recommendations in Offices

A Circadian Lighting Pilot Project in Chicago, IL

January 2023

(This page intentionally left blank)

# Lighting for Health and Wellness Recommendations in Offices

A Circadian Lighting Pilot Project in Chicago, IL

January 2023

Prepared by:  
Pacific Northwest National Laboratory  
Schuler Shook

Sarah Safranek  
Jessica Collier  
Jess Baker  
John Jacobsen  
Andrea Wilkerson

Pacific Northwest National Laboratory  
Richland, Washington 99352

PNNL-32514

**DISCLAIMER**

This report was prepared as an account of work sponsored by an agency of the United States Government. Neither the United States Government nor any agency thereof, nor Battelle Memorial Institute, nor any of their employees, makes any **warranty, express or implied, or assumes any legal liability or responsibility for the accuracy, completeness, or usefulness of any information, apparatus, product, or process disclosed, or represents that its use would not infringe privately owned rights.** Reference herein to any specific commercial product, process, or service by trade name, trademark, manufacturer, or otherwise does not necessarily constitute or imply its endorsement, recommendation, or favoring by the United States Government or any agency thereof, or Battelle Memorial Institute. The views and opinions of authors expressed herein do not necessarily state or reflect those of the United States Government or any agency thereof.

PACIFIC NORTHWEST NATIONAL LABORATORY  
*operated by*  
BATTELLE  
*for the*  
UNITED STATES DEPARTMENT OF ENERGY  
*under Contract DE-AC05-76RL01830*

Printed in the United States of America

Available to DOE and DOE contractors from the  
Office of Scientific and Technical Information,  
P.O. Box 62, Oak Ridge, TN 37831-0062;  
ph: (865) 576-8401  
fax: (865) 576-5728  
email: [reports@adonis.osti.gov](mailto:reports@adonis.osti.gov)

Available to the public from the National Technical Information Service  
5301 Shawnee Rd., Alexandria, VA 22312  
ph: (800) 553-NTIS (6847)  
email: [orders@ntis.gov](mailto:orders@ntis.gov) <<http://www.ntis.gov/about/form.aspx>>  
Online ordering: <http://www.ntis.gov>

## Executive Summary

In 2019, Cook County initiated a request for proposals for a pilot project aimed at designing and specifying an advanced tunable lighting system for government offices in Chicago, Illinois. The primary goal of the project was to replace the existing tubular light-emitting diode (TLED) lighting system with a lighting system that supported the circadian rhythms and well-being of their office employees. A secondary goal was to evaluate the potential energy, health, or productivity impacts of the new lighting system, informing Cook County's internal workplace design standards. This Circadian Lighting Pilot Project focused on the 23<sup>rd</sup> and 24<sup>th</sup> floor of the George W. Dunne Cook County Administration Building, occupied by the transportation department.

Schuler Shook, a Chicago-based lighting design firm, was awarded the pilot project in October 2019 and invited Pacific Northwest National Laboratory (PNNL) to contribute as a research partner. Based on the initial project goals, Schuler Shook and PNNL established design criteria that would also enable research that explored the benefits and drawbacks of using a tunable light-emitting diode (LED) lighting system to meet existing recommendations for lighting and health. Experimental conditions for the year-long study were designed to meet differing circadian lighting recommendations made by the International WELL Building Institute™ (IWBI) and UL for office spaces while also incorporating Illuminating Engineering Society (IES) recommendations and meeting International Energy Conservation Code (IECC) requirements. Due to the global pandemic, the pilot project was concluded prematurely, after the Design Development phase. Despite the unexpected conclusion, the project provided a unique collaboration between PNNL and Schuler Shook that highlights the challenges of designing to meet current light and health recommendations with available LED luminaire and control system technologies.

Several key results and lessons emerged from the Circadian Lighting Pilot Project:

- Delivering the necessary vertical light level at the eye of occupants while also minimizing glare is difficult to accomplish with current luminaire technology. For this project, the tradeoffs between the optical distributions and color tuning options limited the selection of luminaires that could satisfy the desired experimental lighting conditions.
- Designing to meet recommended thresholds of equivalent melanopic lux (EML) and circadian stimulus (CS) throughout the open office spaces in this project resulted in horizontal and vertical illuminance levels three times greater than IES recommendations for visual tasks, as shown in Figure ES1.
- It was not possible to meet EML or CS thresholds recommended by WELL v2 2019 Q2 or UL Design Guideline 24480 at 100% of the workstations in the open office space with electric lighting only. For several CCT conditions, it was possible to achieve the minimal EML threshold (150 m-lux) and CS threshold (0.3) at 95% of workstations.
- The orientation and location of the workstations influenced whether or not EML or CS thresholds were met. An analysis in the private office spaces demonstrated it was possible to meet all WELL and UL recommendations (including the updated WELL v2 2021 Q4 recommendation) by optimizing the location and orientation of the workstation relative to the electric lighting system, window, and room surfaces. Of the 24 private office simulations across the tunable lighting range, 13 scenarios satisfy the 1-point WELL EML recommendation of 150 m-lux, 5 scenarios satisfy the original 3-point recommendation of 240 m-lux, and 3 scenarios satisfy the updated 3-point recommendation of 275 m-lux; nine simulations provide a CS of 0.3 or greater.
- Lighting simulation methods and software tools that do not account for the spectral characteristics of light sources and room surfaces are limited in their ability to estimate the spectrum of light, and subsequently EML and CS, at the vertical viewing positions.

- In each room, the horizontal uniformity at the task plane is 1.2:1 average to minimum, however, the vertical uniformity at standing eye height is over 2:1 average to minimum. While this is not necessarily unusual for office interiors, it draws attention to the complexity of delivering consistent vertical illuminance to moving occupants compared to horizontal illuminance.
- Preliminary results from this study indicated that designing to meet circadian lighting metric recommendations with a tunable LED lighting system resulted in a higher lighting power density (LPD) than allowed by recent energy codes as well as a higher LPD than the existing TLED system designed for visual tasks only. The LPD estimated for the pilot project was less than that for a baseline fluorescent system designed for visual tasks.

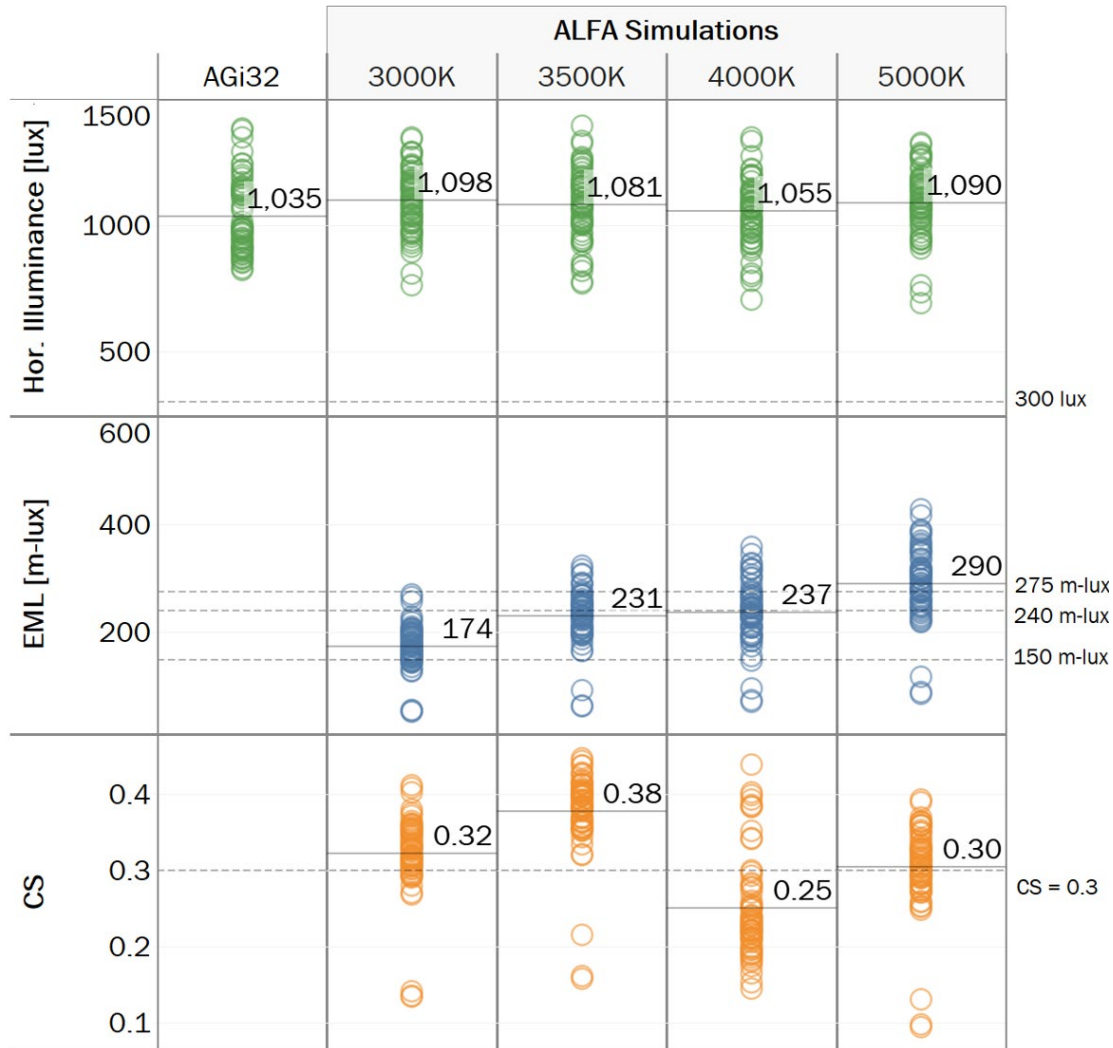

**Figure ES1. Horizontal illuminance, vertical EML, and vertical CS predicted by Agi32 and ALFA simulations for 62 workstations in the open office spaces.** Four CCT conditions were simulated in ALFA whereas Agi32 does not account for light source spectral power distributions and surface spectral reflectance distributions. Each data point represents an individual workstation from the open office spaces on the 23<sup>rd</sup> floor. Reference lines are included to compare the simulation results against the relevant IES, WELL, and UL recommended thresholds for each metric.

## Table of Contents

<b>Executive Summary</b> .....	<b>i</b>
<b>1 Introduction</b> .....	<b>1</b>
<b>2 Background</b> .....	<b>1</b>
<b>3 State of the Industry</b> .....	<b>4</b>
3.1 Circadian Lighting Metrics.....	4
3.2 Design Recommendations .....	5
<b>4 Design Process</b> .....	<b>6</b>
4.1 Design of Experimental Conditions.....	6
4.2 Lighting Design .....	8
<b>5 Lighting Simulations</b> .....	<b>11</b>
5.1 Simulation Software Tools and Methods .....	11
5.2 Open Office Simulations – Comparison of Software Tools and Methods .....	11
5.3 Private Office Simulations – Comparison of Occupant View Direction.....	16
5.4 Storage Space Simulations – Analysis of Vertical Illuminance .....	19
<b>6 Energy Implications</b> .....	<b>20</b>
<b>7 Conclusion</b> .....	<b>22</b>
<b>8 References</b> .....	<b>23</b>

# 1 Introduction

In 2019, Cook County initiated a request for proposals for a pilot project aimed at designing and specifying an advanced tunable lighting system for government offices in Chicago, Illinois. The primary goal of the project was to replace the existing tubular light-emitting diode (TLED) lighting system with a lighting system that supported the circadian rhythms and well-being of their office employees. A secondary goal was to evaluate the potential impacts of the new lighting system, informing Cook County’s internal workplace design standards. This Circadian Lighting Pilot Project focused on two floors of the George W. Dunne Cook County Administration Building, occupied by the transportation department.

Schuler Shook, a Chicago-based lighting design firm, was awarded the pilot project in October 2019 and invited Pacific Northwest National Laboratory (PNNL) to contribute as a research partner. Based on the initial project goals, Schuler Shook and PNNL established design criteria that would also enable research that explored the benefits and drawbacks of using a tunable light-emitting diode (LED) lighting system to meet existing recommendations for lighting and health. This year-long study was designed to further understanding of how electric lighting attributes, such as intensity and spectrum, can affect how office occupants feel and behave at work while accounting for mediating variables such as lifestyle factors (e.g., diet and exercise routines), stress levels, and job satisfaction. Experimental conditions were designed to meet circadian lighting recommendations made by the International WELL Building Institute™ (IWBI) and UL for office spaces while also considering Illuminating Engineering Society (IES) recommendations and meeting International Energy Conservation Code (IECC) requirements.

Schuler Shook was responsible for the design of the lighting system that supported occupants and the research, along with overseeing installation and commissioning. Due to the global pandemic, the pilot project was concluded after the Design Development phase. Despite the unexpected conclusion, the project provided a unique collaboration between PNNL and Schuler Shook that highlights the challenges of designing to meet current light and health recommendations with available LED luminaire and control system technologies. The following report details the lighting design process through Design Development, with summaries of the relevant circadian lighting metrics, simulation tools, energy considerations, and research plan for the pilot project.

# 2 Background

The 35-story George W. Dunne office building (Figure 1) was the workplace for roughly 2000 county employees prior to the pandemic. Designed by Skidmore, Owings & Merrill in 1963 and completed in 1965, the building was historically known as the Brunswick Building and was the tallest reinforced concrete structure of its time. The building was among the early works of noted structural engineer Fazlur Khan and pioneered the tube-within-a-tube structural system. Combined with a waffle slab design, the results were column-free interiors and the iconic “waffle iron” façade. Office floors were typical, each with 20,000-ft<sup>2</sup> floor plates. The building, centrally located within Chicago’s downtown business district and adjacent to other government buildings, became county-owned in 1997. The 23<sup>rd</sup> and 24<sup>th</sup> floors, currently occupied by the transportation department, were designated for the Circadian Lighting Pilot Project.





**Figure 1. Image of George W. Dunne Building in downtown Chicago, IL.**

While the building offered its own set of unique constraints, the project team noted many familiar challenges often found in modern workplaces during a visit to the project site. The main open offices of each floor are situated on the north and south sides, with private offices and meeting rooms primarily occupying the east and west perimeters of the building. Despite the roughly 7-ft-tall windows along the entire perimeter of each floor, the downtown Chicago office tower is situated between tall neighboring towers, resulting in varied access to daylight for employees. All windows in the open and private office spaces also have manually operated white vertical blinds. Figure 2 shows a schematic floorplan with the space type distribution of the 23<sup>rd</sup> floor as well as the current furniture layout in the open office spaces.

Walls had been recently painted lighter neutral tones, with medium grey-blue accent finishes found on interior and meeting room walls. A 2-ft by 2-ft lay-in acoustical ceiling tile grid creates ceiling heights of 8.75 ft, while some ceiling conditions drop to a low of 8 ft due to structural and mechanical constraints. The open office workstations use cubicles with 5-ft-tall, neutrally colored partitions. Workstations in both open and private offices are oriented by employees to predominantly face the interior circulation zones, with their backs and computer monitors toward the perimeter glazing. Examples of these workstations are shown in Figure 3, including the private office spaces with dark desk finishes.

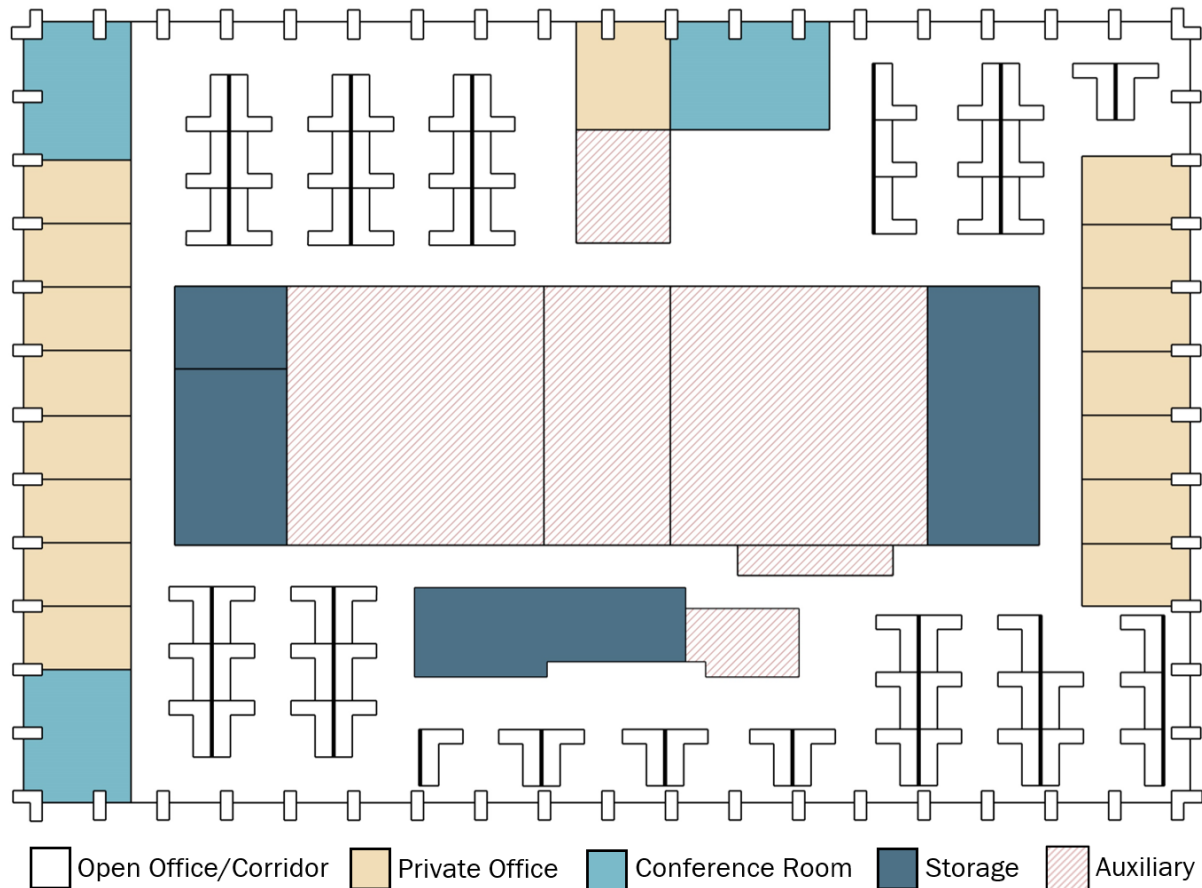

Figure 2. Schematic floorplan of the 23<sup>rd</sup> floor including existing furniture layout and space type distribution.



Figure 3. Examples of the existing furniture and electric lighting layout for the open office spaces (left, center) and private offices (right).

The existing lighting system of the two office floors consisted of 2-ft by 4-ft parabolic reflector fluorescent troffers retrofitted with TLED lamps at a correlated color temperature (CCT) of 4000 K. The luminaires were arranged in a grid with 8-ft spacing in both the open office and private offices. This arrangement resulted in consistently high horizontal illuminance levels over 500 lx on desk work planes, slightly exceeding design

targets recommended by IES for office tasks, though not unusual for a traditional work environment with mixed paper-based and computer tasks. Vertical illumination levels at sitting eye height varied widely depending on the location in the office, with an average of about 200 lx, ranging from 60 to 330 lx<sup>1</sup>.

Cook County initiated this project to further understand how lighting could better support the well-being of employees and planned to use the results to inform their internal lighting standards and make a broader contribution to office lighting research (discussed further in Section 3). The design team was charged not only with developing an advanced tunable lighting system that would demonstrate a sustainable, evidence-based lighting design for the pilot project, but also with turning the County's typical office space into a modern, appealing workplace for current and prospective employees. Although initiated as a lighting focused project, JLK Architects and WMA Engineering were included in the design team to address any architectural or engineering modifications needed to achieve the project's human-centered and sustainability goals. PNNL spearheaded development of the yearlong research study to understand employee response to different lighting conditions.

To create a design standard for happy, healthy, and motivated employees, Cook County and the design team wanted to provide a circadian supportive design that was environmentally conscious with a modern lighting design. As a result, the design team sought tunable luminaires that provided comfortable source brightness, delivered light levels that were not noticeably high, and provided warm color temperatures appropriate to the interior environment. In addition, the lighting design team aimed to embrace modern LED technology, avoiding dated luminaire form-factors such as troffers.

The pilot evaluation required an advanced lighting system that would allow the research team to seamlessly study the potential electric lighting effects on the occupants, as well as their preferences. The design team approached the project with the goal of creating a visually appealing lighting system that would meet industry standards for glare, circadian entrainment, appropriate task illumination levels, and color quality, as well as optimizing user control and minimizing energy use. Consequently, the system would be tasked with meeting numerous current lighting industry standards and recommendations for visual and non-visual health, such as the WELL Building Standard (IWBI 2020), Leadership in Energy and Environmental Design (USGBC 2019), and the 2018 IECC requirements (IECC 2018).

## 3 State of the Industry

### 3.1 Circadian Lighting Metrics

Emerging evidence from the medical research community has linked lighting to physiological responses, including circadian synchronization, mood, and acute alerting effects (Vetter et al. 2022). Research over the past 20 years has demonstrated that these responses have spectral sensitivities that differ from the visual system, leading to new circadian metrics that quantify the potential effects of light. The three most common circadian lighting metrics are equivalent melanopic lux (EML, units of m-lux), circadian stimulus (CS, unitless), and the more recent melanopic equivalent daylight illuminance (M-EDI, units of lux). These metrics weight the spectrum of light using different response functions and incorporate light intensity as a scaling factor. The EML and M-EDI metrics are based on the melanopic response of the intrinsically photosensitive retinal ganglion cells (Lucas et al. 2014) with a peak response at 480 nm, with the only difference being the reference source of equal energy and D65, respectively. It is possible to convert between EML and M-EDI using a scalar multiplier ( $EML \approx M-EDI \times 1.103$ ). The CS metric is the calculated effectiveness of light at suppressing melatonin, using a more complex model of human phototransduction, including data from human nocturnal melatonin suppression experiments combined with estimates of rod and cone photoreceptor responses, with this model most recently updated in 2021 (Rea and Figueiro 2018, Rea, Nagare, and Figueiro 2021). EML was adopted in a slightly modified form to align with SI unit requirements by the International

---

<sup>1</sup> CL-500A Konica Minolta Illuminance Spectrophotometer (10002008) calibrated Aug. 30, 2018.

Commission on Illumination (CIE 2018). More recently, the CIE endorsed M-EDI. CS has not yet been adopted by CIE or the IES.

### 3.2 Design Recommendations

There are currently two organizations with documented recommendations for designing office lighting to account for the human circadian system: IWBI and UL. Over 3.15 billion ft<sup>2</sup> worldwide apply the IWBI WELL recommendation framework since it was originally established in 2013 (IWBI 2020). The framework consists of design features that cover multiple aspects of the built environment, including water, materials, thermal comfort, and light. Points can be earned toward WELL certification by demonstrating that various features have been met. In particular, up to 3 points (maximum possible for most features) can be earned through the circadian lighting design feature by demonstrating that electric lighting can be used to deliver varying thresholds of EML to all workstations in regularly occupied spaces for at least 4 hours per day. UL Design Guideline 24480 (UL 2019) focuses on how circadian-effective lighting designs for offices are to be accomplished and field verified, using CS as the primary metric. The WELL and UL recommendations are summarized in Table 1; meeting both sets of recommendations was a priority for the Circadian Lighting Pilot Project.

At the time the project was initiated, WELL v2 2019 Q2 and UL Design Guideline 24480 were the relevant documents for designing to circadian lighting recommendations and metrics; however, the WELL circadian lighting design feature and recommendations have since been updated along with the CS metric. The 3-point EML threshold in WELL v2 2021 Q4, the current version of WELL v2 at the time of this report, has been increased by 15% to reflect new recommendations made for healthy daytime, evening, and night-time indoor light exposure (Brown 2020). Although this higher EML recommendation did not exist until after the pilot project concluded, it is included in Table 1 as it will be discussed in the later sections of this report.

In addition to the existing recommendations for circadian lighting metrics, typical IES recommendations for glare control, color rendering, and task illumination were incorporated into the lighting design for the office spaces, such as horizontal/vertical illuminance and illuminance/luminance uniformity ratios.

**Table 1. WELL and UL Circadian Lighting Design Recommendations.** The recommended metric thresholds, target height, and minimum duration vary between documents. WELL recommendations for EML were updated after the start of the Circadian Lighting Pilot Project.

<i>Document</i>	<b>Recommendation</b>	<b>Viewing Locations</b>	<b>Height Above Floor (ft)</b>	<b>Minimum Duration (hr)</b>
<i>WELL v2 2019 Q2</i>	1 point: EML $\geq$ 150 [136 M-EDI] OR CS $\geq$ 0.3 3 points: EML $\geq$ 240 [218 M-EDI]	100%	4	4 9 a.m. – 1 p.m.
<i>WELL v2 2021 Q4</i>	1 point: EML $\geq$ 150 [136 M-EDI] 3 points: EML $\geq$ 275 [250 M-EDI]	100%	4	4 Beginning by noon
<i>UL Design Guideline 24480 (2019)</i>	CS $\geq$ 0.3	N/A	3 - 4	2 7 a.m. – 4 p.m.

## 4 Design Process

### 4.1 Design of Experimental Conditions

The design and research teams worked closely to ensure that the lighting for the Circadian Lighting Pilot Project could also be used for a research study on human response to various lighting conditions that could be achieved with a single lighting system. Although the research was not started due to the global pandemic, planning was nearly complete for a year-long research project comparing four lighting conditions to the baseline TLED/troffer lighting condition across the two office floors. In addition to evaluating occupant preference and satisfaction, data regarding occupant health, lifestyle, environmental satisfaction, job satisfaction, and life changes were included to address the holistic nature of the client's goals. While lighting can play a role in fostering an environment for happy, healthy, and motivated employees, other factors like individual stress level, satisfaction with job duties and management, and thermal comfort can also impact someone's overall perception of their work environment, as illustrated in Figure 4 (Collier, Abboushi, and Davis 2020).



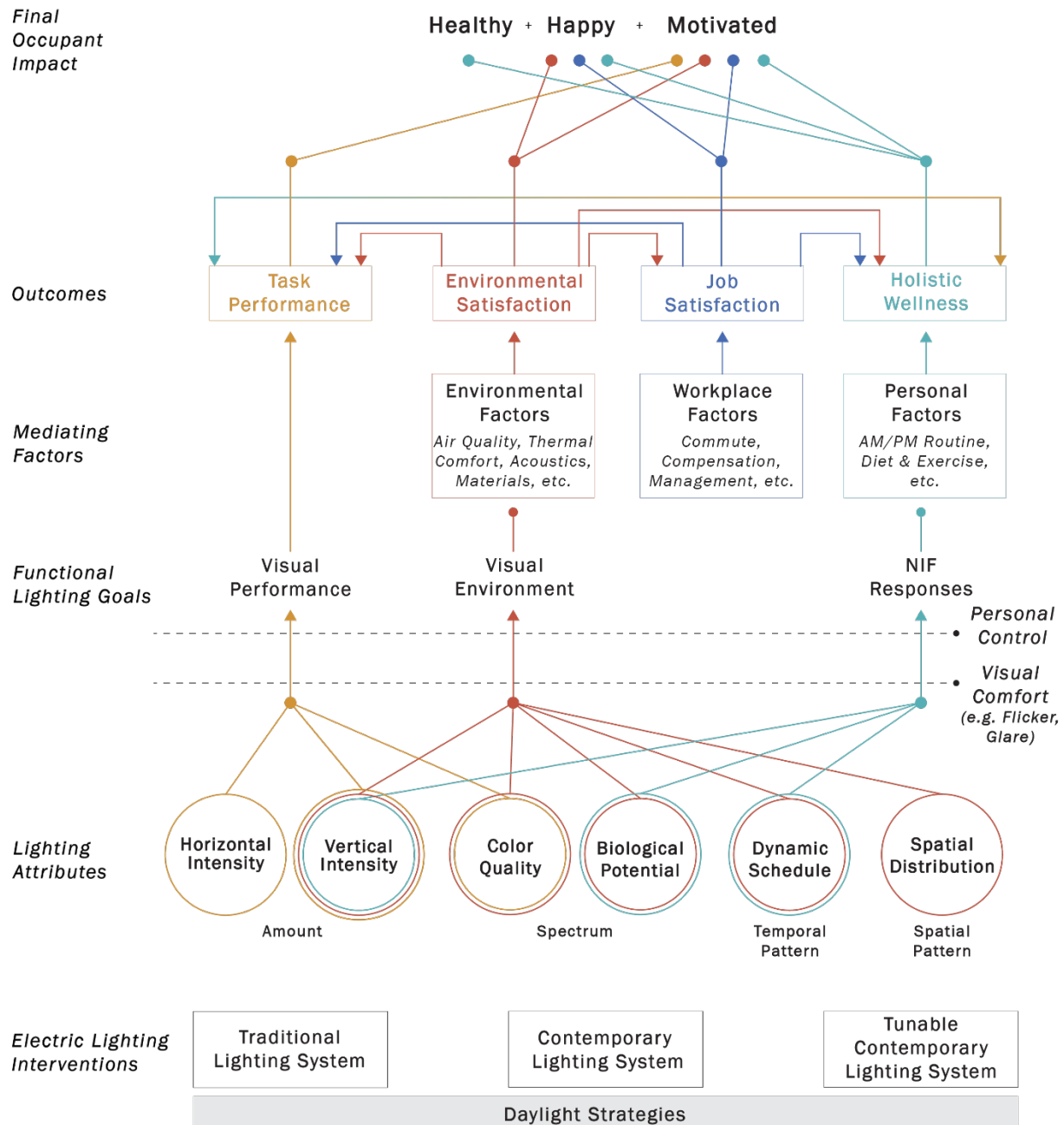

**Figure 4. Theory of change diagram connecting technology-specific electric lighting interventions and related attributes to occupant health, happiness, and motivation via functional lighting goals [visual performance, visual environment, and non-image-forming (NIF) responses] and outcomes (task performance, environmental satisfaction, job satisfaction, and holistic wellness).** The relationships create color-coded pathways that explain how the lighting interventions support outcomes that will lead to the final occupant impact. The dotted lines connected to personal control and visual comfort express additional lighting qualities to be considered, along with other external mediating factors (environmental, workplace, or lifestyle factors), when evaluating how a lighting intervention can influence occupant well-being. It is assumed that daylight strategies have been considered, such as side lighting with blinds or shades, and that the electric lighting interventions build on those strategies to achieve the functional lighting goals.

The four lighting conditions were designed to systematically vary light level and spectrum based on relevant research and recommendations (static-visual, dynamic-visual, static-circadian, dynamic-circadian). Each lighting condition was designed to last six weeks and occur twice on each floor throughout a year timeframe to account for seasonal changes and variable daylight availability. The first static-visual condition would maintain the same spectral power distribution (SPD) and illuminance, meeting existing IES recommendations for task performance and visual quality. The dynamic-visual condition would vary the SPD, while maintaining the same illuminance as the static-visual condition. The last two lighting conditions would meet WELL and UL health and well-being design recommendations, differing in their approach: One was designed to meet the recommendations using a static SPD at maximum output for the entire day, and the other was designed to utilize the high-end of the white-tunable range to deliver more short-wavelength light. Additionally, the dynamic-circadian condition would only meet the circadian metric targets for 4 hours a day and would return to a lower illuminance that met IES recommendations for the rest of the day. The lighting conditions are summarized in Table 2. To seamlessly switch the specific intensity, color, and duration characteristics of the experimental lighting conditions every 6 weeks, a lighting system with color tuning capabilities was required.

**Table 2. Four experimental lighting conditions planned for the Circadian Lighting Pilot Project.** A baseline control condition is compared to three intervention conditions that may or may not satisfy light and health recommendations by varying the light level and CCT delivered to occupants. WELL v2 2019 Q2 suggests a minimum duration of 4 hours per day in the morning or early afternoon, and the UL Design Guideline suggests a minimum duration of 2 hours per day, so 4 hours was selected to satisfy both recommendations.

	Lighting Conditions			
	Static, Visual	Dynamic, Visual	Static, Circadian	Dynamic, Circadian
<i>Meet Light and Health Recommendations</i>	No	No	Yes	Yes
<i>Light Level</i>	IES recommended light levels	IES recommended light levels	High intensity	High intensity 4 hours per day
<i>Color Tuning</i>	Static	Dynamic	Static	Dynamic

The data collection plan incorporated several standardized surveys, such as the Patient Reported Outcomes Measurement Information System (PROMIS) Sleep Disturbance and Sleep Related Impairments questionnaires to assess daytime sleepiness and nighttime sleep disturbances as well as the Warwick-Edinburgh Mental Wellbeing Scale (WEMWBS) to assess mood and perceived stress. In addition, the research team developed shorter questionnaires known as ecological momentary assessments (EMAs) to capture “in the moment” responses to a small number of questions regarding elements of the indoor environment such as satisfaction with different aspects of the lighting conditions, temperature, and noise. Participants were to be prompted with EMAs at scheduled times during their workdays regarding their alertness, mood, and motivation for completing their current task.

## 4.2 Lighting Design

Once the experimental lighting conditions were established, the team set out to balance circadian lighting design goals of the project while complying with energy code and industry recommendations for glare, color rendering, and task illumination levels. The project team sought to design an electric lighting system capable of complying with the applicable lighting recommendations without relying on daylight contributions due to Chicago’s frequent dark, overcast winter days and the inconsistent daylight penetration within the project

space resulting from adjacent buildings. Although this was understood to be a ‘worst case scenario’ in terms of lighting power, it was also anticipated implementation of daylight responsive controls could reduce actual energy consumption from the connected load baseline.

The WELL v2 2019 Q2 and UL Design Guideline 24480 circadian lighting recommendations call for vertical light levels at occupant eye-level that are higher than what is achieved when solely meeting IES recommendations for horizontal task plane illuminance (Safranek, Collier et al. 2020). Glare is always an important consideration for occupant comfort, and even more so with the increase in overall light levels at workstations, so the design team focused on minimizing visible lens brightness and balancing contrast ratios. The design team planned to utilize luminaires with direct/indirect lighting distribution (with separate control of the downlight and uplight components) as well as wall illumination throughout the office, conference, and storage spaces. Reflecting light from the ceiling and walls allowed for a subtle increase to vertical illuminance at the eye of occupants without introducing discomfort glare. Luminaire distributions with greater high-angle output were studied for both direct and indirect components to increase illumination at the eye and potentially decrease energy consumption.

Due to the limited ceiling heights, Lambertian downlight distributions caused high illumination levels at the task plane when meeting the vertical illumination and circadian lighting metric targets, while Lambertian uplight distributions caused non-uniform illumination of the ceiling surface. To increase the effectiveness of the lighting system and address the high horizontal illuminance levels, the design team considered architectural modifications to the office spaces. Specifically, removing the suspended acoustical ceiling entirely would provide an additional 3 ft to the ceiling height and allow for indirect/direct pendant luminaires to be mounted at a more visually appealing location. The exposed ceilings would also make it possible for the design team to achieve a common modern office design with visible decks, ducts, and building systems. After an analysis of the exposed ceiling approach, it was determined that the uniformity would improve and be more visually interesting but would require a higher wattage fixture as the waffle slab structure of the building limited the effectiveness of the indirect component from the pendant luminaires. When presented with the different architectural schemes, Cook County requested that both options be included as part of the project to inform internal workplace design standards. The 23<sup>rd</sup> floor would remain 8 ft with the existing suspended acoustical ceiling and the 24<sup>th</sup> floor would have an exposed ceiling, increasing the ceiling height to 11.75 ft.

It was difficult to identify a luminaire family that provided necessary optics and luminaire selection became even more limited once spectral tuning capabilities were considered. While the intensity of light is key to meeting the circadian lighting metric thresholds recommended by WELL and UL, the spectral characteristics of the source also play an influential role. The initial proof of concept calculations were conducted with static white sources in a CCT range of approximately 3000 K to 3500 K, considered standard for commercial interiors. The design team also investigated spectrally optimized sources to provide more flexibility in balancing circadian lighting metric recommendations with energy efficiency, while maintaining color and visual quality. To achieve the planned experimental conditions, the design team explored tunable lighting systems with three or more spectral channels. While initially optimistic, the designers realized after tirelessly searching for available products that they would have to make a trade-off between spectral capabilities and optical distribution. Multi-primary systems that can vary the spectrum independent of chromaticity did not have the optics necessary to create non-Lambertian distributions. Conversely, products with the desired optical distribution to help meet circadian metrics and code only had two primaries, a warm and cool phosphor-converted LED, with chromaticities deviating from the blackbody locus and producing poorer color fidelity. Even these two-channel tunable products were difficult to find with the desired optics. As a third option, some lighting products alter source spectra to specifically target circadian metrics. These products offered a spectral flexibility that was too limited for the study’s experimental conditions which required slow, visible changes in the color appearance of the light source throughout the day. Finding the desired optical distributions for these products remained a hurdle, particularly in a linear form factor.



Ultimately, a 4-inch-wide by 1-inch-tall direct/indirect linear pendant luminaire, with a Lambertian downlight component and “batwing” uplight component, was selected for the office, conference, and storage spaces. These linear luminaires also offered a wall wash distribution and could be modified for wall mounting and undercabinet lighting. All luminaires had a 2-channel tunable white system (2700 K to 6500 K) and edge-lit 4 in wide injection molded acrylic panels that provided higher vertical illumination levels while limiting potential glare to occupants. The linear luminaires were arranged in a rectangular pattern over each double-width section of cubicle workstations as shown in Figure 5, allowing illumination to be optimally placed for seated employees’ primary vertical view orientations. It was possible to meet recommendations for glare, uniformity, and vertical illuminance using a relatively dense luminaire layout; however, the luminaire spacing negatively impacted the energy efficiency of the lighting system.

While industry recommendations for circadian lighting metrics and glare were generally achieved based on the simulations, initial calculations on the horizontal task surface were still two to three times higher than the light levels recommended by the IES. In addition, the higher vertical surface and ceiling illumination, which were both needed for an effective and comfortable lighting system, increased the connected load above the power allowance determined by the energy code, and sustainability targets set by LEED.



**Figure 5. Lighting layout on the 23rd floor.** Direct/indirect linear pendant luminaires were arranged in a rectangular pattern over the cubicles in the open office spaces and recessed linear wall wash and slot luminaires were used to increase indirect contributions of light to the eye of occupants. The same pendant luminaires were centered in the private office spaces, with linear indirect wall sconces illuminating two of the office walls. Recessed linear downlights and wall wash luminaires were used in the storage spaces.

## 5 Lighting Simulations

### 5.1 Simulation Software Tools and Methods

Schuler Shook used the A*Gi*32 software from Lighting Analysts to calculate photopic and estimate melanopic light levels throughout the office spaces. A*Gi*32 is a commonly used lighting design software tool for predicting photopic quantities in common architectural applications. Traditional radiosity-based lighting simulation tools like A*Gi*32 assume light sources to be of equal energy across the visible spectrum, and non-luminous architectural surfaces are assigned a single reflectance value with a flat spectral reflectance distribution (SRD). For rendering and visualization purposes, luminous and non-luminous surfaces can be assigned red, green, and blue (RGB) color values, and a color bleeding technique is used to depict interreflection of colored surfaces (A*Gi*32 2020). This is a coarse visual representation of what is experienced in a real environment, and photometric values calculated using this method may be inflated due to the misrepresentation of energy transfer during interreflections. Currently, additional steps are necessary to use A*Gi*32 simulation methods to calculate spectrally dependent metrics like EML or CS.

During Design Development, the 23<sup>rd</sup> floor was used to study all typical space types in both conditions of an exposed ceiling and the existing suspended acoustical ceiling, although this report will focus on the latter. Horizontal illuminance calculations were conducted using points on the floor with 2-ft spacing as well as on each task plane, 2.5 ft above finished floor (AFF), with 1-ft spacing. A maintenance light loss factor (LLF) of 0.8 was used in all simulations.

Both glare and melanopic potential were studied in A*Gi*32 using vertically oriented calculations points. Calculations used a continuous point grid with 2-ft spacing, 4 ft AFF, with the calculation points oriented vertically, in each cardinal direction, simulating the employee's primary and peripheral fields of view. To estimate the EML using A*Gi*32, an additional LLF was applied based on the melanopic to photopic (M/P) ratio<sup>2</sup> data obtained from lighting manufacturers. This provided an estimate of EML at the eye, although it does not consider any shift in SPD resulting from interreflection between room surfaces. The use of consistent vertical calculation grids made it apparent that the vertical light levels necessary to avoid discomfort glare required a careful balance with the levels necessary for EML and CS at the eye.

PNNL conducted a second set of lighting simulations for several of the spaces on the 23<sup>rd</sup> floor, including the open office, private office, and storage spaces. These simulations were conducted in Adaptive Lighting for Alertness (ALFA), a relatively new simulation tool that allows for high-resolution spectral simulations of architectural environments. ALFA uses 81 bins (5 nm increments) to represent the spectral characteristics of room surfaces and light sources for calculating the intensity and spectrum of light at horizontal or vertical calculation points. ALFA uses this additional information to estimate spectrally dependent metrics like EML or CS at the eye of potential occupants. It is important to note that ALFA has not been formally validated in academic literature; however, it expands on the capabilities of Radiance, a popular lighting toolkit that uses a validated raytracing method to simulate daylight and electric lighting in three spectral bins.

The following sections use A*Gi*32 and ALFA simulation results to explore how different simulation methods, SPDs and SRDs influence the prediction of lighting metrics in different spaces.

### 5.2 Open Office Simulations – Comparison of Software Tools and Methods

For comparing software tools and calculated metrics, the team conducted one A*Gi*32 simulation and four ALFA simulations using the same lighting and architectural layouts for the open office spaces on the 23<sup>rd</sup>

---

<sup>2</sup> The M/P ratio compares the melanopic content of a light source to the photopic content by weighting the light source spectral power distributions (SPD) by the respective spectral weighting functions, assuming an equal-energy reference spectrum.

floor. The AGi32 simulations followed the procedure used by Schuler Shook during the development of the lighting design described in the previous section.

In AGi32, average reflectance values were assigned to room surfaces, based on the materials observed during a site visit to the existing Cook County office space. These materials and corresponding (photopic) reflectance values are listed in Table 3. Material definitions for the ALFA simulations are more detailed, using 81 spectral bins to capture variations in material reflectance (and color) across the visible spectrum. This increased spectral resolution makes it possible to calculate multiple reflectance values and better predict how materials may attenuate different wavelengths of light. While the M/P ratio is most often discussed in terms of light sources, this ratio can also be used to the spectral reflectance of surfaces. More specifically, melanopic reflectance describes the (unweighted) average of reflectance values within the bounds of the melanopic sensitivity function whereas photopic reflectance describes the average of reflectance values within the bounds of the photopic sensitivity function. A summary of the average reflectance values as well as the M/P ratio of each surface is shown in Table 3. Most of the surfaces used to simulate the Cook County office spaces are spectrally neutral, with an M/P ratio close to 1.00. The tan wall paint, however, is an example of a surface material that does not reflect as much short-wavelength energy compared to mid- or long-wavelength energy.

**Table 3. Summary of the average photopic and melanopic reflectance values and M/P ratios for all surface materials included in the 23<sup>rd</sup> floor spaces.** The AGi32 simulation used the average photopic reflectance value to represent each surface material while the four ALFA colored lighting conditions used the full spectral reflectance distribution from 380 to 780 nm. Material melanopic and M/P values are also included.

SURFACES	MELANOPIC REFLECTANCE	PHOTOPIC REFLECTANCE	MATERIAL M/P
Ceiling	77%	82%	0.94
Desktops	6%	10%	0.65
Desk Cabinets	80%	83%	0.97
Desk Partitions	48%	58%	0.82
Floor	21%	22%	0.98
Exterior Glazing*	46%	45%	1.01
Interior Doors	9%	9%	1.03
Interior Glazing*	89%	88%	1.01
Wall Paint (Blue)	23%	22%	1.08
Wall Paint (Tan)	68%	78%	0.87
Wall Paint (White)	76%	78%	0.97

\*Values correspond to average transmittance of material

The same photometric files were used in AGi32 and ALFA to represent the four luminaire types specified in the open office spaces. The light source SPDs, displayed in Figure 6, represent the different lighting conditions planned for the office space and were simulated using 5-nm increments in ALFA. Four SPD conditions, from 3000 to 5000 K, were simulated in ALFA; for the remainder of this report, these SPDs are described using the nominal CCT values.

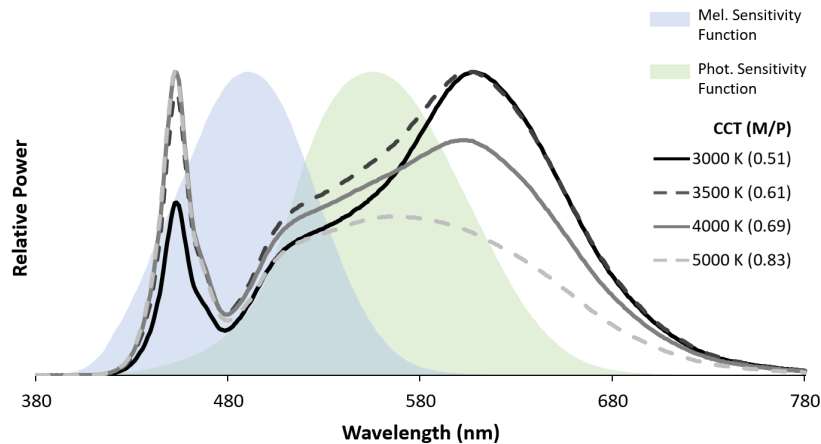

**Figure 6. Relative spectral power distributions used in ALFA simulations.** The four colored lighting conditions that were specified for the Cook County office space are plotted and labeled using the corresponding CCT values. The M/P ratio for each CCT condition is included in parentheses. The melanopic and photopic sensitivity functions are plotted for predicting the melanopsin-driven and visual responses to light.

It cannot be assumed that daylight would contribute consistent levels of EML or CS during the daytime hours, particularly for those workstations further away from the exterior windows, so daylight was not considered in the lighting simulations. It is likely that any daylight contributions would be limited by factors like computer orientation, partition height, use of the manual shading system, and obstructions from neighboring skyscrapers. Additionally, it is currently difficult to conduct annual or climate-based spectral simulations of daylight and spectral daylight models do not exist for the majority for U.S. cities.

For ALFA simulations of the open office spaces on the 23<sup>rd</sup> floor, 62 workstations were assigned one horizontal and one vertical calculation point each. Horizontal calculation points were placed atop the desks, which were assumed to be 2.5 ft AFF. Vertical calculation points were placed 4 ft AFF, representing the field of view of a person sitting at each workstation facing the desk partition. An example of the placement of the horizontal and vertical calculation points is included in Figure 7. Computer monitors were not included in any of the simulated conditions. Both AGi32 and ALFA were used to estimate average horizontal illuminance at each workstation and ALFA was used to estimate vertical EML and CS. The results of these simulations are plotted in Figure 8 and reference lines are included to indicate which workstations are above the metric thresholds recommended by IES, WELL v2, and UL Design Guideline 24480.

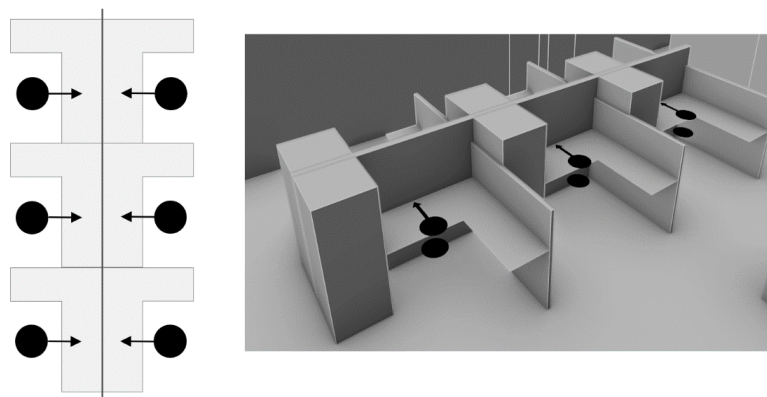

**Figure 7. Layout of horizontal and vertical calculation points used in ALFA simulations of the open office spaces.** One horizontal and one vertical calculation point were placed at each workstation. Vertical calculation points were oriented toward the desk partition, representing the view of an occupant sitting at the workstation.

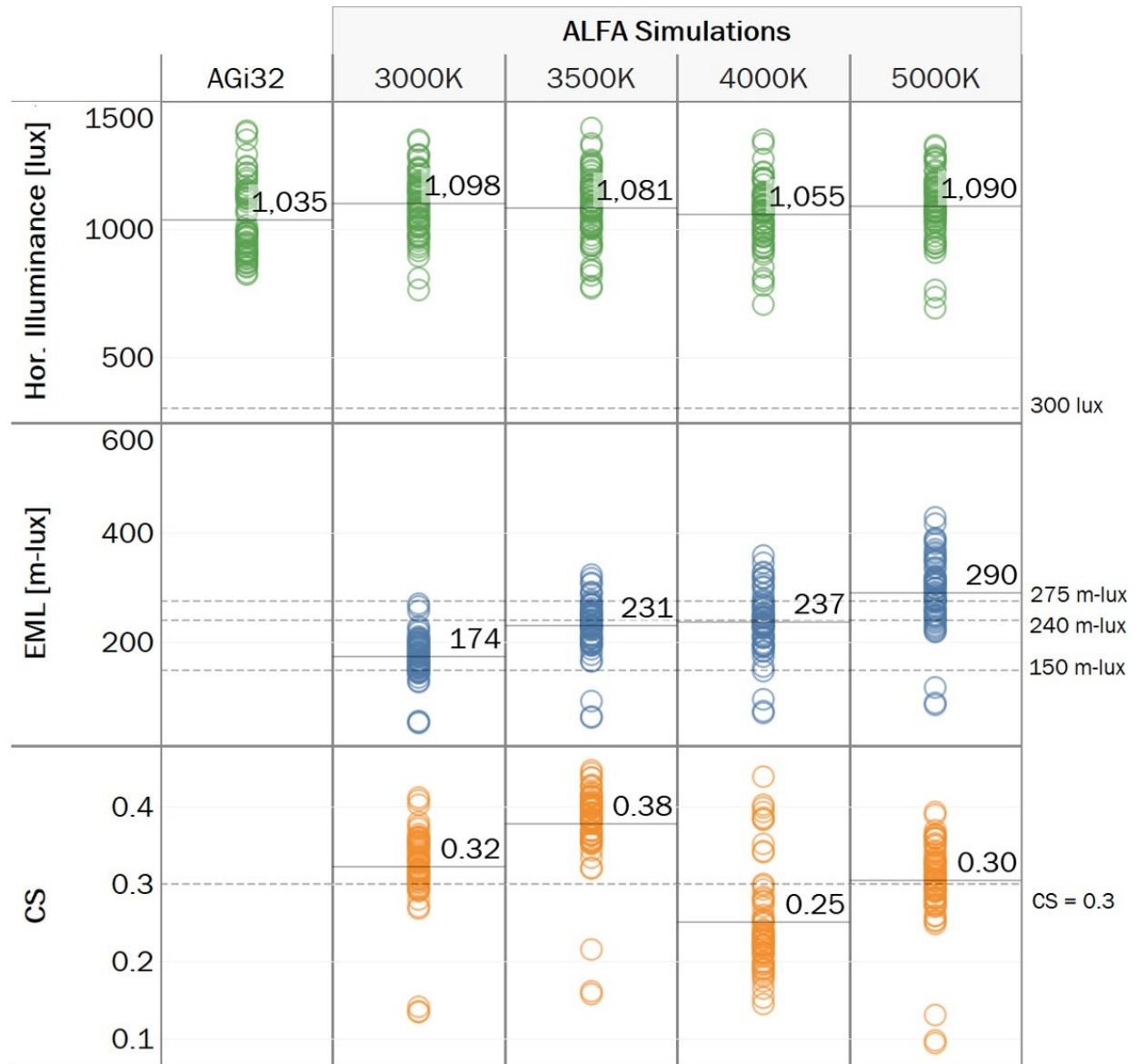

**Figure 8. Horizontal illuminance, vertical EML, and vertical CS predicted by AGi32 and ALFA simulation for 62 workstations in the open office spaces.** Four CCT conditions were simulated in ALFA whereas AGi32 does not account for light source spectral power distributions and surface spectral reflectance distributions. Each data point represents an individual workstation from the open office spaces on the 23<sup>rd</sup> floor. Reference lines are included to compare the simulation results against the relevant IES, WELL, and UL recommended thresholds for each metric.

The estimated average horizontal illuminance for all workstations was between 1000 and 1100 lx for both the AGi32 and ALFA simulations, with general agreement between the two simulation software tools. The small differences observed between the AGi32 and ALFA results may be due to the calculation methods (radiosity and raytracing, respectively) used to simulate the propagation of light throughout the office space. Changing the CCT of the luminaires in the ALFA simulations did not notably influence estimated horizontal illuminance, although the small differences (3% between conditions) can likely be attributed to the differences in SPD within the bounds of the photopic sensitivity function or the raytracing method used by ALFA. Average EML was estimated to be between 174 and 290 m-lux, with EML values increasing as the CCT increased. A different pattern occurs when estimating CS; average CS varies between 0.25 and 0.38, with the 4000 K condition resulting in the lowest CS values.



The location of the workstations within the open office space influenced the resulting horizontal illuminance, with large variations observed between workstations for individual simulation conditions. In AGi32, the horizontal illuminance values estimated for the task plane ranged from 822 to 1382 lx, depending on the location of the workstation. ALFA had a larger range in results estimated for the same workstations, ranging from 706 to 1356 lx. This variation between workstations is also observed for the EML and CS values, which were impacted by the orientation of the vertical calculation points. This is particularly evident for three workstations located in the southeast corner of the 23<sup>rd</sup> floor, oriented such that the occupant would be facing the window. These positions did not receive much reflected light from the electric lighting system given that most of it was transmitted through the glazing material. As a result, EML and CS values at these workstations were notably less for all simulated conditions compared to other workstations throughout the open office, making it difficult to meet the recommendations for circadian lighting metrics with electric lighting only.

For all simulated conditions, average horizontal illuminance in the open office space was estimated to be more than three times greater than what the IES recommends for visual tasks (300 lx for mixed paper-based and computer tasks). At several workstations, the estimated horizontal illuminance was nearly 1400 lx, which is almost five times the IES-recommended value. Despite overall high light levels, none of the CCT conditions considered for the open office space were able to meet the 150 or 240 m-lux EML thresholds recommended by the WELL v2 2019 Q2 Circadian Lighting Design feature at 100% of workstations. Similarly, there are no simulated conditions that would meet 0.3 CS at all workstations, as is recommended by UL Design Guideline 24480.

If the same comparison was done excluding the three workstations in the southeast corner of the open office space, the 3500, 4000, and 5000 K conditions would meet 150 m-lux at all workstations but would still fail to meet 240 m-lux at six or more workstations. Of these lighting conditions, 3500 K is the only condition that would also meet 0.3 CS. As discussed in Section 3, the 3-point EML threshold has been updated to 275 m-lux since the conclusion of the Circadian Lighting Pilot Project. Even excluding the three workstations in the southeast corner, 18 or more workstations would fail to meet this higher EML threshold.

While this report primarily focuses on ALFA estimates of vertical illuminance, EML, and CS, it is valuable to compare how different simulation/calculation methods may impact these metrics. Figure 9 shows a small subset of workstations in the southwest corner of the open office space, comparing AGi32 and ALFA simulation results for vertical viewing positions for the 4000 K lighting condition. AGi32 estimates of vertical illuminance range from 386 to 452 lx while ALFA estimates are similar, ranging from 391 to 442 lx. Note, that these estimates are 2.5-3 times greater than the values recommended by IES. Despite similar results between software tools for vertical illuminance, it is important to acknowledge how other metrics like EML or CS might also be affected. Vertical illuminance values from AGi32 can be multiplied by the M/P ratio of the light source (based on full SPD acquired from the manufacturer) to estimate EML. This can be done within AGi32, using the M/P ratio as an additional light loss factor. Similarly, CS can be estimated by inputting the vertical illuminance from AGi32 and full SPD of the light source using the calculation procedure outlined by UL Design Guideline 24480.

Larger differences between AGi32 and ALFA simulations can be observed in the estimates of EML; using the AGi32 calculation methodology results in higher estimates of EML than ALFA that are above the WELL-recommended thresholds of 150 and 240 m-lux. When simulated in ALFA, all workstations remain above 225 m-lux; however, two workstations no longer meet the higher 240 EML threshold. Estimates of CS using the AGi32 methodology meet existing recommendations for 4 of the 6 workstations. The ALFA simulation predicts generally lower values for CS, with four of the six workstations falling below the 0.3 recommended threshold and as low as 0.22 CS.

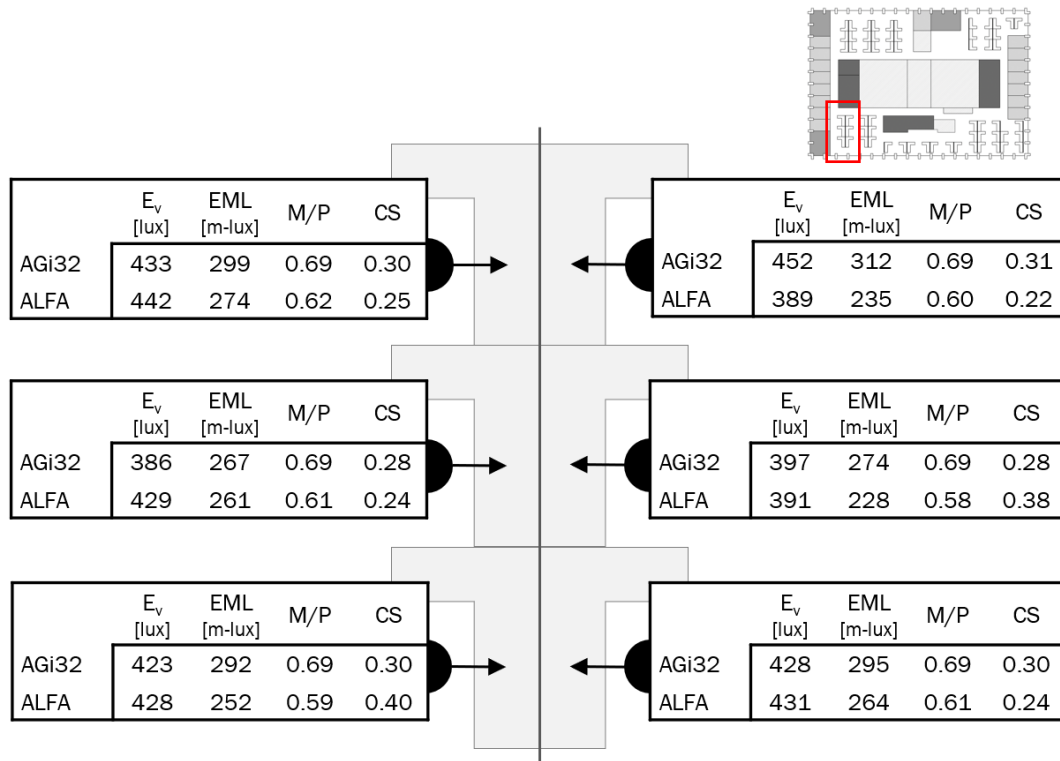

**Figure 9. Comparison of results using AGi32 and ALFA to simulate six workstations for the 4000 K lighting condition.** AGi32 was used to estimate vertical illuminance at six workstations which was then used to estimate EML and CS using the calculation methods provided by WELL and UL Design Guideline 24480. ALFA was used to estimate vertical illuminance and EML at the same workstations. ALFA predictions of SPD at the eye were used to estimate CS using the method provided by UL Design Guideline 24480.

Some of these differences can be explained by comparing the M/P value predicted for each viewing position (also included in Figure 9). Estimates of M/P using the AGi32 calculation methodology match the light source (0.69) and do not account for any shifts in the spectrum of light as it moves from the luminaires throughout the built environment. The M/P values resulting from ALFA display this shift, with values that are less than the light source, ranging from 0.58 to 0.62. Understanding the spectrum of light at the occupant viewing location is particularly important for calculating CS as it is sensitive to small changes when the SPD at the eye is around 3500 K.

The original design for the pilot project was completed before the new EML threshold was established; however, ALFA spectral simulations can help to identify the workstations that need further optimization to meet circadian lighting metrics. As demonstrated in this section, methods for optimization may include increasing vertical illuminance, increasing light source CCT, and intentionally positioning workstations and luminaires relative to one another. With no ability to control cleanliness of workstations, occupant viewing height/direction, and daylight intensity and spectral exposure, it may be even more difficult to meet circadian lighting metrics in the actual environment as compared to simulated environments.

### 5.3 Private Office Simulations – Comparison of Occupant View Direction

Although most private offices had similar furnishings, the layout and use of each individual office space varied among the employees. To investigate some of these variations, six private office configurations were created, varying the occupant's primary view direction. In addition, three of the six rooms assume a bookcase or storage cabinet is attached to the desk, while the other three have a free-standing bookcase. The three offices with an attached bookcase include an additional surface-mounted undercabinet task light. The architectural

lighting is the same across all six offices, consisting of a direct/indirect pendant in the center of the room and two wall-mounted indirect luminaires with an asymmetric distribution mounted 1 ft below the ceiling. A summary of simulation conditions is shown in Figure 10.

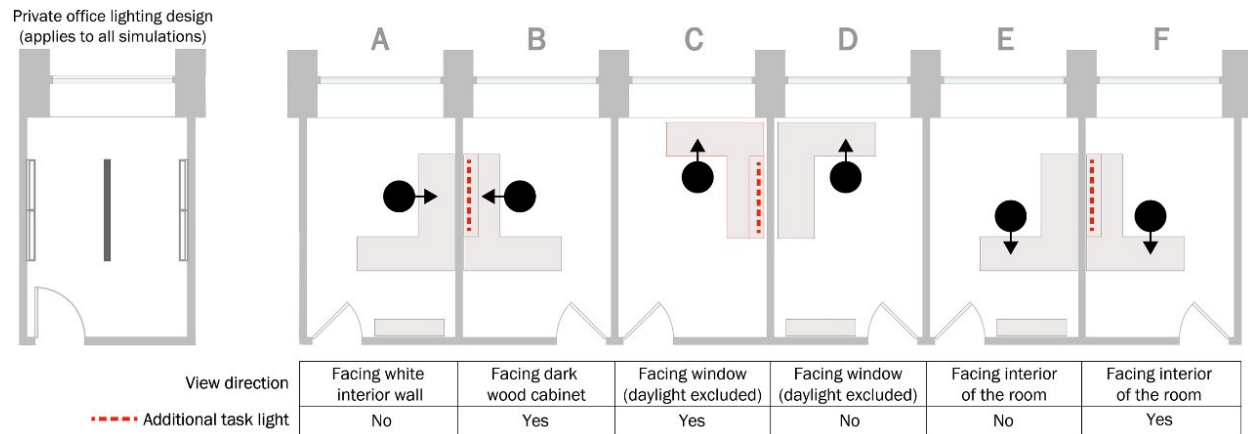

**Figure 10. Simulation conditions for six private offices.** As use of private office spaces varied by employee, six different office arrangements were produced to explore the effects of view directions and supplemental task lighting on horizontal and vertical illuminance levels. The lighting layout on the left applies to all six offices, while three of the six include an additional undercabinet task light.

Horizontal illuminance was calculated on the desk work plane in front of the occupant at 2.5 ft AFF. Across all six offices and tunable options, the horizontal illuminance range was between 609 and 1030 lx with an average of 834 lx, as shown in summary Table 4. The largest source of variation among the offices is due to the relationship between the location of the occupant's workstation and the luminaire in the center of the room. Layouts B, E, and F consistently have the highest illuminance values across the tunable conditions, simply because the desks are under the primary luminaire. As daylight was excluded from the simulations, both layouts facing the perimeter windows (C and D) consistently have the lowest illuminance at the eye and desk work plane due to the lack of reflected light and the position of the desk relative to the luminaires. Even at the low end of the simulated horizontal illuminance range, the values are consistent with the light levels provided by the existing lighting system.

**Table 4. Private office ALFA simulation results for horizontal and vertical illuminance.** Desk work plane illuminance was calculated at 2.5 ft AFF and vertical illuminance at the eye was calculated at 4 ft AFF assuming a primary view direction for the office occupant. The table cells are colored with a gradient such that the minimum horizontal and vertical illuminance values are white and the maximum values are orange.

	Work plane Illuminance [lx]				Vertical Illuminance [lx]			
	3000 K	3500 K	4000 K	5000 K	3000 K	3500 K	4000 K	5000 K
A	714	753	868	717	247	231	221	214
B	859	938	1030	913	307	332	311	333
C	632	609	679	680	55	53	81	63
D	639	714	731	792	100	87	84	82
E	1028	1009	972	1001	390	377	387	404
F	926	948	920	932	373	404	395	393

Horizontal and vertical contribution from the supplemental task light was most noticeable in office layout B. This is expected, as the occupant directly faces the cabinet with the supplemental task light in this layout. Compared to office layout A, which does not include a task light, layout B provides an additional 60 to 120 lx



at the occupant's eyes. There is no noticeable difference caused by task light contribution when the occupant is facing the interior of the room with the task light beside them (F), nor when the occupant is facing the window with the task light beside them (C). Further, the simulations suggest that the white wall adjacent to the occupant in office layout D reflects more light to the eye than the furniture mounted task light provides in layout C.

Of the 24 private office simulations across the tunable lighting range, 13 scenarios satisfy the 1-point WELL EML recommendation of 150 m-lux, 5 scenarios satisfy the original 3-point recommendation of 240 m-lux, and 3 scenarios satisfy the updated 3-point recommendation of 275 m-lux; nine simulations provide a CS of 0.3 or greater. Figure 11 shows that no lighting conditions meet any design recommendations when the occupants are facing the windows. Between both layouts, the maximum EML and CS are 84 m-lux and 0.13, respectively. Occupants in office layouts B, E, and F all receive an EML of 150 m-lux or greater regardless of the color temperature and view direction. Results are similar for CS at 3000 K and 3500 K, however, 4000 K and 5000 K conditions produced lower CS values in some office layouts despite high vertical illuminance levels. In office layout B, the vertical illuminance at 3500 K is 332 lx and the resulting CS is 0.35; at 5000 K, the vertical illuminance is equivalent at 333 lx, but the resulting CS value is 0.21. Office layouts E and F have the highest metric values overall, with an average EML of 244 m-lux and an average CS of 0.33 across the four tunable conditions.

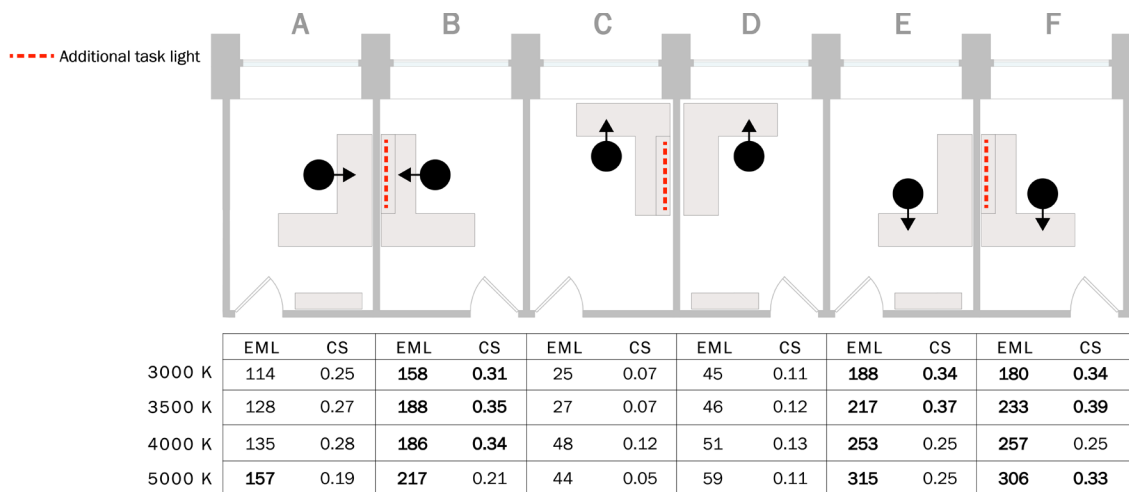
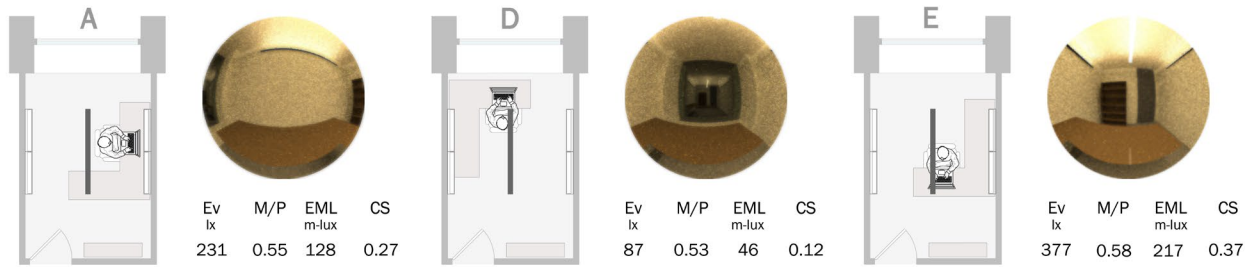

**Figure 11. Summary of light and health metric results for the private office simulations.** Occupants in offices B, E, and F consistently receive more than 150 m-lux regardless of CCT. The two layouts facing the window (C and D) have the lowest metric values, which are all well below the recommended design targets. Bold values indicate that the metric result meets or exceeds the recommended design target.

Daylight contribution is often discussed as a way to supplement electric light levels in order to meet design recommendations without significantly increasing energy consumption, although when the energy consumption of the whole building is considered, this may also lead to an increased thermal load. In this office space, the majority of the private offices are located on the east and west sides of the building and would therefore receive direct sunlight in the morning and afternoon when each façade is not obstructed by other buildings as long as occupants leave the blinds open.

Figure 12 compares the results of three office layouts at 3500 K. Many employees in this office preferred to face the interior of the space with their backs to the windows, and the simulation results suggest that facing this direction can maximize electric light delivered to the occupants' eyes. When the occupant is facing the window, they receive the least amount of electric light contribution and would heavily rely on daylight contribution to meet any light and health metric targets. Office layout A where the occupant is facing the

interior partition allows for access to exterior views while also providing vertical electric light levels that nearly satisfy the design recommendations before considering supplemental daylight.

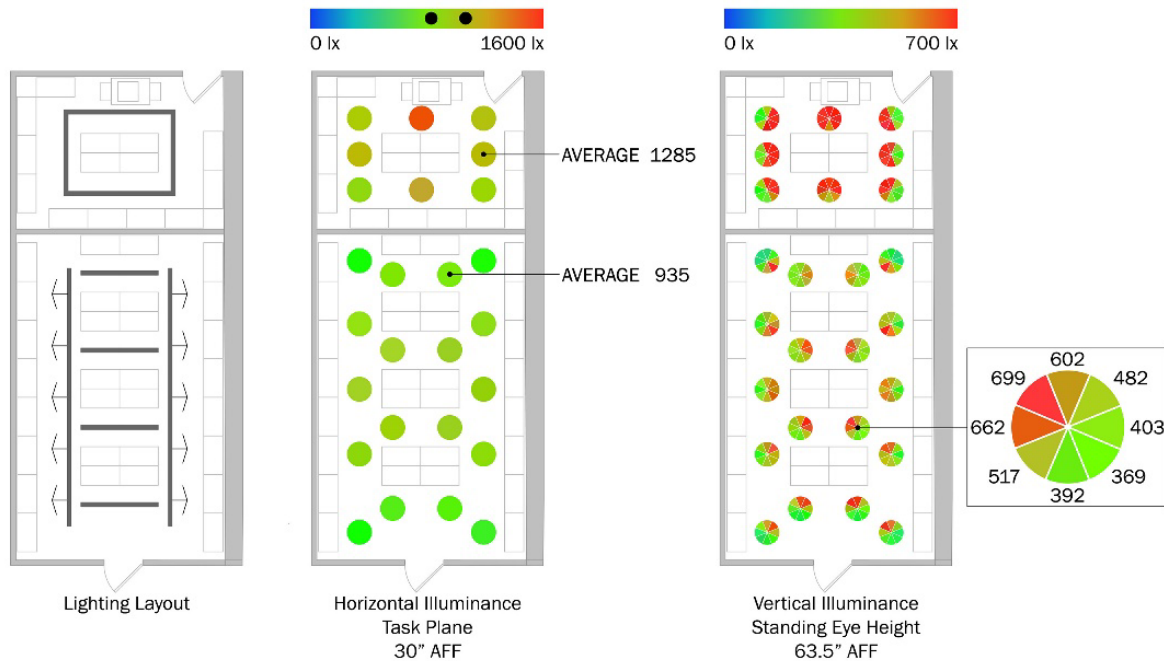

**Figure 12. Comparison of different view directions at 3500 K in the private offices.** Electric light contribution is maximized for this lighting layout when the occupant is facing the interior of the room (E) and is minimized when the occupant is facing the window (D). Although the size of the private office can limit furniture placement, both daylight and electric light could be leveraged in office layout A. Note: ALFA currently models light sources as luminous surfaces and does not visually render the luminaire housing.

#### 5.4 Storage Space Simulations – Analysis of Vertical Illuminance

The transportation department office employees often reference large paper drawing sets, so the office space includes several filing and work areas where employees access and view stored drawings. While there are no primary workstations located in these spaces, employees may spend considerable time (more than an hour) in these spaces reviewing drawings during the day. Additionally, these spaces are adjacent to open office areas, so the same luminaires were used to provide a cohesive visual environment. This includes asymmetric wall wash luminaires that illuminate the faces of the filing cabinets around the perimeter of the room, and recessed luminaires that provide task plane illuminance on tables along the center of the room. It was also important for the design team to balance illumination levels to manage contrast and adaptation for supporting areas such as storage rooms or break rooms.

The simulations show that the average illuminance delivered to the task plane (2.5 ft AFF) in the storage rooms was just over 1000 lx. Although this is much greater than IES illuminance recommendations for storage areas, the value is only slightly lower than the other office spaces by design to support the visual task of reading detailed engineering drawings. Figure 13 shows the simulated horizontal illuminance at 3500 K, ranging from 680 to 1553 lx. In each room, the horizontal uniformity at the task plane is 1.2:1 average to minimum; however, the vertical uniformity at standing eye height is over 2:1 average to minimum. These values are typical for office interiors, but it draws attention to the complexity of delivering consistent vertical illuminance to moving occupants compared to horizontal illuminance. According to the simulation results, when an occupant is standing in the same spot facing the worktables in the center of the room or turned around facing the filing cabinets around the perimeter of the room, the vertical illuminance simulated at the standing eye position (63.5 in AFF) ranges from over 650 lx to below 300 lx.



**Figure 13. Simulation results for two storage rooms.** The lighting consisted of asymmetric wall wash luminaires around the perimeter and recessed linear luminaires in the center of the room. Horizontal illuminance on the task plane in each room is relatively uniform, while the vertical illuminance measured at standing eye height can vary by a factor of two between facing the tables in the middle of the room and the filing cabinets.

## 6 Energy Implications

In 2019, Chicago adopted new building codes based on the International Building Code and other model construction codes published by the International Code Council in alignment with other major cities in the US. Energy conservation was a critical design goal set by Cook County for the Circadian Lighting Pilot Project, especially since implementation of results would be incorporated into their workplace standards. As a permanently installed system, the project design would be required to meet local energy code requirements. The preliminary design results indicated that circadian lighting goals contributed to higher estimated lighting power density (LPD) than a non-circadian supportive design.

The design team needed to comply with the 2018 IECC energy code, which provides requirements for lighting system controls and maximum power allowances. There are two paths for compliance: the building area method and the space-by-space method. Generally, the space-by-space method may provide greater flexibility given the varying needs of each listed space type. Although the building area method features simpler compliance documentation, the space-by-space method will often slightly increase the maximum allowed lighting power. In this case, the building area method allows 11,589 W for the 23<sup>rd</sup> floor, while the space-by-space method allows 11,643 W, just 54 W more than the building area method.

At the conclusion of the Design Development phase, the total lighting connected load on the 23<sup>rd</sup> floor was 15,853 W, or 4,210 W above code compliance. The 2018 IECC space-by-space method allows for tradeoff between space types, like ASHRAE/ANSI/IES Standard 90.1, and also provides flexibility to designers using furniture-mounted supplemental task lighting as well as decorative lighting when it is controlled separately from the general lighting. The summary provided in Table 5 shows that the design had roughly 300 W to spare in the conference rooms but was above the allowable wattage in all other space types. Although Standard 90.1 is not applicable by Chicago codes, as a point of comparison, the 2018 IECC wattage allowances are equivalent to those of Standard 90.1 2016 for all of the space types listed below.

**Table 5. IECC 2018 interior wattage allowance and connected load for the 23rd floor.** The total allowable wattage is slightly higher for the space-by-space method; however, the designed connected load (not considering any decorative wattage allowances) exceeded the allowance by 4,210 W.

Space Types	2018 IECC Allowance (W/ft <sup>2</sup> )	Area (ft <sup>2</sup> )	Allowable Wattage (W)	Connected Load Floor 23 (W)
Corridor	0.66	2206	1456	2501
Storage room	0.46	831	382	886
Enclosed office	0.93	2075	1930	2342
Open plan office	0.81	7719	6252	8539
Lounge/breakroom	0.62	304	188	339
Copy/print room	0.56	355	199	283
Conference/meeting/multipurpose	1.07	793	849	570
Lobby	1.0	387	387	393
<b>Total Interior Allowance, Space-by-Space Method</b>		14,670	<b>11,643</b>	
<b>Total Interior Connected Load</b>				<b>15,853</b>
<b>Total Interior Allowance, Building Area Method</b>	0.79	14,670	<b>11,589</b>	

Although all of the project spaces exhibited illuminances higher than the IES target levels typically used to establish the energy code LPD, the impact of providing increased light levels to meet light and health design recommendations was particularly acute for the active storage areas and corridors adjacent to the open office spaces. If the project had continued, the design team most likely would have decided to reduce luminaire lumen packages in the less frequently used support spaces and the corridors to create a WELL-compliant design in the office spaces with less consistent support spaces for the occupants. The evaluation of the installation would have provided valuable information related to occupant outcomes and energy consumption that would help further streamline the design and application for Cook County's workplace standards.

Apart from interest in light and health, a key adoption criterion for solid-state lighting systems has been the substantial energy savings gained over incumbent technologies. For example, the fluorescent lighting system installed in this office previously had an LPD of 1.37 W/ft<sup>2</sup>. When the system was replaced with TLEDs, the LPD dropped to 0.64 W/ft<sup>2</sup>. The LPD for the 23<sup>rd</sup> floor lighting redesign stands at 1.08 W/ft<sup>2</sup>, which is a 64% increase from the TLED retrofit scenario, and only a 20% decrease from the fluorescent baseline. In this case, the increase in connected load is a direct result of attempting to meet the suggested design guidelines for human health and wellbeing; if only redesigning for visual acuity and aesthetics the design and LPD might look entirely different.

The design recommendations offer a suggested minimum duration to reduce annual energy consumption and deliver energy-intensive stimulus during certain hours of the day. WELL v2 2019 Q2 suggests a minimum duration of 4 hours per day in the morning or early afternoon, and the UL Design Guideline suggests a minimum duration of 2 hours per day, anytime between the hours of 7 a.m. and 4 p.m. Considering these scenarios, annual energy calculations were completed assuming the lighting system operated for 3120 hours per year (12 hours per day, 5 days per week, 52 weeks per year).

The first calculation creates a baseline representing the scenarios where the lighting system is operating at full output in order to support occupant well-being. The second creates an additional baseline at a dimmed level appropriate for visual tasks. The visual baseline was determined using simulations in the open office spaces with an additional applied LLF. At 40% output, the lighting system provided 414 lx on average and was considered an appropriate task plane light level. A linear dimming curve is assumed for this analysis; therefore,

40% of the connected load is used to estimate annual energy consumption. The third calculation represents the WELL scenario, where the energy-intensive lighting operates for 4 hours a day and then dims to the visual baseline for the remainder of the day. The last calculation represents the UL scenario, where the energy-intensive lighting operates for 2 hours a day.

As shown in Table 6, the annual energy usage for the baseline was 19,783 kWh. Providing high-intensity stimulus for just 2-4 hours a day as suggested in the design recommendations increases energy consumption by 25-50%. If high-intensity stimulus is delivered all day, the annual energy usage increases by 150%, totaling just under 50,000 kWh. While higher light levels may be necessary to meet satisfy human health and wellness recommendations in certain applications, tunable LED lighting systems and lighting controls offer the flexibility to provide these higher levels when and where they are needed and otherwise reduced to satisfy recommendations for visual tasks. Hopefully future research studies will be able to carefully study the potential benefits of tunable lighting at recommended light levels for visual tasks to further understanding of how to best support occupants while also minimizing energy consumption. Understanding the influence of other factors beyond lighting both in the workplace and at home is critical to helping designers and researchers improve well-being for occupants.

**Table 6. Comparison of four potential operating scenarios.** For all scenarios, it is assumed that the lighting system operates for 3120 hours per year. Compared to the visual task baseline scenario operating at 40% system output for the entire year, increasing the intensity to support occupant well-being will also increase annual energy consumption between 25% and 150%.

Operating Scenario	Annual Operating Hours			Annual Energy Usage (kWh)	Energy Increase from Visual Baseline (%)
	100% Output	40% Output	Total		
High Intensity Baseline	3120	0	3120	49,461	150
WELL	1040	2080	3120	29,675	50
UL	520	2600	3210	24,729	25
Visual Task Baseline	0	3120	3120	19,783	--

## 7 Conclusion

This report detailed lighting design process through Design Development, with summaries of the relevant circadian lighting metrics, simulation tools, energy considerations, and research plan for the Circadian Lighting Pilot Project. Due to the global pandemic, the Circadian Pilot Project was concluded after the Design Development phase however, several key results and lessons emerged from the pilot project, as summarized below.

### Key Results:

- Delivering the necessary vertical light level at the eye of occupants while also minimizing glare is difficult to accomplish with current luminaire technology. For this project, the tradeoffs between the optical distributions and color tuning options limited the selection of luminaires that could satisfy the desired experimental lighting conditions.
- Designing to meet recommended thresholds of EML and CS throughout the open office spaces in this project resulted in horizontal and vertical illuminance levels three times greater than IES recommendations for visual tasks.
- It was not possible to meet EML or CS thresholds recommended by WELL v2 2019 Q2 or UL Design Guideline 24480 at 100% of the workstations in the open office space with electric lighting only. For

several CCT conditions, it was possible to achieve the minimal EML threshold (150 m-lux) and CS threshold (0.3) at 95% of workstations.

- The orientation and location of the workstations influenced whether or not EML or CS thresholds were met. An analysis in the private office spaces demonstrated it was possible to meet all WELL and UL recommendations (including the updated WELL v2 2021 Q4 recommendation) by optimizing the location and orientation of the workstation relative to the electric lighting system, window, and room surfaces. Of the 24 private office simulations across the tunable lighting range, 13 scenarios satisfy the 1-point WELL EML recommendation of 150 m-lux, 5 scenarios satisfy the original 3-point recommendation of 240 m-lux, and 3 scenarios satisfy the updated 3-point recommendation of 275 m-lux; nine simulations provide a CS of 0.3 or greater.
- Lighting simulation methods and software tools that do not account for the spectral characteristics of light sources and room surfaces are limited in their ability to estimate the spectrum of light, and subsequently EML and CS, at the vertical viewing positions.
- In each room, the horizontal uniformity at the task plane is 1.2:1 average to minimum, however, the vertical uniformity at standing eye height is over 2:1 average to minimum. While this is not necessarily unusual for office interiors, it draws attention to the complexity of delivering consistent vertical illuminance to moving occupants compared to horizontal illuminance.
- Preliminary results from this study indicated that designing to meet circadian lighting metric recommendations with a tunable LED lighting system resulted in a higher LPD than allowed by recent energy codes as well as a higher LPD than the existing TLED system designed for visual tasks only. The LPD estimated for the pilot project was less than that for a baseline fluorescent system designed for visual tasks.

## 8 References

- CIE. 2018. CIE System for Metrology of Optical Radiation for IPRGC-Influence Responses to Light. International Commission on Illumination (CIE). <https://cie.co.at/publications/cie-system-metrology-optical-radiation-iprgc-influenced-responses-light-0>.
- AGi32. 2020. "Color bleed - concepts." Lighting Analysts - Illumination Engineering Software, accessed December 1. [https://docs.agi32.com/AGi32/Content/multi\\_use\\_forms/Color\\_Bleed\\_-\\_Concepts.htm](https://docs.agi32.com/AGi32/Content/multi_use_forms/Color_Bleed_-_Concepts.htm).
- Brown, T.; Brainard, G.; Cajochen, C.; Czeisler, C.; Hanifin, J.; Lockley, S.; Lucas, R.; Munch, M.; O'Hagan, J.; Peirson, S.; Price, L.; Roenneberg, T.; Schlangen, L.; Skene, D.; Spitschan, M.; Vetter, C.; Zee, P.; Wright Jr., K. 2020. "Recommendations for Healthy Daytime, Evening, and Night-Time Indoor Light Exposure." *Preprints*. doi: 10.20944/preprints202012.0037.v1.
- Collier, J. M., B. K. Abboushi, and R. G. Davis. 2020. "Evolving theories of change: Rethinking of the effects of office lighting on occupants." Conference: Proceedings of the 2020 Illuminating Engineering Society Annual Conference, August 24-28; August 31- September 4, 2020, Virtual, United States.
- IECC. 2018. International Energy Conservation Code (IECC). <https://codes.iccsafe.org/content/iecc2018>.
- IWBI. 2020. WELL v2™. <https://v2.wellcertified.com/en/wellv2/overview>: The International WELL Building Institute.
- USGBC. 2019. Leadership in Energy and Environmental Design (LEED). <https://www.usgbc.org/leed>.



- Lucas, R. J., S. N. Peirson, D. M. Berson, T. M. Brown, H. M. Cooper, C. A. Czeisler, M. G. Figueiro, P. D. Gamlin, S. W. Lockley, J. B. O'Hagan, L. L. A. Price, I. Provencio, D. J. Skene, and G. C. Brainard. 2014. "Measuring and using light in the melanopsin age." *Trends in Neurosciences* 37 (1):1-9. doi: 10.1016/j.tins.2013.10.004.
- Rea, M. S., and M. G. Figueiro. 2018. "Light as a circadian stimulus for architectural lighting." *Lighting Research & Technology* 50 (4):497-510. doi: 10.1177/1477153516682368.
- Rea, M. S., R. Nagare, and M. G. Figueiro. 2021. "Modeling Circadian Phototransduction: Quantitative Predictions of Psychophysical Data." *Frontiers in Neuroscience* 15 (44). doi: 10.3389/fnins.2021.615322.
- UL. 2019. Recommended Practice and Design Guideline for Promoting Circadian Entrainment with Light for Day-Active People.
- Vetter, C., P. M. Pattison, K. Houser, M. Herf, A. J. K. Phillips, K. P. Wright, D. J. Skene, G. C. Brainard, D. B. Boivin, and G. Glickman. 2022. "A Review of Human Physiological Responses to Light: Implications for the Development of Integrative Lighting Solutions." *LEUKOS* 18 (3):387-414. doi: 10.1080/15502724.2021.1872383.

(This page intentionally left blank)



U.S. DEPARTMENT OF  
**ENERGY**

*Office of*  
**ENERGY EFFICIENCY &  
RENEWABLE ENERGY**

For more information, visit:  
[energy.gov/eere/ssl](https://energy.gov/eere/ssl)

PNNL-32514 • January 2023