

Welcome to the Undocumented Orphaned Wells Workshop

April 5, 2022



Picture Source: PADEP

Workshop Agenda

- 12:00pm** Welcome and Overview of DOE FECM Undocumented Well Program
- 12:15pm** Environmental Defense Fund
- 12:30pm** Independent Petroleum Association of America
- 12:40pm** Overview of DOI Documented Well Plugging Program and Data Collection
- 1:00pm** IOGCC and State Representation Across the United States
- 1:20pm** Technical Session #1: Defining the Need for Undocumented Orphaned Wells RDD&D
- 1:55pm** Break
- 2:10pm** Technical Session #2: Undocumented Well Finding Technologies
- 2:45pm** Technical Session #3: Undocumented Well Characterization Technologies
- 3:20pm** Technical Session #4: Outcomes (Framework, Best Practices) Strategy
- 3:55pm** Closing Remarks
- 4:00pm** Adjourn

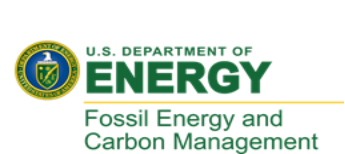



U.S. DEPARTMENT OF
ENERGY

Fossil Energy and
Carbon Management

Undocumented Orphaned Wells Program Overview

Tim Reinhardt
April 5, 2022



Pictures Source: PADEP

Bipartisan Infrastructure Legislation

Relevant Appropriations Language

Section H2 (a, b)

Conduct research and development activities in cooperation with the Interstate Oil and Gas Compact Commission to assist the Federal Land Management Agencies, States, and Indian Tribes in--

- (A) identifying and characterizing undocumented orphaned wells; and
- (B) mitigating the environmental risks of undocumented orphaned wells;

Program Budget

DOE's Undocumented Orphaned Well Program will be executed over **5 years with \$30M** in appropriated budget.

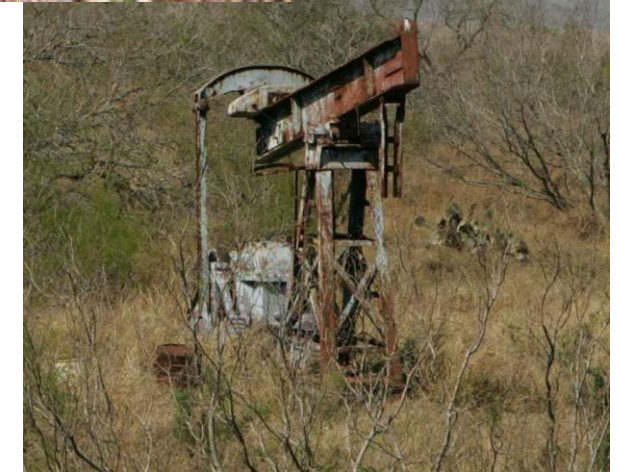

Need for Identification and Characterization

- It is estimated that there are *hundreds of thousands* of **undocumented** orphaned wells in the U.S. that need to be located.¹
- Total estimated number of undocumented orphaned wells reported by the states is between **310,000** and **800,000**.²
- According to a 2015 study cited by the EPA, unplugged wells leaked significantly more methane than plugged wells.³

Estimated Undocumented Orphaned Wells (2020)²

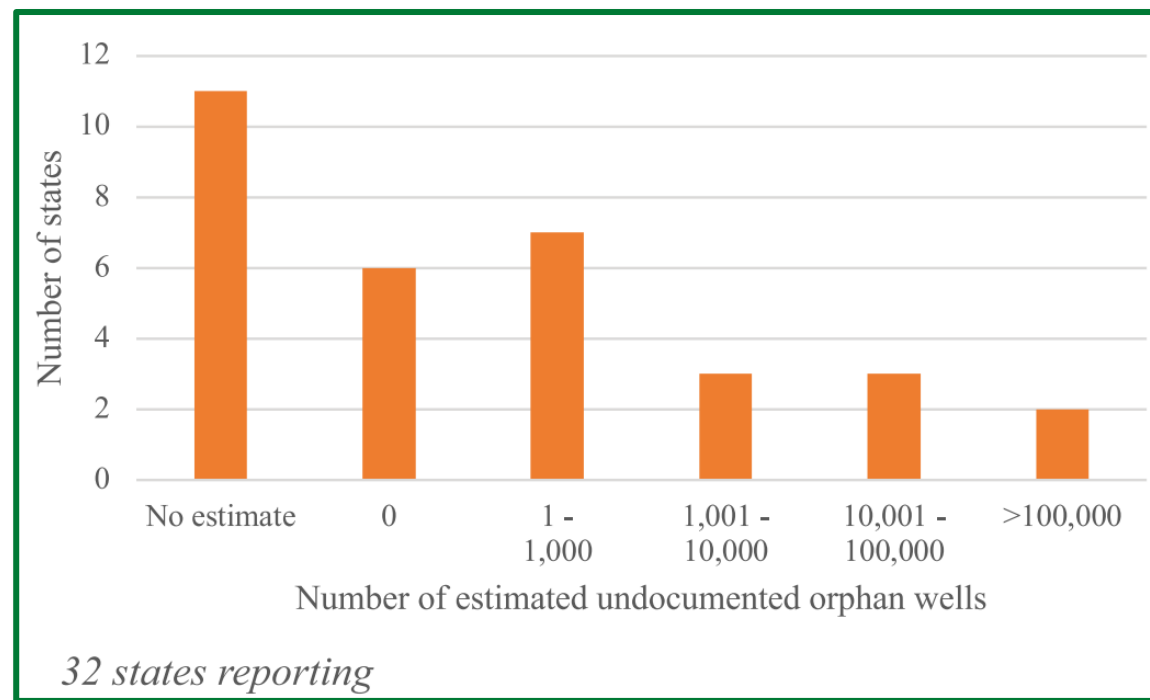

1) Management of Abandoned and Orphaned Oil and Gas Wells, The American Association for the Advancement of Science

2) IDLE AND ORPHAN OIL AND GAS WELLS: STATE AND PROVINCIAL REGULATORY STRATEGIES 2021, IOGCC, December 2021, <https://iogcc.ok.gov/idle-and-orphan-oil-and-gas-wells-2021>.

3) Wright, B., Hide and Seek: The Orphan Well Problem in America, Journal of Petroleum Technology, August 2021



Undocumented Orphaned Well Program Focus

Bipartisan Infrastructure Law Abandoned Well Scope

DOE/FECM (\$30M)

Well Finding

Identification

Characterization

“Conduct **R&D** in cooperation with IOGCC”

“assist the Federal land management agencies, States, and Indian Tribes in--

(A) identifying and characterizing

undocumented orphaned wells”

(B) mitigating the environmental risks of undocumented orphaned wells

Federal/States/Tribes (\$4.7B)

Well Plugging Programs

Inventorying

Ranking Prioritization

Plugging

Remediation

Reclamation

Well Sites

Pipelines

Human Health

Other (see BIL)

DOE Undocumented Orphaned Well Program Focus

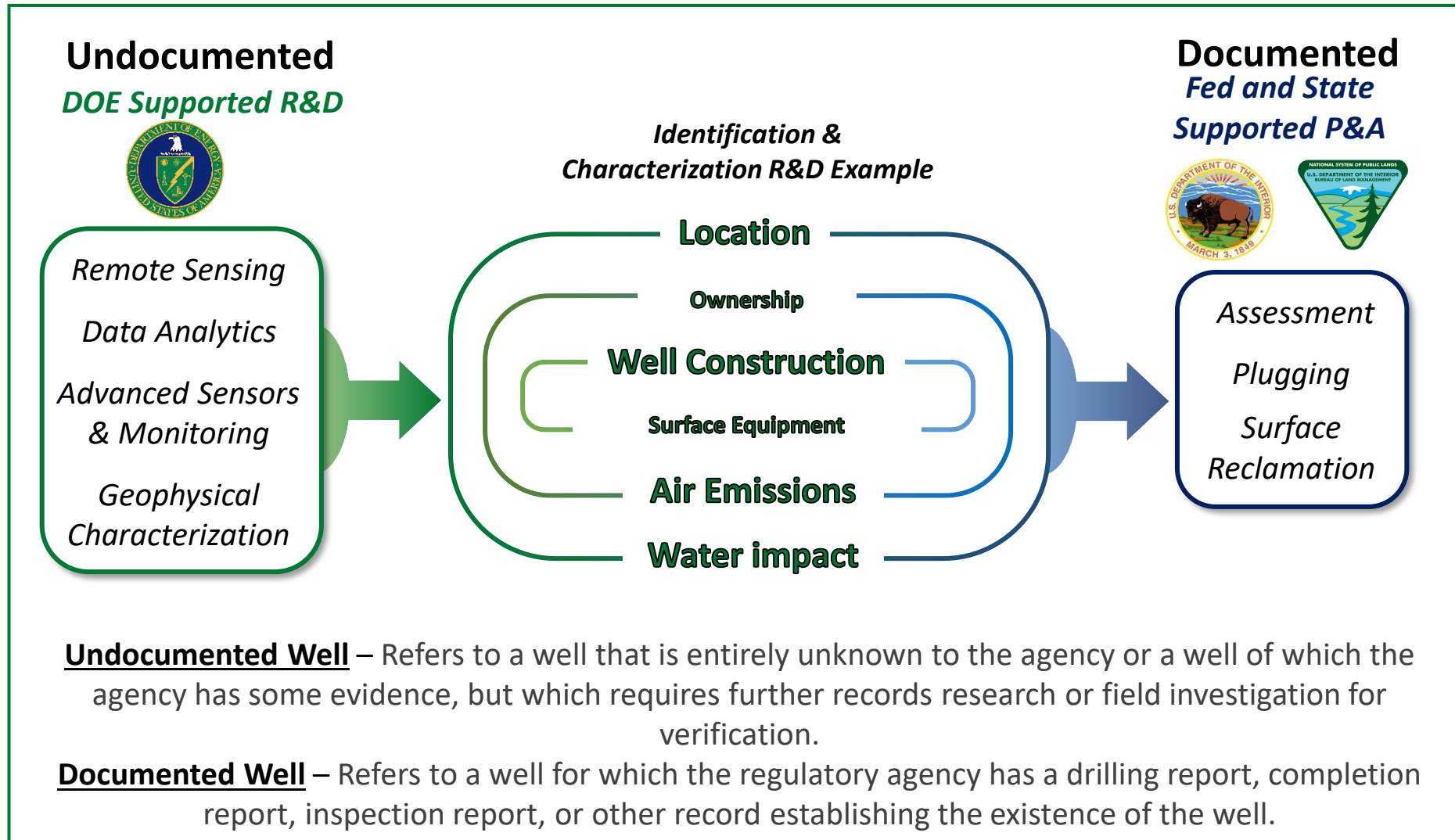

Key Partnerships and Stakeholders

National Laboratories

- Data Analytics/Machine Learning (critical to disparate datasets).
- Well characterization (subsurface and surface).
- Experience with detecting and characterizing undocumented wells.
- **NLs** will be critical in identifying existing and new technology pathways.

IOGCC (States)

- **IOGCC** will collaborate with individual State Agencies to gain critical insight into best practices and technology development needs.
- **IOGCC** will develop and maintain a list of critical points of contact within the **States** and assist in maintaining effective communications.

Department of the Interior

- Understanding the technology needs and estimation of undocumented orphaned wells.
- Collaborate with **IOGCC** to ensure effective communications and project engagement.
- Conduct critical identification and characterization of undocumented orphaned wells on Federal Lands.



U.S. DEPARTMENT OF
ENERGY

Fossil Energy and
Carbon Management

Next Steps for Program Development and Implementation

Develop and Refine Program Structure

- Leverage lead National Laboratory (Los Alamos) to establish team objectives and external engagements.
- Align core capabilities of National Laboratory team to develop preliminary program plan.

Implementation

- Engage state regulators to determine critical RDD&D needs.
- Complete evaluation of existing identification and characterization technologies.
- Establish framework for DOE-lead workshop.



Questions

Timothy Reinhardt

Director, Division of Emissions Mitigation Technologies
Office of Fossil Energy and Carbon Management | Office of
Resource Sustainability

timothy.reinhardt@hq.doe.gov

Jared Ciferno

Program Manager, Methane Mitigation Technologies
Office of Fossil Energy and Carbon Management | Office of
Resource Sustainability

jared.ciferno@hq.doe.gov



Documented Orphan Wells in the US

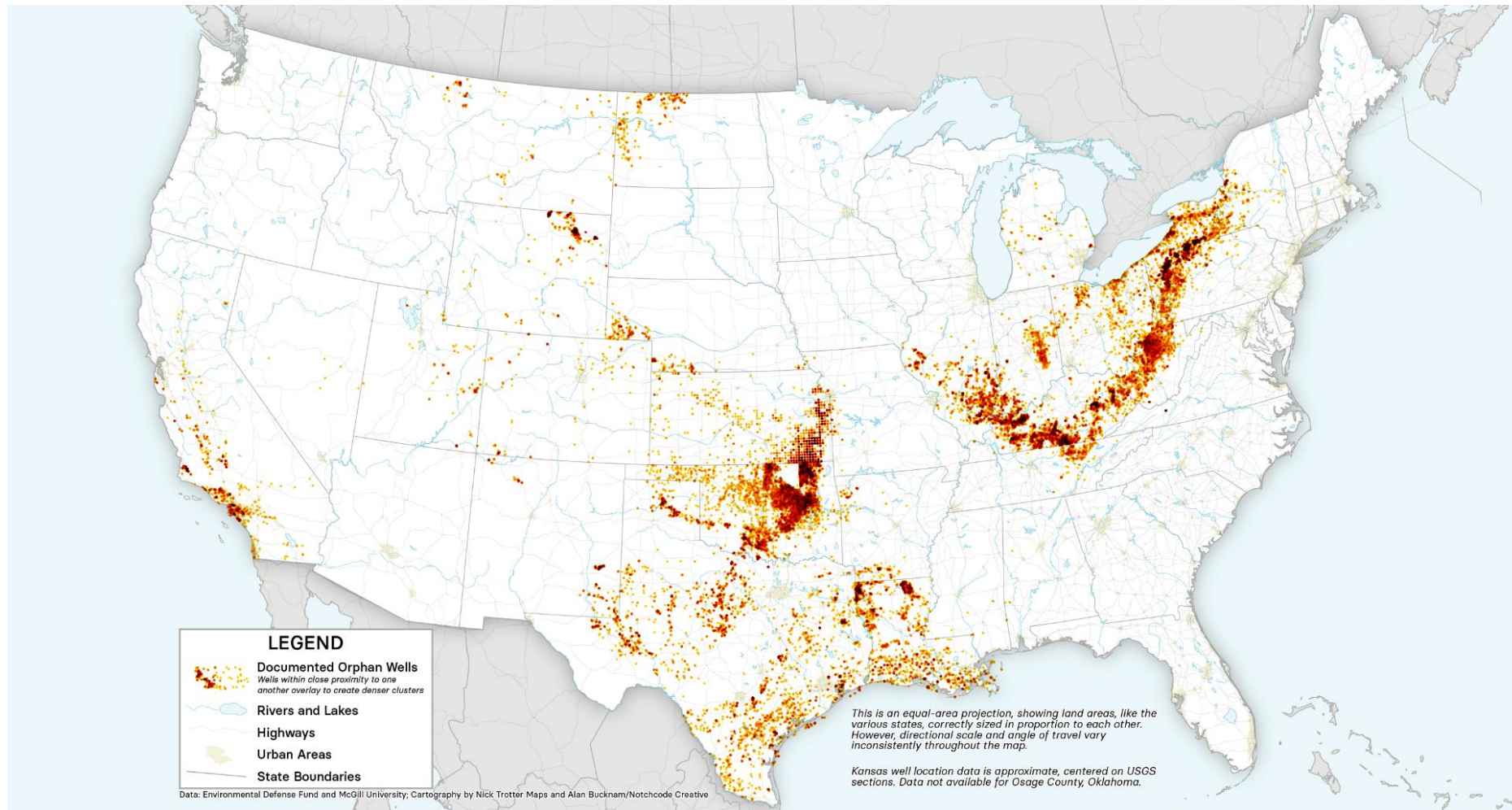

As of Fall 2021

Bipartisan Infrastructure Law:

Legacy Pollution Remediation & Reclamation Program

April 2022

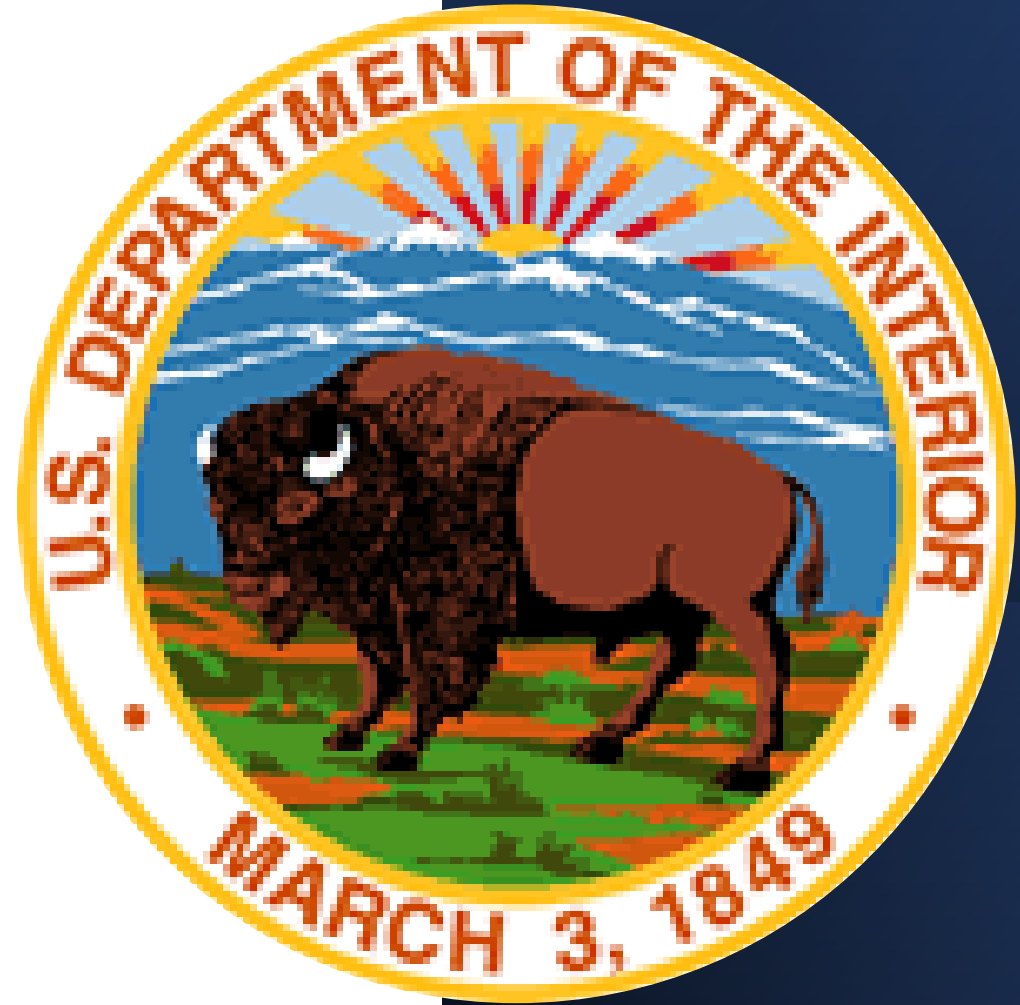

What is the Legacy Pollution Remediation & Reclamation Program?

The Bipartisan Infrastructure Law (IIJA) Includes:

- Orphaned Well Site Plugging, Remediation, & Restoration (40601)
 - \$4.677 billion total (OEPC & BLM)
- Abandoned **Coal** Mine Reclamation (40701)
 - \$11.3 billion (OSMRE)
- Abandoned **Hardrock** Mine Reclamation Section (40704)
 - Establishes a program to address physical safety & contamination at abandoned hardrock (non-coal) mines
 - Authorizes \$3.0 billion (50/50 Feds/States&Tribes)
 - **No appropriations provided in BIL**
 - FY22 budget provides start-up funding (OEPC)

What is the Orphaned Well Program?

Title VI – Methane Reduction Infrastructure, Section 40601

Orphaned Well Site Plugging, Remediation, & Restoration

- \$4.677 billion total
 - Expires 9/30/2030
1. State and Tribal Grant Program – OEPC Lead
 - \$4.3 billion for State and private lands [91.4%]
 - \$150 million for work on Tribal lands [3.2%]
 2. Federal Program – BLM Lead
 - BLM, NPS, FWS, BOEM, USFS
 - \$250 million

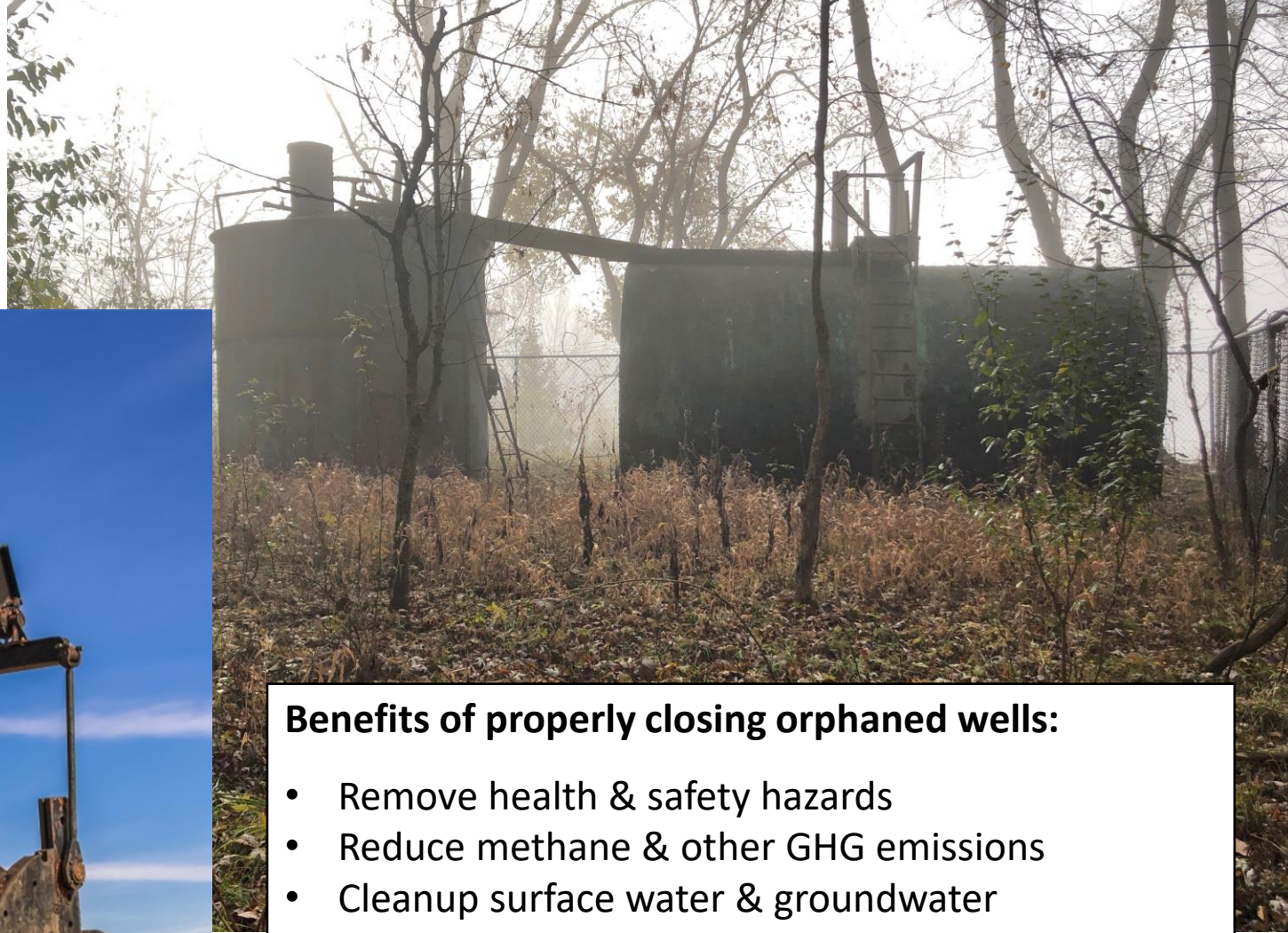

Benefits of properly closing orphaned wells:

- Remove health & safety hazards
- Reduce methane & other GHG emissions
- Cleanup surface water & groundwater contamination
- Restore habitat
- Create jobs, particularly in disproportionately impacted communities

Definitions – Orphaned Well

- with respect to **Federal land or Tribal land** = a well...
 1. that is not used for an authorized purpose, such as production, injection, or monitoring; and
 2. for which no operator can be located;
 3. the operator of which is unable—
 - a. to plug the well; and
 - b. to remediate and reclaim the well site; or
 - c. that is within the National Petroleum Reserve AK
- with respect to **State or private land** –
 1. has the meaning given the term by the applicable State; or
 2. if that State uses different terminology, has the meaning given another term used by the State to describe a well eligible for plugging, remediation, and reclamation by the State.

Definitions – Documented, Undocumented

- Terms not defined in BIL
- IOGCC definitions (emphasis added):

Documented - a well for which the regulatory agency has a drilling report, completion report, inspection report, or other record ***establishing the existence*** of the well.

Undocumented – a well that is entirely unknown to the agency or a well of which the agency has some evidence, but which ***requires further*** records research or field investigation for ***verification***.

Eligible Uses of Funds

1. **Plug, remediate, & reclaim** orphaned wells
2. **Identify and characterize** *undocumented* orphaned wells
3. **Rank** orphaned wells based on factors including, public health / safety, potential environmental harm, & other land use priorities
4. Make information available on a **public website**
5. **Measure and track** –
 - emissions of **methane** and other gases associated with orphaned wells
 - **contamination** of groundwater or surface water
6. Remediate soil & **restore native species habitat** that has been degraded due to the presence of orphaned wells & associated pipelines, facilities, infrastructure
7. Remediate land adjacent to orphaned wells and decommission or remove associated **pipelines, facilities, infrastructure**
8. Identify and address any **disproportionate burden** of adverse human health or environmental effects of orphaned wells on disadvantaged communities, including communities of color, low-income communities, and Tribal & indigenous communities

State Grants

- Initial Grant (\$775M)
 1. Large-scale – up to \$25M
 - May 13, 2022 application deadline
 2. Small-scale – up to \$5M (capacity)
- Formula Grant (\$2B)
 1. Job losses in O&G industry
 2. # documented orphaned wells
 3. Cost of plugging, reclamation, etc
 - December 31, 2021 - NOI deadline (26)
 - January 31, 2022 - eligibility published
- Performance Grants (\$1.5B)
 1. Matching Grants
 2. Regulatory Improvements Grants

Tribal Well Options

Direct Grant

- 5 years to obligate
- One of two approaches
 - Competitive Grant
 - Formula Grant

or

In Lieu of a Grant

- Tribe requests that DOI perform well closure on behalf of the Tribe

Federal Program

- Federal Land = USDOJ & USDA
 1. BLM
 2. NPS
 3. USFWS
 4. BOEM
 5. USFS
- Technical Working Group
 - Matrix, Methane, GW/SW, EJ subgroups
- Shall Prioritize (scoring matrix):
 1. Public health and safety
 2. Potential environmental harm
 3. Other subsurface impacts or land use priorities
 4. Disproportionate burden (~EJ)
- Slate of FY22 project awaiting funds

Annual Report to Congress

1. Updated inventory of wells located on Federal, Tribal, State & private lands that are—
 - a. orphaned wells (OW) *or*
 - b. at risk of becoming OW
2. Estimate of the quantities of—
 - a. methane & other gasses emitted from OW
 - b. emissions reduced as a result of plugging, remediating, and reclaiming OW
3. # jobs created, jobs saved through the plugging, remediation, & reclamation of OW
4. Acreage of habitat restored, with a description of the purposes for which that land is likely to be used

Contacts & Resources

- DOI Infrastructure Site

www.doi.gov/priorities/investing-americas-infrastructure

- State & Tribal Grants Program

Orphanedwells@ios.doi.gov

www.doi.gov/oepc/legacy-pollution-remediation-and-reclamation

- Federal Well Program

Orphanedwells@blm.gov

www.blm.gov/programs/energy-and-minerals/oil-and-gas/federal-orphaned-well-program



DOI Orphaned Well Data Collection and Integration

Alicia Lindauer
U.S. Geological Survey

UNDOCUMENTED ORPHANED WELLS WORKSHOP

APRIL 5, 2022

Challenges

- Information on orphaned wells is difficult to obtain
- Some information that DOI needs is not available, requires new science to develop, and will change over time
- Additional information required under the BIL requires synthesis and analysis of well-specific and Program-level information



Orphaned well in Kanawha County, West Virginia – October 2005 (West Virginia Surface Owners' Rights Association, 2018)

What are Orphaned Wells?

- Orphan well – an unplugged idle oil or gas well for which the operator is unknown or insolvent
 - Interstate Oil and Gas Compact Commission (IOGCC, 2021)
- Abandoned well – an oil or gas well with no recent production, often implies well was plugged
 - Environmental Protection Agency (2022)
- IOGCC estimates 310,000-800,000 **undocumented unplugged** orphan wells in 21 participating states in 2020

Term used	State
Shut In	AL*, NE*, NV*
Orphan	AK, AR, CA*, CO, IN, KY, LA, MI, MS*, NM, OK, TX, UT AR, PA, WY
Deserted, Potentially Deserted	CA*
Temporarily Abandoned	IL
Abandoned	AL*, KS, NE*, NV*, ND, PA, WV
Potential Orphan	MS*
Unknown, Unknown Not Located, Unknown Located	NY*
Orphan Ready, Orphan Pending	OH*
Forfeited	TN

*States that use multiple terms to refer to orphaned wells

Many potential sources for basic information

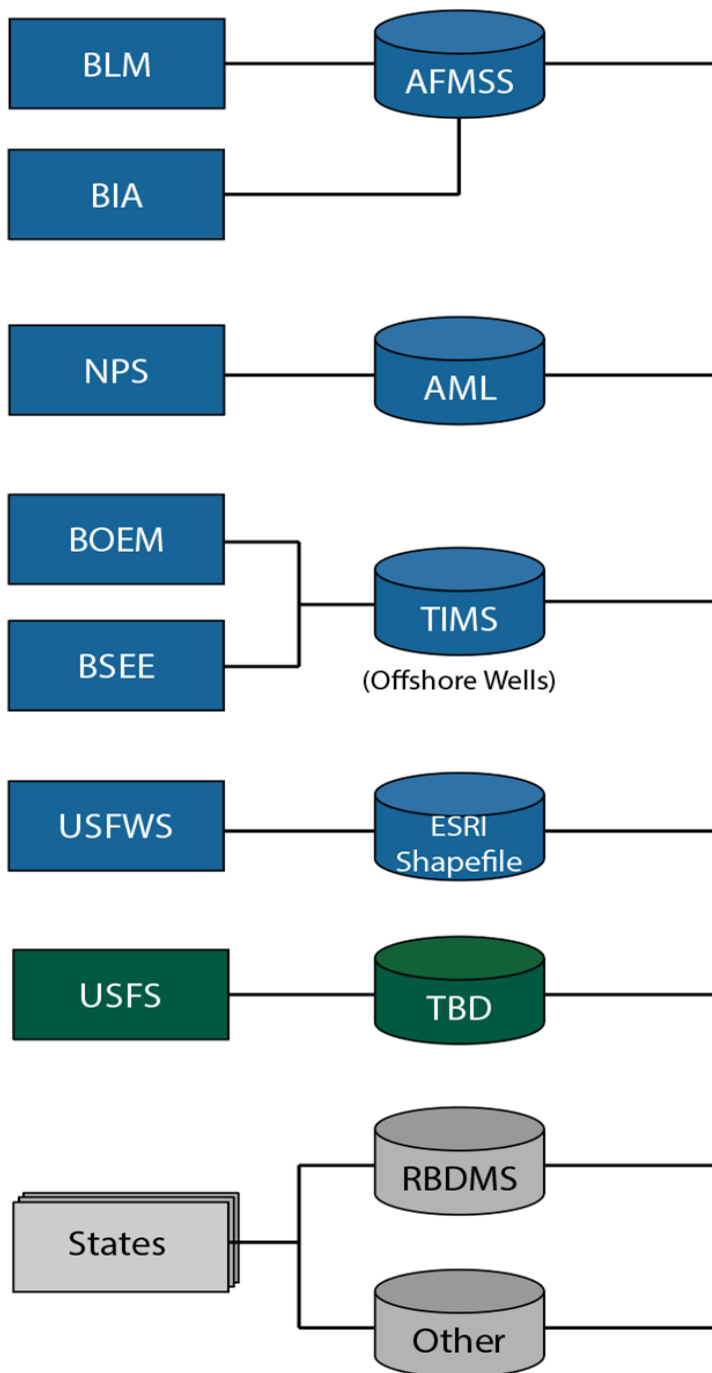

- USGS-led effort to gather stakeholder input identified many tools, but no single “best” tool
- Any effort to draw from these databases will need to:
 - Recognize different terminologies and definitions
 - Accommodate and interact with the unique data structures within each system
- A separate USGS-led effort to collect publicly available information on orphaned wells illustrates some of the challenges

AFMSS: Automated Fluid Management Support System
AML: Abandoned Minerals Lands
TIMS: Technical Information Management System
RBDMS: Risk Based Data Management Solutions

Illustration

- USGS compiled data from 27 States
- Only publicly available data compiled
- Targeted 10 parameters, included any well in the dataset that has at least an API# and well location
- A 14-month effort (to date)

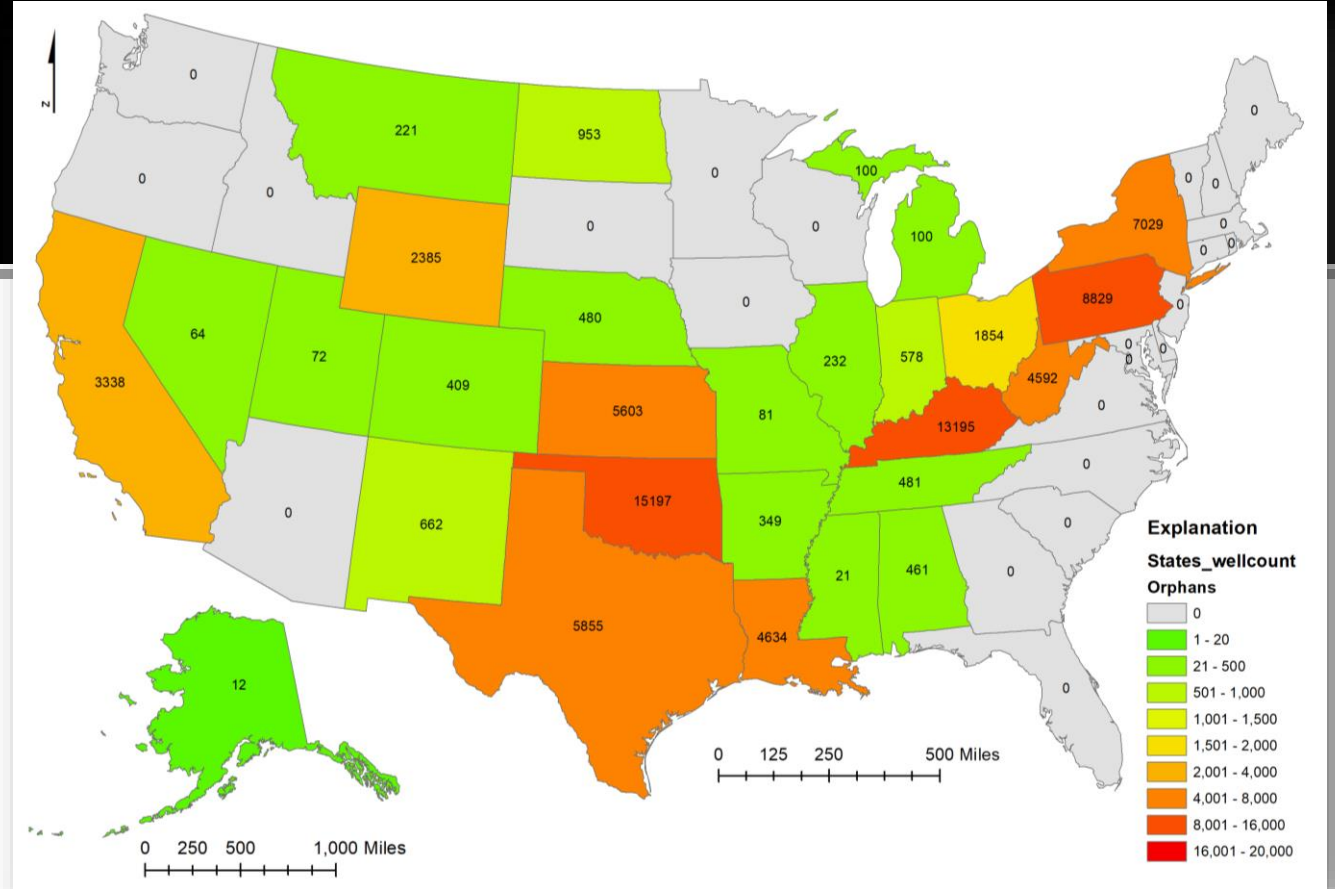

Map of States with wells included in the USGS database

- Currently in quality control phase. Not yet finalized.
- 79,072 documented unplugged orphan wells from 27 states
- 77,647 wells with location coordinates
 - Final numbers pending QC work
- Data received from States in 2019-2022

Comparison to existing data

Agency	States	Well count	Well location	Publicly available
U.S. Geological Survey [dataset under review]	27	79,072	77,647	Summer 2022
Environmental Defense Fund & McGill University	28	81,283	77,839	Not currently
Interstate Oil and Gas Compact Commission	32	92,198	0	No
Bipartisan Infrastructure Law: Notices of Intent to Apply to DOI for a formula Grant to Plug State and Orphan Wells	26	128,846	0	No



1.



2.



3.

1. Environmental Defense Fund/McGill University, 2021
2. IOGCC, 2021
3. U.S. Congress, 2021

Preliminary data structures for a DOI orphaned wells data system

Well-specific data fields potentially available from one or more existing systems	New data requirements (fields not currently or consistently available)	New synthesis data requirements (Program-level; not well-specific)
<p>API well identifier</p> <p>~14 parameters related to well type, status, location, and surface managing entity</p>	<p>Subsurface managing entities</p> <p>~18 parameters related to pre- and post-plugging impacts of the well, including methane emissions, habitat impacts, surface and ground water contamination, community impacts)</p> <p>Costs of plugging and remediation</p>	<p>Jobs created</p> <p>Jobs saved</p> <p>At-risk wells</p>

New information needs and related science



<https://www.nytimes.com/2019/12/13/reader-center/methane-infrared-camera.html>



Source: USGS Southwest Biological Science Center



Source: USGS Wyoming-Montana Water Science Center

- Methane emissions for orphaned wells (pre- and post-plugging)
- Newly funded USGS exploratory project “Identifying Fugitive Methane Emission Factors in Orphaned Oil & Gas Wells”

- Habitats affected / habitat restored
 - USGS/BLM partnership: “Surface Disturbance Analysis and Reclamation Tracking Tool (SDARTT)”
 - Active research on how to successfully and efficiently achieve reclamation success across different ecological sites

- Surface and ground water impacts
- Ongoing, multi-year study of brine contamination from development in the Plains and Prairie Potholes region

Identifying Fugitive Methane Emission Factors in Orphaned Oil and Gas Wells

- USGS is working to identify geologic and drilling factors that contribute to fugitive methane emissions.
 - Why do some orphaned wells emit methane while others do not?
 - What geologic and/or drilling conditions enable the highest methane emitters?
 - Can we establish a correlation between methane emissions and geologic factors, drilling history, or petroleum production?

Bringing subsurface expertise to the challenge of estimating emissions

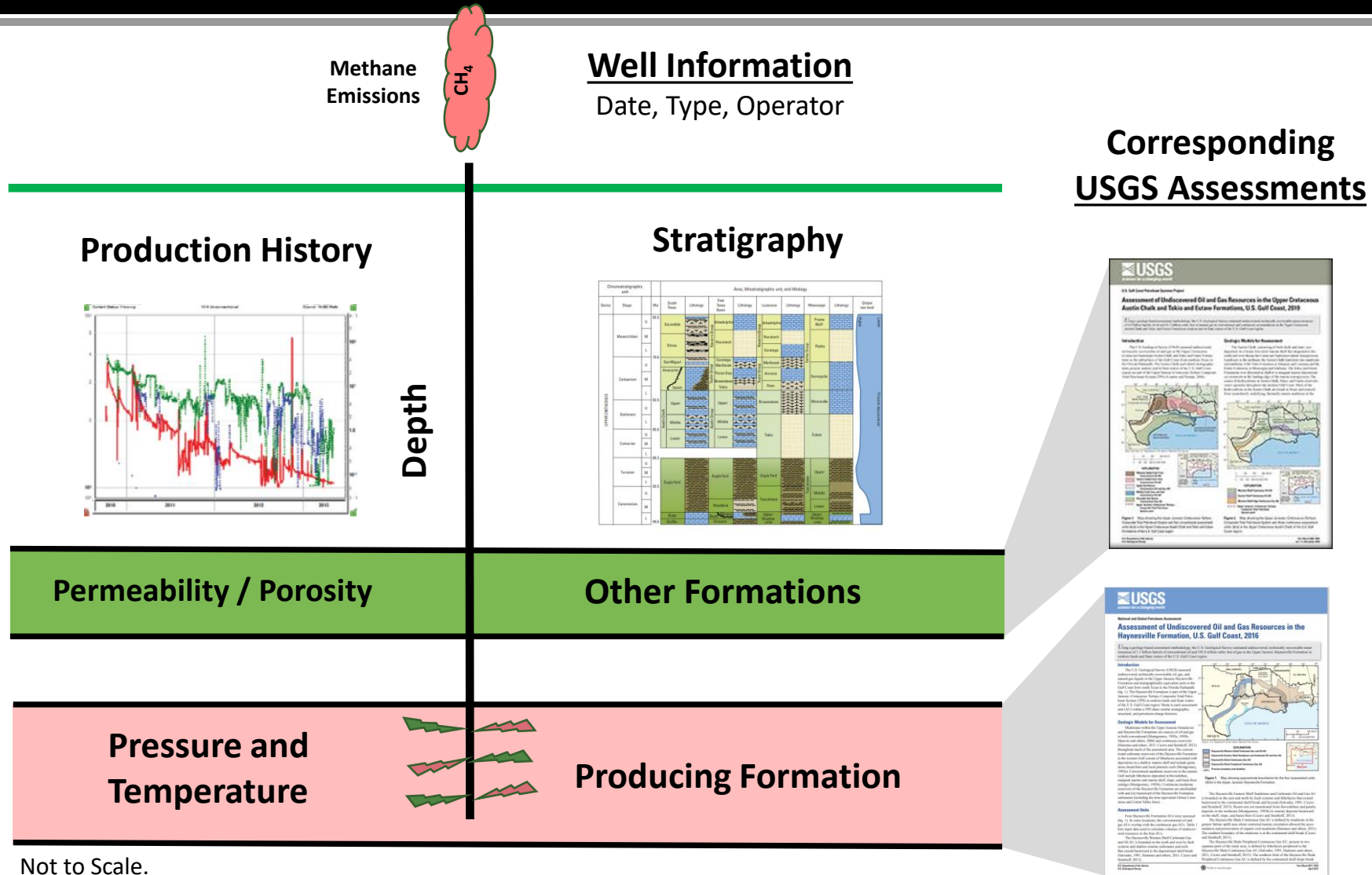

Not to Scale.

Benefits of this work

- Refining fugitive methane emission factors would provide the multi-agency Orphaned Well Program a geologic context for the prioritization of orphaned wells on state, tribal, and federal lands
- States receiving grant money would benefit from a deeper understanding of emissions factors to help identify the highest emitting wells
- Improved understanding of fugitive methane sources can inform policy on methane emissions and implementation of greenhouse gas management

Connections between DOE and DOI

- DOE focus is on undocumented wells; DOI focus is on “known” orphaned wells
- Once undocumented wells are located, they become “known” and may become candidates for DOI support for plugging, remediating and restoring orphaned wells
- It would be very useful to DOI if DOE data collection on undocumented wells included the same data parameters needed for the DOI data system

Connections between DOE and DOI (2)

- Results from DOI tools (existing and under development) for quantifying impacts from “known” orphaned wells could provide useful information for detection approaches that DOE may develop
- For example
 - Estimates of methane emissions from abandoned wells could be used with broad-scale methane detection to identify sources likely to be wells
 - Understanding the scale and type of habitat disturbance around abandoned wells could feed pattern recognition tools for finding undocumented wells based on land imaging
 - Data on the type and the spatial extent of water contamination associated with known wells could inform the use of existing or newly sampled water quality data to identify undocumented sites

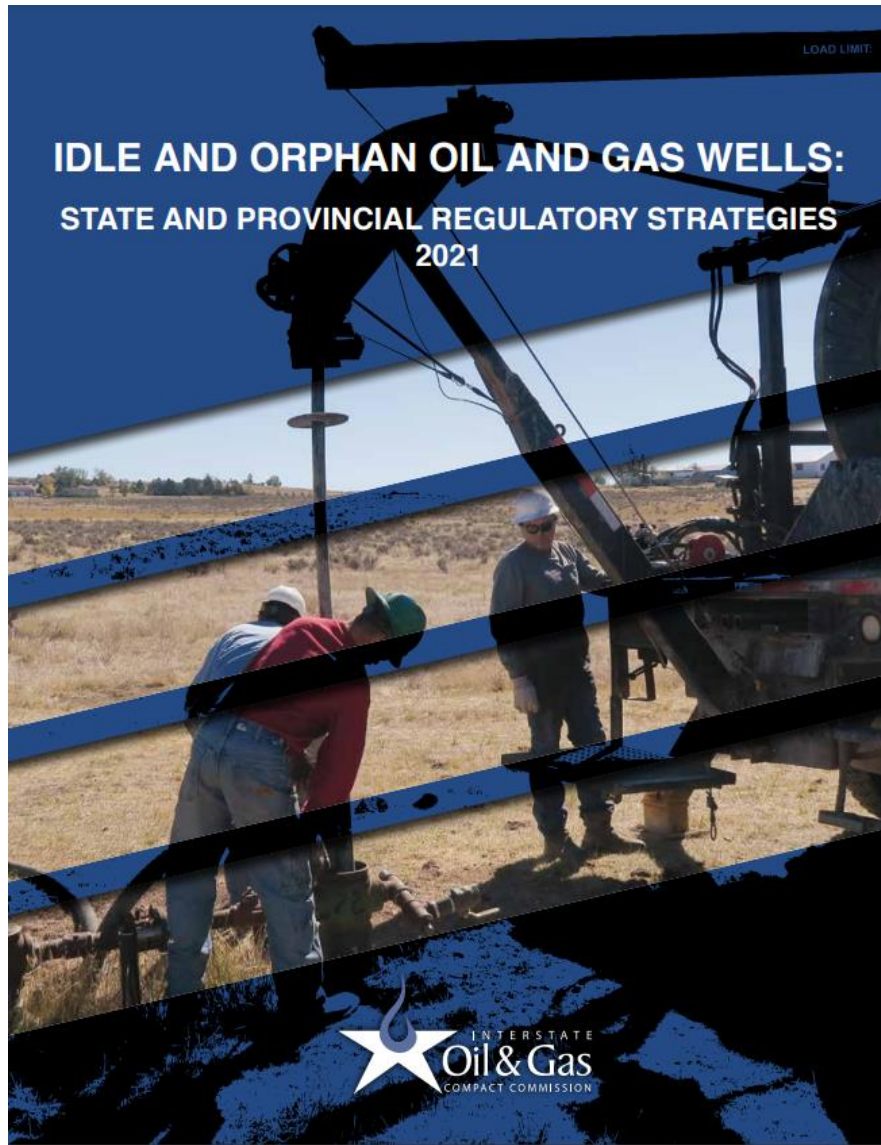

<https://iogcc.ok.gov/idle-and-orphan-oil-and-gas-wells-2021>

Figure 6. Estimated Undocumented Orphan Wells in States (2020)

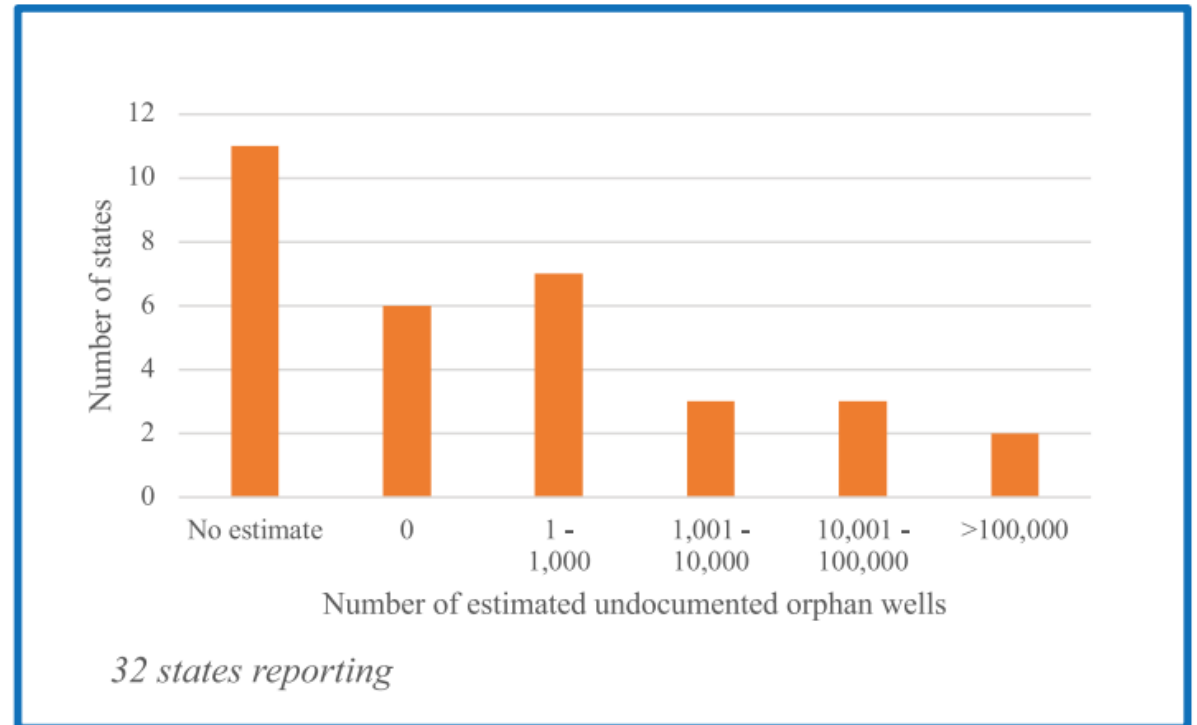



Undocumented Orphaned Wells Workshop

Natalie Pekney, NETL
and the National Laboratories
Consortium

Technical Session #1
Defining the Need for
Undocumented Orphaned Well
RDD&D



Undocumented Orphaned Wells

U.S. Oil and Gas Drilling Started in 1859 – Poor Recordkeeping for Decades

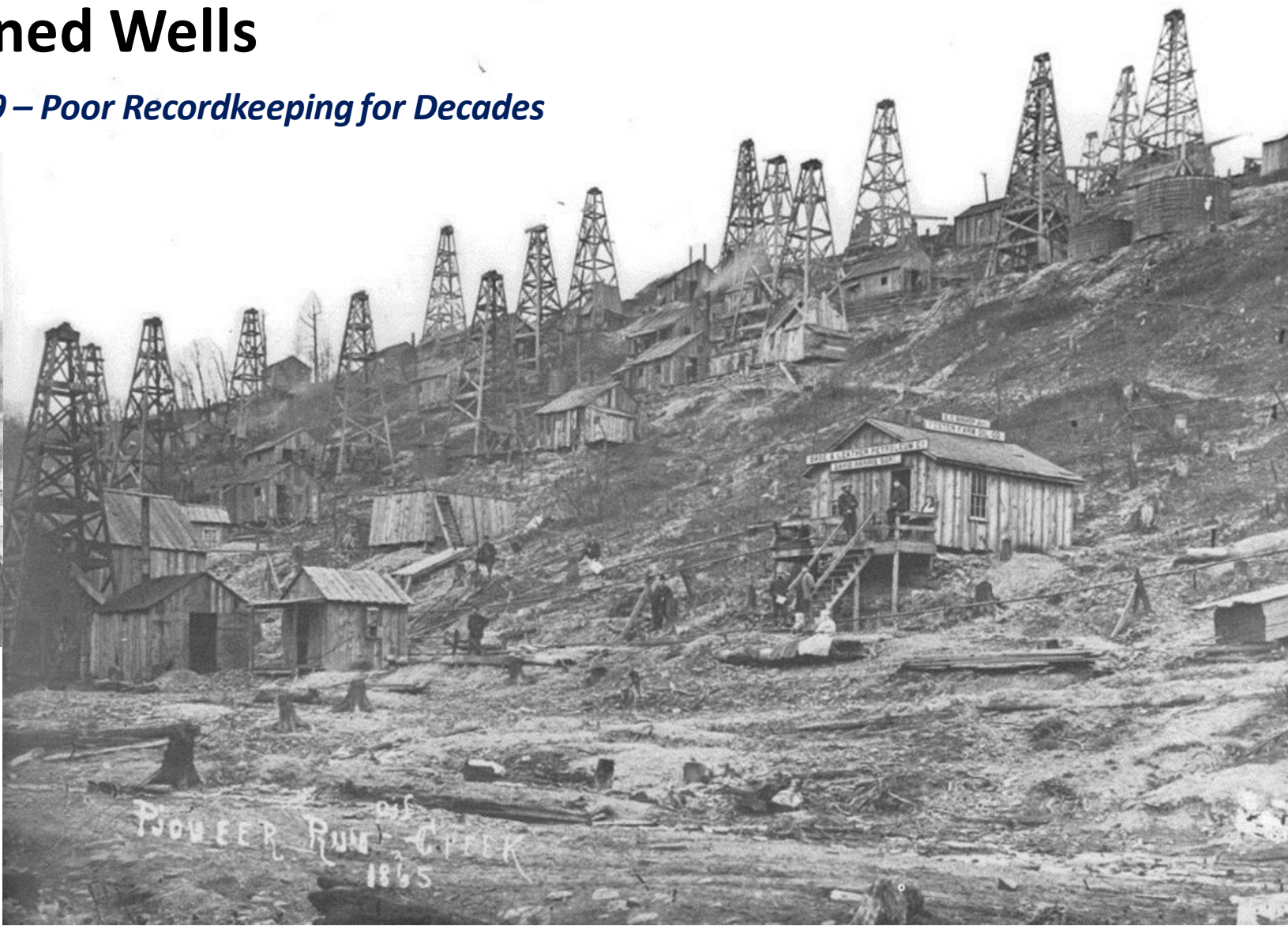

Photos Courtesy of the Drake Well Museum and Park Collection

How Many Orphaned Wells are there in the U.S.?

Orphaned Wells Activity Level: Documented vs. Undocumented Wells

Number of Documented Orphaned Wells by State
Total: 131,227

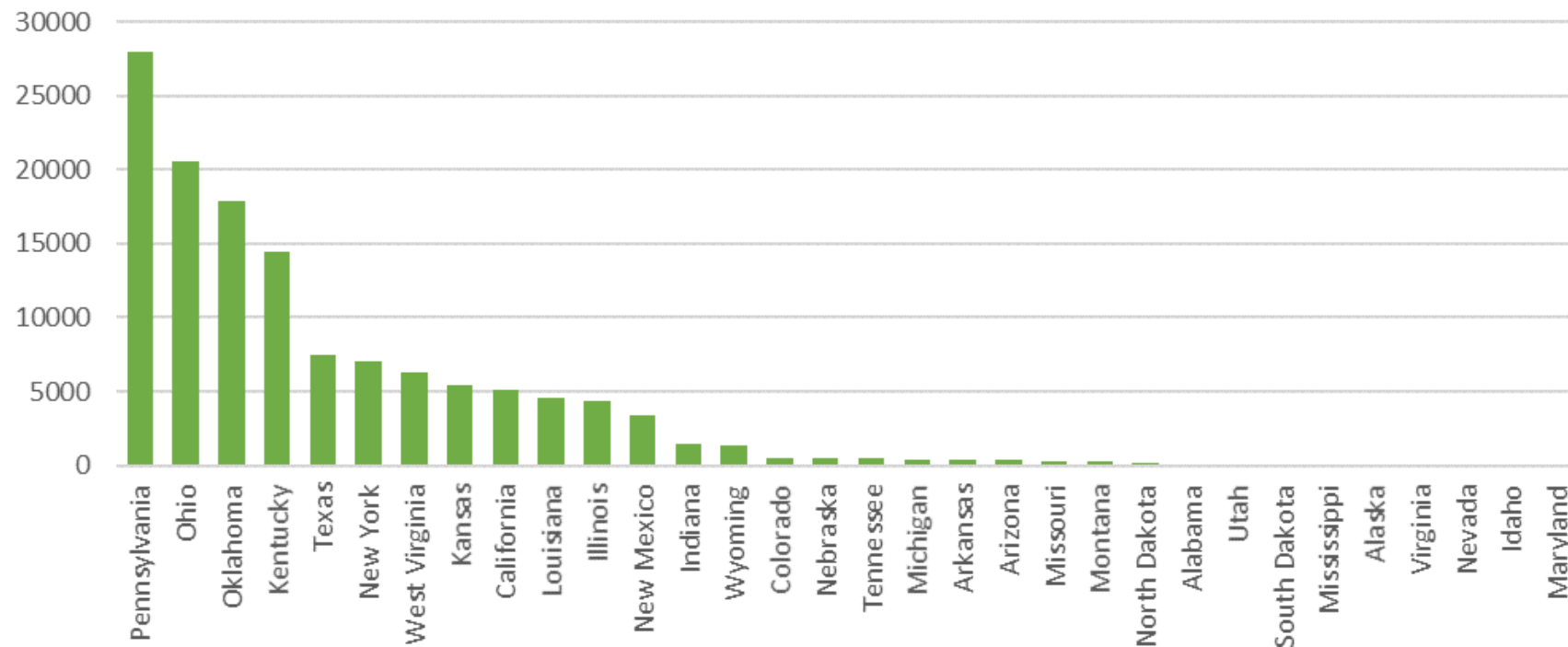

IDLE AND ORPHAN OIL AND GAS WELLS: STATE AND PROVINCIAL REGULATORY STRATEGIES 2021, IOGCC, December 2021, <https://iogcc.ok.gov/idle-and-orphan-oil-and-gas-wells-2021>.

How Many Orphaned Wells are there in the U.S.?

Orphaned Wells Activity Level: Documented vs. Undocumented Wells

- IOGCC Estimates of Undocumented Orphaned Wells: **Between 310,000 and 800,000** as reported by the states¹
- EPA: The GHGI uses Enverus (DrillingInfo, www.enverus.com) for wells with added estimate of number of wells not included in Enverus dataset²
 - The U.S. population of abandoned wells is around 3.5 million (with around 2.9 million abandoned oil wells and 0.6 million abandoned gas wells).
 - Comparing the counts (i.e. 1.93 million abandoned wells from analysis of historical records and USGS data, and 776,000 abandoned wells in the DrillingInfo database), EPA estimates that **1.15 million** abandoned wells in the U.S. are not captured in the DrillingInfo-based methodology.

¹IDLE AND ORPHAN OIL AND GAS WELLS: STATE AND PROVINCIAL REGULATORY STRATEGIES 2021, IOGCC, December 2021, <https://iogcc.ok.gov/idle-and-orphan-oil-and-gas-wells-2021>.

²EPA. 2022. Draft Inventory of U.S. Greenhouse Gas Emissions and Sinks: 1990-2020. U.S. Environmental Protection Agency, EPA 430-P-22-001.

<https://www.epa.gov/ghgemissions/draft-inventory-us-greenhouse-gas-emissions-and10sinks-1990-2020>.

Estimating GHG Footprint of Orphaned Wells

EPA's Inclusion of Abandoned Oil and Gas Wells into the Greenhouse Gas Inventory

Methane Emissions from Energy (2020)

Total Methane: 269.0 MMT CO₂ Eq

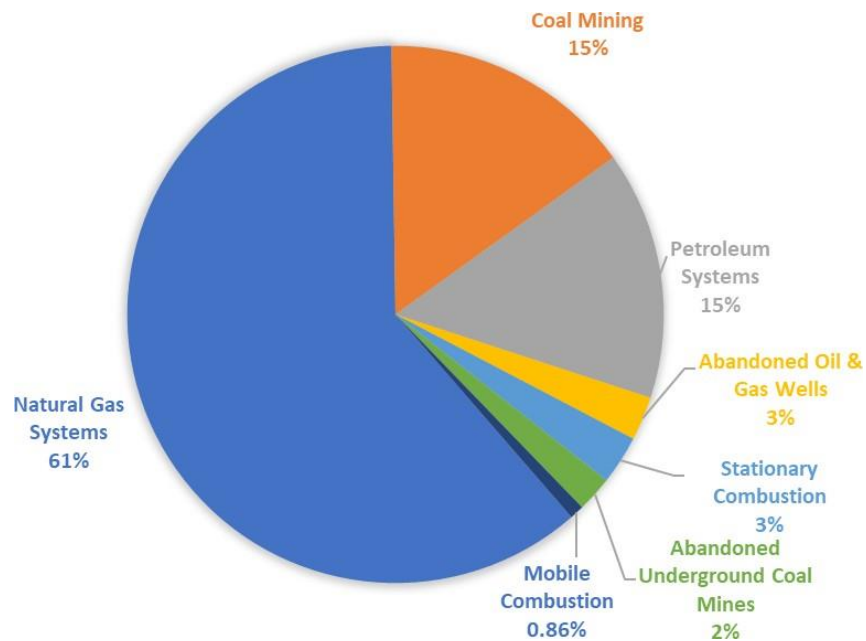

The US EPA began including abandoned wells as a GHG Emissions source in 2018 (2016 GHGI)

From the Inventory:

The term "abandoned wells" encompasses various types of wells:

- Wells with no recent production, and not plugged. Common terms (such as those used in state databases) might include: inactive, temporarily abandoned, shut-in, dormant, and idle.
- Wells with no recent production and no responsible operator. Common terms might include: orphaned, deserted, long-term idle, and abandoned.
- Wells that have been plugged to prevent migration of gas or fluids.

The GHGI estimates methane emissions from abandoned wells by multiplying **emission factors** (mass of methane emitted per well) by **activity levels** (number of wells)

Significant uncertainty in both Emission Factors and Activity Levels

EPA. 2022. Draft Inventory of U.S. Greenhouse Gas Emissions and Sinks: 1990-2020. U.S. Environmental Protection Agency, EPA 430-P-22-001. <https://www.epa.gov/ghgemissions/draft-inventory-us-greenhouse-gas-emissions-and10-sinks-1990-2020>.

Estimating GHG Footprint of Orphaned Wells

Abandoned Well Methane Emission Factors: Sample Size and Distribution Across the US

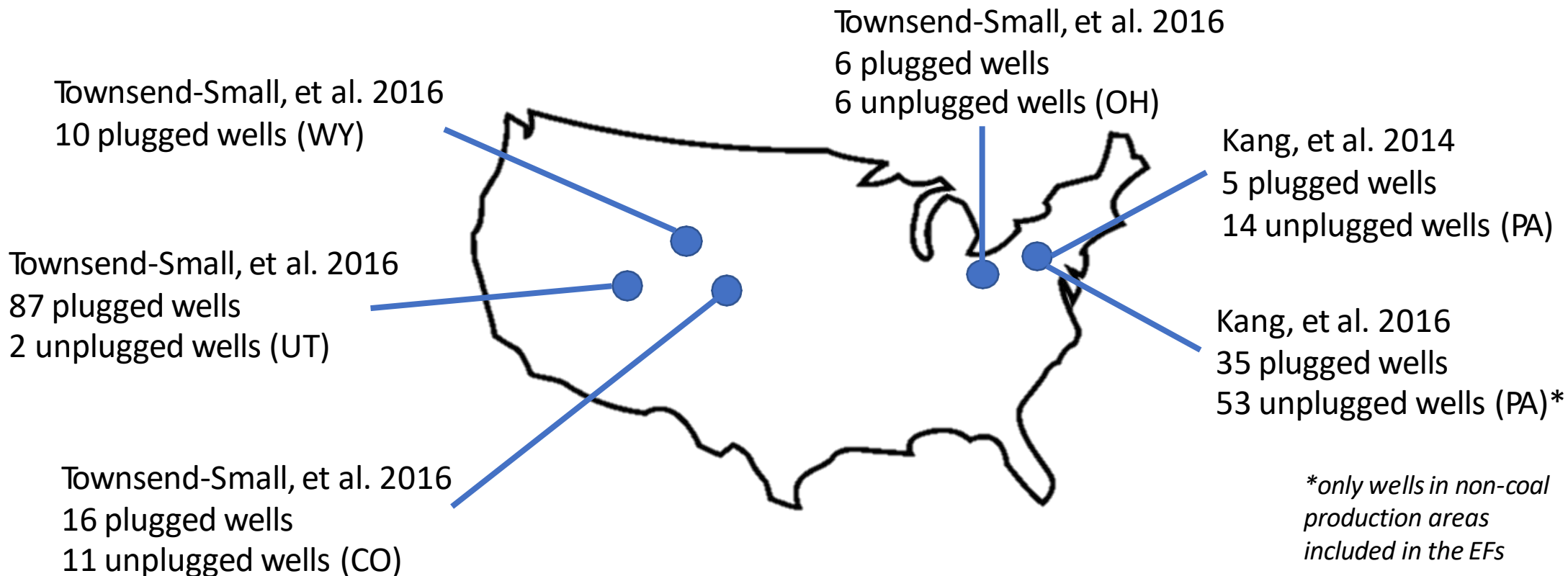

Kang M, et al. (2014) Direct measurements of methane emissions from abandoned oil and gas wells in Pennsylvania. *Proc Natl Acad Sci USA* 111(51):18173-18177.

Kang M, et al. (2016) Identification and characterization of high methane-emitting abandoned oil and gas wells. *Proc Natl Acad Sci USA* 113 (48) 13636-13641.

Townsend-Small et al. (2016) Emissions of coalbed and natural gas methane from abandoned oil and gas wells in the United States. *Geophys Res Lett*

<https://doi.org/10.1002/2015GL067623>.

Estimating GHG Footprint of Orphaned Wells

Abandoned Well Methane Emission Factors: Plugged vs. Unplugged



Table 2. Methane EFs from Townsend-Small et al. Study

Well Category	Number of Measured Wells	Mean (g/h/well)	95% Upper Confidence Limit (g/h/well)
All wells (entire U.S.)	138	1.38	3.17
All wells (eastern U.S.)	12	14.00	32.87
All wells (western U.S.)	126	0.18	0.41
Plugged wells (entire U.S.)	119	0.002	0.005
Unplugged wells (entire U.S.)	19	10.02	22.47
Plugged (eastern U.S.)	6	0	NA
Unplugged (eastern U.S.)	6	28.01	64.00
Plugged (western U.S.)	113	0.002	0.005
Unplugged (western U.S.)	13	1.71	3.83

Bold indicates value used in the 2018 GHGI.

Table 3. Appalachian Basin Methane EFs Developed from Combining Studies

Data Source	Number of Measured Wells	Mean (g/h/well)
Plugged wells		
Kang et al. 2016 – All production types, noncoal areas	23	0.45
Townsend-Small et al. 2016 – Eastern U.S.	6	0
Combined	29	0.36
Unplugged wells		
Kang et al. 2016 – All production types, noncoal areas	36	31
Townsend-Small et al. 2016 – Eastern U.S.	6	28.01
Combined	42	30.57

Bold indicates value used in the 2018 GHGI.

Average methane emission rate for unplugged, abandoned wells in the U.S. is 5,000 times more than for plugged wells

EPA. 2022. Draft Inventory of U.S. Greenhouse Gas Emissions and Sinks: 1990-2020. U.S. Environmental Protection Agency, EPA 430-P-22-001. <https://www.epa.gov/ghgemissions/draft-inventory-us-greenhouse-gas-emissions-and10sinks-1990-2020>.

Estimating GHG Footprint of Orphaned Wells

Abandoned Well Methane Emission Factors: Fat-tailed Distribution Characterized by “Super Emitters”

UNPLUGGED WELLS

Hillman State Park, PA

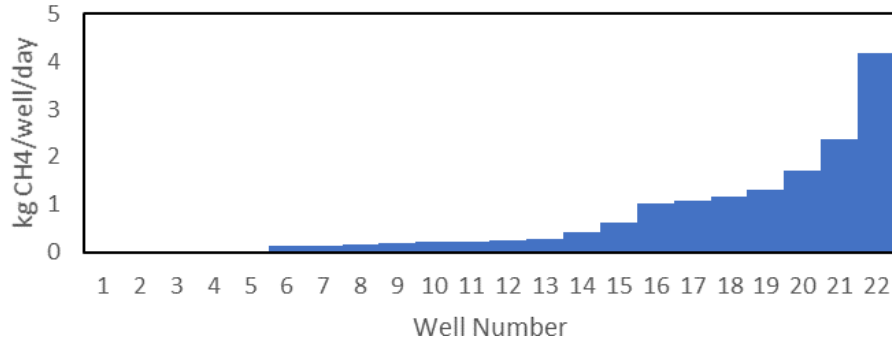

Daniel Boone National Forest, KY

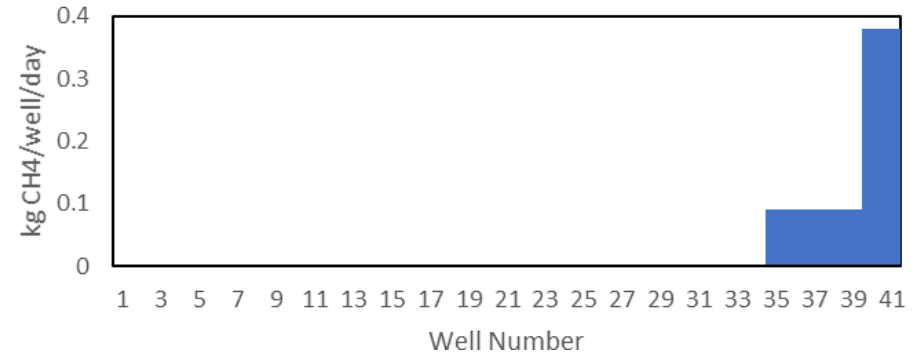

Oil Creek State Park, PA

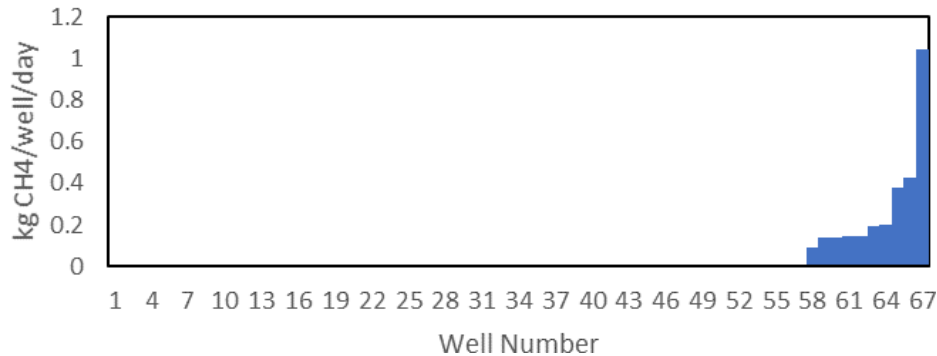

Oologah Lake area, OK

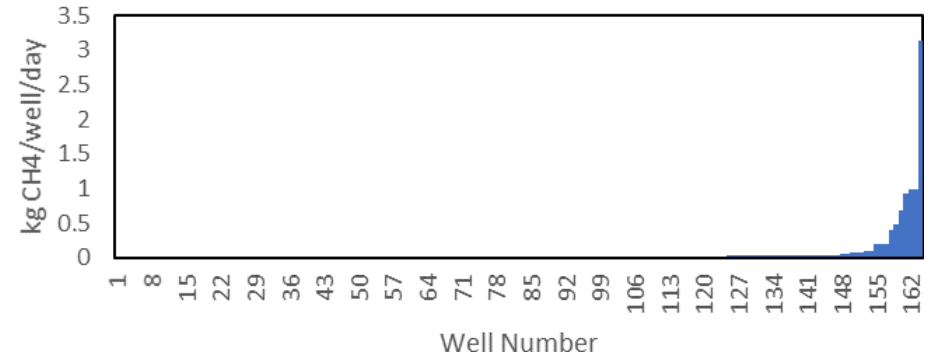

Estimating GHG Footprint of Orphaned Wells

Abandoned Well Methane Emission Factors: Fat-tailed Distribution Characterized by “Super Emitters”

PLUGGED WELLS

Hillman State Park, PA: No plugged wells

Daniel Boone National Forest, KY: No plugged wells

Oil Creek State Park, PA

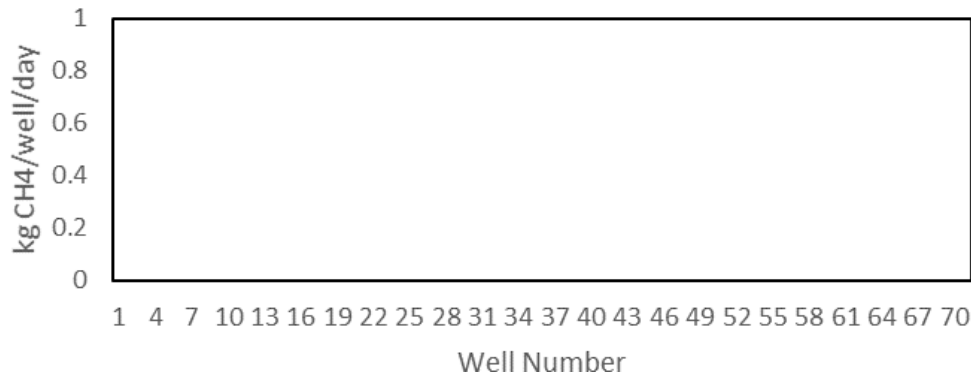

Oologah Lake Area, OK

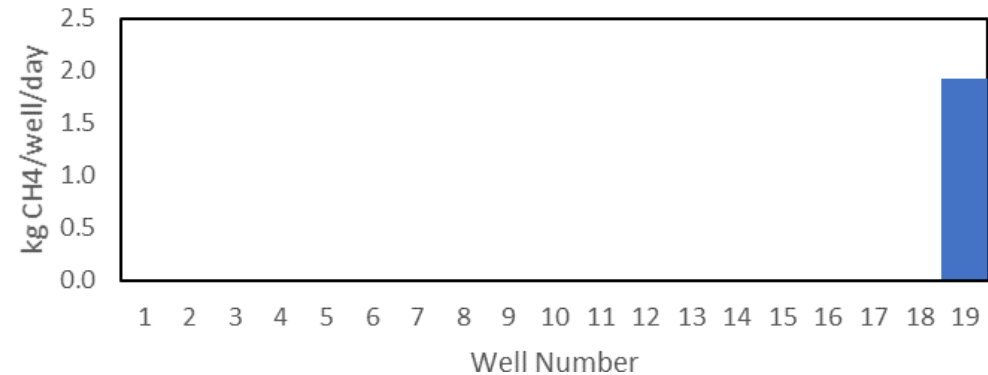

Major Challenge: Finding Undocumented Orphaned Wells

Aerial Magnetic Surveying Approaches for Finding Undocumented Wells

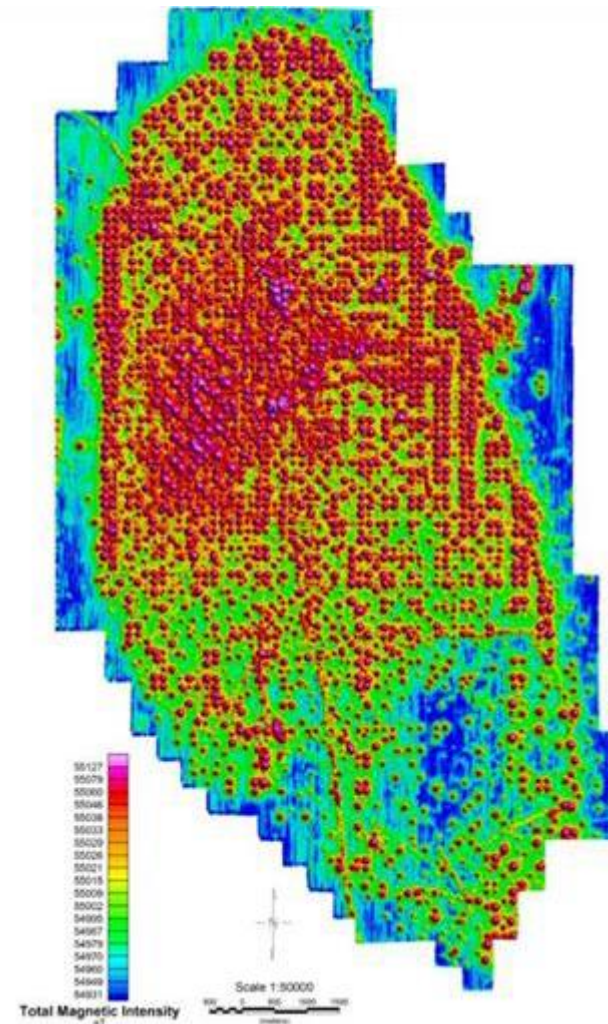
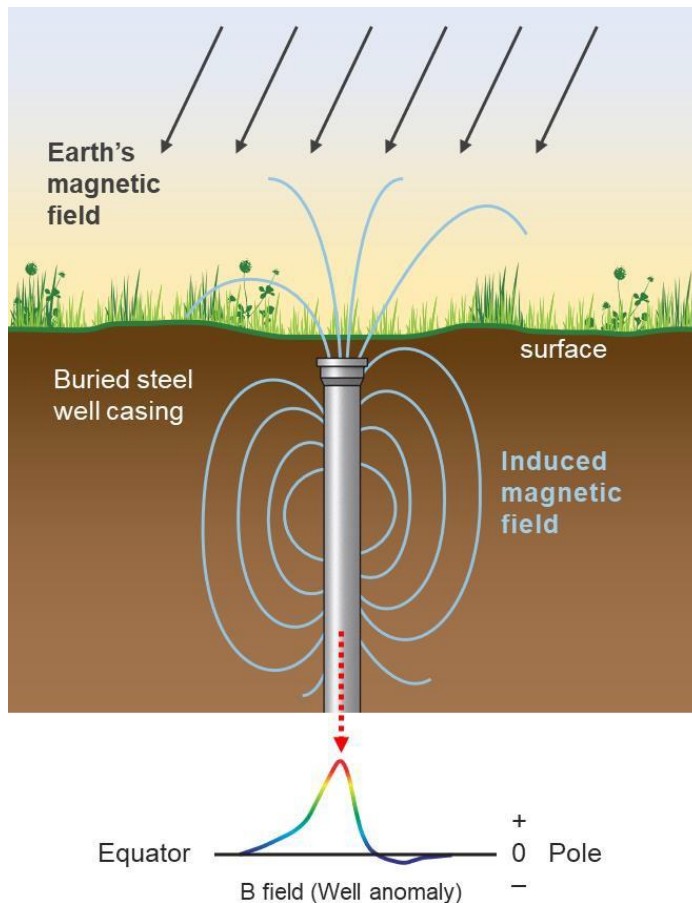

Major Challenge: Finding Undocumented Orphaned Wells

Aerial LiDAR Surveying Approaches for Finding Undocumented Wells

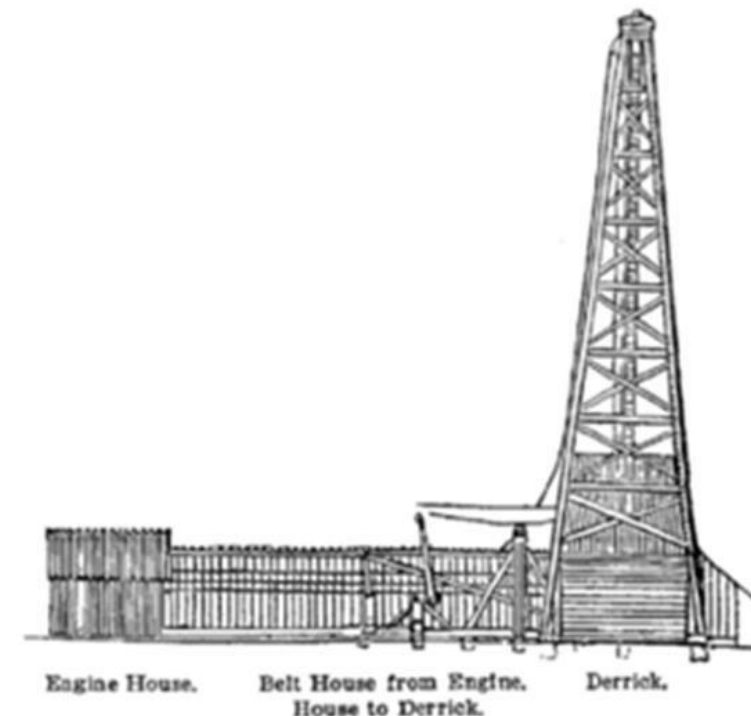
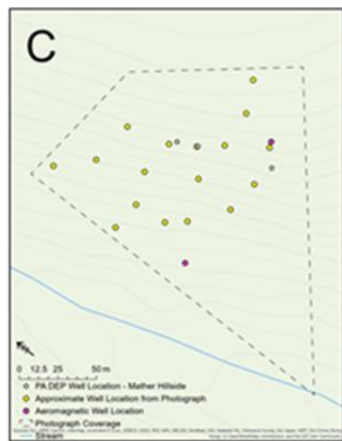
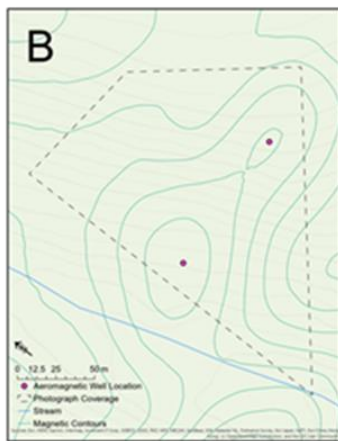
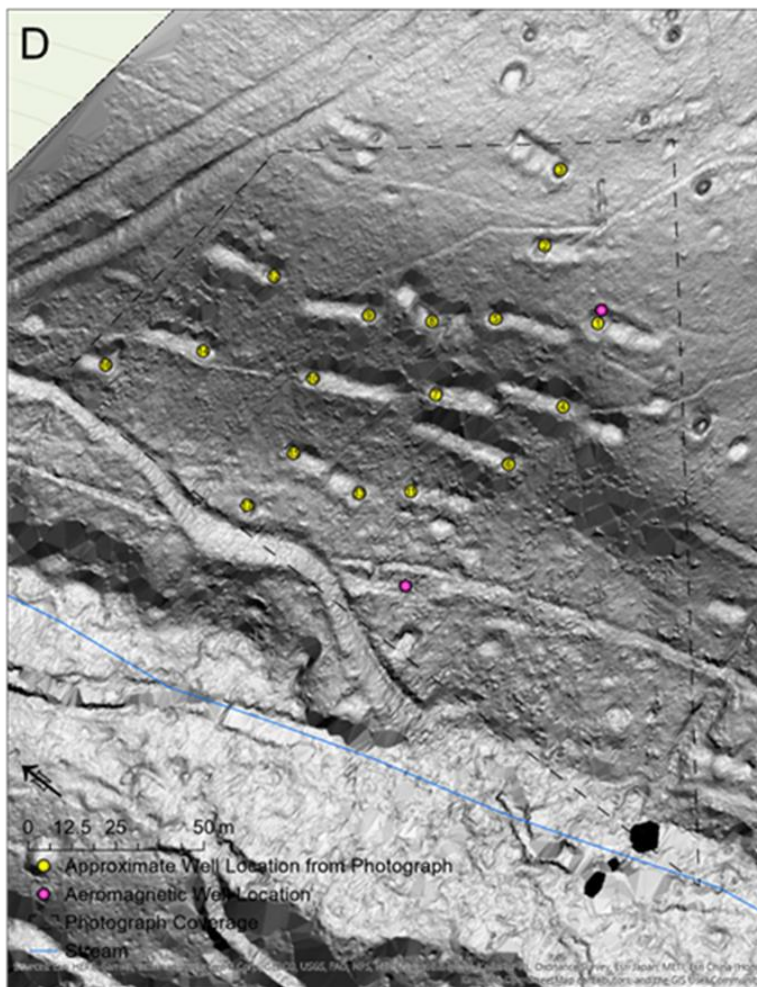
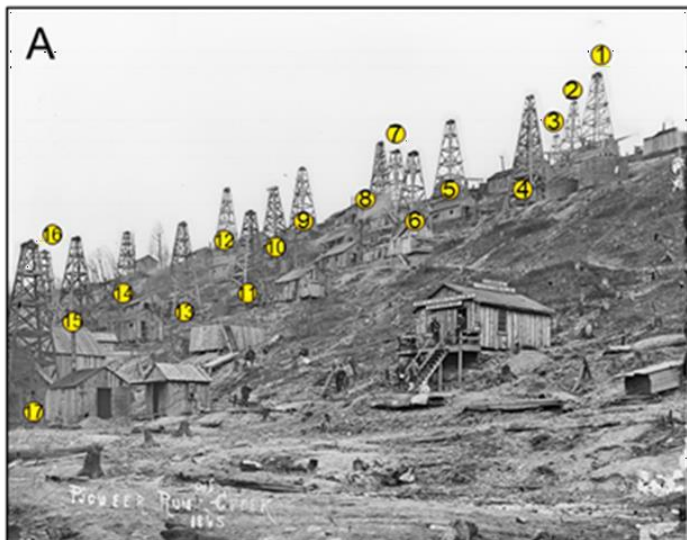

Orphaned Well Potential Hazards

Improved Well Characterization Aids in Strategizing Mitigation Approach

- Proximal
 - Human Receptors
 - Stray gas/oil/brine in or near buildings
 - Gas/oil/brine in water supply
 - Near groundwater supply
 - Agricultural – on land used for crops or pasture
 - Ecological Receptors
 - Distance to (or in) streams, water bodies, swamps, wetlands
 - Near Endangered/threatened/protected species (plants and animals)



Orphaned Well Potential Hazards

Proximal, Biological

- Leaks
 - Methane
 - H₂S
 - NORM
- Well Integrity
 - Wellhead pressure, leaks outside surface casing
- Physical Hazards
 - Open pits, instability
- Coal/Mining Issues
 - Wells within underground mine

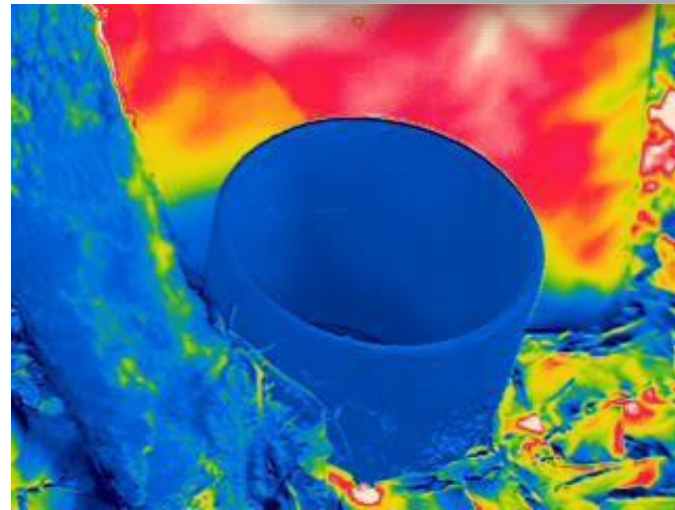

Detection and Measurement of Methane Emissions from Orphaned Wells

Variety of Well Configurations Makes Measurement a Challenge: One Approach Does Not Work at All Wells



*Chosen Approach Depends on Need:
Qualitative vs. Quantitative*

Evaluation Criteria

- Cost
- Time
- Accuracy/Limit of Detection
- Ease of use/Field portability
- Skill level/training required
- Effectiveness for any/many well types

Detection and Measurement of Methane Emissions from Orphaned Wells

Published Emission Rates Based on High Flow Sampling or Flux Chamber Approaches

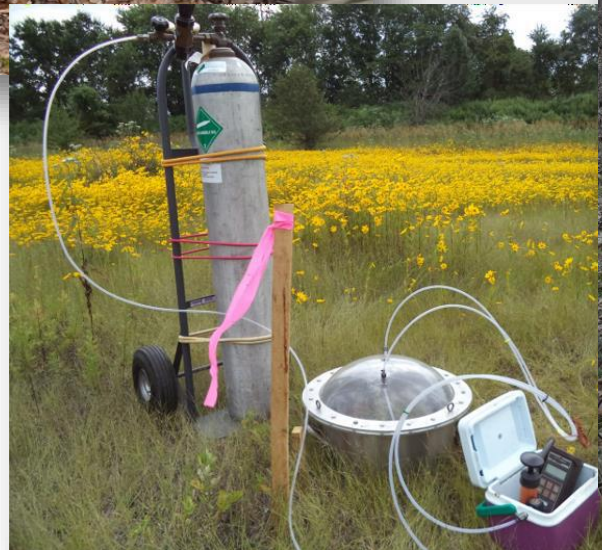

Chamber: $\text{Flux} = \text{Flow Rate} * (C_{\text{out}} - C_{\text{in}}) / \text{Area}$
Bag: $\text{Emission Rate} = \text{Flow Rate} * (C_{\text{out}} - C_{\text{in}})$



Available Resources for Mitigation

State Agencies' Well Plugging Programs

- Median cost of plugging and reclaiming a well is \$76,000, although that figure can vary widely depending on the age, location, well depth, and other key factors.¹
- Using estimates from a 2021 Government Accountability Office report, the cost of plugging all 130,000 *documented* orphaned wells could range from \$2.6 billion to nearly \$19 billion.
- *Undocumented* wells: IOGCC estimates 310,000 – 800,000; EPA estimates 1.15 million
- Infrastructure Investment and Jobs Act Funds to supplement states' existing well plugging programs: \$4.7 Billion to plug and reclaim orphaned and abandoned wells
- Non-profit organizations working to locate, document, and plug orphaned wells

¹Raimi, D.; Krupnick, A.; Shah, J; Thompson, A. (2021) Decommissioning Orphaned and Abandoned Oil and Gas Wells: New Estimates and Cost Drivers. Environ. Sci. & Tech 55(15), 10224-10230. DOI: 10.1021/acs.est.1c02234



Prioritizing Well Plugging

Optimizing Reductions in Hazards with Available Resources

- Rapid regional assessments to locate and characterize undocumented wells (and improve documented well data)
- Strategies for targeting high-priority wells for plugging
- Tools/technologies for continued future assessments and monitoring

Research Technology Areas

DOE Multi-Lab Research Effort Focused on Developing New Tools, Technologies and Processes for Robust, Efficient Identification and Characterization of Undocumented Orphaned Wells

- Methane Detection and Quantification
- Magnetics and Electromagnetics
- Sensor Fusion and Data with Machine Learning
- Characterization
- Integration and Real-Time Best Practices



Sandia
National
Laboratories

BREAK

We will resume the
workshop at 2:15 PM ET



Undocumented Orphaned Wells Workshop

Technical Session #2 Undocumented Well Finding Technologies

Brian Wihl (Lawrence Livermore National Lab)
and the National Laboratories consortium

LLNL-PRES-833488

This work was performed under the auspices of the U.S. Department of Energy by Lawrence Livermore National Laboratory under contract DE-AC52-07NA27344. Lawrence Livermore National Security, LLC



Sandia
National
Laboratories

Outline

- Motivation
- Challenges
- Current state-of-the-art sensing technologies
- Sensor suitability
- Success metric

Well Identification - Motivation

- Orphaned wells can provide pathways for subsurface fluid migration, leading to groundwater contamination and methane emissions to the atmosphere.
- It is important to identify the characteristics of orphaned wells that lead to high methane emissions for prioritized mitigation (plugging).
- Before wells can be characterized to a high degree, they must be found and identified to queue other technologies.

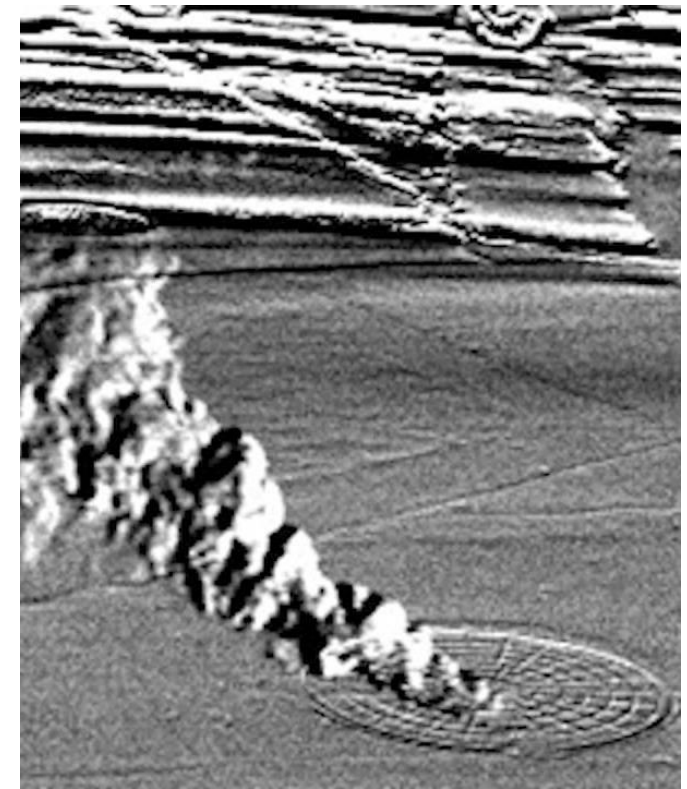

Well Identification - Challenges

- Non-uniform features (surface and sub-surface)
- Challenging environments
- Requires wide area search



Well Identification – Current Sensing Technologies Ready For Application

- Sensor Technologies:
 - High resolution 3D stereo vision camera
 - Hyperspectral imaging (visible and infrared)
 - Magnetometer (magnetic gradiometer)
 - LIDAR
 - Ground Penetrating Radar
 - Gas detectors (methane)
- Sensor Fusion:
 - Machine learning and traditional sensor fusion techniques
 - Signal processing to create physically meaningful data products for each sensor technology
 - Visualization of data layers and fused results
- Vehicle Integration:
 - Unmanned Aerial Systems (UAS)
 - Manned aircraft
 - Unmanned Ground Vehicles (UGV)
 - Handheld/wearables

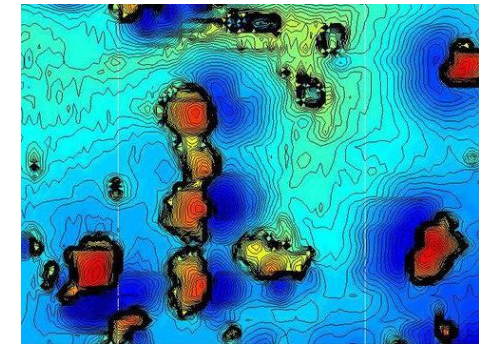
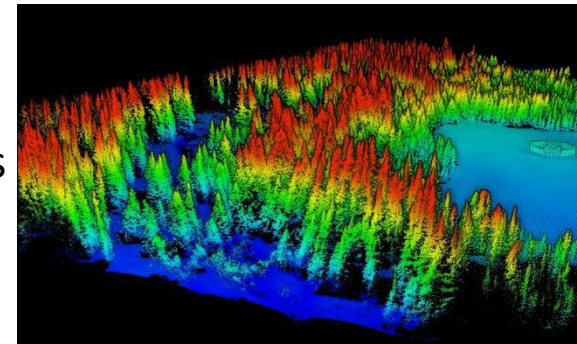
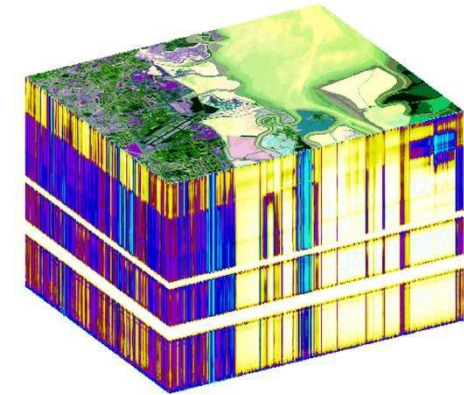

Well Identification – Current Sensing Technologies Ready For Application

High resolution 3D stereo vision camera:

- Low-weight
- Low-power
- High scan speed
- Medium standoff
- Depth and optical imagery

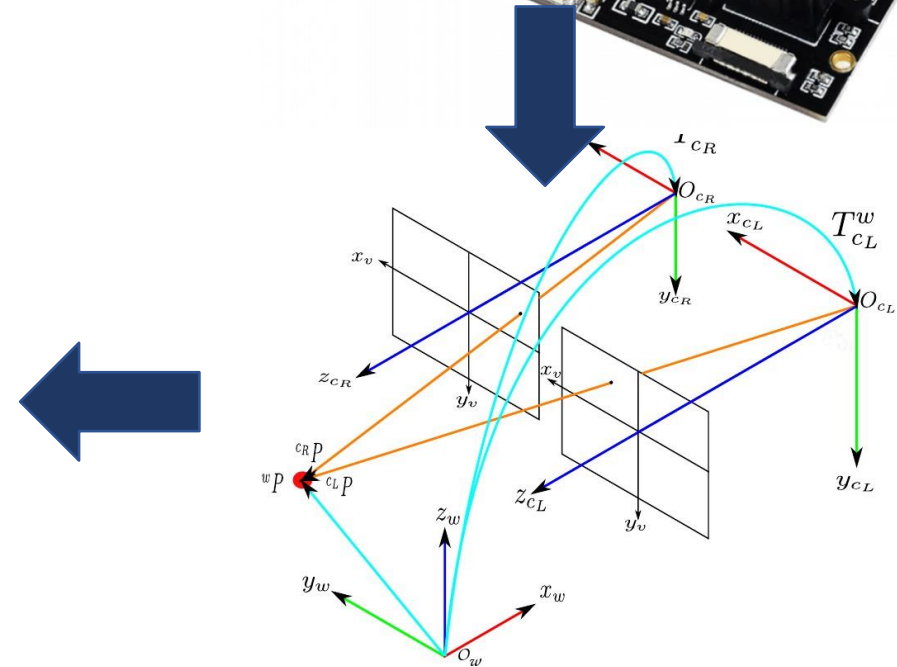
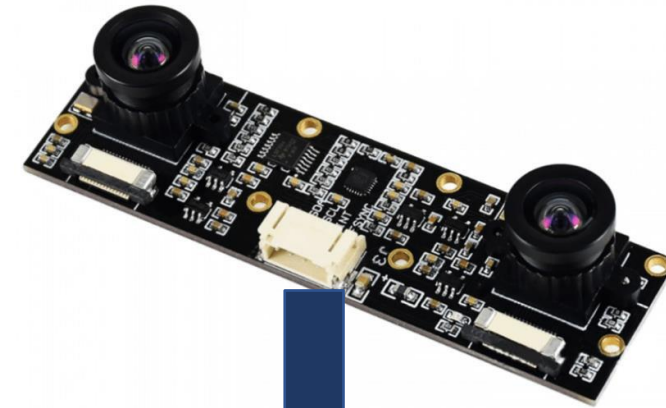

Detects surface features and structures

Well Identification – Sensing Technologies Ready For Application

Hyperspectral imaging:

- Heavy-weight
- Medium-power
- Slow scan speed
- High standoff
- Spectrum response of surface

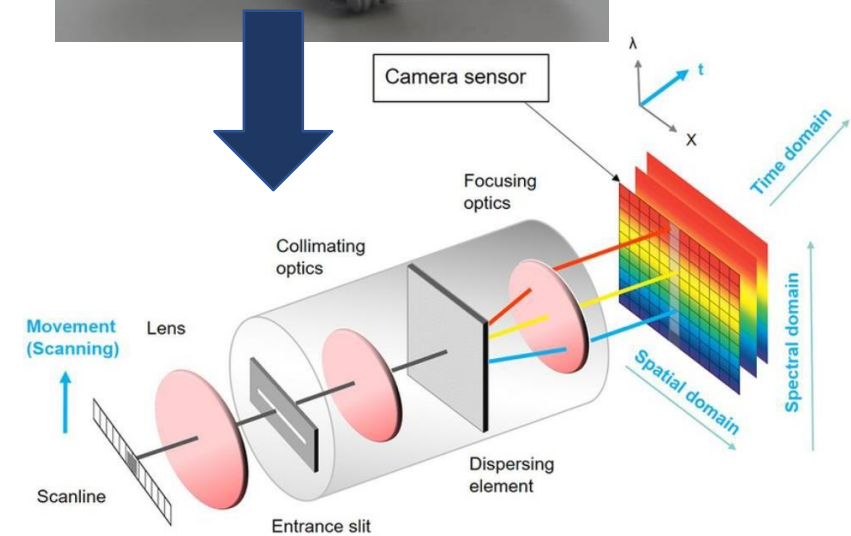
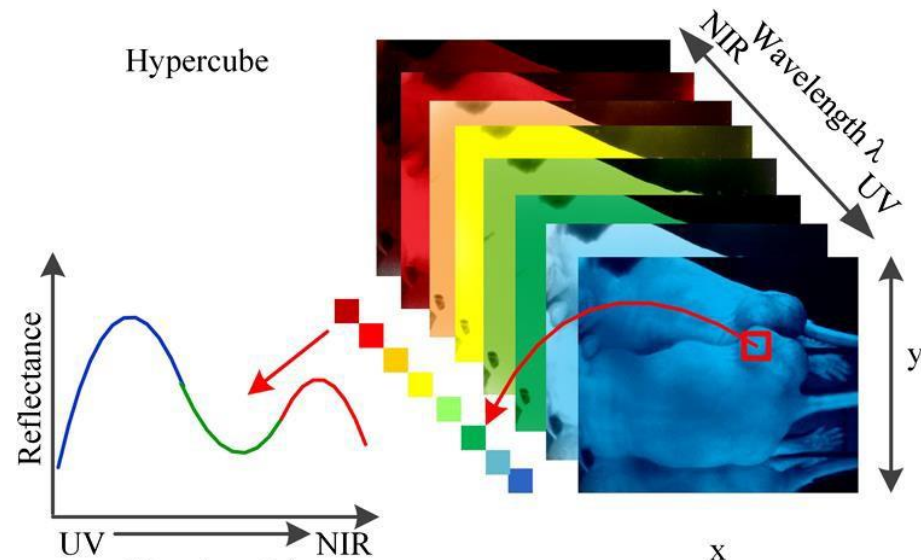

Detects surface features and materials

Well Identification – Sensing Technologies Ready For Application

Magnetometer:

- Medium-weight
- Low-power
- Medium scan speed
- Low standoff
- Magnetic fluctuations/features

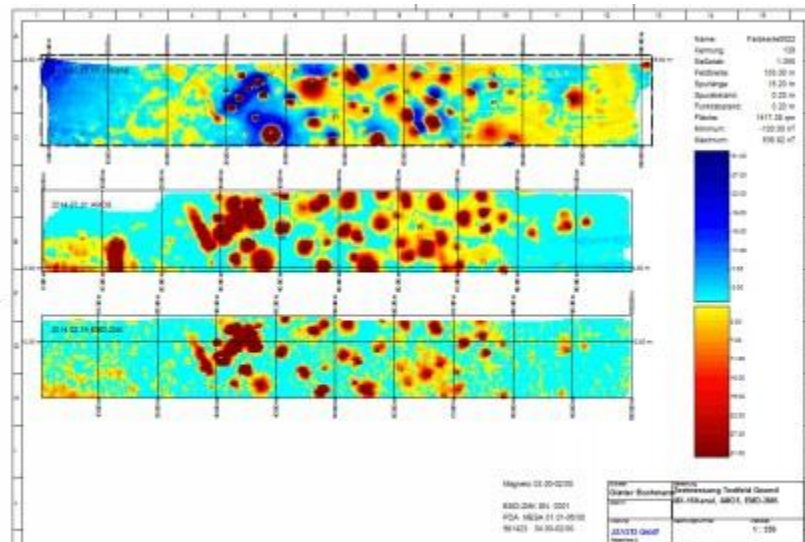

Detects wells with ferrous materials

Well Identification – Sensing Technologies Ready For Application

LIDAR:

- Medium-weight
- Low-power
- Medium scan speed
- High standoff
- Depth imagery

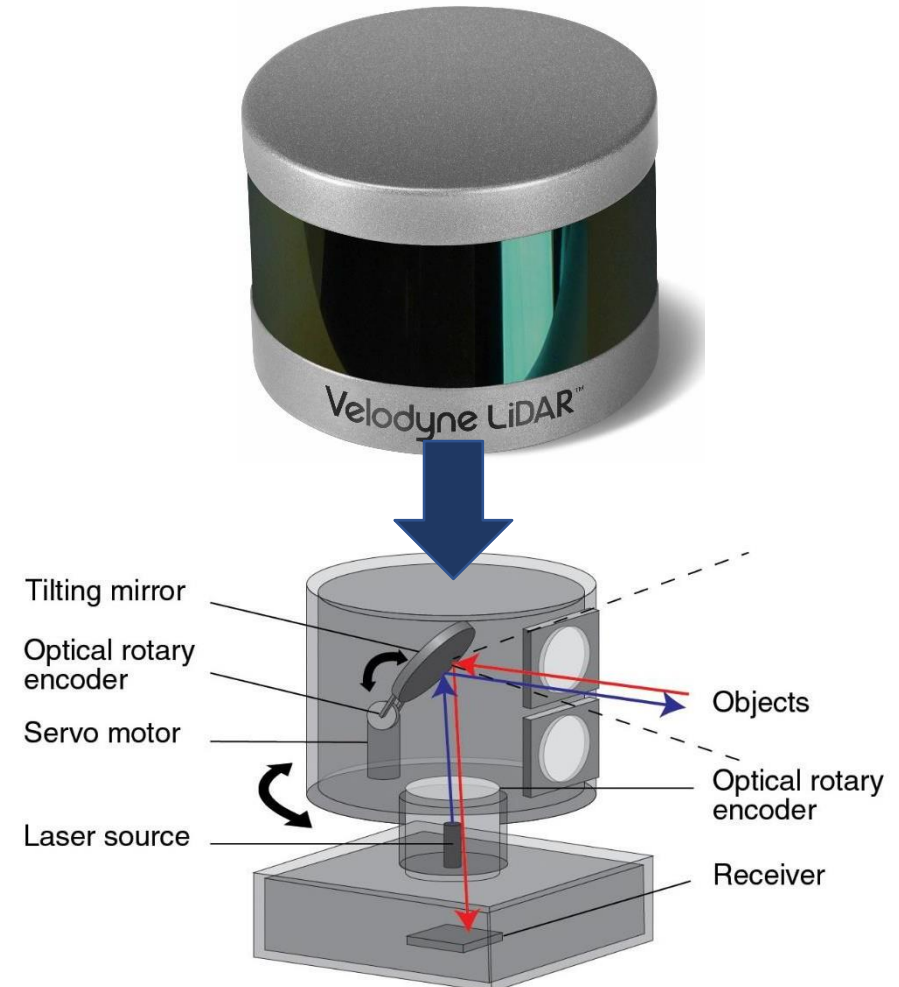
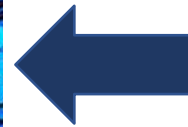
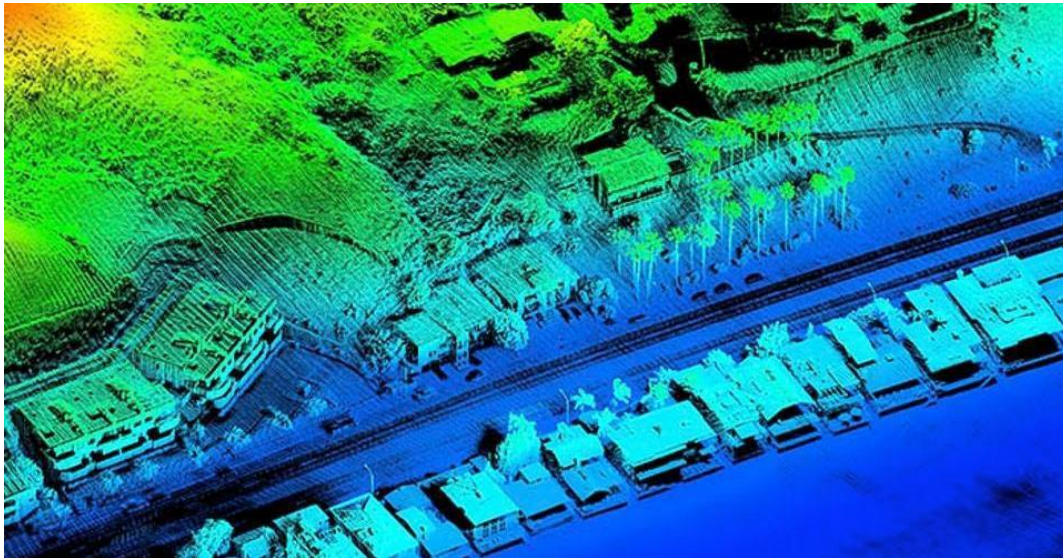

Detects surface structures

Well Identification – Sensing Technologies Ready For Application

Ground Penetrating Radar:

- Heavy-weight
- Low-power
- Low scan speed
- Low standoff
- Subsurface imagery

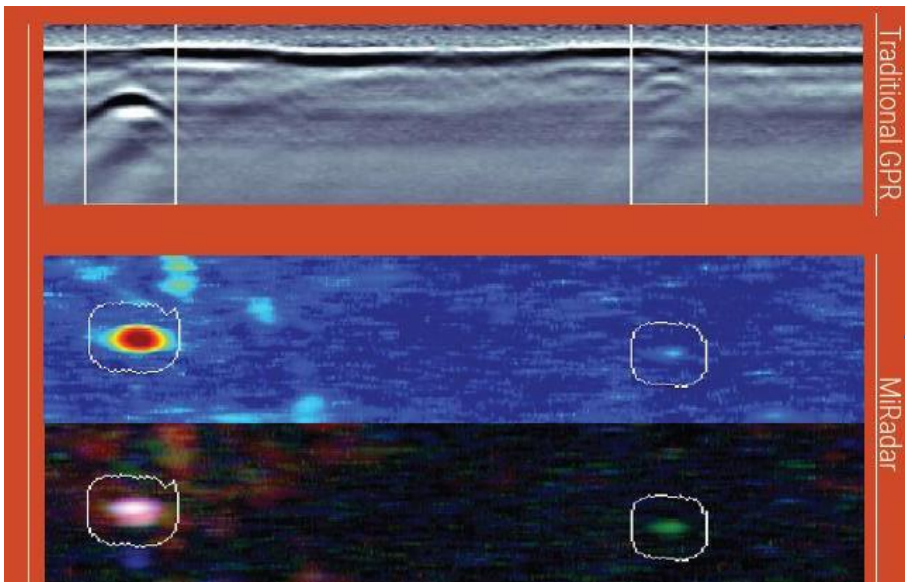

Detects subsurface features

MiRadar systems enable smarter threat-detection strategies and improved troop safety.

MODULAR

Small, low-power arrays mount on any vehicle



SIMPLE TO USE

Intuitive displays require little training



LLNL MiRadar Systems

AUTOMATIC ALERTS

Allows fast detection and unmanned operations

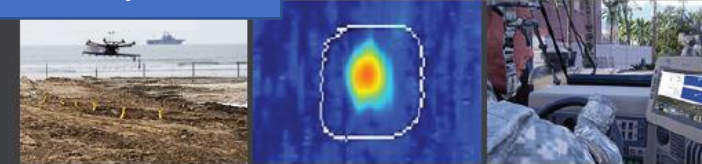

BRIDGE SCANNING

Inspects integrity of concrete structures

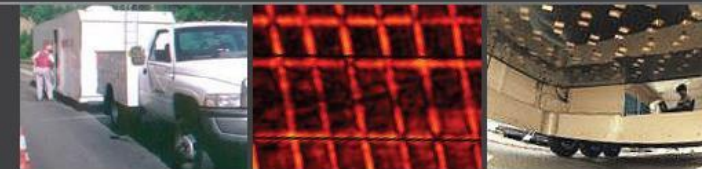

Well Identification – Sensing Technologies Ready For Application

Gas Detector (Methane):

- Light-weight
- Low-power
- High scan speed
- Medium/High standoff
- Methane gas concentration

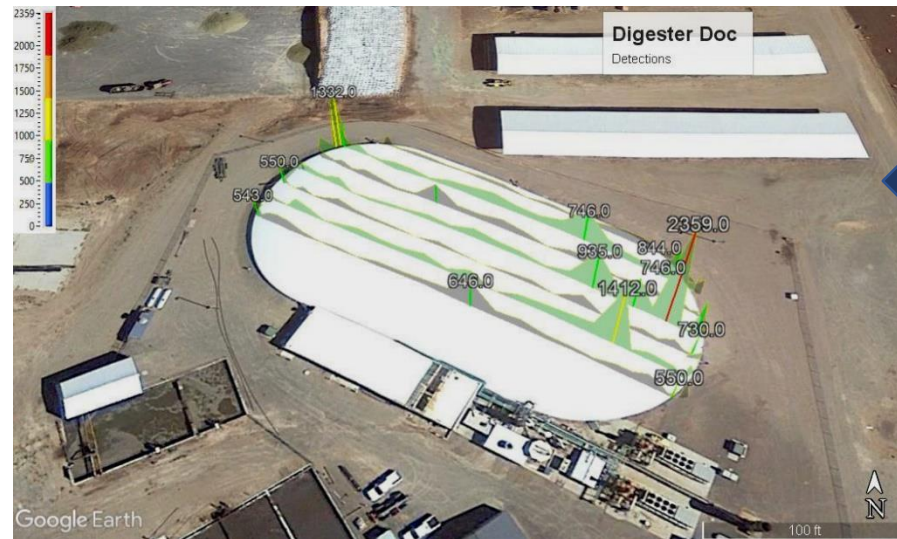

Detects methane emitting wells

Well Identification – Technology Suitability Process

Develop Technology Metrics:

- Detections score:
 - Percentage of wells associated with technology
 - Directivity of detection method
 - Primary features: well structure
 - Secondary features: supporting structures
 - Tertiary features: process/environmental
- Standoff (ft)
- Scan speed (rate of progress, ft/s)
- Processing requirements (TFLOPS)
- Size (cubic in)
- Weight (lbs.)
- Power (W)
- Cost (\$)

Based on requirements, goals, and specifications – can be different for each phase (identification vs. characterization)

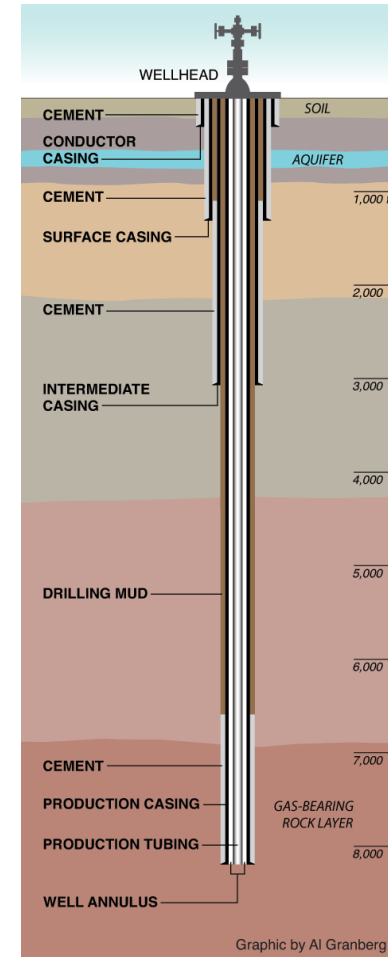

Interaction between Stakeholders and technology developers is key to developing meaningful metrics to drive sensor selection

Well Identification – Technology Suitability Process

	Stereo Camera	HSI Camera	Magnetometer	LIDAR	GPR	Gas Detector
Detection Score	0.19	0.28	0.39	0.05	0.72	0.01
Percentage of wells	1	1	.5	.5	1	.1
Directivity						
Primary Quality	0	0	1	0	1	0
Secondary Quality	0.5	0.75	0.5	0.25	0.25	0
Tertiary Quality	0.5	0.75	0.25	0.25	0.25	1
Standoff (ft)	100	300	30	300	3	300
Scan speed (ft/s)	30	15	10	15	10	30
Processing Requirement (TFLOPS)	2	30	1	1	5	0
Size (in ³)	9	54	864	64	6480	12
Weight (lbs.)	0.37	1.5	4	2	10	1
Power (Watts)	2	20	5	10	20	.5
Cost (\$)	500	30000	20000	5000	30000	1000

***Representative estimates, not actual/real**

Technology developers grade each technology based on metrics

Well Identification – Technology Suitability Process

Utilize multiple sensor modalities and latest sensor fusion algorithms – use stakeholder metrics to optimize sensor solution

***Representative weights and calculations**

Metric	Detection Score	Standoff	Scan Speed	Processing	Size	Weight	Power	Cost
Metric Weight	0.26	0.19	0.13	0.07	0.07	0.1	0.07	0.13

$$\text{Utility} = (\text{Detection Score} * 0.26) + (\text{Standoff} * 0.19) + (\text{Scan Speed} * 0.13) + (\text{Processing} * 0.07) + (\text{Size} * 0.07) + (\text{Weight} * 0.1) + (\text{Power} * 0.07) + ((\text{Target Cost} - \text{Cost}) * 0.13)$$

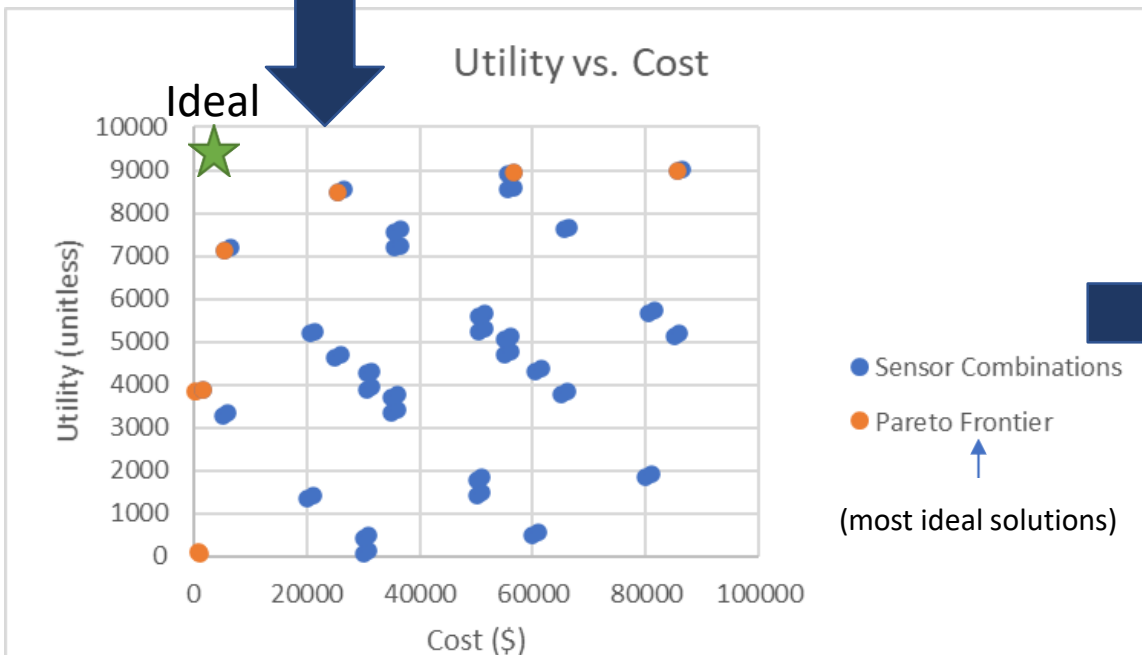

Ideal Sensor Combinations	Cost	Utility
Gas Detector	1000	63
Stereo Camera-Gas Detector	1500	3893
Stereo Camera-LIDAR	5500	7120
Stereo Camera-LIDAR-Gas Detector	6500	7183
Stereo Camera-Magnetometer-LIDAR-Gas Detector	26500	8537
Stereo Camera-HSI Camera-Magnetometer-LIDAR-Gas Detector	56500	8604
Stereo Camera-HSI Camera-Magnetometer-LIDAR-GPR-Gas Detector	86500	9030

Process provides data and metric driven approach to optimizing sensor platform

Wells Identification – Success Metrics

- Provide easy-to-deploy, cost-effective sensors for well detection and identification
- Provide data visualization and sensor fusing algorithms for user and automated well identification
- Generate new data sets with existing deployments to quickly increase data density for future development
- Establish best practices on currently available data
- Identify gaps in current data sets and concepts of operations



Undocumented Orphaned Wells Workshop

Technical Session #3 Undocumented Wells Characterization Technologies

Sébastien Biraud (Berkeley Lab)
and the National Laboratories consortium

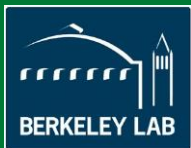

Outline

- Motivation: Why well characterization is important
- Challenges
- Current state-of-the-art of well characterization technologies
- Project team to address this problem
- Success metric



Wells Characterization - Motivation

- Oil & Gas wells: provide leakage pathways that connect oil and gas reservoirs to groundwater aquifers and to the atmosphere, contributing to water and air quality degradations and anthropogenic greenhouse gas emissions.
- Wells characterization should be coordinated across states to maximize the impact of our program.
- Quantification of methane emissions from orphaned wells will improve US EPA estimates of (avoidable) GHG emissions.

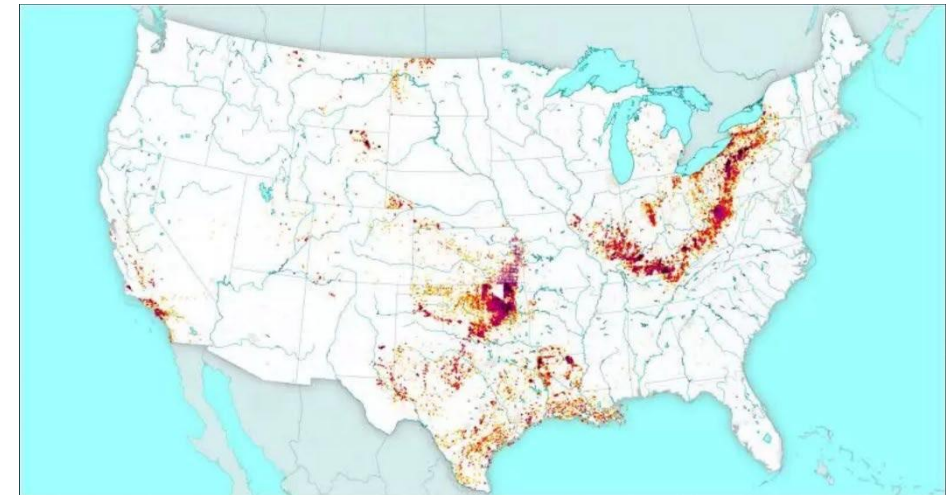

Documented orphan wells as of summer 2021, according to EDF and McGill University. Credit: Nick Trotter Maps and Alan Bucknam/Notchcode Creative

Wells Characterization - Challenges

- Ecosystem of wells is very diverse across the nation
- Heterogeneous subsurface and surface conditions across oil and gas basin
- Plugging priority criteria are different across oil and gas producing states
- Not one technology will work everywhere
- Cost-effective scaling of state-of-the-art technologies

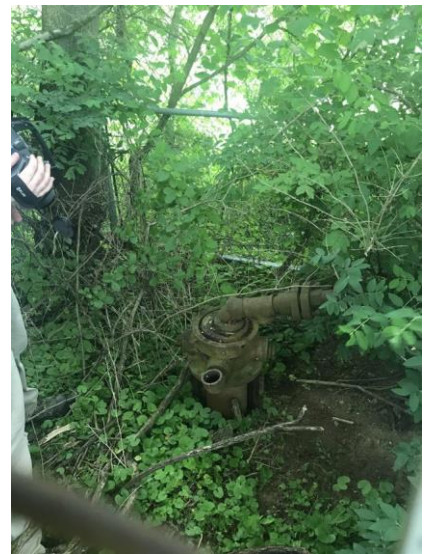

Credit: Natalie Pekney, 2022)

Wells Characterization - Current State-of-the-art

Key Attributes	Computer-based	Ground-based	Remote sensing
Autonomous	yes	yes	no
Continuous	N/A	yes	no
Leak Localization	no	1-10 meters	1-50 meters
Leak Quantification	no	Component-scale	Component-scale / Pad-scale
Cost	\$	\$-\$\$	\$\$-\$\$\$

Characterization of Undocumented Wells Using Data Mining, Fusion and Machine Learning Approaches



State Databases

DEPARTMENT OF NATURAL RESOURCES
DIVISION OF OIL AND GAS RECEIVED

LOS AND CORE RECORD OF OIL OR GAS WELL
OCT 19 1951

Operator: Western Oil Corporation, Well No. "National Iron Sheet" 3, Location: Yuma, Co., Arizona, U.S.A.

DEPTH TO	FORMATION PENETRATED BY WELL	DESCRIPTION
Top of Formation	Thickness	Remarks
COBES ST: 2901	2901	6' 1" Oil sand - dark brown, mottled with green clayey streaks, fine to coarse grained, clayey, silty, gritty, unsorted massive, firm, easily friable, occasional hard silty streaks 2" thick, generally fair permeability, mottled saturation of dark brown tarry oil gives salt-and-pepper appearance; two dark brown cuts.
2918	2931	1' 1" Silty sand - light blue-gray, very fine grained, well sorted, hard, light, massive to roughly bedded, common blocky flakes, barres, occasional blue claystone fragments at bottom, brackish water type.
		Sandy siltstone - light gray, fine grained, well sorted, very fine sandy, abundant carbonaceous matter, brackish water type.

Driller logs

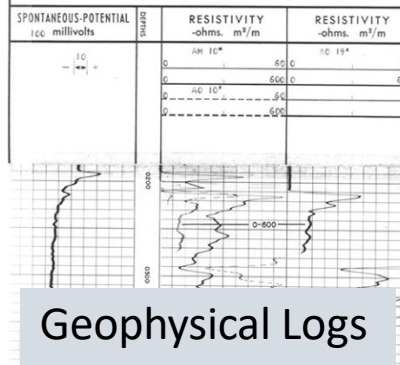

Geophysical Logs

Conceptual Ideas:

Significant amounts of data that have potential to be mined using natural language processing and image classification ML to identify potential well locations:

1. Existing well records (may need OCR)
2. Remote sensing to identify relevant hydrogeological properties
3. Historical archives of news/photos/maps

Figures from <https://webapps.usgs.gov/cogg/overview/digitization-and-mining>

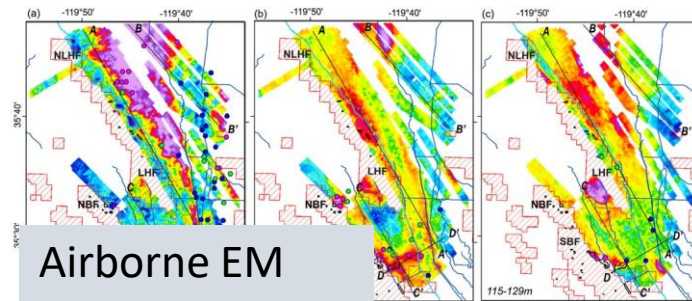

Airborne EM

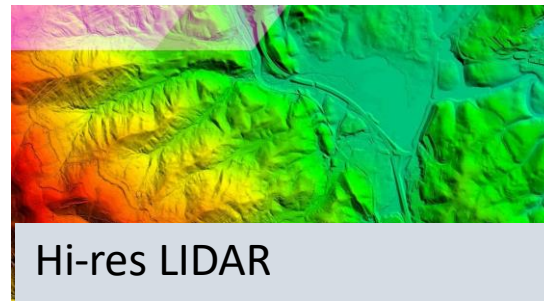

Hi-res LIDAR

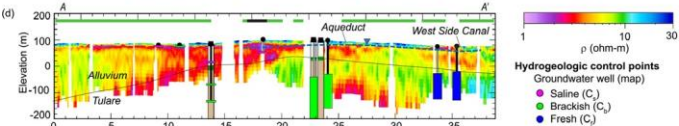

Figure from USGS

Ball et al., 2020 WRR



David Rumsey Map Collection



Wellbore Integrity Assessment with Electromagnetic Time Domain Reflectometry (EM-TDR)

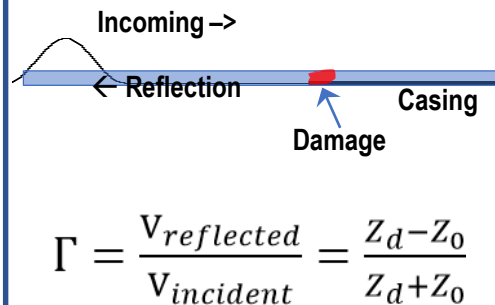
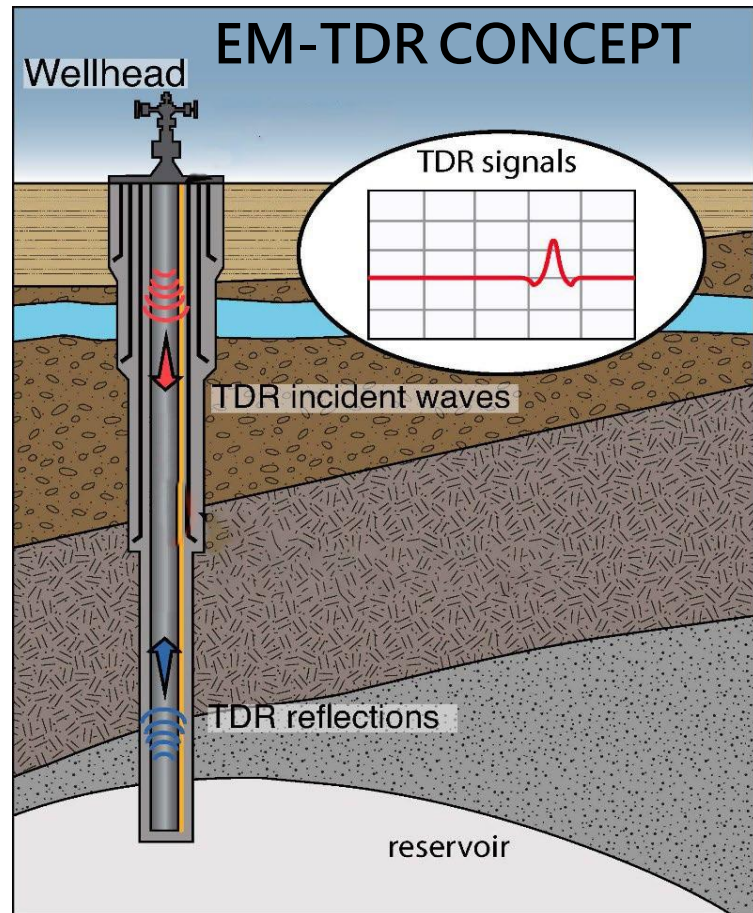

Working principle: Guided EM wave traveling along steel casing. Reflections are generated when damages (or bottom) are encountered. **No downhole sensor deployment needed.**

Numerical simulation

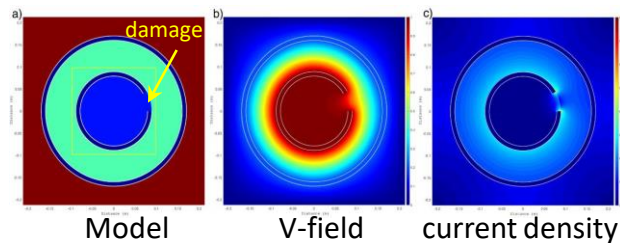

Field tests



O/G well – CA central valley; >700ft

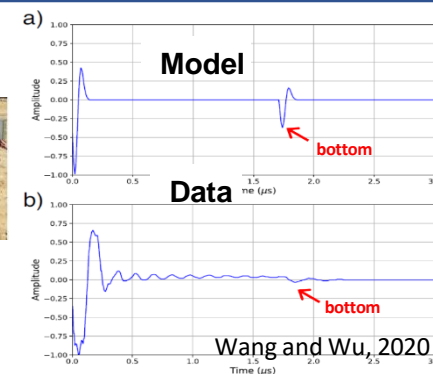

UOW application:

- Identify depth or damages of wells
- Quick integrity screening tool

Atmospheric Methane sensing: Static Chamber Measurements

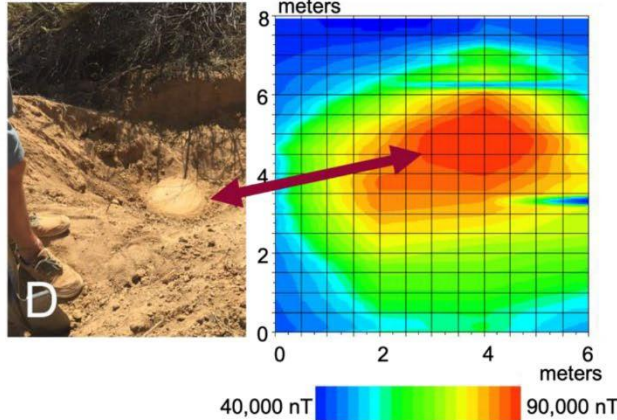

Working principle: $Q = dC/dt V$

- Q is the leak rate (in liters per hour [L/hr]),
- dC is the change in methane concentration (in ppm) over time period dt (in hours)
- V is the volume of the chamber (in L).

UOW application: time-intensive (requiring approximately 1 hour per well) but extremely sensitive (less than 0.001 g CH₄/hr)

Atmospheric Methane sensing: mobile survey

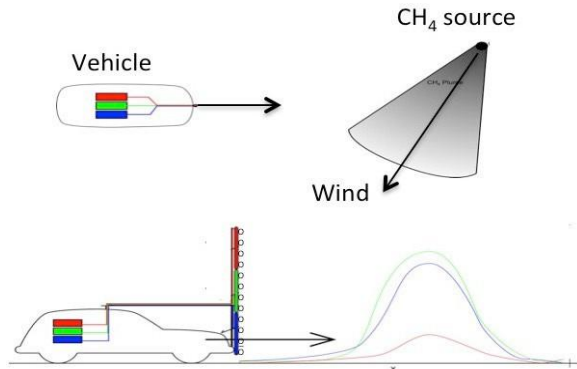

(Fischer et al., 2017)



Working principle:

- Measures methane concentrations at three heights (1, 2, 4 m above ground level) and winds (2.5 m)
- Integration of flux plume quantifies near-surface emissions
- Controlled release testing demonstrates measurement of low level emissions (~ 0.5 g CH₄/hr)
- Applied to measure O&G wells, Compressed NG, fueling stations, dairy manure lagoons, and urban NG leak.

UOW application: Rapid assessment (requiring approximately 10 minutes per well) but less-sensitive than static chamber method.

Atmospheric Methane sensing: manned and unmanned airborne

manned

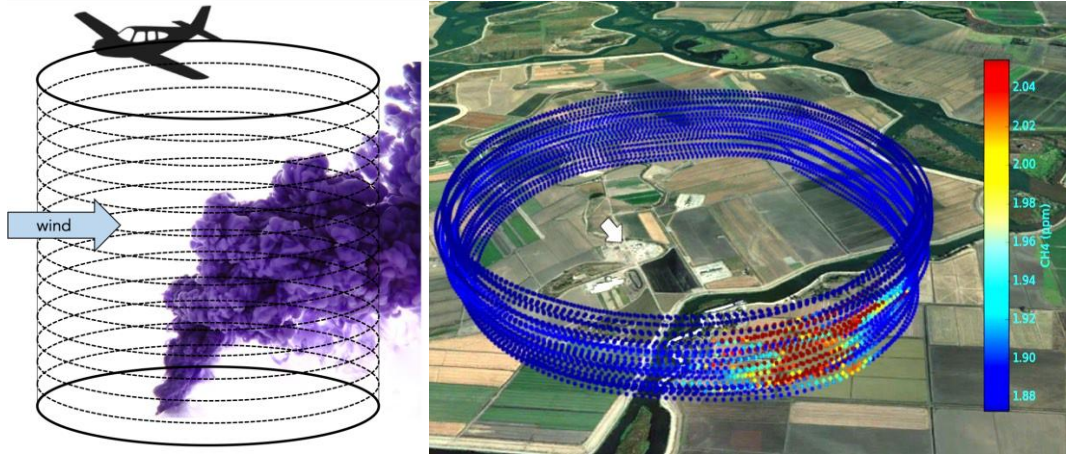

(Tadic et al., 2019)

unmanned

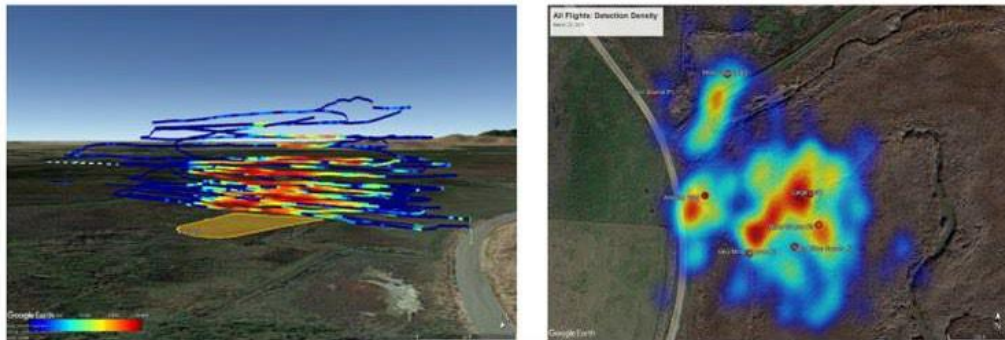

(Zhang et al., 2021)

Working principle:

- Mass-balanced approach
- 400 ft above ground level (AGL) flight altitudes
- Semi-real-time methane emission estimate

Working principle:

- Emissions measurements uses same principle as manned aircraft
- Surface to 400 ft AGL flight altitudes
- Real-time methane concentrations

Atmospheric Methane sensing: Spaceborne

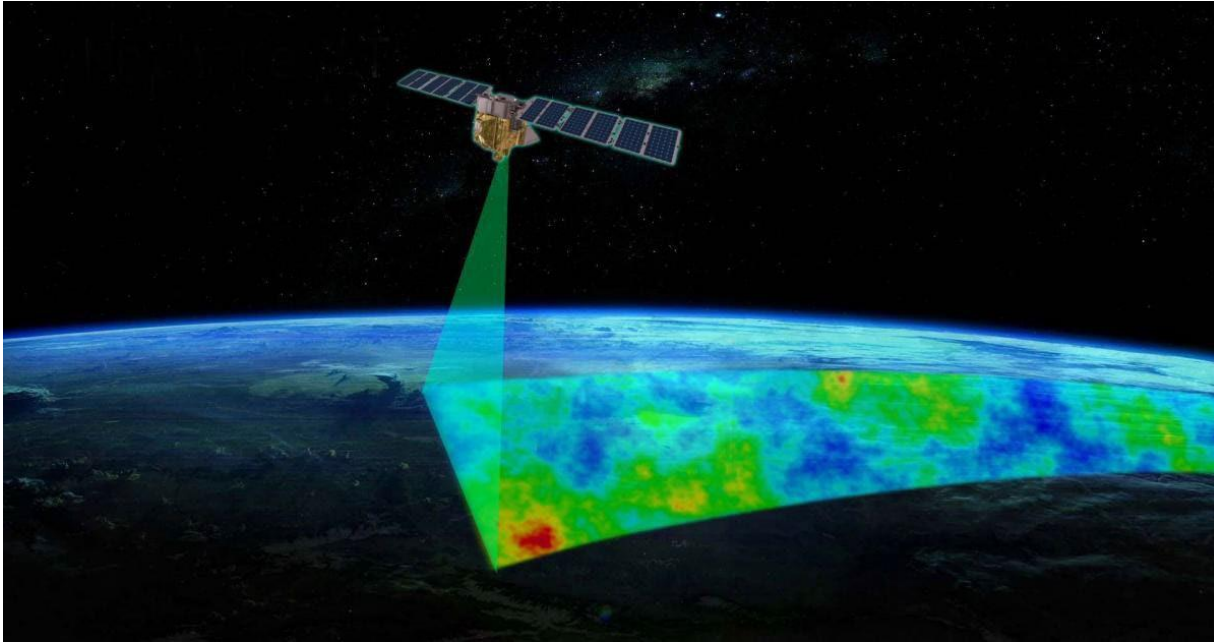

(courtesy www.methanesat.org)

Spaceborne methane monitoring is an active and growing field. There are two relevant methods of observation:

- 1) infrared imaging spectrometers (GOSAT, GOSAT-2, TROPOMI, and SCIAMACHY)
- 2) visible and infrared imaging of flaring at night (VIIRS).

Pros: Observing the world from space has obvious advantages for identifying emission irrespective of site access restriction

Cons: Sensitivity of these systems is much poorer than aircraft and ground-based systems, which limits them to detecting only large and super-emitter sources (>10kg/hr)

Spaceborne sensing not yet suited for this project, but we will keep in an eye on progress made on leak detection as a handful of private-sector missions have recently emerged (GHGSat, WorlView-3, ...)

Wells Characterization – Project Team

- Machine Learning (LANL/LBNL/LLNL)
- Methane Emissions (LANL/LBNL/NETL)
- Well Integrity (LBNL/NETL)



Sebastien Biraud, LBNL



Charu Varadharajan, LBNL

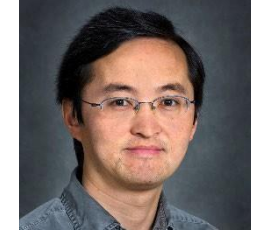

Yuxin Wu, LBNL



Natalie Pekney, NETL



Brian Wihl, LLNL



Alexandra Hakala, NETL



Manvendra Dubey, LANL

Wells Characterization – Success Metric

- Establish best practices on wells characterization
- Improve methane emission estimates from (Un)documented Orphaned Wells
- Provide easy-to-deploy, cost-effective measurement technics for well characterization



Thank You!

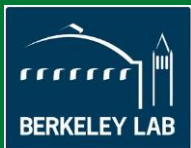

Undocumented Orphaned Wells Workshop

Technical Session #4 Outcomes (Framework, Best Practices) Strategy

Chester J Weiss (Sandia National Laboratories)
and the National Laboratories consortium

[Sandia National Laboratories](#) is a multimission laboratory managed and operated by National Technology and Engineering Solutions of Sandia, LLC, a wholly owned subsidiary of Honeywell International, Inc., for the U.S. Department of Energy's National Nuclear Security Administration under contract DE-NA-0003525.

Outline

- **A problem of scale – “smaller, faster, cheaper” doesn’t even come close.**
- Wideband Usability Spectrum to maximize workforce engagement
 - Citizen Scientist
 - At-the-wellhead assessment
 - Standoff detection and characterization
 - Natural language processing
 - Advanced data reduction (3D, multi-physics, etc.) and specialized measurement discrimination
- **Comprehensive risk assessment model to inform prioritization**
- **Challenges to realization**
 - The technical – advancing technical readiness levels (concept -> field trial -> commercialization)
 - The handoff: teaming with industry, intellectual property, database hosting, maintenance and updates, points of contact, indemnity, access to lab specialists, others?
 - Workforce engagement

Survey Responses – Thank you!

- 37 respondents representing 30 states
- 70% indicated “moderate” or “low” priority -> constrained resources

Q5 What approach/methods has your state been using or contemplated using to identify undocumented orphan wells?

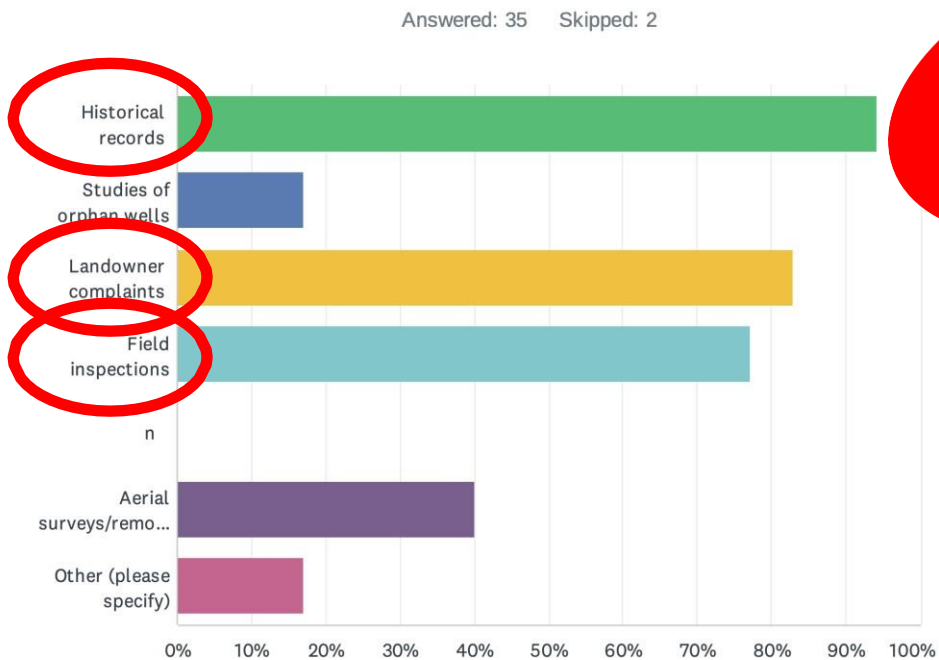

Top Three Responses

Q4 What are your state's biggest data needs/gaps relative to undocumented orphan wells?

Answered: 37 Skipped: 0

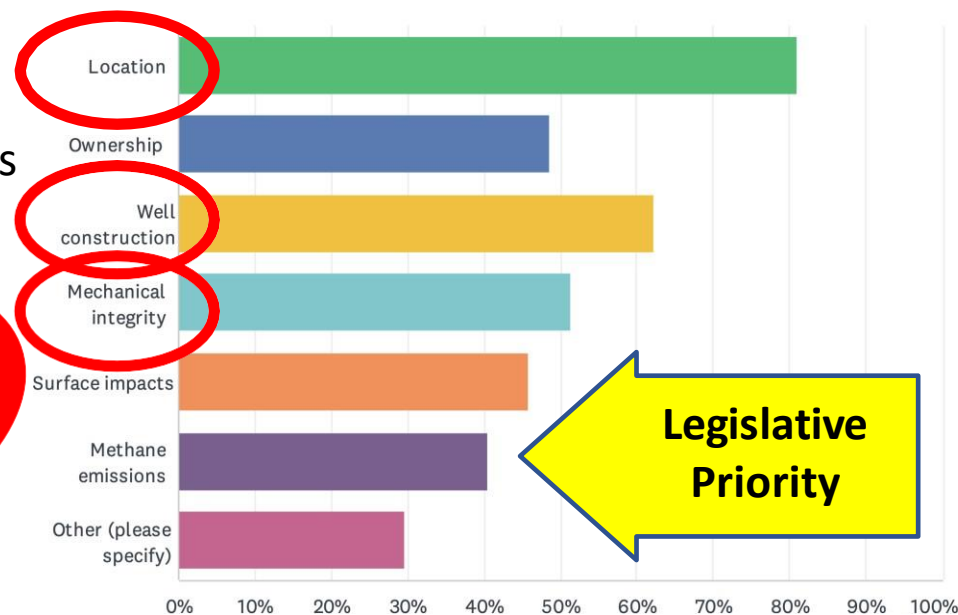

State of Practice

- Labor intensive, largely non-technical
- Where is it? What’s the state of health?
- Varying local constraints on inspection (e.g. Idaho’s no-drone laws)

End-User Scalability Constraints on DOE Products/Framework

- It is estimated that there are hundreds of thousands of undocumented orphaned wells leaking methane in the U.S. that need to be located.¹
 - The total estimated number of undocumented orphaned wells reported by the states is between 310,000 and 800,000.²
 - Per the EPA, there are 2M unplugged and abandoned wells in the U.S. (which includes orphaned wells).³
- **\$4,700M Available to DOI/BLM/States/Tribes**
 - **\$2,350 - \$23,500 BIL funding per well**
 - **21,000 – 200,000 wells/year over 10-year timeline**
 - 100's to >10,000 wells/year, depending on state
- **Current State of practice: <50 well/year (NM), ~500ish wells/week nationwide.**

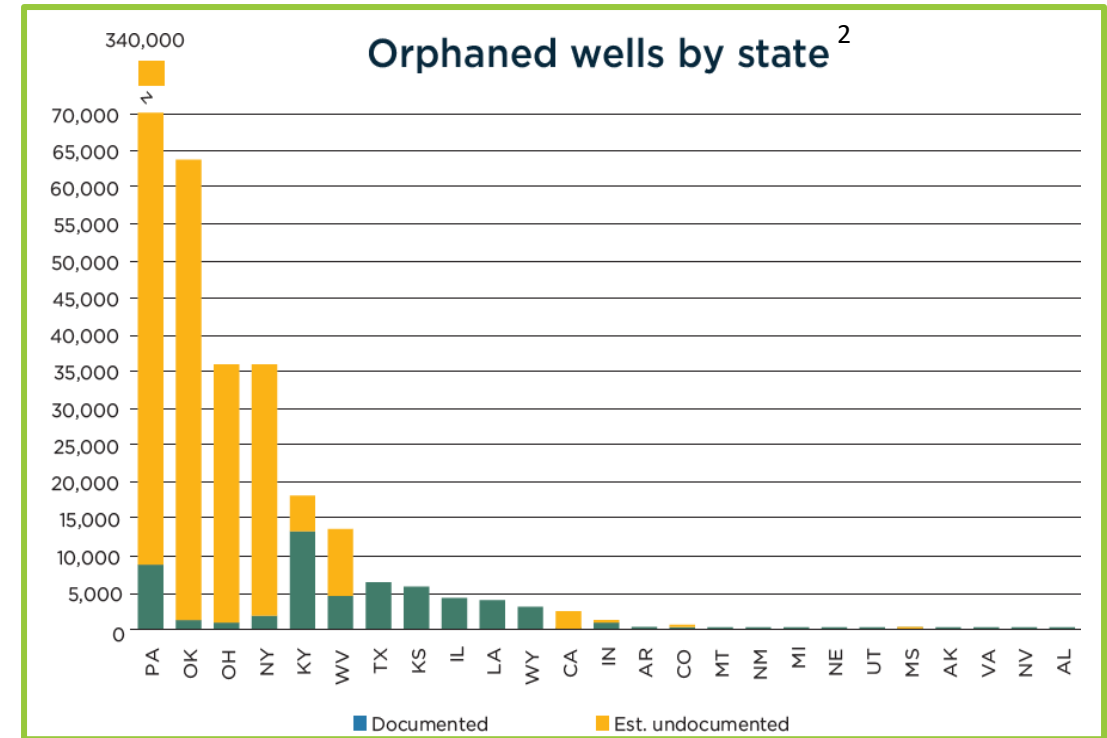

DOE Products/Framework need to upscale current decisioning by factor of 40-400x to fully meet expected needs.

[1] Management of Abandoned and Orphaned Oil and Gas Wells, The American Association for the Advancement of Science; [2] IDLE AND ORPHAN OIL AND GAS WELLS: STATE AND PROVINCIAL REGULATORY STRATEGIES 2021, IOGCC, December 2021, <https://iogcc.ok.gov/idle-and-orphan-oil-and-gas-wells-2021>; [3] Wright, B., Hide and Seek: The Orphan Well Problem in America, Journal of Petroleum Technology, August 2021

Something everyone can use: SmartPhone data collects



RBDMS WellFinder 4+

Ground Water Protection Council

★★★★★ 3.1 • 14 Ratings

Free

- Prior DOE investment/experience with geo-location
- Add to this preliminary geophysical reconnaissance
 - magnetometry
 - lidar

Screenshots iPhone iPad

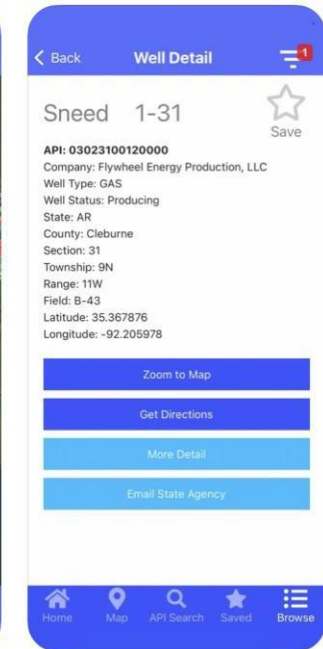
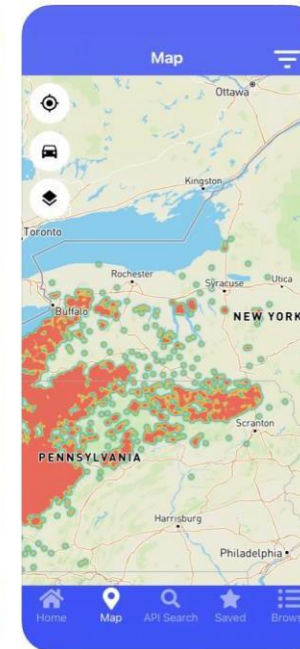

Enabling technology with multiple benefits:

- “rough cut” to prioritize follow-on survey
- Adds another pin on the inventory
- Expands the workforce
- Public engagement/outreach/education

For the technically trained: At-the-wellhead sensor packages

Usability Vision: Geophysical analogue of utility detection. An all-in-one, internet-of-things, multi-physics measurement system.



Wireless (5G, other?)
communications



Uplink for data archiving and
access to ML/cloud algorithms to
inform in-the-field decision making

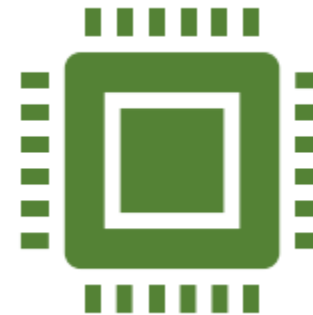

On-board data analysis and
geophysical interpretation

For the technically trained: Standoff sensing/characterization



Power/weight/duration optimized systems for integrated sensing requirements.

Magnetic, LIDAR, SAR, methane, etc. sensor suites



For the technically trained: Natural Language Processing

def: programming computers to process and analyze large amounts of “natural language” data to “understand” content and nuances within.

Historical Documents

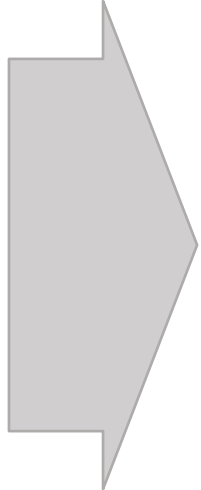

Optical Character Recognition



1010
1010



[A,B,D,...]
[1,2,3,...]

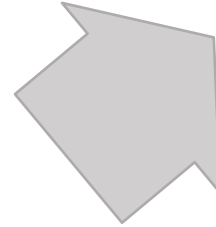

Machine Learning Algorithms
(the modern NLP approach)

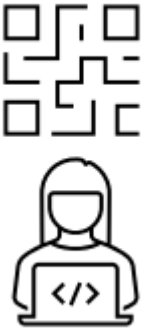
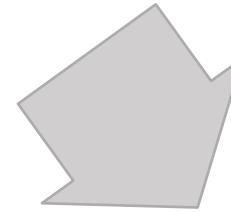

Likelihood estimate of
undocumented well locations

What is the best interactivity model?
Stand-alone algorithms? Cloud solutions?
Teams of document archivists?

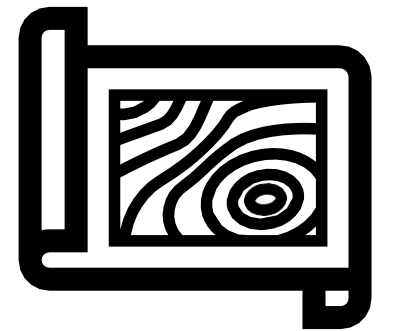

For the technically trained: GIS and Data Fusion, an early win?

Combining georeferenced historical data and other geospatial data sets may help identify areas with high-likelihood of orphaned wells.

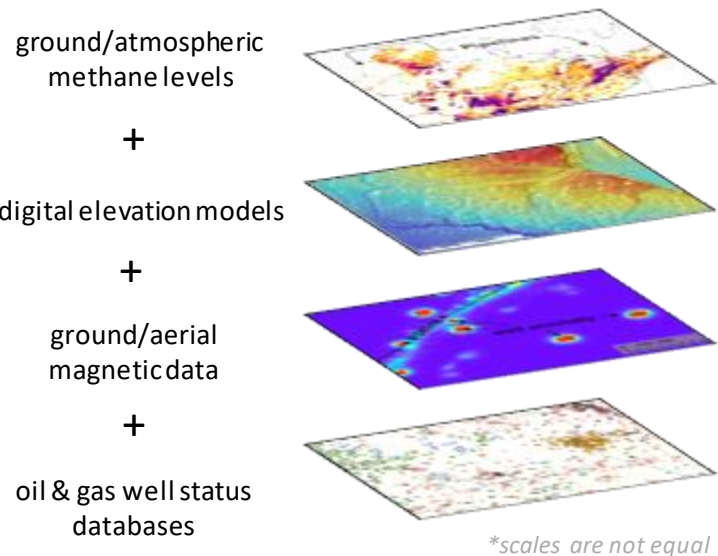

Geospatial Analysis (later phase: Machine Learning)

Types of geospatial data that could be included:

- Historical maps/roads
- Age & status of known wells
- Population density
- DEM/LiDAR
- Depth to aquifer
- Many other types of data can be evaluated for effectiveness

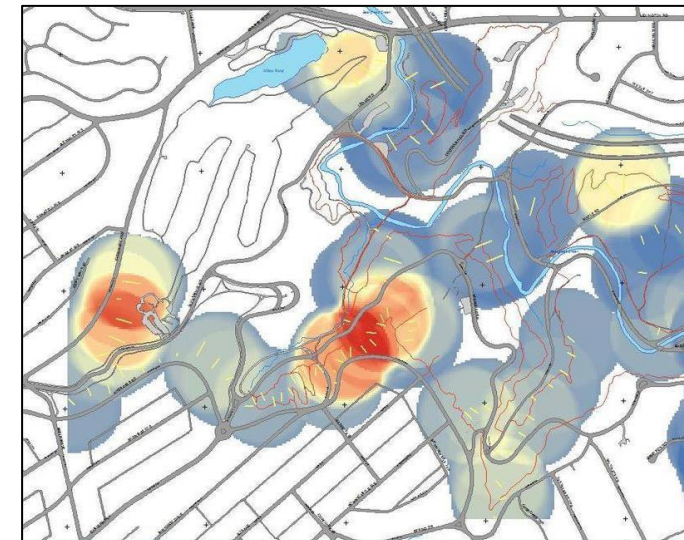

Probability maps, classification results, or even just interacting with multiple data sets visually as overlays may help identify areas likely to have undocumented wells.

Collect readily available data and georeferenced historical data that are potentially indicators of abandoned wells.

Methane map: <https://earthobservatory.nasa.gov/images/149374/mapping-methane-emissions-from-fossil-fuel-exploitation>

DEM: <https://eijournal.com/print/articles/global-elevation-data-enhance-exploration-and-development>

Magnetic map: Patricia M. B. Saint-Vincent, James I. Sams, Richard W. Hammack, Garret A. Veloski, and Natalie J. Pekney *Environmental Science & Technology* 2020 54 (13), 8300-8309 DOI: 10.1021/acs.est.0c00044

Oil & Gas Well Map: <https://gis.ohiodnr.gov/MapViewer/?config=OilGasWells>

For the specialist: Advanced characterization and measurements

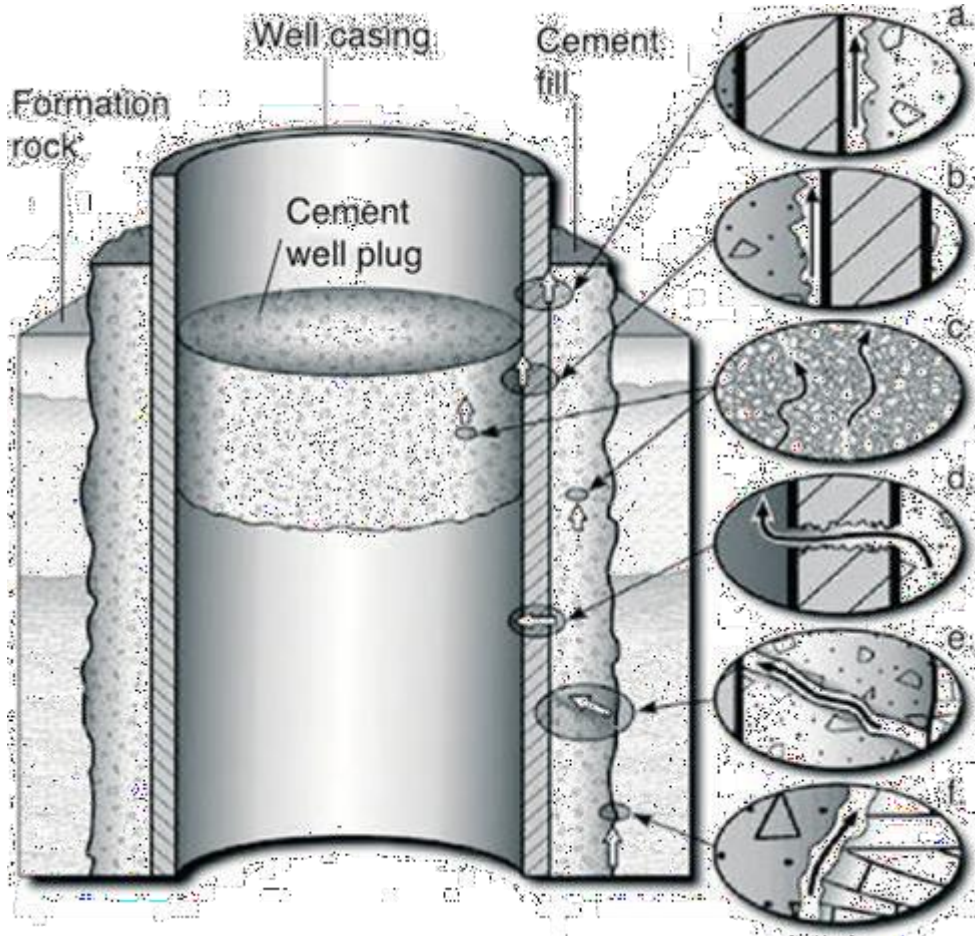

High-Fidelity Assessment of Wellbore Failure Modes

- Delamination between outer casing and cement
- Compromised plug seal
- Excess cement porosity
- Broken casing
- Fractured cement
- Delamination between cement and formation

Candidate Characterization Methods

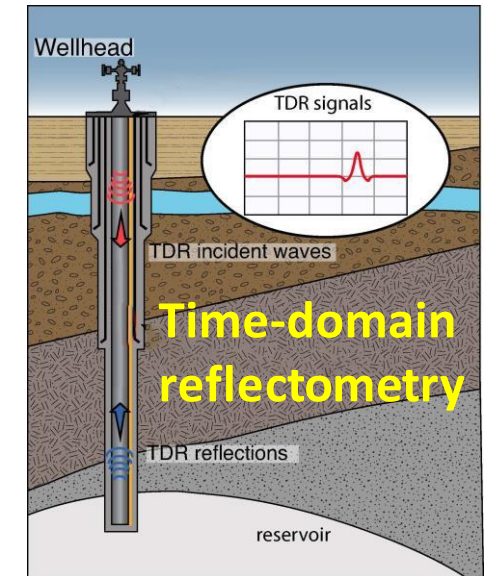
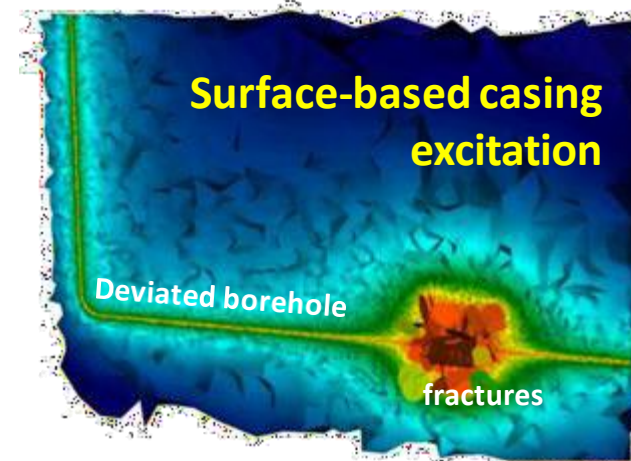

For the decision maker: Comprehensive Risk Assessment Model

Coupling Plug-and-Abandon activities with...

- Workforce availability
- Tech development timelines
- Tech deployment footprint
- Groundwater impact
- Methane mitigation
- CO₂ production (~6 tons of CO₂ per km of plugging, ~400 lbs/yd³)
- Ecosystem/societal impact
- External drivers (economic, population change, climate projections, repurposing options)

... to inform prioritization options and risks with what measurements to take, and when, to maximize return on investment.

Case Study: Regional Power/Water Systems Model

Tidwell, SAND2018-12110PE, 2018

Coupled Hydropower-Thermoelectric Operations

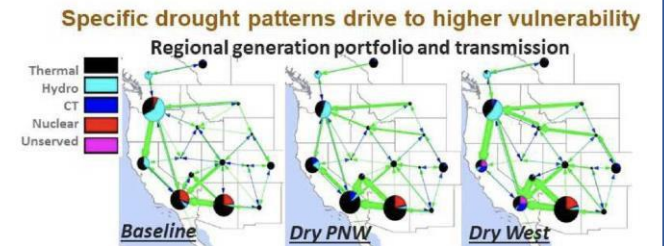
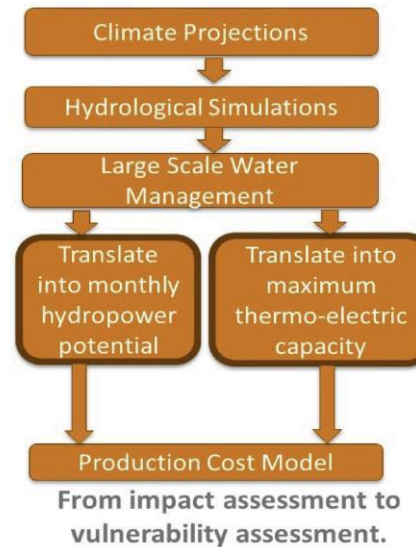

Risk distribution as a function of drought conditions

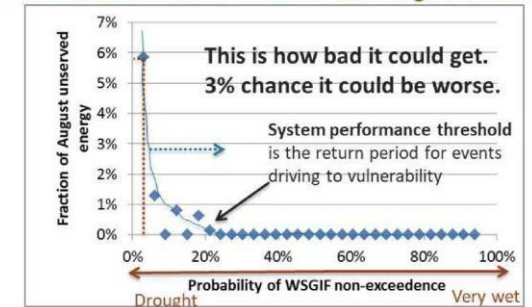

Challenges to Realization

- The technical – advancing technical readiness levels
- The handoff
 - teaming with industry
 - intellectual property
 - database hosting
 - maintenance and updates
 - points of contact
 - indemnity
 - access to technical specialists
- Workforce engagement

Existing mechanisms for transferring IP to commercial sector

- Co-development through Cooperative Research & Development Agreement
- Post-development licensing of IP (no- to low-cost models)



nature

No PhDs needed: how citizen science is transforming research

NEWS FEATURE | 23 October 2018

Projects that recruit the public are getting more ambitious and diverse, but the field faces some growing pains.



Youth-programme participants Donovan Wooten and Maya Sanders record observations with iNaturalist. Credit: Catie Rafferty/mediasanctuary.org

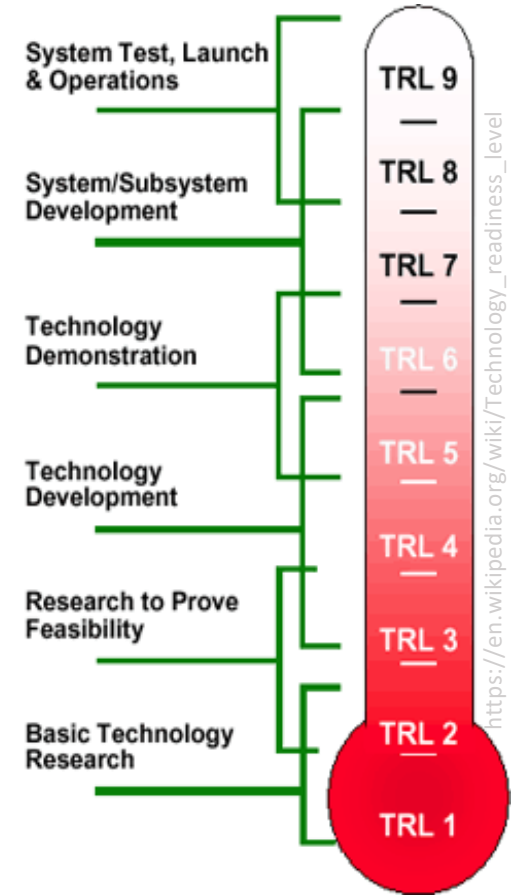

Diverse needs and constraints by the states and stakeholders will require a flexible implementation paradigm.

Closing Remarks (Bill Carey Los Alamos National Lab)

- Objective: Assist State, Federal and Tribal efforts to locate and characterize undocumented wells
- In partnership with States, identify key technology and analysis needs
- Determine effective, cost-efficient and easy-to-use approaches
- Share technology through demonstration, best practice guides, and training seminars
- Establish State-National Laboratory teams for technology deployment
- Integrated toolkit for system analysis and tool and sensor selection
- Potential targets:
 - Schemes for prioritization of where and how to find wells and which wells to fix first
 - Remote-sensing and in-the-field methods to locate undocumented orphan wells
 - Techniques to characterize undocumented well attributes and possible leaks to air and water
 - Quantification of methane emissions avoided through plug & abandonment
 - Data-science and machine-learning methods to integrate and analyze different data sources

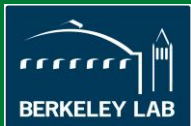

Thank you for attending!

Timothy Reinhardt

Director, Division of Emissions Mitigation Technologies
Office of Fossil Energy and Carbon Management | Office
of Resource Sustainability
timothy.reinhardt@hq.doe.gov

Jared Ciferno

Program Manager, Methane Mitigation Technologies
Office of Fossil Energy and Carbon Management | Office
of Resource Sustainability
jared.ciferno@hq.doe.gov

