

A Natural Gas-Driven Highly Efficient Thermo-Vacuum Clothes Dryer



Oak Ridge National Laboratory

Kashif Nawaz (Group Leader, Multifunctional Equipment Integration)

865-241-0792, nawazk@ornl.gov

Project Summary

Timeline:

Start date: 10-01-2018

Planned end date: 09-30-2022

Key Milestones

1. Develop a performance model for a thermo-vacuum-based clothes drying technology
2. Demonstrate the proposed concept by designing, fabricating, and operating a bench-scale thermo-vacuum clothes dryer
3. Develop a commercialization path by engaging appropriate OEMs and end-use operators

Budget:

	DOE funds	Cost share
FY19	600K	50K
FY20	600K	50K
FY21	600K	150K

Key Partners (full spectrum of expertise):

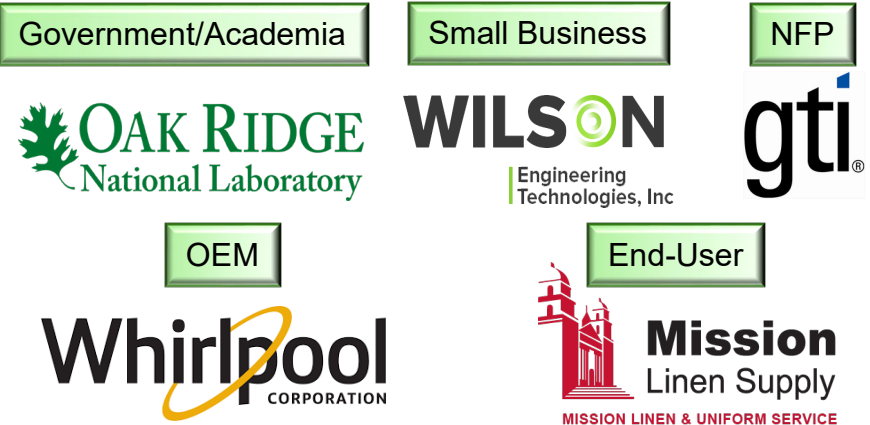

Project Outcome:

- A revolutionary clothes drying technology leading to significant energy and water savings compared with the state-of-the-art drying concepts
- A relatively simple design with minimal moving parts and maintenance requirements
- The technology is to recover and re-use most of the water used on wet laundry
- A potential solution across industrial commercial and residential sectors

How would you feel if your laundry completely dried in 5-10 minutes without exposing to high temperature?

Project Team

- **Oak Ridge National Laboratory**

- Kashif Nawaz (Sr. R&D staff)
- Brian Fricke (Sr. R&D staff)
- Mingkan Zhang (R&D staff)
- Viral Patel (R&D staff)
- Cheng-Min Yang (Postdoc associate)
- Tony Gehl (R&D staff)

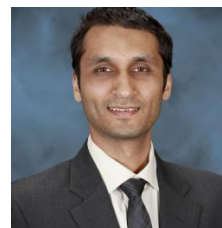

- **Gas Technology Institute**

- Yaroslav Chudnovsky (Team lead)
- Shawn Scott (R&D staff)



- **Wilson Engineering Technologies**

- Olexiy Buyadgie (Team lead)
- Dmytro Buyadgie (Director R&D)



- **Whirlpool**

- Chris Harnett (Design Engineer)

Challenge

- Drying is energy intensive process, consuming on average 290,200 Btu of heat for each 1,000 lb of wet laundry
- Steam released into the atmosphere (0.30 lb per unit pound of wet laundry) intensifies the greenhouse effect and losses of scarce water resources
- The drying process at elevated temperatures (120°C–160°C) degrades fabric and increases energy loss to the environment

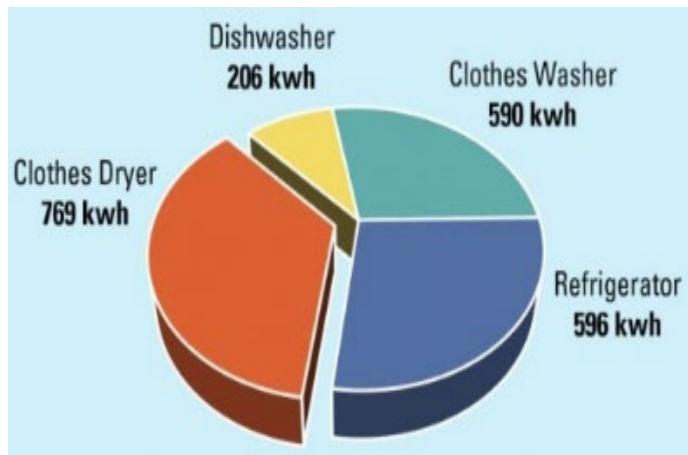

Energy consumption by appliances in residential buildings

0.42 Quads of primary energy annually

Challenge

Sunlight for clothes drying



1963-Auto termination sensors



2016-Heat pump dryer

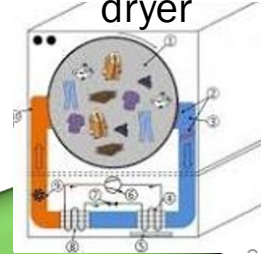

1938-First electric resistance dryer

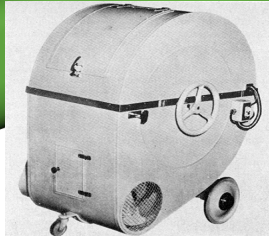

2014-Energy Star clothes dryer



2030- ?

An energy-efficient cost-effective process will transform the market
Exceptional history in next-generation clothes dryers development

Solution Approach

- The innovative thermo-vacuum drying method
- 10 times faster moisture removal than any conventional methods
- Natural-gas driven approach
- Minimal electrical power requirements (drum rotation and controls)
- Waste heat and water recovery for re-use

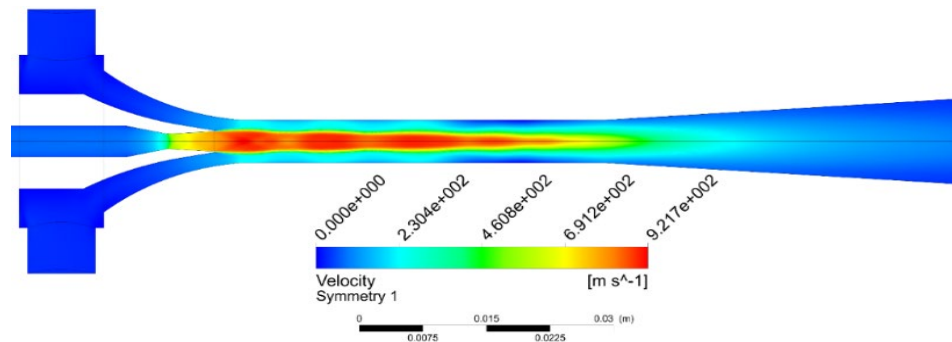

Velocity profile of vacuum ejector

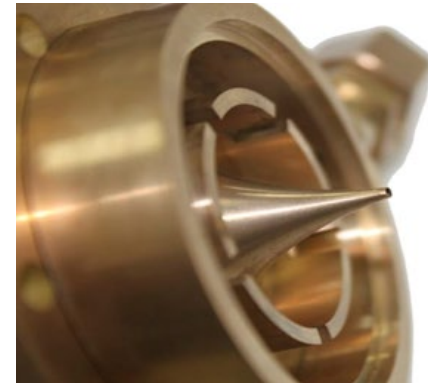

Ejector Nozzle

The steam ejector is the core of the technology that generates dynamic vacuum to intensify the drying process

Solution Approach

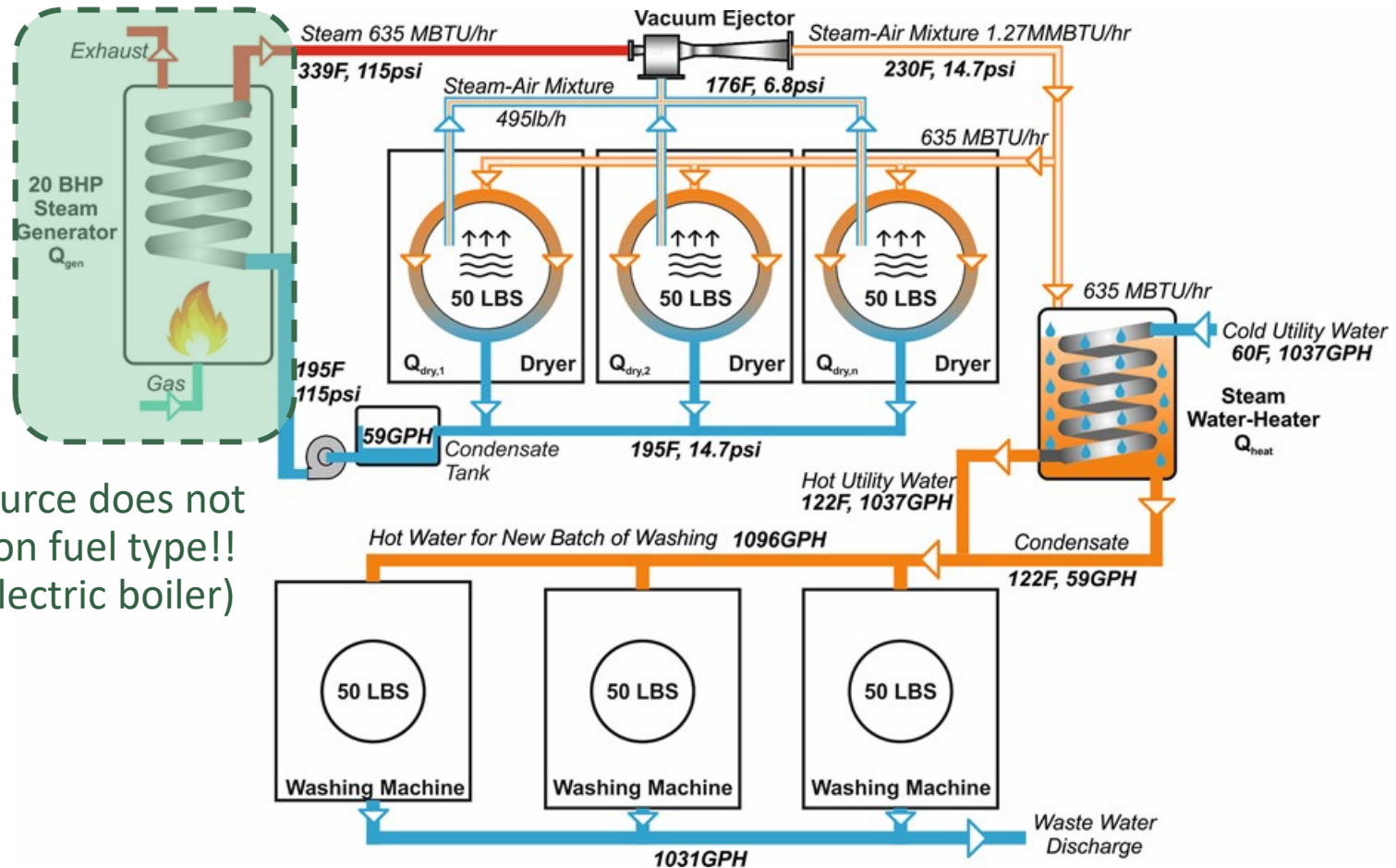

Steam source does not depend on fuel type!! (NG or electric boiler)

- The process heat (635 MBtu/hr) is fully recovered and utilized
- 60-100 GPH of hot water is harvested and re-used for washing
- Drying rate is 150 lb per load with drying time of 8 min

Solution Approach

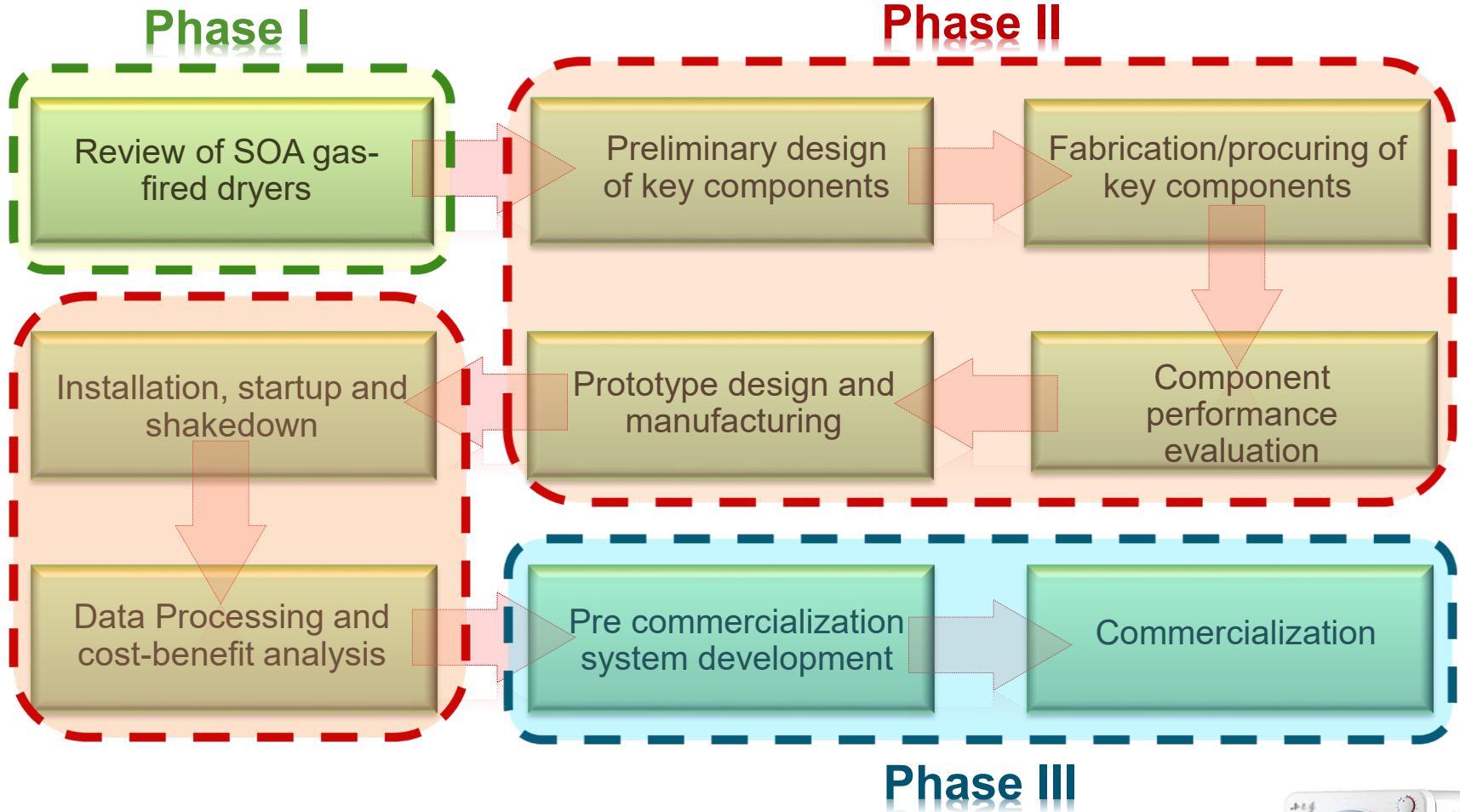

Phase II of the project will focus on two major sectors:

1. Commercial and industrial dryer
2. Residential dryer (multifamily and single family machines)



Project Impact

An improved clothes drying technology:

- Simplified design, improved reliability and durability
- 3-5 times longer life of clothes due to drying process accomplished at lower temperature
- 1.5 times higher combined energy factor (CEF)
- Easy industrial and commercial retrofits
- At least 0.2 Quad/year energy savings
- At least 50 Mt CO₂ emission reduction potential
- The technology is independent of fuel source- source of steam can be electric or natural gas

An energy efficient process for accelerated drying of clothes!!

Proof of Concept

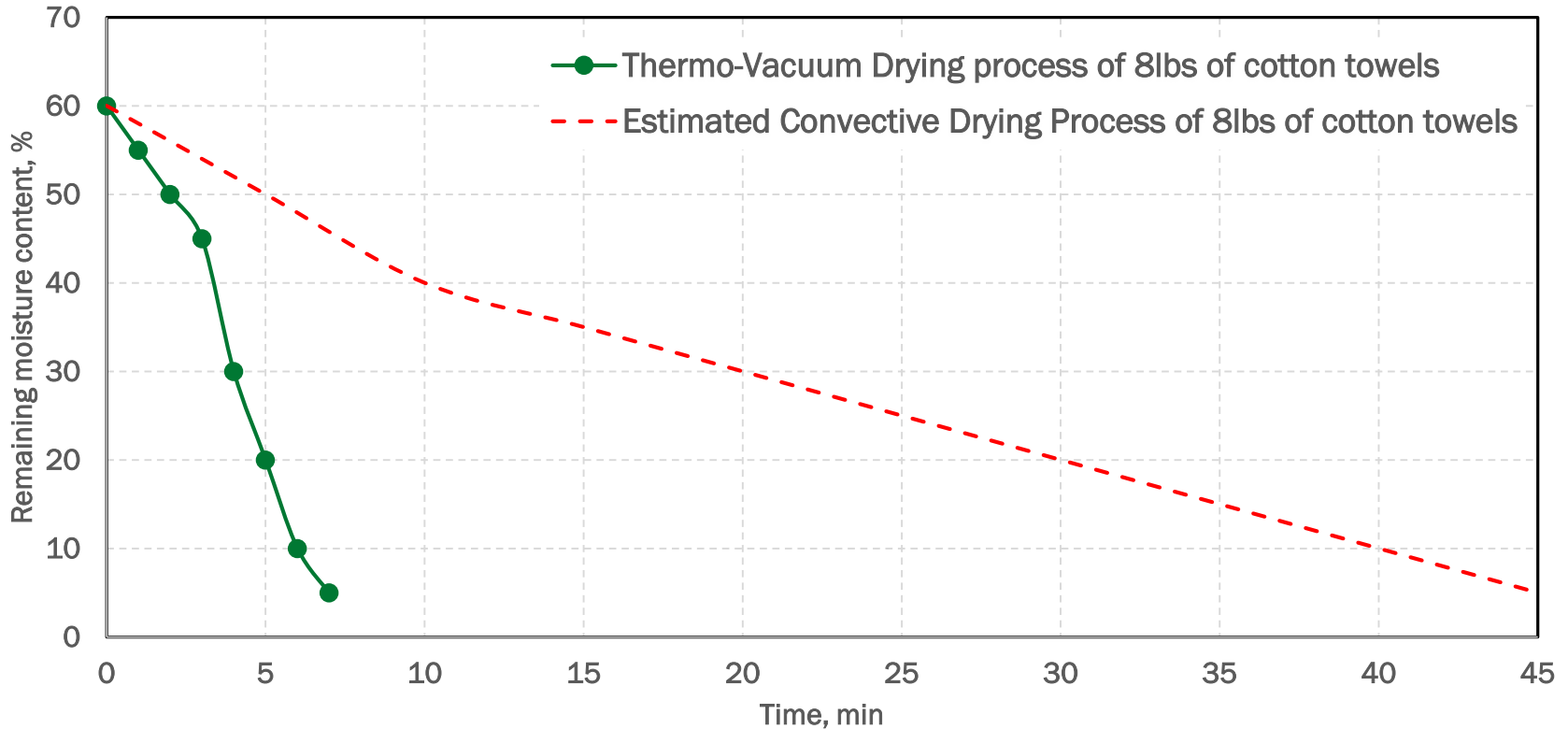

- Conventional drying (air convection) method requires higher drying time and energy input to heat the clothes, heat the air and power the air blower
- The drying rate depends on the moisture content in the clothes

Overview of Market Study

- Commercial and industrial laundries include a variety of facilities and services
- Each site may have from one up to dozens of dryer units
- Wide spectrum of the drying items of different moisture content



Facility Type	Typical Dryer Capacity, lb	Estimated No of Facilities	Source
Multifamily housing	18-50	300,000 - 600,000	DOE/Navigant Consulting (2009)
Coin-operated	30-120	29,500	Coin Laundry Association (2019)
On-premise laundries*	50-170	60,000	DOE/Navigant Consulting (2009)
Dry cleaners	50-170	22,558	US Economic Census (2012)
Industrial operations	200+	2,364	US Economic Census (2012)
*includes hospitality, health care, correctional facilities, live-in institutions, etc.			

Overview of Market Study

- Expected service life will depend on the particular application but is estimated to be between 7–14 years, with a wide range expected.
- Energy breakdown of a typical dryer cycle is roughly 90% for air heating and 10% for motor operation

- **Manufacturers within the US market include**

- Alliance Laundry Holdings (18–200 lb)
- American Dryer Corporation (30–400 lb)
- Braun (300–800 lb)
- Consolidated Laundry Machinery (165–1,200 lb)
- Continental Girbau Inc. (20–200 lb)
- Dexter (20–120 lb)
- Electrolux (small MF)
- GE (small MF)
- Pellerin Milnor (30–750 lb)
- Wascomat (20–135 lb)
- Whirlpool (small MF)



Project Progress

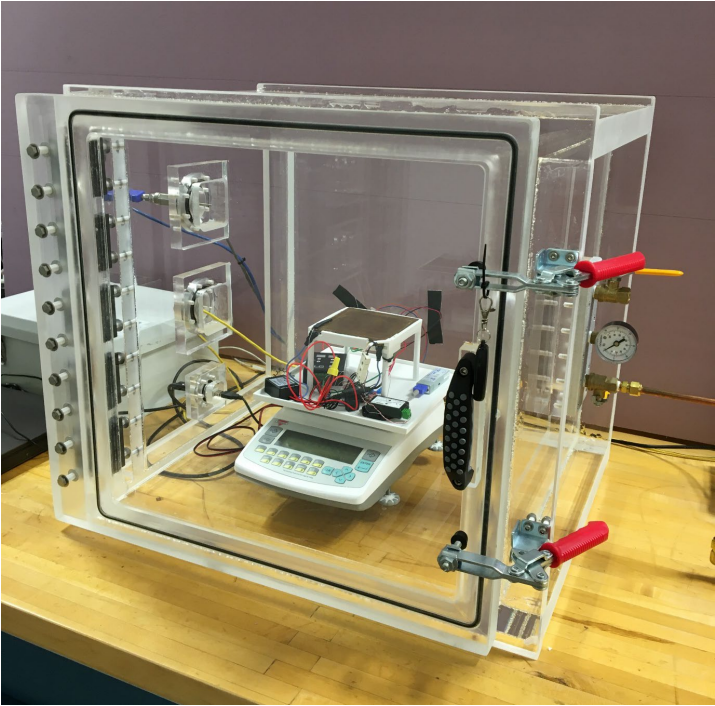

Fabric drying test in vacuum chamber



Static graphics

Project Progress

Test fabrics:

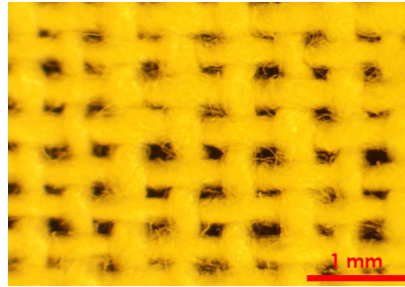

100% Cotton
(Type 1 Ballast)

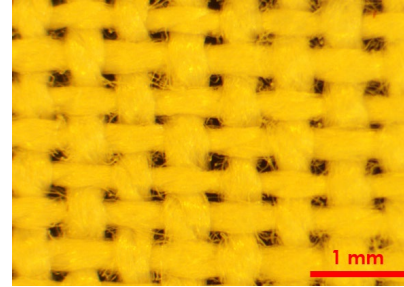

50%/50% Poly/Cotton
(Type 3 Ballast)

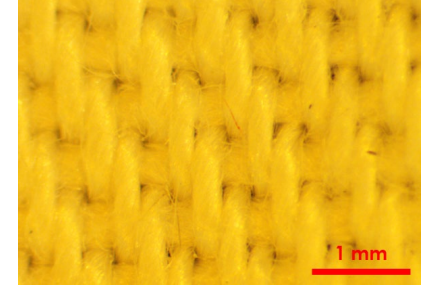

65%/35% Poly/Cotton
(Australian Ballast)

Experimental results:

- Drying curve of single layer fabric from 60% to 2%
- 50%/50% Poly/Cotton
- Various hot plate temperatures and drum pressures

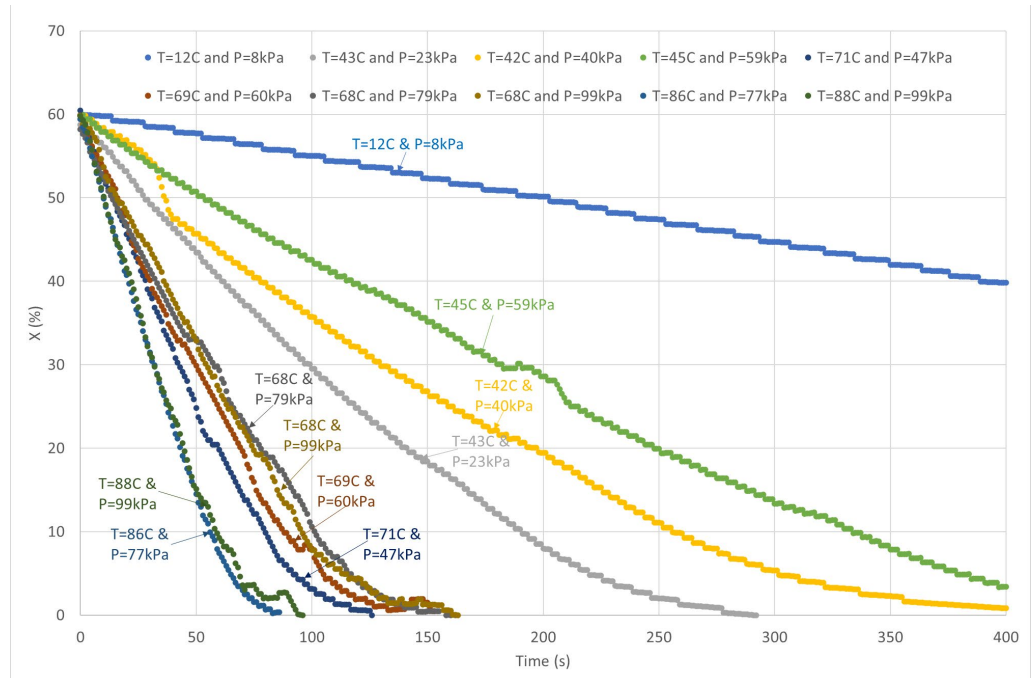

Project Progress

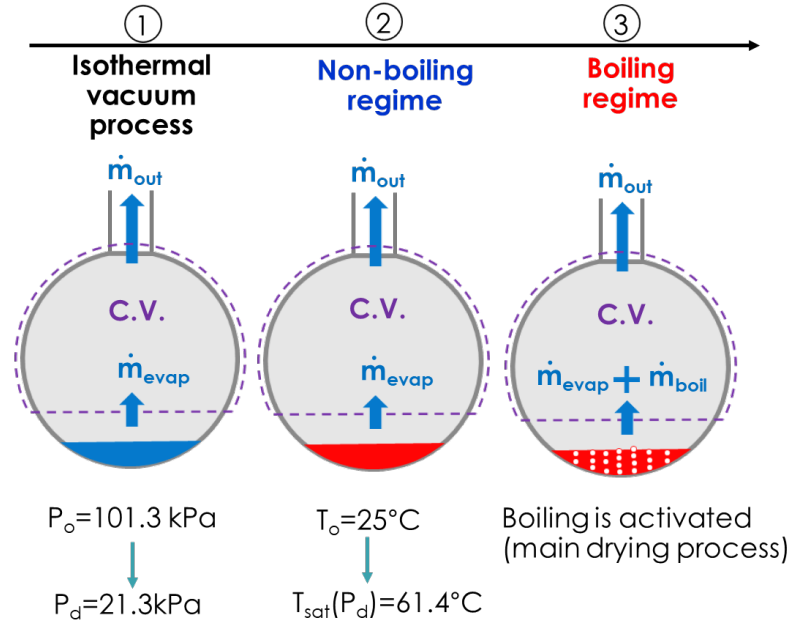
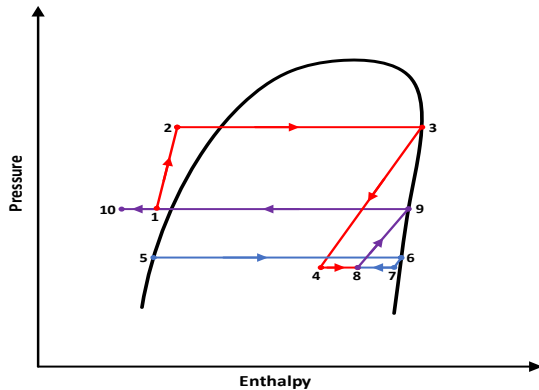
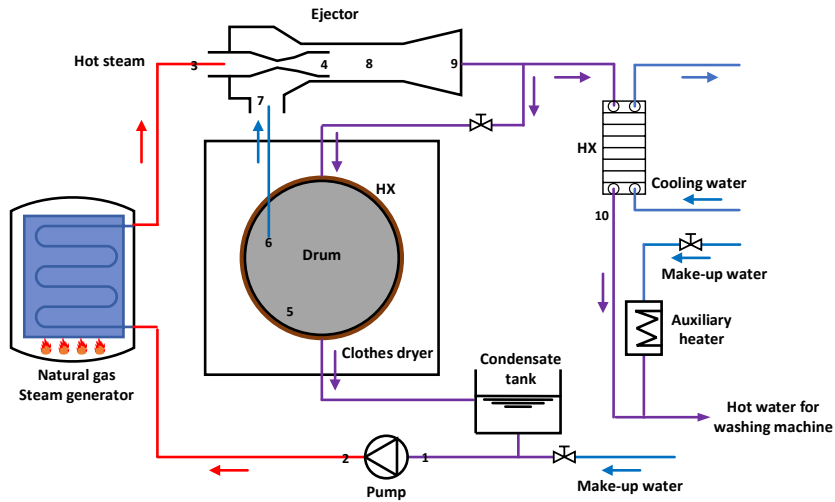

A three-stage model was developed to predict the transient vacuum drying process.

Project Progress

- Drying curve and pressure curve were simulated.
- Compared to convective dryer, TVCD takes around one-fourth of the time to dry the 3 lb textile from 70% to 2.5%.
- Effect of drum pressure on CEF and drying time

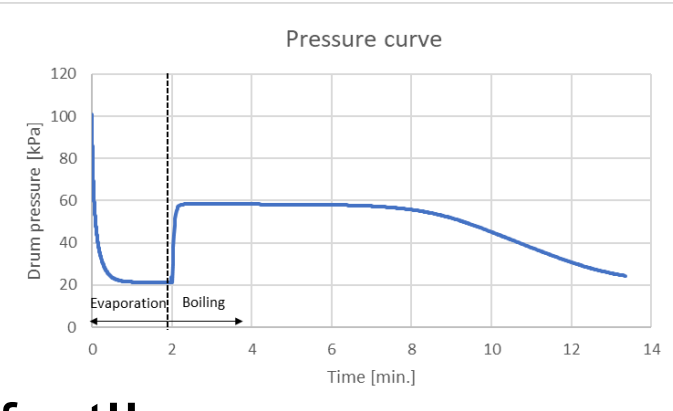
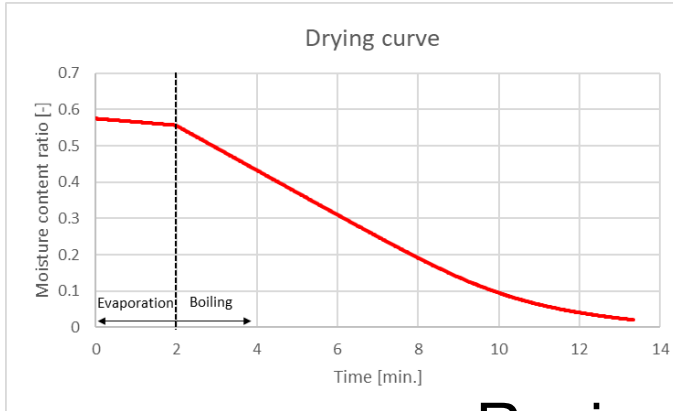

Revise font!!

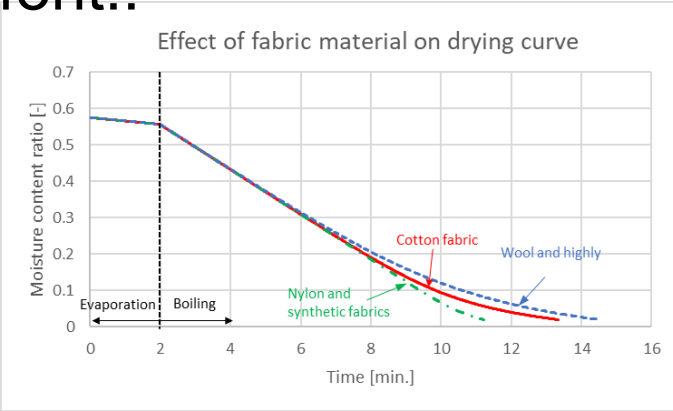
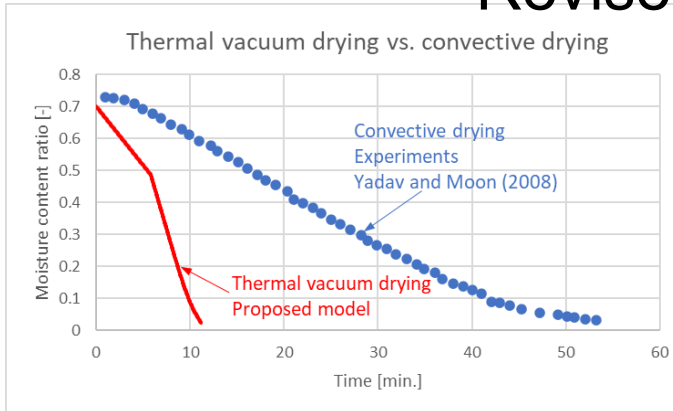

Project Progress

- Prototype of 8.45 lb residential thermal vacuum clothes dryer
- Copper coil wrapped around the metal chamber-steam heat exchanger
- Plastic chamber is pulled vacuum with mini- ejector

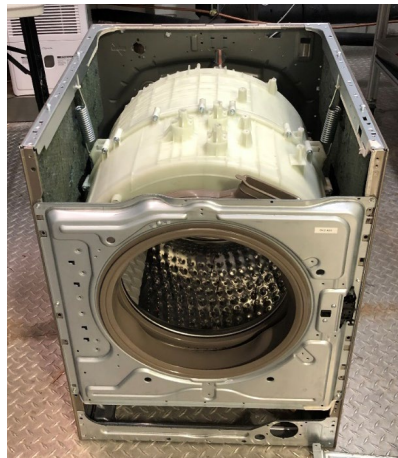
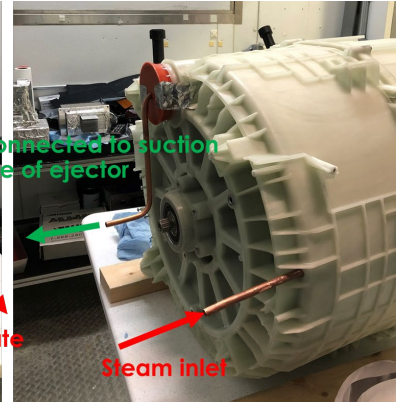
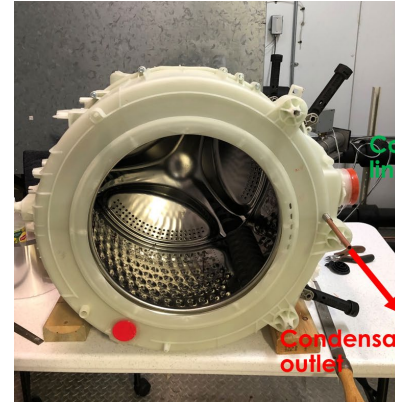

Project Progress

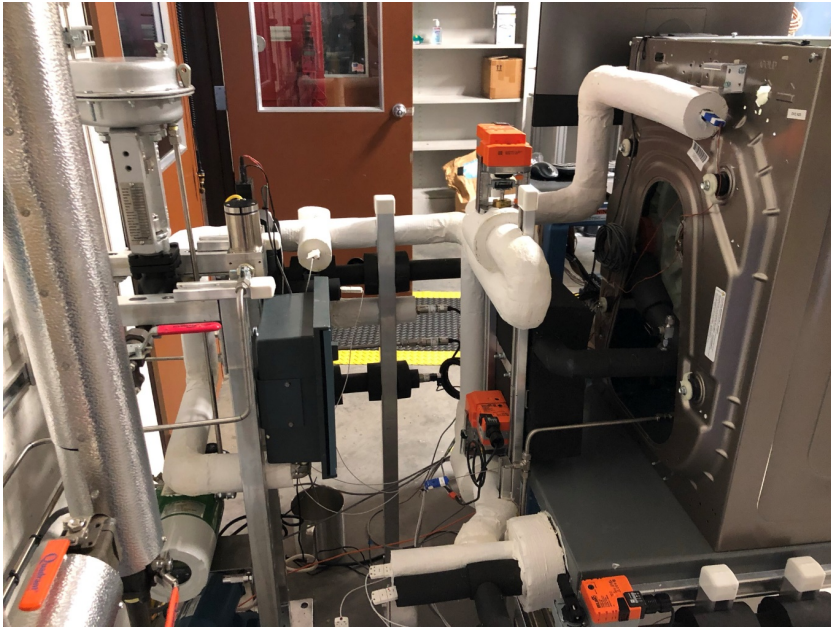

Experimental infrastructure for performance evaluation

Stakeholder Engagement

- **Development of the technology**
 - Participation of commercial laundries
 - Industrial visits and collaboration meetings
 - Analysis of industrial energy data
- **Collaboration with end-users**
 - Site visits and preliminary data analysis
- **Collaboration with OEM**
 - Strong interest in efficiency improvement
- **Meetings with experts at technical platform**
 - ASHRAE (TC 1.3)
 - ASME (IMECE, SHTC)
- **Publications**
 - C.M. Yang, K. Nawaz, W. Asher, B. Fricke, O. Buyadgie, D. Buyadgie, Y. Chudnovsky, Thermodynamic Analysis of Thermo-vacuum Clothes Drying Operation, 18th International Refrigeration and Air Conditioning Conference (2020), paper #2406.
 - W. Asher, K. Nawaz, C.M. Yang, B. Fricke, O. Buyadgie, Thermodynamic Analysis of Thermo-vacuum Clothes Drying Operation, 18th International Refrigeration and Air Conditioning Conference (2020), paper #2661.
 - A provisional patent has been filed on the technology.



Remaining Project Work

- Market assessment of clothes drying industry
- Preliminary design of components
- Fabrication and purchase of components
- Component level performance evaluation
- Prototype design and manufacturing
- Installation, startup and shakedown
- Performance data collection
- Cost benefit analysis
- Final reporting

Thank you

Oak Ridge National Laboratory

Kashif Nawaz

(Group Leader- Multifunctional Equipment Integration)

865-241-0792, nawazk@ornl.gov

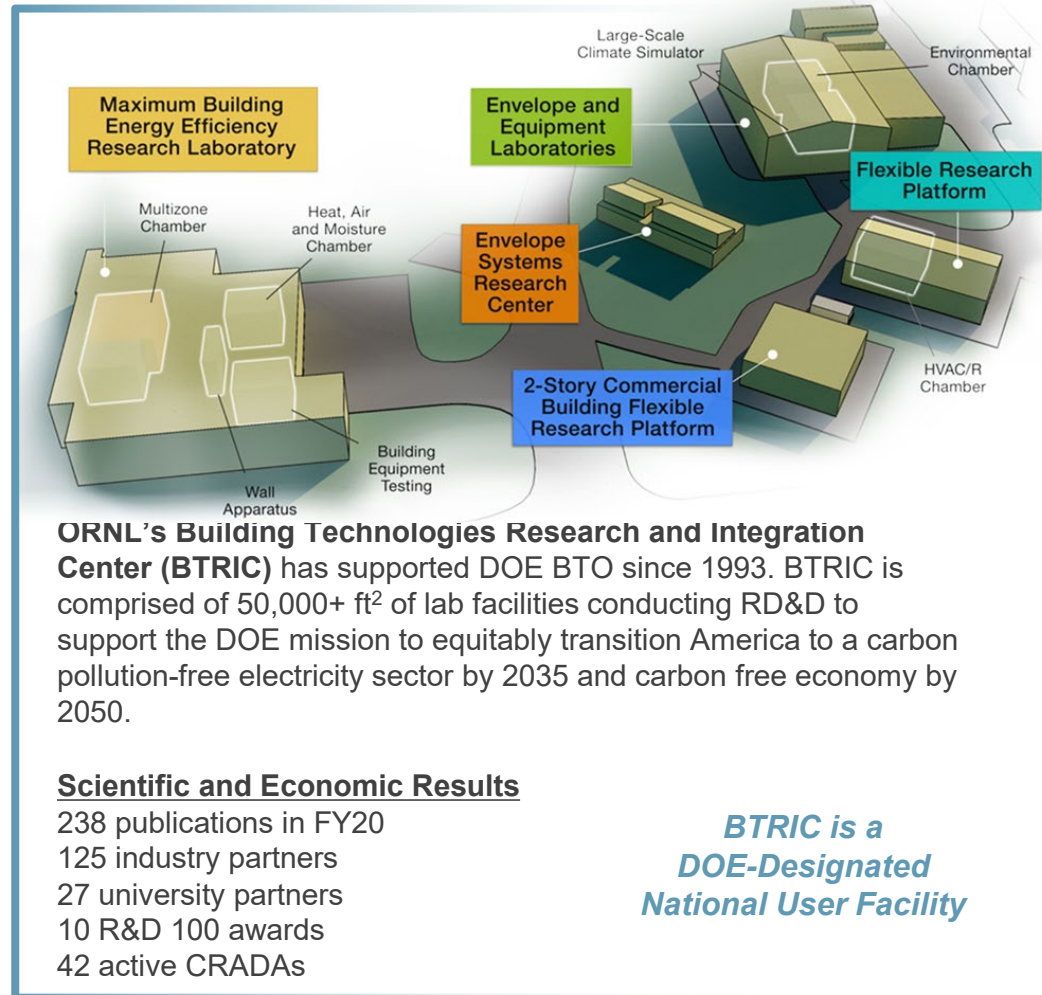

REFERENCE SLIDES

Project Budget

Project Budget: \$1.8M, \$100K cost share

Variances: None

Cost to Date: \$600K

Additional Funding: None

Budget History

FY2019 - FY 2020		FY 2021 (current)		FY 2022 (planned)	
DOE	Cost-share	DOE	Cost-share	DOE	Cost-share
\$600K	\$50K		\$50K	\$1,200K	\$150K

Project Plan and Schedule

Project Schedule												
Project Start: 10-01-2018	Completed Work											
Projected End: 09-30-2021	Active Task (in progress work)											
	◆ Milestone/Deliverable (Originally Planned)											
	◆ Milestone/Deliverable (Actual)											
	FY2019				FY2020				FY2021			
Task	Q1 (Oct-Dec)	Q2 (Jan-Mar)	Q3 (Apr-Jun)	Q4 (Jul-Sep)	Q1 (Oct-Dec)	Q2 (Jan-Mar)	Q3 (Apr-Jun)	Q4 (Jul-Sep)	Q1 (Oct-Dec)	Q2 (Jan-Mar)	Q3 (Apr-Jun)	Q4 (Jul-Sep)
Past Work												
Preliminary assessment of clothes drying market	◆											
Preliminary design of key components			◆									
Fabrication and design of key components					◆							
Component performance evaluation						◆						
Prototype design and manufacturing								◆				
Installation and shakedown testing									◆			
Performance data collection and reporting										◆		
Cost benefit analysis											◆	