



Lignin-First Biorefinery Development

Technology Session Review Area: Biochemical Conversion & Lignin Utilization

PI: Gregg T. Beckham, National Renewable Energy Laboratory

Project overview

Goal: Develop lignin-first biorefining for simultaneous biomass fractionation and lignin valorization

- Alternative to conventional pretreatment that could enable use of woody feedstocks in biochemical conversion
- Collaborate with Lignin Util (analytics, dimer catalysis), SepCon (solvent recovery), with Y. Román at MIT (catalysis)
- Started in FY18

Heilmeier Catechism:

- **Aim:** replace conventional pretreatment and enable feedstock-agnostic fractionation for carbohydrate & lignin valorization
- **Today:** pretreatment condenses lignin, limiting valorization options
- **Important:** lignin up to 40% of biomass carbon; its valorization is critical for biorefinery economics and sustainability
- **Risks:** Energy intensity, solvent recovery

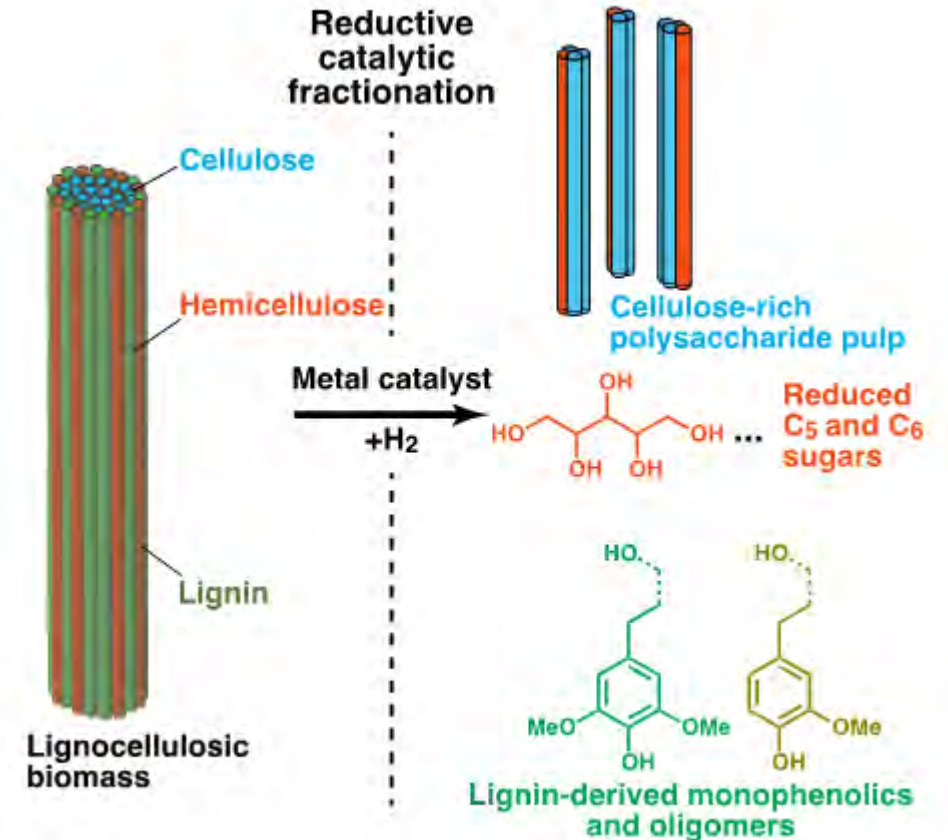

Image from Abu-Omar, Barta, Beckham, Luterbacher, Ralph, Rinaldi, Román-Leshkov, Samec, Sels, Wang, *Energy Env. Sci.* 2020

Management

- **Task 1: Reaction Engineering:** Catalysis & reaction engineering (D. Brandner, J. Kruger, Y. Román)
- **Task 2: Process Development:** Solvent screening & recovery, process design (G. Facas)
- Staffed by experts in chemical engineering and lignin chemistry



Project organization:

- Monthly project meetings (with MIT), 1-on-1 meetings with PI-staff members/postdocs
- Coordinate with Lignin Utilization (analytics, dimer valorization), SepCon (MW fractionation, solvent recovery), Biochem. Analysis (TEA/LCA)
- Ops & Project Managers – labs, equipment, reporting, finances



Risks:

- Current RCF paradigms are expensive and energy-intensive – use analysis to inform R&D
- Solvent use, continuous processing – new reactor designs enable efficiency gains



Key elements of our approach:

- Use TEA and LCA to prioritize R&D – differentiates this project based on *process development*
- Focus on catalyst and process development to demonstrate process viability
- Employ batch, flow, and continuous reactors depending on the question, use hardwoods
- Use advanced catalyst characterization tools, modeling, and microscopy as needed
- Current R&D focus is on *process*, not specific *product*

Challenges:

- Solvent-based processes require recovery and recycling to be viable
- Vast potential product slate to consider

Major milestones, Go/No-Go Decisions:

- FY21: RCF catalyst stability ($\geq 3x$ Ni/C benchmark)
- FY22 G/NG: Develop continuous RCF to enable 4-5 L solvent/kg biomass metric
- FY23: Valorize $\geq 60\%$ wood lignin (with LigU)

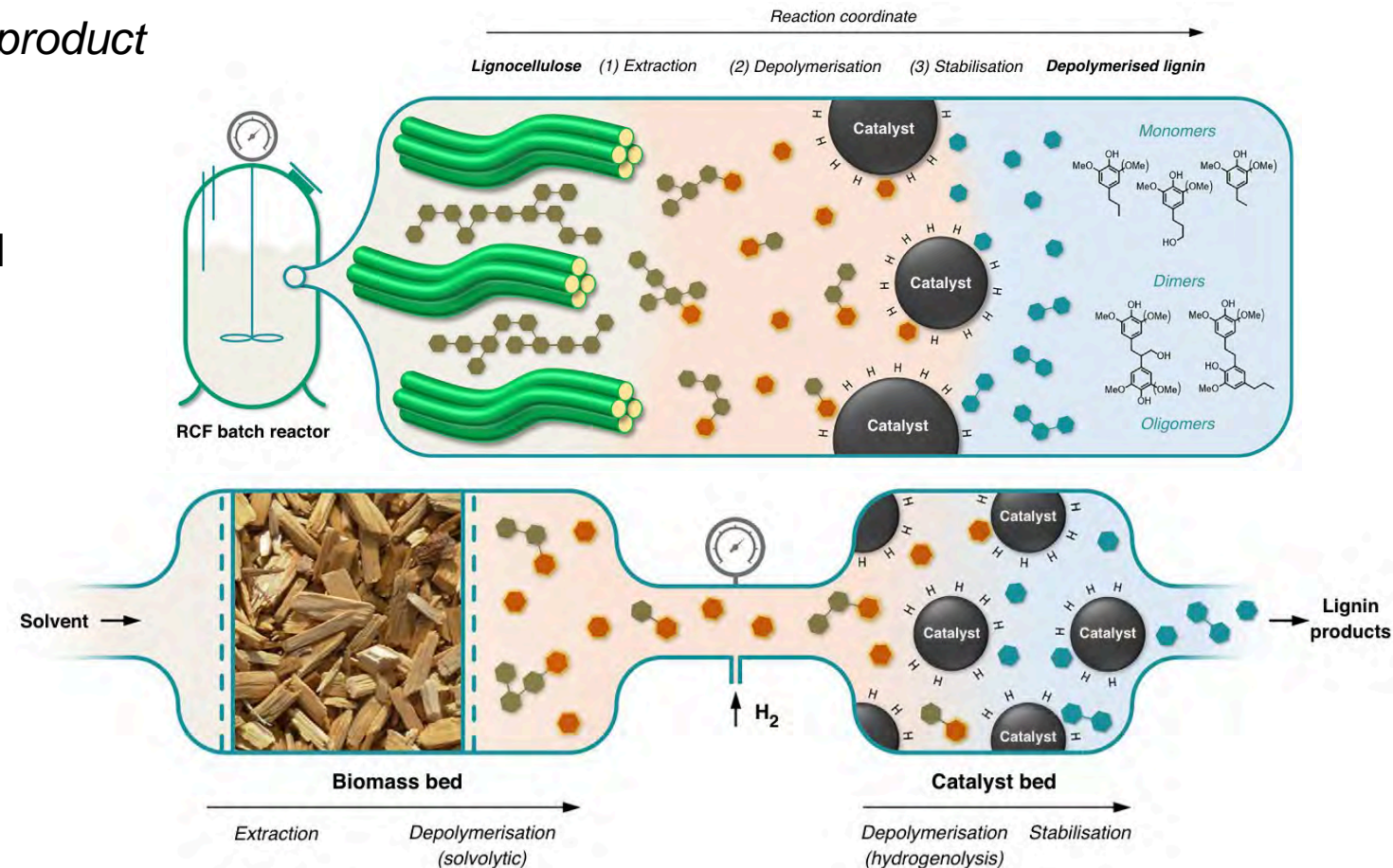

Impact

Scientific:

- Lignin-first biorefining gaining traction because RCF is “catalytic funneling” – high monomer yields attainable from native lignin
- RCF could leverage existing pulp and paper equipment
- Collaborations with leading groups in the community (e.g., “guidelines” paper)

Industrial:

- Pursuing proposals with scale-up partners
- Work with ExxonMobil to evaluate feedstocks
- Interactions with industry directly inform project

ExxonMobil

Overall:

Lignin-first efforts can improve carbon conversion efficiency in feedstock-agnostic biochemical conversion

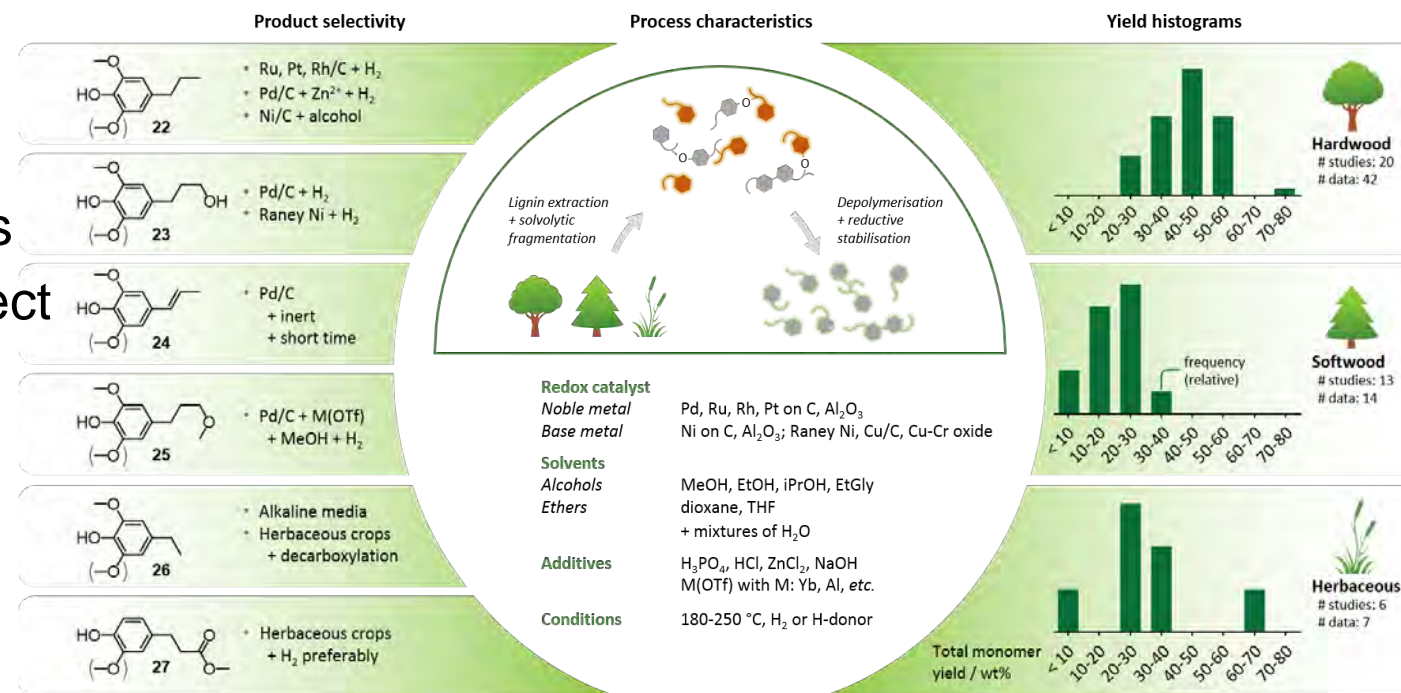

Progress and Outcomes

Outline

- Process modeling, TEA, LCA
- Transport phenomena in RCF
- RCF in a flow-through setup
- Native lignin production
- Catalyst stability and regeneration
- Continuous RCF processing
- Transitioning to higher boiling point solvents
- Work with SepCon for membrane fractionation
- Guidelines for lignin-first biorefining

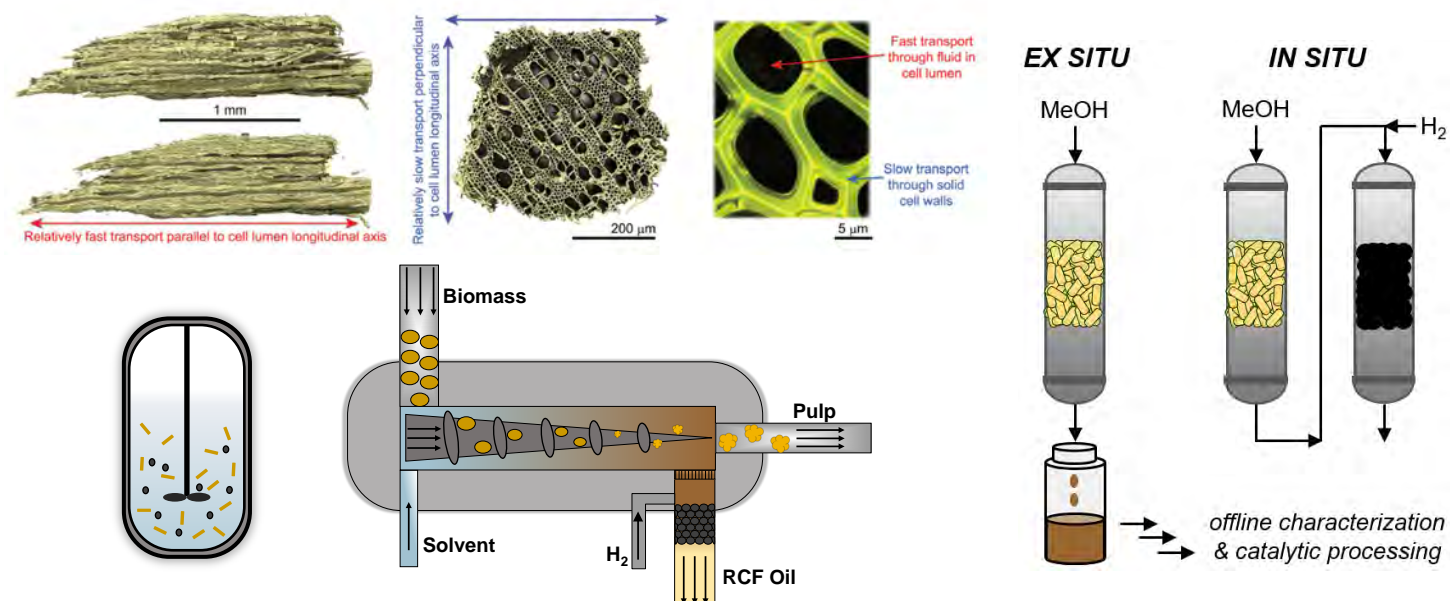
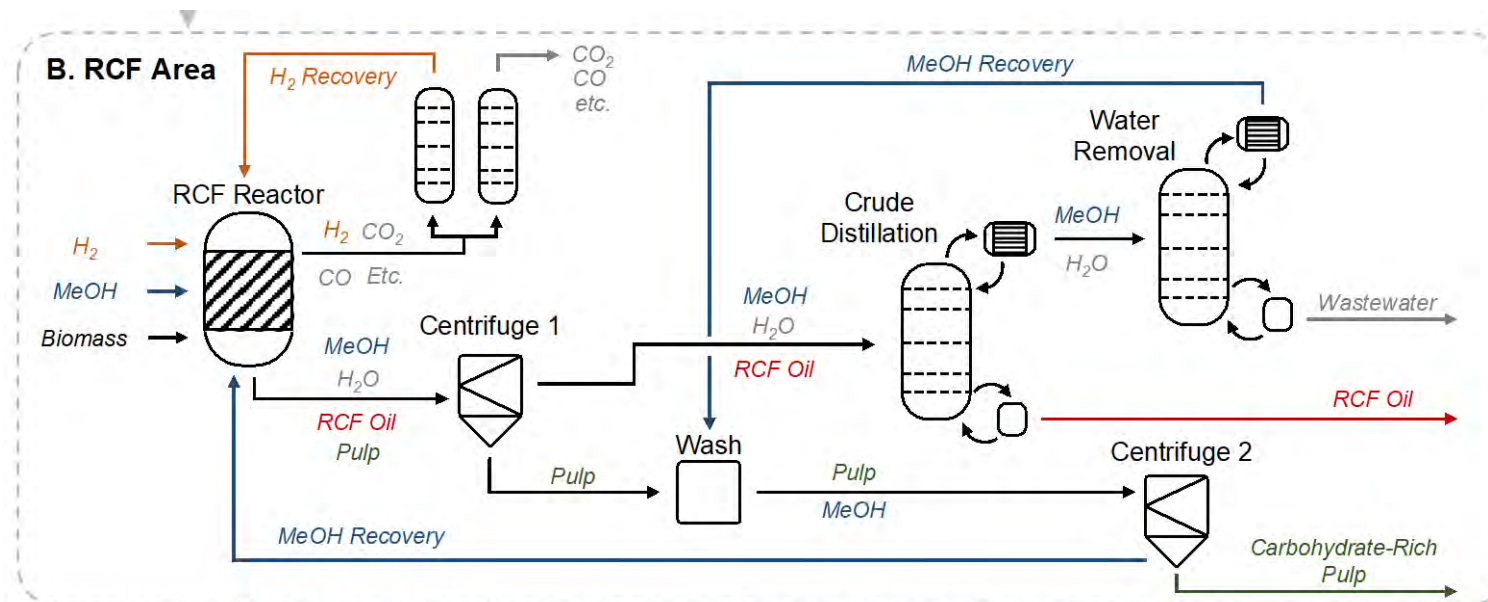

A. Overall Block Flow Diagram

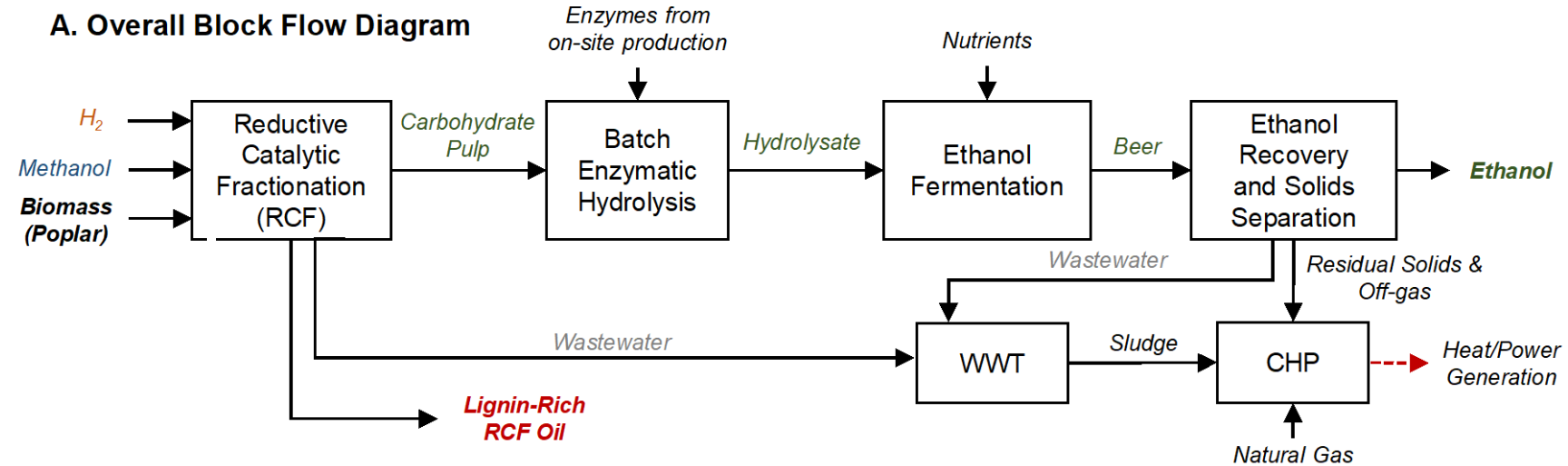

B. RCF Area

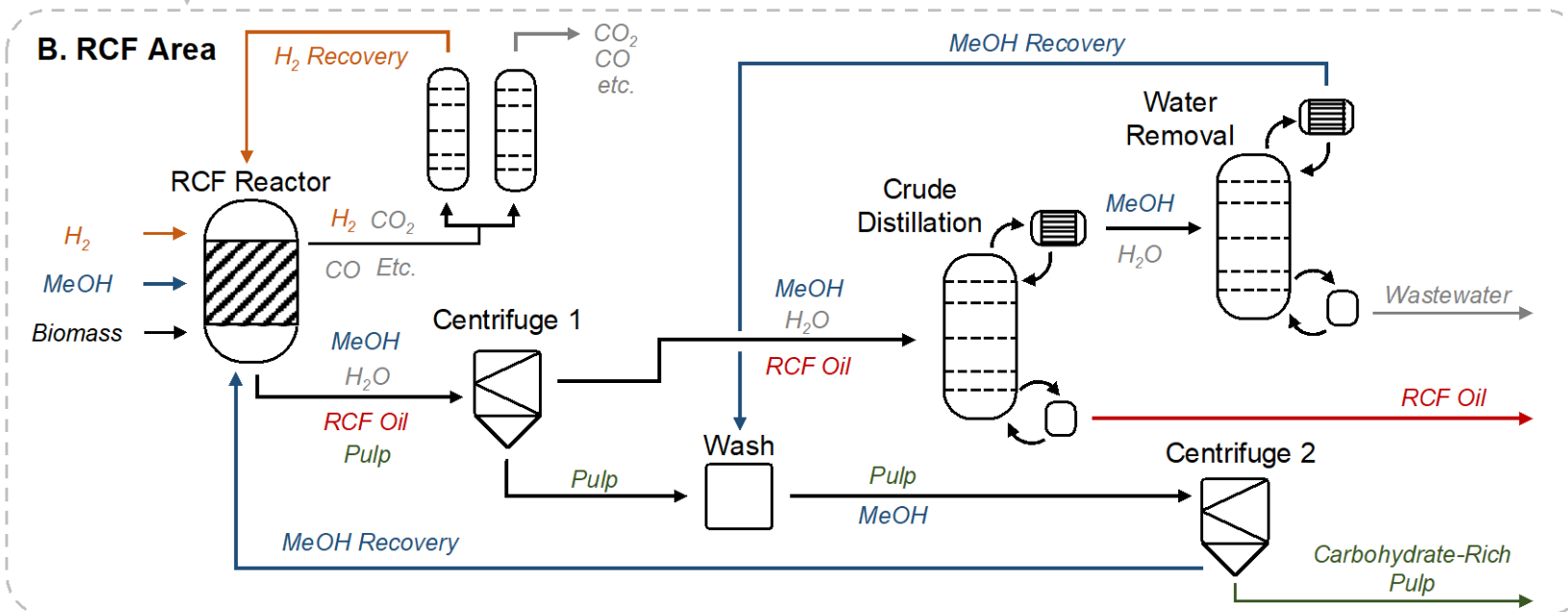

Process model for RCF:

- Humbird 2011 cellulosic EtOH model as basis
- Replaced dilute-acid pretreatment with RCF
- Fixed EtOH price at \$2.50/gge
- Product = RCF oil
- Base case model: MeOH & H₂
- Sensitivity cases around process variables, solvents, and process configurations
- Previous work demonstrated that polysaccharides are enzymatically digestible

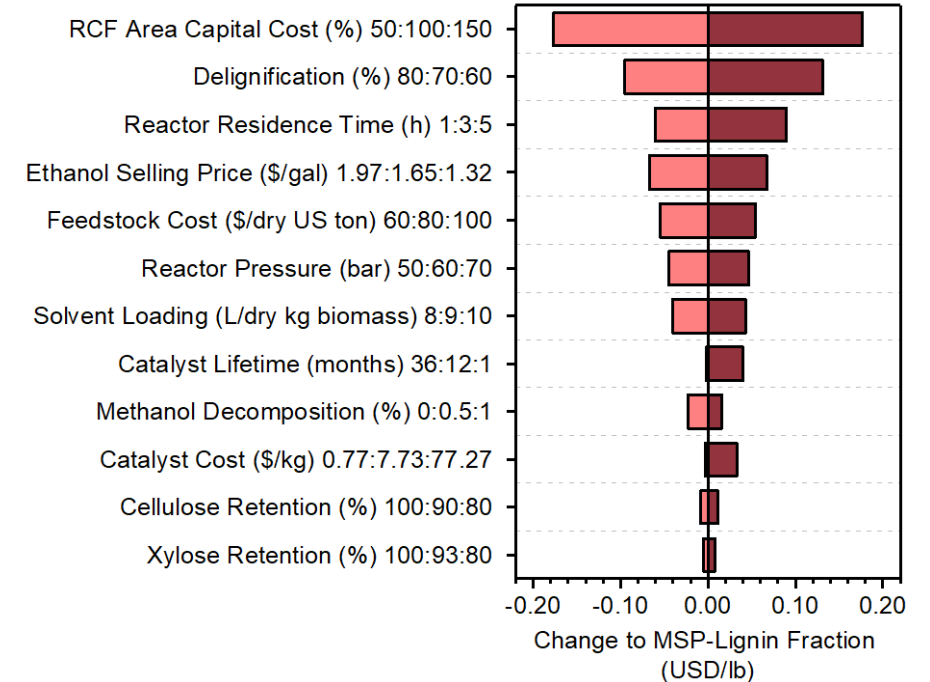
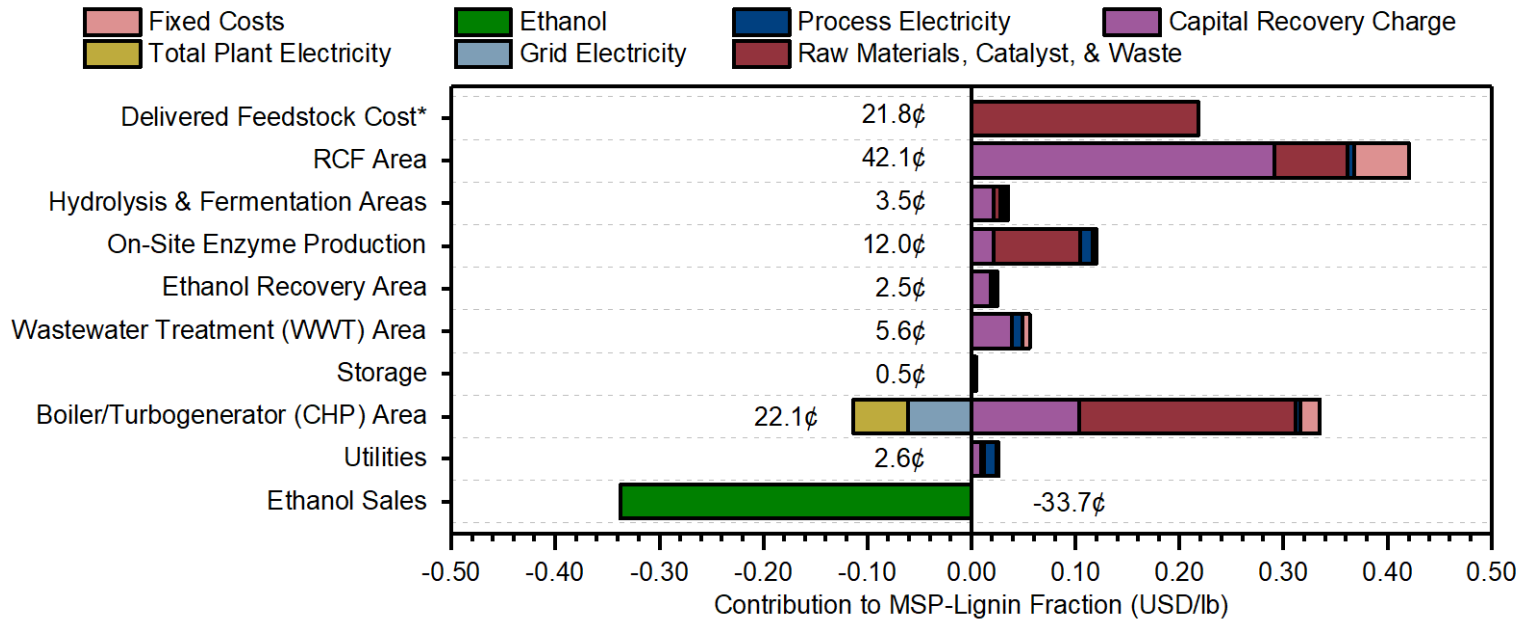

RCF – as commonly practiced in the lab – is expensive (57% total CapEx, 35% OpEx)

- Pressure is a main cost driver – MeOH pressure~750-1,000 psi – suggests shift on lower vapor pressure solvents, shorter residence times, and hydrogen-free operation
- Common foci of RCF studies, such as catalyst cost and polysaccharide retention, not major cost drivers (within studied ranges)

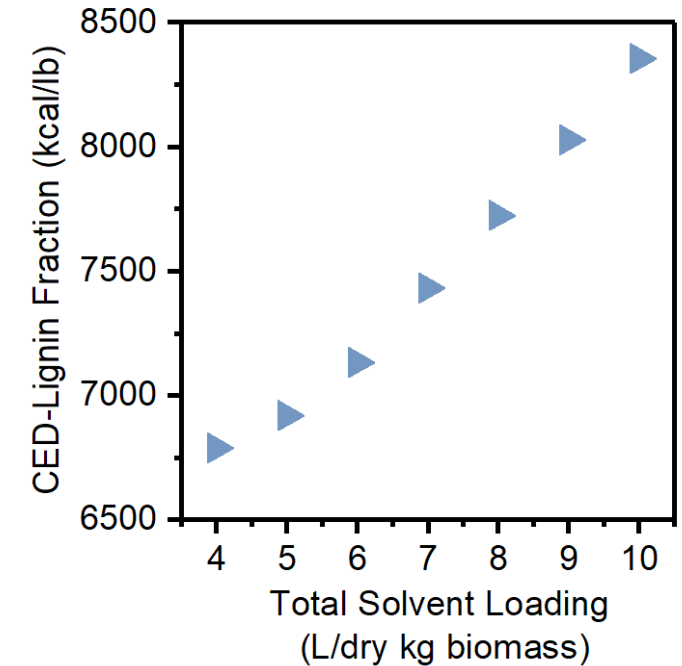
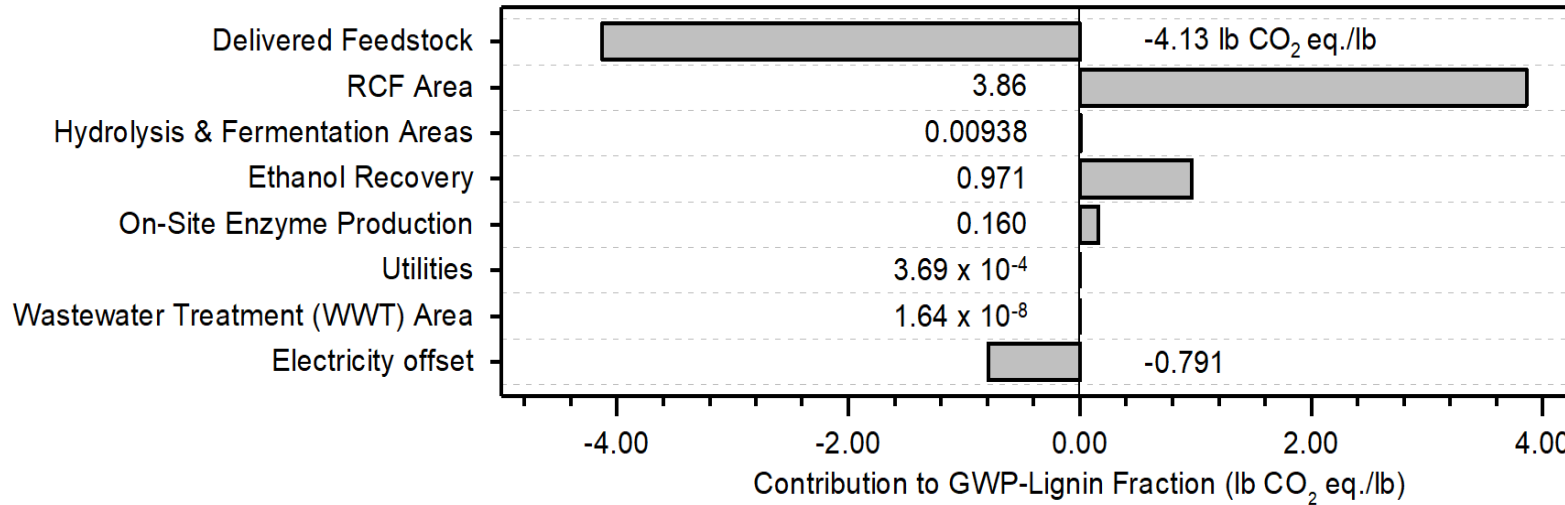

RCF – as commonly practiced in the lab – is energy intensive (73% of biomass LHV)

- Solvent is key for MSP, global warming potential (GWP), and cumulative energy demand (CED)
- Membranes in place of distillation could reduce energy demand to ~25% of biomass energy content
- Suggests use of condensed phase separations (work with SepCon)

Transport phenomena of the RCF process

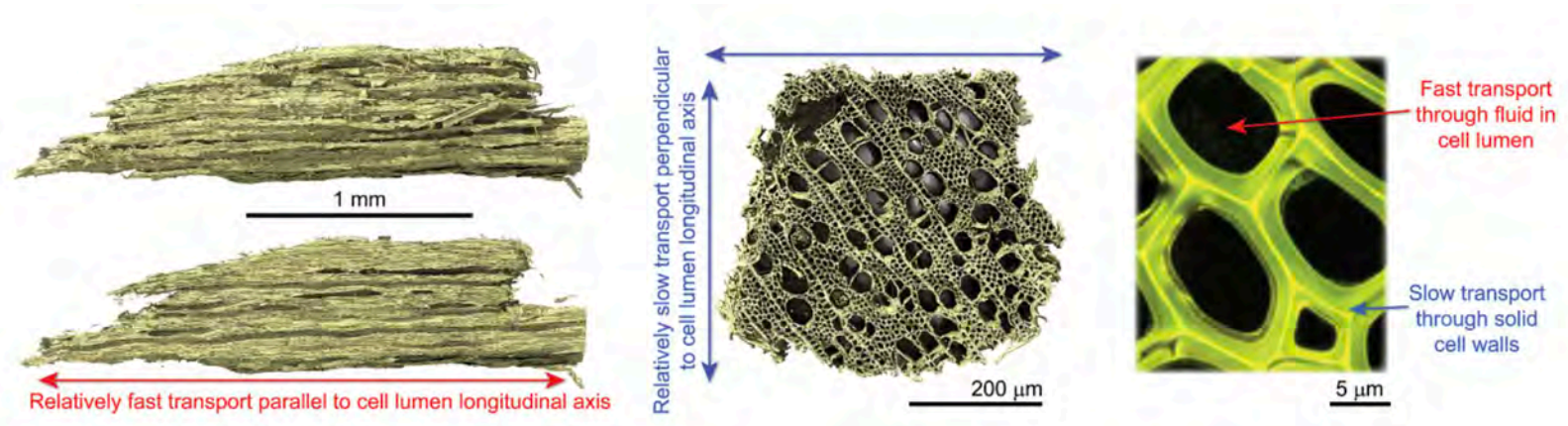

Extraction experiments, microscopy, and CFD modeling to elucidate transport effects in poplar solvolysis

- Simulation framework built to determine intrinsic kinetic parameters for lignin solvolysis
- Mass transfer predicted to dominate solvolysis in poplar particles ≥ 2 mm in length
- Study denotes that RCF will likely always be mass-transfer limited at the industrial scale

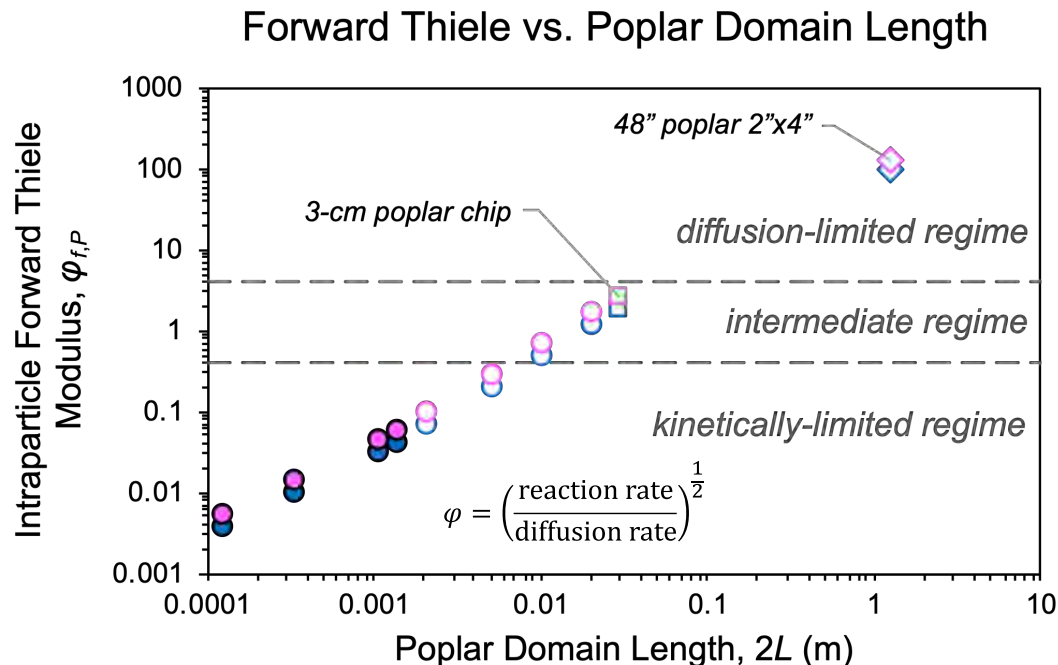

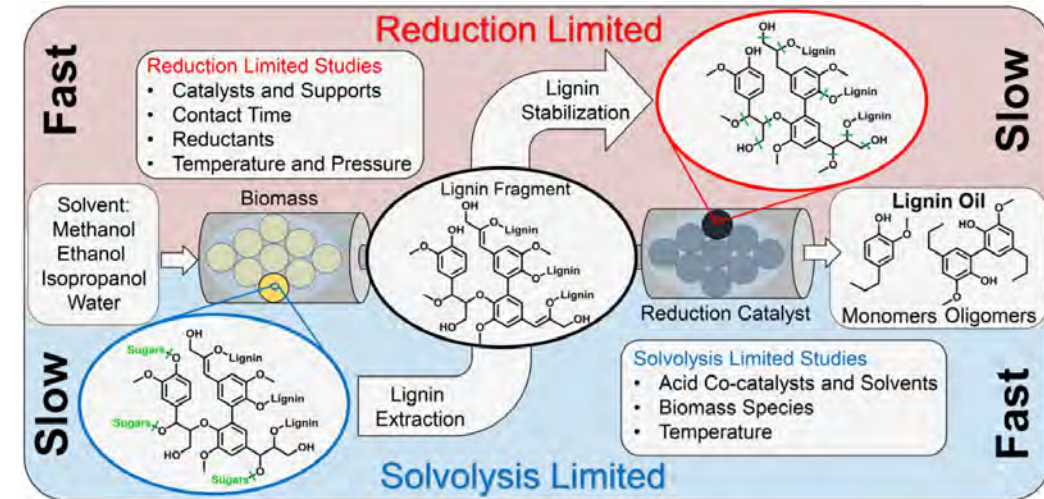

Flow-through RCF allows precise study/optimization by separating solvolysis and hydrogenolysis

- Simplified characterizations of catalysts and biomass
- Programmed reaction steps allow multiple solvolysis/catalysis protocols

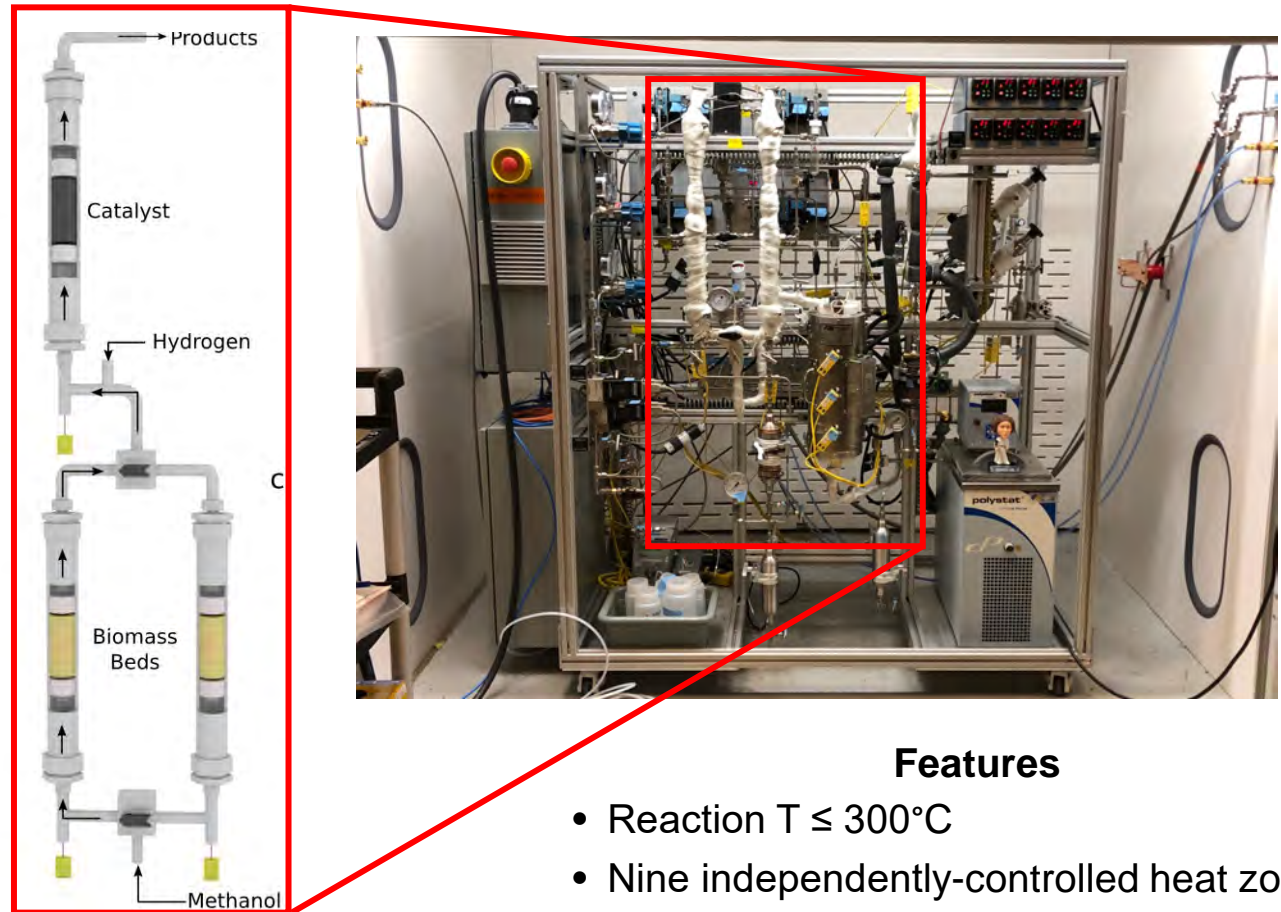

Features

- Reaction $T \leq 300^{\circ}\text{C}$
- Nine independently-controlled heat zones
- Operating $P \leq 2000$ psig
- Biomass beds ≤ 5 g
- Gas flow rates ≤ 4000 sccm
- Liquid flow rates ≤ 10 mL/min
- Designed/interlocked for safe operation

Flow-through solvolysis with MeOH produces shelf-stable, native-like lignin

- Monomer yields from *ex situ* solvolysis and hydrogenolysis match *in situ* yields
- Solvolysis liquor (in MeOH) stable for at least 5 weeks at 25°C
- Enables continuous evaluation of catalyst activity
- Will be useful for studying fundamental lignin properties

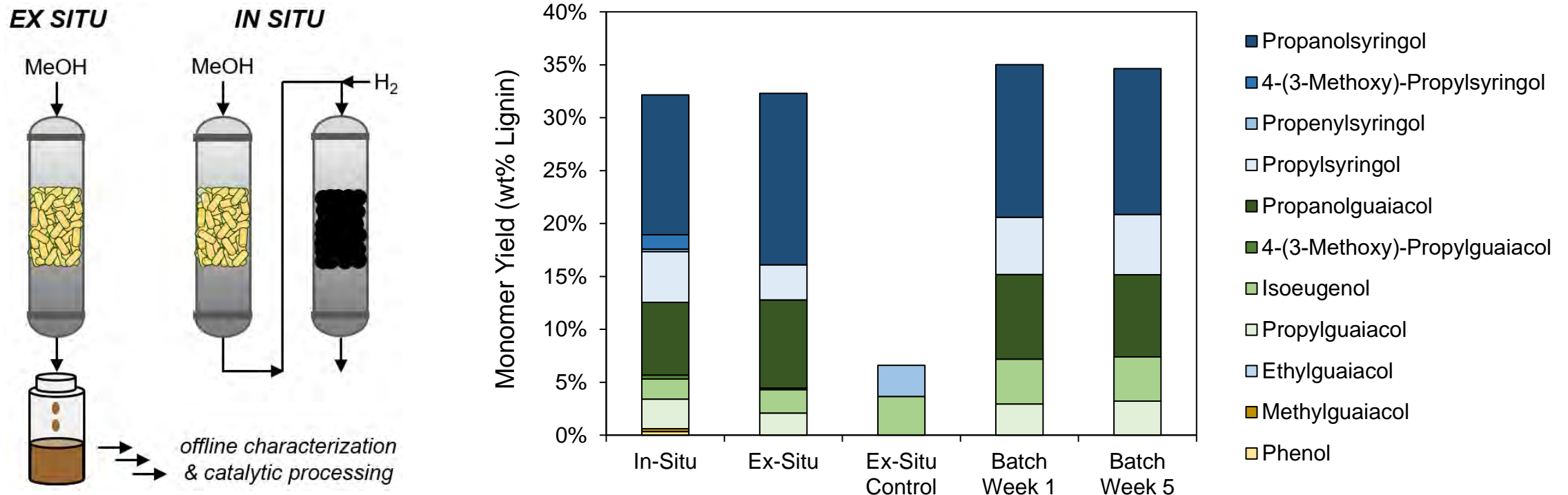

Catalyst stability and regeneration

Baseline C-supported catalysts have major drawbacks

- Ni/C deactivates by sintering, fouling, leaching, oxidation
- TEA suggests catalyst must be stable ≥ 1 month
- Leverage ability to produce native-like lignin to screen new catalysts in batch and study stability in flow
- **Current direction:** Screening Ni and Ru catalysts on oxide supports

Ni/C particle size distributions from TEM

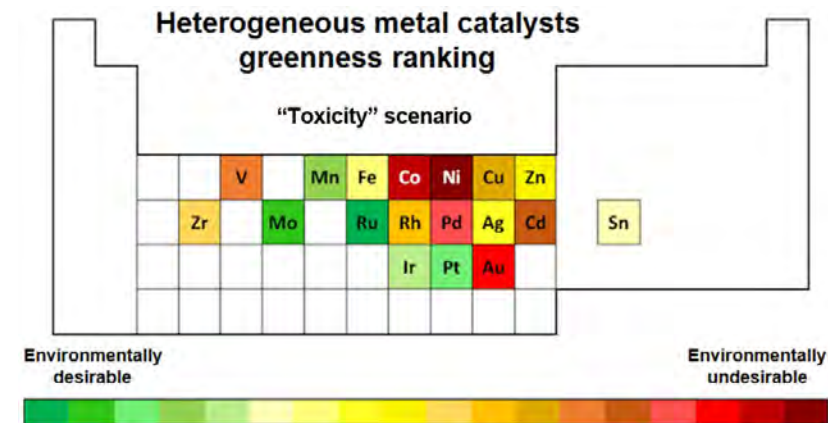
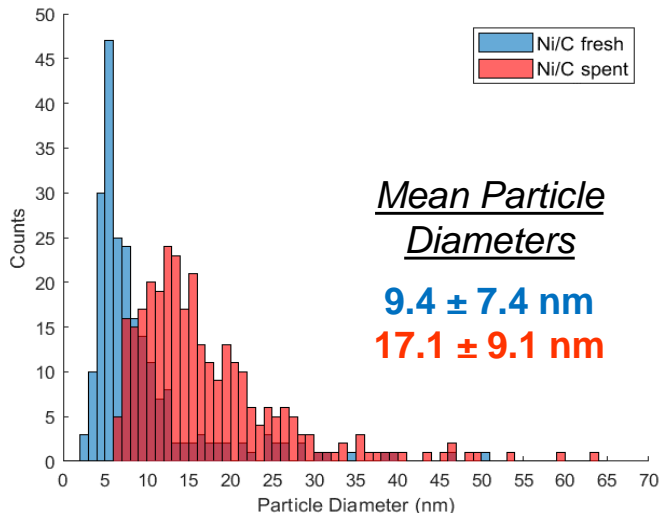

¹Bystrzanowska *et al.*, *ACS SusChemEng*, 2019, 7:18434-

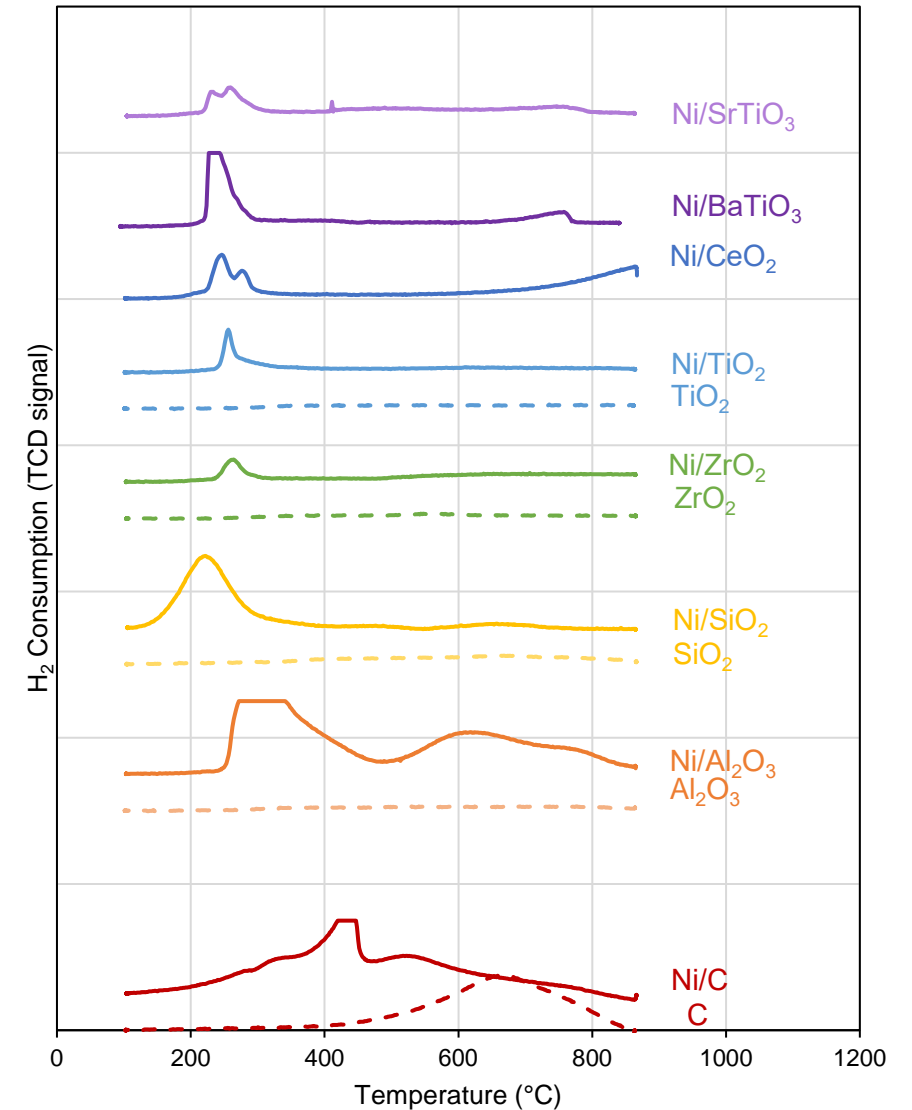

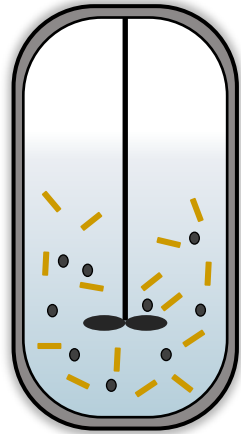

Moving towards continuous RCF processes

Reported RCF reactor configurations



Batch operation:

- Biomass, solvent, & catalyst mixed
- Moderate solvent load (~10 L/kg)
- Difficult solids recovery
- Low throughput

Biomass 
Catalyst 

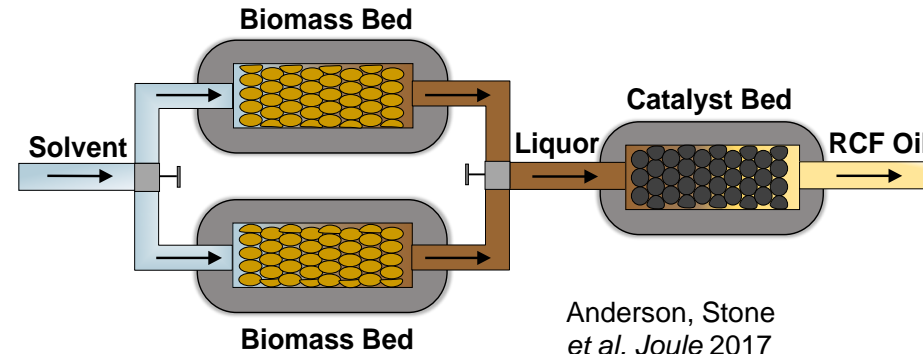

Flow-through operation:

- Solvent flowed over separate biomass & catalyst beds
- Simple biomass & catalyst recovery
- High solvent demand (~100 L/kg)
- Semi-continuous process
 - Beds must be replenished

Current direction: Continuous operation at low solvent load

Extrusion-based processing:

- Biomass & solvent conveyed by twin-screw extruder
- Pulp and liquor separated by extruder die
- RCF oil produced with separate downstream catalyst bed
- Low solvent demand (~3-5 L/kg)
- Simple pulp & catalyst recovery
- Fully continuous process
- Mechanical energy can improve mass transfer for solvolysis

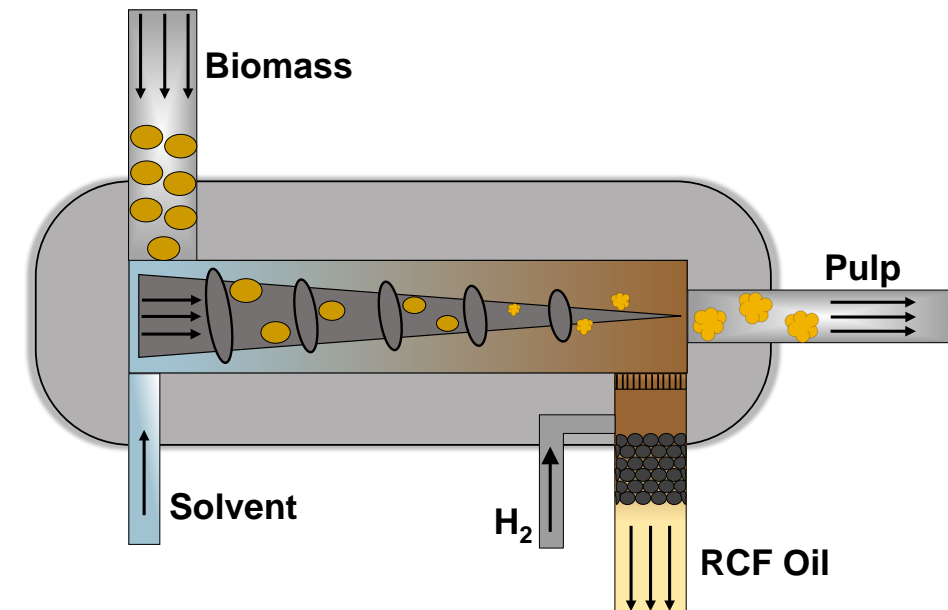

Moving towards continuous RCF processes

Extruder experiments show promise for lignin solvolysis with low solvent loadings

- Bench-scale extruder system with solid-liquid separation via extruder die at outlet
- Have achieved accurate mass closures at multiple extruder operating conditions
- Analysis ongoing currently for composition and lignin extraction extents

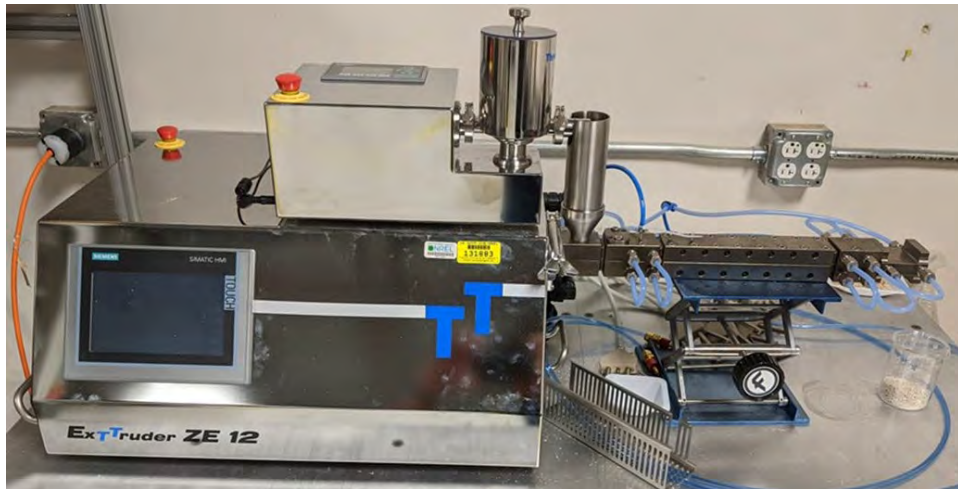

Complete mass balance closure over multi-hour operation

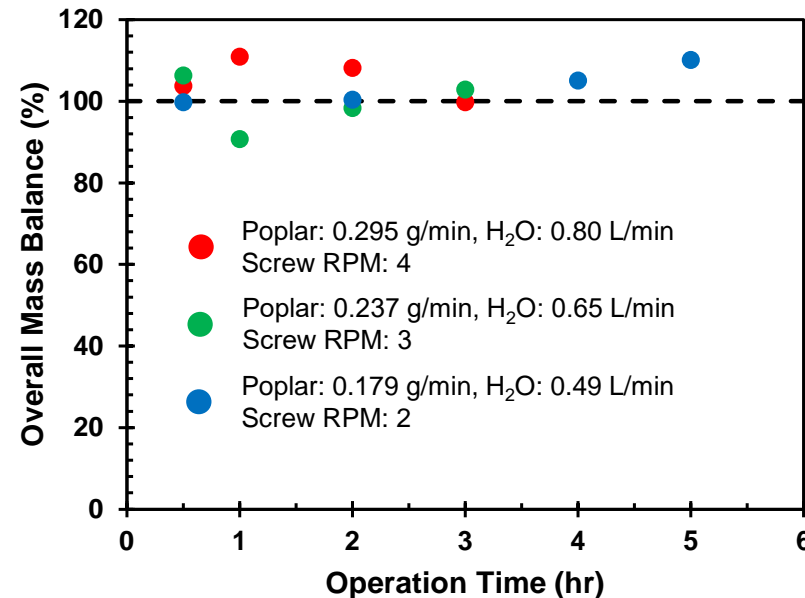

Extrusion liquor has similar consistency to typical solvolysis liquor



Extrusion produced liquor
Left: Room temperature operation
Right: 200°C operation

Transitioning to higher boiling point solvents

Low BP solvents have unfavorable economics and energy demand:

- Vapor pressure of MeOH at RCF T ~750-1,000 psi
- High CapEx needed to operate at these pressures
- MeOH must be boiled 2x to recover from RCF oil & H₂O
- 73% of energy from starting biomass is used

High BP solvents allow for milder conditions:

- Vapor pressure at RCF T ~ 15 psi
- Similar RCF yields with EG as solvent
- **CapEx reduced by 28% with EG**
- **Current direction:** Work with SepCon to recover EG via alternative strategies

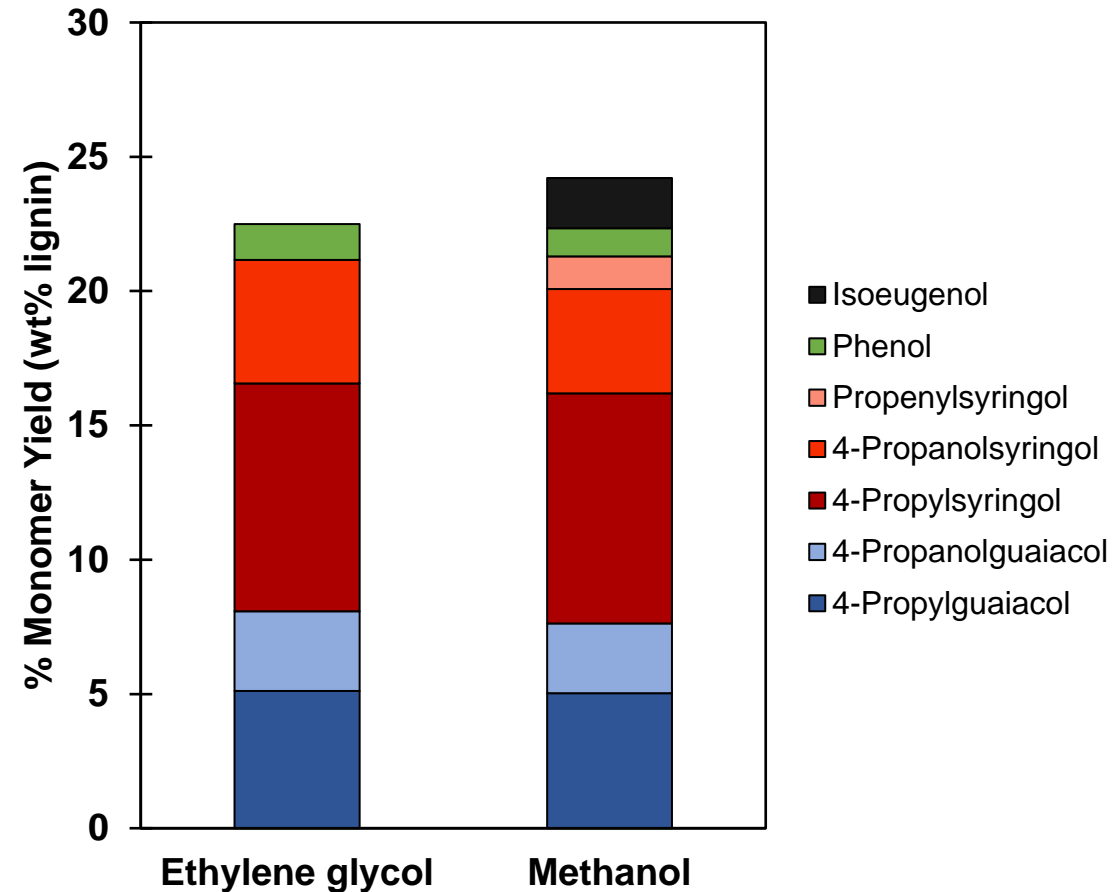

225°C, 1 g poplar, 100 mg 5 wt% Ru/C, 20 mL solvent

Separations of RCF oil

RCF scaled-up 20x (2 gallons) to produce RCF oils in sufficient quantity to explore membrane separations

- Membranes may be feasible alternative to distillation for recovering lignin oil and monomers
 - TEA and LCA suggest distillation is not feasible
- Monomer yields similar to those at smaller scale
- Multiple L RCF oil batches delivered to SepCon – work ongoing

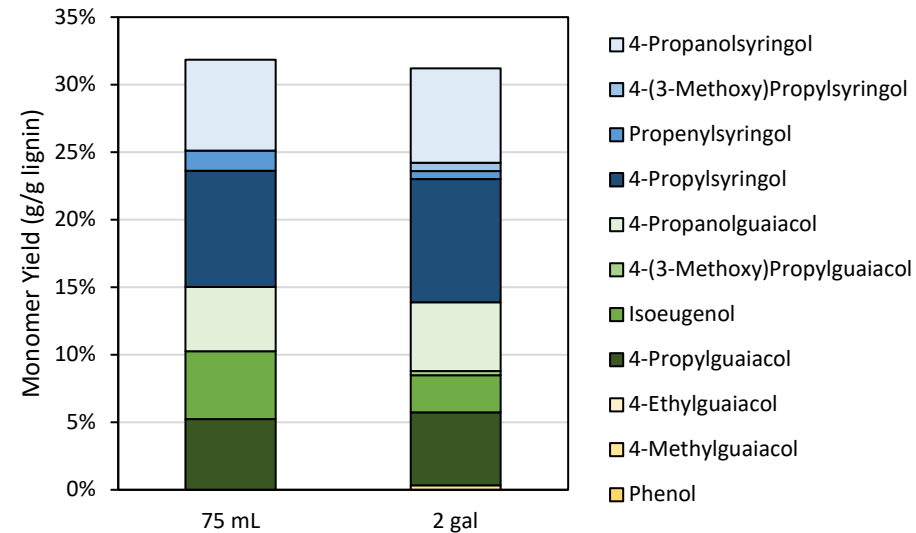
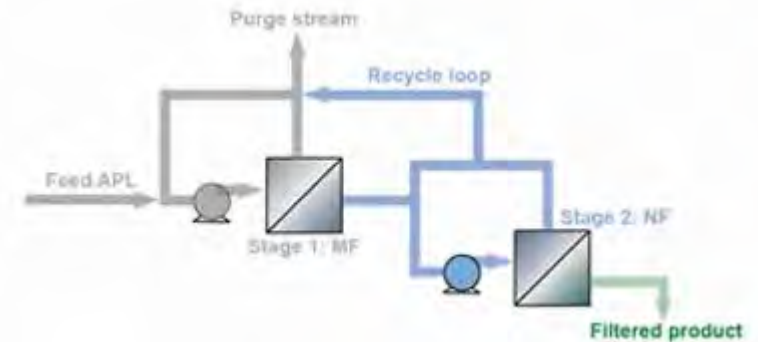

Guidelines for lignin-first biorefining

Energy &
Environmental
Science



PERSPECTIVE

Check for updates

Guidelines for performing lignin-first biorefining

Cite this: DOI: 10.1039/d0ee02870c

Mahdi M. Abu-Omar, ^a Katalin Barta, ^b Gregg T. Beckham, ^{*cd}
Jeremy S. Luterbacher, ^{*e} John Ralph, ^{*f} Roberto Rinaldi, ^g
Yuriy Román-Leshkov, ^{*h} Joseph S. M. Samec, ^{*i} Bert F. Sels ^j and
Feng Wang ^k

Recently co-organized guidelines paper for lignin-first community

- Stemmed from discussions at the Lignin Gordon Conference in 2018
- Presents best practices in lignin-first biorefining (and lignin-related catalysis generally) for:
 - Feedstock and lignin characterization,
 - Process parameters,
 - Product yields,
 - Catalyst performance,
 - Solvent mass balances, and
 - Reactor configurations
- Aim to unite the field around a common set of guidelines and comparisons of studies across labs

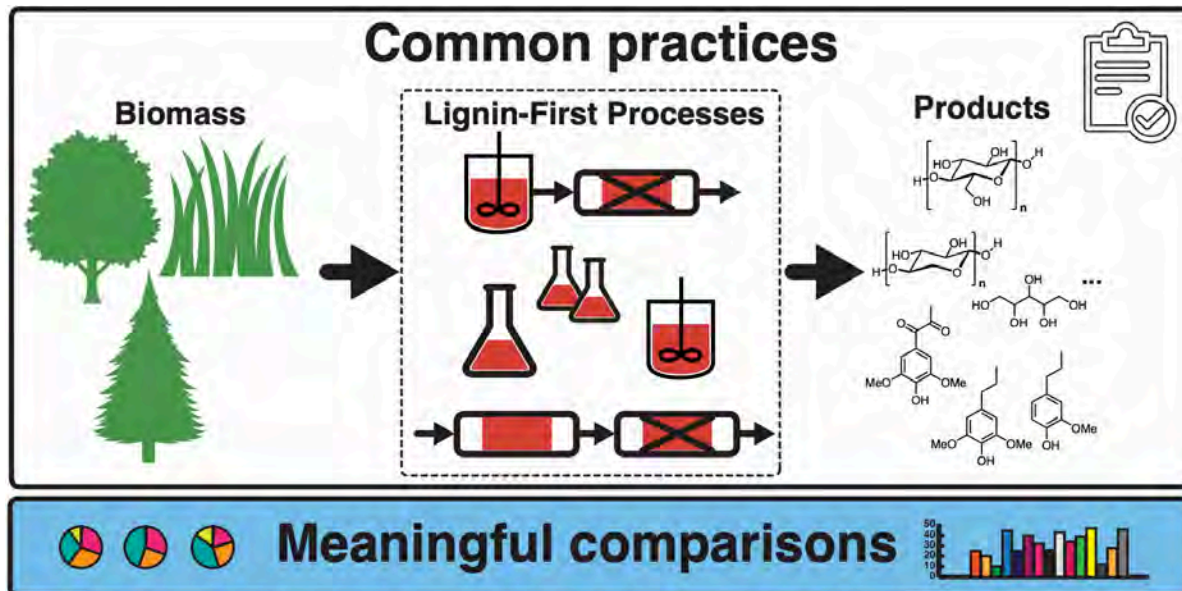

Summary

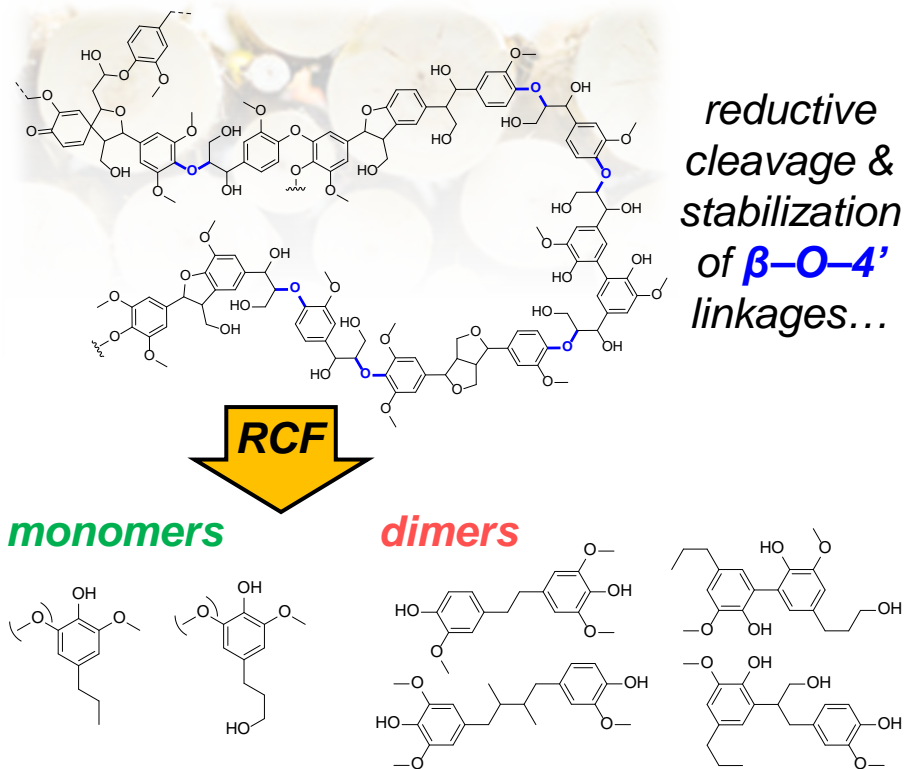

Overview

- Aim to develop viable RCF processes for increased carbon conversion efficiency in biochemical conversion

Management

- Work with multiple projects to enable LigFirst goals, focus on reactor engineering and holistic process development

Approach

- Analysis-guided R&D towards viable process concept

Impact

- Enable high yields of lignin monomers from C-O bond cleavage and viable fractionation for woody feedstocks

Progress and Outcomes

- Conducted first comprehensive TEA and LCA for RCF
- Demonstrated stable lignin oil production for the first time
- Developing continuous RCF with high BP solvents

Quad charts

Timeline

- Active Project Duration: 10/1/2020 – 9/30/2023
- Total Project Duration: 10/1/2017 – 9/30/2023

	FY20	Active Project (FY21-23)
DOE Funding	\$700,000	\$2,100,000

Project Partners

BETO projects: Lignin Utilization (2.3.4.100), Separations Consortium (2.5.5.502), Synthesis and Analysis of Performance-Advantaged Bioproducts (2.3.4.501), Biochemical Platform Analysis (2.1.0.100)

Universities: Massachusetts Institute of Technology, University of Wisconsin-Madison

Barriers addressed

- Ct-B Efficient preprocessing and pretreatment
- Ct-C Process development for conversion of lignin

Project Goal

Develop viable lignin-first biorefining for simultaneous biomass fractionation and lignin valorization

End of Project Milestone

Develop an integrated RCF process from whole biomass to separated and purified lignin monomers (or useable products) at a yield >50% in collaboration with the Separations Consortium and the Lignin Utilization Project. Demonstrate a viable process that is able to reduce the solvent-to-biomass ratio used in the RCF process to that predicted from TEA to be an economically viable option.

Funding Mechanism

Bioenergy Technologies Office FY21 AOP Lab Call (DE-LC-000L079) – 2020

Acknowledgements:

DOE Technology Manager Jay Fitzgerald, Sonia Hammache, and Beau Hoffman

NREL Contributors:

Brenna Black, David Brandner, Nicholas Cleveland, Xueming Dong (LigU), Reagan Dreiling, Rick Elander, Gregory Facas, Renee Happs, Stefan Haugen, Eric Karp (SepCon), Rui Katahira (LigU), Jacob Kenny, Kelsey Kinley, Jacob Kruger, Megan Krysiak, Heather Mayes (BPMS), Joel Miscall, Ana Morais, Michelle Reed, Patrick Saboe (SepCon), Nicholas Thornburg

Collaborators:

Yuriy Román (MIT), John Ralph (UW Madison)

Collaborators on Lignin-First Guidelines paper: Mahdi Abu-Omar (UCSB), Katalin Barta (U Graz), Jeremy Luterbacher (EPFL), John Ralph (UW Madison), Roberto Rinaldi (Imperial), Yuriy Román (MIT), Joseph Samec (U Stockholm), Bert Sels (KU Leuven), Feng Wang (DICP)

Q&A

www.nrel.gov



Additional Slides

Responses to previous reviewer comments

- This project is establishing a process to simultaneously fractionate and valorize lignin and polysaccharides. The process concentrates on producing stable lignin products that are usable by microorganisms, while minimally impacting sugar recovery and use. The team designed and built a flexible reactor system for their process, which is operating very nicely; as a next step, the scalability of their design will be important to demonstrate.
 - We thank the reviewer for the positive feedback. We completely agree that scalability will be critical to demonstrate, and we are working actively on new reaction engineering concepts that would enable fully continuous RCF chemistry to occur, which could significantly reduce solvent demand.
- Revisiting existing biomass pretreatments that were developed for sugar usage in order to valorize more process streams is an appropriate, fundamental approach to improving economics of biorefineries. This project improves upon thermochemical approaches with its RCF method to stabilize reaction products from lignin, ultimately producing aromatic monomers and oligomers of value. Capital expenditures of the approach need to be considered due to methanol and hydrogen, as well as separation operations to recover multiple products.
 - We agree that the capital expenditures must be carefully considered. We have developed the first publicly available TEA for the RCF process, which will be published soon. This TEA work has helped identify key cost drivers and areas for research.
- A lignin-first approach is a great idea. Great progress to date on results coming from thoughtful reactor design and processing approaches. Evaluation of commercial catalysts may advance the work faster, especially if they purchase a pelletized catalyst for flow through the reactor systems. Access to a variety of these were recommended to the team to access through a catalyst recycling company. The team modeled a recirculating reactor, but is this really a loop reactor-type design? Catalytic is the way forward for lower temperatures and pressures. There seems to be a resurgence in work on supercritical water approaches as of late, albeit extreme temperatures and pressures require unique, smaller, multiple reactor designs. Has the team considered that perhaps their lowest-cost solvent could be a mixture of their more volatile lignin products? This could perhaps lower the pressure requirements substantially and create a holistic approach versus using external purchased solvents. Perhaps only a portion of the stream could be used as a solvent while the rest goes to other products.
 - The bench-scale work is not currently a closed-loop reactor design, but we are retrofitting existing equipment to be able to do this. Preliminary experiments have already shown that this process concept is feasible. We also completely agree and think that it is a great idea to use some of the lignin components as a solvent. We are planning to investigate this process concept in FY 2019 and FY 2020.
- Overall, this is a well-conceived project, which has made some significant progress. Changing the biorefinery paradigm to lignin first versus sugar first could have significant value if this approach enables significantly higher lignin value capture with minimal impact on the fuels derived from the carbohydrates. The team is taking a holistic, integrated approach to the problem and should be commended for that. A quantitative analysis through TEA on how an RCF compares in economic performance versus alternative-process technologies would be a useful added study. This would help assess the value of continuing to follow this approach versus trying to improve and optimize the sugarfirsr biorefinery.
 - We have conducted TEA. More details on this will be forthcoming
- The PIs present their take on catalytic biomass hydrogenolysis. This is an old process, but one that shows promise in that it can be used on whole biomass and affords an overall yield of 20%–30% propylphenols from lignin conversion. The potential for using this process to eliminate a biorefinery pretreatment step is important. The project would benefit by including more work on improving the hydrogenolysis itself, and by giving a better sense of its coordination with similar efforts in industry.
 - We agree that the hydrogenolysis step must be improved, and we are working towards that in collaboration with multiple academic groups. We are in close contact and directly collaborate with the only company to our knowledge scaling up RCF chemistry at the moment, thus we are keeping close contact with industrial efforts in this space as we can.

Publications, patents, presentation, awards, and commercialization

Publications

In review or revision:

Andrew W. Bartling, Michael L. Stone, Rebecca J. Hanes, Arpit Bhatt, Yimin Zhang, Garvin A. Heath, Mary J. Bidy, Ryan Davis, Jacob S. Kruger, Nicholas E. Thornburg, Jeremy L. Luterbacher, Roberto Rinaldi, Joseph S.M. Samec, Bert F. Sels, Yuriy Román-Leshkov* Gregg T. Beckham*, Techno-economic analysis and life cycle assessment of a biorefinery utilizing reductive catalytic fractionation, in review.

David G. Brandner‡, Jacob S. Kruger‡, Gregory G. Facas, Jacob K. Kenny, Ana Rita C. Morais, Nicholas E. Thornburg, Daniel G. Wilcox, Nicholas S. Cleveland, Renee M. Happs, Rui Katahira, Darren J. Peterson, Todd B. Vinzant, Yuriy Roman-Leshkov, and Gregg T. Beckham*, Production of native lignin in a flow-through reactor, in review

In print:

Mahdi M. Abu-Omar, Katalin Barta, Gregg T. Beckham*, Jeremy S. Luterbacher*, John Ralph*, Roberto Rinaldi, Yuriy Román-Leshkov*, Joseph S.M. Samec*, Bert F. Sels, and Feng Wang, Guidelines for performing lignin-first biorefining, in press at *Energy Env. Sci.*

Nicholas E. Thornburg, M. Brennan Pecha, David G. Brandner, Michelle L. Reed, Josh V. Vermaas, William E. Michener, Rui Katahira, Todd B. Vinzant, Thomas D. Foust, Bryon S. Donohoe, Yuriy Román-Leshkov, Peter N. Ciesielski,* Gregg T. Beckham*, Mesoscale reaction-diffusion phenomena governing lignin-first biomass fractionation, *ChemSusChem* (2020), 13, 4495-4509.

Eric M. Anderson, Michael L. Stone, Rui Katahira, Michelle Reed, Wellington Muchero, Kelsey Ramirez, Gregg T. Beckham*, Yuriy Román-Leshkov*, Differences in S/G ratio in natural poplar variants do not predict catalytic depolymerization monomer yields, *Nature Comm.* (2019) 2033.

Wouter Schutyser, Tom Renders, Sander Vanden Bosch, Stef Koelewijn, Gregg T. Beckham, Bert Sels*, Chemicals from lignin: an interplay of lignocellulose fractionation, depolymerisation, and upgrading,. *Chem. Soc. Rev* (2018) 47, 10-20.

Publications, patents, presentation, awards, and commercialization

Presentations (2018 – 2020)

Reductive catalytic fractionation – analysis and new insights towards an industrially relevant process, EU FALCON project meeting (via webinar), November 4th, 2020

Efforts towards sustainable performance-advantaged bioproducts and plastics upcycling, Materials Life-Cycle Management Mini-Symposium, University of Delaware (via webinar), October 1st, 2020

Performance-advantaged bioproducts from lignin and carbohydrates, 8th Fuel Science Center International Conference (via webinar), June 24th, 2020

Using selective chemical and biological catalysis to upcycle lignin and plastics, ExxonMobil Research and Engineering, October 25th, 2019

New progresses on biological and catalytic lignin valorization, Great Lakes Bioenergy Research Center and University of Wisconsin Madison, May 13th, 2019

Catalytic valorization of lignin in the biorefinery, 4th Ibero-American Congress on Biorefineries, Plenary Invited Lecture, October 24, 2018

Patent applications

Continuous Processing of Lignin for Reduced Solvent Usage in Reductive Catalytic Fractionation: ROI-21-42, pending

Bio-derived Heat Transfer Fluids for Concentrating Solar Power Applications: ROI-18-34, U.S. patent application 17/008,864, pending