

# BETO 2021 Peer Review Continuous Enzymatic Hydrolysis Development (CEHD)

WBS 2.4.1.101

March 8, 2021  
Biochemical Conversion and Lignin Utilization  
PI: Jim McMillan  
National Renewable Energy Laboratory

# Project Overview

**Goal:** Develop Continuous Enzymatic Hydrolysis (CEH) technology to **reduce cost, improve manufacturability** of biomass sugar-lignin platform

**End of Project Objective: Single-stage CEH performance translated through TEA to a  $\geq 20\%$  lower projected cost** for concentrated sugar production (Minimum Sugar Selling Price, MSSP) relative to conventional batch EH plus solid-liquid separation

## Relevance:

- Process intensify
- Reduce CAPEX
- Increase biocatalyst (enzyme) efficiency
- Enable continuous manufacturing

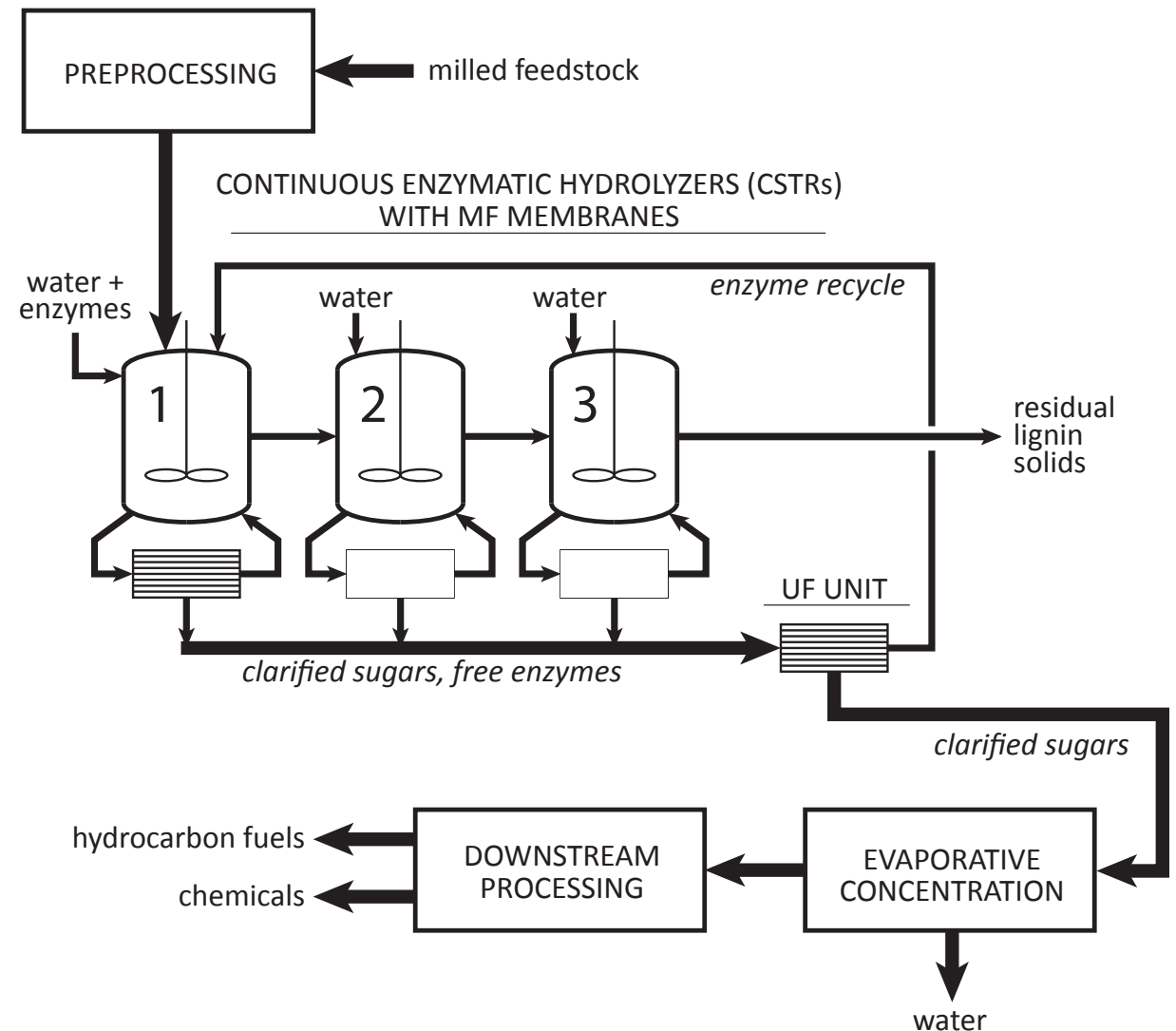

# Heilmeier Catechism

**What are you trying to do:** To develop and derisk lower cost CEH technology.

**How is it done today and what are the limits?** It is done **batchwise** today which is **inefficient** from both capital utilization and operating cost perspectives.

**Why is it important?** CEH has potential to provide a **lower cost route to commodity sustainable sugars and lignin** for fuels and chemicals production to **accelerate deployment of the lignocellulose/cellulosics sugar-lignin platform**

**What are the risks?** Economical CEH requires:





- 1) **Continuous processing of high insoluble solids**  
lignocellulosic slurries (highly non-Newtonian)
- 2) Maintaining effective membrane performance over long operating lifetimes









# Market Trends



## Product

-  Gasoline/ethanol demand decreasing, diesel demand steady
-  Increasing demand for aviation and marine fuel
-  Demand for higher-performance products
-  Increasing demand for renewable/recyclable materials



## Feedstock

-  Sustained low oil prices
-  Decreasing cost of renewable electricity
-  Sustainable waste management
-  Expanding availability of green H<sub>2</sub>
-  Closing the carbon cycle

## Capital

-  Risk of greenfield investments
-  Challenges and costs of biorefinery start-up
-  Availability of depreciated and underutilized capital equipment

## Social Responsibility

-  Carbon intensity reduction
-  Access to clean air and water
-  Environmental equity

## NREL's Bioenergy Program Is Enabling a Sustainable Energy Future by Responding to Key Market Needs

### Value Proposition of CEHD Project

- **Higher sugar yields**, lower costs (over batch)
- Faster EH kinetics (↓ feedback inhibition)
- Lower CAPEX and better capital utilization

### Key Differentiators of CEHD Project

- **Innovating continuous processing** of high insoluble solids slurries
- **Process intensifying rate-limiting EH reaction**; leveraging membrane technology
- Providing lower cost route for producing clarified sugars and **lignin uncontaminated by polyelectrolyte flocculent**

# Quad Chart Overview of CEHD Project

## Timeline

- Project start date: **10/01/2020**
- Project end date: **9/30/2023**

	FY20	Active Project (FY21-23)
DOE Funding		

## Project Partners

- Informally many equipment & membrane vendors, e.g., Koch, Millipore, Pall, Porex, Sefar, Snyder, Texol, Tecweigh, TriSep

## Barriers addressed

Primary barriers (Cts): D - Adv. Process Devel.  
M - Reactor Design  
O - Selective Separations

## Project Goal

Decrease projected cost of CEH relative to conventional batch EH plus solid-liquid separation (SLS) ( $\geq 10\%$  FY21,  $\geq 20\%$  FY23)

## End of Project Milestone

Improve projected CEH cost relative to conventional batch EH plus SLS (Joint with BC Process Analysis), also demonstrating extended single-stage CEH operation simulating both early-stage and later-stage performance.

## Funding Mechanism

NREL Biochemical Platform AOP for FY21.

# 1. Management

**Staffed** by ChE's and research technicians

**Successful implementation:** Sufficient experimental demonstration and TEA modeling to motivate further multi-stage development by / funded by DOE or industry

**Key risks identified, mitigation strategies developed:**

Continuous pumping of high insoluble solids (IS) biomass EH slurries

- Bench → Minipilot

Rapid / facile quantitation of TEA trade-offs in integrated biorefinery context

- AspenPlus → Virtual Engineering (VE)

Availability of sufficient quantities of pretreated feedstock

- Coordinate with allied projects; decouple reaction and membrane loop testing

High-level project structure

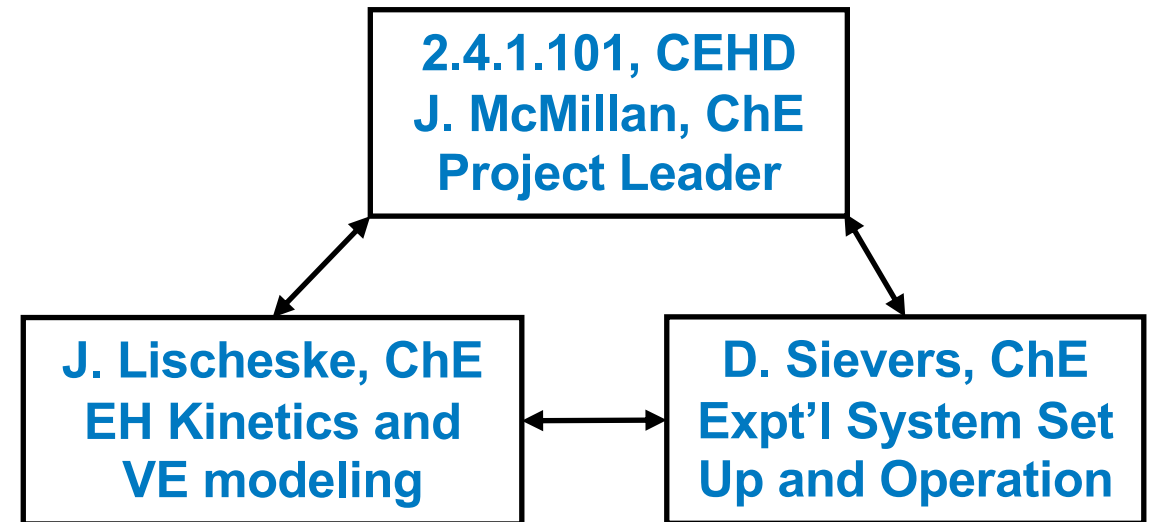

# 1. Management, continued

**Clear management plan** in NREL's AOP

**Implementation strategy:** relevant-scale experimentation coupled with process and cost modeling

**Communication plan:** Weekly/monthly meetings including with allied projects

**Allied projects:**

- TEA modeling and CEH simulation: **Biochemical Platform Analysis (BPA)** and **Virtual Engineering (VE)**
- Pretreated feedstocks: **Low Temperature Advanced Deconstruction (LTAD)** and SDI's **Pilot Scale Integration (PSI)**
- Enzymes: **Bench Scale R&D** and **Enzyme Engineering and Optimization**

## Key Tasks

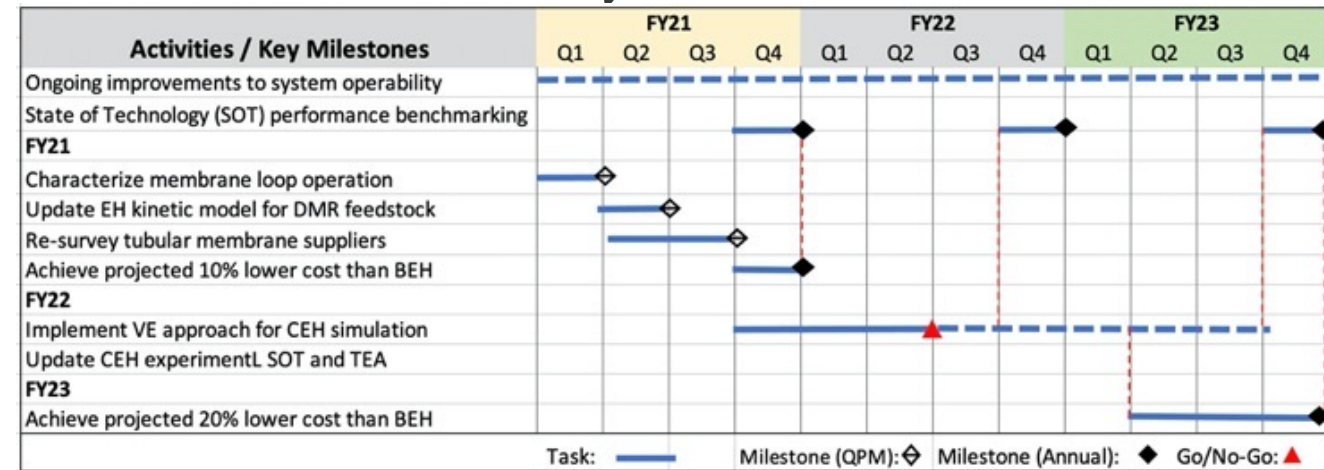

## Communications Plan

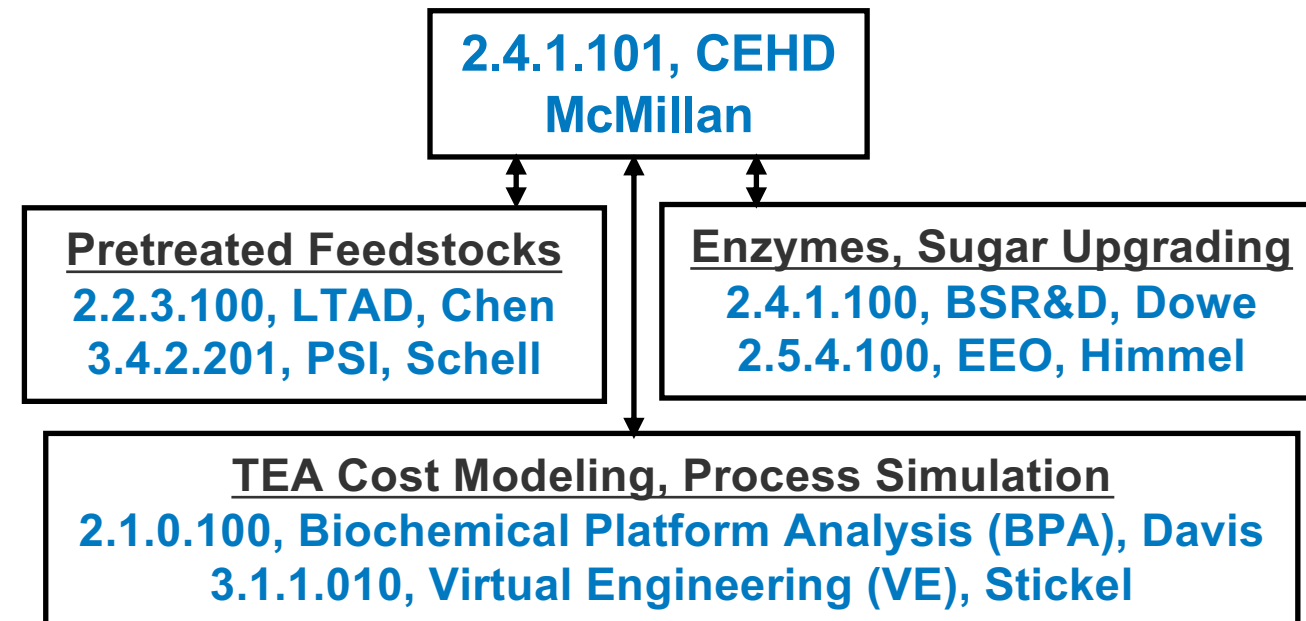

## 2. Approach

**Cost-driven innovative R&D:** Priorities guided by TEA, simulation sensitivities and readily scalable equipment

**VE for TEA:** Enable more facile BPA-consistent TEA cost assessment in integrated biorefinery context based on sugar model (MSSP rather than MFSP)

- **Show CEH potential to lower MSSP** over batch EH ( $\geq 10\%$  FY21,  $\geq 20\%$  FY23)
- **Go/No-go decision** mid FY22 to **verify VE approach**

**Process-realistic experimentation:** De-risk process by using industrially-relevant equipment

- Move beyond bench to enable higher IS slurry processing; **develop high IS capable mini-pilot scale system**

**Key performance measures:**  $\Delta$ MSSP via TEA

- 1) Produced sugar concentration (IS level) and yield
- 2) Membrane permeate flux (and lifetime) and pump power

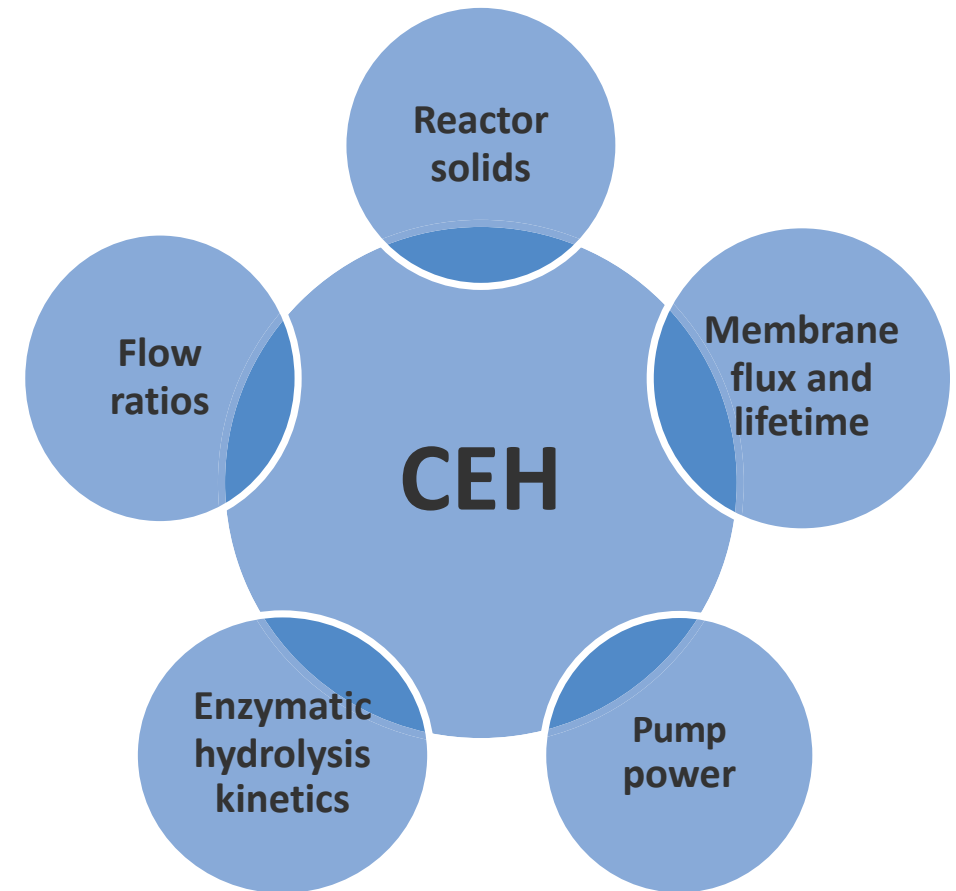



## 2. Approach, continued

### Single CEH reactor-membrane “unit stage” focus

- Understand key performance sensitivities and interactions
- Demonstrate extended pseudo steady state performance
- Model multi-stage performance from single-stage experimental performance and EH kinetics data (CEH model)

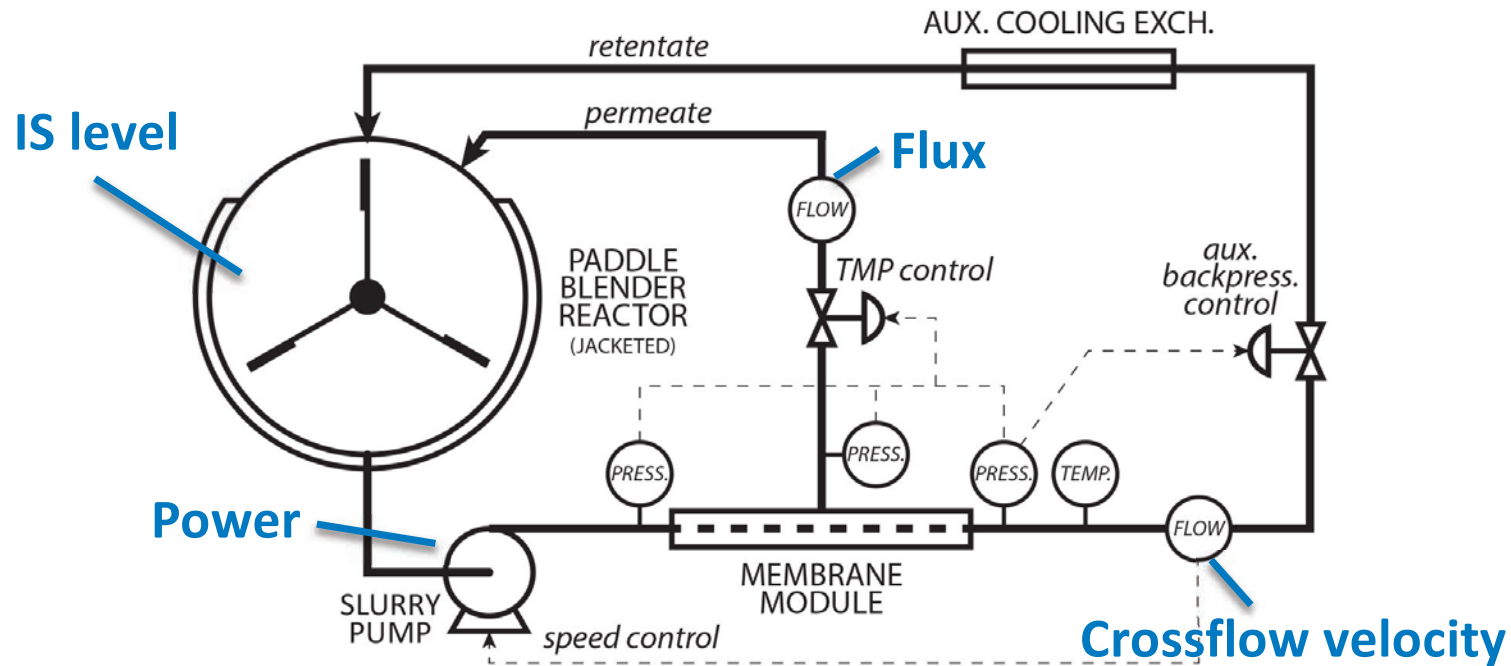

### Challenges

- Extended continuous high IS operation
- Simulating all stages with available single-stage experimental system

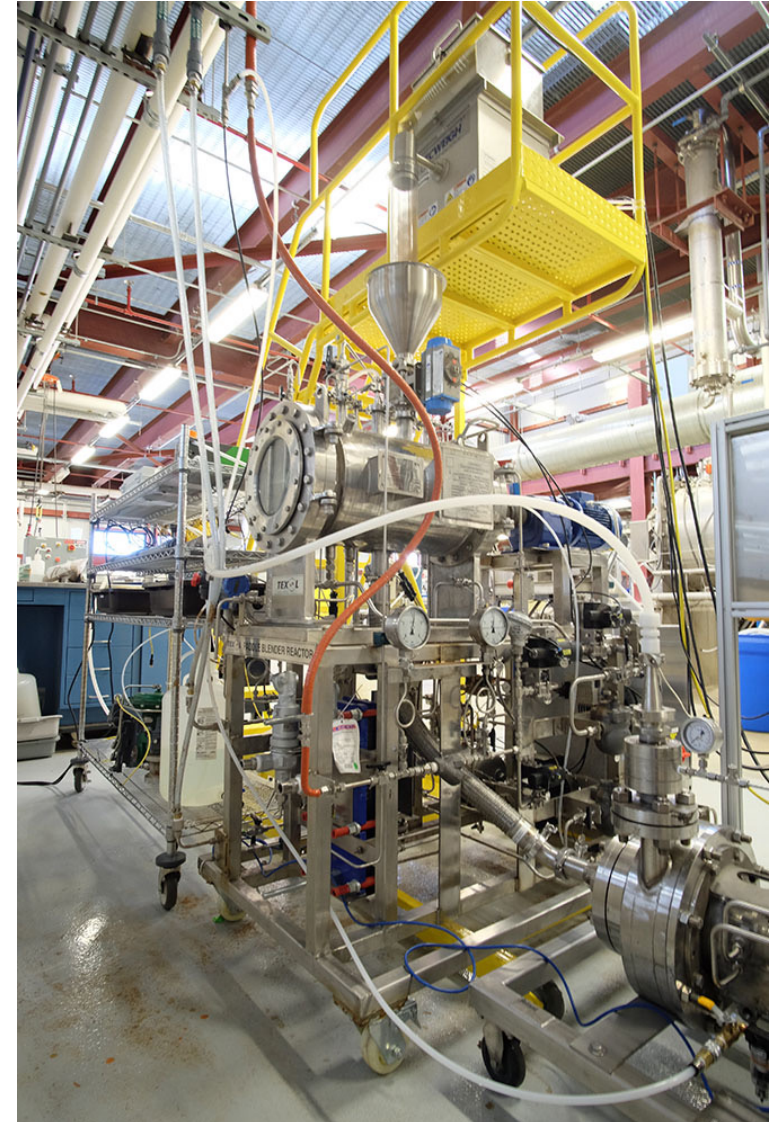

# 3. Impact

**TEAs show large cost savings** over batch due to higher conversion yields at targeted CEH performance levels

- Insoluble solids (IS)  $\geq 7.5\%$
- Membrane flux  $\geq 100$  L/m<sup>2</sup>h (LMH)

**Transformative** lower cost route to **clarified biomass sugars** and **uncontaminated (upgradable) lignin**

**Path to commercialization:** stimulate membrane/cellulosic sugar platform company/DOE interest to implement in industry

**Results disseminated via journal papers and patent filings**

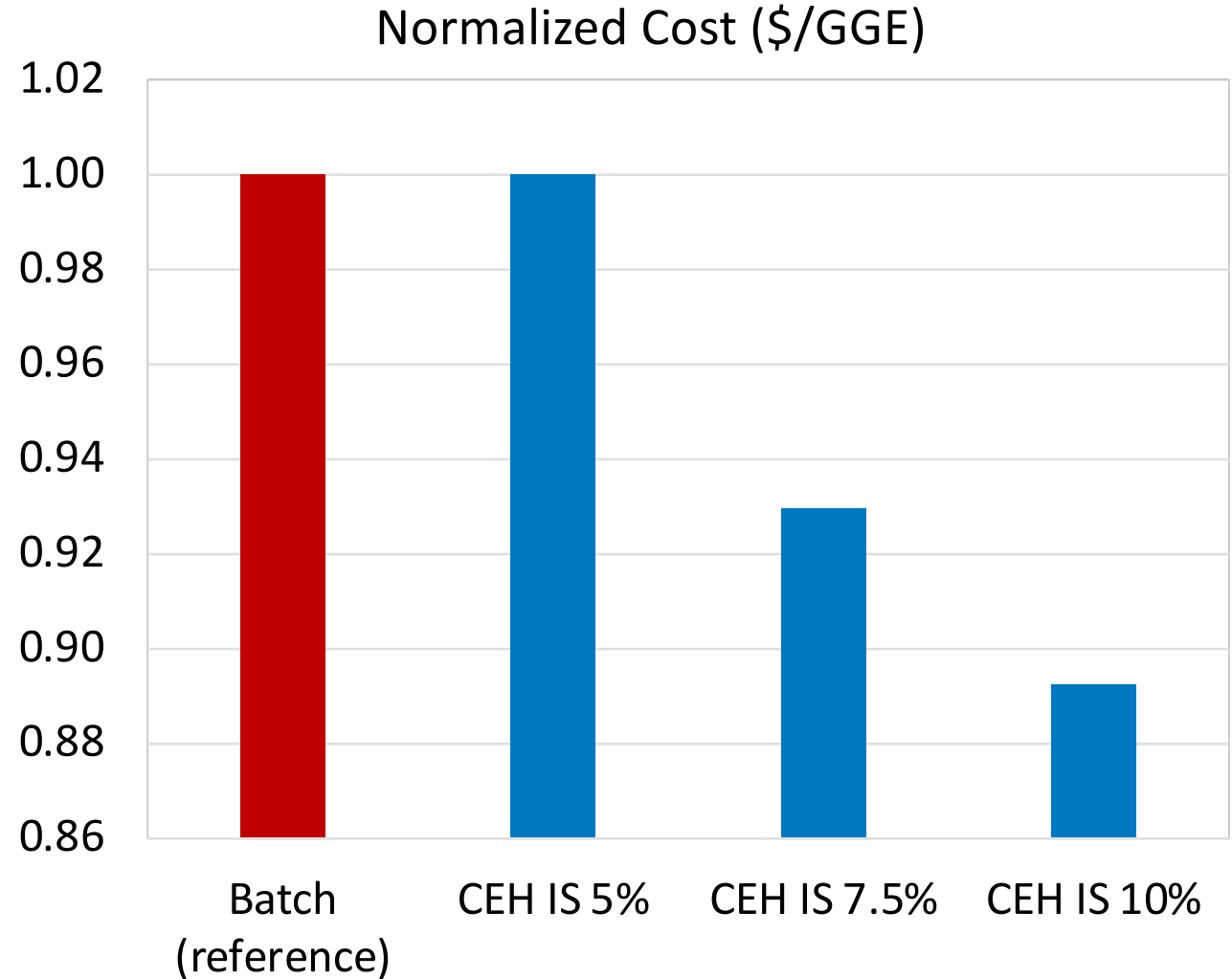

# 3. Impact, continued – Comparative Economics

TEAs based on sugar model show **economic benefit due to CEH’s higher sugar yield**, highlight cost reduction opportunities

Parameter	Batch EH	CEH
Sugar recovery yield (%)	90%	96%
Sugar Post EH (wt%)	11.7%	5.5%
Sugar Post Evap (wt%)	27.1%	27.0%
Relative sugar cost (\$/GGE)	1.00	0.94

**Batch EH TEA dominated by post EH solid-liquid separation** and flocculent costs

**CEH TEA dominated by membranes, evaporation, and higher power requirements**

→ Very different TEA drivers and biorefinery optimization for CEH vs. batch EH

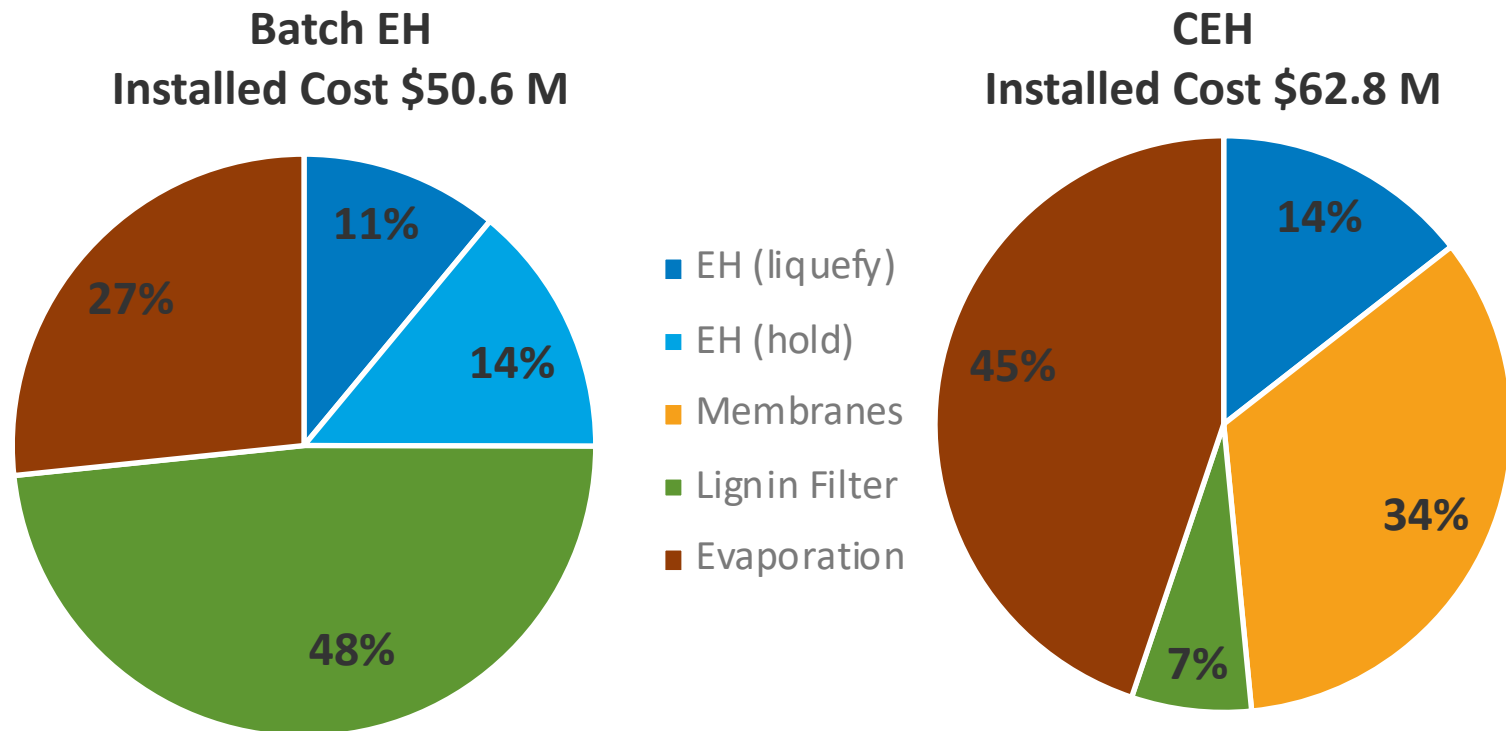



# 4. Progress and Outcomes, High-solids Capable System

Assembled/commissioned high-solids capable single-stage CEH system – a continuously fed horizontal paddle reactor integrated with an external membrane pump around loop.

- Novel non-intrusive vessel level measurement method implemented and validated (**provisional patent awarded**)
- Initial qualification testing **showed ability to operate at  $\geq 8.5\%$  IS** using dilute acid PCS, began transitioning to DMR PCS feedstock

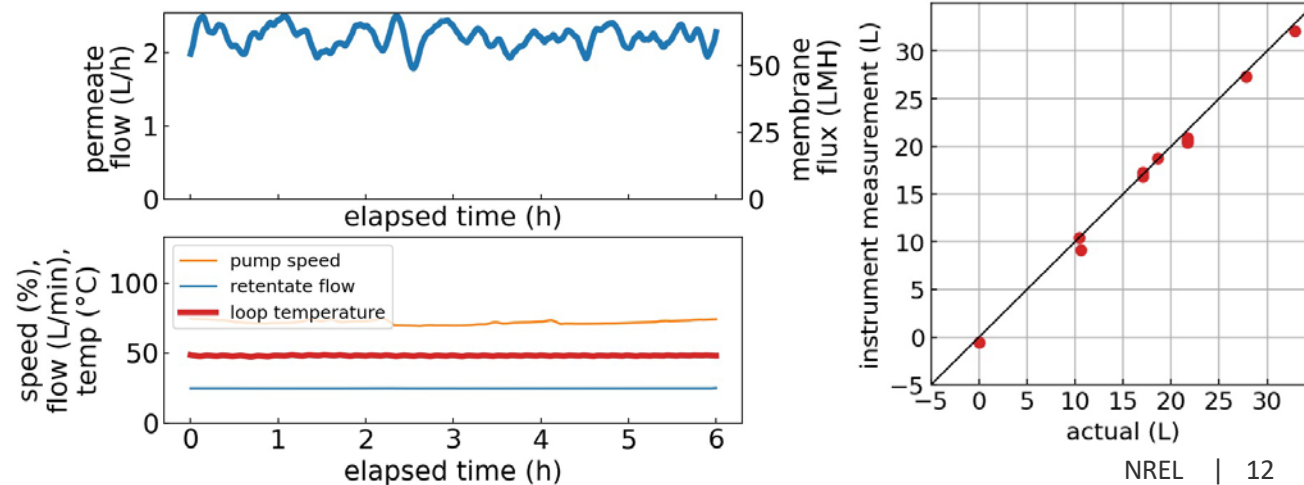
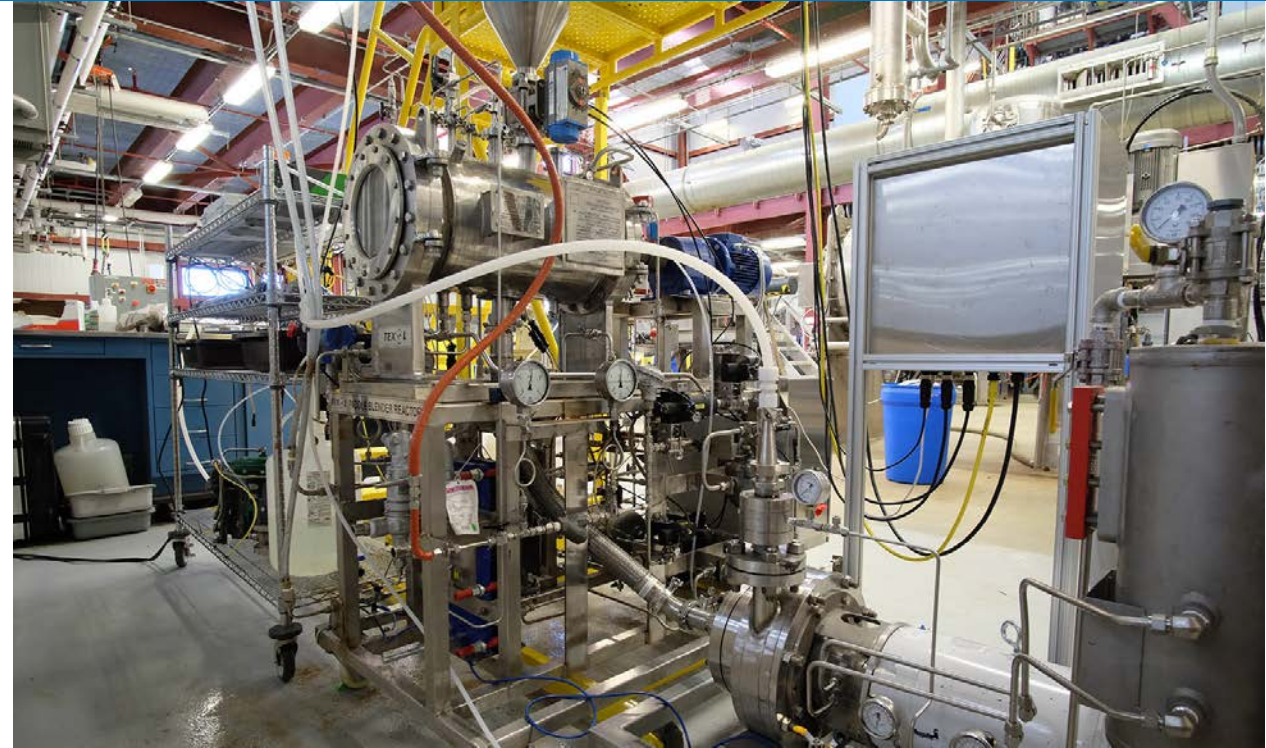



# 4. Progress and Outcomes, DMR Feedstock

More challenging slurry rheology using Deactylated and Mechanically Refined (DMR) pretreated corn stover (PCS) feedstock than the Dilute Acid PCS feedstocks used previously

- **Max. pumpable DMR EH slurry insoluble solids (IS) level is 5-10%** depending on extent of enzymatic hydrolysis; **vs.  $\geq 10\%$  for DA PCS**
- **Extent of conversion significantly influences performance**
- Membrane loop simulation model needed to help optimize cost effective operation

	DMR PCS Feedstock Slurry	DMR PCS EH Slurry	
Recirc. loop flowrate (LPM)	30	25	30
Maximum Steady State IS (%)	5.1	12.6	8.3
Avg. Permeate Flux (LMH/bar)	188	46	25

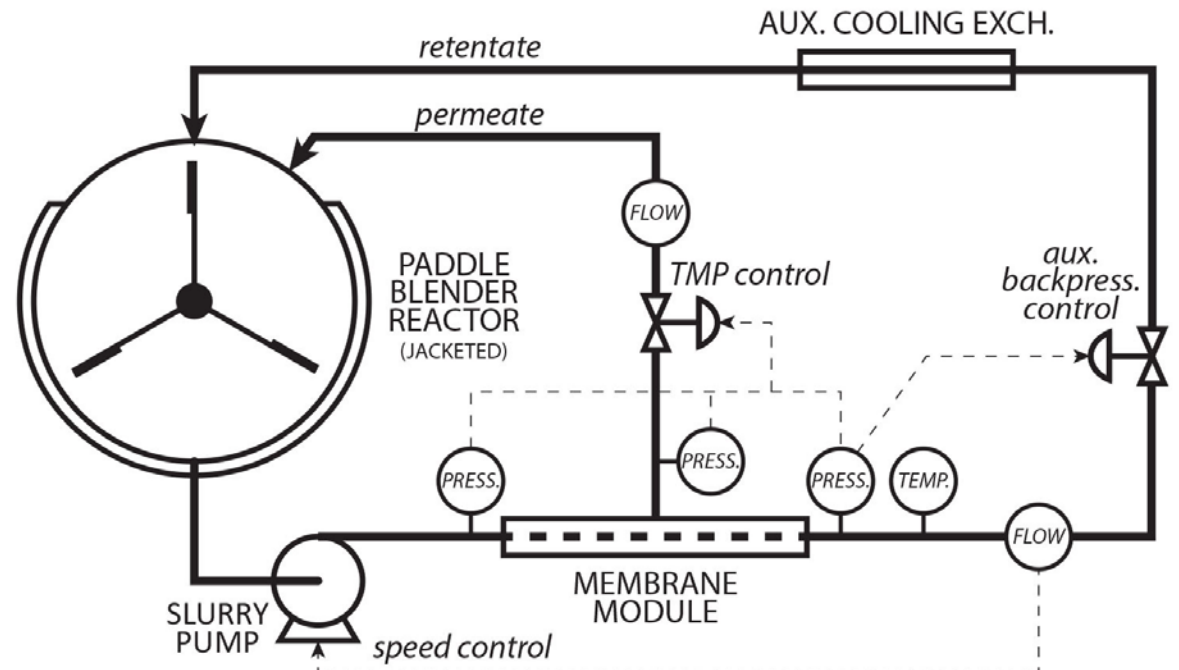

# 4. Progress and Outcomes, Loop Performance

FY21 Q1 milestone (12/31/2020):  
**characterize performance on DMR final EH slurry**

- **Higher velocity (flow) and lower solids offer better membrane flux**, up to 25 LMH (at 1 bar TMP)
- **Long-term flux decline NOT observed**, resistance due to cake formation not compaction; good news!
- **Consistent with literature**: yield stress (velocity & solids loading) effects on flux
- **Results confirm value of current plan** to re-survey available membranes and reassess process performance / TEA tradeoffs using VE approach

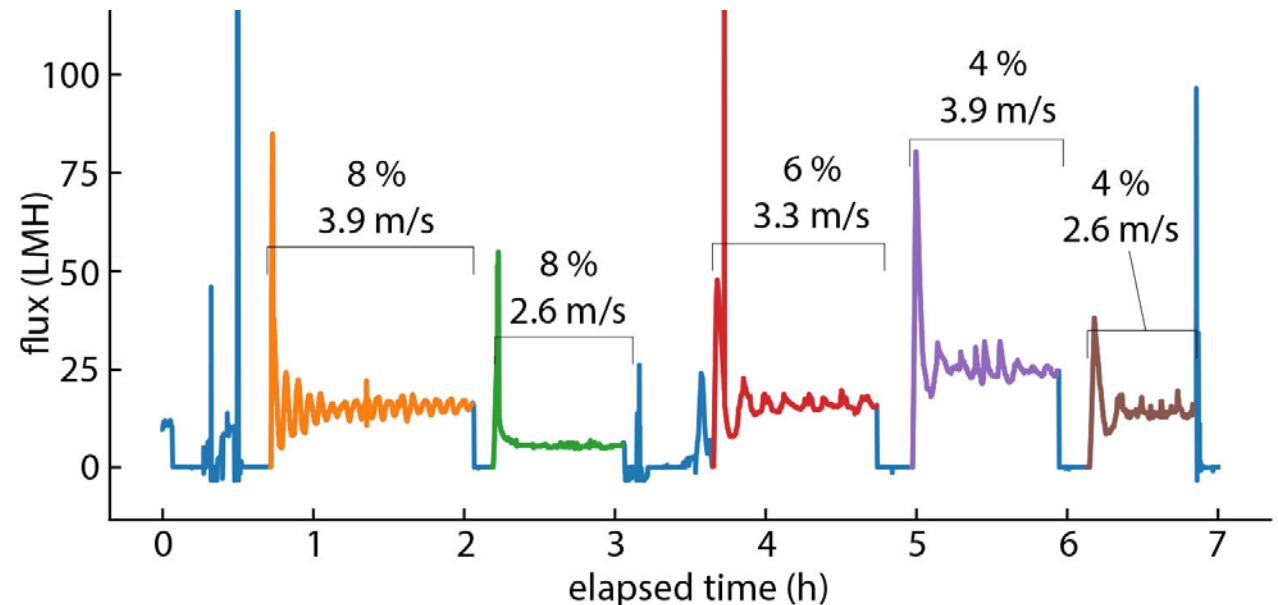
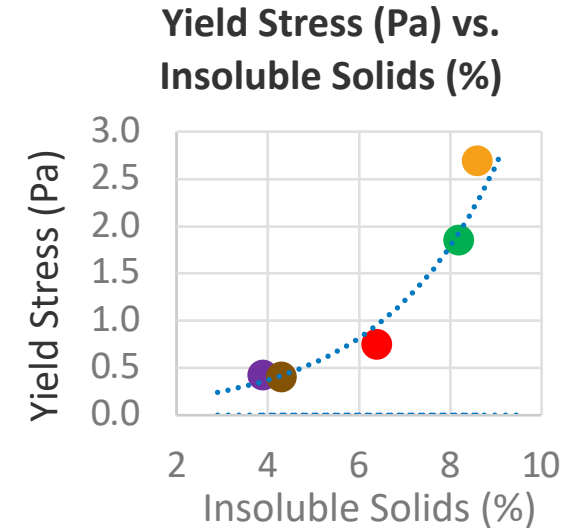
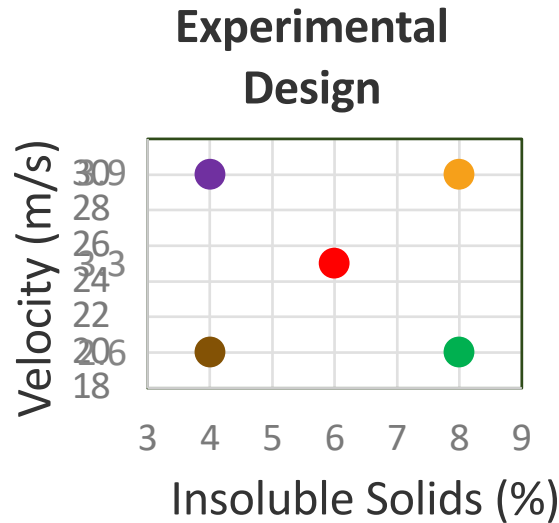

# 4. Progress and Outcomes, Enzyme Recycle

Tested performance of UF membrane for enzyme recycle at bench-scale with positive results

- Achieved same EH conversion yield with liquor (aqueous free enzyme) removed vs controls
- Indicates most active enzymes remain bound to solids during CEH and are not being lost in MF membrane separation

➔ UF filtration step likely not required, **reducing CEH complexity and cost**

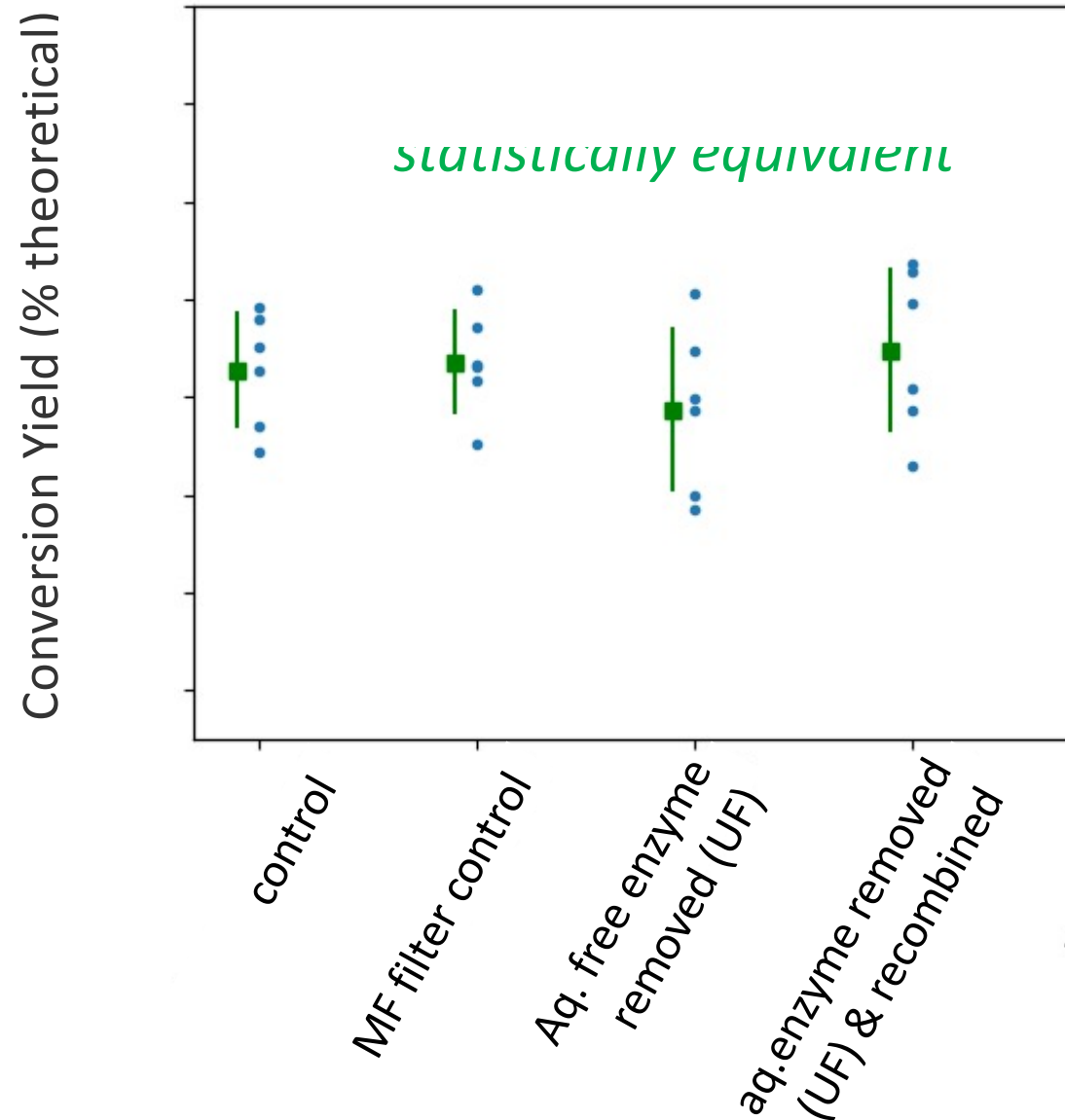

## 4. Progress and Outcomes, Summary

**Mini-pilot system developed, performing well** with high solids slurries

**Transitioning to DMR feedstock**, later unit stage performance, and decoupled membrane loop performance characterization

Research progressing to achieve targeted CEH performance levels

Performance Metric	Target	Achieved	
		DA	DMR
Sugar conversion yield (%), modeled complete system	≥ 90–95	90	95
Sugar conversion yield (%), single-stage experimental	≥ 50	50	pending
Reactor insoluble solids concentration (% IS)	≥ 7.5	10	5–10
Separation-assisting flocculant loading (g/kg IS)	none	none	none
MF (primary) membrane flux (L/m <sup>2</sup> h)	≥ 100	65–90	25-50
UF (enzyme recycle) membrane flux (L/m <sup>2</sup> h)	≥ 65	65	Not needed?
UF (enzyme recycle) recovery (%)	≥ 95	100	Not needed?



# Summary

**Project goal:** Develop CEH technology to improve cost, efficiency and manufacturability of biomass sugar-lignin platform

- 1. Management:** Defined work plan and strategy to advance CEH implementation through experimental de-risking of single unit-stage operation coupled with multi-stage process TEA
- 2. Approach:** Innovative application of process intensification to advance EH processing, highly relevant to sugar-lignin platform
- 3. Impact:** Transformational: potential to significantly reduce costs over batch EH if performance targets can be achieved and sustained
- 4. Progress & Outcomes:** Making good progress with planned approach, adopting risk mitigation strategies to maintain progress on more rheologically challenging DMR feedstock

# Thank you, Q&A

---





[www.nrel.gov](http://www.nrel.gov)

This work was authored by the National Renewable Energy Laboratory, operated by Alliance for Sustainable Energy, LLC, for the U.S. Department of Energy (DOE) under Contract No. DE-AC36-08GO28308. Funding provided by the U.S. Department of Energy Office of Energy Efficiency and Renewable Energy Bioenergy Technologies Office. The views expressed in the article do not necessarily represent the views of the DOE or the U.S. Government. The U.S. Government retains and the publisher, by accepting the article for publication, acknowledges that the U.S. Government retains a nonexclusive, paid-up, irrevocable, worldwide license to publish or reproduce the published form of this work, or allow others to do so, for U.S. Government purposes.







# Summary



## Product

-  Gasoline/ethanol demand decreasing, diesel demand steady
-  Increasing demand for aviation and marine fuel
-  Demand for higher-performance products
-  Increasing demand for renewable/recyclable materials



## Feedstock

-  Sustained low oil prices
-  Decreasing cost of renewable electricity
-  Sustainable waste management
-  Expanding availability of green H<sub>2</sub>
-  Closing the carbon cycle

## Capital

-  Risk of greenfield investments
-  Challenges and costs of biorefinery start-up
-  Availability of depreciated and underutilized capital equipment

## Social Responsibility

-  Carbon intensity reduction
-  Access to clean air and water
-  Environmental equity

## NREL's Bioenergy Program Is Enabling a Sustainable Energy Future by Responding to Key Market Needs

### Value Proposition of CEHD Project

- Higher sugar yields, lower costs (over batch)
- Faster EH kinetics (↓ feedback inhibition)
- Lower CAPEX and better capital utilization

### Key Differentiators of CEHD Project

- Innovating continuous processing of high insoluble solids slurries
- Process intensifying rate-limiting EH reaction; leveraging membrane technology
- Providing lower cost route for producing clarified sugars and lignin uncontaminated by polyelectrolyte flocculent

**Additional Slides**



# Responses to Previous Reviewers' Comments

- Reviewer criticism: A limitation of the project is that the work focuses on single-stage processes and does not address the ultimate goal of developing a multistage process.
- PI response: It makes economic sense to prove out a single stage before confidently committing the additional budget and equipment needed for multi-stage operation. In the previous 3-yr project cycle we primarily focused on initial or early stage (low extent of enzymatic hydrolysis conversion) behavior, and in this current cycle we are putting more emphasis on later stage operation. Previous work has shown that the cross flow solid-liquid separation is most challenging for extensively enzymatically hydrolyzed materials.
- Reviewer comment: ...limitations in bench scale equipment ... have been identified by the project performers. There are numerous challenges inherent in this work in the choice of pumps, reactors, mixing equipment and membranes.
- PI response: Limitations in bench scale systems is what prompted ultimately developing a mini-pilot scale system where, while still challenging, there are better options for reactors, pumps, membranes, etc. At this scale, we have been able to consistently recirculate higher insoluble solids (IS) slurries (up to insoluble solids levels around 10% depending upon the nature of feedstock), compared to maximum IS levels of only about 5% at the bench scale. The mini-pilot scale system is much more effective for evaluating and trialing the CEH technology.

## Publications

- There are no publications yet for the current project cycle. Previous related publications include:
  1. Jonathan J Stickel, Birendra Adhikari, David A Sievers and John Pellegrino. 2018. Continuous enzymatic hydrolysis of lignocellulosic biomass in a membrane-reactor system. **J Chem Technol Biotechnol.**, 93:2181–2190. <https://doi.org/10.1002/jctb.5559>
  2. James J. Lischeske and Jonathan J. Stickel. 2019. A two-phase substrate model for enzymatic hydrolysis of lignocellulose: application to batch and continuous reactors. **Biotechnol. Biofuels**, 12:299. <https://doi.org/10.1186/s13068-019-1633-2>

## Patents

- U.S. provisional patent application No. 63/074,846 corresponding to NREL Record of Invention (ROI) No. 20-39 for novel nonintrusive vessel level measurement was filed on September 4, 2020 at the United States Patent & Trademark Office (USPTO).

Describe the status of any technology transfer or commercialization efforts:

- We continue to try to attract industrial interest in cost-sharing development of CEH, e.g., for corn fiber feedstock. There is at least one major company potentially interested however their corporate focus is internal until greater profitability can be realized/sustained.