

# Connected Lighting Systems Efficiency Study — PoE Cable Energy Losses, Part 1

November 2017  
(Revised January 2019)

# **Connected Lighting Systems Efficiency Study— PoE Cable Energy Losses, Part 1**

---

Prepared for:

Solid-State Lighting Program  
Building Technologies Office  
Energy Efficiency and Renewable Energy  
U.S. Department of Energy

Prepared by:

Pacific Northwest National Laboratory

**November 2017**  
(Revised January 2019)

Authors:

Jason Tuenge  
Karsten Kelly  
Michael Poplawski

**DISCLAIMER**

This report was prepared as an account of work sponsored by an agency of the United States Government. Neither the United States Government nor any agency thereof, nor Battelle Memorial Institute, nor any of their employees, makes **any warranty, express or implied, or assumes any legal liability or responsibility for the accuracy, completeness, or usefulness of any information, apparatus, product, or process disclosed, or represents that its use would not infringe privately owned rights.** Reference herein to any specific commercial product, process, or service by trade name, trademark, manufacturer, or otherwise does not necessarily constitute or imply its endorsement, recommendation, or favoring by the United States Government or any agency thereof, or Battelle Memorial Institute. The views and opinions of authors expressed herein do not necessarily state or reflect those of the United States Government or any agency thereof.

PACIFIC NORTHWEST NATIONAL LABORATORY  
*operated by*  
BATTELLE  
*for the*  
UNITED STATES DEPARTMENT OF ENERGY  
*under Contract DE-AC05-76RL01830*

Printed in the United States of America

Available to DOE and DOE contractors from the  
Office of Scientific and Technical Information,  
P.O. Box 62, Oak Ridge, TN 37831-0062;  
ph: (865) 576-8401  
fax: (865) 576-5728  
email: [reports@adonis.osti.gov](mailto:reports@adonis.osti.gov)

Available to the public from the National Technical Information Service  
5301 Shawnee Rd., Alexandria, VA 22312  
ph: (800) 553-NTIS (6847)  
email: [orders@ntis.gov](mailto:orders@ntis.gov) <<http://www.ntis.gov/about/form.aspx>>  
Online ordering: <http://www.ntis.gov>



This document was printed on recycled paper.

(8/2010)

## Executive Summary

Power over Ethernet (PoE) technology offers the ability to provide both low-voltage direct-current (DC) power and communication over a standard Ethernet cable—also referred to as a local area network (LAN) cable or Category cable. Light-emitting diode (LED) technology has reduced the power required for lighting applications, while advances in PoE standards and technology have yielded substantial increases in the amount of power that can be delivered to a networked device over a single cable. As a result, PoE technology is emerging in lighting and many other applications beyond its historical foothold in telephony and networking equipment. Several major LED luminaire manufacturers have introduced PoE connected lighting systems in recent years, making this a potentially disruptive technology.

PoE lighting systems can offer improved efficiency relative to traditional line voltage alternating current (AC) systems, because AC-DC power conversion losses can be reduced if this work is consolidated among one or more PoE switches, rather than being distributed among a greater number of smaller LED drivers. However, this effect can be offset to some extent by increased losses associated with increased voltage drop in the low-voltage Ethernet cabling. In fact, these losses could exceed 15% in poorly designed systems. Aspects of cable design that can affect cable energy performance include wire gauge, Category (e.g., 5e), fire rating, and shielding. Unfortunately, most cable manufacturers only state maximum DC resistance (DCR) or reference standards that specify DCR limits; few publish nominal DCR values.

This report summarizes the results of an exploratory study investigating power losses in Ethernet cables used between PoE switches and luminaires in PoE connected lighting systems. Testing was conducted at the Pacific Northwest National Laboratory (PNNL) Connected Lighting Test Bed in September 2017. A test setup comprising a PoE switch, a set of luminaires, and a reference meter was used to test nine cable models of varying design. Power measurements for two widely differing cable lengths—one near 50 m and another near 0 m—were used to determine the portion of PoE switch output power dissipated by each cable model. The results were analyzed to explore the impact of cable selection on PoE lighting system energy efficiency, as well as the effectiveness of guidelines recently introduced by the American National Standards Institute (ANSI) C137 Lighting Systems Committee.

The key study finding is that the guidance offered in ANSI C137.3-2017 does appear to be effective in limiting cable energy losses to 5% in PoE lighting applications, provided that the average cable length on a project does not exceed 50 m. Additional findings include the following:

- Cable losses were found to decrease with increasing conductor diameter (i.e., numerically smaller wire gauge), as would be expected. No such trend was observed for cable Category, fire rating, or manufacturer; however, considering the study limitations (e.g., the set of cables tested), this does not mean these parameters do not affect cable losses.
- In addition to the nine unshielded cable models that were tested in this study, three other cable models were acquired but later excluded from testing, due to compatibility issues. Because two of these were the only shielded cables, the effect of shielding on cable energy losses was not evaluated in this study.
- Cable power loss can be accurately determined using values reported by the power sourcing equipment (PSE) if the powered device (PD) input power does not vary with cable length. Notably, of the two luminaires used as a lighting load in this study, one did not hold input power constant in this manner, and neither model reported its own power draw.

The following recommendations, stemming from the study findings, are offered to help streamline the adoption of PoE technology in lighting applications:

- PoE lighting system designers should specify that minimum American Wire Gauge (AWG) must be per ANSI C137.3 guidance, or specify minimum AWG directly if even lower losses are desired.

- PoE lighting system designers/suppliers/installers should publish statistics on PoE cable lengths used for each project (e.g., minimum, maximum, mean, median), along with information on each model used (e.g., wire gauge, Category, fire rating, shielding).
- The Institute of Electrical and Electronics Engineers (IEEE) 802.3 standard requires that PSEs (i.e., PoE switch ports) and PDs (e.g., lighting loads with RJ45 jacks) be compatible with all compliant cabling. Manufacturers of PoE switches or PoE lighting loads that are not compliant with IEEE 802.3 should very clearly state as much in datasheets and other product documentation, make no claims of IEEE PoE compliance, and consider redesigning so these products can be certified compliant in the future. It is not sufficient to only state compatibility in installation instructions, especially if such documentation is only provided after products are received (i.e., after a system has been designed and products have been ordered). To prevent damage and other issues that can arise from incompatibility, buyers and specifiers should consider using products independently certified (e.g., by the Ethernet Alliance) as IEEE PoE compliant.
- Manufacturers of Ethernet cables and connectors (RJ45 plugs) should publish lists of compatible cabling products or parameters relevant to compatibility (e.g., tolerances for overall diameters of cable and insulated conductors) in product documentation.
- Given the growth of high-power PoE applications, more Ethernet cable manufacturers should publish rated DCR values specific to each product. Although these values would be expected to fall between standard nominal and maximum values, knowledge of actual representative DCR values would enable selection of cables that minimize energy losses.
- PoE switch manufacturers should state measurement accuracy for switch-reported PSE output power in product documentation. In addition, PSE output voltage should be reported by the PoE switch.

## Acknowledgements

The authors are grateful to the following individuals and companies for their contributions of time and/or materials to this study.

Ron Tellas — Belden  
Jason Potterf — Cisco Systems  
Wayne Hopkinson — CommScope  
Matt Gentile — General Cable  
Antoine Pelletier — Intertek  
Robert Hick — Leviton  
John Seger — Leviton  
Giovanni Frezza — Molex  
Chris Blount — Molex  
Lisa Isaacson — NuLEDs  
Frank Straka — Panduit  
Lennart Yseboodt — Philips Lighting  
Dan Burns — Superior Essex

The U.S. Department of Energy (DOE) is interested in feedback or comments on all aspects of this study. Please write to [DOE.SSL.UPDATES@ee.doe.gov](mailto:DOE.SSL.UPDATES@ee.doe.gov) and include the study title in the subject line of your email.

## Symbols and Abbreviations

A	ampere(s)
AC	alternating current
ANSI	American National Standards Institute
ASTM	American Society for Testing and Materials
AWG	American Wire Gauge
CCS	Continental Control Systems
CMP	plenum-rated communications
CMR	riser-rated communications
CT	current transformer
DC	direct current
DCR	DC resistance
DMM	digital multimeter
DOE	U.S. Department of Energy
$\Delta$	delta (i.e., difference)
F/UTP	foil (surrounding) unshielded twisted-pairs
$I^2R$	current squared times resistance
IEC	International Electrotechnical Commission
IEEE	Institute of Electrical and Electronics Engineers
IES	Illuminating Engineering Society
LED	light-emitting diode
lm	lumen(s)
LPS	Limited Power Source
m	meter(s)
NEC	National Electrical Code
NFPA	National Fire Protection Association
$\Omega$	ohm(s)
PD	powered device
PoE	Power over Ethernet
PSE	power sourcing equipment
SSL	solid-state lighting
TIA	Telecommunications Industry Association
UPOE	Universal Power Over Ethernet
UTP	unshielded twisted-pair
U/UTP	unshielded and unshielded twisted pairs
V	volt(s)
W	watt(s)

# Table of Contents

Executive Summary.....	iii
Acknowledgements.....	v
Symbols and Abbreviations .....	vi
Table of Contents .....	vii
1 Introduction.....	1
2 Background .....	2
3 Scope .....	3
4 Test Setup .....	3
5 Test Setup Implementation .....	4
5.1 AC Reference Meter .....	6
5.2 PoE Source .....	6
5.3 Powered Devices.....	6
5.4 Temperature Measurement .....	7
6 Test Method and Calculations .....	7
7 Test Units .....	11
8 Test Results.....	14
8.1 Luminaire A as Load.....	14
8.2 Luminaire B as Load.....	15
9 Analysis .....	15
9.1 Impact of Cable Selection.....	16
9.2 Effectiveness of ANSI C137.3 Guidance .....	17
9.3 Luminaires as PDs .....	17
9.4 PoE Lighting System Power .....	18
10 Summary and Recommendations.....	18
10.1 Research Questions, Answers, and Recommendations.....	19
10.2 Next Steps .....	21
Appendix A. Specifications for CCS.....	23
Appendix B. Specifications for Obvius .....	26
Appendix C. Specifications for Cisco .....	30
Appendix D. Specifications for ThermoWorks.....	39
Appendix E. Shielded Cable Compatibility.....	41
References .....	42



# List of Figures

Figure 1.1. The general convergence between LED power requirements (decreasing with improved luminous efficacy) and PoE power capabilities (increasing with new IEEE standards) over time ..... 1

Figure 4.1. Block diagram of the test setup showing candidate measurement locations for this and future studies..... 4

Figure 5.1. Block diagram of the test setup implementation..... 5

Figure 5.2. Photograph of the test setup implementation..... 5

Figure 6.1. Range of expected cable losses for 51 W PD at 20°C ambient ..... 10

Figure 7.1. The set of cables acquired for testing, each splayed at one end to display internal structure, and shown side-by-side for uniform scale. Labels for the three products removed from testing are marked with a dagger (†) symbol. .... 13

Figure 9.1. Impact of cable selection on power losses with luminaire A as PD. Category is distinguished by color; manufacturer is distinguished by symbol. With one exception (labeled CMR), cables were CMP..... 16

Figure 9.2. Expected vs. calculated 50 m cable losses with luminaire A as PD ..... 17

Figure 9.3. System power (including PoE switch and 49 m cables) relative to input power for luminaire A (4 x 44 W) and luminaire B (7 x 51 W) ..... 18

# List of Tables

Table 7.1. The set of cables acquired for testing ..... 12

Table 8.1. Cable power losses with luminaire A as load. Values in  $P_c$  columns are conditionally formatted from low (green) to high (orange). ..... 14

Table 8.2. Cable power losses with luminaire B as load. Conditional formatting for values in  $P_c$  columns uses same scale as in Table 8.1. .... 15

# 1 Introduction

Power over Ethernet (PoE) technology offers the ability to provide low-voltage direct-current (DC) power and communication over a standard Ethernet cable—also referred to as a local area network (LAN) cable or Category cable. Light-emitting diode (LED) technology has reduced the power required for lighting applications, while advances in PoE standards and technology have yielded substantial increases in the amount of power that can be delivered to a networked device over a single cable; this convergence is illustrated in Figure 1.1.<sup>1</sup> As a result, PoE technology is emerging in lighting and many other applications beyond its historical foothold in telephony and networking equipment. Several major LED luminaire manufacturers have introduced PoE connected lighting systems in recent years, making this a potentially disruptive technology (DOE 2017).

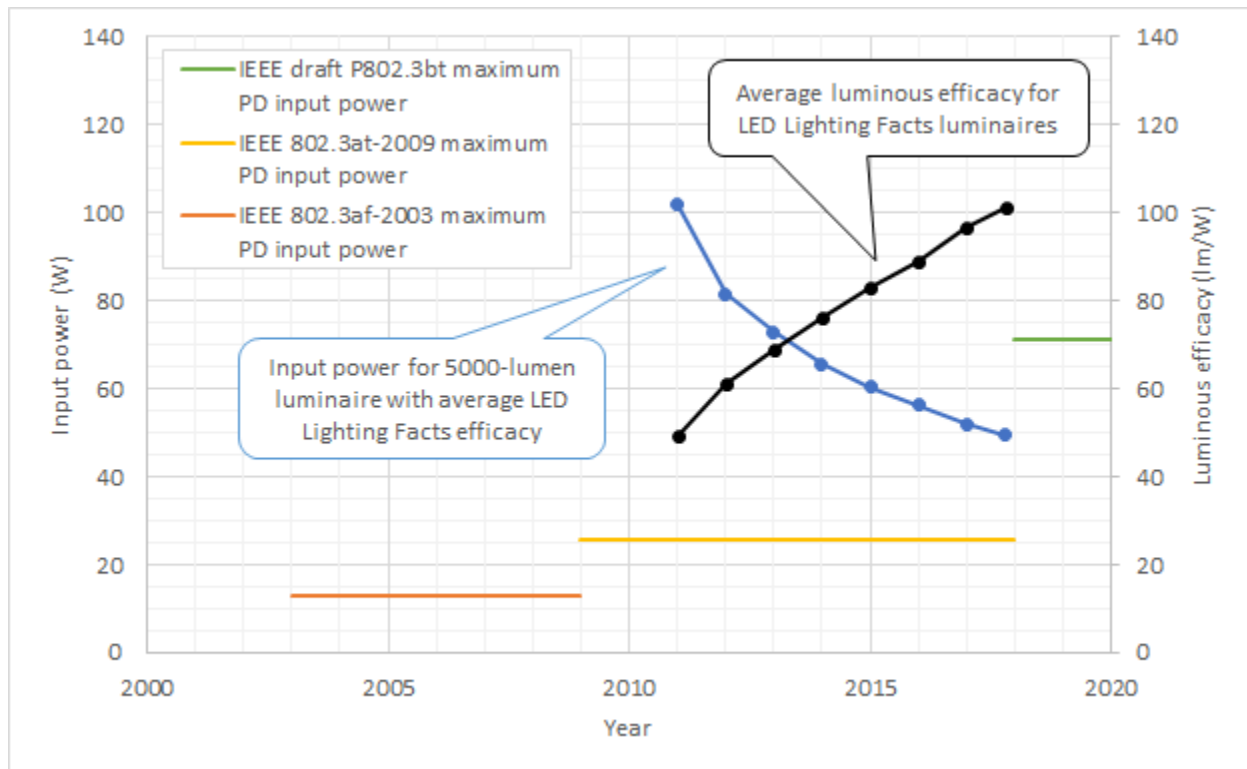

Figure 1.1. The general convergence between LED power requirements (decreasing with improved luminous efficacy) and PoE power capabilities (increasing with new IEEE standards) over time

PoE lighting systems can offer improved efficiency relative to traditional line voltage alternating current (AC) systems, because AC-DC power conversion losses can be reduced if this work is consolidated among one or more PoE switches, rather than being distributed among a greater number of smaller LED drivers (Thomas, Azevedo, and Morgan 2012). However, if the system is poorly designed, this effect can be offset to some extent by increased losses associated with increased voltage drop in the low-voltage Ethernet cabling (i.e., cables and connectors). Such losses are commonly referred to as  $I^2R$  losses, because the power dissipated by an imperfect conductor is the product of its resistance ( $R$ ) and the square of the current ( $I$ ) it conveys.

This report summarizes the results of an exploratory study investigating power losses in Ethernet cables used between PoE switches and luminaires in PoE connected lighting systems. Testing was conducted at the Pacific Northwest National Laboratory (PNNL) Connected Lighting Test Bed in September 2017. A test setup

<sup>1</sup> Chart generated using LED Lighting Facts data (<http://www.lightingfacts.com/Analytics>) accessed 2017-10-20.

comprising a PoE switch, a set of luminaires, and a reference meter was used to test nine cable models of varying design. Power measurements for two widely differing cable lengths—one near 50 m and another near 0 m—were used to determine the portion of PoE switch output power dissipated by each cable model. The results were analyzed to explore the impact of cable selection on PoE lighting system energy efficiency, as well as the effectiveness of guidelines recently introduced by the American National Standards Institute (ANSI) C137 Lighting Systems Committee.

## 2 Background

Clause 33 of Institute of Electrical and Electronics Engineers (IEEE) Standard 802.3-2015 specifies the use of twisted-pair Ethernet cables for PoE applications, where each cable is composed of eight conductors (i.e., four pairs) and is terminated with RJ45 connectors.<sup>2</sup> IEEE 802.3 permits a Class 4 powered device (PD) to sink up to 25.5 W from a Type 2 power sourcing equipment (PSE), which is capable of sourcing up to 30 W over two of the four conductor pairs (2-pair PoE).<sup>3</sup> In contrast, PSEs implementing Cisco’s Universal Power Over Ethernet (UPOE) technology can source up to 60 W over all four conductor pairs (4-pair PoE). Similarly, the draft IEEE P802.3bt will use 4-pair PoE while continuing to comply with the Limited Power Source (LPS) restrictions (IEEE 2013).<sup>4</sup> Power limits between 49 W (PD) and 100 W (PSE) will be introduced for several new PD classes and PSE types, and the amendment is targeted for completion in September 2018 (IEEE 2017).

IEEE 802.3 specifies the use of Category 5 or better cables, limits the overall resistance of the link section<sup>5</sup> (loosely referred to as the “channel”) between PSE and PD, and limits link section length to 100 m. The standard references Telecommunications Industry Association (TIA) 568-C.2 performance requirements for Category 5e or better cabling (TIA 2009), and references its precursor, TIA/EIA-568-A, for Category 5 (TIA 1995).<sup>6</sup> Cable power and energy losses are directly dependent on conductor resistance. Reducing conductor resistance in twisted-pair cables generally entails one or more of the following: reducing the length of cabling from PSE to PD (i.e., the link section), using conductors of numerically smaller American Wire Gauge (AWG) designation (i.e., larger diameter), reducing the number of conductor twists per unit cable length (thereby reducing conductor length), or using higher-conductance (purer copper) material.

Most manufacturers only publish *maximum* DC resistance (DCR) values for Ethernet cables, or instead simply indicate compliance with TIA-568-C.2 limits. However, as PoE products have become more prevalent, some manufacturers have begun publishing *nominal* DCR values below the standard limits; this can provide a better understanding of actual cable performance, in turn helping to minimize cabling losses. Similarly, some manufacturers publish maximum DCR values below the TIA-568-C.2 limits, and others have published a few test reports from laboratories accredited to measure DCR in accordance with TIA-568-C.2. However, many factors can potentially cause DCR to deviate from published values—examples include manufacturing tolerances, installation variables (e.g., bundling), environmental conditions (e.g., ambient temperature), and loading. In addition:

- For a given cable length and equal conductor cross-section characteristics (diameter and material), twisted-conductor DCR is greater than straight-conductor DCR, because the straight conductor is shorter (due to the lower conductor twist rate of zero). It is not clear to what extent twist rate and other relevant design features (e.g., conductor diameter) vary between makes and models for a given Category and AWG.

---

<sup>2</sup> IEEE references International Electrotechnical Commission (IEC) Standard 60603-7 for specific 8-pin 8-contact (8P8C) modular connectors, commonly referred to as RJ45 jacks (i.e., receptacles) and plugs.

<sup>3</sup> The last major update to PoE standards was in amendment IEEE 802.3at-2009. An overview of recent revisions to IEEE 802.3 is provided at <http://www.ieee802.org/3/status/index.html>.

<sup>4</sup> IEEE 802.3at specifies that a PSE shall be classified as a Limited Power Source in accordance with IEC 60950-1, which effectively limits the power sourced from a PSE port to 100 W (Shulman 2015).

<sup>5</sup> In contrast, the term “link segment” can refer to the path from PD to Ethernet switch in midspan PSE applications.

<sup>6</sup> TIA is in the process of changing the naming convention for its 568-series documents from *[number]-[revision].[part]* to *[number].[part]-[revision]* to align with its other publications; for example, whereas TIA-568-B.2 was replaced by TIA-568-C.2, TIA-568-C.2 will be replaced by TIA-568.2-D.

- The Maintain Power Signature (MPS) specified in IEEE 802.3 can have an AC component, and common-mode AC output voltage is used for data transmission; although IEEE limits these AC components, it is unclear whether they can have a substantial effect on cable energy losses (via conductor impedance) that would not be anticipated considering DCR alone.
- Ambient temperature in the field can be expected to vary, and this will affect performance for most system components (e.g., PoE switch efficiency, LED driver efficiency, conductor DCR).

To simplify the design of PoE lighting systems and limit cable losses to less than 5% over an “average” cable length of 50 m, the recently published ANSI C137.3-2017 specifies minimum AWG for unshielded twisted-pair (UTP) Ethernet cables as a function of power dissipated by the PD (ANSI 2017).<sup>7</sup> Notably, ANSI C137.3 bases its guidance on an included table of nominal DCR values derived from data published in American Society for Testing and Materials (ASTM) B258-14 (ASTM 2014) for straight solid conductors at 20°C. Tolerances are left to manufacturer discretion.<sup>8</sup>

### 3 Scope

The goal of the study documented herein was to explore the impact of cable selection on PoE lighting system energy efficiency, while also evaluating the effectiveness of the ANSI C137.3 guidance. Research questions were as follows:

1. To what extent do power losses vary between models of cable differing in AWG, Category, fire rating, shielding, or manufacturer?
2. Is the ANSI C137.3 guidance effective in limiting power losses to less than 5% in a 50 m cable from PSE to PD?
3. What is the range of maximum and nominal DCR values claimed for relevant Ethernet cables, and how does this compare with standard values?
4. Can cable power losses be determined from values reported by PSE or PD?
5. What have prior studies found regarding PoE cable energy losses?

The set of units acquired for testing consisted of 12 cable models differing in AWG, Category, fire rating, shielding, or manufacturer. Two widely differing cable lengths—one near 50 m and another near 0 m—were cut and terminated for each model so that the portion of POE switch output power dissipated by the cables could be determined.

### 4 Test Setup

A functional test setup for measuring energy losses in Ethernet cables is shown in Figure 4.1. This test setup uses a PoE source and PD to establish a known and stable source and sink of power and energy through an Ethernet cable. It offers three possible locations for measuring power and energy:

- I. At or near AC (line-side) input to PoE source.
- II. At or near DC (load-side) output from PoE source.
- III. At or near DC input to PD.

<sup>7</sup> Use of 5 m patch cables is permitted; losses in cables from PD to any indirect PoE loads are excluded.

<sup>8</sup> IEEE and TIA limit DCR for performance; safety limits are given in NFPA 70, the National Electric Code (NEC).

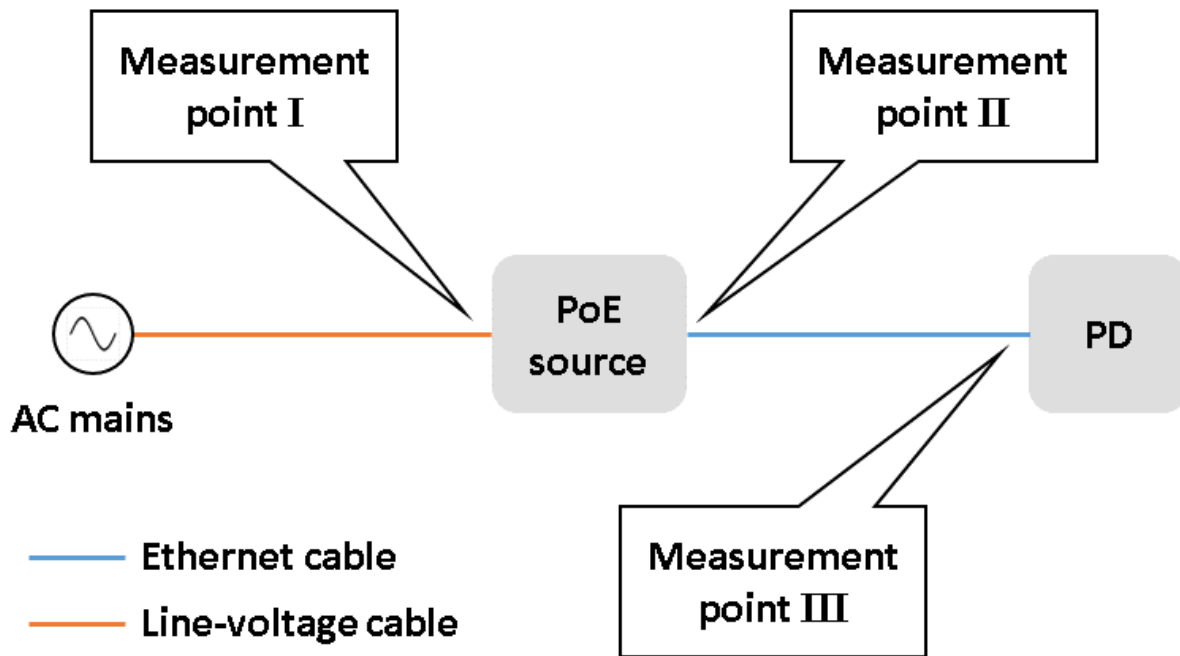

Figure 4.1. Block diagram of the test setup showing candidate measurement locations for this and future studies

## 5 Test Setup Implementation

The test setup described in Figure 4.1 was implemented using the following equipment:

- I. Power was measured at Measurement Point I using a revenue-grade “watt-hour” type reference meter.
- II. The PoE source was implemented by a PoE switch.
- III. Power was measured at measurement Point II by the PoE switch at each PSE port.
- IV. The PD was implemented by a set of PoE luminaires that were configured to draw constant electrical power and thereby function as a fixed load.

Key equipment specifications are presented in the following subsections. A high-level block diagram of the test setup implementation is shown in Figure 5.1. A photograph of the test setup implementation is shown in Figure 5.2.

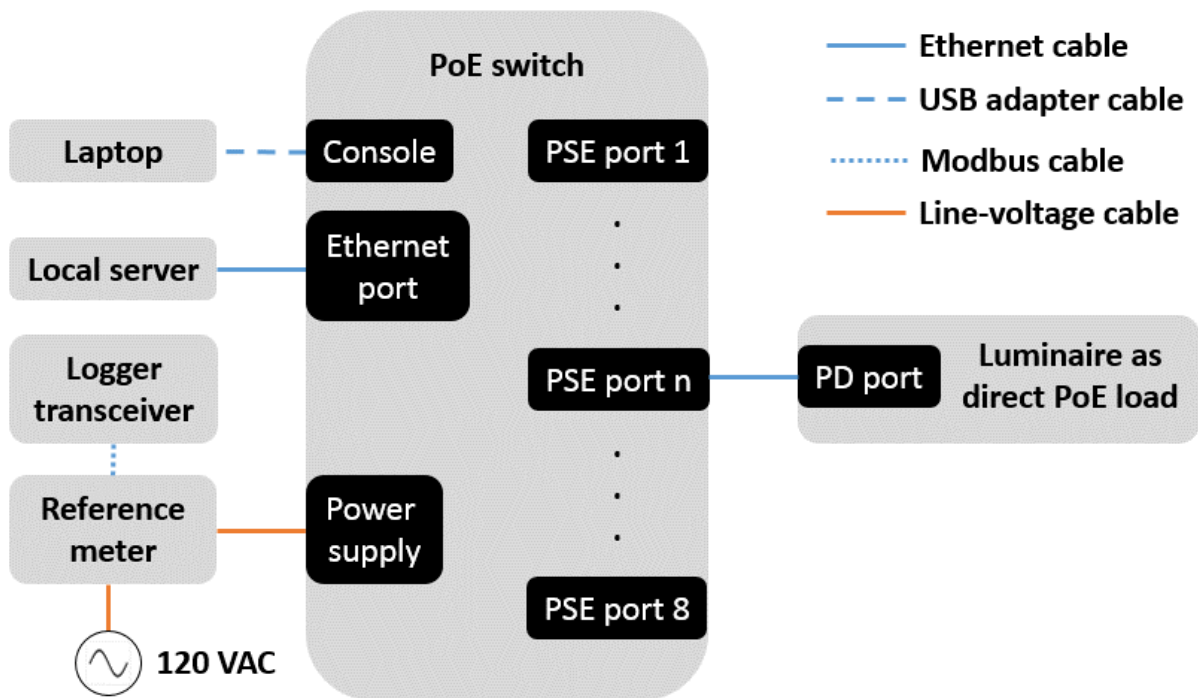

Figure 5.1. Block diagram of the test setup implementation



Figure 5.2. Photograph of the test setup implementation

## 5.1 AC Reference Meter

The AC meter used at Measurement Point I was a Continental Control Systems (CCS) WattNode Revenue watt-hour meter (model RWNC-3Y-208-MB) with CCS Accu-CT current transformer (model ACT-0750-020 Opt C0.6). The devices are separately rated at  $\pm 0.5\%$  accuracy for power measurements down to 5% of rated current (20 A), suggesting a combined accuracy of approximately  $\pm 1.0\%$  down to 1.0 A (corresponding to 120 W at 120 V and 1.0 power factor). Additional details for the CCS devices are captured in Appendix A. The reference meter components were calibrated by the manufacturer for energy measurements in October 2013, and the manufacturer recommended a calibration interval of 8 years. Notably, the calibration certificate issued by CCS indicates that test equipment used for calibration is traceable “to national standards administered by U.S. NIST and/or Euromet members,” but the manufacturer is not accredited to perform calibrations.<sup>9</sup> The reference meter records power measurements once every second by default. Power measurements were transmitted by two Obvius Modbus Transceivers (model R9120-5) from the reference meter to an Obvius AcquiSuite data logger (model A8812), which then uploaded data to the network. Additional details for the Obvius devices are captured in Appendix B. The data logger was configured with a custom device framework for the reference meter to query full-resolution values at every 5-minute mark.

## 5.2 PoE Source

The PoE source used as a DC meter at Measurement Point II was an 8-port Cisco Digital Building series PoE switch that supports UPOE (model CDB-8U) and reports measured output power for each PSE. Cisco does not publish measurement accuracy for this switch; for the purposes of this study, it was assumed to be no more accurate than the reference meter. It was located at one end of the joined cable trays, installed in an open-sided server rack, and operated at a nominal input voltage of 120 V (121.4 V to 124.3 V measured). To enable data capture, a USB adapter cable was used to make a serial connection from a laptop to the console port of the PoE switch. According to the PoE switch datasheet (see Appendix C), the power supply efficiency is 88% when loaded at 20% of capacity, and 91% when loaded to 50% or 100% of capacity. The (input) power rating is 600 W, and power supply capacity is rated at 545 W. In contrast, the eight PSEs support up to 60 W each, for a total switch output capacity of 480 W.

## 5.3 Powered Devices

Luminaires were placed two per shelf on wheeled, open-mesh racks, with minimum 12-inch spacing shelf-to-shelf. It was expected that luminaire input power would not vary appreciably with different lengths of a given model cable (Yseboodt 2017). However, it was also understood that luminaire input power can vary to some extent with luminaire input voltage if input current is not adjusted perfectly to compensate for differences in cable DCR (e.g., due to differences in cable length or conductor diameter). Two different models were used to explore potential differences in their effect on percent cable power losses (e.g., due to behavior and loading relative to PoE switch capacity).

- Luminaire A was a 2x2 LED troffer that acts as a direct PoE load (i.e., that can be connected directly to a PoE switch via Ethernet cabling without any intermediate device) and is rated for use with Cisco UPOE.<sup>10</sup> Four units were acquired in September 2015. At 46 W nominal input power for each luminaire, the set would be expected to load the PoE switch to at least 38% of its capacity. Full output for this dimmable luminaire was achieved using a “Full On” button in the manufacturer-provided software.
- Luminaire B was a 2x2 white-tunable LED troffer that acts as a direct PoE load and is rated for use with Cisco UPOE. Eight units were acquired in June 2017, one of which was set aside as a “spare” unit for bench-top testing. At 51 W nominal input power for each luminaire, the set was expected to more fully

---

<sup>9</sup> Information on International Laboratory Accreditation Cooperation (ILAC) Mutual Recognition Arrangement (MRA) signatories is available online at <http://ilac.org/ilac-mra-and-signatories/>.

<sup>10</sup> ANSI C137.3 is also applicable to systems with luminaires configured as indirect PoE loads, but it does not address voltage drop in cable(s) from PD to luminaire(s) in such applications.

load the PoE switch to at least 74% of its capacity. To obtain full light output, the “Target Dim Level” was set in the manufacturer-provided software to 255 (default value was 250), and the “Cool” and “Warm” sliders were raised to the top of their scales (in lieu of using the “ALL ON” button that also engaged RGB indicator lights).

## 5.4 Temperature Measurement

The thermometer used to measure room air temperature was a ThermoWorks ThermaData Wifi Temp Logger, with a rated accuracy of  $\pm 0.5^{\circ}\text{C}$ . Additional product details are captured in Appendix D. The device was placed on a chair located midway down the length of the joined cable trays. Values measured by the external sensor/probe were recorded; the device also reports internal measurements. Ambient temperature was measured and logged once every minute, but was not regulated.

## 6 Test Method and Calculations

Eight 1.5-m (short) and eight 49-m (long) cable lengths were cut, bundled using zip-ties, and terminated for each cable model. During testing, a bundle of long cables of a given model was laid in four 10-foot-long cable trays joined end-to-end, with 0.5-inch clearance to floor and 18 inches of space side-to-side within tray. The bundle was looped as needed within the 40-foot-long tray to accommodate the 49 m cable lengths from switch to luminaires, taking care to keep cable bend radius well above 4x the cable diameter, per TIA-568-C.0.<sup>11</sup>

Once a set of luminaires was operating in full output mode on a given model and length cable, PoE switch output power was recorded manually at 5-minute intervals and time-stamped by running the “show clock” and “show power inline police” commands from the prompt in a Tera Term shell. The switch reports power for each PSE separately, along with a total value that often differed slightly from the sum of individual values; the total value was used, assuming the discrepancy was due to rounding of reported individual values. Luminaires were operated until power measurements demonstrated they had stabilized<sup>12</sup> to 0.3% according to the following equation:

$$\left( \frac{P_{max}}{P_{min}} - 1 \right) \leq 0.003$$

Where:

$P_{max}$  = maximum power measurement during 20-minute period (W)

$P_{min}$  = minimum power measurement during 20-minute period (W)

For both switch input power and switch output power, average power was then calculated from the five measurements spanning this 20-minute period.<sup>13</sup> To enable comparison with measured switch output power, the measured switch input power was scaled by the rated efficiency of the PoE switch power supply:

---

<sup>11</sup> According to Siemon (<http://www.siemon.com/us/standards/09-06-10-update-568-c.asp>).

<sup>12</sup> By way of comparison, Illuminating Engineering Society (IES) LM-79-08 specifies less than 0.5% maximum-to-minimum variation for at least three measurements over a 30-minute period (IES 2008).

<sup>13</sup> In some cases, as much as 50 minutes of luminaire operation was required before power measurements stabilized. Only the final 20 minutes of (stable) data was used to calculate average power.



$$P_{out} = P_{in} \eta_{ps}$$

Where:

$P_{out}$  = 20-minute average PoE switch output power (W)

$P_{in}$  = 20-minute average PoE switch input power (W)

$\eta_{ps}$  = PoE switch power supply efficiency

To determine percent cable losses for comparison with ANSI C137.3 guidance at 50 m cable length, two quantities must be determined: power dissipated by the cable (the numerator) and PSE output power (the denominator). In this study, the numerator was determined by evaluating the delta ( $\Delta$ ) or difference between power measurements using different cable lengths. Although lengths of 0 m and 50 m would enable direct comparison with the ANSI guidance, a 0 m length is not physically viable. Linear extrapolation was used to estimate switch output power for 0 m and 50 m cable lengths based on the data for 1.5 m and 49 m lengths, respectively:

$$P_{ext} = P_{1.5} + \frac{(L_{ext} - 1.5)(P_{49} - P_{1.5})}{49 - 1.5}$$

Where:

$L_{ext}$  = extrapolated cable length of 0 or 50 (m)

$P_{ext}$  = PoE switch output power at extrapolated cable length (W)

$P_{1.5}$  = PoE switch output power at 1.5 m cable length (W)

$P_{49}$  = PoE switch output power at 49 m cable length (W)

Notably, this assumes that cable length has a negligible effect on PoE switch loading and efficiency (i.e., operating in a narrow band of a relatively flat “constant” region of the efficiency curve). The percentage of PSE output power dissipated in a 50 m length of a given model cable was then calculated as follows:

$$P_{cable,\%} = 100 \left( \frac{P_{50}}{P_0} - 1 \right)$$

Where:

$P_{cable,\%}$  = cable power losses (%)

$P_0$  = PoE switch output power at 0 m cable length (W)

$P_{50}$  = PoE switch output power at 50 m cable length (W)

Expected cable losses were calculated using an I<sup>2</sup>R model (Rogachev 2012, Yseboodt 2017) for comparison with measured values. In the model (shown below), the term “pairset” refers to a set of two pairs—whereas 4-pair PoE entails the use of two pairsets, 2-pair PoE uses one pairset.

$$P_C = R_{CH} \left( \frac{V_{PSE} - \sqrt{V_{PSE}^2 - 4 R_{CH} P_{PD}}}{2 R_{CH}} \right)^2$$

Where:

$P_C$  = cable power losses (W)

$R_{CH}$  = pair loop DCR divided by number of powered pairsets ( $\Omega$ )

$V_{PSE}$  = PSE output voltage (V)

$P_{PD}$  = PD input power (W)

Figure 6.1 shows the expected range of cable power losses for a 51 W luminaire (effectively two 25.5 W Class 4 PDs merged for 4-pair PoE) at 20°C, illustrating sensitivity to PSE output voltage and DCR. Note the following:

- Luminaire input power is assumed to not vary with varying luminaire input voltage.
- IEEE 802.3 specifies a minimum PSE output voltage of 50 V for Type 2 PSEs (capable of sourcing 30 W over 2 pairs), and this value is expected to be applied to Type 3 PSEs in IEEE P802.3bt (capable of sourcing 60 W over 4 pairs). In contrast, typical PSE voltage is expected to be at an intermediate value (e.g., 54 V) between this floor and the 57 V ceiling.<sup>14</sup>
- Cable DCR depends on the selected wire gauge (e.g., 24 AWG) and the actual DCR of the conductors used in the cable, presumed to be a value between the nominal DCR specified in ASTM B258-14 (by AWG) and the maximum DCR specified in TIA-568-C.2. Although some cable manufacturers publish nominal DCR specific to their products, most do not.
- I<sup>2</sup>R losses are nonlinear, so average cable power losses for a system of equal-power luminaires with 50 m average cable length would exceed 5% if a 50 m length had exactly 5% losses. However, the expected headroom at 50 m suggests that cable power losses for a system with 50 m average cable length should still be less than 5% when following the ANSI C137.3 guidance.<sup>15</sup>

<sup>14</sup> Cisco documentation for the CDB-8U switch does not state nominal PSE output voltage.

<sup>15</sup> It is assumed unlikely to have a perfect-storm scenario with IEEE-minimum PSE voltage, TIA-maximum cable DCR, and exactly 50 m average cable length for a system of equal-power luminaires.

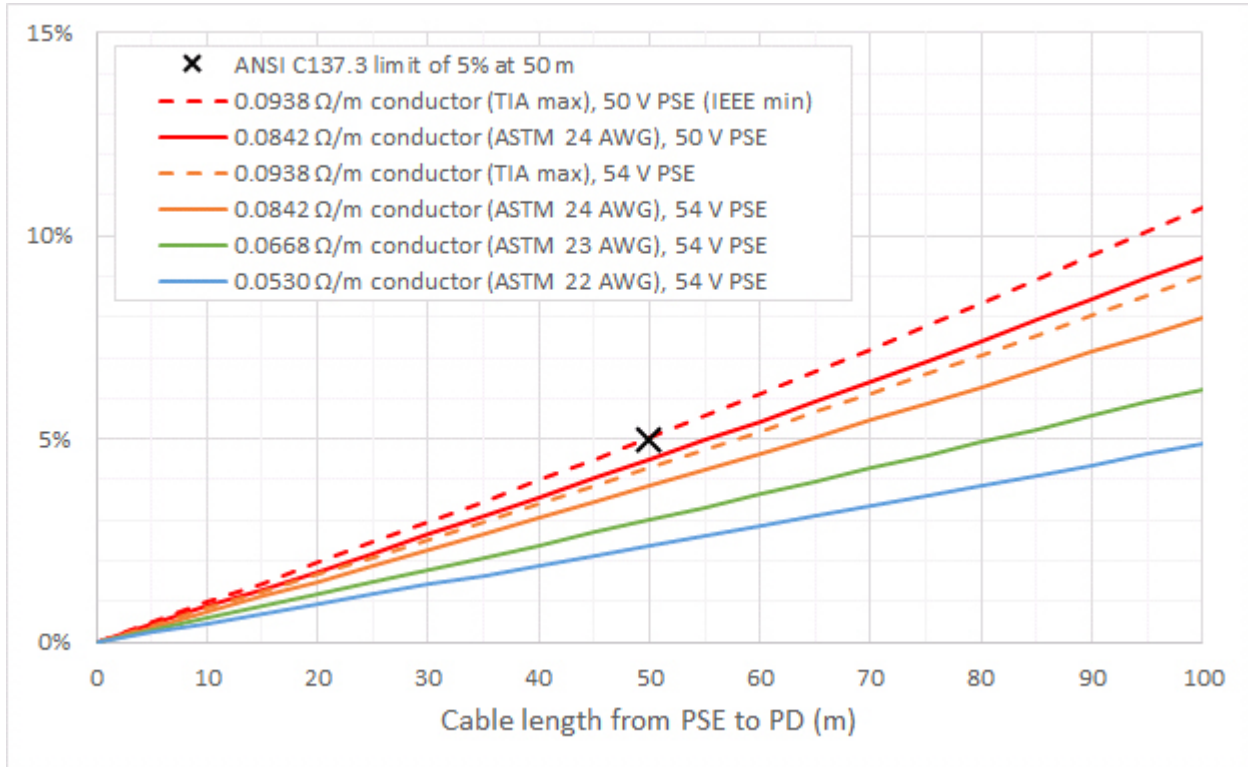

Figure 6.1. Range of expected cable losses for 51 W PD at 20°C ambient

Whereas stated DCR values are typically specific to 20°C (reference temperature) operation, ambient temperature was not controlled during testing. To facilitate comparison with measured losses, DCR values used to calculate expected losses were adjusted using the temperature coefficient of resistance for copper according to the following equation (Dellinger 1911), thereby using ambient temperature as a proxy for conductor temperature:

$$R = R_{ref} [1 + \alpha(T - T_{ref})]$$

Where:

$\alpha$  = temperature coefficient of resistance (0.393% for copper)

R = conductor DCR at temperature T ( $\Omega$ )

$R_{ref}$  = conductor DCR at temperature  $T_{ref}$  ( $\Omega$ )

T = measured temperature ( $^{\circ}\text{C}$ )

$T_{ref}$  = reference temperature ( $^{\circ}\text{C}$ )

The effect of ambient temperature variation on other system elements (e.g., luminaires, PoE switch, reference meter) was assumed to be negligible, because measurements for different lengths of a given model cable were consecutive. Similarly, the effect of connectors on percentage cable power losses was assumed to be negligible, because the same make/model connector was used on both lengths (short and long) of a given make/model cable. No patch panels or patch cables were used in this study.

## 7 Test Units

ANSI C137.3 assumes conductors are solid (rather than stranded) for cable lengths exceeding 5 m, so only solid-conductor cables were considered for testing in this study.<sup>16</sup> The cables selected for testing in this study varied by AWG, Category, fire rating, shielding, and manufacturer. Following is a summary of factors that drove product selection:

- Given the current availability of PoE switches supporting UPOE, and the expected completion of IEEE P802.3bt in 2018, it stands to reason that 4-pair PoE will displace 2-pair PoE—if it has not done so already—so as to minimize cabling losses and the cost of cabling. In 4-pair PoE applications, ANSI C137.3 recommends 24 AWG minimum for PDs  $\leq 55$  W, and 23 AWG minimum for higher-power PDs. These two AWGs appeared to be the most popular according to a search of the Anixter website; they currently account for 54% (23 AWG) and 41% (24 AWG) of 4-pair solid-conductor voice/data cables on the site.<sup>17</sup> In addition, several 22 AWG cables are specifically marketed for PoE applications. These three AWGs were also used in a study conducted by UL and the Plastics Industry Association in September 2015 (UL 2015).
- Similarly, three Categories—5e, 6, and 6A—were the most popular according to Anixter; they presently account for 44% (Category 6), 35% (Category 5e), and 17% (Category 6A) of 4-pair solid-conductor data cables on the website. A recent BSRIA study supports this rank order (Jones 2015), and these three Categories were also used in the UL study.
- Although riser-rated communications (CMR) cables are common, plenum-rated communications (CMP) cable is required in applications where luminaires are installed in a ceiling plenum. These two fire ratings were the most popular according to Anixter; they presently account for 48% (plenum) and 43% (riser) of 4-pair solid-conductor data cables on the website.
- ANSI C137.3 addresses unshielded twisted-pair (UTP) Ethernet cables as defined in TIA-568-C.2. This effectively excludes shielded cables, which have an overall shield containing all eight conductors (e.g., F/UTP) and/or individual shields around each conductor, but includes U/UTP cables.<sup>18</sup> Cable shielding types are also defined in ISO/IEC 11801:200 (Poulos 2015). Shielded cable definitions vary (IEEE 2012),<sup>19</sup> and some cables marketed as UTP contain “isolation wrap” that resembles the foil used in F/UTP cables. In addition, several manufacturers market or recommend shielded cables for use in PoE applications (Love 2015, Siemon 2017, Hitachi 2017), and some PoE luminaire manufacturers indicate compatibility with shielded cables (Cree 2016). U/UTP and F/UTP were the two most popular types according to Anixter; they presently account for 86% (U/UTP) and 13% (F/UTP) of 4-pair solid-conductor data cables on the website.
- Specific makes and models were selected on the basis of popularity on Anixter and a review of manufacturers represented on the TIA TR-42.7 subcommittee, which is responsible for TIA’s 568-series standards for Telecommunications Copper Cabling Systems. The manufacturers included in this first study were Belden (<http://www.belden.com/>), Berk-Tek (<https://www.berktek.us/>), CommScope (<http://www.commscope.com/>), General Cable (<https://www.generalcable.com/>), Panduit (<https://www.panduit.com/>), and Superior Essex (<https://www.superioressex.com/>).

---

<sup>16</sup> Conductors can be solid copper if cables will not be subjected to repeated flexing, which would require stranded-conductor cables (e.g., as used in work areas or between switch and any patch panel).

<sup>17</sup> Of the 2579 products remaining after filtering on 2017-11-02 at [https://www.anixter.com/en\\_us/products/Copper-Cabling-Infrastructure/Voice-and-Data-Cable/c/CV](https://www.anixter.com/en_us/products/Copper-Cabling-Infrastructure/Voice-and-Data-Cable/c/CV).

<sup>18</sup> TIA has defined U/UTP as “unscreened and unshielded twisted pairs” and F/UTP as “foil (surrounding) unscreened twisted-pairs” (TIA 2017).

<sup>19</sup> IEEE 1143-2012 defines F/UTP as “foil / unshielded twisted pair,” and later states: “In the foil twisted pair (FTP) construction the wire pairs are fully covered with an overall foil shield. TIA also calls this cable design ScTP (screened twisted pair). [...] The ISO/IEC nomenclature is S/FTP (screened/foil-twisted pair). Other common terms are F/UTP or foiled/unshielded twisted-pair or S/UTP (screened/unshielded twisted-pair).”

A set of different make/model connectors (i.e., RJ45 plugs) were selected based on overall cable diameter and overall diameter of insulated conductor, as stated in product literature or from correspondence with the manufacturers.

The cables acquired for this study from February through August 2017 are described in Table 7.1 and pictured in Figure 7.1. The Test ID naming convention is AWG-Category-model. For example, 24Cat5e-2 is the second of two cable models by different manufacturers that are 24 AWG and Category 5e. Although stated DCR was not used as a basis for product selection, values (or references to standards that set limits) found in product documentation are included in the table for reference.

**Table 7.1. The set of cables acquired for testing**

Test ID	AWG	Category	Shielding	Fire Rating	Rated Conductor DCR
24Cat5e-1	24	5e	U/UTP	CMP	$\leq 9.38 \Omega / 100 \text{ m}$
24Cat5e-2	24	5e	U/UTP	CMP	$\leq 9.38 \Omega / 100 \text{ m}$
24Cat5e-3	24	5e	F/UTP	CMP	$\leq 9.38 \Omega / 100 \text{ m}$
24Cat6-1	24	6	UTP	CMP	$\leq 9.38 \Omega / 100 \text{ m}$
23Cat6-1	23	6	U/UTP	CMP	$\leq 8.00 \Omega / 100 \text{ m}$
23Cat6-2	23	6	U/UTP	CMP	$7.0 \Omega / 100 \text{ m}$
23Cat6-3	23	6	F/UTP	CMP	$\leq 9.38 \Omega / 100 \text{ m}$
23Cat6A-1	23	6A	U/UTP	CMP	$< 9.38 \Omega / 100 \text{ m}$
23Cat6A-2	23	6A	UTP	CMR	$\leq 9.38 \Omega / 100 \text{ m}$
23Cat6A-3	23	6A	U/UTP	CMP	$\leq 7.61 \Omega / 100 \text{ m}$
22Cat5e-1	22	5e	U/UTP	CMP	Not stated*
22Cat6-1	22	6	U/UTP	CMP	$6.5 \Omega / 100 \text{ m}$

\* Datasheet referenced ANSI/TIA-568-C.2 and ANSI/ICEA S-90-661-2012.

Three of the twelve acquired make/model cables (shaded green in the table) were removed from this study for compatibility reasons:

- Test ID 23Cat6A-3 was not tested because it was found to have an insulated wire diameter visibly smaller than stated on its datasheet, resulting in incompatibility with the selected RJ45 plug that had been selected on the basis of overall cable diameter and overall insulated wire diameter. Notably, the cable manufacturer does not publish a list of compatible plugs.
- Test IDs 24Cat5e-3 and 23Cat6-3 (both F/UTP) were excluded from testing after luminaire B was found to be incompatible with shielded cables—see discussion in Appendix E.

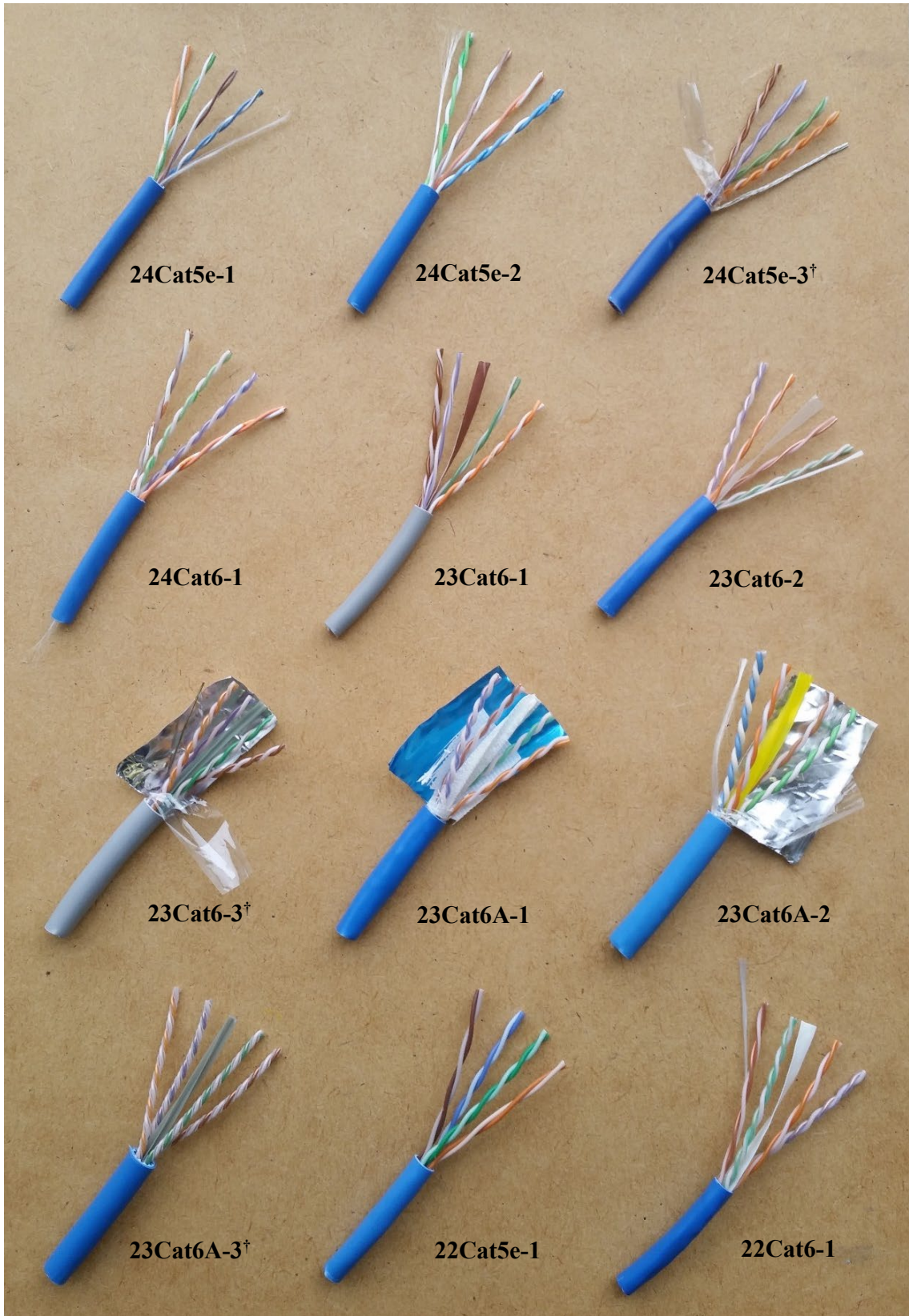

Figure 7.1. The set of cables acquired for testing, each splayed at one end to display internal structure, and shown side-by-side for uniform scale. Labels for the three products removed from testing are marked with a dagger (†) symbol.

## 8 Test Results

Results from testing for the nine remaining cable models using luminaires A and B as lighting loads are detailed in Sections 8.1 and 8.2.

### 8.1 Luminaire A as Load

Measurements from tests using luminaire A as the load are presented in Table 8.1. The switch-reported measurements indicate average luminaire input power of roughly 44 W for each of the four luminaires in the set. According to the product datasheet, this would indicate the PoE switch's power supply was loaded to about 32% of its capacity and was operating at 88%-91% efficiency. Lacking an overall efficiency rating for the PoE switch (which would account for other internal losses in addition to power supply losses), an intermediate value of 89.5% was used to calculate estimated output power from measured input power. As would be expected, this yields estimates that are somewhat higher than the total output power reported by the PoE switch. This may indicate that the actual efficiency of the PoE switch was somewhat lower than 89.5%, but much of the discrepancy could also be explained by overlapping measurement uncertainties for the two instruments (reference meter and PoE switch).

Table 8.1. Cable power losses with luminaire A as load. Values in  $P_c$  columns are conditionally formatted from low (green) to high (orange).

Test ID	length (m)	$T_{avg}$ (°C)	Reference meter-based				PoE switch-based		
			$P_a$ (W)	$P_{as}$ (W)	$P_{ase}$ (W)	$P_c$	$P_a$ (W)	$P_{ae}$ (W)	$P_c$
24Cat5e-1	1.5	23.4	202.5	181.2	181.0	3.5%	176.6	176.4	3.7%
	49	23.4	209.2	187.2	187.4		182.8	182.9	
24Cat5e-2	1.5	22.2	202.4	181.1	181.0	3.4%	176.3	176.1	3.6%
	49	22.1	208.9	186.9	187.1		182.4	182.5	
24Cat6-1	1.5	19.4	202.5	181.2	181.1	2.9%	176.3	176.1	3.2%
	49	19.4	208.1	186.3	186.4		181.7	181.9	
23Cat6-1	1.5	21.4	202.4	181.1	181.0	2.8%	176.3	176.2	3.0%
	49	21.3	207.7	185.9	186.0		181.4	181.5	
23Cat6-2	1.5	22.1	202.5	181.2	181.1	2.8%	176.4	176.2	3.0%
	49	22.0	207.8	186.0	186.1		181.5	181.6	
23Cat6A-1	1.5	18.9	202.3	181.1	181.0	2.5%	176.2	176.0	2.7%
	49	18.9	207.1	185.4	185.5		180.7	180.8	
23Cat6A-2	1.5	19.0	202.3	181.0	180.9	2.7%	176.2	176.0	3.0%
	49	19.0	207.5	185.7	185.8		181.2	181.3	
22Cat5e-1	1.5	23.0	202.4	181.1	181.0	1.9%	176.4	176.3	2.1%
	49	22.8	206.1	184.4	184.5		179.8	179.9	
22Cat6-1	1.5	18.3	202.3	181.1	180.9	2.2%	176.1	176.0	2.4%
	49	18.4	206.6	184.9	185.0		180.2	180.3	

Where:  $P_a$  = average measured power for 20-minute period

$P_{as}$  =  $P_a$  scaled by efficiency

$P_{ase}$  =  $P_{as}$  extrapolated to 0 m or 50 m

$P_{ae}$  =  $P_a$  extrapolated to 0 m or 50 m

$P_c$  = calculated cable power losses, assuming constant-power PD

## 8.2 Luminaire B as Load

Measurements from tests using luminaire B as the load are presented in Table 8.2. The switch-reported measurements indicate average luminaire input power of roughly 51 W for each of the seven luminaires in the set. According to the product datasheet, this would indicate the PoE switch's power supply was loaded to at least 66% of its capacity and was operating at 91% efficiency. Lacking an overall efficiency rating for the PoE switch (which would account for other internal losses in addition to power supply losses), this 91% value was used to calculate estimated output power from measured input power. As would be expected, this yields estimates that are somewhat higher than the total output power reported by the PoE switch. This may indicate that the actual efficiency of the PoE switch was somewhat lower than 91%, but much of the discrepancy could also be explained by overlapping measurement uncertainties for the two instruments (reference meter and PoE switch).

Table 8.2. Cable power losses with luminaire B as load. Conditional formatting for values in  $P_c$  columns uses same scale as in Table 8.1.

Test ID	length (m)	$T_{avg}$ (°C)	Reference meter-based				PoE switch-based		
			$P_a$ (W)	$P_{as}$ (W)	$P_{ase}$ (W)	$P_c$	$P_a$ (W)	$P_{ae}$ (W)	$P_c$
24Cat5e-1	1.5	23.2	400.7	364.7	364.6	1.1%	358.1	358.0	1.1%
	49	23.4	404.9	368.4	368.5		361.9	361.9	
24Cat5e-2	1.5	22.6	401.0	364.9	364.8	1.0%	357.9	357.8	1.0%
	49	22.4	404.7	368.2	368.3		361.4	361.5	
24Cat6-1	1.5	23.3	401.1	365.0	364.9	0.6%	357.9	357.8	0.8%
	49	23.4	403.5	367.2	367.2		360.6	360.7	
23Cat6-1	1.5	20.9	399.9	364.0	363.9	0.8%	357.6	357.5	0.7%
	49	21.1	402.8	366.6	366.6		360.0	360.0	
23Cat6-2	1.5	21.8	400.1	364.1	364.0	0.7%	357.6	357.5	0.8%
	49	21.6	402.8	366.5	366.6		360.2	360.2	
23Cat6A-1	1.5	18.6	399.2	363.2	363.1	1.0%	356.3	356.2	1.1%
	49	18.5	403.0	366.7	366.8		359.9	360.0	
23Cat6A-2	1.5	19.3	399.0	363.1	363.0	1.0%	356.6	356.5	1.0%
	49	19.1	402.9	366.6	366.7		360.0	360.1	
22Cat5e-1	1.5	22.5	400.2	364.2	364.1	0.5%	357.8	357.7	0.5%
	49	22.7	402.1	365.9	365.9		359.6	359.6	
22Cat6-1	1.5	18.0	399.3	363.4	363.3	0.8%	356.5	356.4	0.9%
	49	18.1	402.5	366.2	366.3		359.7	359.8	

Where:  $P_a$  = average measured power for 20-minute period

$P_{as}$  =  $P_a$  scaled by efficiency

$P_{ase}$  =  $P_{as}$  extrapolated to 0 m or 50 m

$P_{ae}$  =  $P_a$  extrapolated to 0 m or 50 m

$P_c$  = calculated cable power losses, assuming constant-power PD

## 9 Analysis

The test results were analyzed primarily to explore the impact of cable selection on PoE system energy efficiency and to evaluate the effectiveness of the ANSI C137.3 guidance. Several unanticipated outcomes and observations—including variation in PoE luminaire behavior as PDs, and the effect of PoE system



characteristics beyond cable selection on overall energy performance—are also discussed in the following subsections.

### 9.1 Impact of Cable Selection

The effect of cable selection on percent cable power losses is illustrated in Figure 9.1. Cable power losses varied with AWG as expected—numerically larger AWG corresponds to smaller diameter and greater DCR per unit length, resulting in greater  $I^2R$  losses. Intra-manufacturer comparison was possible for two of the 24 AWG cables—losses for the Category 6 model were lower than for the Category 5e model. Inter-manufacturer comparison was possible for all three AWGs:

- Losses for the two 24 AWG Category 5e models were comparable.
- Losses for the two 23 AWG Category 6A models were comparable to or lower than for the two 23 AWG Category 6 models.
- In contrast, losses for the one 22 AWG Category 5e model were lower than for the one 22 AWG Category 6 model.

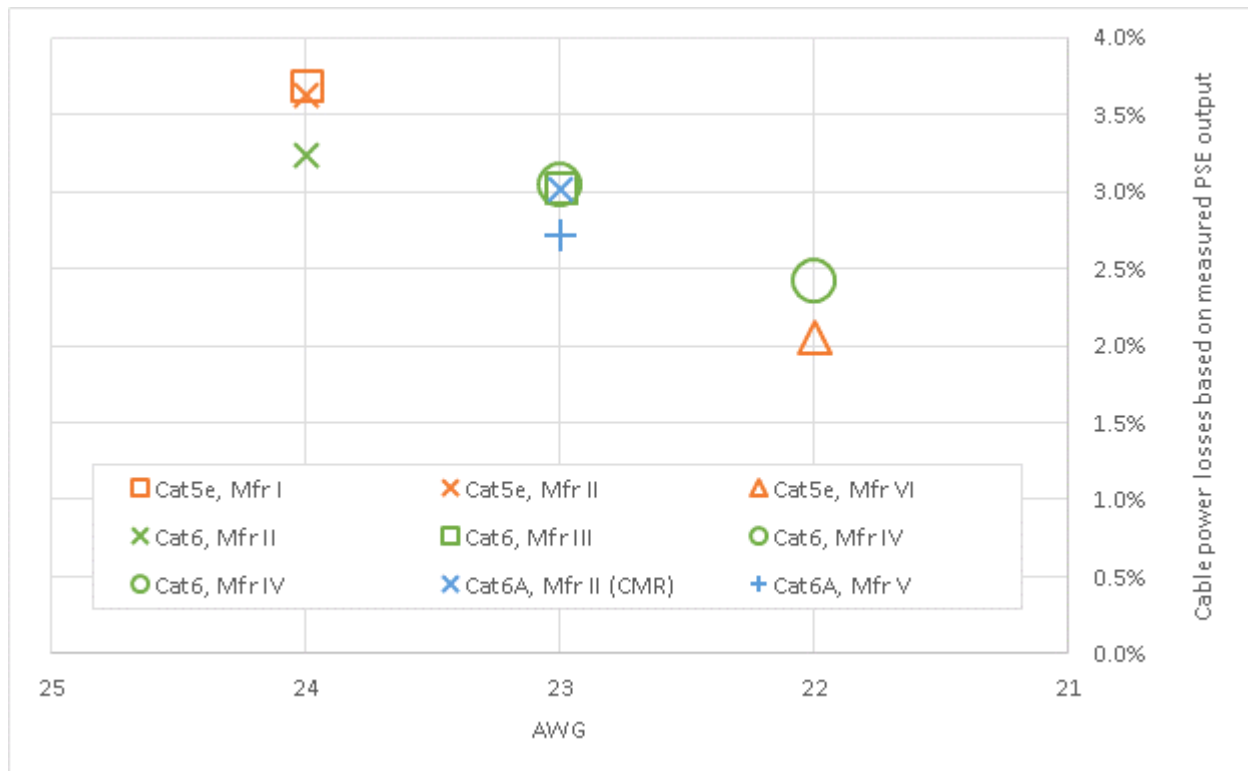

Figure 9.1. Impact of cable selection on power losses with luminaire A as PD. Category is distinguished by color; manufacturer is distinguished by symbol. With one exception (labeled CMR), cables were CMP.

Notably, product acquisition was generally not anonymous—most of the cables used in the study were donated by the manufacturers of these products. Units were not obtained in a random manner, and quantities were not of sufficient size to constitute a representative sample. Consequently, test results should not be construed as being strictly representative of the tested models or other models of the same type.

## 9.2 Effectiveness of ANSI C137.3 Guidance

Percent cable power losses were found to be consistently below the 5% threshold in ANSI C137.3 for all combinations of cable model and cable length. Figure 9.2 shows that cable power losses with 44 W luminaire A as PD ranged from 1.9% to 3.7%. By way of comparison, expected cable power losses with this lighting load range from 2.1% to 3.9%. However, it should be noted that although predicted losses agreed closely with measurements, luminaire A was not strictly proven to hold input power constant as cable length varied.

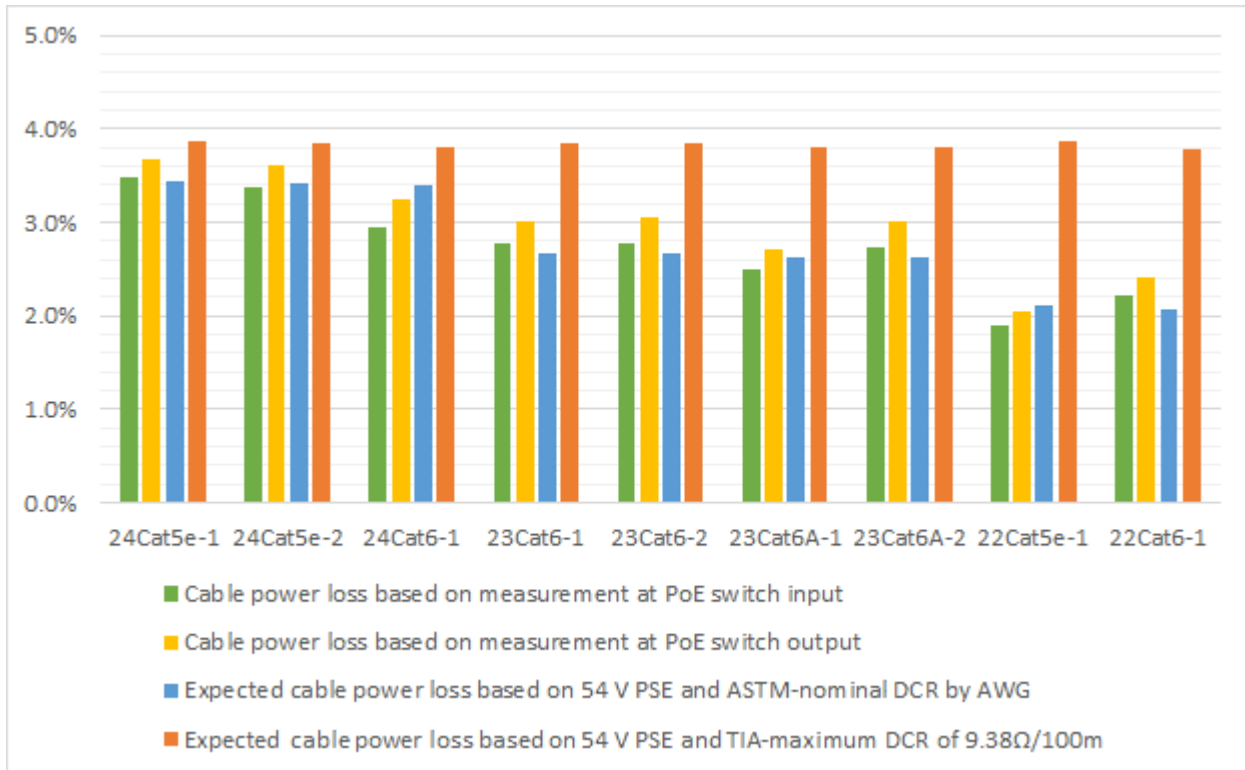

Figure 9.2. Expected vs. calculated 50 m cable losses with luminaire A as PD

## 9.3 Luminaires as PDs

The measurements with luminaire B as lighting load do not provide a clear indication of the energy performance of Ethernet cables in PoE lighting applications, and therefore cannot be used to evaluate the effectiveness of the ANSI C137.3 guidance. Calculated percent cable power losses with 51 W luminaire B as PD ranged from just 0.5% to 1.1%. This runs counter to expectations—increased power and current should translate to greater  $I^2R$  losses relative to PSE output power. By way of comparison, Figure 6.1 shows that expected cable power losses with this lighting load at 20°C range from 2.4% to 4.5%. In addition, the values for percent cable power losses do not appear to vary appreciably with AWG or any other parameter.

To investigate the discrepancy between measured and expected values, a digital multimeter (DMM) was used to measure DC input current, and a power quality analyzer was used to measure input voltage for the LED driver in the eighth (spare) unit of luminaire B. Power was found to vary with cable length, and this was later corroborated through testing conducted by the manufacturer of luminaire B. Given that luminaire B input power decreases when longer cables are used (i.e., input current is not increased to fully compensate for voltage drop), calculated percent cable power losses were lower than would be expected if luminaire input power were instead held constant.

## 9.4 PoE Lighting System Power

The power dissipated by conventional line-voltage lighting systems is traditionally evaluated primarily on the basis of luminaire input power. In low-voltage (e.g., PoE) lighting systems, losses in other elements merit additional consideration. Figure 9.3 shows that in this study, which followed the guidance in ANSI C137.3 to limit cable losses to 5%, measurements that included the PoE switch and 49 m cables were 13% to 19% higher than would have been expected considering luminaire input power alone. Values in the figure were calculated as the quotient of measured PoE switch input power (with 49 m cables) and input power for luminaire A (four 44 W units) or luminaire B (seven 51 W units).

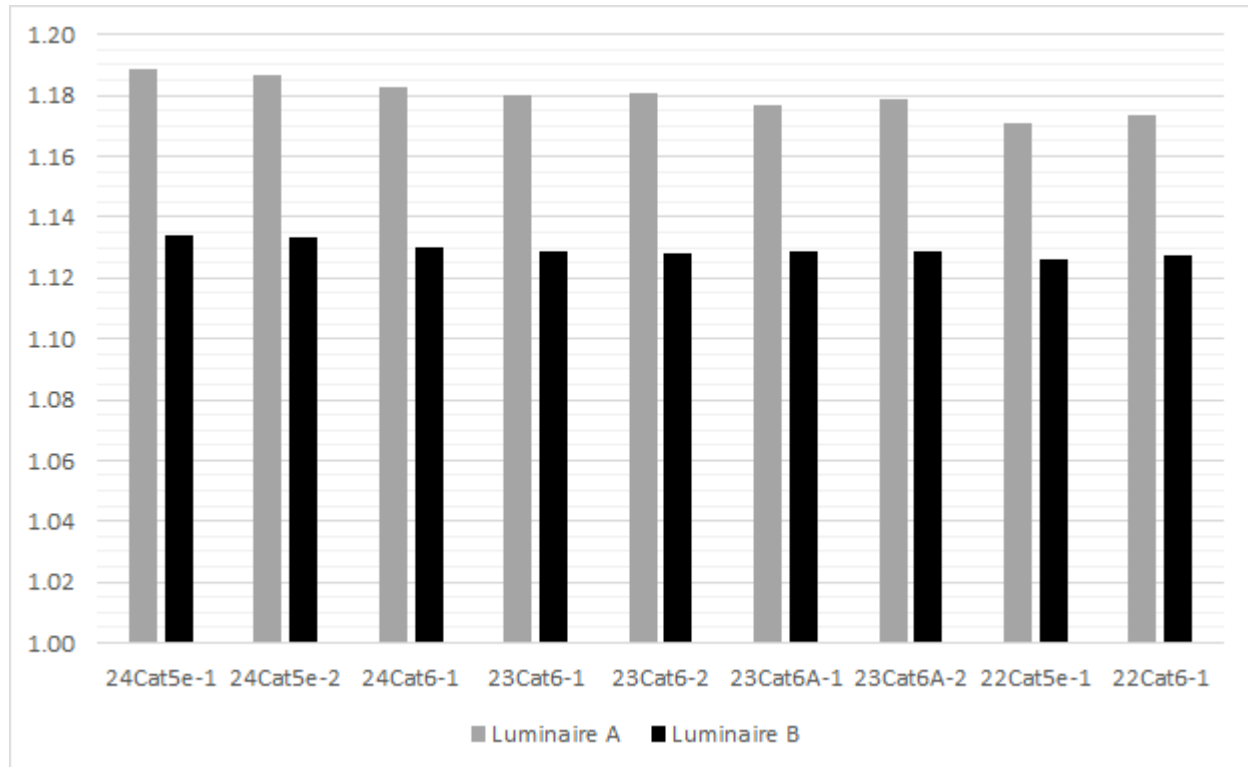

Figure 9.3. System power (including PoE switch and 49 m cables) relative to input power for luminaire A (4 x 44 W) and luminaire B (7 x 51 W)

## 10 Summary and Recommendations

Based on the limited testing conducted for this study, and assuming average cable length does not exceed 50 m in practice, the guidance offered in ANSI C137.3 appears to be effective in limiting cable energy losses to 5% in PoE lighting applications. Although the standard's best-case assumptions of ASTM-nominal DCR and operation at 20°C may tend to understate DCR values in the field, this appears to be offset by the worst-case accommodation of the minimum PSE voltage permitted by Clause 33 of IEEE 802.3. In addition, if luminaires such as luminaire B reduce input power in response to reduced input voltage, this will further reduce cable power losses. However, it should be noted that such a reduction in input power can be unacceptable if it corresponds to an appreciable decrease in light output.

## 10.1 Research Questions, Answers, and Recommendations

PoE is still relatively new to the lighting community, and by the same token, lighting is still relatively new to the PoE community. The key research questions for this study are reviewed below, accompanied by answers based on study findings and recommendations intended to help streamline the adoption of PoE technology in lighting applications.

### 1. Question

- To what extent do power losses vary between models of cable differing in AWG, Category, fire rating, shielding, or manufacturer?

### Answer

- Cable losses were found to decrease with increasing conductor diameter (i.e., numerically smaller AWG), as would be expected based on I<sup>2</sup>R models. No appreciable difference was observed for the other characteristics; however, considering the study limitations (e.g., the set of cables tested), this does not mean these parameters do not affect cable losses.
- Notably, three of the twelve cables acquired for testing were ultimately excluded from this study due to compatibility issues; two of these were the only shielded cables, so the effect of shielding was not evaluated in this study.

### Recommendation(s)

- The Institute of Electrical and Electronics Engineers (IEEE) 802.3 standard requires that PSEs (i.e., PoE switch ports) and PDs (e.g., lighting loads with RJ45 jacks) be compatible with all compliant cabling. Manufacturers of PoE switches or PoE lighting loads that are not compliant with IEEE 802.3 should very clearly state as much in datasheets and other product documentation, make no claims of IEEE PoE compliance, and consider redesigning so these products can be certified compliant in the future. It is not sufficient to only state compatibility in installation instructions, especially if such documentation is only provided after products are received (i.e., after a system has been designed and products have been ordered). To prevent damage and other issues that can arise from incompatibility,<sup>20</sup> buyers and specifiers should consider using products independently certified (e.g., by the Ethernet Alliance) as IEEE PoE compliant.<sup>21</sup>
- Manufacturers of Ethernet cables and connectors (RJ45 plugs) should publish lists of compatible cabling products or parameters relevant to compatibility (e.g., tolerances for overall diameters of cable and insulated conductors) in product documentation.

---

<sup>20</sup> Specifically regarding compatibility with shielded cabling, see IEEE 802.3 subclause 33.4.1 (Isolation).

<sup>21</sup> See <http://ethernetalliance.org/poecert/> for details on the Ethernet Alliance PoE certification program.

## 2. Question

- Is the ANSI C137.3 guidance effective in limiting power losses to less than 5% in a 50 m cable from PSE to PD?

### Answer

- Yes—the guidance was shown to effectively limit power losses to less than 5% in the cables tested (varying in AWG, Category, fire rating, and manufacturer). However, these findings should not be construed as being representative of all cable models and installation practices. For example, test units were not acquired randomly, and the effects of shielding and bundling were not explored in this study.

### Recommendation(s)

- PoE lighting system designers should specify that minimum AWG must be per ANSI C137.3 guidance, or specify minimum AWG directly if even lower losses are desired.
- PoE lighting system designers/suppliers/installers should publish statistics on PoE cable lengths used for each project (e.g., minimum, maximum, mean, median), along with information on each model used (e.g., AWG, Category, fire rating, shielding).

## 3. Question

- What is the range of maximum and nominal DCR values claimed for relevant Ethernet cables, and how does this compare with standard values?

### Answer

- With few exceptions, cable manufacturers only state maximum DCR or reference standards that specify maximum DCR (e.g., TIA-568-C.2).

### Recommendation(s)

- Given the growth of high-power PoE applications, Ethernet cable manufacturers should publish rated DCR values specific to each product. Although these values would be expected to fall between the ASTM-nominal and TIA-maximum values, knowledge of actual representative DCR values would enable selection of products that minimize cable power losses.

## 4. Question

- Can cable power losses be determined from values reported by PSE or PD?

### Answer

- Cable power loss can be accurately determined using values reported by the PSE, if the PD input power does not vary with cable length. Notably, of the two luminaires used as a lighting load in this study, one did not hold input power constant in this manner, and neither model reported its own power draw.

### Recommendation(s)

- PoE switch manufacturers should state measurement accuracy for switch-reported PSE output power in product documentation. In addition, PSE output voltage should be reported by the PoE switch.
- Manufacturers of lighting PDs (e.g., luminaires) should design their products such that input power and light output do not vary with cable length, or should describe in product documentation how these attributes vary with cable length.

## 5. Question

- What have prior studies found regarding PoE cable energy losses?

### Answer

- No other published studies of PoE cable energy losses were discovered. However, ANSI C137.3 states that “*resistive line losses within PoE lighting distribution systems utilizing CAT5/6 cabling can exceed 15% depending on the gauge of PoE cable selected.*” This is supported by worst-case calculations presented in a recent white paper published by the Ethernet Alliance (Yseboodt 2017).

### Recommendation(s)

- Additional studies should be conducted for comparison with the findings reported herein. Some examples are outlined in the next section.

## 10.2 Next Steps

This study is the first in a planned series of investigations into the system-level energy efficiency of PoE and other connected lighting systems. DOE plans to conduct at least one follow-up study of PoE cabling efficiency. Ideas presently under consideration include:

- A. Characterization of additional models of a given cable type. For example, although CMP cables are necessary in plenum applications and might be used more broadly to simplify inventory, CMR cables are generally less expensive. Price also appears to correlate more strongly with Category than with AWG; this may be driving recent product introductions by several manufacturers of 22 AWG Category 5e cables marketed for PoE applications.
- B. Characterization of cable types not yet tested (e.g., shielded, Category 7+). Although the greater complexity of shielded cables appears to increase prices relative to unshielded cables, they are marketed as offering superior heat dissipation (for reduced cable temperature) compared to unshielded cables in PoE applications.
- C. Characterization of the impact of cable installation variables. For example, a minimum radius of 4x cable diameter is specified by TIA for UTP cables, but bends may sometimes be tighter depending on installation practices. Similarly, bundle size is known to affect conductor temperature and DCR through mutual heating.
- D. Improvement of the test setup, perhaps through incorporation of PSE/PD emulators with power measurement capability.<sup>22</sup> Although these types of equipment are not actual PoE switches or lighting loads, they may better implement desired test setup functionality, and they offer the benefit of published measurement accuracy ratings. They can also enable exploration of the effect of different PSE output voltages within the range permitted by IEEE. It is expected that finalization of IEEE P802.3bt will lead to more options for sources and sinks of PoE power that more fully stress cables to standard limits.

DOE is also planning other studies that explore the impact of device selection or varying system use on system energy performance for PoE or other connected lighting systems. Ideas presently under consideration include:

1. Characterization of the effect of PoE switch selection on PoE system energy efficiency.
2. Characterization of the effect of different connected lighting system architectures (e.g., direct or indirect PoE loads from different manufacturers) on system energy efficiency.
3. Characterization of the effect of different connected lighting system use cases (e.g., varying in network traffic) on system energy efficiency.

---

<sup>22</sup> E.g., see Sifos Technologies (<http://sifos.com/>) and Reach Technology (<https://www.reachtech.com/poe-tester/>).

DOE requests feedback on this report, and would welcome any input from lighting and PoE industry representatives and other impacted stakeholders. In particular, DOE is interested in recommendations on what next steps should be prioritized over others. Email us at [DOE.SSL.UPDATES@ee.doe.gov](mailto:DOE.SSL.UPDATES@ee.doe.gov).

# Appendix A. Specifications for CCS



## Revenue-grade Energy and Power Meters

The WattNode Revenue meters are designed for use in applications where revenue-grade or utility-grade accuracy is required. The WattNode Revenue meters meet the accuracy requirements of ANSI C12.1 and support Modbus®, BACnet® or LonTalk® communications protocols or a pulse output.

The WattNode Revenue marks a new level of performance for the WattNode brand of electric power meters. The WattNode Revenue electric power meters are optimized for tenant submetering in residential and commercial spaces, PV energy generation metering, UMCS metering on military bases and more.

The WattNode Revenue meters are designed for 120/208 and 277/480 Vac applications. For ANSI C12.1 accuracy, current transformers compliant with IEEE C57.13 Class 0.6 are required. Each meter is calibrated using NIST traceable equipment following the procedures specified by ANSI C12.1 metering standards and is supplied with a certificate of calibration.

ANSI C12 Load Performance Test - RWNC-3Y-208-MB WattNode Revenue

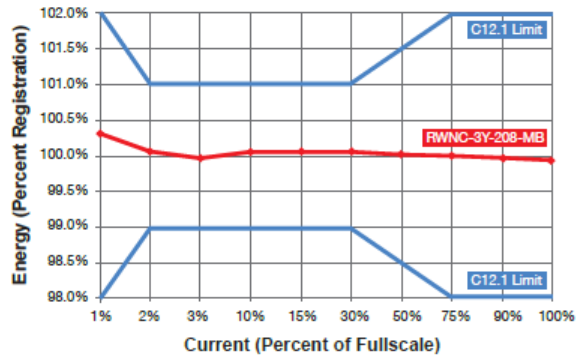

- Meets ANSI C12.1 accuracy standards
- Supplied with NIST traceable certificate of calibration
- Offers bidirectional, true net metering
- 120/208-240 Vac or 277/480 Vac services
- Line powered, compact, easy to install
- Use with safe, low voltage (333 mVac) current transformers
- Available interfaces: BACnet®, LonWorks®, Modbus®, or pulse output

### WATTNODE REVENUE for BACnet

- Native BACnet MS/TP (RS-485)
- Selectable serial baud rates to 76,800
- Field upgradable firmware
- 50+ measurements (kW, kWh, volts, amps, PF, demand and more)

### WATTNODE REVENUE for Modbus

- Modbus RTU protocol (RS-485)
- Supports 127 DIP switch selectable addresses
- 50+ measurements (kW, kWh, volts, amps, PF, demand and more)
- Pulse meter input or 5 volt control output (optional)
- 100+ data registers

### WATTNODE REVENUE for LonWorks

- LonWorks network variables (SNVTs)
- Logger option
- 30+ measurements (kW, kWh, volts, amps, PF, demand and more)
- LNS plug-in (free)

### WATTNODE REVENUE Pulse

- Low cost, high accuracy kWh pulse output
- Bidirectional metering, (consumption and production)
- Single and three phase metering, (energy and power)
- 3-Single phase meters in one (optional)
- Remote display (LCD) available

### CURRENT TRANSFORMERS

- Split-core, solid-core, bus bar and mini
- High accuracy model meets IEEE C57.13 class 0.6
- Ranges from 15 to 400 amps
- Safe 333 mVac output



3131 Indian Road • Boulder, CO 80301 USA  
 sales@ccontrolsys.com • www.ccontrolsys.com  
 (888) 928-8663 • Fax (303) 444-2903

RWNC-06.07.13: Specifications are subject to change



# Accu-CT<sup>®</sup> SPLIT-CORE CTs

**Wide Range, Unprecedented Linearity**



U.S. Patent 8,587,399  
U.S. Patent 8,847,576

## ACTL-0750 / ACT-1250

The Accu-CT<sup>®</sup> family of standard and revenue-grade, split-core current transformers offer outstanding linearity, very low phase angle error, easy one-handed opening and closing, with a safe 333 mVac low voltage output.

The standard Accu-CT meets IEEE C57.13 class 1.2, and when ordered with Option C0.6 it meets IEEE C57.13 class 0.6 accuracy standards. Each option C0.6 CT ships with a certificate of calibration.

Designed specifically for the WattNode<sup>®</sup> energy and power meters, the Accu-CT is available in two window opening sizes. The ACTL-0750 has a window opening of 0.75" x 0.75" for current measurements up to 250 amps while the ACT-1250, with its unique oval shaped window opening of 1.83" x 1.25" is designed for loads up to 600 amps. Both models are available in standard and revenue-grade accuracies with exceptional low-end accuracy from 1% to 120% of primary rated current - 10x better than traditional CTs.

## Specifications

	ACTL-0750	ACTL-0750 Opt C0.6	ACT-1250	ACT-1250 Opt C0.6
Accuracy	0.75%	0.50%	0.75%	0.50%
Rated Amps	5, 20, 50, 100, 200, 250	20, 50, 100, 200, 250	250, 400, 600	250, 400, 600
Optional Rated Amps	15, 30, 70, 150	15, 30, 70, 150		
Accuracy Class	IEEE/ANSI C57.13, Class 1.2	IEEE/ANSI C57.13, Class 0.6	IEEE/ANSI C57.13, Class 1.2	IEEE/ANSI C57.13, Class 0.6
CE Accuracy	IEC 60044-1 Class 1.0	IEC 60044-1 Class 0.5 S	IEC 60044-1 Class 1.0	IEC 60044-1 Class 0.5 S
CE Safety	CE	CE	CE	CE
RoHS Compliance	√	√	√	√
UL USA	UL Listed, XOBA, UL 2808	UL Listed, XOBA, UL 2808	UL Listed, XOBA, UL 2808	UL Listed, XOBA, UL 2808
UL Canada	UL Listed - XOBA7	UL Listed - XOBA7	UL Listed - XOBA7	UL Listed - XOBA7
Standard Lead Length	8 ft (2.4m) 18 AWG	8 ft (2.4m) 18 AWG	8 ft (2.4m) 18 AWG	8 ft (2.4m) 18 AWG
Phase Angle	±0.50 degrees	±0.25 degrees, ±0.50 degrees below 0°C	±0.50 degrees	±0.25 degrees
Output Options	333 mVac, 1 V, 100 mA	333 mVac, 1 V, 100 mA	333 mVac, 1 V, 100 mA	333 mVac, 1 V, 100 mA
Operating Temperature	-40°C to 80°C	-40°C to 80°C	-30°C to 75°C	-30°C to 75°C
Line Frequency	50/60 Hz	50/60 Hz	50/60 Hz	50/60 Hz
Option 50 Hz Available	√	√	Not required	Not required
List Price	\$47.00	\$57.00	\$56.00	\$67.00



3131 Indian Road • Boulder, CO 80301 USA  
sales@ccontrolsys.com • www.ccontrolsys.com  
(888) 928-8663 • Fax (303) 444-2903

ACTL-ACT-5.9.16: Specifications are subject to change

## Dimensions

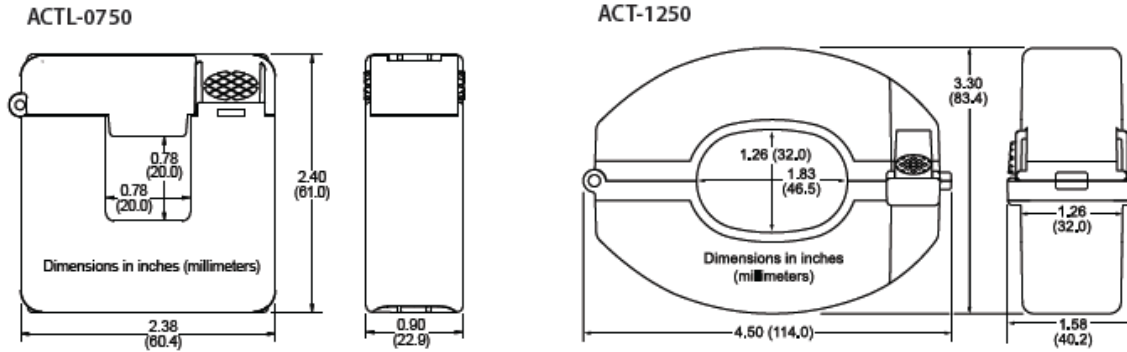

## Performance

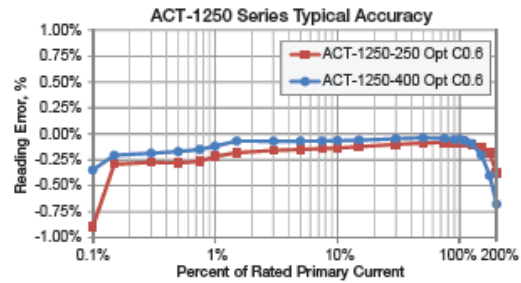
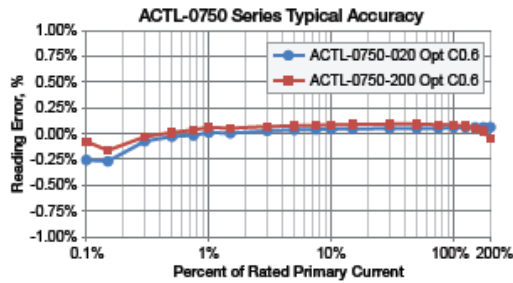

Graphs show typical performance at 23°C, 60 Hz. Graph shows a positive phase angle when the output leads the primary current.

## Model Numbers and Prices

For options and non-stock models, consult factory for pricing.

Standard ACTL-0750 Models	MSRP	Revenue ACTL-0750 Models	MSRP
ACTL-0750-005	\$47.00	Not Available	NA
ACTL-0750-020	\$47.00	ACTL-0750-020 Opt C0.6	\$57.00
ACTL-0750-050	\$47.00	ACTL-0750-050 Opt C0.6	\$57.00
ACTL-0750-100	\$47.00	ACTL-0750-100 Opt C0.6	\$57.00
ACTL-0750-200	\$47.00	ACTL-0750-200 Opt C0.6	\$57.00
ACTL-0750-250	\$47.00	ACTL-0750-250 Opt C0.6	\$57.00
Standard ACT-1250 Models	MSRP	Revenue ACT-1250 Models	MSRP
ACT-1250-250	\$56.00	ACT-1250-250 Opt C0.6	\$67.00
ACT-1250-400	\$56.00	ACT-1250-400 Opt C0.6	\$67.00
ACT-1250-600	\$56.00	ACT-1250-600 Opt C0.6	\$67.00



3131 Indian Road • Boulder, CO 80301 USA  
 sales@ccontrolsys.com • www.ccontrolsys.com  
 (888) 928-8663 • Fax (303) 444-2903

ACTL-ACT-5.9.16: Specifications are subject to change

# Appendix B. Specifications for Obvius



Energy Information Made Obvius

PRODUCT DATASHEET

## AcquiSuite Data Acquisition Server

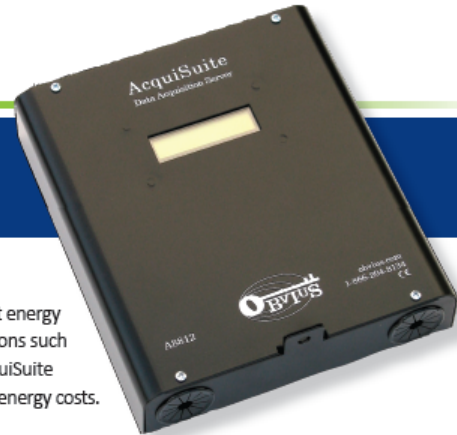

### ACQUISUITE A8812-1 AND A8812-GSM

Obvius' AcquiSuite is an intelligent, flexible data acquisition server allowing users to collect energy data from meters and environmental sensors. Designed to connect to IP-based applications such as enterprise energy management, demand response and smart grid programs, the AcquiSuite server lets you connect thousands of energy points, benchmark energy usage and reduce energy costs.

### DATA COLLECTION

The AcquiSuite collects and logs data from connected (wired or wireless) devices based on user selected intervals. Data from downstream devices is time stamped and stored locally in non-volatile memory until the next scheduled upload or manual download. Using an integrated modem or Ethernet (LAN) connection you can push or pull data via HTTP, XML, FTP or any custom protocol utilizing our AcquiSuite Module to build your own application, including integrated cellular communication options.

### INSTALLATION & FEATURES

No software is required. Easily access information through ANY web browser. The AcquiSuite has eight integrated flex I/O inputs. Each field selectable input can measure resistive, analog (4/20mA / 0-10V) and standard pulse / KYZ pulse output devices. This simplifies installation for basic projects monitoring electric, gas or water meters. There are several additional features including alarming, SNMP Traps, network configuration, wireless diagnostics, security provisions, alarm relays and backlit LCD. Our integrated meter driver library is designed to speed up installation and lower integration costs through "plug-and-play" connectivity.

### COMPATIBILITY

The AcquiSuite is compatible with nearly any front-end software platform allowing customers to use a variety of reporting tools; whether it's a local server or an enterprise wide reporting suite. Obvius offers a free utility for automated .CSV file downloads or an affordable hosted solution for \$195.00 annually (unlimited data storage).

### PARTNERS

Obvius' outstanding integration and software partners supplement our products and services to ensure you receive the very best energy monitoring solution.

### APPLICATIONS

- Utility submetering (electricity, gas, water, etc.)
- Measurement and verification (M&V)
- Reduce energy costs
- Access energy information from local or remote sites
- Benchmark building energy usage
- View "real time" performance data
- Track energy use and peak demand for Demand Response programs
- Monitor performance of critical systems (lighting, HVAC, PDUs, inverters, etc.)
- Alarm notification for data points above or below target levels (including SNMP Traps)
- Monitor renewable energy performance and production
- Create load profiles for energy purchases
- Push or pull meter data to energy dashboards, kiosks and software applications
- LEED / Energy Star certification

### ABOUT OBVIUS

Obvius manufactures data acquisition and wireless connectivity products specifically for energy management. We deliver cost-effective, reliable hardware designed to speed up installation. Our products are based on an open architecture allowing our customers to collect and log energy information from virtually any meter or sensor. The ability to support multiple communication options provides remote access to all your energy information. Founded in 2003, Obvius is located in Tualatin, Oregon. We serve a global clientele and continue to drive innovation by simplifying data collection.

### SOLUTIONS

- Data Acquisition
- Wireless Communication
- Meters & Sensors
- Custom Packaged Solutions
- Integration & Software Partners

### HEADQUARTERS

Tualatin, Oregon

### CONTACT US

sales@obvius.com

## AcquiSuite A8812

Obvius helps customers collect and distribute energy information. Users can begin with one best-of-breed product that satisfies a requirement, or incorporate several products and services for a complete energy management solution.

<b>Specifications</b>	
Processor	ARM9 embedded CPU, ARM7 IO co-processor
Operating System	Linux 2.6
Memory	32 MB RAM
Flash ROM	16 MB NOR Flash (expandable with USB memory device)
Interval Recording	1 to 60 minutes, user selectable
LEDs	8x input, 4 modem activity, Modbus TX/RX, power, system, IO status
Console	2 x 16 LCD character, two push buttons
<b>Power</b>	
North America	110-120VAC, 60Hz, primary
CE/Europe	100-240VAC, 50-60Hz, primary (interchangeable plug adapters optional)
Power Supply	24VDC, 1A, class 2 wall brick transformer included
<b>Communication</b>	
Protocols	Modbus/RTU, Modbus/TCP, TCP/IP, PPP, HTTP/HTML, FTP, NTP, XML, SNMP-Trap
LAN	RJ45 10/100 Ethernet, full half duplex, auto polarity
Modem	V.34 bis, 33,600 bps (A8812-1 only)
Cellular	GSM/GPRS Cellular (A8812-GSM only)
USB	USB expansion port
<b>Inputs</b>	
Serial Port	RS-485 Modbus, supports up to 32 external devices (expandable)
I/O	8x Flex IO inputs with user selectable modes: voltage, current, resistance, pulse and status
<b>Outputs</b>	
Relays	2x, dry contact 30 VDC, 150 mA max
<b>Physical</b>	
Weight	5lbs (2.3kg)
Size	8" x 9.25" x 2.5" (203mm x 235mm x 64mm)
<b>Environment</b>	
North America	0 to 50C, 0-90% RH, non-condensing
CE/Europe	5 to 40C, 0-90% RH, non-condensing
<b>Codes and Standards</b>	
FCC CFR 47 Part 15, Class A, EN 61000, EN 61326, CE	
<b>Additional Notes</b>	
NEMA enclosures available upon request	
Manufactured in the USA	



Obvius  
20497 SW Teton Avenue  
Tualatin, OR 97062

503 601 2099  
866 204 8134 (USA only)  
sales@obvius.com



Energy Information Made Obvius

PRODUCT DATASHEET

## ModHopper Wireless Modbus/Pulse Transceiver



### MODHOPPER R9120-5 AND R9120-5T

The ModHopper is a breakthrough mesh technology design that makes connecting Modbus and pulse devices simple and cost effective. Our “smart” ModHopper transceivers eliminate the need for costly wiring runs allowing users to capture meter data in the most challenging retrofit and campus environments. Collect meter points in existing buildings with minimum down-time or disruption of day-to-day operations.

### WHY USE MODHOPPERS FOR WIRELESS METERING

- Designed specifically for wireless metering
- 256Bit AES, FIPS-197 certified, J/F-12 8306
- No software or programming required
- Devices automatically configure when powered
- Wireless “mesh” network self-healing, self-optimizing
- Frequency hopping, spread spectrum (FHSS)
- Connect up to 32 Modbus and 2 pulse devices
- per ModHopper (expandable)
- Long distance communication (3000ft indoor / 14 miles LOS)
- Visual display of signal strength (LEDs)
- Multiple independent network capability
- Reliable, constant two-way communication and packet verification
- Point to multi-point communication
- Field upgradable firmware

### WIRELESS COMMUNICATION

Obvius developed a wireless Modbus/Pulse transceiver to capture remote meter points. Our high-powered radios allow you to easily collect meter data from multiple buildings over long distances. Our unique “mesh” technology provides optimized routing of communications with no pc or software configuration, meaning the ModHopper works immediately “out of the box.” This self-managed mesh network means that the system will function with high reliability where other wireless systems fail due to short- or long-term interference. ModHoppers can be used with any Modbus Master or gateway making them an ideal solution for any project. Ask us about international frequency options.

### COMPATIBILITY

The ModHopper is compatible with virtually any PLC or Modbus RTU device, allowing customers the flexibility to use the ModHopper in existing Modbus applications. The ModHopper is a “smart” device, which requires no programming. If used with the Obvius AcquiSuite, users can take advantage of numerous diagnostic tools, including a graphical display of the wireless mesh network.

### PARTNERS

Obvius’ outstanding integration and software partners supplement our products and services to ensure you receive the very best energy monitoring solution.

### APPLICATIONS

- Utility submetering (electric, gas, water, etc.)
- Metering in existing buildings (retrofit)
- Metering on campus environments
- Government advanced metering projects (256Bit AES, FIPS-197 certified, J/F-12 8306)
- Multi-tenant submetering projects
- Industrial / Manufacturing facilities
- Demand Response
- Renewable Energy – PV projects (inverters, string monitoring)

### ABOUT OBVIUS

Obvius manufactures data acquisition and wireless connectivity products specifically for energy management. We deliver cost-effective, reliable hardware designed to speed up installation. Our products are based on an open architecture allowing our customers to collect and log energy information from virtually any meter or sensor. The ability to support multiple communication options provides remote access to all your energy information. Founded in 2003, Obvius is located in Tualatin, Oregon. We serve a global clientele and continue to drive innovation by simplifying data collection.

### SOLUTIONS

- Data Acquisition
- Wireless Communication
- Meters & Sensors
- Custom Packaged Solutions
- Integration & Software Partners

### HEADQUARTERS

Tualatin, Oregon

### CONTACT US

sales@obvius.com

## Modhopper R9120-5

Obvius wireless solution help customers collect and distribute energy information in the most challenging environments. Used as a wireless conduit for Modbus and pulse meters, users can eliminate costly wiring runs and eliminate integration headaches. If used with our AcquiSuite, Obvius can truly deliver a plug-and-play metering solution.

Specifications	
Processor	60MHz ARM7 embedded CPU
LEDs	3 x RF, 2 x RS-485, 2 x Pulse, Alive, Alarm
Power	
North America	100-240VAC, 50/60Hz, 0.5A, 12VDC, 1A output class 2 power supply included
R9120-5T	9-30VDC, 900mA Required
Communication	
Protocols	Modbus RTU, 2-wire
Addressing	Modbus address may be set from 1 to 247 via dipswitch
Baud Rate	9600/19200 baud, N, 8, 1
RF	902-928MHz ISM band, 1W, frequency hopping spread spectrum (FHSS)
Inputs	
I/O	2x Pulse, dry contact, standard or KYZ, closure threshold 100Ω to 2.5Ω user selectable
Pulse Rate	User selectable to 10Hz, 50Hz, 100Hz, 250Hz <ul style="list-style-type: none"><li>• Pulse rate option 10Hz, minimum pulse width 50ms</li><li>• Pulse rate option 50Hz, minimum pulse width 10ms</li><li>• Pulse rate option 100Hz, minimum pulse width 5ms</li><li>• Pulse rate option 250Hz, minimum pulse width 2ms</li></ul>
Storage	Pulse counts stored in non-volatile memory
Modbus	Modbus RTU, 2-wire, hard-wire connect up to 32 devices (expandable)
Range	
R9120-5	3000ft (900m) typical indoor, 14 miles (22km) line of sight
Physical	
Weight	1.25lbs (0.67 kg)
Size	6.5" x 4.5" x 2" (260mm x 64mm x 45mm)
Environment	
North America -5T model	-30 to 70C, 0-90% RH, non-condensing
North America -5 model	0 to 50C, 0-90% RH, non-condensing
CE	5 to 40C, 0-90% RH, non-condensing
Altitude	2000M max
Pollution	Degree 2
Codes and Standards	
FCC ID	OUR-9XTEND or MCQ-XBPSX; FCC Part 15.247, Class A
IC (Industry Canada)	4214A-9XTEND or 1846A-XBPSX; IC: RSS-210
Encryption	256Bit AES
Additional Notes	
NEMA enclosures available upon request. Manufactured in the USA. 	
The R9120-5 is not cross-compatible with R9120-3 models. For use with any Modbus RTU device/server.	
<small>As per SIPC LLC, this product may be used in a system and employ or practice certain features and/or methods of one or more of the following patents: U.S. Patent No. 7,103,511, U.S. Patent No. 6,914,893, U.S. Patent No. 6,891,838, U.S. Patent No. 5,714,931, U.S. Patent No. 6,233,327, U.S. Patent No. 7,397,907, U.S. Patent No. 6,618,578, U.S. Patent No. 7,079,810, U.S. Patent No. 7,295,128, U.S. Patent No. 7,263,073, U.S. Patent No. 7,480,501, U.S. Patent No. 6,437,692, U.S. Patent No. 7,468,661, U.S. Patent No. 7,053,767, U.S. Patent No. 7,650,425, U.S. Patent No. 7,739,378</small>	



Obvius  
20497 SW Teton Avenue  
Tualatin, OR 97062

503 601 2099  
866 204 8134 (USA only)  
sales@obvius.com

# Appendix C. Specifications for Cisco



## Cisco Catalyst Digital Building Series Switches

The Cisco® Catalyst® Digital Building Series Switch is the industry's most power-efficient switch optimized for low-voltage Power over Ethernet (PoE) deployments and connectivity. The Digital Building Series Switch lays the foundation for powering and converging disparate building subsystems (lighting, HVAC, badging systems, metering, CCTV, access) onto a single IP network, thereby expanding, enabling, and accelerating the Cisco Digital Building ecosystem.

### Product Overview

Companies today are going digital in an effort to enable new customer experiences, empower workforce innovation, and build innovative business models powered by analytics. Buildings are central to this digital transformation, as buildings are where most traditional businesses run and operate from. For enhanced experiences and improved efficiencies in buildings, owners and facilities managers realize the value in interconnecting various building sub-systems, including lighting, HVAC, security, sensors and audio-video systems, which have historically remained stagnant, disparate and difficult to manage. Although the convergence of these isolated sub-systems is fundamental to digital transformation, it has remained complex and costly to implement thus far.

This complex problem changes their quiet, fanless design and compact footprint, the Cisco Catalyst Digital Building Series Switches offer flexible mounting options and open up a variety of network design and connectivity options. They can be deployed to support a variety of use cases, and are leaps ahead of the last generation of lighting and building technology enablers. Figure 1 shows the Cisco Catalyst Digital Building Switch.

Figure 1. Cisco Catalyst Digital Building Switch



## Cisco Catalyst Digital Building Series Switch Highlights

- 8 fast Ethernet ports and 2 gigabit copper uplink ports, with line-rate forwarding performance
- Universal Power over Ethernet (Cisco UPOE) and Power over Ethernet Plus (PoE+) support with up to 480W of power budget.
- Support for Layer 2 features, optimized for robust connectivity to lighting and other building IoT devices.
- Silent operation due to fanless design, which enhances reliability
- Enhanced Limited Lifetime Warranty (E-LLW)

## Product Features and Benefits

The Cisco Catalyst Digital Building Series Switch is the industry's first purpose-built switch optimized for powering low voltage LED lighting and digital building systems with many unique features. Unlike unmanaged IoT switches, it provides advanced networking features for flexibility, simplicity, security, and scale.

Table 1 lists many of the Cisco Catalyst Digital Building Switch's features and benefits.

Table 1. Digital Building Switch Features and Benefits Summary

Feature	Benefits
<b>Switch Reliability and Scale</b>	
<b>Small form factor; fanless design; silent operation</b>	Industry's first and only <b>semi-ruggedized fanless switch</b> , delivering up to 60W of power/port, ideal for deployment in indoor open workspaces and other areas that require no equipment noise
<b>Increased PoE scale</b>	Provides unprecedented PoE scale, <b>up to 480W of UPOE</b> (2x the power budget in any fanless switch) and <b>240W of PoE+</b>
<b>Perpetual and Fast UPOE</b>	<b>Industry's first Perpetual UPOE</b> ensures uninterrupted powering of endpoints during switch upgrade, reboots and configuration changes. <b>Fast UPOE</b> ensures powering of PoE and UPOE endpoints within <b>5 seconds</b> of power restoration, in case of power losses
<b>System life</b>	<b>This switch comes with the industry's highest reliability</b> and 10 years of system life
<b>Pre-validated architecture</b>	Cisco <b>supports tested, validated, and integrated lighting solutions</b> , which can reduce deployment risk and speed up the time to value. Proven robust technology, existing network and end-to-end security provide a complete digital building solution
<b>Installation Simplicity</b>	
<b>Flexible mounting options</b>	Supports flexible deployment/mounting options, including <b>rack, electrical cabinet, and in ceiling</b>
<b>Flexible powering options</b>	The switch can be powered through <b>direct wires</b> for 100-277VAC applications or with IEC plugs for 100-240VAC voltage inputs
<b>Automated testing in deployment</b>	<b>Smart defaults and integrated mobile app</b> (available on Android and iOS) greatly reduce the effort in testing the deployment by non-IT trained installers, resulting in lower installation costs
<b>Scalable Configuration and Control</b>	
<b>Configuration at scale</b>	The switch is DNA-ready, and can be used as part of the <a href="#">APIC-EM</a> solution for automated switch deployments. It also supports <a href="#">Network Plug-n-Play (PnP)</a> , a secure, scalable solution that accelerates network device deployments <b>by automating the installation/configuration</b> of Cisco IOS® Software, enhancing productivity and user experience, and reducing costs and downtime
<b>Remote upgrades</b>	The switch allows for hassle free upgrades, maintenance, and troubleshooting for lighting and other building networks using <b>over-the-air software change</b> . This is enhanced with the easy offline firmware and configuration upgrades with an SD card using an intuitive mobile app interface
<b>Network management</b>	<ul style="list-style-type: none"> <li>• <a href="#">Cisco Prime™ Infrastructure</a> provides comprehensive network lifecycle management with an extensive library of features that automate initial and day-to-day management. Cisco Prime integrates hardware and software platform expertise and operational experience into a powerful set of workflow-driven configuration, monitoring, troubleshooting, reporting, and administrative tools</li> <li>• <a href="#">Cisco Network Assistant</a> is a PC-based, centralized network management and configuration application for small and medium-sized business (SMB) with up to 250 users. An intuitive GUI lets you easily apply common services across Cisco switches, routers, and access points</li> <li>• <a href="#">Cisco Active Advisor</a> is a cloud-based service that provides essential lifecycle information about your network inventory. Available by itself or as a component of other Cisco network management applications, it helps you reduce your network's overall risk by keeping you up-to-date about the status of your products</li> </ul>



Feature	Benefits
Bluetooth integration	This is the industry's first Bluetooth enabled switch for out-of-band configuration from mobile apps on Android and Apple IOS via a removable radio
Improved web UI	The <a href="#">Cisco Configuration Professional for Catalyst</a> delivers superior management and monitoring of the switch
<b>Software and Security</b>	
Layer 2 features for operational simplicity	<ul style="list-style-type: none"> <li>• IPv6 host support</li> <li>• SNMPv3 for secure configuration, control and information retrieval through appropriate Management Information base (MIBs)</li> <li>• <b>Link Aggregation Control Protocol (LACP)</b> for creating Ethernet channeling with devices that conform to IEEE 802.3ad.</li> <li>• <b>Dynamic Host Configuration Protocol (DHCP)</b> auto-configuration of multiple switches through a boot server</li> <li>• <b>Cisco VLAN Trunking Protocol (VTP)</b>, which supports dynamic VLANs and dynamic trunk configuration across all switches</li> <li>• For enhanced traffic management, monitoring, and analysis, the Embedded <b>Remote Monitoring (RMON)</b> software agent, which supports four RMON groups (history, statistics, alarms, and events)</li> <li>• <b>LLDP</b> and <b>LLDP-MED</b> enhancements for easy identification of end-devices</li> </ul>
CoAP support	This switch functions as a <b>CoAP Proxy</b> . <b>CoAP</b> is a lightweight IoT protocol enabling not only lighting and sensors, but also HVAC and security systems to interoperate for delivering advanced space analytics
Security and threat defense	<ul style="list-style-type: none"> <li>• 802.1x, Webauth and MACAuth, TACACS+, RADIUS authentication capabilities for secure onboarding of end-devices</li> <li>• <b>Secure boot</b> to make sure that only signed and authorized images can load on the switch</li> <li>• <b>Port-based access control lists (ACLs)</b> to let the switch automatically allow or block packets based on policies for source and destination IP addresses. Rules can be set up differently on a port-by-port basis</li> <li>• <b>PVLAN edge</b> for restricting communication between end devices.</li> <li>• <b>Network-as-a-sensor</b>: Along with Cisco Catalyst 3850 as an upstream switch, this switch has <b>Network-as-a-sensor (NaaS)</b> capabilities to provide broad and deep visibility into network traffic flow patterns and rich threat intelligence information that allows rapid identification of security threats.</li> <li>• <b>Network-as-an-enforcer</b>: Along with Cisco Catalyst 3850 as an upstream switch, device profiling and <b>Network-as-an-enforcer (NaaE)</b> are enabled to dynamically enforce role based security to <b>reduce the overall attack surface, contain attacks, and minimize the time needed to isolate threats</b> when detected using Cisco TrustSec<sup>®</sup> with <a href="#">Cisco ISE</a></li> </ul>
<b>Power Management</b>	
Switch hibernate mode	Innovative technology that puts the switch in an ultra-low power mode during periods of no PoE usage. The switch can be configured to be in the hibernate mode using CoAP and comes out of this mode using Wake-on-packet-capabilities.
IEEE 802.3az or energy-efficient Ethernet (EEE)	Ports dynamically sense idle periods between traffic bursts and quickly switch the interfaces into a low-power idle mode, reducing power consumption.
System power efficiency	The switch also improves the industry standard on system <b>power efficiency to 90%</b> using innovative power management techniques.
Cisco Energy Manager	Integrated with the Cisco Energy Management suite for full energy control and visibility.
Power supply	Meets 80-Plus Gold efficiency requirements.

## Product Details

### Switch Models

The Cisco Catalyst Digital Building Switches are available in two switch models. They vary by the output power/port supported by the model. One model supports Power over Ethernet Plus (PoE+), which guarantees 30W/port of power. The other model supports Universal Power over Ethernet (UPOE), which guarantees double the power, 60W/port.

Table 2 compares the available switch models and list the software package that ships by default with each model and how much PoE power is available for the downlink ports.

**Table 2.** Cisco Catalyst Digital Building Series Switch Models and Default Software

Model	Ethernet Ports	PoE Output Ports	Available PoE Power	Uplinks	Default Software
CDB-8U	8 x 10/100 Fast Ethernet UPOE	8	480W	2 x 10/100/1000	LAN Lite
CDB-8P	8 x 10/100 Fast Ethernet PoE+	8	240W	2 x 10/100/1000	LAN Lite

### Switch Software

Cisco Catalyst Digital Building Series switches ship with the LAN Lite version of Cisco IOS® Software, which is optimized for Layer 2 deployments. For more information for the features supported in LAN Lite, refer to the Cisco feature navigator at <http://tools.cisco.com/ITDIT/CFN/isp/index.jsp>

### Licensing and Software Policy

Customers with Cisco Catalyst LAN Lite software feature sets will receive updates and bug fixes designed to maintain the compliance of the software with published specifications, release notes, and industry standards compliance as long as the original end user continues to own or use the product for up to one year from the end-of-sale date for this product, whichever occurs earlier. This policy supersedes any previous warranty or software statement and is subject to change without notice.

### Product Specifications

Table 3 provides hardware specifications for the Cisco Catalyst Digital Building Series Switches.

**Table 3.** Cisco Catalyst Digital Building Series Switch Hardware Specifications

Description	Specification	
<b>Performance</b>	Forwarding bandwidth	2.8 Gbps
	Switching bandwidth (full-duplex capacity)	5.6 Gbps
	Flash memory	256 MB
	Memory DRAM	512 MB
	Max VLANs	64
	VLAN IDs	1-4094
	Maximum transmission unit (MTU)	Up to 1500 bytes
	MAC entries	8192
	Port channels	6
	Queues	4 egress queues/port
	Buffers	1K
	ACLs	180 MAC, IPv4 and IPv6
	Bootup time	35 sec.
	<b>Forwarding Rate 64-Byte Packet Cisco Catalyst Digital Building Series</b>	
	CDB-8U	4.2 mpps
CDB-8P	4.2 mpps	
<b>Connectors and cabling</b>	<b>Cisco Catalyst Digital Building Series Ethernet interfaces:</b>	
	<ul style="list-style-type: none"> <li>• 10BASE-T ports: RJ-45 connectors, 2-pair Category 3, 4, or 5 unshielded twisted-pair (UTP) cabling</li> <li>• 100BASE-TX ports: RJ-45 connectors, 2-pair Category 5 UTP cabling</li> <li>• 1000BASE-T ports: RJ-45 connectors, 4-pair Category 5 UTP cabling</li> </ul>	

Description	Specification		
<b>Power connectors</b>	<ul style="list-style-type: none"> <li>The Cisco Catalyst Digital Building Series Switches utilize a proprietary power connector on the switch itself to make installation, upgrades, and maintenance fast and easy, as well as enabling up to 277VAC operation. The internal power supply is an autoranging AC power supply.</li> <li>Customers utilizing the direct-wire Catalyst Digital Building Flex Mount can provide 100V – 277VAC input voltage.</li> <li>Customers utilizing the C14 Catalyst Digital Building Flex Mount, or the Catalyst Digital Building 5-slot Rack Mount can utilize 100V – 240VAC input voltage.</li> <li>The C14 Catalyst Digital Building Flex Mount and the Catalyst Digital Building 5-slot Rack Mount can be ordered with a variety of country-specific power cords.</li> </ul>		
<b>Indicators</b>	Per-port status: link integrity, disabled, activity, speed, PoE Status System status: system, power saving mode		
<b>Dimensions (H x W x D)</b>	<b>Cisco Catalyst Digital Building Switch Series</b>	<b>Inches</b>	<b>Centimeters</b>
	CDB-8U	2.75 x 8.72 x 11.07	6.98 x 22.15 x 28.12
	CDB-8P	2.75 x 8.72 x 11.07	6.98 x 22.15 x 28.12
<b>Weight</b>	<b>Cisco Catalyst Digital Building Switch Series</b>	<b>Pounds</b>	<b>Kilograms</b>
	CDB-8U	9.65	4.38
	CDB-8P	9.65	4.38
<b>Environmental ranges</b>	<b>Cisco Catalyst Digital Building Switch Series</b>		
	Operating <sup>†</sup> temperature up to 5000 ft (1524 m)	-5°C to +50°C**	+23°F to +122°F
	Operating <sup>†</sup> temperature up to 10,000 ft (3048 m)	-5°C to +45°C	+23°F to +113°F
	Storage temperature up to 15,000 ft (4572 m)	-25°C to +70°C	-13°F to +158°F
	Operating altitude	Up to 3048 m	Up to 10,000 ft
	Storage altitude	Up to 4000 m	Up to 15,000 ft
	Operating relative humidity	5% to 95% noncondensing	
	Storage relative humidity	5% to 95% noncondensing	
	* Minimum ambient temperature for cold start is 0°C (+32°F)		
	** Operation above 40°C may impact service life.		
<b>Mean time between failures (MTBF)</b>	<b>Cisco Catalyst Digital Building Series</b>	<b>MTBF (hours)</b>	
	CDB-8U	710,270	
	CDB-8P	910,280	

Table 4 describes the power specifications for the Cisco Catalyst Digital Building Series Switches

Table 4. Power Specifications for Cisco Catalyst Digital Building Series Switches

Description	Specification				
		I/P Voltage	I/P Current		
			115VAC	230VAC	277VAC
<b>AC/DC input voltage and current</b>	CDB-8U	100VAC – 277 VAC +/- 10%	5.18A	2.59A	2.18A
	CDB-8P	100VAC – 277 VAC +/- 10%	2.68A	1.34A	1.16A
<b>Power rating</b>		<b>Watts</b>			
	CDB-8U	600W			
	CDB-8P	310W			
* Switch dissipation only (excludes PoE, which is dissipated at the end device).					

Description	Specification					
Power supply characteristics	CDB-8U	545W (80-Plus Gold)	20	88%	0.985	
			50	91%	0.995	
			100	91%	0.995	
	CDB-8P	280W (80-Plus Gold)	20	87%	0.982	
			50	90%	0.994	
			100	90%	0.994	
		Capacity	% Load	Efficiency (230 VAC)	Power Factor (pf)	
	CDB-8U	545W (80-Plus Gold)	20	89%	0.840	
			50	93%	0.958	
			100	93%	0.958	
	CDB-8P	280W (80-Plus Gold)	20	87%	0.835	
			50	91%	0.951	
100			91%	0.951		

Table 5 shows switch management and standards support.

Table 5. Management and Standards Support for Cisco Catalyst Digital Building Series Switch

Description	Specification	
SNMP MIB Supported	<ul style="list-style-type: none"> <li>BRIDGE-MIB</li> <li>CISCO-BRIDGE-EXT-MIB</li> <li>CISCO-CDP-MIB</li> <li>CISCO-CONFIG-COPY-MIB</li> <li>CISCO-ENVMON-MIB</li> <li>CISCO-ERR-DISABLE-MIB</li> <li>CISCO-FLASH-MIB</li> <li>CISCO-IF-EXTENSION-MIB</li> <li>CISCO-IGMP-FILTER-MIB</li> <li>CISCO-LAG-MIB</li> <li>CISCO-MEMORY-POOL-MIB</li> <li>CISCO-PAGP-MIB</li> <li>CISCO-PING-MIB</li> <li>CISCO-PORT-STORM-CONTROL-MIB</li> <li>CISCO-PROCESS-MIB</li> <li>CiscoPowerEthernetMIB</li> <li>CISCO-ENTITY-SENSOR-MIB</li> </ul>	<ul style="list-style-type: none"> <li>ciscoPowerEthernetExtMIB</li> <li>ciscoPoePdMIB</li> <li>CISCO-STP-EXTENSIONS-MIB</li> <li>CISCO-SYSLOG-MIB</li> <li>CISCO-TCP-MIB</li> <li>CISCO-UDLD-MIB</li> <li>CISCO-VLAN-IFTABLE-RELATIONSHIP-MIB</li> <li>CISCO-VLAN-MEMBERSHIP-MIB</li> <li>CISCO-VTP-MIB</li> <li>ENTITY-MIB</li> <li>ETHERLIKE-MIB</li> <li>IEEE8021-PAE-MIB</li> <li>IEEE8023-LAG-MIB</li> <li>IF-MIB</li> <li>SNMPv2-MIB</li> <li>TCP-MIB</li> <li>UDP-MIB</li> </ul>
Standards	<ul style="list-style-type: none"> <li>IEEE 802.1D Spanning Tree Protocol</li> <li>IEEE 802.1p CoS Prioritization</li> <li>IEEE 802.1Q VLAN</li> <li>IEEE 802.1s</li> <li>IEEE 802.1w</li> <li>IEEE 802.1X</li> <li>IEEE 802.1ab (LLDP)</li> <li>IEEE 802.3ad</li> <li>IEEE 802.3x: full duplex on 10BASE-T, 100BASE-TX, and 1000BASE-T ports</li> <li>BlueTooth Ver 4.0</li> </ul>	<ul style="list-style-type: none"> <li>IEEE 802.3af and IEEE 802.3at</li> <li>IEEE 802.3 10BASE-T</li> <li>IEEE 802.3u 100BASE-TX</li> <li>IEEE 802.3ab 1000BASE-T</li> <li>IEEE 802.3z 1000BASE-X</li> <li>RMON I and II standards</li> <li>SNMP v1, v2c, and v3</li> <li>IEEE 802.3az</li> <li>IEEE 802.3ae 10Gigabit Ethernet</li> <li>IEEE 802.1ax</li> </ul>

Description	Specification
<b>RFC compliance</b>	<ul style="list-style-type: none"> <li>• RFC 768 - UDP</li> <li>• RFC 783 - TFTP</li> <li>• RFC 791 - IP</li> <li>• RFC 792 - ICMP</li> <li>• RFC 793 - TCP</li> <li>• RFC 826 - ARP</li> <li>• RFC 854 - Telnet</li> <li>• RFC 951 - Bootstrap Protocol (BOOTP)</li> <li>• RFC 959 - FTP</li> <li>• RFC 1112 - IP Multicast and IGMP</li> <li>• RFC 1157 - SNMP v1</li> <li>• RFC 1186 - IP Addresses</li> <li>• RFC 1256 - Internet Control Message Protocol (ICMP) Router Discovery</li> <li>• RFC 1305 - NTP</li> <li>• RFC 1492 - TACACS+</li> <li>• RFC 1493 - Bridge MIB</li> <li>• RFC 1542 - BOOTP extensions</li> <li>• RFC 1901 - SNMP v2C</li> <li>• RFC 1902-1907 - SNMP v2</li> <li>• RFC 7252 - CoAP</li> </ul>
	<ul style="list-style-type: none"> <li>• RFC 1981 - Maximum Transmission Unit (MTU) Path Discovery IPv6</li> <li>• RFC 2068 - HTTP</li> <li>• RFC 2131 - DHCP</li> <li>• RFC 2138 - RADIUS</li> <li>• RFC 2233 - IF MIB v3</li> <li>• RFC 2373 - IPv6 Aggregatable Addrs</li> <li>• RFC 2460 - IPv6</li> <li>• RFC 2461 - IPv6 Neighbor Discovery</li> <li>• RFC 2462 - IPv6 Autoconfiguration</li> <li>• RFC 2463 - ICMP IPv6</li> <li>• RFC 2474 - Differentiated Services (DiffServ) Precedence</li> <li>• RFC 2507 - Assured Forwarding</li> <li>• RFC 2508 - Expedited Forwarding</li> <li>• RFC 2571 - SNMP Management</li> <li>• RFC 3046 - DHCP Relay Agent Information Option</li> <li>• RFC 3376 - IGMP v3</li> <li>• RFC 3580 - 802.1X RADIUS</li> </ul>
<b>Note:</b> RFC, MIB and standards compliance is dependent on Cisco IOS Software level.	

Table 6 shows safety and compliance information.

Table 6. Safety and Compliance Support

Description	Specification
<b>Safety standards</b>	<ul style="list-style-type: none"> <li>• UL 60950-1</li> <li>• CAN/CSA 22.2 No. 60950-1</li> <li>• EN 60950-1</li> <li>• IEC 60950-1</li> <li>• CE Marking</li> <li>• GB 4943</li> <li>• IEC 60825</li> <li>• UL 2043</li> <li>• UL 2108</li> </ul>
<b>Electromagnetic emissions certifications</b>	<ul style="list-style-type: none"> <li>• FCC Part 15, CFR 47, Class A, North America</li> <li>• EN 55022 (CISPR22) and EN 55024 (CISPR24), CE marking, European Union</li> <li>• AS/NZS, Class A, CISPR22:2004 or EN55022, Australia and New Zealand</li> <li>• VCCI Class A, V-3/2007.04, Japan</li> <li>• KCC (formerly MIC, GB17625.1-1998) Class A, KN24/KN22, Korea</li> </ul>
<b>Environmental</b>	Reduction of Hazardous Substances (ROHS) 6

## Ordering Information

To place an order, consult Table 7 for ordering information and visit [Cisco Commerce Workspace](#).

Table 7. Ordering Information for Cisco Catalyst Digital Building Series Switch

Cisco Catalyst Digital Building Series Switches	
Part Number	Description
<b>CDB-8U</b>	Cisco Catalyst Digital Building Switch, 8 x FE, 480W UPOE, Uplinks: 2 x 1G copper, LAN Lite
<b>CDB-8P</b>	Cisco Catalyst Digital Building Switch, 8 x FE, 240W PoE+, Uplinks: 2 x 1G copper, LAN Lite

Cisco Catalyst Digital Building Series Accessories	
Part Number	Description
CDB-MNT-FLEX-C14	Flexible mount with IEC C14 power junction box
CDB-MNT-FLEX-DIR	Flexible mount with direct-wired junction box
CDB-MNT-RACK5-C14	5-RU 19" rack mount chassis for 5 switches.

## Warranty Information

Cisco Catalyst Digital Building Series Switches come with an enhanced limited lifetime hardware warranty that includes 90 days of Cisco Technical Assistance Center (TAC) support and next-business-day hardware replacement free of charge (see Table 8 for details).

Table 8. Enhanced Limited Lifetime Hardware Warranty

Cisco Enhanced Limited Lifetime Hardware Warranty	
<b>Device covered</b>	Applies to Cisco Catalyst Digital Building CDB-8U and CDB-8P switches.
<b>Warranty duration</b>	As long as the original customer owns the product.
<b>EoL policy</b>	In the event of discontinuance of product manufacture, Cisco warranty support is limited to 5 years from the announcement of discontinuance.
<b>Hardware replacement</b>	Cisco or its service center will use commercially reasonable efforts to ship a replacement for next-business-day delivery, where available. Otherwise, a replacement will be shipped within 10 working days after receipt of the RMA request. Actual delivery times might vary depending on customer location.
<b>Effective date</b>	Hardware warranty commences from the date of shipment to customer (and in case of resale by a Cisco reseller, not more than 90 days after original shipment by Cisco).
<b>TAC support</b>	Cisco will provide during business hours, 8 hours per day, 5 days per week basic configuration, diagnosis, and troubleshooting of device-level problems for up to a 90-day period from the date of shipment of the originally purchased Cisco Catalyst Digital Building product. This support does not include solution-level or network-level support beyond the specific device under consideration.
<b>Cisco.com access</b>	Warranty allows guest access only to Cisco.com.

Your formal warranty statement, including the warranty applicable to Cisco software, appears in the Cisco information packet that accompanies your Cisco product. We encourage you to review carefully the warranty statement shipped with your specific product before use. Cisco reserves the right to refund the purchase price as its exclusive warranty remedy.

Adding a Cisco technical services contract to your device coverage provides access to the Cisco Technical Assistance Center (TAC) beyond the 90-day period allowed by the warranty. It also can provide a variety of hardware replacement options to meet critical business needs, as well as updates for licensed premium Cisco IOS Software, and registered access to the extensive Cisco.com knowledge base and support tools.

For additional information about warranty terms, visit <http://www.cisco.com/go/warranty>.

## Cisco and Partner Services

Enable the innovative, secure, intelligent edge using personalized services from Cisco and our partners. Through a discovery process that begins with understanding your business objectives, we help you integrate the next-generation Cisco Catalyst fixed switches into your architecture and incorporate network services onto those platforms. Sharing knowledge and leading practices, we support your success every step of the way as you deploy, absorb, manage, and scale new technology. Choose from a flexible suite of support services (Table 9), designed to meet your business needs and help you maintain high-quality network performance while controlling operational costs.

**Table 9. Technical Services Available for Cisco Catalyst Digital Building Series Switches**

Technical Services
<p><b>Cisco SMARTnet® Service</b></p> <ul style="list-style-type: none"> <li>• Around-the-clock, global access to the Cisco Technical Assistance Center (TAC)</li> <li>• Unrestricted access to the extensive Cisco.com knowledge base and tools</li> <li>• Next-business-day, 8x5x4, 24x7x4, and 24x7x2 advance hardware replacement and onsite parts replacement and installation available</li> <li>• Ongoing operating system software updates within the licensed feature set</li> <li>• Proactive diagnostics and real-time alerts on Smart Call Home-enabled devices</li> </ul>
<p><b>Cisco Smart Foundation Service</b></p> <ul style="list-style-type: none"> <li>• Next business day advance hardware replacement as available</li> <li>• Business hours access to SMB TAC (access levels vary by region)</li> <li>• Access to Cisco.com SMB knowledge base</li> <li>• Online technical resources through Smart Foundation Portal</li> <li>• Operating system software bug fixes and patches</li> </ul>
<p><b>Cisco Focused Technical Support Services</b></p> <ul style="list-style-type: none"> <li>• 3 levels of premium, high-touch services are available <ul style="list-style-type: none"> <li>◦ Cisco High-Touch Operations Management Service</li> <li>◦ Cisco High-Touch Technical Support Service</li> <li>◦ Cisco High-Touch Engineering Service</li> </ul> </li> <li>• Valid Cisco SMARTnet® or SP Base contracts on all network equipment are required</li> </ul>

## Cisco Capital

### Financing to Help You Achieve Your Objectives

Cisco Capital® financing can help you acquire the technology you need to achieve your objectives and stay competitive. We can help you reduce CapEx, accelerate your growth, and optimize your investment dollars and return-on-investment. Cisco Capital financing gives you flexibility in acquiring hardware, software, services, and complementary third-party equipment, with the option of just one predictable payment. Cisco Capital® is available in more than 100 countries. [Learn more.](#)

### Learn More

For more information, contact your Cisco sales account rep or visit [cisco.com/go/digitalbuilding](https://www.cisco.com/go/digitalbuilding)



Americas Headquarters  
Cisco Systems, Inc.  
San Jose, CA

Asia Pacific Headquarters  
Cisco Systems (USA) Pte. Ltd.  
Singapore

Europe Headquarters  
Cisco Systems International BV Amsterdam,  
The Netherlands

Cisco has more than 200 offices worldwide. Addresses, phone numbers, and fax numbers are listed on the Cisco Website at [www.cisco.com/go/offices](http://www.cisco.com/go/offices).

Cisco and the Cisco logo are trademarks or registered trademarks of Cisco and/or its affiliates in the U.S. and other countries. To view a list of Cisco trademarks, go to this URL: [www.cisco.com/go/trademarks](http://www.cisco.com/go/trademarks). Third party trademarks mentioned are the property of their respective owners. The use of the word partner does not imply a partnership relationship between Cisco and any other company. (1110R)

Printed in USA

C78-738206-00 01/17

© 2017 Cisco and/or its affiliates. All rights reserved. This document is Cisco Public Information.

Page 9 of 9

# Appendix D. Specifications for ThermoWorks



[Software \(/software\)](#)  
 [Specials \(/On-Sale/Sale-Item\)](#)  
 [Blog \(http://blog2.thermoworks.com\)](#)  
[Learning Center \(/learning-center\)](#)  
 [Service/Support \(/service-support\)](#)  
 [Calibration \(/calibration-services\)](#)

- [Thermapens \(/Thermapen-Mk4\)](#)  
 [Pocket Digital \(/Pocket-Digital\)](#)  
 [Handheld/Probes \(/Handheld-Probes\)](#)
- [Alarms \(/Alarms\)](#)  
 [Timers \(/Timers\)](#)  
 [Infrareads \(/Infrareads\)](#)  
 [Data Logging \(/Data-Logging\)](#)
- [pH/Humidity \(/pH-Humidity\)](#)  
 [Books/Gifts \(/Books-Gifts\)](#)  
 [Calibration Tools \(/Calibration-Tools\)](#)  
 [More \(/More\)](#)
- [Food Safety \(/Food-Safety\)](#)  
 [Meat/Fish \(/Meat-Poultry-Fish\)](#)  
 [Turkey/Chicken \(/Turkey-Chicken\)](#)
- [BBQ/Smoker \(/BBQ-Grilling\)](#)  
 [Candy/Chocolate \(/Candy-Chocolate\)](#)  
 [Baking \(/Baking\)](#)  
 [Frying \(/Frying\)](#)
- [Sous Vide \(/Sous-Vide\)](#)  
 [Brewing \(/Brewing\)](#)  
 [Other \(/Other-Uses\)](#)

## ThermaQ KITS - 2-CHANNEL COOKING ALARMS

FLAT RATE SHIPPING FROM \$3.99  
[\(/shipping-info\)](#)

<http://www.thermoworks.com/Kits/BBQ-Kit?keywords=thermaq>

HOME () > DATA LOGGING (/DATA-LOGGING) > THERMADATA™ WiFi TEMP LOGGERS (1 OR 2 EXTERNAL SENSORS, FIXED PROBES)

## ThermaData™ WiFi Temp Loggers (1 or 2 External Sensors, Fixed Probes)

[Write a Review](#) | [3 Questions, 3 Answers](#)   SKU: #ThermaData WTH

**\$169.00**

Includes 2-point Cal Cert.



Logger Channel: Single Fixed

- [Single Fixed \(/ThermaData-WiFi-Thermistor-Probes\)](#)
- [Dual Fixed \(/ThermaData-WiFi-Thermistor-Probes?custcol19=2\)](#)

Quantity

**Add to Cart**

[Add to my Wish List](#)

Includes multi use wall bracket for wall or tripod mounting. Bracket is also a bench top stand.



- Resolution of 0.1 °C/°F
- Email alerts when alarm limits exceeded
- Access temperature data worldwide via internet
- Programmable high/low alarm
- User friendly, simple setup
- No cradles, gateways, or cloud storage fees
- Includes 2-point NIST-Traceable Calibration Certificate





Access your critical temperature data from anywhere in the world with our new ThermoData Wi-Fi Loggers. Use your existing Wi-Fi router network with no additional gateways or repeaters, to transmit and view temperature readings of walk-ins, cooking areas, prep areas, cold holding, ovens, and much more. Each logger comes with a 2-point NIST-Traceable calibration certificate to certify its accuracy.

► Details

► Specs

Temp. Range (internal)	32 to 122°F (0 to 50°C)
Temp. Range (external)	Probe: -40 to 257°F (-40 to 125°C) *Cable: 5 to 221°F (-15 to 105°C)
Resolution	0.1°F or °C
Accuracy	±0.9°F (±0.5°C)
Memory	18000 or 2 x 9000 readings
Sample Rate	6 seconds to 330 min.
Battery/Life	2 x 1.5V AA / approx. 12 months
Probe Dimensions	1/8" dia. X 4.25" L w/3' cable
Display	2 LEDs / LCD
Dimensions	1.2 x 2.9 x 3.8 inch (29 x 72.5 x 96 mm)
Weight	5.8 oz. (165g)
Certificate	Includes NIST-Traceable calibration certificate

► Software

► More Info

Kits and Accessories



(/Therma-WiFi-Boot)  
Therma WiFi Boot  
(/Therma-WiFi-Boot)

\$19.00

[See More \(/Therma-WiFi-Boot\)](#)

Related

NEW



(/ThermaData-WiFi-Type-T)

ThermaData™ WiFi Thermocouple Logger (2 External T type mini-connector inputs)  
(/ThermaData-WiFi-Type-T)

Dual T thermocouple inputs, range to 752°F, large display, Wi-Fi

\$229.00

Includes 2-point Cal Cert. Logger only.

NEW



(/ThermaData-WiFi-Type-K)

ThermaData™ WiFi Thermocouple Logger (2 External K type mini-connector inputs)  
(/ThermaData-WiFi-Type-K)

Dual K thermocouple inputs, range to 2501°F, large display, Wi-Fi

\$229.00

Includes 2-point Cal Cert. Logger only.



## Appendix E. Shielded Cable Compatibility

After completing testing on nine different models of unshielded cable loaded with low-voltage Power over Ethernet (PoE) luminaires A and B, testing was attempted for one of the two shielded cable models (Test ID 24Cat5e-3) using luminaire B. The shielded cables were terminated with shielded RJ45 plugs; foil and drain wire were connected at both ends of the cable. While the set of luminaires was being connected to the switch, a flash of light was observed (peripherally) from at least one of the luminaires. Soon after this, it was found that the luminaires were not responding to commands issued via the manufacturer-provided software, suggesting the luminaires and/or switch may have been damaged. As this was the first shielded cable tested, a compatibility issue between cable and luminaire and/or between cable and switch was immediately suspected.

The shielded cables were replaced with unshielded cables (found to work in prior testing), but the luminaires remained unresponsive. The luminaires were then replaced with luminaires A, and these, too, failed to respond to commands issued via software provided by their manufacturer; this appeared to confirm that the switch had been damaged when connected to luminaires B using shielded cabling. The authors then connected luminaires B to a spare PoE switch of the same make/model, and found that these luminaires were still unresponsive. Prior testing of the unshielded cable was repeated using the spare switch and luminaires A, confirming that a) the spare switch and luminaires A appeared to be functioning normally, and b) the original switch and luminaires B appeared to be damaged.

Luminaires A and B were then examined to better understand how their designs interact with shielded cabling. The RJ45 connector shield and internal side springs in luminaire B did not appear to be connected to the troffer chassis as measured at exposed troffer assembly screws—a Fluke 287 digital multimeter (DMM) reported open circuit; however, they did appear to be connected to the same internal cable pins as the power return for the LED drivers (less than  $0.15\ \Omega$  measured via DMM). In contrast, the shield via (the plated metal connection between metal power/signal layers in a printed circuit board) in luminaire A appeared to be connected to the RJ45 shield but not connected to any of the six wires going to the light engine or the identified GND pin or chassis. Thus the two luminaire designs appeared to differ in how they treat cable shields and drain wires connected to shielded (metallic) RJ45 plugs: whereas luminaire B energizes them, luminaire A does not.

Manufacturer guidance regarding use of shielded cabling was investigated by reviewing relevant product documentation (i.e., luminaire datasheet, gateway datasheet, web pages) published by the manufacturer of luminaire B. None of the following keywords were found: *shielded*, *unshielded*, *UTP*, *grounded/grounding*, *isolated/isolation*. This was also true for luminaire A. However, although no user manual or installation instructions for luminaire B were available online, installation instructions shipped with luminaires did include the following guidance in the last of eight steps: “Use a UTP (*unshielded twisted pair*) CAT5E or CAT6 cable.” The PoE switch manufacturer similarly called for “UTP” (versus U/UTP) on the product datasheet and in the installation guide, but did not explicitly discourage F/UTP or other shielded cabling; a company representative indicated in email correspondence that a shielded plug would make a grounded connection at the switch.

Testing results were discussed with the manufacturer of luminaire B, who shortly afterward stated that product documentation would be revised to clarify cabling compatibility, and indicated that the next version of the luminaire (already in development) will be compatible with both shielded and unshielded cabling.

## References

- ANSI. 2017. American National Standard for Lighting Systems—Minimum Requirements for Installation of Energy Efficient Power over Ethernet (PoE) Lighting Systems. Rosslyn: NEMA (National Electrical Manufacturers Association).
- ASTM. 2014. Standard Specification for Standard Nominal Diameters and Cross-Sectional Areas of AWG Sizes of Solid Round Wires Used as Electrical Conductors. West Conshohocken: ASTM (American Society for Testing and Materials) International.
- Cree. 2016. CR Series with SmartCast® PoE Technology: CR22™ 2' x 2' Architectural LED Troffer. edited by Cree. Durham: Cree.
- Dellinger, J. H. 1911. "The temperature coefficient of resistance of copper." *Bulletin of the Bureau of Standards* 7 (1). doi: <http://dx.doi.org/10.6028/bulletin.161>.
- DOE. 2017. PoE Lighting System Energy Reporting Study, Part 1. Washington: DOE (U.S. Department of Energy).
- Hitachi. 2017. Selecting Cables for Power over Ethernet: Factors to Consider when Selecting the Appropriate Cable. Manchester: Hitachi Cable America.
- IEEE. 2012. IEEE Std 1143-2012: IEEE Guide on Shielding Practice for Low Voltage Cables. New York: IEEE (Institute of Electrical and Electronics Engineers).
- IEEE. 2013. IEEE 802.3 4PPoE Objectives, Version 2.0. New York: IEEE (Institute of Electrical and Electronics Engineers).
- IEEE. 2017. Timeline to Finish, IEEE P802.3bt Task Force, November 2017. New York: IEEE (Institute of Electrical and Electronics Engineers).
- IES. 2008. IES LM-79-08. Approved Method: Electrical and Photometric Measurements of Solid-State Lighting Products. New York: IES (Illuminating Engineering Society).
- Jones, Peter. 2015. "NGEABT Study Group Cabling Installed Base Update." IEEE 802.3 Next Generation Enterprise Access BASE-T PHY Study Group, Atlanta, GA, January 13, 2015.
- Love, Grayling. 2015. "Cabling and Connectivity for Power-over-Ethernet." *Leviton Blog*, January 15, 2015. <http://blog.leviton.com/cabling-and-connectivity-power-over-ethernet>.
- Poulos, Kristen. 2015. "STP, UTP, FTP Cable & More: 7 Types & When to Use Them!" *The Right Signals Blog*, July 23, 2015. <http://www.belden.com/blog/datacenters/STP-UTP-FTP-Cable-More-7-Types-When-to-Use-Them.cfm>.
- Rogachev, Artem and Martin Patoka. 2012. Implementing a 60-W, End-to-End PoE System. Application Report SLVA498, February 2012. Dallas: Texas Instruments.
- Shulman, Michael. 2015. Power over Ethernet Lighting – Evolution or Revolution? Northbrook: UL.
- Siemon. 2017. Zone Cabling and Coverage Area Planning Guide: 60W PoE Lighting Applications. Watertown: Siemon.

- Thomas, Brinda A., Inês L. Azevedo, and Granger Morgan. 2012. "Edison Revisited: Should we use DC circuits for lighting in commercial buildings?" *Energy Policy* 45:399-411. doi: <http://dx.doi.org/10.1016/j.enpol.2012.02.048>.
- TIA. 1995. ANSI/TIA/EIA-568-A-1995, Commercial Building Telecommunications Cabling Standard. Arlington: TIA (Telecommunications Industry Association).
- TIA. 2009. ANSI/TIA-568-C.2, Revision C. Balanced Twisted-Pair Telecommunications Cabling and Components Standards. Arlington: TIA (Telecommunications Industry Association).
- TIA. 2017. PN-3-0040: Telecommunications Infrastructure Terms and Symbols, as Modified and Accepted by the TR-42.5 Subcommittee, February 2017. Arlington: TIA (Telecommunications Industry Association).
- UL. 2015. Fact Finding Report on Power over Local Area Network Type Cables (4-Pair Data / Communications Cables) <with errata 1 revisions>. Washington: SPI (Society of the Plastics Industry).
- Yseboodt, Lennart, Chad Jones, David Tremblay. 2017. Power over Ethernet - Cable Losses. Beaverton: Ethernet Alliance.

U.S. DEPARTMENT OF  
**ENERGY**

Office of  
**ENERGY EFFICIENCY &  
RENEWABLE ENERGY**

For more information, visit:  
[energy.gov/eere/ssl](http://energy.gov/eere/ssl)

PNNL-27079 • November 2017 (Revised January 2019)