



THERMOCHEMICAL CONVERSION R&D



TECHNOLOGY AREA

CONTENTS

INTRODUCTION	229
THERMOCHEMICAL CONVERSION R&D OVERVIEW	229
THERMOCHEMICAL CONVERSION R&D REVIEW PANEL	230
TECHNOLOGY AREA SCORE RESULTS.....	231
THERMOCHEMICAL CONVERSION R&D REVIEW PANEL SUMMARY REPORT.....	232
THERMOCHEMICAL CONVERSION R&D PROGRAMMATIC RESPONSE	238
ANALYSIS AND SUSTAINABILITY INTERFACE	241
THERMOCHEMICAL CONVERSION PLATFORM ANALYSIS.....	243
LIQUEFACTION OF AGRICULTURAL AND FOREST BIOMASS TO “DROP-IN” HYDROCARBON BIOFUELS.....	246
THF CO-SOLVENT BIOMASS FRACTIONATION TO CATALYTIC FUEL PRECURSORS WITH HIGH YIELDS.....	248
CATALYTIC UPGRADING OF BIOCHEMICAL INTERMEDIATES	250
ONE-STEP HIGH-YIELD PRODUCTION OF FUNGIBLE GASOLINE, DIESEL, AND JET FUEL BLENDSTOCKS FROM ETHANOL WITHOUT ADDED HYDROGEN.....	253
CATALYTIC PROCESSES FOR PRODUCTION OF α , ω -DIOLS FROM LIGNOCELLULOSIC BIOMASS.....	256
FAST PYROLYSIS AND UPGRADING	259
LIQUID FUELS VIA UPGRADING OF INDIRECT LIQUEFACTION INTERMEDIATES.....	261
ELECTROCHEMICAL METHODS FOR UPGRADING PYROLYSIS OILS	264
RECOVERING AND UPGRADING BIOGENIC CARBON IN BIOMASS-DERIVED AQUEOUS STREAMS	266
CATALYTIC FAST PYROLYSIS (CFP).....	269
A HYBRID CATALYTIC ROUTE TO FUELS FROM BIOMASS SYNGAS.....	272
CATALYTIC UPGRADING OF THERMOCHEMICAL INTERMEDIATES TO HYDROCARBONS: CONVERSION OF LIGNOCELLULOSIC FEEDSTOCKS.....	275
CATALYTIC CONVERSION OF CELLULOSIC OR ALGAL BIOMASS PLUS METHANE TO DROP-IN HYDROCARBON FUELS AND CHEMICALS.....	277
INTEGRATION AND SCALE-UP + THERMOCHEMICAL (TC) CAPITAL EQUIPMENT	279
CATALYTIC UPGRADING OF THERMOCHEMICAL INTERMEDIATES TO HYDROCARBONS – RESEARCH TRIANGLE INSTITUTE.....	282
BIOMASS-DERIVED PYROLYSIS OIL CORROSION STUDIES	285
BRAZIL BILATERAL—NREL PETROBRAS CRADA.....	287
CONSORTIUM FOR COMPUTATIONAL PHYSICS AND CHEMISTRY	291
DEVELOPMENT AND STANDARDIZATION FOR BIO-OIL CHARACTERIZATION TECHNIQUES	294
CATALYST COST MODEL DEVELOPMENT	297
ADVANCED CATALYST SYNTHESIS AND CHARACTERIZATION	300
FRACTIONATION AND CATALYTIC UPGRADING OF BIO-OIL	303
NOVEL ELECTRO-DEOXYGENATION PROCESS FOR BIO-OIL UPGRADING.....	305

IMPROVED HYDROGEN UTILIZATION AND CARBON RECOVERY FOR HIGHER-EFFICIENCY THERMOCHEMICAL BIO-OIL PATHWAYS.....	308
ADVANCED MEMBRANE SEPARATIONS TO IMPROVE EFFICIENCY OF THERMOCHEMICAL CONVERSION.....	311
FRACTIONAL MULTISTAGE HYDROTHERMAL LIQUEFACTION OF BIOMASS AND CATALYTIC CONVERSION INTO HYDROCARBONS.....	313
RENEWABLE HYDROGEN PRODUCTION FROM BIOMASS PYROLYSIS AQUEOUS PHASE.....	315
BUILDING BLOCKS FROM BIOCRUDE: HIGH VALUE METHOXYPHENOLS.....	317
MELT-STABLE ENGINEERED LIGNIN THERMOPLASTIC: A PRINTABLE RESIN	320
CHEMCATBIO OVERVIEW	323
BIOMASS GASIFICATION FOR CHEMICALS PRODUCTION USING CHEMICAL LOOPING TECHNIQUES.....	326

INTRODUCTION

In the Thermochemical Conversion Research and Development (R&D) session, five external experts from industry reviewed a total of 33 presentations (representing more than 33 projects, as a few presentations were collaborations of different projects across multiple national laboratories).

This review addressed a total U.S. Department of Energy (DOE) investment value of approximately \$144,621,875, which represents approximately 20% of the Bioenergy Technologies Office (BETO or the Office) portfolio reviewed during the 2017 Project Peer Review. During the Project Peer Review meeting, the principal investigator (PI) for each project was given 15 to 60 minutes (depending on the project's funding level and relative importance to achieving BETO goals) to

deliver a presentation and respond to questions from the Review Panel.

The Review Panel evaluated and scored projects for their project approach, technical progress and accomplishments, relevance to BETO goals, and future plans. This section of the report contains the results of the project reviews, including full scoring information for each project, summary comments from each reviewer, and any public response provided by the PI. This section also includes overview information on the Thermochemical Conversion R&D Program, full scoring results and analysis, the Review Panel's summary report, and BETO's programmatic response.

BETO designated Andrea Bailey as the Thermochemical Conversion R&D Technology Area Review Lead. In this capacity, Ms. Bailey was responsible for all aspects of review planning and implementation.

THERMOCHEMICAL CONVERSION R&D OVERVIEW

The Thermochemical Conversion R&D session covered projects involving pathways that utilize bio-oil and gaseous intermediates to produce products, including finished fuels, fuel precursors, high-quality intermediates (e.g., sugars, syngas, or stabilized bio-oils), and high-value, biobased chemicals that enable fuels production.

Projects typically utilized one of the following high-temperature deconstruction technologies:

- **Pyrolysis** is the thermal and chemical decomposition of feedstock without the introduction of oxygen to produce a bio-oil intermediate. The bio-oil produced contains hydrocarbons of various lengths, but it contains more oxygenated compounds than petro-

leum crude oils and must undergo upgrading before it can be finished into a fuel or used in a refinery. BETO currently funds research on fast pyrolysis and catalytic (both in-situ and ex-situ) fast pyrolysis.

- **Liquefaction** is a deconstruction process that utilizes wet feedstock slurry under elevated temperature and pressure to produce a bio-oil.
- **Gasification** is the thermal deconstruction of biomass at high temperature (typically >700°C) in the presence of sub-stoichiometric air or an oxygen carrier, and sometimes steam, followed by gas cleanup and conditioning.

Some projects that utilize other intermediates or pathways were presented in this session due to similarities to other technologies.

THERMOCHEMICAL CONVERSION R&D REVIEW PANEL

Name	Affiliation
Shawn Freitas*	Thermochem Recovery International
Lorenz (Larry) Bauer	Independent Consultant
Timothy Brandvold	Abbott Molecular
Jeffrey J. Scheibel	Independent Consultant
Neils Udengaard	Haldor Topsøe (Retired)

*Lead Reviewer

TECHNOLOGY AREA SCORE RESULTS

Average Weighted Scores by Project

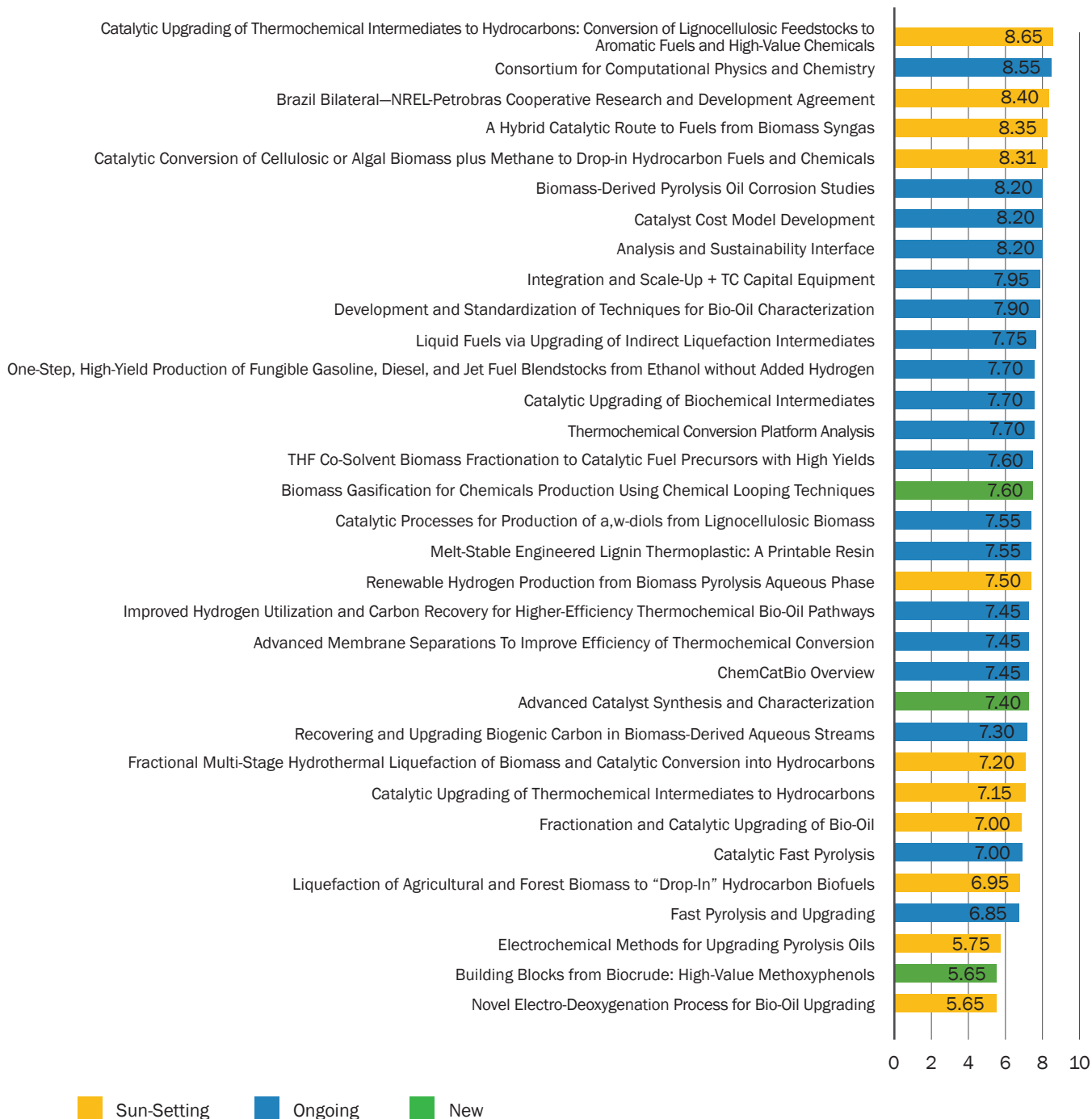

THERMOCHEMICAL CONVERSION R&D REVIEW PANEL SUMMARY REPORT

*Prepared by the Thermochemical Conversion R&D
Review Panel*

Impact

The Review Panel found that all of the projects reviewed were representative of the current state of the art for thermochemical conversions and reflected the industry-leading expertise and professionalism that has become the standard for BETO-funded work. In general, enough technological and operational progress was achieved in the 2015–2017 period that certain key thresholds and milestones were reached for some technologies, setting the stage for additional focus on successful pathways and reduced focus on others. With the lessons learned from these projects, constructive new developments in thermochemical conversions are very likely.

Advancing the State of the Art

The major thermochemical pathways represented in the current portfolio can be broken into three primary areas: liquefaction, gasification, and fast pyrolysis. These pathways are the most likely to contribute to reducing reliance on foreign oil imports, but they are also the most complex and face significant challenges for commercial adoption. The liquefaction and gasification projects in particular were ranked highly and viewed as leading the current state of the art. These technology areas have progressed significantly with BETO support and are viewed as having real commercial potential in the near to medium term. Continued focus on improving process efficiencies and generating high-value products in these areas will maintain the cutting-edge status this work currently represents. The fast pyrolysis work unquestionably represents the current state of the art. However, it was ranked lower due to the lack of evidence for

significant breakthroughs that would support the widespread commercial utilization of pyrolysis liquids as an alternative to oil. The successes with this technology clearly support its capabilities for efficient biomass deconstruction, but outside of isolated cases, the products generated from whole biomass have shown very little potential to become economically integrated into current fuel and chemical supply chains. Continuing to advance the state of the art for fast pyrolysis should be done by targeting biomass fractions like cellulose and lignin or by integrating new co-reactants into the processes to reduce reliance on hydrogen.

Torrefaction, slow pyrolysis, and thermomechanical refining are not currently represented in the portfolio, but these thermochemical pathways have significant potential to contribute to revitalizing the rural economy. Advanced cook stove and pellet heating objectives should also be considered as biomass is a fundamentally important source of heat for rural economies. These technology areas are compelling due their scalability and reduced process intensity, making them better suited for smaller-scale, distributed, and rural implementations. Additional BETO focus in these areas to advance the state of the art would positively contribute to several portfolio objectives important to the bioeconomy.

Relevance of BETO Focus Areas for Investment/Finance

Most of BETO's current focus areas, such as fast pyrolysis and gasification, require major capital investments for commercialization, typically in the hundreds of millions. Due to process intensity, significant economies of scale must be achieved, which necessarily increases the importance of efficiency, product value, and reduced risk profiles. Given major shifts in supply and demand associated with oil and gas resources in the last few years, a shift in BETO's focus may be necessary. With increases in supply due to fracking and decreases in value potentially associated with reduced hedging, the most practical insertion point for thermochemical products is no longer the front end of the refinery, but

further downstream. Thermochemical conversions that efficiently generate lower volumes of higher-value fuels and chemicals should be prioritized to adjust to shifting market needs. This places new importance on conversions pathways like liquefaction, both solvent and hydrothermal, as they are capable of efficiently generating a narrower selection of higher-value products. It also places additional pressure on fast pyrolysis to move away from solutions with a heavy reliance on hydrogen and towards solutions that can be economically implemented without relying on petroleum refineries. Adjusting to support cellulosic ethanol, industrial microbiology, wastewater, and pulp and paper facilities with thermochemical solutions is likely to improve finance options in the near to medium term. For the longer term, a revised look at where biomass can contribute to fuel, chemical, and heat supply chains so that smaller-scale, distributed approaches could be utilized should be considered, as this could improve options for finance. Biomass is a distributed resource and has a long history of being effectively monetized using rural/distributed approaches that are scaled based on access to sub-regional supplies.

High- and Low-Impact Directions

Scaling up a new process or technology from the bench, to a pilot, to a process demonstration, and then to commercial scales is not only difficult, but tends to contain so much uncertainty/risk that it often substantially limits investment options. From this perspective, reviewers identified the highest-impact directions related to projects making a significant effort to utilize existing commercial facilities or commercially relevant reactors to prove a conversion or catalysis step. Specific examples include the Brazil Bilateral—National Renewable Energy Laboratory Petrobras project, the Hybrid Catalytic Route to Fuels from Biomass Syngas project, and the Consortium for Computational Physics and Chemistry project. Opportunities to use commercial facilities are not common, but when possible, these projects should be given high priority as they will generate data critical-

ly important for accelerating the commercialization process. Generating finished products that can be used in existing engines and processes is also highly valuable.

From a technology perspective, one of the most compelling conversion areas currently in the portfolio is liquefaction. Some notable examples are the Catalytic Upgrading of Thermochemical Intermediates to Hydrocarbons: Conversion of Lignocellulosic Feedstocks project, the Tetrahydrofuran (THF) Co-Solvent Biomass Fractionation project and the Liquefaction of Agricultural and Forest Biomass to “Drop-In” Hydrocarbon Biofuels project. The last 3–5 years have seen some fairly significant improvements in solvent and hydrothermal liquefaction technology, and BETO’s support of this work appears to have pushed it towards an inflection point where commercial adoption is more likely. Improved solvent recovery, lower process intensity, and higher-value product options are all seen as constructive developments leading to increased interest in this area. This contrasts with much of the work relying heavily on hydrogen as a method to chemically force whole-biomass pyrolysis liquids into becoming hydrocarbons. The hydrocarbons generated from this hydrotreating are not as valuable as the synthetic hydrocarbons generated from syngas, and they are not as desired by petrochemical refineries because they are still chemically different enough from crude oil that they represent an unnecessary risk. While BETO’s expertise in hydrotreating biomass chemistries is a positive development with potential to enable new contributions to fuel and chemical supply chains, hydrotreating whole-biomass pyrolysis liquids as an alternative to oil is viewed as a low-impact direction unlikely to find wide commercial adoption.

Innovation

Current Thermochemical Innovations

Thermochemical conversions excel in the fast breakdown of large biomass polymers into smaller polymers and chemicals. As a function of this, they have the po-

tential to create chemical building blocks that can then be reassembled into large molecules and oligomers. This is attractive because these products often have more chemical functionality and different structures than those typically generated from a petrochemical refinery. Several well-regarded projects have been innovative in this area in ways that could be noticeably impactful in the future. Specific examples include the Liquid Fuels via Upgrading of Indirect Liquefaction Intermediates project and the Fractionation and Catalytic Upgrading of Bio-Oil project.

Thermochemical products are often highly reactive, but by performing separations and using this reactivity for targeted construction of useful chemicals and fuels, these projects are redefining some of the long-held assumptions about current fuel and chemical supply chains. Projects exploring alternative hydrogen donors to avoid traditional hydrotreating also show notable innovations, such as the Catalytic Conversion of Cellulosic or Algal Biomass plus Methane to Drop-in Hydrocarbon Fuels and Chemicals project and the Liquefaction of Agricultural and Forest Biomass to “Drop-in” Hydrocarbon Biofuels project. Alternative hydrogen donors are yet another way of exploiting the reactivity of thermochemical intermediates because the intermediates will more readily react with a much wider variety of chemicals than hydrocarbons. Innovations in this area promise to show that we can efficiently alter the composition of thermochemical breakdown products using different and more advantageous reactants.

Particularly interesting innovations are also occurring in projects exploring improved solvent recycling and in-situ solvent generation technologies for liquefaction processes, such as the Catalytic Upgrading of Thermochemical Intermediates to Hydrocarbons: Conversion of Lignocellulosic Feedstocks project, the THF Co-Solvent Biomass Fractionation project, and the Liquefaction of Agricultural and Forest Biomass to “Drop-in” Hydrocarbon Biofuels project. The Review Panel considers these developments critical for commercial adoption.

Necessary Future Innovations

To help advance thermochemical conversions to the next level, innovations related to chemical separations and narrowing product distribution are needed. Much like how petrochemical refineries are designed primarily to first separate and often refine the various components of crude oil before chemical modifications are made, a fresh look at how biomass separations can enable thermochemical conversions to generate more specific and higher-purity products must occur. As a result of a singular focus on up-front carbon efficiency associated with solid-to-liquid/gas conversions, innovation in this area has stalled. Too much emphasis has been placed on trying to refine mixed thermochemical biomass products as hydrocarbons and not enough has been done to explore separations unique to biomass and critical to the production of higher-value products. Biomass is easily separated into chemically distinct polymers, and avoiding this separation before conversion perpetuates the idea that thermochemical breakdown products are always crude and difficult to valorize. With additional focus and work to advance up-front separations, downstream separations will be less process intensive and far more likely to generate higher-value products. However, this does not preclude the additional necessity of innovations in downstream separations for pyrolysis liquids, which are fundamentally different than those that can be used for hydrocarbons. The value of a product is directly related to how expensive it is to produce, and separations are consistently one of the most expensive steps for generating fuel and chemical products. As such, further innovations in this area and potentially a new consortium are recommended.

Synergies

Current Synergies

There are currently numerous synergies between projects in the portfolio as a result of BETO’s consortium approach. Since 2013, BETO has steadily moved

toward creating more consortiums. This is a positive and high-impact shift that has reduced redundancies, improved standardization, and accelerated the rate of discovery and progress for all the major technological pathways currently in the portfolio. While not every project is suitable for a consortium, the national laboratories' work to create a shared understanding of TEA models, process models, mass and energy balances, cost models, analysis and characterization standards, and materials studies is impressive, and the Review Panel views this work as extremely important for building the industry. These areas are important for taking ideas from the laboratory and charting a path towards commercialization, and the consortiums are proving an efficient mechanism to not only develop these fundamentals, but to disseminate them in an interdisciplinary way across the BETO portfolio.

The greatest challenge this consortium approach currently faces is how to give projects outside the national laboratories access to the same synergies that are being enjoyed inside the national laboratories. Similarly, improving public dissemination of these projects' various models, standards, and studies must take a higher priority and grow beyond published papers and presentations and into open-source, web-based education and invited workshops where interested parties can directly interact with BETO resources and learn how to utilize these new tools. The Consortium for Computational Physics and Chemistry has done an exceptional job in this area and could be used as model for some of the newer consortiums. If pursued correctly, this is an opportunity to align the broader thermochemical community with a commonly shared set of tools and understanding, a foundation of functional synergies.

Necessary Future Synergies

The synergy between thermochemical and biochemical conversions is an increasingly important synergy that

must be addressed. The long-standing philosophy that thermochemical conversion does not require the same feedstock considerations as biochemical conversion has become limiting for thermochemical advancements. All biomass comminution steps and biomass chemical separations that benefit biochemical conversions will also benefit thermochemical conversions. Similarly, there are numerous opportunities for thermochemical conversions after biochemical conversions, as a way of improving overall process efficiency and economics. Low-value product streams from biochemical processes—including underutilized biomass fractions and fermentation cell mass—can often be thermochemically converted into additional products or low-cost biochemical feedstocks. A closer look at the fundamental needs each these conversion pathways requires for commercial success would likely reveal more similarities than differences and lead to constructive synergies. Areas highly likely to yield such overlaps are biomass separations, product separations, and utilization of downstream waste products.

Focus

Areas Requiring Additional Focus

Improving the domestic fuel supply chain through utilization of biomass means focusing on fuels and fuel infrastructure, which is very different than contributing alternatives to oil or general hydrocarbons. Furthermore, due to reactivity and structural differences, biomass chemistries are less likely to efficiently and economically contribute to lower-value commodity fuel supplies like diesel and gasoline, and they are more likely to contribute to high-performance and specialty areas like jet fuels, fuel additives, and solvents. Contributions in these areas are critically important to accommodate changing transportation trends and improved fuel economy. Two recent and particularly noteworthy examples of this are the use of hydrogenated pinene dimers as a biobased

blendstock for high-energy-density jet fuel JP-10^{25,26} and the use of dihydrolevoglucosenone as biobased performance solvent similar to N-Methyl-2-Pyrrolidone.^{27,28} Pinene is widely available as a byproduct of pulp and paper production, and levoglucosenone is a product of sugar pyrolysis. While neither of these examples has the potential to replace the barrel, they could absolutely contribute positively to the domestic supply of high-energy fuels and to the fuel production process. These examples offer proof that additional focus in the areas of jet fuels, fuel additives, and solvents is not only important, but could have the desired effects of growing the bioeconomy and leveraging domestic biomass resources to improve the fuel supply chain. BETO has been cultivating the expertise to contribute to these areas through focus in thermochemical conversion, hydrogenation, and targeted catalysis, but they have not yet become areas of specific focus. A recalibration based on lessons learned that leans toward high performance and specialty and less toward low-value commodity would likely yield near- to medium-term benefits and improve the probability of commercial adoption.

Areas to Consider Reduced Focus

Two areas needing less focus are hydrogenation of whole-biomass pyrolysis liquids and forced introduction of crude pyrolysis liquids into petrochemical refineries. Hydrogen is a highly valued and fully utilized reactant in commercial processes that require it. Its excessive use as an oxygen removal and stabilization tool for whole-biomass pyrolysis liquids is not practical as the product generated is not valuable enough to support this

level of process intensity. BETO has generated a considerable body of work validating this, and it would be more constructive to apply these techniques to different thermochemical process streams. Similarly, there is insufficient justification inputting pyrolysis liquids into petrochemical refineries as a crude-oil blendstock. Petrochemical refineries are designed to separate, refine, and often upgrade oils, but pyrolysis liquids are not oils, and their conversion into something more oil-like is expensive and complicated. BETO has considered multiple refinery insertion points for a number of years, and based on this work, BETO should reduce its focus on upstream crude-oil blendstock inputs and increase its focus on downstream finished-product blendstocks. This includes fuel additives like antioxidants, octane boosters, oxygenates, multifunctional additives, fuel oil additives, etc. Fuel at the pump is an engineered mixture with numerous components and fairly specific engine-related objectives. If possible, the focus should be on components of these various mixtures that can be generated more efficiently from biomass and thermochemical conversions.

Commercialization

Funding Philosophy

There is no indication that BETO is funding projects at the wrong stage of development, and in fact, based on the constructive growth of conversion areas like liquefaction, there is evidence that the funding philosophy is functioning as needed. Conversion technologies that have not been commercially adopted appear to face more

²⁵ Benjamin G. Harvey, Michael E. Wright, and Roxanne L. Quintana, "High-Density Renewable Fuels Based on the Selective Dimerization of Pinenes," *Energy & Fuels* 24, no. 1 (2009): 267–273, doi:[10.1021/ef900799c](https://doi.org/10.1021/ef900799c).

²⁶ Kale W. Harrison and Benjamin G. Harvey, "Renewable High Density Fuels Containing Tricyclic Sesquiterpanes and Alkyl Diamondoids," *Sustainable Energy & Fuels* 1, no. 3 (2017): 467–473, doi:[10.1039/C6SE00108D](https://doi.org/10.1039/C6SE00108D).

²⁷ James Sherwood, Mario De Bruyn, Andri Constantinou, Laurianne Moity, C. Rob McElroy, Thomas J. Farmer, Tony Duncan, et al., "Dihydrolevoglucosenone (Cyrene) as a Bio-Based Alternative for Dipolar Aprotic Solvents," *Chemical Communications* 50, no. 68 (2014): 9650–9652, doi:[10.1039/c4cc04133j](https://doi.org/10.1039/c4cc04133j).

²⁸ James H. Clark, Thomas J. Farmer, Andrew J. Hunt, and James Sherwood, "Opportunities for Bio-Based Solvents Created as Petrochemical and Fuel Products Transition towards Renewable Resources," *International Journal of Molecular Sciences* 16, no. 8 (2015): 17101–17159, doi:[10.3390/ijms160817101](https://doi.org/10.3390/ijms160817101).

challenges from market acceptance and market penetration issues than from issues with BETO funding. From a bioenergy and biofuels perspective, the current relationship between the Advanced Research Projects Agency – Energy (ARPA-E) and BETO looks to be complementary, keeping novel ideas flowing and down-selecting projects that have matured enough to appear ready for the next stage. BETO should continue to invest at the technology readiness levels (TRLs) that it has in the past and should also continue to enable growth in areas that help to realize its strategic fuels objectives associated with bioeconomy.

Enabling Commercialization

An aspect of commercialization that may need to be considered differently is product value versus market size. Most current approaches are supported by the idea that thermochemical technologies are needed to leverage the considerable biomass supply described by the 2016 Billion-Ton Report and to then feed as much biomass as possible into our domestic petrochemical refineries. This objective assumes that the products will not only be able to compete, but that they will also provide a benefit to the commodity fuels and chemicals markets that justifies the costs associated with change. The market is huge, but the margins are small, and the space is extremely competitive. This is maybe one of the most difficult objectives to choose for introducing a new chemical or material. It also demands that any new, high-risk commercial implementation is enormous so that it can benefit from economies of scale, which in turn makes investment challenging.

To increase the number of commercial successes using an unconventional chemical feedstock like biomass, BETO should consider focusing on product value and let market forces decide how large or small a market will become. There are a number of high-performance fuel, fuel additive, and specialty chemicals directions where biomass chemistries would offer natural strengths and, therefore, a value proposition worth maturing further. If BETO can succeed in increasing the number of commercially adopted technologies, even if the markets are initially

small, they will have contributed to building momentum towards the desired bioeconomy.

Another similar area is renewed focus on valorization of existing biorefining waste and product streams. Cellulosic ethanol, corn ethanol, industrial microbiology, wastewater, and pulp and paper facilities are all foundational in the current bioeconomy. Focus on underutilized byproducts and wastes is important because realizing more value from these outputs immediately improves process economics. Focus on existing product streams is also important because innovations here that lead to improved or new products can potentially expand options and capacity. Commercialization probability with this approach is high because these developments represent an improvement on in-place capital, so financing options will be numerous.

Recommendations

BETO has developed world-class capabilities in the fast pyrolysis area. These resources should be leveraged to advance fast pyrolysis beyond its current role as a front-end solid-to-liquids conversion step and towards a downstream role where more valuable, better-refined products are generated. Pyrolysis as a decomposition process has been utilized for precise conversions of various organic chemistries for well over a hundred years, and its relatively recent use to liquefy whole biomass has not been able to replicate that precision or utility. The substantial body of work on pyrolysis chemistries and the current proficiency at BETO for using and scaling up fast pyrolysis conversions suggests that greater things can be achieved if fast pyrolysis is not limited to generating low-value, mixed liquids that require significant upgrading. It is recommended that BETO work to realign current fast pyrolysis efforts towards conversion of biomass components representing various forms of lignin, cellulose, hemicellulose, and extractives. The Review Panel also recommends exploring co-reactants under fast pyrolysis conditions to expand or improve products. Advancements here have the

potential to noticeably improve both product distribution and product value, which would support improved commercialization efforts.

BETO catalysis projects and consortiums are strongly positioned to support compelling new developments in a wide range of biomass chemistry–related areas. These resources should work in concert with DOE fuel and engine researchers to find new ways to leverage biomass thermochemical products for improving the domestic fuel supply chain, particularly in higher-performance and specialty areas like jet fuels, fuel additives, and solvents. Fuel at the pump is an engineered mixture with numerous components and fairly specific turbine- or engine-related objectives. If some components of these various mixtures can be generated more efficiently from biomass and thermochemical conversions, focus on these chemistries would be constructive. It is recommended that BETO leverage its extensive abilities in both thermochemical conversion and chemical synthesis using thermochemical products to find new and better routes for generating turbine and engine fuel components, such as antioxidants, octane/cetane boosters, oxygenates, multifunctional additives, and fuel oil additives. Contributions in these areas are critically important to accommodate changing transportation trends and improved fuel economy and would have the desired effects of both growing the bioeconomy and leveraging domestic biomass resources to improve the fuel supply chain.

BETO works to revitalize the rural economy by finding new and better ways to enable biomass resources to contribute to the domestic fuel supply chain. Evolving manufacturing techniques, biomass harvesting options, and market needs suggest that in order to continue making an impact on this objective, BETO should consider shifting its project portfolio to include more technologies designed to function at smaller scales. Biomass is a distributed resource and has historically been effectively monetized using rural/distributed approaches, which are fundamentally different than the massive, centralized approaches that are more practical for oil- and gas-using pipelines. As options for manufacturing to de-centralize increase and biomass harvesting become more automated, technologies designed to convert biomass into chemical and fuel products at smaller scales will have a much higher probability of being commercialized and making an impact on rural economies. Furthermore, focused efforts to use thermochemical and biochemical conversions to improve the efficiency and economics of current corn ethanol, cellulosic ethanol, industrial microbiology, wastewater, and pulp and paper facilities would also make a positive contribution to the bioeconomy. The Review Panel recommends that BETO consider revising its portfolio strategy to better reflect some of the major developments occurring in the energy and manufacturing sectors. Additional focus on smaller-scale technologies and on opportunities to leverage underutilized and non-conventional sources of biomass would have a constructive impact on this objective.

THERMOCHEMICAL CONVERSION R&D PROGRAMMATIC RESPONSE

Introduction/Overview

Conversion R&D would like to take the opportunity to thank the five thermochemical conversion reviewers for their time and careful review of the portfolio. We

recognize that this was a difficult review process since additional projects relevant to this area were presented in other sessions due to time constraints. We have worked since the 2015 Project Peer Review to integrate biochemical- and thermochemical-based projects where possible and will continue this effort, taking the panel's recommendations for hybrid pathways into account. For future reviews, we may present projects with a hybrid

focus differently to give reviewers a better picture of the full portfolio. The Review Panel's recommendations will be discussed and taken into consideration when working on future project selection and program design, as future appropriations allow.

The Conversion R&D team recognizes that many of the issues with separations the Review Panel brings up are important barriers to achieving programmatic goals. A national laboratory consortium specifically working on the separations issues raised here presented in the Biochemical Conversion session, but was unable to present in the Thermochemical Conversion session due to time constraints. We will continue to prioritize R&D tackling pervasive separations challenges.

We appreciate the Review Panel's recommendation to increase focus in areas such as "torrefaction, slow pyrolysis, and thermomechanical refining," as well as cook stoves. Research on cook stoves has previously been funded as its own program in BETO, and additional research in this area would not fall under the scope of Conversion R&D. Expanding the portfolio to include additional technologies is subject to available funding, but the recommended areas will be discussed internally moving forward. Responses to the comments on current pyrolysis research and capital-intensive systems are presented in the sections below.

The following sections specifically address the three top recommendations from the Review Panel:

Recommendation 1: Re-Scope Pyrolysis Research

Much of the national laboratory pyrolysis research presented at this Peer Review has been scaling up in anticipation of the 2017 technology pathway verification, which will measure progress towards the Office's goal of an nth-plant modeled minimum fuel selling price (MFSP) of \$3/gasoline gallon equivalent (gge). Additional competitively funded projects working on fast pyrolysis also presented their final results at this review.

With this in mind, we agree that now is an ideal time to carefully consider the direction of future pyrolysis research.

As part of this process, Conversion R&D has already approached the national laboratory staff who have previously contributed to pyrolysis research to discuss their research moving into fiscal year (FY) 2018. The Chemical Catalysis for Bioenergy (ChemCatBio) consortium is increasing focus on other thermochemical and hybrid pathways and deemphasizing research on hydrotreating and other pyrolysis oil stabilization techniques moving forward. Conversations with outside stakeholders who have also provided valuable guidance in the past on pyrolysis research will also be used when developing this new strategy.

Though pyrolysis research will be deemphasized to an extent, we will continue to advance modeling efforts related to pyrolysis on particle heating, hydrodynamics, and other reaction-level mechanisms. We appreciate the Review Panel's feedback on the utility of these computational efforts and will use them to help guide decision making on the recommended potential pathways for pyrolysis research suggested by the panel.

Recommendation 2: Increase the Value Proposition of Biomass

Conversion R&D agrees that additional research should be targeted at increasing the value proposition of biomass by synthesizing higher-value products like fuel additives or chemicals that are closer in structure to biomass feedstocks. Since the 2015 Peer Review, we have kicked off a number of new efforts to begin moving in this direction.

The MEGA-BIO: Bioproducts To Enable Biofuels funding opportunity announcement (FOA), awarded in FY 2016, supported the development of biomass-to-hydrocarbon biofuels conversion pathways that can produce variable amounts of fuels and/or products based on external factors, such as market demand. This effort

to expand the portfolio to include projects that can supplement the development of fuels by tapping into bioproduct markets has further expanded with internal and national laboratory analyses (some of which were presented in other review sessions) on the market potential of bioproducts. The Conversion R&D team has also integrated feedback on bioproducts into broader goals present in the Office-wide 2016 *Strategic Plan for a Thriving and Sustainable Bioeconomy* and continues to seek feedback on products, in addition to fuels, at listening days and workshops.

In June 2017, Conversion R&D also held a workshop focused specifically on performance-advantaged bioproducts, including functional replacements, targeting products that could be made from biomass feedstocks that offer a performance advantage over petroleum-based products. This input will be integrated into the design of future projects as funding allows.

The Conversion R&D team also recognizes that there is overlap between potential research in higher-value fuels and work being done by the Co-Optimization of Fuels and Engines initiative. We will continue to collaborate with the Co-Optimization of Fuels and Engines initiative to avoid duplication and provide input where relevant.

While we plan to take these recommendations into account, it is also important to note that at the time of this review, cost targets for finished hydrocarbon fuels

remain the main driver of R&D. However, given persistent low oil prices, and the importance of flexibility in directing research to areas where it can be the most impactful, alternative success measures are also being considered.

Recommendation 3: Leverage “Waste” Streams and Existing Capital Resources

The Conversion R&D team appreciates this recommendation and recognizes its potential to reduce the large capital costs associated with many potential biorefinery projects, while also valorizing undervalued feedstocks. Much of the Conversion R&D Program’s research on potential “waste” streams was reviewed in the Waste-to-Energy session. This portion of the Conversion R&D portfolio covers projects utilizing municipal, industrial, and agricultural wastes. By design, many of these waste streams come from facilities ideal for the co-location recommended by the panel.

The Office, as a whole, has also made an effort to solicit more projects on modular systems or projects that can take advantage of existing infrastructure. Some of these efforts either were not eligible for this review because they are too new or were reviewed in other sessions.

As the 2017 pathway verification effort draws to a close, we will also look into ways to take this recommendation into account, potentially utilizing more existing infrastructure and avoiding large capital costs.

ANALYSIS AND SUSTAINABILITY INTERFACE

(WBS #: 2.1.0.301)

Project Description

This project provides technical, economic, and sustainability analysis for biomass conversion routes to hydrocarbon fuels and chemicals in order to direct research toward high-impact results. Pacific Northwest National Laboratory develops target conceptual biorefinery models with researcher input and compares them against benchmark models that incorporate currently achieved research results. This (1) identifies barriers, cost-reduction strategies, sustainability impacts; (2) helps to set technical and costs targets; and (3) tracks research progress. Frequent, close interactions with researchers to review sustainable cost-reduction strategies are necessary. Key specific outcomes are the publication of the target design case and the annual state of research technology

Recipient:	Pacific Northwest National Laboratory
Principal Investigator:	Sue Jones
Project Dates:	7/27/2006–9/30/2016
Project Category:	Ongoing
Project Type:	Annual Operating Plan
DOE Funding FY 2014:	\$125,000
DOE Funding FY 2015:	\$725,000
DOE Funding FY 2016:	\$875,000
DOE Funding FY 2017:	\$925,000

reporting for pyrolysis oil upgrading towards meeting the BETO FY 2017 goal of \$3/gge on a modeled mature technology basis. Also supported is catalysis (conversion of oxygenated intermediates) and biochemical (fungal conversion) research to develop targets and track progress towards the 2022 BETO goals. Interactions with researchers and analysts at Argonne National Laboratory, Idaho National Laboratory, the National Renewable Energy Laboratory, and other BETO-funded laboratories enhance project effectiveness.

Weighted Project Score: 8.2

Weighting: For ongoing projects, there is equal weighting across all four evaluation criteria: Approach, Relevance, Accomplishments and Progress, and Future Work.

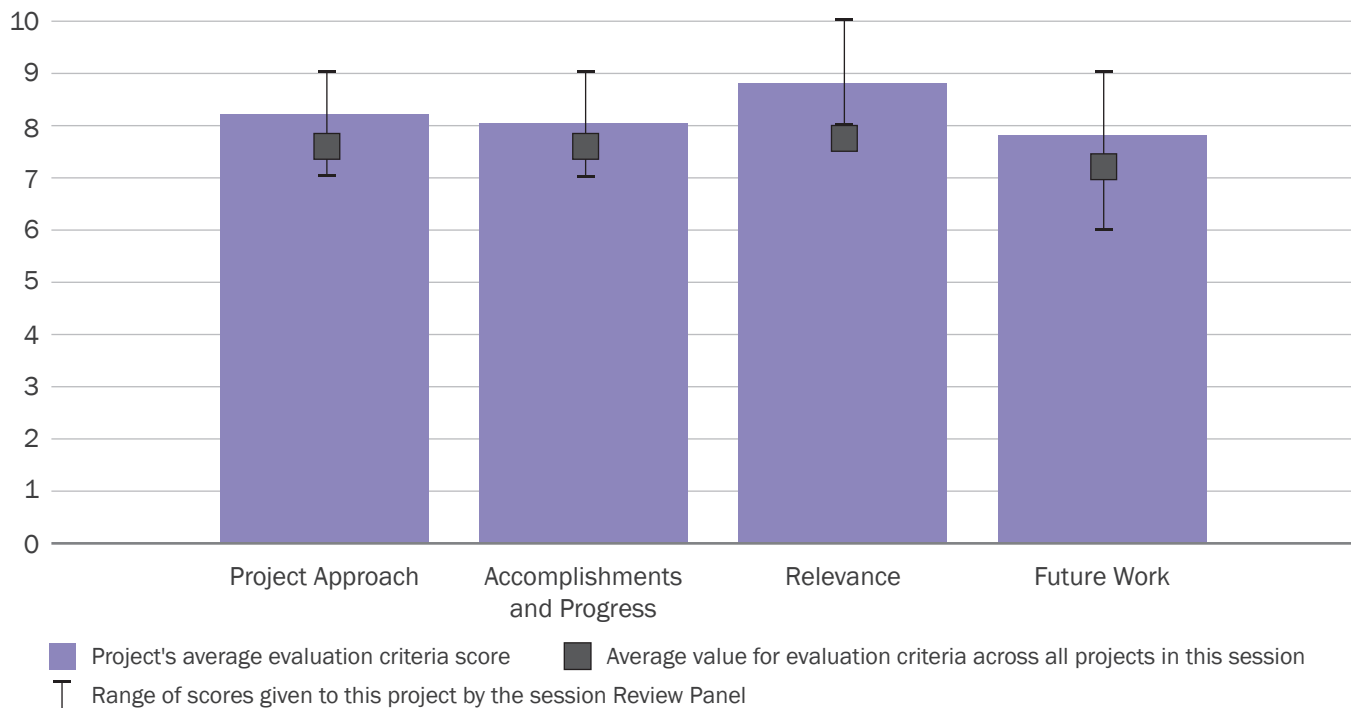

Overall Impressions

- The team demonstrated solid organization both at working and management levels, as well as excellent communication across teams working with the principal investigators (PIs). The feedback mechanisms are solid, as proven by the results of directing PIs toward the right tasks to maximize results and minimize money spent to achieve BETO's goals. There is no indication of weaknesses since the last review's positive feedback in 2015. This project is a well-oiled machine that is even already showing results on task 3 modeling: fungal approach. It might even be useful at some point to share with parts of industry how this team has managed to do so much in a short time frame. Often modeling efforts are not fast enough in industry to impact team direction in a significant way.
- Overall, this is a strong project with very positive impact for the biofuel community. It allows comparisons between different routes on the same basis and can direct research towards the least-costly routes to biofuels.

I am concerned that the results will be taken too literally by outside groups. The model does not take into account the development risks associated with the given routes including outside market factors, application of novel technologies, design complexity, and potential operation issues. The results of the verification study are correctly identified as the critical success factor. Allowing public access to the spreadsheets would be a great additional task for this program, as would open access to the Aspen modeling work.

- This is an excellent project that is/will greatly benefit and provide valuable guidance for overcoming technology and cost barriers in several other bio-energy projects. The project is well managed with clear objectives and goals, as well as milestones. Coordination with multiple national laboratories and research organizations ensures a broad and diverse knowledge base.
- Overall, project relevance is greater than what was suggested in presentation. Models such as these not only help focus catalyst research, but also reactor design, process design, and target product selection. Additionally, they contribute towards streamlining and improving R&D efficiencies, a critical cost-saving measure.
- Well-planned and executed project. Key challenge is ensuring models are used consistently to guide decision making in support of technical project and DOE program objectives.

PI Response to Reviewer Comments

- We thank the reviewers for their thoughtful and informative comments. We agree that although nth-plant analysis assists research focus at the laboratory level, the commercial maturity level can be misunderstood. While this is addressed in the design reports and emphasized in presentations, the need to understand the cost implications for first-of-a-kind plants should be clarified and perhaps could best be handled through public-private partnerships. Public availability of the analysis from this project is a key goal, and we are making progress through increased publications and presentations. While model maintenance for public use is not funded within this project, we do share detailed information with stakeholders when appropriate.

THERMOCHEMICAL CONVERSION PLATFORM ANALYSIS

(WBS#: 2.1.0.302)

Project Description

The National Renewable Energy Laboratory's (NREL's) Thermochemical Platform Analysis provides process design and techno-economic analysis (TEA) for the Thermochemical Conversion Platform to inform and guide NREL/BETO R&D priorities. TEA provides a consistent, business-relevant basis for comparing diverse conversion options through use of process and economic models, which translate key technical parameters into overall economics (dollars and cents). TEA results are used for setting future R&D targets and evaluating experimental progress and any deficiencies against those targets. Outcomes of integrated TEA modeling

Recipient:	National Renewable Energy Laboratory
Principal Investigator:	Michael Talmadge
Project Dates:	5/30/2002–9/30/2016
Project Category:	Ongoing
Project Type:	Annual Operating Plan
DOE Funding FY 2014:	\$1,350,000
DOE Funding FY 2015:	\$2,000,000
DOE Funding FY 2016:	\$1,900,000
DOE Funding FY 2017:	\$1,950,000

are utilized by BETO to guide program plans, and by other NREL/partner projects to quantify the impact of research on key technology barriers. This work is highly relevant to BETO goals as TEA directly informs, supports, and guides R&D for cost-competitive fuels and products. By providing a framework to translate technical performance into cost reductions within conceptual biorefinery designs, our TEA models are leveraged to direct R&D towards the most economically impactful

Weighted Project Score: 7.7

Weighting: For ongoing projects, there is equal weighting across all four evaluation criteria: Approach, Relevance, Accomplishments and Progress, and Future Work.

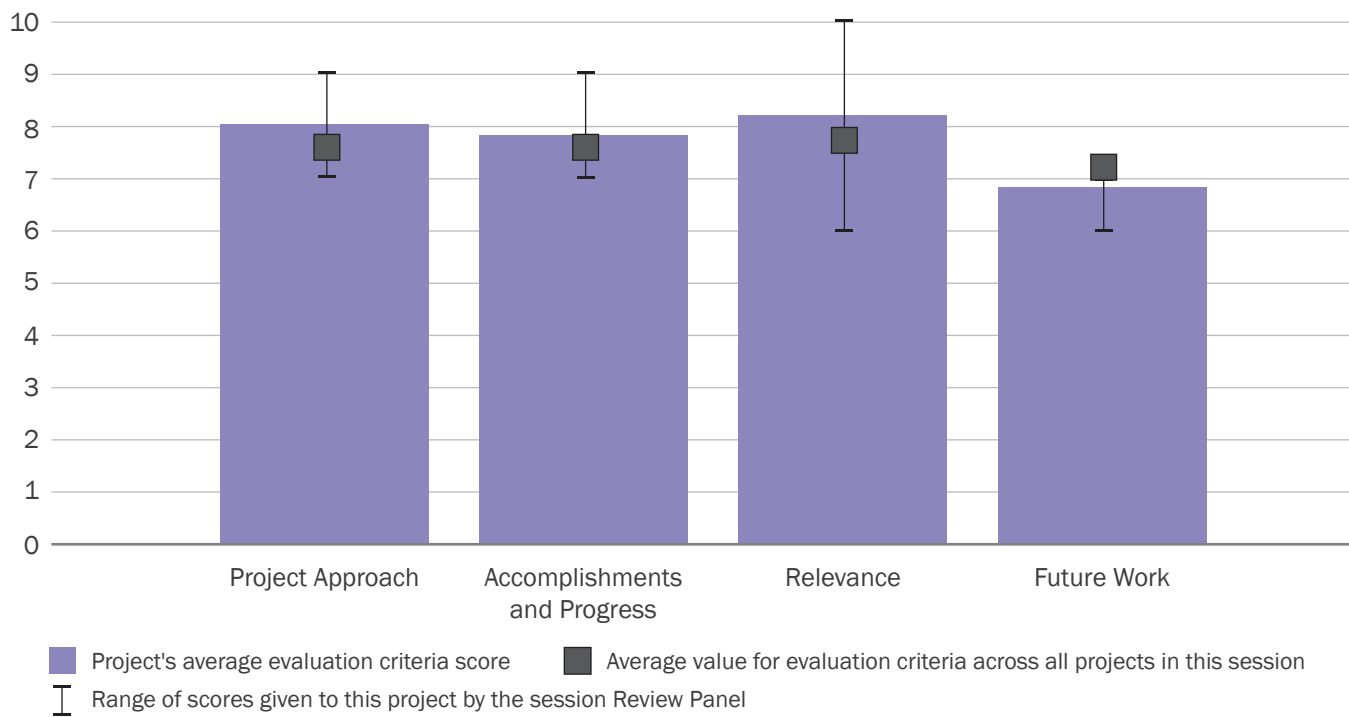

outcomes. This project has made major achievements since the 2015 Peer Review, including completing state-of-technology assessments to quantify R&D cost reductions on catalytic fast pyrolysis and indirect liquefaction pathways, sensitivity analysis for process alternatives, development of new analysis capabilities, and future scope for developing complex, industry-relevant, market-responsive biorefinery designs.

Overall Impressions

- It is a large team and working on so many different aspects to impact the programs, making it hard for the reviewer to fully understand team impact in such a short review time and slides. The examples were helpful, but perhaps showing more examples would have been more helpful for reviewing the team's accomplishments. I understand, however, that it can be hard to show lots of smaller contributions the team has made. I do believe modeling is key and critical to the success of projects. Early modeling is also critical, but I caution that with insufficient data, the modeling can be misleading to teams. Keep focusing on this area as key to drive success.
 - This is a very strong project with a history of successfully providing key information. I have found that the results from the earlier part of the projects matched the results from the analysis from my similar process development work.
 - It would be great if there was a method for accessing the resulting tools interactively to evaluate outside work. However, the fast turnaround analysis portion of the program could help with this kind of request. I am concerned that the dollar amounts for the sale price resulting from the model are misleading due to failure to include risk and other outside factors that influence the value.
 - The project provides excellent information and evaluations that will help other bioenergy projects to focus on relevant targets. The project is well-managed with clearly defined barriers and critical issues.
- Overall, TEA models are notoriously complex and hard to replicate because, like all models, they are only as good as the data you put into them, and the more they encompass, the more complex they are, which tends to decrease the probability that their predictions will be accurate. It is validating that these models have already been shown to improve some existing BETO projects, but more cases should be run and additional validation should be completed using existing industrial processes.
 - This is a good project. I'd like to see some discussion of how the tools (TEA, phase equilibria, kinetic modelling) are evaluated independently of the technical projects, possibly by benchmarking against well-understood technologies. While none of these will be used alone to make key program decisions, DOE wants to make sure the models are pointing in the correct direction.

PI Response to Reviewer Comments

- Thank you for your helpful feedback and guidance. The project team agrees with the reviewer feedback and recognizes the challenges in assessing risks and uncertainties associated with capital and operating costs for emerging technologies, operational learning curves in early stages of commercial deployment, and inherent uncertainties in projecting mature plant economics based on early-stage R&D. In this context, we will continue to engage experts from industry, academia, and partner laboratories to ensure that analysis continues to maintain high quality and transparency and that we make improvements based on critical feedback. Per the reviewers' recommendations, we will increase focus on smaller-scale conversion systems, while studying in parallel how technologies might integrate into more complex, industry-relevant designs for the co-production of fuels and products.

The project team appreciates the recommendation to increase benchmarking with developed technol-

ologies and will seek opportunities to improve this aspect of the project. The team develops capital and operating cost structures for biomass conversion pathways by often leveraging published industrial data on capital and operating costs for comparable commercially mature technologies. In order to complement the ground-up approach for capital costs for new technologies, the team compares costs with similar industrial technologies where relevant, e.g., utilizing published data on capital costs for various mature catalytic reforming units (semi-regeneration, cyclic-regeneration, and continuous-regeneration) to assess capital costs for low-pressure vapor swing-reactor systems in biomass conversion processes.

To address the challenge of industry confidentiality regarding catalyst costs, the TEA team is leveraging the Catalyst Cost Model being developed under ChemCatBio (that project also has critical industrial input). The development of TEA for the co-processing of pyrolysis oil in a fluid catalytic cracking unit

is a good example where we benchmarked relative to commercial fluid catalytic cracking units before extending analysis to pyrolysis-oil co-processing.

The project team also maintains and utilizes capabilities to assess biorefinery economic scenarios outside of the mature/nth-plant basis. While we do not regularly report pioneer plant economics, we provide this information to BETO whenever it is necessary to extend our economic projections to pioneer plants. In this context, we also worked with industry partners to develop TEAs for the immediate (first-of-a-kind plant) integration of bio-intermediates into the existing petroleum refining infrastructure, as well as the commercial deployment of syngas-derived products based on NREL's catalyst R&D.

As detailed in previous responses, the team will also continue to identify and utilize channels for presenting our work, disseminating our models/tools in the public domain, and seeking collaborative projects with industry partners.

LIQUEFACTION OF AGRICULTURAL AND FOREST BIOMASS TO “DROP-IN” HYDROCARBON BIOFUELS

(WBS#: 2.2.2.401)

Project Description

Iowa State University has developed and implemented a continuous pilot-scale process in which loblolly pine is converted to a partially deoxygenated bio-oil via solvent liquefaction. The primary objective of this project is to convert the pine feed to a bio-oil containing less than 20 weight percent (wt%) oxygen at a 50 wt% yield using a recycled wood oil product. This bio-oil will then be hydroprocessed to biocrude and upgraded to gasoline- and diesel-range hydrocarbons. The pilot-scale system generated three unique cuts of bio-oil (light, medium, and heavy wood oil), an aqueous fraction, non-condensable gaseous products, and bio-char. Biomass and solvent (hydrocarbon and wood oil) were fed to the

Recipient:	Iowa State University of Science and Technology
Principal Investigator:	Ryan Smith
Project Dates:	1/1/2013–12/31/2015
Project Category:	Sun-setting
Project Type:	FY 2011–BRDI: DE-FOA-0000510
Total DOE Funding:	\$3,500,000

liquefaction unit at rates of 0.5–1 kg/hour and 2–4 kg/hour, respectively. The liquefaction unit was operated between 300°–400°C and 27–48 bar. Preliminary experiments utilizing a hydrocarbon solvent resulted in a biomass conversion of 83.5% and mass closure of 99.8 wt%. Bio-oil yield was 55.3 wt%, surpassing the project goal of 50.0 wt%. Initial moisture-free and solvent-free elemental analysis of a mixture of light, medium, and heavy wood oil determined the oxygen content to be 19.7 wt%. The use of recycled wood oil as a solvent has not yet been conducted in the pilot-scale system. Instead, a surrogate recycled wood oil has been used in the solvent mix to simulate product recycle. The result was

Weighted Project Score: 7.0

Weighting: Approach–25%; Relevance–25%; Accomplishments and Progress–50%.

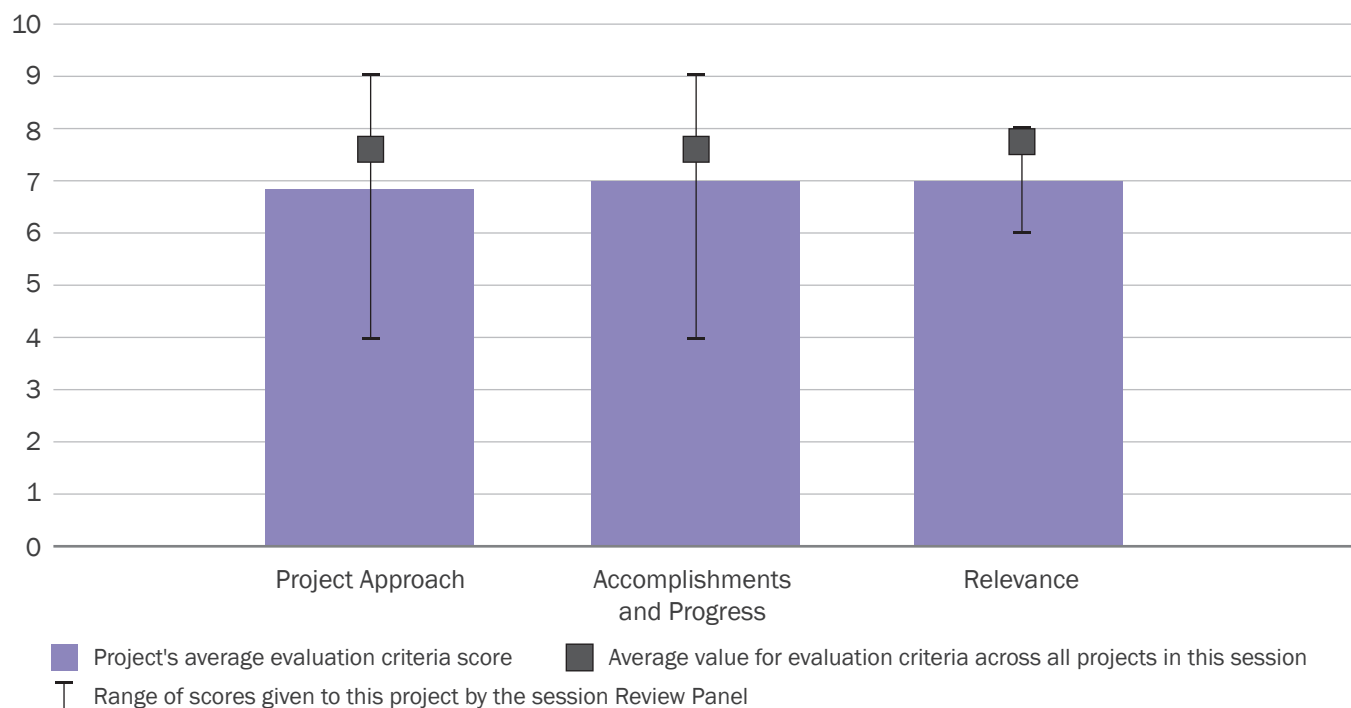

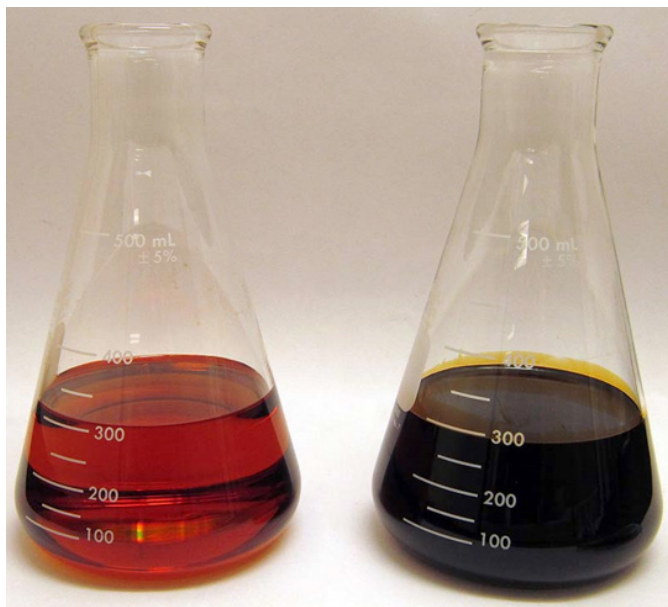

an increase in biomass conversion to 91.0% and mass closure of 93.6 wt%.

Overall Impressions

- Excellent work results show the utility of solvent liquefaction, which has been standard in coal liquefaction. The key will be whether the economics for biomass match that for existing coal liquefaction practiced today. I would also like to see environmental impact studies run also in parallel to techno-economic analysis (TEA), as these types of processes have quite a bit of chemical solvent moving around the system and should require cleanup at some time after longer use. Although the project is ending, it is key to get the following final information:
 - Bio-oil upgrading catalyst work—it will be interesting to see if constraints on poisons are reduced by solvent processing.
 - TEA is not yet defined, so claim of less than \$3/gallon should not be made yet.
 - Exploring lignin conversion should fit well with results from coal liquefaction.

- The project confirmed that high-pressure thermal solvolysis can produce good yields of a bio-oil with high carbon retention. This approach is one of the most promising of those being studied. However, the project failed to meet many of its stated goals of exploring upgrading the products by hydroprocessing and using an actual recycle stream. More importantly, there was no TEA analysis to allow the technology to be compared with other approaches.
- Project appears almost completed, but future tasks are still listed? The results so far are encouraging, but time will show how this technology will be accepted as a competitive alternative.
- Overall, this is a very compelling project. Process uses relatively mild temperatures and pressures, which dramatically improves its commercial potential. Future publications that explain solvent chemistry and mechanisms will provide important insights regarding the contribution of this work to the pyrolysis community.
- While the technical achievements of this project were limited, successful biomass upgrading technology will likely utilize the concepts incorporated in this project.

PI Response to Reviewer Comments

- The less than \$3/gallon figure is a target, and the TEA will be included in the final report.

Regarding future work, results so far are encouraging, but time will show how this technology will be accepted as a competitive alternative.

The project officially ends June 30, 2017, leaving time to conduct the hydroprocessing work and finalize the TEA results, which are currently underway.

THF CO-SOLVENT BIOMASS FRACTIONATION TO CATALYTIC FUEL PRECURSORS WITH HIGH YIELDS

(WBS#: 2.2.4.400)

Project Description

The overall goal of this project is to advance transformative co-solvent enhanced lignocellulosic fractionation technology to achieve high yields of fuel precursors, such as furfural and 5-hydroxymethylfurfural, from hardwood poplar and their conversion to “drop-in” fungible fuel blendstocks (methylated furans, higher alcohols, and hydrocarbons). The project will concurrently capitalize on the co-solvent enhanced lignocellulosic fractionation process’s extremely high lignin-extraction capability to produce liquid fuels and aromatic platform chemicals from lignin to increase process revenues. The project will be divided into two budget periods, lasting 12 months (1 year) each, and four main tasks

Recipient:	University of California, Riverside
Principal Investigator:	Charles Wyman
Project Dates:	9/1/2015–2/28/2018
Project Category:	Ongoing
Project Type:	FY 2013—Incubator: DE-FOA-0000974
Total DOE Funding:	\$1,060,000
DOE Funding FY 2015:	\$1,185,000
DOE Funding FY 2016:	\$1,190,000
DOE Funding FY 2017:	\$1,190,000

corresponding to the four project milestones, including a techno-economic analysis.

Overall Impressions

- This is a very impressive work result for a first year or so effort. I like the solvent/catalyst approach as it makes the best utilization of biomass and lignin and fits with other work on transformations in the BETO programs. The team has done an outstanding job. I do think the team needs to present what they

Weighted Project Score: 7.6

Weighting: For ongoing projects, there is equal weighting across all four evaluation criteria: Approach, Relevance, Accomplishments and Progress, and Future Work.

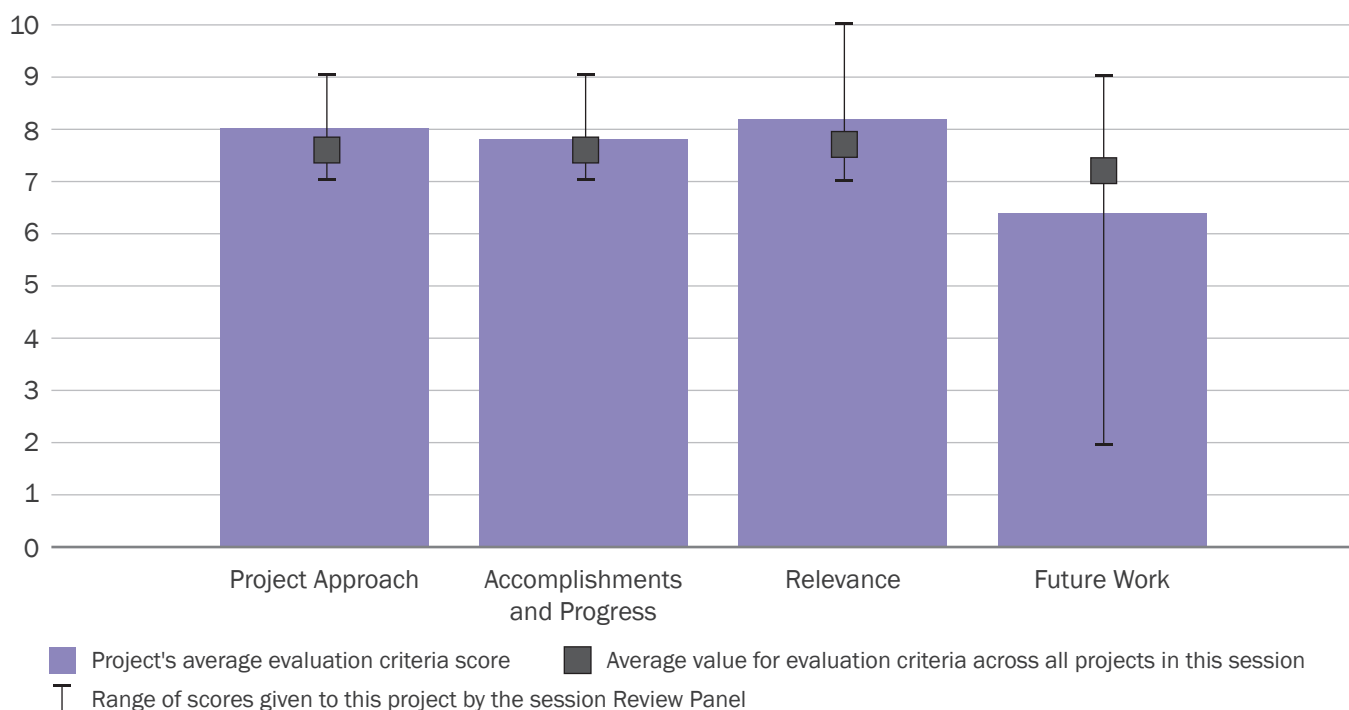

believe are killer issues, which were not addressed in this review: (1) solvent impact on market and (2) contribution cost to raw material cost of solvent easily calculated at various levels (such as 80%, 90%, 100% recovery) without using fancy modeling. The same could be said for (3) defining cost and market impact on iron halide use and recovery. These are simple calculations that can be done by any scientist for an early rough estimate. I believe, however, that this team has a right to succeed in their program in the next year or more, but the key will be the future economic assessment and solvent recovery results.

- This project is off to very good start but will need some input from people with more commercial experience. The potential of the approach was clearly demonstrated. I am concerned with the use of THF as solvent in terms of both cost and safety. The techno-economic analysis done so far is not very strong and could use input from the BETO consortium. The project could also use input from people with commercial experience.
- This is an interesting project for the longer term. There are still many issues that need to be solved and demonstrated before the technology is ready for commercialization.
- Overall, this is a very compelling addition to the organosolv liquefaction community. The choice of THF as solvent was well thought out and supports very efficient recovery and reuse of solvent. However, while this is very effective chemistry, lessons need to be learned from the industrial furfural and furfuryl alcohol industries. Understanding the commercially relevant routes for furfural and furfuryl alcohol derivatives, as well as the existing markets, needs to be part of the design decision-making

process. THF is also a classic example of a solvent where great power comes with great responsibility—it is frequently avoided at commercial scales for its volatility, flammability, and generally hazardous nature. This must be considered more in the future.

- Overall, this is a nice project showing reasonable progress by processing biomass feedstocks in parallel. But, it needs to consider transitioning from a reaction to a process.

PI Response to Reviewer Comments

- We would love to be able to collaborate with groups specialized in performing techno-economic analysis if permitted by BETO management. Our project is currently being advised by commercial partner MG Fuels, who is committed to commercializing the co-solvent enhanced lignocellulosic fractionation process in North America and has begun pilot-scale testing based on our experimental results.

We have already performed high-level economic analysis of raw material costs, as reported in our Quarter 2–Quarter 4 reports, demonstrating positive cash flow and reasonable operating margins (suitable for return on investment of <5 years) using experimentally derived yield data and solvent recycle efficiencies.

We have mentioned strategies we have implemented in our proposed process design to mitigate the dangers of THF usage in our responses for sections 1, 2, and 3.

We are working with our commercial partner, MG Fuels, to achieve our laboratory results at a continuously operated pilot scale.

CATALYTIC UPGRADING OF BIOCHEMICAL INTERMEDIATES

(WBS#: 2.3.1.100-3)

Project Description

The Catalytic Upgrading of Biochemical Intermediates project is a multi-laboratory effort within ChemCatBio that is specifically focused on catalytic upgrading of sugars/related intermediates from biochemical deconstruction and/or biologically derived (i.e., fermentation) intermediates to hydrocarbon fuels. As several companies are developing catalytic upgrading routes from clean sugars, this project will help facilitate a transition to catalytic upgrading of biomass-derived intermediates by providing a quantitative performance and economic assessment of several catalytic upgrading approaches using biochemical deconstruction/fermentation intermediates.

While there are strong reasons for use of biochemical conversion—appropriate feedstocks and deconstruction

Recipient:	National Renewable Energy Laboratory, Oak Ridge National Laboratory, Los Alamos National Laboratory, Pacific Northwest National Laboratory
Principal Investigator:	Rick Elander
Project Dates:	7/25/2011–9/30/2019
Project Category:	Ongoing
Project Type:	Annual Operating Plan
DOE Funding FY 2014:	\$950,000
DOE Funding FY 2015:	\$2,100,000
DOE Funding FY 2016:	\$2,100,000
DOE Funding FY 2017:	\$1,950,000

methods, numerous challenges exist, including integration of biochemical upstream and catalytic downstream operations; understanding inhibitory impacts on upstream and downstream operations; developing specifications for biochemically derived feed streams to catalytic processes; and quantifying impacts of such

Weighted Project Score: 7.7

Weighting: For ongoing projects, there is equal weighting across all four evaluation criteria: Approach, Relevance, Accomplishments and Progress, and Future Work.

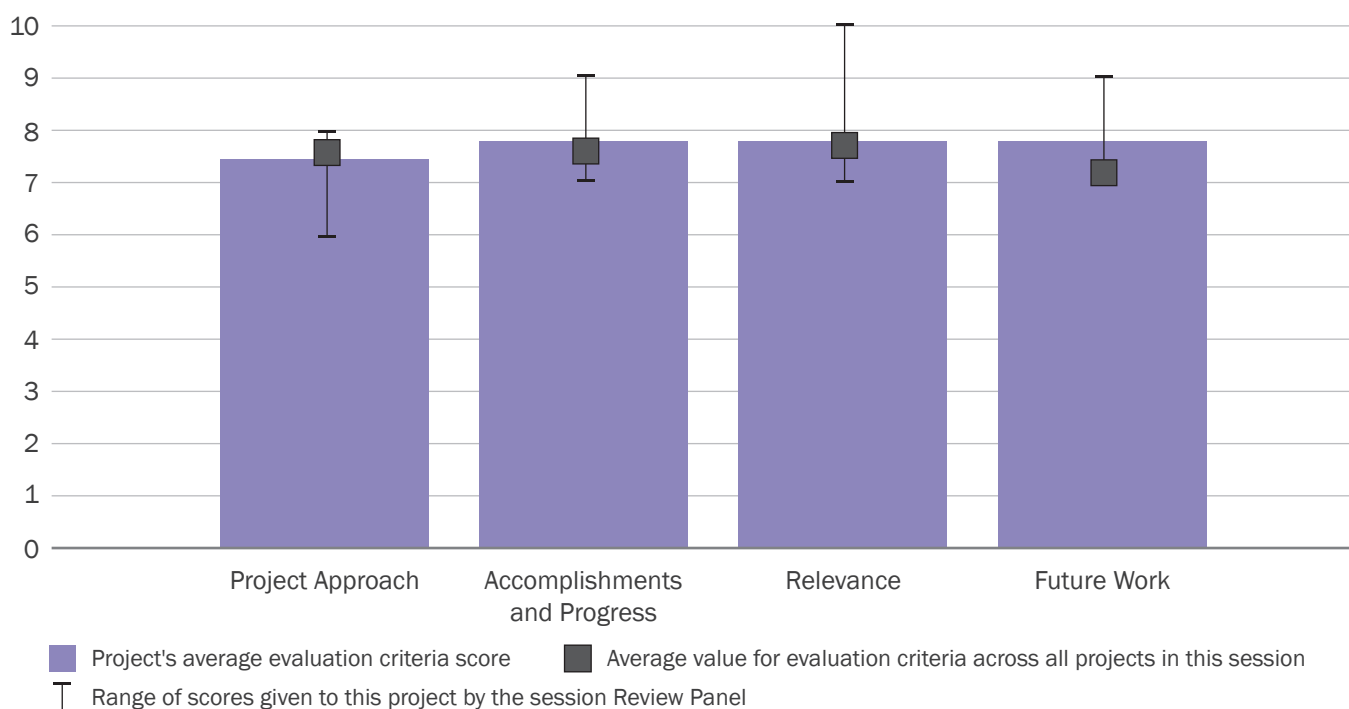



feed-streams on catalyst durability/lifetime, efficiency, and selectivity. The main project outcome will be the evaluation of four routes for catalytic upgrading of sugars and sugar-derived intermediates into hydrocarbon fuels and co-products and select routes(s) that can achieve hydrocarbon fuel costs of \$3/gge in 2022 (when coupled with lignin co-product valorization), with >25% (gge basis) in the jet or diesel range.

Overall Impressions

- The teams have done a great job in exploring the potential routes feasible that will maximize the use of all the carbon versus other approaches. I see this approach overall as having best chance to be successful in the long term if sufficient funds continue to be put into this program. It requires complex chemistry to achieve all the processing steps commercially at economics, but the team has the right approach to narrow the possibilities and should continue to attempt to combine steps into one or two where feasible. Initially some carbon loss may occur, but the key challenge for this approach will be the capital necessary for all the unit operations. The team did the best job in their presentation in providing summary slide of approach, accomplishments, relevance, and future work. Ethanol utilization was highlighted from the last review but will be most economically challenging, even in the

future, for cellulosic-derived ethanol. The cost of producing cellulosic ethanol by fermentation and the fermentation cost need to be defined if this will even be close to ever meeting the cost needed in the future. Chemical processes are much easier to predict on scale-up, so my key cautionary statement to the team is from my past teams' experience—the fermentation piece will be easy early on, as shown, while catalyst conversion will be more challenging early on in program. In the long run, chemical processes are more readily scaled than biological ones, from my experience.

- This project continues to produce important results. The production of biochemical intermediates and their conversion to chemicals and fuels is increasingly recognized as the most promising route for replacing fossil fuels with biomass. This route is the best suited to take advantage of the available biomass and the potential growth in high yield varieties grown specifically for fuels, as outlined in the 2016 *Billion-Ton Report*.

The project has clearly demonstrated the chemistry can work. The focus should begin to shift towards optimizing the process to provide data to the techno-economic analysis (TEA) by choice of catalyst and reactor conditions. Scale-up to produce sufficient quantities to allow product evaluation should be considered as a next step.

There is significant prior work involving these routes. The next step should be to place these in a commercial context and conduct careful TEA on the same basis. The performance of each of the routes needs to be benchmarked against the prior work both in government and in outside laboratories.

Most of the biomass the fuel processes produce light oxygenates that can be upgraded to fuel via these routes, making this project relevant across many platforms.

- This is a well-organized project with clear goals. The project will provide an excellent knowledge basis that will enhance the chance of making bioenergy projects successful. The project leverages on experience from several national laboratories.
- Overall, great work—this program’s focus on sugar conversions is showing that it can efficiently produce narrow product distributions and also products with high potential value. This is a result that continues to elude whole-biomass conversion and therefore is a solid step forward in a constructive direction. However, technical success is different than commercial or strategic success, and the number of steps required to take sugars all the way to hydrocarbon fuels is concerning. Looking at biomass sugars and selecting conversion targets that could be produced with the least steps, in a thermodynamically favorable way, is a logical approach for reducing process intensity and improving the odds of commercial/strategic success. It is possible that the program would contribute to the fuel supply in a more constructive manner if focus was on increasing availability/decreasing costs of fuel additives like antioxidants, octane boosters, multifunctional additives, fuel oil additives, etc. Fuel is not a neat chemical; it is an engineered mixture with numerous components, and if there are components that can be generated more efficiently from sugars than petroleum, that would be most helpful.
- This is a big, ambitious project focusing on conversion strategies. Good technical work demonstrated to date.

PI Response to Reviewer Comments

- We thank the Review Panel for their supportive and constructive comments regarding this project. We are evaluating and developing a targeted range of process routes to exploit the specificity of intermediate compounds associated with bio-

chemical deconstruction and biological upgrading of biomass to target more specific fuel compounds and blendstocks. This is one of the key advantages afforded by the generation of biochemically derived intermediates. We agree with the Review Panel’s recommendation to identify potentially higher-value fuel additives, oxygenates, octane boosters, etc., and we will work with BETO technical managers, other projects within the ChemCatBio project landscape, other relevant projects within the BETO portfolio (such as the Co-Optimization of Fuels and Engines effort), and the future ChemCatBio Industrial Advisory Board to identify such opportunities.

The TEA activities within this project will also be utilized to perform a wide-ranging analysis that considers both the volume and the value of potential fuel compounds and additives that can be produced via the various process routes within the project, both individually and as a broader suite of compounds. This will be a central theme of the FY 2018 go/no-go deliverable, which can be used as a mid-project focusing mechanism for the second half of this project. In conjunction with this, we intend to utilize the opportunities within ChemCatBio’s future industrial engagement mechanisms to guide project direction and focus efforts on the R&D approaches and pathways of greatest relevance to industrial stakeholders.

As initial TEAs around these process routes are developed, opportunities to reduce process complexity and increase process intensification will be identified, using sensitivity analysis to identify the most economically impactful opportunities. Additionally, the TEA activities in this project will leverage and utilize rigorous integrated biochemical deconstruction and biological upgrading modeling modules that are already available within the BETO portfolio, coupled with appropriate catalytic upgrading modeling methodologies for the upgrading routes being developed in this project.

ONE-STEP HIGH-YIELD PRODUCTION OF FUNGIBLE GASOLINE, DIESEL, AND JET FUEL BLEND-STOCKS FROM ETHANOL WITHOUT ADDED HYDROGEN

(WBS#: 2.3.1.201)

Project Description

Most fuel ethanol is currently produced from starch in the United States and cane sugar in Brazil, and new technologies are emerging for producing ethanol from cellulosic biomass, such as wood, grasses, and agricultural and forestry residues. However, U.S. ethanol is used primarily as 10% blends with gasoline, and current U.S. ethanol production has virtually saturated that market. The resulting “blend wall” and limited infrastructure to supply or use higher ethanol levels inhibits expansion of bioethanol production. Vertimass, LLC, through an exclusive license from Oak Ridge National Laboratory, seeks to commercialize novel catalyst technology to convert

Recipient:	Vertimass LLC
Principal Investigator:	John Hannon
Project Dates:	5/15/2015–5/14/2017
Project Category:	Ongoing
Project Type:	FY 2014—Biological and Chemical Upgrading: DE-FOA-0001085
Total DOE Funding:	\$1,600,000
DOE Funding FY 2015:	\$1,450,000
DOE Funding FY 2016:	\$1,232,500
DOE Funding FY 2017:	\$1,232,500

ethanol into diesel fuel, gasoline, and jet fuel blendstocks compatible with the current transportation fuel infrastructure. The blendstocks produced are anticipated to fall under the Renewable Fuel Standard at the same level as feedstock ethanol. The catalytic process benefits from (1) production of minimal amounts of light components, (2) relatively mild temperatures and pressures, (3) the ability to process 5% to 100% inlet ethanol concentrations, (4) product flexibility to respond to changing market demands, and (5) no need to add hydrogen. In this project,

Weighted Project Score: 7.7

Weighting: For ongoing projects, there is equal weighting across all four evaluation criteria: Approach, Relevance, Accomplishments and Progress, and Future Work.

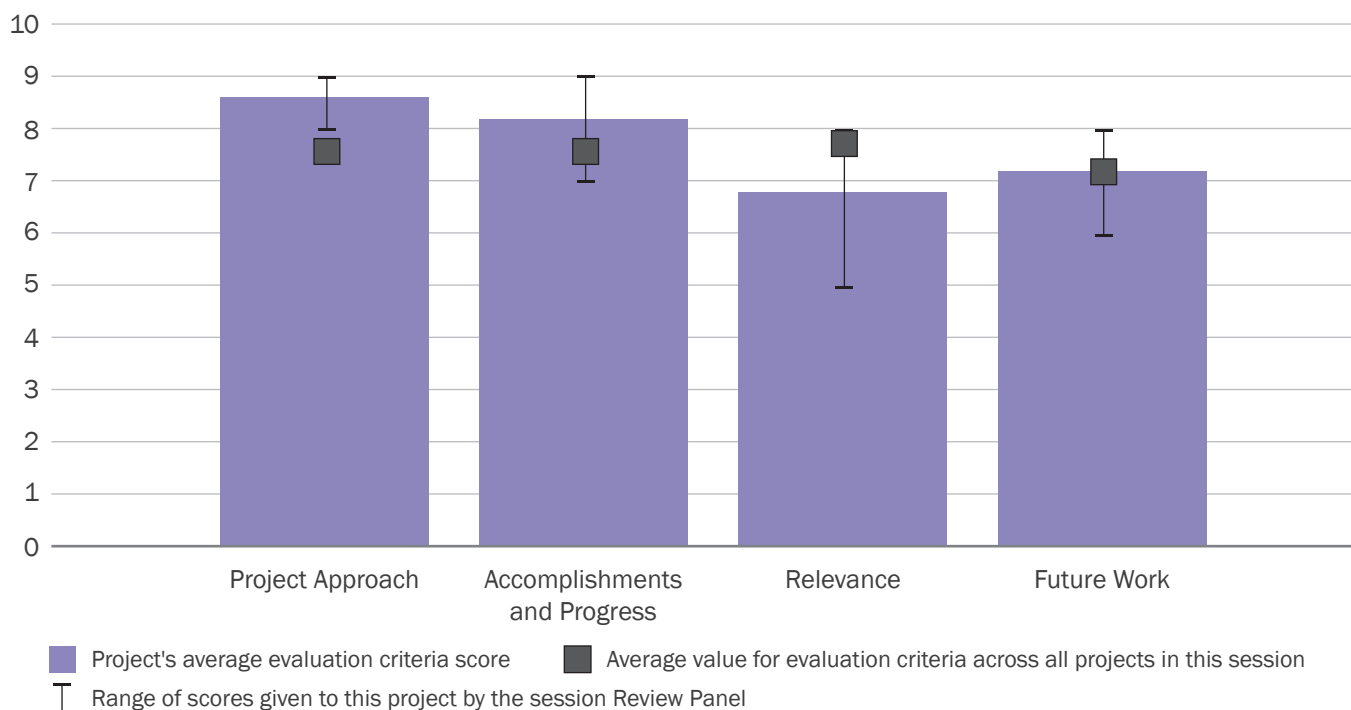



Vertimass has taken major steps in advancing this technology to date, including (1) scaling up the process 150x, (2) maintaining 100% conversion yields of ethanol, (3) increasing liquid yield product distribution from 36% to 83%, (4) moving from powder to pelletized catalyst form, and (5) running ethanol feedstocks with no dilution. The technology advances through Phase 1 of this project have enabled economic feasibility of the Vertimass bolt-on for industrial application.

Commercialization of this novel technology would overcome fungibility issues that limit ethanol use in gasoline for light-duty vehicles and open up new markets for ethanol for heavy-duty vehicles and aircraft. Vertimass plans to partner with ethanol producers—with particular emphasis on emerging cellulosic ethanol plants—as rapidly as possible to overcome the blend wall and also to allow airlines to achieve U.S. Federal Aviation Administration targets of 1 billion gallons of renewable aviation fuel by 2018. This technology would expand opportunities to use more sustainable fuels in the United States. BETO funding will accelerate the scale-up of this technology to realize the important goals of reduced greenhouse gas emissions, enhanced energy security, and domestic jobs.

Overall Impressions

- This is excellent work by the team and a nice fit with ethanol producers to make additional money on chemicals, but this no longer fits with the BETO goal of the fuel program. Also, from past experience, chemical value is questionable for production at ethanol site, which still means it has to go to a fuel/chemical producer mega-plant for isomerization to higher p-xylene fraction to maximize value. Transport and handling of benzene-containing materials is challenging to permit and, as such, would require numerous plants in the future producing ethanol at a smaller scale. Thus, what is an interesting proposition can become a benzene-production nightmare across the entire United States if implemented at numerous plants. This concern needs to be addressed quickly if ethanol producers are to be advantaged by this extra production of BTEX (benzene, toluene, ethylbenzene, xylenes) for value.

Capital and operating expenses for this technology are also an issue as the plant must have a business case that justifies upgrading to BTEX versus selling product as ethanol. Return on investment is a key concern in the long run for the corn producers. It is yet to be seen if this can add value on top of cellulosic, as there is no Renewable Identification Number (RIN) credit for BTEX.

- The project is well-run, and the results are very positive. It is likely that the ethanol conversion process could be commercialized, depending on the price.

This project anticipates that there will be a surplus of ethanol in the near future, and the RINs will not be available. It is prudent to develop a hedge against this time. However, the assumption that this can be a quick add-on to an ethanol plant is not viable because the products include aromatics, which will greatly affect the Occupational Safety and Health Administration and U.S. Environmental Protection Agency burden on the plants.

- This is a nice project that helps solve the issue of excess ethanol caused by the “blending wall” by converting it into fuels and chemicals. The project shows good progress and is well-managed, including relevant partners.
- Overall, this is a very interesting and timely project given the parallel developments happening in ethanol to olefins. Efficient conversion of ethanol into hydrocarbons has the potential to dramatically change the conversation regarding ethanol’s importance in the chemical supply chain. This would not only affect corn and cellulosic ethanol, but also the coal-based ethanol that could come online in the future. As far as this project is concerned, yields have been improved, scale has been increased, multiple ethanol concentrations have been tested, and the process does not require hydrogen. Overall, this project’s accomplishments and progress have been very impressive. Some future work around mixed alcohol feeds, or other even mixed volatile fatty acid feeds, could expand utility and options.

- This is a very promising project with team dedicated to technology commercialization. It is a good use of DOE funding to accelerate development and commercialization of ethanol conversion technology.

PI Response to Reviewer Comments

- We are engaging industrial contacts regarding both our gasoline-like main product and chemical (BTEX) co-product values and how they can be incorporated into existing refining infrastructure. Our main product still is a fuel, and the BTEX is intended as a co-product to offset operating expenses.

The ethanol producers will have the flexibility to partially or fully produce Vertimass products (gasoline-like fuel and concentrated BTEX) or continue to make ethanol to take advantage of market conditions and maximize their revenue. We anticipate the ethanol RINs will transfer into our fuel product, supporting higher prices. However, the ethanol RINs do not currently transfer into the BTEX product, but these BTEX products command a price premium over fuels, so this is partially hedged.

CATALYTIC PROCESSES FOR PRODUCTION OF α , ω -DIOLS FROM LIGNOCELLULOSIC BIOMASS

(WBS#: 2.3.1.204)

Project Description

This project is developing a multi-step catalytic approach for converting biomass into 1,6-hexanediol and 1,5-pentanediol. These α,ω -diols are high-volume (2.6 million tons/year), high-value (\$2,000–\$4,600/ton) commodity chemicals used in the production of polyurethanes, coatings, acrylates, adhesives, polyesters, and plasticizers. The biomass is first converted into furfural, lignin, and cellulose. The cellulose is then converted into levoglucosan, which is dehydrated into levoglucosenone (LGO) in the condensed phase with dilute acid using a polar, aprotic solvent. The product selectivity is a function of the water concentration, the solvent type, and the cellulose loading. Increasing the water content

Recipient:	University of Wisconsin
Principal Investigator:	George Huber
Project Dates:	2/1/2015–1/31/2018
Project Category:	Ongoing
Project Type:	FY 2014—Biological and Chemical Upgrading: DE-FOA-0001085
Total DOE Funding:	\$2,957,576

in the solvent leads to the production of 5-hydroxymethylfurfural. The LGO is then hydrogenated into dihydrolevoglucosenone, levoglucosan, and tetrahydropyran-2-methanol. The tetrahydropyran-2-methanol then undergoes selective C-O-C hydrogenolysis to produce 1,6-hexanediol using a bifunctional catalyst with more than 90% selectivity to 1,6-hexanediol. The furfural then undergoes a series of reactions to produce 1,5-pentanediol. We will describe the catalytic chemistry that happens in each of these steps and estimate the economic viability of our approach to produce infrastructure-compatible biomass based commodity chemicals.

Weighted Project Score: 7.6

Weighting: For ongoing projects, there is equal weighting across all four evaluation criteria: Approach, Relevance, Accomplishments and Progress, and Future Work.

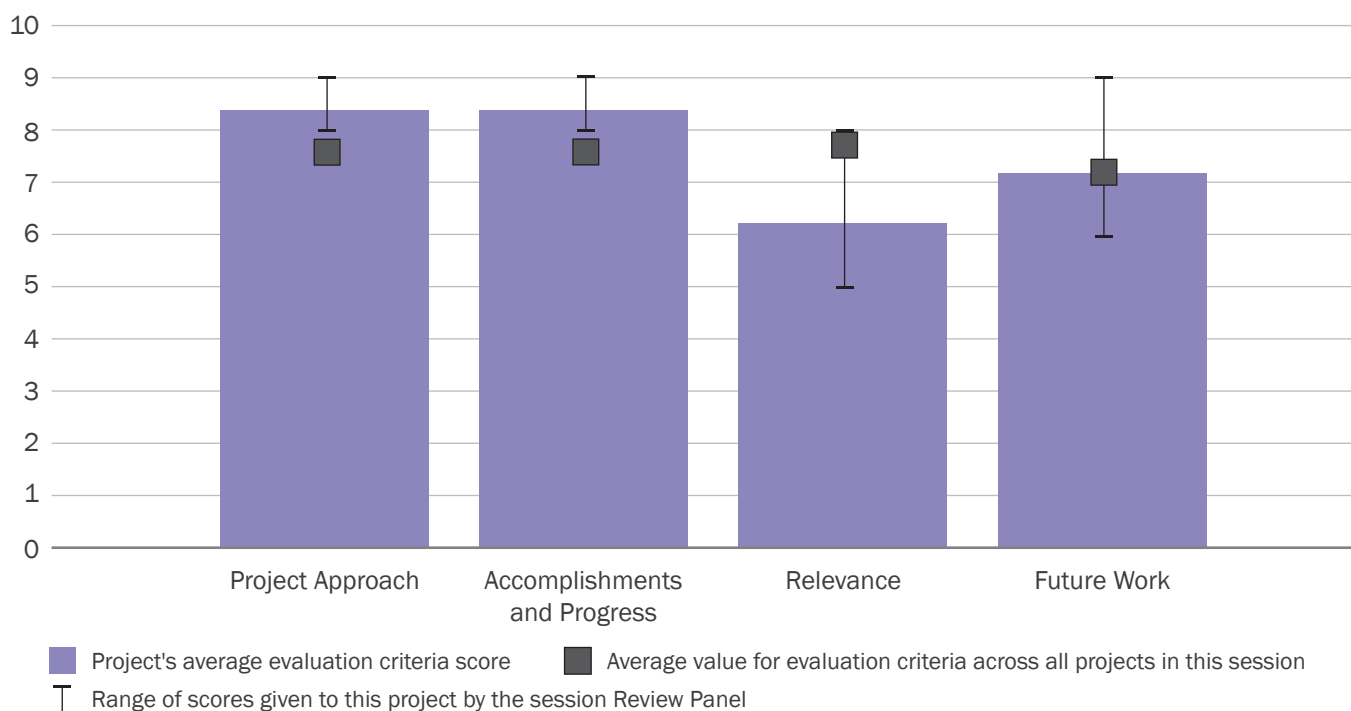

Overall Impressions

- The work was high quality as always by George, with clear goals and solid achievements. Economics appears more challenging than presented, considering the number of process steps and use of large amounts of solvent to recycle. If possible, in the final project year it would be useful to prove out conversion of 1,6-hexanediol to a commercial polymer to compare side by side to the current petrol-produced material.
- This project is more appropriate for a startup company with the goal of producing the diols rather than as an add-on to a biofuel project. The complexity of the project suggests it will take many years to completely develop. Does BETO have the resources to be ready to commit for the long term? The value of the diols produced is limited by the global market needs. Only 2–3 plants would fill this need. It is unclear whether the amount of fuel co-produced by the technology would significantly progress BETO's mission to use 1 billion tons of biomass for energy.
- This is an interesting alternative process scheme for production of valuable chemicals from biomass. It's still to be seen if the technology can attract commercial interest from industry. The process scheme appears very complex.
- Overall, this is an impressive and compelling project. The team has shown considerable levels of innovation and adaptability as more has been learned about these conversions. Consideration of alternative C6 products with better yields, such as LGO, cyrene, tetrahydrofuran-dimethanol, and 1,2,6-hexanetriol is interesting. Chemical conversions are well thought out, and experimental results mostly show conversion efficiencies that can be worked with. There is a high probability that this work will contribute to important new developments in the field, but economics should first be grounded in facilities purchasing commercially available raw

materials, like furfural and cellulose, before making the leap to mega-scale biorefinery integrations that could potentially collapse the market for some of these specialty, niche chemicals.

- This was a good overall discussion of an interesting technology option for biomass valorization. However, feed molecule substitution in the polymer area is tough. Unless the technology provides tangible benefits (cost!) compared to existing processes, it is difficult to see a scenario in which pentanediol demand will be sufficient to justify investment. Hexanediol is used in substantial amounts so market penetration has a higher likelihood of success.

PI Response to Reviewer Comments

- We thank the reviewers for their comments and analysis of this project. We are legally constrained to follow the guidelines put forth in the FOA for this project. The FOA requires starting with lignocellulosic biomass. Therefore, we focused our analysis on technology for the conversion of lignocellulosic biomass into 1,5-pentanediol and 1,6-hexanediol. As described in our presentation a plant that produces 43 kilotons (kt) α,ω -diols/year from white birch costs \$810 million. We also agree that a process that converts lignocellulosic biomass into α,ω -diols has too many process steps to make economic viability right now. However, as described in our presentation, this technology could economically convert furfural into 1,5-pentanediol with a low capital cost and only three steps. We estimate that a plant that produces 37 kt 1,5 pentanediol per year would have a capital cost of \$50 million.

Each of the three steps for the conversion of furfural into 1,5-pentanediol has been done in continuous flow reactors in our laboratory with hundreds of hours of time on stream. Based on our rigorous economic analysis and assuming an internal rate of return of 10%, the minimum selling price of 1,5-pentanediol from furfural ranges from \$1,300–\$3,000

per ton. We agree that a biorefinery that focuses on conversion of lignocellulosic biomass into α,ω -diols would take years to completely develop. However, a biorefinery that takes furfural and converts it into 1,5-pentanediol is simpler and would take less time and resources to develop. The same is true for a biorefinery that converts cellulose into some of the other oxygenated molecules we produce in our approach.

One of the reviewers claims that only 2–3 plants would fill the need for α,ω -diols. This is not correct. The current production of 1,4-butanediol and 1,6-hexanediol is 2,500 and 138 kt/year, respectively. These markets are growing at over 5% year. Therefore, the annual growth of the diols market volume is about 130 kt. Thus, if our technology was to become the low-cost producer of α,ω -diols and capture the growth of this market, then 2–3 plants would have to be built each year.

The scope of this project is to develop and commercialize new technology for biomass conversion, which is a feedstock that has inherent disadvantages, such as low energy density and the presence of solids, compared with fossil fuels. Based on the financial reality, we think the prices of α,ω -diols are high enough to represent reasonable commercial targets. There are no high-price and large-volume

materials. Targeting a larger market volume leads to a lower price that would seriously threaten commercial viability. Thus, to attain a large-volume and low-price commoditized market is extremely high risk.

Another reviewer stated that “it would be useful to prove out conversion of 1,6-hexanediol to a commercial polymer to compare side by side to the current petrol-produced material.” We agree this is an important goal in the technology development pathway. Unfortunately, the legal rules of the current FOA do not allow us to do this type of research with this funding. We are in the process of trying to obtain funding to do this important research step. We also agree that this technology has the potential to produce other niche chemicals like LGO, cyrene, tetrahydrofuran-dimethanol, and 1,2,6-hexanetriol and are studying ways we can produce these products more efficiently.

We would like to thank the reviewers for their time in reviewing this project. We would also like to thank DOE for supporting this research. In this project, we are studying and demonstrating new catalytic chemistry that has previously been unexplored. We think this project will lead to new commercial technologies for biomass conversion into commodity chemicals. We will continue to discuss our technology with interested industrial partners.

FAST PYROLYSIS AND UPGRADING

(WBS#: 2.3.1.301-2)

Project Description

The project objective is to advance the technology for converting liquid transportation fuel from biomass via pyrolysis and catalytic upgrading. This will be accomplished by techno-economic analysis (TEA)—targeted research to drive the technology toward targets established in the 2016 Multi-Year Program Plan. The approach combines understanding of chemistry, catalyst, and process development for improved efficiency and economy, guided and measured by TEA, stakeholder involvement, and demonstration of the technology at scale. This project addresses the major challenges associated with fast pyrolysis bio-oil upgrading, including the following: (1) bio-oil deep stabilization by hydrogenation enabling bio-oil upgrading via hydrotreating; (2) highly reactive catalyst, contaminant management, and efficient regeneration to significantly enhance stabilization catalyst

Recipient:	Oak Ridge National Laboratory, Pacific Northwest National Laboratory
Principal Investigator:	Jae-Soon Choi
Project Dates:	10/1/2016–9/30/2019
Project Category:	Ongoing
Project Type:	Annual Operating Plan
DOE Funding FY 2014:	\$1,430,000
DOE Funding FY 2015:	\$2,210,000
DOE Funding FY 2016:	\$2,450,000
DOE Funding FY 2017:	\$1,925,787

lifetime; and (3) demonstration at different feedstocks and reactor scales to enhance technology viability.

The project has made continuous improvements to meet BETO's targets for the fast pyrolysis state of technology every year since 2009, targeted and measured by TEA, and is on schedule to meet BETO's 2017 target of \$3.50/gge. It also seeks to enable technology-to-market transformation by demonstrating at scale, contributing

Weighted Project Score: 6.9

Weighting: For ongoing projects, there is equal weighting across all four evaluation criteria: Approach, Relevance, Accomplishments and Progress, and Future Work.

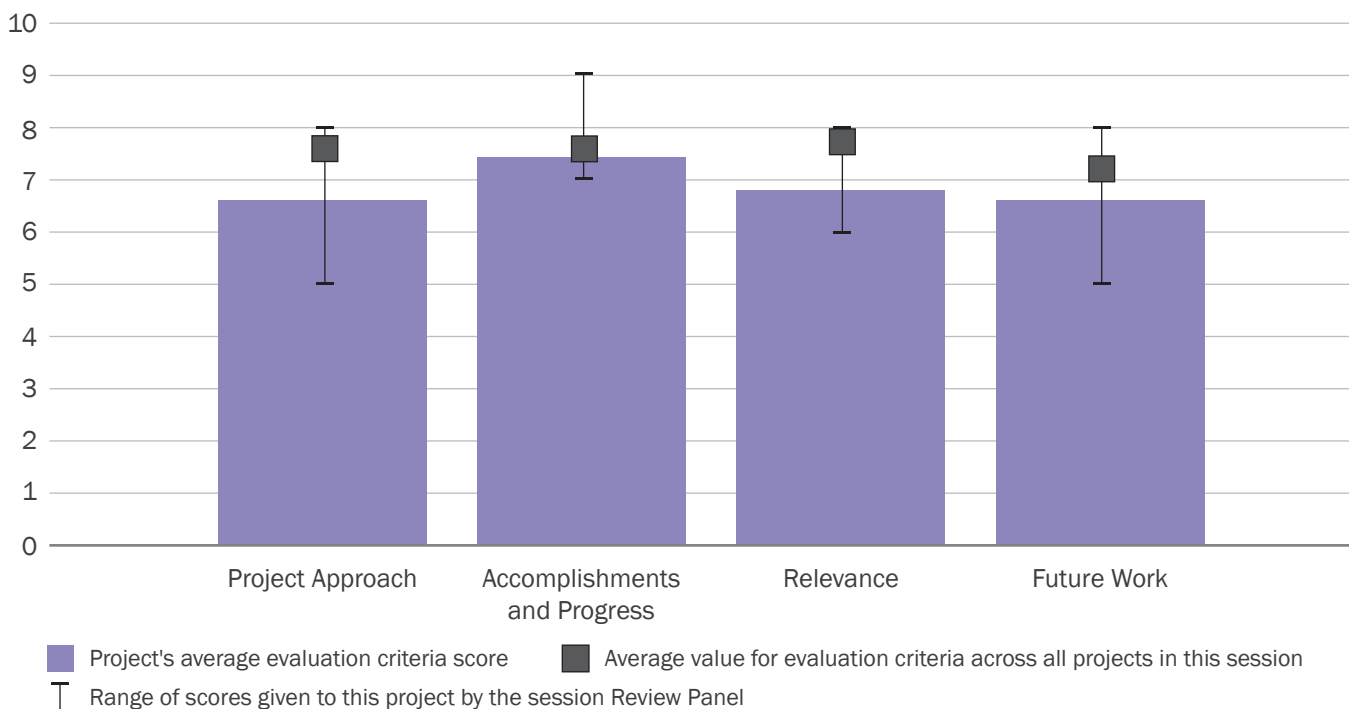

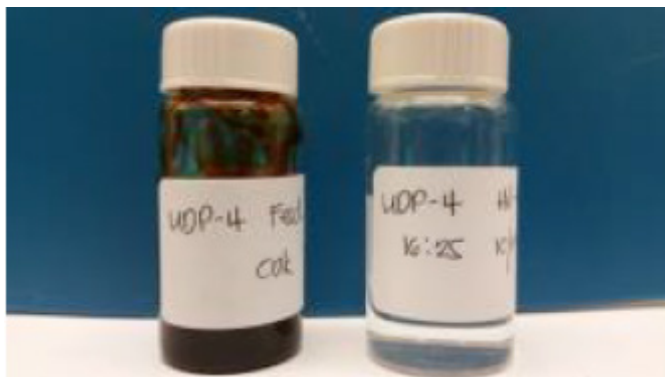

experimental measurements to reactor modeling efforts, and developing technology options based on TEA/ life-cycle analysis and input from stakeholders. Results from this project, including upgrading processes, catalysts, and capabilities, will be leveraged by existing and future BETO-funded efforts.

Overall Impressions

- This is a high-impact, high-quality project that provides useful, realistic information on feedstock supply. It is well-integrated with commercial and sustainability aspects of the BETO portfolio.
- This is excellent work to estimate the potential and growth of the industry.
- This project has presented useful research. However, there needs to be integration with agencies, universities, and industry. The project needs to validate simulations with real data. The project should put more emphasis on the near term (e.g., the next 5 years) and less on the long term (e.g., 15–20 years).
- This project has accomplished a lot with its integrated modeling work; however, these studies seem disjointed and it is not clear if data are available to validate these complex processes.
- This project utilizes best available information from BETO and other biomass logistics projects to conduct a systems analysis of the supply chains and

associated biorefineries. These efforts are closely linked to and support the *BT16* estimations of biomass availability. Technical accomplishments include the prediction of available biomass quantities at varying costs and the resulting number of biorefineries. The assumptions made are obviously overly optimistic, as a projection of 73 biorefineries in 2017 was shown, when we actually have two. Methodologies to benchmark and adjust predictions with current conditions should be considered.

The work presented and the future activities effectively utilize expertise in the national laboratories, particularly Oak Ridge National Laboratory and INL. The planned work on modeling of biomass moisture management should be closely aligned with the efforts at INL to consider the storage and processing of high moisture materials. This project makes valuable contributions to BETO.

- Overall, the project has developed and integrated field drying modeling into the FSL model to manage and monitor the moisture content of delivered feedstock. It is expected that the future work will include additional feedstock quality specifications explicit to a biorefinery for accurately estimating the feedstock cost, while minimizing the feedstock quality risks.

PI Response to Reviewer Comments

- In the last 2 years, the Oak Ridge National Laboratory logistics modeling team have been working with their industrial partners to collect field data such as equipment speed, fuel consumption, bale bulk density, and harvest moisture content, etc. These models currently have updated input data. New harvest data were collected from biomass producers, aggregators, and equipment manufacturers (i.e., local farmers, State University of New York harvest team in New York and Oregon, Antares, Pacific Ag, and AGCO Corporation).

LIQUID FUELS VIA UPGRADING OF INDIRECT LIQUEFACTION INTERMEDIATES

(WBS#: 2.3.1.304-5)

Project Description

This project seeks to develop a responsive, integrated biorefinery concept based on indirect liquefaction technologies that (1) produces a suite of fuels and co-products and (2) provides control over the product distribution such that process operation can be adjusted to meet increasing distillate fuel market demand. Advanced upgrading technologies from syngas are critically needed for the successful commercial implementation of fuel production at a scale relevant for biomass. Research tasks leverage light oxygenate intermediates from syngas and focus on the development of new catalytic pathways with lower severity conditions to achieve high-carbon yields of gasoline, diesel, and jet fuel with integrated routes to co-products that

Recipient:	Pacific Northwest National Laboratory, National Renewable Energy Laboratory
Principal Investigator:	Rob Dagle
Project Dates:	10/1/2016–9/30/2019
Project Category:	Ongoing
Project Type:	Annual Operating Plan
DOE Funding FY 2014:	\$3,258,000
DOE Funding FY 2015:	\$3,750,000
DOE Funding FY 2016:	\$3,750,486
DOE Funding FY 2017:	\$3,600,000

can improve overall economics. Each pathway under investigation offers promise to generate high-quality fuels (e.g., high-octane gasoline with low aromatics, desirable jet- and diesel-range hydrocarbons) and to achieve favorable cost targets by 2022. Recent catalyst and process-development accomplishments are shown in the 2x–3x productivity increase in two of the pathways under investigation. By the end of FY 2019, this project will develop a new indirect liquefaction process

Weighted Project Score: 7.8

Weighting: For ongoing projects, there is equal weighting across all four evaluation criteria: Approach, Relevance, Accomplishments and Progress, and Future Work.

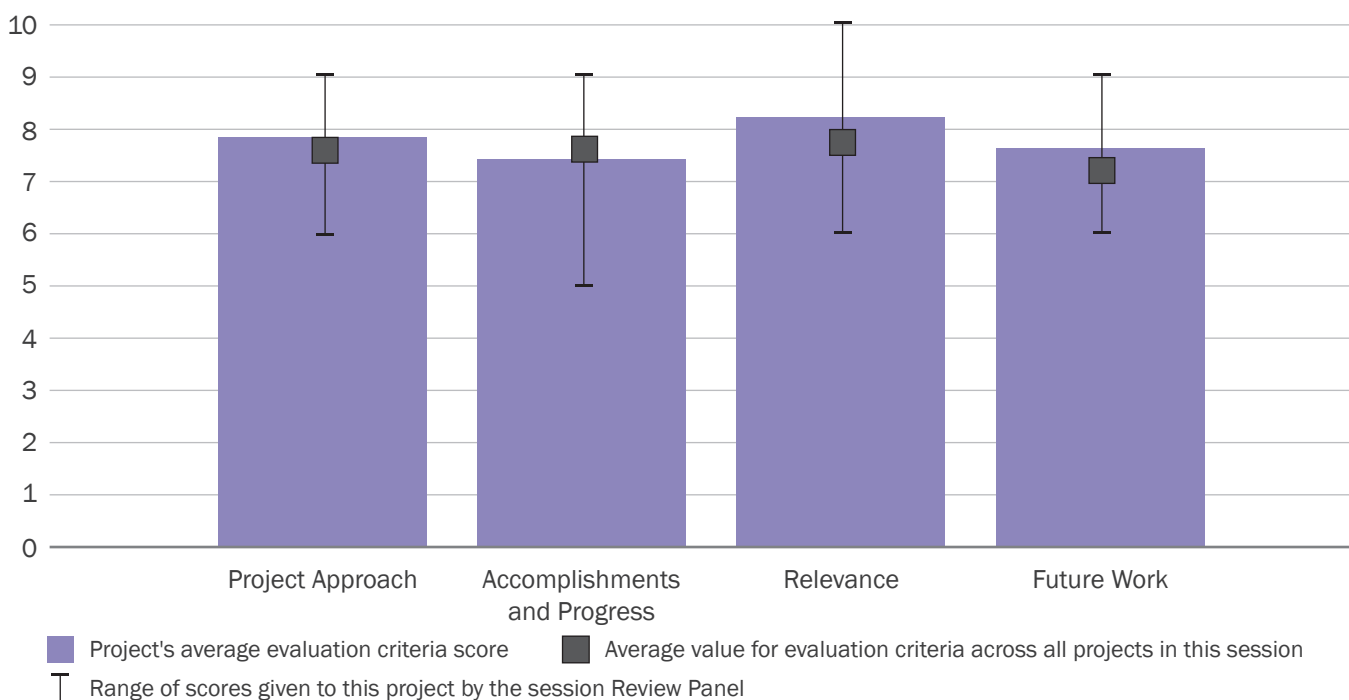

for distillate fuel production for verification in FY 2022. This new process will exceed the distillate fuel product yield of 27.4 gge/dry ton biomass of the benchmark Mobil olefin-to-gasoline/distillate process.

Overall Impressions

- Team results are impressive and commendable. The team has well-planned approaches and excellent organizational structure to maximize results, from modeling to catalyst development to improvements since last review. One question I may have not seen an answer to is carbon efficiency for the various processes. I did see gge cost clearly identified and highlighted for Task 1. Is this in progress for Task 2?
- The project promotes alternatives to the Fischer-Tropsch process for the conversion of syngas via light oxygenates. These alternative routes are currently too expensive to be competitive with other routes for the production of lower-quality fuels. However, the team has found target markets that take advantage of the high-octane and other properties of the feed that provide more venues.

It may be difficult to select between the alternative processes in the time available. Catalyst life, regenerability, and process complexity should be factors in the selection process.

The use of an Rh catalyst should be avoided; however, the team responded that they were already moving away from rhodium.

Direct conversion of bio-syngas to light olefins would be the most attractive route. The Ni-Co catalysts are being developed by a number of groups as the next wave of Fischer-Tropsch catalysts. Showing that this type of catalyst and process conditions can be adjusted to produce olefins from real biomass would be a major leap forward.

- This is an interesting project that will develop new

and maybe more economical ways to produce fuel from syngas rather than the current Fischer-Tropsch and methanol-to-gasoline technologies. It is important for the project team to stay focused and not get distracted by the multiple options for fuel flexibility and co-products. Co-products in a biorefinery may add value, but they also add complexity, as well as uncertainties for the future profitability of the biorefinery if the co-product value decreases.

- Overall, there are promising developments and a good perspective on how to address challenges. The program is working to reduce process intensity and is targeting higher-value fuels. To some extent, this is being done by using product octane content as a standard or measure, and this is a great idea. Fewer separations, less H₂ utilization, and close work with the fuel/engine teams is a recipe for success that will support commercial relevance.
- The technical approaches described in this project presentation were sound. The technical work performed in the prior budget period was described in detail, and the results were impressive, so I'm willing to grant some leeway. But, the FY 2017 project plan lacked detail that would have been helpful in project evaluation.

PI Response to Reviewer Comments

- We appreciate the reviewers' positive remarks about the project results, approach to target high-value fuels, organizational structure, and incorporation of enabling technologies and researchers with fuel property expertise.

We appreciate the reviewers' encouragement to stay focused and not get distracted in too many directions. This is reflected in our 2018 go/no-go milestone, where a single pathway will be selected for detailed development and verification in 2022, and we understand that the 2018 go/no-go is an ambitious goal. We appreciate the suggestion of addition-

al factors, such as catalyst life, regenerability, and process complexity to aid in the decision. We note that we have begun to address some of these issues with extended operation and regenerability demonstration for both the copper/zeolite beta polymorph (100 hours) and the Guerbet ethanol coupling catalyst (500 hours). Also, process complexity is certainly a major concern and is incorporated in the techno-economic analyses. We will certainly incorporate these factors in the selection processes. The reviewers' comments about co-product value and, importantly, fluctuations in value are well put and appreciated.

We agree that the use of an Rh catalyst may not enable cost-effective production of commodity chemicals. This is one reason why we have shifted away from the use of the Rh mixed oxygenate catalyst to other more promising pathways.

With sustained funding, we will continue to develop the direct pathway from syngas to light olefins over Ni-Co catalyst (Task 3), and we agree that success in this area represents a major leap forward for syngas conversion specifically. We do note that while this pathway offers tremendous potential, there are major challenges as well that need to be overcome, particularly with respect to carbon efficiency. Thus, we consider this a high-risk but high-reward pathway. We plan to continue to develop this route given adequate resources.

We did not highlight carbon efficiency for the processes during the presentation, but rather, focused on the technical accomplishments that feed into that

calculation and the resulting MFSP versus mature industry comparisons (e.g., Fischer-Tropsch, Mobil olefin-to-gasoline/distillate). For example, in Task 1, moving from the parent zeolite H-beta polymorph catalyst to the National Renewable Energy Laboratory's copper/zeolite beta polymorph catalyst results in an increase in C efficiency to C5+ product from 20.8% to 31.0%, which nearly reaches the maximum in this design case of 31.2%. For both Task 2 ethanol conversion pathways (i.e., butadiene and Guerbet), we project carbon efficiency to a final distillate to be >70% from ethanol. Note that this does not take into account carbon efficiency prior to the ethanol production. Due to time constraints, we were not able to highlight the overall processing pathways (which includes oligomerization of produced olefins, etc.). Also, techno-economics using recent data are being fed into models for determining overall performance and cost assessments. Overall, carbon efficiency is certainly one of the most important factors in assessing processing effectiveness.

We apologize that the future project plan was not presented in sufficient detail for one reviewer. To elaborate here, our FY 2017 plan is the initial year targeting distillate fuels. We will set the state-of-technology and initial techno-economic analysis models for the processes based on initial technical accomplishments. Also, we will complete our previous effort that focused on gasoline production through an integrated verification from biomass to hydrocarbon fuels, targeting 300 hours of continuous operation.

ELECTROCHEMICAL METHODS FOR UPGRADING PYROLYSIS OILS

(WBS#: 2.3.1.307-9)

Project Description

This project has sought to develop an electrochemical processing method to upgrade biomass materials and waste streams. Electrochemical upgrading of bio-oil is a potential substitute for hydrothermal stabilization processing where several upgrading functions are possible in a single step: partial hydrogenation without adding elemental hydrogen, total acid number reduction and separation, and recovery of carboxylic acids. Starting as a lab-directed seed project, work over 3 years has focused on achieving a process to economically stabilize bio-oil. A phased approach to development involved advancement in several tasks: processing with a single membrane cell, anion exchange membrane development, acid separation cell testing, theoretical modeling/experimental assessment, and techno-economic analy-

Recipient:	Idaho National Laboratory, Pacific Northwest National Laboratory, Argonne National Laboratory
Principal Investigator:	Tedd Lister
Project Dates:	10/1/2015–9/30/2016
Project Category:	Sun-setting
Project Type:	Annual Operating Plan
DOE Funding FY 2014:	\$815,000
DOE Funding FY 2015:	\$825,000
DOE Funding FY 2016:	\$935,000
DOE Funding FY 2017:	\$0

ses. In the last year, the team integrated knowledge from these tasks into developing a dual-membrane electrochemical cell, which possesses the ability to reduce bio-oil and separate bio-oil. While the goals of the project were not fully realized, the project has made significant strides in understanding the issues and technological challenges ahead for using electrochemistry to upgrade bio-oil. The project identified a promising path using the dual membrane system that significantly increased pH,

Weighted Project Score: 5.8

Weighting: Approach–25%; Relevance–25%; Accomplishments and Progress–50%.

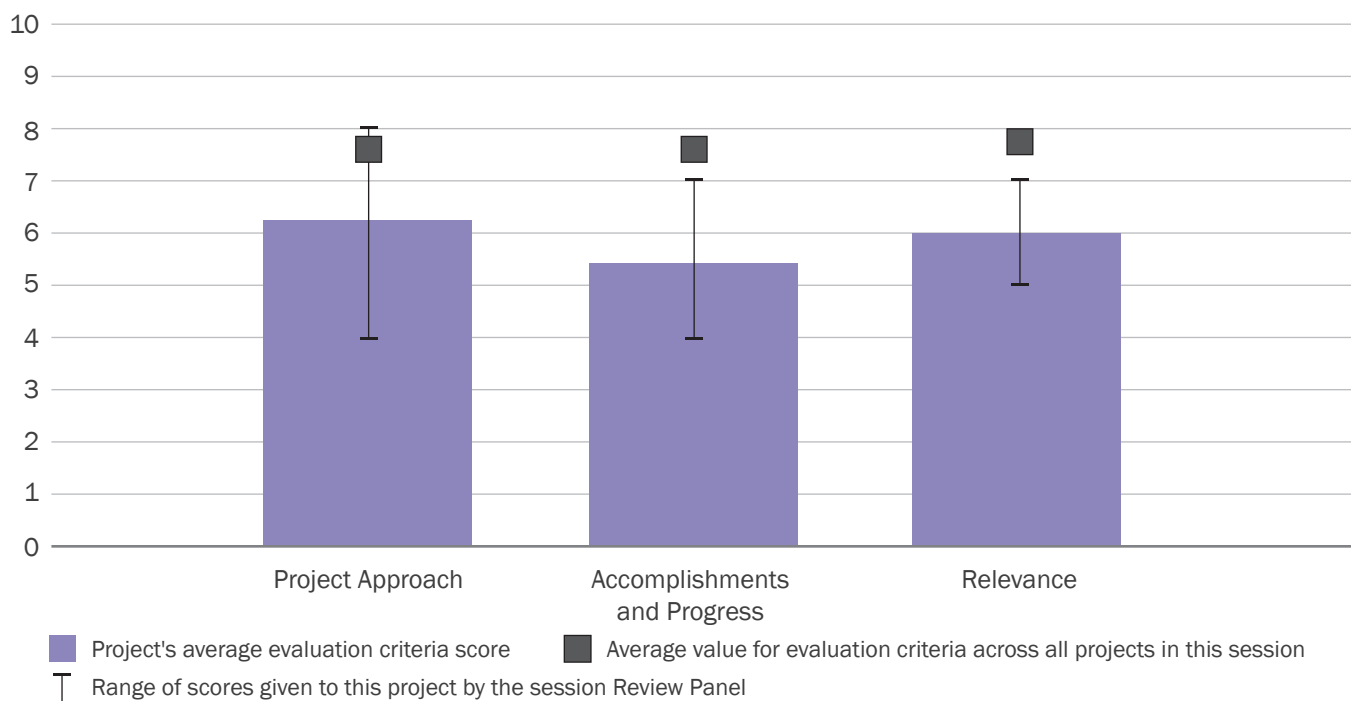

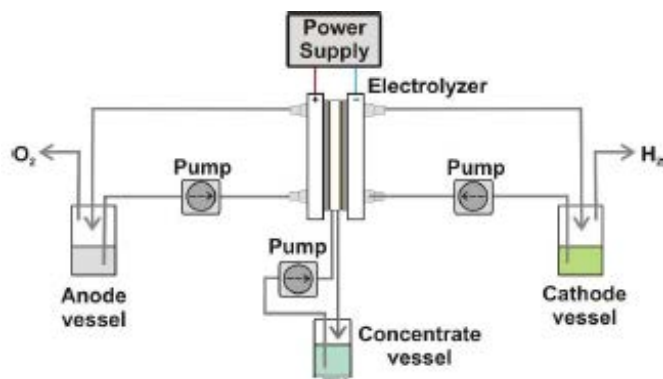

removed organic acids, and showed modest carbonyl reduction.

Overall Impressions

- This was a novel and interesting approach, but the hurdles and challenges were far too great to have the ability to provide a route for stabilization of fast pyrolysis oils. I am still happy that BETO is exploring some unique and novel approaches along with the standard ones. Keep looking to unique breakthrough approaches, even though this one was not successful.
- This was a good attempt to employ a new technology to biomass upgrading. I am unsure that storing renewable energy as hydrocarbons will ever be able to beat the rapidly developing battery technology. I believe that the separation applications have more promise as a method for water purification or pulling out highly polar species from the bio-oil phase. Distillation of biomass products is very difficult, and alternatives are needed.
- The project investigated an interesting alternative route for biofuel upgrading. Several challenges were

identified. The project has not resulted in an optimal solution.

- Overall, this is an interesting project. An important issue is that the standard of measure is H₂ hydrogenation, which will almost certainly never be a commercial reality at any significant scale. It is also widely accepted that water hydrolysis is a more expensive way to generate H₂ at scale than steam reforming. However, it is likely that this technology would have more utility as a form of low-pressure membrane concentration for other waste streams containing a high level of acid or ionic components.
- This was an interesting approach to pyrolysis oil stabilization and worth investigation. Technical results were promising. I still want to know whether or not the EC-treated oil showed enhanced stability and particularly improved lifetime in hydrodeoxygenation (or other upgrading approaches) to hydrocarbon fuels.

PI Response to Reviewer Comments

- A final thank you to the reviewers for your comments—I feel this was a very constructive experience. While battery technology is a viable option, fuels from biomass leverage significant combustion technology and infrastructure that batteries will struggle to match. Moving forward with all viable options is the best path. Clearly, we did not perform to the level we had hoped. However, we do feel that there are some very positive results coming from the work performed. Given that we were venturing into unknown terrain, there was always a risk to delivering a scale-up ready process.

RECOVERING AND UPGRADING BIOGENIC CARBON IN BIO-MASS-DERIVED AQUEOUS STREAMS

(WBS#: 2.3.1.310-1)

Project Description

Biomass direct liquefaction processes (e.g., hydrothermal liquefaction [HTL], catalytic fast pyrolysis, or fast pyrolysis) produce aqueous phases during bio-oil generation and/or subsequent hydrotreating. The objective of this project is to enhance the economic viability of converting biomass to fuel by converting “waste” aqueous-phase organic compounds to value-added chemicals or fuels while reducing wastewater treatment costs, which can be considerable, especially for phenolic rich streams. Pacific Northwest National Laboratory and the National Renewable Energy Laboratory are developing complementary thermocatalytic and separation processes,

Recipient:	Pacific Northwest National Laboratory, National Renewable Energy Laboratory
Principal Investigator:	Karl Albrecht
Project Dates:	10/1/2016–9/30/2019
Project Category:	Ongoing
Project Type:	Annual Operating Plan
DOE Funding FY 2014:	\$1,925,000
DOE Funding FY 2015:	\$1,900,000
DOE Funding FY 2016:	\$1,910,200
DOE Funding FY 2017:	\$1,750,000

es, each with advantages and disadvantages depending upon the types and concentrations of organics present.

Pacific Northwest National Laboratory developed a LaxZryOz catalyst with excellent stability in condensed water, with demonstrated stable ketonization activity for thousands of hours. A \$0.30/gge modeled decrease in MFSP for HTL was demonstrated by converting aqueous acids to olefins. Pacific Northwest National Labora-

Weighted Project Score: 7.3

Weighting: For ongoing projects, there is equal weighting across all four evaluation criteria: Approach, Relevance, Accomplishments and Progress, and Future Work.

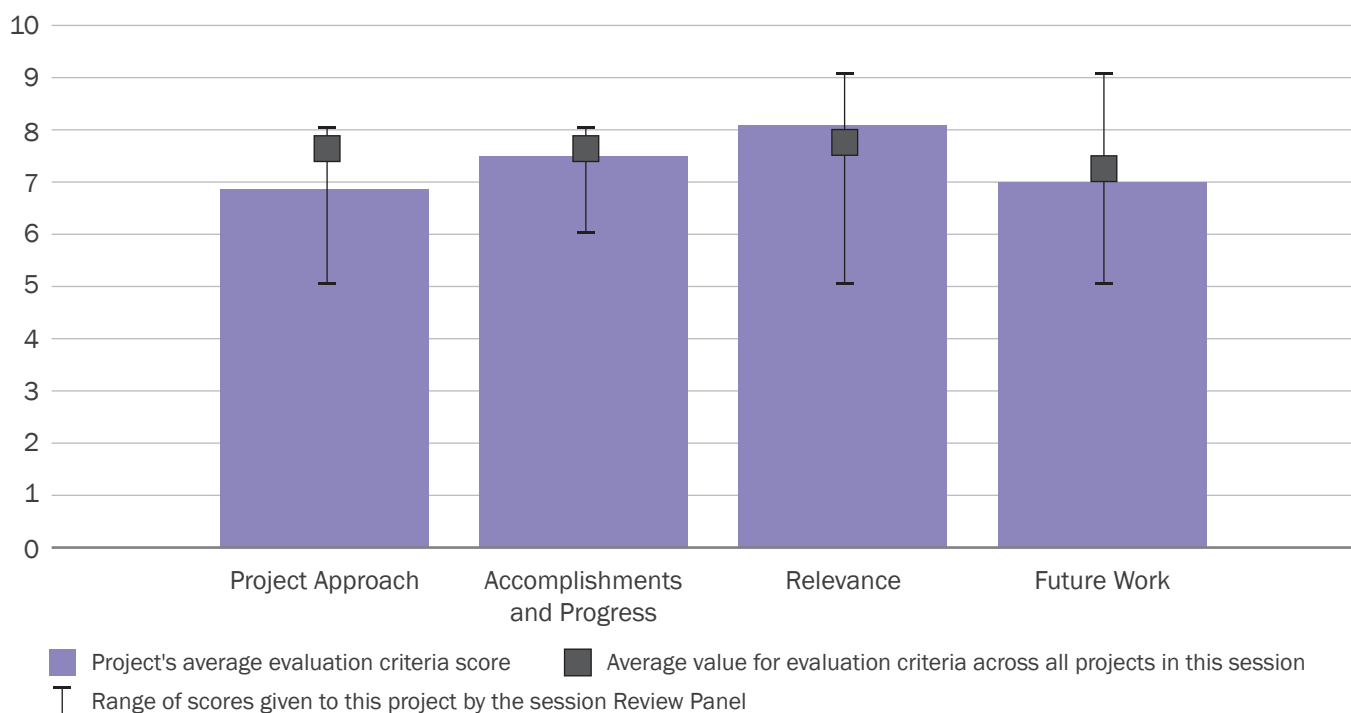

Goals for SOT experiments

- Assess **yield and selectivity** of conversion to **BTX**
- Compare **best** catalysts (HZSM-5 and Ga/HZSM-5)

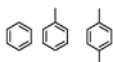

Aqueous phase from catalytic fast pyrolysis*

Carbon: 13.8 wt%
Hydrogen: 8.1 wt%
Water: 67 wt%

Composition of CFP Aqueous Phase*

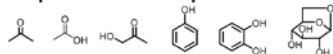

Contain some unreacted pyrolysis products

tory also developed a new dual-bed ketonization-steam reforming process that converts HTL-derived acid-rich feedstock to H_2 . An H_2 yield of 96% was demonstrated and with 4x less coke on the catalyst than when using steam methane reforming catalyst alone. Complimentary gas-phase technologies to produce fuels (aromatics) and chemicals (furans) with zeolitic and amorphous Si-Al are also under development at the National Renewable Energy Laboratory. A process for converting catalytic fast pyrolysis-derived aqueous product to aromatics was developed that is projected to decrease the MFSP by \$0.20/gge.

Overall Impressions

- The team has done a nice job of laying out the approaches, the key need, and organization. Work results, considering how long the team has been in place, are substantial. The approach via oxidation chemistry of aromatics will be extremely challenging on economics. It may make more sense to convert them to acetate esters for separation and isolation to make other materials, as a suggestion.
- Finding the best methods for recovering carbon from the aqueous product of biomass processing is critical to improving the process economics. Combining the efforts of all of the national laboratories should help accelerate this work and generate new ideas and synergies. The approaches need to be held to a rigorous economic standard to help focus on those most likely to succeed. The development of a comprehensive guide to wastewater treatment from biomass conversion process will be a major help to smaller commercial companies. There are examples

of companies stopped very late in the demonstration process by issues concerning water management.

- The project is an important and valuable part of the BETO portfolio. It is always great to convert “waste” into “valuable co-products.” It will be interesting to follow the developments.
- Overall, these are innovative ideas and some interesting potential developments. However, there are serious scale-up issues with the quest for complete carbon utilization, and many forest products and agro-industrial processes have faced a similar dilemma regarding how to address their wastewater. Many of these challenges are not new and have been studied and focused on for decades, often with the same results—local/onsite wastewater treatment plant or onsite anaerobic digestion. It is important to focus efforts on waste streams that have species or concentrations that can justify the expense of separation and purification. It is better to focus on opportunities where there are naturally occurring thermodynamic advantages, rather than increasing process intensity to valorize dilute waste streams.
- Upgrading of the biomass-derived aqueous phase is a promising approach that could be one technical piece for addressing biomass valorization. While I believe that there are valid approaches that include biomass fractionation, the number of unit operations (with attendant capital costs) will need to be carefully evaluated in detail for overall process economics.

PI Response to Reviewer Comments

- We appreciate the reviewers’ time and dedication to providing useful and implementable comments on our project. Moving forward, we plan to continue to use techno-economic analysis to determine what is economically feasible when converting these potentially lucrative streams into valuable co-products. We will also focus on sharing the results of our research and techno-economic analyses with stakeholders through peer-reviewed publications and presentations. Not all aqueous streams investigated are

candidates for our processes. For example, algal-derived and wastewater-sludge-derived HTL aqueous streams have very low levels of organics and are likely best sent back to the algae pond for nutrient recycle or anaerobic digestion to produce fuel gas. It is important to analyze and consider process streams on a case-by-case basis even as we develop processes that are applicable to a wide variety of chemical functional groups.

Certainly, the minimization of process steps and process intensification must be a focus whenever possible in all chemical process development. As this project inherently proposes to increase process steps in the pursuit of providing greater value, we must be continually cognizant of the trade-offs between higher yield, greater product purity, and sufficient decontamination of feedstocks. The processes we are developing are robust and capable of handling low levels of impurities, e.g., 10–100s of parts per millions of dissolved solids. We believe this project is also well-aligned with the role of the national laboratories to consider the development of higher-risk/higher-reward research that the forest products and agro-chemical industries may not see as immediately viable. These areas often require technological breakthroughs to demonstrate feasi-

bility. This project is working diligently to provide these types of breakthroughs. For example, hydrothermally stable catalysts are needed throughout the bioenergy space and indeed are interesting as catalysts outside bioenergy. As part of the ChemCatBio consortium, we will work to understand the needs and challenges of these industries through our external advisory board. Along the way, we will continue to be open to new suggestions and ideas for these streams. As an example, suggestions provided by the reviewers for the formation of phenyl acetate and using the HTL aqueous stream as a pretreatment stream will be considered.

Finally, we appreciate the comments regarding the need for a guiding document focused on wastewater valorization and disposal throughout the bioenergy community. This is again an area where our work has the potential to impact numerous stakeholders. In order to fill the wastewater disposal guidance gap, we will begin to compile literature and reviews that discuss wastewater disposal as a first step towards the aqueous-phase options task. Publishing a review paper as a lead-in to our anticipated valorization and disposal guiding document is a worthy first step in the pursuit of rapid information dissemination.

CATALYTIC FAST PYROLYSIS (CFP)

(WBS#: 2.3.1.312, 14, 15)

Project Description

Fast pyrolysis of biomass is a promising route for converting lignocellulosic feedstocks into fungible biofuels; however, the resulting bio-oil must be upgraded prior to utilization as a fuel or blendstock. The focus of this project is to improve the fuel quality and stability of bio-oil through catalytic fast pyrolysis (CFP), in which catalytic upgrading is performed in the vapor phase prior to condensation. The major challenge for CFP is to achieve high carbon yields to the desired fuel-range molecules while operating under relatively harsh conditions that are conducive to catalyst deactivation via carbon deposition.

The overarching goal of this project is to develop a market-responsive biorefinery concept based on CFP, which

Recipient:	Pacific Northwest National Laboratory, National Renewable Energy Laboratory
Principal Investigator:	Huamin Wang
Project Dates:	10/1/2016–9/30/2019
Project Category:	Ongoing
Project Type:	Annual Operating Plan
DOE Funding FY 2014:	\$4,635,000
DOE Funding FY 2015:	\$4,090,000
DOE Funding FY 2016:	\$5,985,500
DOE Funding FY 2017:	\$5,230,329

is capable of producing both cost-competitive biofuels and high-value co-products with targeted yields and compositions. To advance the state of technology, this project will demonstrate by 2019 the production of fuel blendstocks (<1 weight percent oxygen) from optimized CFP processes coupled with hydrotreating that achieve an MFSP of less than \$4/gge, with greater than 25% of the fuel in the diesel range. Over the last 2 years, the

Weighted Project Score: 7.0

Weighting: For ongoing projects, there is equal weighting across all four evaluation criteria: Approach, Relevance, Accomplishments and Progress, and Future Work.

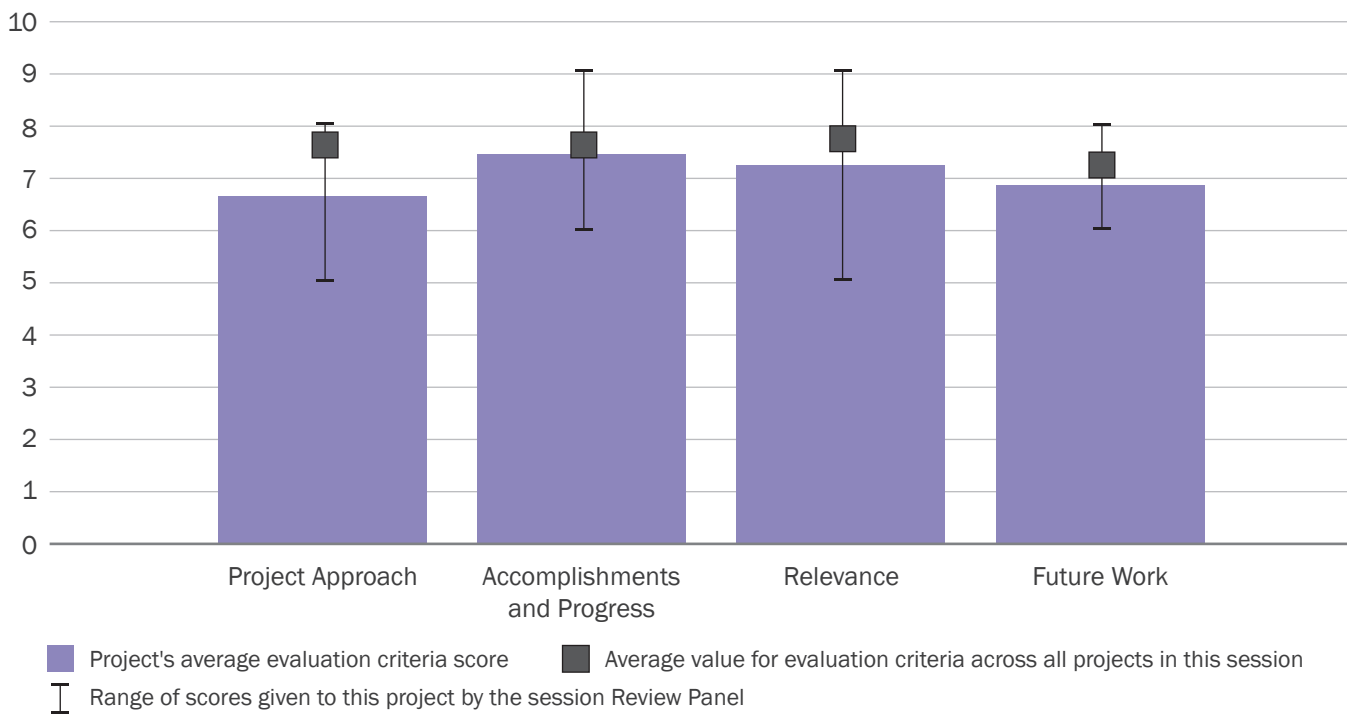

carbon efficiency for the process has been improved from 23% to 28%, resulting in a reduction in MFSP of over \$1.40/gge.

Overall Impressions

- The team has done a great job of assessing three complex approaches to date using solid modeling and solid thinking on what are key factors to address in all three process approaches. It is challenging to say if fast pyrolysis will meet future needs over other approaches, such as isolation of sugars and lignin approaches. However, I believe both need to continue to be developed towards the goals as it is too early to tell which will be the overall best final solution, and the answer most likely will be that multiple approaches are needed to achieve BETO goals in the long term.

I would like to see broader testing of off-the-shelf catalysts outside the Johnson Matthey catalysts and internal catalyst synthesis work. However, perhaps team has done this already? I do not see any specific flaws in team structure, approaches, or work definition and accomplishments to date, which are solid.

- Major improvements in carbon efficiency are needed to make catalytic pyrolysis a viable route. I support the process scheme changes, like evaluating the fixed-bed scheme. Radical changes are needed.

Targeting stabilization makes sense since it may allow integration with refinery processes. This may require the use of a specialized centralized hydroprocessing facility rather than integration into current unit operations. New process configurations like the fixed-bed reactor are very promising and should be emphasized. Reducing the costs of catalysts is vital. Extending the lifetime of the catalyst may be the most effective route to accomplish this. This may require feed pretreatment to reduce ash and/or finding a market for an equilibrium zeolite catalyst.

Input from the modeling group concerning the effect of reactor design, heat transfer, and feed particle

size and structure could have a significant impact on carbon efficiency.

Of course, substituting a less expensive material is also a good approach, but at high attrition almost any material will be expensive.

I believe the use of red mud is a significant lead. However, red mud itself presents problems with consistency since it is not deliberately produced. Looking at the effect of red mud composition or other natural ores would be an interesting approach.

Current catalyst costs are out of line with any current commercial fuel process. Catalyst costs should be significantly less than 5% of the selling price. Methods for reducing these costs should be investigated, including changes in feed.

Replacement of noble metals, particularly Ru, is necessary. There are no commercial commodity chemical processes using Ru because of its lack of natural abundance, despite its advantage as a catalyst for many reactions.

Attempting to process the lignin and cellulose portions of the biomass in the same thermochemical reactor has not accomplished the original goal of simplifying pretreatment and processing requirements. The cellulosic material decomposes into small molecules at temperatures well below those needed to break apart the lignin. The catalysts have not succeeded in adjusting the activities to balance the activities of two fractions.

- The project is well-managed and well-defined and has shown a steady development. The industrial partnership is important for future market acceptance of the technology by industry.
- Overall, this is a solid project with accomplishments that reflect the hard work and determination of the team. Given the thermodynamic challenges being faced head on by this project, the progress is impressive. However, the narrow focus on hydro-

treating is concerning, even if the source of the hydrogen comes from light gases produced *in situ*. More focus on staged pyrolysis to drive off light O₂ rich gases would be more economic, and more focus on catalytic conversion of biomass fractions (crude fiber and cellulosic ethanol lignin) would lead to narrower product distributions. Additionally, *ex-situ* fixed-bed CFP is a logical solution to addressing the challenges of fast pyrolysis on whole biomass, but it is not a logical solution for leveraging what has been learned about catalytic pyrolyzers. Rather than re-tool the pyrolyzer, these learnings should be focused on more-refined biomass feedstocks that enable the catalytic pyrolyzers to generate products of interest.

- This project is a continuation of approaches that have been attempted for many years. While the technical work done so far is interesting, I do not envision the future work plan as described overcoming the remaining technical and commercial challenges.

PI Response to Reviewer Comments

- We thank the reviewers for their support of our accomplishments, team, and management. We acknowledge that CFP is a complex and challenging process, but it has many distinct advantages. CFP allows for utilization of the entire plant matter and produces a narrower product slate as compared to fast pyrolysis. We greatly appreciate the reviewers' constructive feedback and guidance on how to best advance the state of technology towards commercialization, especially in regard to innovative process configurations, alternative downstream processing, evaluation of off-the-shell catalysts, reductions in catalyst cost, integration with modeling, and utilization of refined or fractionated feedstocks. The reviewers also raised a number of valid concerns, and we have addressed specific comments below.

Feedstock properties definitely affect CFP performance. These effects are currently being evaluated

in the Thermochemical Feedstock Interface project, a joint effort between the National Renewable Energy Laboratory, Pacific Northwest National Laboratory, and Idaho National Laboratory, and will be further evaluated in the future as part of the Feedstock-Conversion Interface Consortium. We have evaluated various biomass fractions for CFP in small-scale experiments (pyrolysis-gas chromatography/pyrolysis-molecular-beam mass spectrometry) to target specific product distributions and will evaluate CFP of these fractions at a larger scale in 2018 using the pyrolyzer–Davison Circulating Riser system. We plan to use these experiments to guide feedstock selection (and feedstock engineering).

We agree that the high catalyst replacement rate for in-situ CFP is a major challenge for that approach. The red mud catalyst under development within this project was identified because of its low cost, resistance to deactivation, regenerability, and comparable catalytic performance to HZSM-5. However, we agree that the red mud composition and properties will not be consistent as it is not deliberately produced as a catalytic material. To address this concern, our research is and will continue to focus on determining the composition-performance relationship of red mud and on assessing red mud variability based on the source. Using this information, we can evaluate the commercial feasibility of using red mud as a catalyst for in-situ CFP and can identify strategies to produce similar low-cost materials, but with consistent properties.

We agree with the reviewers that processing lignin and cellulose together through CFP is challenging; however, we believe that significant improvements can still be made in this area through design of bi(multi)-functional catalysts and implementation of new process configurations (e.g., catalytic hot gas filtration or dual fixed-bed systems) that enable strategic upgrading based on targeted reaction chemistry.

A HYBRID CATALYTIC ROUTE TO FUELS FROM BIOMASS SYNGAS

(WBS#: 2.3.1.403)

Project Description

LanzaTech, with partners Pacific Northwest National Laboratory, Imperium Aviation Fuels, InEnTec, Orochem Technologies, University of Delaware, Michigan Technological University, National Renewable Energy Laboratory, and the Boeing Company, developed a cost-effective hybrid conversion technology to catalytically upgrade biomass-derived syngas to jet fuel that meets the price, quality, and environmental needs of the aviation industry. The process makes a type of “alcohol-to-jet” (ATJ) synthetic paraffinic kerosene from ethanol. Objectives also included co-product chemicals (e.g. 2,3-butanediol, a precursor to key chemical intermediates). The project successfully demonstrated the viability of a future model with distributed ATJ production fed by multiple ethanol sources and showed the value of co-product chemicals to

Recipient:	LanzaTech Inc.
Principal Investigator:	Mike Schultz
Project Dates:	10/1/2011–6/30/2016
Project Category:	Sun-setting
Project Type:	FY 2011–TC Upgrading: DE-FOA-0000467
Total DOE Funding:	\$1,480,763

reduce ATJ costs, accelerating commercial production of alternative jet fuel from biomass. The project also generated key data for the review process required to add ethanol to D7566 Annex 5, the ASTM (previously an abbreviation for American Society for Testing and Materials) standard for alternative jet fuels. Challenges identified in the project included the following: (1) high capital cost of gasification, addressed by additional integration in future commercial designs, including full utility integration; (2) ATJ catalyst development, addressed through extensive studies, leading to a new oligomerization catalyst that was successfully scaled up and demonstrated; and (3) high cost of co-product separation, addressed by design of a novel separations scheme.

Weighted Project Score: 8.4

Weighting: Approach–25%; Relevance–25%; Accomplishments and Progress–50%.

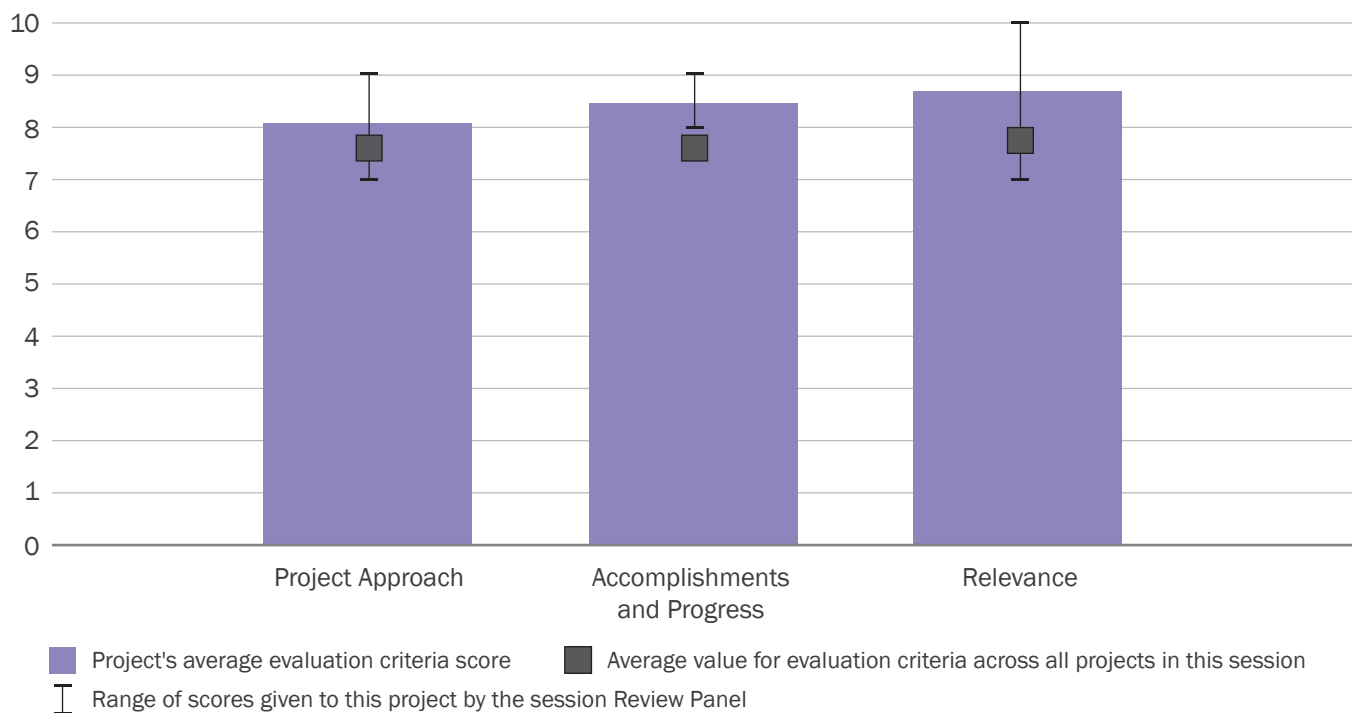



Overall Impressions

- This is an outstanding team work result for pilot scale, meeting BETO objectives and goals. The team did an excellent job managing complex relationships and program integrations to be able to output real fuel for trials. This is one of the top programs I have assessed. My only concern was the lack of mention of potential value of the isolated olefin oligomers. These could further drop the cost from \$3/gge since these go into the detergent market.
- The project successfully demonstrated the production of jet fuel from biomass syngas at a scale sufficient to product material for jet fuel certification. The final products were successfully tested and certified. Previous reviewers' concerns with the difficulty of integrating the chemical and bioprocess proved to be valid. Gasification of biomass is still a technology that needs further development work. Now would be a good time for an independent review of the techno-economics of the process to establish a solid cost of production. Future work should closely track operations, including run times and any operational issues that will lead to lower plant throughput.
- This is an interesting integration of biomass gasification and syngas fermentation for the production of jet fuel. Overall cost-competitiveness is a challenge and will rely on co-production of valuable chemicals.
- Overall, this is a very innovative project that successfully integrated a complete gasification system and a product upgrading system. It is compelling

that this conversion pathway does not require a complex $H_2:CO$ ratio, high pressures, ultra-clean syngas, or high temperatures. However, the fermentation broth is complex, and the economics are reliant on multiple revenue streams coming from both fuels and chemicals. While this project team successfully addressed the gas-cleanup challenges faced by INEOS Bio at the Vero Beach facility, the necessity to generate multiple product streams means there is important work to be done regarding separations and process optimization. That said, a commercial-scale success with this technology would be extremely meaningful.

- This was a very well-designed and well-executed project. The project team clearly understands what needs to be done to successfully commercialize the technology. There are no apparent technical show-stoppers, so commercial viability seems to depend on overall economics. Good luck!

PI Response to Reviewer Comments:

- Thank you for the positive comments. We address three related comments posed by the reviewers.

In response to the paraphrased reviewer comment of “the requirement for integrated gasifier may make it difficult to achieve goals in timely fashion,” in parallel with the project, LanzaTech operated a pilot-scale fermentation unit on MSW syngas for over two years, providing technical confidence in integrated operation on syngas. The project was reformulated to demonstrate integrated operation of LanzaTech’s Gas Testing Station with the InEnTec gasifier for a minimum of one week on each of three biomass feedstocks. Ethanol samples were produced in laboratory fermenters using bottled syngas from each biomass feedstock and used to validate conversion to jet blendstock.

In response to the paraphrased reviewer comment of “this approach is risky since it involves coupling biological and thermochemical systems,” the project

demonstrates that gasification is an effective means of deconstructing different types of biomass into a consistent intermediate for biochemical upgrading to ethanol. The project demonstrated that ethanol as an intermediate isolates the catalytic upgrading from biomass feedstock variability. The ethanol to jet process was successfully demonstrated on ethanol from multiple sources with no impact on performance.

In response to the paraphrased reviewer question of “how this process compares to cost for Fischer-Tropsch (F-T), when the process still requires syngas production and cleanup but adds costly separation steps. It must be driven by the cost of chemical co-products,” gasification is required to produce syngas from biomass for both F-T and gas fermentation processes. Gas fermentation is very flexible because biologic processes can accommodate a wide range of syngas compositions (e.g., $H_2:CO$ ratios). This reduces gasification costs by eliminating the water-gas shift process step needed to control syngas composition for F-T processes. Gas fermentation requires less stringent syngas cleanup, representing a cost

savings. Gas fermentation inhibitors are reversible and once a contaminant is removed, its impact on a microbial gas fermentation system is eliminated. In contrast, even a short contaminant breakthrough can poison millions of dollars of costly F-T catalyst and result in extended downtime.

Biomass F-T project cost estimates often only cover the gasification to F-T crude portion excluding the substantial capital expenditures for conversion of F-T crude to actual fuel products. The steps necessary to process F-T crude, such as hydrocracking, hydroisomerization, and several fractionation columns, are often integrated with refinery operations elsewhere. Note that ethanol to jet conversion is the smallest contributor to capital expenditures in the biomass-based ethanol-to-jet process. While additional separations are required for a chemical co-product such as butanediol, separation costs are more than outweighed by additional product revenues. As shown in techno-economic analyses, inclusion of a chemical co-product enables the cash cost of production for the ATJ product to be competitive with conventional jet fuel.

CATALYTIC UPGRADING OF THERMOCHEMICAL INTERMEDIATES TO HYDROCARBONS: CONVERSION OF LIGNOCELLULOSIC FEEDSTOCKS

(WBS#: 2.3.1.406)

Project Description

The goal of the project is to couple Virent Energy Systems' (Virent's) biomass liquefaction process (solvolysis) with the BioForming® process to convert bagasse, corn stover, and loblolly pine into aromatic-rich fuels and chemicals. The unique ability to effectively solubilize hemicellulose, cellulose, and lignin components of biomass into convertible intermediates sets this process apart from other approaches. Solvolysis involves solvent-assisted liquefaction of biomass coupled with stabilization of the reactive species through the use of catalysts. After stabilization, the intermediates can be

Recipient:	Virent Energy Systems Inc.
Principal Investigator:	Randy Cortright
Project Dates:	10/3/2011–10/2/2015
Project Category:	Sun-setting
Project Type:	FY 2011–TC Upgrading: DE-FOA-0000467
Total DOE Funding:	\$4,000,000

fed into a condensation reactor, producing a stream of aromatic-rich hydrocarbons for use as fuels and high-value chemicals.

Since the project's inception in Quarter 4 of 2011, the team has reached several project milestones, including biomass liquefaction in excess of 95% and soluble oxygenate yields exceeding 80%. The team improved the stability and lifetime of the stabilization catalyst and built, commissioned, and operated a larger-scale, fully continuous deconstruction system. In order to optimize the fully integrated system, a 2,000-hour demonstration

Weighted Project Score: 8.7

Weighting: Approach–25%; Relevance–25%; Accomplishments and Progress–50%.

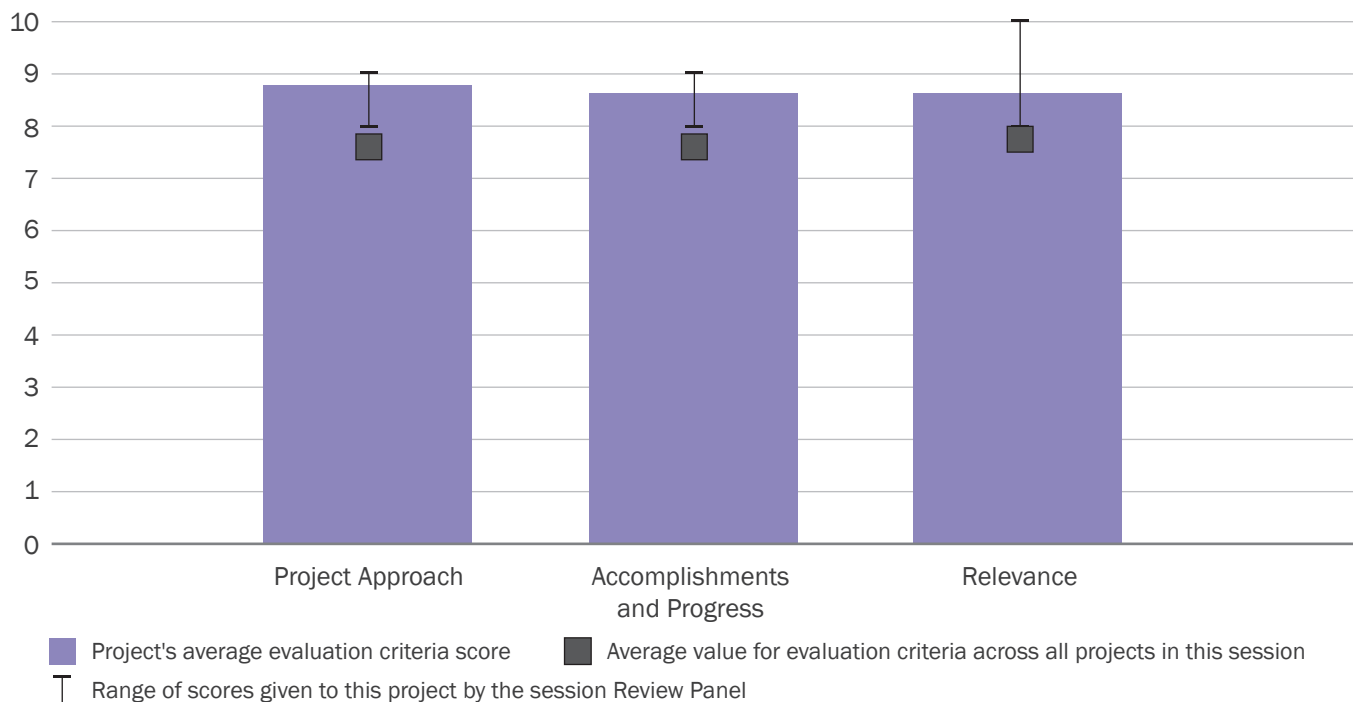

run of the fully integrated system was completed inclusive of process simulation and cost models updated. The project was completed in October 2015, and results will be discussed during the review.

Overall Impressions

- I was surprised that the true values are not on the chart for economics, only showing relative information in slide 18. Is the cost info proprietary to Virent? This is my only question and concern. As always, I think Virent does a great job of putting together programs and being clear about results. Other teams now can benefit from the results since solvents are in several other programs in BETO, as well as conversion technologies of intermediates that are the same in this operation.
- This was a very strong program, showing good integration between the partners at Virent and Iowa State. The solvolysis deconstruction has great promise. As with all pretreatment technologies, the costs versus benefits need to be carefully evaluated. It is becoming clear that thermal treatment of cellulosic and lignin material at the same conditions is problematic and causes low carbon recovery or the production of a very low-quality product. The products from solvolysis have proved to be more easily upgraded by the Virent reforming technology to value-added products.

- This is a well-managed project for conversion of biomass into aromatic products. The technology appears competitive and with the potential for even further improvements.
- Overall, this is a very innovative project with a fascinating approach for solvent liquefaction related to *in-situ* solvent generation and recovery. Solvent chemistry allowed the project to operate at reasonable conditions and solubilize 90% of the biomass, which is very impressive. The 2016 *Billion-Ton Report* makes it clear that grass feedstocks will be considerably more important than wood feedstocks in the future bioeconomy. Project work with corn stover and bagasse increases the relevance of these results to future challenges and proves that the process has an appropriate level of flexibility. However, increasing catalyst life will be fundamentally important for commercial success, and moving to a cheaper, more sacrificial catalyst may be necessary.
- This is a good application of DOE money to support commercial-adjacent technology. The project seems to have a chance at commercial viability.

PI Response to Reviewer Comments

No official response was provided at the time of report publication.

CATALYTIC CONVERSION OF CELLULOSIC OR ALGAL BIOMASS PLUS METHANE TO DROP-IN HYDROCARBON FUELS AND CHEMICALS

(WBS#: 2.3.1.411)

Project Description

The objective of this project is to catalytically convert biomass plus methane to drop-in hydrocarbon liquid fuels and chemicals. The goal of the project is to increase C4+hydrocarbon yields from biomass, while decreasing hydrogen consumption and capital cost. In this project, bench-scale experiments have been completed using the Gas Technology Institute's mini bench unit (1) to catalytically convert model compounds and also (2) to catalytically convert biomass plus methane to drop-in hydrocarbon liquid fuels and chemicals, using methane or methane plus hydrogen fluidizing gas mixtures in catalytic methane/hydrolysis. The hydrogen transfer

Recipient:	Gas Technology Institute
Principal Investigator:	Terry Marker
Project Dates:	2/9/2015–5/31/2017
Project Category:	Sun-setting
Project Type:	FY 2013—Incubator: DE-FOA-0000974
Total DOE Funding:	\$1,485,415

catalyst provided by W.R. Grace has been used to activate the methane so that it reacts with the olefins, free radicals, and oxygenates produced from biomass devolatilization. The project participants are the Gas Technology Institute, W.R. Grace, Algae Energy, the National Renewable Energy Laboratory, and Michigan Technological University.

Overall Impressions

- I take issue with the project basis on one point— literature as foundation for funding. The team, however, did nice job of getting positive results by further exploring possibilities and shifting approach and experiments, once poor results were shown in the laboratory for the initial studies of Ga-ZSM-5.

Weighted Project Score: 8.3

Weighting: Approach–25%; Relevance–25%; Accomplishments and Progress–50%.

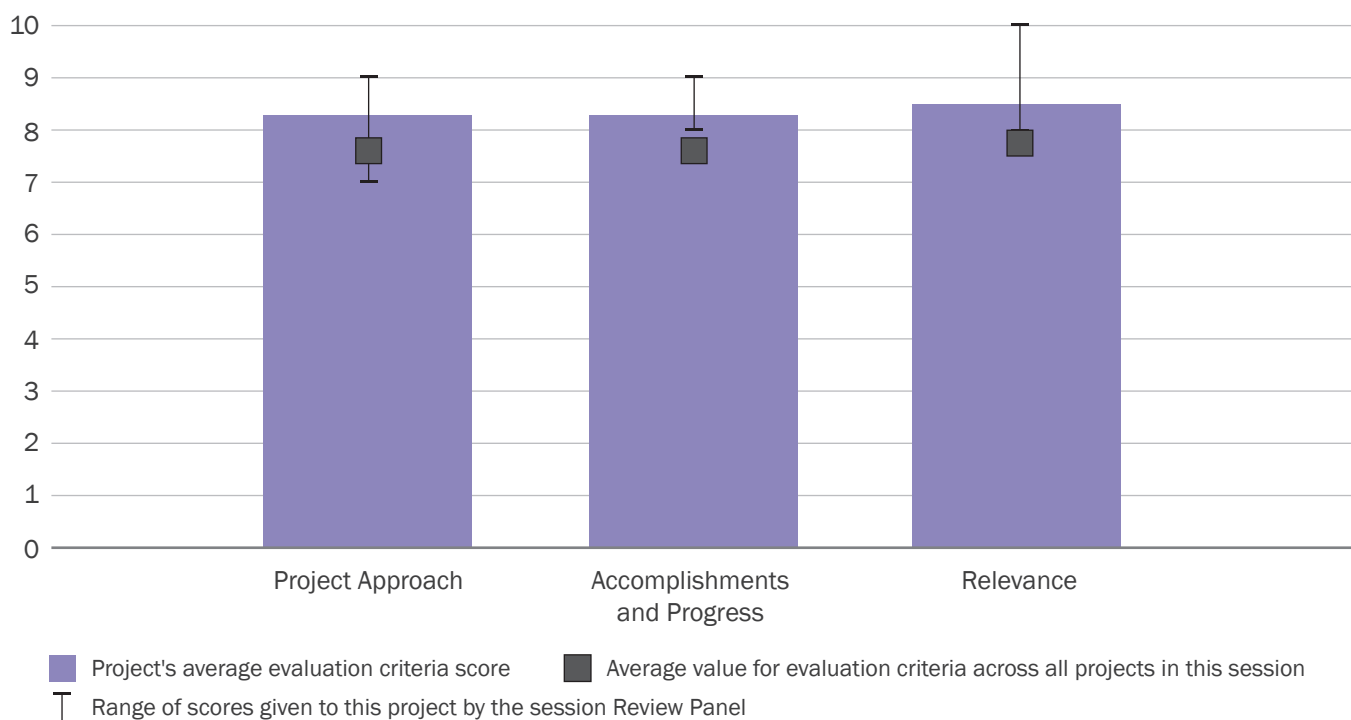

I am also glad to see the use of realistic feeds in the testing. I am not sure that the benefit of going to higher diesel is worth the loss in yield, which is substantially more important.

The higher-temperature improved yield of 16% is unexpected and nice to see. A key question for the team is do they believe optimum reaction temperature is now 482°C? Did they identify the increased temperature sweet spot? An 82°C difference in temperature is huge in thermodynamic terms. Did the team do laboratory experiments on the bench unit at 410–500°C in 10-degree increments and only show the best data in slide 16 at 482°C, which is optimum? Good science dictates temperature ramps in ranges of a maximum of 20°C, and preferred 10°C, to make sure the temperature result is as robust as possible.

Finally, is the intent to use methane really adding substantial value to project? Techno-economic analysis will define. I also am surprised that, once they identified improvement with methane, they did not pursue experiment with natural gas to see if this brought further improvement, since ethane and propane give more hydrogen transfer than methane and natural gas (sulfur removed of course) would give better result than methane accordingly. I am not sure, however, that the economics improves in terms of raw material cost, due to resale value of the separated ethane and propane versus remaining pure methane.

- The Integrated Hydrolysis and Hydroconversion process has the highest carbon retention in fuel of any thermochemical approach to biomass con-

version. The technology is very far along. A critical review of this technology is needed to determine the barriers to its cost. Is it concerned about high-pressure hydrogen use, feed preparation, overall complexity? What is DOE's role in supporting the technology? This project is an extension of prior work that was DOE-funded.

- This is interesting work that will improve the Integrated Hydrolysis and Hydroconversion technology. It would be interesting to confirm if methane could be replaced by natural gas, as such co-feed of natural gas and biomass may be an attractive way to accelerate the use of biomass due to the relatively low price of natural gas.
- Overall, this is a great project with a talented team. Even though methane contribution was minimal, showing any effect at all was significant. Methane is the hardest hydrocarbon target that the team could chose to be catalytically activated for these reactions. Using C2-C4 hydrocarbons should noticeably improve the thermodynamics and still have a positive effect over traditional H₂ hydrogenation approaches. Additionally, economics could be improved further if natural gas liquids or natural gas were utilized instead of methane because a process like this would not suffer from the utilization of a cheaper, mixed hydrocarbon feed. This is a strong step forward in an innovative direction.

PI Response to Reviewer Comments

No official response was provided at the time of report publication.

INTEGRATION AND SCALE-UP + THERMOCHEMICAL (TC) CAPITAL EQUIPMENT

(WBS#: 2.4.1.301)

Project Description

This project uses the Thermochemical Process Development Unit (TCPDU), a more than 0.5 ton/day pilot plant, to verify thermochemical biomass conversion catalysts, processes, and other technologies developed at the lab scale. The project team develops engineering solutions necessary for scale-up, thereby enabling commercialization and reducing cost and risk to industry. The TCPDU can be configured for fast pyrolysis, *ex-situ* catalytic fast pyrolysis, and indirect liquefaction pathways. It has been a BETO asset for over 20 years, contributing to achieving BETO goals and being used by industry. This project also provides samples and

Recipient:	National Renewable Energy Laboratory
Principal Investigator:	Esther Wilcox
Project Dates:	10/1/2014–9/30/2017
Project Category:	Ongoing
Project Type:	Annual Operating Plan
DOE Funding FY 2014:	\$3,000,000
DOE Funding FY 2015:	\$2,100,000
DOE Funding FY 2016:	\$2,500,000
DOE Funding FY 2017:	\$2,500,000

pilot-scale data to support numerous other research efforts.

The primary challenge is designing systems prior to completion of lab-scale research in order to have operational pilot-scale systems for technology verifications. The team overcomes this challenge by communicating with the researchers to understand the potential needs, designing in flexibility, and providing design limits to guide the research. Recently, we designed, fabricated,

Weighted Project Score: 8.0

Weighting: For ongoing projects, there is equal weighting across all four evaluation criteria: Approach, Relevance, Accomplishments and Progress, and Future Work.

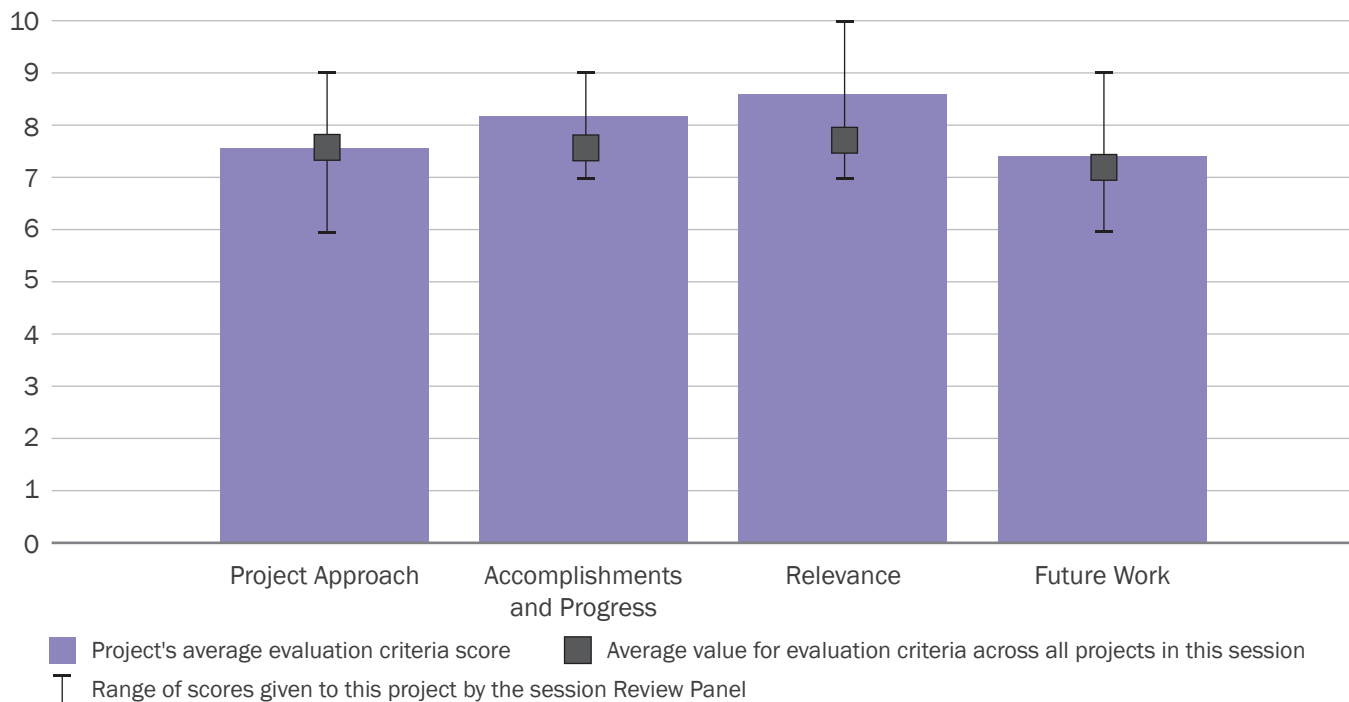

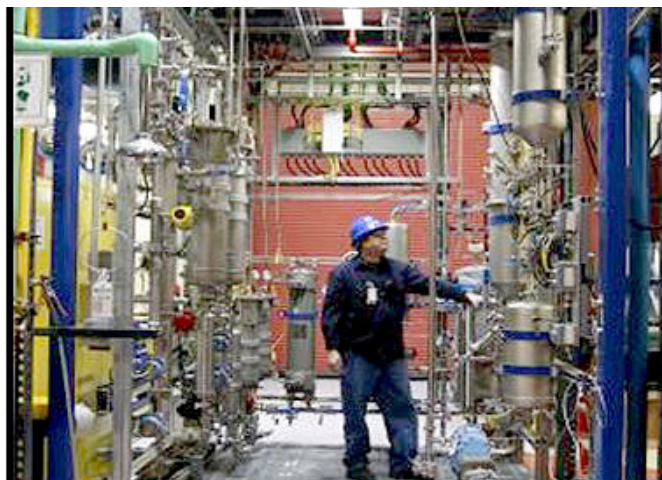

and installed two new unit operations in the TCPDU. This added *ex-situ* catalytic fast pyrolysis capabilities, which will be used for BETO's FY 2022 verification. In FY 2017, the TCPDU produced more than 200 gallons of fast pyrolysis oil from an industrially relevant blended feedstock to enable achievement of BETO's Government Performance and Results Act goal. The oil met performance targets and is being hydrotreated at Pacific Northwest National Laboratory (PNNL) to complete a pilot-scale fast pyrolysis pathway verification.

Overall Impressions

- The team has done great job to solve issues on pilot-scale designs, provide pyrolysis oil for upgrading teams, and keep work on track to meet the needs of the various teams. I see no issue with results to date.
- Creating a separate project for design, construction, and maintenance of the national laboratories' pilot plants is a good idea and allows for coordination and standardization. The approach of the team and project management looks good. Economic and timing constraints have placed constraints on the experimental design. For example, the need to adapt a gasifier feed system and entrained flow reactor in the pyrolysis scale-up may limit yields due to heat transfer and residency time effects.

- The need to split the pyrolysis conversion and upgrading adds some uncertainty to the integration work. It would be much better to have the two tests collocated. My experience is that hydroprocessing aged feeds is different than hydroprocessing fresh feeds.
- This is an excellent project that provides important support for accelerated commercialization of bioenergy technologies and catalysts. Having a common, flexible pilot plant facility with an experienced crew will make pilot demonstrations more economical and reliable.
- Overall, this is solid work. It is very difficult to build, commission, troubleshoot, and operate a fully integrated system, and the hard work and successes of this team are clearly reflected in the hours on stream and the reliability of the system. Several innovative approaches appear to have been developed to get this system online and running under steady-state conditions, which is impressive. However, now that a platform system exists, additional unit operations should be added to improve the capabilities of the process and to give it unit operations more in line with current commercial trends. This is not something the project could have planned for, but it is something that should be addressed in the future.
- I am very much in favor of continuing this effort. A dedicated pilot plant support effort, focused on technology integration and scale-up, will provide value for the long term, regardless of the specific technologies investigated in the future.

PI Response to Reviewer Comments

- We have taken into consideration the concern regarding fluid bed versus entrained flow reactors. Based on experimental results, the TCPDU entrained flow reactor performs comparably to the bench-scale fluid bed systems. There is currently

an ongoing effort with the Consortium for Computational Physics and Chemistry to model both the entrained flow reactor and fluid bed systems. The entrained flow reactor does provide some advantages, from a research perspective, that fluid beds cannot, such as independently changing the residence time. Since the TCPDU is intended to be a flexible research pilot plant, we can design and install a fluid bed pyrolyzer if it is deemed critical to industry and the capital funds are provided for the effort.

We agree with the reviewers' concerns regarding co-location of hydroprocessing. The National Renewable Energy Laboratory houses the pyrolysis pilot plant, and PNNL possesses the demonstration-scale hydrotreating capabilities. Given the ex-

pertise and equipment available at both laboratories and the needs of the verification, we determined to separate the processes. The efforts at PNNL leading up to the verification included hydrotreating aged pyrolysis oils, thereby minimizing the risk associated with not co-locating the processes. All oils were maintained in cold rooms and were cold-shipped to PNNL to minimize aging.

We will initiate a directed effort in FY 2018 based on the Energy I-Corps (previously LabCorp) approach, which will entail reaching out to industry, gaining an understanding of the challenges they face, and then aligning our R&D activities to meet industry needs.

CATALYTIC UPGRADING OF THERMOCHEMICAL INTERMEDIATES TO HYDROCARBONS – RESEARCH TRIANGLE INSTITUTE

(WBS#: 2.4.1.403)

Project Description

This project demonstrates a technology that integrates catalytic biomass pyrolysis with hydroprocessing to produce advanced hydrocarbon biofuels. RTI International is developing a novel single-step catalytic biomass pyrolysis process to produce a hydrocarbon-rich biocrude intermediate. Haldor Topsøe has developed a strategy for upgrading biocrude intermediates based on extensive hydroprocessing catalyst and process development expertise. The technical goals are to optimize the catalytic biomass pyrolysis process to produce a

Recipient:	RTI International
Principal Investigator:	David Dayton
Project Dates:	10/1/2011–9/30/2016
Project Category:	Sun-setting
Project Type:	FY 2011–TC Upgrading: DE-FOA-0000467
Total DOE Funding:	\$4,349,928

low-oxygen-content, thermally stable biocrude intermediate and evaluate the impact of biocrude quality on the hydroprocessing step. The desired outcome for the integrated process is to minimize hydrogen demand while maximizing biofuels yield. We scaled up the catalytic biomass pyrolysis process to a 1 ton/day pilot unit, and a commercially scalable hydroprocessing unit has been designed, built, commissioned, and operated. The project team has produced more than 200 gallons of biocrude and achieved more than 2,000 cumulative hours of upgrading.

Weighted Project Score: 7.2

Weighting: Approach–25%; Relevance–25%; Accomplishments and Progress–50%.

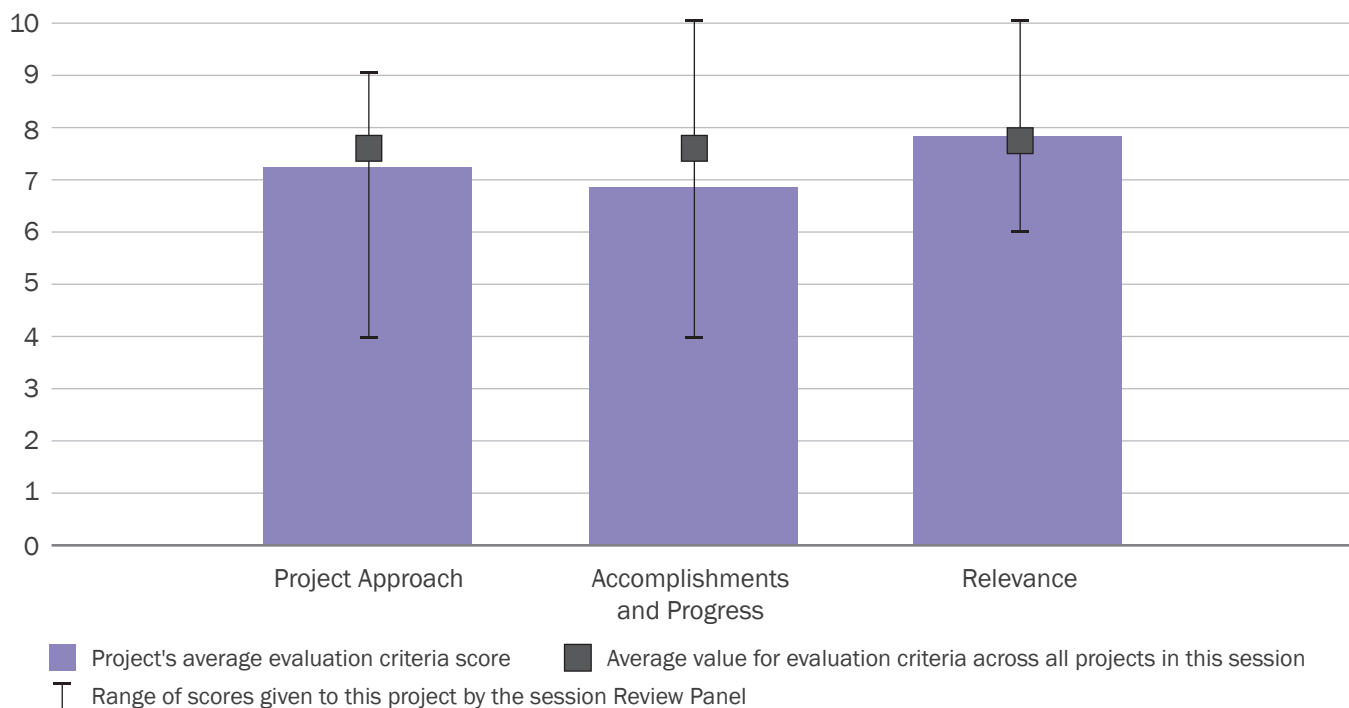



Overall Impressions

- These are well-orchestrated project scale-up and integration results on a challenging area of work for the pilot scale, i.e., bio-oil and upgrading. I have no concerns over the data or results generated. This was a well-presented project as well. The team did an outstanding job overall. My concern with the bio-oil catalyst upgrading is with future feedstocks and ash associated, which will be the biggest challenge for catalytic pyrolysis issues.
- The scale-up of the catalytic pyrolysis process is a major accomplishment, but the performance of the plant was questionable. Hopefully, the report will include details of the operation and equipment, explaining what happened. This would be a great learning tool for future projects in this area. It would be a shame for these details to be lost.

Greater care in planning is required to ensure that feed and catalyst are available in the quantities needed to run the plant. Additional partners should have been found or additional funds requested for these purposes.

- This is a great project with good results.
- Overall, this is a solid project that showed that it is technically feasible to consistently generate 20% O₂ pyrolysis liquids and that these liquids can be effectively hydrotreated into low-oxygen fuel blendstocks. However, technical success often does not lead to commercial or strategic success, and in this case, the process intensity in combination

with the realistically low commercial value of the product means that new approaches for constructively utilizing these processes and equipment must be explored. Focusing on the conversion of whole, unmodified biomass makes the probability of generating a valuable end product very low. Like produced crude oil, separations can and should begin before the high-temperature processes happen. Furthermore, from a process objective perspective, pyrolysis conversions have more in common with a fractional distillation tower than they do with a fluid catalytic cracking unit. Biomass can be broken into fiber, lignin, and extractive fractions fairly easily, and pyrolysis of these individual fractions will absolutely generate a narrower product distribution that should be easier to upgrade/separate efficiently. The project should take its highly impressive pyrolysis reactor testing setup and apply it to biomass fractions that are commercially available, like crude fiber and cellulosic ethanol lignin. Trying to solve these challenges through brute force H₂ hydrogenation is unlikely to be constructive in the long term.

- This is a continuation of a technical approach that has been well-studied. In my opinion, this project did not demonstrate any novel pathways or catalytic results compared with the state of the technology at project start. I do not see an obvious path forward for this technology, absent a major breakthrough in catalytic fast pyrolysis product yield and quality and catalyst stability.

PI Response to Reviewer Comments

- This project was a continuation of laboratory-scale catalyst and process development supported by a DOE/ARPA-E project awarded in 2009. The scope of this project was to evaluate the integration of catalytic fast pyrolysis with hydrotreating to produce advanced biofuels. The design, construction, and commissioning of the 1 ton/day pyrolysis unit was completed in the DOE/ARPA-E project. This

project supported the operation of the unit. Early experiments were hampered by fouling of a heat exchanger that was originally installed directly downstream of the spray quench. This design was not suitable for long-term operation, so a new design was developed and modifications were implemented. The quench system modifications that are still in use today significantly improved system operability and led to the operational success of the unit. The project team surpassed the biocrude production target deliverable of 75 gallons with a total biocrude production of 230 gallons for upgrading.

This project also supported the design and fabrication of a laboratory-scale hydroprocessing unit. This unit was successfully commissioned and operated to meet project deliverables amid certain operational challenges expected with such larger research units. The hydroprocessing studies at RTI on vacuum gas oil and biocrudes were performed for close to 2,000 hours; specifically, upgrading of pine and oakwood biocrudes were performed for more than 1,500 hours. The original upgrading target for the project was a total of 2,000 hours of biocrude upgrading. Additionally, Haldor Topsøe performed the co-processing studies of hydrotreated liquid products from pine and oakwood with straight run gas oil and light cycle oil were performed for more than 1,800 hours.

Pilot-scale quantities of catalyst and feedstock are more difficult to find than sufficient quantities needed for small laboratory systems, but we found sources of both catalyst and feedstock to meet the project needs. We used feedstock from a previous DOE/BETO project (the National Advanced Biofuels Consortium), and after the first go/no-go decision point, we worked with Idaho National Laboratory to obtain additional feedstocks. Unfortunately, the material we received from Idaho National Laboratory (4 tons of ground hybrid poplar) did not

successfully feed in our system. The bulk density was too low, and the material bridged in the lower section of the feeder. We worked with Idaho National Laboratory to try and get material that was more suitable, but their pilot-scale feedstock preparation unit proved too inflexible to significantly alter the physical properties of prepared biomass to be of use to the project. We eventually found a local provider of loblolly pine sawdust that was suitable for our system. We also went back to Iowa State University (the source of the National Advanced Biofuels Consortium feedstock) and procured red oak sawdust that we successfully converted to biocrude in our system.

Different commercially available catalysts, such as fluid catalytic cracking and non-zeolite alumina catalysts, were also evaluated. While we were not able to scale up the catalyst identified and developed in the previous ARPA-E project, we could find a commercially available alumina catalyst that was available in sufficient quantities to run our system. Laboratory testing validated the performance of the alumina catalyst, and it was used to produce over 230 gallons of biocrude.

Several technical challenges remain before catalytic biomass pyrolysis becomes a commercial reality; most notably, biocrude yields and quality still need to be improved. A lot of activity in this area occurred in the past 10+ years, with notable successes and failures; however, very little technical information is available in the open literature from pilot-scale studies, such as those performed in this project. This project showed that it is technically feasible to reproduce small-scale pyrolysis yields at the 1 ton/day scale and consistently generate 20% O₂ pyrolysis liquids that can be effectively hydro-treated.

BIOMASS-DERIVED PYROLYSIS OIL CORROSION STUDIES

(WBS#: 2.4.2.301)

Project Description

Thermochemical liquefaction of biomass offers a promising means to produce liquid fuels and high-value chemicals from a wide variety of biomass sources. The high oxygen content of biomass results in formation of a wide variety of oxygen-containing organic compounds, including carboxylic acids, aldehydes, and ketones, which can cause significant degradation of metallic and non-metallic (elastomers, plastics, etc.) materials. The organic acids in bio-oils can result in an acidity that is the equivalent of a pH in the 2–3 range, thus presenting a corrosion concern for many metallic structural materials. Other carbonyl-containing compounds can degrade many non-metallic materials. This project seeks to identify the bio-oil components degrading materials and to identify materials with sufficient resistance for use in bio-oil production, processing, and storage environ-

Recipient:	Oak Ridge National Laboratory
Principal Investigator:	Jim Keiser
Project Dates:	10/1/2016–9/30/2019
Project Category:	Ongoing
Project Type:	Annual Operating Plan
DOE Funding FY 2014:	\$1,265,000
DOE Funding FY 2015:	\$1,600,000
DOE Funding FY 2016:	\$1,600,000
DOE Funding FY 2017:	\$1,600,000

ments. Identification of corrosion-resistant materials is essential if promising liquefaction technologies are to be taken to the commercialization stage. The wide variety of liquefaction methods and processing technologies result in unique environmental issues and, consequently, unique material requirements for each liquefaction scheme. Our studies have identified many organic compounds that could degrade structural materials, as well as corrosion mechanisms that are operative in these environments. We have identified improved materials, and samples are being exposed in operating systems in North America and Europe.

Weighted Project Score: 8.2

Weighting: For ongoing projects, there is equal weighting across all four evaluation criteria: Approach, Relevance, Accomplishments and Progress, and Future Work.

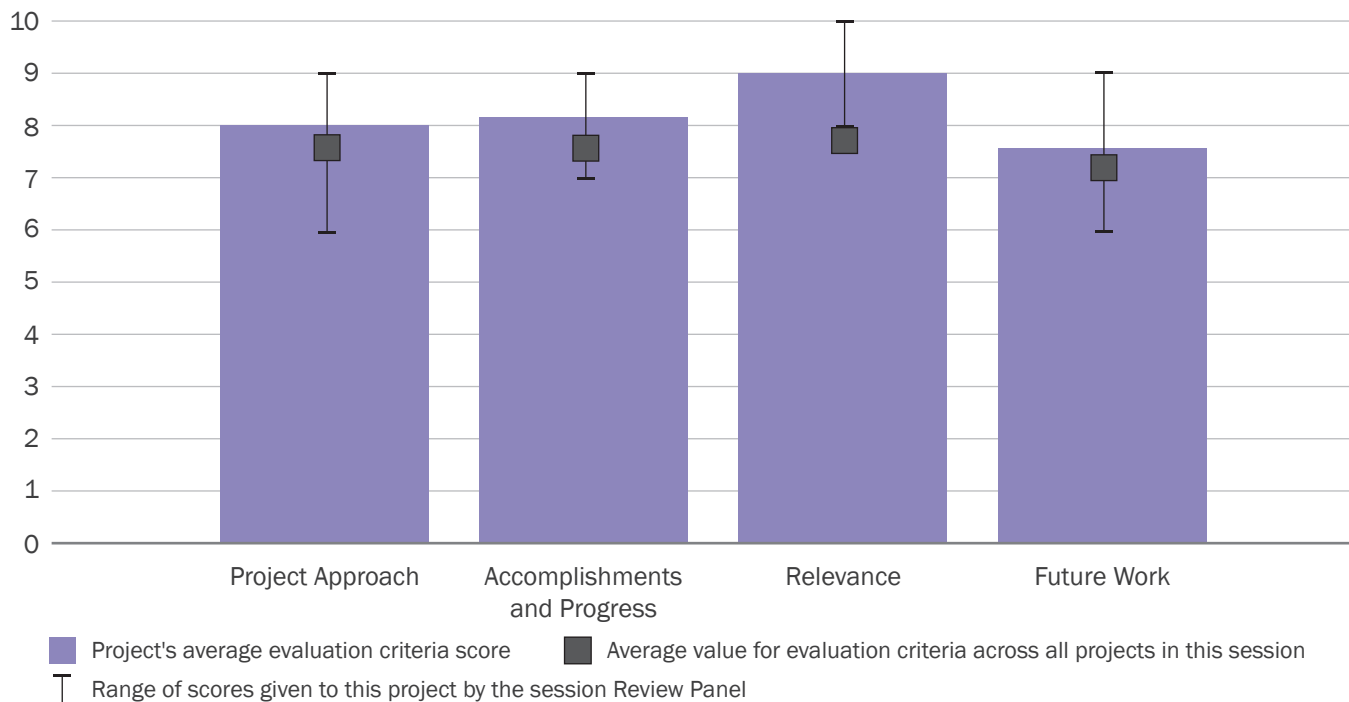



Overall Impressions

- This is a solid work result program, as corrosive studies are always challenging in industry and particularly so for such complex chemical mixtures, such as bio-oils. I applaud the team for using blends of real compounds to study for early insight into impact of mixtures that are well-defined. Broadening work to other feedstocks will be critical.
- This project is close to a perfect example of how the capabilities of national laboratories can be used to support the development of an industry. The information collected is of general interest, and they are willing to take on specific projects when requested at little or modest costs.

Equipment designers must have information on the compatibility and corrosion of materials to design robust plants. The choice of materials has a major effect on the costs of equipment and plant operability. The experimental results presented provide vital information to plant designers and potential bio-oil customers. There are data available concerning both metals and polymers. The information concerning the relationship between oxygen type and corrosion will help establish targets for the future.

- This is a comprehensive project focusing on the very important issue of corrosion by bio-oil and

intermediates in production equipment, as well as storage and transportation. There are, of course, numerous construction materials available, and it may be difficult to focus in on the best candidates. It was not clear from the presentation how the selection of the materials to be tested was handled.

- Overall, this is a great project working to advance a fundamental need of the industry that is often overlooked until it's too late. Identification and development of materials that are resistant to pyrolysis liquids is extremely important. The focus on low-cost, economic materials makes this work even more valuable. Given that pyrolysis liquids have more in common with blackstrap molasses than they do with petroleum products, there should be additional inquiry into the metallurgical experiences that the molasses industry has had. There could also be some interesting materials comparisons with the furfural and pulp and paper industries, given the kind of conversions they typically carry out on both woody and grassy biomass.
- This is a very important project for biomass utilization. While this is a large project in terms of time and dollars, corrosion issues are likely to be encountered for most anticipated feedstocks, so building knowledge of corrosion mechanisms and correlations with feedstock composition will be critical to enabling commercial development. I strongly recommend continuation of this work, whether as a separate team or as a funded task within other funded projects.

PI Response to Reviewer Comments

- We greatly appreciate all the positive comments provided by the reviewers, and we will do our best to maintain a high standard of performance and identify the most suitable materials for the various processes and processing conditions.

BRAZIL BILATERAL—NREL PETROBRAS CRADA

(WBS#: 2.4.2.303)

Project Description

The Petrobras–National Renewable Energy Laboratory (NREL) Cooperative Research and Development Agreement (CRADA) aims to demonstrate preliminary technical and economic feasibility of co-processing raw fast pyrolysis oil in fluid catalytic cracking (FCC) operation in a conventional refinery. The project is part of the Strategic Energy Dialogue between the governments of the United States and Brazil in advanced biofuels. Using Ensyn pine pyrolysis oil, the project produced 400 gallons each of diesel and gasoline co-processed precursor fuels that enabled industrial partners to produce hydro-treated finished fuels in the United States. The finished fuels met U.S. specifications, thus leading to the approval of the co-processing pathway by the U.S. Environmental Protection Agency and California Air Resources Board (2015/2016). CRADA results at 5 weight percent

Recipient:	National Renewable Energy Laboratory
Principal Investigator:	Helena Chum
Project Dates:	10/1/2007–9/30/2016
Project Category:	Sun-setting
Project Type:	Annual Operating Plan
DOE Funding FY 2014:	\$100,000
DOE Funding FY 2015:	\$115,000
DOE Funding FY 2016:	\$87,000
DOE Funding FY 2017:	\$0

(wt%) and 10 wt% bio-oil and vacuum gas oil (VGO) were published in *Fuel*, volume 188, and a prior Petrobras paper (in *Fuel Processing Technology*, volume 131) enabled NREL to develop two co-processing models. With these models, we examined the economic feasibility of many co-processing scenarios. Co-processing at 5% py-oil with VGO is economically feasible in the near term. At 10%, it is promising with progress in the pyrolysis industry in reducing costs (scale) and technology. The impact of 5% FCC co-processing with VGO is similar to that of a 1,000–1,200 tons/day cellulosic fuel facility with minimal refinery investment. The direct

Weighted Project Score: 8.4

Weighting: Approach–25%; Relevance–25%; Accomplishments and Progress–50%.

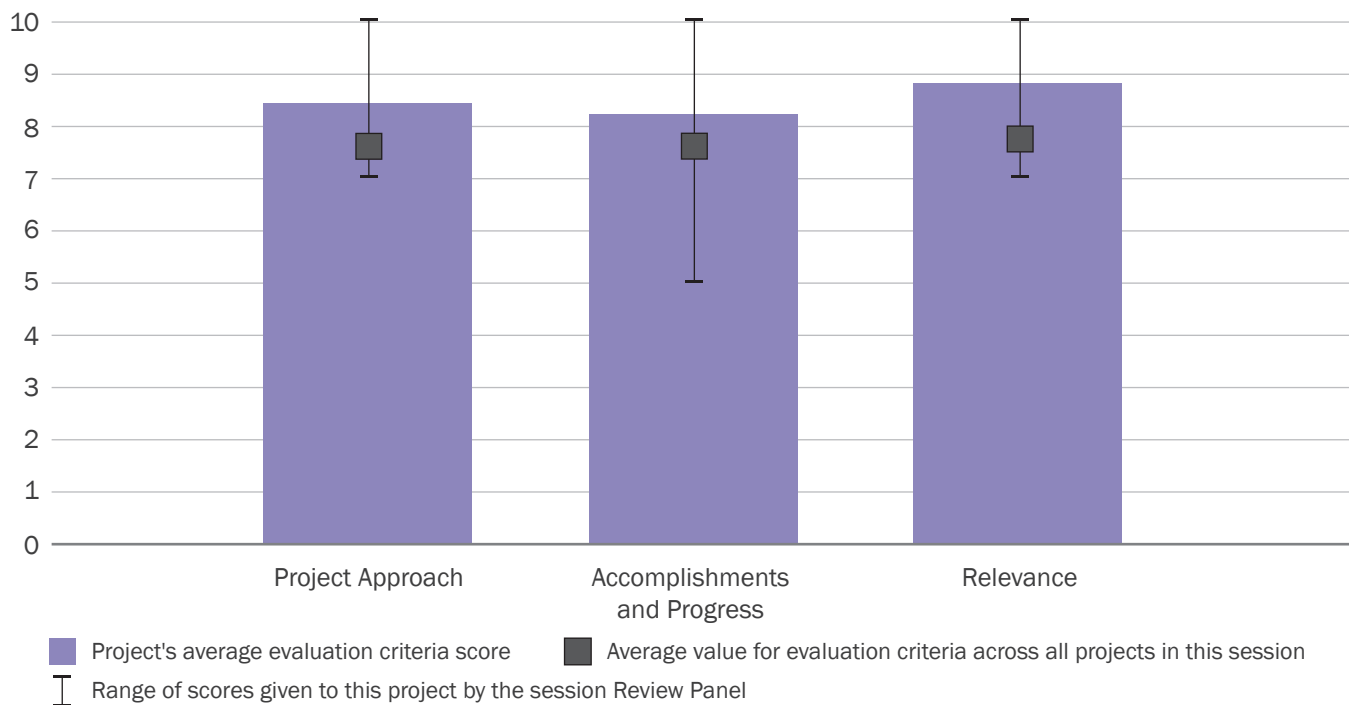



FCC co-processing of pyrolysis oil in a refinery has the potential to contribute significantly towards U.S. (e.g., Renewable Fuel Standard, California Air Resources Board's Low Carbon Fuel Standard) and global future biofuels goals.

Overall Impressions

- This is an outstanding program of cooperation with Brazil and Petrobras to define feasibility. I am concerned that some incentives are necessary if this blend approach is to be implemented in the near term. I am not sure about your statement that co-processing at 5% is economically feasible in the near term without incentive due to the price of oil in \$50/barrel range currently in the United States. What is the intention of DOE in terms of encouraging this implementation in the near term in the United States? I did not see any specifics on how this will be potentially moved forward beyond finalization of the modeling and life-cycle analysis. Since bio-oil was old, I am unsure what the impact of fresh oil would be on process. Are there any plans to address this concern that results might be substantially different and hard to predict? Also, the project only used the easiest feedstock to process. When would grasses be assessed?
- This project is a good example of international cooperation between commercial companies and a national laboratory. The results from this project are very relevant to the future of fast pyrolysis. Adding bio-oil to an FCC unit is likely the fastest way of incorporating it into a refinery and obtaining the environmental positive impact of displacing fossil fuels. I am still not entirely convinced that gas yields from the reaction of the bio-oil do not limit the carbon efficiency of the process. The Ensyn fast pyrolysis plants have already been commercialized. The techno-economic and life-cycle analyses conducted by NREL provide information that validates the Ensyn information in commercial proposals. It is possible that localities with aggressive environmental programs, like California, will decide to be early adopters of this co-processing approach.
- This is an excellent project that is very well-executed and provided promising results that should accelerate the commercialization of biofuels projects. This is a great collaboration across borders between a DOE laboratory, refiner, and bio-oil supplier.
- Overall, this is a fascinating and extremely useful project that enables important insights into benefits and drawbacks of inserting pyrolysis liquids into a petrochemical FCC unit. While this work is extremely intriguing, questions around the economic decisions underpinning commercial viability are legitimate. It may be that what was proven here was that commercial-scale integration is possible, but it should be done with an independent unit operation (alongside the traditional petrochemical unit ops), and it should be optimized to accept primarily pyrolysis liquids and then convert them into something inherently valuable to the refinery. The ultimate objective here has to be direct and provable contribution of the pyrolysis liquids to the fuel products.
- Very nice work. Demonstration at steady-state conditions for longer runs and/or at near commercial scale is the key next step, along with tightening up the biogenic carbon analysis. If pyrolysis oil is simply acting as a char (and light gas) machine, there may

be alternate technologies that are more economical (e.g., burning pyrolysis oil directly for heat/power).

PI Response to Reviewer Comments

- We thank the reviewers for their very positive comments on our demonstration of steady-state conditions at near-commercial-size scale of co-processing bio-oil with VGO in an FCC unit operating at 200 kg/hour of a Petrobras demonstration, development, and troubleshooting unit.

Specific responses:

- **Total run time.** Regular FCC test protocols set 1 hour as the run time for FCC pilot riser units (Davison Circulating Riser). The demonstration-scale FCC unit is equipped with a pseudo-adiabatic riser reactor and a continuous catalyst regenerator, operating under steady-state conditions. Thus, the catalyst is being continuously burnt during the test. We used 2 or 3 hours run time for each test. However, the entire first set of experiments (using the “young” 9-months-old bio-oil) was carried out by varying operating conditions—such as bio-oil feed rate, as shown in our paper (Fig. 6a), and feed temperature—during more than 70 hours, without any need to stop the unit. Moreover, another long-duration test was carried out to produce high amounts liquid effluent (gasoline and diesel cuts), which lasted more than 70 hours. It is important to emphasize that, although the riser reactor diameter is 2 inches, we did not observe any coke formation inside the riser after the first set of experiments. Nevertheless, Petrobras believes that some of the effects of bio-oil co-processed, if they behave differently from regular heavy VGO feedstocks, could only be detected in a commercial riser reactor because some of features of the test unit geometry do not emulate perfectly a commercial riser reactor. Therefore, a commercial test, which would require much

larger amounts of bio-oil, would be necessary to clarify concerns related with coke formation and catalyst deactivation caused by alkali metals. On the other hand, corrosion effects caused by the presence of CO₂ in the water may be reliably simulated by using ionic simulation.

- **Bio-oil age.** The same bio-oil from Ensyn was used twice: the first time when it was 9 months old and the second time when it was 21 months old (see our paper). However, Petrobras assumes that bio-oils deteriorate when they age, polymerizing and producing higher-molecular-weight compounds, which would theoretically yield less-valuable products. Therefore, these results would be conservative if compared with “brand new” bio-oil results. Moreover, although coke-plugging events were observed with the 21-months-old bio-oil, product yield profiles were not altered when compared with the 9-months-old bio-oil.
- **Carbon efficiency.** The co-processing approach requires a reliable method to confirm the amount of renewable carbon in the products because fossil and renewable streams are being blended at some point in the refinery. Therefore, our initial approach used the 14C analysis to measure renewable carbon in the liquid product. We are confident that at least 30 wt% of the total carbon in the bio-oil ends up in the liquid fraction. Two different sets of experiments with two pinewood bio-oils from different producers confirm this value. Therefore, it is not possible that bio-oil is producing solely char, CO, and CO₂, since significant levels of renewable carbon were measured in different gasoline- and diesel-range cuts in many different experiments (two of them were already published, while other results were not published at the moment). CO₂ rejection was 0.4 wt% and 0.6 wt% from experiments with 5 wt% and 10 wt% of bio-oils. It is worth noting that bioprocesses such as sugar fermentation reject, as

CO₂, 50% of the total carbon present in the sugar (i.e., its efficiency is 50% only), and it is not possible to use lignin as raw material, only cellulose and hemicellulose. However, we understand that higher carbon efficiency must be pursued, and it is possible that the co-processing of raw bio-oil in catalytic cracking units represent only an initial step to a better use of the bio-oils in the future. Chemical evidence of incorporation of renewable carbon in the liquefied petroleum gas fraction was found.

CONSORTIUM FOR COMPUTATIONAL PHYSICS AND CHEMISTRY

(WBS#: 2.5.1.301-6)

Project Description

The Consortium for Computational Physics and Chemistry (CCPC) is a team of five national laboratories (Oak Ridge National Laboratory, Argonne National Laboratory, Pacific Northwest National Laboratory, the National Renewable Energy Laboratory, and the National Energy Technology Laboratory) with a common goal to accelerate progress on experimental BETO projects toward critical program verification goals and successful techno-economic analysis outcomes. The CCPC is an enabling project of the ChemCatBio consortium, and it collaborates with experimental projects across the BETO Conversion R&D Program, including the Feedstock-Conversion Interface Consortium and integration and scale-up projects. In addition to close collaboration with experimental teams, the CCPC utilizes an experienced industry advisory panel to guide technical scope

Recipient:	Oak Ridge National Laboratory, Argonne National Laboratory, Pacific Northwest National Laboratory, National Renewable Energy Laboratory, National Energy Technology Laboratory
Principal Investigator:	Stuart Daw
Project Dates:	10/1/2015–9/30/2018
Project Category:	Ongoing
Project Type:	Annual Operating Plan
DOE Funding FY 2014:	\$2,655,515
DOE Funding FY 2015:	\$3,135,000
DOE Funding FY 2016:	\$3,085,106
DOE Funding FY 2017:	\$3,276,500

and ensure industrial relevance. The CCPC creates process and catalyst models to address bio-complexity, scalability, and catalyst discovery challenges. Critical outcomes include (1) process models that capture feedstock complexity and accurately predict reactor performance at multiple scales, as well as (2) predictions

Weighted Project Score: 8.6

Weighting: For ongoing projects, there is equal weighting across all four evaluation criteria: Approach, Relevance, Accomplishments and Progress, and Future Work.

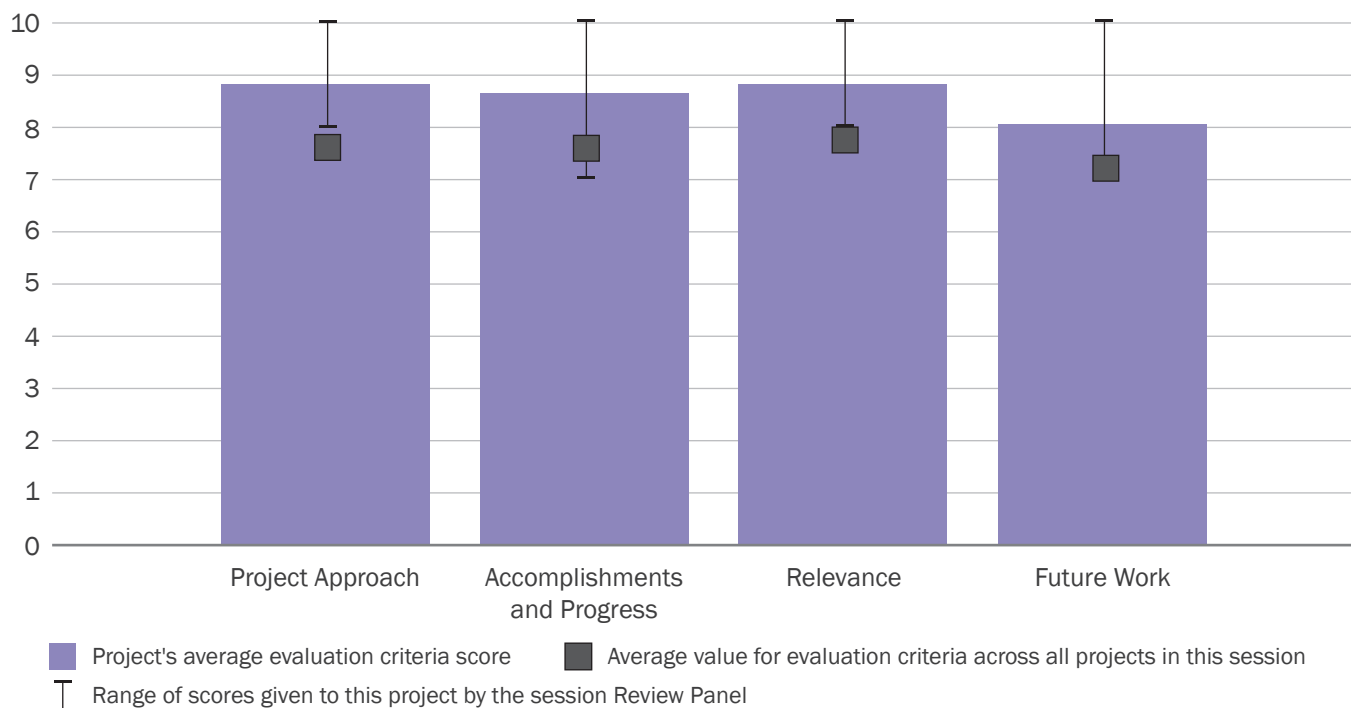

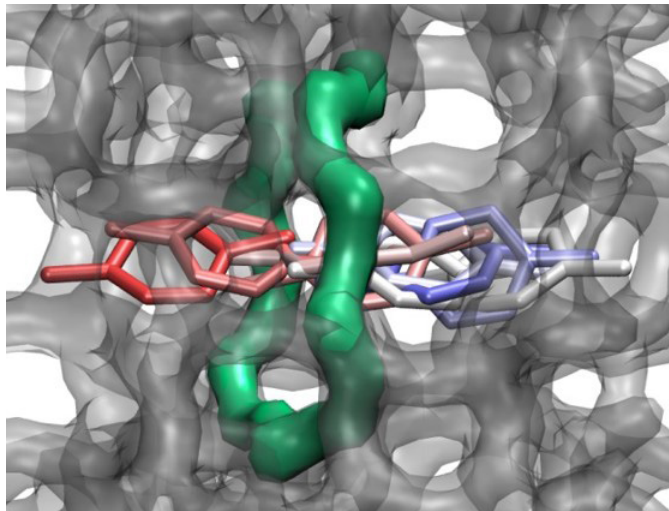

and testable hypotheses that accelerate ChemCatBio's synthesis of new catalysts with improved lifetime, activity, and selectivity. Since the last Peer Review in 2015, the CCPC has authored 30 publications and 29 presentations and has transferred technology related to toolsets for reactor modeling and catalyst discovery.

Overall Impressions

- There is an impressive amount of work for programs. The budget is quite high but necessary for all teams to succeed and accelerate programs. Continue what the team is doing as they are doing well. Do not change anything. There is an impressive amount of publications as well since the last review. I applaud the team and their ability to influence and impact programs in such a complex set of programs. I give this team my highest ratings.
- There is a very high impact for the cost of the project. One wonders where the resources are coming from to accomplish all that was reported and if this can be continued in the future. Predicting the performance of process from small-scale experiments requires a strong modeling effort that can identify potential problems. The phase behavior in the converter and the effect of particle and reactor hold up as the scale increases are critical factors that can be predicted using the models developed by this group.

It will be particularly important to access the effects of the reactor configuration, including the shape, size, inlet design, etc.

- This is a great project with lots of valuable information available for other bioenergy projects. The industry advisory panel helps focus the work on areas that will accelerate the commercialization of bioenergy technologies. The project leverages several experts from multiple laboratories and organizations. This is exciting work.
- Overall, this is a solid program with a number of significant historical contributions, as well as quite a few potentially promising contributions in the future. Models are a critical component for both communication and commercialization. CCPC's high level of competency and expertise in this area is priceless for both BETO and the public. Focus on scalability, bio-complexity, and basic catalysis science is spot on and reflects good understanding of most of the major variables that drive commercialization in the bioenergy/biofuels industry.
- These are impressive project accomplishments to date. Congratulations! If the modeling tools can be successfully applied to the benefit of the catalytic project teams, this will have been a very valuable program.

PI Response to Reviewer Comments

- The CCPC team appreciates the reviewer comments. In general, reviewers expressed positive comments on project approach, accomplishments, relevance, and future work; thus, the team plans to continue overall direction and focus. In particular, we will continue to utilize and expand the following aspects of the project highlighted by reviewers, if possible: (1) use of the industry advisory panel, (2) alignment/collaboration with biomass conversion projects, (3) open-source code and tech transfer mechanisms, (4) emphasis on capturing biomass complexity in scalable models, and (5) study of zeolite catalysis transport and deactivation mechanisms.

The reviewers also offered some constructive criticism and potential new areas of research that the CCPC has considered for future direction. Responses to specific comments are as follows:

- Regarding transfer of methodologies and models and potential commercial partners for transfer: While some modeling in the project is using commercial software, many efforts in the project utilize open-source and/or publicly available software (e.g., MFIX). In addition, the CCPC publishes methodologies in peer-reviewed journals and presents at public conferences; we also post a significant amount of our code as open source on GitHub and on our CCPC website. We agree that transfer of models to specific commercial partners may present a good opportunity for improving transfer and utility of CCPC models, and the CCPC will investigate that opportunity.
- Regarding expanding scope to include separations: While collaborating projects or industry advisors have not requested separations modeling to date, the CCPC considers this an interesting opportunity and will begin discussions with the relatively new BETO Separations Consortium to determine what challenges could be aided by modeling.
- Regarding tangible benefits to and support of technical projects in program: Yes. In many cases, we are already in the process of transitioning from model development to industry-relevant technical project support. Such efforts are focused during our quarterly stakeholder meetings and periodic industry advisory board updates. It is our belief that the current flexible approach allows us to rapidly leverage the broad capabilities across the national laboratory system while maximizing our utility to the core BETO programs/mission.
- Regarding the Davison Circulating Riser: We acknowledge the limitations of the Davison Circulating Riser, but the modeling of two other vastly different scale vapor-phase upgrading reactors greatly mitigates issues with the Davison Circulating Riser for our overall objectives. We plan to focus on those reactors and capturing parameters that need critical consideration for scalability and reactor operations, which, together with our vapor-phase upgrading catalysis activity modeling, translates to yield and commercial relevance.
- Regarding broad project scope and prioritization: Our broad scope is challenging from a prioritization and resource allocation perspective, but we benefit from our role as a centralized hub of conversion program relevance. Our enabling role and structure that encompasses joint and linked collaborative milestones with many projects across the program keeps our priorities focused on critical program needs toward techno-economic analysis and commercial success. In addition, our diverse interdisciplinary team operates more efficiently, which enables acceleration of research progress on complex challenges. We intend to rely on guidance from the Peer Review process, our industry advisory panel, and frequent meetings with experimental project teams to prioritize activities and resources.

DEVELOPMENT AND STANDARDIZATION FOR BIO-OIL CHARACTERIZATION TECHNIQUES

(WBS#: 2.5.2.301)

Project Description

This project began in FY 2014 to address the lack of standard chemical characterization analytical methods for bio-oils. Bio-oils are very complex and present numerous analytical challenges, yet reliable chemical information (quantification of both individual compounds and chemical functional groups) is needed to inform upgrading research and refinery co-processing. In this project, we first determine analysis needs from the bio-oil community. We then develop standard methods to meet these needs, and then subsequently validate these methods via inter-laboratory studies with external partners. Methods that are successfully validated (more than 10% variability) are then shared as laboratory analytical procedures, which are free and publicly available.

Recipient:	National Renewable Energy Laboratory
Principal Investigator:	Jack Ferrel
Project Dates:	10/1/2013–9/30/2017
Project Category:	Ongoing
Project Type:	Annual Operating Plan
DOE Funding FY 2014:	\$498,574
DOE Funding FY 2015:	\$990,000
DOE Funding FY 2016:	\$1,000,000
DOE Funding FY 2017:	\$1,000,000

We are also pursuing ASTM standardization to facilitate worldwide adoption of methods standardized in this project. To date, four analytical methods have been standardized: gas chromatography-mass spectrometry, carboxylic acid titration (CAN/TAN analysis), carbonyl titration, and ³¹P nuclear magnetic resonance. These methods have been published as laboratory analytical procedures and represent the first examples of standard chemical characterization techniques for bio-oils. Furthermore, we are pursuing ASTM standardization with the carbonyl titration method, with widespread participation from the international bio-oil community. This

Weighted Project Score: 7.9

Weighting: For ongoing projects, there is equal weighting across all four evaluation criteria: Approach, Relevance, Accomplishments and Progress, and Future Work.

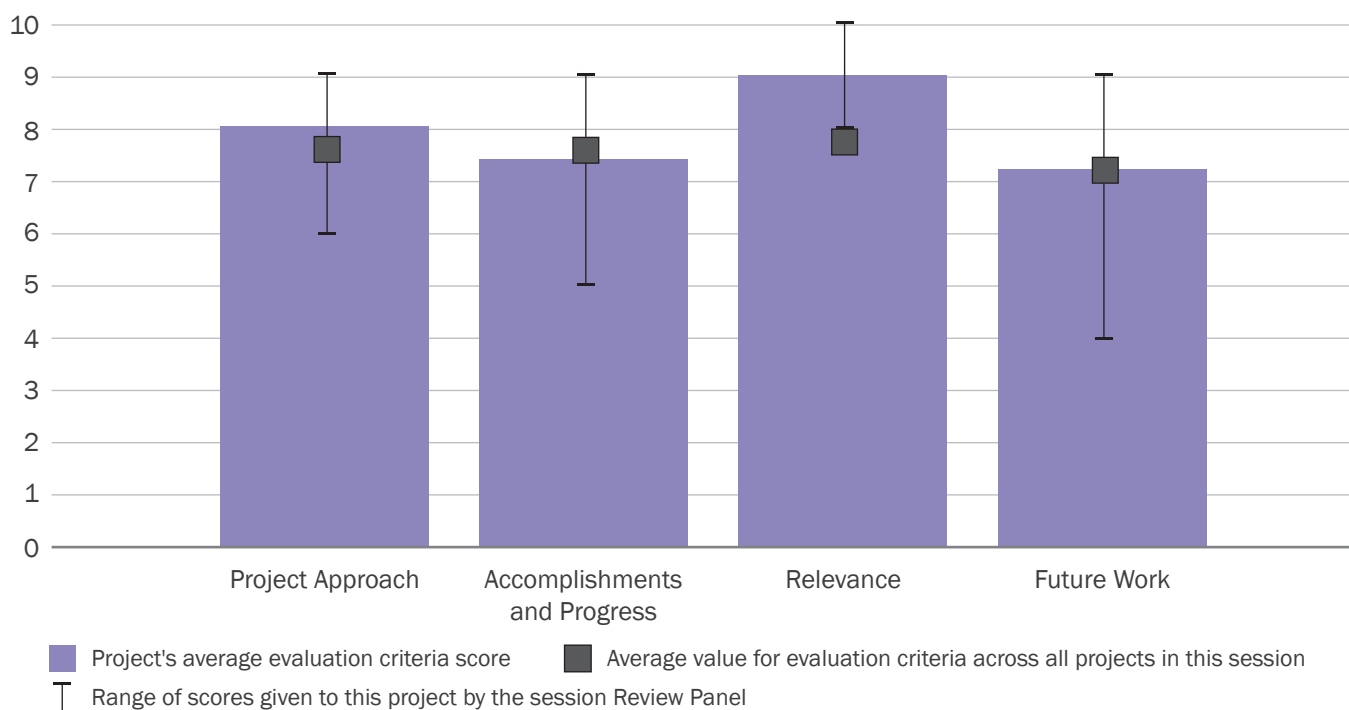

work is meeting the analysis needs of the bioenergy community and will ultimately enable the commoditization of bio-oils.

Overall Impressions

- Excellent progress was made by the analysis team in very challenging mixtures coming from bio-oils. The key will be aging understanding for the future to define if stabilization is truly sufficient. Carbonyl titration ASTM standard is a good first step, but the rest of the work needs to be accelerated as it could have substantial impact on conversion teams and their approaches. Simple should be the guide for future methods as actual plants will not be able to routinely run complex methods due to cost of equipment and personnel trained to run such equipment.
- Developing standardized analytical methods is a requirement for commercializing biofuels. It also provides a basis for accurate and independent evaluation of the results between platforms. The time and costs of analytical methods can be a significant part of the experimental program. Developing routine methods that can be used to follow continuous operation is critical.

It is particularly useful to have this work conducted by a national laboratory with independent funding. The results from the study are of very wide application and are costly. It is difficult for developers to afford funding the required effort to develop these methods internally.

One weakness is the failure to include commercial analytical laboratories on the team to speak towards practicality in the real world.

Another is the lack of focus on methods that can be run outside of a sophisticated analytical laboratory. Robust methods are needed for analysis by a small analytical laboratory at the plant location. The speed of the analysis is critical. Feedback is needed as rapidly as possible to guide operations. The potential for same-day turnaround should be a goal.

- This is a well-managed project that provides important standardization for bio-oil analysis. The methods will be validated by round robin test to confirm target accuracy. Extensive contact with bio-oil developers, process designers, users, etc. is important to ensure that the standardized analysis methods include all the parameters that will be needed for sizing and construction materials selection of equipment handling bio-oil in future integrated biorefineries.
- Overall, this is a very logical and timely project. The approach is pragmatic, and this work should be prioritized, given its value to the biofuels/bioenergy industry. It is critically important that this effort does not call pyrolysis liquid an oil or try to build the new ASTM specs on older ASTM specs associated with oil. Naming conventions are very important in chemistry, and to the extent that a produced standard is meaningful, consistent, and transferable, as a community of practice we need to stop addressing pyrolysis liquids as bio-oils. This project is strategically positioned to effect that change. Adoption and use of new standards will be more impactful if efforts are made to ensure that commercial laboratories have all available equipment and also a comfort level with what is being proposed. Workshops should be held and commercial laboratories should be approached to solicit their feedback/review.
- Getting detailed, reliable characterization of pyrolysis oil will be a major factor in widespread pyrolysis oil acceptance. I'm not convinced the right methods were selected for investigation.

PI Response to Reviewer Comments

- Thank you very much for the comments. We will get feedback from commercial analytical laboratories moving forward, and we have already begun this process. We have also emphasized simple analytical methods in our work, and our two most

reliable methods are titrations with quick turnaround times. Furthermore, our development of a new carbonyl titration method not only resulted in a more accurate method, but cut down analysis time from 24 hours to 2 hours. This method has been used to successfully predict plugging during high-temperature hydrotreatment of raw pyrolysis liquids. We are currently using this method to develop a new aging test, as previous aging tests based on the viscosity measurement were unreliable.

While we have emphasized simple and quick analytical techniques, we have also pursued more advanced techniques, such as chromatography and nuclear magnetic resonance. These methods are widely

used by the research community, and researchers also benefit from analytical standardization. Standardization of these advanced techniques will allow for detailed comparisons between different pyrolysis samples, and these comparisons are critical to inform R&D across the pyrolysis platform. As this project serves the needs of both the research community as well as the emerging pyrolysis industry, we have chosen to pursue analytical standardization of both simple and more advanced techniques. Finally, we agree that bio-oil is neither a descriptive nor accurate name, and we plan to identify a better naming convention and encourage the community to use it.

CATALYST COST MODEL DEVELOPMENT

(WBS#: 2.5.4.301-2)

Project Description

The goal of the Catalyst Cost Model (CCM) project is to develop a catalyst cost estimation tool to enable rapid and informed cost-based decisions in early-stage research and commercialization of catalysts. Prior to the creation of the CCM, an integrated tool for assessing the economic considerations of catalyst development and manufacture was not available. However, for many biomass conversion processes in the BETO portfolio that rely on catalysis, sensitivity analyses have identified that catalyst cost is a major contributor to the MFSP and significantly affects the overall process economics of the integrated biorefinery.

The CCM tool is a first-of-its-kind publicly available tool for determining the costs of precommercial catalysts, paving the way for faster commercialization

Recipient:	National Renewable Energy Laboratory, Pacific Northwest National Laboratory
Principal Investigator:	Frederick Baddour
Project Dates:	10/1/2015–10/1/2018
Project Category:	Ongoing
Project Type:	Annual Operating Plan
DOE Funding FY 2014:	\$0
DOE Funding FY 2015:	\$0
DOE Funding FY 2016:	\$300,000
DOE Funding FY 2017:	\$300,000

of catalytic materials. By employing state-of-the-art estimation methods coupled with an intuitive user interface and comprehensive visualization tools, the CCM tool simplifies the process of assembling cost estimates for precommercial catalysts. This information enables researchers to (1) focus R&D efforts on areas of greatest cost, (2) make informed decisions based on performance per dollar, and (3) guide catalyst synthesis early in development. An industrially reviewed prototype of the CCM tool has been developed with an initial focus on

Weighted Project Score: 8.2

Weighting: For ongoing projects, there is equal weighting across all four evaluation criteria: Approach, Relevance, Accomplishments and Progress, and Future Work.

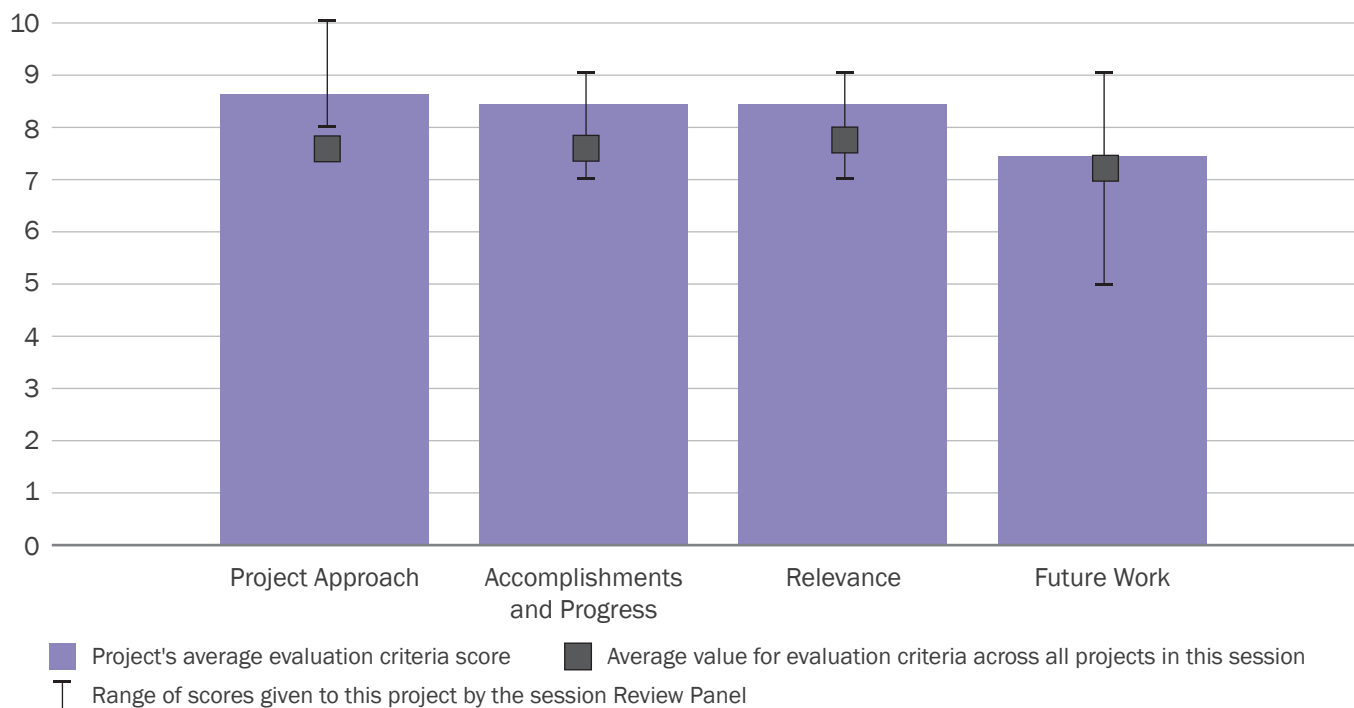

raw materials costs and has been successfully employed to assess the value proposition of catalysts currently under development in the core catalyst projects.

Overall Impressions

- Team organization, feedback from industrial experts, and initial progress is impressive and commendable. Tools such as this are needed for both internal BETO use as well as external use since catalysts are such a key factor in the initial development for biomass conversion technologies versus mature industries.
- Developing a shared tool for estimating the cost of a catalyst will be a major advance for all chemical catalyst research. It will help to guide groups new to catalyst commercialization. Understanding the cost of a catalyst is a vital part of developing economic models for the different processes. It can help guide future work in an area. The work so far has shown clear examples of the impact of catalyst cost on the TEA for an ex-situ catalytic fast pyrolysis case study. The validity of the model has not been proven. It would be worth trying to estimate the cost of some commercially available catalysts as a test.
- The project appears well-organized and will provide a valuable tool for estimating consistent costs of precommercial catalysts to be used in techno-economic analysis at the early stage of various bioenergy process schemes. I strongly recommended including industrial partners in the project for estimating the expected cost of commercially manufactured catalysts, as such cost may be substantially lower than the estimated precommercial catalyst cost.
- Overall, this is a great project that should be given a high priority and more support to accelerate its progress. Going into a commercial venture without truly understanding many of these catalyst cost

variables has resulted in the failure of a number of promising young companies. Additionally, lack of this knowledge also encourages a lot of ideas that should not have been pursued in the first place, wasting time and money. The level of general misunderstanding regarding catalyst production, cost, regeneration, and recycling is staggering, and this project has already made significant gains towards addressing those issues. This is hugely valuable not only to ChemCatBio consortium projects, but also to the public bioenergy/biofuels community.

- This is an impressive effort. As a catalyst researcher, this tool would be very useful in the Stage 1–2 (stage-gate terminology) project phase, where approaches are being evaluated and lead concepts being selected. I look forward to seeing the outcome.

PI Response to Reviewer Comments

- We appreciate the reviewers' helpful suggestions on ways to improve our project. We agree that establishing the validity of the methods we are building into the catalyst cost estimation tool will be critically important to a successful deployment. We are actively evaluating a series of commercially available industrial catalysts using our cost estimation methodology to benchmark the accuracy of the tool.

We have targeted industrial catalysts for benchmarking that are manufactured differently (e.g., zeolite crystallization, wet impregnation, metal salt precipitation) to identify areas of our operating cost estimation methodology that accurately reproduce the manufacturing costs of these catalysts and areas of weakness that need further refinement to reach agreement with the costs of these commercial catalysts. Upon completion of this internal validation, we will submit our validation strategy to our industrial reviewers for assessment to ensure that our benchmarking approach is appropriate and that the results it generates are meaningful.

We thank the reviewers for their helpful comments on the importance of leveraging industrial partners during the development of our catalyst cost estimation tool. We agree that insight from the catalyst manufacturing sector is crucial to ensuring our tool is able to generate catalyst manufacturing cost estimates that are aligned with the realities of the industry, and we are actively seeking industrial input and working towards increasing the size and scope of our industrial review board.

ADVANCED CATALYST SYNTHESIS AND CHARACTERIZATION

(WBS#: 2.5.4.303-5)

Project Description

The Advanced Catalyst Synthesis and Characterization (ACSC) project delivers high-performance cost-effective catalysts that meet the needs of the ChemCatBio catalysis projects by leveraging advanced characterization capabilities and synthesis expertise at DOE national laboratories. The ACSC is based on a successful collaboration between Argonne National Laboratory and the National Renewable Energy Laboratory, in which X-ray absorption spectroscopy coupled with experiment identified active sites responsible for the enhanced performance of a Cu-zeolite catalyst for the dimethyl ether-to-hydrocarbons pathway. As the ACSC, this collaborative effort was expanded to encompass X-ray absorption spectroscopy at Argonne National Laboratory, sub-Angstrom resolution electron microscopy at Oak Ridge National Laboratory, and a dedicated synthetic

Recipient:	National Renewable Energy Laboratory, Argonne National Laboratory, Oak Ridge National Laboratory
Principal Investigator:	Theodore Krause
Project Dates:	10/1/2016–9/30/2019
Project Category:	New
Project Type:	Annual Operating Plan
DOE Funding FY 2014:	\$0
DOE Funding FY 2015:	\$0
DOE Funding FY 2016:	\$0
DOE Funding FY 2017:	\$900,000

effort at the National Renewable Energy Laboratory focused on developing next-generation catalysts through innovative synthetic routes. This integrated approach enables the ACSC to (1) identify active site structures in working catalysts, (2) inform computational models to predict structures with enhanced performance, and (3) deliver next-generation catalysts that exceed performance targets. This accelerated catalyst development cycle will be demonstrated by developing a predictive model for zeolite catalyst deactivation that minimizes carbon lost to coke, as well as tailored multi-metal

Weighted Project Score: 7.4

Weighting: Approach–25%; Relevance–25%; Future Work–50%.

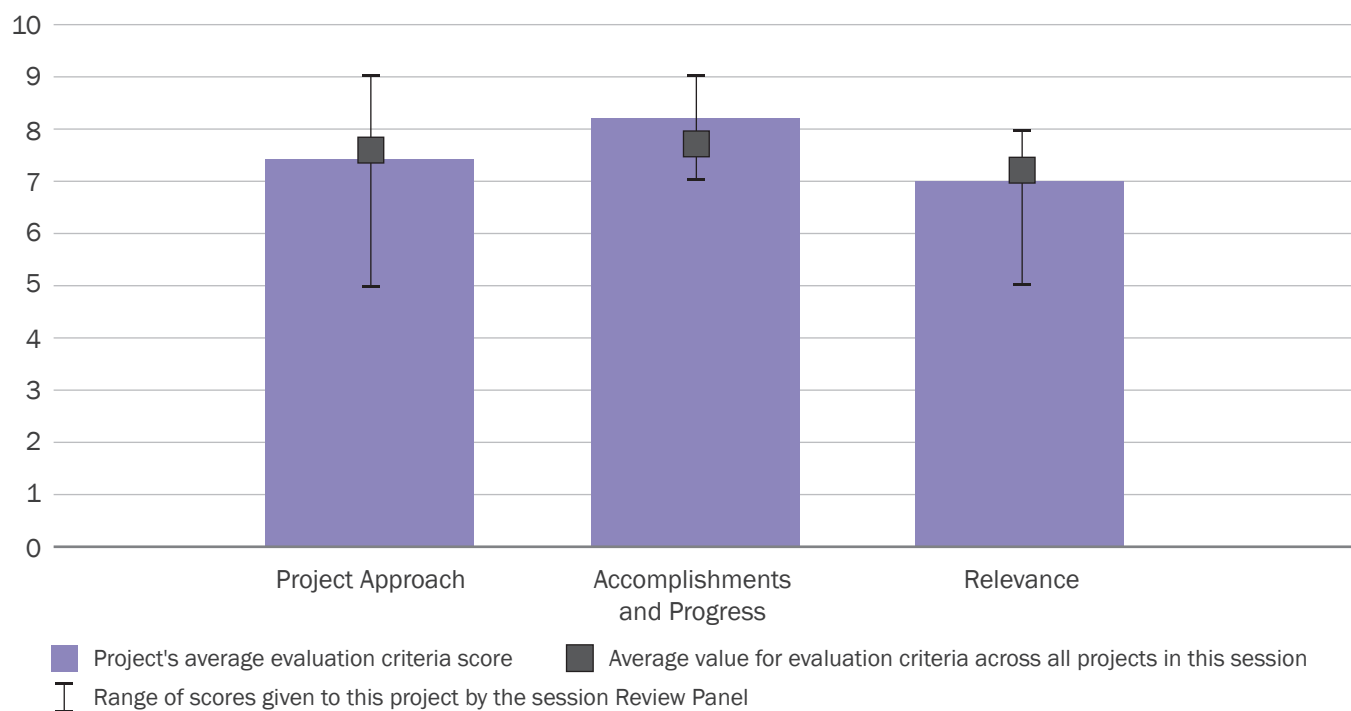



zeolites to increase the yield of jet fuel from dimethyl ether by 1.5-fold, leading to reduced conversion costs for biomass processes.

Overall Impressions

- The team has done good job in a very difficult area of work, i.e., designing new catalyst systems for such complex processes. This work is highly relevant to the program as some standard catalysts have not functioned well on biomass, and clearly sulfur tolerance and coking are key areas to improve on with new catalysts. The key will be focusing on the right catalyst-process combination with other teams to provide the biggest impact since the team cannot work on improving all the slate of catalysts being explored by the teams and processes.
- I did not see much emphasis on the catalyst synthesis and preparation portion of the project. The ability to obtain sufficient amounts catalysts has hindered several programs. I believe the team has the ability to scale up catalyst production to meet the needs of the larger-scale equipment currently being developed in the national laboratories. Larger-scale preps are needed for multiple experiments and comparisons.

The characterization tools available are impressive and will be useful to any catalyst development effort. Offering access to these to outside groups would facilitate development efforts.

It would be worthwhile to develop a relationship with the high-field mass spectrometry group in Florida. There is a lack of sophisticated techniques for organic compound identification in the program.

- The project effort is leveraging the expertise and knowledge available at several national laboratories. I strongly recommend that the activities under this project are limited to evaluation and identification of special catalytic needs for the BETO programs, and that the actual final catalyst formulation and manufacture of such new catalysts are outsourced to commercial catalyst companies who already have these types of skills and experience. By doing so, the commercialization of the new catalysts will be accelerated. I therefore recommend that the team get industry partners with experience in catalyst development and manufacturing more directly involved, when it comes to the manufacturing step of the project.
- Overall, this project has a lot to offer ChemCatBio and is a very straightforward and fundamentally important component of the consortium. It is important that every project associated with ChemCatBio has access to standardized analysis and post-mortem characterization, as that is often the only way to make sure everyone is speaking the same language. Major focus should be on supporting consortium project analysis and characterization needs, rather than novel catalyst development, but clearly, where opportunities present themselves (such as metallic and ionic Cu work), work should be completed. Post-mortem analysis of commercial catalysts that have been utilized under various relevant bioenergy/biofuels process conditions is critically important to directing industrial partners on how to improve their products.
- If successful, I think this project, along with the other enabling projects, has the potential to lead to significant advances in understanding the catalytic conversion of biomass oxygenates. I strongly support resources directed to this activity.

PI Response to Reviewer Comments

- We appreciate the positive feedback from the reviewers regarding the successful design of new catalyst systems for complex conversion processes,

the relevance of this work to the overall program, and the fundamental importance of catalyst characterization and development to the ChemCatBio consortium and scientific community.

In response to the comment on our level of emphasis on the catalyst synthesis portion of the project, we envision two critical roles for catalyst synthesis within the ACSC. The first is as an integral part of the advanced characterization effort. In this capacity, we have shown that for a technical Cu-zeolite catalyst, which contains multiple potential active sites, we can synthesize model catalysts containing only one of each type of active site. Evaluation of these model catalysts by the collaborating catalysis group and advanced characterization by the ACSC established which active site was responsible for the targeted transformation. This information enabled the development of an active site model by the Consortium for Computational Physics and Chemistry, which led to the prediction of next-generation catalyst development targets. The second role for catalyst synthesis within the ACSC is to prepare these predicted catalyst targets using controlled synthesis techniques to confirm and understand performance improvements enabled by the catalyst development cycle. As a new start project in FY 2017, we have not yet proven our approach on multiple efforts, but we have presented the Cu-zeolite case as an example that demonstrates the critical role of the ACSC in the catalyst development cycle.

With regards to the scale of catalyst synthesis, although our team generally prepares catalysts on a 1–100-g scale, which is suitable for many of the reactors available within ChemCatBio, we have previously worked with industrial partners to increase the scale of catalyst synthesis beyond this development level. We appreciate the reviewer's suggestion that we involve catalyst production experts, potentially in collaboration with a national laboratory effort, in early-stage catalyst development in order to understand the requirements of larger-scale catalyst

design. We will also consider adding a task within the ACSC dedicated to catalyst scale-up.

We agree with the reviewer that the tools and methodologies being developed within the ACSC will be useful to external catalyst development efforts, and consequently, we have placed a high priority on the publication of our results to make them available to the scientific community. Additionally, many of the capabilities are part of DOE user facilities, and we will consider how best to work with external partners as we move forward with the ChemCatBio consortium. Energy Materials Network consortia, like ChemCatBio, are focused on engaging with industry, and therefore, the guidance from the reviewer integrates well with the ChemCatBio mission.

We agree that organic compound identification is an important part of understanding deactivation by coke formation, for example. Currently, we are using nuclear magnetic resonance techniques and in-situ thermogravimetric analysis with infrared spectroscopy analysis of volatilized species to identify organic functionalities that can be removed from the spent catalysts chemically or thermally, as well as species that remain within the catalysts. We appreciate the suggestion to consider mass spectrometry as a complementary method for organic compound identification.

We thank the reviewer for the comments and agree that we need to identify the most important catalyst-process combinations to provide the greatest impact to the ChemCatBio catalysis projects. One way we are seeking to do this is by identifying overarching challenges, such as zeolite deactivation, that are relevant to multiple conversion processes. Once we have developed the characterization methodologies and models through the Consortium for Computational Physics and Chemistry, we can more efficiently evaluate the impact of the different conversion processes, reactor scales, and catalyst features on deactivation.

FRACTIONATION AND CATALYTIC UPGRADING OF BIO-OIL

(WBS#: 2.5.4.401)

Project Description

The goal is to develop a biomass conversion process that optimizes fractionation and conversion to maximize carbon efficiency and hydrogen consumption to obtain drop-in fuels. The team obtained selective fractionation of raw biomass via multi-stage thermal fractionation to produce different streams that are enriched in a particular chemical family (acids, furanics, or phenolics). These streams were later catalytically upgraded in both liquid or vapor phase to perform C-C bond formation and hydrodeoxygenation. Among various upgrading strategies investigated, we have identified an effective path in which cyclopentanone is a crucial intermediate that can be derived from furfural and other furanics obtained in high concentrations from this thermal staged process. Cyclopentanone is a very versatile molecule,

Recipient:	University of Oklahoma, Idaho National Laboratory
Principal Investigator:	Daniel Resasco
Project Dates:	9/30/2013–3/31/2017
Project Category:	Sun-setting
Project Type:	FY 2013–CHASE: DE-FOA-0000812
Total DOE Funding:	\$2,393,370
DOE Funding FY 2015:	\$0
DOE Funding FY 2016:	\$0
DOE Funding FY 2017:	\$900,000

which can couple with itself to produce high-quality jet fuel, or couple with phenolic or furanics to create long chain molecules. These (still oxygenated) compounds can be hydrotreated to direct drop-in fuels. Interestingly, we have found that the conversion of furfural to cyclopentanone is not affected by acetic acid, and, more importantly, it is enhanced by water. These are very significant findings, since water and acetic acid are always present in all streams. These results have allowed detailed life-cycle analysis and techno-economic anal-

Weighted Project Score: 7.0

Weighting: Approach–25%; Relevance–25%; Future Work–50%.

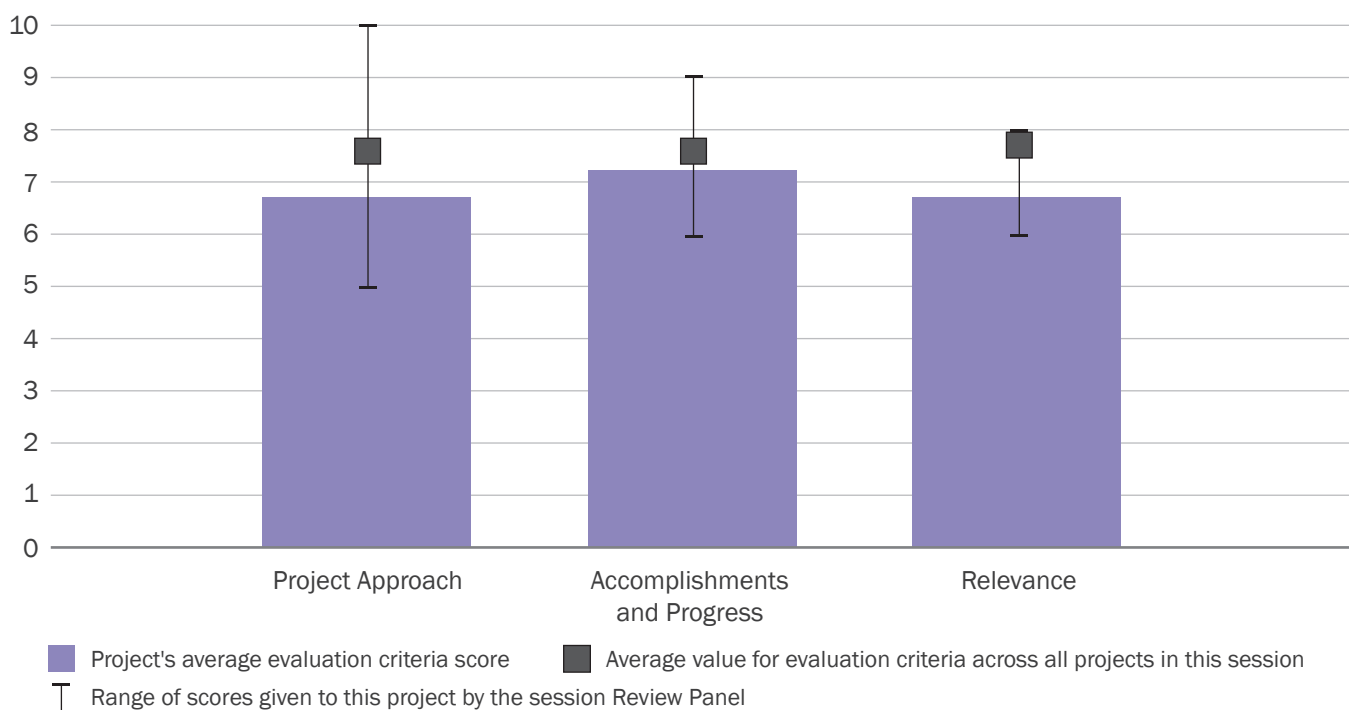

ysis studies that are back-fed to the experimentalists to refine the catalyst selection and process operations with the objective of maximizing C efficiency at minimum H utilization.

Overall Impressions

- This project explores some fundamental chemistry of the major components obtained by thermal deconstruction of biomass at different temperatures. The work provides important data and has illustrated new chemistry and, as such, is a success. The commercial framework proposed and techno-economic analysis are less impressive due their complexity. It was difficult to follow the cost comparison and overall carbon retention.
- This is an interesting concept that seems a little more theoretical than practical. It still needs more optimization to reduce complexity and capital expenditure.

- Overall, this is a very compelling project that showed the value of staged pyrolysis and explored downstream acylation reactions as a way to combine and valorize multiple product streams. Significant work remains to scale up conversions and consider economics, but this is a very strong start down a promising and logical path. By targeting two of the most abundant products from the staged pyrolysis, this project is working with thermodynamics instead of fighting it. This is relevant because these design decisions will ultimately lead to higher efficiencies, better separations, and improved economics.
- This project focused on basic conversion pathways for biomass-derived oxygenates. This is interesting from a fundamental chemistry perspective, which remains a gap for biomass upgrading to fuels and chemicals.

PI Response to Reviewer Comments

No official response was provided at the time of report publication.

NOVEL ELECTRO-DEOXYGENATION PROCESS FOR BIO-OIL UPGRADING

(WBS#: 2.5.4.403)

Project Description

Lignocellulosic biomass residue, such as agricultural and forestry residue, can be converted to liquid fuels via bio-oil production by fast pyrolysis. The high oxygen content and instability of bio-oil poses a challenge for its practical use. The conventional approach to deoxygenate and stabilize bio-oil is the hydrodeoxygenation process, which requires a large volume of hydrogen and is amenable to only centralized processing. Typical bio-oil is biphasic, and only the organic phase is processed in subsequent upgrading steps, leaving behind valuable carbon-containing material in the aqueous phase. This project investigates a novel electro-deoxygenation process using a solid-state ceramic device. Deoxygenation of model compounds and aqueous phase of pine wood bio-oil has been tested using oxygen ion-conduct-

Recipient:	Ceramatec
Principal Investigator:	Elango Elangovan
Project Dates:	9/30/2013–9/13/2016
Project Category:	Sun-setting
Project Type:	FY 2013–CHASE: DE-FOA-0000812
Total DOE Funding:	\$2,604,152

ing, ceramic membrane-based, electrochemical cells operated in the temperature range of 500°–600°C. The product from the electrochemical cell contained a suite of compounds with significantly lower oxygen content. An integrated test of an electrochemical stack with a slip stream of pyrolysis vapor showed that the product is significantly different from unprocessed bio-oil in terms of functional groups. An additional integrated test of longer duration is planned to fully characterize the electro-deoxygenation product. Life-cycle analysis, supply chain logistics, and techno-economic process models are underway.

Weighted Project Score: 5.7

Weighting: Approach–25%; Relevance–25%; Future Work–50%.

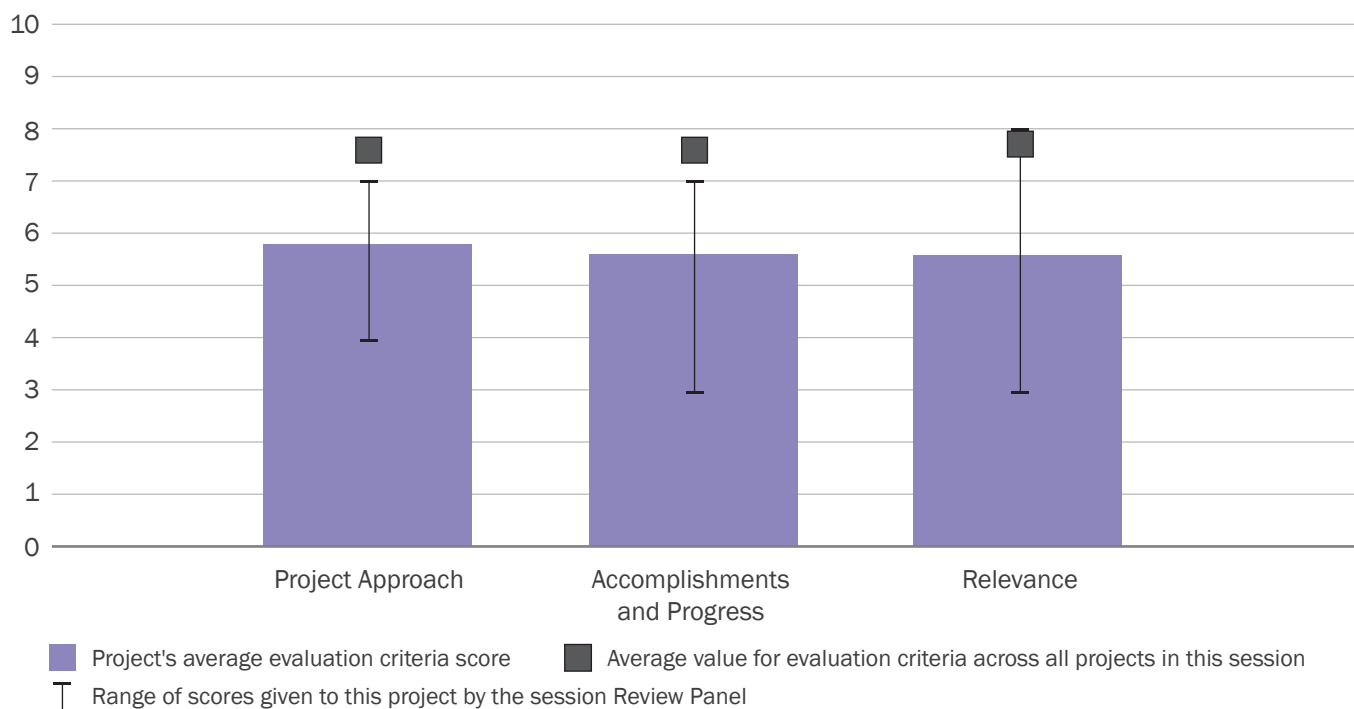

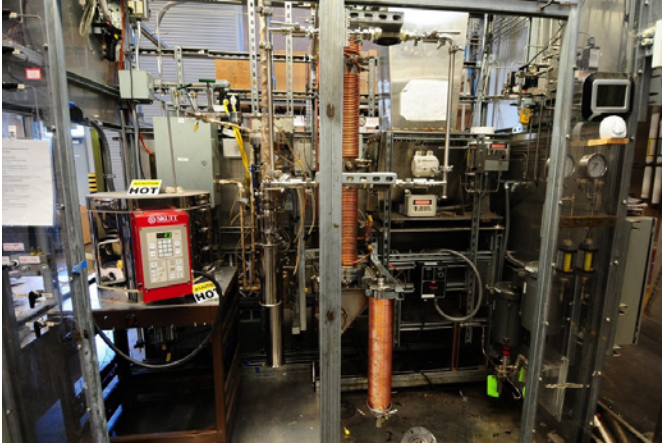

Overall Impressions

- This project has too many concerns and issues to be relevant for BETO goals. There are other ways to generate hydrogen for processing. I do not see proof that the system really is doing more than further temperature pyrolysis, as acid is also present in substantial amount via water phase in a two-phase system. Also, this is a costly approach due to ceramic equipment, which was not provided, but I expect it will have high capital expenditure for large unit ops.
- This project was a success in that it evaluated an electrochemical and membrane approach to upgrading biomass-derived liquids without hydrogen. BETO should be commended for including these types of projects in its portfolio. Unfortunately, the results of the experiment did not show commercially relevant conversion was possible. This may rule out ceramic membranes for use in this application.

The concept of using renewably generated electricity to produce biofuels as a method of storing energy is very relevant. However, it couples the costs of the two processes, which complicates evaluation.

- This is an interesting project using reverse solid-oxide fuel cell (SOFC) technology. Reverse SOFC must operate at lower temperature than SOFC, which will reduce efficiency. It may therefore be an expensive alternative as SOFC is expensive technology.

- Overall, this is an intriguing new application of solid-oxide electrochemical processes. An important issue is that the standard of measure is H₂ hydrogenation, which will almost certainly never be a commercial reality at any significant scale. It is also widely accepted that water hydrolysis is a more expensive way to generate H₂ at scale than steam reforming. However, one of the more interesting developments in this work is the preference for methoxyls over hydroxyls. If this process can be utilized to efficiently remove certain functional groups and support targeted decomposition reactions, it could play an important role in other downstream processing/refining challenges.
- This is an interesting idea that has not generated technical results of sufficient quality to evaluate thoroughly. Process robustness is a major concern.

PI Response to Reviewer Comments

- “The experiment did not show commercially relevant conversion was possible. This may rule out ceramic membranes.”

This is a feasibility demonstration project, and many of the shortcomings identified need to be addressed. One such shortcoming is the performance of the electrochemical device. We used the materials set that was developed to operate at 800°C to establish the process feasibility at 600°C or below. Further improvement in performance of the device is clearly required to show commercially relevant conversion. Several major activities are currently underway to improve stack performance such that the present 800°C capability can be achieved at 600°C or below. Furthermore, the life-cycle analysis that is ongoing may show that partial deoxygenation has better economics and lower emissions than full deoxygenation. In that case, the performance improvements required may be moderate.

- “It couples the costs of the two processes (deoxygenation and renewable energy), which complicates evaluation.”

We do not anticipate co-locating renewable energy generation and pyrolyzer. The grid mix in certain areas (e.g., the Pacific Northwest) uses more renewable, and locating pyrolyzer–electro-deoxygenation in such locations will reduce greenhouse gas emissions. The inherent use of low to no hydrogen in this process will also offset greenhouse gas emissions from steam reforming to produce hydrogen.

- “There are other ways to generate hydrogen. I do not see proof that the system really is doing more than further temperature pyrolysis. Also, this is a costly approach due to ceramic equipment, which was not provided, but I expect it will have high capital expenditure for large unit ops.”

There are other ways of producing hydrogen. However, the cost of compression and transportation is a large factor in hydrogen cost as hydrogen is less likely to be economical to produce in a distributed manner, as the pyrolysis units would require. The electricity is more widely available as a substitute for hydrogen in this process. This approach also eliminates the difficulty in storing and transporting unstable pyrolysis oil to a downstream processing facility.

Per Pacific Northwest National Laboratory’s experience, higher-temperature fast pyrolysis will produce a different product, and it will be somewhat more deoxygenated and with lower yield of liquid; this can even change it enough to force the phase separation of an aqueous layer. Tests done at Pacific Northwest National Laboratory in the 1980s at 650°C have shown that effect. However, the difference at 550°–600°C would not be as great as was found with electro-deoxygenation.

The cost of the ceramic equipment is a concern. We will be doing a preliminary cost estimate and performing a trade study of performance required and capital cost to supplement the life-cycle analysis.

- “It may therefore be an expensive alternative, as SOFC is expensive technology.”

We agree that cost is a concern. The energy required to remove oxygen at the lower temperature will be more than that needed at the higher temperature. However, based on life-cycle analysis to date, the significant reduction in the required hydrogen may offset the higher capital cost. As another reviewer pointed out, hydrodeoxygenation is “inefficient” and “hydrogenation will almost certainly never be a commercial reality at any significant scale.” This project is aimed at demonstrating the technical feasibility of an alternative approach and evaluating its economic feasibility.

- “If this process can be utilized to efficiently remove certain functional groups and support targeted decomposition reactions, it could play an important role in other downstream processing/refining challenges.”

We appreciate the suggestion. While beyond the scope of the project, it can be envisioned that by introducing additional catalysts in the electrode, more specific functional groups can be removed and formed to make the process more compatible with downstream processing.

- “Process robustness is a major concern.”

The team shares the concern about process robustness. The next experiment at Pacific Northwest National Laboratory will operate the integrated unit for a longer duration to understand the process stability and device robustness.

IMPROVED HYDROGEN UTILIZATION AND CARBON RECOVERY FOR HIGHER-EFFICIENCY THERMOCHEMICAL BIO-OIL PATHWAYS

(WBS#: 2.5.4.405)

Project Description

This project focuses on the potential for improved hydrogen utilization and carbon recovery in a novel, direct biomass liquefaction process. The primary objective is to use hydrogen during in-situ catalytic biomass pyrolysis to maximize the biomass carbon and energy recovery in a low-oxygen-content, thermally stable biocrude intermediate that can be efficiently upgraded into a finished biofuel. The secondary objective is to improve the carbon efficiency of the integrated process by converting the carbon in the aqueous stream to methane for hydrogen production. New and novel catalysts are being developed to improve hydrodeoxygenation during cata-

Recipient:	Research Triangle Institute
Principal Investigator:	Dave Dayton
Project Dates:	9/1/2014–12/31/2017
Project Category:	Ongoing
Project Type:	FY 2013—CHASE: DE-FOA-0000812
Total DOE Funding:	\$3,140,526
DOE Funding FY 2015:	\$0
DOE Funding FY 2016:	\$0
DOE Funding FY 2017:	\$900,000

lytic biomass pyrolysis to reduce biocrude oxygen content, reduce char formation, and subsequently improve hydrogen utilization during biocrude upgrading. We are evaluating anaerobic digestion for aqueous-phase carbon conversion to methane that can be reformed for hydrogen production.

Overall Impressions

- This is a well-managed and well-run project providing details and clear goals and accomplishments. The team is to be commended. I see no issues or

Weighted Project Score: 7.5

Weighting: For ongoing projects, there is equal weighting across all four evaluation criteria: Approach, Relevance, Accomplishments and Progress, and Future Work.

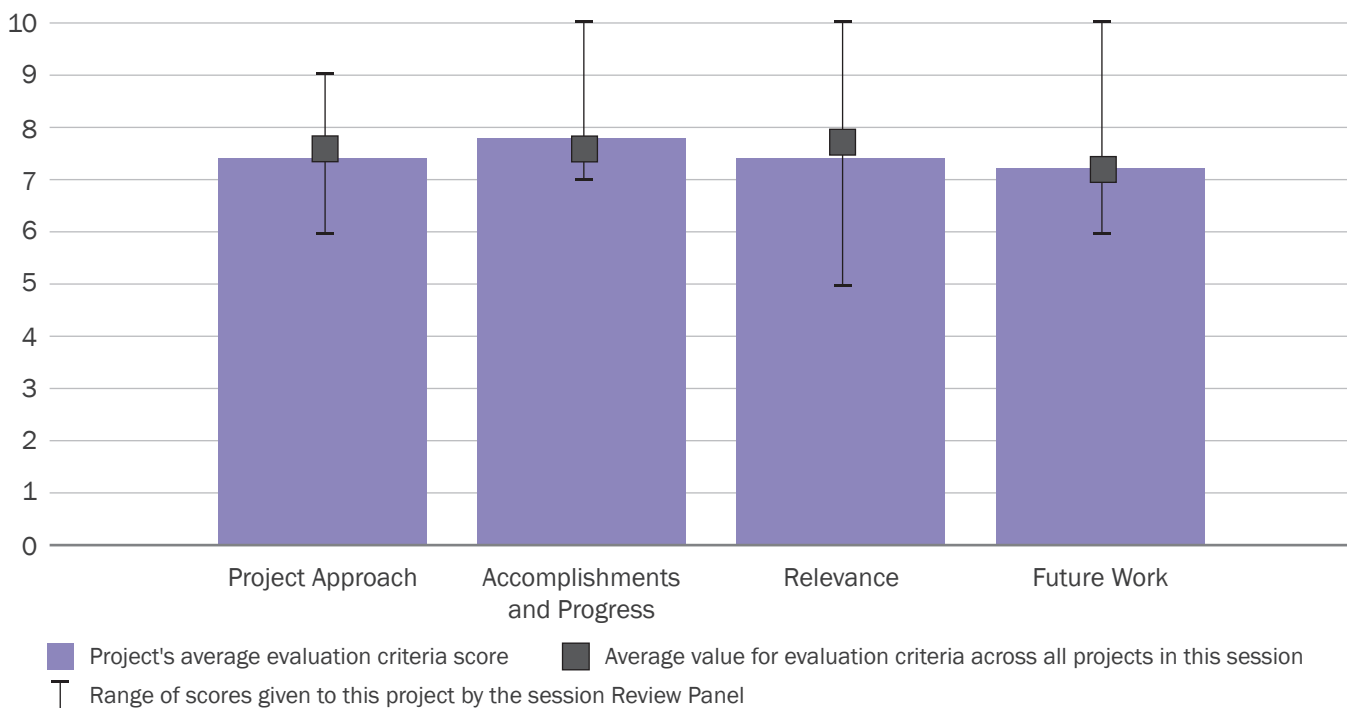



concerns other than catalyst lifetime, which will be worked on in phase 2.

- This is a very interesting project; however, it is basically integrated hydro-pyrolysis plus hydroconversion technology (IH₂) “light.” It confirms the benefit of using a hydrogen transfer catalyst and added hydrogen on retention of carbon during pyrolysis. However, IH₂ has already demonstrated this fact. The unique feature in this approach is lower-pressure operation. The anaerobic digester work shows the potential of this technique to produce hydrogen for the process. However, there are still concerns about the toxicity of the feed. The long time scale needed to condition the microbes will be a significant operational constraint.
- This is a good project for a highly integrated technology, which results in a more efficient process scheme. Techno-economic analysis will confirm if the integrated process is competitive (high capital cost?).

- Overall, this is a solid project that contributes to a growing portfolio of fast pyrolysis reactors capable of running under H₂ atmosphere. That said, at commercial scales, even if the hydrogen comes from light gases produced *in situ*, natural gas steam-methane reforming will be more economic and financeable. Furthermore, it is widely known that high H₂ partial pressures reduce coking and increase liquid yields. So, it is not clear how this project has advanced the state of the art in that regard. An expanded look at carbon efficiency versus realistic product value needs to take place, starting with a close look at “where” carbon efficiency should take place (based on what has been learned in the last 10 years of pyrolysis research). If the objective is to convert the pyrolysis liquid into a fuel blendstock outside of a refinery, the most economical way to do this is the removal of oxygen, not through hydrogenation, but through staged pyrolysis since the light pyro-gases often contain the most O₂. If the objective is to make value-added chemicals (such as fuel/oil additives) from biomass, then keeping the oxygen and leveraging the reactivity of biomass chemistry to make valuable non-hydrocarbon chemicals makes the most sense. Trying to solve these challenges through brute force H₂ hydrogenation and utilization of catalysts in harsh conditions is unlikely to be constructive in the long term.
- This is an ambitious project, but I’m skeptical that the overall, integrated process for catalytic pyrolysis in the presence of hydrogen will result in improved operability compared with “conventional” catalytic fast pyrolysis.

PI Response to Reviewer Comments

- There is no doubt that hydro-pyrolysis is an effective process for producing a low-oxygen content biocrude with improved yields and reduced char formation compared to catalytic fast pyrolysis; however, we feel that one of the more significant chal-

Challenges for scaling up this technology will be feeding biomass into a pressurized reactor. That said, we are anxiously following the scale-up activities for the IH2 technology.

We are addressing this technical challenge by developing an atmospheric pressure process that utilizes hydrogen in a catalytic biomass pyrolysis process—reactive catalytic fast pyrolysis—yet has comparable biocrude yields and quality to the high-pressure process. There is scant literature detailing the benefits of utilizing hydrogen in biomass pyrolysis at low pressure outside of small microreactor systems and model compound studies. This project aims to fill that technical gap and provide information for hydrodeoxygenation of biomass pyrolysis vapors at the large laboratory and pilot scales.

The reactive catalytic fast pyrolysis process is also integrated with an anaerobic digestion process to investigate the potential of recovering carbon from the aqueous phase and converting it into renewable methane. Anaerobic digestion has been done commercially for decades, but the application of anaerobic digestion to a biomass pyrolysis aqueous stream is unique to this project. In fact, with methane from the anaerobic digestion, no additional fossil hydrogen

is required in the process, ensuring that it meets the 50% greenhouse gas emissions reduction required for advanced biofuels. This opens the possibility of finding alternative uses for the pyrolysis gases.

Initially, the biofuel wastewater was very toxic to the microbes, even at 0.02% addition, by best management practice tests. We have since started very slowly on acclimation, and we have improved the performance significantly—going from zero removal to more than 70% removal and conversion to CH₄. The innovation is the adaption of the microbial population in the sludge for converting carbon in the aqueous phase containing various organics, many of which can be toxic to anaerobic microorganisms. Future work in the project is focused on improving the carbon conversion in anaerobic digestion using proper pretreatments and process optimization.

Catalyst regeneration during reactive catalytic fast pyrolysis and the safe addition of hydrogen to the 1 ton/day pilot plant remain technical challenges for scaling up the process. We will perform additional laboratory experiments to evaluate the efficacy of other regeneration options and develop a strategy for catalyst regeneration in the pilot plant tests. Efforts are also underway at RTI to produce large quantities of fluidizable and attrition-resistant catalysts.

ADVANCED MEMBRANE SEPARATIONS TO IMPROVE EFFICIENCY OF THERMOCHEMICAL CONVERSION

(WBS#: 2.5.5.301)

Project Description

The objective of the project is to develop and employ robust advanced membranes to improve the efficiency of bio-oil processing. These porous membranes take advantage of surface tunability (from superhydrophilicity to superhydrophobicity) to achieve high permeability while maintaining high selectivity. This effort is relevant to BETO's barriers (Ct-L) Aqueous Phase Utilization and Wastewater Treatment, (Tt-E) Liquefaction of Biomass and Bio-Oil Stabilization, and (Tt-G) Fuel Synthesis and Upgrading. Key challenges are enabling higher flux (at desirable separation factor), improving chemical/thermal stability and fouling resistance, and developing a path forward to a small unit volume but high-productivity membrane module. By September

Recipient:	Oak Ridge National Laboratory
Principal Investigator:	Michael Hu
Project Dates:	10/1/2016–9/30/2019
Project Category:	Ongoing
Project Type:	Annual Operating Plan
DOE Funding FY 2014:	\$500,000
DOE Funding FY 2015:	\$790,000
DOE Funding FY 2016:	\$790,000
DOE Funding FY 2017:	\$715,000

2019, we plan to demonstrate a separation technology to meet performance targets (>1 liter/m²/hour liquid dewatering flux at separation factor >20) and achieve a >8% reduction in MFSP (\$/gge). Over the past 2 years, we have made significant advancements in vapor-phase dewatering and liquid-phase separation technologies. For example, we demonstrated a >5x improvement in the permeation flux for dewatering membranes, which will lead to a more efficient process for recovering carbon from aqueous waste streams. Our work has led to an industry-funded commercialization project that is

Weighted Project Score: 7.5

Weighting: For ongoing projects, there is equal weighting across all four evaluation criteria: Approach, Relevance, Accomplishments and Progress, and Future Work.

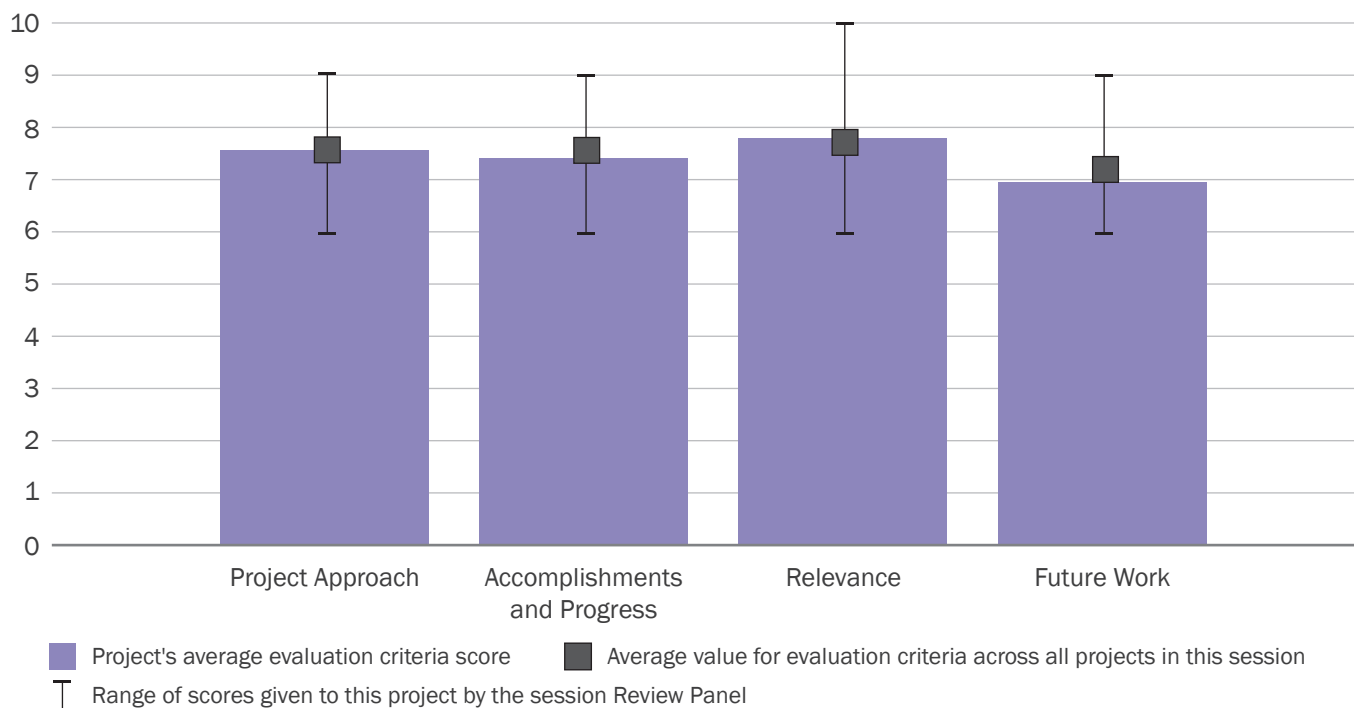

seeking to integrate advanced emulsion separation technologies with biofuel conversion reactors to increase overall production yield.

Overall Impressions

- The key will be long-term continuous operation trials and further improvement of flux via polymer-graphene coated membranes. However, the progress to date is impressive. Future work in 2018 to explore hydrophobic membranes to lower membrane costs and reduce surface area requirements seems a bit counterintuitive, as the team indicated superhydrophilic gave such good results so far. Perhaps the team can explain further the logic behind the shift in future work? I assume the go/no-go decision in 2018 of separation factor >10 and flux of >0.4 liter/m²/hour is for hydrophobic membrane, as superhydrophilic already achieved this result?
- The use of membrane separation of carbon from the aqueous phase is well worth examining. The approach taken by the researchers has one of the best chances of success. They have made major strides in developing a new membrane technology and are using the methods most likely to resist fouling.
- This is an interesting project. The use of membrane is, on the other hand, a challenge due to corrosive and fouling issues.
- Overall, this is a very interesting development. Thermal stability of the hydrophobic and hydrophilic coatings at 250–400°C is very impressive and suggests a wide range of industrial utility. Chemical stability and fouling resistance is also very intriguing given the small particulate often found in pyrolysis liquids. However, it was not clear how these results compared to current commercial acetic acid and vinegar concentration processes, and additional investigation into these comparisons would provide much-needed context for the level of improvement being proposed.

- Dewatering a byproduct stream may be a necessary component for valorization of biomass aqueous phase. But, the cost to benefit will depend on overall process efficiency, not only of the membrane, but also of the upstream and downstream technologies. The team needs to guard against unit proliferation to have any hope of overall economic process.

PI Response to Reviewer Comments

- Most aqueous product streams contain more water than organics; therefore, less membrane surface area is required to permeate the smaller quantity of organics, assuming hydrophilic and hydrophobic membranes have the same flux. However, if the flux of hydrophilic membranes is an order of magnitude higher than hydrophobic membranes, or if they are made from much less expensive materials, then hydrophilic membranes may be the most cost-effective option for streams containing more water than organics. Alternatively, if the aqueous stream contains less water than organics, then hydrophilic membranes may be the best option, although this is not the case for most aqueous product streams.

Traditional separation methods for acetic acid from water include energy-intensive distillation processes. Membrane separations have the potential to improve the energy efficiency of the process. In future work, we will conduct more separation tests to provide better data to improve the techno-economic analysis in order to justify membrane performance and economics.

Regarding dewatering, we agree with the reviewer. Too many downstream upgrading and separation steps will negatively impact economics. Sending the concentrated organics to hydrotreating for fuel production does not require additional equipment, but impact on fuel selling price may not be significant. Thus, converting organics to higher-value chemicals is necessary, but additional costs will depend on conversion performance/selectivity, separation technology, and product selling price.

FRACTIONAL MULTISTAGE HYDROTHERMAL LIQUEFACTION OF BIOMASS AND CATALYTIC CONVER- SION INTO HYDROCARBONS

(WBS#: 2.5.5.401)

Project Description

The purpose of this project is to demonstrate the technical and commercial feasibility of producing distillate fuels from lignocellulosic materials. Virent is developing a novel multistage hydrothermal liquefaction deconstruction process, which will be paired with Virent's BioForming® process to produce advantaged jet fuel and diesel. Previous testing has demonstrated that both fuels meet or exceed specifications for commercial and military use. In addition to Virent, the project is leveraging expertise of Idaho National Laboratory for the procurement, pre-conversion, and analysis of woody biomass and corn stover. Since its inception in Quarter 4 of 2013, the project has progressed through TRL 2

Recipient:	Virent Inc.
Principal Investigator:	Randy Cortright
Project Dates:	10/1/2013–9/30/2016
Project Category:	Sun-setting
Project Type:	FY 2013–CHASE: DE-FOA-0000812
Total DOE Funding:	\$3,400,000

and completed design, construction, and operation of a pilot unit to demonstrate the hydrothermal liquefaction process. In Quarter 1 of 2016, the project went through a formal stage-gate review to evaluate progress on milestones. The progress and the current status of the project will be detailed during the review.

Overall Impressions

- This is a nice bit of demonstration at pilot-scale work, in terms of biomass to end product fuel. However, project results fell short of the goals and needs for the BETO program. The techno-economic analysis is hard to understand as there was no real

Weighted Project Score: 7.2

WWeighting: Approach–25%; Relevance–25%; Accomplishments and Progress–50%.

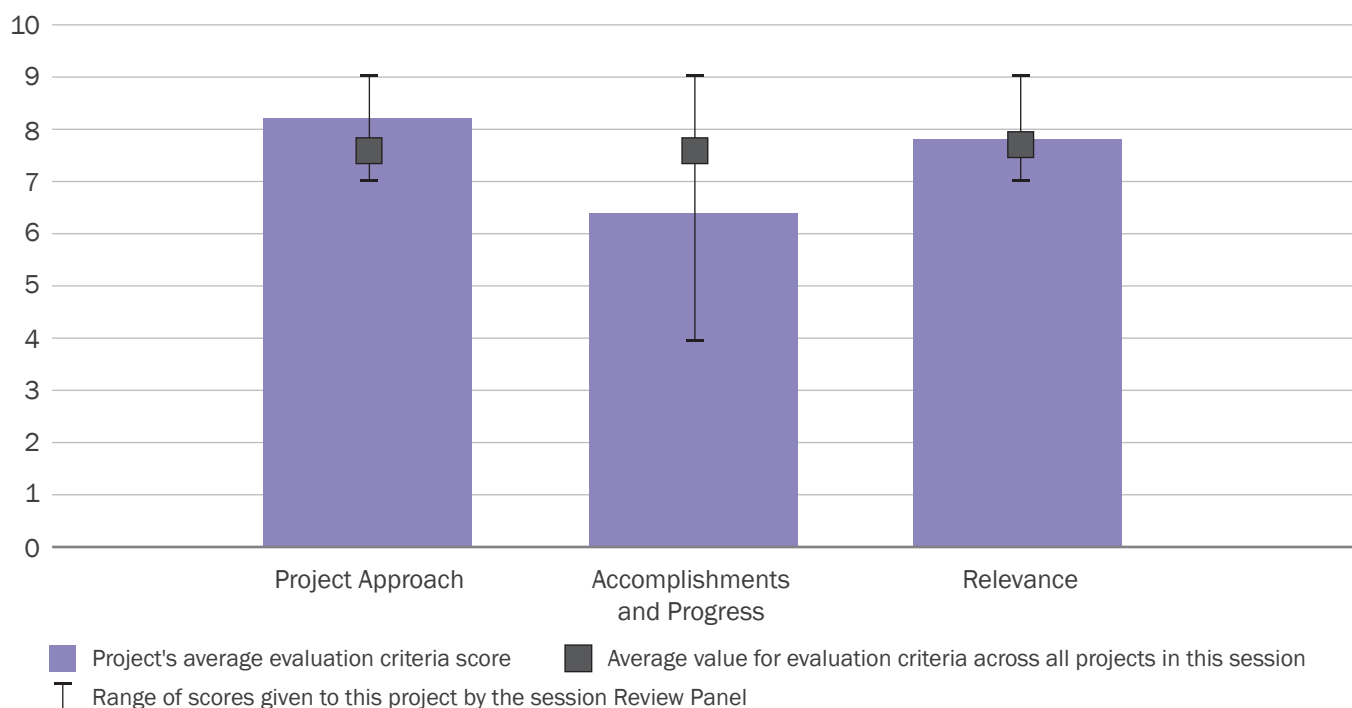



cost info in the slide. Is this proprietary? This was not made clear, so I am asking for clarification on slide 23. My concern is the cost of three solvent systems for separation. I have no concern over Virent backend-to-fuel conversion technology, which was well-demonstrated prior to the project. They were off on some targets for front-end separation product recovery.

- The pilot plant built for this project is a significant resource that could be used to develop other solvent and chemical deconstruction technology. The approach of chemical deconstruction followed by hydrothermal extraction still has some promise, so further testing is needed with longer run times that would allow a better assessment of operability. It would be interesting to see the techno-economic analysis data for this approach in comparison to other solvent extraction and pyrolysis approaches.

- This is a great complete project from biomass to transportation biofuel. There was solid project management with proper scheduling, reporting, and key milestones, as well as critical market and business success factors that were clearly defined. The project has passed the technology readiness steps TRL 2 (applied research) and TRL 3 (proof of concept).
- Overall, despite ending the project early, the results were important because of commercially reasonable conditions and cheap solvent (water). Exploring staged hydrothermal liquefaction at relatively mild thermal conditions and achieving 55% solubilization of feed carbon provided an important data set for assessing biomass deconstruction using water. Most traditional pyrolysis type decompositions occur at 400°C, so this work provides very valuable data for assessing recovery of biomass polymers in more native, unmodified forms. Commercial relevance of these polymers is an entirely different challenge.
- This was a well-executed project despite limited technical success. Some form of biomass pre-fractionation will likely be required to efficiently utilize biomass for energy/fuels.

PI Response to Reviewer Comments

No official response was provided at the time of report publication.

RENEWABLE HYDROGEN PRODUCTION FROM BIOMASS PYROLYSIS AQUEOUS PHASE

(WBS#: 2.5.5.403)

Project Description

Aqueous-phase utilization and hydrogen production are two important barriers in the thermochemical biofuels pathway. This project focusses on utilization of the pyrolysis aqueous phase for hydrogen production via microbial electrolysis cell technology. Biocatalysis and electrocatalysis are used to break down complex and inhibitory organic compounds to produce electrons in the anode and reduce protons in the cathode to generate hydrogen. Critical success factors include development of a diverse microbial consortium to convert carboxylic acids, anhydrosugars, furans, and phenolic compounds at sufficient rates to achieve target hydrogen productivity greater than 15 L-H₂/L-reactor-day. Using switchgrass bio-oil aqueous phase, a rate of 11.7 L/L-re-

Recipient:	Oak Ridge National Laboratory
Principal Investigator:	Abhijeet Borole
Project Dates:	10/1/2013–9/30/2016
Project Category:	Sun-setting
Project Type:	FY 2013–CHASE: DE-FOA-0000812
Total DOE Funding:	\$0

actor-day was achieved. Additionally, we demonstrated a hydrogen production efficiency of 62%. This performance is sufficient to now allow commercial consideration of this technology. Microbial electrolysis cell-associated separations, including oil-water separation and effluent cleanup via membranes, were also demonstrated successfully.

Overall Impressions

- The team is to be commended for outstanding work and program. The scale-up to 1 L is critical, and I wish the team success with that objective. A challenging focus will be optimizing biocatalyst growth

Weighted Project Score: 7.5

WWeighting: Approach–25%; Relevance–25%; Accomplishments and Progress–50%.

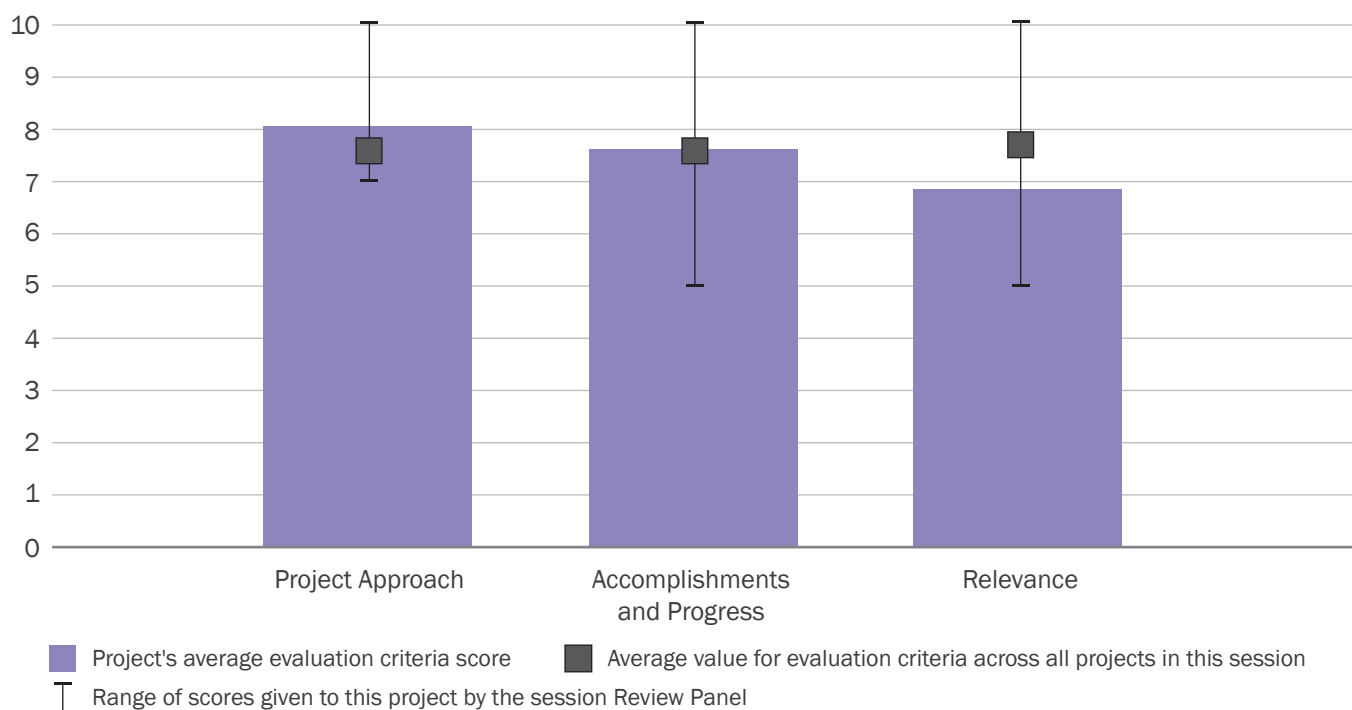



for industrial application. This is always the key issue in all microbial scale-ups, as often this does not translate from laboratory, to pilot, to industrial scale well and has many hiccups, from my own past experience on programs involving biocatalysts (i.e., organisms). Funding for scale-up may require further government funding for reason stated above—that skepticism will be prevalent until proven at a fairly large pilot scale. Thus, the question I have is why is this not being supported beyond 2017 for further scale-up if 1 L is successful?

- The microbial electrolysis cells used in this work are an exciting new development, and BETO should be commended for funding this type of application research.

The cost of the hydrogen produced appears to be tracking higher than the commercial target. This would make the technology viable only in cases where there was very low-cost electricity and a need for hydrogen in stranded locations that it is difficult to reach with normal hydrogen supplies.

The application of this approach may be limited to relatively small-scale operations. When asked about scale-up, the researchers commented that this would

be accomplished by using multiple small modules in parallel and series. This is a very expensive approach.

- This is a good project that has progressed well towards commercialization. There is still a need for additional scale-up and performance optimization and testing.
- Overall, this is a welcome addition to the growing portfolio of bio-hydrogen production technologies. Speciation of electroactive anaerobic microbial community generated interesting data that should contribute positively to the growing microbial fuel cell community. However, it is unclear how this technology would transfer to the existing fixed-film or membrane bioreactor industry. The most parallels would be drawn with the commercialized reactors in use at wastewater treatment plants, so some level of comparison should be completed to improve commercial relevance. Additionally, clearly establishing the preferred carbon source of these organisms is important for future work.
- I'm open to the idea of using the bio-derived aqueous phase for hydrogen generation, but it seems that carbon recovery is likely to be more economically sound.

PI Response to Reviewer Comments

- Thank you so much for the positive comments. We greatly appreciate the question raised by the reviewer: “Thus, the question I have is why is this not being supported beyond 2017 for further scale-up if 1 L is successful?”

Scale-up of the microbial electrolysis cell technology is the next step. However, since this is a sun-setting project, we have no means of pursuing it at this time. We hope BETO will fund further work to scale this technology.

BUILDING BLOCKS FROM BIOCRUDE: HIGH VALUE METHOXYPHENOLS

(WBS#: 2.5.5.406)

Project Description

Integrating biofuels production with bioproducts presents an opportunity to explore options for recovering high-value chemicals as additional revenue-generating products from biofuel conversion pathways. Also, the inherent functionalized nature of biomass offers a unique opportunity for producing oxygenated chemicals that are not easily synthesized from petroleum. However, efficient separation approaches are required to recover the oxygenated species as marketable value-added products. RTI International, Arkema, and AECOM are investigating the technical feasibility and economic potential, as well as the environmental and sustainability benefit, of recovering mixed methoxyphenols (eugenols and guaiacols) from biocrude as building block chemi-

Recipient:	RTI International
Principal Investigator:	Ofei Mante
Project Dates:	10/1/2016–9/30/2019
Project Category:	New
Project Type:	FY 2016–MEGA-BIO
Total DOE Funding:	\$1,987,148

icals alongside the production of biofuels. The optimization of a comprehensive separation strategy to recover the target methoxyphenols as bioproducts is at the heart of this project. Successful completion of this research will result in a process design, techno-economic analysis (TEA), and life-cycle analysis of an integrated biorefinery for biofuel production and co-product recovery. A product development assessment will also be conducted. Achieving technical success in recovering high-value methoxyphenols from biocrude prior to upgrading to biofuels could provide a significant source of revenue to improve overall process economics and help meet the \$3/gge modeled production cost target for advanced biofuels technologies by 2022.

Weighted Project Score: 5.7

WWeighting: Approach–25%; Relevance–25%; Accomplishments and Progress–50%.

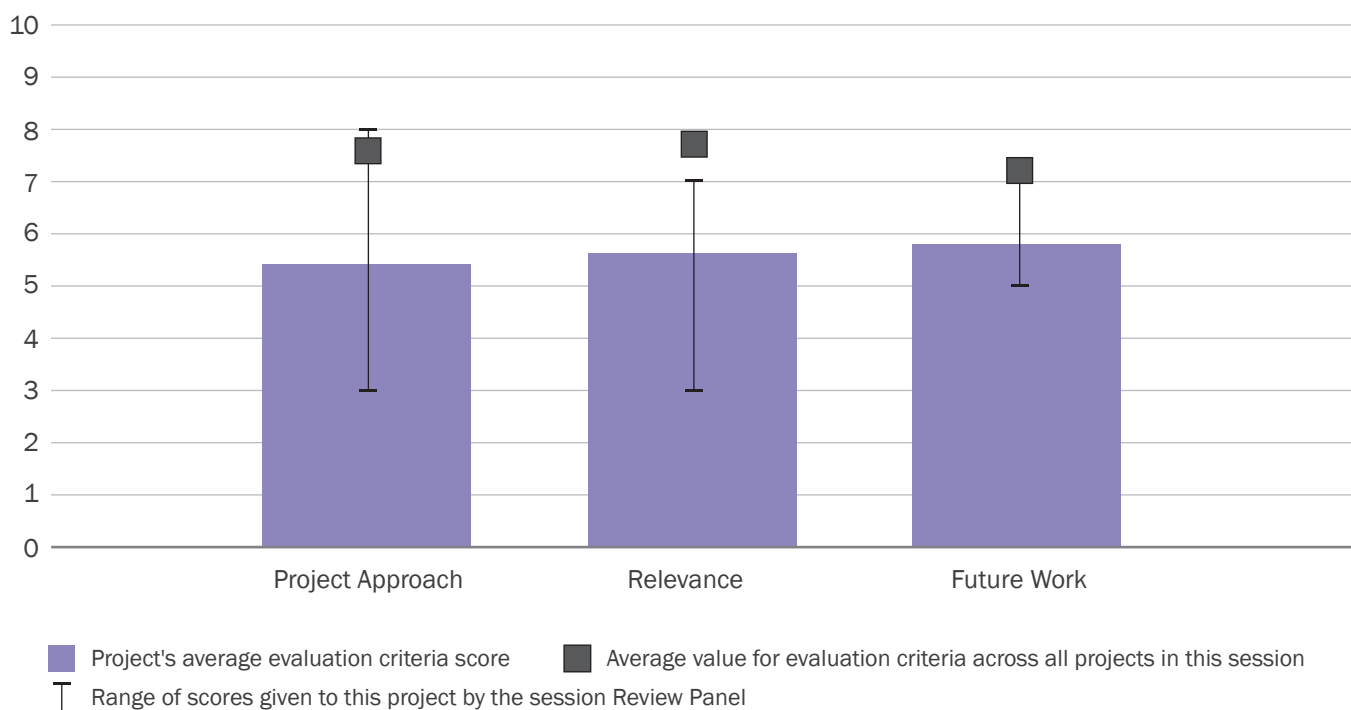



Overall Impressions

- This is one of the few projects where I feel that the targets are not relevant to the goals of BETO. The current market for eugenol is in the few-thousand-ton range. Its high cost is reasonable since eugenol end-use is very specialized, the product is very sensitive to minor odor components, and end-users often require further purification.

Billion-ton feed use is mismatched with thousand-ton market and, as such, cannot impact BETO fuel cost in the long term. I applaud the team's results, which were outstanding, but relevance outweighs the solid work results of the program. I am not sure that the TEA would provide any different result if market impact is taken into account. Any substantial volume production of the material targets would totally disrupt the current market price. Again, the team did a nice job working the program and accomplishments on goals, but the program is not a fit with BETO needs.

- Producing higher-value chemicals to support the development and use of renewable fuels has become a major theme in the BETO development efforts. The hope is that these could supplement or replace renewable energy credits. Until now, the justifications

for this program for bio-oils have not been based on a rigorous TEA with participation of a chemical manufacturer. This project addresses this need. The program leverages RTI's ability to produce large quantities of cata-pyrolysis and pyrolysis liquids. This is a key enabler of many related projects involving upgrading of the liquids and aqueous-vapor products and should be funded if possible.

The difficulty with this project is that the proposed experimental work is weak. There is no evidence of a deep understanding of the problems associated with separation of bio-oil relative to other types of chemical feedstocks. Information from prior efforts to separate bio-oil in the open literature and patents are not included in the planning and used as a kick-off. There are processes for separating chemicals from coal gasification, coal tar, and low-temperature coal pyrolysis in the past that include commercial process design and economics.

- This is an interesting project that may add value to integrated biorefinery projects. It will be interesting to follow the progress of this newly started project.
- Overall, the methoxyphenol objective is sound (at small scales), and the equipment is proven and makes sense. However, the project must seriously consider efficiencies for the results to have any commercial relevance. If the target is methoxyphenols and the feedstock is biomass, moving to a lignin-only, solvent liquefaction pyrolysis is both logical and necessary.
- I am highly skeptical that there is any market for a mixed biogenic phenol streams. Therefore, in budget period two, identification of feasible purification strategy and identification of markets will need to be efficiently executed for this project to be successful.

PI Response to Reviewer Comments

- This is a new R&D project that was awarded under the MEGA-BIO: Bioproducts to Enable Biofuels

FOA (DE-FOA-0001433). The objective of the FOA was to examine strategies that capitalize on revenue from bioproducts as part of cost-competitive biofuel production. The pathways that were considered responsive to the FOA included a route to a platform chemical that could be converted to products/fuels or a route that co-produces chemicals and fuels. Based on the FOA, this project proposed to develop and optimize a hybrid separation strategy to recover high-value methoxyphenols as bioproducts to improve the process economics and environmental impact of the production of advanced biofuels via catalytic pyrolysis integrated with hydroprocessing.

Furthermore, this project falls under the FOA's topical area 1 (TRL 2–3), which seeks to optimize one-unit operation of a proposed pathway. Hence, the technical focus of this project is not on the production of methoxyphenols, but rather on the separation of methoxyphenols present in biocrude produced from the biomass catalytic pyrolysis technology. While the targeted methoxyphenols could be produced from isolated lignin stream, this doesn't fit into the scope of the present project as 51% of the biomass carbon is required to end up in an advanced biofuel. The role of Arkema in evaluating the market potential of the mixed methoxyphenols and developing a business opportunity for the use of the methoxyphenols as chemical building blocks for other high-value products cannot be overstated. Additionally, the participation of AECOM in evaluating the impact of separating out the methoxyphenols as bioproducts on the process economics and life cycle of the pathway is a critical aspect of the project.

Preliminary TEA suggests that the recovery of methoxyphenols could help reduce the cost of fuel production if economical and efficient separation of methoxyphenols could be achieved. Based on available data, the market prices of methoxyphenols are between \$3–\$5/kg. Effective and efficient sepa-

ration of methoxyphenols has the potential to reduce the overall biofuel cost of production. Bioproducts recovery has the potential to have a much more significant impact on the process economics compared to, for example, the application of D5 Renewable Identification Numbers at \$1.00/gal (\$0.33/kg) for advanced biofuels.

The project is divided into eight tasks over 36 months, with two go/no-go decision points and three validations (initial, intermediate, and final). The experimental work includes bench-scale development of a separation strategy to recover methoxyphenols with 85% efficiency, 10% residual losses, and methoxyphenol purity of at least 90%. There is also a task on the scale-up of the separation method once developed to perform laboratory separation evaluation. Other experimental tasks include upgrading of the remaining biocrude after separation and evaluation of co-product pathway that utilizes the mixed methoxyphenols as a chemical feedstock. The market feasibility assessment, product development, TEA, and life-cycle analysis are other tasks to be performed in the project.

The separation work will focus on solvent extraction using alkaline and switchable hydrophilic solvents (e.g., N,N-dimethylcyclohexylamine) and fraction distillation under vacuum in the development of a hybrid approach for isolation, concentration, and purification on the methoxyphenols bioproduct. The research plan and the project execution strategy have been designed to be flexible enough to accommodate possible technical challenges. For instance, adsorption separation (e.g., using an acrylic ester sorbent XAD-7 or a strongly basic anion exchange resin) is in the separation research plan as a mitigation strategy to ensure that the target concentration of methoxyphenols is achieved. The challenge with final product quality/purity will be addressed in the project work, and the cost of additional separation processes will be captured in the TEA.

MELT-STABLE ENGINEERED LIGNIN THERMOPLASTIC: A PRINTABLE RESIN

(WBS#: 2.5.6.103)

Project Description

The objective of this research is to produce and commercialize lignin-derived, industrial-grade polymers and composites with properties, including printability, rivaling current petroleum-derived alternatives. Technologies that enable high-value uses of lignin, a biorefinery waste stream, are important to facilitate the cost-competitive production of biofuels. In this research, we will produce a novel family of commercial-ready, lignin-based thermoplastic polymers and polymer composites suitable for high-volume applications, specifically those that are inherently recyclable, with the capability to retain their unprecedented mechanical properties after repeated thermal processing. We utilized fractionated lignins to melt-mix with soft rubbery matrices. Various mixtures

Recipient:	Oak Ridge National Laboratory
Principal Investigator:	Amit Naskar
Project Dates:	4/1/2016–9/30/2018
Project Category:	Ongoing
Project Type:	Annual Operating Plan
DOE Funding FY 2014:	\$0
DOE Funding FY 2015:	\$0
DOE Funding FY 2016:	\$500,000
DOE Funding FY 2017:	\$500,000

were investigated for making 3D-printing filaments. Interestingly, strong interactions between source-specific lignin macromolecules and cross-linking chemistry present an excellent and unexpected thermal response on elastic recovery of the material. Therefore, tuning such properties of selected composites was investigated. A new composition based on thermoplastic matrix reveals better control with rheological behavior. These compositions offer potential intellectual properties, and currently three industrial partners are negotiating license options (on background intellectual properties) with

Weighted Project Score: 7.6

Weighting: For ongoing projects, there is equal weighting across all four evaluation criteria: Approach, Relevance, Accomplishments and Progress, and Future Work.

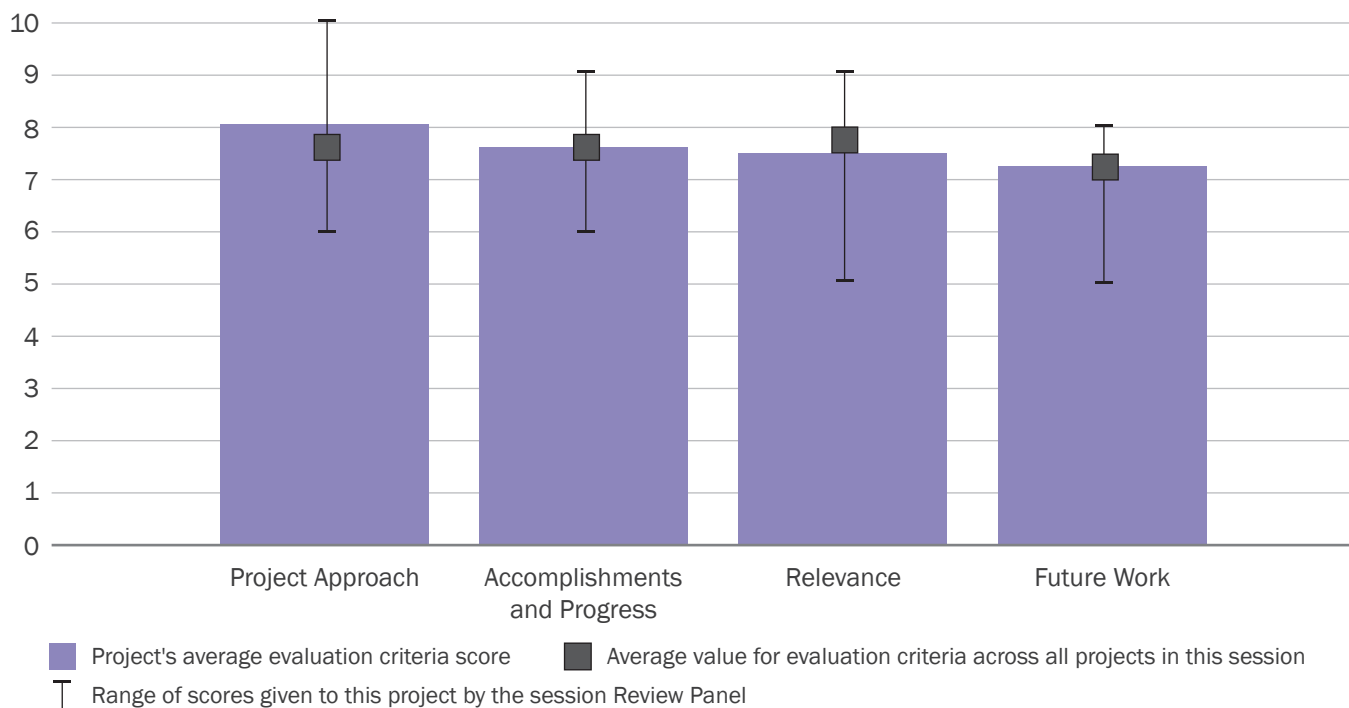

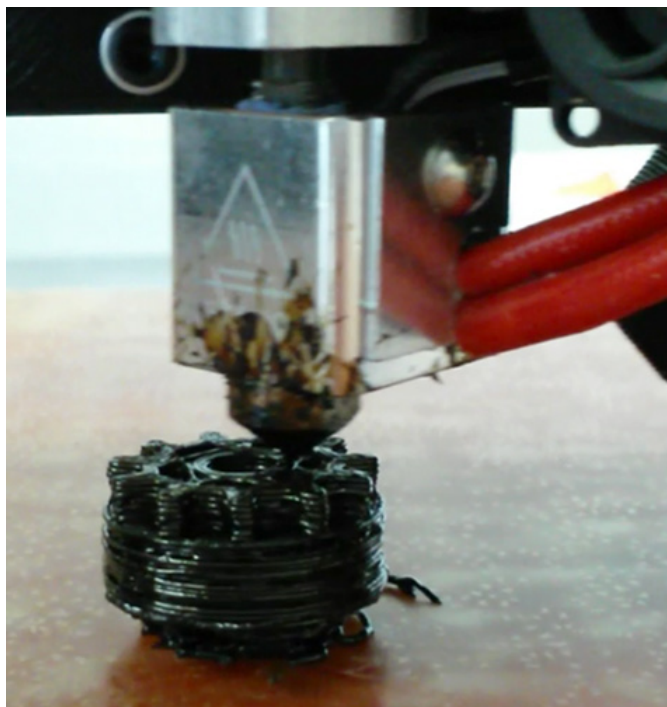

Oak Ridge National Laboratory. Our approach utilizes unmodified lignin at 50% volume to produce engineered plastic materials with values of \$2,000–\$5,000/metric ton.

Overall Impressions

- Overall assessment: This is an extremely relevant approach to fixing the old problem of how to make money on lignin. This could be solution to many of the economic challenges of the more complex conversion of sugar and other intermediates to fuels, if successful, and it is a nice way to increase the use of carbon in biomass in a high-value-added way.

Adoption in this industry can be challenging for new materials processed, as noted by lengthy time it took new plastics like polylactic acid, etc., to gain interest and even still, there was slow market penetration. Early involvement of the plastic industry is critical.

- The project is great example of finding value-added use for the co-products from biomass deconstruction. Using lignin directly to produce a polymer product has great potential. The researchers have

generated significant commercial interest. BETO should continue to fund efforts to find these types of alternative uses for the co-products from biomass conversion.

No information on the potential market size was presented; as a result, the impact of this work on overall fuel production cannot be evaluated.

- This is a successful project that may result in valuable licensing opportunities.
- Overall, this is an extremely interesting project with a great deal of potential. The team is correct that enabling the use of lignin as a component in 3D-printable resins could help open a significant and important regional biopolymer market. Exploration of stress versus strain for different lignin–nitrile butadiene rubber mixtures was very compelling. Rheology data is a nice complement and supports a high degree of integration between the polymers, but proof of cross-linking needs additional work.
- This is an interesting extension of Oak Ridge National Laboratory's base technology in 3D printing. Lignin valorization will be a key enabling factor for the economical utilization of fractionated biomass. I look forward to more detailed market analysis to demonstrate that this has the potential to be more than a niche product.

PI Response to Reviewer Comments

- So far, we have developed a composition that outperforms some petroleum-derived plastics (e.g., ABS resin). Appropriate market size will be estimated based on ease of scaled-up processing and the aging performance of these new compositions.

Penetrating the market with these new compositions is indeed challenging. Early involvement within the plastic industry is very important! Fortunately, our background intellectual property includes primarily toughened lignin polymer blends (pending patent

application 14/798,729) and is being commercialized by UT-Battelle, LLC (Oak Ridge National Laboratory). Three license applications are being considered. We admit that these compositions are thermoplastic elastomers and have not yet demonstrated 3D printability. However, in the last quarter (January–March 2017), based on new results, we have disclosed two new intellectual properties related to 3D printability of lignin-based thermoplastics. In these cases, as-received lignin aids 3D printability as it offers room-temperature rigidity and high-temperature plasticity. We expect combination of our ongoing commercialization effort and the development of newer printable compositions will strengthen our goal. Also, we know that one of the licensees wants to incorporate part of this technology into the construction industry. This could be a low-hanging fruit.

We are currently working on demonstrating the nitrile butadiene rubber–lignin interaction by nuclear magnetic resonance, rheology, swelling data, and solvent based separation and quantification of unbound lignin to the nitrile butadiene rubber matrix.

Appropriate market size analysis will be conducted based on ease of scaled-up processing and the aging performance of these new compositions. At this moment, our priority is to establish fundamental understanding associated with the compositions and to fine-tune performance and processability of the material. Once the TRL is elevated (for 3D printable materials), we will put our best effort forward to deliver a successful commercialization and a product.

CHEMCATBIO OVERVIEW

(WBS#: CCB1)

Project Description

As part of the DOE Energy Materials Network, ChemCatBio leverages unique DOE national laboratory capabilities to address technical risks associated with accelerating the development of catalysts and related technologies for the commercialization of biomass-derived fuels and chemicals, leading to enhanced energy security and national leadership in the global bioeconomy. ChemCatBio consists of technical capabilities experts, technology transfer agreement experts, and data experts from seven DOE national laboratories with demonstrated experience in developing advanced catalytic materials. A steering committee—made up of technical capability experts from the participating laboratories and DOE representatives—guides the ChemCatBio consortium's research direction and approach, coordinated streamlined industry access, and identification and incorporation of unique national laboratory capabilities.

Recipient:	National Renewable Energy Laboratory, Pacific Northwest National Laboratory
Principal Investigator:	Josh Schaidle
Project Dates:	10/1/2016–9/30/2019
Project Category:	Ongoing
Project Type:	Annual Operating Plan
DOE Funding FY 2014:	\$0
DOE Funding FY 2015:	\$0
DOE Funding FY 2016:	\$0
DOE Funding FY 2017:	\$0

This consortium establishes an integrated and collaborative portfolio of catalytic and enabling technologies that spans from foundational science to demonstration-scale integrated biomass-to-fuels processes. The outcome is a reduction in the time and cost required to transition catalytic materials from discovery to deployment by targeting both pathway-specific and overarching catalysis challenges and by engaging industry at all phases of the materials development process.

Weighted Project Score: 7.5

Weighting: For ongoing projects, there is equal weighting across all four evaluation criteria: Approach, Relevance, Accomplishments and Progress, and Future Work.

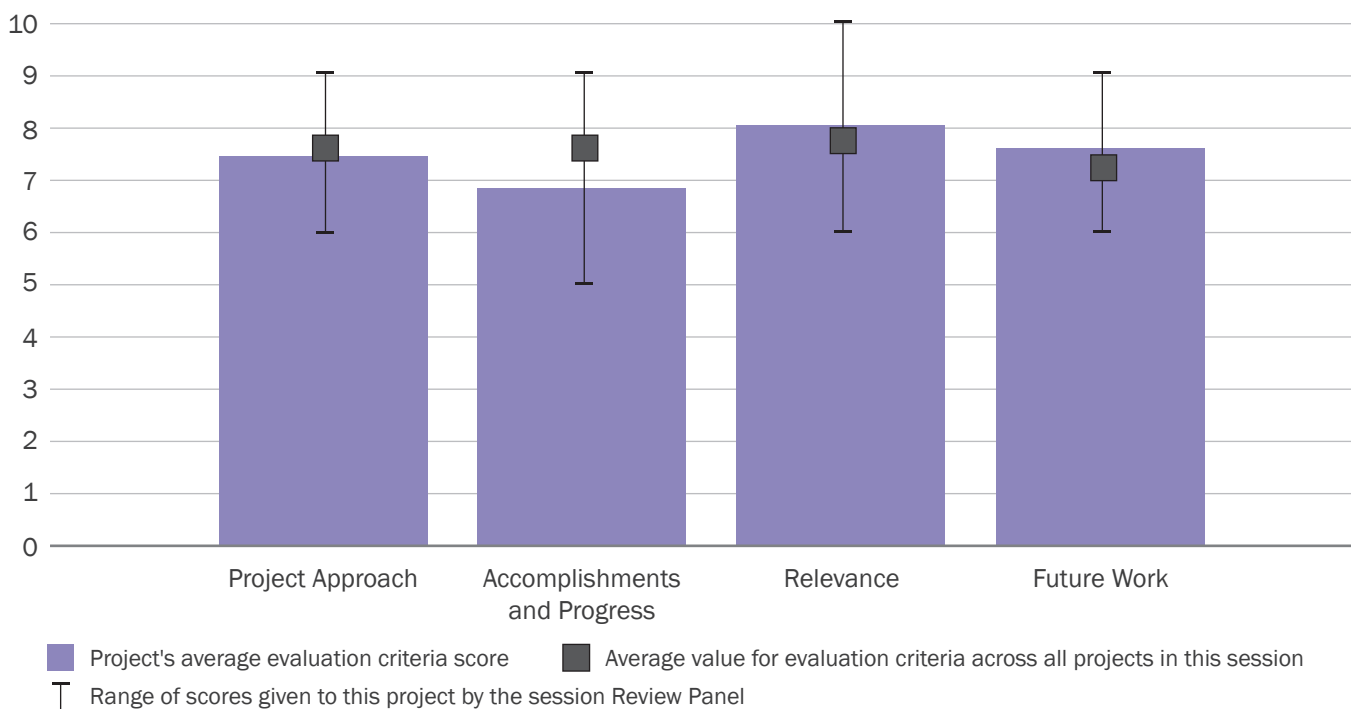

Overall Impressions

- This is a great team and an important structure to have in place to make sure catalyst development does not slow progress of the projects. An industry advisory board is critical for such a group and needs to be set up ASAP. I would make sure you get a variety of people, not just from catalyst companies, but also technical catalyst R&D people from industry—both chemical and fuels that use catalyst suppliers and have developed with suppliers' new catalysts. Also, perhaps an industry advisory board would be well-suited for evaluating the project team's spent catalyst for front-end trapping.

Also, as I have indicated, it would be good to make sure that sufficient industrial catalyst screening has taken place as well. I did not feel I had seen this in the reviews I sat through. Was this done prior? There are, as I have indicated, good sources of actual catalyst available without license or restrictions. These come from companies (I used Resale Catalyst, which has a good stock usually). They are reasonable on cost of sampling, at least in 2011–2013 or so when I used them to explore conversion chemistry on stream. Pints or quarts were available for a few hundred dollars at the time, each with a discount for a larger number of sampled catalysts.

- The idea behind the consortium should eventually lead to more rapid improvement. The project managers should be looking for examples of synergy that would have not occurred in the absence of the consortium. The consortium should be evaluating ideas from outside the laboratories in the patent and open literature.
- This is an important project that will be even better by involving industrial partners in the guidance of future work. The risk of reinventing “the wheel” will be greatly reduced, and more realistic (lower) catalyst costs may be achieved.

- Overall, this is a great consortium that has the potential to drive alignment across a wide array of projects and programs. However, BETO exists more to enable the biofuels/bioenergy industry, as opposed to deploying and commercializing home-grown new technologies. As such, integrating all phases of catalyst R&D, discovery through deployment, could put ChemCatBio in a redundant position, with industrial catalyst partners doing exactly the same thing (but with more money and resources). As ChemCatBio is unlikely to produce commercially adopted catalysts, its focus on reducing the catalyst development life cycle should be based on enabling industry catalyst partners to commercially produce catalysts that, in turn, enable the biofuels/bioenergy industry. This enabling function must be rooted in recommendations from the catalyst industry itself.
- This is an ambitious project. I am skeptical that catalyst development cycle time (time from discovery to commercialization) will be significantly impacted, mainly due to reluctance of industry to be completely forthcoming about what it knows and what it wants. However, if the underlying projects significantly build the catalyst fundamentals expertise at the laboratories, that will be a valuable contribution to the catalysis community.

PI Response to Reviewer Comments

- We greatly appreciate the reviewers' constructive feedback. We agree that the consortium has great potential to accelerate catalyst development and lead to greater technology advancements. The reviewers have adeptly identified many of the key success factors to the consortium, including industry engagement, a clear value proposition that does not compete with existing entities in the catalyst development ecosystem, a focus on fundamentals that enable deployment, and the fostering of synergies between core projects and enabling projects.

We will use this excellent feedback to guide our path forward.

We agree with the reviewers that forming the industry advisory board and engaging industry are keys to the success of the consortium. We are actively working on forming the industry advisory board and have scheduled our first stakeholder listening day for June 9, to be held in conjunction with the North American Catalysis Society meeting in Denver, Colorado. We just finished drafting an industry advisory board charter and have a list of potential members that we will be reaching out to within the next couple of months. These potential members have diverse backgrounds and experience and can provide technical guidance, insights into industrial relevance, “big picture” perspectives, and policy implications. We plan to use our first stakeholder listening day in June to shape our value proposition for the consortium and to ensure that we are not directly competing with industry. We appreciate the guidance to focus on the fundamentals (i.e., characterization, mechanisms, modeling) and leave the commercial catalyst formulation to industry. We apologize if our use of the word “deployment” was misleading. We should have chosen a different phrase. We do not intend to take catalysts to market or try to produce finished formulations. We meant that one capability of our consortium is catalyst evaluation at the pilot scale using our in-house systems, which saves money and reduces risk for industrial partners, thus enabling commercial deployment.

Even though this consortium is still in its infancy, we have already identified specific synergies, including (1) development of hydrothermally-stable mixed metal oxide ketonization catalysts that are applicable to multiple conversion pathways, as well as (2) identification of linkages between vapor-phase and liquid-phase upgrading over metal carbide catalysts, allowing for the development of deactivation mitigation strategies and approaches for enhancing performance through promoters/dopants. As the consortium matures, we expect that these synergies will grow. Experience from the Consortium for Computational Physics and Chemistry suggests it takes over 3 years before such a complex team is fully integrated and synergies are being turned into success stories. We are leveraging their experience to hopefully reach that point sooner for ChemCatBio. We expect to demonstrate significant successes in the coming years that would not have been possible without the consortium structure and agree with the reviewers that this is a key success factor of the consortium.

We thank the reviewers for their suggestion to evaluate ideas from outside the laboratories in the patent and open literature and reach out specifically to those groups. We also appreciate the suggestion to evaluate more industry standard catalyst materials to compare to catalysts under development within the consortium. We will pursue both of these approaches moving forward.

BIOMASS GASIFICATION FOR CHEMICALS PRODUCTION USING CHEMICAL LOOPING TECHNIQUES

(WBS#: EE0007530)

Project Description

The biomass-to-syngas process is a unique gasification process developed at Ohio State University that provides a highly cost-effective and energy-efficient alternative to the conventional biomass gasification processes. The gasification of biomass is accomplished through the unique combination of a co-current moving bed reactor and iron-titanium composite metal oxide oxygen carrier developed at Ohio State. It allows for conversion of biomass to high-quality syngas with an H₂:CO ratio of 2:1 in a single step without the use of molecular oxygen and capital-intensive units like a tar reformer, water gas shift reactor, and air separation unit. Such high-quality syngas generated permits the downstream processing to be readily conducted to produce chemicals and liquid

Recipient:	Ohio State University
Principal Investigator:	Andrew Tong
Project Dates:	10/1/2016–9/30/2019
Project Category:	New
Project Type:	FY 2015–BRDI
Total DOE Funding:	\$1,500,000
DOE Funding FY 2015:	\$0
DOE Funding FY 2016:	\$0
DOE Funding FY 2017:	\$0

fuels without requiring syngas conditioning systems for tar cracking and/or hydrogen upgrading. The 1 Kath bench-scale moving bed reactor studies have confirmed that biomass gasification with varied rates of low-steam feeding can achieve the H₂:CO ratio in syngas of 1.7 to 2.2 with greater than 60% syngas purity. The project's specific goals are to (1) design, construct and operate a 10 Kath commercially scalable sub-pilot biomass-to-syngas system, and (2) complete a comprehensive techno-economic analysis of the biomass-to-syngas process using methanol production as an example. The support from 10 industrial partners will ensure the com-

Weighted Project Score: 7.6

Weighting: Approach–25%; Relevance–25%; Future Work–50%.

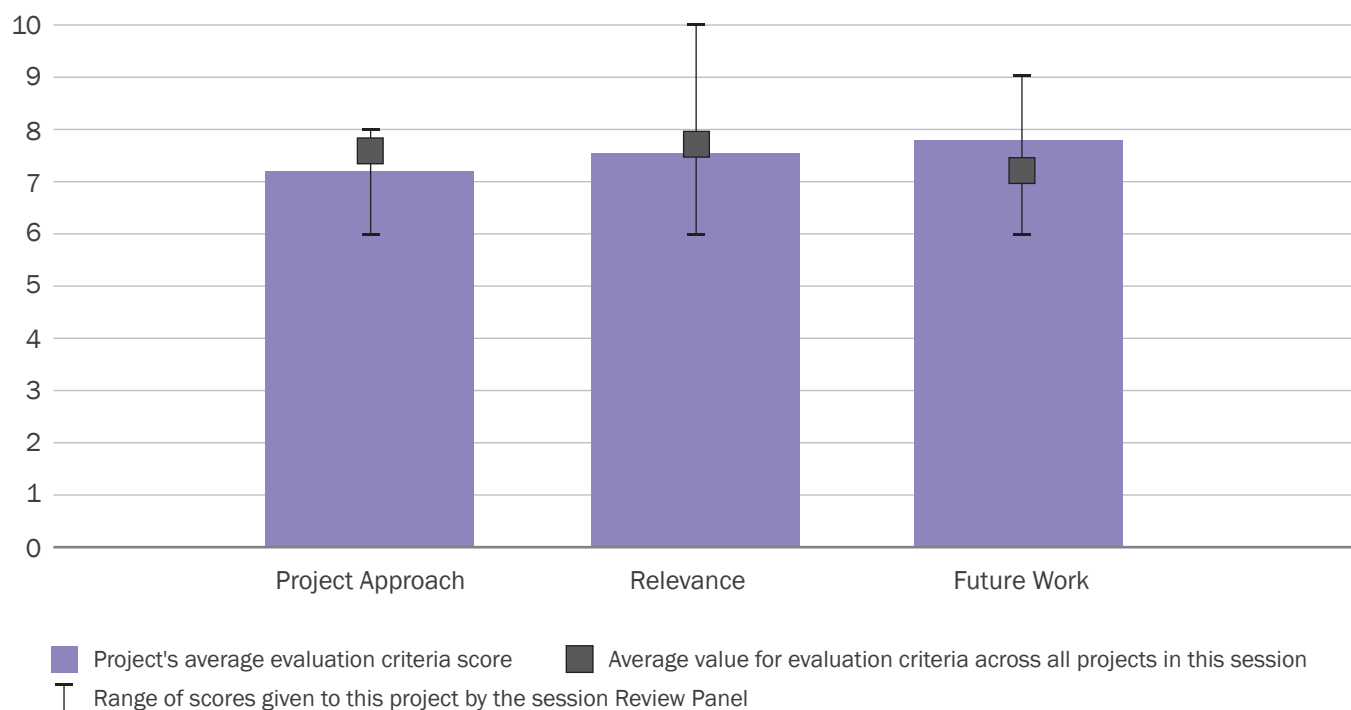

mercial relevance of the proposed sub-pilot testing and techno-economic analysis objective.

Overall Impressions

- I really think this project has a lot of potential to help BETO meet their goals. The key will be cost/size analysis and long-term operation without issues at larger scale. Close attention to feed input and completeness of conversion in larger unit operation will be critical. One concern is how fast and at what cost feed can be inputted into system. High cost and slow speed can be avoided by addressing the issue of irregular particle sizes causing plugging, considering that they are running solid catalyst through the system along with woody biomass particles or later grasses. I did not see any info about how ash will be handled in the system and its impact on the catalyst. I see that mercury is accounted for in the system, and acid gas removal as well, but not addressing ash? Is it a given that it will be removed post-combustor, or will the unit have to be shut down, cleaned of ash, and restarted again?
- Chemical looping is an intriguing concept for controlling the reaction of oxygen and preserving biomass carbon. This project provides the best opportunity to test this concept for biomass under potential commercial conditions. There is a large potential payoff in terms of improved yields and cost reductions.

The project leverages a large investment in evaluating the chemical looping approach. There is a unique large test facility that can be adapted to

evaluating biomass by building an add-on modular pilot unit.

- This will be interesting to follow. It is too early to evaluate if the cost savings due to process intensification will be real or if they will be counteracted by the new biomass-to-syngas technology itself.
- Overall, this is an interesting project that could bring some much-needed innovation into the gasification space. Chemical looping oxidants has a colorful history with coal and petrochemical conversions, but doesn't have much of a history with biomass. Looping of bed material through a combustor does, however, have a considerable history with biomass (and should be studied to inform design decisions here). As long as contaminants, ash, operating conditions, and bed material chemistry are watched closely, this work has the potential to generate some compelling results. Economically, carbon conversion efficiency will also be an important variable since biomass heating is generally more expensive than natural gas heating.
- Chemical looping reactor technology always seems like such a good idea for oxidation reactions, but there are well-documented case studies showing the operational challenges. This organization has the skills to perform the technical tasks, but they should be fully aware of the likely problems. Good luck.

PI Response to Reviewer Comments

No official response was provided at the time of report publication.