

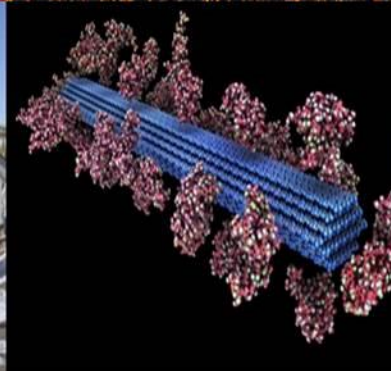

U.S. DEPARTMENT OF
ENERGY

Energy Efficiency &
Renewable Energy



*U.S. Department of Energy (DOE)
Bioenergy Technologies Office (BETO)
2017 Project Peer Review*

1.2.1.3 Multiscale Physical and Structural Particle Mechanics

March 9, 2017

*This presentation does not contain any proprietary, confidential,
or otherwise restricted information*

Feedstock Supply and Logistics

*Tyler Westover
Hai Huang*

*Idaho National Laboratory
INL Document # 17-41198*

Goal Statement

- Existing bulk solid flow models and characterization methods are not suitable for biomass. **This project will develop the tools to reliably predict the feeding behavior of compressible and anisotropic biomass bulk solids** in bench-, pilot- and commercial-scale equipment.
- Outcome:** Model framework and methods to measure material properties that will enable predicting the flow behavior of biomass over a wide range of industrial operations *at any scale*

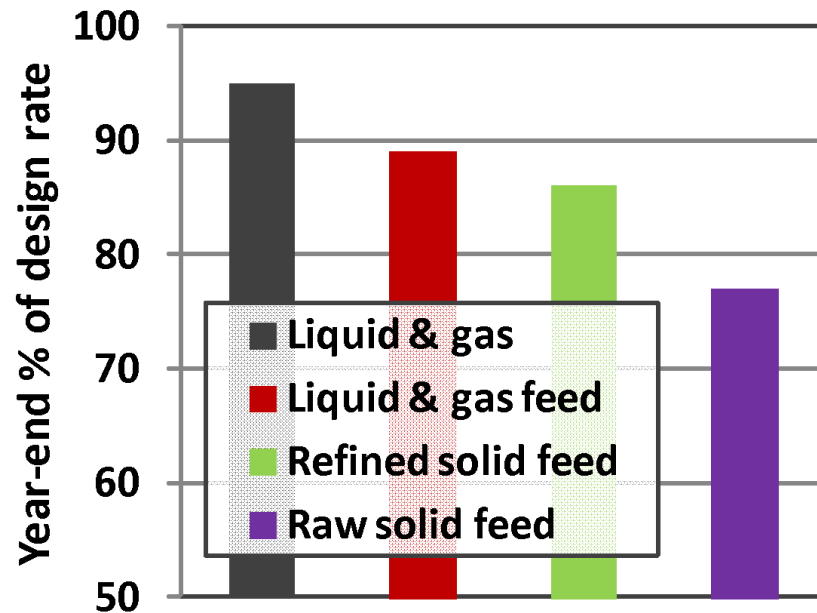

*Median performance of 508 new plants
(Merrow, Chem Innov. Jan. 2000 for
years 1996-1998)*

Quad Chart Overview

Timeline

- [New Project](#)
- Start: 10/01/2016
- End: 09/30/2019
- 8% complete

Partners

- Biomass Feedstock National User Facility, BFNUF
- Computational Chemistry and Physics Consortium, CCPC
- Purdue University
- Idaho State University
- Material Flow Solutions, Inc.
- Jenike & Johanson, Inc.

Barriers

- Ft-H: Biomass Material Handling and Transportation*
- Ft-I: Overall Integration and Scale-Up*
- Ct-B: Reactor Feed Introduction*
- [Technical target: Validate efficient low-cost handling and feeding system to deliver feedstock to the reactor*](#)

* *BETO MYPP Mar. 2016, pp. 1-30, 2-20, 2-21, 2-67*

Budget

	FY 17	FY 18	FY 19	Total
INL	\$650	\$650	\$650	\$1.95M

1 – Project Overview: Common Problems

Hoppers

- Arching
- Erratic flow
- Flooding
- Ratholing
- Segregation
- Spoiling of material stuck to walls
- Loss of live storage

Augers and transfer lines

- Plugging
- Excessive motor and parts wear
- Segregation
- Erratic flow

Problems occur because of mismatch between fixed equipment design and dynamic material properties

- Material properties change according to material type and harvesting, storage and preprocessing conditions.

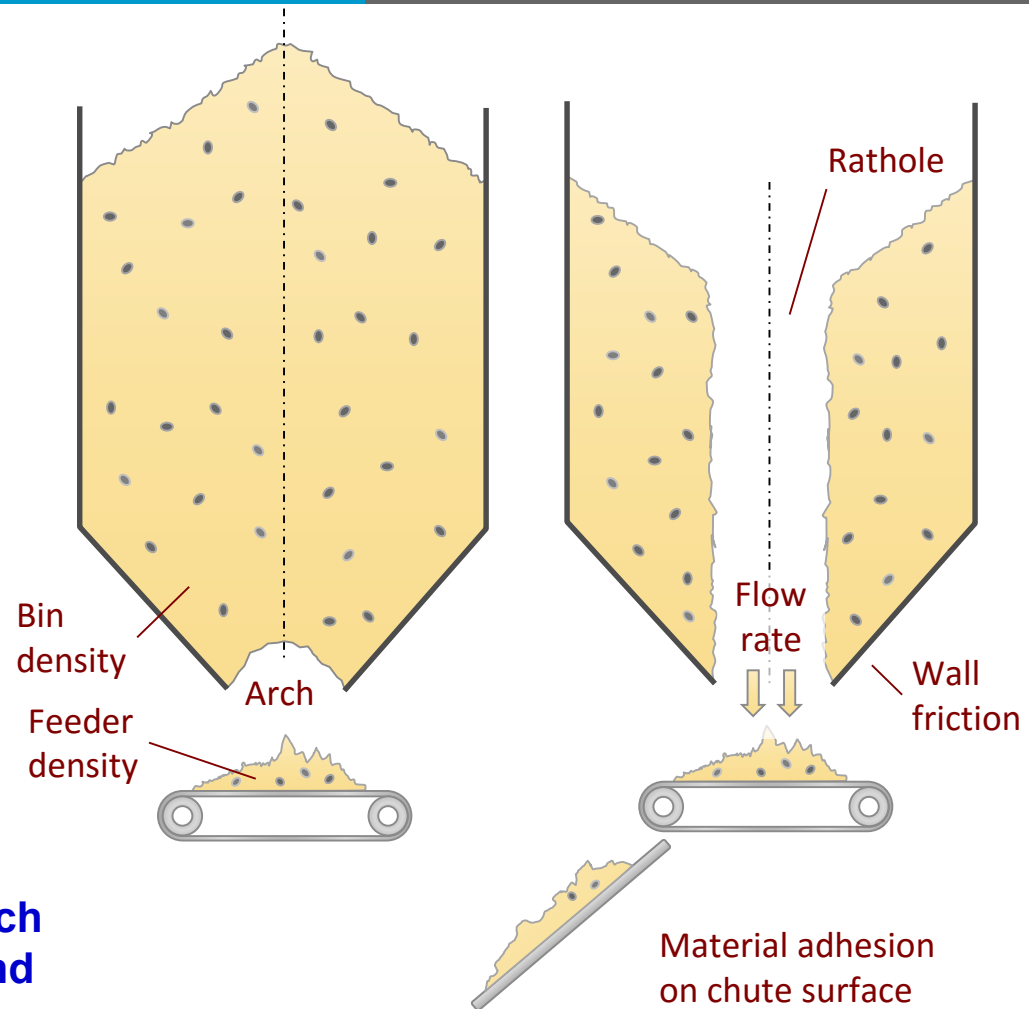

1 – Project Overview

- Understanding the feeding and handling (**F&H**) behavior of materials is a critical enabling factor for many industries:
 - Examples: petroleum, food, pharmaceutical, and manufacturing
- Conventional design of F&H equipment is based upon technology developed for fine powders 40 years ago; not adequate for biomass
- Newer models based upon computational continuum mechanics and discrete element modeling (**DEM**) are being *slowly* developed

This project provides :

1. Flow data from physical tests to validate computational models
2. Accurate methods to measure physical and mechanical properties of biomass materials
3. Boost to computational modeling efforts
 - Continuum: homogeneous solid
 - Discrete: separate particles



2 – Approach (Technical): Summary

1. Determine scale-independent properties (characterization)
2. Develop computational models
3. Validate models with physical tests

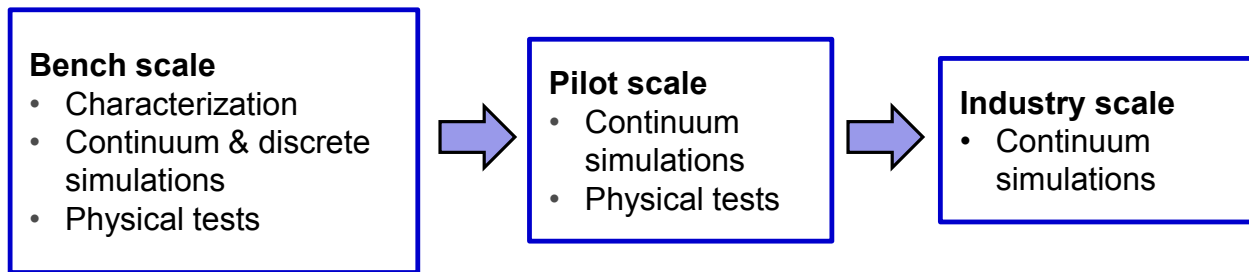

- **Challenges**
 - Methods do not yet exist to measure scale-independent properties of compressible, anisotropic materials
 - Computational methods do not yet exist to model compressible, anisotropic materials
- **Critical Success Factors**
 - >85% agreement between models and validation tests
 - Acceptance of characterization methods by Jenike & Johanson, Inc., or Material Flow Solutions, Inc.

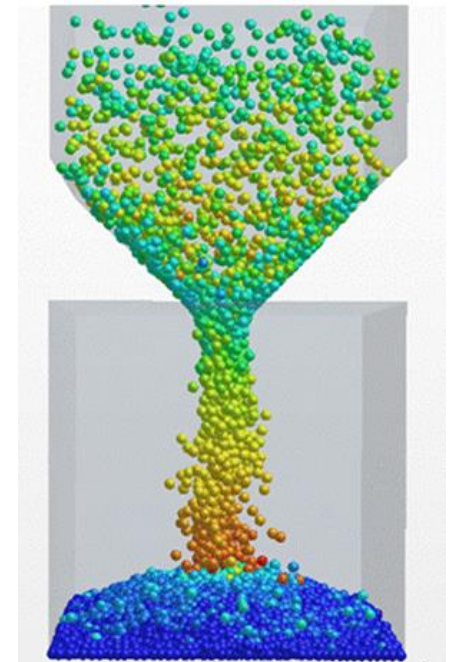

Recent INL simulation

2 – Approach (Technical): Current Test Methods

Uni-axial shear testers

- Apply vertical force
- Measure force needed to shear horizontally (linear or rotary)
- Require hours per test
- Poor resolution at low pressure
- **Do not account for anisotropy or severe compressibility**
 - Many bulk solids can compress > 80%

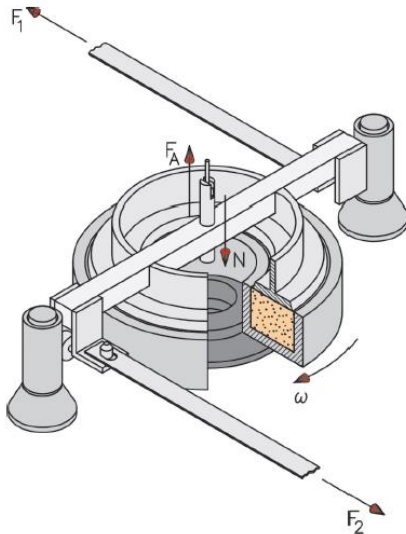

<http://www.dietmar-schulze.de/powtve.pdf>

Hopper with roll-away gate

- Qualitatively compares materials
- **Cannot measure properties** (non-symmetric geometry causes non-uniform pressure and shear stress fields)

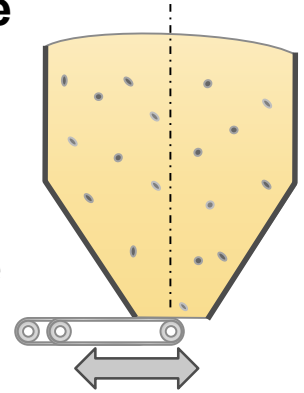

Hopper with detachable sections

- Qualitatively compares materials
- **Cannot measure properties** (pressure and shear stress fields are unknown)
- Poor resolution and repeatability
- Very slow

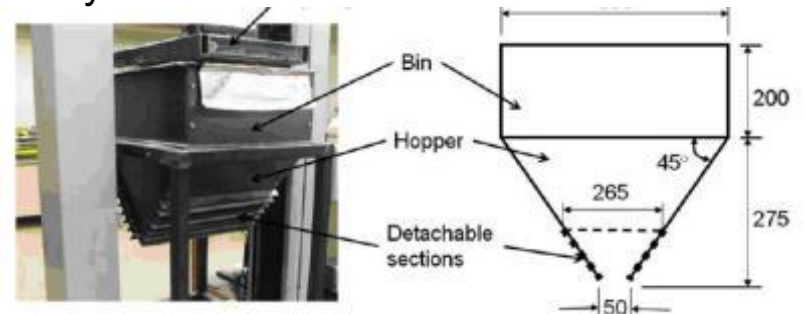

Guan & Zhang, *J. Food Engin.* 94, 227 (2009).

2 – Approach (Technical): Example

Flow of chopped vs. ground switchgrass (SwGr) in a bin reclaimer (from BETO's High Tonnage Switchgrass Project)

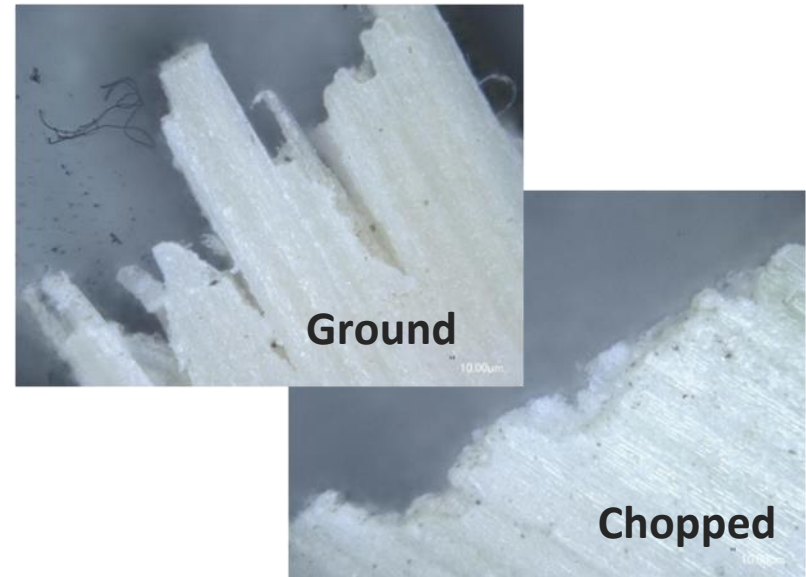
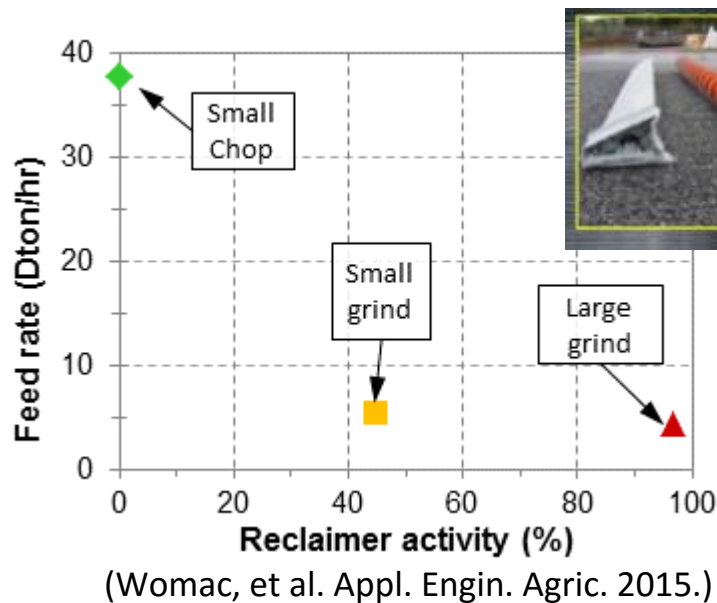

- Chopped SwGr flowed freely with reclaimer off, while ground SwGr flowed at $\approx 20\%$ of design capacity even at maximum motor speed (see figure)
- Across range of all measured properties, the only consistent difference was tip morphology (Westover, et al., Biofuels 2015)
- **Small change in preprocessing can have big impact on F&H performance**
 - Need advanced DEM (i.e. particle models) to determine impact of tip morphology

2 – Approach (Technical): Innovation

V-shaped hopper with moving walls

- Walls can rotate (1) to apply uniform radial pressure or weight can be applied to top
- Walls slide upward (2) in tracks to increase size of exit and cause material arch to break
- Stationary liner insulates material from motion of walls
- Results correlate to flow in high-tonnage reclaimer (see figure)
- Symmetry facilitates quantitative determination of flow properties using computational flow models
- Can be configured to assess flowability in real-time for quality assurance and control (QA/QC)

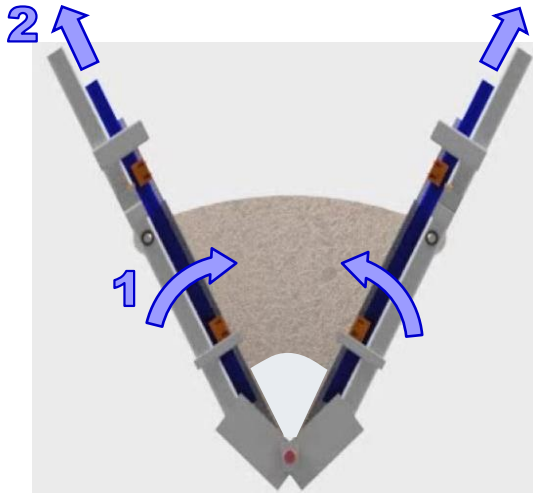

More details by Perkins, *Biofuels Journal* 2016:Q2 38-41.

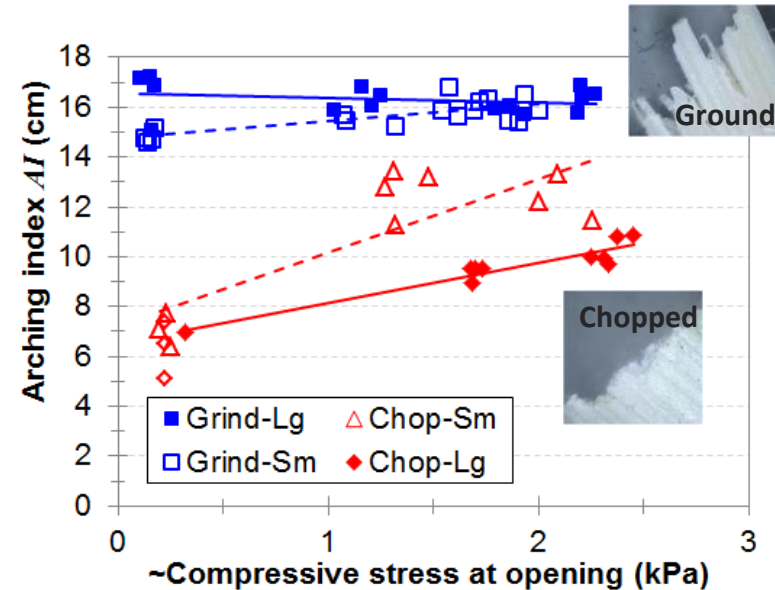

Source: Westover, et al., *Biofuels*, 2015: 6(5-6), 249-260.

2 – Approach (Management)

- Task leadership: plan, prioritize, coordinate, review progress
 - Bi-weekly team coordination meetings
 - Quarterly BETO review meeting
- Leverage related BETO-sponsored work
 - Biomass Feedstock National User Facility (BFNUF)
 - Computational Chemistry and Physics Consortium (CCPC)
- Create & follow approved project management plans
 - Regular milestones (1/quarter) and deliverables (annual reports)
 - Go/No-Go Decision Point (described later)
- Responsibilities
 - Experimental: Tyler Westover
 - Discrete element modeling (DEM): Hai Huang
 - Continuum modeling: Shared

4 – Relevance

Enabling biofuels by developing robust feeding and handling technologies

- Directly supports BETO's Mission:
 - “Develop and transform our renewable biomass resources into commercially viable, high performance biofuels”
 - Project fulfills a critical need to provide F&H solutions at all scales
 - F&H difficulties at pioneer biorefineries are leading to significant reduction in throughput versus design
- Project metrics and targets driven by quantitative agreement between flow experiments and improved models. Enables:
 1. Improved design of equipment and processes
 2. In-situ, real-time QA/QC

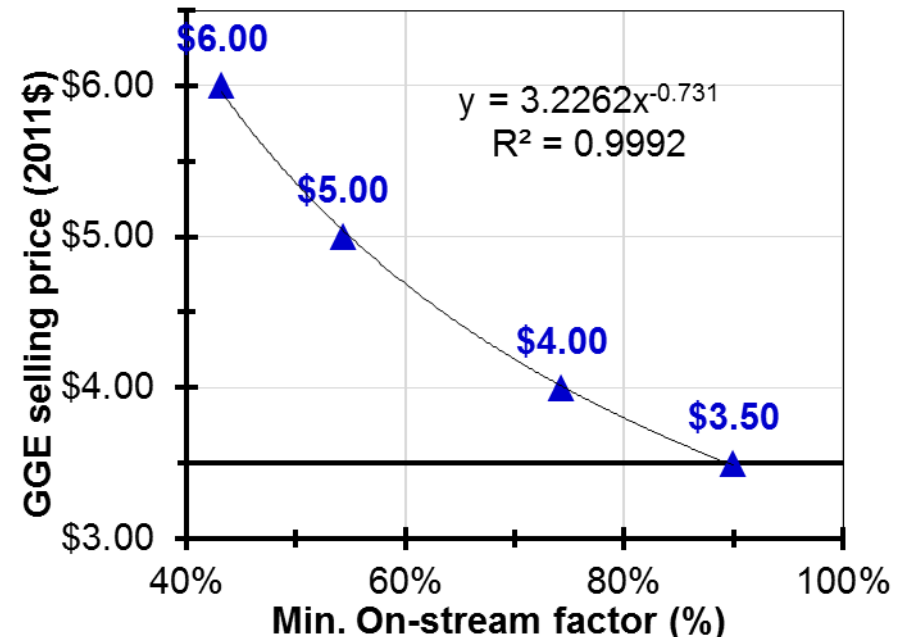

Gallon of gasoline equivalent (GGE) selling price as a function of minimum on-stream factor. Source: values from recent NREL/PNNL analysis.

4 – Relevance (Applications)

Primary applications: bin/hopper feeders & (plug-flow) auger feeders

- Validating material characterization methods and flow models for these systems for a range of materials will demonstrate the robustness of the approach

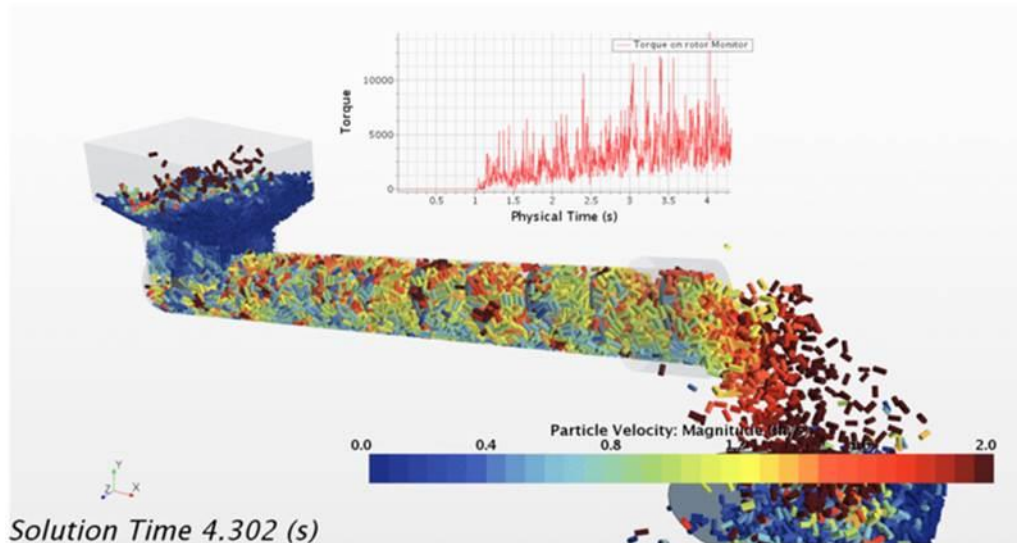

Pellets fed through hopper into an auger system. Source: Recent INL simulation.

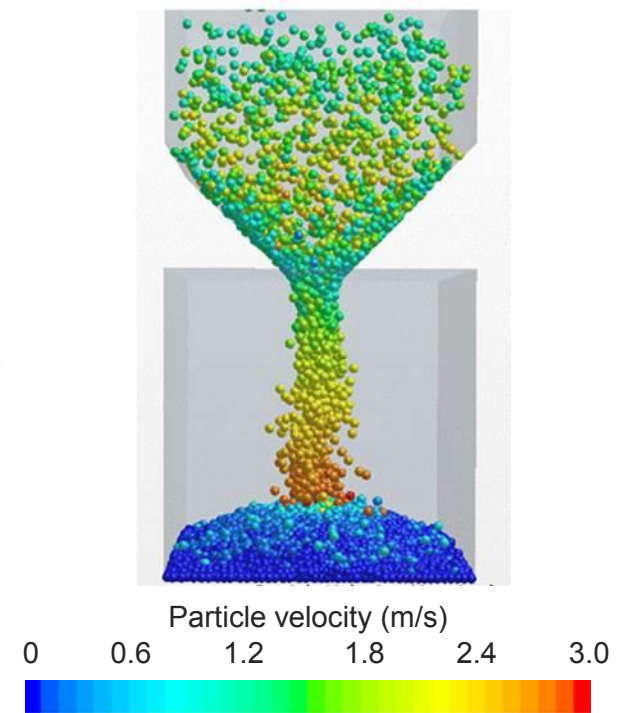

Spherical particles fed through hopper/silo. Source: Recent INL simulation.

5 – Future Work: Overview

- Project requires success in five areas:
 1. **Particle and bulk solid characterization:** determine physical and mechanical properties of particles and bulk solid materials
 - **Measured at bench scale but must apply at all scales**
 2. **DEM simulations:** Model the flow of discrete biomass particles in specialized situations with limited numbers of particles (bench scale)
 3. **Continuum simulations:** Develop models that approximate the flow of compressible and anisotropic biomass materials (all scales)
 - **Provides transfer function to commercial scale**
 4. **Hopper and auger tests:** Physical tests validate simulations (bench & pilot scale)
 5. **Inline QA/QC tests:** Develop inline tests that can assess the variation in "flowability" of material in real-time (needed to ensure that materials meet F&H specifications) (pilot scale)
- Required depth & breadth of work is a good fit for national lab effort
- **Need to focus on immediate key applications**

Focus of this talk

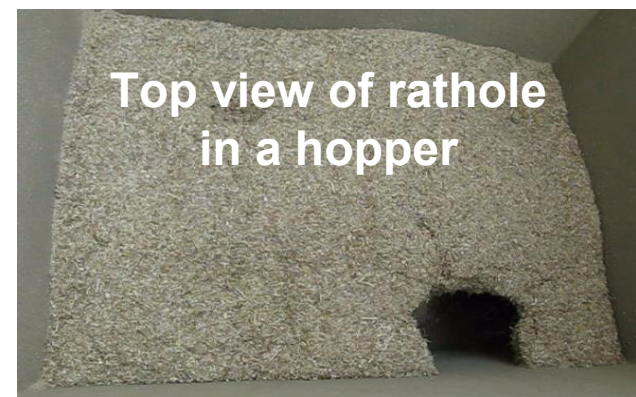

5 – Future Work: Timeline

- **Year 1: Continuum approach (2-D quasi-static tests and models)**
 - **Annual milestone:** Validate continuous flow models for a woody and a herbaceous material in a V-shaped hopper in multiple formats. **Criteria:** Models will include properties (constitutive relations) to enable modeling the F&H performance of biomass bulk solids at bench, pilot and commercial scales. Target agreement with lab tests using instrumented hopper and X-ray video tracker is **>85% correlation**.
- **Year 2: Multiscale approach (3-D quasi-static continuum & DEM)**
 - **Annual milestone:** Validate multiscale flow models for same materials in a quasi-static 3D test, such as a ring shear tester or mixer, in multiple formats. **Criteria:** same as Year 1
- **Year 3: Multiscale approach (3-D dynamic continuum & DEM)**
 - **Annual milestone: Validate multiscale flow models for three industrial operations (hopper, standard auger and plug-flow auger) for 2 woody and 2 herbaceous materials. Criteria:** same as above
- **18 Month Go/No-Go Decision:** Quasi-static flow models for 8 biomass materials (4 woody & 4 herbaceous) in a silo and a V-shaped hopper validated by bench and pilot scale tests. **Criteria:** same as above.

5 – Future Work: Physical Hopper Tests

- Instrumented bulk flow hopper tests:
 - Specialized geometry and method ensures \approx uniform stress fields in material
 - Arrays of pressure sensors measure wall pressure
 - X-ray video tracks tracer particles
 - **Modifications to tests will provide both material properties and validation for computational models**

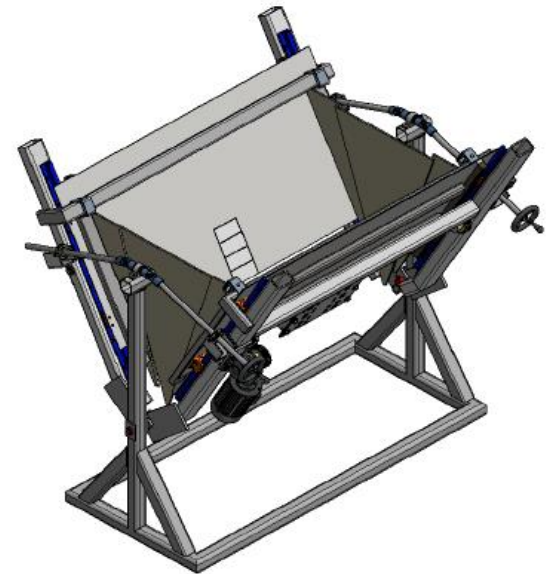

Automated V-shaped hopper for dynamic 3-D tests (QA/QC)

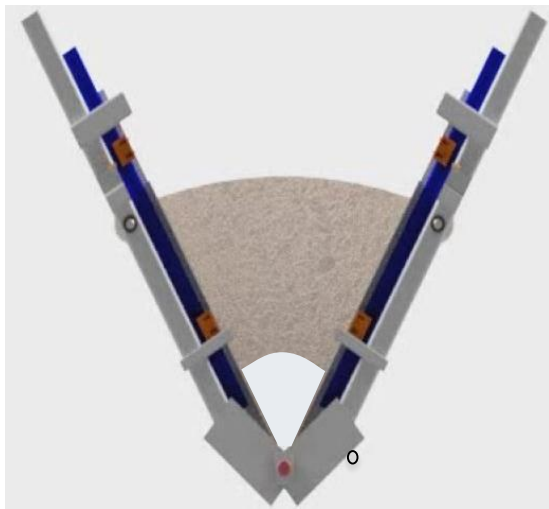

End-view of flow hopper test

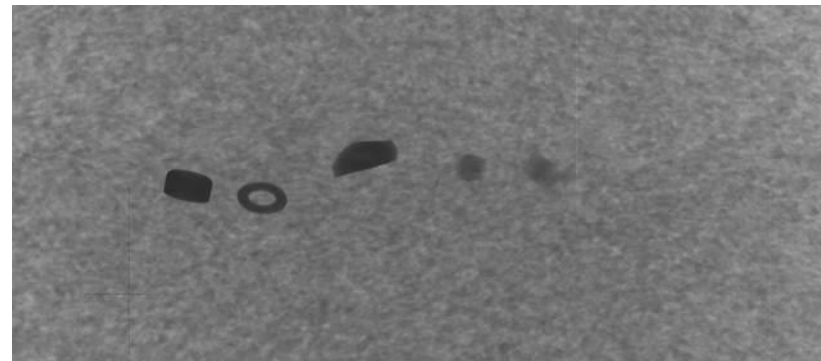

X-ray image of tracker particles inside sawdust

5 – Future Work: Physical Auger Tests

- Instrumented bulk flow auger tests:
 - Mass feed and volume feed modes with various auger types and sizes
 - Sensors record feed rate, time variation of feed rate and power consumption
 - X-ray video tracks tracer particles
 - **Will provide validation for computational models**



Auger feeder

5 – Future Work: Continuum Simulations

- Variety of models are available but all will require modification
 - Mohr-Coulomb model:
 - Suitable for isotropic, incompressible flow (available from Purdue as benchmark models)
 - Smoothed-Particle Hydrodynamics (SPH) model:
 - Suitable for modeling fluid and solid dynamics
 - Modified Drucker-Prager-Capp (DPC) model:
 - Can include effects of plastic and elastic compressibility
 - Models are typically finite element model (FEM) or control-volume (CV) based

Substantial modeling challenges:

- Highly nonlinear, inelastic and anisotropic
- Rate dependent (viscoelastic)
- Includes permanent deformation (plastic)
- Includes severe hysteresis due to micromechanical friction that locks energy in fibers, resulting in memory effect.

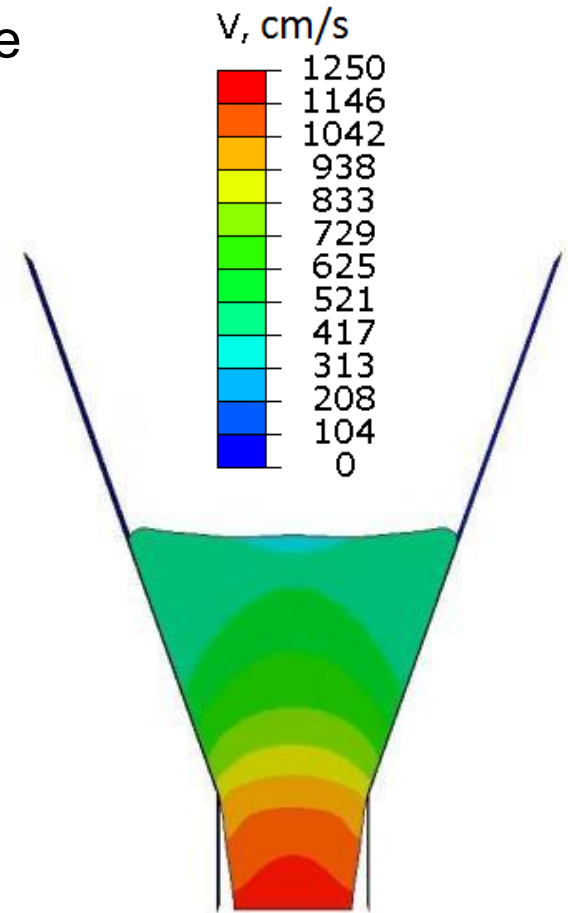

Purdue simulation of limestone powder flow in a 55° conical hopper

5 – Future Work: Continuum Simulations

- Advanced rheological models can be adapted from existing multiphase computational fluid dynamics (CFD) models at INL

Level set simulations of air bubble rising in water

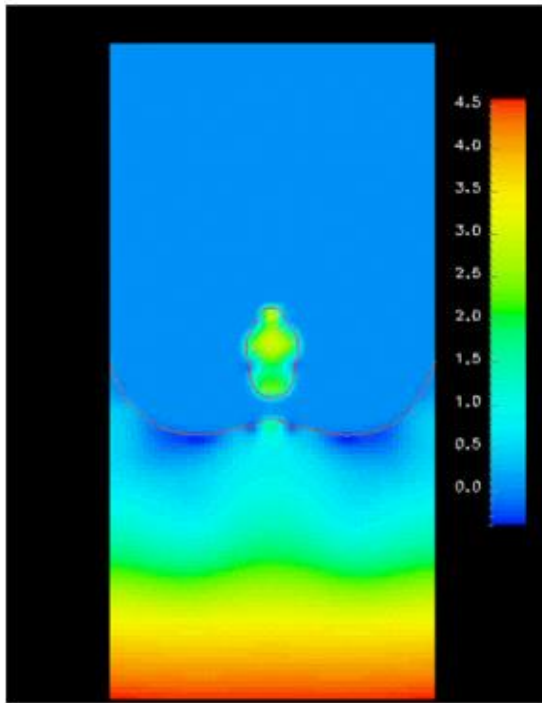

Volume of Fluid (VOF) model of dripping faucet

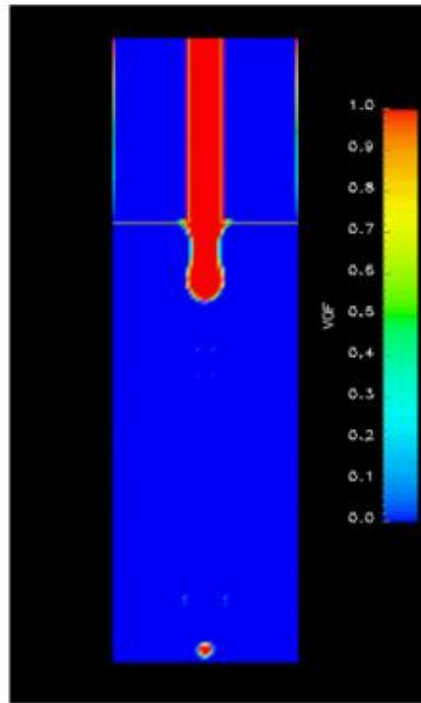

Volume of Fluid (VOF) model of water-air flow in fractures

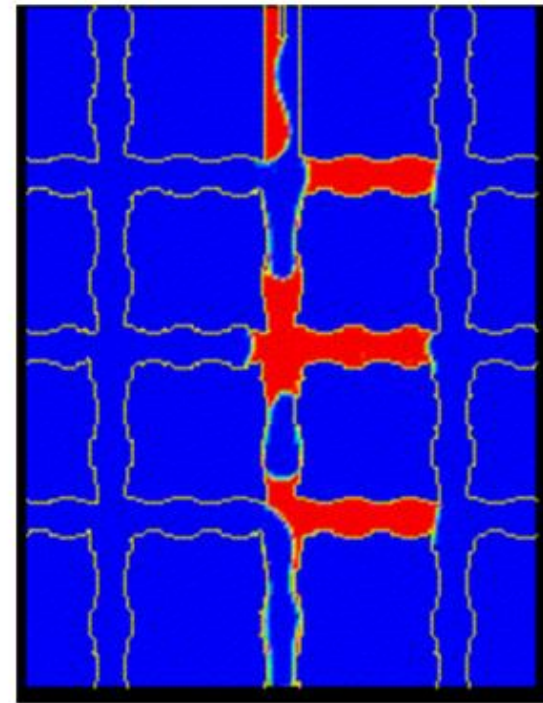

- Physics-based: includes surface tension, wetting/contact angle dynamics, inertial, gravitational & viscous forces
- Numerically stable for large density/viscosity contrasts
- Straightforward to extend to solid particles by changing viscosity and stress/strain relations

5 – Future Work: DEM* Simulations

- Objectives
 - Better understanding of the physics controlling particle flowability
 - Guide and validate laboratory experimental activities
 - Improve input constitutive relations for continuum models
- Key features
 - Arbitrary shapes, sizes
 - Compressibility of biomass particle
 - Complex geometry in feeding/handling equipment
 - Elastic & inelastic particle-particle mechanical interactions
 - Capillary cohesion between particles
 - Flexible to allow easy coupling to continuum simulations
 - Strong parallel scalability: *hundreds of millions of DEM particles*
- INL's in-house DEM capabilities
 - Meet needed capability to model biomass particle flow

* *DEM: Discrete element model (i.e. models individual particles)*

5 – Future Work: DEM Simulations

- Multi-sphere approach
 - Overlapping, bonded spheres for arbitrary shapes
 - Accounts for particle deformation by connecting spheres with springs and dashpots
 - Four basic shapes implemented now
 - Final goal is to define a **library of common particle shapes**
- Plan to also **expand to coupled sphere-cylinder model**

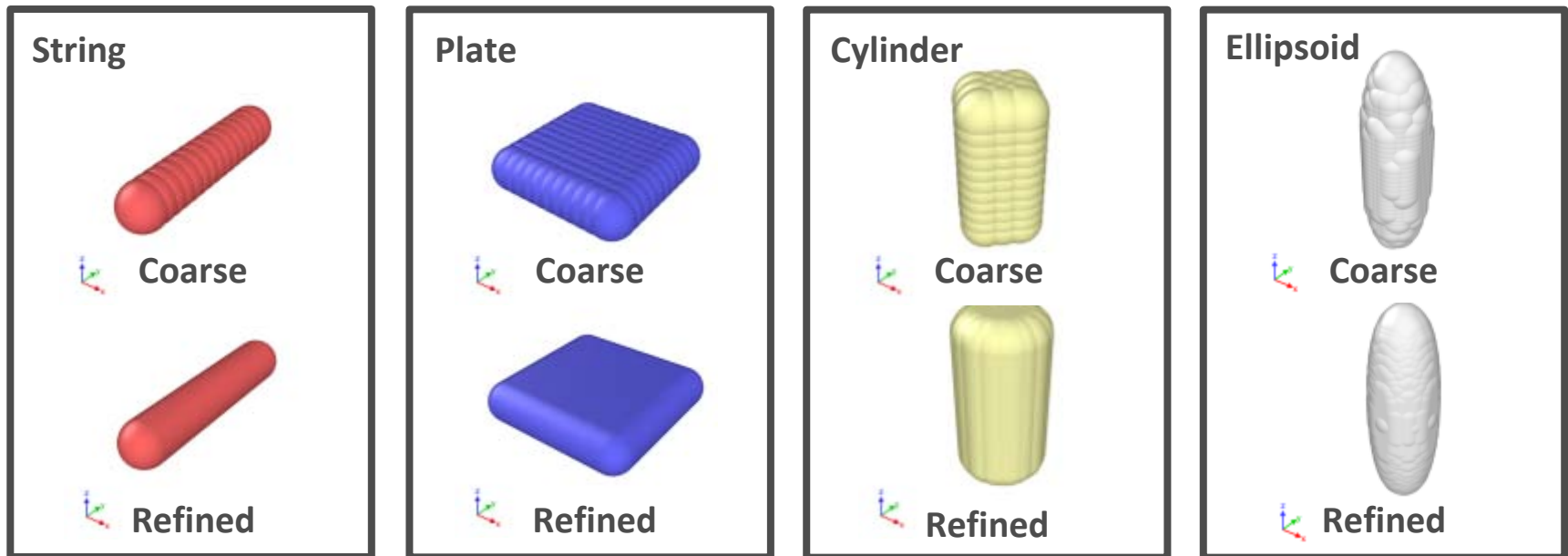

5 – Future Work: coupled DEM & CFD

- Flexible handling of complex equipment/particle interface
 - Example of type of DEM simulation that will be performed (dual-ribbon blender rotating and transporting granular particles)
 - Future simulations will include a variety of realistic biomass particles (DEM simulation) coupled to air flow (computational fluid dynamics simulation) for fully scalable and robust model

(a) Initial

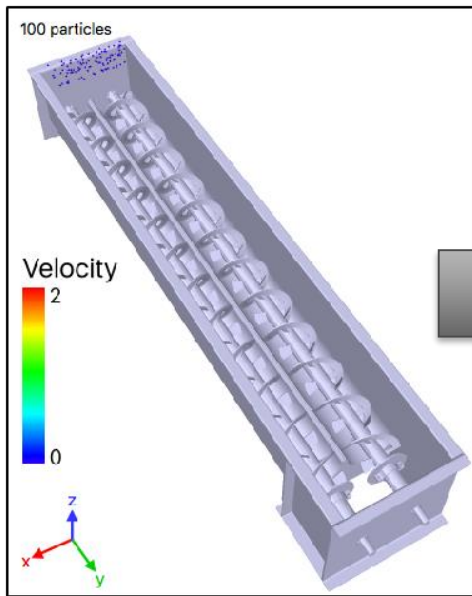

(b) Filling

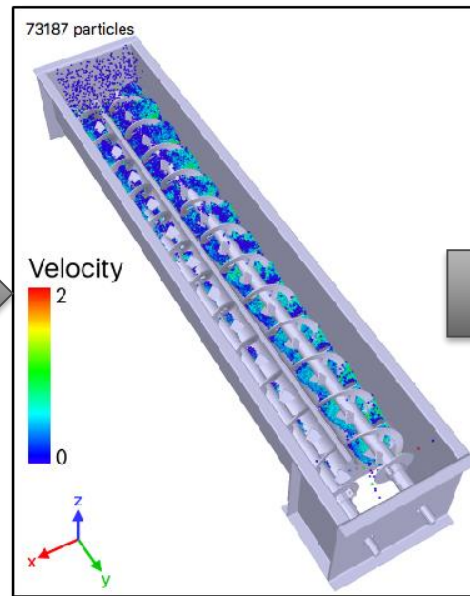

(c) Dynamically steady

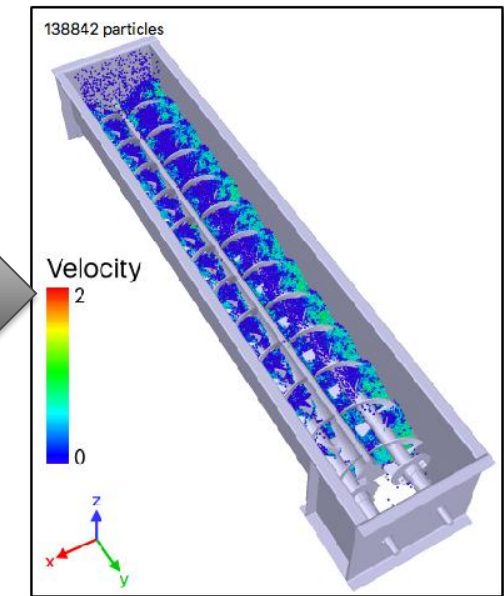

Summary

- **Outcomes:** Model framework and methods to measure material properties that will enable predicting the flow behavior of biomass over a wide range of industrial operations *at any scale*
- Requires success in particle and bulk solid characterization and modeling.
- Project requires strong integration between feedstock characterization, pilot-scale F&H, and numerical simulation.
 - INL has strong capabilities in all of these areas
- Outcome is crucial to help pioneer and future biorefineries achieve target throughputs.



Additional Slides

Acknowledgements

Peter Ciesielski (NREL)
Matt Dee (INL)
Carrie Hartford (Jenike & Johanson, Inc.)
Sergio Hernandez (INL)
Kerry Johanson (Material Flow Solutions, Inc.)
Corey Landon (INL)
Glen Monson (INL)
Kunal Pardikar (Purdue)
Carl Wassgren (Purdue)
C. Luke Williams (INL)
Yidong Xia (INL)

*This work was supported by the **Bioenergy Technologies Office (BETO)** at the U.S. Department of Energy's Office of Energy Efficiency and Renewable Energy. **Idaho National Laboratory** is operated by Battelle under contract no. DE-AC07-05ID14517 with the Department of Energy Idaho Operations Office.*

Publications, Patents, Awards, and Commercialization

This project:

- S. Hernandez, T.L. Westover, J.C. Ryan A.C. Matthews, C.L. Williams
Feeding properties and behavior of hammer- and knife-milled pine, submitted for publication.

Previous related project:

- T.L. Westover, J.C. Ryan A.C. Matthews, S. Hernandez, Hopper apparatus for processing a bulk solid, and related systems and methods, application no. 15/235,895, filed 08/12/2016.
- J. Perkins (ed.) Testing feedstock: INL researcher finds way to accurately test flowability, Jerry Perkins, Biofuels Journal 2016:Q2 38-41.
- T.L. Westover, M. Phanphanich, J.C. Ryan, Comprehensive rheological characterization of chopped and ground switchgrass. Biofuels, 6(5-6) (2015), 249-260.
- T.L. Westover, FY14-Q1 1.2.1.3.ML.1 INL Biomass Feeding Survey Report, INL External Report 14-31687, April 2014.

Responses to 2015 Peer Review

Past related project: “Biomass Engineering: Transportation and Handling,” FY14-FY15. Total funding: \$675K.

1. Bench-scale equipment performance with a single feedstock is not particularly relevant when not tied to a specific need, nor a plan to test at production scale. Minimal ties to industry have meant that research results have not been implemented. It is unclear if this is because the research question did not address a true industry need or if results have not been adequately conveyed.
 - Multiple feedstocks were tested, although not all results were shown. The objective was to establish a correlation between “simple” laboratory tests and feeding performance of high-impact biomass materials and then use the simple laboratory tests to provide early indication of flow problems as processes are developed/optimized. This avoids problems during scale-up, especially during conversion validations.
2. The project is developing important baseline information to improve feedstock handling. This project sits very close to commercialization as the information will immediately inform manufacturers and plant designers. There needs to be closer collaboration with industry to facilitate the transfer of knowledge to application and to inform the key research questions that INL can pursue.
 - The objective of the project is too fundamental to be directly commercialized. In-line assessment of feeding properties will be useful to assure in real-time that material plugging does not cause expensive feeding and handling problems. As that technology is developed, it will be commercialized.

2 – Approach (Technical): Example # 2

From previous project: Transportation & Handling 2012-2014

- Compared measured hopper opening size needed to ensure flow ($W_{min,meas}$) with predicted values ($W_{min,pred}$) based upon conventional methods for bulk solids for a range of pine materials
- Poor agreement between experiments and predicted values highlights need for more reliable methods to measure properties of both bulk materials and particles

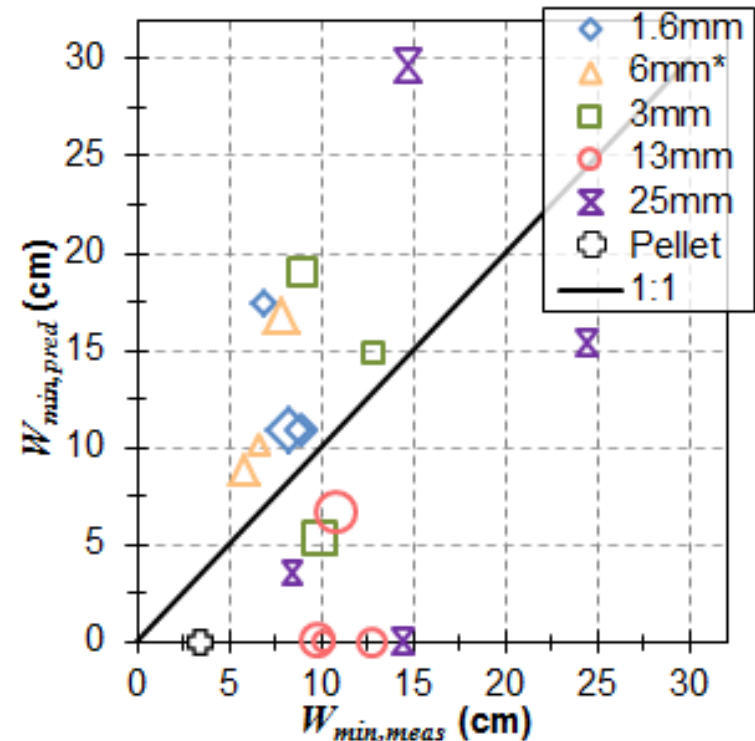

Predicted hopper opening size to cause flow vs. measured hopper opening size. Symbol size indicates moisture content from 10% (small) to 40% (large) (Hernandez, Westover, et al. , submitted for publication).

2 – Approach: Simulations

- Both particles and bulk solid materials can likely be approximated as orthotropic materials (*i.e.* three orthogonal planes of microstructural symmetry)
- Orthotropic condition will be created in physical tests of bulk solids by symmetry of applied consolidation pressure
- **Within orthotropic approximation, 9 independent terms in the stiffness matrix will need to be measured as a function of stress history** (coefficients are not constants but depend upon past loads and also upon loading rate)
 - Effect of past loading can likely be accounted for using hysteresis models
 - It may be possible to account for effect of loading rate using a “master curve” [Kelly, J. Textile Institute, (2011) 102(8) 689-699]

Stiffness matrix

$$\begin{bmatrix} \sigma_1 \\ \sigma_2 \\ \sigma_3 \\ \sigma_4 \\ \sigma_5 \\ \sigma_6 \end{bmatrix} = \begin{bmatrix} C_{11} & C_{12} & C_{13} & 0 & 0 & 0 \\ & C_{22} & C_{23} & 0 & 0 & 0 \\ & & C_{33} & 0 & 0 & 0 \\ & & & C_{44} & 0 & 0 \\ & & & & C_{55} & 0 \\ & & & & & C_{66} \end{bmatrix} \begin{bmatrix} \epsilon_1 \\ \epsilon_2 \\ \epsilon_3 \\ \epsilon_4 \\ \epsilon_5 \\ \epsilon_6 \end{bmatrix}$$

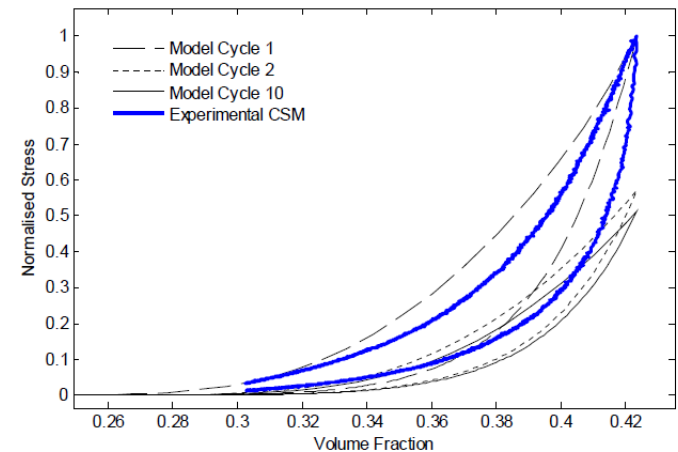

Figure 3: Chopped Strand Mat single cycle experimental data and Model cyclic data – Normalised stress vs. Volume Fraction

Source: Cheng, Kelly, Bickerton, *A Thermomechanical Constitutive model for fibrous reinforcements*, ICCM17, Edinburgh, UK July 27-31, 2009.

2 – Approach: Continuum Simulations

- Example: Finite element model (FEM) of flow in a conical hopper (Purdue)
 - Discharging wheat grains in conical hopper with half angle 30°
 - FEM results validated with similar FEM performed by other researchers (A.B. Yu, et. al.) and with experimental data
 - Adapting available Mohr-Coulomb models from Purdue will allow quick start and benchmark for advanced rheological models

Velocity Validation

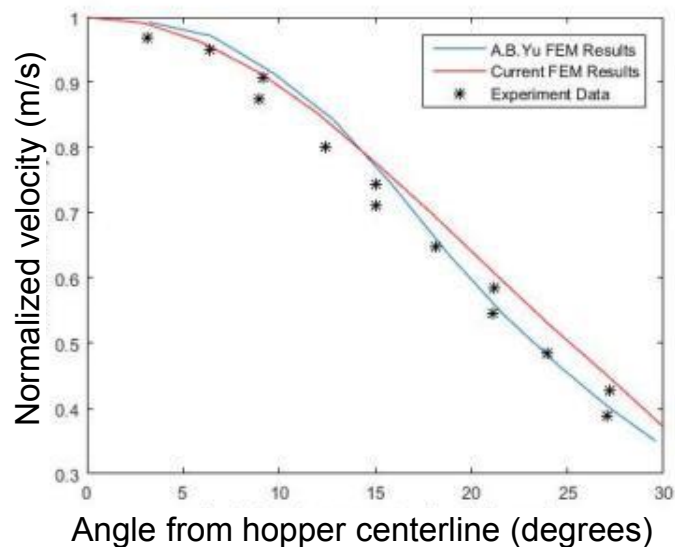

Wall stress Validation

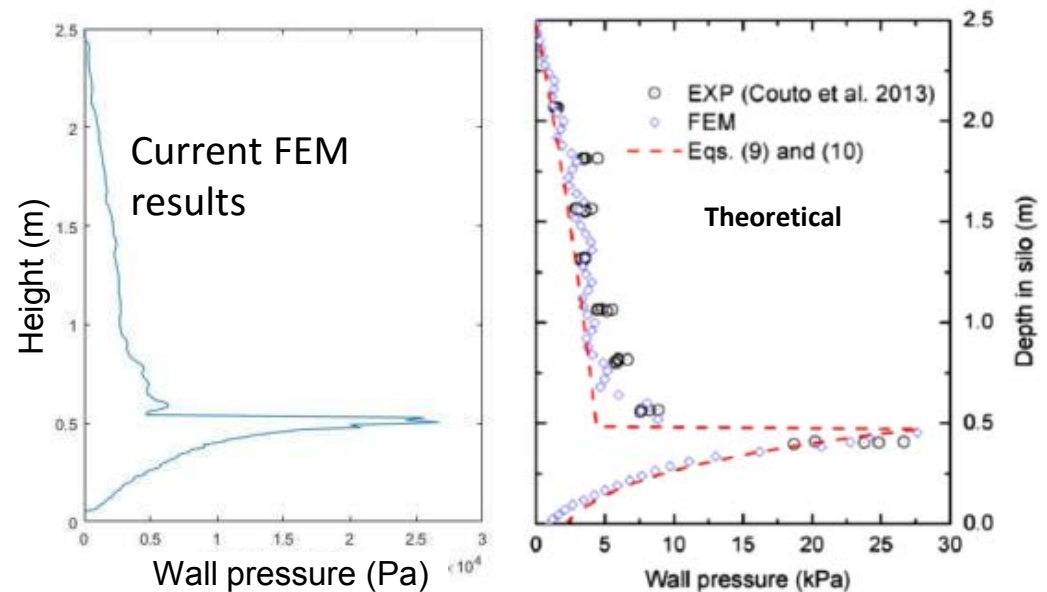

Source: Recent Purdue simulation.

5 – Future Work: Simulations

Discrete Element Model (DEM) For Granular Geomaterials

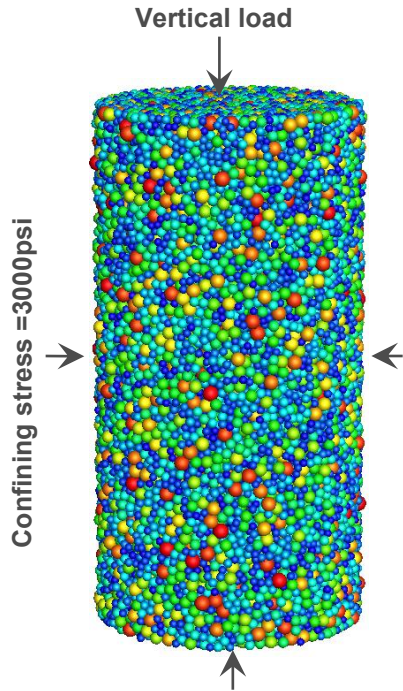

- **Rock is represented by assembly of discrete mechanic elements-a natural representation of granular materials**
 - ✓ *circle in 2D or sphere in 3D*
- **Particles interact through:**
 - ✓ *grain-grain interaction: repulsion and friction;*
 - ✓ *bonds: axial compression/tension, bending, torsion*
- **Bond can break: fracture initiation & propagation:**
 - ✓ *tensile and shear failure mode*
- **Repulsive/friction forces between grains in contact after breakage:**
 - ✓ *no cohesion after breakage*
- **Extensively applied for rock failure simulations at various scales:**
 - ✓ *sub-grain, core sample to large faults*
- **Plasticity was triggered if either grain or bond (compressive) deformation exceeds a critical critical threshold:**
 - ✓ *Ideal micro-plasticity model*

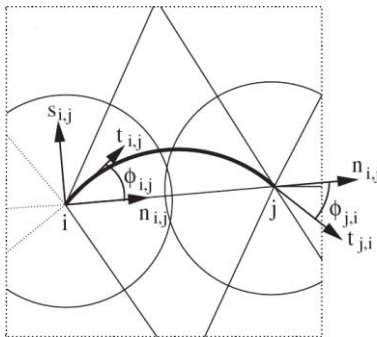

$d^n = R_i + R_j - R_{ij}$	$F_{ij}^{Bn} = k^n A d^n$
$F_{ij}^{Gn} = \begin{cases} K^n d^n & d^n > 0 \\ 0 & d^n \leq 0 \end{cases}$	$\Delta F_{ij}^{Bs} = -k^s A \Delta d^s$
$\Delta F_{ij}^{Gs} = \begin{cases} -K^s \Delta d^s & d^n > 0 \\ 0 & d^n \leq 0 \end{cases}$	$M_{ij}^{Bn} = -k^n J \theta^n$
${}^{t+\Delta t} F_{ij}^{Gs} = {}^t F_{ij}^{Gs} + \Delta F_{ij}^{Gs}$	$M_{ij}^{Bn} = -k^n I \theta^n$
	${}^{t+\Delta t} F_{ij}^{Bs} = {}^t F_{ij}^{Bs} + \Delta F_{ij}^{Bs}$

Stress (psi)

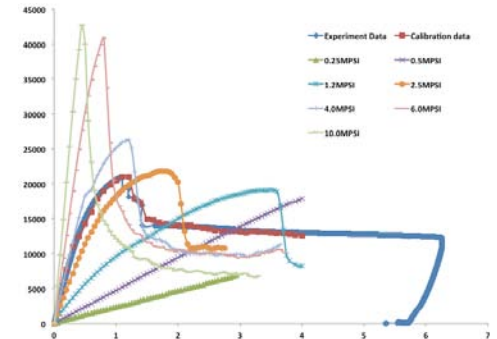

5 – Future Work: Efficiency of DEM Simulations

- Strong parallel scalability and efficiency of INL's DEM codes
 - Benchmark test: a 3-D simulation of quasi-2-D granular flow in a wedge hopper

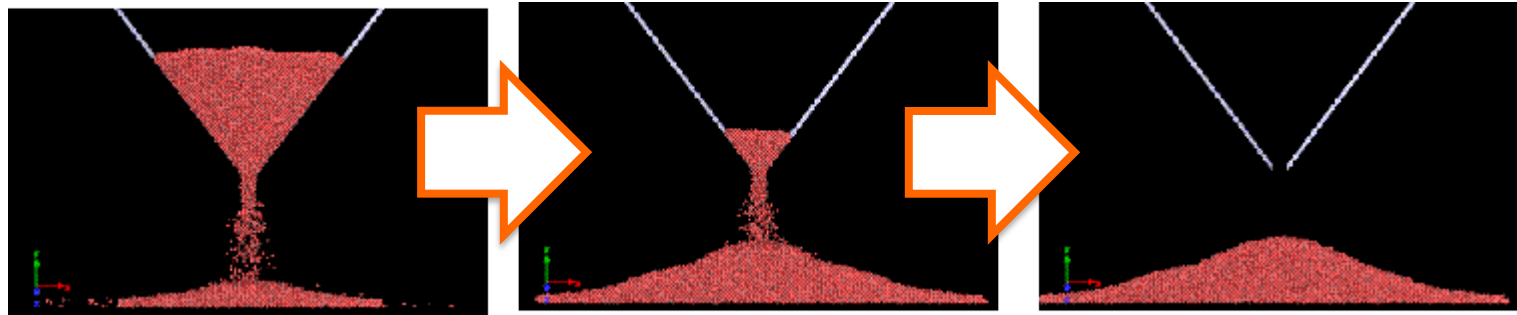

- Up to 720 CPU processors were used on INL's FALCON HPC to simulate 10 physical seconds of approximately 400,000 particles

Speedup ratio: $S = T_{48}/T_{Nx48}$

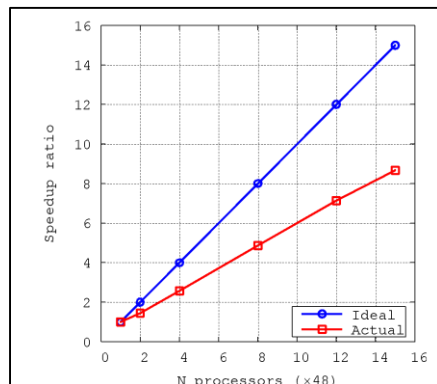

Parallel efficiency: $E = S/N$

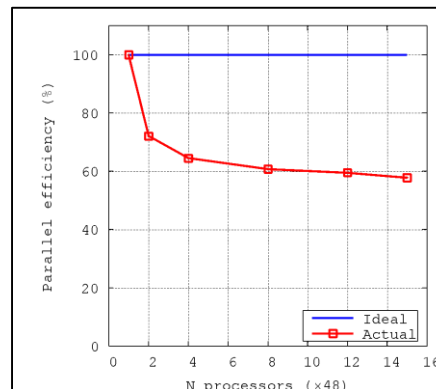

Partitioning groups of particles for CPU load balancing

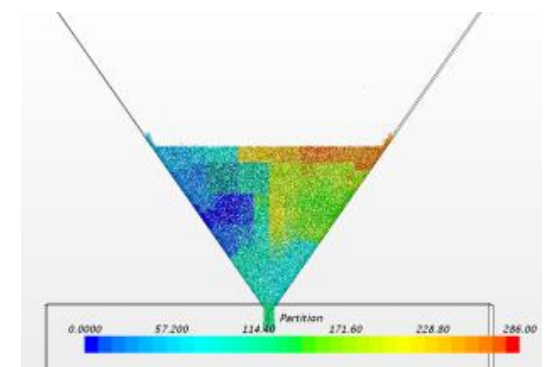

5 – Future Work: Simulations

A Coupled CFD-DEM Approach for Modeling Multiphase Flow and Biomass Particle Transport

- Modeling fluids: VOF-based CFD coupled with DEM
 - The Navier-Stokes equations that incorporate fluid-solid interaction force is used to describe multiphase flow (e.g. water and air) containing immersed DEM particles

$$\left\{ \begin{array}{l} \frac{\partial(\phi\rho)}{\partial t} + \nabla \cdot (\phi\rho\mathbf{U}^f) = 0 \\ \frac{\partial(\phi\rho\mathbf{U}^f)}{\partial t} + \nabla \cdot (\phi\rho\mathbf{U}^f\mathbf{U}^f) - \phi\nabla \cdot (\mu\nabla\mathbf{U}^f) = -\nabla p - \mathbf{f}^p + \phi\rho\mathbf{g} \end{array} \right.$$

Fluid-solid interaction force

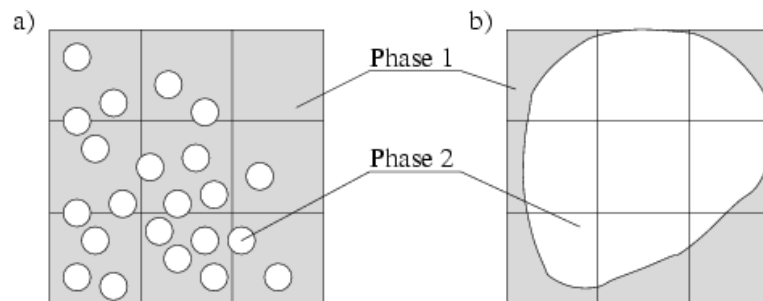

5 – Future Work: Simulations

A Coupled CFD-DEM Approach for Modeling Multiphase Flow and Biomass Particle Transport

- Modeling biomass particles: DEM coupled with VOF-based CFD
 - The momentum balance equations are used to describe motions of DEM particles immersed in VOF-based multiphase flow (e.g. water and air)

$$\left\{ \begin{array}{l} m_i \frac{d\mathbf{U}_i^p}{dt} = \sum_{j=1}^{n_i^c} \mathbf{F}_{ij}^c + \mathbf{F}_i^f + \mathbf{F}_i^g \\ I_i \frac{d\boldsymbol{\omega}_i}{dt} = \sum_{j=1}^{n_i^c} \mathbf{M}_{ij} \end{array} \right.$$

Fluid-solid interaction force

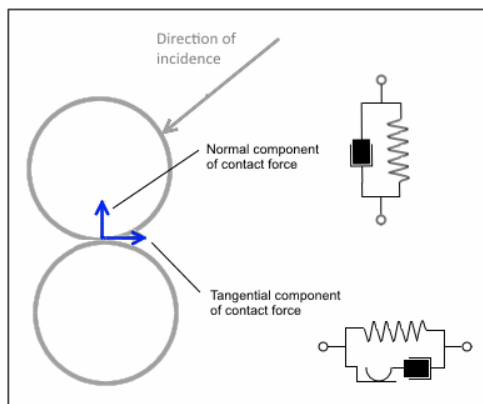

- Contact force model
 - Repulsion
 - Friction
 - Capillary cohesion model



- Water “bridge” between particles:
- shape, size, humidity

5 – Future Work: DEM Simulations

- Physical properties that affect flowability of granular particles, e.g.:
 - Wedge-hopper
 - Mixture of particle shapes and sizes
string, plate, cylinder, ellipsoid, 0.5~2mm
 - Rolling frictions between particles; surface liquid content of particles

(a) *Water film volume/particle volume = 1e-8 (low moisture, slow flow)*

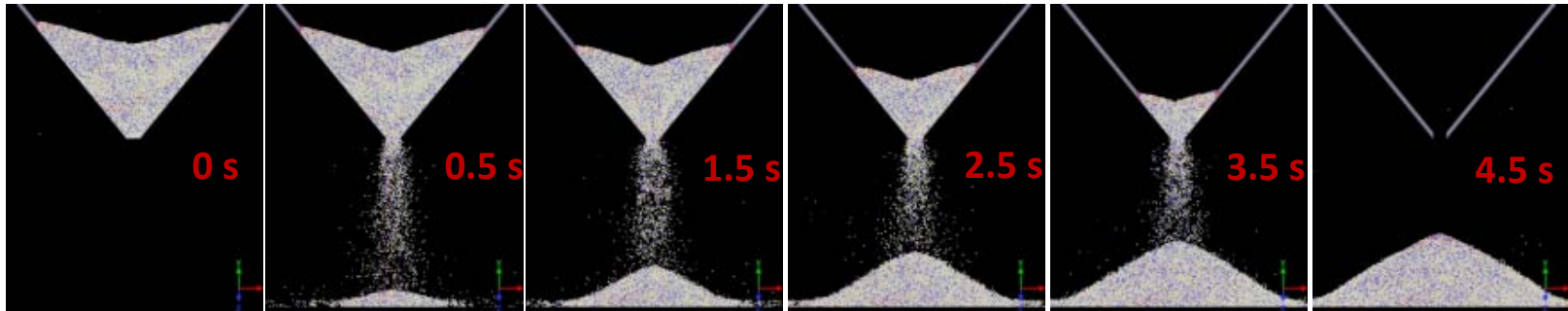

(b) *Water film volume/particle volume = 1e-7 (high moisture, faster flow)*

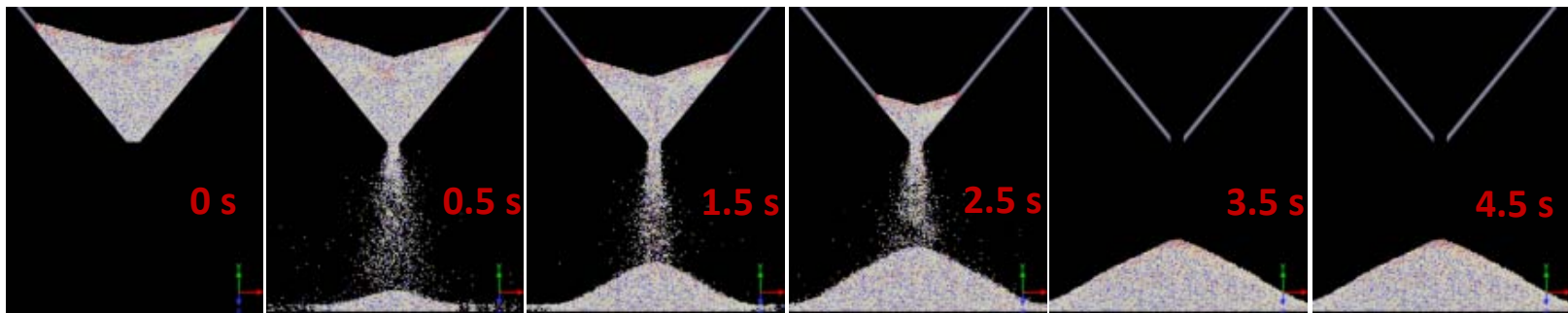

Risks and Improvement Areas

Risks

1. Project is \approx 3 year focused effort with closely coupled multiscale modeling and lab tests.
2. Multiple instruments and disciplines are needed to characterize interactions between particle attributes and feeding behavior.
3. Results will not be widely adopted if they are too complex

Mitigations

1. Early expectations must be managed
2. INL has staff with needed expertise. Efforts must be shared to ensure staff continuity.
3. Focus on simple flow tests and criteria.

Improvement Areas

1. Need better understanding of industrial experience
2. How can we have near-term impact?
3. How can we help couple chemical and mechanical engineering efforts?

Due to 'wind-up', elastic materials have greater strengths at hopper openings

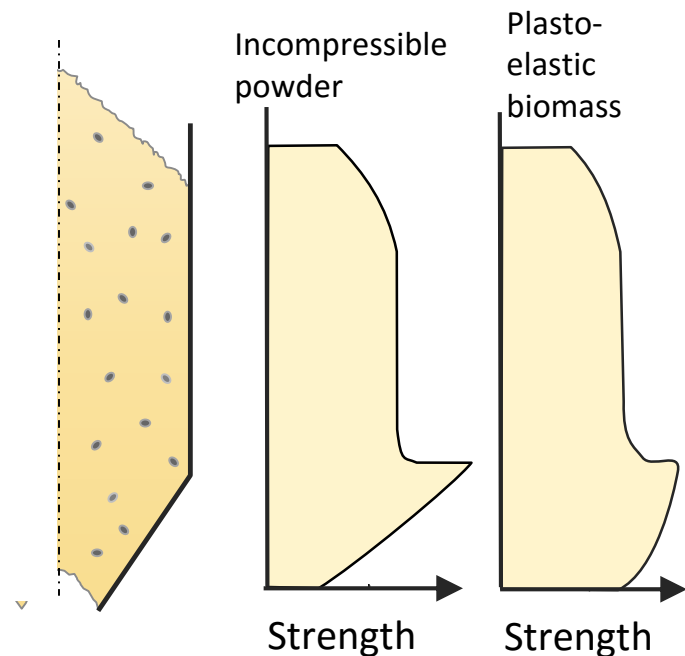

Many biofuels processes can be improved by incorporating particle mechanics and chemistry to mutual advantage (e.g. reducing elasticity or controlling inter-particle forces).