

# Adhesive Bonding of Aluminum and Copper in HVAC&R Applications

2017 Building Technologies Office Peer Review



# Project Summary

## Timeline:

Start date: 10/1/16

Planned end date: 9/30/19

## Key Milestones

1. DMP and IPMP, 12/31/16
2. Verify surface preparation techniques, 3/31/17
3. Define joint strength requirement, 6/30/17
4. Preliminary Commercialization Plan, 9/30/17

## Budget:

### **Total Project \$ to Date:**

- DOE: \$23.1K
- Cost Share: \*

### **Total Project \$:**

- DOE: \$1,500K
- Cost Share: \*

\* In-kind contribution from CRADA partner – exceeds DOE funding level; exact total is confidential information

## Key Partners:

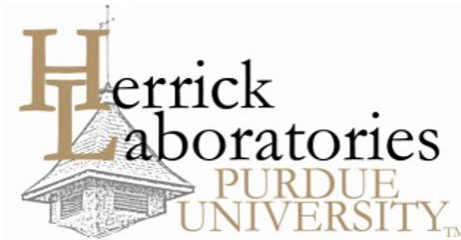

## Project Outcome:

Aluminum-Copper, Aluminum-Aluminum, and Copper-Copper adhesive joints that supplant traditional brazing in HVAC&R applications

# Problem Statement

Improving joining technologies for HVAC&R equipment has to potential to:

- Increase lifetime equipment operating efficiency
- Decrease equipment cost
- Reduce HFC refrigerant leakage

With a focus on:

- Brazing and Joining technologies, processes
- Advanced component design and materials
- Installation, operation, and maintenance

*R&D Opportunities for Joining Technologies in HVAC&R, BTO, October 2015*

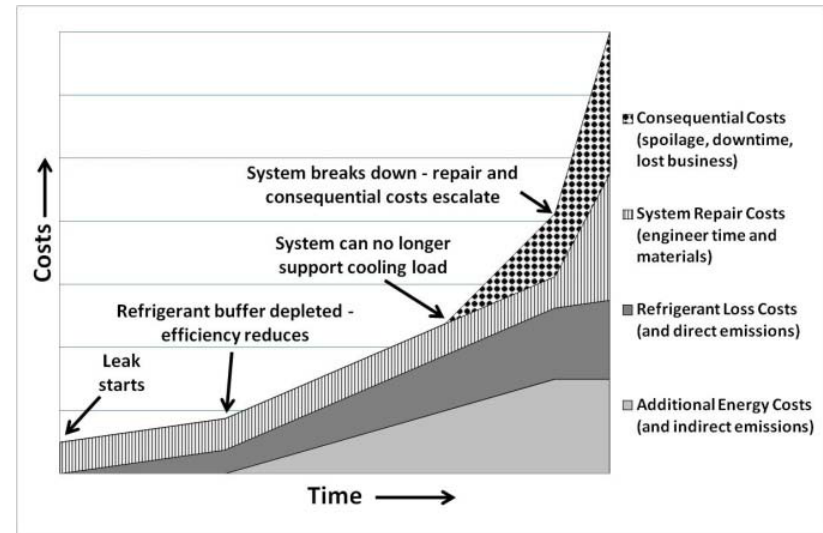

*After ETSU (1997), Cutting the cost of refrigerant leakage, Good Practice Guide 178, Energy Technology Support Unit, Didcot, UK.*

# Purpose and Objectives

## Adhesive Bonding of Aluminum and Copper in HVAC&R Applications

### Target Market and Audience:

Residential and commercial systems, penetrating >90% of the HVAC&R market

### Impact of Project:

- Reduce heat exchanger production cost by 30-40% (time/power consumption – controlled atmosphere brazing, materials)
- Safer installations
- more compact, lighter units requiring less refrigerant charge
- Minimize corrosion potential and stress concentrators (electrical insulation, bonding after bending, etc.)



# Objective –Adhesive Bonds

Al-Cu heat exchanger  
to tubing



Al-Al manifolds

Cu-Cu  
U-joints and pre-packaged field

# Approach

## Technology Solution – Adhesive Bonding

Develop adhesives with specific chemistries for bonding to aluminum and copper

Enhanced surface preparation (laser structuring, etc.) and characterization (XPS, SEM, etc.)

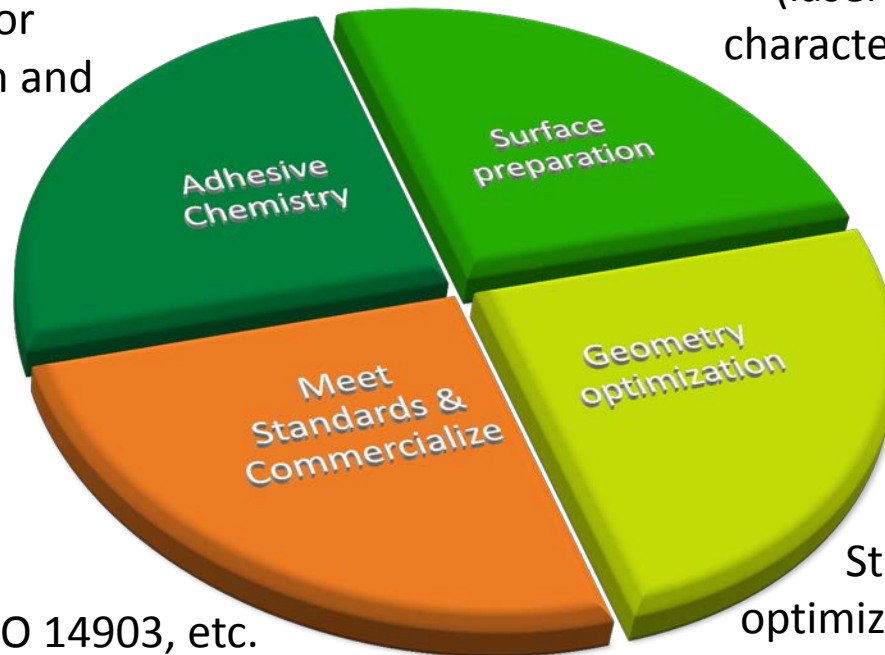

UL207, ASHRAE 15, ISO 14903, etc.  
Commercial Implementation

Structural analysis and optimization and non-destructive coverage quantification via neutron imaging

# Project Decision Points

## 3 Year Project

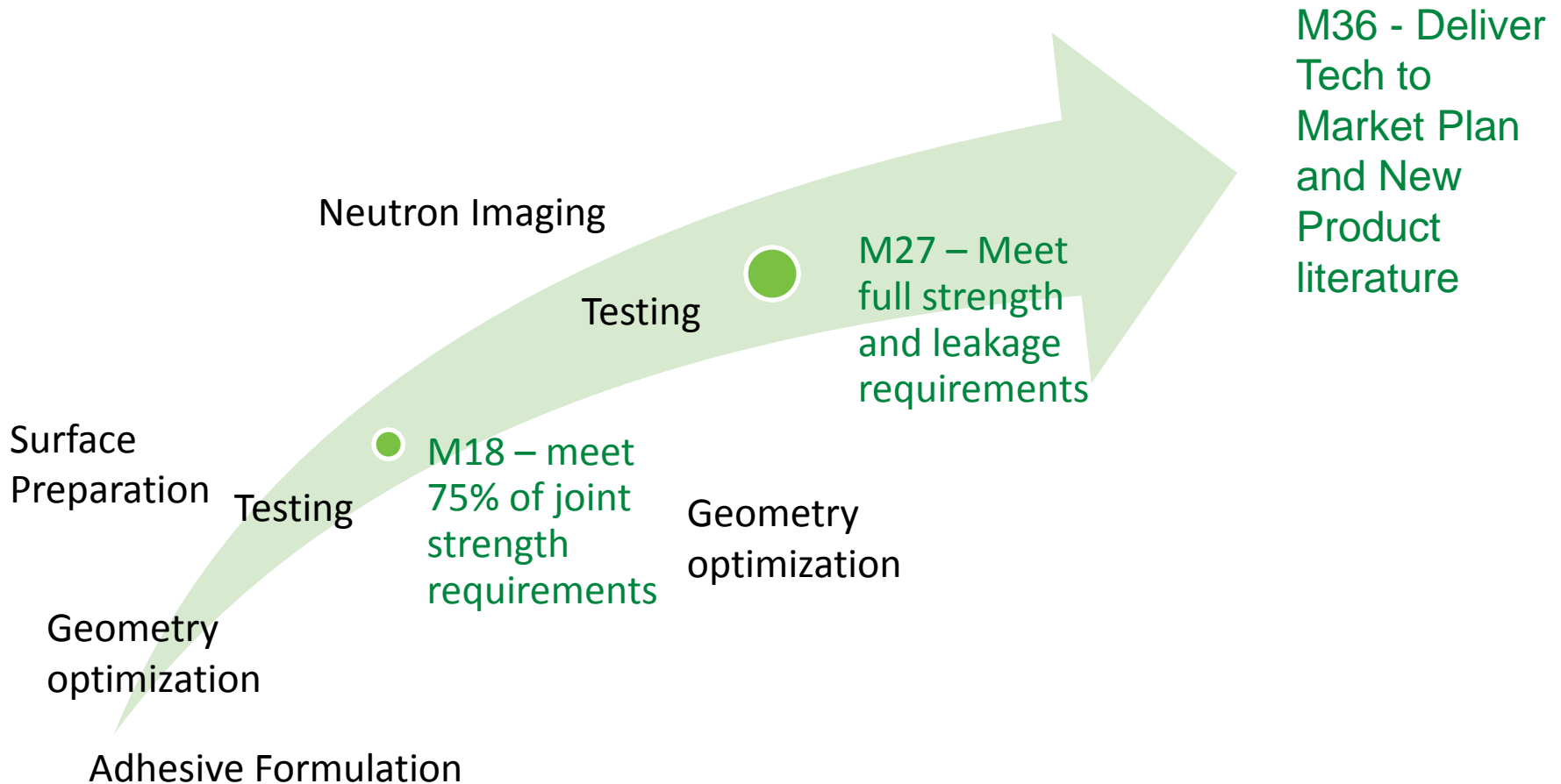

# Approach – Joint geometry optimization through FEA

- Cohesive Zone Modeling, capturing the adhesive chemical bonding
- Fine resolution of the surface topology

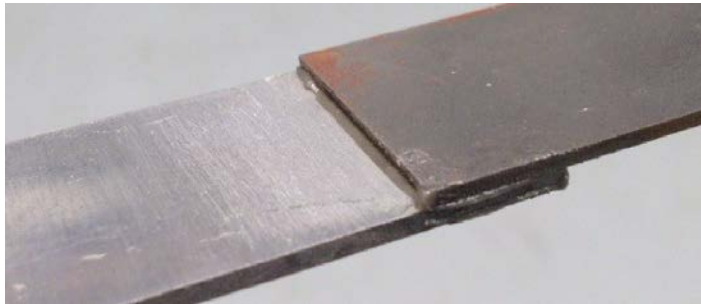

2 mm sheets of aluminum alloy and steel

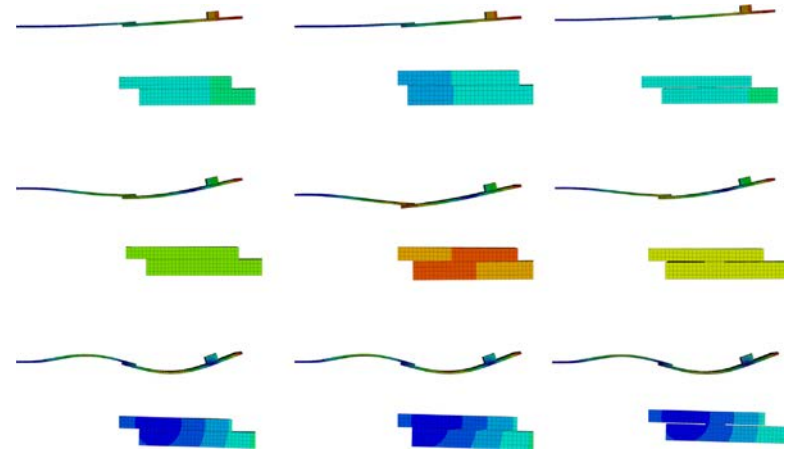

Milestone – Joint strength (M9)

Progress – Purdue University have began modeling existing geometries

Y. Du & L. Shi, Effect of vibration fatigue on modal properties of single lap adhesive joints, Int. J. Adhesion & Adhesives, 53 (2014)



# Approach – Surface Preparation

- Chemical cleaning – solvent degreasing, vapor degreasing, alkaline or aqueous cleaning, acid pickling (immersion, spray, circulation)
- Mechanical cleaning – wire brushing, vibratory polishing, blasting
- Laser structuring

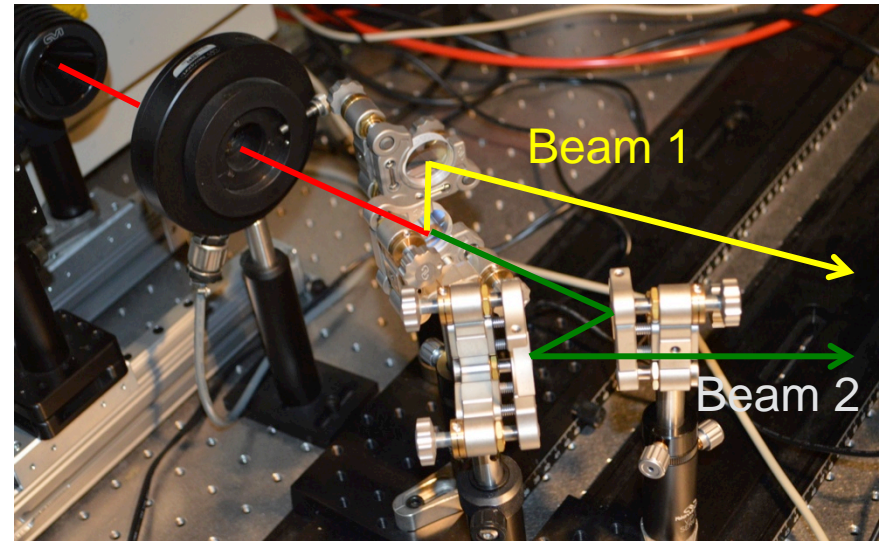
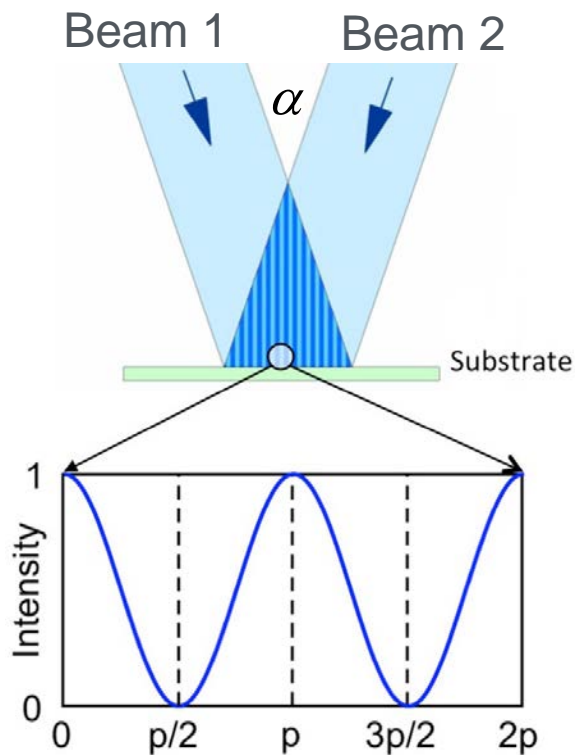

$$p \propto \frac{\lambda}{2 \sin(\alpha/2)}$$

# Distinctive Approach – Laser structuring

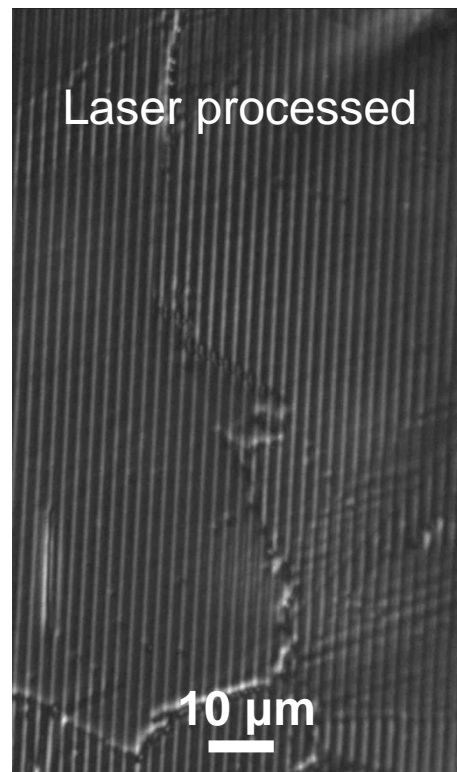
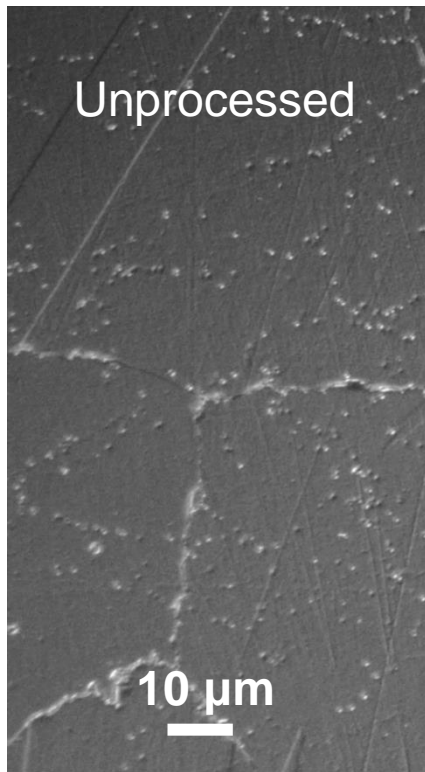

- X-ray photoelectron spectroscopy (XPS) measures the “cleanliness” of the structured surfaces

Milestone – Verify practical surface preparation techniques, (M6)

Progress – Flat Al coupons surfaces laser processed, setting up for tubes

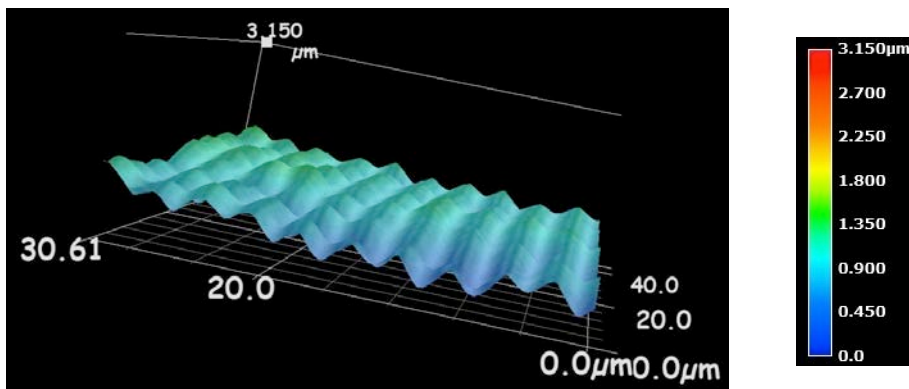

Key Issue – Internal surface structuring

# Distinctive Approach – Neutron Radiography

- Quantitative coverage assessment
- Non-destructive, becomes the yard stick to which other measuring approaches are compared
- Metals of interest transmit neutrons, hydrogen containing adhesives attenuate

$$I_m = I_0 e^{-\mu_m t_m}$$



*High Flux Isotope Reactor, ORNL*

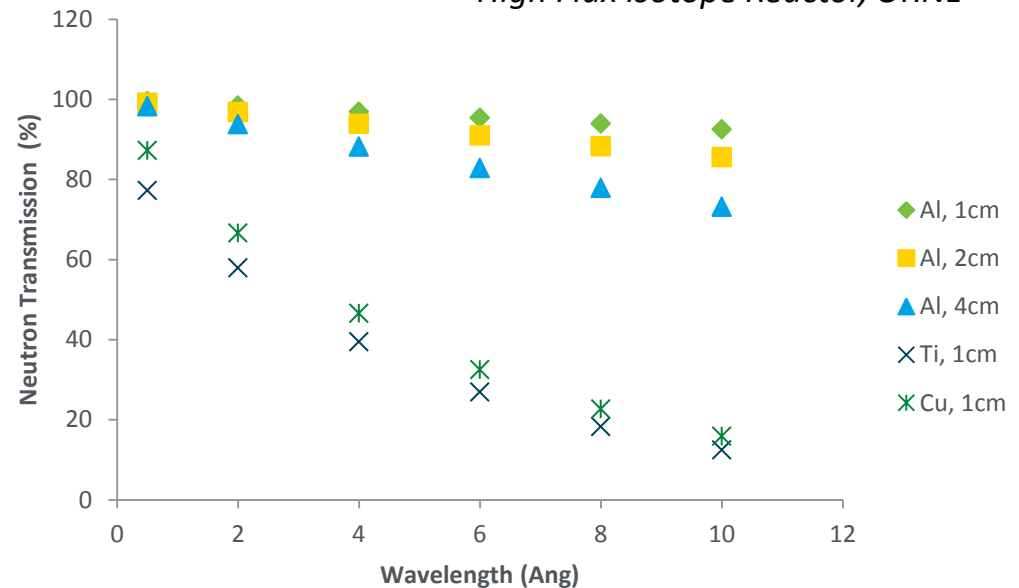

# Distinctive Approach – Neutron Radiography

- Single lap joint specimen

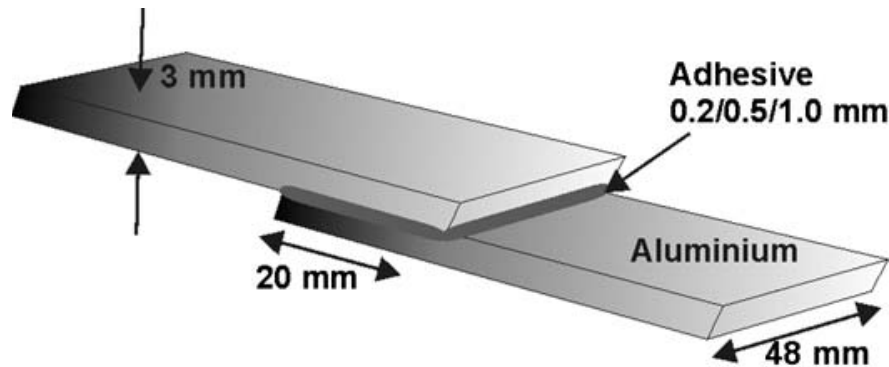

M. Michaloudaki, E. Lehmann, D. Kosteas, Neutron imaging as a tool for the non-destructive evaluation of adhesive joints in aluminium, Int. J. Adhesion Adhesives 25 (2005) 257-267

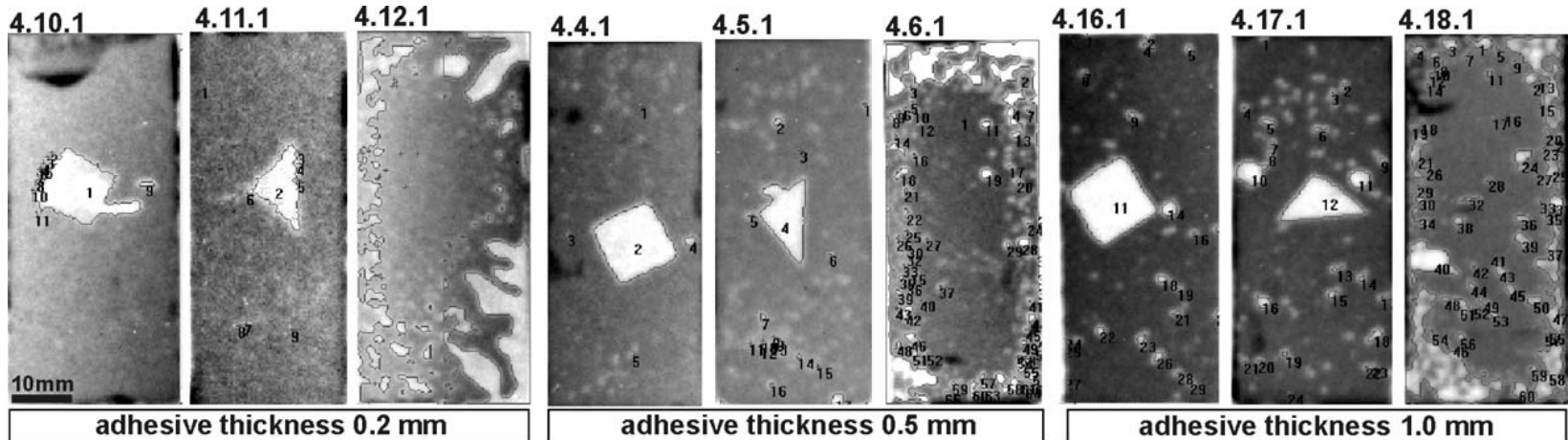

Betamate 1496 with imperfections

# Distinctive Approach – Neutron Radiography

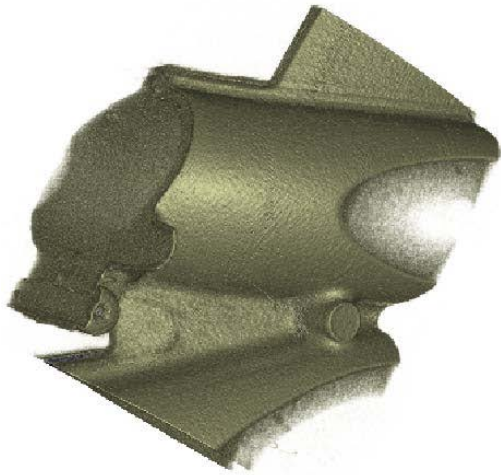

Adhesive joining of a car intake manifold segment

P. Vontobel, E. Lehmann, G. Frei. Performance characteristics of the tomography setup at the PSI NEUTRA thermal neutron radiography facility. Proceedings of Computed Tomography and Image Processing for Industrial Radiology, June 23-25, 2003, Berlin, Germany.

Key issue – matching cure time to neutron flux for in-situ coverage quantification

Milestone – Identify joints that reach > 98% coverage, M21

Progress – Neutron beam time this Summer

# Approach – Adhesive Chemistry

- Develop adhesives with specific chemistries for bonding Al and Cu
- Performance Characterization (overlap shear strength and peel strength at 2-3 temperatures)
- Basic rheology characterization of viscosity and modulus vs. time for strength build
- Characterization of glass transition temperature

Milestone – Formulation and characterization of 3-5 adhesives, M15

# Approach – Bigger Picture

## Testing:

- Mechanical testing of joints according to relevant standards
- Standards ISO 14903, ASHRAE 15, UL207, etc.
- New adhesively joined heat exchanger will be assembled and tested in a real HVAC&R system to validate performance and reliability

## New geometry designs:

- One stop fabrication of manifolds and bends

## Commercialization Plan:

- Gauge level of interest from HVAC&R manufacturers
- Preliminary cost analysis of current brazing techniques
- Cost analysis of adhesive joining
- Tech-to-market plan and new product literature

Accomplishment – DMP and IPMP in place, M3 delayed to M6

# Project Integration and Collaboration

## Partners, Subcontractors, and Collaborators:

- **ORNL:** Expertise in building equipment, neutron radiography, laser structuring and material characterization
- **3M:** World leaders in adhesives  
Subcontract is near completion, awaiting DOE verification of 3M proposal cost
- **Purdue University:** Dedicated testing resources and renowned graduate program  
Prof. Eckhard Groll, Prof. Justin Weibel, Haotian Liu
- **HeatCraft RPD:** Advisory role, Rob Akins

## Project Integration:

- In constant communication with ORNL via conference calls, emails, and task reports





# REFERENCE SLIDES

# Project Budget

**Project Budget:** DOE Total \$1500k

**Cost to Date:** \$23.1k

**Additional Funding:** None expected

## Budget History

10/1/16 – FY 2017 (past)		FY 2017 (current)		FY 2017 – 9/30/19 (planned)	
DOE	Cost-share	DOE	Cost-share	DOE	Cost-share
\$0k	*	\$500k	*	\$1000k	*

\* In-kind contribution from CRADA partner – exceeds DOE funding level; exact total is confidential information

# Project Plan and Schedule

	◆ Milestone/Deliverable (Actual) use when met on time											
	FY2017				FY2018				FY2019			
Task	Q1 (Oct-Dec)	Q2 (Jan-Mar)	Q3 (Apr-Jun)	Q4 (Jul-Sep)	Q1 (Oct-Dec)	Q2 (Jan-Mar)	Q3 (Apr-Jun)	Q4 (Jul-Sep)	Q1 (Oct-Dec)	Q2 (Jan-Mar)	Q3 (Apr-Jun)	Q4 (Jul-Sep)
<b>Past Work</b>												
Q1 Milestone: DMP and IPMP	◆	◆										
<b>Current/Future Work</b>												
Q2 Milestone: Verify surface preparation techniques												
Q3 Milestone: Joint strength requirement												
Q4 Milestone: CP - gauge HVAC&R interest												
Q1 Milestone: CP - cost analysis of brazing												
Q2 Go/No Go: 75% joint strength requirement												