

Appendix A

Description of the Proposed Project and
Alternatives

Chapter 2

Description of the Proposed Project and Alternatives

This chapter describes the Proposed Project and alternatives; proposed construction, operation and maintenance, and decommissioning activities; and the Environmental Protection Measures (EPMs) and standard construction, operation, and maintenance practices that would be implemented as part of the Project. It also identifies the Environmentally Preferred Alternative.

Pending completion of the EIS/EIR, the exact locations and quantities of project components (e.g., transmission line right-of-way, transmission line support structures, new substations or expanded substation areas, access roads, staging areas, pulling sites) are unknown and, in some cases, quantities of project components are estimated. This EIS/EIR uses the term *Project area* to collectively describe the area within which Project components could be located. A *corridor* is a linear area within which the easements (also known as rights-of-way) would be located; proposed corridors are part of the Project area.

2.1 Proposed Project

Western proposes to construct, own, operate, and maintain about 95 miles of new transmission lines within easements ranging from 125 to 250 feet wide through Alameda, San Joaquin, Stanislaus, and Merced Counties along the foothills of the Diablo Range in the western San Joaquin Valley. Western also would upgrade or expand its existing substations, make the necessary arrangements to upgrade or expand existing PG&E substations, or construct new substations to accommodate the interconnections of these new transmission lines. An overview of the Proposed Project is illustrated in Figure 2-1.

2.1.1 Overview

The Proposed Project consists of:

- **A 500-kV transmission line.** A single-circuit 500-kV transmission line, about 65 miles long, terminating at the existing, expanded, or new substations in the Tracy and Los Banos areas.
- **230-kV transmission lines.** A single-circuit 230-kV transmission line, about 3 miles long, connecting the San Luis Substation and the existing Los Banos Substation or new Los Banos West Substation (called the “tie-line”) and a single-circuit 230-kV transmission line, about 20 miles long, connecting the San Luis and Dos Amigos Substations.
- **A 70-kV transmission line.** A single-circuit 70-kV transmission line, about 7 miles long connecting the San Luis and O’Neill Substations.

Much of the Proposed Project would be located adjacent to existing high-voltage transmission line easements along the foothills west of Interstate 5 (I-5).

Western is proposing to construct two new 500-kV substations: Tracy East Substation and Los Banos West Substation. The Tracy East Substation would be adjacent to and east of the existing Tracy Substation with a footprint of up to 50 acres (see Figure 2-6a). The Los Banos West Substation would be adjacent to and west of the existing Los Banos Substation with a footprint of up to 50 acres (see Figure 2-6c). The existing Tracy, Los Banos, San Luis, and/or Dos Amigos Substations may be expanded to add new or modify existing 230-kV terminal bays. Western would also construct a 230/70-kV transformer bank and associated facilities at the San Luis Substation.

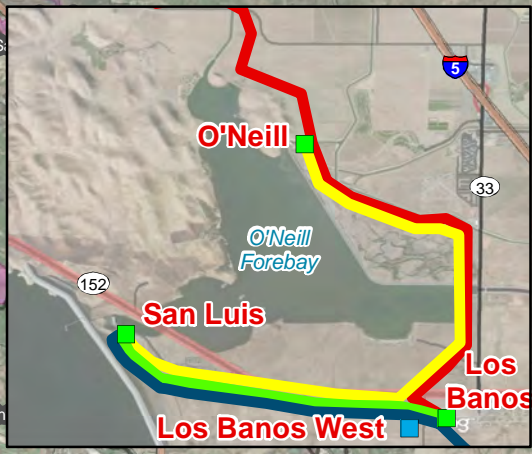
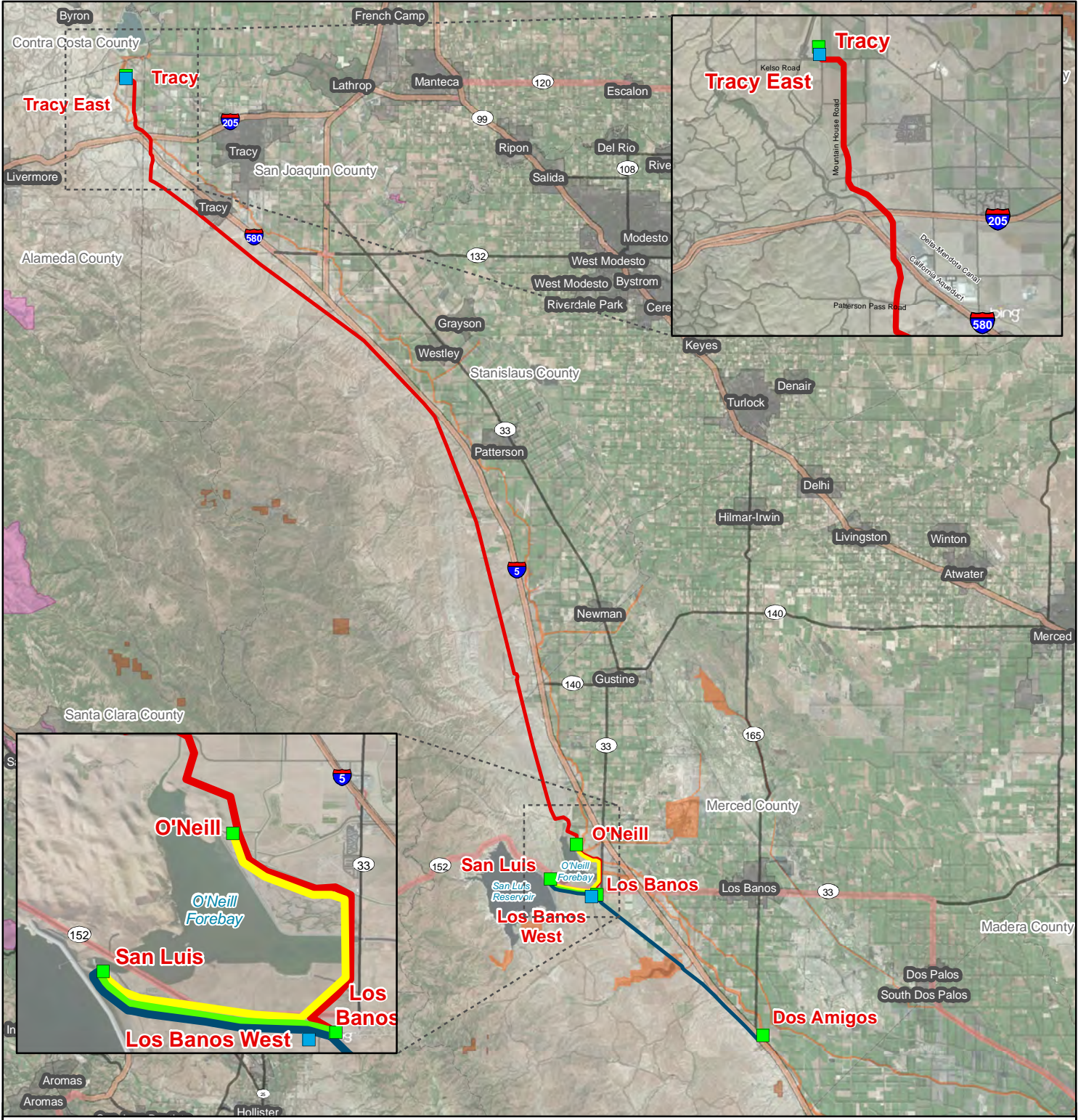

OFFICIAL USE ONLY

May be exempt from public release under the Freedom of Information Act (5 U.S.C.552) Exemption 2 - Circumvention of statute.

Western review required before public release.

Name/Org: SNR Date: 3/17/2015

- Existing Substations
- Proposed New Substations
- Streets
- City Boundary
- Counties

Proposed Project

- 500-kV Corridor
- 230-kV Corridor (tie-line)
- 230-kV Corridor
- 70-kV Corridor

Land Ownership

- Bureau of Land Management
- Bureau of Reclamation
- California Dept. of Fish and Wildlife
- California Dept. of Parks and Recreation
- Dept. of Energy
- Fish and Wildlife Service
- Lands Commission
- Local Government
- Military
- Parks and Preserves
- Unclassified

Figure 2-1

Proposed Project Overview



The Proposed Project would also include ancillary facilities, such as communication facilities, improvements to existing access roads, new permanent access roads, and temporary access roads to facilitate construction activities. Western would acquire the necessary easements and fee land for the Proposed Project.

2.1.1.1 500-kV Transmission Line

As shown in Figure 2-1, the proposed single-circuit 500-kV transmission line corridor begins at the Tracy Substation, located at the intersection of Mountain House Road and Kelso Road, about six miles northwest of the City of Tracy in Alameda County. From the substation, the proposed corridor heads east along Kelso Road and turns south, adjacent to an existing 230-kV transmission line through agricultural fields. The proposed corridor then continues south and crosses the Delta-Mendota Canal (Canal) and a 69-kV transmission line. Then, it turns southeast to cross these features again and continues along the northeastern side of the canal and into San Joaquin County, crossing Interstate 205 (I-205) and a 230-kV transmission line. The proposed corridor then turns south, and continues adjacent to two existing 230-kV and 500-kV transmission lines to an area just east of PG&E's Tesla Substation, south of Patterson Pass Road.

Next, the proposed corridor turns south and runs adjacent to the east side of the existing transmission line corridor, which contains up to five high-voltage transmission lines. Along this section, the existing easements adjacent to the proposed corridor contain several 500-, 230-, and 115-kV transmission lines in various configurations. The proposed corridor runs adjacent to these transmission lines, with minor deviations to avoid existing infrastructure, south to the O'Neill Forebay.

Just north of the O'Neill Forebay, the proposed corridor turns southeast, around the east side of the O'Neill Forebay and terminates into the existing Los Banos Substation or new Los Banos West Substation.

2.1.1.2 230-kV Transmission Lines

There are two proposed single-circuit 230-kV transmission lines. The first proposed 230-kV transmission line corridor is between the San Luis Substation and the Los Banos Substation area south of Highway 152; this transmission line is also referred to as the "tie-line." The second proposed 230-kV transmission line would connect the San Luis and Dos Amigos Substations. This proposed transmission line corridor would head east along Highway 152 from San Luis Substation, in the same corridor as the tie-line, to a point just south of the Los Banos Substation; no interconnection with the Los Banos or Los Banos West Substations would occur. At this point, the corridor heads southeast for about 7 miles adjacent to and east of the existing PG&E transmission line. Just south of the Los Banos Reservoir, it crosses to the west of the existing PG&E transmission line corridor and continues southeast for about 7 miles until it crosses I-5 to the Dos Amigos Substation. These proposed corridors are shown in Figure 2-1.

2.1.1.3 70-kV Transmission Line

The proposed single-circuit 70-kV transmission line connects the San Luis and O'Neill Substations around the east side of the O'Neill Forebay. This component of the Proposed Project is located within the proposed 230-kV and 500-kV corridors described above (see Figure 2-1).

2.1.1.4 Operational Voltage Options

As described in Section 1.2, the operational voltage needed for the project is dependent on the participation of an eligible transmission customer. The Proposed Project described herein assumes participation by the customer. If the customer declines to participate, one of the following operational voltage options may be selected by Western and the Authority in their decision-making processes pursuant to NEPA and CEQA.

500-kV Transmission Line operated at 230-kV

This voltage option would consist of a 500-kV transmission line constructed between the Tracy and Los Banos Substations. However, it would be operated at 230-kV. The proposed Tracy East and Los Banos West Substations would not be constructed. The 230-kV transmission line between the San Luis and Dos Amigos Substations, as well as the 70-kV transmission line between the San Luis and O'Neill Substations, are the same as the Proposed Project.

230-kV Transmission Line

This voltage option would consist of a 230-kV line constructed between the Tracy and San Luis Substations. The proposed Tracy East and Los Banos West Substations would not be constructed. The 230-kV transmission line between the San Luis and Dos Amigos Substations, as well as the 70-kV transmission line between the San Luis and O'Neill Substations, are the same as the Proposed Project.

2.1.2 Project Components

2.1.2.1 Easements

Western does not have existing transmission line easements within the Project area, and therefore, would need to acquire easements for the entire Project. Western would locate lines adjacent to existing easements or transmission lines wherever possible. Generally, easements would be 125 to 175 feet wide for a 230-kV transmission line and 200 to 250 feet wide for a 500-kV transmission line. The actual width and location of the proposed easement within the corridor may vary depending on engineering considerations, as well as constraints identified during environmental surveys.

2.1.2.2 Access Roads

Improvements to existing access roads, new permanent access roads, and temporary access roads would be needed for construction and maintenance of the transmission line. Typically, access roads are 14 feet wide along straightaways and 16 to 20 feet wide through corners to facilitate safe movement of equipment and vehicles.

Although specific locations have not been determined, new access roads for the Project would be located to minimize environmental impacts and to accommodate engineering constraints. Access roads would be occasionally graded for maintenance purposes and culverts would be added, as needed. Appendix E quantifies the estimated area of disturbance for proposed new and existing access roads.

2.1.2.3 Structures

Tubular steel monopoles or lattice steel structures would be used to support the 500-kV and 230-kV lines of the Proposed Project, and smaller wood or steel monopoles would be used for the 70-kV line. Typical dimensions of the proposed structures are shown in Figures 2-2 through 2-4 and summarized in Table 2-1.

Table 2-1. Typical Structure Dimensions

Structure Type	Height (feet)	Structures Per Mile
500-kV single-circuit lattice	100-170	4 to 5
500-kV single-circuit steel pole	140-170	4 to 5
230-kV single- or double-circuit lattice	100-150	4 to 5
230-kV single- or double-circuit steel pole	125-140	4 to 5
70-kV wood or steel pole	50-70	10 to 15

Ancillary Facilities

Communication facilities, including fiber optic overhead ground wires, would be installed on the transmission line structures for control and protection. Construction, expansion, and maintenance of these facilities would occur within the corridors.

2.1.3 Construction

2.1.3.1 Construction Schedule

Construction would commence after securing all required permits and land rights. Multiple crews would work simultaneously on different project components. Table 2-2 presents Western’s proposed schedule for constructing the SLTP.

Construction generally would take place between 7 a.m. and 7 p.m., six days per week, except for those areas where local ordinances and traffic considerations dictate otherwise, in which case working hours would be consistent with local requirements.

Table 2-2. SLTP Proposed Construction Schedule

Construction Phases	Estimated Days	Estimated Schedule
Engineering and Design	430	Begin in Fall 2017
Construction	525	Begin in Summer 2018
Final Testing/Operation	135	2021

2.1.3.2 Ground Disturbance

Ground disturbance would occur from grading construction staging areas, grading and drilling holes for new structure foundations, constructing and improving roads for vehicle and equipment access, establishing pull sites for conductor installation, as well as expanding existing and/or construction of new substations. The typical ground disturbance area for each of these activities is shown in Table 2-3. Proposed construction methods are described in the following sections.

Table 2-3. Typical Ground Disturbance for Construction Activities¹

Activity		Temporary Disturbance	Permanent Disturbance
Staging area		5 acres every 15 miles	0 acres
Structure footing	500-kV lattice	up to 0.9 acres	up to 0.1 acres
	500-kV steel pole	up to 0.9 acres	up to 0.1 acres
	230-kV lattice	up to 0.6 acres	up to 0.1 acres
	230-kV steel pole	up to 0.6 acres	up to 0.1 acres
	70-kV wood or steel pole	up to 0.1115 acres	up to 0.0001 acres
Foundation excavation	500-kV and 230-kV lattice and steel poles	40 feet deep, 12 feet in diameter	0 acres ²
	70-kV wood or steel pole	8 to 10 feet deep, 4 feet in diameter	0 acres ²
Conductor pull site		0.4 acres	0 acres
Access road construction/improvement		Up to 30 feet wide	12 feet wide
Tracy, Los Banos, San Luis, and Dos Amigos Substation expansion		up to 0.1 acres within existing substation	up to 0.1 acres within existing substation
Tracy East Substation		0 acres	up to 50 acres
Los Banos West Substation		0 acres	up to 50 acres

1 - These dimensions represent worst-case and are used in the impact analysis of Chapter 4, but could be reduced during final engineering design or consultation with resources agencies. Note that these dimensions will be influenced by topography, location, easement width, etc. Also see Appendix E for details on disturbance assumptions.

2 - Included in structure footings

Single-Circuit Lattice Tower

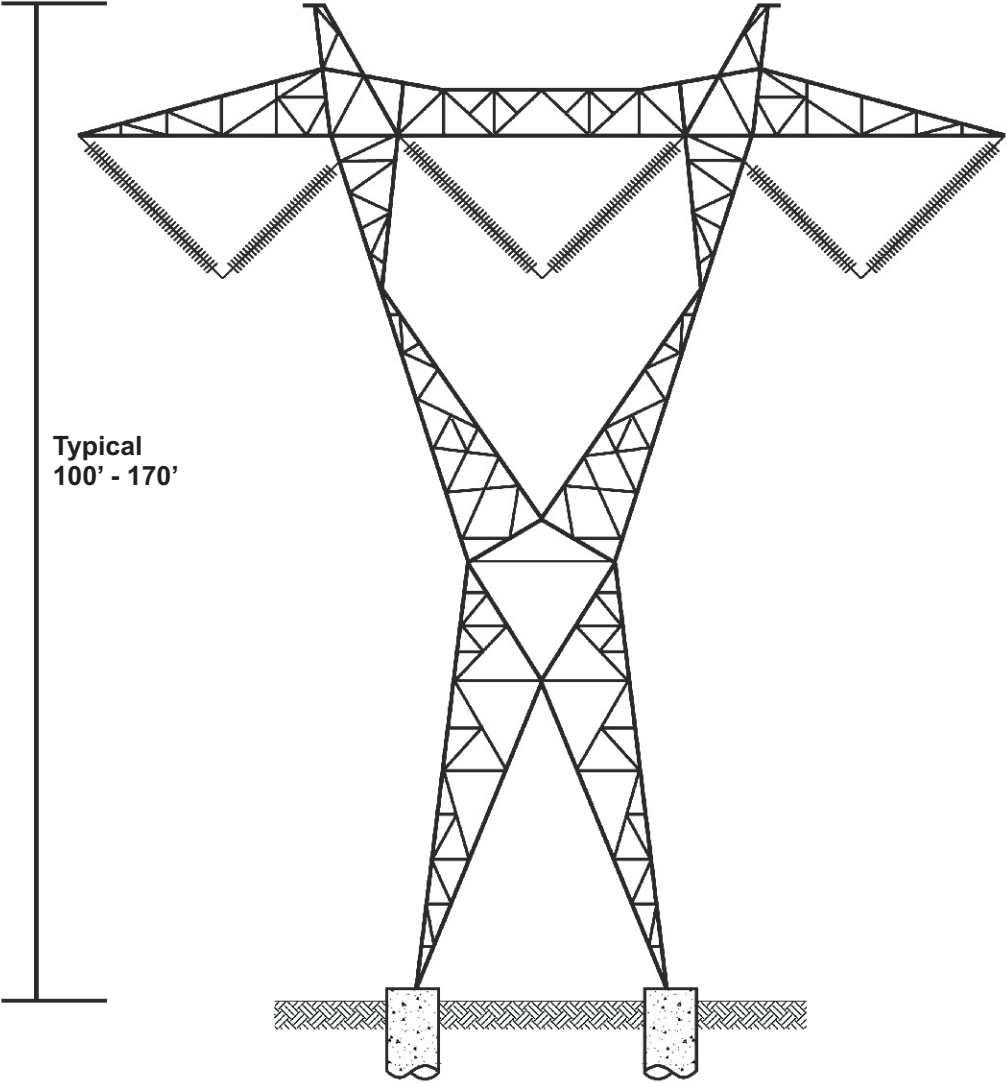

Single-Circuit Steel Pole

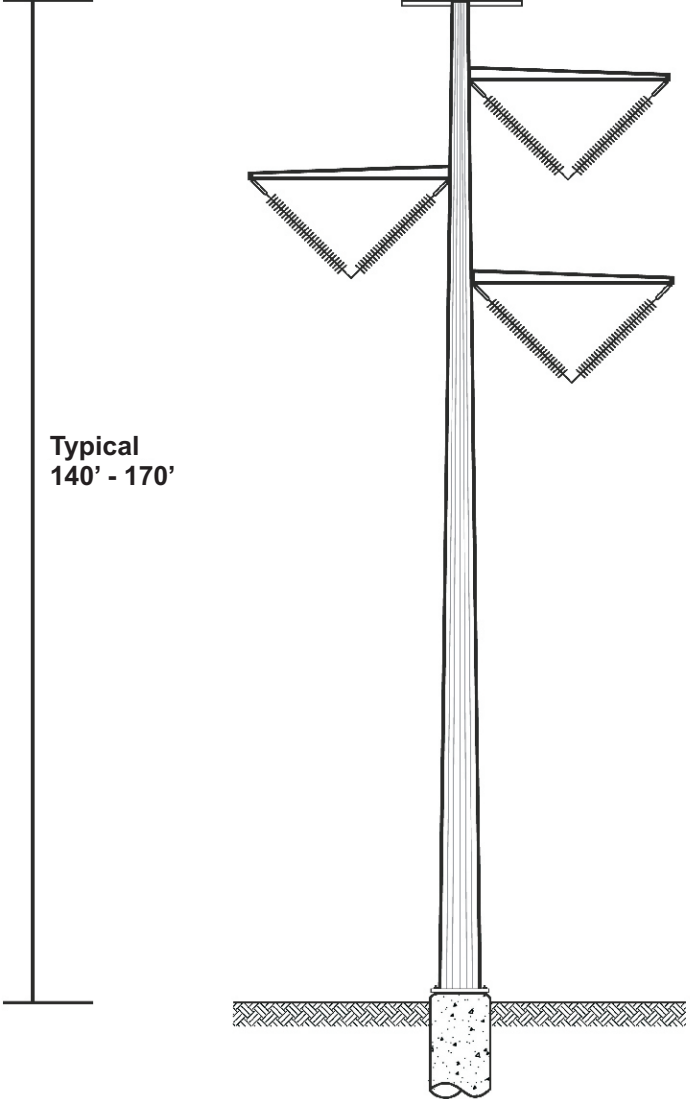
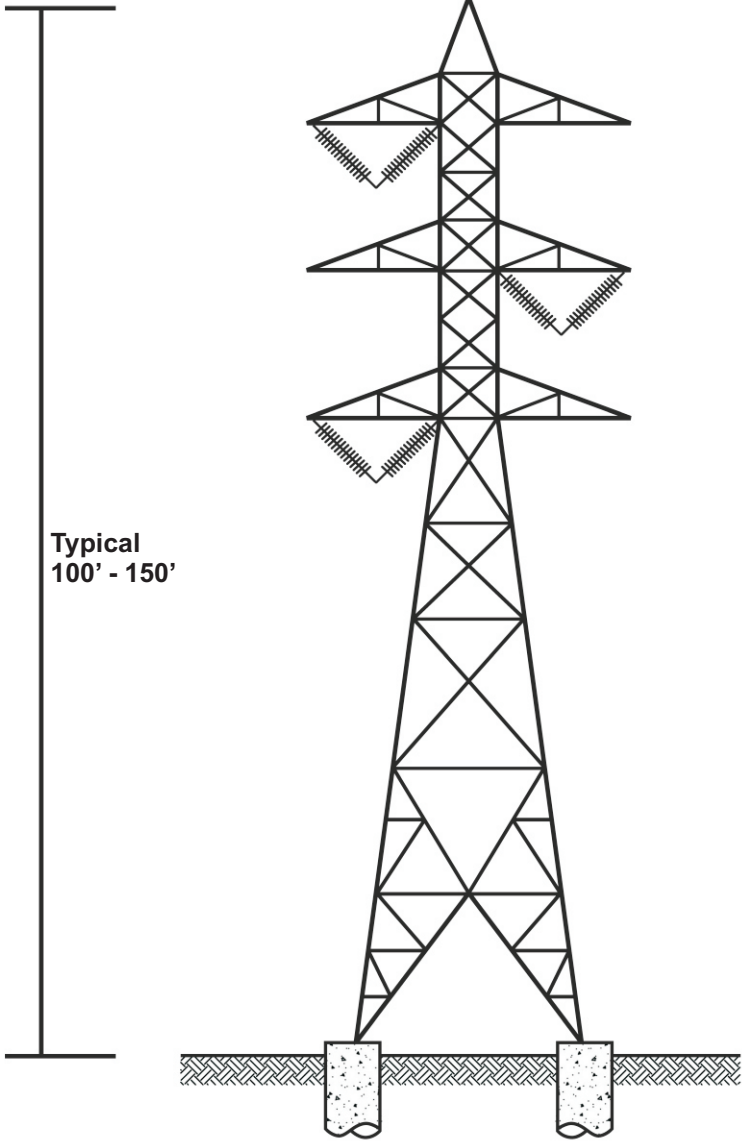

Figure 2-2

SLTP Representative 500-kV Structure Types

Single-Circuit Lattice Tower



Single-Circuit Steel Pole

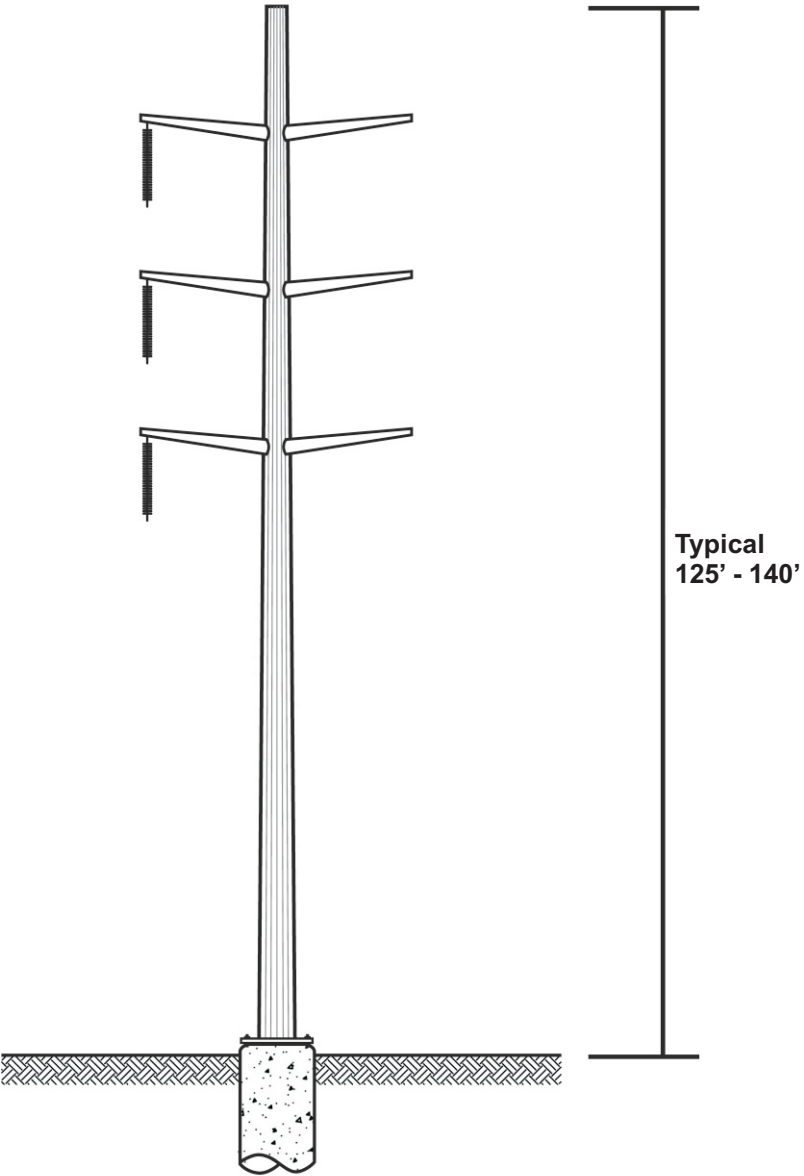

Figure 2-3

SLTP Representative 230-kV Structure Types

Single-Circuit Steel or Wood Pole

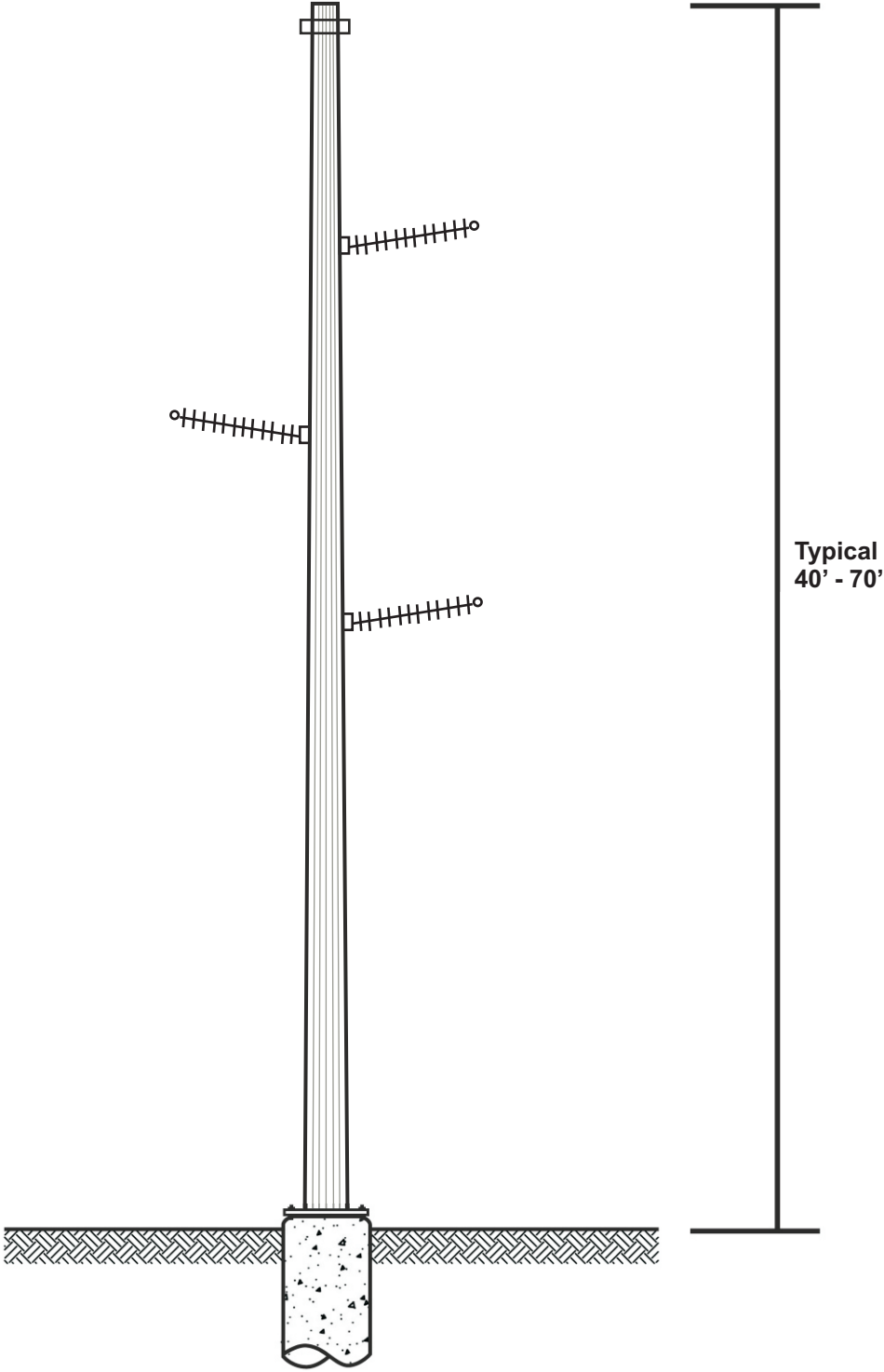

Figure &-4

SLTP Representative 70-kV Structure Types

2.1.3.3 Construction Equipment and Workforce

Typical quantities of personnel and equipment needed for proposed construction activities are shown in Table 2-4. The tasks would be conducted in stages; therefore, personnel and equipment would not be working on all tasks simultaneously at a given location, but there would be some overlap in tasks.

Table 2-4. Typical Personnel and Equipment

Activity	Personnel	Equipment
Right-of-Way (access roads and vegetation clearing)	2 to 4 equipment operators	<ul style="list-style-type: none"> ▪ 1 motor grader ▪ 2 pickup/trucks ▪ 2 bulldozers ▪ 1 backhoe
Excavation for foundations	4 to 8 laborers/equipment operators	<ul style="list-style-type: none"> ▪ 2 augers ▪ 2 backhoes ▪ 2 pickup trucks ▪ 2 compressors
Foundation installation (anchor bolt/rebar cages)	4 to 6 laborers/equipment operators 3 to 5 ironworkers	<ul style="list-style-type: none"> ▪ 2 flat-bed trucks ▪ 2 pickup trucks ▪ 2 air compressors ▪ 2 hydro lifts ▪ 2 welders ▪ 2 to 3 mixer trucks per structure for direct-embedded foundations ▪ 10 to 12 mixer trucks per structure anchor bolt foundations
Structure assembly and erection	4 to 6 linemen/laborers and crane operators	<ul style="list-style-type: none"> ▪ 2 hydro-cranes ▪ 2 tractors ▪ 2 manlifts ▪ 2 pickup trucks
Helicopter use	1 pilot 1 ground person fueler	<ul style="list-style-type: none"> ▪ Helicopter Hughes 500 ▪ fuel truck
Conductor stringing	20 to 25 linemen/groundmen	<ul style="list-style-type: none"> ▪ 2 pullers ▪ 2 tensioners ▪ 2 bulldozers ▪ 4 reel trailers ▪ 1 materials truck ▪ 2 manlifts ▪ 5 to 6 pickup trucks ▪ 1 light truck
Disturbance area restoration (Cleanup and Revegetation)	3 to 6 laborers	<ul style="list-style-type: none"> ▪ 1 bulldozer w/ripper ▪ 1 blader ▪ 1 front-end loader ▪ 1 tractor/harrow/disc ▪ 1 light truck
Substation improvements and expansion	20-25 electricians, linemen, laborers, equipment, operators, and ironworkers	<ul style="list-style-type: none"> ▪ 2 flatbed trucks ▪ 2 bulldozers ▪ 2 cranes ▪ 2 excavators ▪ 5 pickup trucks ▪ 1 fuel truck ▪ 1 puller ▪ 1 tensioner ▪ 2 reel trailers ▪ 1 tractor ▪ 2 materials trucks ▪ 1 blader ▪ 2 mixer trucks ▪ 1 front end loader
Substation construction (Tracy East and Los Banos West)	20-40 electricians, linemen, laborers, equipment, operators, and ironworkers	<ul style="list-style-type: none"> ▪ 2 flatbed trucks ▪ 2 bulldozers ▪ 2 cranes ▪ 2 excavators ▪ 5 pickup trucks ▪ 1 fuel truck ▪ 1 puller ▪ 1 tensioner ▪ 2 reel trailers ▪ 1 tractor ▪ 2 materials trucks ▪ 1 blader ▪ 2 mixer trucks ▪ 1 front end loader

2.1.3.4 Construction Staging

Temporary construction staging areas would be needed to store and stage materials, construction equipment, and vehicles. Although the exact locations have not been determined, locations would be selected that minimize ground disturbance.

2.1.3.5 Right-of-Way Access and Improvements

Construction of a new transmission line requires access to each tower site for construction crews, materials, and equipment. Access to each site would be on an existing road where possible or new roads. Existing roads may need to be improved.

Improving existing access roads would involve brush clearing, grading, erosion control and the installation of culverts or rip-rap to maintain stormwater flows within ephemeral wash areas. Lost surface material would be replaced and the road would be graded and shaped. A motor grader is the primary equipment type used to conduct this work, but bulldozers may be used in some areas. Watering may be required to control dust and to retain fine surface rock.

In determining the final location of new roads, large trees or other natural features will be avoided. New access roads would be constructed using a bulldozer or grader, followed by a roller to compact and smooth the ground. Front-end loaders would be used to move the soil locally or offsite.

After project construction, existing and new permanent access roads would be used by maintenance crews and vehicles for inspection and maintenance activities. Temporary construction roads not required for future maintenance access would be removed and restored to pre-construction condition to the extent possible.

2.1.3.6 Excavation and Foundation Installation for Transmission Line Structures

Installation of structure foundations may require grading and vegetation removal. Where grading is needed, topsoil would be removed and stockpiled for use in site restoration. Temporary topsoil stockpiles would be protected from erosion during construction. Excavating transmission structure foundations is typically done with a backhoe, front-end loader, or pressure auger. Excavation to bedrock or other suitable base material would be required. A rock drill may be used if rock is encountered during excavation. Four holes would be excavated for each lattice structure and one for each tubular steel or wood pole.

Reinforced concrete foundations would be used for most structures. After foundation concrete is placed, a mechanical tamp would be used to re-compact soil around the foundation. The disturbed area would be re-graded so that surfaces drain naturally, blend with the natural terrain, and are left in a condition that will facilitate re-vegetation or re-seeding, provide for proper drainage, and prevent erosion.

2.1.3.7 Structure Assembly and Erection

Structure components would typically be transported to installation sites by truck or helicopter. Structures are erected with cranes. Structure assembly equipment may include cranes (ground or helicopter), augers, bulldozers, bucket trucks, backhoes, air compressors, electric generators, pickup trucks and other vehicles, machinery, and equipment. Structures would be assembled, erected, and attached to the foundations (see Figure 2-5).

2.1.3.8 Conductor Stringing

Conductor stringing would occur at designated pull and tensioning sites (see Figure 2-5). Generally the pull sites would be located within the easement. Angle-structure pull sites would require temporary easement rights if located outside the easement to pull the conductor on a straight line. The locations of pull sites depend on environmental constraints, conductor length, and equipment access. Pull sites would be located within the study area.

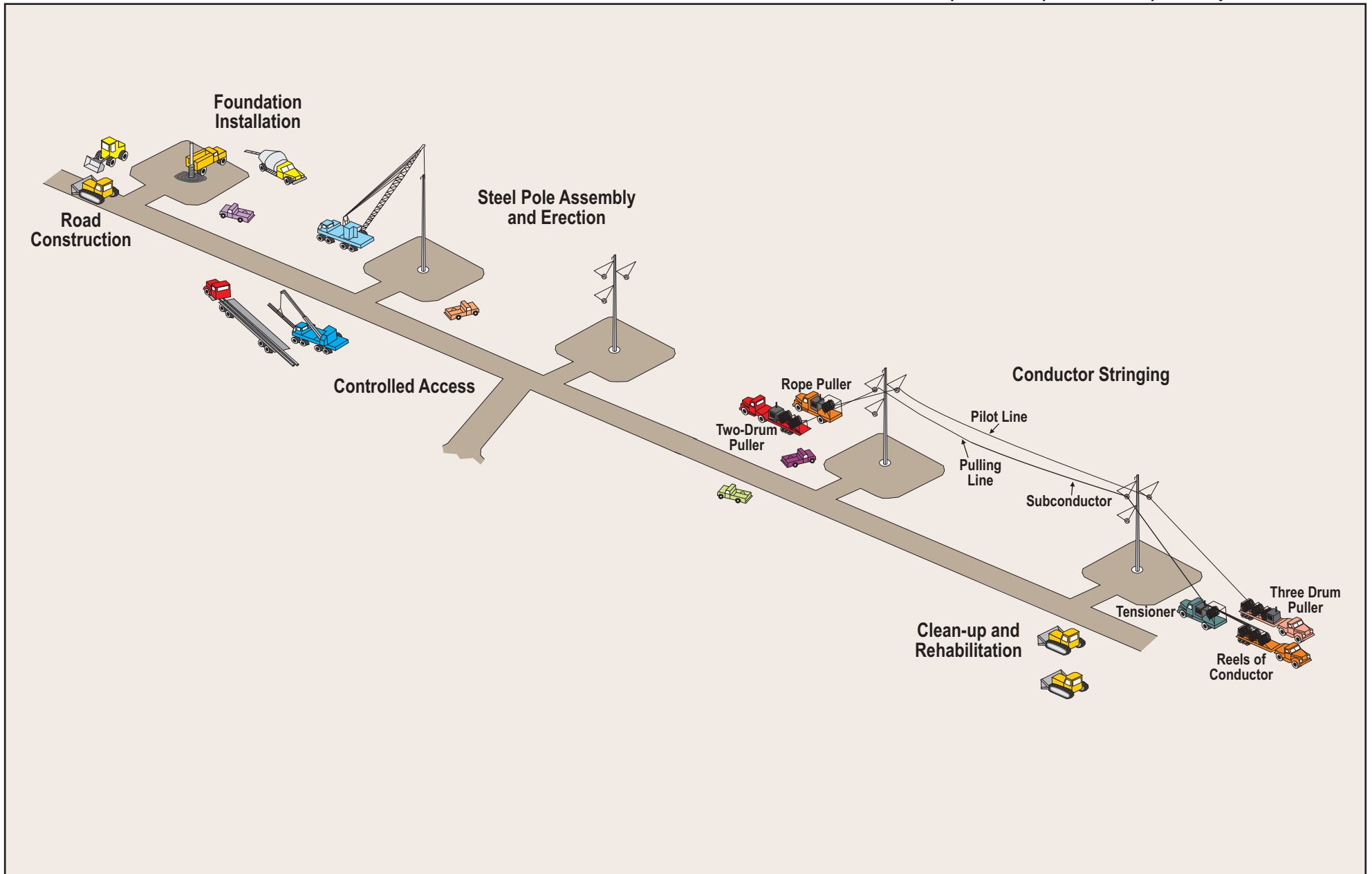

Figure 2-5
Typical Tower Construction and
Wire Conductioning Activities and Equipment

Large reels of conductor would be transported to the staging areas or pulling sites on flatbed trucks. Other equipment would include stringing trailers, tensioning machines, pullers, bulldozers, and several trucks including a bucket truck.

Temporary stringing sheaves or travelers (pulleys) would be attached on the cross-arms of each structure at the bottom of the insulator strings. A sock line (rope or lightweight wire) would then be strung from structure to structure through the stringing sheaves. This may be completed using a helicopter. A pulling line would then be attached to the end of the sock line and pulled back through the sheaves, between pull site locations. Conductor would then be strung using the pulling line.

Powered pulling equipment would be used at one end and tensioning equipment would be used at the other end to establish the proper tension and sag for crews to permanently “clip” conductors and ground wires onto structure hardware, and to maintain the proper ground clearance for the conductors. After conductor and ground wire are clipped in, the stringing sheaves would be removed and the new conductor would be connected to the insulators hanging from the cross-arms. Ground wire would be installed last and would be attached to the top of the structures using a pulling technique similar to that used for the conductors.

2.1.3.9 Substations

Existing Substations

Modifications to and/or expansion of existing substations would be needed to interconnect SLTP facilities. Modifications would include constructing new 230-kV breaker terminal bay facilities at the Tracy, San Luis, Los Banos and/or Dos Amigos Substations. Expansion of existing substations may be required if the existing substations are unable to accommodate a new terminal bay. Western also would construct a new 230/70-kV transformer bank bay and interconnection facility at the San Luis Substation. To accommodate these modifications, the existing substations may be expanded within the limits of the Project area.

Proposed New Substations

Generally, substation construction would include site grading, property and substation fencing, and landscaping and installation of electrical facilities. The site would be excavated and graded to accommodate the required construction and permanent facility buildings, equipment and electrical structures. A fence would be erected around the substation perimeter. Up to 50 acres would be graded for each new substation.

The electrical facilities proposed for the Tracy East Substation would accommodate the termination of one 500-kV transmission line. These facilities would include a 500 kV terminal bay, associated breakers, disconnect switches, protective relays, metering and Supervisory Control and Data Acquisition (SCADA) system equipment and associated features.

The electrical facilities proposed for the Los Banos West Substation would accommodate the termination of three 500 kV transmission lines and one 230-kV transmission line. These facilities would include three 500 kV terminal bays a 230-kV terminal bay, a 500/230-kV transformer bay and associated breakers, disconnect switches, protective relays, metering and Supervisory Control and Data Acquisition (SCADA) system equipment and associated features.

2.1.3.10 Disturbance Area Restoration

Areas temporarily disturbed by construction would be restored to pre-construction conditions, to the extent possible. Western would re-grade disturbed areas to establish original contours, and redistribute topsoil. All disturbed soil, other than surfaces intended for permanent access roads, would be seeded with native species free of invasive seed. Where necessary, water diversions (i.e., waterbars) would be constructed along access roads to control surface water drainage and erosion. See Appendix E for SLTP ground disturbance assumptions.

2.1.4 Operation and Maintenance

Western must comply with North American Electric Reliability Corporation and Western Electricity Coordinating Council standards and requirements for transmission system reliability, including maintenance and vegetation management. In order to comply with these requirements, Western has a comprehensive O&M program for all of its property and facilities including transmission lines, substations, communication facilities, and legal access roads. This O&M program ensures reliability of the transmission systems and safe, all-weather access to the transmission line structures and other Western facilities. The O&M activities proposed for the SLTP would be consistent with Western's O&M program, which is presented in Appendix D.

2.1.5 Decommissioning

The transmission line would be removed if the facilities are no longer needed. If removed, decommissioning would involve the removal of wire, insulators, hardware, and structures from the easements. All decommissioning activities would occur within the same disturbance area identified for construction.

Structures and foundations would be removed. Material would be disposed of in an appropriate manner; and may be salvaged or sold. The equipment required to safely remove the wires and structures would be nearly the same as that required for installation. Following removal, any areas disturbed during line dismantling would be restored and rehabilitated. Disturbed surfaces would be restored to the original contour. All disturbed soil, other than surfaces intended for permanent access roads, would be seeded with native species free of invasive seed.

Western would reclaim temporary service roads following abandonment in accordance with land management agency or landowner agreements. Equipment and personnel for restoration operations would be similar to that required at the end of construction. Where required by the land management agency or landowner, compacted areas would be ripped (with a dozer) and appropriate sediment control measures (e.g., revegetation) would be implemented.

2.1.6 Environmental Protection Measures and Construction Standards

Western implements Environmental Protection Measures (EPMs) and Construction Standards to reduce environmental consequences associated with its construction and maintenance activities. The analysis of environmental consequences (Chapter 4) assumes that the EPMs listed below and the Construction Standards presented in Appendix F would be implemented as part of the Project.

Table 2-5. Environmental Protection Measures

Resource	EPM
Agriculture	Where practical and feasible, construction and maintenance activities would be scheduled to minimize impacts to agricultural activities. If this is not possible and damage occurs, the landowner would be compensated.
Air Quality	Project participants will comply with federal, state, and local rules and regulations regarding air quality.
Air Quality	Equipment and vehicles will be operated in compliance with federal, state, and local rules and regulations regarding air quality.
Air Quality	Vehicles and equipment used in construction and maintenance of the Proposed Project or alternatives will maintain appropriate emissions control equipment and be appropriately permitted.
Air Quality	Regular watering of exposed soils and unpaved access roads will be conducted during the construction period.
Air Quality	Engine idling will be in accordance with an idling policy compliant with the California state regulations.
Air Quality	If new sulfur hexafluoride equipment is installed as part of the Project, these items will be reported to natural resources. Best management practices will be followed to eliminate sulfur hexafluoride emissions during installation and commissioning.
Biological Resources	Tower locations will be sited, to the extent feasible and practicable, outside of any mapped or known special-status vegetation communities and populations of special-status plant species.
Biological Resources	All Western and contract crews will complete biological awareness training to ensure they are familiar with project sensitive biological resources and the associated EPMs and mitigation measures. All supervisors and field personnel will have on file a signed agreement that they have completed the training, and understood and agreed to the terms. EPMs and applicable mitigation measures will be written into the contract for construction and O&M work, and contractors will be held responsible for compliance.
Biological Resources	Vehicle traffic will be restricted to designated access routes and the immediate vicinity of construction and O&M sites. Vehicle speeds will not exceed 15 mph on nonpublic access and maintenance roads and 10 mph on unimproved access routes. Vehicles and equipment will be parked on pavement, existing roads, and previously disturbed areas, to the maximum extent feasible.
Biological Resources	No pets or firearms will be permitted at project sites.
Biological Resources	At the end of each work day, construction and O&M workers will leave work areas and adjacent habitats to minimize disturbance to actively foraging animals, and remove food-related trash from the work site in closed containers for disposal. Workers will not deliberately or inadvertently feed wildlife.
Biological Resources	Nighttime construction and O&M activities will be minimized to emergency situations. If nighttime construction and O&M work is required, lights will be directed to the minimum area needed to illuminate project work areas. If night time work is required, a speed limit of 10 mph will be enforced on all nonpublic access roads.
Biological Resources	Mortalities or injuries to any wildlife that occur as a result of project- or maintenance-related actions will be reported immediately to the Western Natural Resources Department or other designated point of contact, who will instruct construction and O&M personnel on the appropriate action, and who will contact the appropriate agency if the species is listed. The phone number for the Western Natural Resources Department or designated point of contact will be provided to maintenance supervisors and to the appropriate agencies.
Biological Resources	Caves, mine tunnels, and rock outcrops will never be entered, climbed upon, or otherwise disturbed.
Biological Resources	If a pesticide label stipulates a buffer zone width for protection of natural resources that differs from that specified in a project mitigation measure or EPM, the buffer zone width that offers the greatest protection will be applied.
Biological Resources	At completion of work and at the request of the land owner/manager, all work areas except access roads will be scarified or left in a condition that will facilitate natural or appropriate vegetation, provide for proper drainage, and prevent erosion.

Table 2-5. Environmental Protection Measures

Resource	EPM
Biological Resources	Prior to any application of herbicide, Western will query the California Department of Pesticide Regulation PRESCRIBE database, entering location information by county, township, range, and section, entering both the commercial name and the formulation of the desired pesticide, and will follow all use limitations provided to ensure compliance with applicable pesticide standards. This database is currently located at http://www.cdpr.ca.gov/docs/endspec/prescint.htm . The measures generated by the PRESCRIBE database will supersede those in the project EPMs where they are different.
Biological Resources	Seed mixtures applied for erosion control and restoration will be certified as free of noxious weed seed, and will be composed of native species or sterile nonnative species.
Biological Resources	Equipment will be washed prior to entering sensitive areas within the project area to control noxious weeds. The rinse water will be disposed of through the sanitary sewage system or other appropriate disposal method that minimizes the spread of noxious weeds.
Biological Resources	Measures described in the Suggested Practices for Avian Protection on Power Lines: The State of the Art in 2006 (Avian Power Line Interaction Committee 2006 or more current version) and Reducing Avian Collisions with Power Lines: The State of the Art in 2012 (Avian Power Line Interaction Committee 2012 or more current version) will be implemented during O&M activities to minimize bird mortality and injury. At such time when Western finalizes an Avian Protection Plan, Western will adhere to the guidance in that document.
Biological Resources	Construction and O&M excavations greater than 3 feet deep will be fenced, covered, or filled at the end of each working day, or have escape ramps provided to prevent the entrapment of wildlife. Trenches and holes will be inspected for entrapped wildlife before being filled. Any entrapped animals will be allowed to escape voluntarily before construction and O&M activities resume, or they may be removed by qualified personnel, with an appropriate handling permit if necessary.
Biological Resources	A hazardous-spill plan will be developed prior to construction and will remain in effect for all O&M activities. The plan will describe what actions will be taken in the event of a spill of toxic or hazardous materials. The plan will incorporate preventive measures to be implemented for vehicle and equipment staging, cleaning, maintenance, and refueling, and for containment management and storage of hazardous materials, including fuel. In the event of a contaminant spill, work at the site will immediately cease until the contractor has contained and mitigated the spill. The contractor will immediately prevent further contamination, notify appropriate authorities, notify Western's regional environmental manager, and will mitigate damage as appropriate. Adequate spill containment materials, such as oil diaper mats and hydrocarbon cleanup kits, will be available on site at all times, as will containers for storage, transportation, and disposal of contaminated absorbent materials.
Cultural Resources, Paleontological Resources	Before construction, all construction personnel will be instructed by Western on the protection of cultural and paleontological resources and that cultural and paleontological resources might be present in the study area. To assist in this effort, the construction contract will address applicable federal and state laws regarding cultural and paleontological resources, including historic and prehistoric resources, and fossils. Construction personnel will be informed of the penalties for collection and removal of such resources, as well as the importance of these resources and the purpose and necessity of protecting them. Contractors will be trained to stop work near any discovery and notify Western's regional environmental manager immediately, who will ensure that the resource is evaluated and avoided. Known cultural and paleontological resources will be flagged for avoidance and a minimum distance maintained for work disturbances.
Cultural Resources	Western will have qualified archaeological monitors on site during ground disturbing construction activities. Archaeological monitors will look for any inadvertent cultural resource discoveries or other sensitive resources that may be important to tribes. Archaeologists will stop work in the immediate area should any such resources be uncovered until an assessment of the find can be made by Western.

Table 2-5. Environmental Protection Measures

Resource	EPM
Cultural Resources	Cultural resources would be considered during post-EIS/EIR phases of Project implementation. Surveys would be completed prior to any ground disturbing activities or project construction activities in order to inventory and evaluate cultural resources of the Preferred Alternative, or of any components that might be added to the project, or any existing components that would be modified. These surveys and any resulting historic property evaluation and analysis of effects would be conducted in accordance with Section 106 of the National Historic Preservation Act (NHPA) and in consultation with the State Historic Preservation Officer (SHPO). If adverse effects to historic properties cannot be avoided, Western would develop a Programmatic Agreement (PA) or Memorandum of Agreement (MOA) in consultation with the SHPO to determine appropriate mitigation to avoid lessen any adverse effects to cultural resources.
Geology, Soils, and Mineral Resources	Erosion control measures will be implemented to prevent loss of soil. Construction will be in conformance with Western's Integrated Vegetation Management Environmental Guidance Manual.
Land Use and Agriculture	Post proper signage in areas within the easement that will require temporary closure or limited access to accommodate certain land uses.
Land Use and Agriculture	On completion of the work, all work areas except permanent access roads will be returned to pre-construction conditions unless otherwise specified by the landowner/manager.
Land Use and Agriculture	During construction, movement will be limited (to the greatest extent possible) to the access roads and within a designated area in the easement to minimize damage to agricultural land.
Land Use and Agriculture	Damaged fences and gates will be repaired or replaced to restore them to their pre-construction condition.
Land Use	Construction and operations will be conducted in a manner that prevents unnecessary destruction, scarring, or defacing of the natural surroundings and to preserve the natural landscape to the extent practicable.
Land Use	No permanent discoloring agents will be applied to rocks or vegetation to indicate limits of survey.
Noise	All vehicles and equipment will be equipped with required exhaust noise abatement suppression devices.
Traffic and Transportation	Western will restrict all necessary lane closures or obstructions on major roadways associated with construction activities to off-peak periods to avoid substantial traffic congestion and delays.
Traffic and Transportation	Western will ensure that roads or sidewalks damaged by construction activities will be properly restored to their pre-construction condition.
Traffic and Transportation	Conform with safety requirements for maintaining the flow of public traffic and conduct construction operations to offer the least possible obstruction and inconvenience to public transportation.
Traffic and Transportation	Mark structures and/or shield wire with highly visible devices for identified locations, as required by applicable laws and regulations (for example, the Federal Aviation Administration regulations).
Water Resources, Wetlands	Runoff from the construction and O&M sites will be controlled and meet RWQCB storm water requirements and the conditions of a construction storm water discharge permit. A storm water pollution prevention plan will be prepared and implemented.
Water Resources and Floodplains	All contaminated discharge water created by construction and O&M activities (e.g., concrete washout, pumping for work area isolation, vehicle wash water, drilling fluids) will be contained and disposed of in accordance with applicable federal, state, and local regulations.
Water Resources and Floodplains	All fill or rip-rap placed within a stream or river channel will be limited to the minimum area required for access or protection of existing Western facilities.
Water Resources and Floodplains	All equipment will be stored, fueled, and maintained in vehicle staging areas 300 feet or the maximum distance possible from any aquatic habitat (vernal pool, vernal pool grassland, seasonal wetland, seep, spring, pond, lake, river, stream, or marsh) and no closer than 200 feet unless a bermed (no ground disturbance) and lined refueling area is constructed and hazardous-material absorbent pads are available in the event of a spill. Vehicles and construction equipment will be inspected daily for fluid leaks before leaving staging areas during construction and O&M activities. Fluid leaks will be repaired before equipment is moved from staging areas.

Table 2-5. Environmental Protection Measures

Resource	EPM
Water Resources and Floodplains	All instream work, such as culvert replacement or installation, bank recontouring, or placement of bank protection below the high-water line, will be conducted during no-flow or low-flow conditions and in a manner to avoid impacts to water flow, and will be restricted to the minimum area necessary for completion of the work.
Water Resources and Floodplains	All equipment used below the ordinary high-water mark will be free of exterior contamination.
Water Resources and Floodplains	Excavated material or other construction materials will not be stockpiled or deposited near or on stream banks, lake shorelines, or other watercourse perimeters.
Water Resources and Floodplains	Non-biodegradable debris will be collected and removed from the easement daily and taken to a disposal facility. Slash and other biodegradable debris will be left in place or disposed of.
Water Resources and Floodplains	All soil excavated for structure foundations will be backfilled and tamped around the foundations, and used to provide positive drainage around the structure foundations. Excess soil will be removed from the site and disposed of appropriately. Areas around structure footings will be reseeded with native plants.
Water Resources and Floodplains	Wherever possible, new structures and access roads will be sited out of floodplains. Bridges will be used at new stream crossings wherever possible. If avoidance is not possible, Western will consult with U.S. Army Corps of Engineers (USACE) and obtain permits as required.
Water Resources and Floodplains	If wet areas cannot be avoided, Western will use wide-track or balloon tire vehicles and equipment and/or timber mats.
Water Resources and Floodplains	Construction vehicle movement outside of the easement will be restricted (to the greatest extent possible) to approved access or public roads.
Water Resources and Floodplains	Where feasible, all construction activities will be rerouted around wet areas while ensuring that the route does not cross sensitive resource areas.

2.2 Alternatives Development

One of the most important aspects of the NEPA and CEQA processes is the identification and assessment of reasonable alternatives that have the potential for avoiding or minimizing the impacts of a Proposed Project. This EIS/EIR presents a range of alternatives based on whether or not the alternatives meet (1) most of the project objectives/purpose and need; (2) are considered feasible; and (3) would avoid or substantially lessen any potential significant effects of the Proposed Project. For additional information on the alternatives development process refer to the Alternatives Screening Report in Appendix A.

2.2.1 Corridor Alternatives

The alternatives presented below have been chosen for detailed analysis in the EIS/EIR through the alternative screening process. Alternatives corridors begin and end at points in common with the Proposed Project and other alternatives. The Project area was divided at the common points into four segments in order to facilitate a fair or equal comparison between the impacts of the alternatives and the Proposed Project. Table 2-6 and Figures 2-6a through 2-6e present the segments and the alternatives retained for analysis within each segment.

Table 2-6. Alternatives by Segment

Segments	Number of Alternatives	Alternative Name(s)
North Segment	0	None
Central Segment	1	Patterson Pass Alternative
San Luis Segment	2	Butts Road Alternative West of Cemetery Alternative
	1 (70-kV)	West of O'Neill Forebay Alternative
South Segment	2	San Luis to Dos Amigos Alternative Billy Wright Road Alternative

2.2.1.1 Patterson Pass Road Alternative

An alternative corridor would extend from a point near Patterson Pass Road in the north to a point near Butts Road in the south. It would run parallel to the Proposed Project, but on the western side of the existing high-voltage transmission lines, further from I-5 for approximately 48 miles.

2.2.1.2 Butts Road Alternative

At Butts Road, this alternative corridor would continue south on the west side of the existing transmission corridor for approximately 2.2 miles. At about McCabe Road, this alternative would turn southwest for about 4.0 miles, crossing State Route (SR) 152 and bypassing the existing San Luis Substation. This alternative would then head east paralleling SR 152 to the south for 2.8 miles where it would interconnect with the Los Banos Substation or new Los Banos West Substation, using the same corridor as tie-line. This alternative is about 10 miles long.

2.2.1.3 West of Cemetery Alternative

At Butts Road, this alternative would head west and then south from the existing transmission corridor and then extend around the west side of the San Joaquin Valley National Cemetery (Cemetery) for approximately 2.6 miles. At this point, it would begin to follow an existing PG&E 500-kV corridor for about 1.4 miles until it turns southwest, crossing SR 152 and bypassing the existing San Luis Substation. This alternative would then head east paralleling SR 152 to the south for 2.8 miles where it would interconnect with either the existing Los Banos Substation or new Los Banos West Substation, using the same corridor as the tie-line. This alternative is about 10 miles long.

2.2.1.4 West of O'Neill Forebay 70-kV Alternative

This alternative corridor would extend from the San Luis Substation, cross SR 152, and run northeast for about one mile. At this point, it would begin to follow an existing PG&E transmission corridor for about 2.6 miles around the west side of the O'Neill Forebay to a point just north of McCabe Road. At that point, it would turn east and then turn to the southeast, around the northeast side of the Forebay, following another PG&E high-voltage transmission corridor, to a point where it would terminate at the O'Neill Substation.

2.2.1.5 San Luis to Dos Amigos Alternative

This alternative would start at San Luis Substation and would parallel SR 152 heading east for approximately 2.8 miles, using the same corridor as the tie-line, to a point near the Los Banos Substation; no interconnection with the Los Banos or Los Banos West Substations would occur. At this point, this alternative corridor would extend approximately 6 miles south along the western side of the existing high-voltage transmission lines. Just north of the Los Banos Creek Reservoir, this alternative would cross the existing high-voltage transmission lines and would join the Proposed Project corridor for approximately 8 miles extending to the Dos Amigos Substation. This alternative is about 17 miles long.

2.2.1.6 Billy Wright Road Alternative

This alternative would start at San Luis Substation and would parallel SR 152 heading east for approximately 2.8 miles, using the same corridor as the tie-line, to a point near the Los Banos Substation; no interconnection with the Los Banos or Los Banos West Substations would occur. At this point, the alternative corridor would head south adjacent to and east of the existing PG&E 500-kV transmission lines for approximately 9 miles, before turning due east for approximately 4.5 miles to join the Proposed Project corridor as it extends to the Dos Amigos Substation.

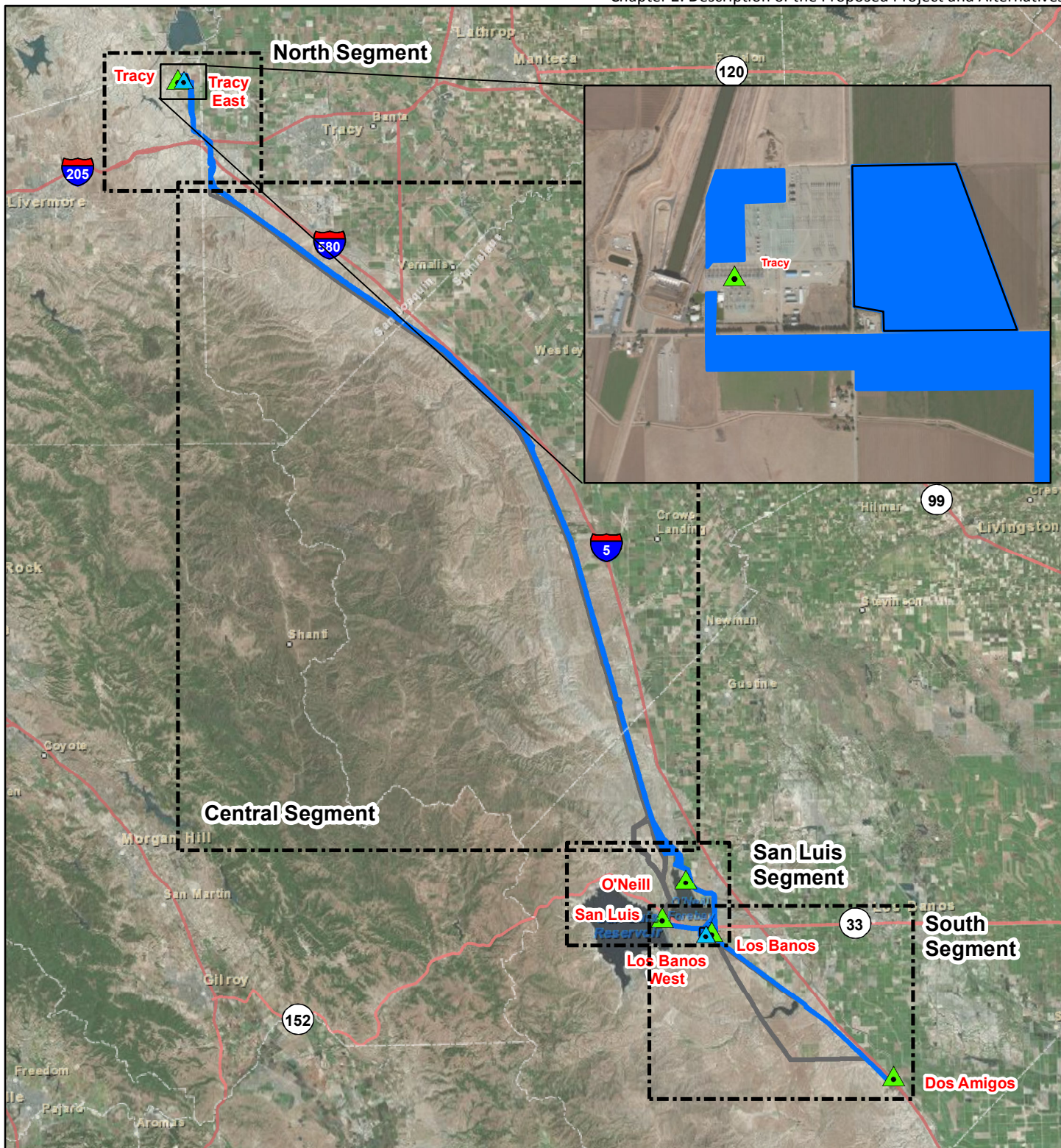

OFFICIAL USE ONLY

May be exempt from public release under the Freedom of Information Act (5 U.S.C.552) Exemption 2 - Circumvention of statute.

Western review required before public release.

Name/Org: SNR Date: 3/17/2015

This cartographic product and GIS data were prepared in accordance with professional practice standards. Data is only as accurate as its primary source and is spatially relative-grade. It should not replace or be used in place of survey data. Refer to metadata for source and accuracy.

This map and data are the property of WAPA/DOE and are intended for planning and analysis only. No reproduction or copying of this product is allowed without the sole consent of WAPA/DOE.
Source: WAPA SNR, Aspen EG, ESRI

- Proposed New Substations
- Existing Substations
- Tracy East Substation Area*
- Proposed Project Corridor
- Corridor Alternatives

Figure 2-6a.

Project Segments

* Proposed new Tracy East Substation would occupy up to 50 acres within this area

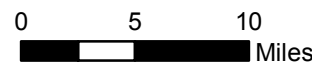

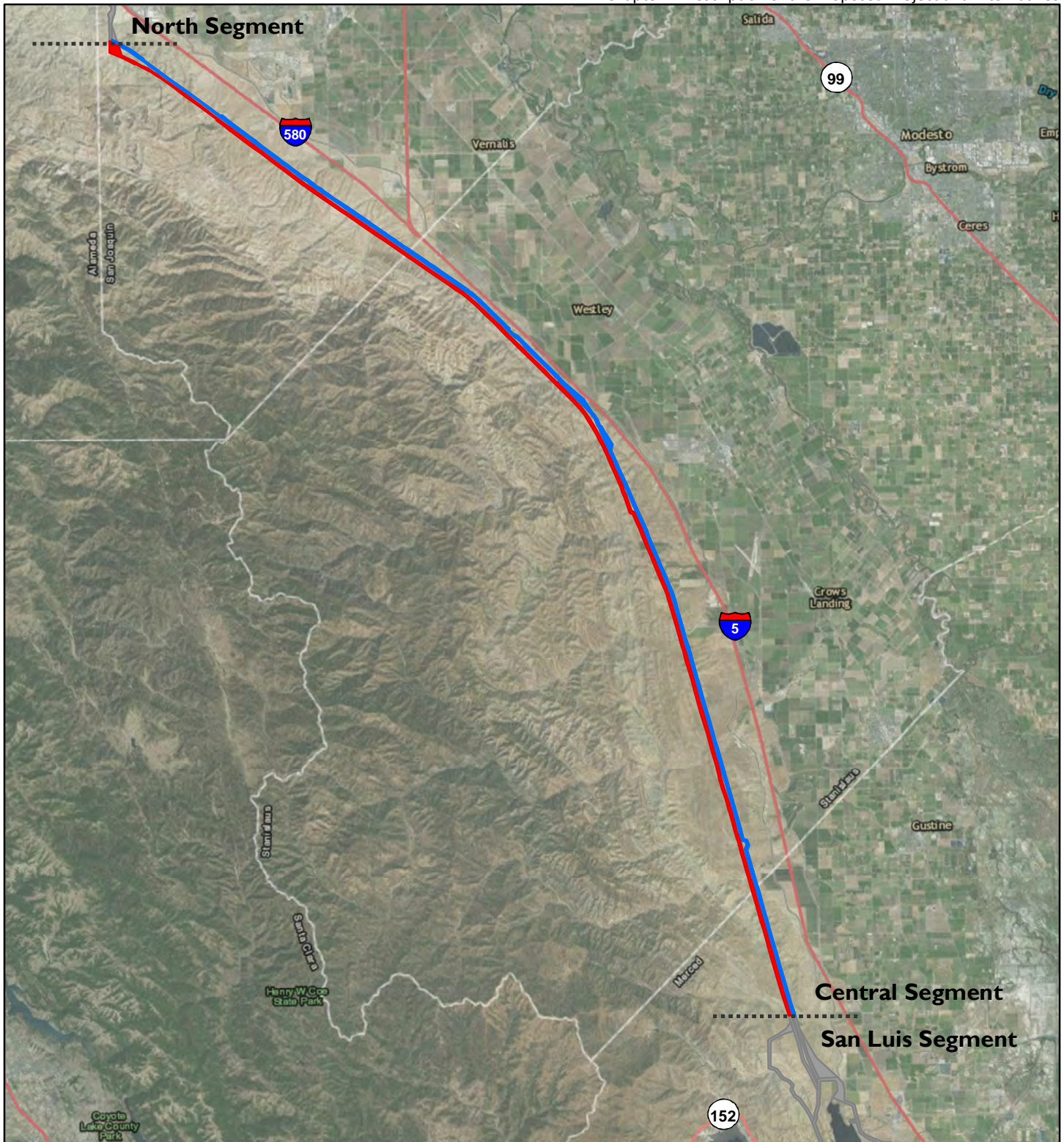

OFFICIAL USE ONLY

May be exempt from public release under the Freedom of Information Act (5 U.S.C.552) Exemption 2 - Circumvention of statute.

Western review required before public release.

Name/Org: SNR Date: 3/17/2015

This cartographic product and GIS data were prepared in accordance with professional practice standards. Data is only as accurate as its primary source and is spatially relative-grade. It should not replace or be used in place of survey data. Refer to metadata for source and accuracy.

This map and data are the property of WAPA/DOE and are intended for planning and analysis only. No reproduction or copying of this product is allowed without the sole consent of WAPA/DOE.

Source: WAPA SNR, Aspen EG, ESRI

- Patterson Pass Road Alternative
- Proposed Project
- Other Corridors

Figure 2-6b.

**Corridor Alternatives
Central Segment**

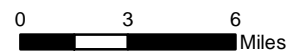

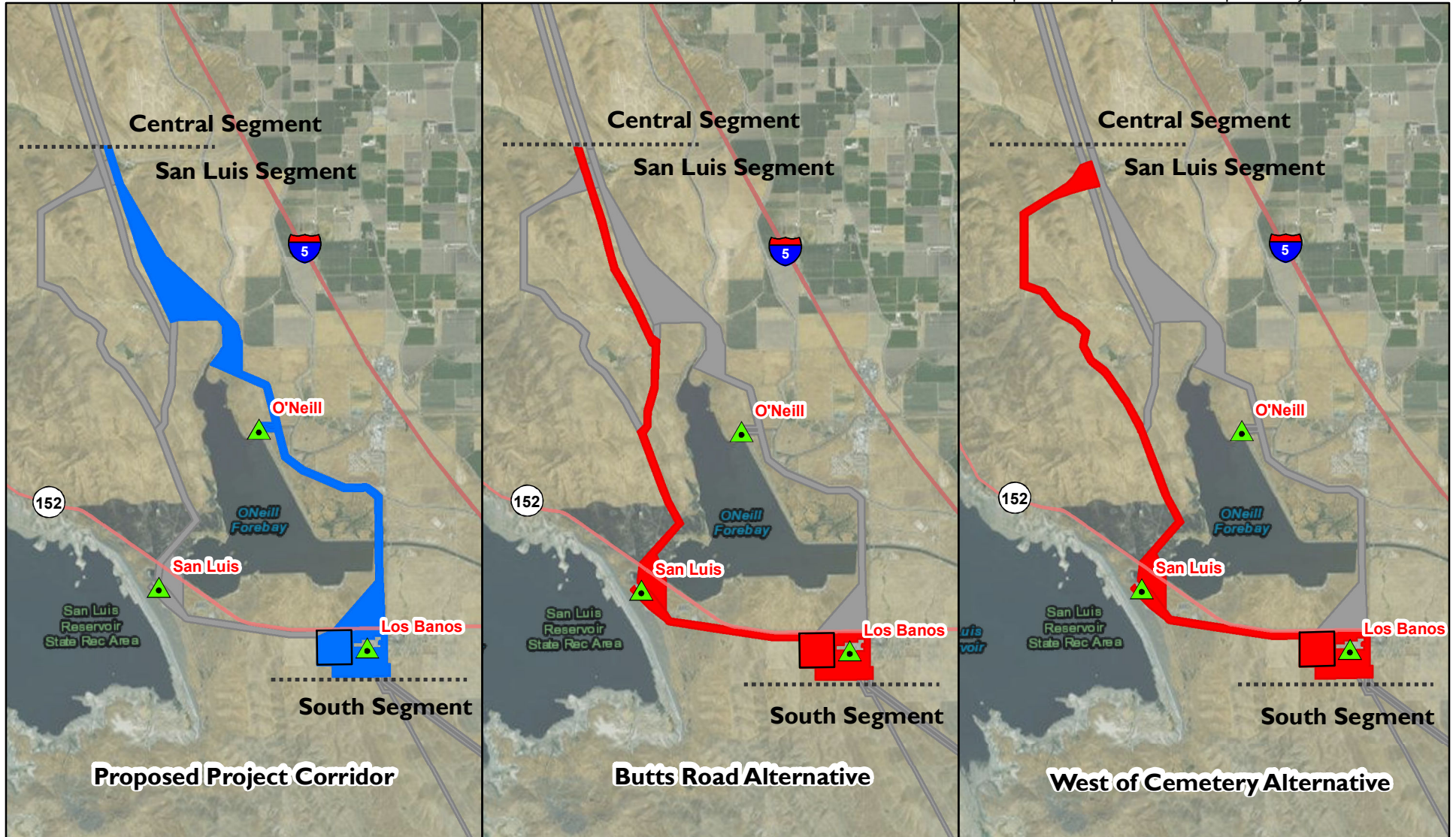

OFFICIAL USE ONLY

May be exempt from public release under the Freedom of Information Act (5 U.S.C. 552) Exemption 2 - Circumvention of statute.

Western review required before public release.

Name/Org: SNR Date: 4/17/2015

This cartographic product and GIS data were prepared in accordance with professional practice standards. Data is only as accurate as its primary source and is spatially relative-grade. It should not replace or be used in place of survey data. Refer to metadata for source and accuracy.

This map and data are the property of WAPA/DOE and are intended for planning and analysis only. No reproduction or copying of this product is allowed without the sole consent of WAPA/DOE.

Source: WAPA SNR, Aspen EG, ESRI

- Existing Substations
- Los Banos West Substation Area*
- Corridor Alternative
- Proposed Project
- Other Corridors

* Proposed new Los Banos West Substation would occupy up to 50 acres within this area

Figure 2-6c.

Corridor Alternatives
San Luis Segment

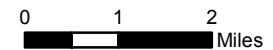

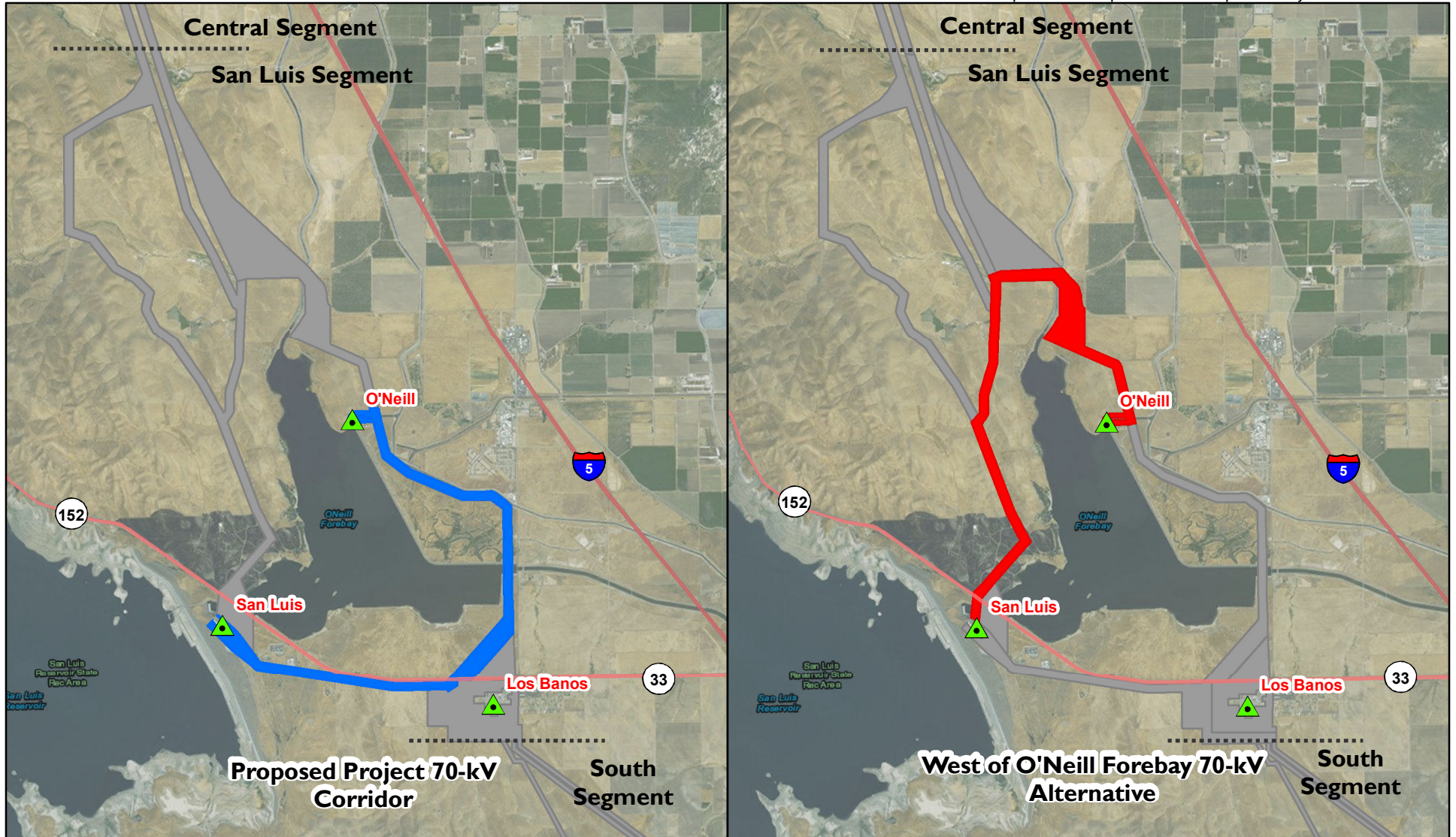

OFFICIAL USE ONLY

May be exempt from public release under the Freedom of Information Act (5 U.S.C. 552) Exemption 2 - Circumvention of statute.

Western review required before public release.

Name/Org: SNR Date: 3/17/2015

This cartographic product and GIS data were prepared in accordance with professional practice standards. Data is only as accurate as its primary source and is spatially relative-grade. It should not replace or be used in place of survey data. Refer to metadata for source and accuracy.

This map and data are the property of WAPA/DOE and are intended for planning and analysis only. No reproduction or copying of this product is allowed without the sole consent of WAPA/DOE.

Source: WAPA SNR, Aspen EG, ESRI





-  Existing Substations
-  Corridor Alternative
-  Proposed Project
-  Other Corridors

Figure 2-6d.

70-kV Corridor Alternatives
San Luis Segment



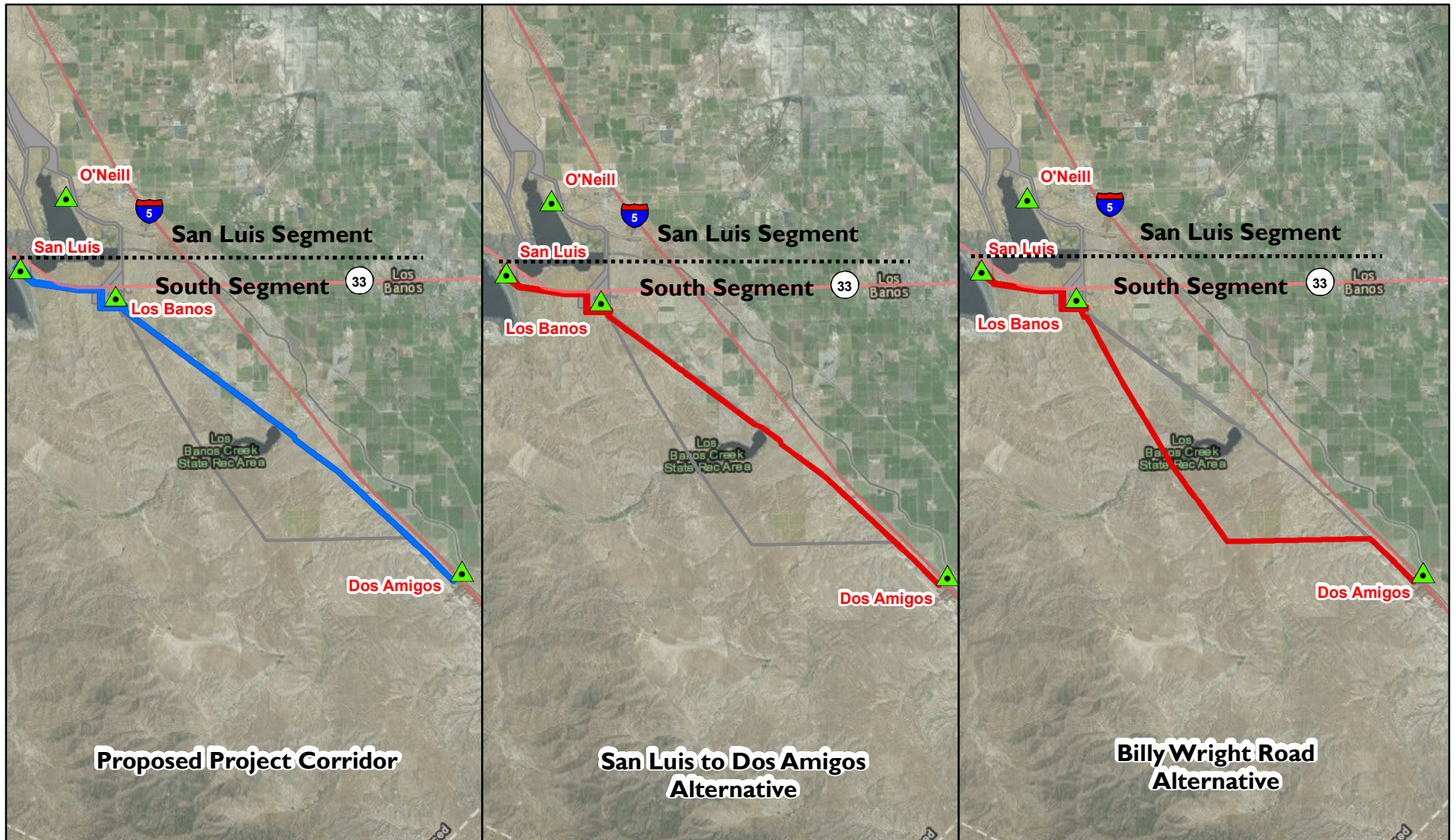

OFFICIAL USE ONLY



Western Area Power Administration

May be exempt from public release under the Freedom of Information Act (5 U.S.C. 552) Exemption 2 - Circumvention of statute.

Western review required before public release.

Name/Org: SNR Date: 3/17/2015

This cartographic product and GIS data were prepared in accordance with professional practice standards. Data is only as accurate as its primary source and is spatially relative-grade. It should not replace or be used in place of survey data. Refer to metadata for source and accuracy.

This map and data are the property of WAPA/DOE and are intended for planning and analysis only. No reproduction or copying of this product is allowed without the sole consent of WAPA/DOE.

Source: WAPA SNR, Aspen EG, ESRI

▲ Existing Substations

■ Proposed Project

■ Corridor Alternative

■ Other Corridors

Figure 2-6e.

Corridor Alternatives

South Segment

0 2.5 5 Miles



2.2.2 Alternatives Considered and Eliminated

The alternatives listed in Table 2-7 were eliminated from consideration in the EIS/EIR. Detailed descriptions of these alternatives and the reasons for their elimination are presented in the ASR (Appendix B).

Table 2-7. Alternatives Considered and Eliminated

Alternative	Description
Mountain House Road 500-kV Corridor	Western developed this alternative to minimize the length of the Proposed Project and reduce impacts to houses in the Mountain House Developments. This alternative corridor would exit the Tracy Substation and extend due south for about 0.9 miles along Mountain House Road, then turn southeast for approximately 0.8 miles through agricultural fields before intersecting the Proposed Project at the existing transmission corridor. In comparison to the Proposed Project, however, it would result in greater agricultural and visual impacts and construction disturbance to nearby school and residents.
Grant Line Road 500-kV Corridor	Western developed this alternative corridor to minimize canal crossings. It would deviate from the Proposed Project and the existing transmission line corridor to remain along the east side of the Delta-Mendota Canal for about 0.7 miles. This short alternative segment would be about the same length as the Proposed Project. However, it would be about 0.25 miles closer to a new residential community along Grant Line Road in unincorporated Tracy, and therefore result in greater visual impacts.
Delta-Mendota Canal/Interstate 580 500-kV Corridor	Western developed this alternative in response to comments requesting an alternative that uses the corridor between the Delta-Mendota Canal and Interstate 580, to avoid houses west of the Proposed Project near Patterson Pass Road. The California Aqueduct runs down the center of this corridor and therefore, more specifically, the route would be located between the California Aqueduct and Interstate 580. This alternative also avoids impacts to the Tracy Hills conservation easements located west of Interstate 580. This corridor would deviate from the Proposed Project just south of the California Aqueduct and would continue south for about 7.3 miles between the California Aqueduct and Interstate 580 until it turns southwest, across Interstate 580, to rejoin the Proposed Project. In comparison to the Proposed Project, it would reduce land use and biological resource impacts. However, this alternative would be outside of any existing transmission corridor, thereby resulting in greater potential visual impacts than the Proposed Project. Furthermore, it would be technically infeasible as certain locations between the California Aqueduct and Interstate 580 are too narrow to allow for construction, operation, and maintenance of a transmission line.
East of Delta-Mendota Canal 500-kV Corridor	Western developed this alternative corridor to address public comments about the proximity of the Proposed Project to houses near Patterson Pass Road. It would provide another option to the Delta-Mendota Canal/Interstate 580 Alternative. It would deviate from the Proposed Project 0.1 miles south of Interstate 205 and continue southeast on the east side of the Delta-Mendota Canal for about 3 miles. It would then cross the California Aqueduct and extend southeast, traversing agricultural fields, between the Delta-Mendota Canal and the California Aqueduct for about 1.3 miles before crossing the California Aqueduct to join the Delta-Mendota Canal/Interstate 580 Alternative. In comparison to the Proposed Project, this alternative would potentially reduce land use and biological resource impacts, but would potentially increase visual and agricultural impacts. Furthermore, this alternative is infeasible due to engineering constraints.
West of Cemetery 2 500-kV Corridor	Western developed this alternative corridor to avoid approved solar development and to reduce visual impacts to visitors of the San Joaquin National Cemetery. It would provide another option to the West of Cemetery Alternative that is further from the San Joaquin Valley National Cemetery. This alternative would extend south from the West of Cemetery Alternative Corridor at about 1.4 miles northeast of the Cemetery. This corridor would follow a valley, behind a ridge line, until it turns east to rejoin the West of Cemetery Alternative about one mile southeast of the Cemetery. In comparison to the Proposed Project, this alternative would reduce potential land use conflicts and visual impacts. However, due to the ruggedness of the terrain this alternative would potentially cause soil erosion and water quality impacts, and may be technically infeasible.

Table 2-7. Alternatives Considered and Eliminated

Alternative	Description
Forebay 500-kV Corridor	Western developed this alternative corridor to shorten the length of the Project and maximize use of existing transmission corridors. This alternative would provide another option to the West of O'Neill Forebay Alternative. This alternative would deviate from the West of O'Neill Forebay Alternative where that alternative turns southwest towards the San Luis Substation. This alternative would continue southeast following two existing PG&E 500-kV transmission lines across the southeastern portion of the O'Neill Forebay to the Los Banos Substation. A 0.7-mile segment of this alternative would cross the O'Neill Forebay in the existing transmission corridor. This alternative would maximize the use of existing transmission line easements. However, construction in the Forebay would result in potential water quality, soil erosion, and recreation impacts.
Jasper Sears Road Alternative	Western developed this alternative in response to scoping comments about potential land use conflicts of the Proposed Project with proposed solar development (Wright Solar Park), and current and proposed residential development (The Villages of Laguna San Luis), south of the Los Banos Substation. Scoping comments suggested an alternative alignment along Jasper Sears Road to minimize conflicts to The Villages of Laguna San Luis. This alternative corridor would exit the Los Banos Substation from the south and follow Jasper Sears Road and Western's existing 500-kV transmission line for about 9 miles before turning due east for about 5.3 miles to join the Proposed Project. This alternative would avoid proposed solar development; however, it would conflict with the planned Agua Fria development. It would result in more ground disturbance than the Proposed Project.

2.3 No Action/No Project Alternative

Under the No Action/No Project Alternative, construction of the San Luis Transmission Project would not occur. Western would arrange for transmission service for the San Luis Unit from the CAISO using existing electric infrastructure. Western has studied and compared the total cost of CAISO service with the estimated costs of constructing, operating, and maintaining the SLTP over the life of the project. Refer to Section 1.2 for additional information on the economic analysis.

2.4 Comparison of Alternatives

The section identifies the environmentally preferred alternative and presents detailed justification for its selection pursuant to the requirements of NEPA and CEQA.

2.4.1 Regulatory Requirements for Alternatives Comparison

California Environmental Quality Act

CEQA requires the following for alternatives analysis and comparison:

The EIR shall include sufficient information about each alternative to allow meaningful evaluation, analysis, and comparison with the Proposed Project. A matrix displaying the major characteristics and significant environmental effects of each alternative may be used to summarize the comparison. If an alternative would cause one or more significant effects in addition to those that would be caused by the project as proposed, the significant effects of the alternative shall be discussed, but in less detail than the significant effects of the project as proposed. Guidelines Section 15126.6(d)

If the environmentally superior alternative is the No Project Alternative, CEQA requires identification of an environmentally superior action alternative among the other alternatives [CEQA Guidelines Section 15126.6(e)(2)]. In this EIS/EIR, the term environmentally preferred alternative is analogous to CEQA's environmentally superior alternative.

Appendix B

List of Affected and Adjacent Quads (43)

US Fish and Wildlife Service Species List for All
Affected Quads

California Natural Diversity Database
Records Search (Summary Table) for Affected and
Adjacent Quads

US Geological Survey 7.5-minute quadrangles included in the CNDDDB nine-quad search

Altamont
Brentwood
Brush Lake
Byron Hot Springs
Cedar Mountain
Charleston School
Clifton Court Forebay
Copper Mountain
Crevison Peak
Crows Landing
Delta Ranch
Dos Palos
Gustine
Hammonds Ranch
Holt
Howard Ranch
Ingomar
Laguna Seca Ranch
Lone Tree Creek
Los Banos
Los Banos Valley
Mariposa Peak
Midway
Mount Boardman
Mustang Peak
Newman
Orestimba Peak
Ortigalita Peak
Ortigalita Peak NW
Pacheco Pass
Patterson
Ripon
Ruby Canyon
San Luis Dam
San Luis Ranch
Solyo
Tracy
Union Island
Vernalis
Volta
Westley
Wilcox Ridge
Woodward Island

**U.S. Fish & Wildlife Service
Sacramento Fish & Wildlife Office
Federal Endangered and Threatened Species that Occur in
or may be Affected by Projects in the
Clifton Court Forebay, Midway, Tracy, Lone Tree Creek, Solyo, Westley, Patterson, Orestimba Peak,
Newman, Howard Ranch, San Luis Dam, Volta, Ortigalita Peak NW, Charleston School, and Los Banos Valley
U.S.G.S. 7 1/2 Minute Quads**

Report Date: June 12, 2014

Listed Species

Invertebrates

Branchinecta conservatio

Conservancy fairy shrimp (E)

Branchinecta longiantenna

longhorn fairy shrimp (E)

Branchinecta lynchi

Critical habitat, vernal pool fairy shrimp (X)

vernal pool fairy shrimp (T)

Desmocerus californicus dimorphus

valley elderberry longhorn beetle (T)

Lepidurus packardi

vernal pool tadpole shrimp (E)

Fish

Acipenser medirostris

green sturgeon (T) (NMFS)

Hypomesus transpacificus

Critical habitat, delta smelt (X)

delta smelt (T)

Oncorhynchus mykiss

Central Valley steelhead (T) (NMFS)

Critical habitat, Central Valley steelhead (X) (NMFS)

Oncorhynchus tshawytscha

Central Valley spring-run chinook salmon (T) (NMFS)

winter-run chinook salmon, Sacramento River (E) (NMFS)

Amphibians

Ambystoma californiense

California tiger salamander, central population (T)

Critical habitat, CA tiger salamander, central population (X)

Rana draytonii

California red-legged frog (T)

Critical habitat, California red-legged frog (X)

Reptiles

Gambelia (=Crotaphytus) sila

blunt-nosed leopard lizard (E)

Masticophis lateralis euryxanthus
Alameda whipsnake [=striped racer] (T)

Thamnophis gigas
giant garter snake (T)

Birds

Vireo bellii pusillus
least Bell's vireo (E)

Mammals

Dipodomys ingens
giant kangaroo rat (E)

Dipodomys nitratooides exilis
Fresno kangaroo rat (E)

Sylvilagus bachmani riparius
riparian brush rabbit (E)

Vulpes macrotis mutica
San Joaquin kit fox (E)

Plants

Amsinckia grandiflora
Critical habitat, large-flowered fiddleneck (X)
large-flowered fiddleneck (E)

Lasthenia conjugens
Critical habitat, Contra Costa goldfields (X)
Contra Costa goldfields (E)

Key:

- (E) Endangered - Listed as being in danger of extinction.
- (T) Threatened - Listed as likely to become endangered within the foreseeable future.
- (P) Proposed - Officially proposed in the Federal Register for listing as endangered or threatened.
- (NMFS) Species under the Jurisdiction of the [National Oceanic & Atmospheric Administration Fisheries Service](#). Consult with them directly about these species.
- Critical Habitat - Area essential to the conservation of a species.
- (PX) Proposed Critical Habitat - The species is already listed. Critical habitat is being proposed for it.
- (C) Candidate - Candidate to become a proposed species.
- (V) Vacated by a court order. Not currently in effect. Being reviewed by the Service.
- (X) Critical Habitat designated for this species

California Department of Fish and Game
 Natural Diversity Database
 CNDDDB Wide Tabular Report
 Nine-quad records search SLTP (43 quads)

Name (Scientific/Common)	CNDDDB Ranks	Other Lists	Listing Status	Total EO's	Element Occ Ranks						Population Status		Presence		
					A	B	C	D	X	U	Historic >20 yr	Recent <=20 yr	Pres. Extant	Poss. Extirp.	Extirp.
Accipiter cooperii Cooper's hawk	G5 S3	CDFG:	Fed: None CalNone	102 S:1	0	1	0	0	0	0	0	1	1	0	0
Acemispon rubriflorus red-flowered bird's-foot-trefoil	G1 S1	CNPS: 1B.1	Fed: None CalNone	8 S:2	0	0	1	0	0	1	2	0	2	0	0
Agelaius tricolor tricolored blackbird	G2G3 S2	CDFG: SC	Fed: None CalNone	429 S:56	10	8	3	1	5	29	34	22	51	2	3
Alkali Meadow	G3 S2.1		Fed: None CalNone	8 S:6	0	0	0	0	0	6	6	0	6	0	0
Alkali Seep	G3 S2.1		Fed: None CalNone	10 S:2	0	0	0	1	0	1	2	0	2	0	0
Allium sharsmithiae Sharsmith's onion	G2 S2	CNPS: 1B.3	Fed: None CalNone	8 S:7	4	0	1	0	0	2	6	1	7	0	0
Ambystoma californiense California tiger salamander	G2G3 S2S3	CDFG: SC	Fed: Threatened CaThreatened	1094 S:165	11	43	9	3	14	85	76	89	151	11	3
Ammospermophilus nelsoni Nelson's antelope squirrel	G2 S2	CDFG:	Fed: None CaThreatened	254 S:4	0	0	0	0	0	4	4	0	4	0	0
Amsinckia grandiflora large-flowered fiddleneck	G1 S1	CNPS: 1B.1	Fed: Endangered CalEndangered	8 S:4	0	1	0	1	2	0	0	4	2	0	2
Anniella pulchra pulchra silvery legless lizard	G3G4T3T4 Q S3	CDFG: SC	Fed: None CalNone	91 S:5	0	3	0	0	1	1	1	4	4	1	0
Anthicus sacramento Sacramento anthicid beetle	G1 S1	CDFG:	Fed: None CalNone	13 S:4	0	0	0	0	0	4	4	0	4	0	0
Antrozous pallidus pallid bat	G5 S3	CDFG: SC	Fed: None CalNone	402 S:5	1	0	0	0	0	4	4	1	5	0	0
Aquila chrysaetos golden eagle	G5 S3	CDFG:	Fed: None CalNone	308 S:14	9	1	0	0	0	4	4	10	14	0	0
Arctostaphylos manzanita ssp. laevigata Contra Costa manzanita	G5T2 S2	CNPS: 1B.2	Fed: None CalNone	10 S:1	0	0	0	0	0	1	1	0	1	0	0
Ardea herodias great blue heron	G5 S4	CDFG:	Fed: None CalNone	132 S:2	0	2	0	0	0	0	1	1	2	0	0

California Department of Fish and Game
Natural Diversity Database
CNDDDB Wide Tabular Report
Nine-quad records search SLTP (43 quads)

Name (Scientific/Common)	CNDDDB Ranks	Other Lists	Listing Status	Total EO's	Element Occ Ranks						Population Status		Presence		
					A	B	C	D	X	U	Historic >20 yr	Recent <=20 yr	Pres. Extant	Poss. Extirp.	Extirp.
<i>Astragalus tener</i> var. <i>tener</i> alkali milk-vetch	G2T2 S2	CNPS: 1B.2	Fed: None CalNone	65 S:10	0	3	0	2	3	2	5	5	7	2	1
<i>Athene cunicularia</i> burrowing owl	G4 S2	CDFG: SC	Fed: None CalNone	1850 S:184	18	59	36	17	7	47	49	135	177	3	4
<i>Atriplex cordulata</i> var. <i>cordulata</i> heartscale	G3T2 S2	CNPS: 1B.2	Fed: None CalNone	68 S:13	0	2	3	0	2	6	7	6	11	1	1
<i>Atriplex coronata</i> var. <i>vallicola</i> Lost Hills crownscale	G4T2 S2	CNPS: 1B.2	Fed: None CalNone	80 S:2	0	1	0	1	0	0	1	1	2	0	0
<i>Atriplex depressa</i> brittlescale	G2 S2	CNPS: 1B.2	Fed: None CalNone	61 S:15	4	5	4	0	0	2	6	9	15	0	0
<i>Atriplex joaquinana</i> San Joaquin spearscale	G2 S2	CNPS: 1B.2	Fed: None CalNone	109 S:35	1	8	14	2	3	7	18	17	32	0	3
<i>Atriplex minuscula</i> lesser saltscale	G2 S2	CNPS: 1B.1	Fed: None CalNone	37 S:6	0	1	0	0	0	5	4	2	6	0	0
<i>Atriplex persistens</i> vernal pool smallscale	G2 S2	CNPS: 1B.2	Fed: None CalNone	41 S:6	0	0	0	0	1	5	4	2	5	1	0
<i>Balsamorhiza macrolepis</i> big-scale balsamroot	G2 S2	CNPS: 1B.2	Fed: None CalNone	43 S:1	0	0	0	0	1	0	1	0	0	0	1
<i>Blepharizonia plumosa</i> big tarplant	G2 S2	CNPS: 1B.1	Fed: None CalNone	48 S:30	3	14	4	1	0	8	9	21	30	0	0
<i>Branchinecta conservatio</i> Conservancy fairy shrimp	G1 S1	CDFG:	Fed: Endangered CalNone	35 S:4	0	1	0	0	0	3	3	1	4	0	0
<i>Branchinecta longiantenna</i> longhorn fairy shrimp	G1 S1	CDFG:	Fed: Endangered CalNone	10 S:4	0	1	1	1	0	1	3	1	4	0	0
<i>Branchinecta lynchi</i> vernal pool fairy shrimp	G3 S2S3	CDFG:	Fed: Threatened CalNone	611 S:21	4	8	2	0	0	7	7	14	21	0	0
<i>Branchinecta mesovallensis</i> midvalley fairy shrimp	G2 S2	CDFG:	Fed: None CalNone	101 S:3	1	0	0	0	0	2	1	2	3	0	0
<i>Branta hutchinsii leucopareia</i> cackling (=Aleutian Canada) goose	G5T3 S2	CDFG:	Fed: Delisted CalNone	19 S:11	1	0	0	0	0	10	11	0	11	0	0

California Department of Fish and Game
Natural Diversity Database
CNDDDB Wide Tabular Report
Nine-quad records search SLTP (43 quads)

Name (Scientific/Common)	CNDDDB Ranks	Other Lists	Listing Status	Total EO's	Element Occ Ranks						Population Status		Presence		
					A	B	C	D	X	U	Historic >20 yr	Recent <=20 yr	Pres. Extant	Poss. Extirp.	Extirp.
<i>Buteo regalis</i> ferruginous hawk	G4 S3S4	CDFG:	Fed: None CalNone	102 S:33	0	1	1	0	0	31	31	2	33	0	0
<i>Buteo swainsoni</i> Swainson's hawk	G5 S2	CDFG:	Fed: None CalThreatened	2394 S:264	46	58	26	3	1	130	47	217	263	0	1
<i>California macrophylla</i> round-leaved filaree	G2 S2	CNPS: 1B.1	Fed: None CalNone	155 S:17	3	1	1	1	1	10	9	8	16	1	0
<i>Calochortus pulchellus</i> Mt. Diablo fairy-lantern	G2 S2	CNPS: 1B.2	Fed: None CalNone	40 S:1	0	0	0	0	0	1	0	1	1	0	0
<i>Calyptridium parryi</i> var. <i>hesseae</i> Santa Cruz Mountains pussypaws	G3G4T2 S2	CNPS: 1B.1	Fed: None CalNone	10 S:1	0	0	0	0	0	1	0	1	1	0	0
<i>Campanula exigua</i> chaparral harebell	G2 S2	CNPS: 1B.2	Fed: None CalNone	32 S:11	6	1	0	0	0	4	7	4	11	0	0
<i>Campanula sharsmithiae</i> Sharsmith's harebell	G1 S1	CNPS: 1B.2	Fed: None CalNone	6	3	0	0	0	0	3	5	1	6	0	0
<i>Carex comosa</i> bristly sedge	G5 S2	CNPS: 2B.1	Fed: None CalNone	29 S:1	0	0	0	0	1	0	1	0	0	1	0
<i>Caulanthus lemmonii</i> Lemmon's jewelflower	G3 S3	CNPS: 1B.2	Fed: None CalNone	62 S:5	0	0	0	0	0	5	5	0	5	0	0
<i>Centromadia parryi</i> ssp. <i>congdonii</i> Congdon's tarplant	G3T2 S2	CNPS: 1B.1	Fed: None CalNone	91 S:2	0	2	0	0	0	0	0	2	2	0	0
<i>Ceratochrysis menkei</i> Menke's cuckoo wasp	G1 S1	CDFG:	Fed: None CalNone	2 S:1	0	0	0	0	0	1	1	0	1	0	0
<i>Charadrius montanus</i> mountain plover	G3 S2?	CDFG: SC	Fed: None CalNone	88 S:3	0	2	0	0	0	1	0	3	3	0	0
<i>Chloropyron molle</i> ssp. <i>hispidum</i> hispid salty bird's-beak	G2T2 S2	CNPS: 1B.1	Fed: None CalNone	35 S:30	9	6	2	0	1	12	19	11	29	0	1
<i>Chloropyron palmatum</i> palmate-bracted salty bird's-beak	G1 S1	CNPS: 1B.1	Fed: Endangered CalEndangered	26 S:1	0	1	0	0	0	0	0	1	1	0	0
<i>Cicuta maculata</i> var. <i>bolanderi</i> Bolander's water-hemlock	G5T3T4 S2	CNPS: 2B.1	Fed: None CalNone	17 S:1	0	0	0	0	0	1	1	0	1	0	0

California Department of Fish and Game
Natural Diversity Database
CNDDDB Wide Tabular Report
Nine-quad records search SLTP (43 quads)

Name (Scientific/Common)	CNDDDB Ranks	Other Lists	Listing Status	Total EO's	Element Occ Ranks						Population Status		Presence		
					A	B	C	D	X	U	Historic >20 yr	Recent <=20 yr	Pres. Extant	Poss. Extirp.	Extirp.
Circus cyaneus northern harrier	G5 S3	CDFG: SC	Fed: None CalNone	43 S:9	4	3	1	0	0	1	2	7	9	0	0
Cirsium crassicaule slough thistle	G2 S2	CNPS: 1B.1	Fed: None CalNone	19 S:1	0	0	0	0	0	1	1	0	1	0	0
Cirsium fontinale var. campylon Mt. Hamilton fountain thistle	G2T2 S2	CNPS: 1B.2	Fed: None CalNone	39 S:8	0	4	1	0	0	3	5	3	8	0	0
Cismontane Alkali Marsh	G1 S1.1		Fed: None CalNone	4 S:3	0	0	0	0	0	3	3	0	3	0	0
Clarkia concinna ssp. automixa Santa Clara red ribbons	G5?T3 S3.3	CNPS: 4.3	Fed: None CalNone	20 S:1	0	0	0	0	0	1	1	0	1	0	0
Coastal and Valley Freshwater Marsh	G3 S2.1		Fed: None CalNone	60 S:6	0	1	0	0	0	5	6	0	6	0	0
Coccyzus americanus occidentalis western yellow-billed cuckoo	G5T3Q S1	CDFG:	Fed: Proposed Threatened CalEndangered	119 S:1	0	0	0	0	1	0	1	0	0	1	0
Corynorhinus townsendii Townsend's big-eared bat	G3G4 S2S3	CDFG: SC	Fed: None Candidate CalThreatened	237 S:1	1	0	0	0	0	0	1	0	1	0	0
Coturnicops noveboracensis yellow rail	G4 S1S2	CDFG: SC	Fed: None CalNone	1	0	0	0	0	0	1	1	0	1	0	0
Deinandra bacigalupii Livermore tarplant	G1 S1	CNPS: 1B.2	Fed: None CalNone	3	0	1	0	0	0	2	0	3	3	0	0
Delphinium californicum ssp. interius Hospital Canyon larkspur	G3T3 S3	CNPS: 1B.2	Fed: None CalNone	28 S:5	1	1	0	0	0	3	2	3	5	0	0
Delphinium recurvatum recurved larkspur	G3 S3	CNPS: 1B.2	Fed: None CalNone	96 S:8	2	2	0	0	0	4	6	2	8	0	0
Desmocerus californicus dimorphus valley elderberry longhorn beetle	G3T2 S2	CDFG:	Fed: Threatened CalNone	201 S:6	0	0	0	0	0	6	5	1	6	0	0
Dipodomys ingens giant kangaroo rat	G2 S2	CDFG:	Fed: Endangered CalEndangered	124 S:1	0	0	0	0	1	0	1	0	0	1	0

California Department of Fish and Game
Natural Diversity Database
CNDDDB Wide Tabular Report
Nine-quad records search SLTP (43 quads)

Name (Scientific/Common)	CNDDDB Ranks	Other Lists	Listing Status	Total EO's	Element Occ Ranks						Population Status		Presence		
					A	B	C	D	X	U	Historic >20 yr	Recent <=20 yr	Pres. Extant	Poss. Extirp.	Extirp.
Egretta thula snowy egret	G5 S4	CDFG:	Fed: None CalNone	15 S:1	0	1	0	0	0	0	1	0	1	0	0
Elanus leucurus white-tailed kite	G5 S3	CDFG:	Fed: None CalNone	158 S:7	0	3	2	0	0	2	1	6	7	0	0
Elderberry Savanna	G2 S2.1		Fed: None CalNone	4 S:1	0	0	1	0	0	0	1	0	1	0	0
Emys marmorata western pond turtle	G3G4 S3	CDFG: SC	Fed: None CalNone	1137 S:73	8	38	7	2	0	18	16	57	73	0	0
Eremophila alpestris actia California horned lark	G5T3Q S3	CDFG:	Fed: None CalNone	77 S:23	0	4	3	1	0	15	18	5	23	0	0
Eriastrum hooveri Hoover's eriastrum	G3 S3.2	CNPS: 4.2	Fed: Delisted CalNone	47 S:2	0	0	0	0	2	0	2	0	0	2	0
Eriastrum tracyi Tracy's eriastrum	G3Q S3	CNPS: 3.2	Fed: None CalRare	90 S:2	0	0	0	0	0	2	2	0	2	0	0
Eryngium racemosum Delta button-celery	G1Q S1	CNPS: 1B.1	Fed: None CalEndangered	26 S:14	2	3	1	0	5	3	10	4	9	5	0
Eryngium spinosepalum spiny-sepaled button-celery	G2 S2.2	CNPS: 1B.2	Fed: None CalNone	90 S:4	0	0	0	0	0	4	1	3	4	0	0
Eschscholzia rhombipetala diamond-petaled California poppy	G1 S1	CNPS: 1B.1	Fed: None CalNone	10 S:5	1	1	0	0	1	2	3	2	4	1	0
Eucerceris ruficeps redheaded sphecid wasp	G1G3 S1S2	CDFG:	Fed: None CalNone	3 S:1	0	0	0	0	0	1	1	0	1	0	0
Eumops perotis californicus western mastiff bat	G5T4 S3?	CDFG: SC	Fed: None CalNone	293 S:2	1	0	0	0	0	1	2	0	2	0	0
Falco columbarius merlin	G5 S3	CDFG:	Fed: None CalNone	34 S:1	1	0	0	0	0	0	1	0	1	0	0
Falco mexicanus prairie falcon	G5 S3	CDFG:	Fed: None CalNone	457 S:16	4	0	0	0	0	12	13	3	16	0	0
Fritillaria agrestis stinkbells	G3 S3.2	CNPS: 4.2	Fed: None CalNone	32 S:10	2	1	5	0	0	2	10	0	10	0	0

California Department of Fish and Game
Natural Diversity Database
CNDDDB Wide Tabular Report
Nine-quad records search SLTP (43 quads)

Name (Scientific/Common)	CNDDDB Ranks	Other Lists	Listing Status	Total EO's	Element Occ Ranks						Population Status		Presence		
					A	B	C	D	X	U	Historic >20 yr	Recent <=20 yr	Pres. Extant	Poss. Extirp.	Extirp.
<i>Fritillaria falcata</i> talus fritillary	G2 S2	CNPS: 1B.2	Fed: None CalNone	17 S:10	5	0	0	0	0	5	8	2	10	0	0
<i>Gambelia sila</i> blunt-nosed leopard lizard	G1 S1	CDFG:	Fed: Endangered CalEndangered	301 S:7	0	1	0	0	0	6	7	0	7	0	0
Great Valley Cottonwood Riparian Forest	G2 S2.1		Fed: None CalNone	56 S:3	0	0	2	0	0	1	3	0	3	0	0
Great Valley Mixed Riparian Forest	G2 S2.2		Fed: None CalNone	68 S:1	0	1	0	0	0	0	1	0	1	0	0
Great Valley Valley Oak Riparian Forest	G1 S1.1		Fed: None CalNone	33 S:4	0	1	0	0	0	3	4	0	4	0	0
<i>Haliaeetus leucocephalus</i> bald eagle	G5 S2	CDFG:	Fed: Delisted CalEndangered	316 S:1	0	0	1	0	0	0	1	0	1	0	0
<i>Helianthella castanea</i> Diablo helianthella	G2 S2	CNPS: 1B.2	Fed: None CalNone	96 S:1	0	0	1	0	0	0	1	0	1	0	0
<i>Hesperolinon breweri</i> Brewer's western flax	G2 S2	CNPS: 1B.2	Fed: None CalNone	25 S:2	0	0	0	0	0	2	1	1	2	0	0
<i>Hesperolinon tehamense</i> Tehama County western flax	G3 S3	CNPS: 1B.3	Fed: None CalNone	51 S:6	4	2	0	0	0	0	0	6	6	0	0
<i>Hibiscus lasiocarpus</i> var. <i>occidentalis</i> woolly rose-mallow	G5T2 S2	CNPS: 1B.2	Fed: None CalNone	173 S:42	0	23	9	6	0	4	13	29	42	0	0
<i>Hoita strobilina</i> Loma Prieta hoita	G2 S2	CNPS: 1B.1	Fed: None CalNone	30 S:1	0	0	0	0	0	1	1	0	1	0	0
<i>Hygrotus curvipes</i> curved-foot hygrotus diving beetle	G1 S1	CDFG:	Fed: None CalNone	21	0	0	0	0	0	21	21	0	21	0	0
<i>Hypomesus transpacificus</i> Delta smelt	G1 S1	CDFG:	Fed: Threatened CalEndangered	27 S:4	0	0	0	0	0	4	0	4	4	0	0
<i>Lanius ludovicianus</i> loggerhead shrike	G4 S4	CDFG: SC	Fed: None CalNone	94 S:10	1	8	1	0	0	0	0	10	10	0	0
<i>Lasiurus blossevillii</i> western red bat	G5 S3?	CDFG: SC	Fed: None CalNone	119 S:1	0	0	0	0	0	1	0	1	1	0	0

California Department of Fish and Game
Natural Diversity Database
CNDDDB Wide Tabular Report
Nine-quad records search SLTP (43 quads)

Name (Scientific/Common)	CNDDDB Ranks	Other Lists	Listing Status	Total EO's	Element Occ Ranks						Population Status		Presence		
					A	B	C	D	X	U	Historic >20 yr	Recent <=20 yr	Pres. Extant	Poss. Extirp.	Extirp.
Lasiurus cinereus hoary bat	G5 S4?	CDFG:	Fed: None CalNone	235 S:4	0	0	0	0	0	4	3	1	4	0	0
Lasthenia glabrata ssp. coulteri Coulter's goldfields	G4T3 S2.1	CNPS: 1B.1	Fed: None CalNone	89 S:1	0	0	0	0	0	1	0	1	1	0	0
Laterallus jamaicensis coturniculus California black rail	G4T1 S1	CDFG:	Fed: None CalThreatened	241 S:7	1	4	0	0	0	2	7	0	7	0	0
Lathyrus jepsonii var. jepsonii Delta tule pea	G5T2 S2.2	CNPS: 1B.2	Fed: None CalNone	130 S:7	1	3	2	0	1	0	3	4	6	1	0
Lavinia symmetricus ssp. 1 San Joaquin roach	G4T3Q S3	CDFG: SC	Fed: None CalNone	8 S:1	1	0	0	0	0	0	0	1	1	0	0
Layia munzii Munz's tidy-tips	G1 S1	CNPS: 1B.2	Fed: None CalNone	28 S:1	0	0	0	0	0	1	1	0	1	0	0
Lepidium jaredii ssp. album Panoche pepper-grass	G2T2 S2	CNPS: 1B.2	Fed: None CalNone	16 S:1	0	0	0	0	1	0	1	0	0	0	1
Lepidurus packardii vernal pool tadpole shrimp	G3 S2S3	CDFG:	Fed: Endangered CalNone	274 S:9	1	1	2	0	0	5	4	5	9	0	0
Leptosyne hamiltonii Mt. Hamilton coreopsis	G2 S2.2	CNPS: 1B.2	Fed: None CalNone	22 S:3	1	1	0	0	0	1	2	1	3	0	0
Lilaeopsis masonii Mason's lilaeopsis	G2 S2	CNPS: 1B.1	Fed: None CalRare	196 S:38	0	24	10	1	0	3	10	28	38	0	0
Limosella australis Delta mudwort	G4G5 S2	CNPS: 2B.1	Fed: None CalNone	58 S:9	0	8	0	0	0	1	1	8	9	0	0
Linderiella occidentalis California linderiella	G3 S2S3	CDFG:	Fed: None CalNone	384 S:5	0	1	0	0	0	4	3	2	5	0	0
Lomatium observatorium Mt. Hamilton lomatium	G1 S1?	CNPS: 1B.2	Fed: None CalNone	4 S:2	0	0	0	0	0	2	1	1	2	0	0
Lytta moesta moestan blister beetle	G2 S2	CDFG:	Fed: None CalNone	12 S:3	0	0	0	0	0	3	3	0	1	2	0
Lytta molesta molestan blister beetle	G2 S2	CDFG:	Fed: None CalNone	17 S:2	0	0	0	0	0	2	2	0	2	0	0

California Department of Fish and Game
Natural Diversity Database
CNDDDB Wide Tabular Report
Nine-quad records search SLTP (43 quads)

Name (Scientific/Common)	CNDDDB Ranks	Other Lists	Listing Status	Total EO's	Element Occ Ranks						Population Status		Presence		
					A	B	C	D	X	U	Historic >20 yr	Recent <=20 yr	Pres. Extant	Poss. Extirp.	Extirp.
<i>Madia radiata</i> showy golden madia	G2 S2	CNPS: 1B.1	Fed: None CalNone	52 S:2	0	0	0	0	0	2	2	0	2	0	0
<i>Malacothamnus arcuatus</i> arcuate bush-mallow	G2Q S2.2	CNPS: 1B.2	Fed: None CalNone	21 S:1	0	0	0	0	0	1	1	0	1	0	0
<i>Malacothamnus hallii</i> Hall's bush-mallow	G2Q S2	CNPS: 1B.2	Fed: None CalNone	37 S:5	1	1	0	0	0	3	2	3	5	0	0
<i>Masticophis flagellum ruddocki</i> San Joaquin whipsnake	G5T2T3 S2?	CDFG: SC	Fed: None CalNone	82 S:20	2	3	0	1	0	14	14	6	20	0	0
<i>Masticophis lateralis euryxanthus</i> Alameda whipsnake	G4T2 S2	CDFG:	Fed: Threatened CalThreatened	145 S:13	0	0	0	0	1	12	8	5	12	1	0
<i>Melospiza melodia</i> song sparrow ("Modesto" population)	G5 S3?	CDFG: SC	Fed: None CalNone	92 S:20	0	0	0	2	0	18	2	18	20	0	0
<i>Mylopharodon conocephalus</i> hardhead	G3 S3	CDFG: SC	Fed: None CalNone	32 S:1	0	0	0	0	0	1	0	1	1	0	0
<i>Myotis yumanensis</i> Yuma myotis	G5 S4?	CDFG:	Fed: None CalNone	256 S:3	0	2	0	0	0	1	0	3	3	0	0
<i>Navarretia gowenii</i> Lime Ridge navarretia	G1 S1	CNPS: 1B.1	Fed: None CalNone	3 S:1	0	0	0	0	0	1	0	1	1	0	0
<i>Navarretia nigelliformis</i> ssp. <i>radians</i> shining navarretia	G4T2 S2	CNPS: 1B.2	Fed: None CalNone	64 S:3	0	0	0	0	0	3	3	0	3	0	0
<i>Navarretia prostrata</i> prostrate vernal pool navarretia	G2 S2	CNPS: 1B.1	Fed: None CalNone	60 S:6	3	0	0	0	0	3	3	3	6	0	0
<i>Neotoma fuscipes riparia</i> riparian (=San Joaquin Valley) woodrat	G5T1Q S1	CDFG: SC	Fed: Endangered CalNone	3	0	0	0	0	0	3	2	1	3	0	0
Northern Claypan Vernal Pool	G1 S1.1		Fed: None CalNone	21 S:2	0	0	0	0	0	2	2	0	2	0	0
<i>Oenothera deltoides</i> ssp. <i>howellii</i> Antioch Dunes evening-primrose	G5T1 S1	CNPS: 1B.1	Fed: Endangered CalEndangered	10 S:1	0	0	0	0	0	1	0	1	1	0	0
<i>Perdita scitula antiochensis</i> Antioch andrenid bee	G1T1 S1	CDFG:	Fed: None CalNone	2 S:1	0	0	0	0	1	0	1	0	0	0	1

California Department of Fish and Game
Natural Diversity Database
CNDDDB Wide Tabular Report
Nine-quad records search SLTP (43 quads)

Name (Scientific/Common)	CNDDDB Ranks	Other Lists	Listing Status	Total EO's	Element Occ Ranks						Population Status		Presence		
					A	B	C	D	X	U	Historic >20 yr	Recent <=20 yr	Pres. Extant	Poss. Extirp.	Extirp.
Perognathus inornatus inornatus San Joaquin pocket mouse	G4T2T3 S2S3	CDFG:	Fed: None CalNone	109 S:17	0	3	2	0	0	12	13	4	17	0	0
Phacelia phacelioides Mt. Diablo phacelia	G1 S1	CNPS: 1B.2	Fed: None CalNone	16 S:4	1	0	0	0	0	3	3	1	4	0	0
Phrynosoma blainvillii coast horned lizard	G3G4 S3S4	CDFG: SC	Fed: None CalNone	677 S:15	0	10	1	1	0	3	5	10	15	0	0
Plagiobothrys glaber hairless popcornflower	GH SH	CNPS: 1A	Fed: None CalNone	9 S:1	0	0	0	0	0	1	1	0	0	1	0
Plagiobothrys verrucosus warty popcorn-flower	G4? S1	CNPS: 2B.1	Fed: None CalNone	4 S:1	0	0	0	0	0	1	1	0	1	0	0
Pogonichthys macrolepidotus Sacramento splittail	G2 S2	CDFG: SC	Fed: None CalNone	15 S:1	0	0	0	0	0	1	1	0	1	0	0
Pyrgulopsis diablensis Diablo Range pyrg	G1 S1	CDFG:	Fed: None CalNone	1	0	0	0	0	0	1	0	1	1	0	0
Rana boylei foothill yellow-legged frog	G3 S2S3	CDFG: SC	Fed: None CalNone	805 S:18	2	2	0	0	1	13	10	8	17	1	0
Rana draytonii California red-legged frog	G2G3 S2S3	CDFG: SC	Fed: Threatened CalNone	1335 S:211	25	75	29	9	2	71	33	178	208	1	2
Sagittaria sanfordii Sanford's arrowhead	G3 S3	CNPS: 1B.2	Fed: None CalNone	93 S:3	0	0	0	0	0	3	3	0	3	0	0
Scutellaria galericulata marsh skullcap	G5 S2	CNPS: 2B.2	Fed: None CalNone	31 S:1	0	0	0	0	0	1	1	0	1	0	0
Senecio aphanactis chaparral ragwort	G3? S2	CNPS: 2B.2	Fed: None CalNone	47 S:3	0	2	0	0	0	1	1	2	3	0	0
Spea hammondii western spadefoot	G3 S3	CDFG: SC	Fed: None CalNone	423 S:24	3	7	4	3	0	7	9	15	24	0	0
Sphenopholis obtusata prairie wedge grass	G5 S2.2	CNPS: 2B.2	Fed: None CalNone	19 S:1	0	0	0	0	0	1	1	0	1	0	0
Spirinchus thaleichthys longfin smelt	G5 S1	CDFG: SC	Fed: Candidate CalThreatened	45 S:6	0	0	0	0	0	6	1	5	6	0	0

California Department of Fish and Game
Natural Diversity Database
CNDDDB Wide Tabular Report
Nine-quad records search SLTP (43 quads)

Name (Scientific/Common)	CNDDDB Ranks	Other Lists	Listing Status	Total EO's	Element Occ Ranks						Population Status		Presence			
					A	B	C	D	X	U	Historic >20 yr	Recent <=20 yr	Pres. Extant	Poss. Extirp.	Extirp.	
Streptanthus insignis ssp. Iyonii Arburua Ranch jewelflower	G3G4T2 S2	CNPS: 1B.2	Fed: None CalNone	18 S:11	0	2	0	0	0	0	9	11	0	11	0	0
Stuckenia filiformis ssp. alpina slender-leaved pondweed	G5T5 S3	CNPS: 2B.2	Fed: None CalNone	21 S:1	0	0	0	0	0	0	1	1	0	1	0	0
Sycamore Alluvial Woodland	G1 S1.1		Fed: None CalNone	17 S:3	0	0	0	1	0	0	2	3	0	3	0	0
Sylvilagus bachmani riparius riparian brush rabbit	G5T1 S1	CDFG:	Fed: Endangered CalEndangered	4 S:2	0	0	0	0	1	1	1	1	1	1	0	1
Symphotrichum lentum Suisun Marsh aster	G2 S2	CNPS: 1B.2	Fed: None CalNone	172 S:7	0	0	4	1	0	0	2	1	6	7	0	0
Taxidea taxus American badger	G5 S4	CDFG: SC	Fed: None CalNone	471 S:31	1	7	5	1	0	0	17	19	12	31	0	0
Thaleichthys pacificus eulachon	G5 S3	CDFG: SC	Fed: Threatened CalNone	10 S:1	0	0	0	0	0	0	1	1	0	1	0	0
Thamnophis gigas giant garter snake	G2G3 S2S3	CDFG:	Fed: Threatened CalThreatened	268 S:31	1	3	3	0	0	0	24	20	11	31	0	0
Trichocoronis wrightii var. wrightii Wright's trichocoronis	G4T3 S1	CNPS: 2B.1	Fed: None CalNone	9 S:1	0	0	0	0	0	0	1	1	0	1	0	0
Trifolium hydrophilum saline clover	G2 S2	CNPS: 1B.2	Fed: None CalNone	49 S:1	0	0	1	0	0	0	0	0	1	1	0	0
Tropidocarpum capparideum caper-fruited tropidocarpum	G1 S1	CNPS: 1B.1	Fed: None CalNone	18 S:10	0	0	0	0	0	8	2	10	0	2	3	5
Valley Needlegrass Grassland	G3 S3.1		Fed: None CalNone	45 S:2	0	0	0	0	0	0	2	2	0	2	0	0
Valley Sacaton Grassland	G1 S1.1		Fed: None CalNone	9 S:3	1	1	1	0	0	0	0	3	0	3	0	0
Valley Sink Scrub	G1 S1.1		Fed: None CalNone	29 S:12	0	1	2	3	0	0	6	12	0	12	0	0
Vireo bellii pusillus least Bell's vireo	G5T2 S2	CDFG:	Fed: Endangered CalEndangered	410 S:2	0	0	0	1	0	0	1	1	1	2	0	0

California Department of Fish and Game
 Natural Diversity Database
 CNDDDB Wide Tabular Report
 Nine-quad records search SLTP (43 quads)

Name (Scientific/Common)	CNDDDB Ranks	Other Lists	Listing Status	Total EO's	Element Occ Ranks						Population Status		Presence		
					A	B	C	D	X	U	Historic >20 yr	Recent <=20 yr	Pres. Extant	Poss. Extirp.	Extirp.
Vulpes macrotis mutica San Joaquin kit fox	G4T2T3 S2S3	CDFG:	Fed: Endangered CalThreatened	961 S:95	8	20	4	6	0	57	74	21	95	0	0
Xanthocephalus xanthocephalus yellow-headed blackbird	G5 S3S4	CDFG: SC	Fed: None CalNone	11 S:1	0	0	0	0	0	1	1	0	1	0	0

Appendix C

Habitat Codes

List of Codes for Habitat Types in Proposed and Alternative Corridors San Luis Transmission Project, April–May 2014 and March 2015

Based on *Preliminary Descriptions of the Terrestrial Natural Communities of California* (Holland 1986)

Agriculture, rice (Agri): rice fields, note if flooded or fallow

Agriculture, orchard (Agor): fruit trees, note type if can

Agriculture, pasture (Agps): note if irrigated

Agriculture, grain (Aggr): alfalfa, hay: note if irrigated

Agriculture, vineyard (Agvn): grapes, kiwi

Barren (Bar): rock, pavement, sand, etc.

Commercial, industrial (Com): developed land use other than residential or farms

Coyote brush scrub (Cbcs): coyote brush (*Baccharis pilularis*) dominant species, characterized by low shrubs, usually dense with scattered grassy openings.

Elderberry, isolated (Ebis): elderberry shrub not in savanna setting

Grasslands, non-native annual/naturalized (Gnn): soft chess, wild oats, ripgut, ryegrass: <3,000'

Grasslands, native perennial (Gnp): soft chess, orchardgrass, oatgrass, fescue, hairgrass

Other (Oth): describe habitat type with dominant species—for SLTP the Oth type included areas mapped as eucalyptus groves; areas noted as planted trees, such as planted pines, oaks, and eucalyptus, including a possible mitigation site with planted native trees; an area of native California sagebrush (*Artemisia californica*); and an area mapped as a debris pile consisting of a pile of old branches and pieces of wood.

Riparian, Great Valley forest (Rgf): valley oak, black walnut, sycamore, cottonwood, elderberry: <500 feet elevation

Riparian, Great Valley scrub (Rgs): willows, elderberry, verbena, blackberry: <1,000 feet elevation

Waters, creek, intermittent (Waci): intermittent creek, < 20 feet wide

Waters, creek, perennial (Wacp): continually flowing, < 20 feet wide

Waters, pond (Wapd): small, <6' deep

Waters, lake (Walk): large, > 6' deep

Waters, river (Warv): perennial/intermittent, > 20 feet wide

Waters, impoundment (Waim): stock pond, man-made ponding feature

Waters, drainage (Wadr): ditches, agriculture drainages (usually well vegetated and shallow)

Waters, irrigation canal (Waic): flooded up to supply irrigation water to fields, usually deeper

Waters, other (Waot): in the SLTP project area this habitat code was applied to the Delta-Mendota Canal, California Aqueduct, a man-made drainage with culvert, a man-made overflow channel with no wetland vegetation, and other drainage features that were not rivers, creeks, ponds, lakes, or irrigation ditches.

Wetlands, freshwater marsh (Wfm): perennial sedge, rushes, nutgrass, cattail, bulrush: <7,500'

Wetlands, other (Wot): wetland not classified in other categories

Wetlands, seasonal (Wse): seasonal ponding, ryegrass, barley, curly dock, rushes, eleocharis

Wetlands, vernal pool (Wvp): seasonal ponding, coyote thistle, popcorn flower, downingia, toad rush, goldfields, typically with colorful, concentric rings: hydrologically connected to a creek or drainage: jurisdictional under USACE guidelines.

Wildflower field (Wldf): vegetation dominated more by forbs than grasses noted for conspicuous annual wildflower displays: usually on poor sites low in nutrients: can have 50 percent or more bare ground: associated with grasslands or oak woodlands.

Appendix D

Plants and Wildlife Seen During Spring 2014 and
Spring 2015 Reconnaissance Surveys

Appendix Table D-1. List of plants observed on San Luis Transmission project during spring reconnaissance surveys in 2014 and 2015.

Scientific Name	Common Name	Native
<i>Achyrrachaena mollis</i>	Blow-wives	yes
<i>Acmispon strigosus</i>	Bishop lotus	yes
<i>Allenrolfea occidentalis</i>	Iodine bush	yes
<i>Allium</i> sp.	Onion	yes
<i>Amarantha</i> sp.	Amaranth	no
<i>Amsinckia menziesii</i>	Fiddleneck	yes
<i>Anthemis cotula</i>	Mayweed	no
<i>Anthoxanthum odoratum</i>	Sweet vernal grass	no
<i>Artemisia californica</i>	California sage	yes
<i>Arundo donax</i>	Giant reed	no
<i>Asclepias fascicularis</i>	Narrow-leaved milkweed	yes
<i>Astragalus</i> sp.	Milk vetch	yes
<i>Atriplex fruticulosa</i>	Ball saltbush	no
<i>Atriplex lentiformis</i>	Big saltbush	yes
<i>Atriplex semibaccata</i>	Australian saltbush	no
<i>Avena barbata</i>	Slender wild oats	no
<i>Avena fatua</i>	Wild oats	no
<i>Baccharis pilularis</i>	Coyote brush	yes
<i>Baccharis salicifolia</i>	Mulefat	yes
<i>Bolboschoenus maritimus</i> ssp. <i>paludosus</i>	Alkali bulrush	yes
<i>Brassica nigra</i>	Black mustard	no
<i>Brassica rapa</i>	Field mustard	no
<i>Briza minor</i>	Little quacking grass	no
<i>Brodiaea elegans</i>	Harvest brodiaea	yes
<i>Bromus caroli-henrici</i>	Weedy brome	no
<i>Bromus diandrus</i>	Ripgut brome	no
<i>Bromus hordeaceus</i>	Soft chess	no
<i>Bromus madritensis</i>	Red brome	no
<i>Calandrinia ciliata</i>	Red maids	yes
<i>California macrophylla</i> - CNPS Rank 1B	Round-leaved filaree	yes
<i>Capsella bursa-pastoris</i>	Shepherd's purse	no
<i>Carduus pycnocephalus</i>	Italian thistle	no
<i>Carduus tenuiflorus</i>	Winged thistle	no
<i>Carex</i> sp.	Sedge	yes
<i>Castilleja exserta</i>	Purple owl's clover	yes
<i>Centaurea melitensis</i>	Tocalote	no
<i>Centaurea solstitialis</i>	Yellow star thistle	no
<i>Centromadia fitchii</i>	Fitch's spikeweed	yes
<i>Centromadia</i> sp.	Tar plant	yes
<i>Chenopodium album</i>	White lambsquarters	yes
<i>Chenopodium murale</i>	Nettle-leaf goosefoot	no
<i>Chenopodium</i> sp.	Lambsquarters	yes
<i>Chlorogalum pomeridianum</i>	Soap plant	yes

Scientific Name	Common Name	Native
<i>Chrysothamnus viscidiflorus</i>	Green rabbitbrush	yes
<i>Clarkia purpurea</i> ssp. <i>quadrivulnera</i>	Winecup clarkia	yes
<i>Clarkia</i> sp.	Clarkia	yes
<i>Conium maculatum</i>	Poison hemlock	no
<i>Convolvulus arvensis</i>	Field bindweed	no
<i>Convolvulus simulans</i> - CNPS Rank 4	Small-flowerd morning-glory	yes
<i>Cotula coronopifolia</i>	Brass buttons	no
<i>Crassula connata</i>	Sand pygmyweed	yes
<i>Croton setiger</i>	Turkey mullein	yes
<i>Cyperus eragrostis</i>	Tall flatsedge	yes
<i>Datura wrightii</i>	Sacred datura	yes
<i>Delphinium parryi</i> ssp. <i>parryi</i>	San Bernardino larkspur	yes
<i>Dichelostemma capitatum</i>	Blue dicks	yes
<i>Distichlis spicata</i>	Salt grass	yes
<i>Dittrichia graveolens</i>	Stinkweed	no
<i>Eleocharis macrostachya</i>	Creeping spikerush	yes
<i>Elymus caput-medusae</i>	Medusa-head	no
<i>Elymus ponticus</i>	Rush wheatgrass	no
<i>Elymus triticoides</i>	Beardless wildrye	yes
<i>Eriogonum</i> sp.	Buckwheat	yes
<i>Erodium botrys</i>	Long-beaked filaree	no
<i>Erodium cicutarium</i>	Red-stem filaree	no
<i>Erodium moschatum</i>	White-stem filaree	no
<i>Eryngium</i> sp.	Coyote thistle	yes
<i>Eschscholzia californica</i>	California poppy	yes
<i>Eucalyptus globulus</i>	Blue gum	no
<i>Eucalyptus</i> sp.	Eucalyptus	no
<i>Festuca myuros</i>	Rattail fescue	no
<i>Festuca perennis</i>	Italian ryegrass	no
<i>Frankenia salina</i>	Alkali heather	yes
<i>Gilia tricolor</i>	Tricolor gilia	yes
<i>Grindelia camporum</i>	Gum plant	yes
<i>Gutierrezia microcephala</i>	Small-headed matchweed	yes
<i>Heliotropium curassavicum</i> var. <i>oculatum</i>	Seaside heliotrope	yes
<i>Helminthotheca echioides</i>	Bristly ox-tongue	no
<i>Hemizonia</i> sp.	Tar plant	yes
<i>Herniaria hirsuta</i>	Hairy rupturewort	no
<i>Hesperevax caulescens</i> - CNPS Rank 4	Hogwallow starfish	yes
<i>Heterotheca</i> sp.	Telegraph weed	yes
<i>Hirschfeldia incana</i>	Shortpod mustard	no
<i>Holocarpha virgata</i>	Sticky tarweed	yes
<i>Hordeum marinum</i> ssp. <i>gussoneanum</i>	Mediterranean barley	no
<i>Hordeum murinum</i> ssp. <i>leporinum</i>	Lepor barley	no
<i>Hypochaeris glabra</i>	Smooth cat's ears	no
<i>Hypochaeris radicata</i>	Rough cat's ear	no
<i>Juglans</i> sp.	Walnut	no

Scientific Name	Common Name	Native
<i>Juncus balticus</i>	Baltic rush	yes
<i>Juncus bufonius</i>	Toad rush	no
<i>Juncus</i> sp.	Rush	yes
<i>Kochia</i> sp. (?)	Kochia	no
<i>Koeleria macrantha</i>	Junegrass	yes
<i>Lactuca serriola</i>	Prickly lettuce	no
<i>Lamium</i> sp.	Hen bit	no?
<i>Lasthenia californica</i>	California gold fields	yes
<i>Lasthenia fremontii</i>	Fremont's goldfields	yes
<i>Lasthenia gracilis</i>	Common goldfields	yes
<i>Lepidium dictyotum</i>	Alkali pepperweed	yes
<i>Lepidium latifolium</i>	Perennial pepperweed	no
<i>Lepidium latipes</i>	Dwarf peppergrass	yes
<i>Lepidium nitidum</i>	Common peppergrass	yes
<i>Logfia gallica</i>	Daggerleaf cottonrose	no
<i>Lonicera involucrata</i> (planted)	Twin-berry	yes
<i>Lotus corniculatus</i>	Bird's foot trefoil	no
<i>Lupinus</i> sp.	Lupine	yes
<i>Madia nutans</i>	Nodding madia	yes
<i>Malva parviflora</i>	Cheeseweed	no
<i>Malvella leprosa</i>	Alkali mallow	yes
<i>Marrubium vulgare</i>	Horehound	no
<i>Matricaria discoidea</i>	Pineapple weed	no
<i>Medicago polymorpha</i>	Bur-clover	no
<i>Medicago sativa</i>	Alfalfa	no
<i>Melilotus indicus</i>	Small melilot	no
<i>Melilotus officinalis</i>	Yellow sweet clover	no
<i>Micropus californicus</i>	Q-tips	yes
<i>Microseris douglasii</i> ssp. <i>douglasii</i>	Douglas' microseris	yes
<i>Mimulus guttatus</i>	Swamp monkelflower	yes
<i>Monolopia major</i>	Cupped monolopia	yes
<i>Muhlenbergia rigens</i> (planted)	Deer grass	yes
<i>Phacelia ciliata</i>	Phacelia	yes
<i>Phalaris aquatica</i>	Harding grass	no
<i>Phalaris paradoxa</i>	Hood canary grass	no
<i>Pinus</i> sp. (ornamental)	Pine tree	no
<i>Plagiobothrys greenei</i>	Greene's popcorn flower	yes
<i>Plagiobothrys</i> sp.	Popcorn flower	yes
<i>Plagiobothrys stipitatus</i>	Slender popcorn flower	yes
<i>Plantago erecta</i>	Foothill plantain	yes
<i>Platanus racemosa</i>	Sycamore	yes
<i>Poa annua</i>	Annual bluegrass	no
<i>Poa bulbosa</i>	Bulbous bluegrass	no
<i>Polypogon monspeliensis</i>	Rabbits-foot grass	no
<i>Populus fremontii</i>	Fremont's cottonwood	yes
<i>Prosopis glandulosa</i> var. <i>torreyana</i>	Honey mesquite	yes
<i>Prunus dulcis</i>	Almond	no

Scientific Name	Common Name	Native
<i>Prunus</i> spp.	Fruit trees	no
<i>Psilocarphus tenellus</i>	Woolly marbles	yes
<i>Quercus</i> sp. (ornamental)	Oak	no
<i>Ranunculus muricatus</i>	Spiny-fruited buttercup	no
<i>Ranunculus</i> sp.	Buttercup	yes
<i>Raphanus raphanistrum</i>	Wild radish	no
<i>Raphanus sativus</i>	Wild radish	no
<i>Rosa</i> sp.	Rose	no
<i>Rubus armeniacus</i>	Himalayan blackberry	no
<i>Rumex crispus</i>	Curly dock	no
<i>Rumex</i> sp.	Dock	no
<i>Salix exigua</i>	Narrow-leaved willow	yes
<i>Salix lasiolepis</i>	Arroyo willow	yes
<i>Salix</i> sp.	Willow	yes
<i>Salsola tragus</i>	Russian thistle	no
<i>Sambucus nigra</i> ssp. <i>canadensis</i>	Blue elderberry	yes
<i>Schoenoplectus acutus</i> var. <i>occidentalis</i>	Tule, bulrush	yes
<i>Schoenoplectus americanus</i>	Olney's three-square bulrush	yes
<i>Senecio vulgaris</i>	Common groundsel	no
<i>Silybum marianum</i>	Milk thistle	no
<i>Sinapis arvensis</i>	Charlock mustard	no
<i>Sisymbrium irio</i>	London rocket	no
<i>Solanum elaeagnifolium</i>	White horse-nettle	no
<i>Sonchus asper</i>	Prickly sow thistle	no
<i>Sonchus oleraceus</i>	Common sow thistle	no
<i>Spergularia</i> sp.	Sand spurry	yes
<i>Stephanomeria virgata</i>	Tall stephanomeria	yes
<i>Stipa pulchra</i>	Purple needle grass	yes
<i>Tamarix parviflora</i>	Fourstamen tamarisk	no
<i>Trichostemma lanceolatum</i>	Vinegar weed	yes
<i>Trifolium albopurpureum</i>	Indian clover	yes
<i>Trifolium depauperatum</i> var. <i>amplectens</i>	Pale sack clover	yes
<i>Trifolium hirtum</i>	Rose clover	no
<i>Triteleia laxa</i>	Ithuriel's spear	yes
<i>Tropidocarpum gracile</i>	Dobie pod	yes
<i>Typha angustifolia</i>	Narrow-leaved cattail	yes
<i>Urtica dioica</i>	Stinging nettles	yes
<i>Vicia villosa</i>	Hairy vetch	no
<i>Vitis vinifera</i>	Wine grapes	no
<i>Xanthium strumarium</i>	Cocklebur	no

Appendix Table D-2. General wildlife species or their sign seen or heard during spring 2014 and spring 2015 surveys in the San Luis Transmission project area.

Reptiles and Amphibians

American bullfrog	<i>Lithobates catesbeianus</i>
California toad (formerly western toad)	<i>Anaxyrus boreas halophilus</i>
Northern Pacific rattlesnake	<i>Crotalus oreganus oreganus</i>
Pacific gopher snake	<i>Pituophis catenifer catenifer</i>
Sierran treefrog (formerly Pacific treefrog)	<i>Pseudacris sierra</i>
Side-blotched lizard	<i>Uta stansburiana</i>
Western fence lizard	<i>Sceloporus occidentalis</i>
Western pond turtle	<i>Emys marmorata</i>

Birds

American avocet	<i>Recurvirostra americana</i>
American coot	<i>Fulica americana</i>
American crow	<i>Corvus brachyrhynchos</i>
American kestrel	<i>Falco sparverius</i>
American robin	<i>Turdus migratorius</i>
American wigeon	<i>Anas americana</i>
Anna's hummingbird	<i>Calypte anna</i>
Ash-throated flycatcher	<i>Myiarchus cinerascens</i>
Barn swallow	<i>Hirundo rustica</i>
Black phoebe	<i>Sayornis nigricans</i>
Brewer's blackbird	<i>Euphagus cyanodephalus</i>
Brown-headed cowbird	<i>Molothrus ater</i>
Bufflehead	<i>Bucephala albeola</i>
Bullock's oriole	<i>Icterus bullockii</i>
Burrowing owl	<i>Athene cunicularia</i>
California gull	<i>Larus californicus</i>
California horned lark	<i>Eremophila alpestris actia</i>
California quail	<i>Callipepla californica</i>
Canada goose	<i>Anser canadensis</i>
Cliff swallow	<i>Hirundo pyrrhonota</i>
Common raven	<i>Corvus corax</i>
Cooper's hawk	<i>Accipiter cooperi</i>
Double-crested cormorant	<i>Phalacrocorax auritus</i>
Eared grebe	<i>Podiceps nigricollis</i>
Eurasian collared dove	<i>Streptopelia decaocto</i>
European starling	<i>Sturnus vulgaris</i>
Ferruginous hawk	<i>Buteo regalis</i>
Gadwall	<i>Anas strepera</i>
Golden eagle	<i>Aquila chrysaetos</i>
Great blue heron	<i>Ardea herodias</i>
Great egret	<i>Ardea alba</i>
Great horned owl	<i>Bubo virginianus</i>
Greater yellowlegs	<i>Tringa melanoleuca</i>
House finch	<i>Carpodacus mexicanus</i>
House sparrow	<i>Passer domesticus</i>

Killdeer
Lark sparrow
Lewis's woodpecker
Lincoln's sparrow
Loggerhead shrike
Long-billed curlew
Mallard
Marsh wren
Mourning dove
Northern flicker
Northern harrier
Northern mockingbird
Northern rough-winged swallow
Pied-billed grebe
Red-tailed hawk
Red-winged blackbird
Rock pigeon
Rock wren
Ruddy duck
Savannah sparrow
Say's phoebe
Snowy plover
Song sparrow
Swainson's hawk
Tree swallow
Turkey vulture
Western bluebird
Western kingbird
Western meadowlark
Western scrub-jay
White-crowned sparrow
Yellow-billed magpie

Mammals

Black-tailed hare
Black-tailed deer
Botta's pocket gopher (burrows)
Brush rabbit
California ground squirrel
Coyote
Deer mouse
Desert cottontail
Red fox (carcass)
San Joaquin kit fox (carcass)
Striped skunk (two skulls)
Tule elk

Charadrius vociferus
Chondestes grammacus
Melanerpes lewis
Melospiza lincolni
Lanius ludovicianus
Numenius americanus
Anas platyrhynchos
Cistothorus palustris
Zenaida macroura
Colaptes auratus
Circus cyaneus
Mimus polyglottos
Stelgidopteryx serripennis
Podylimbus podiceps
Buteo jamaicensis
Agelaius phoeniceus
Columba livia
Salpinctes obsoletus
Oxyura jamaicensis
Passerculus sandwichensis
Sayornis saya
Charadrius [alexandrinus] nivosus
Melospiza melodia
Buteo swainsoni
Tachycineta bicolor
Cathartes aura
Sialia mexicana
Tyrannus verticalis
Sturnella neglecta
Aphelocoma californica
Zonotrichia leucophrys
Pica nuttallii

Lepus californicus
Odocoileus hemionus
Thomomys bottae
Sylvilagus bachmani
Otospermophilus beecheyi
Canis latrans
Peromyscus maniculatus
Sylvilagus audubonii
Vulpes vulpes
Vulpes macrotis mutica
Mephitis mephitis
Cervus canadensis nannodes

Appendix E

Project Area Photos



Photo 1. Agricultural drainage (Wadr) within proposed/alternative corridor.



Photo 3. Seasonal wetland (Wse) within alternative corridor.



Photo 2. Irrigation canal (Waic) with many bullfrogs of all age classes, within proposed/alternative corridor.



Photo 4. Seasonal wetland (Wse) within alternative corridor.



Photo 5. Impoundment (Waim) outside of but near proposed corridor.



Photo 7. Impoundment/seasonal wetland adjacent to proposed corridor.



Photo 6. Impoundment (Waim); outside of project corridors (which are in distance) but within zone of overlap of project with California red-legged frog critical habitat.



Photo 8. Cliff habitat within Patterson Pass A alternative corridor.



Photo 9. Intermittent/ephemeral creek facing west from proposed corridor.



Photo 11. Intermittent/ephemeral creeks in distance, steep terrain; facing south within proposed corridor.



Photo 10. Intermittent/ephemeral creek facing east within proposed corridor.



Photo 12. Intermittent/ephemeral creek, steep terrain; facing west from proposed corridor.

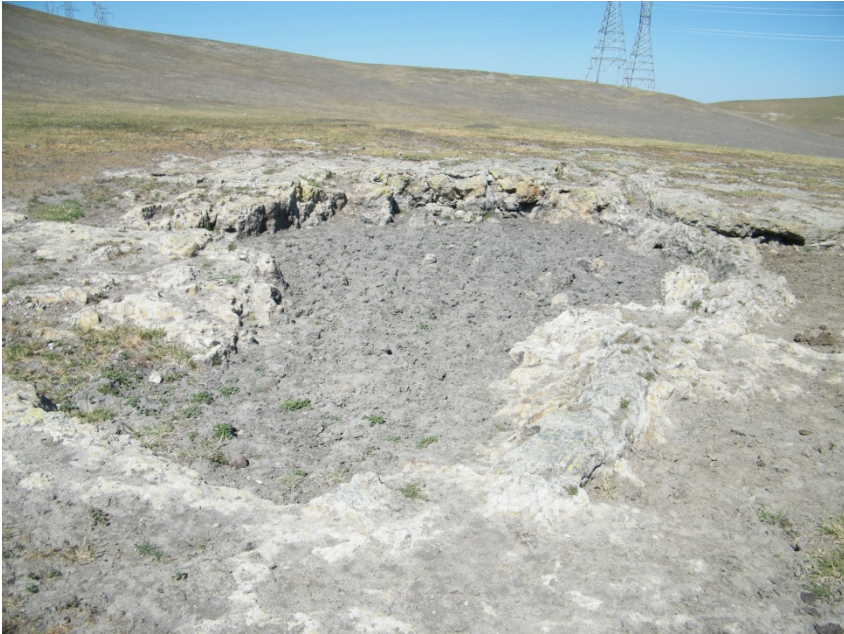

Photo 13. Vernal pool (Wvp) with *Eryngium* in alternative corridor; several other vernal pools in this area outside but adjacent to both corridors.



Photo 15. Great Valley riparian forest (Rgf) within proposed corridor east of O'Neill Forebay.



Photo 14. Coyote brush scrub (Cbsc) in the proposed/alternative corridor east of San Luis Substation.



Photo 16. Freshwater marsh (Wfm) within proposed corridor east of O'Neill Forebay.



Photo 17. Mountain House Creek with impoundment facing south along proposed/alternative corridor.



Photo 19. Corral Hollow Creek near proposed corridor.



Photo 18. Patterson Run facing east toward proposed/alternative corridor.



Photo 20. Lone Tree Creek facing west from proposed corridor; eucalyptus grove and adjacent cottonwood, site of 10+ species of nesting bird.



Photo 21. Hospital Creek facing north within proposed corridor.



Photo 23. Del Puerto Creek within alternative corridor.



Photo 22. Martin Creek facing west from proposed corridor.



Photo 24. Del Puerto Creek and freshwater marsh (Wfm) within proposed corridor.



Photo 25. Salado Creek facing west from proposed corridor into alternative corridor; flowering elderberry bushes in lower right (more in distance, not visible).



Photo 27. Garzas Creek in proposed and alternative corridors.



Photo 26. Crow Creek facing west from within proposed corridor toward alternative corridor.



Photo 28. Romero Creek within proposed corridor.

Appendix F

Blunt-nosed Leopard Lizard Table
Blunt-nosed Leopard Lizard Memo

From Dos Amigos Substation in the south to Santa Nella in the north, assessment of habitat suitability for blunt-nosed leopard lizard (in order of descending milepost numbers). Surveys conducted spring 2014.

Table F-1. BNLL Habitat Assessment

Reach	Milepost* MP-P = Preferred Corridor MP-A = Alternative Corridor	BNLL Suitability	Comments
Dos Amigos Substation SW to I-5	MP-P 82.25-82.00	Low	Heavily disturbed by roadways and land use
I-5 NW to Mercey Springs Rd (Hwy 165)	MP-P 82.00-81.25	Low	Steep E-facing slopes (>20%); rangeland; drainages are narrow, steep
Across from Hwy 165 NW to Ortigalita Creek	MP-P 81.25-78.50	Low	Steep E-facing slopes (>20%); rangeland; unnamed drainages and contributive slopes are flatter
Ortigalita Creek NW to Arburua Road	MP-P 78.50-78.00	Moderate to High	Ortigalita Creek channel is flat; contributive slopes to E and W are relatively flat; rangeland; little to no shrub cover, but rodent burrows common
Arburua Road NW to unnamed drainage	MP-P 78.00-77.75	None	Active agriculture
Unnamed drainage NW to Salt Creek	MP-P 77.75-76.75	Moderate	Variable topography (steep to moderate slopes), but unnamed drainages are relatively flat, but narrow
Just south of Salt Creek NW to just north of Salt Creek	MP-P 76.75-76.5	High	Salt Creek narrow, incised, but widens upstream of project corridor; some areas show evidence of past disking
Salt Creek NW to Canyon Road	MP-P 76.5-75.25	Low	Portions disked in the past; some areas with no burrows; disked areas are recovering
Canyon Road NW to Los Banos Creek	MP-P 75.25-74.50	Low to Moderate	Much of this reach has been disked in past (low); slopes heading into Los Banos Creek look better for BNLL (moderate potential here)
Los Banos Creek	MP-P 74.50	High	Creekbed beneath existing power poles not suitable, but downstream floodplain provides good habitat
Los Banos Creek NW to Dirt Road and Fence	MP-P 74.50-74.00 MP-A 60.75-60.25	High	Rangeland; gentle to moderate slopes
Dirt Road and Fence NW to Farmland	MP-P 74.0-73.25 MP-A 60.25-59.25	Low	Disked in recent past
	MP-P 73.25-71.75	None	Agricultural land; cultivated
Farmland NW to Billy Wright Road	MP-P 71.75-70.25 MP-A 58.00-56.50	Low to Moderate	Patchy land use; some actively dry-farmed (low); some rangeland (moderate)
Billy Wright Road NW to Los Banos Substation	MP-P 70.25-67.25 MP-A 56.50-54.75	High	High-quality, relatively flat rangeland (steep slopes in some ravines); areas around Los Banos Substation support shrubs (<i>Baccharis</i>)
Los Banos Substation to San Luis Substation	MP-P 67.25-64.50	Moderate to High	Best BNLL habitat is between MP-P 64.50-66.75; MP-P 66.75-67.25 is marshy in places (low potential here)

Table F-1. BNLL Habitat Assessment

Reach	Milepost* MP-P = Preferred Corridor MP-A = Alternative Corridor	BNLL Suitability	Comments
Hwy 152 N to end of State property	MP-A 54.25-52.50	Low to Moderate	Low-lying areas near San Luis Forebay are marshy or support dense vegetation; uplands from MP-A 54.00 northward have patchy good BNLL habitat, but side slopes are steep (>20%)
State property N to McCabe Road	MP-A 52.50-50.25	Moderate	Rangeland; much on flats or gently sloping ground
Los Banos Substation to O'Neill Forebay Outfall	MP-P 64.50-63.25	Moderate to High	Dense grassland (rangeland) on flats
O'Neill Forebay Outfall to Small Drainage	MP-P 63.25-61.25	None	Too wet
Small Drainage N to O'Neill Substation	MP-P 61.25-60.50	Low to Moderate	Grassland; potentially too much human disturbance
O'Neill Substation N to Disked Area	MP-P 60.50-59.0	Moderate to High	Grassland (rangeland); suitability reduced in places by disking

*Mileposts are approximate

From Gonzaga Road in the north SE to Interstate 5 in the south (Billy Wright Road alternative corridor), assessment of habitat suitability for blunt-nosed leopard lizard (in order of ascending milepost numbers). Surveys conducted spring 2015.

Table F-2. BNLL Habitat Assessment

Reach	Milepost* MP-A = Billy Wright Road Alternative	BNLL Suitability	Comments
Los Banos West site	No MPs assigned	Moderate to High	Heavily disturbed by OHV use (trails) but site supports shrub-grassland habitat; historic BNLL records in vicinity
Los Banos Power Station SSE to parcel boundary	MP-A 71.75-72.00	Moderate to High	Level ground; rangeland; historic records for BNLL in vicinity
Parcel boundary SSE to next parcel boundary	MP-A 72.00-72.25	None	Level ground, but actively dry-farmed
Parcel boundary SSE to access road	MP-A 72.25-72.75	Low to Moderate	Rangeland on >20% E-facing slopes (low), but flat ground to east (moderate); vegetation is classified as 'wildflower fields', which has less vegetation density than non-native grassland; rodent burrows uncommon to absent
Access road SSE to S-facing slope N of stock pond	MP-A 72.75-73.25	Low	Rangeland on >20% E-facing slopes with dense annual grassland; no rodent burrows observed

Table F-2. BNLL Habitat Assessment

Reach	Milepost* MP-A = Billy Wright Road Alternative	BNLL Suitability	Comments
S-facing slope N of stock pond to base of N-facing slope S of stock pond	MP-A 73.25-73.50	Moderate to High	Wildflower fields on slopes have less dense vegetation (moderate); flat swale associated with stock pond provides good BNLL habitat (high)
Hills S of stock pond	MP-A 73.50-74.00	Low	Steep E- or S-facing slopes with dense annual grassland; few to no rodent burrows
N of Billy Wright Rd S to parcel boundary	MP-A 74.00-75.00	Moderate to High	Rangeland on variable topography, mostly low hills (moderate) separated by broad swales (high); some rodent burrows; vegetation varies from dense grassland to wildflower fields; historic BNLL records from this area
Parcel boundary SE to swale	MP-A 75.00-75.25	Low to Moderate	Rangeland on steep (>20%) slopes; appears to be dense grassland
Swale SE to hills	MP-A 75.25-75.75	Moderate to High	Level grassland in broad swale
Hills SE to swale	MP-A 75.75-76.25	Low to Moderate	Rangeland on steep (>20%) slopes; appears to be dense grassland
Swale	MP-A 76.25-76.50	Moderate	Narrow swale bordered by steep slopes that connects to broad swale noted in MP 3.6-3.9
Swale SE to Los Banos Creek	MP-A 76.50-77.00	Low to Moderate	Rangeland on steep, variable topography; appears to be dense grassland
Los Banos Creek SE to vicinity Salt Creek	MP-A 77.00-79.00	Low	Dense annual grassland and steep (> 20%) slopes of variable direction; few rodent burrows, scattered rock outcrops
Vicinity Salt Creek SE to pt. where route angles to E	MP-A 79.00-80.25	High	Rangeland on gentle to moderate slopes; rodent burrows; broad, flat swales in drainages; historic BNLL records from vicinity
Angle pt. E to Arburua Rd	MP-A 80.25-81.00	High	Rangeland on gentle to moderate slopes; rodent burrows; broad, flat swales in drainages; historic BNLL records from this area
Arburua Rd E to parcel boundary	MP-A 81.00-81.75	None to Low	Active dry farming in recent past
Parcel boundary E to Interstate 5	MP-A 81.75-84.75	Moderate to High	Rangeland on variable slopes and grassland of variable density (moderate), but Ortigalita Creek and tributaries have flat, broad swales with lower grass density and some shrubs (high)

*Mileposts are approximate

PROJECT MEMORANDUM: SAN LUIS TRANSMISSION PROJECT

Date: March 18, 2014
To: Tish Saare (Western)
From: Lawrence Hunt (Hunt and Associates) and Heather Blair (Aspen)
Subject: Blunt-nosed leopard lizard (*Gambelia sila*) habitat requirements

Topography

Blunt-nosed leopard lizard (BNLL) inhabit flat or open to rolling slopes and alluvial fans sparsely vegetated with grassland, alkali flats, and washes on the San Joaquin Valley floor and in the surrounding foothills.

Vegetation

On the Valley floor, BNLL are most commonly found in:

- Non-native annual grassland;
- Valley needlegrass grassland;
- Valley sink scrub, characterized as low, open to dense succulent shrublands dominated by alkali-tolerant chenopod shrubs and having a sparse to absent understory (this plant community has been almost completely extirpated, the remaining fragments are seasonally flooded);
- Valley saltbush scrub, similar to Valley sink scrub, but with a herbaceous annual understory;
- Interior Coast Range saltbush scrub (much of this community has been converted to non-native annual grassland as a result of grazing); and
- Alkali playa.

The common denominator across these plant communities is that BNLL prefer open scrub communities with little or no understory. Long-term studies show BNLL population trends have dramatically declined in population density following consecutive above-average rainfall years (Germano *et al.* 2004; Germano *et al.* 2005; Germano and Williams 2005; Germano *in litt.* 2006; Williams *in litt.* 2006). BNLL generally avoid areas of dense vegetation, such as dense grasses, that appear during years of above-average rainfall. Microhabitat use and home range characteristics of BNLL were compared at two sites near Elk Hills in Buena Vista Valley that differed in ground cover (Warrick *et al.* 1998). These authors reported that BNLL microhabitat use differed significantly between the two study sites. At the more densely vegetated site, blunt-nosed leopard lizards used dry wash areas significantly more than grassland, floodplain, and road habitats. Conversely, at the more sparsely vegetated site, grassland was used more than wash habitat, and hills were used less than all other habitats. In general, BNLL are absent from steep slopes, dense vegetation, or areas subject to seasonal flooding. The average male home range size is about 10 acres and the average female home range size is about 5 acres (Warrick *et al.*, 1998), which is large enough to encompass more than one plant community.

The following exotic species are frequently observed within BNLL habitat, and have adversely affected the species by producing dense live vegetative biomass and residual thatch accumulation: *Bromus rubens madritensis* (red brome), *Vulpia myuros* (mouse-tail fescue) *Schismus arabicus* (Arabian grass), *Hordium murinum glaucum* (foxtail), *Bromus diandrus* (ripgut brome), and *Bromus bordeaceus* (soft

chess) (Germano *et al.* 2001). Introduced grasses and herbs often create an impenetrable thicket for small ground-dwelling vertebrates. BNLL movement is restricted in dense herbaceous cover, as observed with the ease of catching them by hand in dense grass compared to more open habitats (Germano *et al.* 2001; Germano *et al.* 2004). Radiotelemetry studies near the Elk Hills have documented that BNLL are generally restricted to more open habitats (e.g. washes, roads, grazed pastures) when grass cover is thick, but they may use grassland areas if the herbaceous cover is sparse (Warrick *et al.* 1998).

Overgrazing may negatively affect BNLL by compacting soil, damaging rodent burrows that the lizards depend on for cover, and stripping away vegetative cover used by both the lizard and its prey (Hansen *et al.* 1994). However, the cessation of grazing is likely to be even more detrimental to blunt-nosed leopard lizard due to the dense growth of exotic grasses (Germano *et al.* 2001; Germano *et al.* 2005). Grazing is used as a management technique to reduce exotic grass and weed infestations in many BNLL preserves (USFWS, 2010).



Typical BNLL microhabitat (left) and habitat (right)—open scrub and non-native annual grassland on relatively level ground (photos taken from www.wanderingherpetologist.com)

Blunt-nosed leopard lizards also inhabit Valley Saltbush Scrub, which is a low shrubland with an annual grassland understory, that occurs on the gently sloping alluvial fans of the foothills of the southern San Joaquin Valley and adjacent Carrizo Plain. This community is dominated by the chenopod shrubs, common saltbush (*Atriplex polycarpa*) and spiny saltbush (*Atriplex spinifera*), and is associated with non-alkaline, sandy or loamy soils. Similar to this community, but dominated principally by common saltbushes, are the Sierra-Tehachapi saltbush scrub (extending from the southern Sierra Nevada north of Porterville to the Grapevine in the Tehachapi Mountains) and Interior Coast Range saltbush scrub. The latter plant community ranges from Pacheco Pass to Maricopa but, for the most part, has been converted by grazing and fire to non-native annual grassland by intensive livestock grazing. Other foothill communities that occur within the range of BNLL are Upper Sonoran subshrub scrub and serpentine bunchgrass (Holland 1986). The San Luis Transmission Project occurs within the latter region (i.e., Pacheco Pass to Maricopa).

Breeding

Germano and Williams (2005) compared data from the Elkhorn Plain study area with a Valley floor study area and noted the following differences in breeding behavior among the two regions: on the Elkhorn Plain, females were generally gravid by late April or early May, while some females were found with eggs in early July. Clutch size on the Elkhorn Plain ranged from 1 to 6 eggs, with a mean clutch size of 3.4 eggs. Many females produced multiple clutches in a year with up to four clutches observed in a single female. On Valley floor sites, clutch size ranged from 2 to 5 eggs with a mean of 2.9 to 3.3 eggs per clutch, and only a few females produced a second clutch. The greater clutch size and greater

frequency of multiple clutches observed on the Elkhorn Plain compared to the Valley floor was attributed to greater prey abundance with the irruptive population growth of grasshoppers in 1992 (Germano and Williams 2005). This comparison demonstrates BNLL populations show regional, opportunistic variation in breeding effort and breeding season, depending on food resources.

Seasonal and Thermal Activity

In drought years, BNLL activity may be depressed. For example, Germano and Williams (2005) reported that BNLL activity was completely absent for 21 months from July 1989 until April 1991 as individuals remained below ground due to dry conditions. Conversely, as previously noted, localized population declines have been observed following consecutive years of above-average precipitation.

The following information is summarized from the California State University Stanislaus Endangered Species Recovery Program website (<http://esrp.csustan.edu/>), which is a compilation from various sources:

Seasonal above-ground activity in BNLL habitat is correlated with weather conditions, primarily temperature. Optimal activity occurs when air temperatures are between 25 degrees and 35 degrees Celsius (77 and 95 degrees Fahrenheit) and ground temperatures are between 22 degrees and 36 degrees Celsius (72 and 97 degrees Fahrenheit). Some activity has been observed at temperatures as high as 50 degrees Celsius (122 degrees Fahrenheit). Body temperatures range from 32.2 to 42 degrees Celsius (90 and 108 degrees Fahrenheit). Because diurnal activity is temperature dependent, BNLL are most likely to be observed in the morning and late afternoon during the hotter days. Smaller lizards and young have a wider activity range than the adults. This results in the smaller, subadult lizards emerging from hibernation earlier than adults, remaining active later in the year, and being active during the day earlier and later than adults. Adults are active above ground in the spring months from about March or April through June or July, with the amount of activity decreasing so that by the end of June or July almost all sightings are of subadult and hatchling leopard lizards. Following the breeding season, males tend to cease surface activity sooner than females. Adults captured on the surface in August are about 70 percent females. Adults retreat to their burrows and enter a dormancy period beginning in August or September, but hatchlings are active until mid-October or November, depending on weather

Summary Table of BNLL Habitat Criteria

Suitability Criteria	Present	Absent
Geographic Range and Project Route	Merced County: Extant populations occur from just north of San Luis Reservoir southeastward to Dos Amigos substation (approximately 22 miles of project route). Potentially suitable habitat may occur north of San Luis Reservoir.	Contra Costa, Alameda, and Stanislaus Cos.
Topography	Plains, alkali flats, rolling hills, dissected alluvial fans	Slopes > 20%
Vegetation	Sparse annual grassland Native perennial grassland Valley sink scrub Valley saltbush scrub Inner Coast Range saltbush scrub Alkali playa	Dense annual grassland Woodlands and savanna Coastal sage scrub Chaparral Riparian and riparian scrub

Land Use	<ul style="list-style-type: none"> - Rangeland (grazing) - Rangeland containing infrastructure (electrical transmission towers, oil and natural gas pipelines, and other lower-intensity development) - Disused agricultural land adjacent to rangeland (not routinely disked) - Oil Fields - Dirt roads through rangeland 	<ul style="list-style-type: none"> - Row-crop agriculture - Irrigated pasturage (e.g., alfalfa, barley, etc.) - Regularly disked fallow fields - Paved roadways
Seasonal Activity	<ul style="list-style-type: none"> - Abundance relatively high and stable in consecutive "normal" rainfall years - Adults: 15 Apr to 15 July - Subadults and hatchlings: March-Sept 	<ul style="list-style-type: none"> - Abundance depressed in consecutive drought or wet years - Adults: 15 July to 15 Apr - Subadults and hatchlings: Oct-Feb
Diurnal Activity	After sunrise to 1400 hrs (or if maximum air temperature is reached first); activity is bimodal (morning and late afternoon) in July and August	<ul style="list-style-type: none"> - 1400 hrs to sunset (or when air temperature rises above 95F) - Nighttime
Thermal Regime	Optimal air temperature: 77-95F. Optimal ground temperature: 72-97F.	Air temperature: < 77F; > 95F. Ground temperature: < 72F; > 97F.

References

- California Dept. Fish and Wildlife. 2004. Approved survey methodology for the blunt-nosed leopard lizard. Fresno, CA. May. 5 pp.
- Germano, D.J., G.B. Rathbun, and L. R. Saslaw. 2001. Managing exotic grasses and conserving declining species. *Wildlife Society Bulletin* 29:551-559.
- Germano, D.J., D.F. Williams, and P. Kelly. 2004. Long-term fluctuation of a population of blunt-nosed leopard lizards in relation to precipitation and herbaceous plant biomass. Presented at the San Joaquin Natural Communities Conference, May 25, 2004, Bakersfield, California.
- Germano, D.J., G.B. Rathbun, E. Cypher, L.R. Saslaw, and S. Fitton. 2005. Effects of livestock grazing on a community of species at risk of extinction in the San Joaquin Valley, California. 2005 Annual Report. The Lokern Grazing Study Project. Bureau of Land Management, Bakersfield, California. Available on the internet at <http://www.csub.edu/~dgermano/GrazingWebSite.htm> and www.esrp.scustan.edu. Accessed on 19 March 2014.
- Germano, D. J., and D. F. Williams. 2005. Population ecology of blunt-nosed leopard lizards in high elevation foothill habitat. *Journal of Herpetology* 39:1-18.
- Hansen, R.W., R.R. Montanucci, and K.H. Switak. 1994. Blunt-nosed leopard lizard. *Life on the Edge*. Volume 1: *Wildlife* 1:272-273.
- Holland, R.F. 1986. Preliminary descriptions of the terrestrial natural communities of California. California Department of Fish and Game, Sacramento, California 156 pp.
- USFWS. 2010. Blunt-nosed leopard lizard (*Gambelia sila*) 5-year review: summary and evaluation. Sacramento Fish and Wildlife Office, Sacramento, CA. February. 79 pp.
- Warrick, G.D., T.K. Kato, and B.R. Rose. 1998. Microhabitat use and home range characteristics of blunt-nosed leopard lizards. *Journal of Herpetology*. 32(2): 183-191.