



DEPARTMENT OF ENERGY
National Nuclear Security Administration
Los Alamos Site Office
Los Alamos, New Mexico 87544



MAY 19 2011

Mr. Arnold M. Edelman, R. E. M.
Office of Disposal Operations
Office of Environmental Management
U.S. Department of Energy
Cloverleaf Bldg. (EM-12)
1000 Independence, Ave., SW
Washington, DC 20585

Dear Mr. Edelman:

Please find attached Recommendation 2011-05, unanimously adopted by the Northern New Mexico Citizens Advisory Board (NNMCAB) during its meeting on May 12th, 2011.

Please include and consider this Recommendation as public comment during the Department's decision making process on the Draft Greater Than Class C (GTCC) Environmental Impact Statement (EIS). The NNMCAB looks forward to your EIS team's response to this Recommendation in the Public Response Document as part of the Administrative Record to the Final GTCC EIS.

We wish you and your team a swift decision and ROD on this national issue. Please contact us if you have any questions.

Edwin P. Worth
Co-Designated Deputy Federal Officer
505-606-0398

M. Lee Bishop
Co-Deputy Designated Federal Officer
505-606-1804

Enclosure

EPO-26LB-213-348714

NNMCAB Recommendation 2011-05
Approved May 12, 2011

NORTHERN NEW MEXICO CITIZENS' ADVISORY BOARD
Recommendation to the Department of Energy

No. 2011-05
"Recommendation that Los Alamos National Laboratory Not Be
Selected for Disposal of Greater Than Class C Low-Level
Radioactive Waste"

Drafted by the Waste Management (WM) Committee
Primary Author: Caroline Mason

Background:

The Draft Environmental Impact Statement (EIS) for the Disposal of Greater-Than-Class C (GTCC) Low-Level Radioactive Waste and GTCC-Like Waste (DOE/EIS-0375-D) is available for public comment. Los Alamos National Laboratory is one of five sites being evaluated for disposition of this waste.

GTCC waste and the companion GTCC-like waste refer to LLW that has radionuclide concentrations that exceed the limits for Class C Low Level Waste given in U.S. Nuclear Regulatory Commission 10CFR 61.55 and cannot be disposed of in currently licensed commercial LLW disposal facilities. The federal government is responsible for the disposal of this waste. The same is true for GTCC-like waste (consists of LLW and potential no-defense generated TRU waste). Both types of waste have no identified path for disposal.

The disposal requirements in the EIS are based on an assumption of approximately 420,000 cubic feet of waste which includes existing waste and waste expected to be generated in the next 20 to 30 years. Some of the radionuclides in the GTCC wastes either have long half-lives (in excess of 10,000 years) or are present in high concentrations.

The draft EIS discusses five proposed methods for the development, operation, and long-term management of a disposal facility or facilities for GTCC LLW and DOE GTCC-like waste.

The five proposed disposal methods are:

1. No action,
2. Disposal at WIPP,
3. Disposal in a New Intermediate- Depth Borehole Facility,
4. Disposal in a New Enhanced near Surface Trench Disposal facility,
5. Disposal in a New Above-Grade Vault Disposal facility.

The only options presented in the EIS for the location of a waste disposal facility (1 or more) are: WIPP (or near WIPP); Los Alamos National Laboratory (LANL); Hanford Laboratory; Idaho National Laboratory (INL); Savannah River Site (SRS); and Nevada National Security Site (NNSS).

Comments and Observations:

The specific location at LANL that the option discussed in the EIS proposes for either borehole, trench or vault is Technical Area 54 (TA-54). This very location is the subject of extensive remediation in Material Disposal Areas (MDAs) G, L and H and is scheduled for completion in 2015 under an agreement with the New Mexico Environment Department (New Mexico 2005 Order on Consent).

Technical Area-54 is the only current Department of Energy laboratory property which shares a boundary with Native American pueblo land. The San Ildefonso Pueblo has long considered this area as

L284-1 DOE is performing environmental restoration activities at LANL. The ongoing cleanup efforts will continue.

The disposal methods and sites evaluated in the EIS represent the range of reasonable alternatives for the disposal of GTCC LLRW and GTCC-like wastes. This range is consistent with NEPA implementing regulations in Parts 1500-1508 of Title 40 of the Code of Federal Regulations (40 CFR Parts 1500-1508). In this GTCC EIS, DOE analyzed a range of disposal methods (i.e., geologic repository, near-surface trench, intermediate-depth borehole, and above-grade vault) and federally owned sites (i.e., Hanford Site, INL, LANL, NNSS, SRS, and the WIPP Vicinity, for which two reference locations - one within and one outside the WIPP Land Withdrawal Boundary - were considered). DOE has determined that it was reasonable to analyze these six sites because they currently have operating radioactive waste disposal facilities, except for the WIPP Vicinity, which is near an operating geologic repository.

DOE agrees that use of a geologic repository would be a protective and safe method for the disposal of the entire inventory of GTCC LLRW and GTCC-like wastes. The GTCC EIS evaluation for the WIPP geologic repository alternative supports this statement. However, the degree of waste isolation provided by a geologic repository may not be necessary for all of the GTCC LLRW and GTCC-like wastes evaluated in the GTCC EIS. The GTCC EIS evaluation indicates that certain wastes (e.g., those containing short-lived radionuclides such as Cs-137 irradiators) could be safely disposed of in properly designed land disposal facilities at sites with suitable characteristics, such as low precipitation rates, high soil distribution coefficients, and sufficient depths to groundwater. Based on the GTCC EIS evaluation, land disposal facilities located in arid climates (e.g., NNSS and WIPP Vicinity) would isolate radionuclides for a sufficient period of time to allow for significant radioactive decay to occur.

While 10 CFR Part 61 identifies one NRC-approved method for GTCC LLRW disposal (disposal in a geologic repository), these regulations also indicate that other disposal methods could be approved. The GTCC EIS evaluates three land disposal methods (i.e., enhanced near-surface trench, intermediate-depth borehole, and above-grade vault). The GTCC EIS evaluation indicates that land disposal methods employed at sites with suitable characteristics would be viable and safe alternatives for the disposal of GTCC LLRW.

In selecting the preferred alternative, DOE considered existing agreements as well as potential cultural and historic resource impacts. Final siting of a disposal facility for GTCC LLRW and GTCC-like wastes would involve further NEPA review as needed and be in accordance with applicable laws and regulations and would involve local stakeholders and tribal government involvement and consent.

L284-1

Northern New Mexico Citizens' Advisory Board, Commenter ID No. L284 (cont'd)

*NNMCAB Recommendation 2011-05
Approved May 12, 2011*

part of their sacred lands and remediation options for MDA G must consider these cultural and visual impacts. Currently, TA-54 is scheduled to be closed to new waste disposal following remediation. Long term plans are for a visually pleasing cap, restricted or prohibited access to the land, and long term monitoring. Any proposal to return TA-54 into an active waste disposal area would be in direct opposition to the goals of the New Mexico Order on Consent for environmental restoration, and would be counter to the broader objectives of reducing waste disposal at LANL. DOE has been removing TRU waste from TA-54 under the original baseline budget of a cost of \$564M. The EIS option to move TRU waste back to LANL will defeat the purpose of the environmental restoration effort.

Members of the Northern New Mexico Citizens Advisory Board (NNMCAB) have for many years consistently advised the DOE on issues that could help in the removal of legacy wastes from LANL, and have conducted public outreach to the Northern New Mexico communities to make these waste removal and remediation activities apparent. It is clear from the Board's recommendations to DOE that the NNMCAB advises the waste should be removed from LANL, not added to a future disposal problem. Current NRC policy for the disposition of GTCC-LLRW is in a geologic repository. The geologic repository alternative represents the lowest potential for human health impact.

The residents of Northern New Mexico expect no less from DOE and LANL than completion of the legacy waste remediation on schedule. To reverse this policy and add new waste will severely jeopardize LANL relations with its neighbors both near and far and negate much of the progress accomplished under the 2005 Order on Consent.

Recommendations:

No. 1. The DOE should not consider using LANL as an option for disposal of GTCC waste and the GTCC-like waste.

No. 2. The NNMCAB feels the following are more appropriate sites for disposal of GTCC waste and GTCC-like waste (with equal priority):

- a) Waste Isolation Pilot Plant (WIPP). Although use of the WIPP facility is currently considered the most expensive alternative of those presented in the EIS, it appears to provide the most long-term permanent and perhaps safest choice.
- b) Nevada National Security Site (NNSS). NNSS presently serves as a regional disposal site for LLRW and mixed LLRW generated by DOE facilities and EIS tables indicate almost no Human Health Long-Term Impacts if this site is chosen.
- c) Yucca Mountain. The EIS has failed to consider what may be the best and most practical option for GTCC waste disposal. The existing demonstration tunnels, shafts and underground rooms at the Yucca Mountain Project site maybe suited for this class of waste. DOE should add this option to the EIS.

Intent:

The intent of this NNMCAB recommendation is to see that the required cleanup at LANL is completed in the safest way, specifically relative to movement of waste.

References:

1. Draft Environmental Impact Statement (EIS) for the Disposal of Greater-Than-Class C (GTCC) Low-Level Radioactive Waste and GTCC-Like Waste (DOB/EIS-0375-D), <http://www.stccsis.anl.gov/>
2. U.S. Nuclear Regulatory Commission (NRC) Waste classification 10CFR 61.55, <http://www.nrc.gov/reading-rm/doc-collections/cfr/part061/part061-0055.html>
3. New Mexico Order on Consent, 2005.

L284-2 The disposal methods and sites evaluated in the EIS represent the range of reasonable alternatives for the disposal of GTCC LLRW and GTCC-like wastes. This range is consistent with NEPA implementing regulations in Parts 1500–1508 of Title 40 of the Code of Federal Regulations (40 CFR Parts 1500–1508). In this GTCC EIS, DOE analyzed a range of disposal methods (i.e., geologic repository, near-surface trench, intermediate-depth borehole, and above-grade vault) and federally owned sites (i.e., Hanford Site, INL, LANL, NNSS, SRS, and the WIPP Vicinity, for which two reference locations – one within and one outside the WIPP Land Withdrawal Boundary – were considered). DOE has determined that it was reasonable to analyze these six sites because they currently have operating radioactive waste disposal facilities, except for the WIPP Vicinity, which is near an operating geologic repository.

Final siting of a disposal facility for GTCC LLRW and GTCC-like wastes would involve further NEPA review as needed and be in accordance with applicable laws and regulations and would involve local stakeholder involvement and consent.

L284-3 Based on the GTCC EIS evaluation and WIPP's operating record, DOE believes that the WIPP repository would be a safe location for the disposal of GTCC LLRW and GTCC-like wastes, some of which include long-lived radionuclides. DOE recognizes that the use of WIPP for the disposal of GTCC LLRW and GTCC-like wastes would require modification to existing law. In addition, it would be necessary to revise the Agreement for Consultation and Cooperation between Department of Energy and the State of New Mexico for the Waste Isolation Pilot Plant, the WIPP compliance certification with EPA, and the WIPP Hazardous Waste Facility Permit.

The State of New Mexico has indicated a willingness to accept GTCC LLRW and GTCC-like wastes for disposal at WIPP. Twenty-eight New Mexico State Senators signed a proclamation made in the Fiftieth Legislature, First Session, 2011, stating: "Be it resolved that we, the undersigned, support the opportunity for other potential missions in southeast New Mexico to adequately address the disposal of defense high-level waste, commercial high-level waste, Greater Than Class C LLRW and surplus plutonium waste, as well as the interim storage of spent nuclear fuel." In response to the Draft GTCC EIS, Secretary David Martin, Secretary of the New Mexico Environment Department, sent a letter to DOE on June 27, 2011, stating that "the Department encourages DOE to support the WIPP or WIPP Vicinity proposed locations as the preferred alternatives addressed in the Draft EIS. The geologic repository is the favored alternative being more effective for the enduring time frames for this waste type." In addition, the Governor of New Mexico, in a letter to DOE Secretary Steven Chu on September 1, 2011, stated that the State of New Mexico encourages DOE to support the proposed location of WIPP as the preferred alternative for the disposal of GTCC LLRW and GTCC-like wastes.

L284-4 This EIS does consider NNSS for disposal of GTCC LLRW and GTCC-like wastes.

L284-5 The EIS considered the range of reasonable alternatives for disposal of the inventory of GTCC LLRW and GTCC-like wastes identified for inclusion in these analyses. The Secretary of Energy determined that a permanent repository for high-level waste and spent nuclear fuel at Yucca Mountain, Nevada, is not a workable option and will not be developed. Therefore, DOE concluded that co-disposal at a Yucca Mountain repository is not a reasonable alternative and has eliminated it from evaluation in this EIS, as described in Section 2.6 of the EIS. DOE has included analysis of generic commercial facilities in the event that a facility could become available in the future. In that case, before making a decision to use a commercial facility, DOE would conduct further NEPA reviews, as appropriate.

Nuclear Watch New Mexico, Commenter ID No. E102

From: Edelman, Arnold <Arnold.Edelman@em.doe.gov>
Sent: Wednesday, June 29, 2011 5:56 AM
To: Kovac, Scott <Alert>; gtcccis@anl.gov
Cc: Jay Coghlan; john
Subject: RE: Nuclear Watch NM GTCC Comments

Thank you for your comments. No problem at all.
Be safe.
Arnie

-----Original Message-----
From: Kovac, Scott <Alert>
Sent: Tuesday, June 28, 2011 6:42 PM
To: gtcccis@anl.gov
Cc: Jay Coghlan; john
Subject: Nuclear Watch NM GTCC Comments

Dear Mr. Edelman:

Nuclear watch New Mexico respectfully submits these comments on the Draft Environmental Impact Statement for the Disposal of Greater Than Class C (GTCC) Low Level Radioactive Waste and GTCC Like Waste (GTCC EIS). We recognize that our submittal is one day late, which is entirely attributable to the wildfire emergency in Los Alamos, which we had to monitor and respond to media. We trust that our GTCC comments will nevertheless be accepted.

Please reply as to the receipt and readability of the attached comments.

Thank you,
Scott Kovac
Operations and Research Director
Nuclear Watch New Mexico
551 W. Cordova Road #808
Santa Fe, NM, 87505
505.989.7342 office & fax
www.nukewatch.org



June 28, 2011

Mr. Arnold M. Edelman,
EIS Document Manager, GTCC EIS
U.S. Department of Energy
Cloverleaf Building, EM-43
1000 Independence Ave., S.W.
Washington, D.C. 20585

Via email: gtcceis@anl.gov

RE: Comments on the Draft Environmental Impact Statement for the Disposal of Greater-Than-Class-C (GTCC) Low-Level Radioactive Waste and GTCC-Like Waste (DOE/EIS-0375-D)

Dear Mr. Edelman:

We respectfully submit these comments on the Draft Environmental Impact Statement for the Disposal of Greater-Than-Class-C (GTCC) Low-Level Radioactive Waste and GTCC-Like Waste (GTCC EIS). We recognize that our submittal is one day late, which is entirely attributable to the wildfire emergency in Los Alamos, which we had to monitor and respond to media. We trust that our GTCC comments will nevertheless be accepted.

The draft EIS evaluates potential alternatives involving various disposal methods for use at DOE and generic commercial sites. DOE should broaden the scope of this EIS to a Programmatic EIS, thereby fulfilling DOE's obligations under the National Environmental Policy Act's (NEPA's) Rules and Regulations.

We support safe, monitored storage of radioactive wastes as a matter of national security and environmental protection. However, that should not be interpreted as support for more nuclear weapons, nuclear power, or the generation of more nuclear wastes. In our view, the best way to treat radioactive wastes is to not produce them to begin with.

Programmatic EIS for GTCC Waste Disposal

We contend that disposal of GTCC waste is a "program," defined by DOE under its NEPA regulations as systematic and connected agency decisions allocating

Nuclear Watch New Mexico, Comments on Greater Than Class C Draft EIS
551 W. Cordova, #808, Santa Fe, NM 87505 • Phone and fax: 505.989.7342
info@nukewatch.org • www.nukewatch.org • http://www.nukewatch.org/watchblog/

E102-1 DOE does not agree that a programmatic EIS as described in this comment must be prepared before this EIS is completed. DOE tailored the scope of this EIS to ensure the analyses will adequately inform the decisions at issue, including the selection of sites and technologies for the disposal of GTCC and GTCC-like waste. This EIS presents the environmental information needed to adequately inform decision makers regarding many of the questions and points raised in this comment; other questions and points raised remain outside of the scope of this document. DOE plans a tiered decision making process in which DOE would conduct further site-specific NEPA reviews before implementing an alternative ultimately selected on the basis of this EIS.

E102-2 Stopping the generation of nuclear waste is also outside the scope of the GTCC EIS, the scope of which is to evaluate disposal alternatives to enable the selection of a safe alternative or alternatives for the disposal of GTCC LLRW and GTCC-like wastes. The GTCC EIS evaluates the range of reasonable alternatives for the disposal of GTCC LLRW and GTCC-like wastes in compliance with the requirements specified in NEPA, the Low-Level Radioactive Waste Policy Amendments Act (P.L. 99-240), and Section 631 of the Energy Policy Act of 2005 (P.L. 109-58). The GTCC EIS evaluates the potential environmental impacts of the proposed disposal alternatives for GTCC LLRW and GTCC-like wastes. Based on the evaluation, DOE has determined that there are safe and secure alternatives for the disposal of GTCC LLRW and GTCC-like wastes. The GTCC EIS provides information that supports this determination, and, as discussed in Section 1.1, Purpose and Need for Agency Action, DOE is responsible for the disposal of GTCC LLRW and GTCC-like wastes.

E102-3 Refer to the discussion regarding a programmatic EIS in the response to E102-1.

DOE explained in the WM PEIS (DOE, 1997, *Final Waste Management Programmatic Environmental Impact Statement for Managing Treatment, Storage, and Disposal of Radioactive and Hazardous Waste*, DOE/EIS-0200-F, Office of Environmental Management, Washington, D.C.) that additional analyses would be prepared to implement DOE's programmatic decisions. The GTCC EIS analyzes the potential environmental impacts associated with the disposal of GTCC LLRW and GTCC-like (DOE) wastes. Since the WM PEIS relates only to DOE waste, the inclusion of commercial waste in the WM PEIS is premature until the GTCC EIS is finalized and a ROD is issued. Depending on the outcome of this ROD, DOE will evaluate whether additional programmatic or site-specific NEPA reviews or updates to previous decisions are needed, as appropriate. Any additional NEPA reviews or considerations will be conducted with full opportunity for public input, consistent with Council on Environmental Quality and DOE NEPA requirements.

E102-1

E102-2

E102-3

Nuclear Watch New Mexico, Commenter ID No. E102 (cont'd)

agency resources to implement a specific statutory program or executive directive. The federal government is responsible for the disposal of any low-level radioactive waste with concentrations of radionuclides that exceed the limit established by the Commission for Class C Waste, as per Section 61.55 of Title 10, Code of Federal Regulations (CFR). Therefore the statute-driven nature of the DOE GTCC waste disposal proposal is evident.

Moreover, the GTCC EIS analyzes differing conceptual disposal methods for multiple candidate sites (including generic commercial locations) to implement this plan. This strongly indicates that systematic and connected agency decisions will have to be considered in the GTCC EIS.

The Council on Environmental Quality (CEQ), impeded by NEPA, issued implementing regulations as part of the Code of Federal Regulations (CFRs) that all executive branch agencies had to incorporate. At 40 CFR 1502.4(a) the CEQ required that, "Agencies shall make sure the proposal which is the subject of an environmental impact statement is properly defined." At 40 CFR 1502.4(b) the CEQ stated, "Environmental Impact Statements may be prepared, and are sometimes required, for broad Federal actions such as the adoption of new agency programs (Sec. 1508.18). Agencies shall prepare statements on broad actions so that they are relevant to policy and are timed to coincide with meaningful points in agency planning and decision-making."

Because of these CEQ requirements, DOE NEPA implementing regulation 10 CFR 1021.330(a) states, "When required to support a programmatic decision DOE shall prepare a programmatic EIS or EA." [Cites to two other statutes in 10 CFR 1021 omitted in this quote.] Given the CEQ NEPA regulations and the Department's implementing regulations, we argue that DOE is obliged to prepare and complete a programmatic environmental impact statement for GTCC waste disposal so that its proposal is properly defined and analyzed. Any subsequent Record of Decision should then select a disposal method or methods and a specific site or sites, and only then should a site-specific EIS or EISs go forward. In sum, this GTCC waste disposal environmental impact statement should be broadened to a programmatic environmental impact statement.

The long-term costs of GTCC must be thoroughly analyzed.

As an irretrievable commitment of taxpayers' dollars, this EIS must analyze of all projected costs for the proposed GTCC waste disposal program and analyze the costs of each proposed alternative separately.

Please answer these questions: What is the comparison of costs of all the different proposed disposal alternatives (including hardened on-site storage)? Please calculate the costs of building each proposed disposal option at each proposed site, the transportation of waste, operating expenses, health costs for treatment of occupational illnesses and accident victims, and the costs of security of

Nuclear Watch New Mexico, Comments on Greater Than Class C Draft EIS 2
551 W. Cordova, #808, Santa Fe, NM 87505 • Phone and fax: 505.989.7342
info@nukewatch.org • www.nukewatch.org • http://www.nukewatch.org/watchblog/

E102-4 Consistent with NEPA requirements, the EIS does consider and evaluate the irreversible and irretrievable commitment of resources for each action alternative. The resources that would be irreversibly and irretrievably committed for the disposal of GTCC LLRW and GTCC-like wastes at WIPP would include the underground space, energy, raw materials, and other natural and human-made resources used to construct the additional rooms needed (see Section 4.6). The resources that would be irreversibly or irretrievably committed during the disposal of GTCC LLRW and GTCC-like wastes by using the land disposal methods would include the land encompassed by the facility footprint, water, energy, raw materials, and other natural and human-made resources for construction of the disposal facility (see Section 5.4).

Estimated costs for implementing the various alternatives are given in this EIS to the extent that this information was available. A detailed cost evaluation is not required to be included in an EIS under NEPA. Detailed cost information could be provided in a future site-specific NEPA review, as needed.

E102-3
(Cont.)

E102-4

Nuclear Watch New Mexico, Commenter ID No. E102 (cont'd)

the facilities. Please compare that to the costs of not implementing the GTCC program. What will be the entire life cycle costs of the GTCC proposal?

Disposal of GTCC radioactive wastes should be the starting point for public discussions of nuclear reactor decommissioning and proposed future reactors, not an afterthought.

Much of the future GTCC wastes will be the reactor parts themselves that won't enter into the waste streams until the 2060's. Reactor decommissioning is a tough problem. Do we wait 100 years for the radioactivity to decay away? That leaves an abandoned, contaminated site where no one will take responsibility. Should they be entombed? More broadly, are more nuclear power plants worth the expense and intractable waste problems that taxpayers will inevitably be required to pay for? It is imperative that DOE analyze these issues because they have direct impact on the future generation of GTCC radioactive wastes. Please include in this EIS a discussion on the future of nuclear power.

All true alternatives for safe storage must be identified and analyzed

DOE should reject in advance irretrievable disposal of GTCC wastes. Given potential future innovations that could provide safer disposal methods, or the discovery of greater risks at any one site than previously foreseen, it is necessary *ipso facto* that all disposal options be reversible. Decisions now about disposal sites and technologies are premature. There is time to learn from experience. At a minimum, DOE must consider interim "Hardened On-Site Storage" (HOSS) at existing nuclear facilities as a real alternative (further discussion immediately below).

Analyze Hardened On-Site Storage

In our view, GTCC radioactive wastes should be safely stored as close to the site of generation as possible and be safeguarded in hardened, on-site storage facilities. HOSS facilities should be considered and analyzed from the perspective that these wastes must be zealously protected from risks posed by wildfire or other natural or man-made disasters. HOSS facilities must not be designed as permanent waste disposal solutions, and therefore should not be constructed deep underground. The wastes must be retrievable, and real-time radiation and heat monitoring at the HOSS facility must be implemented for early detection of radiation releases.

The overall objective of HOSS should be that the amount of releases projected in even serious terrorist attacks should be low enough that the storage system would be unattractive as a target to begin with. Design criteria must include resistance to severe attacks, such as a direct hit by high explosive or an aircraft loaded with fuel and/or explosives. Please explain why HOSS was not posed as an alternative in the Notice of Intent for the GTCC EIS. If HOSS is not analyzed in the draft GTCC EIS, please provide detailed reasons for its rejection.

E102-4
(Cont.)

E102-5

E102-6

E102-7

- E102-5 Even though it is beyond the scope of this GTCC EIS, the comment is noted. This GTCC EIS addresses the potential environmental impacts associated with the proposed development, operation, and long-term management of a disposal facility or facilities for GTCC low-level radioactive waste (LLRW) and DOE GTCC-like waste.
- E102-6 Due to the relatively small quantities and nature of GTCC waste (high activity and potential national security concerns) greater confinement is warranted. Several disposal methods identified in the EIS do provide appropriate protection for future generations including disposal in a geologic repository. Retrieval of waste is not a requirement in the Low-Level Radioactive Waste Policy Amendments Act (P.L. 99-240).
- E102-7 The use of HOSS and other approaches for long-term storage of GTCC LLRW and GTCC-like wastes are outside the scope of this EIS because they do not meet the purpose and need for agency action. Consistent with Congressional direction in Section 631 of the Energy Policy Act of 2005 (P.L. 109-58), DOE plans to complete an EIS and a ROD for a permanent disposal facility for this waste, not for long-term storage options. The GTCC EIS evaluates the range of reasonable disposal alternatives and, as also required under NEPA, a No Action Alternative. Under the No Action Alternative, current practices for storing GTCC LLRW and GTCC-like wastes would continue in accordance with current requirements.

Nuclear Watch New Mexico, Commenter ID No. E102 (cont'd)

Commercial wastes must be stored safely at the power plants for the decades that they operate and longer. The GTCC EIS document should consider Hardened On-Site Storage to improve safeguards for the wastes. DOE rejected that advice, saying that it is only considering disposal, not storage. This is a false assumption. At least 85 percent of existing reactors and any new ones are expected to operate beyond 2030, which means GTCC waste disposal could not begin for years after that. GTCC waste has been and will be stored for many decades. Storage must be an option, because it is already a reality.

DOE should dedicate funding to local and state governments for independent monitoring

- Funding for independent monitoring of the HOSS facilities at each site must be provided to local and state governments, with the right of review of that monitoring by the potentially affected public.

Periodic review of HOSS facilities should be required

- An annual report reviewing the safety condition of each HOSS facility should be prepared with meaningful participation from public stakeholders, regulators, and utility managers at each site. A good summary of the report must be made publicly available and provide for possible recommendations for any needed corrective actions.

This EIS must be withdrawn and sites other than DOE sites must be analyzed

Do not send GTCC to DOE sites. Nation-wide, DOE sites are still facing 100's of billions of dollars and decades worth of cleanup from the Cold War. Commitments must be met to clean up about all DOE nuclear weapons sites.

A Second Repository Must Be Examined

Highly radioactive and long-lived radioactive wastes belong in a deep geologic repository. The legal requirement for another repository exists, yet the alternative of putting the GTCC waste into that repository is not even mentioned. Scientists have agreed for decades that the best geologic formation for highly radioactive wastes is the Granite Shield of North America. But DOE has refused to consider such a site, even after dropping Yucca Mt. Nevada because it was not suitable.

New Mexico must not be the site for the disposal of any of the 160,000,000 curies of GTCC waste.

There are not suitable sites in New Mexico for disposal of this waste. The people of New Mexico were promised on numerous occasions that the Waste Isolation Pilot Plant (WIPP) would be for defense, not commercial, waste. The WIPP Land Withdrawal Act prohibits any commercial waste at WIPP. Any site at or near WIPP also is inappropriate because it would be an attempt to circumvent that prohibition. Los Alamos National Laboratory (LANL) has thousands of cubic meters

Nuclear Watch New Mexico, Comments on Greater Than Class C Draft EIS 4
551 W. Cordova, #808, Santa Fe, NM 87505 • Phone and fax: 505.989.7342
info@nukewatch.org • www.nukewatch.org • http://www.nukewatch.org/watchblog/

E102-7
(Cont.)

E102-8

E102-9

E102-10

E102-11

E102-8 The development of a regulatory framework for the use of HOSS at commercial nuclear power plants is outside the scope of the GTCC EIS. DOE does not have authority to regulate the storage of radioactive wastes at commercial facilities, including nuclear power plants. Under the Atomic Energy Act of 1954 as amended (AEA) (see United States Code: 42 USC § 2011), the NRC is responsible for regulating storage of such wastes. Radioactive waste storage requirements can be found in 10 CFR Part 30 (Rule of General Applicability to Domestic Licensing of Byproduct Material), 10 CFR Part 70 (Domestic Licensing of Special Nuclear Material), and 10 CFR Part 72 (Licensing Requirements for the Independent Storage of Spent Nuclear Fuel, High-Level Radioactive Waste, and Reactor-Related Greater Than Class C Waste). In addition, the NRC has provided guidance for the storage of LLRW in SECY-94-198, Review of Existing Guidance Concerning the Extended Storage of Low-Level Radioactive Waste, which was issued on August 1, 1994.

E102-9 DOE is performing environmental restoration activities at the Hanford Site, INL, LANL, NNS, and SRS. The ongoing cleanup efforts at these sites will continue. If GTCC LLRW or GTCC-like waste were to be disposed at these sites, DOE does not anticipate negative impacts to ongoing cleanup activities at these sites.

E102-8 The disposal methods and sites evaluated in the EIS represent the range of reasonable alternatives for the disposal of GTCC LLRW and GTCC-like wastes. This range is consistent with NEPA implementing regulations in Parts 1500–1508 of Title 40 of the Code of Federal Regulations (40 CFR Parts 1500–1508). In this GTCC EIS, DOE analyzed a range of disposal methods (i.e., geologic repository, near-surface trench, intermediate-depth borehole, and above-grade vault) and federally owned sites (i.e., Hanford Site, INL, LANL, NNS, SRS, and the WIPP Vicinity, for which two reference locations – one within and one outside the WIPP Land Withdrawal Boundary – were considered). DOE has determined that it was reasonable to analyze these six sites because they currently have operating radioactive waste disposal facilities, except for the WIPP Vicinity, which is near an operating geologic repository.

E102-10 The EIS considered the range of reasonable alternatives for the disposal of the GTCC waste inventory, including disposal in a deep geologic repository. DOE did not evaluate developing a geologic repository exclusively for disposal of GTCC LLRW and GTCC-like wastes because DOE determined that such an alternative is not reasonable due to the time and cost associated with siting a deep geologic repository and the relatively small volume of GTCC LLRW and GTCC-like wastes identified in the GTCC EIS. DOE believes that the results presented in this EIS for the WIPP geologic repository alternative are indicative of the high degree of waste isolation that would be provided by disposal in a geologic repository. DOE has included analysis of generic commercial facilities in the event that a facility could become available in the future. In that case, before making a decision to use a commercial facility, DOE would conduct further NEPA reviews, as appropriate.

E102-11 DOE recognizes that disposal of GTCC LLRW and GTCC-like wastes in the WIPP geologic repository would require modification to existing law. In addition, it may be necessary to revise the Agreement for Consultation and Cooperation between Department of Energy and the State of New Mexico for the Waste Isolation Pilot Plant, the WIPP compliance certification with the EPA, and the WIPP Hazardous Waste Facility Permit.

E102-11 DOE is performing environmental restoration activities at LANL. The ongoing cleanup efforts will continue. If GTCC LLRW or GTCC-like waste were to be disposed at these sites, DOE does not anticipate negative impacts to ongoing cleanup activities at these sites.

The disposal methods and sites evaluated in the EIS represent the range of reasonable alternatives for the disposal of GTCC LLRW and GTCC-like wastes. This range is consistent with NEPA implementing regulations in Parts 1500–1508 of Title 40 of the Code of Federal Regulations (40 CFR Parts 1500–1508). In this GTCC EIS, DOE analyzed a range of disposal

Nuclear Watch New Mexico, Commenter ID No. E102 (cont'd)

of waste that must be cleaned up, and it is inappropriate to bring any commercial waste to LANL for disposal. New Mexico also has millions of tons of waste from uranium mining and milling. Thus, New Mexicans are already burdened with more than our share of the nation's nuclear waste.

E102-11
(Cont.)

Do Not Bring GTCC Waste To Los Alamos

Estimates for cleanup of Cold War legacy radioactive contamination at Los Alamos National Laboratory (LANL) range from \$2 to \$30+ billion. This wide range has to do with the type of cleanup that the State approves for the Lab, which ranges from "cap-and-cover" to exhumation. A legally binding agreement requires DOE and LANL to investigate and clean up decades worth of contamination across the lab's 40 square-mile property by 2015. Signed in 2005, the Consent Order lays out cleanup milestones and requires the federal government to pay fines if LANL fails to meet them. The Lab must focus on this cleanup and not bring any more waste, including Greater-than-Class C (GTCC), to the Lab.

E102-12

Shipment of all GTCC waste to LANL is estimated at 12,600 truckloads involving a total distance of 22 million miles. The estimated peak annual doses from the use of contaminated water within 10,000 years of disposal of GTCC at LANL were calculated to occur between 500 years and 1,100 years. These times represent the time after failure of the cover and engineered barriers (which is assumed to begin 500 years after closure of the disposal facility).

In 1970, the old Atomic Energy Commission (AEC) decided that all Transuranic wastes – i.e., Plutonium – should go to deep underground repository, not be disposed any longer in unlined trenches, such as proposed for LANL.

The location of the Lab in a seismic fault zone between a rift and a dormant volcano is not the place for radioactive waste that is dangerous for tens of thousands of years.

E102-13

Do Not Send GTCC to WIPP

Finish the original mission at WIPP. WIPP must be safely operated to meet the "start clean, stay clean" standard. WIPP must be safely closed, decontaminated, and decommissioned, beginning in about 2030 or earlier. The WIPP repository is in a salt formation in NM. It is barred by federal law from taking nondefense waste and from taking this amount of very radioactive wastes. New Mexico and Congress unlikely to agree should DOE select WIPP.

E102-14

Heed the American Indian Text

We appreciate the inclusion of the American Indian Text Boxes. Now listen to them!

E102-15

Nuclear Watch New Mexico, Comments on Greater Than Class C Draft EIS
551 W. Cordova, #808, Santa Fe, NM 87505 • Phone and fax: 505.989.7342
info@nukewatch.org • www.nukewatch.org • http://www.nukewatch.org/watchblog/

methods (i.e., geologic repository, near-surface trench, intermediate-depth borehole, and above-grade vault) and federally owned sites (i.e., Hanford Site, INL, LANL, NNSS, SRS, and the WIPP Vicinity, for which two reference locations – one within and one outside the WIPP Land Withdrawal Boundary – were considered). DOE has determined that it was reasonable to analyze these six sites because they currently have operating radioactive waste disposal facilities, except for the WIPP Vicinity, which is near an operating geologic repository.

Disposal of GTCC LLRW and GTCC-like wastes at WIPP or the WIPP Vicinity site is included in the range of reasonable alternatives and is evaluated in this EIS. DOE acknowledges that only defense-generated TRU waste is currently authorized for disposal at the WIPP geologic repository under the WIPP LWA as amended (P.L. 102-579 as amended by P.L. 104-201) and that legislation would be required to allow disposal of waste other than TRU waste generated by atomic energy defense activities at WIPP and/or for siting a new facility within the land withdrawal area. It would also be necessary to revise the Agreement for Consultation and Cooperation between Department of Energy and the State of New Mexico for the Waste Isolation Pilot Plant, the WIPP compliance certification with EPA, and the WIPP Hazardous Waste Facility Permit. In addition, site-specific NEPA reviews would be conducted as needed, including further characterization of the waste (e.g., radionuclide inventory and heat loads) as well as the proposed packaging for disposal.

However, NEPA does not limit an EIS to proposing and evaluating alternatives that are currently authorized. Furthermore, the Agreement for Consultation and Cooperation between Department of Energy and the State of New Mexico for the Waste Isolation Pilot Plant recognizes that the mission of WIPP may change and provides provisions to modify the agreement. For example, the Agreement states: "The parties to this Agreement recognize that future developments including changes to applicable laws (e.g., Public Law [P.L.] 96-164) may make it desirable or necessary for one or both parties to seek to modify this Agreement. Either party to this Agreement may request a review of the terms and conditions."

DOE acknowledges the TRU waste disposal limitations for WIPP specified in the WIPP LWA as amended (P.L. 102-579 as amended by P.L. 104-201) and in the Agreement for Consultation and Cooperation between Department of Energy and the State of New Mexico for the Waste Isolation Pilot Plant. Information on these limitations is provided in this EIS (see Section 4.1.1) and was considered in developing the preferred alternative. Based on the GTCC EIS evaluation, disposal of GTCC LLRW and GTCC-like wastes at WIPP would result in minimal environmental impacts for all resource areas evaluated, including human health and transportation. Both the annual dose and the latent cancer fatality (LCF) risk would be zero because there would be no releases to the accessible environment and therefore no radiation doses and LCFs during the first 10,000 years following closure of the WIPP repository. DOE recognizes that the use of WIPP for the disposal of GTCC LLRW and GTCC-like wastes would require legislative changes and site-specific NEPA reviews would be conducted as needed, including further characterization of the waste (e.g., radionuclide inventory and heat loads), as well as the proposed packaging for disposal.

Final siting of a disposal facility for GTCC LLRW and GTCC-like wastes would involve further NEPA review as needed and be in accordance with applicable laws and regulations and would involve local stakeholder involvement and consent.

E102-12 Refer to the first paragraph in the E102-11 response regarding a discussion on ongoing cleanup activities at LANL.

E102-13 The site-specific environmental factors identified by commenters were evaluated in the EIS as appropriate. The issue of seismicity at LANL (see Section 8.1.2.1.4) was one of many factors that DOE considered in selecting the preferred alternative.

DOE Fails To Properly Analyze The Risks Of Extremely Radioactive GTCC Waste

DOE estimated 816 fatal cancers in ADULTS along truck routes from routine exposure to trucked spent fuel in the Global Nuclear Energy Program (GNEP) PEIS. (Table S. 4-10, page S-52 in GNEP draft PEIS 12-2008). The fatal cancers from trucking estimated in the GTCC EIS are many times less. Please explain the difference.

Radiation doses one meter away from shipments of GTCC, remote-handled TRU or other GTCC-like wastes are grossly understated in the GTCC EIS. DOE ignored children and NAS data (BEIR VII), which would increase the estimated cancer risks. GTCC EIS fails to show real risks along actual truck routes or cancer estimate as was analyzed in the GNEP draft PEIS. This results in false presentation of total LCF (Latent Cancer Fatalities). The GTCC EIS estimate is based on 50 years of repeated exposure resulting in .5 to 1.0 mrem total dose. (Page 5-83) GTCC EIS fails to base dose on limit of radiation dose allowed which is 10 mrem / hour 2 meters away from the cask - e.g., next lane in traffic. (This criticism applies to inspectors and parking lots, etc., where GTCC EIS says total dose it projects is .5 to 1 mrem. One inspection is likely to result in dose of 7.5 mrem, which is 7.5 to 15 times higher than GTCC EIS projects for lifetime dose to inspector. The projected effects and risks of exposures must be re-analyzed.

Conclusion

The treatment and handling of GTCC wastes must be protective of human health and the environment for many tens of thousands of years. Analyses to do so are not only best done in a programmatic environmental impact statement, but we argue are required to be done in a PEIS. DOE must consider storage of GTCC waste as interim until improved safe methods of disposal are discovered. Out-of-sight, out-of-mind permanent burial must not be considered just because no other method is now known. The relatively small volumes but high activity level of GTCC wastes make it an ideal issue in which to seriously consider hardened on-site storage. We urge DOE to do so.

Respectfully Submitted,

Jay Coghlan
Executive Director

Scott Kovac
Operations and Research Director

*Nuclear Watch New Mexico, Comments on Greater Than Class C Draft EIS
551 W. Cordova, #808, Santa Fe, NM 87505 • Phone and fax: 505.989.7342
info@nukewatch.org • www.nukewatch.org • http://www.nukewatch.org/watchblog/*

E102-14 Disposal of GTCC LLRW and GTCC-like wastes at WIPP or the WIPP Vicinity site is included in the range of reasonable alternatives and is evaluated in this EIS. DOE acknowledges that only defense-generated TRU waste is currently authorized for disposal at the WIPP geologic repository under the WIPP LWA as amended (P.L. 102-579 as amended by P.L. 104-201) and that legislation would be required to allow disposal of waste other than TRU waste generated by atomic energy defense activities at WIPP and/or for siting a new facility within the land withdrawal area. It would also be necessary to revise the Agreement for Consultation and Cooperation between Department of Energy and the State of New Mexico for the Waste Isolation Pilot Plant, the WIPP compliance certification with EPA, and the WIPP Hazardous Waste Facility Permit. In addition, site-specific NEPA reviews would be conducted as needed, including further characterization of the waste (e.g., radionuclide inventory and heat loads) as well as the proposed packaging for disposal.

However, NEPA does not limit an EIS to proposing and evaluating alternatives that are currently authorized. Furthermore, the Agreement for Consultation and Cooperation between Department of Energy and the State of New Mexico for the Waste Isolation Pilot Plant recognizes that the mission of WIPP may change and provides provisions to modify the agreement. For example, the Agreement states: "The parties to this Agreement recognize that future developments including changes to applicable laws (e.g., P.L. 96-164) may make it desirable or necessary for one or both parties to seek to modify this Agreement. Either party to this Agreement may request a review of the terms and conditions."

DOE acknowledges the TRU waste disposal limitations for WIPP specified in the WIPP LWA as amended (P.L. 102-579 as amended by P.L. 104-201) and in the Agreement for Consultation and Cooperation between Department of Energy and the State of New Mexico for the Waste Isolation Pilot Plant. Information on these limitations is provided in this EIS (see Section 4.1.1) and was considered in developing the preferred alternative. Based on the GTCC EIS evaluation, disposal of GTCC LLRW and GTCC-like wastes at WIPP would result in minimal environmental impacts for all resource areas evaluated, including human health and transportation. Both the annual dose and the latent cancer fatality (LCF) risk would be zero because there would be no releases to the accessible environment and therefore no radiation doses and LCFs during the first 10,000 years following closure of the WIPP repository. DOE recognizes that the use of WIPP for the disposal of GTCC LLRW and GTCC-like wastes would require legislative changes and site-specific NEPA reviews would be conducted as needed, including further characterization of the waste (e.g., radionuclide inventory and heat loads), as well as the proposed packaging for disposal.

The State of New Mexico has indicated a willingness to accept GTCC LLRW and GTCC-like wastes for disposal at WIPP. Twenty-eight New Mexico State Senators signed a proclamation made in the Fiftieth Legislature, First Session, 2011, stating: "Be it resolved that we, the undersigned, support the opportunity for other potential missions in southeast New Mexico to adequately address the disposal of defense high-level waste, commercial high-level waste, Greater Than Class C LLRW and surplus plutonium waste, as well as the interim storage of spent nuclear fuel." In response to the Draft GTCC EIS, Secretary David Martin, Secretary of the New Mexico Environment Department, sent a letter to DOE on June 27, 2011, stating that "the Department encourages DOE to support the WIPP or WIPP Vicinity proposed locations as the preferred alternatives addressed in the Draft EIS. The geologic repository is the favored alternative being more effective for the enduring time frames for this waste type." In addition, the Governor of New Mexico, in a letter to DOE Secretary Steven Chu on September 1, 2011, stated that the State of New Mexico encourages DOE to support the proposed location of WIPP as the preferred alternative for the disposal of GTCC LLRW and GTCC-like wastes.

E102-16

E102-17

E102-18

E102-17
(Cont.)

E102-15 Text prepared by potentially affected American Indian tribes is included in this EIS. DOE considered this text for Hanford, INL, LANL, and NNSS; however, DOE also needed to ensure consistency in the EIS analyses between the various sites, so that an even comparison could be made between alternatives as required by NEPA. Because of this, it was not possible to fully utilize all of the information provided by the tribal governments in order to perform specific analyses associated with exposure events unique to a given American Indian tribe (such as greater intakes of fish, game, and plants; the use of sweat lodges; and the use of natural pigment paints for traditional ceremonies). Once a decision is made on a specific site location and method, site-specific NEPA reviews would be conducted as needed, including appropriate analysis of exposure events unique to the impacted local American Indian tribes.

However, the information provided in these narratives was considered in the identification of the preferred alternative presented in this EIS. The information provided in the narratives for Hanford, INL, LANL, and NNSS was very useful, and DOE appreciates the time and effort expended by the various tribes in supporting this EIS process.

E102-16 The fatal cancers from trucking estimated in the GTCC EIS are many times less than in the *Draft Global Nuclear Energy Partnership Programmatic Environmental Impact Statement* (GNEP PEIS) because there were many times less radioactive truck shipments. Up to 12,600 truck shipments were estimated in the GTCC EIS whereas up to approximately 1,730,000 truck shipments were estimated for one alternative in the GNEP PEIS.

E102-17 Calculation of the collective population risk (under routine and accident conditions) is provided in the EIS. While these estimates are conservative, the calculations used expected values where practical (e.g., external shipment dose rates) and provide a reasonable measure for comparison among alternatives, as summarized in Tables 2.7 5 and 2.7 6, and the estimates show that the transportation risks would be small. All alternatives involve routes of hundreds of miles through similar types of rural, suburban, and urban areas. For specific local impacts, Section 5.3.9.2 provides information on potential human health impacts on individuals during normal waste transport along a route. However, the consideration of specific local stakeholder concerns is more appropriate during the final planning stages of a project when actual route selections are finalized, not at the level addressed in this EIS. A generic accident consequence assessment was performed because there is no way to predict the exact location and conditions of an accident, as discussed in C.9.3.3 of the EIS. For all alternatives, potential accidents, even those at the same location, could have impacts that range from negligible to significant depending on the waste involved, the accident severity, and weather conditions. Such an analysis would not help distinguish between alternatives because all alternatives involve routes through or near major population centers.

Once an alternative is selected in a ROD for this EIS for implementation, site-specific NEPA reviews would be conducted as needed, including an assessment of specific routing and an accident analysis, including dedicated trains and the potential for multiple railcar accidents if applicable. This process will include planning that involves transportation and other stakeholders.

E102-18 Disposition of the GTCC LLRW and GTCC-like wastes will be handled in a manner that is protective of human health and the environment and in compliance with applicable requirements and regulations. Doses to workers and the public will be minimized to the extent practical. The methodology used to estimate the radiological human health impacts in the EIS is based on standard practices that are subject to revision as our understanding of the effects of radiation on humans evolves. The same methodology is used in the evaluation of all alternatives; thus, any modification of this methodology (e.g. attempting to use risk factors for children) would not affect the comparisons among alternatives and the identification of the preferred alternative.

Capital Reporting Company

25

1

2

3

4

5

MR. BROWN: Thank you.

6

Okay. Scott is next and Nathaniel Fuentes

7

will follow.

8

MR. KOVAC: Thank you.

9

Thanks, everyone, for coming out tonight.

10

This proposal for greater-than-Class-C waste

11

includes seven different sites, four different methods

12

which equals about somewhere over 25 different options,

13

and none of them are good. With all of these

14

alternatives, it is a problem that DOE does not have a

15

preferred alternative.

16

LANL currently buries its low level

17

radioactive waste in unlined trenches, pits and shafts

18

at Area G at Tech Area 54. The final determination by

19

DOE and the New Mexico Environment Department of what

20

happens to the hazardous and radioactive waste at Area

21

G has not yet been made.

22

The decision to bury greater than Class C

866.488.DEPO

www.CapitalReportingCompany.com

T85-1

A preferred alternative is not required to be included in a Draft EIS. The Council on Environmental Quality regulations in 40 CFR 1502.14(e) specify that the section on alternatives in an EIS shall identify the agency's preferred alternative or alternatives, if one or more exists, in the Draft EIS and identify such alternative(s) in the Final EIS unless another law prohibits the expression of such a preference; that is, a preferred alternative shall be identified in the Draft EIS if one exists. If no preferred alternative has been identified at the Draft EIS stage, a preferred alternative need not be included. By the time the Final EIS is filed, 40 CFR 1502.14(e) presumes the existence of a preferred alternative and requires its identification in the Final EIS unless another law prohibits the expression of such a preference.

DOE did not have a preferred alternative at the time of issuance of the Draft EIS because of the complex nature of the proposed action and the potential implications for disposal of GTCC LLRW and GTCC-like wastes. To seek public input on how to identify a preferred alternative for inclusion in the Final EIS, the Draft EIS presented considerations for developing a preferred alternative in the Summary (in Section S.6) and in Section 2.9. As required by 40 CFR 1502.14(e), the Final EIS contains a preferred alternative for the disposal of GTCC LLRW and GTCC-like wastes (see Section 2.10). In developing the preferred alternative, DOE took into consideration public comments on the Draft EIS, public EIS scoping comments, and other factors identified in Sections S.6 and 2.9 of the EIS.

The publication by the EPA of a NOA of the Final EIS in the Federal Register initiated a 30-day public availability or "waiting" period. While the availability period is not a formal public comment period, the public can comment on the Final EIS, including the preferred alternative, prior to final agency action. Comments received will be addressed by DOE in a ROD. As required by the Energy Policy Act of 2005, DOE must submit a Report to Congress that includes the alternatives considered in the EIS and await Congressional action before making a final decision regarding which alternative(s) to implement. The Report to Congress will be made available to the public on the GTCC EIS website (<http://www.gtcceis.anl.gov/>).

T85-1

Nuclear Watch New Mexico, Commenter ID No. T85 (cont'd)

Capital Reporting Company

26

1 waste could predetermine what other waste and could
2 predetermine the outcome of that condition.

3 I was looking.. It's hard to find out exactly
4 how many Curies are in Area G, but it seems to be
5 around a million Curies only have been buried at Area G
6 at Los Alamos. I mean, I say "only," but have been
7 buried over the last 40 years or so. And DOE now plans
8 to or is considering adding 160 million Curies to that
9 site? This is outrageous.

10 The shipment of all greater-than-Class-C waste
11 to LANL by truck would result in approximately 12,600
12 shipments involving a total distance of 22 million
13 miles. The estimated peak doses from the contaminated
14 water within 10,000 years of the greater-than-Class-C
15 at LANL were calculated to occur between 500 and 1,100
16 years. That means that the peak dose to the
17 groundwater will occur between 500 and 1,100 years at
18 Los Alamos.

19 These times represent the time after the
20 failure of the cover and the engineered barrier. This
21 is assumed to begin at 500 years after the closure of
22 the disposal facility. This is out of the EIS. So

866.488.DEPO
www.CapitalReportingCompany.com

T85-2

T85-2

DOE believes that 500 years is a realistic time period for the longevity of the types of engineering barriers assumed in the analyses. DOE believes the approach and the assumptions used in the EIS are reasonable for performing the comparative analysis of alternatives required by NEPA. For example, as discussed in Section E.2.2, the assumption of a 20% natural background infiltration rate after 500 years was based on a study at SRS (Phifer et al. 2007) that indicated that after 10,000 years, the closure cap at the F-area would still shed about 80% of the cumulative precipitation falling on it, with an effectiveness that would be greater before 10,000 years, then decrease very slowly after 10,000 years. The approach used in the EIS is more conservative than indicated by this study.

Capital Reporting Company

1 they're planning. The plan is to have the disposal
2 barrier and cover fail after 500 years. They know that
3 that's going to happen. That's what they're planning
4 on.

5 It's also confusing about this. The
6 construction period is listed as 3.4 years, but yet
7 most of the waste will not be ready for disposal, for 50
8 or 40 years. It's very confusing.

9 Los Alamos is located in a seismic fault zone
10 between a rift valley and a dormant volcano. It is not
11 the place for radioactive waste that is dangerous for
12 tens of thousands of years. Sending greater-than-
13 Class-C waste to LANL would go against the current
14 mission of clean-up and footprint reduction.

15 Do not send greater-than-Class-C waste to DOE
16 sites. Nationwide DOE sites are facing hundreds of
17 billions of dollars and decades' worth of clean-up from
18 the Cold War legacy.

19 DOE should develop a national waste management
20 strategy to address these waste types. Such a strategy
21 is needed to integrate the management of these wastes
22 as opposed to a piecemeal approach that is currently

866.488.DEPO
www.CapitalReportingCompany.com

T85-2
(cont.)

T85-3

T85-4

T85-5

T85-6

T85-3 As discussed in Sections 5.1.4.1, it is assumed that initial site construction would take about 820 workdays spread over 3.4 years (240 workdays per year). The construction period would cover the time necessary for initial site preparation, infrastructure emplacement, and support structure construction. It was assumed that construction of the disposal units (borehole, trench, or vault) would occur in parallel with their operations. Approximately 8,500 cubic meters of GTCC waste is projected to be available for disposal during the first 16 years of disposal operations (see Section 3.4.2) with the majority of the activated metal waste from nuclear utilities being generated after 2035.

T85-4 The site-specific environmental factors identified by commenters were evaluated in the EIS as appropriate. The issue of seismicity at LANL (see Section 8.1.2.1.4) was one of many factors that DOE considered in selecting the preferred alternative.

T85-5 DOE is performing environmental restoration activities at LANL and other DOE sites considered in the GTCC EIS. These ongoing cleanup efforts will continue. If GTCC LLRW or GTCC-like waste were to be disposed at these sites, DOE does not anticipate negative impacts to ongoing cleanup activities at these sites.

T85-6 The scope of this EIS is adequate to inform decision-making for the disposal of GTCC LLRW and GTCC-like waste. Sufficient information is available to support the current decision-making process to identify (an) appropriate site(s) and method(s) to dispose of the limited amount of GTCC LLRW and GTCC-like waste identified in the EIS.

DOE developed this EIS to support a decision on selecting a disposal facility or facilities for GTCC LLRW and GTCC-like waste, to address legislative requirements, to address national security concerns (especially for sealed sources), and to protect public health and safety. The purpose and need for the proposed action is stated in the EIS (Section 1.1). The scope of the EIS is focused on addressing the need for developing a disposal capability for the identified inventory of GTCC LLRW and GTCC-like wastes.

DOE explained in the WM PEIS (DOE, 1997, *Final Waste Management Programmatic Environmental Impact Statement for Managing Treatment, Storage, and Disposal of Radioactive and Hazardous Waste*, DOE/EIS-0200-F, Office of Environmental Management, Washington, D.C.) that additional analyses would be prepared to implement DOE's programmatic decisions as part of its national waste management strategy. The GTCC EIS analyzes the potential environmental impacts associated with the disposal of GTCC LLRW and GTCC-like (DOE) wastes. Since the WM PEIS relates only to DOE waste, the inclusion of commercial waste in the WM PEIS is premature until the GTCC EIS is finalized and a ROD is issued. Depending on the outcome of this ROD, DOE will evaluate whether additional programmatic or site-specific NEPA reviews or updates to previous decisions are needed, as appropriate. Any additional NEPA reviews or considerations will be conducted with full opportunity for public input, consistent with Council on Environmental Quality and DOE NEPA requirements.

The use of HOSS and other approaches for long-term storage of GTCC LLRW and GTCC-like wastes are outside the scope of this EIS because they do not meet the purpose and need for agency action. Consistent with Congressional direction in Section 631 of the Energy Policy Act of 2005 (P.L. 109-58), DOE plans to complete an EIS and a ROD for a permanent disposal facility for this waste, not for long-term storage options. The GTCC EIS evaluates the range of reasonable disposal alternatives and, as also required under NEPA, a No Action Alternative. Under the No Action Alternative, current practices for storing GTCC LLRW and GTCC-like wastes would continue in accordance with current requirements.

Capital Reporting Company

28

1 being used by the department.

2 Such a strategy, moreover, should be assessed
3 through a programmatic NEPA process that addresses
4 major federal actions that could significantly affect
5 the quality of the human environment. This is
6 particularly important when considering the disposal of
7 long-lived radioactive waste, which are not suitable
8 for shallow land burial.

9 MR. BROWN: About a minute left.

10 MR. KOVAC: The DOE rejection of hardened on-
11 site storage alternative is unacceptable, given that
12 this is the actual status of the greater-than-Class-C
13 low level waste at present and will not be outside the
14 scope of alternatives that should be considered for
15 this EIS.

16 DOE rejects the alternative that many New
17 Mexicans and others from around the country have been,
18 you know, proposing since 2007. Keeping the waste in
19 HOSS would reduce the risk of accidents or terrorist
20 attacks during transport. While HOSS is not a
21 permanent solution, it would be more protective of
22 human health and the environment than any of DOE's

866.488.DEPO
www.CapitalReportingCompany.com

T85-5
(Cont.)

T85-6
(Cont.)

Nuclear Watch New Mexico, Commenter ID No. T85 (cont'd)

Capital Reporting Company

29

1 current dumping practices and the alternative presented
2 in this draft environmental impact statement.

T85-6
(Cont.)

3 MR. BROWN: Fine.

4 MR. KOVAC: Thank you.

Nuclear Watch South, Commenter ID No. T7

18

1
2 MS. GLENN CARROLL: My name is Glenn Carroll and I
3 am coordinator of Nuclear Watch South. We're based in
4 Atlanta, Georgia. Appreciate of Fukushima being
5 acknowledged tonight. I felt like, you know, that song
6 how can the sun keep on shining, how can the birds keep
7 on flying. You know, it seems like everything has
8 changed except the nuclear industry. And it's
9 interesting to be here tonight. This issue has been
10 really hard to wrap my mind around. It's been really
11 hard to actually identify what greater-than-class C
12 waste is. And I want to comment on--the most positive
13 thing I can think of saying is here we are together
14 making it up as we go so I'm glad I'm here because I
15 trust my thinking, I trust my responses to what I see.
16 One of the things that grieves me and leaves me at a
17 loss for words is that I thought everybody would know
18 the world changed when Fukushima happened, and yet the
19 game has been studiously brought back to the same old,
20 same old. It's relatively safe if you don't count
21 three major meltdowns in 30 years. That's one every
22 ten years when each of our facilities have a point of
23 1.23 probability of a problem. We produced three major
24 can't-happen accidents in 30 years, and this is not
25 counting your less--your less-than-well-known
26 accidents. Of course I'm referring to Three Mile

Nuclear Watch South - T7

Nuclear Watch South, Commenter ID No. T7 (cont'd)

1 Island, Chernobyl and Fukushima, which isn't even been
2 an issue yet. We've got bazillions of gallons of
3 radioactive water and we hope there isn't an earthquake
4 that shatters the building. And so some of the things
5 that lump out at me tonight and we will enter some more
6 formal comments. By the way, there is a call, but
7 several groups have signed a letter requesting an
8 extension to the comment period as most of the documents
9 in the EIS have not been available until recently so
10 hopefully that--that deadline extension will happen. I
11 want to call foul. You don't put out a Draft EIS for
12 public comment and then reserve your preferred
13 alternative for the final that will receive the public
14 comment. So that just isn't right. The preferred
15 alternatives that Nuclear Watch South promotes is a
16 hardened on-site storage interim approach somewhat like
17 we've crafted principles which are available on our
18 nonukesyall.org website. You can read these principles
19 for storage. And since we're making it up as we go
20 let's not do anything hasty and let's keep this really,
21 really hot stuff that is not that big and is already,
22 according to several speakers tonight, being safely
23 stored at the site for a generation it should remain
24 there. I think the sealed sources do need a different
25 look. They are out all over the place under an
26 agreement state status. That is pretty squirrely.

T7-1

T7-2

T7-1

A preferred alternative is not required to be included in a Draft EIS. The Council on Environmental Quality regulations in 40 CFR 1502.14(e) specify that the section on alternatives in an EIS shall identify the agency's preferred alternative or alternatives, if one or more exists, in the Draft EIS and identify such alternative(s) in the Final EIS unless another law prohibits the expression of such a preference; that is, a preferred alternative shall be identified in the Draft EIS if one exists. If no preferred alternative has been identified at the Draft EIS stage, a preferred alternative need not be included. By the time the Final EIS is filed, 40 CFR 1502.14(e) presumes the existence of a preferred alternative and requires its identification in the Final EIS unless another law prohibits the expression of such a preference.

DOE did not have a preferred alternative at the time of issuance of the Draft EIS because of the complex nature of the proposed action and the potential implications for disposal of GTCC LLRW and GTCC-like wastes. To seek public input on how to identify a preferred alternative for inclusion in the Final EIS, the Draft EIS presented considerations for developing a preferred alternative in the Summary (in Section S.6) and in Section 2.9. As required by 40 CFR 1502.14(e), the Final EIS contains a preferred alternative for the disposal of GTCC LLRW and GTCC-like wastes (see Section 2.10). In developing the preferred alternative, DOE took into consideration public comments on the Draft EIS, public EIS scoping comments, and other factors identified in Sections S.6 and 2.9 of the EIS.

The publication by the EPA of a NOA of the Final EIS in the Federal Register initiated a 30-day public availability or "waiting" period. While the availability period is not a formal public comment period, the public can comment on the Final EIS, including the preferred alternative, prior to final agency action. Comments received will be addressed by DOE in a ROD. As required by the Energy Policy Act of 2005, DOE must submit a Report to Congress that includes the alternatives considered in the EIS and await Congressional action before making a final decision regarding which alternative(s) to implement. The Report to Congress will be made available to the public on the GTCC EIS website (<http://www.gtcceis.anl.gov/>).

T7-2

The use of HOSS and other approaches for long-term storage of GTCC LLRW and GTCC-like wastes are outside the scope of this EIS because they do not meet the purpose and need for agency action. Consistent with Congressional direction in Section 631 of the Energy Policy Act of 2005 (P.L. 109-58), DOE plans to complete an EIS and a ROD for a permanent disposal facility for this waste, not for long-term storage options. The GTCC EIS evaluates the range of reasonable disposal alternatives and, as also required under NEPA, a No Action Alternative. Under the No Action Alternative, current practices for storing GTCC LLRW and GTCC-like wastes would continue in accordance with current requirements.

Nuclear Watch South, Commenter ID No. T7 (cont'd)

20

1 Most of that stuff is nuclear waste that got repackaged
2 and sold as a source and I think that does need a
3 different consideration. Those need to be reigned back
4 in. Now, can anybody think of this, we're having this
5 problem, why do we keep doing it, why do we keep
6 sending this stuff out there that we're scratching our
7 heads now trying to figure out what to do with it. Oh,
8 we might clean up West Valley but we're going to decide
9 and in ten years maybe we won't clean up West Valley.
10 How can you make a decision like this when everything
11 keeps changing. The phrase comes to mind, I'm afraid
12 this will be offensive, you can't argue with a sick
13 mind. Why am I here? That's supposed to get a laugh.
14 So another thing that caught my attention was that most
15 of the activated metals that we're talking about
16 haven't been generated yet. Now, that's good news.
17 Let's not do it. We have got to figure this out.
18 Nuclear power died at Three Mile Island. It's still
19 dead. There is a mission--there is a mission for the
20 bulk of the people in this room that receive their
21 employment in this industry. We do have nuclear waste
22 to take care of. We do need to develop the technology.
23 We don't need to dump it in trenches and we don't need
24 to be moving it around and changing it into--trying to
25 change it into other things and creating new waste
26 streams. There is a future for this industry and it is

T7-3

T7-3

Stopping the generation of nuclear waste is outside the scope of the GTCC EIS, the scope of which is to evaluate disposal alternatives to enable the selection of a safe alternative or alternatives for the disposal of GTCC LLRW and GTCC-like wastes. The GTCC EIS evaluates the range of reasonable alternatives for the disposal of GTCC LLRW and GTCC-like wastes in compliance with the requirements specified in NEPA, the Low-Level Radioactive Waste Policy Amendments Act (P.L. 99-240), and Section 631 of the Energy Policy Act of 2005 (P.L. 109-58). The GTCC EIS evaluates the potential environmental impacts of the proposed disposal alternatives for GTCC LLRW and GTCC-like wastes. Based on the evaluation, DOE has determined that there are safe and secure alternatives for the disposal of GTCC LLRW and GTCC-like wastes. The GTCC EIS provides information that supports this determination, and, as discussed in Section 1.1, Purpose and Need for Agency Action, DOE is responsible for the disposal of GTCC LLRW and GTCC-like wastes.

Nuclear Watch South, Commenter ID No. T7 (cont'd)

21

1 long. We have radioactive factories. We're talking
2 about them tonight and they need to be dismantled and
3 we don't know how and we don't know where the money is.
4 And we have the high-level spent nuclear fuel and we
5 don't know what to do with it and we're not going to
6 reprocess it and we are wasting time and we need a new
7 mission for the nuclear industry. There is work to be
8 done. We need to get this spent fuel out of the pools
9 and into hardened storage. And so our--we promote the
10 HOSS alternative. We're crying foul that you don't
11 include that now and that you claim that you'll figure
12 out what you want later after you're done hearing from
13 us. And that will do me for tonight. Thank you.

Nye County Nuclear Waste Repository Project Office (NWRPO),
Commenter ID No. E32

From: Elizabeth Enriquez <eenriquez@co.nye.nv.us>
Sent: Monday, June 27, 2011 5:42 PM
To: gtcc@anl.gov
Cc: wades@nv.doe.gov; christine.gelles@em.doe.gov; Joni Eastley; Gary Hollis
Subject: Nye County, NV - GTCC Letter and Comments
Attachments: GTCC - Nye County, NV Comments.pdf; GTCC Letter.pdf

Good Afternoon,

Please find the attached letter and comments from Nye County, Nevada on GTCC.

Please contact me should you have any questions, or problems with the attachment.



Thank you,
Elizabeth Enriquez

Administrative Secretary
Nye County NWRPO
2101 E. Calvada Blvd. Ste., 100
Pahrump, NV 89048
Direct (775) 727-3483
Office (775) 727-7727
Fax (775) 727-7919

*****This communication is for use by the intended recipient and contains information that may be privileged, confidential or copyrighted under applicable law. Should the intended recipient of this electronic communication be a member of a public body within the State of Nevada be aware that it is a violation of the Nevada Open Meeting Law to use electronic communications to circumvent the spirit or letter of the Open Meeting Law (NRS Chapter 241) to act, outside of an open and public meeting, upon a matter over which the public body has supervision, control, jurisdiction or advisory powers. If you are not the intended recipient, you are hereby formally notified that any use, copying or distribution of this e-mail, in whole or in part, is strictly prohibited. Please notify the sender by return e-mail and delete this e-mail from your system. Unless explicitly and conspicuously designated as "E-Contract Intended," this email does not constitute a contract offer, a contract amendment, or an acceptance of a counteroffer. This email does not constitute consent to the use of sender's contact information for direct marketing purposes or for transfers of data to third parties.

Nye County Nuclear Waste Repository Project Office (NWRPO),
Commenter ID No. E32 (cont'd)



ENCLOSURE

NYE COUNTY, NEVADA
COMMENTS

U.S. Department of Energy (DOE)
Draft Environmental Impact Statement (DEIS) for the Disposal of Greater-Than-Class C
(GTCC) Low-Level Radioactive Waste and GTCC-Like Waste

GENERAL COMMENTS/OBSERVATIONS

1. **Comment:** The scoping meetings and call for scoping comments regarding the GTCC EIS occurred in 2007. The Yucca Mountain repository was identified as a potential alternative for GTCC disposal in the Notice of Intent that initiated this process. At the time the scoping meetings were held, it was expected that the license application (LA) for a Yucca Mountain repository would be submitted to the NRC by June 2008. Waiting four years to complete the Draft EIS is not acceptable, particularly given that, in the interim and without opportunity for comment, the Yucca Mountain repository was eliminated from consideration as an alternative for disposal of GTCC waste. This action was taken prior to resolution of issues raised over the past two years about the legality of Administration and DOE actions to terminate the project. Unless Yucca Mountain is included in the Final EIS as an alternative for GTCC disposal, scoping should be redone to inform the public of today's circumstances and to provide an opportunity for additional comment on the scope of the document.

Rationale: Scoping hearings were held in 2007, a point in time where the DOE had announced that submittal of the LA for the Yucca Mountain repository, a specific alternative identified in the Notice of Intent for GTCC disposal, would take place less than one year later. The Draft GTCC EIS excludes the potential Yucca Mountain repository from consideration as a disposal option. There can be little doubt that those submitting scoping comments were aware of the Yucca Mountain repository program and the fact that the 2002 EIS for the repository had considered the potential impacts associated with disposal of the projected inventory of GTCC wastes in the repository, as well as rail transport of waste to the repository in large casks. Nuclear Regulatory Commission (NRC) regulations at 10 CFR 61.55(a)(2)(iv) state that for GTCC waste: . . . *in the absence of specific requirements in this part, such waste must be disposed of in a geologic repository as defined in part 60 or 63 of this chapter unless proposals for disposal of such waste in a disposal site licensed pursuant to this part are approved by the Commission.* Removal from consideration of the only GTCC disposal alternative to address the relevant requirements for a geologic repository, 10 CFR Part 63 in the case of Yucca Mountain, has a significant negative impact on this Draft GTCC EIS and on the ability of the DOE to support selection of an alternative disposal method or site. This is especially true since there are lawsuits challenging the Secretary's abandonment of the Yucca Mountain site, which was approved by Congress in 2002 as the site for a repository, and termination of the repository program mandated under the NWPA. The Secretary has testified that if directed by the Courts or Congress he will execute the program as required by current law. As those submitting

E32-1

The EIS considered the range of reasonable alternatives for disposal of the inventory of GTCC LLRW and GTCC-like wastes identified for inclusion in these analyses. The Secretary of Energy determined that a permanent repository for high-level waste and spent nuclear fuel at Yucca Mountain, Nevada, is not a workable option and will not be developed. Therefore, DOE concluded that co-disposal at a Yucca Mountain repository is not a reasonable alternative and has eliminated it from evaluation in this EIS, as described in Section 2.6 of the EIS. DOE has included analysis of generic commercial facilities in the event that a facility could become available in the future. In that case, before making a decision to use a commercial facility, DOE would conduct further NEPA reviews, as appropriate.

DOE did not evaluate developing a geologic repository exclusively for disposal of GTCC LLRW and GTCC-like wastes because DOE determined that such an alternative is not reasonable due to the time and cost associated with siting a deep geologic repository and the relatively small volume of GTCC LLRW and GTCC-like wastes identified in the GTCC EIS. DOE believes that the results presented in this EIS for the WIPP geologic repository alternative are indicative of the high degree of waste isolation that would be provided by disposal in a geologic repository. DOE has included analysis of generic commercial facilities in the event that a facility could become available in the future. In that case, before making a decision to use a commercial facility, DOE would conduct further NEPA reviews, as appropriate.

DOE agrees that use of a geologic repository would be a protective and safe method for the disposal of the entire inventory of GTCC LLRW and GTCC-like wastes. However, the degree of waste isolation provided by a geologic repository may not be necessary for all of the GTCC LLRW and GTCC-like wastes evaluated in the GTCC EIS. The GTCC EIS evaluation indicates that certain wastes (e.g., those containing short-lived radionuclides such as Cs-137 irradiators) could be safely disposed of in properly designed land disposal facilities at sites with suitable characteristics, such as low precipitation rates, high soil distribution coefficients, and sufficient depths to groundwater. Based on the GTCC EIS evaluation, land disposal facilities located in arid climates (e.g., NNSS and WIPP Vicinity) would isolate radionuclides for a sufficient period of time to allow for significant radioactive decay to occur.

While 10 CFR Part 61 identifies one NRC-approved method for GTCC LLRW disposal (disposal in a geologic repository), these regulations also indicate that other disposal methods could be approved. The GTCC EIS evaluates three land disposal methods (i.e., enhanced near-surface trench, intermediate-depth borehole, and above-grade vault). The GTCC EIS evaluation indicates that land disposal methods employed at sites with suitable characteristics would be viable and safe alternatives for the disposal of GTCC LLRW.

E32-1

**Nye County Nuclear Waste Repository Project Office (NWRPO),
Commenter ID No. E32 (cont'd)**

June 27, 2011
GTCC Comments
Page 2 of 10

scoping comments could not have anticipated the current situation, the Draft GTCC EIS cannot be responsive to public perspectives on how the current situation affects issues related to GTCC disposal alternatives. Closure on the status of Yucca Mountain should be completed before the GTCC EIS goes forward and certainly prior to any decision on a disposal method or location by the DOE or Congress. Scoping should be redone if Yucca Mountain is not to be considered in order to provide an opportunity for informed public comment.

- 2 **Comment:** The Draft GTCC EIS does not include adequate information on the alternatives evaluated. This severely limits the scope and value of the potential comments that might be received on the document.

Rationale: If the public is expected to provide meaningful comments on the alternative disposal methods and locations being considered for disposal facilities, it has a right to expect information giving adequate consideration to economic, environmental, technical, and other factors about the alternatives. The Draft EIS does not provide such information at a level appropriate to permit discrimination among the alternative disposal methods and facility locations, or among the potential combinations of disposal method and location. The document also provides no perspective about which alternative or alternatives the agency believes would best fulfill its statutory mission and responsibilities. Without a better indication of how the DOE intends to proceed, or more meaningful information that would allow discrimination among the alternatives, the public's ability to generate meaningful comments on the document is compromised.

- 3.1 **Comment:** It is not clear that NRC acceptance of the near-surface alternatives, namely trench or vault burial, for disposal of all GTCC wastes should be considered a foregone conclusion, or even the likely result of a licensing proceeding. At a minimum, the DOE should formally engage the NRC on this matter before recommending to Congress a path forward that the Commission ultimately may not support.

Rationale: The Draft GTCC EIS seems to be written from the perspective that the two relatively near-surface alternatives, namely trench and vault burial, will be acceptable to the NRC. The NRC regulations at 10 CFR Part 61 suggest otherwise. In 10 CFR 61.7(a)(5) the NRC states that: *Waste with concentrations above these [class C] limits is generally unacceptable for near-surface disposal. It further states that: [T]here may be some instances where waste with concentrations greater than permitted for Class C would be acceptable for near-surface disposal with special processing or design. These will be evaluated on a case-by case basis.* Although the NRC is willing to consider that in some instances waste with concentrations greater than permitted for Class C would be acceptable for near-surface disposal, there is no reason to assume that all GTCC wastes would qualify for this exemption, as appears to be the case in the Draft EIS. The NRC makes it clear in 10 CFR 61.55(a)(2)(iv) that: *[I]n the absence of specific requirements in this part, such waste [GTCC waste] must be disposed of in a geologic repository as defined in part 60 or 63 of this chapter unless proposals for disposal of such waste in a disposal site licensed pursuant to this part are approved by the Commission.* Any recommendation by the DOE to Congress for a preferred disposal method that relies on an NRC finding that near-surface disposal of high-activity, long-lived GTCC LLW waste is generally acceptable is a risky position for the DOE to take. It would seem appropriate for the DOE to formally engage the NRC on this matter, to identify and resolve potential licensing issues related to

E32-1
(Cont.)

E32-2

E32-3

E32-2

The specific locations that would be used at each potential site for development of a disposal facility for GTCC LLRW and GTCC-like wastes are not known at this time. The use of "reference locations" was used in the EIS to allow for a quantitative assessment of the impacts that could occur at each site. While some parameters could change within a short distance, most would not. The migration of radionuclides from the GTCC LLRW and GTCC-like wastes placed into the conceptual disposal facility designs for the three land disposal methods was modeled (not all three methods were evaluated for each site). Site-specific information provided by technical staff from various sites that were evaluated was used in these modeling analyses to the extent it was available, and conservative assumptions were used to fill any remaining data gaps. While the computer model was largely developed to support environmental restoration activities, it has a number of features that make it a good choice for use in this EIS. The analysis presented in the EIS is adequate for the comparison of the disposal alternatives evaluated. Fate and transport parameters utilized in the estimations were based on site-specific (e.g., specific to the reference location to the extent available) information and, as such, are considered reasonable for the purpose of the comparison made in the EIS. However, DOE recognizes that additional project- and site-specific information, such as the actual depth to groundwater over the entire disposal area, could be used to inform the implementation of a disposal facility at a given location. This additional information is expected to reduce the uncertainty associated with these types of evaluations to the extent possible. Site-specific information would be evaluated in any site-specific NEPA review that would be conducted based on a ROD for this EIS.

The estimated costs associated with the construction and operation of GTCC waste disposal facilities at each of the sites – including costs for direct and indirect labor, equipment, materials, services, and subcontracts – are included in the assessment of each waste management alternative in the EIS. The cost estimates for the land disposal methods are based on a conceptual design of the disposal facility and could increase with actual implementation. Costs shown for WIPP are based on actual costs experienced to date and reflect construction and operation costs of an operating geologic repository. The economic analysis in the EIS addresses the potential economic impacts, including potential impacts resulting from migration of workers or their families during the construction period, and any consequent impacts on housing, public finances, public service employment, and traffic.

E32-3

The LLRWPAA (P.L. 99-240) specifies that GTCC LLRW, designated a federal responsibility under section 3(b)(1)(D) that results from activities licensed by the NRC, is to be disposed of in an NRC-licensed facility that has been determined to be adequate to protect public health and safety. However, unless specifically provided by law, the NRC does not have authority to license and regulate facilities operated by or on behalf of DOE. Further, the LLRWPAA does not limit DOE to using only non-DOE facilities or sites for GTCC LLRW disposal. Accordingly, if DOE selects a facility operated by or on behalf of DOE for disposal of GTCC LLRW for which it is responsible under section 3(b)(1)(D), clarification from Congress would be needed to determine NRC's role in licensing such a facility and related issues. In addition clarification from Congress may be needed on NRC's role if DOE selects a commercial GTCC LLRW disposal facility licensed by an Agreement State rather than by NRC.

The NRC served as a commenting agency on the GTCC EIS and therefore did not actively participate in the preparation of the GTCC EIS. Issues associated with potential regulatory changes or NRC licensing would be addressed as necessary to enable implementation.

**Nye County Nuclear Waste Repository Project Office (NWRPO),
Commenter ID No. E32 (cont'd)**

June 27, 2011
GTCC Comments
Page 3 of 10

this higher-activity, longer-lived LLW, before recommending to Congress a path forward that the NRC ultimately may not support, with the result that time and taxpayer dollars are wasted.

- 4 **Comment:** The estimated volumes and activities of GTCC wastes that would result from the reprocessing of civilian and defense-related SNF are not included in the GTCC waste inventory, and hence, are not evaluated in the Draft EIS. Ongoing discussions in the scientific and regulated communities indicate that the volumes and activities of the resulting GTCC would be several times the amount analyzed in the Draft EIS.

Rationale: As described in the EIS, GTCC wastes are placed in one of two groups for purposes of analysis. "Group 1 consists of wastes that are either already in storage or are expected to be generated from existing facilities (such as commercial nuclear power plants). Group 2 consists of wastes that may be generated in the future as the result of actions proposed by DOE or commercial entities, such as wastes from proposed commercial reactors that have not been licensed or constructed. *Some or all of the Group 2 waste may never be generated, depending on the outcomes of proposed actions that are independent of this EIS.*" (emphasis added) There has been significant discussion recently regarding the potential role of reprocessing in the nuclear fuel cycle, both for recovery of the energy content of SNF and for its potential to reduce the volume and half-life of waste requiring deep geologic disposal. The NRC is in the early stages of developing its regulatory basis for licensing commercial reprocessing facilities. Ongoing discussions in the scientific and regulated communities indicate that the volumes and activities of the GTCC wastes that would result from the reprocessing of civilian and defense-related SNF would be several times the amount analyzed in this EIS. Estimates of the quantities of GTCC resulting from reprocessing were previously reported in the *Draft Global Nuclear Energy Partnership (GNEP) Programmatic Environmental Impact Statement (PEIS)* (DOE/EIS-0396, 2008). In light of these factors, the potential for generation of additional GTCC waste from reprocessing of SNF falls within the basis for defining the waste inventory considered in Group 2. The need to dispose of this additional waste is, therefore, a reasonably foreseeable action, the consequences of which must be considered in this EIS. The Draft GTCC EIS is deficient in that it fails to include this additional GTCC waste in the evaluation of potential impacts.

5. **Comment:** The Draft GTCC EIS assumes that the effective life of the intruder barriers will be 500 years, that the maximum concentration of radionuclides at the end of the 500 year period will be at a level that does not pose an unacceptable hazard to an intruder or to public health and safety, and that the GTCC waste form will be stable. A reasonable comparison among the proposed alternatives would require a meaningful demonstration that these requirements will be met by each of the various disposal method and site options.

Rationale: The Draft GTCC EIS does not address how the DOE intends establish a reasonable basis to assure decision makers that the selected disposal option (method and site) will be allowable under the 10 CFR Part 61 requirements if other than a repository disposal option is selected. It seems

E32-4 The GTCC LLRW and GTCC-like waste inventory evaluated in the EIS is based on the best available information on the stored and projected GTCC LLRW and GTCC-like wastes from ongoing and planned activities. The estimated 12,000 m³ of GTCC LLRW and GTCC-like wastes is a relatively small volume of waste when compared to other wastes disposed of by DOE. For example, this volume of GTCC LLRW and GTCC-like wastes is only about 20% of the 59,000 m³ of LLRW disposed of at one site (NNSS) in one year (fiscal year 2010). DOE canceled the *Draft Global Nuclear Energy Partnership Programmatic Environmental Impact Statement* (GNEP PEIS) (74 FR 31017); therefore, the generation of additional GTCC LLRW under GNEP is not anticipated. In addition, the inventory includes wastes expected to be generated during the production of Mo-99 for medical applications from two potential generators. While the potential generator(s) of this waste may change, the estimated characteristics and volumes are representative of the amounts expected to supply the demand for the Mo 99. DOE believes that expanding the inventory to include potential GTCC LLRW and GTCC-like wastes from undefined or unplanned future activities would introduce excessive uncertainty in the EIS evaluations. DOE believes that the inventory included in the GTCC EIS is reasonable for the purposes of the NEPA process and that it provides a supportable basis for conducting the EIS evaluation and the identification of the preferred alternative in the Final EIS. In the future, should additional waste be identified, appropriate NEPA review would be conducted to reflect these changes and also changes that would be needed to the existing infrastructure or the identification of additional disposal sites.

E32-5 DOE agrees that the GTCC waste disposal facility must ensure the protection of a hypothetical future inadvertent human intruder, especially for the wastes disposed of in an enhanced near surface trench. In the conceptual design for the trench disposal facility, the trenches are about 3 m (10 ft.) wide, 11 m (36 ft.) deep, and 100 m (330 ft.) long. The GTCC waste disposal placement is assumed to be about 5 to 10 m (16 to 33 ft.) below ground surface.

On the basis of the depth of waste disposal, DOE believes that the only reasonable potential for intrusion is from a future drilling event, such as drilling for a well. The likelihood of inadvertent intrusion from a drilling event would be very low for a GTCC waste trench disposal facility because of (1) the narrow width of the trench, (2) the use of intruder barriers, (3) the remoteness of the sites, (4) DOE's commitment to long-term institutional control, (5) site conditions such as the general lack of easily accessible resources and the great depth to groundwater, and (6) waste form stability. On the basis of these considerations, DOE did not include a quantitative analysis of inadvertent human intruder in the EIS. Site-specific NEPA reviews would be conducted as needed.

Potential inadvertent human intrusion into WIPP is addressed in the documentation supporting its current operations. Inclusion of GTCC LLRW and GTCC-like wastes with the wastes already planned for disposal in this repository would not be expected to change the results associated with this hypothetical intrusion event.

The LLRWPAA (P.L. 99-240) specifies that GTCC LLRW, designated a federal responsibility under section 3(b)(1)(D) that results from activities licensed by the NRC, is to be disposed of in an NRC-licensed facility that has been determined to be adequate to protect public health and safety. However, unless specifically provided by law, the NRC does not have authority to license and regulate facilities operated by or on behalf of DOE. Further, the LLRWPAA does not limit DOE to using only non-DOE facilities or sites for GTCC LLRW disposal. Accordingly, if DOE selects a facility operated by or on behalf of DOE for disposal of GTCC LLRW for which it is responsible under section 3(b)(1)(D), clarification from Congress would be needed to determine NRC's role in licensing such a facility and related issues. In addition clarification from Congress may be needed on NRC's role if DOE selects a commercial GTCC LLRW disposal facility licensed by an Agreement State rather than by NRC.

The NRC served as a commenting agency on the GTCC EIS and therefore did not actively participate in the preparation of the GTCC EIS. Issues associated with potential regulatory changes or NRC licensing would be addressed as necessary to enable implementation.

E32-3
(Cont.)

E32-4

E32-5

Nye County Nuclear Waste Repository Project Office (NWRPO),
Commenter ID No. E32 (cont'd)

June 27, 2011
GTCC Comments
Page 4 of 10

reasonable that borehole disposition at sufficient depth might be acceptable to the NRC, particularly for disposal of sealed sources and if sealing requirements are addressed. However, it is not clear what will be required for the DOE to obtain NRC approval for other than repository disposal of higher-activity, longer-lived GTCC LLW given the lack in 10 CFR Part 61 of explicit requirements for licensing facilities based on near-surface disposal methods. The Draft EIS adopts a number of general assumptions about factors important to the performance of near-surface disposal facilities. It assumes that the effective life of the intruder barriers for these near-surface alternatives will be 500 years, that the maximum concentration of radionuclides at the end of the 500 year period will be at a level that does not pose an unacceptable hazard to an intruder or public health and safety, and that GTCC waste will be stable. A reasonable comparison among the proposed options would require a meaningful demonstration that the assumptions made regarding these factors are appropriate for each facility and site evaluated, to support an evaluation of compliance with applicable performance requirements. The potential issues and uncertainties associated with NRC approval of near-surface disposal facilities for GTCC LLW in the absence of explicit requirements for licensing such facilities should be discussed to better inform the decision process. It would also be appropriate to discuss the potential for use of different disposal methods based on the content of longer-lived radionuclides.

6. **Comment:** Little information is presented that would allow local communities to understand how the projected transportation of GTCC waste would affect them.

Rationale: While it is likely that the transportation risk calculations used reasonable assumptions about shortest transit times and interstate highways, there is no recognition that alternate routes likely would be specified, as is currently the case in Nevada, for example, for LLW and mixed LLW shipments coming to the Nevada National Security Site (NNSS). If the NNSS were selected as the site for a GTCC disposal facility, under existing agreements the shipments of GTCC waste would have to avoid Las Vegas and come through small rural communities to the NNSS, which is located entirely within Nye County. This would focus the burden for emergency response capability on local governments, including Nye County and surrounding rural counties, something that is not addressed in the Draft EIS. Similar situations are likely to exist for at least some of the other sites considered.

7. **Comment:** The Draft GTCC EIS does not address how likely changes to 10 CFR Part 61, including changes to the waste classification system and establishment of risk-informed/performance-based requirements, would affect decisions about the method or site selected for disposal and the compliance methodology required to support licensing.

Rationale: The NRC has announced that it intends to propose changes to 10 CFR Part 61 to make it risk-informed and performance-based. One potential outcome is that the classification scheme for LLW could change. For example, the internationally accepted scheme for waste classification, IAEA Safety Standards Series No. GSG-1, *Classification of Radioactive Waste, General Safety Guide* (International Atomic Energy Agency, Vienna, 2009), does not have a classification for GTCC waste. The international approach to waste classification is based on consideration of the combination of activity content and half-life, with the longer-lived wastes requiring greater isolation. If the NRC

E32-6 As stated in Section C.9.4.1.1 of the EIS on route selection, many of the GTCC LLRW and GTCC-like wastes considered in the EIS would meet the definition of a highway route HRCQ (49 CFR 173.403). However, as noted in the discussion, states and Native American tribes have the opportunity to designate "preferred routes" to replace or supplement the interstate highway system. For those wastes not specifically designated as HRCQ, the selection of a route is left to the carrier, but in the case of GTCC LLRW and GTCC-like wastes, additional consultation with transportation stakeholders would occur.

DOE/NNSA analyzed various radioactive waste shipping routes through and around metropolitan Las Vegas, Nevada, in the Draft NNSS SWEIS. DOE/NNSA continued discussions with the State of Nevada on routing options throughout the preparation of the Final NNSS SWEIS. After taking into consideration the comments and concerns expressed by State, county, and local government officials and the public in general during the review and comment period for the Draft NNSS SWEIS, DOE/NNSA decided to maintain the current highway routing restrictions for shipments of low-level radioactive waste (LLW) and mixed-low level radioactive waste (MLLW), as described in the Waste Acceptance Criteria (WAC) for the site. DOE/NNSA explained this decision in the Final NNSS SWEIS. The unchanged WAC restrictions are to avoid (1) crossing the Colorado River near Hoover Dam and (2) the greater metropolitan Las Vegas interstate system. DOE/NNSA is not considering, nor is it making, changes to the NNSS WAC with regard to routing.

Once an alternative is selected in a ROD for this EIS, implementation will include, as needed and appropriate, NEPA reviews and other analysis (e.g., transportation).

E32-7 The likelihood of potential changes to existing regulations is outside the scope of the GTCC EIS.

E32-5
(Cont.)

E32-6

E32-7

Nye County Nuclear Waste Repository Project Office (NWRPO),
Commenter ID No. E32 (cont'd)

June 27, 2011
GTCC Comments
Page 5 of 10

adopts a similar classification scheme (a possibility driven by potential incidental wastes associated with reprocessing), the classification of GTCC and, hence, the requirements governing disposal of these wastes could change significantly. The revised rule may also institute requirements for site-specific performance assessments of any disposal facility as one basis for assessing compliance with the performance objectives, as well as revised requirements for the evaluation of human intrusion. The potential issues associated with uncertain regulatory changes and how they might affect the decision process and schedule should be discussed to better inform decision-makers.

8. **Comment:** The Draft GTCC EIS does not adequately treat the difficulty in requesting that Congress change the WIPP Land Withdrawal Act to permit disposal of GTCC waste of both commercial and defense origin in a facility approved only for disposal of defense-related TRU waste under EPA and State regulatory authority.

Rationale: The WIPP Land Withdrawal Act and other applicable laws would need to be amended if the DOE recommends geologic disposal at the existing WIPP repository. The Draft GTCC EIS identifies this issue for the WIPP permits and Land Withdrawal Act, but does not provide an adequate discussion of the issues that would arise in the process of implementing such legislative changes, and the time required to implement these changes. One required change would be to amend existing laws to transfer regulatory authority over disposal of GTCC waste from the NRC to the EPA. There is an additional complication resulting from the Secretary's decision to abandon Yucca Mountain as an NRC-licensed repository, which resulted in the dismissal of Yucca Mountain from consideration in this Draft EIS as an alternative for geologic disposal of GTCC waste. There is no basis for concluding that the courts or, ultimately, Congress will support the Secretary's abandonment of Yucca Mountain, which is designated as the site for a geologic repository under the Nuclear Waste Policy Act. The Draft EIS needs to recognize and acknowledge the uncertainty introduced until the issues regarding Yucca Mountain are resolved to inform any decisions that may be made based on the evaluations in the document. It would be inappropriate to make a premature recommendation for a preferred path forward that is contingent on Congress changing the WIPP Land Withdrawal Act and potentially jeopardizing the existing permitted disposal activities at the WIPP should repository disposal at WIPP be selected as the preferred alternative.

9. **Comment:** The Draft GTCC EIS does not adequately discuss the potential impacts that might result from disposal in the WIPP of a greater volume of waste and nearly thirty times as much total radioactivity as are allowed under the WIPP Land Withdrawal Act and agreements with the State of New Mexico.

Rationale: The Draft EIS correctly points out that the total capacity for disposal of TRU waste established under the WIPP Land Withdrawal Act is 175,675 m³ (6.2 million ft³). The Consultation and Cooperative Agreement with the State of New Mexico (1981) established a total remote-handled (RH) TRU capacity of 7,080 m³ (250,000 ft³), with the remaining capacity for contact-handled (CH) TRU at 168,500 m³ (5.95 million ft³). The Land Withdrawal Act limits the total radioactivity of RH waste to 5.1 million curies. For comparison, the GTCC RH volume is approximately 5,050 m³ (178,000 ft³) and the RH total radioactivity about 157 million curies. On the basis of emplaced and

E32-8 DOE acknowledges that the WIPP LWA limits disposal at WIPP to defense generated TRU waste. The use of WIPP was included as an alternative in the EIS because the use of this repository for GTCC LLRW and GTCC-like wastes is a reasonable approach. To protect public health and the environment, DOE intends to dispose of GTCC-like waste on the basis of its radiological and physical characteristics. It is recognized that WIPP cannot be used for the GTCC LLRW and GTCC-like waste inventory addressed in the EIS under current law. However, GTCC LLRW and GTCC-like wastes having characteristics similar to those of the defense-generated TRU wastes that are currently being disposed of at WIPP would be expected to be managed in a manner that is generally comparable to that used for defense-generated TRU wastes to ensure the health and safety of the general public for the long term.

Should WIPP be selected in DOE's ROD as part of the approach for disposing of GTCC LLRW and GTCC-like waste legislative changes would be necessary prior to implementation. Although WIPP is not currently authorized to dispose of GTCC LLRW and GTCC-like wastes, NEPA does not preclude DOE from considering WIPP as a reasonable alternative for disposing of GTCC LLRW and GTCC-like wastes. The need for legislative modifications to enable WIPP to be used for the disposal of GTCC LLRW and GTCC-like wastes is identified and discussed in the EIS.

E32-9 The analysis of the WIPP repository in the GTCC EIS assumes that the entire GTCC LLRW and GTCC-like waste inventory identified in the EIS would be disposed of at that facility. Based on the results of the EIS evaluation for WIPP, both the annual dose and LCF risk would be zero because there would be no releases to the accessible environment and therefore no radiation doses and LCF risks during the first 10,000 years following closure of the WIPP repository. DOE recognizes that radioactivity from disposal of the entire GTCC LLRW and GTCC-like waste inventory at WIPP would greatly exceed the radioactivity in all the wastes that have been previously disposed of at WIPP. DOE considered the radioactivity of the GTCC LLRW and GTCC-like waste inventory in selecting the preferred alternative identified in the Final EIS.

Site-specific NEPA reviews would be conducted as needed to assure the safe operation of WIPP over the extended time period required for disposal of GTCC LLRW and GTCC-like wastes. Specific items to be considered would include the waste shaft and main underground haul route, and potential modifications to waste handling procedures and the Waste Handling Building would need to be evaluated.

E32-7
(Cont.)

E32-8

E32-9

Nye County Nuclear Waste Repository Project Office (NWRPO),
Commenter ID No. E32 (cont'd)

June 27, 2011
GTCC Comments
Page 6 of 10

anticipated waste volumes, the disposal of all GTCC waste at WIPP would exceed the limits for RH volume by nearly a factor of two and RH total activity by a factor of 30. The WIPP LWA (P.L. 102-579) limits disposal in WIPP to defense-generated TRU waste, so modification of the WIPP Land Withdrawal Act to authorize acceptance of non-defense and non-TRU waste, increase the disposal capacity limit for total curies of RH waste, and change the Consultation and Cooperative Agreement to authorize an increase in the total volume of RH wastes would be required. The FEIS and SEIS for Yucca Mountain consider the potential impacts from emplacement of all GTCC wastes; the WIPP EIS does not. Not only would the WIPP Land Withdrawal Act need to be amended, the WIPP EIS would need to be supplemented as well if the volume and activity of radioactive waste were substantially increased.

10) **Comment:** Alternative methods for disposal of GTCC waste, other than in a geologic repository, are considered on a general basis with respect to the range of options for a disposal site. The evaluation of the WIPP as the only geologic repository disposal alternative considered is both site- and facility-specific. No rationale is given for not considering other sites for a geologic repository for GTCC disposal.

Rationale: Alternative methods for disposal of GTCC waste, other than in a geologic repository, are considered on a general basis with respect to the range of options for a disposal site. The WIPP is the only geologic repository disposal alternative considered and the evaluation is both site- and facility-specific. A second geologic repository alternative identified in the Notice of Intent - the potential for disposal of GTCC waste in a Yucca Mountain repository - was eliminated following scoping on the basis of an Administration policy decision prior to the resolution of legal issues raised regarding this action. Under NEPA, a broader range of alternative sites should be considered for the geologic repository disposal alternative, or a rationale should be provided for only looking at an existing facility (or in the case of Yucca Mountain, a repository planned to be developed at a site designated by law).

11) **Comment:** The performance assessments described in the Draft GTCC EIS are based on a number of general assumptions about the key factors to which performance is most sensitive. Absent better information about the likely site- and design-specific values of the key parameters, the performance assessments provide little basis for decision-makers to select a preferred site or disposal alternative.

Rationale: The performance assessments described in the Draft GTCC EIS are based on a number of assumptions. The performance assessments assumed that: a) the engineering measures (e.g., a cover system) would remain intact for 500 years after the disposal facility is closed, b) after 500 years, the barriers would gradually fail, c) the water infiltration rate to the top of the waste disposal area would be zero for the first 500 years and then 20% of the natural rate for the area for the remainder of the period of calculation (10,000 years), and d) the natural background infiltration rate is appropriate to use at the perimeter of the waste disposal units. The performance assessments thus are not true indicators of the potential differences in performance among the disposal methods and sites. More importantly, the sensitivity study performed indicated that the results were sensitive to the assumptions. In other words, if the assumptions prove to be incorrect, the likely performance would not be well constrained and might be worse than estimated. Absent better information about the

E32-10 The EIS considered the range of reasonable alternatives for the disposal of the GTCC waste inventory, including disposal in a deep geologic repository. DOE did not evaluate developing a geologic repository exclusively for disposal of GTCC LLRW and GTCC-like wastes because DOE determined that such an alternative is not reasonable due to the time and cost associated with siting a deep geologic repository and the relatively small volume of GTCC LLRW and GTCC-like wastes identified in the GTCC EIS. DOE believes that the results presented in this EIS for the WIPP geologic repository alternative are indicative of the high degree of waste isolation that would be provided by disposal in a geologic repository. DOE has included analysis of generic commercial facilities in the event that a facility could become available in the future. In that case, before making a decision to use a commercial facility, DOE would conduct further NEPA reviews, as appropriate.

E32-11 The EIS analyses are based on conceptual engineering information and necessitated the use of a number of simplifying assumptions. This approach is consistent with NEPA, which requires such analyses to be made early in the decision-making process. The various land disposal conceptual designs were assumed to be constructed and operated in a comparable manner at each of the various sites. Information on the conceptual engineering designs for the three proposed land disposal methods is provided in Section D.3 of Appendix D in the EIS. By using the same conceptual designs at all of the sites evaluated in the GTCC EIS, except for cases where a design did not apply (e.g., an intermediate-depth borehole at a site with shallow groundwater), the potential impacts (e.g., radionuclides reaching the groundwater) at the different environmental settings could be readily compared.

DOE recognizes that modeling potential releases of radionuclides from the conceptual disposal sites far into the future approximates what might actually occur. Sufficient detail was included in these designs for use in the EIS analyses, consistent with the current stage of this process. Some of the input values may change in the future and could result in higher impacts (such as from increased precipitation at some sites due to climate change), while others could result in lower impacts (due to decreased precipitation).

DOE believes that 500 years is a realistic time period for the longevity of the types of engineering barriers assumed in the analyses. DOE believes the approach and the assumptions used in the EIS are reasonable for performing the comparative analysis of alternatives required by NEPA. For example, as discussed in Section E.2.2, the assumption of a 20% natural background infiltration rate after 500 years was based on a study at SRS (Phifer et al. 2007) that indicated that after 10,000 years, the closure cap at the F-area would still shed about 80% of the cumulative precipitation falling on it, with an effectiveness that would be greater before 10,000 years, then decrease very slowly after 10,000 years. The approach used in the EIS is more conservative than indicated by this study.

The specific locations that would be used at each potential site for development of a disposal facility for GTCC LLRW and GTCC-like wastes are not known at this time. The use of "reference locations" was used in the EIS to allow for a quantitative assessment of the impacts that could occur at each site. While some parameters could change within a short distance, most would not. The RESRAD-OFFSITE computer code was used to model the migration of radionuclides from the GTCC LLRW and GTCC-like wastes placed into the conceptual disposal facility designs for the three land disposal methods (not all three methods were evaluated for each site). Site-specific information provided by technical staff from various sites that were evaluated was used in these modeling analyses to the extent it was available, and conservative assumptions were used to fill any remaining data gaps.

E32-9
(Cont.)

E32-10

E32-11

**Nye County Nuclear Waste Repository Project Office (NWRPO),
Commenter ID No. E32 (cont'd)**

June 27, 2011
GTCC Comments
Page 7 of 10

likely site- and design-specific values of the key parameters, the performance assessments provide little basis for decision-makers to select a preferred site or disposal alternative.

- 12.) **Comment:** The Draft GTCC EIS does not present a substantiated basis to demonstrate that a near-surface disposal alternative could meet the likely performance required for GTCC wastes. There is also no substantive discussion of the uncertainty introduced by the current absence of defined performance and licensing requirements for disposal of GTCC waste in other than a geologic repository.

Rationale: The performance assessment results indicated that the peak annual dose would increase as the water infiltration rate increased. This result is not unexpected because when more water enters the waste disposal horizon, more radionuclides would be leached and released from the disposal facility. The increase in the peak dose is approximately proportional to the increase in the infiltration rate and indicates the need for a very effective cover to minimize the amount of infiltrating water that could contact the GTCC wastes. This is an important reason for the NRC position that GTCC wastes require greater disposal depths than class C LLW, with a geologic repository being the only currently accepted method for disposal of these wastes. Rather than basing the potential selection of a disposal option on the assumed performance of a near-surface design, the decision maker ought to be presented with a technically-supported argument demonstrating that the cover for a near surface facility could meet the likely performance required for this class of waste before any decision is made on the preferred disposal method or siting option. The potential issues in licensing a near-surface disposal facility given the uncertainties associated with the current absence of defined performance and licensing requirements for disposal of GTCC waste in other than a geologic repository need to be discussed to inform the decision process.

- 13.) **Comment:** The footprints for disposal alternatives other than disposal in the WIPP geologic repository are small, being only slightly larger than the area needed to accommodate the disposal and surface facilities. Since offsite dose is evaluated at the facility boundary, consideration should be given to applying concepts similar to the "controlled area" and "accessible environment," which are employed in assessing the performance of a geologic repository under 10 CFR Parts 60 and 63, to evaluating the safety of the near-surface disposal alternatives for GTCC waste.

Rationale: The NRC makes it clear in 10 CFR 61.55(a)(2)(iv) that: *[I]n the absence of specific requirements in this part, such waste [GTCC waste] must be disposed of in a geologic repository as defined in part 60 or 63 of this chapter unless proposals for disposal of such waste in a disposal site licensed pursuant to this part are approved by the Commission.* In the absence of specific risk-informed, performance-based requirements in the current 10 CFR Part 61 for licensing facilities for disposal of GTCC waste in other than a geologic repository, it is important to engage the NRC in discussion of the acceptability of near-surface disposal methods and the criteria by which the safety of such facilities would be judged. Consideration of a controlled area with a maximum extent specified by rule and a requirement for monuments and a records system to preclude incompatible activities following closure provides explicit recognition that to ensure the safety of future generations a reasonable amount of land must be dedicated as a disposal zone and activities that might compromise

E32-11
(Cont.)

E32-12

E32-13

While the computer model was largely developed to support environmental restoration activities, it has a number of features that make it a good choice for use in this EIS. The analysis presented in the EIS is adequate for the comparison of the disposal alternatives evaluated. Fate and transport parameters utilized in the estimations were based on site-specific (e.g., specific to the reference location to the extent available) information and, as such, are considered reasonable for the purpose of the comparison made in the EIS. However, DOE recognizes that additional project- and site-specific information, such as the actual depth to groundwater over the entire disposal area, could be used to inform the implementation of a disposal facility at a given location. This additional information is expected to reduce the uncertainty associated with these types of evaluations to the extent possible. Site-specific information would be evaluated in any site-specific NEPA review that would be conducted based on a ROD for this EIS.

- E32-12 As summarized in Section 2.7.4.2 and Table 2.7-3, the use of near-surface disposal alternatives at various locations could meet the performance requirements required for GTCC wastes.

The NRC served as a commenting agency on the GTCC EIS and therefore did not actively participate in the preparation of the GTCC EIS. Issues associated with potential regulatory changes or NRC licensing would be addressed as necessary to enable implementation.

- E32-13 The proposed footprints used for the near-surface disposal facility concepts are consistent with current DOE operations. While 10 CFR Part 61 identifies one NRC-approved method for GTCC LLRW disposal (disposal in a geologic repository), these regulations also indicate that other disposal methods could be approved. The GTCC EIS evaluates three land disposal methods (i.e., enhanced near-surface trench, intermediate-depth borehole, and above-grade vault). The GTCC EIS evaluation indicates that land disposal methods employed at sites with suitable characteristics would be viable and safe alternatives for the disposal of GTCC LLRW.

Nye County Nuclear Waste Repository Project Office (NWRPO),
Commenter ID No. E32 (cont'd)

June 27, 2011
GTCC Comments
Page 8 of 10

the performance of this zone must be precluded to the extent practicable. Such considerations can only be implemented through interactions with the NRC on the requirements for alternative disposal methods. Given that the NRC is planning to revise its LLW rule at 10 CFR Part 61, there should be an opportunity to include appropriate licensing criteria for disposal of long-lived LLW meeting the current GTCC definition.

14. **Comment:** The Draft GTCC EIS does not recognize that removal of the sheet piling following trench disposal would create a fast pathway for water to infiltrate and contact the waste.

Rationale: The construction method described for the trench disposal option is a deep slit trench with the sides supported by sheet piling until after the trench is filled with waste and covered. The Draft EIS does not address the potential consequence to performance of removal of the sheet piling. As the sheet piling is removed loose soil would fill in the void created as the piling is pulled. This loose soil would create a preferential pathway for water to bypass the engineered cover of the trench and allow more water than the nominal (assumed) infiltration rate to contact the GTCC wastes. The potential consequences of such a scenario should be considered in the performance assessments.

15. **Comment:** The Draft GTCC EIS does not adequately address the potential impacts to historic artifacts or biological resources.

Rationale: The Draft GTCC EIS states that once a specific site (sites) is (are) selected for further consideration, the DOE plans to consult with other agencies, including the Advisory Council on Historic Preservation, the appropriate State Historic Preservation Officer(s), and pertinent Regional Fish and Wildlife Service Office(s). It is not clear how the Draft EIS can be said to have considered and addressed the associated impacts without identification and consideration of the more important site-specific issues likely to be encountered.

SPECIFIC COMMENTS/OBSERVATIONS

1. Section 1.3 on page 1-3 discusses a report that is required to be submitted to Congress. The report must, "... include a description of all alternatives under consideration . . ." This Draft EIS is deficient in that it does not consider the Yucca Mountain repository as an alternative. Yucca Mountain was designated by Congress as the site for a repository in 2002, it was included as an alternative in the Notice of Intent for the GTCC EIS in 2007, and substantial legal uncertainty surrounds the ultimate resolution of Administration actions regarding the future of Yucca Mountain as a repository. There is no valid basis at present to exclude a Yucca Mountain repository as a reasonably foreseeable alternative for disposal of GTCC waste.
2. Section 1.5 gives a brief summary of the public scoping process. It notes that an Advance Notice of Intent was issued in 2005 and public scoping meetings were held in 2007. Now the Draft EIS is being issued four years later. It is unacceptable to wait two years after an

E32-14 The disposal facility conceptual design would be modified to complement the site and waste characteristics when implemented. Such details would be assessed in site-specific NEPA review. In the case of the removal of the sheet piling, the loose fill around the packages in the disposal trench would fill the gap and compaction of the fill over the entire area of the trench would be performed before emplacing the cover materials. Or the sheet piling could be left in place with the cover extending over the edge of the trench as defined by the location of the sheet piling. In either case, water infiltration would not have a preferential pathway (once through the cover materials). It would be dictated by the rate through the surrounding soil or the compacted backfill in the trench.

E32-15 Because the disposal sites were considered to be at reference locations, only existing information on historic artifacts and biologic resources was reviewed and assessed for each site. The selection of a specific site and location for disposal of waste following approval of the preferred alternative would take into consideration any sensitive areas and also result in consultations with the appropriate State Historic Preservation Officer and the U.S. Fish and Wildlife Service.

E32-16 The EIS considered the range of reasonable alternatives for the disposal of the GTCC waste inventory, including disposal in a deep geologic repository. The Secretary of Energy determined that a permanent repository for high-level waste and spent nuclear fuel at Yucca Mountain, Nevada, is not a workable option and will not be developed. Therefore, DOE concluded that co-disposal at a Yucca Mountain repository is not a reasonable alternative and has eliminated it from evaluation in this EIS, as described in Section 2.6 of the EIS.

E32-17 DOE disagrees that the scoping process should be redone. As noted in the EIS, the Secretary of Energy determined that a permanent repository for high-level waste and spent nuclear fuel at Yucca Mountain, Nevada, is not a workable option and will not be developed. Therefore, DOE concluded that co-disposal at a Yucca Mountain repository is not a reasonable alternative and has eliminated it from evaluation in this EIS, as described in Section 2.6 of this EIS. In terms of other circumstances, DOE acknowledged in the beginning of Chapter 4 of this EIS that two events occurred at WIPP in February 2014, one regarding a fire that involved an underground vehicle and the other regarding a radiological event. DOE plans to resume disposal operations at WIPP when it is safe to do so and the schedule for restart of limited operations is currently under review. DOE believes WIPP is still viable alternative for disposal of GTCC LLRW and GTCC-like waste and does not believe re-scoping is necessary.

E32-13
(Cont.)

E32-14

E32-15

E32-16

E32-17

Nye County Nuclear Waste Repository Project Office (NWRPO),
Commenter ID No. E32 (cont'd)

June 27, 2011
 GTCC Comments
 Page 9 of 10

advanced notice of intent before scoping and four years after completion of scoping to complete a draft EIS. Scoping should be redone to inform the public of today's circumstances, which have changed dramatically and without opportunity for comment regarding the DOE's posture and actions concerning the role of Yucca Mountain in radioactive waste management.

3. Section 1.6 purportedly lists other DOE NEPA activities related to the proposed actions for disposal of GTCC waste described in this Draft EIS. The Draft EIS is deficient in that it does not consider the Final EIS (2002) and Final Supplemental EIS (2008) for the Yucca Mountain repository. The potential impacts of disposal of GTCC waste in a Yucca Mountain repository were evaluated in these documents. Given the uncertainty surrounding resolution of the future of Yucca Mountain pending action by the courts and, ultimately, by Congress, a Yucca Mountain repository and the associated rail line must be considered among the proposed DOE NEPA actions under current law.
4. Chapter two lists alternatives considered in the Draft EIS. The scoping meetings in 2007 specifically called for the Yucca Mountain geologic repository to be considered as an alternative. This Draft EIS is deficient in that it does not consider the Yucca Mountain repository as an alternative and provides no valid basis under current law for its elimination.
5. Section 2.9.3.2 states that "DOE successfully demonstrated the use of borehole facilities to dispose of radioactive waste at NNSS (formerly NTS) during 1981 through 1989. The boreholes operated from 1984 through 1989 and received DOE waste similar to GTCC LLRW." The purported "success" of this facility may have been more in terms of lessons learned regarding potential issues associated with implementing borehole disposal, including issues related to: constructing and backfilling boreholes; thermally loading subsurface soils and geologic media; and combining volatile and thermal waste streams in the same borehole. Results of monitoring found that the wastes and daughter-products were not confined to the borehole and, shortly after disposal, were found to migrate from the borehole into the soil column, the principal transport mechanism being gaseous diffusion. There is also no discussion in the Draft EIS of constraints on use of the borehole disposal method under existing federal (and state) laws, specifically the Safe Drinking Water Act (SDWA) and the Underground Injection Control Regulations. Injection of radionuclides into the ground via injection wells is prohibited and boreholes may be considered as injection wells if used for disposal. Another Congressional action would be required to exempt this activity from the SDWA regulations.
6. Section 2.9.3.4 discusses construction and operating costs for the various disposal alternatives considered. Table 2.9.2-1 estimates that the construction cost for the WIPP would be \$14 million. This represents an underestimate of the cost of the geologic repository alternative if implemented at any site other than WIPP, where a repository and surface facilities already exist (the same would be true for the construction cost at a Yucca Mountain repository if GTCC waste were to be disposed of in the same facility). The "green field" cost of a geologic repository at a new site would undoubtedly be prohibitive and preclude use of a

E32-17
 (Cont.)

E32-18

E32-19

E32-20

E32-21

- E32-18 The EIS considered the range of reasonable alternatives for the disposal of the GTCC waste inventory, including disposal in a deep geologic repository. The Secretary of Energy determined that a permanent repository for high-level waste and spent nuclear fuel at Yucca Mountain, Nevada, is not a workable option and will not be developed. Therefore, DOE concluded that co-disposal at a Yucca Mountain repository is not a reasonable alternative and has eliminated it from evaluation in this EIS, as described in Section 2.6 of the EIS. Shipping by rail to the NNSS was evaluated in the EIS.
- E32-19 See E32-18 response.
- E32-20 To better characterize the borehole demonstration at NNSS, the term "successfully" has been deleted from the referenced statement in Section 2.9.3.2, but it is accurate that this technology was implemented at NNSS as described. Text was added to indicate that the use of boreholes at NNSS may be subject to Underground Injection Control Regulations and other requirements.
- E32-21 Estimated costs for implementing the various alternatives are given in this EIS to the extent that this information was available. A detailed cost evaluation is not required to be included in an EIS under NEPA. Detailed cost information could be provided in a future site-specific NEPA review, as needed.

Nye County Nuclear Waste Repository Project Office (NWRPO),
Commenter ID No. E32 (cont'd)

June 27, 2011
GTCC Comments
Page 10 of 10

geologic repository as a disposal alternative, even though it is currently the only method approved by the NRC. The EIS should provide more perspective on the distinctions between the cost evaluation for geologic disposal at the WIPP and those for other disposal alternatives.

- 7] Section 5.3.4.3 lines 43-45, page 5-65 the conclusion presented in that paragraph [As the distance would increase from 100 m (330 ft) to 500 m (1,600 ft), the maximum annual radiation dose would increase by more than 70%] is incorrect and is inconsistent with the argument presented. The dose should decrease under this argument.
8. The discussion of transportation in Section 9.1.9 is deficient because it does not consider rail access to the Yucca Mountain repository, which was evaluated in the Final EIS (2002) and Final SEIS (2008) for the repository. Even if GTCC disposal did not take place in Yucca Mountain, rail transportation to the NNSS should be considered as an alternative in the GTCC EIS because, under current law, Yucca Mountain is a reasonably foreseeable action that may impact GTCC disposal and should be considered under NEPA. The existence of rail access to a Yucca Mountain repository could substantially reduce the number of and potential impacts from shipments of GTCC waste to the NNSS. Note on p. 9-52, line 14, Caliente is in Lincoln County, Nevada, not in New Mexico. Caliente is also the location proposed for the start of the rail line to a Yucca Mountain repository.
9. Section 9.4.1.6 discusses future projects at the NNSS. It omits discussion of the Yucca Mountain repository even though the Yucca Mountain site is designated by current federal law as the site for a geologic repository and the project was funded in fiscal year 2011 through a series of Congressional continuing resolutions, at least through March 4.
- 10] Section 9.4.2 considers the potential impacts of the proposed action (GTCC disposal) “. . . in combination with the impacts of past, present, and reasonably foreseeable future actions” at the NNSS. It omits discussion of the Yucca Mountain repository even though the Yucca Mountain site is designated by current federal law as the site for a geologic repository and the project was funded in fiscal year 2011 through a series of Congressional continuing resolutions, at least through March 4. Given uncertainty about the legality of Administration actions regarding Yucca Mountain and pending action in the courts, the Yucca Mountain repository should be considered as a reasonably foreseeable action, the impacts from which would add to those from a separate action to dispose of GTCC waste in a near-surface facility on the NNSS. In addition, the cumulative impacts, primarily on Nye County, from transportation of both CH and RH GTCC waste to the NNSS, combined with the impacts from transportation of DOE LLW and mixed-LLW to the NNSS, as well as those from transportation of SNF and HLW to a Yucca Mountain repository, are not adequately addressed. The fact that rail access was planned to support operation of the Yucca Mountain repository should be considered in this evaluation as it could substantially reduce the potential impacts from transportation of GTCC waste to the NNSS for disposal.

E32-21
(Cont.)

E32-22

E32-23

E32-24

E32-25

E32-22 The text was corrected. “increase” was changed to “decrease.”

E32-23 See response to E32-18 regarding a discussion on Yucca Mountain and its associated rail line as an alternative.

The text was corrected to note that Caliente is in Nevada.

E32-24 See response to E32-16.

E32-25 The Secretary of Energy determined that a permanent repository for high-level waste and spent nuclear fuel at Yucca Mountain, Nevada, is not a workable option and will not be developed. Therefore, DOE concluded that co-disposal at a Yucca Mountain repository is not a reasonable alternative and has eliminated it from evaluation in this EIS, as described in Section 2.6 of the EIS.

Nye County Nuclear Waste Repository Project Office (NWRPO),
Commenter ID No. E33

3133



Nye County
Nuclear Waste Repository Project Office
2101 E. Calvada Blvd., Ste. #100 • Pahrump, Nevada 89048
(775) 727-7727 • Fax (775) 727-7919

11-126-DL(L)

June 27, 2011

Mr. Arnold M. Edleman, EIS Document Manager
U.S. Department of Energy, GTCC EIS
Cloverleaf Building, EM-43
1000 Independence Avenue, SW
Washington, DC 20585

RE: Notice of Availability of the Draft Environmental Impact Statement for the Disposal of Greater-Than-Class C (GTCC) Low-Level Radioactive Waste and GTCC-Like Waste, and Notice of Public Hearings, 76 FR 10574, February 25, 2011.

Reference:

1. Notice of Intent to Prepare an Environmental Impact Statement for the Disposal of Greater-Than-Class-C Low-Level Radioactive Waste, 72 FR 40135, July 23, 2007
2. Letter from Gary Hollis, Chairman, Nye County Board of County Commissioners, to James L. Joyce, Document Manager, U.S. Department of Energy, December 4, 2007, submitting comments on the scope of the GTCC EIS

Dear Mr. Edleman:

Nye County appreciates the opportunity to submit comments on the Draft GTCC EIS. Nye County is host to the Nevada National Security Site (NNSS), one of the DOE sites explicitly considered in the Draft EIS as an alternative location for a facility for disposal of GTCC and GTCC-like waste (collectively referred to as GTCC waste in these comments). Nye County is also host to the Yucca Mountain site, which, under current law, is the designated site for development of a geologic repository for disposal of commercial spent nuclear fuel (SNF), DOE-owned SNF, and high-level waste (HLW) from defense nuclear activities. The Yucca Mountain repository was identified as an alternative for GTCC disposal in the 2007 Notice of Intent to prepare the GTCC EIS (Ref. 1), as noted in Nye County's scoping comments (Ref. 2). Although the governing laws have not changed, the Yucca Mountain repository was eliminated by the DOE from consideration in the Draft EIS as an alternative for disposal of GTCC waste.

Nye County has no inherent objection to consideration of the NNSS, or more appropriately a geologic repository at Yucca Mountain, for disposal of GTCC waste, subject to efforts to ensure that the health, safety, and economic well-being of the County and its residents are adequately protected, including receiving tangible benefits from the government's action (see Ref. 2). However, there is significant uncertainty regarding a number of issues that are important to any decision by the DOE or Congress regarding selection of a method or site for GTCC disposal.

E33-1 (L302) Disposal of GTCC LLRW and GTCC-like waste will be in accordance with applicable statutes, regulations, and other requirements regarding the protection of the health, safety and economic well-being of the public.

E33-2 The scope of this EIS is adequate to inform decision-making for the disposal of GTCC LLRW and GTCC-like waste. Sufficient information is available to support the current decision-making process to identify (an) appropriate site(s) and method(s) to dispose of the limited amount of GTCC LLRW and GTCC-like waste identified in the EIS.

DOE believes that this EIS process is not premature and is in compliance with NEPA. On the basis of an assumed starting date of 2019 for disposal operations, more than half (about 6,700 m³ [240,000 ft³] of the total GTCC LLRW and GTCC-like waste inventory of 12,000 m³ [420,000 ft³]) is projected to be available for disposal between 2019 and 2030. An additional 2,000 m³ (71,000 ft³) would become available for disposal between 2031 and 2035. This information is presented in Figure 3.4.2-1. DOE believes this EIS is timely, especially given the length of time necessary to develop a GTCC waste disposal facility.

DOE developed this EIS to support a decision on selecting a disposal facility or facilities for GTCC LLRW and GTCC-like waste, to address legislative requirements, to address national security concerns (especially for sealed sources), and to protect public health and safety. The purpose and need for the proposed action, as discussed above, is stated in the EIS (Section 1.1). The scope of the EIS is focused on addressing the need for developing a disposal capability for the identified inventory of GTCC LLRW and GTCC-like wastes. DOE plans a tiered decision-making process, in which DOE would conduct further site-specific NEPA reviews before implementing an alternative ultimately selected on the basis of this EIS.

E33-1

E33-2

Nye County Nuclear Waste Repository Project Office (NWRPO),
Commenter ID No. E33 (cont'd)

June 27, 2011
GTCC Letter and comments
Page 2 of 5

The County believes that completion of this EIS, any report to Congress under Sec. 631(b)(1)(B) of the Energy Policy Act of 2005, and any decision on either a disposal method or location for a disposal facility are premature for the reasons documented below. Additional comments are provided in the enclosure.

U.S. Nuclear Regulatory Commission (NRC) Regulations

Disposal of GTCC waste in a geologic repository is the only method currently approved by the NRC (10 CFR 61.55(a)(2)(iv)). Absent new regulatory direction or specific approval of an alternative method, any facility for disposal of GTCC waste must be licensed by the NRC under the regulations governing geologic disposal - either the general rule at 10 CFR Part 60, or the Yucca Mountain-specific rule at 10 CFR Part 63. Yet, with the elimination of Yucca Mountain from consideration, only one alternative for geologic disposal of GTCC waste is considered in the Draft EIS, the Waste Isolation Pilot Plant (WIPP) in New Mexico. The other alternative disposal methods and locations evaluated do not comply with current NRC requirements and any assumptions made by the DOE about the likelihood of obtaining an NRC license for an alternative disposal method are premature prior to interactions with the NRC to identify and resolve potential licensing issues associated with near-surface disposal of these higher-activity, longer-lived wastes.

The NRC will be revising its rule for disposal of low-level radioactive waste (LLW), 10 CFR Part 61, which establishes the current requirements for disposal of GTCC waste. The potential scope and impact of these revisions, which may include changes to the waste classification scheme and to the requirements applicable to licensing of LLW disposal facilities, on future decisions related to disposal of GTCC LLW waste cannot be known at this time.

The NRC also has indicated that the general rule for licensing geologic repositories, 10 CFR Part 60, needs to be revised. Any such revision is likely to incorporate the risk-informed, performance-based approach implemented in the Yucca Mountain-specific rule at 10 CFR Part 63 and in other recent NRC rules. The impact of such changes on licensing a geologic repository at any site other than Yucca Mountain is unknown.

At a minimum, the regulatory issues surrounding alternatives for GTCC disposal and the potential impacts of the uncertainties associated with these issues need to be fully discussed in the Final EIS so that both the DOE and Congress can make informed decisions.

Resolution of the Future of Yucca Mountain as a Geologic Repository

At scoping four years ago in 2007, the potential for disposal of GTCC waste in a geologic repository at Yucca Mountain was explicitly identified as an alternative. It was known at that time that the 2002 Final EIS for a Yucca Mountain repository (DOE/EIS-0250F) evaluated the potential impacts of including the projected inventory of GTCC waste in

E33-3

The Secretary of Energy determined that a permanent repository for high-level waste and spent nuclear fuel at Yucca Mountain, Nevada, is not a workable option and will not be developed. Therefore, DOE concluded that co-disposal at a Yucca Mountain repository is not a reasonable alternative and has eliminated it from evaluation in this EIS, as described in Section 2.6 of the EIS. DOE did not evaluate developing a geologic repository exclusively for disposal of GTCC LLRW and GTCC-like wastes because DOE determined that such an alternative is not reasonable due to the time and cost associated with siting a deep geologic repository and the relatively small volume of GTCC LLRW and GTCC-like wastes identified in the GTCC EIS. DOE believes that the results presented in this EIS for the WIPP geologic repository alternative are indicative of the high degree of waste isolation that would be provided by disposal in a geologic repository. DOE has included analysis of generic commercial facilities in the event that a facility could become available in the future. In that case, before making a decision to use a commercial facility, DOE would conduct further NEPA reviews, as appropriate.

DOE agrees that use of a geologic repository would be a protective and safe method for the disposal of the entire inventory of GTCC LLRW and GTCC-like wastes. The GTCC EIS evaluation for the WIPP geologic repository alternative supports this statement. However, the degree of waste isolation provided by a geologic repository may not be necessary for all of the GTCC LLRW and GTCC-like wastes evaluated in the GTCC EIS. The GTCC EIS evaluation indicates that certain wastes (e.g., those containing short-lived radionuclides such as Cs-137 irradiators) could be safely disposed of in properly designed land disposal facilities at sites with suitable characteristics, such as low precipitation rates, high soil distribution coefficients, and sufficient depths to groundwater. Based on the GTCC EIS evaluation, land disposal facilities located in arid climates (e.g., NNSS and WIPP Vicinity) would isolate radionuclides for a sufficient period of time to allow for significant radioactive decay to occur.

While 10 CFR Part 61 identifies one NRC-approved method for GTCC LLRW disposal (disposal in a geologic repository), these regulations also indicate that other disposal methods could be approved. The GTCC EIS evaluates three land disposal methods (i.e., enhanced near-surface trench, intermediate-depth borehole, and above-grade vault). The GTCC EIS evaluation indicates that land disposal methods employed at sites with suitable characteristics would be viable and safe alternatives for the disposal of GTCC LLRW.

The NRC served as a commenting agency on the GTCC EIS and therefore did not actively participate in the preparation of the GTCC EIS. Issues associated with potential regulatory changes or NRC licensing would be addressed as necessary to enable implementation.

The likelihood of potential changes to existing regulations is outside the scope of the GTCC EIS.

E33-2
(Cont.)

E33-3

J-433

January 2016

Final GTCC EIS

Appendix I: Comment Response Document

Nye County Nuclear Waste Repository Project Office (NWRPO),
Commenter ID No. E33 (cont'd)

June 27, 2011
GTCC Letter and comments
Page 3 of 5

the repository. This analysis was updated in the 2008 Supplemental EIS (DOE-0250F-S1). It was also known that the license application (LA) for the Yucca Mountain repository was scheduled to be submitted to the NRC in June 2008, so it was likely that at least one potential pathway would exist for GTCC disposal consistent with existing NRC requirements. In the Draft GTCC EIS, the alternative for disposal of GTCC waste in a geologic repository at Yucca Mountain was taken off the table prior to resolution of the regulatory and legal issues raised since the administration determined that Yucca Mountain was "not a workable option" and the DOE moved to withdraw its LA from NRC licensing review in 2010. The NRC's licensing board denied this motion on June 29, 2010. The issue has been under review by the Commission for nearly a year with no final decision.

Resolution of the future of Yucca Mountain as a geologic repository for disposal of SNF and HLW awaits action by the court and, ultimately, by Congress. Until the Nuclear Waste Policy Act (NWPA) is amended or repealed, Yucca Mountain is the site designated by law for a repository. Yucca Mountain is also the only alternative identified in the 2007 Notice of Intent that would satisfy existing NRC requirements for geologic disposal of GTCC waste. In records of decision based on the 2002 Yucca Mountain EIS, the DOE selected "mostly rail" as the preferred transportation alternative and the Caliente corridor as the preferred route for a rail line to the repository. These decisions were confirmed based on the 2008 Supplemental EIS for the repository and the EIS for the alignment for the rail line to the repository. The Yucca Mountain repository and rail system for transport of SNF and HLW were based on use of large transportation casks and disposal packages. Premature elimination of a Yucca Mountain repository from consideration has the effect of increasing the potential impacts from transportation of GTCC waste for disposal due to the need to use smaller casks to ship GTCC waste to the other alternative sites, which is likely to increase the number of shipments.

At a minimum, disposal of GTCC waste in a repository at Yucca Mountain should be considered as an alternative in the GTCC EIS. The statutory basis for the inclusion of a Yucca Mountain repository consistent with current law should be discussed, together with uncertainties associated with decisions on the future of the repository, which await action by the court and, ultimately, by Congress.

Consideration of the WIPP as an Alternative

The WIPP, the only operating geologic repository in the U.S., is evaluated in the Draft EIS as an alternative for disposal of GTCC waste and is the only location evaluated in the Draft EIS for which the geologic disposal method is considered. There are several issues associated with consideration of the WIPP as an alternative for disposal of GTCC waste under the current statutory and regulatory framework. The disposal of GTCC waste is regulated by the NRC under the existing statutory framework. The WIPP is not licensed by the NRC; it is certified by the U.S. Environmental Protection Agency (EPA), consistent with the provisions of the WIPP Land Withdrawal Act of 1992. The WIPP

E33-4

Disposal of GTCC LLRW and GTCC-like wastes at WIPP is included in the range of reasonable alternatives and is evaluated in this EIS. DOE acknowledges that only defense-generated TRU waste is currently authorized for disposal at the WIPP geologic repository under the WIPP LWA as amended (P.L. 102-579 as amended by P.L. 104-201) and that legislation would be required to allow disposal of waste other than TRU waste generated by atomic energy defense activities at WIPP and/or for siting a new facility within the land withdrawal area. It would also be necessary to revise the Agreement for Consultation and Cooperation between Department of Energy and the State of New Mexico for the Waste Isolation Pilot Plant, the WIPP compliance certification with EPA, and the WIPP Hazardous Waste Facility Permit. In addition, site-specific NEPA reviews would be conducted as needed, including further characterization of the waste (e.g., radionuclide inventory and heat loads) as well as the proposed packaging for disposal.

However, NEPA does not limit an EIS to proposing and evaluating alternatives that are currently authorized. Furthermore, the Agreement for Consultation and Cooperation between Department of Energy and the State of New Mexico for the Waste Isolation Pilot Plant recognizes that the mission of WIPP may change and provides provisions to modify the agreement. For example, the Agreement states: "The parties to this Agreement recognize that future developments including changes to applicable laws (e.g., Public Law [P.L.] 96-164) may make it desirable or necessary for one or both parties to seek to modify this Agreement. Either party to this Agreement may request a review of the terms and conditions."

DOE acknowledges that the WIPP LWA as amended (P.L. 102-579 as amended by P.L. 104-201) limits disposal at WIPP to defense generated TRU waste. The use of WIPP was included as an alternative in the EIS because the use of this repository for GTCC LLRW and GTCC-like wastes is a reasonable approach. To protect public health and the environment, DOE intends to dispose of GTCC-like waste on the basis of its radiological and physical characteristics. It is recognized that WIPP cannot be used for the GTCC LLRW and GTCC-like waste inventory addressed in the EIS under current law. However, GTCC LLRW and GTCC-like wastes having characteristics similar to those of the defense-generated TRU wastes that are currently being disposed of at WIPP would be expected to be managed in a manner that is generally comparable to that used for defense-generated TRU wastes to ensure the health and safety of the general public for the long term.

DOE acknowledges the TRU waste disposal limitations for WIPP specified in the WIPP LWA as amended (P.L. 102-579 as amended by P.L. 104-201) and in the Agreement for Consultation and Cooperation between Department of Energy and the State of New Mexico for the Waste Isolation Pilot Plant. Information on these limitations is provided in this EIS (see Section 4.1.1) and was considered in developing the preferred alternative. Based on the GTCC EIS evaluation, disposal of GTCC LLRW and GTCC-like wastes at WIPP would result in minimal environmental impacts for all resource areas evaluated, including human health and transportation. Both the annual dose and the latent cancer fatality (LCF) risk would be zero because there would be no releases to the accessible environment and therefore no radiation doses and LCFs during the first 10,000 years following closure of the WIPP repository. DOE recognizes that the use of WIPP for the disposal of GTCC LLRW and GTCC-like wastes would require legislative changes and site-specific NEPA reviews would be conducted as needed, including further characterization of the waste (e.g., radionuclide inventory and heat loads), as well as the proposed packaging for disposal.

Should WIPP be selected in DOE's ROD as part of the approach for disposing of GTCC LLRW and GTCC-like wastes, legislative changes would be necessary prior to implementation. Although WIPP is not currently authorized to dispose of GTCC LLRW and GTCC-like wastes, NEPA does not preclude DOE from considering WIPP as a reasonable alternative for disposing of GTCC LLRW and GTCC-like wastes. The need for legislative modifications to enable WIPP to be used for the disposal of GTCC LLRW and GTCC-like wastes is identified and discussed in the EIS.

E33-3
(Cont.)

E33-4

J-434

January 2016

Nye County Nuclear Waste Repository Project Office (NWRPO),
Commenter ID No. E33 (cont'd)

June 27, 2011
GTCC Letter and comments
Page 4 of 5

also requires a Resource Conservation and Recovery Act (RCRA) permit from the State of New Mexico.

To ensure that the WIPP can continue its current mission for disposal of defense-related TRU waste, this framework would need to be amended to transfer authority for regulation of GTCC waste from the NRC to EPA. Congressional action would be required. The use of the WIPP for disposal of GTCC waste also would require changes to the WIPP Land Withdrawal Act and the establishment of agreements with the State of New Mexico to permit disposal of other than defense-related transuranic waste (TRU). The limits on the radionuclide inventory permitted at the WIPP, currently about 5 million curies of remote handled waste, would need to be lifted to accommodate the approximately 160 million curies of GTCC waste estimated in the Draft EIS. This would require approval by Congress and the State of New Mexico. The Draft EIS does not adequately address these issues or the assumptions made with regard to the likelihood or timing of the major Congressional action to make the necessary legislative changes.

The potential legal and regulatory challenges associated with selection of the WIPP for disposal of GTCC waste should be fully discussed. The nature and extent of the necessary legislative and regulatory changes, and changes to the agreements with the State of New Mexico should be described, together with the schedule impacts that would be likely to occur.

Acceptability of Alternative Disposal Methods for an NRC License

The two near-surface disposal methods considered as alternatives – trenches and vaults – would require approval from the NRC in a licensing proceeding on the merits of the selected disposal method at a specific site. The result of this process should not be considered to be a foregone conclusion, particularly in light of NRC plans to revise its LLW rule at 10 CFR Part 61. Such revisions would likely affect the waste classification system that is the basis for designating GTCC waste and the licensing requirements for LLW disposal facilities. As a result, any decisions made regarding use of either method at any of the alternative locations prior to interactions with the NRC and resolution of potential licensing issues for disposal of GTCC LLW is premature. Deep borehole disposal, particularly of sealed sources, would be more likely to be approved by the NRC because of the greater depths involved, but would still require a site-specific licensing proceeding, the outcome of which is not guaranteed. A full discussion of the regulatory issues and uncertainties involved in seeking NRC approval for the near-surface disposal alternatives for high-activity, long-lived LLW should be provided to better inform decisions by the DOE and Congress.

For the reasons stated above, Nye County believes that there is significant uncertainty regarding a number of issues that are critical to any decision by either the DOE or Congress regarding a method or site for GTCC disposal. The County believes that completion of this EIS, any report to Congress under Sec. 631(b)(1)(B) of the Energy Policy Act of 2005, and any decision on

E33-5 The LLRWPAA (P.L. 99-240) specifies that GTCC LLRW, designated a federal responsibility under section 3(b)(1)(D) that results from activities licensed by the NRC, is to be disposed of in an NRC-licensed facility that has been determined to be adequate to protect public health and safety. However, unless specifically provided by law, the NRC does not have authority to license and regulate facilities operated by or on behalf of DOE. Further, the LLRWPAA does not limit DOE to using only non-DOE facilities or sites for GTCC LLRW disposal. Accordingly, if DOE selects a facility operated by or on behalf of DOE for disposal of GTCC LLRW for which it is responsible under section 3(b)(1)(D), clarification from Congress would be needed to determine NRC's role in licensing such a facility and related issues. In addition clarification from Congress may be needed on NRC's role if DOE selects a commercial GTCC LLRW disposal facility licensed by an Agreement State rather than by NRC.

The NRC served as a commenting agency on the GTCC EIS and therefore did not actively participate in the preparation of the GTCC EIS. Issues associated with potential regulatory changes or NRC licensing would be addressed as necessary to enable implementation.

E33-6 See response to E33-2.

E33-4
(Cont.)

E33-5

E33-6

Nye County Nuclear Waste Repository Project Office (NWRPO),
Commenter ID No. E33 (cont'd)

June 27, 2011
GTCC Letter and comments
Page 5 of 5

either a disposal method or location are likely to be premature pending resolution of these issues.
Additional comments are provided in the enclosure.

Thank you for the opportunity comment on the Draft GTCC EIS.

Sincerely,



Darrell Lacy, Director
Nye County Nuclear Waste Repository Project Office

Enclosure: Nye County, Nevada Comments

CC: Christine Gelles, Director, Office of Disposal Operations, EM-43
Scott Wade, Assistant Manager for Environmental Management, NS
Nye County BOCC

E33-6
(Cont.)

Nye County Nuclear Waste Repository Project Office (NWRPO),
Commenter ID No. T46

1
2
3
4
5
6
7
8
9
10
11
12
13
14
15
16
17
18
19
20
21
22
23
24
25

MR. BROWN: And following Darrell, I believe
that Ian Zabarte with the Western Shoshoni government.

So proceed.

MR. LACY: Thank you. My name is Darrell
Lacy, representing Nye County, Nevada.

(Reading) Nye County is the site county for
two of the potential disposal sites, one at Yucca

Nye County Nuclear Waste Repository Project Office (NWRPO),
Commenter ID No. T46 (cont'd)

38

1 Mountain or generic, the Nevada National Security Site.
2 We appreciate the opportunity to provide these summary
3 comments and observations. We would intend to provide
4 detailed comments by the June deadline.

5 We feel this EIS, in general, has several
6 deficiencies and does not meet the requirements of
7 NEPA. When the scoping hearings on this EIS were held
8 in 2007, DOE had announced that it would submit a
9 license application for Yucca Mountain, and Yucca
10 Mountain was one of the proposed sites, and the Draft
11 Supplemental EIS for Yucca Mountain considered disposal
12 of Greater-than-Class C waste in that repository.

13 Four years later now, this Draft EIS excludes
14 Yucca Mountain from consideration. The amount of
15 Greater-than-Class C waste considered in the scoping
16 for this was based on a once-through fuel cycle that
17 we're not on Yucca Mountain to handle any spent fuel.
18 Changes that might come out of the Blue Ribbon
19 Commission that would include possibly reprocessing,
20 this could significantly increase the amount of
21 Greater-than-Class C waste and should be addressed in
22 alternatives.

23 NRC regulations require that, in the absence
24 of specific approval by the Commission, Greater-than-
25 Class C waste must be disposed of in a geologic

T46-1

T46-2

T46-1 The EIS considered the range of reasonable alternatives for the disposal of the GTCC waste inventory, including disposal in a deep geologic repository.

The Secretary of Energy determined that a permanent repository for high-level waste and spent nuclear fuel at Yucca Mountain, Nevada, is not a workable option and will not be developed. Therefore, DOE concluded that co-disposal at a Yucca Mountain repository is not a reasonable alternative and has eliminated it from evaluation in this EIS, as described in Section 2.6 of this EIS.

DOE did not evaluate developing a geologic repository exclusively for disposal of GTCC LLRW and GTCC-like wastes because DOE determined that such an alternative is not reasonable due to the time and cost associated with siting a deep geologic repository and the relatively small volume of GTCC LLRW and GTCC-like wastes identified in the GTCC EIS. DOE believes that the results presented in this EIS for the WIPP geologic repository alternative are indicative of the high degree of waste isolation that would be provided by disposal in a geologic repository. DOE has included analysis of generic commercial facilities in the event that a facility could become available in the future. In that case, before making a decision to use a commercial facility, DOE would conduct further NEPA reviews, as appropriate.

The Blue Ribbon Commission (BRC) on America's Nuclear Future, in its final report to DOE on January 26, 2012, provided recommendations, which included the development of one or more permanent deep geologic facilities for the safe disposal of spent nuclear fuel and high-level radioactive waste and the development of one or more consolidated interim storage facilities as part of an integrated, comprehensive plan for managing the back end of the nuclear fuel cycle. In its Strategy for the Management and Disposal of Spent Nuclear Fuel and High Level Radioactive Waste (DOE 2013), developed in response to the BRC Report, the Administration agreed "that the development of geologic disposal capacity is currently the most cost-effective way of permanently disposing of used nuclear fuel and high-level radioactive waste while minimizing the burden on future generations" and proposed to "engage in a consent-based siting process and begin to conduct preliminary site investigations for a geologic repository." The Administration's goal is to have a repository constructed and its operations started by 2048. The Administration will work with Congress using the strategy as an actionable framework for building a national program for the management and disposal of the nation's used nuclear fuel and high-level radioactive waste (DOE 2013).

T46-2 The GTCC LLRW and GTCC-like waste inventory evaluated in the EIS is based on the best available information on the stored and projected GTCC LLRW and GTCC-like wastes from ongoing and planned activities. The estimated 12,000 m³ of GTCC LLRW and GTCC-like wastes is a relatively small volume of waste when compared to other wastes disposed of by DOE. For example, this volume of GTCC LLRW and GTCC-like wastes is only about 20% of the 59,000 m³ of LLRW disposed of at one site (NNSS) in one year (fiscal year 2010). Any potential nuclear fuel cycles involving advanced reactors or recycling of used fuel and the wastes associated with these activities are uncertain at this time and therefore not estimated in this EIS. DOE believes that expanding the inventory to include potential GTCC LLRW and GTCC-like wastes from undefined or unplanned future activities would introduce excessive uncertainty in the EIS evaluations. DOE believes that the inventory included in the GTCC EIS is reasonable for the purposes of the NEPA process and that it provides a supportable basis for conducting the EIS evaluation and the identification of the preferred alternative in the Final EIS. In the future, should additional waste be identified, appropriate NEPA review would be conducted as needed to reflect these changes and also changes that would be needed to the existing infrastructure or the identification of additional disposal sites.

Nye County Nuclear Waste Repository Project Office (NWRPO),
Commenter ID No. T46 (cont'd)

39

1 repository as defined in 10 CFR, Part 60 or Part 63.
2 The only two sites in this discussion that meet this
3 requirement are Yucca Mountain and/or
4 WIPP.

5 This type of waste is currently excluded from
6 WIPP by legislation and agreements with the state of
7 New Mexico and was not included in the WIPP EIS when it
8 was cited or in any characterization activities that
9 have been done at WIPP.

10 The WIPP Land Withdrawal Act limits the total
11 radioactivity of remote handled TRU waste to 5.1
12 million curies. For comparison purposes, the total
13 radioactivity of the Greater-than-Class C waste
14 discussed here is estimated to be 157 million curies.
15 Reprocessing could greatly increase the amount of this
16 Greater-than-Class C waste above what was discussed in
17 the scoping of this EIS. WIPP was not licensed by the
18 NRC, and any assumption that legislation or NRC
19 regulations will be changed to suit DOE for this
20 process for Greater-than-Class C are invalid.

21 Performance assessments described in Draft
22 GTCC EIS are based on a number of generic and
23 simplified assumptions. The performance assessments
24 are not true indicators of the differences in
25 performance among the various sites or even disposal

T46-3

Disposal of GTCC LLRW and GTCC-like wastes at WIPP is included in the range of reasonable alternatives and is evaluated in this EIS. DOE acknowledges that only defense-generated TRU waste is currently authorized for disposal at the WIPP geologic repository under the WIPP LWA as amended (P.L. 102-579 as amended by P.L. 104-201) and that legislation would be required to allow disposal of waste other than TRU waste generated by atomic energy defense activities at WIPP and/or for siting a new facility within the land withdrawal area. It would also be necessary to revise the Agreement for Consultation and Cooperation between Department of Energy and the State of New Mexico for the Waste Isolation Pilot Plant, the WIPP compliance certification with EPA, and the WIPP Hazardous Waste Facility Permit. In addition, site-specific NEPA reviews would be conducted as needed, including further characterization of the waste (e.g., radionuclide inventory and heat loads) as well as the proposed packaging for disposal.

However, NEPA does not limit an EIS to proposing and evaluating alternatives that are currently authorized. Furthermore, the Agreement for Consultation and Cooperation between Department of Energy and the State of New Mexico for the Waste Isolation Pilot Plant recognizes that the mission of WIPP may change and provides provisions to modify the agreement. For example, the Agreement states: "The parties to this Agreement recognize that future developments including changes to applicable laws (e.g., Public Law [P.L.] 96-164) may make it desirable or necessary for one or both parties to seek to modify this Agreement. Either party to this Agreement may request a review of the terms and conditions."

DOE acknowledges the TRU waste disposal limitations for WIPP specified in the WIPP LWA as amended (P.L. 102-579 as amended by P.L. 104-201) and in the Agreement for Consultation and Cooperation between Department of Energy and the State of New Mexico for the Waste Isolation Pilot Plant. Information on these limitations is provided in this EIS (see Section 4.1.1) and was considered in developing the preferred alternative. Based on the GTCC EIS evaluation, disposal of GTCC LLRW and GTCC-like wastes at WIPP would result in minimal environmental impacts for all resource areas evaluated, including human health and transportation. Both the annual dose and the latent cancer fatality (LCF) risk would be zero because there would be no releases to the accessible environment and therefore no radiation doses and LCFs during the first 10,000 years following closure of the WIPP repository. DOE recognizes that the use of WIPP for the disposal of GTCC LLRW and GTCC-like wastes would require legislative changes and site-specific NEPA reviews would be conducted as needed, including further characterization of the waste (e.g., radionuclide inventory and heat loads), as well as the proposed packaging for disposal.

T46-3

T46-4

The specific locations that would be used at each potential site for development of a disposal facility for GTCC LLRW and GTCC-like wastes are not known at this time. The use of "reference locations" was used in the EIS to allow for a quantitative assessment of the impacts that could occur at each site. While some parameters could change within a short distance, most would not. The RESRAD-OFFSITE computer code was used to model the migration of radionuclides from the GTCC LLRW and GTCC-like wastes placed into the conceptual disposal facility designs for the three land disposal methods (not all three methods were evaluated for each site). Site-specific information provided by technical staff from various sites that were evaluated was used in these modeling analyses to the extent it was available, and conservative assumptions were used to fill any remaining data gaps. While the computer model was largely developed to support environmental restoration activities, it has a number of features that make it a good choice for use in this EIS. The analysis presented in the EIS is adequate for the comparison of the disposal alternatives evaluated. Fate and transport parameters utilized in the estimations were based on site-specific (e.g., specific to the reference location to the extent available) information and, as such, are considered reasonable for the purpose of the comparison made in the EIS. However, DOE recognizes that additional project- and site-specific information, such as the actual depth to groundwater over the entire disposal area, could be used to inform the implementation of a disposal facility at a given location. This additional information is expected to reduce the uncertainty associated with these types of

T46-4

Nye County Nuclear Waste Repository Project Office (NWRPO),
Commenter ID No. T46 (cont'd)

40

1 methods. Absent better information about the key
2 parameters considered, the performance assessments
3 provide little basis for decisionmakers to select a
4 preferred site or disposal alternatives.

5 This EIS should wait until the Yucca Mountain
6 issues are resolved by the courts or legislation and
7 the Blue Ribbon Commission make their recommendation
8 and the votes are finalized; then the Greater-than-
9 Class C waste should go through a new scoping process,
10 based on the available alternative sites and/or amounts
11 of materials that needs to be disposed of.

12 Without appropriate assumptions and detailed
13 analysis of the realistic alternatives, this EIS is
14 faulty and does not meet the minimum requirements of
15 NEPA and the CEQ.

16 We will submit detailed comments by the June
17 deadline. Thank you.

18 (Whereupon Exhibit No. 5 was marked for
19 identification.)

T46-4
(Cont.)

T46-5

evaluations to the extent possible. Site-specific information would be evaluated in any site-specific NEPA review that would be conducted based on a ROD for this EIS.

T46-5 DOE developed this EIS to support a decision on selecting a disposal facility or facilities for GTCC LLRW and GTCC-like waste, to address legislative requirements, to address national security concerns (especially for sealed sources), and to protect public health and safety. The purpose and need for action, as discussed above, is stated in the EIS (Section 1.1). DOE believes that this EIS process is not premature and is in compliance with NEPA.

The Secretary of Energy determined that a permanent repository for high-level waste and spent nuclear fuel at Yucca Mountain, Nevada, is not a workable option and will not be developed. Therefore, DOE concluded that co-disposal at a Yucca Mountain repository is not a reasonable alternative and has eliminated it from evaluation in this EIS, as described in Section 2.6 of the EIS.



received
APR 22 2011

April 12, 2011

Arnold Edelman
EIS Document Manager
Office of Environmental Management
U.S. Department of Energy
Cloverleaf Building, EM-43
1000 Independence Avenue, SW
Washington, DC 30585

Subject: Comments on the Draft Environmental Impact Statement (EIS) for the Disposal of Greater-Than-Class-C (GTCC) Low-Level Radioactive Waste and GTCC-Like Waste (DOE/EIS-0375-D)

Dear Mr. Edelman:

The Citizens' Advisory Panel (CAP) of the Oak Ridge Reservation (ORR) Local Oversight Committee (LOC) has reviewed the subject draft EIS. These comments have not been reviewed or endorsed by the LOC Board and should be attributed to the CAP only.

The ORR currently stores minor quantities of wastes that are considered GTCC-like (2.9 m³ of activated metals and 4.0 m³ of remote-handled [RH] "other waste" with a projected additional 130 m³ of the latter) and is expected to generate significant quantities of both contact-handled and RH GTCC-like wastes in the future. It is important for DOE to have disposal capabilities for all types of radioactive waste generated either by cleanup or ongoing missions, as well as civilian sources of GTCC waste. ORR has taken responsibility for disposal of large quantities of low-level waste generated by Environmental Management cleanup activities and historically acted as a regional disposal site; however it is an unsuitable location for disposal of GTCC or GTCC-like wastes.

Although DOE does not specify a preferred alternative, choice of one or more disposal sites should evaluate geologic suitability, the degree of engineering required to ensure long-term site performance, and willingness of the host community (or communities). For reasons of equity, each selected host community should receive financial and in-kind compensation to offset the potential environmental damages, security and emergency planning needs, and harm to its image for hosting a major radioactive waste disposal site.

L289-1

L289-2

- L289-1 DOE agrees that geologic suitability, engineering to ensure long-term site performance, and willingness of the host community are important factors when selecting the preferred alternative. These factors were taken into consideration in the selection of the preferred alternative.
- L289-2 Even though it is beyond the scope of this GTCC EIS, the comment is noted. This GTCC EIS addresses the potential environmental impacts associated with the proposed development, operation, and long-term management of a disposal facility or facilities for GTCC low-level radioactive waste (LLRW) and DOE GTCC-like waste.

Anderson • Meigs • Rhea • Roane • City of Oak Ridge • Knox • Loudon • Morgan

102 Robertsville Rd., Suite B • Oak Ridge, TN 37830 • Phone (865) 483-1333 • (888) 770-3073 • Fax (865) 482-6572 • loc@cx.net • www.local-oversight.org

Oak Ridge Reservation Local Oversight Committee, Commenter ID No. L289 (cont'd)

A. Edelman
04/12/11
Page 2 of 2

The CAP appreciates the opportunity to comment on the draft EIS.

Sincerely,

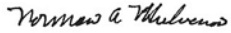

Norman A. Mulvenon
Chair, LOC Citizens' Advisory Panel

cc: LOC Document Register
LOC Board
LOC CAP
John Owsley, Director, TDEC DOE-O
John Eschenberg, Asst. Manager for EM, DOE ORO
Pat Halsey, FFA Coordinator, DOE ORO EM
Jeffrey L. Crane, EPA Region 4
Ron Murphree, Chair, ORSSAB
Amy Fitzgerald, Assistant City Manager, COR

The Oak Ridge Reservation Local Oversight Committee, Inc. (LOC) is a non-profit regional organization that reflects the interests of local communities regarding DOE's environmental management program and the operation of the Oak Ridge Reservation. The Board of Directors of the LOC is composed of the County Mayors/Executives of the seven counties surrounding or downstream of the Oak Ridge Reservation (representing over 600,000 residents), the Mayor of the City of Oak Ridge, the chair of the Oak Ridge Environmental Quality Advisory Board, and the chair of the LOC's Citizens' Advisory Panel (CAP). The CAP makes recommendations to the LOC board, the DOE, and state and federal regulators on technical and other matters of concern to local stakeholders.

Oregon Conservancy Foundation, Commenter ID No. T120

Capital Reporting Company

56

1

2 MR. BROWN: David Hess is next, and Martha Perez
3 will follow.

4 MR. HESS: Hi. My name is David Hess, and I'm
5 also a member of the Oregon Progressive Party. And,
6 you know, I'm here, actually, tonight to speak on
7 behalf of Lloyd Marbet, who unfortunately wasn't able
8 to be here. But following on Greg's thought, you
9 know, we've been recently told by the FBI that the
10 threat of terrorism in this region was so great that
11 we had to rejoin the Joint Terrorism Task Force. I
12 mean, we just couldn't be separated from it.

13 But now the federal government wants to come in
14 here and tell us, don't worry, it's completely safe
15 to bring 12,000 moving terrorist targets through your
16 region; I don't see a conflict.

17 But on behalf of Lloyd Marbet, I want to read
18 this statement. He says: I, Lloyd Marbet, apologize
19 for not being able to attend this meeting due to
20 conflicting events in my schedule, and I appreciate
21 Dave Hess reading this short statement in the record.
22 I, and the Oregon Conservancy Foundation, would like
23 to go on record in opposition to any storage of
24 radioactive waste as Hanford. Hanford needs to
25 completely clean up its own nuclear waste.

866.488.DEPO
www.CapitalReportingCompany.com

T120-1 DOE is performing environmental restoration activities at the Hanford Site. The ongoing cleanup effort will continue.

T120-1

J-443

January 2016

Oregon Conservancy Foundation, Commenter ID No. T120 (cont'd)

Capital Reporting Company

57

1 We also wish to go on record opposing any
2 licensing extension of the Columbia Generating
3 Station Nuclear Plant with its continuing
4 accumulation of nuclear waste on site. The recent
5 nuclear diaster at Fukushima shows the failure in
6 disaster planning for all the nuclear power plants.

7 So this DVD that I have been handing out
8 tonight -- and I have plenty more if you haven't got
9 one yet -- is entitled "At the Source." It has a
10 four-part interview with Dr. Jan Sherman. She is
11 author of Life's Delicate Balance and editor of
12 "Chernobyl: The consequence of the catastrophe for
13 people and the environment."

14 So the interview covers the book, the Chernobyl
15 book, which is a recent study of the health effects
16 of above-ground nuclear testing, and responses to
17 Stewart Brand's book Whole Earth Discipline with its
18 misguided promotion of the greening of nuclear power.
19 And it also contains free copies of both of
20 Dr. Sherman's books. I really highly recommend that
21 you download them and you read them and give them to
22 your friends.

23 So Lloyd wants to end by saying: We need to
24 make a massive commitment to renewable energy in
25 response to the growing impact of climate change.

866.488.DEPO
www.CapitalReportingCompany.com

T120-2

T120-3

T120-2 Stopping the generation of nuclear waste (i.e., nuclear power) is outside the scope of the GTCC EIS, the scope of which is to evaluate disposal alternatives to enable the selection of a safe alternative or alternatives for the disposal of GTCC LLRW and GTCC-like wastes. The GTCC EIS evaluates the range of reasonable alternatives for the disposal of GTCC LLRW and GTCC-like wastes in compliance with the requirements specified in NEPA, the Low-Level Radioactive Waste Policy Amendments Act (P.L. 99-240), and Section 631 of the Energy Policy Act of 2005 (P.L. 109-58). The GTCC EIS evaluates the potential environmental impacts of the proposed disposal alternatives for GTCC LLRW and GTCC-like wastes. Based on the evaluation, DOE has determined that there are safe and secure alternatives for the disposal of GTCC LLRW and GTCC-like wastes. The GTCC EIS provides information that supports this determination, and, as discussed in Section 1.1, Purpose and Need for Agency Action, DOE is responsible for the disposal of GTCC LLRW and GTCC-like wastes.

T120-3 Comment noted. Commitments to renewable energy are not within the scope of the GTCC EIS.

Oregon Conservancy Foundation, Commenter ID No. T120 (cont'd)

Capital Reporting Company		58
1	The time to disinvest ourselves of nuclear power is	
2	now.	

T120-3
(Cont.)

Oregon Department of Energy, Commenter ID No. E70

From: Niles, Ken <ken.niles@odoe.state.or.us>
Sent: Monday, June 27, 2011 4:43 PM
To: gtceis@anl.gov
Cc: Edelman, Arnold
Subject: Oregon Legislative Action Related to GTCC Draft EIS
Attachments: Oregon HJM_28.pdf

Arnie,

I wanted to submit a House Joint Memorial passed last week by the Oregon Legislature that addresses – in part – the draft GTCC EIS.



Ken Niles
Administrator, Nuclear Safety and Energy
Emergency Preparedness Division
Oregon Department of Energy
625 Marion Street NE
Salem, OR 97301

503-378-4906 - work
503-884-3905 - cell
ken.niles@odoe.state.or.us

762ND OREGON LEGISLATIVE ASSEMBLY-2011 Regular Session

Enrolled
House Joint Memorial 28

Sponsored by Representatives BAILEY, BERGER, Representatives BARKER, BARNHART, BENTZ, BEYER, BOONE, BREWER, BUCKLEY, CAMERON, CANNON, CLEM, CONGER, COWAN, DEMBROW, DOHERTY, ESQUIVEL, FREDERICK, FREEMAN, GARRARD, GARRETT, GELSER, GILLIAM, GREENLICK, HARKER, HOLVEY, HOYLE, HUFFMAN, HUNT, JENSON, KENNEMER, KOMP, KOTEC, MATTHEWS, MCLANE, NATHANSON, NOLAN, READ, ROBLAN, SCHAUFLEB, SHEEHAN, J SMITH, SPRENGER, THOMPSON, TOMEL, WAND, WEIDNER, WINGARD, WITT; Senators BURDICK, DEVLIN, DINGFELDER, HASS, JOHNSON, MONROE, PROZANSKI, ROSENBAUM, SHIELDS, VERGER

To the President of the United States and the Senate and the House of Representatives of the United States of America, in Congress assembled:

We, your memorialists, the Seventy-sixth Legislative Assembly of the State of Oregon, in legislative session assembled, respectfully represent as follows:

Whereas the federal government is currently considering the Hanford Nuclear Reservation for disposal of highly radioactive waste from across the nation; and

Whereas this is the sixth time since environmental cleanup began at Hanford that the federal government has proposed bringing radioactive waste, including highly radioactive waste, to Hanford for storage, disposal or both; and

Whereas Hanford is the site of the largest environmental cleanup program in the world, due to more than 40 years of generating waste during the production of plutonium for our nation's nuclear weapons program; and

Whereas millions of cubic feet of solid waste were disposed of improperly and placed in trenches and burial sites at Hanford and, because of this operation, Hanford is the most contaminated nuclear site in the United States today; and

Whereas more than 50 million gallons of radioactive waste are currently stored in underground tanks at Hanford, and approximately 440 billion gallons of less contaminated liquids have been discharged into the soil, creating an area of groundwater contamination of more than 80 square miles beneath the site; and

Whereas throughout the history of the site, extensive amounts of radioactive elements are known to have been released into the environment, some decaying over time but others remaining present due to their abundance and persistence, including strontium-90, plutonium, cesium-137 and technetium; and

Whereas the operations of the Hanford site have resulted in more than 43 million cubic yards of radioactive waste and more than 130 million cubic yards of contaminated soil and debris, representing two-thirds of the nation's high-level radioactive waste by volume; and

Whereas analysis by the United States Department of Energy shows persistent contamination in Hanford groundwater for thousands of years, even before accounting for additional waste disposal from off-site; and

Whereas existing cleanup efforts have been valuable, and there is still significant work needed in order to successfully rehabilitate the area; and

Whereas proposals to bring in additional waste to Hanford for disposal distract from and are contrary to the cleanup effort; and

Whereas Hanford is located along the Columbia River, just upriver from Oregon, where more than one million people live downriver in Portland, Hood River, The Dalles and other Oregon communities; and

E70-1 DOE's ROD 78 FR 75913 dated December 13, 2013, stated that DOE has deferred a decision on importing waste from other DOE sites (with limited exceptions as described in the Settlement Agreement with the State of Washington Department of Ecology) for disposal at Hanford at least until WTP is operational.

However, regardless of where the GTCC waste disposal facility is ultimately located, a relatively small amount of GTCC LLRW and GTCC-like wastes may be transported through the Columbia River Gorge on their way to the disposal facility. The waste would be generated within the states of Oregon and Washington and would include actinide sealed sources and Cs-137 irradiators from local medical institutions, research facilities, universities, and other NRC and Agreement State licensees.

DOE is performing environmental restoration activities at the Hanford Site. The ongoing cleanup effort will continue.

E70-2 DOE's ROD 78 FR 75913 dated December 13, 2013, stated that DOE has deferred a decision on importing waste from other DOE sites (with limited exceptions as described in the Settlement Agreement with the State of Washington Department of Ecology) for disposal at Hanford at least until WTP is operational.

If DOE decides to implement its preferred alternative for the TC&WM EIS, GTCC LLRW and GTCC-like wastes would not be shipped through the Columbia River Gorge for disposal at the Hanford Site until the waste treatment plant is operational. However, regardless of where the GTCC waste disposal facility is ultimately located, a relatively small amount of GTCC LLRW and GTCC-like wastes may be transported through the Columbia River Gorge on their way to the disposal facility. The waste would be generated within the states of Oregon and Washington and would include actinide sealed sources and Cs-137 irradiators from local medical institutions, research facilities, universities, and other NRC and Agreement State licensees.

The transportation of radioactive waste will meet or exceed DOT and NRC regulations that promote the protection of human health and the environment. These regulations include requirements for radioactive materials packaging, marking, labeling, placarding, shipping papers, and highway routing. The waste shipments would be on preferred routes, which are interstate highways or alternative routes designated by a state routing agency in accordance with DOT regulations (49 CFR Part 397, Subpart D). The GTCC LLRW and GTCC-like wastes would be shipped in approved waste packages and transportation casks. The robust nature of these casks limits the potential release of radioactive and chemically hazardous material under the severest of accident conditions. It is unlikely that the transportation of GTCC LLRW and GTCC-like wastes to any of the alternative sites evaluated in the EIS would cause an additional fatality as a result of radiation from either incident-free transportation or postulated transportation accidents.

E70-1

E70-2

J-447

January 2016

Oregon Department of Energy, Commenter ID No. E70 (cont'd)

Whereas besides river contamination, those who live along the interstate system would be adversely affected by Hanford's selection as a site for permanent storage of radioactive waste, due to vast increases in truckloads of radioactive waste traveling along interstate routes, passing through our cities; and

Whereas in the past, statements describing the scope of disaster involved following a foreseeable accident associated with a site for storage of radioactive waste were often considered extreme, after the events at Fukushima, Japan, all recognize that such dire outcomes may not be so easily dismissed; now, therefore,

Be It Resolved by the Legislative Assembly of the State of Oregon:

(1) The United States Department of Energy is urged to remove the Hanford Nuclear Reservation from the list of candidate sites for national permanent disposal of radioactive waste, both now and in the future.

(2) A copy of this memorial shall be sent to the President of the United States, to the Senate Majority Leader, to the Speaker of the House of Representatives, to the Secretary of Energy and to each member of the Oregon Congressional Delegation.

Adopted by House June 16, 2011

Ramona Kenady Line, Chief Clerk of House

Bruce Hanna, Speaker of House

Arnie Roblan, Speaker of House

Adopted by Senate June 22, 2011

Peter Courtney, President of Senate

E70-3 Impacts from potential accidents and intentional destructive acts resulting in potential releases of radioactive material were considered in the GTCC EIS in Sections 5.3.4.2, 5.3.4.4, and 5.3.9.3.

E70-4 The disposal methods and sites evaluated in the EIS represent the range of reasonable alternatives for the disposal of GTCC LLRW and GTCC-like wastes. This range is consistent with NEPA implementing regulations in Parts 1500–1508 of Title 40 of the Code of Federal Regulations (40 CFR Parts 1500–1508). In this GTCC EIS, DOE analyzed a range of disposal methods (i.e., geologic repository, near-surface trench, intermediate-depth borehole, and above-grade vault) and federally owned sites (i.e., Hanford Site, INL, LANL, NNSS, SRS, and the WIPP Vicinity, for which two reference locations – one within and one outside the WIPP Land Withdrawal Boundary – were considered). DOE has determined that it was reasonable to analyze these six sites because they currently have operating radioactive waste disposal facilities, except for the WIPP Vicinity, which is near an operating geologic repository.

Final siting of a disposal facility for GTCC LLRW and GTCC-like wastes would involve further NEPA review as needed and be in accordance with applicable laws and regulations and would involve local stakeholder involvement and consent.

DOE's ROD 78 FR 75913 dated December 13, 2013, stated that DOE has deferred a decision on importing waste from other DOE sites (with limited exceptions as described in the Settlement Agreement with the State of Washington Department of Ecology) for disposal at Hanford at least until WTP is operational.

E70-2
(Cont.)

E70-3

E70-4



OREGON
DEPARTMENT OF
ENERGY
625 Marion St. NE
Salem, OR 97301-3737
Phone: (503) 378-4040
Toll Free: 1-800-221-8035
FAX: (503) 373-7806
www.Oregon.gov/ENERGY

June 22, 2011

Arnold Edelman, Document Manager
Greater-Than-Class C Low-Level Radioactive Waste EIS
Office of Technical and Regulatory Support (EM-43)
U.S. Department of Energy
1000 Independence Avenue, SW
Washington, DC 20585-0119

Dear Mr. Edelman:

Oregon appreciates the opportunity to review the *Disposal of Greater-than-Class C (GTCC) Low-Level Radioactive Waste and GTCC-Like Waste Draft Environmental Impact Statement* (DOE/EIS-0375-D), February 2011. Last month, the Acting Director of this agency – in a joint letter with the Director of the Washington State Department of Ecology – expressed strong opposition to the potential selection of the Hanford Site for disposal of wastes examined in this draft EIS. That letter pointed out the incompatibility of adding highly radioactive and long-lived waste to Hanford’s subsurface, while tens of billions of dollars are being spent on the current cleanup effort.

The comments that follow in this letter expand on that position and also raise other concerns with various proposals considered in the draft GTCC EIS. In addition, we recognize that simply opposing the selection of Hanford without providing some alternatives to consider is not useful input to this process, so we do provide some recommendations for how to deal with the wastes covered by this proposed action.

Conflicts with the Hanford cleanup mission

As the U.S. Department of Energy’s (DOE) Environmental Management program is fully aware, the Hanford Site is home to immense contamination from more than 40 years of plutonium production for America’s nuclear weapons program. Hanford is also home to the largest environmental cleanup endeavor in the world – a cleanup that is now expected to stretch well past the year 2050.

Since cleanup began at Hanford in 1989, we and others have been increasingly frustrated by repeated attempts by DOE to add waste not associated with Hanford to the substantial environmental burden that exists here and that will exist for hundreds and even thousands of years into the future. DOE’s own analysis in the draft Tank Closure & Waste Management

E72-1

The disposal methods and sites evaluated in the EIS represent the range of reasonable alternatives for the disposal of GTCC LLRW and GTCC-like wastes. This range is consistent with NEPA implementing regulations in Parts 1500–1508 of Title 40 of the Code of Federal Regulations (40 CFR Parts 1500–1508). In this GTCC EIS, DOE analyzed a range of disposal methods (i.e., geologic repository, near-surface trench, intermediate-depth borehole, and above-grade vault) and federally owned sites (i.e., Hanford Site, INL, LANL, NNSS, SRS, and the WIPP Vicinity, for which two reference locations – one within and one outside the WIPP Land Withdrawal Boundary – were considered). DOE has determined that it was reasonable to analyze these six sites because they currently have operating radioactive waste disposal facilities, except for the WIPP Vicinity, which is near an operating geologic repository.

Final siting of a disposal facility for GTCC LLRW and GTCC-like wastes would involve further NEPA review as needed and be in accordance with applicable laws and regulations and would involve local stakeholder involvement and consent.

DOE is performing environmental restoration activities at the Hanford Site. The ongoing cleanup effort will continue.

E72-1

Oregon Department of Energy, Commenter ID No. E72 (cont'd)

(TC&WM) EIS, released in late 2009, found that even after cleanup is complete, waste already in Hanford's soil column will continue to contaminate Hanford's groundwater for thousands of years. Modeling in the draft TC&WM EIS clearly indicated that additional waste from off-site would have unacceptable environmental consequences, especially if that waste contained mobile and long-lived contaminants such as iodine 129 and technetium 99.

In addition, uranium contamination in the Hanford soils and groundwater far exceeds acceptable levels. Despite DOE's best efforts, attempts to treat these plumes have to date been unsuccessful. The continued movement of uranium through the vadose zone and into groundwater is predicted in the draft TC&WM EIS to be the dominant risk far exceeding allowable levels over the next 10,000 years and beyond. As such, new wastes containing uranium would aggravate an already massive cleanup effort and increase the scope of environmental contamination.

The draft GTCC EIS recognizes the iodine and technetium limitation (and to a lesser extent the uranium problems) at Hanford. It recognizes the moratorium on sending new waste to Hanford until at least 2022. It also recognizes that use of Hanford for disposal of this waste would result in far more transportation than for any of the other alternatives that were considered. Given all this – plus the efforts that are underway to clean up the site – we have to ask the question: Why hasn't Hanford already been eliminated from consideration for this action?

The draft GTCC EIS says that Hanford and other DOE sites were evaluated on the basis of "mission compatibility" – that they have radioactive waste disposal as part of their ongoing mission. Importing highly radioactive waste and disposing of it in the shallow or intermediate subsurface at Hanford is not at all compatible with the cleanup mission. It is actually counter to the cleanup, as much of the Hanford cleanup mission is already devoted to retrieving waste from Hanford's shallow and intermediate subsurface. Adding new off-site wastes would only exacerbate an already challenging situation.

The draft GTCC EIS does not have a preferred alternative as DOE indicates it does not have a preference at this time. DOE is also awaiting further input from Congress, which directed DOE to conduct this EIS. However, it is DOE's responsibility to eliminate alternatives that are not reasonable or protective. Using Hanford for disposal of GTCC wastes is neither reasonable nor protective and Hanford should be removed from consideration as an alternative.

Geologic versus near-surface disposal

Federal law (10 CFR 61.55) is clear that GTCC waste "is generally not acceptable for near-surface disposal." Congress did allow that there may be some instances where GTCC waste would be acceptable for near-surface disposal with special processing or design. These would be evaluated on a case-by-case basis.

E72-2

The EIS analysis is used to assess the viability of an alternative as well as its relative performance compared to the other alternatives. Exclusion of a reasonable alternative from the EIS without first evaluating the site is contrary to a thorough NEPA analysis. All alternatives are retained in the Final EIS because such evaluations are needed to support selection of the preferred alternative. In addition, as discussed in Section 1.4.2, the conceptual disposal facility designs analyzed in the EIS could be modified to perform better in specific locations. Thus, poor performance in the EIS analysis does not necessarily exclude an alternative from consideration.

E72-1
(Cont.)

E72-2

Oregon Department of Energy, Commenter ID No. E72 (cont'd)

As DOE began this EIS process, the proposed high-level waste repository at Yucca Mountain was one of the options to be considered. DOE also planned to examine the existing geologic disposal site – the Waste Isolation Pilot Plant (WIPP) in New Mexico (even though current law forbids use of this facility for these wastes).

With the apparent demise of Yucca Mountain and the considerable level of uncertainty over America's plans for a high-level waste repository, DOE analyzed only WIPP for geologic disposal. Given that there is still the expectation that at some point the United States will site and construct a high-level waste repository, we strongly recommend that DOE analyze a "generic" repository in a medium other than salt (since DOE has already analyzed WIPP) for disposal of part or all of the wastes considered in this EIS.

DOE also went forward with examination of a range of alternatives of near-surface or intermediate-depth disposal. This wide-sweeping look at alternatives to deep geologic disposal would be difficult to justify on a case-by-case basis and suggests that long-term protectiveness may be overshadowed by efforts to reduce potential disposal costs. Decisions related to waste disposal should be commensurate with both the hazards posed by the wastes and with the time frames over which the waste remains dangerous. The uncertainty surrounding a national high-level waste repository should not lead to a premature decision to use less than protective alternatives.

From the risk analysis in the GTCC EIS, it is clear that trench and borehole disposal leads to impacts vastly exceeding regulatory standards at many of the sites considered. Despite these results, DOE has retained all of the sites and methods for consideration within the draft GTCC EIS. We believe the trench and borehole methods should be withdrawn from consideration. Experience with near-surface trenches at Hanford and around the DOE complex have shown repeatedly that steel containers rapidly degrade in the soil. This is not surprising, as the pH and humidity in Hanford and other soils is high, even though the moisture content is low.

Arid vs. Wet sites

At a high level, DOE argues that a major discriminator between sites is whether they are arid sites or wet sites. While it is true that the relative differences in rainfall and snow melt from site to site are important, this glosses over other major factors that can and often do outweigh this as a factor. For example: uranium is highly mobile when complexed with carbonate at above neutral pH. The arid sites all tend to be carbonate and silicate rich and to have high pH soils, which renders uranium highly mobile. Wet sites often have a lower pH and binding capacity that may render uranium far less mobile. In addition, wet sites are likely to have reducing conditions in soils, which can greatly affect mobility of radioisotopes and other contaminants. Technetium is likewise somewhat less mobile at wet sites, while it is completely and freely mobile at many

E72-3 The EIS considered the range of reasonable alternatives for the disposal of the GTCC waste inventory, including disposal in a deep geologic repository. DOE did not evaluate developing a geologic repository exclusively for disposal of GTCC LLRW and GTCC-like wastes because DOE determined that such an alternative is not reasonable due to the time and cost associated with siting a deep geologic repository and the relatively small volume of GTCC LLRW and GTCC-like wastes identified in the GTCC EIS. DOE believes that the results presented in this EIS for the WIPP geologic repository alternative are indicative of the high degree of waste isolation that would be provided by disposal in a geologic repository. DOE has included analysis of generic commercial facilities in the event that a facility could become available in the future. In that case, before making a decision to use a commercial facility, DOE would conduct further NEPA reviews, as appropriate.

E72-3 DOE recognizes that disposal of GTCC LLRW and GTCC-like wastes in the WIPP geologic repository would require modification to existing law. In addition, it may be necessary to revise the Agreement for Consultation and Cooperation between Department of Energy and the State of New Mexico for the Waste Isolation Pilot Plant, the WIPP compliance certification with the EPA, and the WIPP Hazardous Waste Facility Permit.

E72-4 DOE agrees that use of a geologic repository would be a protective and safe method for the disposal of the entire inventory of GTCC LLRW and GTCC-like wastes. The GTCC EIS evaluation for the WIPP geologic repository alternative supports this statement. However, the degree of waste isolation provided by a geologic repository may not be necessary for all of the GTCC LLRW and GTCC-like wastes evaluated in the GTCC EIS. The GTCC EIS evaluation indicates that certain wastes (e.g., those containing short-lived radionuclides such as Cs-137 irradiators) could be safely disposed of in properly designed land disposal facilities at sites with suitable characteristics, such as low precipitation rates, high soil distribution coefficients, and sufficient depths to groundwater. Based on the GTCC EIS evaluation, land disposal facilities located in arid climates (e.g., NNSS and WIPP Vicinity) would isolate radionuclides for a sufficient period of time to allow for significant radioactive decay to occur.

E72-4 While 10 CFR Part 61 identifies one NRC-approved method for GTCC LLRW disposal (disposal in a geologic repository), these regulations also indicate that other disposal methods could be approved. The GTCC EIS evaluates three land disposal methods (i.e., enhanced near-surface trench, intermediate-depth borehole, and above-grade vault). The GTCC EIS evaluation indicates that land disposal methods employed at sites with suitable characteristics would be viable and safe alternatives for the disposal of GTCC LLRW.

E72-5 DOE recognizes the importance of waste form and potential chemical reactions in the subsurface environment. As mentioned in Section 1.4.2, the land-disposal facilities considered are conceptual and generic in nature so as to evaluate site performance. As such, a uniform release rate after a given time period was assumed for each waste category across all land-disposal sites irrespective of environment. While contaminant release will be highly dependent on the interactions of the contaminant with the soil chemistry or environment, the conceptual designs could be altered or enhanced, as necessary, to provide the optimal application at a given location as mentioned in Section 1.4.2. When comparing results across sites, the post-closure analysis clearly shows the potential for subsequent migration downward through the unsaturated zone(s) to groundwater (the water table) in most cases is highly dependent on the amount of water available to move the contamination. In addition, the analysis also shows the importance of the interactions of the contaminant with the soil chemistry or environment which is reflected through the use and impact of site-specific distribution (partition) coefficients, otherwise known as Kd factors, such as in different locations within the unsaturated zone at the same site. Thus, based on the post-closure analysis, which attempts to provide a simulation of complex soil and groundwater processes, it was shown that arid sites generally performed better than wet sites. Selection of the preferred alternative took this finding into account along with other site-specific factors that included potential effects of interactions of the contaminant with the soil chemistry or environment.

Oregon Department of Energy, Commenter ID No. E72 (cont'd)

arid sites. DOE should not rely on the misleading simple attribute of water availability in comparing arid versus wet sites in its evaluations.

Models

The GTCC EIS relies on the use of the RESRAD computer model suite. Experience in Hanford's 100 and 300 Areas demonstrated serious flaws in the model. DOE now uses the "Surface Transport over Multiple Phases" (STOMP-W) and MODFLOW modeling codes for Hanford groundwater modeling. Though STOMP has serious limitations, it is vastly superior to RESRAD. STOMP-W is the basis of the TC&WM EIS now under development at Hanford.

In responding to commenters who noted RESRAD's limitations and offered alternatives, DOE acknowledges RESRAD's inadequacies. DOE replied that precise answers are not required; that all that is needed is an ability to compare the alternatives. DOE does a disservice to the public in making this argument and in using a flawed model. Given the fact these wastes will pose a hazard for thousands of years, DOE should use the best model that is available, while also recognizing its limitations.

Recommendations for Wastes Covered in the EIS

Activated Metals

The activated metals included in the EIS present some unique challenges. They are very radioactive in the near term with intense gamma radiation from cobalt 60. Some of the reactor vessels and associated components are quite large, which raise challenges in transport and in disposal other than in a trench. The high levels of radiation would make it difficult for workers to safely cut the vessels into smaller pieces to make them easier to transport or dispose. However, the EIS points out that little of these materials are currently in storage. Most activated metals are expected to be generated in the future and in many cases not for several decades. There is therefore no urgency to designate a disposal path for this waste stream. DOE should consider placing these reactor vessels and related components in surface or near-surface storage pending 50 to 75 years of decay to eliminate the hazard from the cobalt 60, prior to appropriate final disposal within the regions in which they originate.

Scaled Sources

The sealed sources can pose an immediate hazard. They are potentially attractive for use by terrorists. These should be rapidly recovered by DOE and stored in a highly secure storage facility pending the siting and construction of a high-level waste repository suitable to receive

E72-6 The RESRAD-OFFSITE code, like all codes, has limitations. This code was selected for the GTCC EIS analysis because of its manageable number of input parameters, its comprehensive transport analysis for radionuclides in the unsaturated zones and saturated zone, and its flexibility in accepting radionuclide release rates calculated outside the RESRAD-OFFSITE framework. Furthermore, the RESRAD-OFFSITE code has been benchmarked with other computer codes. The results obtained from the code are considered to be technically sound estimates.

Additional site-specific information, if available, and different models, if necessary, would be used in any site-specific NEPA review that would be conducted based on a ROD for this EIS.

E72-7 The recommendations given (storage of activated metals to reduce the hazard level, disposal of sealed sources in a deep geologic repository, and disposal of non-defense transuranic waste consistent with that for defense-related transuranic waste) were taken into consideration, as appropriate, in the selection of the preferred alternative.

E72-5
(Cont.)

E72-6

E72-7

them. Proper disposal in a deep geologic repository is the most protective approach. Given the limitation on the waste that can be received at WIPP, this reinforces the need for the nation to develop a new repository.

Other Wastes

The EIS points out that many of the GTCC-like wastes have long-lived transuranic radionuclides and will remain hazardous for many thousands of years. Similar wastes are currently being disposed of in a geologic repository (WIPP) because of this concern. We recommend DOE (and the U.S. Nuclear Regulatory Commission) consider and treat defense and non-defense transuranic wastes in a comparable manner with comparable protection by disposing of this waste solely into a deep geologic repository.

We do not have sufficient information to assess whether exhumation of the West Valley disposal areas should occur. However, if the decision is made to exhume those wastes, they should be disposed of consistently with similar materials and consistent with our comments above.

EIS Organization/Readability

The authors, writers and editors of the GTCC EIS have done a commendable job of producing a clear, concise and highly readable document. DOE staff also did a good job in providing direct and clear responses to comments provided during the scoping for this EIS.

We also commend DOE for working with Native American tribes in allowing them to provide their perspective throughout the draft EIS. However, in so recognizing the special relationship between Native people and the land and environment, it raises the expectation that DOE will fully consider this perspective in selecting a preferred alternative and moving forward with a decision that honors the Treaty-reserved rights of the tribes.

We look forward to working with DOE as it completes analysis of the GTCC EIS. If you have any questions or comments about our recommendations, please contact myself or Dirk Dunning of my staff at 503-378-3187.

Sincerely,



Ken Niles
Nuclear Safety Division Administrator

E72-7
(Cont.)

Oregon Department of Energy, Commenter ID No. E72 (cont'd)

Cc: Matt McCormick, U.S. Department of Energy, Richland
Scott Samuelson, U.S. Department of Energy, Office of River Protection
Jane Hedges, Washington Department of Ecology
Dennis Faulk, U.S. Environmental Protection Agency
Stuart Harris, Confederated Tribes of the Umatilla Indian Reservation
Russell Jim, Yakama Indian Nation
Gabriel Bohnee, Nez Perce Tribe
Max Power, Chair, Oregon Hanford Cleanup Board
Susan Leckband, Chair, Hanford Advisory Board

Oregon Hanford Cleanup Board, Commenter ID No. E71

From: Niles, Ken <ken.niles@odoe.state.or.us>
Sent: Monday, June 27, 2011 4:39 PM
To: gtcccis@anl.gov
Cc: Edelman, Arnold
Subject: Comments on behalf of the Oregon Hanford Cleanup Board
Attachments: Oregon Hanford Cleanup Board_GTCC comments.pdf

Attached are comments that are being submitted on behalf of the Oregon Hanford Cleanup Board.



Ken Niles
Administrator, Nuclear Safety and Energy
Emergency Preparedness Division
Oregon Department of Energy
625 Marion Street NE
Salem, OR 97301

503-378-4906 - work
503-884-3905 - cell
ken.niles@odoe.state.or.us

OREGON HANFORD CLEANUP BOARD

Max Power, Chair

June 27, 2011

Mecal Sankow, Vice-Chair

Pat Hart

Maxine Hines

Wayne Lei

Robert McFarlane, M.D.

Kristen McNall

Shelby Rihala

David Ripma

Lyle Smith

Athena Huestice-Wolf
Confederated Tribes of
the Umatilla Indian
Reservation

Bob Repinc
Oregon Dept. of Energy

Governor's Office

Phil Ward, Director
Water Resources
Department

Sen. David Nelson

Rep. Jules Bailey

Rep. Vicki Berger

Rep. John Huffman

Shelley Carlson
Administrator

Arnold Edelman, EIS Document Manager
Greater-Than-Class C Low-Level Radioactive Waste EIS
Office of Technical and Regulatory Support (EM-43)
U.S. Department of Energy
1000 Independence Avenue, SW
Washington, DC 20585-0119

Dear Mr. Edelman:

The Oregon Hanford Cleanup Board (Board) appreciates the opportunity to comment on the *Disposal of Greater-than-Class C (GTCC) Low-Level Radioactive Waste and GTCC-Like Waste Environmental Impact Statement* (DOE/EIS-0375-D), February 2011. The Board was created by the Oregon legislature to provide advice on issues involving the Hanford nuclear site that affect Oregonians. The Board includes state agency representatives, legislators, a Tribal representative, and public members with a range of expertise and interests that include nuclear engineering and physical and environmental sciences.

The Board discussed the GTCC EIS during our meeting on June 23-24, 2011. As part of that discussion, we reviewed the June 22 comment letter submitted by the Oregon Department of Energy (ODOE) and also reviewed the discussion between Board leaders and the EIS Document Manager on May 19 in Portland. The Board concurs with several of the positions stated by ODOE. Without elaborating on these specific topics the board acknowledges the more detailed discussion by ODOE and advises that:

1. Importing additional waste to Hanford should be dropped from further consideration. Import of additional waste is clearly incompatible with the existing mission of Hanford cleanup. Moreover, as shown in this EIS and in the U.S. Department of Energy's (DOE's) 2009 draft Tank Closure and Waste Management EIS for the Hanford Site, import of some of the waste forms and use of disposal approaches proposed in this document is projected to result in groundwater contamination and risks that greatly exceed regulatory standards.
2. DOE should re-evaluate disposal options framed by this EIS. Analyses presented in the EIS show that disposal in trenches and boreholes is not protective of human health at Hanford or at other sites evaluated in the EIS. Consistent with federal regulation (10 CFR 61.55), we recommend that geologic disposal be regarded as the default disposal method for all

phone 503.378.4040 800.221.8035 in Oregon fax 503.373.7806

825 Marion Street, N.E., Salem, Oregon 97301-3737

www.oregon.gov/ENERGY/NUCSAF/HCB/hwboard.shtml

E71-1

The GTCC EIS evaluates the transportation impacts from the shipments that would be required to dispose of the entire inventory of GTCC LLRW and GTCC-like wastes at the Hanford Site and all the other sites being evaluated.

The GTCC EIS evaluates collective population risks during routine conditions and accidents, radiological risks to the highest exposed individuals during routine conditions, and consequences to individuals and populations as a result of transportation accidents, including the release of radioactive or hazardous chemical materials. For the truck option, it is estimated that about 12,600 shipments resulting in about 50 million km (30 million mi) of travel would be required. This transport of GTCC LLRW and GTCC-like wastes would not result in any LCFs, although one fatality directly related to an accident might occur (see Section 6.2.9.1).

In addition, Chapter 6 of the TC&WM EIS also has evaluated cumulative impacts addressing disposal of potential future wastes (including GTCC LLRW and GTCC-like waste) at the Hanford site.

E71-2

DOE agrees that use of a geologic repository would be a protective and safe method for the disposal of the entire inventory of GTCC LLRW and GTCC-like wastes. The GTCC EIS evaluation for the WIPP geologic repository alternative supports this statement. However, the degree of waste isolation provided by a geologic repository may not be necessary for all of the GTCC LLRW and GTCC-like wastes evaluated in the GTCC EIS. The GTCC EIS evaluation indicates that certain wastes (e.g., those containing short-lived radionuclides such as Cs-137 irradiators) could be safely disposed of in properly designed land disposal facilities at sites with suitable characteristics, such as low precipitation rates, high soil distribution coefficients, and sufficient depths to groundwater. Based on the GTCC EIS evaluation, land disposal facilities located in arid climates (e.g., NNSS and WIPP Vicinity) would isolate radionuclides for a sufficient period of time to allow for significant radioactive decay to occur.

While 10 CFR Part 61 identifies one NRC-approved method for GTCC LLRW disposal (disposal in a geologic repository), these regulations also indicate that other disposal methods could be approved. The GTCC EIS evaluates three land disposal methods (i.e., enhanced near surface trench, intermediate-depth borehole, and above-grade vault). The GTCC EIS evaluation indicates that land disposal methods employed at sites with suitable characteristics would be viable and safe alternatives for the disposal of GTCC LLRW.

E71-1

E71-2

- GTCC wastes except on a case-by case basis where alternate disposal methods are shown to clearly be protective.
3. Sealed sources represent a significant existing security threat to the United States. We recommend that these materials be recovered expeditiously and stored by DOE in a highly secure site pending permanent repository storage.
 4. Like wastes should be handled and stored in a like manner. The board believes that all defense and non-defense wastes with transuranic radionuclides should be regulated and disposed in a similar manner, with permanent disposal in a deep geologic repository.

In addition, the Board is concerned with the apparent lack of clear decision processes for evaluating alternatives for GTCC waste disposal. It is unclear which procedures will be used and how criteria will be applied in making decisions to select specific sites and disposal methods for ultimate disposal of the wastes considered in this EIS. It is important to avoid using decision techniques which are based on political considerations, when the optimal solutions will be found according to the objective standards of rigorous decision analysis.

To ensure broad public acceptance of the decisions reached in the final EIS, it is important to articulate and to apply a well-defined, transparent decision process that considers factors such as consistency with federal regulations and guidance, compatibility with ongoing site mission, short- and long-term protectiveness, community support, life-cycle costs, etc. We recommend that the final EIS include a formal decision analysis process (including identification of uncertainties, all relative parameters, and values/utilities), and that the preferred alternative be based on results of that formal decision analysis.

We look forward to working with DOE as it completes analysis of the GTCC EIS. If you have questions or comments about our recommendations, please contact Dirk Dunning of the ODOE staff at 503-378-3187.

Sincerely,

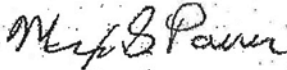

Max Power, Chair

E71-3 The basis for DOE's selection of the preferred alternative is presented in Section 2.9 of the EIS and identified in Section 2.10.

E71-2
(Cont.)

E71-3

Oregon Legislative Assembly, Commenter ID No. L299

76th OREGON LEGISLATIVE ASSEMBLY-2011 Regular Session

**Enrolled
House Joint Memorial 28**

Sponsored by Representatives BAILEY, BERGER; Representatives BARKER, BARNHART, BENTZ, BEYER, BOONE, BREWER, BUCKLEY, CAMERON, CANNON, CLEM, CONGER, COWAN, DEMBROW, DOHERTY, ESQUIVEL, FREDERICK, FREEMAN, GARRARD, GARRETT, GELSEY, GILLIAM, GREENLICK, HARKER, HOLVEY, HOYLE, HUFFMAN, HUNT, JENSON, KENNEMER, KOMP, KOTEK, MATTHEWS, MCLANE, NATHANSON, NOLAN, READ, ROBLAN, SCHAUFELER, SHEEHAN, J SMITH, SPRENGER, THOMPSON, TOMEI, WAND, WEIDNER, WINGARD, WITT. Senators BURDICK, DEVLIN, DINGFELDER, HASS, JOHNSON, MONROE, PROZANSKI, ROSENBAUM, SHIELDS, VERGER

To the President of the United States and the Senate and the House of Representatives of the United States of America, in Congress assembled:

We, your memorialists, the Seventy-sixth Legislative Assembly of the State of Oregon, in legislative session assembled, respectfully represent as follows:

Whereas the federal government is currently considering the Hanford Nuclear Reservation for disposal of highly radioactive waste from across the nation; and

Whereas this is the sixth time since environmental cleanup began at Hanford that the federal government has proposed bringing radioactive waste, including highly radioactive waste, to Hanford for storage, disposal or both; and

Whereas Hanford is the site of the largest environmental cleanup program in the world, due to more than 40 years of generating waste during the production of plutonium for our nation's nuclear weapons program; and

Whereas millions of cubic feet of solid waste were disposed of improperly and placed in trenches and burial sites at Hanford and, because of this operation, Hanford is the most contaminated nuclear site in the United States today; and

Whereas more than 50 million gallons of radioactive waste are currently stored in underground tanks at Hanford, and approximately 440 billion gallons of less contaminated liquids have been discharged into the soil, creating an area of groundwater contamination of more than 80 square miles beneath the site; and

Whereas throughout the history of the site, extensive amounts of radioactive elements are known to have been released into the environment, some decaying over time but others remaining present due to their abundance and persistence, including strontium-90, plutonium, cesium-137 and technetium; and

Whereas the operations of the Hanford site have resulted in more than 43 million cubic yards of radioactive waste and more than 130 million cubic yards of contaminated soil and debris, representing two-thirds of the nation's high-level radioactive waste by volume; and

Whereas analysis by the United States Department of Energy shows persistent contamination in Hanford groundwater for thousands of years, even before accounting for additional waste disposal from off-site; and

Whereas existing cleanup efforts have been valuable, and there is still significant work needed in order to successfully rehabilitate the area; and

Whereas proposals to bring in additional waste to Hanford for disposal distract from and are contrary to the cleanup effort; and

Whereas Hanford is located along the Columbia River, just upriver from Oregon, where more than one million people live downriver in Portland, Hood River, The Dalles and other Oregon communities; and

Enrolled House Joint Memorial 28 (HJM 28-A)

Page 1

L299-1 DOE's ROD 78 FR 75913 dated December 13, 2013, stated that DOE has deferred a decision on importing waste from other DOE sites (with limited exceptions as described in the Settlement Agreement with the State of Washington Department of Ecology) for disposal at Hanford at least until WTP is operational.

However, regardless of where the GTCC waste disposal facility is ultimately located, a relatively small amount of GTCC LLRW and GTCC-like wastes may be transported through the Columbia River Gorge on their way to the disposal facility. The waste would be generated within the states of Oregon and Washington and would include actinide sealed sources and Cs-137 irradiators from local medical institutions, research facilities, universities, and other NRC and Agreement State licensees.

DOE is performing environmental restoration activities at the Hanford Site. The ongoing cleanup effort will continue.

L299-1

J-458

January 2016

Oregon Legislative Assembly, Commenter ID No. L299 (cont'd)

Whereas besides river contamination, those who live along the interstate system would be adversely affected by Hanford's selection as a site for permanent storage of radioactive waste, due to vast increases in truckloads of radioactive waste traveling along interstate routes, passing through our cities; and

Whereas in the past, statements describing the scope of disaster involved following a foreseeable accident associated with a site for storage of radioactive waste were often considered extreme, after the events at Fukushima, Japan, all recognize that such dire outcomes may not be so easily dismissed; now, therefore,

Be It Resolved by the Legislative Assembly of the State of Oregon:

(1) The United States Department of Energy is urged to remove the Hanford Nuclear Reservation from the list of candidate sites for national permanent disposal of radioactive waste, both now and in the future.

(2) A copy of this memorial shall be sent to the President of the United States, to the Senate Majority Leader, to the Speaker of the House of Representatives, to the Secretary of Energy and to each member of the Oregon Congressional Delegation.

Adopted by House June 16, 2011

Ramona Kenady Line, Chief Clerk of House

Bruce Hanna, Speaker of House

Arnie Roblan, Speaker of House

Adopted by Senate June 22, 2011

Peter Courtney, President of Senate

L299-2

L299-3

L299-4

L299-2 DOE's ROD 78 FR 75913 dated December 13, 2013, stated that DOE has deferred a decision on importing waste from other DOE sites (with limited exceptions as described in the Settlement Agreement with the State of Washington Department of Ecology) for disposal at Hanford at least until WTP is operational.

If DOE decides to implement its preferred alternative for the TC&WM EIS, GTCC LLRW and GTCC-like wastes would not be shipped through the Columbia River Gorge for disposal at the Hanford Site until the waste treatment plant is operational. However, regardless of where the GTCC waste disposal facility is ultimately located, a relatively small amount of GTCC LLRW and GTCC-like wastes may be transported through the Columbia River Gorge on their way to the disposal facility. The waste would be generated within the states of Oregon and Washington and would include actinide sealed sources and Cs-137 irradiators from local medical institutions, research facilities, universities, and other NRC and Agreement State licensees.

The transportation of radioactive waste will meet or exceed DOT and NRC regulatory requirements that promote the protection of human health and the environment. These regulations include requirements for radioactive materials packaging, marking, labeling, placarding, shipping papers, and highway routing. The waste shipments would be on preferred routes, which are interstate highways or alternative routes designated by a state routing agency in accordance with DOT regulations (49 CFR Part 397, Subpart D). The GTCC LLRW and GTCC-like wastes would be shipped in approved waste packages and transportation casks. The robust nature of these casks limits the potential release of radioactive and chemically hazardous material under the severest of accident conditions. It is unlikely that the transportation of GTCC LLRW and GTCC-like wastes to any of the alternative sites evaluated in the EIS would cause an additional fatality as a result of radiation from either incident-free transportation or postulated transportation accidents.

L299-3 Impacts from potential accidents and intentional destructive acts resulting in potential releases of radioactive material were considered in the GTCC EIS in Sections 5.3.4.2, 5.3.4.4, and 5.3.9.3.

L299-4 The disposal methods and sites evaluated in the EIS represent the range of reasonable alternatives for the disposal of GTCC LLRW and GTCC-like wastes. This range is consistent with NEPA implementing regulations in Parts 1500-1508 of Title 40 of the Code of Federal Regulations (40 CFR Parts 1500-1508). In this GTCC EIS, DOE analyzed a range of disposal methods (i.e., geologic repository, near-surface trench, intermediate-depth borehole, and above-grade vault) and federally owned sites (i.e., Hanford Site, INL, LANL, NNSS, SRS, and the WIPP Vicinity, for which two reference locations - one within and one outside the WIPP Land Withdrawal Boundary - were considered). DOE has determined that it was reasonable to analyze these six sites because they currently have operating radioactive waste disposal facilities, except for the WIPP Vicinity, which is near an operating geologic repository.

Final siting of a disposal facility for GTCC LLRW and GTCC-like wastes would involve further NEPA review as needed and be in accordance with applicable laws and regulations and would involve local stakeholder involvement and consent.

DOE's ROD 78 FR 75913 dated December 13, 2013, stated that DOE has deferred a decision on importing waste from other DOE sites (with limited exceptions as described in the Settlement Agreement with the State of Washington Department of Ecology) for disposal at Hanford at least until WTP is operational.

Oregon Physicians for Social Responsibility, Commenter ID No. E46

From: John Howieson <howiesoj@comcast.net>
Sent: Wednesday, June 22, 2011 11:41 AM
To: gtcceis@anl.gov
Subject: Comment on Draft EIS for disposal of GTCC waste:

Comment on Draft EIS for disposal of GTCC waste:

Oregon Physicians for Social Responsibility concurs completely with comments submitted by U.S. Senators Wyden and Merkley, Oregon Nuclear Safety Division Director Ken Niles and Portland Mayor Sam Adams opposing shipping of GTCC waste to the Hanford reservation. After more than 20 years of cleanup effort at a cost of man billions of dollars it would be counterproductive to add to the burden of cleanup of this site. In addition there are dangers attendant to transport of these highly radioactive materials that make this an unacceptable alternative. As stated by Senator Wyden, this alternative should not have been included in the draft EIS.

John Howieson, MD

- E46-1 DOE is performing environmental restoration activities at the Hanford Site. The ongoing cleanup effort will continue.
- E46-2 DOE is responsible under the Low-Level Radioactive Waste Policy Amendments Act (P.L. 99-240) for the disposal of GTCC LLRW. The purpose of the EIS is to evaluate alternatives for the safe and secure disposal of GTCC LLRW and GTCC-like wastes. Continued storage of GTCC LLRW at the generating facilities was evaluated as part of the No Action alternative. Transportation of GTCC LLRW and GTCC-like wastes from generating facilities to a GTCC LLRW disposal facility is a required component of the disposal process that would be identified for the GTCC LLRW and GTCC-like wastes because the disposal site(s) or location(s) would not be the same as the generator sites for reasons provided in the EIS. DOE believes that the transportation of GTCC LLRW and GTCC-like wastes to a more centralized disposal facility would result in lower overall human health risks compared to managing the wastes at multiple locations and can be conducted in a safe manner based on compliance with comprehensive regulatory requirements and past experiences.
- E46-1 The EIS evaluates the transportation impacts from the shipments that would be required to dispose of all of the GTCC LLRW and GTCC-like wastes at each of the reference locations evaluated. The EIS addresses the collective population risks during routine conditions and accidents, the radiological risks to the highest exposed individuals during routine conditions, and the consequences to individuals and populations as a result of transportation accidents, including those that could release radioactive or hazardous chemical contaminants. The EIS also evaluated the impact of intentional destructive acts that could occur during waste handling, transportation, and disposal (see Section 2.7.4.3 of the EIS). The potential risk of such destructive acts is estimated to be low. DOE sites considered in the EIS are secure, and the packaging for the GTCC LLRW and GTCC-like wastes would be robust. Because GTCC LLRW and GTCC-like wastes are not readily dispersible, the potential physical impacts from an intentional destructive act (e.g., an explosive blast) would be no greater than those from the release of any radioactivity from a severe accident during waste handling, transportation, and disposal.
- E46-2 DOE's requirements for transportation of radioactive waste are developed and continually revised to ensure maximum protection of public health and the environment, thereby minimizing the risk of a traffic accident. DOE has established a comprehensive emergency management program that provides detailed, hazard specific planning and preparedness measures to minimize the health impacts of accidents involving loss of control over radioactive material or toxic chemicals. DOE's transportation emergency preparedness program was established to ensure that DOE and its contractors, state, tribal, and local emergency responders are prepared to respond promptly, efficiently, and effectively to accidents involving DOE shipments of radioactive materials. Should an accident occur that involves a release of radioactive material to the environment, it would be promptly remediated in accordance with these procedures. These measures would help DOE to minimize and mitigate any impacts on the environment.
- E46-3 The EIS analysis is used to assess the viability of an alternative as well as its relative performance compared to the other alternatives. Exclusion of a reasonable alternative from the EIS without first evaluating the site is contrary to a thorough NEPA analysis. All alternatives are retained in the Final EIS because such evaluations are needed to support selection of the preferred alternative. In addition, as discussed in Section 1.4.2, the conceptual disposal facility designs analyzed in the EIS could be modified to perform better in specific locations. Thus, poor performance in the EIS analysis does not necessarily exclude an alternative from consideration.

Capital Reporting Company

54

1
2
3
4
5
6
7
8
9
10
11
12
13
14
15
16
17
18
19
20
21
22
23
24
25

MR. BROWN: David Hess will follow Gregory.

MR. KAFOURY: Hi. I'm Greg Kafoury. I'm here
for the Oregon Progressive Party.

Why do we have to tolerate torture, black sites,
a government that listens to our phone calls, that
tracks our e-mails? Terrorism. Why do we have to
subject our children to being sexually abused at
airports? You have heard about the terrorists,
haven't you?

Now we're going to have to eat other people's
nuclear waste because of terrorism. Somebody is
going to get this stuff and make a dirty bomb. Well,
really? Ninety-eight percent of the radioactivity is
encased in steel. It's irradiated metal. What are
they going to do with that? Put it in the air?
Dissolve it in the water? Who you kidding?

You know, if somebody wants to hurt us -- and
our national security state is very busy dreaming up
plots to entrap more stupid people in so they can
parade them before press conferences and try and

866.488.DEPO
www.CapitalReportingCompany.com

T133-1

Oregon Progressive Party, Commenter ID No. T133 (cont'd)

Capital Reporting Company

55

1 scare us all. If you really want to hurt us, it's
2 really easy to do. All you have to do is climb over
3 a cyclone fence and slap some dynamite or plastique
4 to the side of one of these chemical plants.

5 You know, the highly respected GAO, the
6 government's investigative arm, in 2003 reported
7 there were 700 sites, chemical sites, where an
8 explosion could kill as many as a hundred thousand
9 people. There were many where you could kill a
10 million people. It's not that tough to do. Congress
11 investigated this. The chemical industry came in and
12 said, Well, we don't need federal regulation. Just
13 let us create some voluntary standards.

14 Congress said, Well, that's okay. Because the
15 chemical industry is the evil twin of the nuclear
16 industry when it comes to running Congress. And now
17 they try to scare us with a dirty bomb? Who are you
18 kidding? The truth is, we got rid of our nuclear
19 installation, the Trojan Nuclear Plant. A lot of the
20 people in this room worked for 15 years to make it
21 happen, and we backed them over the edge, didn't we?

22 Well, you know what? If there's one place that
23 doesn't deserve to get the poison pill, it's the
24 state of Oregon. And we are the big city near the
25 Columbia River. We are the big city downwind from

866.488.DEPO
www.CapitalReportingCompany.com

T133-2 DOE's ROD 78 FR 75913 dated December 13, 2013, stated that DOE has deferred a decision on importing waste from other DOE sites (with limited exceptions as described in the Settlement Agreement with the State of Washington Department of Ecology) for disposal at Hanford at least until WTP is operational.

T133-2

Oregon Progressive Party, Commenter ID No. T133 (cont'd)

	Capital Reporting Company	56
1	Hanford. Not here.	

T133-2
(Cont.)

Oregon State Legislature, Commenter ID No. W69

From: gtceiswebmaster@anl.gov
Sent: Tuesday, May 24, 2011 10:28 AM
To: mail_gtceisarchives; gtceiswebmaster@anl.gov; gtceis@anl.gov
Subject: Greater-Than-Class-C Low-Level Radioactive Waste EIS Comment GTCC10069
Attachments: HanfordLetter_OregonLeg_GTCC10069.pdf

Thank you for your comment, Jules Bailey.

The comment tracking number that has been assigned to your comment is GTCC10069. Please refer to the comment tracking number in all correspondence relating to this comment.

Comment Date: May 24, 2011 10:28:03AM CDT

Greater-Than-Class-C Low-Level Radioactive Waste EIS Draft Comment: GTCC10069

First Name: Jules
Last Name: Bailey
Organization: Oregon State Legislature
Address: 900 Court St. NE
Address 2: H-274
City: Salem
State: OR
Zip: 97301
Country: USA
Email: rep.julesbailey@state.or.us
Privacy Preference: Don't withhold name or address from public record
Attachment: HanfordLetter_OregonLeg.pdf

Questions about submitting comments over the Web? Contact us at: gtceiswebmaster@anl.gov or call the Greater-Than-Class-C Low-Level Radioactive Waste EIS Webmaster at (630) 252-5705.



received
JUN - 6 2011

May 23, 2011

Secretary Steven Chu
U.S. Department of Energy
1000 Independence Ave., SW
Washington, DC 20585

Arnold Edelman
GTCC EIS Document Manager
Office of Disposal Operations (EM-43)
U.S. Department of Energy
1000 Independence Ave., SW
Washington, DC 20585

Secretary Chu and Mr. Edelman:

As State Legislators representing Portland, Oregon, we urgently and respectfully ask that the Hanford Nuclear Reservation be removed from the U.S. Department of Energy's list of candidate sites for national permanent storage of radioactive waste.

While we recognize the need for energy resources and proper storage of waste, Hanford Nuclear Reservation is not a viable option. We believe that there are important unresolved matters that demand further scrutiny before the site is committed to further storage of nuclear waste.

The Dept. of Energy is already engaged in one of the largest and most complex cleanup projects in U.S. history at Hanford. For forty years, millions of cubic feet of solid waste were disposed of improperly, placed in trenches and burial sites.

W69-1 The disposal methods and sites evaluated in the EIS represent the range of reasonable alternatives for the disposal of GTCC LLRW and GTCC-like wastes. This range is consistent with NEPA implementing regulations in Parts 1500–1508 of Title 40 of the Code of Federal Regulations (40 CFR Parts 1500–1508). In this GTCC EIS, DOE analyzed a range of disposal methods (i.e., geologic repository, near-surface trench, intermediate-depth borehole, and above-grade vault) and federally owned sites (i.e., Hanford Site, INL, LANL, NNSS, SRS, and the WIPP Vicinity, for which two reference locations – one within and one outside the WIPP Land Withdrawal Boundary – were considered). DOE has determined that it was reasonable to analyze these six sites because they currently have operating radioactive waste disposal facilities, except for the WIPP Vicinity, which is near an operating geologic repository.

DOE also conducted a generic evaluation of commercial disposal facilities on nonfederal lands in the EIS to order to provide, to the extent possible, information regarding the potential long-term performance of other (nonfederal) locations for siting a GTCC waste land disposal facility.

Final siting of a disposal facility for GTCC LLRW and GTCC-like wastes would involve further NEPA review as needed and be in accordance with applicable laws and regulations and would involve local stakeholder involvement and consent.

W69-2 DOE is performing environmental restoration activities at the Hanford Site. The ongoing cleanup effort will continue.

DOE's ROD 78 FR 75913 dated December 13, 2013, stated that DOE has deferred a decision on importing waste from other DOE sites (with limited exceptions as described in the Settlement Agreement with the State of Washington Department of Ecology) for disposal at Hanford at least until WTP is operational.

DOE believes that the analyses presented in the EIS are sufficient to compare the potential cumulative impacts of GTCC LLRW and GTCC-like waste disposal for the sites that were evaluated. In particular, existing concentrations of various radionuclides in contaminated soil and groundwater at the candidate sites were taken into consideration in the selection of the preferred alternative. Additional cumulative impact analyses would be conducted in site-specific NEPA reviews, if needed, for the alternative selected in a ROD. Such follow-on analyses would be based on additional site-specific information.

W69-1

W69-2



Because of this operation, Hanford is today the most contaminated nuclear site in the United States.

Currently, more than 50 million gallons of radioactive waste are stored in underground tanks. Approximately 475 billion gallons of less-contaminated liquids have been discharged into the soil, creating an area of groundwater contamination in excess of 100 square miles beneath the site.

Throughout the history of the site, over 65 radioactive elements are known to have been released into the environment. While some have decayed over time, others remain present due to their abundance and persistence. These include strontium-90, tritium, cesium-137, and cobalt-6.

The operations of the Hanford Site have resulted in more than 43 million cubic yards of radioactive waste, and over 130 million cubic yards of contaminated soil and debris. This represents two-thirds of the nation's high-level radioactive waste in volume. Although existing efforts have been valuable, there is still significant work needed in order to successfully rehabilitate the area.

Hanford is just across the Columbia River from Oregon and is the most contaminated site in the Western Hemisphere. With over one million people living downriver in Portland, Hood River, The Dalles and other Oregon cities and towns, the contamination also exists within our communities.

The existing situation is perilous enough without adding further waste. Besides the river contamination, those living along the interstate system will be affected much more directly. If Hanford is selected, we will begin to see truckloads of radioactive waste traveling along interstate routes, passing through our cities.

Although not included in recent drafts of the Environmental Impact Statement, a 2008 USDOE study estimated 800 deaths would occur due to ambient radiation from the transport vehicles alone. This does not include the unimaginable number of deaths from a truck accident, earthquake or intentional attack that could happen in or near the centers of our population.

Another study vetted by nuclear scientists in 2004, indicated up to 57 square miles could be rendered uninhabitable, wiping out much of the City of Portland if an accident were to occur at the confluence of I-84 and I-205. While in the past, this was considered an extreme statement, after the events at Fukushima, no one can be so quick to dismiss such a possibility.

We, the undersigned, urge you to immediately remove Hanford from the list of candidate sites.

W69-3 DOE's ROD 78 FR 75913 dated December 13, 2013, stated that DOE has deferred a decision on importing waste from other DOE sites (with limited exceptions as described in the Settlement Agreement with the State of Washington Department of Ecology) for disposal at Hanford at least until WTP is operational.

However, regardless of where the GTCC waste disposal facility is ultimately located, a relatively small amount of GTCC LLRW and GTCC-like wastes may be transported through the Columbia River Gorge on their way to the disposal facility. The waste would be generated within the states of Oregon and Washington and would include actinide sealed sources and Cs-137 irradiators from local medical institutions, research facilities, universities, and other NRC and Agreement State licensees.

The transportation of radioactive waste will meet or exceed DOT and NRC regulatory requirements that promote the protection of human health and the environment. These regulations include requirements for radioactive materials packaging, marking, labeling, placarding, shipping papers, and highway routing. The waste shipments would be on preferred routes, which are interstate highways or alternative routes designated by a state routing agency in accordance with DOT regulations (49 CFR Part 397, Subpart D). The GTCC LLRW and GTCC-like wastes would be shipped in approved waste packages and transportation casks. The robust nature of these casks limits the potential release of radioactive and chemically hazardous material under the severest of accident conditions. It is unlikely that the transportation of GTCC LLRW and GTCC-like wastes to any of the alternative sites evaluated in the EIS would cause an additional fatality as a result of radiation from either incident-free transportation or postulated transportation accidents.

The EIS evaluated the transportation impacts from the shipments that would be required to dispose of all of the GTCC LLRW and GTCC-like wastes at the various disposal sites. The EIS addressed the collective population risks during routine conditions and accidents, the radiological risks to the highest exposed individuals during routine conditions, and the consequences to individuals and populations as a result of transportation accidents, including those that could release radioactive or hazardous chemical materials. About 12,600 shipments would be required to transport all of the GTCC LLRW and GTCC-like wastes to the Hanford Site for disposal. This would result in about 50 million km (30 million mi) of highway travel, with no expected LCFs. One fatality directly related to an accident might occur (see Section 6.2.9.1).

The EIS also evaluated the impact of intentional destructive acts that could occur during waste handling, transportation, and disposal (see Section 2.7.4.3 of the EIS). The potential for such destructive acts is low. DOE sites considered in the EIS are secured, and the packaging for the GTCC LLRW and GTCC-like wastes would be robust. The GTCC LLRW and GTCC-like wastes are not readily dispersible, and the impacts from any attempts to disperse these materials during transportation (such as the impacts from an explosive blast) would be greater than the impacts from any potential release of radioactivity. Impacts from severe natural phenomena, such as earthquakes and tornados, would not be expected to be significant, given that the GTCC LLRW and GTCC-like wastes are largely not dispersible and given the robust nature of the waste packages and containers.

DOE's standard operating procedure for transportation of radioactive waste is developed and continually revised to ensure that the utmost protection of public health and the environment is achieved and that the risk of a traffic accident is minimized. For example, DOE has established a comprehensive emergency management program (Transportation Emergency Preparedness Program or TEPP) that provides detailed, hazard specific planning and preparedness measures to minimize the health impacts from accidents involving loss of control over radioactive material or toxic chemicals. DOE's TEPP was established to ensure that its contractors and state, tribal, and local emergency responders are prepared to respond promptly, efficiently, and effectively to accidents involving DOE shipments of radioactive materials.

W69-2
(Cont.)

W69-3

W69-4

Oregon State Legislature, Commenter ID No. W69 (cont'd)

Respectfully,



Rep. Jules Bailey

Rep. Ben Cannon



Rep. Michael Dembrow



Rep. Margaret Doherty



Rep. Lew Frederick



Rep. Chris Garrett

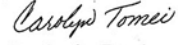

Rep. Mitch Greenlick

Rep. Mary Nolan

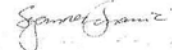

Rep. Tobias Read

Rep. Carolyn Tomei

Sen. Suzanne Bonamici

Sen. Ginny Burdick

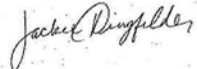
Sen. Richard Devlin

Sen. Jackie Dingfelder

Sen. Mark Hass

Sen. Rod Monroe

Sen. Chip Shields

If an accident that involved a release of radioactive material to the environment occurred, it would be remediated promptly in accordance with these procedures. These measures would help DOE minimize and mitigate any impacts on the environment.

W69-4 The EIS analysis is used to assess the viability of an alternative as well as its relative performance compared to the other alternatives. Exclusion of a reasonable alternative from the EIS without first evaluating the site is contrary to a thorough NEPA analysis. All alternatives are retained in the Final EIS because such evaluations are needed to support selection of the preferred alternative.

Oregon Wild, Commenter ID No. W7

From: gtceiswebmaster@anl.gov
Sent: Friday, May 06, 2011 4:32 PM
To: gtceiswebmaster@anl.gov
Subject: Receipt: Greater-Than-Class-C Low-Level Radioactive Waste EIS Comment GTCC10007

Thank you for your comment, Doug Heiken.

The comment tracking number that has been assigned to your comment is GTCC10007. Please refer to the comment tracking number in all correspondence relating to this comment.

Comment Date: May 6, 2011 04:31:45PM CDT

Greater-Than-Class-C Low-Level Radioactive Waste EIS Draft Comment: GTCC10007

First Name: Doug
Last Name: Heiken
Organization: Oregon Wild
Address: PO Box 11648
City: Eugene
State: OR
Zip: 97440
Country: USA
Email: dh@oregonwild.org
Privacy Preference: Don't withhold name or address from public record

Comment Submitted:
Please keep Oregon Wild informed of opportunities to be informed of and comment on this proposal.

We are very interested in converting the waste to physical forms that are least likely to be mobilized over the short-term or long-term, e.g., potentially vitrification.

We are opposed to burying the waste in any geologic zone that is likely to be permeated by groundwater during the period that the waste remains hazardous.

We are opposed to waste disposal methods that are irreversible. It is wise to keep options open in case the situation changes, or technology changes or improves.

Please develop alternatives and detailed NEPA analysis to address these issues.

Questions about submitting comments over the Web? Contact us at: gtceiswebmaster@anl.gov or call the Greater-Than-Class-C Low-Level Radioactive Waste EIS Webmaster at (630) 252-5705.

- W7-1 DOE's goal with regard to its public participation process is to be able to disseminate the information to the public so that input from the interested public can be obtained to inform the Final EIS. To this end, nine public hearings at venues accessible to the interested public for the various sites evaluated in the EIS were conducted. Notices were placed in various local newspapers to announce the public hearings before and during the scheduled hearings. DOE will also provide NOA of the Final EIS on the GTCC EIS web site and distribute an announcement to individuals and organizations on our mailing lists. For additional information, see Section J.1.
- W7-2 Treatment of the wastes, such as vitrification, prior to disposal was considered to be outside the scope of the EIS. Such treatment would be done prior to receipt of the GTCC LLRW and GTCC-like wastes at the disposal site. The waste characteristics and physical form of the waste would have to meet the disposal facility waste acceptance criteria before being accepted for disposal.
- W7-3 Comment noted.
- W7-4 Long-term storage and a retrievable "disposal" option were considered to be outside the scope of the EIS because neither would provide a permanent disposal solution.
- W7-5 The EIS considered the range of reasonable alternatives for disposal of the inventory of GTCC LLRW and GTCC-like wastes identified for inclusion in these analyses. Treatment of the wastes prior to disposal was considered to be outside the scope of the EIS. Such treatment would be done prior to receipt of the GTCC LLRW and GTCC-like wastes at the disposal site. The waste characteristics and physical form of the waste would have to meet the disposal facility waste acceptance criteria before being accepted for disposal. Long-term storage and a retrievable "disposal" option were considered to be outside the scope of the EIS because neither would provide a permanent disposal solution.

- W7-1
W7-2
W7-3
W7-4
W7-5

Physicians for Social Responsibility - KC, Commenter ID No. W563

From: gtcciswebmaster@anl.gov
Sent: Monday, June 27, 2011 10:50 PM
To: gtcciswebmaster@anl.gov
Subject: Receipt: Greater-Than-Class-C Low-Level Radioactive Waste EIS Comment GTCC10563

Thank you for your comment, Ann Suellentrop.

The comment tracking number that has been assigned to your comment is GTCC10563. Please refer to the comment tracking number in all correspondence relating to this comment.

Comment Date: June 27, 2011 10:50:00PM CDT

Greater-Than-Class-C Low-Level Radioactive Waste EIS Draft Comment: GTCC10563

First Name: Ann
Middle Initial: C
Last Name: Suellentrop
Organization: Physicians for Social Responsibility - KC
Address: 1865 S. Pyle St.
City: Kansas City
State: KS
Zip: 66103-1335
Country: USA
Email: annsuelen@gmail.com
Privacy Preference: Don't withhold name or address from public record

Comment Submitted:

No More Waste can get added to Hanford!! Put Clean-Up First!!!
Extremely radioactive wastes belong in deep geologic repositories, not in surface landfills. USDOE must start over and consider disposing of these wastes in a deep geologic repository in the North American Granite Shield, not limit to sites which USDOE owns. Hanford poses the highest truck risks. USDOE needs to redo IES and reissue for comment with the actual truck routes to Hanford through Oregon and WA and the cumulative risks from USDOE's other proposal to truck 3 million cubic feet of radioactive waste to Hanford. The cancer risks and groundwater contamination should disqualify use of Hanford for any more offsite wastes. This is especially important for children, who are much more vulnerable. This is a genocidal decision for the Tribes with Treaty rights to live on site and use the water.

Questions about submitting comments over the Web? Contact us at: gtcciswebmaster@anl.gov or call the Greater-Than-Class-C Low-Level Radioactive Waste EIS Webmaster at (630) 252-5705.

- W563-1 DOE is performing environmental restoration activities at the Hanford Site. The ongoing cleanup effort will continue.
- W563-2 DOE agrees that use of a geologic repository would be a protective and safe method for the disposal of the entire inventory of GTCC LLRW and GTCC-like wastes. The GTCC EIS evaluation for the WIPP geologic repository alternative supports this statement. However, the degree of waste isolation provided by a geologic repository may not be necessary for all of the GTCC LLRW and GTCC-like wastes evaluated in the GTCC EIS. The GTCC EIS evaluation indicates that certain wastes (e.g., those containing short-lived radionuclides such as Cs-137 irradiators) could be safely disposed of in properly designed land disposal facilities at sites with suitable characteristics, such as low precipitation rates, high soil distribution coefficients, and sufficient depths to groundwater. Based on the GTCC EIS evaluation, land disposal facilities located in arid climates (e.g., NNSS and WIPP Vicinity) would isolate radionuclides for a sufficient period of time to allow for significant radioactive decay to occur.

While 10 CFR Part 61 identifies one NRC-approved method for GTCC LLRW disposal (disposal in a geologic repository), these regulations also indicate that other disposal methods could be approved. The GTCC EIS evaluates three land disposal methods (i.e., enhanced near-surface trench, intermediate-depth borehole, and above-grade vault). The GTCC EIS evaluation indicates that land disposal methods employed at sites with suitable characteristics would be viable and safe alternatives for the disposal of GTCC LLRW. For additional information, see Section J.2.3.

- W563-3 The EIS considered the range of reasonable alternatives for the disposal of the GTCC waste inventory, including disposal in a deep geologic repository. DOE did not evaluate developing a geologic repository, such as in the North American Granite Shield, exclusively for disposal of GTCC LLRW and GTCC-like wastes because DOE determined that such an alternative is not reasonable due to the time and cost associated with siting a deep geologic repository and the relatively small volume of GTCC LLRW and GTCC-like wastes identified in the GTCC EIS. DOE believes that the results presented in this EIS for the WIPP geologic repository alternative are indicative of the high degree of waste isolation that would be provided by disposal in a geologic repository. DOE has included analysis of generic commercial facilities in the event that a facility could become available in the future. In that case, before making a decision to use a commercial facility, DOE would conduct further NEPA reviews, as appropriate.

- W563-4 The primary radiological transportation risk to the public for any alternative, including Hanford, is from the low level of radiation emanating from the transport vehicle. As discussed in Section 5.3.9.1, the collective population risk is a measure of the total risk posed to society as a whole. A comparison of the collective population risk provides a meaningful evaluation of the relative risks between disposal locations, as provided in Tables 2.7.5 and 2.7.6. The magnitude of the collective population risk is primarily determined by the number of routes, the length of each route, the number of shipments along each route, the external dose rate of each shipment, and the population density along a given route. The primary differences between alternatives from the standpoint of transportation are the lengths of the routes as determined by the location of the disposal sites (destination of the shipments). Thus, higher collective population risks are associated with alternatives that require transportation over longer distances. All alternatives involve routes that have similar characteristics, with no significant differences for comparison among alternatives, requiring transportation through a range of rural and urban areas, including sensitive areas. In addition, the routes used in the analysis are considered representative routes (as discussed in Appendix C, Section C.9.4.1.1, because the actual routes used would be determined in the future. For each disposal site, the routes most affected would be the interstate highways that are in closest proximity to the site.

Physicians for Social Responsibility, Commenter ID No. W563 (cont'd)

DOE believes that the analyses presented in the EIS are sufficient to compare the potential cumulative impacts of GTCC LLRW and GTCC-like waste disposal for the sites that were evaluated. In particular, existing concentrations of various radionuclides in contaminated soil and groundwater at the candidate sites were taken into consideration in the selection of the preferred alternative. Also, while up to 12,600 truck shipments were assessed for transport of the GTCC LLRW and GTCC-like wastes to a proposed disposal facility, these shipments would be spread out over a 60 year time period, with the result that only about one to two shipments a day might be expected at the facility in addition to current traffic. Additional cumulative impact analyses would be conducted in site-specific NEPA reviews, if needed, for the alternative selected in a ROD. Such follow-on analyses would be based on additional site-specific information.

W563-5 DOE has considered cumulative impacts at the Hanford Site in this GTCC EIS. The disposal of GTCC LLRW and GTCC-like waste at the Hanford Site could result in environmental impacts that may warrant mitigation for Tc-99 and I-129 through limiting receipt of these waste streams (see Table 6.2.4.2 and Figure 6.2.4.1 in this EIS).

DOE's ROD 78 FR 75913 dated December 13, 2013, stated that DOE has deferred a decision on importing waste from other DOE sites (with limited exceptions as described in the Settlement Agreement with the State of Washington Department of Ecology) for disposal at Hanford at least until WTP is operational.

The methodology used to estimate the radiological human health impacts in the EIS is based on standard practices that are subject to revision as our understanding of the effects of radiation on humans evolves. The same methodology is used in the evaluation of all alternatives; thus, any modification of this methodology (e.g. taking an even more conservative approach for assessment of the area children) would not affect the comparisons among alternatives and the identification of the preferred alternative.

Plazm Media, Commenter ID No. W17

From: gtceiswebmaster@anl.gov
Sent: Friday, May 13, 2011 12:41 AM
To: gtceiswebmaster@anl.gov
Subject: Receipt: Greater-Than-Class-C Low-Level Radioactive Waste EIS Comment GTCC10017

Thank you for your comment, josh berger.

The comment tracking number that has been assigned to your comment is GTCC10017. Please refer to the comment tracking number in all correspondence relating to this comment.

Comment Date: May 13, 2011 12:40:37AM CDT

Greater-Than-Class-C Low-Level Radioactive Waste EIS Draft Comment: GTCC10017

First Name: josh
Last Name: berger
Organization: plazm media
Address:
City:
State:
Zip:
Country:
Email: design07@plazm.com
Privacy Preference: Withhold address only from public record

Comment Submitted:

Please do NOT bring more radioactive waste to the Hanford nuclear reservation. This is the worst possible thing that could be done. Highly radioactive and long-lived wastes should be disposed deep underground in stable geologic formations - not in landfills, trenches, boreholes and vaults which threaten groundwater and health. Besides, why don't we clean up the waste that is already there - leaching into the groundwater every day? That would be a good start. Think of all the people who live downstream. Thanks.

Questions about submitting comments over the Web? Contact us at: gtceiswebmaster@anl.gov or call the Greater-Than-Class-C Low-Level Radioactive Waste EIS Webmaster at (630) 252-5705.

W17-1 DOE's ROD 78 FR 75913 dated December 13, 2013, stated that DOE has deferred a decision on importing waste from other DOE sites (with limited exceptions as described in the Settlement Agreement with the State of Washington Department of Ecology) for disposal at Hanford at least until WTP is operational.

W17-2 DOE agrees that use of a geologic repository would be a protective and safe method for the disposal of the entire inventory of GTCC LLRW and GTCC-like wastes. The GTCC EIS evaluation for the WIPP geologic repository alternative supports this statement. However, the degree of waste isolation provided by a geologic repository may not be necessary for all of the GTCC LLRW and GTCC-like wastes evaluated in the GTCC EIS. The GTCC EIS evaluation indicates that certain wastes (e.g., those containing short-lived radionuclides such as Cs-137 irradiators) could be safely disposed of in properly designed land disposal facilities at sites with suitable characteristics, such as low precipitation rates, high soil distribution coefficients, and sufficient depths to groundwater. Based on the GTCC EIS evaluation, land disposal facilities located in arid climates (e.g., NNSS and WIPP Vicinity) would isolate radionuclides for a sufficient period of time to allow for significant radioactive decay to occur.

While 10 CFR Part 61 identifies one NRC-approved method for GTCC LLRW disposal (disposal in a geologic repository), these regulations also indicate that other disposal methods could be approved. The GTCC EIS evaluates three land disposal methods (i.e., enhanced near-surface trench, intermediate-depth borehole, and above-grade vault). The GTCC EIS evaluation indicates that land disposal methods employed at sites with suitable characteristics would be viable and safe alternatives for the disposal of GTCC LLRW.

W17-3 DOE is performing environmental restoration activities at the Hanford Site. The ongoing cleanup effort will continue.

W17-1
W17-2
W17-3

Capital Reporting Company

5

1

2

3

4

5

6

7

8

9

10

11

12

13

14

15

16

17

18

19

20

21

MS. GAUTREAU: Because we actually have our
honorable mayor here tonight, I would very much like
to defer to the honorable mayor first.

22

23

24

MAYOR ADAMS: Thank you. Thank you for the
courtesy, and I apologize for skipping ahead in line

25

866.488.DEPO
www.CapitalReportingCompany.com

Capital Reporting Company

6

1 for those of you that signed up earlier. We have,
2 actually, a budget hearing across town, but I wanted
3 to personally deliver a summary of our remarks as
4 Portland City Council.

5 The Portland City Council opposes the
6 transportation of nuclear waste through our region
7 and supports the alternatives in the GTCC EIS, which
8 are most protective of the long-term health of
9 Columbia River and its citizens. We are dismayed
10 that there has been potential changes to the criteria
11 of some of the proposals that might unduly rank
12 Hanford as a suitable site. It is not. We believe
13 that there are alternatives for dealing with this
14 issue, but that Hanford is not the site.

15 Given that we already have many barriers to
16 quickly and adequately cleaning up the existing
17 nuclear waste at Hanford, one of the most polluted
18 sites in the world, it is plainly unacceptable to
19 consider importing additional waste from other sites.

20 The City urges the U.S. DOE to follow through on
21 the agency's fourth strategic theme, environmental
22 responsibility, protecting the environment by
23 providing a responsible resolution to the
24 environmental legacy of nuclear weapons and weapons
25 production long before this is considered for any

866.488.DEPO
www.CapitalReportingCompany.com

T127-1

T127-2

T127-3

T127-1 The disposal methods and sites evaluated in the EIS represent the range of reasonable alternatives for the disposal of GTCC LLRW and GTCC-like wastes. This range is consistent with NEPA implementing regulations in Parts 1500–1508 of Title 40 of the Code of Federal Regulations (40 CFR Parts 1500–1508). In this GTCC EIS, DOE analyzed a range of disposal methods (i.e., geologic repository, near-surface trench, intermediate-depth borehole, and above-grade vault) and federally owned sites (i.e., Hanford Site, INL, LANL, NNSS, SRS, and the WIPP Vicinity, for which two reference locations – one within and one outside the WIPP Land Withdrawal Boundary – were considered). DOE has determined that it was reasonable to analyze these six sites because they currently have operating radioactive waste disposal facilities, except for the WIPP Vicinity, which is near an operating geologic repository.

Final siting of a disposal facility for GTCC LLRW and GTCC-like wastes would involve further NEPA review as needed and be in accordance with applicable laws and regulations and would involve local stakeholder involvement and consent.

DOE's ROD 78 FR 75913 dated December 13, 2013, stated that DOE has deferred a decision on importing waste from other DOE sites (with limited exceptions as described in the Settlement Agreement with the State of Washington Department of Ecology) for disposal at Hanford at least until WTP is operational.

If DOE decides to implement its preferred alternative for the TC&WM EIS, GTCC LLRW and GTCC-like wastes would not be shipped through the Columbia River Gorge for disposal at the Hanford Site until the waste treatment plant is operational. However, regardless of where the GTCC waste disposal facility is ultimately located, a relatively small amount of GTCC LLRW and GTCC-like wastes may be transported through the Columbia River Gorge on their way to the disposal facility. The waste would be generated within the states of Oregon and Washington and would include actinide sealed sources and Cs-137 irradiators from local medical institutions, research facilities, universities, and other NRC and Agreement State licensees.

The transportation of radioactive waste will meet or exceed DOT and NRC regulatory requirements that promote the protection of human health and the environment. These regulations include requirements for radioactive materials packaging, marking, labeling, placarding, shipping papers, and highway routing. The waste shipments would be on preferred routes, which are interstate highways or alternative routes designated by a state routing agency in accordance with DOT regulations (49 CFR Part 397, Subpart D). The GTCC LLRW and GTCC-like wastes would be shipped in approved waste packages and transportation casks. The robust nature of these casks limits the potential release of radioactive and chemically hazardous material under the severest of accident conditions. It is unlikely that the transportation of GTCC LLRW and GTCC-like wastes to any of the alternative sites evaluated in the EIS would cause an additional fatality as a result of radiation from either incident-free transportation or postulated transportation accidents.

The EIS evaluated the transportation impacts from the shipments that would be required to dispose of all of the GTCC LLRW and GTCC-like wastes at the various disposal sites. The EIS addressed the collective population risks during routine conditions and accidents, the radiological risks to the highest exposed individuals during routine conditions, and the consequences to individuals and populations as a result of transportation accidents, including those that could release radioactive or hazardous chemical materials.

About 12,600 shipments would be required to transport all of the GTCC LLRW and GTCC-like wastes to the Hanford Site for disposal. This would result in about 50 million km (30 million mi) of highway travel, with no expected LCFs. One fatality directly related to an accident might occur (see Section 6.2.9.1).

Portland City Council, Commenter ID No. T127 (cont'd)

Capital Reporting Company		7
1	other uses.	
2	Clean up Hanford first. Thank you.	

T127-3
(Cont.)

DOE's standard operating procedure for transportation of radioactive waste is developed and continually revised to ensure that the utmost protection of public health and the environment is achieved and that the risk of a traffic accident is minimized. For example, DOE has established a comprehensive emergency management program (Transportation Emergency Preparedness Program or TEPP) that provides detailed, hazard specific planning and preparedness measures to minimize the health impacts from accidents involving loss of control over radioactive material or toxic chemicals. DOE's TEPP was established to ensure that its contractors and state, tribal, and local emergency responders are prepared to respond promptly, efficiently, and effectively to accidents involving DOE shipments of radioactive materials.

- T127-2 DOE's ROD 78 FR 75913 dated December 13, 2013, stated that DOE has deferred a decision on importing waste from other DOE sites (with limited exceptions as described in the Settlement Agreement with the State of Washington Department of Ecology) for disposal at Hanford at least until WTP is operational.
- T127-3 DOE is performing environmental restoration activities at the Hanford Site. The ongoing cleanup effort will continue.

Progressive Leadership Alliance of Nevada, Commenter ID No. T50

- 1
- 2
- 3
- 4
- 5
- 6
- 7
- 8
- 9
- 10
- 11
- 12
- 13
- 14
- 15
- 16
- 17
- 18
- 19
- 20
- 21
- 22
- 23
- 24
- 25

MR. BROWN: Thanks. Thanks, Walter.

Our next speaker is Launce Rake.

MR. RAKE: "Launce."

MR. BROWN: "Launce."

MR. RAKE: Good evening. My name is Launce Rake. That's L-A-U-N-C-E, R-A-K-E. I'm with the Progressive Leadership Alliance of Nevada, 700 South Sixth Street, Las Vegas 89101.

People have spoken eloquently on the technical problems with this EIS and with this proposal. With the proposed storage of Lower-Level Nuclear Waste at the Nevada Nuclear Security Site, I just wanted to say that, in the history of various experimentation and work with nuclear materials and

1 nuclear technologies, it's been a history of failures,
2 sometimes catastrophic failures.

3 We fail to protect groundwater. We fail to
4 live up to our legal obligations. We have failed to
5 consider the social and cultural implications of the
6 impacts of the technologies that we're working with.
7 That's true globally, and it's true specifically here
8 in our experience in Southern Nevada.

9 My group plan works with about 30 different
10 organizations as part of our coalition. I don't
11 believe any of them support this. So that would
12 indicate very wide, very deep opposition to this
13 proposal that needs to be taken into account with the
14 assessment of this very flawed proposal.

15 We have had experiences in Southern Nevada,
16 in Southern Utah, in this part of the world with the
17 failure of the companies working with atomic materials,
18 nuclear materials, and failure of the government to
19 protect citizens from exposure to nuclear materials and
20 radioactivity. We know that these failures could be
21 catastrophic or chronic, and that is why we oppose the
22 siting of this material anywhere near us.

23 We also support Hardened On-Site Storage as
24 the go-ahead mechanism for dealing with this unwanted
25 material for two reasons: One is it's the safest way

T50-1

T50-2

T50-1 Comment noted. The disposal methods and sites evaluated in the EIS represent the range of reasonable alternatives for the disposal of GTCC LLRW and GTCC-like wastes. This range is consistent with NEPA implementing regulations in Parts 1500–1508 of Title 40 of the Code of Federal Regulations (40 CFR Parts 1500–1508). In this GTCC EIS, DOE analyzed a range of disposal methods (i.e., geologic repository, near-surface trench, intermediate-depth borehole, and above-grade vault) and federally owned sites (i.e., Hanford Site, INL, LANL, NNS, SRS, and the WIPP Vicinity, for which two reference locations – one within and one outside the WIPP Land Withdrawal Boundary – were considered). DOE has determined that it was reasonable to analyze these six sites because they currently have operating radioactive waste disposal facilities, except for the WIPP Vicinity, which is near an operating geologic repository.

DOE also conducted a generic evaluation of commercial disposal facilities on nonfederal lands in the EIS to order to provide, to the extent possible, information regarding the potential long-term performance of other (nonfederal) locations for siting a GTCC waste land disposal facility.

Final siting of a disposal facility for GTCC LLRW and GTCC-like wastes would involve further NEPA review as needed and be in accordance with applicable laws and regulations and would involve local stakeholder involvement and consent.

T50-2 The use of HOSS and other approaches for long-term storage of GTCC LLRW and GTCC-like wastes are outside the scope of this EIS because they do not meet the purpose and need for agency action. Consistent with Congressional direction in Section 631 of the Energy Policy Act of 2005 (P.L. 109-58), DOE plans to complete an EIS and a ROD for a permanent disposal facility for this waste, not for long-term storage options. The GTCC EIS evaluates the range of reasonable disposal alternatives and, as also required under NEPA, a No Action Alternative. Under the No Action Alternative, current practices for storing GTCC LLRW and GTCC-like wastes would continue in accordance with current requirements.

Progressive Leadership Alliance of Nevada, Commenter ID No. T50 (cont'd)

50

1 to deal with this material, for the time being.

2 But the second is that we believe, I believe

3 that those elements, those commercial activities that

4 generate this material have, should have a legal and

5 moral responsibility to take care of that stuff. If

6 they do, it becomes disincentive to simply continue

7 their industrial processes and stick the material in

8 our backyard and pretend it doesn't exist.

9 Thank you.

T50-2
(Cont.)

T50-3

T50-3 The Low-Level Radioactive Waste Policy Amendments Act (LLRWPA, P.L. 99-240) assigns DOE responsibility for the disposal of GTCC LLRW generated by NRC and Agreement State licensees. The LLRWPA (P.L. 99-240) does not limit DOE to using only non-DOE facilities or sites for GTCC LLRW disposal. Under NEPA, DOE must evaluate the range of reasonable alternatives for a GTCC LLRW disposal facility. DOE sites represent reasonable alternatives for a GTCC LLRW disposal facility. Changes in public policy that would assign GTCC LLRW disposal responsibility to entities other than DOE are outside of the scope of this EIS.

Public Safety Resources Agency, Commenter ID No. W3

From: gtceiswebmaster@anl.gov
Sent: Saturday, April 02, 2011 2:54 PM
To: mail_gtceisarchives; gtceiswebmaster@anl.gov; gtceis@anl.gov
Subject: Greater-Than-Class-C Low-Level Radioactive Waste EIS Comment GTCC10003
Attachments: Draft_GTCC_EIS_GTCC10003.doc

Thank you for your comment, William Mead.

The comment tracking number that has been assigned to your comment is GTCC10003. Please refer to the comment tracking number in all correspondence relating to this comment.

Comment Date: April 2, 2011 02:53:27PM CDT

Greater-Than-Class-C Low-Level Radioactive Waste EIS Draft Comment: GTCC10003

First Name: William
Middle Initial: P
Last Name: Mead
Organization: Public Safety Resources Agency
Address: 14962 NE Rose Parkway
City: Portland
State: OR
Zip: 97230
Country: USA
Email: w_mead_49@msn.com
Privacy Preference: Don't withhold name or address from public record
Attachment: C:\fakepath\Draft GTCC EIS.doc

Questions about submitting comments over the Web? Contact us at: gtceiswebmaster@anl.gov or call the Greater-Than-Class-C Low-Level Radioactive Waste EIS Webmaster at (630) 252-5705.

Public Safety Resources Agency, Commenter ID No. W3 (cont'd)

William P. Mead
Director
Public Safety Resources Agency
14962 NE Rose Parkway
Portland, OR 97230
w_mead_49@msn.com

March 27, 2011

I am submitting the following comments on DOE's Draft GTCC EIS behalf of PSRA, and request that they be included in the record and also that DOE specifically respond to the comments and objections that appear below:

2.7.4.2. Impacts on Members of the General Public.
[page 2-16; paragraph 4; lines 28-35]

Engineering measures are expected to reduce the water infiltration rate to 20% of the natural flow after 500 years after closure. "This reduced rate is assumed to be effective for the entire remaining period of analysis."

This 80% reduction of "the natural background infiltration rate" is based on "the use of an improved cover over the waste disposal units." This appears to base this assumption on a projected 10,000 year span on rainfall, entirely ignoring groundwater movement through aquifers.

This fallacy is continued in section 5.3.4.3., "Post Closure":
[page 5-65; paragraph 1]

"...The natural background infiltration rate was used at the perimeter of the waste disposal units. This method is assumed to be a reasonable way to model the use of an improved cover for the purposes of this analysis."

In paragraph 4 of page 5-65, the focus continues to be on the "cover" but does not address the vertical perimeter issues of groundwater intrusion. Even though those effects are mentioned as being real, no provision or mitigation studies have been cited to for this aspect of the repository's effect on the environment and future generations.

W3-1

The disposal unit designs that were analyzed in the EIS are consistent with existing DOE disposal practices. The disposal units for the intermediate depth and enhanced near-surface concepts are located in the unsaturated zone, above the water table. Thus, groundwater flow is not expected to impact the disposal units. The cover directly above the waste is expected to provide sufficient protection from infiltration which is expected to move primarily in the vertical direction.

W3-1

Public Safety Resources Agency, Commenter ID No. W3 (cont'd)

PSRA: Draft GTCC EIS, Page 2

"The results indicated that the peak annual dose would increase as the water infiltration rate increased, because when more water would enter the waste disposal horizon, more radionuclides would be leached and released from the disposal facility. The increase in the peak dose would be approximately proportional to the increase in the water infiltration rate. This result is not unexpected, and it indicates the need for a very effective cover to minimize the amount of infiltration water that could contact the GTCC wastes."

It is not reasonable to concentrate on modeling an "improved cover" to the exclusion of other transmission factors. The vertical perimeter of the repository must also be impervious for 500 years.

This EIS appears to admit that water infiltration is expected, but limits any mitigation efforts to the "cover" cap to shield the waste from rain, but entirely ignores the issues of controlling groundwater travel that will transport contamination through the site and beyond those boundaries.

W3-1
(Cont.)

2.7.12 Cumulative Impacts.
[page 2-24; paragraph 2; lines 9-30]

DOE admits "the likely exception of potential human health impacts in the long term. That is, during the Post-Closure phase of the proposed action, potential leaching of radionuclides from the GTCC waste inventory into the groundwater could contribute to doses and LCF risks."

DOE admits past Te-99 leaks at Hanford and suggests that off-site I-129 and Te-99 wastes not be disposed of at Hanford.

PSRA: Draft GTCC EIS, Page 3

Table 2.7-2 Comparison of Potential Impacts...
[page 2-30]

**(3.) Borehole Method – Hanford
Water Resources:**

"In addition, groundwater could become contaminated with radionuclides from GTCC waste disposal, as indicated by estimates from the post-closure performance of a borehole disposal facility."

(4) Trench Method – Hanford
[page 2-35]

Water Resources:

"Same as for the borehole method with regard to the potential for radionuclide contamination in groundwater from the proposed trench facility during the post-closure phase."

**Table 2.7-3 Comparison of Potential Impacts on
Human Health.**
[page 2-41]

Of the 3 methods under consideration at Hanford – borehole, trench and vault – Hanford leads all sites as projecting the "Highest Individual Dose From [a] Waste Handling Accident" in REMs.

**Table 2.7-5 Potential Transportation Impacts –
Truck...**
[page 2-52]

Hanford's selection would be the most hazardous of all sites for [1] Distance Travelled (50,300,000 km); [2] Collective Population Dose (160 person-REMs); [3] Collective Transportation Crew Dose (500 person-REMs); and [4] Accident Fatalities (1). Hanford would tie with NNSS for the highest number of "Collective Population LCFs (0.09) and "Collective Transportation Crew LCFs (0.3).

PSRA: Draft GTCC EIS, Page 4

"LCF" means "Latent Cancer Fatalities", and "NNSS" is the "Nevada National Security Site"; the current name for the old Nevada Test Site where nuclear weapons were detonated above and below ground level.

This Table projects that by selecting Hanford, the number of miles travelled will be higher, and the number of exposures will be higher than at any other location in the United States - including where we used to test bombs that contaminated other states by fallout.

It should be noted that the figures for Rail Transportation are not much better. In any event, the majority of shipments during the expected 64 years of emplacement operations will be via truck.

Also, as noted in Table 5.3.9-4., "Potential Radiological Consequences to the Highest-Exposed Individual from Severe Transportation Accidents" [page 5-88], rail accidents were postulated to be approximately twice as serious than truck accidents because each rail car would carry twice the truck's normal load.

One problem that I see is that while DOE assumed the worst scenarios for truck and rail accidents, they appear to have assumed that a rail accident would only involve a breach of the contents of a single railcar. This is not a valid assumption and the impacts should be based on the effects of breaching of multiple railcars and the release of the contents into the environment. We have all seen images of several railcars on their sides after a derailment, and there is absolutely no reason to expect that it will not happen during transportation of these wastes.

If we assume that the technology for the alternatives were standardized for each of the 3 disposal options for each of the proposed sites, why would Hanford be so excessively hazardous when compared to other sites?

Considering that DOE would enforce uniform standards at each site, and that a series of operational protocols would be followed and compliance would be documented, why is Hanford postulated to be more dangerous for this proposal?

W3-2

The risks from severe truck and rail accidents presented in the EIS are considered to be representative of potential higher impacts that could occur. The EIS analysis assumed the shipment of waste in a general freight consignment with only one railcar shipped at one time. Many of the sites considered would not have enough waste for more than one railcar in a shipment over a period of many years. However, if a dedicated train were to be used for a rail shipment, with two or more railcars with waste, it is unlikely that there would be sufficient physical or thermal forces to breach even one Type B container. Dedicated trains would be operated at lower speeds consistent with their cargo (reducing the risk from physical impact or crush force) and dedicated trains would not be hauling other railcars with flammable material that could contribute to a fire (reducing the risk from thermal impacts) that would result in even a minor release of material from a cask.

W3-2

PSRA: Draft GTCC EIS, Page 5

2.8.3. Assumptions Used to Simulate the Integrity of Engineered Barriers and Waste Stabilizing Practices. [page 2-56]

DOE postulates that engineered controls will remain intact for an initial 500 years but tried to project potential groundwater impacts out for the 10,000 years that the wastes must be isolated.

DOE admitted that "How and when the waste packages, engineering controls, and stabilization agents would begin to degrade and how this degradation would progress over time are very difficult to determine."

DOE continues by stating "For this EIS, it is assumed that the engineered controls would remain intact for the first 500 years after the closure of the disposal facility and that during this time, essential no infiltrating water would reach the wastes from the top of the disposal facility. It is assumed that after 500 years, the amount of infiltrating water that would contact the wastes would represent 20% of the site-specific natural infiltration rate for each of the sites evaluated, and that the water infiltration rate around and beneath the disposal facilities would be 100% of the natural rate of the site area."

DOE is chaining its assumptions in the hopes that they will become true.

In plain language, DOE is stating that its barriers are expected to last 500 years, but that the site must be protected for 10,000 years. It then infers that although the barrier around the waste may degrade, 80% of the groundwater will detour around the wastes, the problem won't really exist!

5.2.4.3. Radiological [Health] Impacts [page 5-30]

It should be noted that the NCRP (National Council on radiation Protection & Measurements) recently updated its estimate on the amount of background radiation we receive. The old annual estimate was 360 mREM/year, but the new estimate nearly doubled to 620 mREM/year.

W3-3

The EIS analyses are based on conceptual engineering information and necessitated the use of a number of simplifying assumptions. This approach is consistent with NEPA, which requires such analyses to be made early in the decision-making process. The various land disposal conceptual designs were assumed to be constructed and operated in a comparable manner at each of the various sites. Information on the conceptual engineering designs for the three proposed land disposal methods is provided in Section D.3 of Appendix D in the EIS. By using the same conceptual designs at all of the sites evaluated in the GTCC EIS, except for cases where a design did not apply (e.g., an intermediate-depth borehole at a site with shallow groundwater), the potential impacts (e.g., radionuclides reaching the groundwater) at the different environmental settings could be readily compared.

In performing these evaluations, a number of engineering measures were included in the conceptual facility designs to minimize the likelihood of contaminant migration from the disposal units. No facility design can guarantee that radionuclide migration from the facility would not occur over and beyond a 10,000-year time period. It was assumed that these measures would perform similarly for all conceptual designs, remaining intact for 500 years after the disposal facility closed. After 500 years, the barriers would gradually fail. To account for these engineered features in the modeling calculations, it was assumed that the water infiltration to the top of the waste disposal area would be zero for the first 500 years and then 20% of the natural rate for the area for the remainder of the time period (through 10,000 years). A water infiltration rate of 20% of the natural rate for the area was only used for the disposal area; the natural background infiltration rate was used at the perimeter of the waste disposal units. Again, this approach enables a comparative evaluation of the influence that site-specific environmental factors would have on the potential migration of radionuclides from the disposal facilities and the potential impacts on human health. It should be emphasized that project- and site-specific engineering factors would be incorporated into the actual facility designs of the site or sites selected in a ROD to dispose of GTCC LLRW and GTCC-like wastes.

DOE recognizes that modeling potential releases of radionuclides from the conceptual disposal sites far into the future approximates what might actually occur. Sufficient detail was included in these designs for use in the EIS analyses, consistent with the current stage of this process. Some of the input values may change in the future and could result in higher impacts (such as from increased precipitation at some sites due to climate change), while others could result in lower impacts (due to decreased precipitation).

DOE believes that 500 years is a realistic time period for the longevity of the types of engineering barriers assumed in the analyses. DOE believes the approach and the assumptions used in the EIS are reasonable for performing the comparative analysis of alternatives required by NEPA. For example, as discussed in Section E.2.2, the assumption of a 20% natural background infiltration rate after 500 years was based on a study at SRS (Phifer et al. 2007) that indicated that after 10,000 years, the closure cap at the F-area would still shed about 80% of the cumulative precipitation falling on it, with an effectiveness that would be greater before 10,000 years, then decrease very slowly after 10,000 years. The approach used in the EIS is more conservative than indicated by this study.

W3-4

DOE's ROD 78 FR 75913 dated December 13, 2013, stated that DOE has deferred a decision on importing waste from other DOE sites (with limited exceptions as described in the Settlement Agreement with the State of Washington Department of Ecology) for disposal at Hanford at least until WTP is operational.

W3-3

W3-4

Public Safety Resources Agency, Commenter ID No. W3 (cont'd)

PSRA: Draft GTCC EIS, Page 6

The "natural" background sources have not changed (they average about 310 mREM/year) but we now receive an average of another 310 mREM/year from man-made sources, including medical procedures and consumer products.

DOE has already identified Hanford as the most dangerous site for this repository. Let's not add that jeopardy to our already-increasing radiologic burden.

An additional note:

I do not have the actual numbers available as I write this comment, however I remember from my research in the 1980s that the soils approximately one mile from the PUREX Plant's stack showed a higher inventory of Plutonium than was found at a distance of one kilometer from the hypocenter of the Nagasaki explosion.

I believe Nagasaki's contamination was about 5,500 pCi/m² while Hanford's was about 6,600 pCi/m²; a difference of about 1,100 pCi/m² some forty years after the war had ended. I found it ironic that even though Hanford's plutonium was used to destroy Nagasaki, Hanford's contamination was greater than Nagasaki's at a distance forty percent greater from the relative sources of the plutonium.

The other significant factor was that Hanford's contamination of the 200 East area was of a type referred to as "dry" plutonium; the difference being that Hanford's plutonium was more likely to become airborne if the surface soil was disturbed, and was less likely to become "fixed" on the surface.

I would like to see this aspect of the potential impacts thoroughly reviewed in the EIS. It may be that the construction activity, which is different for the three disposal methods would not be suitable at the referenced location if it were to disturb the existing plutonium or cause it to become airborne to re-contaminate additional areas.

W3-5 Existing contamination at potential disposal sites was taken into consideration when selecting the preferred alternative. The site-specific location chosen for implementation of a disposal facility would be thoroughly characterized and assessed in site-specific NEPA review.

W3-4
(Cont.)

W3-5

PSRA: Draft GTCC EIS, Page 7

5.3. Environmental Consequences.
[page 5-43]

"Because the proposed disposal facilities are expected to be available to contain the waste for a very long time (for the next hundreds of years), the decommissioning phase of the proposed action could be better evaluated at the time the disposal facility would be ready to be decommissioned. Hence, evaluations for the decommissioning phase are not included in this EIS; instead, subsequent NEPA documentation would be prepared at a later time to address the decommissioning phase."

This is the type of approach that contributed to much of our current problems involving radiologic wastes: Previous generations of DOE management focused on "production" and admitted that they planned to store wastes until a future generation was able to solve the problems of the high-level liquid wastes and the other types of wastes that were generated during the past 60 years.

The disposal facility is expected to operate for approximately 64 years and then be sealed. A responsible and honest EIS should include thorough EIS is intended to examine those issues instead of ignoring them. The EIS could indicate areas of needed research, with the understanding that future events or advances in technologies could modify the current document.

Examining potential future issues and solutions now makes sense and is supported by DOE's statements in section 5.5, "Inadvertent Human Intruder Scenario" [page 5-95]:

DOE states, "The designs considered for this EIS are suggested starting points for enhanced disposal facilities; if necessary, they could be fortified further, depending on site-specific considerations and the actual waste characteristics once a final site(s) and disposal method(s) were selected."

There is absolutely no rational justification for not including a basis for discussion and examination of decommissioning issues in this EIS. It will not be a complete document without identifying what is currently known to be required in the future, and the failure by DOE to include this critical component invalidates any claim of thoroughness.

W3-6

The EIS notes that the decommissioning of a GTCC waste disposal facility is part of the proposed action, but because the facility would not be closed and decommissioned until far into the future (after 2083), the impact analysis for the decommissioning phase would be conducted at that time. It is not possible at this time to evaluate with any degree of confidence the environmental impacts from decommissioning a facility that has not yet been selected.

The GTCC waste disposal facility would be designed to facilitate future decommissioning consistent with applicable law, guidance, and policies. The appropriate site-specific NEPA review will be conducted in the future as part of the decommissioning plan.

W3-6

PSRA: Draft GTCC EIS, Page 8

The next paragraph continues, "However, given enough time (on the order of thousands of years), it is possible that groundwater at the various sites could become contaminated with some highly soluble radionuclides (e.g., C-14, Tc-99, and I-129). Indirect impacts on surface water (except at NNSS) could also result from aquifer discharges (of contaminated groundwater) to seeps, springs, and rivers."

We have already experienced these types of discharges from Hanford's contaminated aquifers. We should not add more radiologic contamination to an area that is already dramatically contaminated by nuclear wastes.

5.3.4.1.1. Workers.
[page 5-52]

"It is assumed that all of the wastes would arrive at the site as solid materials that could be placed directly into the disposal facility. Any necessary waste treatment would have already occurred at the site that generated or staged the wastes prior to shipment, and the impacts associated with those activities are outside the scope of this EIS."

Although I can understand DOE's rationale for not including the exposures that may occur at the point of origin, I do not agree with it.

DOE has included truck and rail transportation exposures in this EIS and it also should include the exposures at the point of origin.

Any honest EIS would address the preparation of the wastes to be shipped. It is dishonest to not attempt to quantify the impacts at the originating site when those operations are an integral part of the project that is the subject of this EIS.

A major portion of the exposures will occur at the point of origin when the initial sources are transferred to storage and shipping containers. Those operations cannot be separated from this project's EIS because they must be accomplished before any wastes can be shipped to any repository or disposal facility.

W3-7 Comment noted.

DOE's ROD 78 FR 75913 dated December 13, 2013, stated that DOE has deferred a decision on importing waste from other DOE sites (with limited exceptions as described in the Settlement Agreement with the State of Washington Department of Ecology) for disposal at Hanford at least until WTP is operational.

W3-8 Operations such as the packaging and loading of shipments fall under the responsibility of the shipping organization and would be covered by the respective organization's operating procedures, safety measures, and NEPA reviews, as appropriate. Also, packaging and loading of the GTCC LLRW and GTCC-like wastes at each generator location would be the same for all alternative disposal sites, with the exception of remote-handled waste at WIPP, and would not be a discriminator in selecting an alternative.

W3-7

Originating facilities handling GTCC LLRW or GTCC-like waste should already have plans in place to deal potential accidents or acts of terrorism.

W3-8

PSRA: Draft GTCC EIS, Page 9

We need an honest explanation of those actions and the expected risks to the workers and the communities involved. Those exposures are going to happen, regardless of the site that is finally selected, so we should address those issues and start planning our mitigation strategies.

DOE estimates that "activated metal wastes" may constitute about 17% of the total GTCC shipments. It also stated "The gamma exposure rates on the surfaces of these containers, assuming there would be no additional shielding, could exceed 1,000 roentgen/hour (R/h). These dose rates are somewhat small than, but generally comparable to, those associated with SNF and high-level radioactive wastes."

In other words, the radiation dose would be similar to someone who tried to walk in the separation canyon at PUREX when we recovered Uranium and Plutonium from spent nuclear fuel at Hanford.

As I write this, Japan is experiencing core damage and radiologic releases from SNF (Spent Nuclear Fuel) in 4 reactors and has increased the allowable dose for workers to approximately 25 REMs, an amount that is virtually guaranteed to result in additional LCFs.

A dose rate of 1,000 R/hr needs serious consideration in this EIS instead of pretending that the wastes will "auto-magically" jump directly from the source into a shipping package without human intervention.

The disposal operations are expected to continue at the repository "over a period lasting up to 64 years..." Unless DOE has a magic plan to get the wastes into shipping containers at the source without using workers, we can expect other communities will be involved in the packaging and shipping of wastes for that period of time.

Those exposures must be included in an honest EIS, and DOE's decision to ignore those realities violates the intent of those laws.

W3-8
(Cont.)

PSRA: Draft GTCC EIS, Page 10

On page 5-70 [5.3.4.4.3. Disposal Options], DOE states "During transport to the disposal facility, waste materials would be in heavily shielded casks that would prevent the release of any radioactive material under any but the most severe conditions,... Once at the facility, waste would be unloaded from the transport vehicle and placed in secure temporary storage. CH waste containers such as 208-L (55 gal) drums or SWBs would be taken out of the transport packaging, such as a TRUPACT-II container, and staged in a temporary storage area at the WHB prior to emplacement in a disposal unit. RH waste would either be stored in its Type B transport cask or be removed from its cask and temporarily stored in a heavily shielded room in the WHB before emplacement. Only limited numbers of waste containers would be in the WHB at any given time."

This is a good description of what will be required at the final waste disposal site, and it explains how different protocols would be used when handling the relatively low-level CH waste, versus the need to actively isolate intensely radioactive RH wastes, the types that will emit radiation levels similar to spent (irradiated) reactor fuel.

DOE's explanation of the precautions that are needed essentially validates my argument that we must include the potential exposures at the point of origin or package preparation. This EIS should be a complete overview of the entire process from the original source location to the final repository. RH wastes are not going to be created in the Type B transport cask, they have to be placed inside that container for shipping. We need to include an examination of those exposure scenarios just as surely as we need to know what to expect at the end of that journey.

The current U.S. Department of Homeland Security relocation guidelines of 2 REM/year [73 FR 45029] could also effect the originating communities in the event of an accident or intentional terrorist act. The EIS should include those communities instead of ignoring them.

W3-8
(Cont.)

PSRA: Draft GTCC EIS, Page 11

6.1.2.1.6. Slope Stability, Subsidence, and Liquefaction.
[page 6-24]

DOE states, "However, groundwater levels in the 200 Areas are changing as a result of changes in wastewater discharge practices in the area."

This refers to groundwater movement in the area of the Hanford reservation that I referred to earlier in my comments.

It is not likely that we can accurately characterize the groundwater during even the expected operational time period of 64 years. It is even less likely that we will be accurate in predicting groundwater flow through and from the repository during the next 500 years. And, it is entirely specious to try to extrapolate groundwater movement during the next 10,000 years. When combined with the effects of the current wastes migrating near the referenced repository location, Hanford should not be considered for this project.

6.1.3.1.1. Rivers and Streams.
[page 6-29]

The argument and statement of the "American Indian Text" is so pertinent that I am going to cite it in its entirety and support it by including it in my comments:

"The Columbia River is the lifeblood of the Indian People. It supports the salmon and every food or material that they rely on for subsistence. It is an essential human right to have clean water. If water is contaminated it then contaminates all living things. Tribal members that exercise a traditional lifestyle would also become contaminated. A perfect example is making a sweat lodge and sweating. It is a process of cleansing and purification. If water is contaminated then the sweat lodge materials and process of cleansing would actually contaminate the individual."

W3-9 Modeling potential releases of radionuclides from the conceptual disposal sites far into the future approximates what might actually occur. Sufficient detail was included in these designs for use in the EIS analyses, consistent with the current stage of this process. DOE acknowledges there are uncertainties during the 10,000 year period of analysis and what is predicted is not exact estimates of what will occur in the future. That does not mean the analysis is not useful. NEPA requires DOE to disclose estimates of long-term impacts and their uncertainties to inform the decision making process.

W3-10 DOE is performing environmental restoration activities at the Hanford Site. The ongoing cleanup effort will continue.

DOE's ROD 78 FR 75913 dated December 13, 2013, stated that DOE has deferred a decision on importing waste from other DOE sites (with limited exceptions as described in the Settlement Agreement with the State of Washington Department of Ecology) for disposal at Hanford at least until WTP is operational.

W3-9

W3-10

Public Safety Resources Agency, Commenter ID No. W3 (cont'd)

PSRA: Draft GTCC EIS, Page 12

"Indian People are well known for adopting technology if it were instituted wisely and did not sacrifice or threaten the survival of the group as a whole. This approach applies to tribal use of groundwater. Even though groundwater was not used except at springs, tribes would have potentially used technology for developing wells and would have used groundwater if seen to be an appropriate action. The existing contamination is considered an impact to tribal rights to utilize this valuable resource."

The hyporheic zone in the Columbia River needs to be more fully characterized to understand the location and potential of groundwater contaminants discharging to the Columbia River."

"Contaminated groundwater plumes at Hanford are moving towards the Columbia River and some contaminants are already recharging to the river. It is the philosophy of the Indian People that groundwater restoration and protection be paramount to DOE's management of Hanford. Institutional controls, such as preventing use of groundwater, should only be a temporary measure for the safety of people and animals. It will be questioned when DOE views institutional controls as a viable long-term management option to allow natural attenuation. The timeline of natural attenuation may not best represent a Tribal preference of a proactive corrective cleanup measure(s) for contamination plumes. Cleanup should be a priority before considering placement of additional waste like GTCC in the 200 area."

W3-10
(Cont.)

6.1.3.1.2. Surface Water Quality.
[page 6-35]

"...Elevated nitrate concentrations at the Hanford Site shoreline are from the contaminated groundwater plumes emanating from the 200 Area. ... Tritium, Sr-90, I-129, and Pu-239/240 are present in worldwide fallout from historical nuclear weapons testing as well as in effluent from Hanford Site facilities."

PSRA: Draft GTCC EIS, Page 13

"Surface water sampled across transects at various locations along the Columbia River shows a statistical increase in tritium and uranium between samples taken upstream at the site at Vernita Bridge and those taken downstream of the site at the Richland pump house. These constituents are known to be entering the river from contaminated groundwater beneath the Hanford Site."

The paragraph continues with the notation that the highest concentrations were measured near the Hanford town site, and at the 300 Area transect.

A few lines later, the DOE reports "Radionuclides consistently detected at low levels in Columbia River sediment in 2008 included K-40, Cs-137, U-234, U-235, Pu-238, Pu-239/240, and progeny products from naturally occurring radionuclides."

6.1.3.2 Groundwater.

The referenced location at Hanford is south of the 200 East Area, an area that is already highly-contaminated by past nuclear and chemical process dating back to 1943.

Hanford produced approximately 100 metric tonnes of Plutonium during its operations. The plutonium was created by irradiating uranium-238 in reactors and then dissolving the fuel rods in an acid bath inside a chemical separations canyon.

Hanford used three generations of chemical separation systems, each with different efficiencies, which meant that earlier processes did not recover as much uranium and plutonium as was achievable using newer technologies. In addition to not recovering a significant percentage of uranium and plutonium, these technologies created a volume of wastes that is difficult for persons to visualize. The major waste streams were composed of liquid "high level" wastes, with accompanying airborne releases of radiation and noxious gasses.

W3-11 A number of sites in the 200 East Area had contaminants disposed starting in the early 1940's and 1950's, and received high volumes of liquids discharged with them. This results in the water forcing the contamination down through the soil which is reflected in some of the plumes in the Hanford Groundwater Monitoring Report.

The GTCC disposal facility reference location south of the 200 East Area is far from groundwater contamination found in the 300 Area. The reference location is a site which would be considered a "dry" site, meaning if the waste were disposed of at Hanford it would have a barrier placed on top to reduce the infiltration through the site. Therefore, the operation of the GTCC land disposal facility would not be expected to impact groundwater flow.

DOE took into consideration groundwater, human health and other environmental factors in the selection of the preferred alternative.

W3-11

PSRA: Draft GTCC EIS, Page 14

Each of the 220,400 pounds of plutonium that was produced and separated at Hanford generated approximately 4,132,000 gallons of high-level liquid wastes. Some were pumped directly into the aquifers by "reverse" (injection) wells, and other liquids were sent either to storage tanks which leaked, or to "cribs" that allowed the wastes to percolate into the soil. In one instance a crib approached criticality and was in danger of detonating as had happened in Russia in the 1950s. The trench was carefully exhumed and the wastes were dispersed to lower the chances of accidental criticality.

A significant amount of those wastes were disposed of at the 200 East Area adjacent to the site that would also host the GTCC repository. Several years ago the U.S. Geological Survey noted that 7 distinct aquifers were known to exist below Hanford, and also that the flow rates and directions for these aquifers was not uniform, nor characterized.

The groundwater in that area is already flowing into the Columbia River, bringing with it the current inventory of wastes that have escaped containment. Further characterization is essential so we know what to expect with the current wastes in the area, and also to better understand how construction, operation and closure of the proposed repository will effect groundwater flows in the surrounding areas.

As previously cited, DOE acknowledges that the groundwater in the 300 Area is radiologically and chemically contaminated. Adding additional radionuclides to this contamination is not sound public policy for future human and environmental health.

Perhaps it would be wiser to strike Hanford from consideration for this proposal, and instead concentrate on the critically-important tasks that are needed to clean-up our sites that area still grossly contaminated from the production frenzy of the 1940s, 1950s, 1960s, 1979s and early 1980s.

W3-11
(Cont.)

PSRA: Draft GTCC EIS, Page 15

6.1.3.2.1 Unsaturated Zone.
[page 6-36]

"In the vicinity of the GTCC reference location, the thickness of the vadose zone is about 100 m (330 feet)."

6.1.3.2.2 Aquifer Units.
[page 6-37]

"On the north side of the 200 East Area, there is evidence of erosional channels that may allow interaquifer flow between the unconfined and uppermost basalt-confined aquifer. Depth to groundwater ranges from 0 m (0 feet) at the Columbia River to more than 100 m (330 feet) beneath parts of the central plateau."

"The hydrology of the 200 Area has been strongly influenced by the discharge of large quantities of wastewater to the ground over a 50-year period between the 1940s and 1990s. The discharges caused elevated groundwater levels across much of the Hanford Site, resulting in a large groundwater mound beneath the former U Pond in the 200 West Area and a smaller mound beneath the former B Pond, just to the northeast of the 200 East Area. The general increase in groundwater elevation caused the unconfined aquifer to extend upward into the Hanford Formation over a larger area, particularly near the 200 East Area. This resulted in an increase in groundwater velocity because of both the greater volume of groundwater and the higher permeability of the newly saturated Hanford Formation sediments."

PSRA: Draft GTCC EIS, Page 16

6.1.3.2.3. Groundwater Flow.
[page 6-37]

"Groundwater in the unconfined aquifer system flows from recharge areas in the elevated region near the western boundary of the Hanford Site toward the Columbia River on the eastern and northern boundaries. The Columbia River is the primary discharge area for the unconfined aquifer. The Yakima River borders the Hanford Site on the southwest and is generally regarded as a source of recharge. The rate of total discharge of groundwater from the Hanford Site aquifer to the Columbia River is in the range of 1.1 to 2.5 cms (39 to 88 cubic feet per second), a very small rate relative to the river's average flow of 3,300 cms (116,500 cubic feet per second)."

Although the DOE is correct in its statement that the discharge rate is small in relation to the Columbia River's average flow, the discharge will have a very significant impact if it is a direct source of contamination.

"Studies have indicated that the residence time of groundwater at the Hanford Site is on the order of thousands of years in the unconfined aquifer and more than 10,000 years for groundwater in the shallow confined aquifer, consistent with the recharge conditions expected for a semiarid climate. However, groundwater travel time from the 200 East Area to the Columbia River has been shown to be much faster, in the range of 10 to 30 years, because of the large volumes of wastewater discharged at the site in the past and the relatively high permeability of the Hanford Formation sediments."

It appears that instead of siting the repository in an area that is stable for 10,000 years, DOE is suggesting that the reference site for this 10,000 experiment should be sited in an area where Hanford's previous liquid waste discharges have accelerated the travel time from the site into the Columbia River to a mere 10 to 30 years!

In the mid-1980s my research for a legislative project indicated that 59 billion gallons of liquid high-level wastes had been admitted via cribs or injected directly into Hanford's soils and aquifers. At that time DOE stated that that calculation was not correct, but it refused to provide the accurate amount on the basis that it was "classified national security production information."

W3-12 Comment noted.

W3-13 DOE disagrees with the statement that the location of the GTCC disposal site is not stable. The reference locations were placed near existing disposal operations at the DOE sites. While some parameters could change within a short distance, most would not. Site-specific information was provided by the sites and that information was used in these modeling analyses to the extent it was available. Conservative assumptions were used if information was not available. For more information on past Hanford site discharges, which are not part of the scope of the GTCC EIS, see the final TC&WM EIS.

W3-12

W3-13

PSRA: Draft GTCC EIS, Page 17

On page 6-40, DOE now admits that between 1944 and the end of the 1990s, they discharged approximately "4.44 x 10¹¹ gallons" of liquid to disposal ponds and cribs. Even though DOE finally gave a figure, I noted that they did not clarify its meaning for those persons who may be concerned about the issue but somewhat fuzzy on math. DOE made sure we understood that 208 liters meant a 55 gallon drum, and that 100 meters equaled 330 feet, but they should have been more honest here by plainly admitting that the total was 444 BILLION gallons. This type of obfuscation destroys our trust of DOE's information and raises questions about their motives in repository proposals.

6.1.3.2.3 Groundwater Quality
[page 6-40]

"Groundwater in the unconfined aquifer beneath large areas of the Hanford Site has been contaminated by radiological and chemical constituents because of past site operations. These contaminants were primarily introduced through wastewater discharged to cribs, ditches, injection wells, trenches, and ponds. Additional contaminants from spills, leaking waste tanks, and burial grounds (landfills) have also entered groundwater in some areas. Contaminant plumes had sources in the 200 East Area and extend to the east and southeast; contaminant concentrations in these plumes are expected to decline through radioactive decay, mineral adsorption, chemical degradation, and dispersion. However, contaminants also exist within the vadose zone beneath waste sites as well as in waste storage and disposal facilities. These contaminants have the potential to continue to move downward into the aquifer."

"Currently, no active groundwater remediation is occurring at the operable unit (200-PO-1) underlying the southern portion of the 200 East Area."

In other words, DOE is actively remediating groundwater at 100-D, 100-H, 100-K and the 200 West Area, but is **not** remediating groundwater in the 200 East Area where they want to dig this repository.

W3-14 DOE Hanford has prioritized groundwater remediation activities by taking into account several factors. Groundwater contaminant plumes close to the river (i.e., in the 100 and 300 areas) have a high priority because they have the shortest travel times to the river. The vadose zone is also thinner in these areas and DOE has taken advantage of this easier access to contaminant plumes with a number of innovative containment and barrier designs. In 2012, DOE implemented a groundwater pump and treat system in 200 West to confine and remove contaminants near source areas and mitigate impacts to large areas of the unconfined aquifer down gradient from the sources. Active groundwater remediation beneath the 200 East area is much more difficult and less effective. This is an area of high hydraulic conductivity in the aquifer and the plumes in this area are relatively dispersed. Confinement and removal is not as an effective option for groundwater remediation in this area. DOE's strategy for the 200 East area relies primarily on detection and removal of contaminants in the vadose zone and natural attenuation in the aquifer.

W3-14

PSRA: Draft GTCC EIS, Page 18

"Operable Unit 200-PO-1 encompasses the southern portion of the 200 East Area and a large part of the Hanford Site extending to the east and southeast. Groundwater within 200-PO-1 is contaminated with plumes of tritium, nitrate, and I-129 that exceed drinking water standards."

Table 6.1.3-1 Maximum Concentrations of Selected Groundwater Contaminants at Operable Unit 200-PO-1 During FY 2006. [page 6-42]

The 200 East Area showed higher than allowable levels of arsenic, gross alpha, gross beta, I-129, Nitrate, SR-90, Te-99, and Tritium.

Considering what we know about the radiological and chemical contamination that exists and is migrating from the 200 East Area into the Columbia River, why would DOE even consider Hanford's 200 East Area for a disposal facility that will increase these contaminants?

Conclusion and Recommendation.

In summary, DOE's proposal for the reference site at Hanford's 200 East Area will require it to dig into the soils that are already highly contaminated by past waste disposal methods to such an extent that it has dramatically altered the groundwater characteristics and effectively destabilized and countered any ability to isolate wastes away from the Columbia River.

A realistic and honest review of the reference site's characteristics would preclude further consideration: It is being proposed for an area that is already contaminated, the existing wastes have not been responsibly managed, and the groundwater of the site has not been remediated.

Of additional concern is DOE's focus on protecting the repository from a few inches of rainfall by "capping" the project, while entirely ignoring any proposal to isolate the repository from the groundwater intrusion that poses the greatest threat.

W3-15 The disposal units for the intermediate depth and enhanced near-surface concepts are located in the unsaturated zone, above the water table. Thus, groundwater flow is not expected to impact the disposal units. The cover directly above the waste is expected to provide sufficient protection from infiltration which is expected to move primarily in the vertical direction.

W3-14
(Cont.)

W3-15

PSRA: Draft GTCC EIS, Page 19

The repository is expected to operate for 64 years and then be closed. DOE estimates that engineered barriers will protect the top from rainfall for 500 years, but the GTCC wastes will be dangerous for another 10,000 years. Conversely, water that was essentially stationary and required 10,000 years to reach the Columbia River is now moving through the site at a rate a thousand times faster because it is being pushed by contaminated mounds of radwaste.

I also question the validity of DOE's decision to not examine the repository's decommissioning plans: Those plans should be included in a responsible EIS because they will effect the environment and they might help up to identify issues that need to be addressed, such as the horizontal intrusion of groundwater through the repository, and any remedial engineering that might be indicated to reduce permeability of the repository. The repository will only operate for 64 years, so we really should include those issues in the EIS, even if only as a basis for future discussion and possible design changes.

Although I understand that the preparation of the shipments at the source's point of origin does not have a direct impact for any of the proposed locations, the EIS should include a discussion of those issues and expected exposures and accidents so we have a better understanding of them. The same waste packages that we intend to be very careful in handling at the final repository will also require even more diligence at the packaging facility. DOE should include this data as an Appendix or at least cite a single volume that is available for reference. This would be beneficial to source communities as a basis for disaster planning.

I believe that the reference site in Hanford's 200 East Area is not a proper location for the proposed GTCC Waste Repository. We need to place this waste in a stable dry soils that have a reasonable expectation of isolating it from the environment for the approximate 10,000 years needed to allow radioactive decay. Hanford's grossly contaminated groundwater will rapidly facilitate the movement of additional contamination into the Columbia River.

W. P. Mead
Director, PSRA

W3-16 The EIS notes that the decommissioning of a GTCC waste disposal facility is part of the proposed action, but because the facility would not be closed and decommissioned until far into the future (after 2083), the impact analysis for the decommissioning phase would be conducted at that time. It is not possible at this time to evaluate with any degree of confidence the environmental impacts from decommissioning a facility that has not yet been selected.

The GTCC waste disposal facility would be designed to facilitate future decommissioning consistent with applicable law, guidance, and policies. The appropriate site-specific NEPA analysis will be conducted in the future as part of the decommissioning plan.

W3-17 Operations such as the packaging and loading of shipments fall under the responsibility of the shipping organization and would be covered by the respective organization's operating procedures, safety measures, and NEPA reviews, as appropriate. Also, packaging and loading of the GTCC LLRW and GTCC-like wastes at each generator location would be the same for all alternative disposal sites, with the exception of remote-handled waste at WIPP, and would not be a discriminator in selecting an alternative.

W3-18 The specific locations that would be used at each potential site for development of a disposal facility for GTCC LLRW and GTCC-like wastes are not known at this time. The use of "reference locations" was used in the EIS to allow for a quantitative assessment of the impacts that could occur at each site. The reference locations were placed near existing disposal operations at the DOE sites. While some parameters could change within a short distance, most would not. Site-specific information provided by technical staff from various sites that were evaluated was used in these modeling analyses to the extent it was available, and conservative assumptions were used to fill any remaining data gaps. The analysis presented in the EIS is adequate for the comparison of the disposal alternatives evaluated. Fate and transport parameters utilized in the estimations were based on site-specific (e.g., specific to the reference location to the extent available) information and, as such, are considered reasonable for the purpose of the comparison made in the EIS. However, DOE recognizes that additional project- and site-specific information, such as the accelerated travel time to the Columbia River, could be used to inform the implementation of a disposal facility at a given location. This additional information is expected to reduce the uncertainty associated with these types of evaluations to the extent possible. Site-specific information would be evaluated in any site-specific NEPA review that would be conducted based on a ROD for this EIS

Final siting of a disposal facility for GTCC LLRW and GTCC-like wastes would involve further NEPA review as needed and be in accordance with applicable laws and regulations and would involve local stakeholder involvement and consent.

W3-16

W3-17

W3-18

Pueblo de San Ildefonso DECP, Commenter ID No. L279

Office of Governor
Perry Martinez



02 Tunyo Po
Santa Fe, NM 87506

Telephone (505) 455-2273
FAX (505) 455-1120



SI11-DECP-466

April 25, 2011

Greater-Than-Class C Low-Level Radioactive Waste EIS
Office of Technical and Regulatory Support (EM-43)
U.S. Department of Energy
1000 Independence Avenue, SW
Washington, DC 20585-0119

To Whom it May Concern:

The Pueblo de San Ildefonso (the Pueblo) Department of Environmental and Cultural Protection (DECP) has completed a review of the U.S. Department of Energy's (DOE's) Greater-Than-Class C (GTCC) Low-Level Radioactive Waste EIS. Our comments, both general and section-specific, are enclosed.

Thank you for the opportunity to interact on a Government-to-Government basis, and to have our concerns addressed.

Sincerely,

Neil S. Weber, Director
Department of Environmental and
Cultural Preservation
Pueblo de San Ildefonso

Enclosure

Pueblo de San Ildefonso DECP - L279

GENERAL COMMENTS

General Comment #1: LANL has a poor history with trenches and bore holes. Past efforts are now expensive, dangerous clean-ups. Yes, current technology and practices are much-improved over the past, but the past efforts represented the state of the art for their time, much as the current alternatives do for this time. Current bore holes and trenches may well be the leaking Solid Waste Management Units of the future.

General Comment #2: The Pueblo has grave concerns with reliance on Institutional Controls (IC). The Pueblo has been here long before LANL, and will continue to be here long after LANL is gone. IC does not provide any assurance of safety for a time span of relevance to the Pueblo.

General Comment #3: The Pueblo has grave concerns with reliance on concrete barriers, for the reasons stated in the comment above.

COMMENTS ON SPECIFIC SECTIONS

S.2.6.4 Los Alamos National Laboratory (LANL)

"(TA)-54 on Mesita del Buey: Zone 6, North Site, and North Site Expanded; Its northern border coincides with the boundary between LANL and the San Ildefonso Pueblo; Engineered shafts are actively used to dispose of RH LLRW."

Comment: This section should note that there are plumes from leaking shafts in this area, which borders the Pueblo's Sacred Area.

S.3 SUMMARY AND COMPARISON OF POTENTIAL ENVIRONMENTAL IMPACTS

"On the basis of the site-specific precipitation rates that were assumed, it is estimated that the federal sites located in the arid regions of the country (Hanford Site, LANL, NNSS, and WIPP Vicinity) would generally have lower long-term human health impacts from the groundwater pathway than would the sites located in more humid regions (such as SRS)."

Comment: However, arid regions may be 100% groundwater dependent; which magnifies the risk to groundwater resources, even though humidity may be lower.

"The exception is INL, this assumption was made as a conservative approach to account for the basalt layer that is present in some parts of INL."

Comment: LANL also has basalt layers, and "surge beds", which may represent fast paths to groundwater. Any exception for INL based on basalt may apply to LANL also.

L279-1 Comment noted.

The three land disposal facility conceptual designs (above-grade vault, enhanced near-surface trench, and intermediate-depth borehole) were selected as being representative of a range of land disposal configurations (varying degrees of waste consolidation and geometry) that could be employed for the disposal of the GTCC LLRW and GTCC-like waste inventory. As discussed in Section 1.4.2, each concept has its roots in practice at DOE sites. The same vault, borehole, and trench characteristics were considered for the disposal sites evaluated in order to compare the performance of each site's natural hydrological, geological, and meteorological properties relative to contaminant fate and transport once any engineered barriers would begin to fail.

L279-1

The conceptual nature of these configurations takes into account the characteristics of all of the disposal sites for which they were considered, but their designs (e.g., width, depth, cover depth, reinforced containment) could be altered or enhanced, as necessary, to provide an optimal solution at a specific location. As an example, the cover depth could be adjusted to ensure that roots from vegetation would not compromise the top of the engineered barrier. In addition, the dimensions of the generic land disposal units (e.g., trench - width and depth, borehole - diameter and depth, vault - width, depth, and height) were selected based on similar existing facilities, existing equipment and methods for construction, and optimized (maximized waste volume disposed of for a given disposal unit volume; simple waste handling procedures to minimize exposure) for the types of waste packages considered. All designs could also accommodate different disposal packages (existing and proposed) with minor variations in their dimensions, but the EIS analyses would remain relevant for each option considered. As an example, actual implementation of a disposal option at a specific location at a given site may have to be modified (i.e., the depth of a trench or a borehole may need to be reduced to avoid groundwater issues).

L279-2

Past operational experience with these types of disposal facilities at DOE sites has shown that when properly implemented, they can provide isolation of radioactive waste from the environment for extended time periods. Past problems that have arisen with each option provide additional information to improve the design and performance of future land disposal facilities. Issues related to performance over time would be analyzed in a project-specific analysis to address technical and long-term cultural concerns (e.g., tribal issues).

L279-3

L279-2 DOE appreciates the input provided by the Pueblo de San Ildefonso, on the EIS, both in the tribal narratives and in comments on the Draft EIS. This input was considered by DOE in identifying a preferred alternative.

L279-4

In the EIS, it was assumed that institutional controls of the land disposal units would be maintained for 100 years and that corrective measures could be implemented during this time period to ensure that the engineered barriers lasted for at least 500 years. This assumption is consistent with the institutional control time frame given in both NRC and DOE requirements and was determined to be a reasonable approach for assessing the long-term performance of the disposal units in the EIS.

In evaluating the performance of the proposed land disposal facilities, a number of engineering measures were assumed in the conceptual facility designs to minimize infiltration of water into the wastes and thereby minimize contaminant migration from the disposal units. These measures would also limit exposure pathways, such as the ingestion of plants having very long roots. It was assumed in this EIS that these measures would remain intact for 500 years after the disposal facility closed. Any defects identified in the disposal facilities were assumed to be corrected during the 100-year institutional control period, so that the 500-year time period would be met.

Pueblo de San Ildefonso DECP, Commenter ID No. L279 (cont'd)

S.5 UNCERTAINTIES ASSOCIATED WITH THE EVALUATIONS IN THE DRAFT GTCC EIS

Comment: The lack of knowledge of the LANL subsurface should be discussed in this section.

S.6.3.2 Construction and Operational Experience

“DOE successfully demonstrated the use of borehole facilities to dispose of radioactive waste at NNSS (formerly NTS),”

Comment: The success of borehole disposal has not been proven for a time frame of relevance to the Pueblo.

S.6.4.1 Human Health Impacts – “However, when the impacts of Tc-99 from past leaks and cribs and trenches (ditches) are combined, DOE believes it may not be prudent to add significant additional Tc-99 to the existing environment.”

Comment: This section should discuss contaminants adding to the leaks which exist at LANL.

L279-5

L279-6

L279-7

While this time period of 500 years may not be long enough to be of relevance to various American Indian tribes, it was determined to be a reasonable basis to use for comparing the merits of various land-disposal concepts and sites in the EIS and to allow for the selection of a preferred alternative.

L279-3 Text has been added to S.2.6.4 and section 8.1.3.2 to identify the existence of contaminant plumes from leaking shafts.

L279-4 The site-specific environmental factors identified in the comment were evaluated in the EIS as appropriate. DOE agrees that arid regions may be 100% dependent on groundwater. The issue of precipitation as well as depth to groundwater was also taken into consideration in the selection of the preferred alternative in the Final EIS. Site-specific analysis would be conducted for those sites selected as a preferred alternative to address any specific impacts related to the various environmental resource areas including geology (e.g. basalt and surge beds underlying the site).

L279-5 Should LANL be selected, site-specific analysis would be conducted to further identify and evaluate LANL subsurface geology and hydrology.

L279-6 Should LANL be selected, site-specific analysis and consultation with the Pueblo governments would be conducted to further evaluate issues related to performance over time of the disposal method selected for implementation.

L279-7 DOE believes that the analyses presented in the EIS are sufficient to compare the potential cumulative impacts of GTCC LLRW and GTCC-like waste disposal for the sites that were evaluated. In particular, existing concentrations of various radionuclides in contaminated soil and groundwater at the candidate sites were taken into consideration in the selection of the preferred alternative. Additional cumulative impact analyses would be conducted in site-specific NEPA reviews, if needed, for the alternative selected in a ROD. Such follow-on analyses would be based on additional site-specific information.

Pueblo of Acoma, Commenter ID No. W15

From: gtceiswebmaster@anl.gov
Sent: Wednesday, May 11, 2011 3:42 PM
To: mail_gtceisarchives; gtceiswebmaster@anl.gov; gtceis@anl.gov
Subject: Greater-Than-Class-C Low-Level Radioactive Waste EIS Comment GTCC10015
Attachments: GTCC_EIS_GTCC10015.docx

Thank you for your comment, Laura Watchempino.

The comment tracking number that has been assigned to your comment is GTCC10015. Please refer to the comment tracking number in all correspondence relating to this comment.

Comment Date: May 11, 2011 03:41:50PM CDT

Greater-Than-Class-C Low-Level Radioactive Waste EIS Draft Comment: GTCC10015

First Name: Laura
Last Name: Watchempino
Address: P.O. Box 407
City: Pueblo of Acoma
State: NM
Zip: 87034
Country: USA
Email: 5000wave@gmail.com
Privacy Preference: Don't withhold name or address from public record
Attachment: C:\akepath\GTCC EIS.docx

Questions about submitting comments over the Web? Contact us at: gtceiswebmaster@anl.gov or call the Greater-Than-Class-C Low-Level Radioactive Waste EIS Webmaster at (630) 252-5705.

Pueblo of Acoma, Commenter ID No. W15 (cont'd)

Arnold Edelman, Document Manager

Email: gtceis@anl.gov

Draft Environmental Impact Statement for the Disposal of Greater-Than-Class C (GTCC) Low-Level Radioactive Waste and GTCC-Like Waste

The Draft Environmental Impact Statement for the Disposal of Greater-Than-Class C (GTCC) Low-Level Radioactive Waste and GTCC-Like Waste released by the Department of Energy (DOE) is premature since the vast majority of waste will not exist for at least 20 years. Nor has the Blue Ribbon Commission on America's Nuclear Future presented its final recommendations for the disposal of high level nuclear waste and GTCC waste.

Hardened On-Site Storage and No Action Alternatives

DOE should consider a "no disposal" option with the intent on exploring a retrievable storage option called Hardened On-Site Storage (HOSS), which is similar to one of the disposal concepts (vaults) that DOE is considering for storage.

HOSS could also be used to store spent nuclear fuel at the reactor site where it is generated, thus allowing a dual purpose for these storage facilities. Transportation of the spent fuel offsite would be eliminated and the storage/disposal issue could be linked to the communities that produced it. HOSS also addresses security issues with fewer intermediary steps. HOSS would allow GTCC waste and irradiated spent fuel to remain at commercial nuclear power plants in long-term storage so that they can be monitored and are protected from aircraft crashes or terrorist attacks.

HOSS is more protective of human health and the environment than any of the alternatives presented in the DEIS and the Nuclear Regulatory Commission has determined that spent nuclear fuel can stay at commercial reactors for up to 100 years.

Additionally, any discussion of the long-term disposal of GTCC waste from nuclear reactors must include curbing the initial generation of the waste. A "No Action" alternative that discusses a halt to the construction of new taxpayer funded nuclear reactors must be analyzed. The Nuclear Regulatory Commission has not given its approval for a permanent nuclear waste disposal repository in the United States, but it continues to approve the start-up new uranium mines and mills, often in cultural and iconic landscapes, such as the Grand Canyon in Arizona and Mt. Taylor in New Mexico. Yet the Nuclear Waste Policy Act of 1982 has required the development of one or more other repositories for the long-term disposal of nuclear waste.

Waste Isolation Pilot Plant

The DOE should avoid the consideration of an alternative that would "dump" GTCC waste on states or communities that are already disproportionately impacted by the nuclear fuel cycle, from hosting uranium mines, processing facilities or national labs that conduct experiments with the use of nuclear power.

The long-term care and maintenance of over 160,000,000 curies of radioactivity is 30 times more radioactivity than originally planned for the Waste Isolation Pilot Plant (WIPP) in New Mexico and would eliminate the ban on commercial waste. It would open the door for the transformation of WIPP into a dumping ground for the nation's high-level waste and spent nuclear fuel, also currently banned at the WIPP site.

W15-1 The scope of this EIS is adequate to inform decision-making for the disposal of GTCC LLRW and GTCC-like waste. Sufficient information is available to support the current decision-making process to identify (an) appropriate site(s) and method(s) to dispose of the limited amount of GTCC LLRW and GTCC-like waste identified in the EIS.

DOE believes that this EIS process is not premature and is in compliance with NEPA. On the basis of an assumed starting date of 2019 for disposal operations, more than half (about 6,700 m³ [240,000 ft³] of the total GTCC LLRW and GTCC-like waste inventory of 12,000 m³ [420,000 ft³]) is projected to be available for disposal between 2019 and 2030. An additional 2,000 m³ (71,000 ft³) would become available for disposal between 2031 and 2035. This information is presented in Figure 3.4.2-1. DOE believes this EIS is timely, especially given the length of time necessary to develop a GTCC waste disposal facility.

W15-1 The Blue Ribbon Commission (BRC) on America's Nuclear Future, in its final report to DOE on January 26, 2012, provided recommendations, which included the development of one or more permanent deep geologic facilities for the safe disposal of spent nuclear fuel and high-level radioactive waste and the development of one or more consolidated interim storage facilities as part of an integrated, comprehensive plan for managing the back end of the nuclear fuel cycle. In its Strategy for the Management and Disposal of Spent Nuclear Fuel and High Level Radioactive Waste (DOE 2013), developed in response to the BRC Report, the Administration agreed "that the development of geologic disposal capacity is currently the most cost-effective way of permanently disposing of used nuclear fuel and high-level radioactive waste while minimizing the burden on future generations" and proposed to "engage in a consent-based siting process and begin to conduct preliminary site investigations for a geologic repository." The Administration's goal is to have a repository constructed and its operations started by 2048. The Administration will work with Congress using the strategy as an actionable framework for building a national program for the management and disposal of the nation's used nuclear fuel and high-level radioactive waste (DOE 2013).

W15-2

W15-2 The use of HOSS and other approaches for long-term storage of GTCC LLRW and GTCC-like wastes are outside the scope of this EIS because they do not meet the purpose and need for agency action. Consistent with Congressional direction in Section 631 of the Energy Policy Act of 2005 (P.L. 109-58), DOE plans to complete an EIS and a ROD for a permanent disposal facility for this waste, not for long-term storage options. The GTCC EIS evaluates the range of reasonable disposal alternatives and, as also required under NEPA, a No Action Alternative. Under the No Action Alternative, current practices for storing GTCC LLRW and GTCC-like wastes would continue in accordance with current requirements.

W15-3

W15-3 Stopping the generation of nuclear waste is outside the scope of the GTCC EIS, the scope of which is to evaluate disposal alternatives to enable the selection of a safe alternative or alternatives for the disposal of GTCC LLRW and GTCC-like wastes.

W15-4 Comment noted. The Nuclear Waste Policy Act of 1982 applies to the disposal of Spent Nuclear Fuel and High Level Waste.

W15-4 Disposal of GTCC LLRW and GTCC-like wastes at WIPP or the WIPP Vicinity site is included in the range of reasonable alternatives and is evaluated in this EIS. DOE acknowledges that only defense-generated TRU waste is currently authorized for disposal at the WIPP geologic repository under the WIPP LWA as amended (P.L. 102-579 as amended by P.L. 104-201) and that legislation would be required to allow disposal of waste other than TRU waste generated by atomic energy defense activities at WIPP and/or for siting a new facility within the land withdrawal area. It would also be necessary to revise the Agreement for Consultation and Cooperation between Department of Energy and the State of New Mexico for the Waste Isolation Pilot Plant, the WIPP compliance certification with EPA, and the WIPP Hazardous Waste Facility Permit. In addition, site-specific NEPA reviews would

Pueblo of Acoma, Commenter ID No. W15 (cont'd)

Los Alamos National Laboratory

There are significant groundwater contamination risks associated with the disposal of GTCC radioactive waste at Los Alamos National Laboratory (LANL) in New Mexico. LANL buries its low-level radioactive waste in unlined trenches, pits and shafts at Area G. A final determination by DOE and the New Mexico Environment Department on the burial of hazardous and radioactive wastes at Area G has not yet been made and is a highly controversial issue. A decision to add GTCC waste to the mix would predetermine the outcome of that decision, posing a threat to groundwater in the region for generations to come.

Conclusion

The DOE acted irresponsibly in releasing nuclear power generation into the stream of commerce. Commercial nuclear waste disposal has now become a critical issue of our time, far beyond the capacity of any current disposal alternatives.

The DOE should not proceed with a final GTCC EIS, but instead should develop a new DEIS that includes HOSS facilities as the best solution for GTCC wastes in this century and for new geologic disposal sites to dispose of GTCC waste in the next. In the alternative, DOE should issue a supplement to its 1997 *Final Waste Management EIS* that looks at reasonable alternatives for "GTCC-like" waste and other wastes for which long-term storage and disposal has not been determined, along with updated information and policy directives from the Blue Ribbon Commission on America's Nuclear Future.

W15-5

W15-6

W15-7

be conducted as needed, including further characterization of the waste (e.g., radionuclide inventory and heat loads) as well as the proposed packaging for disposal.

However, NEPA does not limit an EIS to proposing and evaluating alternatives that are currently authorized. Furthermore, the Agreement for Consultation and Cooperation between Department of Energy and the State of New Mexico for the Waste Isolation Pilot Plant recognizes that the mission of WIPP may change and provides provisions to modify the agreement. For example, the Agreement states: "The parties to this Agreement recognize that future developments including changes to applicable laws (e.g., Public Law [P.L.] 96-164) may make it desirable or necessary for one or both parties to seek to modify this Agreement. Either party to this Agreement may request a review of the terms and conditions."

A number of comments, primarily from sources within New Mexico, were made supporting the use of WIPP and the WIPP Vicinity for the disposal of GTCC LLRW and GTCC-like wastes. These comments generally noted that as an operating facility for disposal of defense-generated TRU waste, WIPP was a logical choice to provide the necessary disposal capability for GTCC LLRW and GTCC-like wastes to address this national need. Legislative action would be necessary to allow for the disposal of GTCC LLRW and GTCC-like wastes in the WIPP repository. In addition, the evaluation for a near-surface land disposal facility at the WIPP Vicinity reference locations indicated that potential human health and environmental impacts would be minimal.

The State of New Mexico has indicated a willingness to accept GTCC LLRW and GTCC-like wastes for disposal at WIPP. Twenty-eight New Mexico State Senators signed a proclamation made in the Fiftieth Legislature, First Session, 2011, stating: "Be it resolved that we, the undersigned, support the opportunity for other potential missions in southeast New Mexico to adequately address the disposal of defense high-level waste, commercial high-level waste, Greater Than Class C LLRW and surplus plutonium waste, as well as the interim storage of spent nuclear fuel." In response to the Draft GTCC EIS, Secretary David Martin, Secretary of the New Mexico Environment Department, sent a letter to DOE on June 27, 2011, stating that "the Department encourages DOE to support the WIPP or WIPP Vicinity proposed locations as the preferred alternatives addressed in the Draft EIS. The geologic repository is the favored alternative being more effective for the enduring time frames for this waste type." In addition, the Governor of New Mexico, in a letter to DOE Secretary Steven Chu on September 1, 2011, stated that the State of New Mexico encourages DOE to support the proposed location of WIPP as the preferred alternative for the disposal of GTCC LLRW and GTCC-like wastes.

- W15-5 Comment noted. This issue as well as other factors were taken into consideration when selecting the preferred alternative for the disposal of GTCC LLRW and GTCC-like waste.
- W15-6 Even though it is beyond the scope of this GTCC EIS, the comment is noted. This GTCC EIS addresses the potential environmental impacts associated with the proposed development, operation, and long-term management of a disposal facility or facilities for GTCC low-level radioactive waste (LLRW) and DOE GTCC-like waste.
- W15-7 The action alternatives evaluated in the GTCC EIS did not include interim storage of GTCC LLRW and GTCC-like wastes until a geologic repository for spent nuclear fuel and high-level radioactive waste becomes available because such interim storage (e.g., HOSS) is outside the scope of the GTCC EIS. The purpose of the GTCC EIS is to evaluate the range of reasonable alternatives for the safe and secure disposal of GTCC LLRW and GTCC-like wastes. The No Action Alternative evaluates continued storage of GTCC LLRW and GTCC-like wastes consistent with ongoing practices.

Pueblo of Acoma, Commenter ID No. W15 (cont'd)

DOE explained in the WM PEIS (DOE, 1997, *Final Waste Management Programmatic Environmental Impact Statement for Managing Treatment, Storage, and Disposal of Radioactive and Hazardous Waste*, DOE/EIS-0200-F, Office of Environmental Management, Washington, D.C.) that additional analyses would be prepared to implement DOE's programmatic decisions. The GTCC EIS analyzes the potential environmental impacts associated with the disposal of GTCC LLRW and GTCC-like (DOE) wastes. Since the WM PEIS relates only to DOE waste, the inclusion of commercial waste in the WM PEIS is premature until the GTCC EIS is finalized and a ROD is issued. Depending on the outcome of this ROD, DOE will evaluate whether additional programmatic or site-specific NEPA reviews or updates to previous decisions are needed, as appropriate. Any additional NEPA reviews or considerations will be conducted with full opportunity for public input, consistent with Council on Environmental Quality and DOE NEPA requirements.

R Graham Graphics, Commenter ID No. W108

From: gtcciswebmaster@anl.gov
Sent: Wednesday, June 15, 2011 7:20 PM
To: gtcciswebmaster@anl.gov
Subject: Receipt: Greater-Than-Class-C Low-Level Radioactive Waste EIS Comment GTCC10108

Thank you for your comment, Robert Graham.

The comment tracking number that has been assigned to your comment is GTCC10108. Please refer to the comment tracking number in all correspondence relating to this comment.

Comment Date: June 15, 2011 07:19:17PM CDT

Greater-Than-Class-C Low-Level Radioactive Waste EIS Draft Comment: GTCC10108

First Name: Robert
Middle Initial: H
Last Name: Graham
Organization: rgrahamgraphics
Address: 775 Jackson, S.W.
Address 3: 775 Jackson, S.W.
City: Bandon
State: OR
Zip: 97411
Country: USA
Email: rgraham@cardas.com
Privacy Preference: Don't withhold name or address from public record

Comment Submitted:
Secretary Chu and Mr. Edelman:

The Hanford Nuclear Reservation is the wrong place to store and dispose of highly dangerous radioactive material. It is already the most contaminated site in the Western Hemisphere and the Department of Energy is already engaged in one of the largest and most complex cleanup projects in U.S. history at Hanford. You should stop nuclear waste from leaking into the Columbia River and clean up the existing site at Hanford. No new nuclear waste should be transported to Hanford.

Using the Hanford site means thousands of trucks with dangerous radioactive waste would be traveling along the Columbia River Gorge National Scenic Area. The risk of an accident is simply too great, and the environmental and human health costs are unacceptable.

The Draft of the Environmental Impact Statement (DEIS) fails to consider the risks involved in transporting these waste materials to Hanford. The DEIS does not include a 2008 USDOE study estimated that 800 adult cancer deaths would occur due to ambient radiation from the transport vehicles alone. Nor does the DEIS include the number of deaths and environmental damage resulting from a truck accident.

W108-1 DOE is performing environmental restoration activities at the Hanford Site. The ongoing cleanup effort will continue.

DOE's ROD 78 FR 75913 dated December 13, 2013, stated that DOE has deferred a decision on importing waste from other DOE sites (with limited exceptions as described in the Settlement Agreement with the State of Washington Department of Ecology) for disposal at Hanford at least until WTP is operational.

W108-2 DOE's ROD 78 FR 75913 dated December 13, 2013, stated that DOE has deferred a decision on importing waste from other DOE sites (with limited exceptions as described in the Settlement Agreement with the State of Washington Department of Ecology) for disposal at Hanford at least until WTP is operational.

If DOE decides to implement its preferred alternative for the TC&WM EIS, GTCC LLRW and GTCC-like wastes would not be shipped through the Columbia River Gorge for disposal at the Hanford Site until the waste treatment plant is operational. However, regardless of where the GTCC waste disposal facility is ultimately located, a relatively small amount of GTCC LLRW and GTCC-like wastes may be transported through the Columbia River Gorge on their way to the disposal facility. The waste would be generated within the states of Oregon and Washington and would include actinide sealed sources and Cs-137 irradiators from local medical institutions, research facilities, universities, and other NRC and Agreement State licensees.

The transportation of radioactive waste will meet or exceed DOT and NRC regulatory requirements that promote the protection of human health and the environment. These regulations include requirements for radioactive materials packaging, marking, labeling, placarding, shipping papers, and highway routing. The waste shipments would be on preferred routes, which are interstate highways or alternative routes designated by a state routing agency in accordance with DOT regulations (49 CFR Part 397, Subpart D). The GTCC LLRW and GTCC-like wastes would be shipped in approved waste packages and transportation casks. The robust nature of these casks limits the potential release of radioactive and chemically hazardous material under the severest of accident conditions. It is unlikely that the transportation of GTCC LLRW and GTCC-like wastes to any of the alternative sites evaluated in the EIS would cause an additional fatality as a result of radiation from either incident-free transportation or postulated transportation accidents.

The EIS evaluated the transportation impacts from the shipments that would be required to dispose of all of the GTCC LLRW and GTCC-like wastes at the various disposal sites. The EIS addressed the collective population risks during routine conditions and accidents, the radiological risks to the highest exposed individuals during routine conditions, and the consequences to individuals and populations as a result of transportation accidents, including those that could release radioactive or hazardous chemical materials. About 12,600 shipments would be required to transport all of the GTCC LLRW and GTCC-like wastes to the Hanford Site for disposal. This would result in about 50 million km (30 million mi) of highway travel, with no expected LCFs. One fatality directly related to an accident might occur (see Section 6.2.9.1).

DOE's standard operating procedure for transportation of radioactive waste is developed and continually revised to ensure that the utmost protection of public health and the environment is achieved and that the risk of a traffic accident is minimized. For example, DOE has established a comprehensive emergency management program (Transportation Emergency Preparedness Program or TEPP) that provides detailed, hazard specific planning and preparedness measures to minimize the health impacts from accidents involving loss of control over radioactive material or toxic chemicals. DOE's TEPP was established to ensure that its contractors and state, tribal, and local emergency responders are prepared to respond promptly, efficiently, and effectively to accidents involving DOE shipments of radioactive materials.

W108-1

W108-2

W108-3

W108-4

R Graham Graphics, Commenter ID No. W108 (cont'd)

I am joined in opposition to transporting more nuclear waste to Hanford by Friends of the Columbia Gorge, Heart of America Northwest, Columbia Riverkeeper, 17 Oregon legislators, Congressman Earl Blumenauer, U.S. Senator Merkley, U.S. Senator Wyden and many others.

Thank you for your time and consideration.

Questions about submitting comments over the Web? Contact us at: gtccsiswebmaster@anl.gov or call the Greater-Than-Class-C Low-Level Radioactive Waste EIS Webmaster at (630) 252-5705.

W108-5

If an accident that involved a release of radioactive material to the environment occurred, it would be remediated promptly in accordance with these procedures. These measures would help DOE minimize and mitigate any impacts on the environment.

W108-3 A number of commenters indicated they believed shipping offsite waste would result in 800 LCFs. This value for transportation risk does not exist in this GTCC EIS. DOE believes that the value of approximately 800 LCFs, cited in the public comments, is from the results provided in the *Draft Global Nuclear Energy Partnership Programmatic Environmental Impact Statement* (GNEP PEIS) regarding transportation of spent nuclear fuel (SNF) and HLW. This value represents the maximum impacts associated with 50 years of transportation activities supporting the operations of all existing U.S. commercial light-water reactors if they all were replaced with high-temperature, gas-cooled reactors. The GNEP PEIS was canceled by DOE on June 29, 2009 (74 FR 31017).

The GNEP PEIS involved many more shipments than those for disposal of GTCC LLRW and GTCC-like wastes. Because of this, the resulting estimated impacts for that program (now terminated) were much greater than those given in this EIS. The same types of analyses were done in both the GNEP PEIS and this EIS, but no LCFs are expected to result from transportation of the GTCC LLRW or GTCC-like wastes to the potential disposal sites considered in the GTCC EIS due to the much lower shipment numbers.

Tables 2.7-5 and 2.7-6 summarize the transportation impacts for truck and rail, respectively, for all alternatives. The accident fatalities column indicates the potential number of fatalities from transportation accidents, and the collective population LCFs column includes accident risks (from radioactive material releases) as well as from normal transport.

W108-4 Many commenters made reference to an estimate of 800 LCFs in the *Draft Global Nuclear Energy Partnership Programmatic Environmental Impact Statement* (GNEP PEIS, DOE/EIS 0396). This value is not relevant to the proposed action in the GTCC EIS. This value represents the maximum impacts associated with 50 years of transportation activities supporting the operations of all existing domestic commercial light-water reactors if all of them were replaced with high temperature, gas-cooled reactors. DOE cancelled the GNEP PEIS process on June 29, 2009 (74 FR 31017).

The GNEP PEIS involved many more shipments than those for disposal of GTCC LLRW and GTCC-like wastes. Because of this, the resulting estimated impacts for that program (now terminated) were much greater than those given in this EIS. The same types of analyses were done in both the GNEP PEIS and this EIS, but no LCFs are expected to result from transportation of the GTCC LLRW or GTCC-like wastes to the potential disposal sites considered in the GTCC EIS due to the much lower shipment numbers.

W108-5 See response to W108-2.

Rosemere Neighborhood Association, Commenter ID No. T134

Capital Reporting Company 84

1

2

3

4 Okay. This is Dvija Michael Bertish.

5 MR. BERTISH: There's a few of you left at

6 least. That's good. Dvija Michael Bertish, Rosemere

7 Neighborhood Association based in Vancouver,

8 Washington, abutting I-5, which is one of the

9 transportation corridors. So our neighborhood would

10 be directly affected. And our organization and those

11 of our supporters oppose this proposal.

12 Relative to the Environmental Impact Statement,

13 we ask that there be no pursuit of a Final

14 Environmental Impact Statement until the comments

15 that have been produced by all of the various public

16 forums be addressed as a systematic response summary

17 matrix and adjustments made to the Environmental

18 Impact Statement to discuss how those grievances

19 would be addressed in any final.

20 So no Record of Decision based on that. And we

21 would ask that, actually, the Environment Impact

22 Statement be back-pedaled and redone, because not

23 every alternative has been adequately outlined under

24 the guidelines of NEPA.

25 Personally, and representing the interests of

866.488.DEPO
www.CapitalReportingCompany.com

T134-1

T134-2

T134-3

T134-1 In preparing the Final GTCC EIS, DOE gave equal consideration to all public comments received. DOE responses to these comments are provided in this appendix. Changes in response to these comments are noted in our responses to the comments and "side-bars" indicating changes to the Final EIS are included in this document.

As part of the NEPA process, DOE engages the public in providing input. This input is considered in evaluation of the various alternatives presented in the EIS. Cumulative impacts from other actions at the site are also considered in making a final decision.

T134-2 The scope of this EIS is in compliance with the NEPA guidelines and is adequate to inform decision-making for the disposal of GTCC LLRW and GTCC-like waste. Sufficient information is available to support the current decision-making process to identify (an) appropriate site(s) and method(s) to dispose of the limited amount of GTCC LLRW and GTCC-like waste identified in the EIS.

DOE believes that this EIS process is not premature and is in compliance with NEPA. On the basis of an assumed starting date of 2019 for disposal operations, more than half (about 6,700 m³ [240,000 ft³] of the total GTCC LLRW and GTCC-like waste inventory of 12,000 m³ [420,000 ft³]) is projected to be available for disposal between 2019 and 2030. An additional 2,000 m³ (71,000 ft³) would become available for disposal between 2031 and 2035. This information is presented in Figure 3.4.2-1. DOE believes this EIS is timely, especially given the length of time necessary to develop a GTCC waste disposal facility.

DOE developed this EIS to support a decision on selecting a disposal facility or facilities for GTCC LLRW and GTCC-like waste, to address legislative requirements, to address national security concerns (especially for sealed sources), and to protect public health and safety. The purpose and need for the proposed action, as discussed above, is stated in the EIS (Section 1.1). The scope of the EIS is focused on addressing the need for developing a disposal capability for the identified inventory of GTCC LLRW and GTCC-like wastes. DOE plans a tiered decision-making process, in which DOE would conduct further site-specific NEPA reviews before implementing an alternative ultimately selected on the basis of this EIS.

T134-3 Comment noted.

Rosemere Neighborhood Association, Commenter ID No. T134 (cont'd)

T134-4 Comment noted. DOE believes that disposal of the GTCC LLRW and GTCC-like waste would take such material out of the public domain and put it in a place that would be currently inaccessible and difficult to retrieve.

Capital Reporting Company

85

1 our organization and our fellow partners, we don't
 2 believe that the U.S. Department of Energy nor the
 3 regulatory commission of the United States can
 4 adequately protect the public by creating another
 5 repository that's shallow. We do not believe that
 6 the justification for this, keeping this stream of
 7 nuclear medicine or nuclear weapons that are
 8 dispersed around the world and bringing them to one
 9 place, would solve that problem.

T134-3
(Cont.)

10 That is not an adequate justification to create
 11 a suppository. We believe that the U.S. Department
 12 of Energy is disingenuous and that it has -- at the
 13 last meeting, we provided comments, similar to what
 14 the lady before me just spoke about, the MOX fuel
 15 that was being readied for the Hanford generating
 16 station. And the Department of Energy representative
 17 said that had nothing to do with them and that it was
 18 all Energy Northwest's doing. But you work in
 19 partnership, and so we feel, based on that, that it's
 20 not a trustworthy thing to say that we can agree that
 21 you would be able to protect such a repository that
 22 would multiply the degree of contamination at the
 23 site.

T134-4

24 I mirror the comments of most all of the people
 25 that were here tonight, including elected officials

866.488.DEPO
 www.CapitalReportingCompany.com

Rosemere Neighborhood Association, Commenter ID No. T134 (cont'd)

Capital Reporting Company

86

1 from both -- elected and appointed officials from
2 both Oregon and Washington who say, Don't bring the
3 stuff here. We agree.
4 And there was a gentleman who asked earlier
5 where the stuff was coming from and why couldn't it
6 be left where it was in terms of nuclear waste, and
7 it's my understanding -- and it's common knowledge --
8 that it's even being discussed that we would be
9 importing nuclear waste from Europe and that it would
10 travel through the United States, and that there
11 would be American corporations springing up that
12 would deal with the waste stream and transmute it and
13 say, Pay us and we'll take your waste off your hands
14 and we'll do dump it at Hanford. It's already moved
15 across the Great Lakes from Canada. There's a
16 company in Tennessee that wants to take it from
17 Germany, and we have no say in all this. And we
18 don't think it is appropriate.
19 Leave it where it's at. Make the people who
20 make the stuff responsible for it forever. Leave it
21 in place, make them deal with it, and we'll deal with
22 our own. Thank you.

T134-5

T134-6

T134-7

T134-5 DOE's ROD 78 FR 75913 dated December 13, 2013, stated that DOE has deferred a decision on importing waste from other DOE sites (with limited exceptions as described in the Settlement Agreement with the State of Washington Department of Ecology) for disposal at Hanford at least until WTP is operational.

T134-6 See response to T134-5.

T134-7 DOE is responsible under the Low-Level Radioactive Waste Policy Amendments Act (P.L. 99-240) for the disposal of GTCC LLRW. The purpose of the EIS is to evaluate alternatives for the safe and secure disposal of GTCC LLRW and GTCC-like wastes. Continued storage of GTCC LLRW at the generating facilities was evaluated as part of the No Action alternative. Transportation of GTCC LLRW and GTCC-like wastes from generating facilities to a GTCC LLRW disposal facility is a required component of the disposal process that would be identified for the GTCC LLRW and GTCC-like wastes because the disposal site(s) or location(s) would not be the same as the generator sites for reasons provided in the EIS. DOE believes that the transportation of GTCC LLRW and GTCC-like wastes to a more centralized disposal facility would result in lower overall human health risks compared to managing the wastes at multiple locations and can be conducted in a safe manner based on compliance with comprehensive regulatory requirements and past experiences.

Leaving the waste in place (i.e., the No Action Alternative) is evaluated in the EIS to provide a baseline for comparison with the action alternatives. This evaluation confirmed the risks posed by these wastes and the need to develop appropriate disposal capability. The potential radiation doses for the No Action Alternative covered a time period of 10,000 years in a manner comparable to that done for the action alternatives. Relatively high impacts could occur shortly after the 100-year institutional control period under this alternative.

SANTA CLARA

POST OFFICE BOX 580
(505) 753-7330
(505) 753-5375 Fax



INDIAN PUEBLO

ESPAÑOLA, NEW MEXICO
87532
OFFICE OF GOVERNOR



June 24, 2011

Arnold Edelman,
GTCC DEIS Document Manager
Office of Environmental Management
US Department of Energy
Cloverleaf Building, EM-43
1000 Independence Avenue SW
Washington, DC 20585

Re: **Santa Clara Pueblo's Comments on the Draft Environmental Impact Statement for the Disposal of Greater-Than-Class-C (GTCC) Low Level Radioactive Waste and GTCC-Like Waste (DOE/EIS-0375-D)**

Dear Mr. Edelman:

Santa Clara Pueblo submits the following comments on the Draft *Environmental Impact Statement for the Disposal of Greater-Than-Class-C (GTCC) Low Level Radioactive Waste and GTCC-Like Waste* ("GTCC DEIS").

We trust these comments will be respected as part of our government-to-government relationship with the U.S. Department of Energy ("DOE"), which is formalized not only in the DOE Order 144.1 (approved January 16, 2009) and the DOE American Indian and Alaska Native Tribal Government Policy ("DOE Indian Policy") but also more specifically through an Accord developed in 1992 directly between our Pueblo and the DOE which was restated and reaffirmed by both governments in 2006 ("2006 Accord").

While we applaud the DOE for its efforts to try to meaningfully involve Tribal governments early in the process of developing the GTCC DEIS and for including Tribal viewpoints in the draft document, we are dismayed that much of the Tribal input was not actually factored into the analysis conducted by the DOE for the GTCC DEIS.

We begin our comments with some background information regarding Santa Clara Pueblo to provide context for our comments and then follow with specific comments regarding the GTCC DEIS with a focus on why the DOE's preferred alternative for a disposal facility or disposal facilities for Greater-Than-Class-C ("GTCC") low level radioactive waste and DOE GTCC-like

L95-1

DOE initiated government-to-government consultations with potentially affected American Indian tribes in a timely manner consistent with DOE Order 144.1 and DOE's NEPA implementing guidelines. These consultations were done at a time that DOE had compiled and developed sufficient information for the Draft EIS (including identification of the GTCC LLRW and GTCC-like waste inventory) to allow for an informed consultation with potentially affected American Indian tribes. These consultations resulted in some of the tribes providing narrative text for inclusion in the EIS.

DOE considered the input provided by American Indian tribes (as reflected in the tribal narratives in the EIS) in identifying the preferred alternative. Tribal narratives identified several tribal issues related to NNSS, Hanford, INL, and LANL; however, no affiliated tribes were identified for the purpose of developing tribal narratives associated with WIPP and SRS.

The Department is committed ensuring government to government consultations and following the policy, principles, and commitments in the DOE Order on American Indian Tribal Government Interactions and the American Indian and Alaska Native Tribal Government Policy (DOE Order 144.1). DOE formally consulted with the Santa Clara Pueblo and American Indian Tribes to assure that tribal rights, responsibilities, and concerns are addressed prior to making any final decision on the selection of (an) alternative(s) for the disposal of GTCC LLRW and GTCC-like waste and/or implementing GTCC programs that may affect the Pueblos and American Indian Tribes.

Text prepared by potentially affected American Indian tribes is included in this EIS. DOE considered this text for Hanford, INL, LANL, and NNSS; however, DOE also needed to ensure consistency in the EIS analyses between the various sites, so that an even comparison could be made between alternatives as required by NEPA. Because of this, it was not possible to fully utilize all of the information provided by the tribal governments in order to perform specific analyses associated with exposure events unique to a given American Indian tribe (such as greater intakes of fish, game, and plants; the use of sweat lodges; and the use of natural pigment paints for traditional ceremonies). Once a decision is made on a specific site location and method, appropriate site-specific NEPA review would be conducted, as needed.

However, the information provided in these narratives was considered in the identification of the preferred alternative presented in this EIS. The information provided in the narratives for Hanford, INL, LANL, and NNSS was very useful, and DOE appreciates the time and effort expended by the various tribes in supporting this EIS process. For additional information, see Section J.2.5.

L95-2

The disposal methods and sites evaluated in the EIS represent the range of reasonable alternatives for the disposal of GTCC LLRW and GTCC-like wastes. This range is consistent with NEPA implementing regulations in Parts 1500-1508 of Title 40 of the Code of Federal Regulations (40 CFR Parts 1500-1508). In this GTCC EIS, DOE analyzed a range of disposal methods (i.e., geologic repository, near-surface trench, intermediate-depth borehole, and above-grade vault) and federally owned sites (i.e., Hanford Site, INL, LANL, NNSS, SRS, and the WIPP Vicinity, for which two reference locations - one within and one outside the WIPP Land Withdrawal Boundary - were considered). DOE has determined that it was reasonable to analyze these six sites because they currently have operating radioactive waste disposal facilities, except for the WIPP Vicinity, which is near an operating geologic repository.

DOE also conducted a generic evaluation of commercial disposal facilities on nonfederal lands in the EIS to order to provide, to the extent possible, information regarding the potential long-term performance of other (nonfederal) locations for siting a GTCC waste land disposal facility.

L95-1

L95-2

Santa Clara Pueblo - L95

Santa Clara Pueblo, Commenter ID No. L95 (cont'd)

Mr. Edelman
Santa Clara Pueblo's Comments on the GTCC DEIS
June 24, 2011
Page 2

waste should *not* include any such disposal at Los Alamos National Laboratory ("LANL").

Although the DOE must adhere to specific a regulatory and statutory process for this particular environmental impact statement in order to comply with the National Environmental Policy Act ("NEPA"), the Low-Level Radioactive Waste Policy Amendments Act of 1985, and the Energy Policy Act of 2005, please remember that this is no sterile regulatory matter for Santa Clara Pueblo. The Pajarito Plateau, where LANL is situated, contains many areas of traditional importance to the Santa Clara Tribal community. Environmental degradation of this place that is profoundly holy to the Santa Clara community affects the cultural survival of Santa Clara Pueblo. While others may believe it appropriate to bury more waste at LANL because they only see barren land or otherwise "undeveloped and relatively undisturbed areas," *see* GTCC DEIS at 1-35 (discussing LANL proposed waste disposal location), we do not believe it is appropriate because these areas both at and near LANL are actually our Bethlehem, our Mecca, our Jerusalem. Imagine if you were asked to comment on a proposal to dispose of wastes, some of which have half-lives in excess of 10,000 years, in your most holy place of worship. Would that be a simple regulatory matter to you? As you review these comments, please bear this in mind and please remember that, prior to the Manhattan Project, the Pajarito Plateau was pristine and Santa Clara's connection to this area goes back to the beginning of time.

I. Overview regarding Santa Clara Pueblo

Santa Clara Pueblo is a federally-recognized Indian tribe located in northern New Mexico, approximately twenty-five (25) miles northwest of the City of Santa Fe. Much of the City of Española, approximately one (1) mile to the west of our Tribal government offices, actually is located within the exterior boundaries of Santa Clara lands. While our Tribal offices are approximately eighteen (18) miles away from LANL, our closest border is actually only about five (5) miles from the current-day boundaries of LANL. In fact, early maps reveal that LANL once shared a boundary with Santa Clara Pueblo and that the area now located between LANL and Santa Clara was once referred to as "Area E." Our traditional lands include lands taken for the Manhattan Project.

While we always will emphasize the need for DOE to respect its government-to-government relationship with the Pueblo, Santa Clara Pueblo is not only a government in some bureaucratic sense of the word. In the broader cultural sense, we are also an Indian community of people, a society unto ourselves numbering less than a few thousand, distinct from every other Indian community in our traditions. We have similarities with the other Pueblos in New Mexico, especially those who also speak our Tewa language, but we are a separate sovereign Indian nation, recognized as such over the past 400 years by three different sovereign governments – Spain, Mexico, and the United States of America. Tribal leaders at Santa Clara Pueblo still carry the canes presented to our ancestral leaders by the Spanish and Mexican governments, as well as a similar cane presented by President Abraham Lincoln after New Mexico was annexed by the United States. Tribal protection and management of our natural resources along our ancestral homelands in the Jemez Mountains, Pajarito Plateau, and Rio Grande Valley began many thousands of years ago, long before the Spanish, Mexican, or American periods of our

Final siting of a disposal facility for GTCC LLRW and GTCC-like wastes would involve further NEPA review as needed and be in accordance with applicable laws and regulations and would involve local stakeholder involvement and consent.

L95-3 DOE has taken into consideration the concerns of the Santa Clara Pueblo related to cultural and religious concerns in the selection of the preferred alternative for the disposal of GTCC LLRW and GTCC-like waste.

L95-2
(Cont.)

L95-3

Santa Clara Pueblo, Commenter ID No. L95 (cont'd)

Mr. Edelman
Santa Clara Pueblo's Comments on the GTCC DEIS
June 24, 2011
Page 3

history.

The modern-day boundaries of our Pueblo include over 53,000 acres of land. This acreage figure includes some of our traditional lands that we have fought to regain but does not encompass all of our aboriginal territory. Many of the various vegetative communities and the innumerable wildlife species they support have significant traditional and spiritual value to us as a people. The Pajarito Plateau contains many areas of cultural importance to our people and our cultural practices connected to these areas continue to this day. Some of these places and practices were already highlighted in the comments already provided by Santa Clara Pueblo for this GTCC DEIS (See GTCC DEIS, Appendix G at G-79 through G-92).

II. Disposal of GTCC and the DOE's GTCC-like waste at LANL should not be part of DOE's preferred alternative because such disposal at LANL is in direct opposition to the purpose of the DOE's 2005 Order on Consent with the State of New Mexico and directly contravenes the DOE's clean-up and footprint reduction missions for LANL.

The GTCC DEIS assumes there will be a need to dispose of approximately 420,000 cubic feet of GTCC and GTCC-like waste, some of which exists now but some of which is expected to be generated within the next twenty to thirty years. See GTCC DEIS at S-10 and 1-3. According to the GTCC DEIS, some of the radionuclides in the GTCC wastes are present in high concentrations or have very long half-lives (in excess of 10,000 years) such that disposal facilities are needed for a 10,000 year timeframe. *Id.* at S-9 and 1-3. Some of the options assessed in the GTCC DEIS are to dispose of these wastes at LANL in intermediate-depth boreholes, enhanced near-surface trenches, or above-grade vaults on Mesita del Buey. The locations for LANL assessed are primarily within Technical Area ("T.A.")54 with some locations identified at the adjacent TA-51. *Id.* at 1-35 and 8-1.

Strangely, the GTCC DEIS states explicitly that there are no settlement agreements or consent orders for LANL that would be affected by the proposal to bury these wastes at LANL at TA-54. See *id.* at 8-98. Yet, TA-54 is the very location of extensive remediation under a March 2005 Compliance Order on Consent between the New Mexico Environment Department and LANL ("2005 Consent Order"). The purposes of the 2005 Consent Order are: (1) to define the extent of releases of contaminants at LANL; (2) to evaluate corrective measures to clean up contaminants and prevent or mitigate the migration of contaminants; and (3) to implement such corrective measures. In fact, extensive work is underway now to identify how all the existing unlined subsurface pits, trenches and shafts in Material Disposal Area G at TA-54 will be comprehensively remediated and closed in conjunction with the 2005 Consent Order. TA-54 is scheduled to be closed to new waste disposal following the 2005 Consent Order remediation. Therefore, the proposal in the GTCC DEIS to turn TA-54 back into an active waste disposal area would contradict the very purpose of the remediation effort already underway.

Moreover, DOE, through its Environmental Management ("EM") branch, has made clean-up of legacy wastes and reduction of the footprint in the nuclear complex two of its top four priorities for its current mission as part of its "Journey to Excellence." See U.S. DOE, Office of

L95-4 DOE is performing environmental restoration activities at LANL. The ongoing cleanup effort will continue.

A discussion of the 2005 consent order was added to Section 8.5 in the EIS. The 2005 Consent Order is currently under re-negotiation with NMED. Once the agreement is finalized (projected in 2016), it will supersede the 2005 Consent Order.

L95-4

Santa Clara Pueblo, Commenter ID No. L95 (cont'd)

Mr. Edelman
Santa Clara Pueblo's Comments on the GTCC DEIS
June 24, 2011
Page 4

Environmental Management, *Roadmap - EM Journey to Excellence* (Revision 0- December 16, 2010). According to EM's roadmap:

Footprint Reduction is defined as remediation of an area and the immediately surrounding buffer zone, if necessary, such that cleanup has achieved all regulatory requirements (i.e., all soil contamination has been remediated, contaminated facilities dispositioned, and a groundwater remediation system is in-place and operable) and whereby the previously affected land area may be made available for potential beneficial reuse, transitioned to long-term remedial operations, or made ready for transfer for long-term environmental stewardship.

Id. at 9.

Disposing of GTCC and DOE GTCC-like waste at LANL would defeat EM's recently heralded mission of footprint reduction since, according to the GTCC DEIS, the acreage needed for GTCC and GTCC-like waste at TA-54 and TA-51 at LANL would be 110 acres for boreholes, 50 acres for trenches, and 60 acres for the vaults. See GTCC EIS at S-21 through S-24. It is hard to envision how, as part of footprint reduction, the "previously affected land area" already scheduled for clean-up of legacy waste at TA-54 could then be "made available for potential beneficial reuse, or transitioned to long-term remedial operations, or made ready for transfer for long-term environmental stewardship" if the new use for the land is to build another whole new waste disposal area on 50 to 110 acres.

The GTCC DEIS states that DOE will choose its preferred alternative and that the preferred alternative must, among other things, fulfill DOE's statutory mission and responsibilities. See GTCC DEIS at S-53. Since permanent disposal of GTCC waste at LANL would contravene the DOE's own stated mission and would contravene and undermine the 2005 Consent Order with the State of New Mexico, the DOE should reject any alternative that includes storage at LANL when choosing its preferred alternative for the final EIS for this waste stream.

III. Disposal of GTCC and the DOE's GTCC-like waste at LANL should not be part of DOE's preferred alternative because new information about seismic risks at LANL makes LANL a clearly unsafe and unjustifiable choice

LANL was built on the Pajarito Fault System along the Rio Grande Rift. The Pajarito Fault connects to a number of secondary faults -- the Santa Clara Canyon Fault, the Rendija Canyon Fault, the Guaje Mountain Faults, and the Sawyer Canyon Fault. This fault system connects to Santa Clara Pueblo's landbase and, among other concerns, Santa Clara Pueblo remains deeply concerned that this fault system provides a means of transport for groundwater contamination to our lands. See GTCC DEIS at G-82.

The GTCC DEIS does acknowledge the seismic faults at and around LANL, and does incorporate information from the seismic hazard study for LANL conducted in 2007, see GTCC DEIS at 8-19 through 8-22, but there is newer information about the seismic risks that was not incorporated

L95-5

The site-specific environmental factors identified were evaluated in the EIS as appropriate. In terms of recent analyses, an update to the Probabilistic Seismic Hazards Assessment of the Los Alamos National Laboratory (May, 2007) was completed in 2009 (Final Report, Update of the Probabilistic Seismic Hazard Analysis and Development of CMRR Design Ground Motions, Los Alamos National Laboratory, New Mexico, URS Corporation for Los Alamos National Laboratory, October 2009). This update indicates that the ground motions associated with seismic hazard at Los Alamos were slightly lower than predicted in the 2007 study. In design and evaluation of LANL nuclear structures, DOE looks at the potential for earthquakes on all known seismic sources in the vicinity of LANL that could produce strong ground shaking. The seismic hazard at LANL is defined at annual frequencies of exceedance from less than 1x10⁻² (1/100 years) to about 1x10⁻⁶ (1/1,000,000 years). The 2,500 year return period event that is referred to is associated with the design basis earthquake. This does not mean that the DOE does not look at the impact of more rare events in managing the seismic risk to the laboratory. The facility designs are conservative. A properly designed structure has less than a 1% probability of failure if the 2,500 year event were to occur. The GTCC EIS did take into consideration all the latest information available related to seismic issues in selecting the preferred alternative.

L95-4
(Cont.)

L95-5

Santa Clara Pueblo, Commenter ID No. L95 (cont'd)

Mr. Edelman
Santa Clara Pueblo's Comments on the GTCC DEIS
June 24, 2011
Page 5

in the GTCC DEIS. In April of this past year, LANL "self-reported" to the National Nuclear Safety Administration another analysis from LANL's Seismic Analysis of Facilities and Evaluation of Risk (SAFER) Project which showed "that a large earthquake . . . might occur in north-central New Mexico every 2,500 years." See news release, "Preliminary study assesses potential impact of seismic event at Los Alamos," at <http://www.lanl.gov/news/releases/>. This self-reported analysis from LANL is in keeping with findings from CIRES, the Cooperative Institute for Research in Environmental Science, which is an earth sciences research institute jointly operated by the National Oceanic and Atmospheric Administration and the University of Colorado at Boulder. CIRES has reported that volcanos in the Rio Grande Rift, in which LANL is located, are "dormant, [but] not extinct" and that "a large earthquake (7.0 magnitude or larger) will occur at some point in the future." See <http://cires.colorado.edu/science/groups/sheehan/projects/riogrande/faq>.

While LANL's self-reporting of a large earthquake in a 2,500 year timeframe may seem like a long enough period of time to dismiss risks, 2,500 years needs to be compared to the half-life of some GTCC wastes which the DOE has indicated could remain radioactive for 10,000 years.

The DOE thus should eliminate LANL from any of its alternatives for GTCC and GTCC-like waste disposal and not include LANL within its preferred alternative because the location of LANL in a seismic fault zone between a rift and a dormant volcano, when coupled with LANL's own acknowledgement that a large earthquake is quite possible within the timeframe necessary for safe disposal of this waste, make LANL a choice where the impacts on the human environment of GTCC and GTCC-like waste disposal are not only significant but are unsafe and unjustifiable.

As if NEPA impacts were not reason enough, according to the GTCC DEIS, to comply with the Low-Level Radioactive Waste Policy Amendments Act of 1985, GTCC waste must be disposed of in a facility that is adequate to protect public health and safety (and is licensed by the NRC, which LANL is not). See GTCC DEIS at 1-2. Consequently, given the nature of the newer information about seismic risks at LANL as those risks relate to the long half-lives of some of the radionuclides in GTCC wastes, LANL cannot meet the specified criteria for GTCC waste disposal in the Low-Level Radioactive Waste Policy Amendments Act of 1985.

IV. Disposal of GTCC and the DOE's GTCC-like waste at LANL should not be part of DOE's preferred alternative because of the significant and adverse impacts to the Santa Clara Pueblo community

Santa Clara Pueblo was invited by the DOE to provide comments early on in the GTCC process and we did so. See GTCC DEIS, Appendix G, at G-79 through G-92. In the Tribal Narrative we provided with some of our neighboring Pueblos, we described how our practices result in exposures beyond those exposures experienced by the general public or even the DOE's choice of a Maximally Exposed Individual, the so-called "hypothetical resident farmer." See GTCC DEIS at E-8 through E-9.

L95-6

Text prepared by potentially affected American Indian tribes is included in this EIS. DOE considered this text for Hanford, INL, LANL, and NNSS; however, DOE also needed to ensure consistency in the EIS analyses between the various sites, so that an even comparison could be made between alternatives as required by NEPA. Because of this, it was not possible to fully utilize all of the information provided by the tribal governments in order to perform specific analyses associated with exposure events unique to a given American Indian tribe (such as greater intakes of fish, game, and plants; the use of sweat lodges; and the use of natural pigment paints for traditional ceremonies). Once a decision is made on a specific site location and method, appropriate site-specific NEPA review would be conducted, including appropriate analysis of exposure events unique to the impacted local American Indian tribes.

However, the information provided in these narratives was considered in the identification of the preferred alternative presented in this EIS. The information provided in the narratives for Hanford, INL, LANL, and NNSS was very useful, and DOE appreciates the time and effort expended by the various tribes in supporting this EIS process. For additional information, see Section J.2.5.

L95-5
(Cont.)

L95-6

Santa Clara Pueblo, Commenter ID No. L95 (cont'd)

Mr. Edelman
Santa Clara Pueblo's Comments on the GTCC DEIS
June 24, 2011
Page 6

In the Tribal Narrative we already provided for the GTCC DEIS, we described how Santa Clara Pueblo members utilize springs and seeps and other surface sources of water in our traditional areas in their natural, unfiltered state, as part of our cultural practices and how our potters have "direct and intimate contact with stream and surface clay deposits." *Id.* at G-82. We also described how we use natural pigment paints for ceremonies which are placed on our bodies and kept there for long periods of time during which there is considerable physical activity that opens the pores. *Id.* at G-82 and G-83. We actually enumerated many of the traditional plants and animals located on or near the proposed GTCC and GTCC-like waste disposal area at LANL and noted that we collect and utilize numerous wild plants and herbs for medicinal and other cultural purposes. *Id.* at G-83. It is also important to note that our use of traditional animals is more extensive than the general public or even the DOE's assumed "hypothetical resident farmer." When we harvest elk or deer, in addition to the meat, we consume the bone marrow, the organs, and the blood. We also noted that, if LANL were chosen for GTCC disposal, the Pueblos along the transportation routes would be exposed twice - once to current LANL waste leaving for the Waste Isolation Pilot Plant, and secondly to new GTCC waste shipments that are arriving from DOE and commercial facilities from all over the country. *Id.* at G-89.

Santa Clara and our neighboring Pueblos were not the only Tribes to describe the nature and extent to which Tribal interaction with the natural world is underestimated in DOE risk assessments. For example, in the Tribal Narrative for the Confederated Tribes for the Umatilla Indian Reservation, the Umatillas advocated that the DOE incorporate into the risk assessment for GTCC disposal the Umatillas own Tribal-specific exposure scenario, taking into account their cultural values and unique lifestyles and interactions as Indian people and using appropriate Tribal reference populations instead of the generic Caucasian 20-30 year old "Reference Man." *See id.* at G-124 through G-136. This is necessary, the Umatillas explained, because the links between Indian individuals and their resources are a far more complex and interconnected web than is depicted in the DOE analyses. *See id.* at G-98. The Nez Perce Tribe in its Tribal Narrative expressed a similar sentiment that we echo here as well: for Native people, everything in the environment is viewed as living and having a spirit. *Id.* at G-65.

Despite these explanations provided in advance to DOE by Santa Clara Pueblo and other Tribes about why there are considerably more exposures and more complex exposures for Tribal members neighboring these DOE facilities, the DOE did not actually take this into account in any such analysis in the GTCC DEIS, at least for Santa Clara Pueblo or any of the other Pueblos surrounding LANL.

In the text of the GTCC DEIS, DOE indicated that because it "respects the unique and special relationship between American Indian tribal governments and the Government of the United States," the "DOE has presented tribal views and perspective in this Draft EIS to ensure full and fair consideration of tribal rights and concerns before making decisions or implementing programs that could affect tribes." GTCC DEIS at 8-1. Yet, it does not appear that the comments previously submitted by Santa Clara have been considered in the analysis. They were reprinted in the document but not included in or actually factored into the DOE analysis thus far. This is evidenced by the environmental justice section for LANL in the GTCC DEIS which

L95-6
(Cont.)

Santa Clara Pueblo, Commenter ID No. L95 (cont'd)

Mr. Edelman
Santa Clara Pueblo's Comments on the GTCC DEIS
June 24, 2011
Page 7

simply states that:

[b]ecause the health impacts on the general population within the 80-km (50-mi) assessment area during construction and operations would be negligible, no impacts on minority and low-income populations as a result of the construction and operations of a GTCC waste disposal facility are expected.

Id. at 8-93.

We understand and respect that many Tribes shy away from the term "environmental justice" because they believe the interpretation of Executive Order 12898, *Federal Actions to Address Environmental Justice in Minority Populations and Low-Income Populations*, 59 Fed. Reg. 7629 (Feb. 11, 1994) ("Executive Order 12898"), simply relegates Tribes to being just another minority group. Minority group status alone, of course, fails to recognize Tribes' sovereign status, the government-to-government relationship, and the Federal trust responsibility to Tribes. However, at Santa Clara Pueblo, we believe environmental justice is not the only avenue for analysis for DOE to use in its NEPA process but still is an important analysis for DOE to conduct properly with respect to Tribes.

In 1997, the Council on Environmental Quality issued a guidance document regarding environmental justice that "interprets NEPA as implemented through the CEQ regulations in light of Executive Order 12898." See CEQ, *Environmental Justice: Guidance Under the National Environmental Policy Act* (Dec. 10, 1997), <http://ceq.ch.doe.gov/nepa/reg/ej/justice.pdf> ("CEQ Environmental Justice Guidance").

As explained in the CEQ Environmental Justice Guidance, Executive Order 12898 "recognizes the importance of research, data collection, and analysis, particular with respect to multiple and cumulative exposures to environmental hazards for . . . Indian tribes. Thus, data on these exposure issues should be incorporated into NEPA analyses as appropriate." CEQ Environmental Justice Guidance at 3. The CEQ Environmental Justice Guidance also instructs that "[a]gencies should recognize the interrelated cultural, social, occupational, historical, or economic factors that may amplify the natural and physical environmental effects of the proposed agency action" and that such factors "should include . . . the effect of any disruption on the community structure associated with the proposed action." *Id.* at 9.

One area where the GTCC DEIS particularly fails to address "the effect of any disruption on the community structure" of Santa Clara Pueblo associated with proposed GTCC waste disposal at LANL is in the discussion of cultural resources. The LANL section of the GTCC DEIS does note that "numerous cultural resources have been identified in TA-54" including "[c]hildren's archaeological sites" but then simply indicates that the DOE will have to consult with affected tribes at some later time "to determine if traditional cultural properties are present within the GTCC reference location." *Id.* at 8-62. This statement seems to completely ignore the fact that the surrounding Pueblos (which included Santa Clara Pueblo) have *already* explained in the GTCC DEIS that there *are* traditional cultural properties and sacred sites in the area at issue. See

L95-7 The comment on addressing Environmental Justice in the NEPA process is well taken. During the preparation of this EIS, DOE invited interested pueblos, including the Santa Clara Pueblo, to join in a partnership to draft portions of text that would reflect pueblo perspectives. These writings were incorporated into Chapter 8, the LANL Chapter of this EIS and the full text can be found at Appendix G. The narrative text developed by the pueblos and included in this EIS provides tribal perspectives related to the various environmental resource areas evaluated in the EIS. The narratives recognize the interrelationships among cultural, social, occupational, historical, or economic factors that will potentially impact the tribes based on the proposed action.

DOE considers Executive Order 12898 to apply as much to Indian tribal populations as it does to other population groups covered by the Order. The Environmental Justice Analysis found in Section 8.2.7, indicates that there would not be disproportionately high and adverse risks to any minority or low-income population. Were the LANL site to be selected as an option, among the most potentially affected populations in the 80-km (50-mi) assessment area are the adjacent Pueblos. In line with Environmental Justice considerations subsequent NEPA analysis to support any GTCC implementation schemes involving LANL would consider unique exposure pathways (such as subsistence fish, vegetation, or wildlife consumption, spring or well water use) to determine additional potential health and environmental impacts.

In terms of consultation, the Department considers its consultations with the tribes as important components of its overall responsibilities to host communities. In the process of identifying preferred alternative described in Section 2.10, DOE considered the information provided by the tribes for this EIS. In making final decisions where the choice of a host site raises concern to a tribe or tribes, DOE would undertake appropriate consultations to ensure consistency with the DOE American Indian Policy, DOE Order 144.1, and Executive Order 12898, Federal Actions to Address Environmental Justice in Minority Populations and Low-Income Populations.

L95-8 As required by NEPA, the EIS evaluates the potential impacts of the proposed action on cultural resources at the various DOE sites in sufficient detail to assess the potential impacts of the proposed alternatives. DOE recognizes that development of a disposal facility for GTCC LLRW and GTCC-like wastes would require that future land uses be restricted at and near the site for the protection of the general public. This action could affect areas that may be important to American Indian tribes.

DOE considered the text provided by the participating affiliated American Indian tribes for each of DOE sites evaluated in selection of the preferred alternative. Information provided by the tribal governments associated with exposure pathways unique to American Indian tribes (e.g., greater intakes of fish, game, and plants; use of sweat lodges; use of natural pigment paints for traditional ceremonies) would be evaluated in site-specific NEPA analyses for the alternative(s) selected in a ROD for this EIS.

L95-6
(Cont.)

L95-7

L95-8

Santa Clara Pueblo, Commenter ID No. L95 (cont'd)

Mr. Edelman
Santa Clara Pueblo's Comments on the GTCC DEIS
June 24, 2011
Page 8

id. at 8-62 through 8-64 and G-89.

It is important to note that our 2006 Accord with the DOE states that the DOE "will avoid unnecessary interference with traditional practices." 2006 Accord at 3. Moreover, Executive Order No. 13007, *Indian Sacred Sites* (May 24, 1996) states that, when not clearly inconsistent with essential agency functions, executive branch agencies "shall . . . avoid adversely affecting the physical integrity of [Indian] sacred sites." In addition, this issue is addressed in the CEQ Environmental Justice Guidance. The CEQ Environmental Justice Guidance indicates that, when impacts are "significant" in accordance with NEPA, those impacts need to be addressed in an environmental justice analysis for an environmental impact statement. NEPA regulations defining the term significance instruct that significance can refer to the intensity of an impact which can include unique characteristics of the geographic area such as proximity to cultural resources. See CEQ Environmental Justice Guidance at 26; see also 40 C.F.R. §1508.27. Consequently, looking at this issue through these different lenses - Tribal sovereignty, executive orders, or environmental justice - all lead to the same place: LANL is an improper choice for a preferred alternative for GTCC disposal because of the manner in which such disposal would have significant impacts on Santa Clara Pueblo. And, when one factors in the more comprehensive and holistic approach to addressing the extensive nature and type of exposures that Santa Clara people have with the surrounding environment at and near LANL, which is advocated in the CEQ Environmental Justice Guidance and was advocated by Santa Clara Pueblo and the other Tribes in the Tribal Narratives Section of the GTCC DEIS, it is clear that the impacts to Santa Clara Pueblo of disposing of GTCC and GTCC-like waste at LANL would be disproportionately high and adverse. This is due to the greater nature and type of interaction that the Santa Clara Pueblo community has with the natural resources and animals at and near LANL and the manner in which disruptions to our traditional uses undermine the entire ecological, cultural, human health, and social fabric of our existence as an Indian nation.

V. Disposal of GTCC and the DOE's GTCC-like waste at LANL should not be part of DOE's preferred alternative because of the cumulative impact it would have on the Natural Resource Damage Assessment and Restoration Process for LANL

NEPA regulations state that agencies, in assessing cumulative impacts in an environmental impact statement, have to address:

the impact on the environment which results from the incremental impact of the action when added to other past, present and reasonably foreseeable future actions regardless of what agency (Federal or non-Federal) or person undertakes such other actions. Cumulative impacts can result from individually minor but collectively significant actions taking place over a period of time.

40 C.F.R. at §1508.7.

One "reasonably foreseeable future action" that was not analyzed in the GTCC DEIS is the work of the LANL Trustee Council, comprised of the DOE, the Department of Interior, the United

L95-9 DOE is performing environmental restoration activities at LANL. The ongoing cleanup effort will continue.

DOE believes that the analyses presented in the EIS are sufficient to compare the potential cumulative impacts of GTCC LLRW and GTCC-like waste disposal for the sites that were evaluated. In particular, existing concentrations of various radionuclides in contaminated soil and groundwater at the candidate sites were taken into consideration in the selection of the preferred alternative. The EIS evaluated the cumulative impacts of constructing and operating a GTCC waste disposal facility in combination with the impacts of past, present, and reasonably foreseeable future actions taking place within and around each of the candidate sites. For most resource areas, the impacts of past and present actions are generally accounted for in the affected environment section. For example, the current air quality reflects both past and present activities occurring in the region. Off-site activities might also contribute to cumulative impacts; these include clearing land for agriculture and urban development, grazing, water diversion and irrigation projects, power generation projects, waste management activities, industrial emissions, and the development of transportation and utility networks. Reasonably foreseeable future actions at each of the candidate sites include those that are ongoing, under construction, or planned for future implementation. These are also described and considered at each location. Additional cumulative impact analyses would be conducted in site-specific NEPA reviews, if needed, for the alternative selected in a ROD. Such follow-on analyses would be based on additional project- and site-specific information.

Once a decision is made on selection of a disposal location for GTCC and GTCC-like LLRW, appropriate site-specific NEPA analysis and other analysis as appropriate, including addressing the Natural Resource Damage Assessment and Restoration process will be undertaken. Input from site-specific groups dealing with the NRDA Restoration Program, such as the LANL Trustee Council will be consulted if LANL is selected as a preferred alternative.

L95-8
(Cont.)

L95-9

Santa Clara Pueblo, Commenter ID No. L95 (cont'd)

Mr. Edelman
Santa Clara Pueblo's Comments on the GTCC DEIS
June 24, 2011
Page 9

State Department of Agriculture, the State of New Mexico, Santa Clara Pueblo, San Ildefonso Pueblo, and Jemez Pueblo, to collaboratively address natural resource damage assessment and restoration ("NRDAR") at LANL. The DOE has to factor in the cumulative impact that disposal of GTCC and GTCC-like waste at LANL would have on the NRDAR process.

The NRDAR process is governed by the Comprehensive Environmental Response, Compensation, and Liability Act. The purpose of NRDAR is to assess the extent to which natural resources have been injured by the release of hazardous substances from LANL and the extent to which there has been lost use of those resources because of the injury. The ultimate goal of NRDAR is to restore the natural resources and the services they provide to the same condition they would have been in without the release of the contaminant substances or to provide some sort of equivalent replacement. Restoration processes can address conditions that were not fully addressed through the remediation process.

Just as disposal of GTCC and GTCC-like waste at LANL would undermine the remediation process (see section II, above), such disposal at LANL would also undermine the restoration process now finally underway. This is a cumulative impact that underscores why LANL is an improper choice for GTCC or GTCC-like waste disposal.

VI. Next steps DOE must take in addressing these comments, which include government-to-government consultation with Santa Clara Pueblo

No final environmental impact statement regarding disposal of GTCC and the DOE's GTCC-like waste should be issued without first consulting with Santa Clara Pueblo to ensure compliance with our 2006 Accord. See 2006 Accord at 3 ("DOE will consult with the Pueblo to assure that tribal rights, responsibilities, and concerns are addressed prior to the DOE taking action, making decisions, or implementing programs that may affect the Pueblo."). Such government-to-government consultation is also required to ensure DOE has lived up to its commitment to "protect and promote" Tribal Trust resources in order try to avoid impacts to those resources. See DOE Indian Policy at 3 (Section I).

For all the reasons we have stated above and in the Tribal Narrative we already provided before the GTCC DEIS was issued, we urge that LANL options be excluded from the preferred alternative for disposal of GTCC waste. However, if LANL is included in the preferred alternative, then government-to-government consultation with Santa Clara Pueblo must first occur to ensure impacts are avoided or properly mitigated if impacts cannot be avoided. DOE Indian Policy is clear that, when avoidance of impacts through "DOE trust protection measures" cannot be fully carried out, the DOE will work with the affected Tribe regarding corrective measures. *Id.* Consultation with any affected Tribes is also part of the DOE's environmental justice duties. See CEQ Environmental Justice Guidance at 10; see also Comprehensive Presidential Documents No. 279, *Memorandum from the President to the Heads of Departments and Agencies, EPA-175-N-94-001* (Feb. 11, 1994) at http://www.epa.gov/fedfac/documents/executive_order_12898.htm#memo.

L95-10 DOE will ensure compliance with the 2006 Accord and will continue to consult with the Santa Clara Pueblo and other affected Pueblo's, as appropriate, related to selection of LANL as a preferred alternative if that is the case.

L95-11 The EIS analysis is used to assess the viability of an alternative as well as its relative performance compared to the other alternatives. Exclusion of a reasonable alternative from the EIS without first evaluating the site is contrary to a thorough NEPA analysis. All alternatives are retained in the Final EIS because such evaluations are needed to support selection of the preferred alternative. In addition, as discussed in Section 1.4.2, the conceptual disposal facility designs analyzed in the EIS could be modified to perform better in specific locations. Thus, poor performance in the EIS analysis does not necessarily exclude an alternative from consideration.

L95-9
(Cont.)

L95-10

L95-11

Santa Clara Pueblo, Commenter ID No. L95 (cont'd)

Mr. Edelman
Santa Clara Pueblo's Comments on the GTCC DEIS
June 24, 2011
Page 10

VII. Conclusion

The CEQ, in its NEPA regulations, advises that:

NEPA's purpose is not to generate paperwork—even excellent paperwork—but to foster excellent action. The NEPA process is intended to help public officials make decisions that are based on understanding of environmental consequences, and take actions that protect, restore, and enhance the environment.

40 C.F.R. §1500.1(c).

It is with this spirit that Santa Clara Pueblo offers these comments, because the environment that we seek to have DOE protect, restore, and enhance, is connected to, and part of, our home and place of worship, which is integral to the cultural survival of the Santa Clara people.

For all the reasons discussed herein, Santa Clara Pueblo urges you in the strongest possible terms to ensure LANL not be included in the DOE's preferred alternative for a disposal facility or disposal facilities for GTCC waste and for the DOE's GTCC-like waste.

Sincerely,

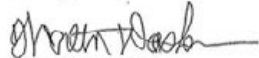

Walter Dasheno, Sr.
Governor

cc:

Members of the Santa Clara Tribal Council
DOE Secretary Steven Chu
NNSA Administrator Thomas P. D'Angostino
DOE Director of Intergovernmental and Tribal Affairs David Conrad
Senator Jeff Bingaman
Senator Tom Udall
Representative Ben Ray Lujan
Representative Martin Heinrich
Representative Steve Pearce
Governor Susana Martinez
New Mexico Environment Department Secretary F. David Martin
New Mexico Indian Affairs Department Secretary Arthur Allison
Joseph M. Chavarria
Jessica Aberly

SANTA CLARA

POST OFFICE BOX 580
(505) 753-7330
(505) 753-5375 Fax



INDIAN PUEBLO

ESPANOLA, NEW MEXICO
87532
OFFICE OF GOVERNOR

RESOLUTION NO. 2011 - 20

APPROVING THE SUBMISSION OF COMMENTS FOR SANTA CLARA PUEBLO TO THE DEPARTMENT OF ENERGY REGARDING THE DRAFT ENVIRONMENTAL IMPACT STATEMENT FOR THE DISPOSAL OF GREATER-THAN-CLASS-C (GTCC) LOW LEVEL RADIOACTIVE WASTE AND GTCC-LIKE WASTE

- WHEREAS,** Santa Clara Pueblo (the "Pueblo") is a sovereign Indian tribe, recognized as such by the United States Government, with the Pueblo's Tribal Council as its governing body, whose authority is defined by the Pueblo's Constitution and Bylaws approved on December 20, 1935; and,
- WHEREAS,** the Pueblo has maintained a recognized and formalized government-to-government relationship with the Department of Energy (the "DOE") as set forth first in 1992 and then in 2006 in the *Restatement of Accord between the Pueblo of Santa Clara, a Federally-Recognized Indian Tribe and the United States Department of Energy* (October 31, 2006); and,
- WHEREAS,** the DOE has issued a draft Environmental Impact Statement (the "DEIS") regarding the DOE's proposed disposal of Greater-Than-Class-C ("GTCC") and GTCC-like waste; and
- WHEREAS,** the DOE does not have a preferred alternative in the GTCC DEIS but analyzes various alternatives for GTCC and GTCC-like waste disposal at Los Alamos National Laboratory ("LANL."); and,
- WHEREAS,** the Tribal Council opposes the disposal of GTCC and GTCC-like waste at LANL because of its concerns about the impacts to the Santa Clara Pueblo community that would result from disposal of such waste at LANL and because disposal of such waste at LANL would undermine remediation and restoration efforts and would be unsafe due to the recently-acknowledged increased risks of seismic events at LANL; and,

L95-12

L95-12 Comment noted. Human health impacts were one of the many factors considered in the selection of the preferred alternative. DOE is performing environmental restoration activities at LANL.

Santa Clara Pueblo, Commenter ID No. L95 (cont'd)

WHEREAS, after careful consideration, the Tribal Council is of the view that it is in the best interest of the Pueblo to submit the attached comments regarding the GTCC DEIS;

NOW THEREFORE BE IT RESOLVED that the Tribal Council hereby approves the attached comments regarding the GTCC DEIS.

BE IT FURTHER RESOLVED that the Tribal Council authorizes and directs the Governor to execute and submit the attached comments regarding the GTCC DEIS on behalf of the Pueblo.

CERTIFICATION

I, the undersigned, duly elected Governor of the Santa Clara Pueblo, do hereby certify that the Tribal Council, at a duly called meeting that was convened with proper notice and was held on the 24 day of June, 2011, at Santa Clara Pueblo, New Mexico, a quorum being present, approved the foregoing Resolution with 9 in favor, and 0 opposed, 1 abstaining, 2 being absent.

Governor Walter Dasheno, Sr.

ATTEST:

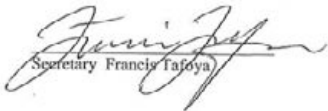
Secretary Francis Fajoya

Santa Clara Pueblo, Commenter ID No. T86

Capital Reporting Company

29

1

2

3

4

5 MR. BROWN: Great. Thanks, Scott.

6 Nathaniel is next and Marian Naranjo will
7 follow Nathaniel. Thank you.

8 MR. FUENTES: Good evening, everyone. My name
9 is Nathaniel Fuentes. I am a tribal descendent of
10 Chapo Wingate, also known as Santa Clara.

11 I don't have anything in hand, written before
12 me. So please excuse me. I want to address this
13 particular situation about transporting new waste to
14 Area G in Los Alamos or anywhere here in the state.

15 As I said in the beginning, I am a tribal
16 descendent for Chapo Wingate, and my people, the Pueblo
17 people, have been here for millenniums, and as this
18 waste builds and continue to accumulate and if it is
19 transported to our state and to Los Alamos, as these
20 safeguards begin to fail and radioactive material is
21 then exposed to our environment, it is more than likely
22 that my people will end up having to deal with this

866.488.DEPO
www.CapitalReportingCompany.com

T86-1

T86-1

The disposal methods and sites evaluated in the EIS represent the range of reasonable alternatives for the disposal of GTCC LLRW and GTCC-like wastes. This range is consistent with NEPA implementing regulations in Parts 1500–1508 of Title 40 of the Code of Federal Regulations (40 CFR Parts 1500–1508). In this GTCC EIS, DOE analyzed a range of disposal methods (i.e., geologic repository, near-surface trench, intermediate-depth borehole, and above-grade vault) and federally owned sites (i.e., Hanford Site, INL, LANL, NNSS, SRS, and the WIPP Vicinity, for which two reference locations – one within and one outside the WIPP Land Withdrawal Boundary – were considered). DOE has determined that it was reasonable to analyze these six sites because they currently have operating radioactive waste disposal facilities, except for the WIPP Vicinity, which is near an operating geologic repository.

DOE also conducted a generic evaluation of commercial disposal facilities on nonfederal lands in the EIS to order to provide, to the extent possible, information regarding the potential long-term performance of other (nonfederal) locations for siting a GTCC waste land disposal facility.

Final siting of a disposal facility for GTCC LLRW and GTCC-like wastes would involve further NEPA review as needed and be in accordance with applicable laws and regulations and would involve local stakeholder involvement and consent.

Capital Reporting Company

30

1 situation in ten to 20 generations at the very least,
2 if not even sooner.

T86-1
(Cont.)

3 I remember when I was a child and being able
4 to smell and taste the air of New Mexico for the first
5 time, and I remember -- some people don't have this far
6 back memory of being like two years old, but I'm able
7 to remember -- and the air and the taste was something
8 that was more unique than anything, and I knew for some
9 reason in my heart and in my spirit that this was a
10 part of me.

11 And to have nuclear waste come and be added
12 into my back yard, it kind of -- it kind of disheartens
13 what I've gotten to know, and it only says that we are
14 expendable and that what we know and what we've done
15 and how we live is also expendable.

16 I believe that we shouldn't have any more
17 nuclear waste come into our state, to come to Area G
18 because in 500 years and in 20 generations my great-
19 great-great grandchildren may be walking a pilgrimage
20 and going on a ceremony or some type of spiritual walk
21 only to then be exposed by an abandoned city that had
22 spelled safeguards that were only going to last for 500

T86-2

866.488.DEPO

www.CapitalReportingCompany.com

Santa Clara Pueblo, Commenter ID No. T86 (cont'd)

Capital Reporting Company

31

1 years. To have them exposed during some type of
2 initiation or some type of story telling down the line,
3 it really disheartens me to think about that.

4 And I would really urge the people of this
5 community as you become more naturalized, if you're not
6 already, and you see down in the future 20 generations
7 of your children and their children, think about that.

8 Another thing to think about is as if these
9 type of materials are stored in such an area and the
10 fight for water increases here in this area and our
11 rainwaters and our snow caps begin to become less and
12 less and our river becomes more and more dry and
13 Cochiti Dam becomes lower and lower and our winds
14 become stronger and stronger, I think we might have a
15 problem more sooner than 500 years; maybe in ten years.
16 Really don't know, and that's exactly what this all is.

17 We should really take in account the lessons
18 that the Japanese have had to face and deal with not
19 once but twice, and think about those types of
20 situations here in our area. We do live in a rift.
21 Los Alamos is on fault lines, and Area G is in a sacred
22 site to my people.

866.488.DEPO
www.CapitalReportingCompany.com

T86-3 Even though it is beyond the scope of this GTCC EIS, the comment is noted. This GTCC EIS addresses the potential environmental impacts associated with the proposed development, operation, and long-term management of a disposal facility or facilities for GTCC low-level radioactive waste (LLRW) and DOE GTCC-like waste.

T86-4 The site-specific environmental factor, seismic activity, was evaluated in the EIS as appropriate. Both environmental and cultural resource issues were taken into consideration in the selection of the preferred alternative.

T86-3

T86-4

Santa Clara Pueblo, Commenter ID No. T86 (cont'd)

Capital Reporting Company

32

- 1 So I don't understand really what the issue
- 2 is. I don't think it should be an issue.
- 3 Thank you.

T86-4
(Cont.)

Santa Clara Pueblo, Commenter ID No. T93

Capital Reporting Company

48

1
2
3
4
5
6
7
8
9
10
11
12
13
14
15
16
17
18
19
20
21
22

MR. BROWN: Okay. Mary will be followed by
Doug Doran.

MS. WEAKKEE: Good evening. My name is Mary
Weakkee, and I'm with the Santa Clara Pueblo, Arkhopo
Wingate (phonetic), and I'm also half Comanche.

I work for the Museum of New Mexico, Office of
Archeological Studies. I really didn't expect to
speak. However, if I saw there not speaking, I
couldn't sleep tonight.

866.488.DEPO
www.CapitalReportingCompany.com

Capital Reporting Company

49

1 My feelings are for my grandchildren. I know
2 these sites, and my job is to record them and preserve
3 them and study them and carry on that knowledge to my
4 children, and it would devastate me to know that
5 they're just going to punch holes and lay trenches and
6 destroy something that's been there for thousands of
7 years.

8 I've seen it done. I've seen sites. I see
9 after we finish digging, destroy days, destroy, you
10 know, archeological sites, and to have them pour this
11 poison into my mother. My children bathe to purify
12 themselves. I bathe to purify myself before I dance

13 I pray for this place all the time even though
14 I do archeology for the state. I open the sites. I
15 pray for the safety of the archeologists spiritually.
16 I close the sites. I pray for them after the closing
17 of the sites so that none of us go home and be harmed.

18 How can I stand here and listen to how much
19 harm is going to be done by DOE and be ignorant and
20 close my eyes and sleep and hear my children, my
21 grandchildren running back and forth?

22 And to think that their children are going to

866.488.DEPO
www.CapitalReportingCompany.com

Capital Reporting Company

50

1 be affected. The old people already suffer now. I've
2 seen it, and how can I tell stories about my people
3 when the alternative for burial is cremation?

4 I study human remains. I do burials. That's
5 my position with the Office of Archeological studies,
6 and, yes, I get criticized by my people. But I know
7 that these histories and these words and these views
8 have to be retained, and these sensitive sites that
9 these people consider as nothing? Well, I don't
10 consider that.

11 And I hope that everybody looks to another
12 alternative, please. WE still use all the minerals.
13 I've seen minerals used. I've seen what pains they
14 use, what ceremonial purposes. I've seen so many, many
15 things, and I can live these spiritual happenings.

16 I dance so that we can have rain. I go and do
17 water ceremonies so we can drink and have safe waters.
18 I just hope that we can all think about what's going to
19 happen, and there has to be a voice, maybe from
20 Creator, but right now my concern is with our
21 generations to come.

22 And I will continue to dig and record and
866.488.DEPO
www.CapitalReportingCompany.com

T93-1

The disposal methods and sites evaluated in the EIS represent the range of reasonable alternatives for the disposal of GTCC LLRW and GTCC-like wastes. This range is consistent with NEPA implementing regulations in Parts 1500–1508 of Title 40 of the Code of Federal Regulations (40 CFR Parts 1500–1508). In this GTCC EIS, DOE analyzed a range of disposal methods (i.e., geologic repository, near-surface trench, intermediate-depth borehole, and above-grade vault) and federally owned sites (i.e., Hanford Site, INL, LANL, NNSS, SRS, and the WIPP Vicinity, for which two reference locations – one within and one outside the WIPP Land Withdrawal Boundary – were considered). DOE has determined that it was reasonable to analyze these six sites because they currently have operating radioactive waste disposal facilities, except for the WIPP Vicinity, which is near an operating geologic repository.

DOE also conducted a generic evaluation of commercial disposal facilities on nonfederal lands in the EIS to order to provide, to the extent possible, information regarding the potential long-term performance of other (nonfederal) locations for siting a GTCC waste land disposal facility. It would not be reasonable to analyze in detail an essentially unlimited number of additional non-DOE or nonfederal sites.

Final siting of a disposal facility for GTCC LLRW and GTCC-like wastes would involve further NEPA review as needed and be in accordance with applicable laws and regulations and would involve local stakeholder involvement and consent.

T93-1

Santa Clara Pueblo, Commenter ID No. T93

Capital Reporting Company

51

1 respect and honor my people until I can't anymore. And

2 thank you very much.

3 (Applause.)

SHINE Medical Technologies, Commenter ID No. W532

From: gtccseiswebmaster@anl.gov
Sent: Monday, June 27, 2011 12:11 PM
To: mail_gtccseisarchives; gtccseiswebmaster@anl.gov; gtccseis@anl.gov
Subject: Greater-Than-Class-C Low-Level Radioactive Waste EIS Comment GTCC10532
Attachments: SHINE_Medical_Technologies_Draft_EIS_Comments_GTCC10532.docx

Thank you for your comment, Gregory Piefer.

The comment tracking number that has been assigned to your comment is GTCC10532. Please refer to the comment tracking number in all correspondence relating to this comment.

Comment Date: June 27, 2011 12:11:09PM CDT

Greater-Than-Class-C Low-Level Radioactive Waste EIS Draft Comment: GTCC10532

First Name: Gregory
Last Name: Piefer
Organization: SHINE Medical Technologies
Address: 8123 Forsythia St.
Address 2: Suite 140
City: Middleton
State: WI
Zip: 53562
Country: USA
Email: greg.p@shinemed.com
Privacy Preference: Don't withhold name or address from public record
Attachment: C:\fakepath\SHINE Medical Technologies Draft EIS Comments.docx

Questions about submitting comments over the Web? Contact us at: gtccseiswebmaster@anl.gov or call the Greater-Than-Class-C Low-Level Radioactive Waste EIS Webmaster at (630) 252-5705.

SHINE Medical Technologies, Commenter ID No. W532 (cont'd)

June 20th, 2011

Greater-Than-Class C Low-Level Radioactive Waste EIS
Office of Technical and Regulatory Support (EM-43)
U.S. Department of Energy
1000 Independence Avenue, SW.
Washington, DC 20585-0119

Dear Madam or Sir:

Thank you for the opportunity to provide comment on the draft EIS. As the CEO of a company that will produce half of US demand for medical molybdenum-99 (⁹⁹Mo) by 2015, I am keenly aware of the pressing need for a GTCC waste disposal site. The opening of such a site will be of tremendous benefit to SHINE Medical Technologies and companies like ours that are currently working to address the recurring medical isotope shortages this country has seen over the past several years. As you may know, ⁹⁹Mo is the precursor for a range of radiopharmaceuticals that are used in over 55,000 medical procedures each day to diagnose a wide variety of ailments, including heart disease and cancer. Today, the US imports all of this essential isotope from foreign countries, where the vast majority of ⁹⁹Mo is produced in aging nuclear reactors using proliferation-sensitive highly enriched uranium.

In contrast, SHINE will produce ⁹⁹Mo domestically, without a reactor, using low-enriched uranium, and creating over 200 times less nuclear waste than current production methods. The opening of a GTCC waste disposal site will be of significant benefit to our ability to provide this essential medical isotope for our neighbors and our country. I encourage DOE to move expeditiously in opening a reliable GTCC disposal site consistent with all applicable laws and regulations.

Additionally, on behalf of SHINE, I offer the following suggestions for incorporation into the final EIS:

1. SHINE would like to see waste associated with its production of ⁹⁹Mo to be included in the GTCC EIS inventory. At peak production SHINE will generate less than 48 kCi of GTCC waste annually. We are planning to store the GTCC LLRW produced by SHINE at the generating site for 65 weeks prior to shipment to the disposal facility to allow the short-lived radionuclides to decay. The total volume of GTCC LLRW generated by SHINE will be approximately 1870 cubic feet annually. The draft EIS assumes a disposal operations start date in 2019, and makes no mention of interim storage before that date. SHINE will begin operations in 2015 and will have limited capacity to store the GTCC waste on-site. SHINE recommends that interim storage at the GTCC site be incorporated before the 2019 disposal operations start date.

Sincerely,

Gregory Piefer, PhD
CEO, SHINE Medical Technologies

- W532-1 GTCC waste from the production of Mo-99 is included in the GTCC LLRW waste inventory (See Appendix B).
- W532-2 Storage of the GTCC LLRW waste prior to the availability of the GTCC disposal facility is not within the scope of the EIS.

W532-1

W532-2

SHINE Medical Technologies, Commenter ID No. W532 (cont'd)

Phone: (608) 831-0814
Fax: (608) 831-8110
Email: greg.p@shinemed.com
8123 Forsythia St. Suite 140
Middleton, WI 53562

Snake River Alliance, Commenter ID No. E4

From: Beatrice Brailsford <bbrailsford@snakeriveralliance.org>
Sent: Monday, June 27, 2011 3:03 PM
To: gtcc@ani.gov
Subject: Snake River Alliance draft EIS comments
Attachments: gtcc comments.pdf

Beatrice Brailsford
Snake River Alliance
Box 425
Pocatello, ID 83204
208/233-7212
bbrailsford@snakeriveralliance.org

Snake River Alliance, Commenter ID No. E4 (cont'd)

June 27, 2011

Arnold Edelman
Document Manager
Office of Technical and Regulatory Support (EM-43)
U.S. Department of Energy
1000 Independence Avenue, SW.
Washington, DC 20585-0119
By email to gtcecis@anl.gov

Re: Department of Energy draft environmental impact statement on the disposal of greater-than-Class C low-level radioactive waste and GTCC-life waste (DOE/EIS-0375-D)

Dear Mr. Edelman:

The Snake River Alliance has served as Idaho's grassroots nuclear watchdog since 1979. The following comments and questions on the above draft EIS are submitted on behalf of our dues-paying members.

By law, the federal government, specifically the Department of Energy (DOE), is responsible for the disposal of Greater-than-Class C (GTCC) waste. For decades it's been accepted that GTCC waste is not suitable for near-surface disposal. In fact, NRC regulations require GTCC waste be disposed of in a deep geologic repository unless it approves an alternative method. If the disposal method is to be changed, that policy decision must be made after far more robust consideration than is included in the draft EIS. Furthermore, the draft EIS seems to ignore the legal requirement for a deep geologic repository for high-level waste, which is not the Waste Isolation Pilot Plant.

The draft EIS looks at how to dispose of 12,000 cubic meters (1,100 already in storage; 11,000 projected) containing 160 million curies. Far and away the bulk of the radioactivity comes from future decommissioning of *commercial* nuclear reactors.

The DOE has chosen to look at four disposal scenarios: deep geologic disposal; intermediate depth borehole (30 to 40 meters below ground); "enhanced" near-surface trenches (5 to 10 meters deep); and above ground vaults. All the sites considered are already controlled by the DOE. All but one is in the West. The draft EIS does not even attempt to assert that these sites are the best choices for GTCC disposal based on any objective criteria at all. Of all the arid sites, the Idaho National Laboratory would have the *highest* long-term human health impacts because of exposure through radioactively contaminated groundwater.

E4-1 While 10 CFR Part 61 identifies one NRC-approved method for GTCC LLRW disposal (disposal in a geologic repository), this regulation also indicates that other disposal methods could be approved. The GTCC EIS evaluates three land disposal methods (i.e., enhanced near-surface trench, intermediate-depth borehole, and above-grade vault). The GTCC EIS evaluation indicates that land disposal methods employed at sites with suitable characteristics would be viable and safe alternatives for the disposal of GTCC LLRW.

E4-2 Comment noted. The scope of the EIS does not include the disposal of high-level waste.

E4-3 The disposal methods and sites evaluated in the EIS represent the range of reasonable alternatives for the disposal of GTCC LLRW and GTCC-like wastes. This range is consistent with NEPA implementing regulations in Parts 1500–1508 of Title 40 of the Code of Federal Regulations (40 CFR Parts 1500–1508). In this GTCC EIS, DOE analyzed a range of disposal methods (i.e., geologic repository, near-surface trench, intermediate-depth borehole, and above-grade vault) and federally owned sites (i.e., Hanford Site, INL, LANL, NNSS, SRS, and the WIPP Vicinity, for which two reference locations – one within and one outside the WIPP Land Withdrawal Boundary – were considered). DOE has determined that it was reasonable to analyze these six sites because they currently have operating radioactive waste disposal facilities, except for the WIPP Vicinity, which is near an operating geologic repository.

DOE also conducted a generic evaluation of commercial disposal facilities on nonfederal lands in the EIS to order to provide, to the extent possible, information regarding the potential long-term performance of other (nonfederal) locations for siting a GTCC waste land disposal facility.

Final siting of a disposal facility for GTCC LLRW and GTCC-like wastes would involve further NEPA review as needed and be in accordance with applicable laws and regulations and would involve local stakeholder involvement and consent.

E4-1

E4-2

E4-3

Snake River Alliance, Commenter ID No. E4 (cont'd)

Furthermore, INL is in the midst of what the DOE considers a successful cleanup effort. To ship more nuclear waste to INL, particularly in light of the 1995 Settlement Agreement's waste removal requirements, seems irrational.

By and large, the analyses of the sites are merely cursory and not even sufficient to support narrowing the list of alternatives.

There is a fifth scenario that must be considered. The Snake River Alliance has long advocated that nuclear waste be stored as safely as possible as close to its point of generation as possible. That means that, by and large, nuclear waste stays where it is in hardened on-site storage, and commercial reactors in the east can't willy-nilly send their waste to the West. The Idaho National Laboratory has some GTCC waste that was generated in Idaho. For now, it would stay here in hardened on-site storage (HOSS). HOSS is *not* "no action."

The draft EIS does not include an adequate discussion of the licensing requirements for any new disposal or long-term storage facility. Nor is it apparent what agency would regulate facilities that handle both commercial and government waste. Those questions must be resolved.

WIPP is the only deep geologic repository on the planet. It was opened with a promise to the people of New Mexico that it would be used *solely* for waste from nuclear weapons production. Commercial waste is specifically prohibited. The federal government can't now tell New Mexicans: "You took the nose, now take the camel." To do so would show every other community asked to host a permanent repository in the future that they might well get more than they bargained for.

Respectfully submitted,

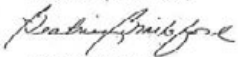

Beatrice Drallsford
Program director

1-1-55

E4-4

E4-5

E4-6

E4-7

E4-8

E4-4 DOE is performing environmental restoration activities at INL. The ongoing cleanup effort will continue.

E4-5 The use of HOSS and other approaches for long-term storage of GTCC LLRW and GTCC-like wastes are outside the scope of this EIS because they do not meet the purpose and need for agency action. Consistent with Congressional direction in Section 631 of the Energy Policy Act of 2005 (P.L. 109-58), DOE plans to complete an EIS and a ROD for a permanent disposal facility for this waste, not for long-term storage options. The GTCC EIS evaluates the range of reasonable disposal alternatives and, as also required under NEPA, a No Action Alternative. Under the No Action Alternative, current practices for storing GTCC LLRW and GTCC-like wastes would continue in accordance with current requirements.

E4-6 The LLRWPA (P.L. 99-240) assigns DOE responsibility for the disposal of GTCC LLRW generated by NRC and Agreement State licensees. The LLRWPA (P.L. 99-240) specifies that GTCC LLRW, designated a federal responsibility under section 3(b)(1)(D) that results from activities licensed by the NRC, is to be disposed of in an NRC-licensed facility that has been determined to be adequate to protect public health and safety. However, unless specifically provided by law, the NRC does not have authority to license and regulate facilities operated by or on behalf of DOE. Further, the LLRWPA does not limit DOE to using only non-DOE facilities or sites for GTCC LLRW disposal. Accordingly, if DOE selects a facility operated by or on behalf of DOE for disposal of GTCC LLRW for which it is responsible under section 3(b)(1)(D), clarification from Congress would be needed to determine NRC's role in licensing such a facility and related issues. In addition clarification from Congress may be needed on NRC's role if DOE selects a commercial GTCC LLRW disposal facility licensed by an Agreement State rather than by NRC.

E4-7 DOE recognizes that including GTCC-like wastes within the scope of this EIS along with GTCC LLRW may complicate the implementation of GTCC LLRW disposal alternative(s). However, DOE determined that the most efficient approach was to address both types of waste, which have many similar physical and radioactive characteristics, in a single NEPA process. DOE's intent is to facilitate the overall process for addressing the disposal needs of both waste types. Issues associated with potential regulatory changes or NRC licensing would be addressed as necessary to enable implementation.

E4-8 Disposal of GTCC LLRW and GTCC-like wastes at WIPP or the WIPP Vicinity site is included in the range of reasonable alternatives and is evaluated in this EIS. DOE acknowledges that only defense-generated TRU waste is currently authorized for disposal at the WIPP geologic repository under the WIPP LWA as amended (P.L. 102-579 as amended by P.L. 104-201) and that legislation would be required to allow disposal of waste other than TRU waste generated by atomic energy defense activities at WIPP and/or for siting a new facility within the land withdrawal area. It would also be necessary to revise the Agreement for Consultation and Cooperation between Department of Energy and the State of New Mexico for the Waste Isolation Pilot Plant, the WIPP compliance certification with EPA, and the WIPP Hazardous Waste Facility Permit. In addition, site-specific NEPA reviews would be conducted as needed, including further characterization of the waste (e.g., radionuclide inventory and heat loads) as well as the proposed packaging for disposal.

However, NEPA does not limit an EIS to proposing and evaluating alternatives that are currently authorized. Furthermore, the Agreement for Consultation and Cooperation between Department of Energy and the State of New Mexico for the Waste Isolation Pilot Plant recognizes that the mission of WIPP may change and provides provisions to modify the agreement. For example, the Agreement states: "The parties to this Agreement recognize that

Snake River Alliance, Commenter ID No. E4 (cont'd)

future developments including changes to applicable laws (e.g., Public Law [P.L.] 96-164) may make it desirable or necessary for one or both parties to seek to modify this Agreement. Either party to this Agreement may request a review of the terms and conditions.”

DOE acknowledges the TRU waste disposal limitations for WIPP specified in the WIPP LWA as amended (P.L. 102-579 as amended by P.L. 104-201) and in the Agreement for Consultation and Cooperation between Department of Energy and the State of New Mexico for the Waste Isolation Pilot Plant. Information on these limitations is provided in this EIS (see Section 4.1.1) and was considered in developing the preferred alternative. Based on the GTCC EIS evaluation, disposal of GTCC LLRW and GTCC-like wastes at WIPP would result in minimal environmental impacts for all resource areas evaluated, including human health and transportation. Both the annual dose and the latent cancer fatality (LCF) risk would be zero because there would be no releases to the accessible environment and therefore no radiation doses and LCFs during the first 10,000 years following closure of the WIPP repository. DOE recognizes that the use of WIPP for the disposal of GTCC LLRW and GTCC-like wastes would require legislative changes and site-specific NEPA reviews would be conducted as needed, including further characterization of the waste (e.g., radionuclide inventory and heat loads), as well as the proposed packaging for disposal.

Snake River Alliance, Commenter ID No. T20

1
2
3
4
5
6
7
8 MR. BROWN: Thanks very much.
9 Beatrice Brailsford, and she will be
10 followed by Dennis Donnelly.
11 BEATRICE BRAILSFORD: Thank you. My name is
12 Beatrice Brailsford, I'm with Snake River Alliance,
13 Idaho's nuclear watchdog and advocate for clean
14 energy since 1979.
15 MR. BROWN: Can you speak a little more into
16 the mic?
17 BEATRICE BRAILSFORD: Okay. The Alliance --
18 well, then I can't see my notes.
19 MR. BROWN: Okay.
20 BEATRICE BRAILSFORD: There. How is that?
21 The Alliance will be submitting written comments,
22 thank heavens. The Snake River Alliance has long
23 advocated that nuclear waste is to be stored as
24 safely as possible as close as possible to its point
25 of generation.

T20-1

T20-1

The use of HOSS and other approaches for long-term storage of GTCC LLRW and GTCC-like wastes are outside the scope of this EIS because they do not meet the purpose and need for agency action. Consistent with Congressional direction in Section 631 of the Energy Policy Act of 2005 (P.L. 109-58), DOE plans to complete an EIS and a ROD for a permanent disposal facility for this waste, not for long-term storage options. The GTCC EIS evaluates the range of reasonable disposal alternatives and, as also required under NEPA, a No Action Alternative. Under the No Action Alternative, current practices for storing GTCC LLRW and GTCC-like wastes would continue in accordance with current requirements.

Snake River Alliance, Commenter ID No. T20 (cont'd)

1 After 9/11, the Alliance, many other
2 organizations that share similar views, re-examined
3 that perspective, and added the notion that the
4 storage as close as possible to its point of
5 generation should be in hardened on-site storage.
6 I would like to state very firmly
7 hardened on-site storage is not no action. You know,
8 the whole notion that "If we don't move waste, we're
9 not doing anything with waste," is not correct.
10 This study has a number of problems, and
11 I will just note a couple of them. This -- the waste
12 that we're talking about here is not even yet waste.
13 It's still in the middle of the reactor buildings, by
14 and large. It's not a waste stream. It is decades
15 from being a waste stream. So we don't have to
16 decide this evening what to do with it. It will be,
17 what, 60 years before this waste stream is a waste
18 stream.
19 Another issue with this particular
20 study, all the sites, not surprisingly, are DOE
21 sites, all of the sites that we're looking at for
22 disposal of this waste. They don't necessarily have
23 anything else in common other than that they're
24 Department of Energy sites and they're already
25 contaminated.

T20-1
(Cont.)

T20-2

T20-2

The disposal methods and sites evaluated in the EIS represent the range of reasonable alternatives for the disposal of GTCC LLRW and GTCC-like wastes. This range is consistent with NEPA implementing regulations in Parts 1500–1508 of Title 40 of the Code of Federal Regulations (40 CFR Parts 1500–1508). In this GTCC EIS, DOE analyzed a range of disposal methods (i.e., geologic repository, near-surface trench, intermediate-depth borehole, and above-grade vault) and federally owned sites (i.e., Hanford Site, INL, LANL, NNSS, SRS, and the WIPP Vicinity, for which two reference locations – one within and one outside the WIPP Land Withdrawal Boundary – were considered). DOE has determined that it was reasonable to analyze these six sites because they currently have operating radioactive waste disposal facilities, except for the WIPP Vicinity, which is near an operating geologic repository.

DOE also conducted a generic evaluation of commercial disposal facilities on nonfederal lands in the EIS to order to provide, to the extent possible, information regarding the potential long-term performance of other (nonfederal) locations for siting a GTCC waste land disposal facility.

Final siting of a disposal facility for GTCC LLRW and GTCC-like wastes would involve further NEPA review as needed and be in accordance with applicable laws and regulations and would involve local stakeholder involvement and consent.

1 I would say that the DOE has to go back
 2 and look more broadly down the road, "What do we need
 3 for this kind of waste?" I would like to obviously
 4 reiterate the notion that if the Nuclear Regulatory
 5 Commission says this should be in a deep geologic
 6 repository, then that is -- that's the starting point
 7 for the analysis.

8 But the repository question as discussed
 9 in this Draft, is a little odd. First of all, the
 10 Department of Energy, the United States Government is
 11 required by law to develop a second repository, other
 12 than Yucca Mountain, and certainly other than WIPP.

13 The Waste Isolation Pilot Plant is by
 14 law -- and, again, you know, the Department of Energy
 15 is a government agency, by law, WIPP cannot accept
 16 commercial waste. And I want to talk about that as
 17 someone from Idaho. You know, Idaho sends a fair
 18 amount of waste to other places for disposal,
 19 noticeably WIPP, but, you know, the Nevada Test Site,
 20 EnviroCare -- Energy Solutions, I'm sorry.

21 But we also receive waste for long-term
 22 storage, noticeably from the Nuclear Navy. The --
 23 there is, you know, the nuclear waste management has
 24 a lot of aspects to it. It's, you know, a technical
 25 problem. It's an economic problem, for sure. It's a

T20-3

T20-4

T20-5

T20-3 DOE agrees that use of a geologic repository would be a protective and safe method for the disposal of the entire inventory of GTCC LLRW and GTCC-like wastes. The GTCC EIS evaluation for the WIPP geologic repository alternative supports this statement. However, the degree of waste isolation provided by a geologic repository may not be necessary for all of the GTCC LLRW and GTCC-like wastes evaluated in the GTCC EIS. The GTCC EIS evaluation indicates that certain wastes (e.g., those containing short-lived radionuclides such as Cs-137 irradiators) could be safely disposed of in properly designed land disposal facilities at sites with suitable characteristics, such as low precipitation rates, high soil distribution coefficients, and sufficient depths to groundwater. Based on the GTCC EIS evaluation, land disposal facilities located in arid climates (e.g., NNSS and WIPP Vicinity) would isolate radionuclides for a sufficient period of time to allow for significant radioactive decay to occur.

While 10 CFR Part 61 identifies one NRC-approved method for GTCC LLRW disposal (disposal in a geologic repository), these regulations also indicate that other disposal methods could be approved. In addition to a deep geologic repository, the GTCC EIS evaluates three land disposal methods (i.e., enhanced near-surface trench, intermediate-depth borehole, and above-grade vault). The GTCC EIS evaluation indicates that land disposal methods employed at sites with suitable characteristics would be viable and safe alternatives for the disposal of GTCC LLRW.

T20-4 The EIS considered the range of reasonable alternatives for the disposal of the GTCC waste inventory, including disposal in a deep geologic repository. DOE did not evaluate developing a geologic repository exclusively for disposal of GTCC LLRW and GTCC-like wastes because DOE determined that such an alternative is not reasonable due to the time and cost associated with siting a deep geologic repository and the relatively small volume of GTCC LLRW and GTCC-like wastes identified in the GTCC EIS. DOE believes that the results presented in this EIS for the WIPP geologic repository alternative are indicative of the high degree of waste isolation that would be provided by disposal in a geologic repository. DOE has included analysis of generic commercial facilities in the event that a facility could become available in the future. In that case, before making a decision to use a commercial facility, DOE would conduct further NEPA reviews, as appropriate.

T20-5 Disposal of GTCC LLRW and GTCC-like wastes at WIPP or the WIPP Vicinity site is included in the range of reasonable alternatives and is evaluated in this EIS. DOE acknowledges that only defense-generated TRU waste is currently authorized for disposal at the WIPP geologic repository under the WIPP LWA as amended (P.L. 102-579 as amended by P.L. 104-201) and that legislation would be required to allow disposal of waste other than TRU waste generated by atomic energy defense activities at WIPP and/or for siting a new facility within the land withdrawal area. It would also be necessary to revise the Agreement for Consultation and Cooperation between Department of Energy and the State of New Mexico for the Waste Isolation Pilot Plant, the WIPP compliance certification with EPA, and the WIPP Hazardous Waste Facility Permit. In addition, site-specific NEPA reviews would have to be conducted, including further characterization of the waste (e.g., radionuclide inventory and heat loads) as well as the proposed packaging for disposal.

However, NEPA does not limit an EIS to proposing and evaluating alternatives that are currently authorized. Furthermore, the Agreement for Consultation and Cooperation between Department of Energy and the State of New Mexico for the Waste Isolation Pilot Plant recognizes that the mission of WIPP may change and provides provisions to modify the agreement. For example, the Agreement states: "The parties to this Agreement recognize that future developments including changes to applicable laws (e.g., Public Law [P.L.] 96-164) may make it desirable or necessary for one or both parties to seek to modify this Agreement. Either party to this Agreement may request a review of the terms and conditions."

Snake River Alliance, Commenter ID No. T20 (cont'd)

1 cultural problem. And it's a social -- it raises
2 some social questions. And one of the most important
3 questions it raises is equity.

4 And if Idaho -- you know, the deal has
5 been made that Idaho will accept a certain number of
6 shipments a year of extraordinarily radioactive
7 waste, part of that deal is that Idaho is
8 acknowledged not to be the appropriate place for that
9 waste to stay until the end of time.

10 That's a deal we've made. If we then
11 advocate that it's okay for the DOE to break its deal
12 with the people of New Mexico, what's to stop the DOE
13 from breaking the deal with the people of Idaho?
14 Where do we stand in that equation?

15 As important, you know, on this planet,
16 nobody has really figured out how to establish a deep
17 geological repository for high-level waste. And if
18 we start breaking our promises to the only place on
19 this planet that has accepted the establishment of a
20 deep geologic repository, think how hard the next one
21 is going to be to establish.

22 You know, if folks in Finland, or folks
23 in any place else on the planet say, "Okay, New
24 Mexico said they would take a certain quantity of a
25 certain kind of waste and the United States

T20-6

DOE acknowledges the TRU waste disposal limitations for WIPP specified in the WIPP LWA as amended (P.L. 102-579 as amended by P.L. 104-201) and in the Agreement for Consultation and Cooperation between Department of Energy and the State of New Mexico for the Waste Isolation Pilot Plant. Information on these limitations is provided in this EIS (see Section 4.1.1) and was considered in developing the preferred alternative. Based on the GTCC EIS evaluation, disposal of GTCC LLRW and GTCC-like wastes at WIPP would result in minimal environmental impacts for all resource areas evaluated, including human health and transportation. Both the annual dose and the latent cancer fatality (LCF) risk would be zero because there would be no releases to the accessible environment and therefore no radiation doses and LCFs during the first 10,000 years following closure of the WIPP repository. DOE recognizes that the use of WIPP for the disposal of GTCC LLRW and GTCC-like wastes would require legislative changes and site-specific NEPA reviews would be conducted as needed, including further characterization of the waste (e.g., radionuclide inventory and heat loads), as well as the proposed packaging for disposal .

T20-6 See response to T20-2.

Snake River Alliance, Commenter ID No. T20 (cont'd)

1 Government broke their word," that's going to be a
2 problem. And it's certainly going to be a problem
3 here in Idaho if we start seeing the twinkle in the
4 eye of the federal government that it's going to
5 break its promise to us.
6 So I would say that the problem with
7 this Draft is there's no rush. It's like, we're
8 having to make this decision in 2012 to solve a
9 problem that we don't yet really have, and we're
10 looking at it -- a lot of what we're looking at as
11 alternatives are really not alternatives if we accept
12 the notion that the federal government is going to
13 obey the law.
14 So I would suggest that the Department
15 of Energy withdraw this Draft. I'm glad to hear that
16 other members of the public have advocated hardened
17 on-site storage. And I will say that I heard some
18 folks in the Blue Ribbon Commission the other day
19 speaking fairly acceptingly of that notion. Thanks.

T20-7

T20-7 DOE believes this EIS process is appropriate given the current circumstances. Sufficient information is available to support the current decision-making process to identify (an) appropriate site(s) and method(s) to dispose of the limited amount of GTCC LLRW and GTCC-like waste identified in the EIS.

DOE believes that this EIS process is not being rushed. On the basis of an assumed starting date of 2019 for disposal operations, more than half (about 6,700 m³ [240,000 ft³]) of the total GTCC LLRW and GTCC-like waste inventory of 12,000 m³ [420,000 ft³]) is projected to be available for disposal between 2019 and 2030. An additional 2,000 m³ (71,000 ft³) would become available for disposal between 2031 and 2035. This information is presented in Figure 3.4.2-1. DOE believes this EIS is timely, especially given the length of time necessary to develop a GTCC waste disposal facility.

DOE developed this EIS to support a decision on selecting a disposal facility or facilities for GTCC LLRW and GTCC-like waste, to address legislative requirements, to address national security concerns (especially for sealed sources), and to protect public health and safety. The purpose and need for the proposed action, as discussed above, is stated in the EIS (Section 1.1). The scope of the EIS is focused on addressing the need for developing a disposal capability for the identified inventory of GTCC LLRW and GTCC-like wastes. DOE plans a tiered decision-making process, in which DOE would conduct further site-specific NEPA reviews before implementing an alternative ultimately selected on the basis of this EIS.

South Carolina Department of Health and Environmental Control,
Commenter ID No. W2

From: gtcciswebmaster@anl.gov
Sent: Friday, March 18, 2011 8:25 AM
To: mail_gtccisarchives; gtcciswebmaster@anl.gov
Subject: Greater-Than-Class-C Low-Level Radioactive Waste EIS Comment GTCC10002
Attachments: GTCC_March_2011_GTCC10002.doc

Thank you for your comment, Michelle Wilson.

The comment tracking number that has been assigned to your comment is GTCC10002. Please refer to the comment tracking number in all correspondence relating to this comment.

Comment Date: March 18, 2011 08:24:48AM CDT

Greater-Than-Class-C Low-Level Radioactive Waste EIS Draft Comment: GTCC10002

First Name: Michelle
Middle Initial: D
Last Name: Wilson
Organization: SC Department of Health and Environmental Control
Address: 2600 Bull Street
City: Columbia
State: SC
Zip: 29201
Country: USA
Email: wilsonmd@dhec.sc.gov
Privacy Preference: Don't withhold name or address from public record
Attachment: C:\fakepath\GTCC March 2011.doc

Questions about submitting comments over the Web? Contact us at: gtcciswebmaster@anl.gov or call the Greater-Than-Class-C Low-Level Radioactive Waste EIS Webmaster at (630) 252-5705.

South Carolina Department of Health and Environmental Control,
Commenter ID No. W2 (cont'd)

COMMENTS FROM THE
SOUTH CAROLINA DEPARTMENT OF HEALTH
AND ENVIRONMENTAL CONTROL
ON THE
DEPARTMENT OF ENERGY
DRAFT ENVIRONMENTAL IMPACT STATEMENT FOR THE DISPOSAL OF
GREATER-THAN-CLASS C (GTCC) LOW-LEVEL RADIOACTIVE WASTE
(LLRW) and GTCC-LIKE WASTE

March 18, 2011

- 1) The Savannah River Site (SRS) is not an appropriate location for additional radioactive waste burden given its current waste management status. Approximately thirty-seven million gallons of high-level mixed waste are stored in aging tanks with leak sites. A substantial volume of transuranic waste remains in storage at SRS awaiting appropriate disposition. Radioactive contamination remains in many areas slated for future cleanup decisions. Disposal of Greater-Than-Class C (GTCC) and GTCC-like waste is inappropriate at SRS given the current cleanup backlog. Any new disposal activities at SRS would influence future cleanup and closure decisions, given the objective of the State to minimize residuals remaining at SRS for long-term care.
- 2) Any new mixed waste disposal activities at SRS would have to meet the requirements for new disposal facilities in R.61-104, Hazardous Waste Management Location Standards in addition to other disposal facility requirements including R.61-79, South Carolina Hazardous Waste Management Regulations.

W2-1

W2-2

- W2-1 DOE is performing environmental restoration activities at SRS. The ongoing cleanup effort will continue. If GTCC LLRW or GTCC-like waste were to be disposed at SRS, DOE does not anticipate negative impacts to ongoing cleanup activities at this site.
- W2-2 Comment noted. Development of the waste acceptance criteria for the new GTCC disposal facility would be in accordance with the final facility design and site requirements.



SOUTHWEST RESEARCH AND INFORMATION CENTER
P.O. Box 4524 Albuquerque, NM 87106 505-262-1862 FAX: 505-262-1864

June 27, 2011

Mr. Arnold M. Edelman, EIS Document Manager
U.S. Department of Energy
GTCC EIS
Cloverleaf Building, EM-43
1000 Independence Ave., S.W.
Washington, D.C. 20585

VIA ELECTRONIC MAIL

RE: Comments on the Draft Environmental Impact Statement for the Disposal of Greater-Than-Class-C (GTCC) Low-Level Radioactive Waste and GTCC-Like Waste (DOE/EIS-0375-D)

Dear Mr. Edelman:

Southwest Research and Information Center (SRIC), a 40-year-old nonprofit organization with more than 35 years experience in working on nuclear waste issues, submits these comments in response to the Department of Energy (DOE) Draft Environmental Impact Statement for the Disposal of Greater-Than-Class-C (GTCC) Low-Level Radioactive Waste and GTCC-Like Waste (DOE/EIS-0375-D). These comments are in addition to letters from SRIC during the comment period and oral testimony provided at the Albuquerque hearing on April 27, 2011. DOE must respond to these comments and all of the previous ones.

The GTCC Draft Environmental Impact Statement (DEIS) is fatally flawed legally, as a matter of public policy, and technically. It does not provide an adequate basis for a final EIS. Therefore, the EIS process must stop and start over.

1. The GTCC DEIS is the wrong document. DOE must instead prepare a programmatic EIS (PEIS) for Greater-than-Class C wastes, and issue a supplemental or new PEIS for DOE wastes ("GTCC-like").

DOE has never prepared a PEIS for GTCC wastes, and it must do so as a prerequisite for preparing an EIS to choose specific disposal sites and technologies. DOE does not know what the types and amounts of GTCC waste there will be from existing commercial powerplants, from planned plants, and from other activities. A PEIS including storage and disposal alternatives has not been done and must be done before a draft EIS for disposal is issued. Such a PEIS should address issues that are not included in the DEIS, including:

- Should DOE sites be used for commercial wastes?
- Could GTCC waste be disposed in a high-level waste/spent nuclear fuel (HLW/SNF) repository?
- What are the options for GTCC waste storage at existing reactor sites for several decades or more

L6-1

DOE does not agree that a programmatic EIS as described in this comment must be prepared before this EIS is completed. DOE tailored the scope of this EIS to ensure the analyses will adequately inform the decisions at issue, including the selection of sites and technologies for the disposal of GTCC and GTCC-like waste. This EIS presents the environmental information needed to adequately inform decision makers regarding many of the questions and points raised in this comment; other questions and points raised remain outside of the scope of this document. DOE plans a tiered decision making process in which DOE would conduct further site-specific NEPA reviews before implementing an alternative ultimately selected on the basis of this EIS.

Regarding the types and exact amount of GTCC from existing commercial power plants ultimately requiring disposal, DOE does not agree this is an issue warranting preparation of a PEIS as a prerequisite to this EIS. Nevertheless, considerable attention is given to waste inventories in this EIS, which quantifies and analyzes potential impacts from the range of potential quantities of wastes from commercial power plants as well as from other types of GTCC waste. The EIS is structured to inform potential decisions to employ different technologies and disposal sites from the different types of GTCC and GTCC-like wastes, as is the case under the preferred alternative identified in this Final EIS.

Contrary to points raised in this comment, this EIS also provides substantial attention to inventories and characteristics of GTCC-like wastes and analyzes in detail potential impacts of transportation and disposal options. This EIS also answers the question posed regarding whether GTCC waste could be disposed of in a repository for high-level waste and spent nuclear fuel; the EIS concludes that use of a geologic repository would be a protective and safe method for disposal of the entire inventory of GTCC and GTCC-like wastes evaluated in this EIS (see response to A.2.3 under *Topics of Interest*).

The issues raised in the comment regarding regulatory factors such as NRC licensing do not affect the health and environmental analyses which are appropriately the subject of this EIS, and do not support the proposition that a PEIS is needed. Those matters would be addressed as DOE proceeds to implement future decisions pursuant to this EIS, which is focused on the identification of a suitable location or locations for the safe and secure disposal of these wastes; accordingly, DOE proposes to make a site-specific decision.

The EIS explains why existing commercial sites are not available for inclusion in the scope of this EIS and why analysis of generic commercial sites for future consideration is a valid approach (see Chapter 12). DOE's treatment of this topic is programmatic in nature, consistent with DOE's understanding of the comment. Issues pertaining to storage of GTCC LLRW and GTCC-like waste are outside the scope of this EIS, which is focused on disposal of the waste as stated in DOE's Purpose and Need for Action and in the Proposed Action itself. The Final EIS includes a No Action Alternative, in which long-term storage of GTCC LLRW is analyzed (Chapter 3).

DOE does not agree that the draft GTCC EIS is fatally flawed legally, as a matter of public policy and technically. DOE believes that the draft GTCC EIS provides an adequate basis for the Final GTCC EIS. Refer to specific comment responses in L6 that address each of these areas in more detail.

L6-1

- What are the options for consolidating GTCC waste storage at commercial site(s)?
- What are the options for commercial sealed sources without a disposal path?
- Could commercial sealed sources be secured and/or disposed without being co-mingled with other GTCC wastes?
- Could any of the existing commercial low-level waste (LLW) disposal sites meet technical requirements for storage or disposal of some or all of the GTCC wastes?
- What are the possible disposal options; and is Nuclear Regulatory Commission (NRC) licensing required?
- What changes are needed in NRC regulations for the various disposal options?
- What changes are needed in NRC regulations regarding transportation?
- What changes in NRC regulations are required if a licensed facility (nuclear power plant or other NRC licensee) sends waste to an unlicensed facility (DOE disposal sites)?

SRIC and other commentors requested a PEIS during the scoping process. The DEIS states that those comments were considered to be outside the scope of the EIS. The cursory response in the DEIS is:

“This EIS has been scoped to provide adequate environmental information to support the decision-making process to identify an appropriate site(s) and technology(s) to dispose of a limited amount of GTCC LLRW and GTCC-like waste. If appropriate, DOE would conduct further NEPA review, tiered from this EIS, before implementing decisions.” at A-12.

That response is totally inadequate and does not even describe the matters that have been raised in support of a PEIS, let alone providing a reasoned basis for not proceeding with the requested PEIS. That response also does not address the many issues that have yet to be answered that should be addressed in a PEIS. Thus, the need for a PEIS remains. Further, what kind of EIS is required also is certainly not outside the scope of an EIS.

Regarding “GTCC-like” waste, DOE issued a **Waste Management Programmatic Environmental Impact Statement** (DOE/EIS-0200-F) in May 1997. That PEIS included, or should have included as low-level or transuranic waste, much if not all of the waste that is now called “GTCC-like” waste. *See*, pages 1-23 to 1-31. Thus, since DOE is now considering alternative technologies and sites for such waste that were not included in the Waste Management PEIS, the required procedure is to supplement that PEIS for those “GTCC-like” wastes. Such a supplement should, among other things, discuss:

- Whether there should be such a category as “GTCC-like” waste and what are its specific characteristics or whether the waste is included in low-level waste, mixed low-level waste, transuranic waste, or environmental reclamation waste;
- Inventory of such waste;
- Detailed description of and options for DOE wastes with no disposal path;
- Alternative storage technologies;
- Alternative DOE sites for storage and disposal;

L6-2

DOE is not contemplating a change in its decisions regarding the waste analyzed in the Waste Management Programmatic EIS (WM PEIS). The GTCC and GTCC-like wastes having characteristics that would permit those wastes to meet established Waste Acceptance Criteria are considered for disposal in existing disposal facilities evaluated in the WM PEIS. GTCC LLRW and GTCC-like wastes that may not be qualified for disposal in existing facilities would have to be disposed of in safe and secure facilities suitable for those wastes, and new construction is evaluated in this EIS. For the purposes of analysis, this EIS uses the term “GTCC-like waste” to distinguish DOE wastes having characteristics similar to commercial GTCC waste. Chapter 1 and Appendix B provide detailed information on the definition and inventory of these wastes. As stated above, this EIS includes a No Action Alternative, in which long-term storage is analyzed.

L6-1 (Cont.)

L6-2

- Cumulative impacts of storage and disposal, including existing and future missions of each DOE site;
- Transportation options and their impacts;
- Environmental impacts of the various technologies and alternatives;
- Licensing requirements that exist or would be needed for DOE sites to take commercial wastes.

SRIC further suggests that DOE conduct a scoping process for the WM PEIS supplement, including an analysis of whether an entire new EIS process is needed, given that the WM PEIS is 14 years old.

2. The DEIS is legally flawed because it does not consider all reasonable alternatives. Council on Environmental Quality (CEQ) regulations under the National Environmental Policy Act (NEPA) clearly state that alternatives including the proposed action are:

"the heart of the environmental impact statement. Based on the information and analysis presented in the sections on the Affected Environment (§1502.15) and the Environmental Consequences (§1502.16), it should present the environmental impacts of the proposal and the alternatives in comparative form, thus sharply defining the issues and providing a clear basis for choice among options by the decisionmaker and the public. In this section agencies shall:

- Rigorously explore and objectively evaluate all reasonable alternatives, and for alternatives which were eliminated from detailed study, briefly discuss the reasons for their having been eliminated.
- Devote substantial treatment to each alternative considered in detail including the proposed action so that reviewers may evaluate their comparative merits.
- Include reasonable alternatives not within the jurisdiction of the lead agency.
- Include the alternative of no action.
- Identify the agency's preferred alternative or alternatives, if one or more exists, in the draft statement and identify such alternative in the final statement unless another law prohibits the expression of such a preference.
- Include appropriate mitigation measures not already included in the proposed action or alternatives." 40 CFR § 1502.14 (emphasis added).

The DEIS totally fails to fulfill the requirement to "consider all reasonable alternatives."

A. The DEIS does not consider the only alternative that is consistent with existing law – GTCC waste disposal in a licensed geologic repository under the Nuclear Waste Policy Act (NWPA).

The NWPA, Public Law 97-425, as amended, (42 U.S.C. § 10101 et seq.) requires the federal government to site, construct, and operate "repositories that will provide a reasonable assurance that the public and the environment will be adequately protected from the hazards posed by high-level radioactive waste and such spent nuclear fuel as may be disposed of in a repository." 42 U.S.C. § 10131(b)(1). The NWPA does not preclude disposal in such repositories of GTCC waste.

L6-3

As explained in Section 2.6, DOE determined that Yucca Mountain is not a reasonable alternative for this EIS. DOE did not evaluate developing a geologic repository exclusively for disposal of GTCC LLRW and GTCC-like wastes because DOE determined that such an alternative is not reasonable due to the time and cost associated with siting a deep geologic repository and the relatively small volume of GTCC LLRW and GTCC-like wastes identified in the GTCC EIS. DOE believes that the results presented in this EIS for the WIPP geologic repository alternative are indicative of the high degree of waste isolation that would be provided by disposal in a geologic repository. DOE has included analysis of generic commercial facilities in the event that a facility could become available in the future. In that case, before making a decision to use a commercial facility, DOE would conduct further NEPA reviews, as appropriate.

The Blue Ribbon Commission (BRC) on America's Nuclear Future, in its final report to DOE on January 26, 2012, provided recommendations, which included the development of one or more permanent deep geologic facilities for the safe disposal of spent nuclear fuel and high-level radioactive waste and the development of one or more consolidated interim storage facilities as part of an integrated, comprehensive plan for managing the back end of the nuclear fuel cycle. In its Strategy for the Management and Disposal of Spent Nuclear Fuel and High Level Radioactive Waste (DOE 2013), developed in response to the BRC Report, the Administration agreed "that the development of geologic disposal capacity is currently the most cost-effective way of permanently disposing of used nuclear fuel and high-level radioactive waste while minimizing the burden on future generations" and proposed to "engage in a consent-based siting process and begin to conduct preliminary site investigations for a geologic repository." The Administration's goal is to have a repository constructed and its operations started by 2048. The Administration will work with Congress using the strategy as an actionable framework for building a national program for the management and disposal of the nation's used nuclear fuel and high-level radioactive waste (DOE 2013).

DOE has identified DOE sites that do have compatible missions and existing infrastructure to support the disposal of GTCC LLRW and GTCC-like wastes. DOE also included an analysis of generic commercial facilities in the event that such a facility could become available in the future. DOE plans a tiered decision-making process, in which DOE would conduct further project-specific NEPA reviews before implementing an alternative ultimately selected on the basis of this EIS.

As described in the comment, this EIS considers the use of HOSS to be outside the scope of the EIS. This approach would not satisfy the purpose and need to isolate the waste permanently, and accordingly, it would not be a reasonable alternative. DOE recognizes that the longer the waste would remain in storage, the higher the risk it could re-enter the environment over a long term. Further, the No Action Alternative provides a comparatively conservative analysis of the potential health and environmental impacts of long-term storage. See A.2.3 under *Topics of Interest* for a further discussion.

L6-2
(Cont.)

L6-3

As amended by Congress in 1987, the NWPA designates Yucca Mountain, NV as currently the only site undergoing development as a repository. However, the NWPA continues to maintain the requirement for repositories, noted above. The NWPA also places a limit of 70,000 metric tons of HLW/SNF in the first repository (42 U.S.C. § 10134(d)), thereby allowing for other future repositories. The NWPA also requires the Secretary of Energy to report to the President and Congress on the need for a second repository. § 161(b). Such a report was issued in December 2008 and, among other things, stated: "Unless Congress raises or eliminates the current statutory capacity limit of 70,000 MTHM in the NWPA, the Nation will need a second repository for SNF and HLW." *The Report to the President and the Congress by the Secretary of Energy on the Need for a Second Repository* (DOE/RW-0595) at 2. Congress has not taken any action to raise or eliminate the capacity limit.

Thus, existing law requires development of Yucca Mountain as the first repository and does not prohibit GTCC waste disposal in that repository. Thus, consideration of Yucca Mountain for GTCC disposal is a reasonable alternative.

In its Notice of Intent (NOI), DOE stated that the GTCC EIS "intends to analyze disposal at Yucca Mountain in Nevada." 72 *Federal Register* 40137, c.3. The NOI also included Yucca Mountain as Alternative 3." 72 *Federal Register* 40138, c.2.

However, the DEIS does not include Yucca Mountain as an alternative. The DEIS states that:

"since publication of the NOI, the Administration has determined that developing a permanent repository for high-level waste and spent nuclear fuel at Yucca Mountain, Nevada, is not a workable option and that the project should be terminated....Therefore, because a repository for high-level waste and spent nuclear fuel at Yucca Mountain has been determined not to be a workable option and will not be developed, co-disposal at a Yucca Mountain repository is not a reasonable alternative." at 2-9.

SRIC has long maintained that Yucca Mountain is not a safe repository site for many reasons, including that it is not a technically suitable site and does not meet the requirements of 40 CFR 191. Thus, SRIC would oppose the use of Yucca Mountain for SNF, HLW, GTCC, or "GTCC-like" storage or disposal. However, just as SRIC opposes use of the Waste Isolation Pilot Plant (WIPP) for GTCC disposal, as will be discussed further below, WIPP can be considered a legally reasonable alternative and Yucca Mountain can also be considered a legally reasonable alternative.

Even if DOE does not consider Yucca Mountain as a reasonable alternative, it *must* include a future repository or repositories as reasonable alternative(s). The exclusion of any consideration any SNF/HLW repository as a reasonable alternative for GTCC disposal is clearly contrary to law. Even if DOE does not take SRIC's recommendation to undertake one or more PFISs, it cannot issue an Final EIS and must instead issue a new DEIS that includes at least one SNF/HLW repository as a reasonable alternative.

L6-3
(Cont.)

B. The DEIS does not adequately consider disposal at specific commercial sites as a reasonable alternative.

The DEIS considers that DOE geologic repositories are not the only reasonable alternatives for GTCC waste disposal. The DEIS does not demonstrate that near surface disposal technologies could only occur at DOE sites. Indeed the DEIS includes two "WIPP Vicinity" sites, and four "generic regional commercial disposal sites." Yet the DEIS does not include any of the eight commercial LLW disposal sites as reasonable alternatives. Over the past 50 years, disposal of LLW has occurred at Barnwell, SC; Beatty, NV; Energy Solutions, Clive, UT; US Ecology, Richland, WA; Maxey Flats, KY; Sheffield, IL; and West Valley, NY. In addition, Waste Control Specialists, Andrews, TX may receive LLW in the future.

GTCC waste will be generated and stored at dozens of commercial nuclear power plants and other sites around the country over the next several decades. Yet none of those specific locations are considered reasonable alternatives of GTCC waste disposal in the DEIS.

The DEIS does not specifically analyze whether any of the commercial LLW disposal sites (active and closed) could be used for the technologies that do not require geologic disposal. The DEIS also does not analyze whether at least one of the dozens of commercial generation and storage sites (now and in the future) could be used for the technologies that do not require geologic disposal. That none of those sites has "volunteered" to be considered for GTCC waste disposal does not mean that each one of them is unsuitable.

The "generic" sites included in the DEIS are more appropriate for a PEIS and are certainly not identified sufficiently for the environmental analysis required for the DEIS for disposal alternatives.

C. The DEIS does not consider Hardened On Site Storage (HOSS) as a reasonable alternative. Dozens of scoping commentors advocated that HOSS be considered as an alternative. The DEIS states that those comments were considered to be outside the scope of the EIS. On page 1-43 (and very similar language on A-9):

Comment: Hardened on-site storage (HOSS) should be added to the alternatives evaluated in the EIS. In addition, HOSS should be the preferred alternative.
Response: HOSS and other waste storage approaches beyond the No Action Alternative are considered to be outside the scope of this EIS because they do not meet the purpose and need for agency action. Consistent with Congressional direction in Section 631 of the Energy Policy Act of 2005, DOE plans to complete an EIS and a ROD for a permanent disposal facility for this waste, not for long-term storage options. In addition, the No Action Alternative evaluates storage of this waste consistent with ongoing practices.

However, the DEIS analysis of the No Action Alternative is that "current practices for storing GTCC LLRW and GTCC like waste would continue." at 3-1. That is not an analysis of HOSS. It is a reasonable alternative to consider HOSS as improved on-site storage. "Principles for Safeguarding Nuclear Waste at Reactors" have been endorsed by SRIC and citizen organizations based in all 50 states. Attachment 1. Those organizations support numerous actions that are

L6-3
(Cont.)

Southwest Research and Information Center, Commenter ID No. L6 (cont'd)

much different practices than the DEIS "no action" alternative. Those practices are not geologic disposal, but rather would result in SNF (and GTCC waste) being stored as close as possible to existing reactors (active or decommissioned) for decades in more secure storage than has been used for the past 50 years at reactor sites.

The DEIS has not analyzed whether HOSS would provide storage of GTCC waste that is more secure and would have lesser environmental impacts than its "no action" alternative. The DEIS also has not analyzed whether HOSS would provide equivalent and improved environmental protection to GTCC waste compared with the "no action" alternative or the action alternatives.

To dismiss HOSS because it is not "disposal" is unreasonable. None of the disposal technologies other than geologic disposal has been demonstrated to meet NRC disposal requirements for GTCC waste. Given that there has never been a U.S. geologic repository for commercial waste, it is certainly reasonable and possible that there will be no disposal site for GTCC waste for decades or centuries. During such an extended period of time with no GTCC disposal, DOE and Congress should consider what the environmental impacts of long-term storage at reactors of the approximately 160,000,000 curies of GTCC waste would be.

3. The DEIS is legally flawed because it does not adequately state a purpose and need. There is no clear statement of purpose and need beyond: "There is currently no disposal capability for GTCC LLRW." at 1-2. However, there is currently no disposal capability for high-level waste. There is no current disposal capability for spent nuclear fuel. Thus, the lack of "disposal capability" is not a sufficient statement of need. NEPA requires the need to be properly defined. Here again, SRIC believes that an adequate statement of need should be developed and addressed through programmatic EISs.

The DEIS seems to indicate that the near-term issue is the protection of disused sealed sources, including storage and disposal of commercial sealed sources, which comprise less than one percent of the activity and volume of GTCC waste. The DEIS makes no showing that current storage methods and locations are inadequate. The DEIS provides no adequate information that current storage methods under the no action alternative or some enhanced no action alternative are not sufficient for the next few decades. If there is a current problem with storage and security of sealed sources, that issue should be specifically addressed. Such an analysis would include, among other things, inventory, current storage capabilities and vulnerabilities, options to improve storage, reasonable storage technologies, reasonable storage locations, need for disposal if secure storage for decades exists. Such an analysis could provide the information and clear choices that decisionmakers and the public need and that NEPA requires.

Although sealed sources appears to be an overriding concern for DOE, the DEIS does not provide any analysis of many of the existing sealed sources. The DEIS states:

"Sources recovered by GTRI/OSRP for national security or public health and safety reasons are stored at LANL or off-site contractor facilities pending disposal...To date, all of the sources recovered by GTRI/OSRP have an identified path to disposal and are therefore not included in the GTCC EIS inventory." at 1-17.

L6-4 DOE developed this EIS to support a decision on selecting a disposal facility or facilities for GTCC LLRW and GTCC-like waste, to address legislative requirements, to address national security concerns (especially for sealed sources), and to protect public health and safety. The purpose and need for the proposed action is stated in the EIS (Section 1.1). The potential security concerns presented by disused sealed sources are also discussed in Section 1.1 of the EIS.

L6-5 Section 1.4.1.2, Sealed Sources, describes the sealed sources included in the GTCC EIS inventory. To date, all of the sources recovered by GMS/OSRP have an identified path to disposal and are therefore not included in the GTCC EIS inventory. Storage of sources recovered by GMS/OSRP at LANL or off-site contractor facilities is outside the scope of this EIS.

L6-3 (Cont.)

L6-4

L6-5

Thus, the DEIS does not discuss all sealed sources, nor does it describe and analyze those "off-site contractor facilities" and what role they could play regarding the sealed sources that are included in the DEIS.

The DEIS Table 1.4.1-2 indicates that 98 percent of the radioactivity in the wastes included in the DEIS are activated metals from decommissioned nuclear power plants. The DEIS, however, never includes readily available information from the Nuclear Regulatory Commission website, (<http://www.nrc.gov/reactors/operating/licensing/renewal/applications.html>), regarding the actual licensing status of licensed nuclear power plants. That information indicates that of the 104 operating reactors, 66 are licensed to 2030 or beyond; 18 more renewal applications under review; and at least 11 more renewal applications expected. Therefore, at least 85% of existing reactors expect to operate beyond 2030 – which means GTCC activated metals disposal is not available to even begin disposal for years after that.

The DEIS does not analyze and discuss why when 98 percent of the radioactivity of GTCC waste is not available for disposal for more than two decades into the future that there is a need to make a determination about disposal technologies and sites now for those wastes. There should be an analysis of whether it is premature to make any technology and disposal site decisions so far in advance of when waste is actually available for disposal. In fact, an adequate DEIS would state that apparently the only reasonable alternative for the next few decades is on-site storage of such activated metals.

The DEIS inappropriately conflates different purposes and needs into the DEIS, contrary to NEPA requirements. There is a perceived need to secure sealed sources as soon as possible. There is not a need to make disposal decisions about approximately 98 percent of GTCC wastes. There is no analysis of whether storage, including improved storage through HOSS would make the timeframe for decisions about activated metals from decommissioned nuclear power plants disposal technologies and sites even several more decades into the future.

Once again, a PEIS would provide the appropriate NEPA document to discuss these issues so that decisionmakers and the public are aware of the purpose and need, including timeframes for decision and action regarding the various GTCC wastes.

4. The DEIS is legally flawed because it does not adequately consider cumulative impacts. CEQ regulations under NEPA and caselaw clearly require consideration of cumulative impacts. CEQ regulations state:

"Cumulative impact is the impact on the environment which results from the incremental impact of the action when added to other past, present, and reasonably foreseeable future actions regardless of what agency (Federal or non-Federal) or person undertakes such other actions. Cumulative impacts can result from individually minor but collectively significant actions taking place over a period of time." 40 CFR § 1508.7

The Supreme Court has clearly ruled that cumulative impacts must be analyzed in an EIS:

L6-5
(Cont.)

L6-6

L6-7

L6-8

L6-6 DOE agrees that most of the activated metals from nuclear power plants will not be generated for decades. DOE did determine that including these activated metals in the preferred alternative (Section 2.10 of this Final EIS) was appropriate.

L6-7 DOE believes this EIS process is appropriate given the current circumstances. Sufficient information is available to support the current decision-making process to identify (an) appropriate site(s) and method(s) to dispose of the limited amount of GTCC LLRW and GTCC-like waste identified in the EIS. DOE believes that this EIS process is not being rushed. On the basis of an assumed starting date of 2019 for disposal operations, more than half (about 6,700 m³ [240,000 ft³]) of the total GTCC LLRW and GTCC-like waste inventory of 12,000 m³ [420,000 ft³] is projected to be available for disposal between 2019 and 2030. An additional 2,000 m³ (71,000 ft³) would become available for disposal between 2031 and 2035. This information is presented in Figure 3.4.2-1. DOE believes this EIS is timely, especially given the length of time necessary to develop a GTCC waste disposal facility.

DOE developed this EIS to support a decision on selecting a disposal facility or facilities for GTCC LLRW and GTCC-like waste, to address legislative requirements, to address national security concerns (especially for sealed sources), and to protect public health and safety. The purpose and need for the proposed action, as discussed above, is stated in the EIS (Section 1.1). The scope of the EIS is focused on addressing the need for developing a disposal capability for the identified inventory of GTCC LLRW and GTCC-like wastes. DOE plans a tiered decision-making process, in which DOE would conduct further site-specific NEPA reviews before implementing an alternative ultimately selected on the basis of this EIS.

As described in the comment, this EIS considers the use of HOSS to be outside the scope of the EIS. This approach would not satisfy the purpose and need to isolate the waste permanently, and accordingly, it would not be a reasonable alternative. DOE recognizes that the longer the waste would remain in storage, the higher the risk it could re-enter the environment over a long term. Further, the No Action Alternative provides a comparatively conservative analysis of the potential health and environmental impacts of long-term storage.

DOE agrees that most of the activated metals from nuclear power plants will not be generated for decades. DOE did determine that including these activated metals in the preferred alternative (Section 2.10 of this Final EIS) was appropriate. However, a path for disposal is included in the preferred alternative described in Section 2.10 of this Final EIS.

L6-8 DOE has considered cumulative impacts of disposal of GTCC LLRW and GTCC-like waste at all of the alternative sites evaluated in this EIS. Past practices are reflected in the Affected Environment sections for each alternative site, while reasonably foreseeable actions are discussed with the respective resource area impact results in all the site Chapters. Worker exposures are also discussed within each of the site chapters and the impact assessment methodologies 1 approach is discussed in Appendix C.

"when several proposals for ...actions that will have a cumulative or synergistic environmental impact upon a region are pending concurrently before an agency, their environmental consequences must be considered together." *Kleppe v. Sierra Club*, 427 U.S. 390, 410 (1976).

All of the DOE sites considered in the DEIS have other missions with their own environmental impacts. An adequate EIS must consider the impacts of those past, present, and future activities and the impacts of GTCC disposal. The DEIS makes no serious attempt to provide such an analysis, as the cumulative impact discussion does not fully describe and evaluate the existing impacts at each site, let alone the additional cumulative and synergistic impacts of GTCC waste.

Among the needed analyses is consideration of historic and current releases of radioactive and hazardous contaminants into the environment. The DEIS does not detail the current inventories of radioactive and hazardous materials at each DOE site, nor describe and analyze the current and past releases of contaminants. The DEIS does not discuss the additional impacts that GTCC wastes would have, nor does it discuss the impacts that management of existing waste at each site could have on GTCC waste disposal.

Among the needed analyses is consideration of historic and current contamination and illnesses of workers. Because of the actual (and underestimated and underreported) contamination of workers and contractors at DOE sites, Congress enacted the Energy Employees Occupational Injury Compensation Program (EEOICP) of 2000. The EEOICP covers radiation-induced cancers (Part B) and exposures to toxic substances (Part E). More than \$7 billion has been paid in compensation and medical expenses for tens of thousands of DOE workers and contractors. <http://www.dol.gov/owcp/energy/regs/compliance/weeklstats.htm>. Each of the DOE sites being considered in the DEIS has compensated workers. An adequate DEIS would, among other things, include detailed information about the workers and contractors involved with EEOICP, including the specific illnesses, timeframes of the employment and contamination, sources of contamination, and how past and current monitoring data compares with the findings of the dose reconstruction and other claims decisions. The DEIS would analyze how the new and additional exposures to workers handling GTCC waste would contribute to future worker health effects.

While contamination and worker exposures at other DOE sites have been reported in the media, SRIC especially believes that a description and analysis of worker exposures and illnesses at WIPP are especially important, given the site's mission to "start clean and stay clean." The large amounts of additional radioactivity in GTCC waste coming to WIPP also could increase worker radiation exposure. Such exposures may already be a problem at WIPP. Under the EEOICP, four WIPP workers have been approved for compensation for work-related illnesses from radiation exposure. http://www.dol.gov/owcp/energy/regs/compliance/statistics/WebPages/WASTE_ISO_PILOT.htm. SRIC has made further inquiries to the Department of Labor and has been informed that all four workers also have been employed at other DOE sites. Thus, while their illnesses are definitively from radiation exposure, how much of the exposure is WIPP-related has not been determined. Nevertheless, worker radiation exposure must be addressed. In addition, there are also six decisions under Part E regarding toxic substances exposure and illness. The cumulative impacts

L6-8
(Cont.)

Southwest Research and Information Center, Commenter ID No. L6 (cont'd)

of additional radioactive and hazardous chemical exposures has not been discussed and analyzed in the DEIS.

5. The DEIS has insufficient policy options because it effectively considers only DOE sites for commercial waste disposal.

The burden of disposal of 160,000,000 curies of commercial wastes should not be limited to DOE sites that have an enormous inventory of waste to manage, some of which DOE estimates will be ongoing for more than 50 years. To create the burdens of additional waste transportation and disposal at DOE sites is inappropriate. An adequate PEIS and EIS must seriously consider specific non-DOE sites that can have similar environmental analysis as DOE sites. Just as communities near DOE sites have received the economic activity – and the environmental burden – of nuclear weapons activities, so too communities near power plants must receive economic activity and the environmental burden of nuclear power. Not even seriously considering sites at or near commercial nuclear power plants for GTCC disposal is not consistent with fairness and good public policy. The generic commercial locations in the DEIS do not provide for comparing the site specific impacts that NEPA and good public policy require.

6. The DEIS has insufficient policy options regarding regulatory requirements.
The DEIS makes assumptions about regulatory requirements without providing adequate basis. Moreover, such assumptions are not the only reasonable ones. Thus, decisionmakers and the public are not provided with sufficient information and policy options.

The DEIS states:

“Available information indicates that much of this waste is characteristic hazardous waste as regulated under the Resource Conservation and Recovery Act (RCRA); therefore, this EIS assumes that for the land disposal methods, the generators will treat the waste to render it nonhazardous under federal and state laws and requirements.” at 1-12.

That assumption is not the only reasonable one. It is certainly possible that some or all of the waste will not be treated to render it nonhazardous. That such treatment will not occur is clearly a reasonable and realistic option. Further, the DEIS does not discuss the costs for such treatment. The DEIS does not discuss the treatment technologies, including whether there are existing treatment technologies for all of the waste. The DEIS does not discuss why treatment will occur given that there is no legal or regulatory requirement to do so.

The DEIS states:

“NRC regulations at 10 CFR 61.55 (a)(2)(iv) require that GTCC LLRW must be disposed of in a geologic repository unless alternative methods of disposal are proposed to the NRC and approved by the Commission.” at 1-20.

The DEIS assumes that proposed alternative methods (boreholes, trenches, vaults) will be approved by NRC. However, the DEIS presents no information or evidence to support that assumption.

L6-9 See response to L6-1.

L6-10 DOE does not agree that the EIS does not provide an adequate basis for its content regarding regulatory requirements. For example, waste having characteristics that would cause it to be regulated under RCRA would be disposed of only in facilities having the requisite RCRA permit(s), and such waste would be treated to comply with RCRA specifications.

NEPA does not require agencies to include detailed cost analyses in their EISs. DOE would consider costs among other factors, as well as the results of the EIS and public comments, in decision making about disposal facilities to be used, their locations, and the necessary treatment technologies.

Issues associated with potential regulatory changes or NRC licensing would be addressed as necessary to enable implementation.

The EIS evaluates the range of reasonable alternatives as required under NEPA. Accordingly, the scope is adequate to inform potential decisions and outcomes postulated in this comment, such as the potential disposal of different types of GTCC waste at different sites using different technologies (see response to comment L6-1).

L6-8
(Cont.)

L6-9

L6-10

Once again, the assumption in the DEIS is not the only reasonable one. An adequate DEIS would analyze the option that some or all of the GTCC waste would not be approved for the alternative methods. An adequate DEIS would analyze whether some or all of the GTCC waste could be disposed in commercial LLW disposal sites. An adequate DEIS would analyze each of the waste types and describe what information would be needed for such waste to be licensed under each alternative method. An adequate DEIS would analyze each of the waste forms and describe what information would be needed for the existing waste form to be licensed under each alternative method. An adequate DEIS would analyze each of the waste forms and describe what information would be needed for alternative waste forms to be licensed under each alternative method. An adequate DEIS would analyze each of the existing waste containers and describe what information would be needed for alternative containers to be licensed under each alternative method.

7. The DEIS has insufficient policy options because it considers "disposal" as the only policy option.

Some of the radionuclides in GTCC waste – uranium and plutonium-239, for example – have half-lives of tens of thousands of years or more and pose dangers to public health and the environment for thousands of generations. The DEIS does not discuss the fact that those timeframes are longer than human history. Therefore, humanity has no adequate basis to determine the range of information needed by future generations that will be affected by those wastes.

An important issue not discussed in the DEIS is will disposal site(s) attract intrusion by future generations, as, for example, the pyramids of Egypt and Yucatan have attracted recent generations? What are the impacts of human intrusion on the performance of the disposal site? What is the reliability of today's assumptions and calculations about the environmental impacts of such disposal technologies and sites regarding future human intrusion? What methods would be needed to adequately inform future generations about the wastes and dangers of those sites? What are the various methods to communicate with future generations and what is the likelihood that we will communicate our desired message and that the message would be understood?

An adequate analysis of those uncertainties could inform decisionmakers and the public about whether storage options adequately protect the wastes into the future.

8. The DEIS has insufficient policy options because it does not consider entities other than DOE to management GTCC disposal.

Decisions to be made by Congress about GTCC waste could result in changes in several laws. The DEIS assumes that DOE will be responsible for disposal, based on existing law. That is not the only possible option, as another entity could take over that role, and such other options must be considered in an adequate DEIS. Just as Congress would have to enact laws to implement many of the aspects discussed in the DEIS, it could also change that law that gives the responsibility to DOE.

L6-10 (Cont.)

L6-11

L6-12

L6-11 DOE recognizes that some of the radionuclides comprising the GTCC LLRW and GTCC-like waste types have very long half-lives, making disposal a safer long-term strategy for isolating them from humans and the environment than storage.

DOE agrees that use of a geologic repository could be a protective and safe method for the disposal of GTCC LLRW and GTCC-like wastes. The GTCC EIS evaluation for the WIPP geologic repository alternative supports this statement. However, the degree of waste isolation provided by a geologic repository may not be necessary for all of the GTCC LLRW and GTCC-like wastes evaluated in the GTCC EIS.

While 10 CFR Part 61 identifies one NRC-approved method for GTCC LLRW disposal (disposal in a geologic repository), these regulations also indicate that other disposal methods could be approved. Thus the GTCC EIS evaluates three land disposal methods (i.e., enhanced near-surface trench, intermediate-depth borehole, and above-grade vault).

The GTCC EIS evaluation indicates that certain wastes (e.g., those containing short-lived radionuclides such as Cs-137 irradiators) could be safely disposed of in properly designed land disposal facilities at sites with suitable characteristics, such as low precipitation rates, high soil distribution coefficients, and sufficient depths to groundwater. Based on the GTCC EIS evaluation, land disposal facilities located in arid climates (e.g., NNS and WIPP Vicinity) would isolate radionuclides for a sufficient period of time to allow for significant radioactive decay to occur. The GTCC EIS evaluation also indicates that land disposal methods employed at sites with suitable characteristics would be viable and safe alternatives for the disposal of GTCC LLRW.

L6-12 DOE recognizes that options for organizational configurations and legislative changes into the future are many and varied. DOE's proposed action and preferred alternative are intended to balance near-term progress toward safe and secure disposal of GTCC LLRW and GTCC-like waste with a longer-term outlook on wastes that can be expected to be generated over several decades.

Indeed, there are two recent reports from government and non-governmental sources that recommend that DOE no longer manage the U.S. waste disposal programs. The DEIS should include options and analyses regarding other management entities.

The Blue Ribbon Commission on America's Nuclear Future Disposal Subcommittee issued its Draft Report on June 1, 2011:
http://www.brc.gov/sites/default/files/documents/draft_disposal_report_06-01-11.pdf.

The Subcommittee's Recommendation #2 is:

"A new, single-purpose organization is needed to develop and implement a focused, integrated program for the transportation, storage, and disposal of nuclear waste in the United States.

"The U.S. Department of Energy (DOE) and its predecessor agencies, subject to annual appropriations and policy direction by Congress, have had primary responsibility for implementing U.S. nuclear waste policy for the last 60 years. Having examined this experience, the Subcommittee concludes that new institutional leadership for the nation's nuclear waste program is needed. A new organization offers the best opportunity to establish—from the outset—the track record of consultation, transparency, accountability, and scientific and technical credibility needed to re-establish trust with the public and key stakeholders." at iv.

The MIT Energy Initiative issued a new report on March 31, 2011:
http://web.mit.edu/mitei/research/studies/documents/nuclear-fuel-cycle/The_Nuclear_Fuel_Cycle-all.pdf

Among the report's recommendations:

"Based on our analysis, we have concluded that the U.S. should create a new organization responsible for the management of long-lived radioactive wastes— independent of the final outcome of the Yucca Mountain Project." at 64.

An adequate analysis of those and other management options should be discussed and analyzed in the DEIS.

9. The DEIS has insufficient policy options regarding commitment of resources. CEQ regulations under NEPA require consideration of "any irreversible or irretrievable commitments of resources which would be involved in the proposal should it be implemented." 40 CFR § 1502.16. In addition to the NEPA requirements, decisionmakers and the public must understand the commitment of resources required by GTCC waste, especially given present concerns regarding the national debt and deficit spending.

The DEIS does not adequately consider the resources required for GTCC wastes, including costs of treatment, packaging, and transportation at each of the sites. The discussion of construction and operating costs in Section 2.9.3.4 is seriously inadequate. The DEIS states: "Costs for facility permits, licenses, transportation, packaging, and post-closure activities are not included

L6-13

As stated in DOE's response to comment 10, NEPA does not require agencies to include detailed cost analyses in their EISs. DOE would consider costs separately among other factors, as well as the results of the EIS and public comments, in decision making about disposal facilities to be used, their locations, and the necessary treatment technologies.

L6-12
(Cont.)

L6-13

in the estimates.” at 2-64. That admission of inadequacy does not suffice to comply with NEPA or to provide sufficient total cost estimate information for decisionmakers and the public.

Those construction and operating costs are inadequate as they do not consider the DOE's historic practice of construction and operating costs of its facilities being substantially higher than predicted and construction taking much longer than projected. The DEIS includes no discussion of numerous Government Accountability Office (GAO) reports on those matters. For example, *Department of Energy Actions Needed to Develop High-Quality Cost Estimates for Construction and Environmental Cleanup Projects*, (GAO-10-199), January 2010. <http://www.gao.gov/new.items/d10199.pdf>.

The brief discussion in Section 5.1.4.4 of the estimated construction and operating costs of the Borehole, Trench, and Vault facilities also is seriously deficient. While Appendix D contains more detail about the basis of the costs, it also does not include total costs of the alternatives, including treatment, packaging, and transportation. Nor does it include discussion and analysis of historic DOE practices and cost overruns and schedule delays.

10. The DEIS is technically flawed because there are major aspects of all the proposed sites that are not accurately described and analyzed.

All of the DOE alternative sites in the DEIS have substantial technical issues. The full range of information available about the sites, including environmental impacts of past, present, and future activities is not included in the DEIS and its references. The DEIS does not adequately describe the current missions of each of those sites. The DEIS does not adequately describe and analyze the long-term future use of sites and how GTCC operations for decades would affect such future use. The DEIS does not adequately analyze the cumulative impacts of bringing 160,000,000 million curies of commercial wastes to those sites along with the past, present, and future activities at each site. The DEIS does not adequately analyze the cumulative impacts of transportation shipments to or from those DOE sites during the timeframe of operation of GTCC disposal operations.

A. The discussion of WIPP seriously deficient.

Section 4 contains the analysis of WIPP. A few of the many inadequacies include:

1. The facility's operational history.

The DEIS states:

“On the basis of current mining experience in the area, it is assumed that the existing mine shafts, shaft stations, and underground haul routes and tunnels would be functional during the period projected for the disposal of GTCC LLRW and GTCC-like waste.” at 4-1.

There is no technical documentation provided for that assertion. Indeed, the actual operational experience of WIPP is not discussed, and does not support such an assertion. The existing operations have shown that the mine environment is not so stable and that DOE and its contractors have not been able to fully use the existing shafts, haul routes, and disposal rooms. That history includes that much of the facility's capacity has not been used. Panel 1 contains 10,496.65 cubic meters of waste, less than 59 percent of permitted capacity, because of the

L6-14

In selecting sites for evaluation in this EIS, DOE considered current and projected missions at each candidate site. Only sites with current and projected missions potentially compatible with the requirements for disposal of GTCC and GTCC-like were identified for inclusion within the scope of this EIS.

DOE believes the Final EIS provides transportation and cumulative impacts analyses suitable to serve as a basis of comparison, along with other factors, for identifying a site or sites that would be appropriate for the disposal of GTCC and GTCC-like wastes. These analyses are provided for each site evaluated in the Final EIS, and the analytical methodology is described in Appendix C. Further, DOE considered the data contained in the sites' Annual Environmental Reports, which provide detailed monitoring data such as groundwater analyses, that indicate current trends and conditions resulting from past practices.

L6-15

An extensive description of WIPP is found in Section 4.1.2 of the DEIS. The WIPP operational experience and WIPP vicinity potash mines do support the assertion that existing WIPP mine shafts, shaft stations and underground haulage routes can be maintained during the period projected for GTCC disposal. WIPP mine workings are similar to local potash mines in the area. The oldest local potash mine (Intrepid Potash West Mine) sank its first shaft in 1929 (then called "American Potash"). This shaft is used daily for current potash production, demonstrating the long life of nearby mine workings. If, however, the WIPP access ways become difficult to maintain, new access drifts could be mined, although this is not anticipated.

The assertion that WIPP waste emplacement in Panel 1 is related to the ability to maintain mine workings and ensure safety is incorrect. Panel 1 was the first panel mined and was open much longer than expected prior to waste being emplaced. Due to normal mine creep, three rooms in Panel 1 could not meet the operational design requirements for ventilation space above the waste stacks if additional mining and maintenance were not performed. These rooms were mined and left open longer than was expected because of the timeframe needed to characterize, permit and certify WIPP. After WIPP became operational, the DOE requested (to the EPA) a change to the standard waste emplacement scheme in these rooms to emplace in either one high, two high or three high waste stacks. EPA did not agree to this configuration change and DOE decided to not emplace waste in these three rooms (EPA Docket A-98-49, Category IIB-3, item 19). The decision not to emplace waste in these rooms of Panel 1 was not made because waste could not be emplaced or that the rooms could not be maintained. Secondly, there is no link between waste emplacement efficiencies and the ability to maintain underground mine workings. All other panels have been mined and maintained to the WIPP design specifications. The differences in emplaced waste volumes in each panel is not due to mining, safety, or the ability to maintain haulage routes. Emplacement efficiencies are related to stacking efficiencies, dunnage drums from shipping requirements, the types of containers or overpacks used by the generator sites and certain MgO requirements that take up waste emplacement floor space. The waste volumes referenced in the comment are permitting requirement from the NMED Hazardous Waste Facilities Permit and are not related to any long-term radioactive waste performance requirements. There are no waste emplacement arrangement requirements or panel volume limits in the EPA radioactive waste Certification Application.

The DEIS states in Section 4.1.4.2 that all GTCC waste will be shipped in containers that allow the waste to be emplaced as contact-handled waste. Some containers will be shielded (not the same as WIPP shielded containers - see response to comment L6-16). As such, the curie content of the waste is not relevant to the operational capabilities of the Waste Handling Building. Since GTCC waste is contact-handled waste, the remote-handled waste handling capabilities in the Waste Handling Building would not be needed.

L6-13 (Cont.)

L6-14

L6-15

danger of collapsing ceilings injuring workers and releasing waste into the environment. While Panel 2 has 17,997.67 cubic meters of waste (100 percent of its permitted capacity), subsequent panels also are not filled. Panel 3 was filled with 17,902.06 cubic meters of CH waste (91 percent of permitted capacity), Panel 4 was filled with 14,257.54 cubic meters of CH waste (76 percent of permitted capacity), and while Panel 5 is still receiving CH waste, it will not be completely filled to the 18,750 cubic meter permitted capacity. Thus, cumulatively for panels 1-5, WIPP will empace less than 78,000 cubic meters of contact-handled (CH) transuranic (TRU) waste, or about 85 percent of permitted capacity. For remote-handled (RH) TRU waste, Panels 1-5 contain 462 canisters, or less than 51 percent of the permitted capacity. Disposal statistics are on the WIPP website (<http://www.wipp.energy.gov/general/GenerateWippStatusReport.pdf>). Permitted capacities are in the WIPP Hazardous Waste Permit, Table 4.1.1 (<http://www.nmenv.state.nm.us/wipp/documents/Part4.pdf>).

The main WIPP underground haul route (E-140) must be re-mined and stabilized, requiring use of an alternative haul route (W-30) that was not previously planned and permitted. Deterioration of existing underground facilities less than 25 years after they were mined does not support the assertion that they could be used for the next 60+ years, as would be required for GTCC waste. The DEIS does not analyze the reasonable possibility that the existing underground haulage routes could not be used, as an adequate DEIS must do.

2. The Waste Shaft.

The possibility of not being able to use the waste shaft for GTCC wastes is not considered in the DEIS, but must be considered in an adequate document. In addition to stability issues, there has been no documentation that the existing shaft can be safely used for another 60 years in order to accommodate GTCC (or other) wastes.

3. The Waste Handling Building.

The 160,000,000 curies of GTCC waste is more than 20 times more radioactivity than all the waste coming to WIPP, and its volume is much less than the amount of CH and RH waste designated for WIPP. That the existing Waste Handling Building could handle that much more highly radioactive waste has not been demonstrated in the DEIS and its references.

4. Safety performance.

The DEIS states:

“Even though some of the GTCC LLRW and GTCC-like wastes may have radiation dose rates above those for the TRU wastes currently being disposed of at WIPP, the safety envelope established for CH and RH wastes in the documented safety analysis reports (DOE 2006c,d) should be adequate for disposal of this waste at WIPP.” at 4-55.

There is no further basis for that totally unsupported assertion. The safety analysis reports mentioned do not include GTCC wastes.

Moreover, the assertion itself is not credible. The 160,000,000 curies of GTCC waste is more than 20 times more radioactivity than all the waste coming to WIPP, and its volume is much less

L6-15
(Cont.)

Southwest Research and Information Center, Commenter ID No. L6 (cont'd)

than the amount of CH and RH waste designated for WIPP. Thus, a more accurate statement would be that "much of the GTCC waste will have radiation dose rates many times those of the TRU wastes currently being disposed at WIPP."

5. RH waste containers.
The DEIS states:

"Consistent with this planned change request, this EIS assumes that all activated metal waste and Other Waste - RH would be packaged in shielded containers that would be emplaced on the floor of the mined panel rooms in a manner similar to that used for the emplacement of CH waste," at 2-4.

In fact, shielded containers have not yet been approved by either the Environmental Protection Agency or NMED, both of which have to separately approve in different regulatory processes. Thus, it is as best premature to conclude that they will be used. Even if shielded containers are approved, some RH will continue to be placed in the walls, not on the floor. An adequate DEIS must include analysis of the option that some or all of the activated metals would not be in shielded containers.

6. Surrounding oil and gas resources and pressurized brine reservoirs.
The WIPP Land Withdrawal Area is surrounded by oil and gas resources and hundreds of wells. Active drilling would be underway through much of the WIPP site, except for the provision preventing such leasing and mining in the WIPP Land Withdrawal Act (LWA - Public Law 102-579), Section 3(a)(1). The DEIS must analyze the impacts of mining on the safety performance of the proposed 26 rooms for GTCC waste. Such an analysis is not included in the DEIS.

A pressurized brine reservoir was found when borehole WIPP-12 was deepened in 1980. The DEIS must analyze the impacts of drilling into a pressurized brine reservoir on GTCC waste disposal.

7. The impacts of mixed radioactive and hazardous waste.
The DEIS states the much of GTCC waste contains hazardous chemical contaminants. Of course, much of the waste coming to WIPP is mixed and all of the waste is handled under the WIPP Hazardous Waste Permit as if it is mixed.

WIPP's operational history shows that volatile organic compounds (VOCs) are a significant problem that was not adequately analyzed in other WIPP-related NEPA documents. Regarding VOCs, WIPP has not accomplished that part of its mission to "start clean, stay clean." The DEIS is seriously deficient because it contains no discussion or analysis of the issue. Since late 2008, carbon tetrachloride has been released in higher than expected levels in the WIPP underground. That situation first became publicly known on July 24, 2009, when, pursuant to the Hazardous Waste Permit, DOE informed the New Mexico Environment Department (NMED) that carbon tetrachloride of 281 parts per billion volume (ppbv) was detected in July 1, 2009 sampling. Since it was issued in 1999, the Permit required notification if levels exceed 165 ppbv. Sampling errors were discovered on October 23, 2009 that resulted in recalculation of the levels so that the July 1 sample was changed to 393.65 ppbv. The recalculation also disclosed that there were "21 additional exceedances for carbon tetrachloride between December 22, 2008 and September 30,

L6-15
(Cont.)

L6-16

L6-17

L6-18

L6-16 Text has been included in Section 2.2 to clarify that the shielded container discussed for WIPP remote-handled waste is not the same container intended for GTCC waste. GTCC waste is assumed to be packaged in half activated metal containers (h-AMCs). Per Section 4.1.4.2 (page 4-11) of the DEIS, a yet-to-be designed half activated metal container (that is shielded) is to be used for the higher activity waste. The WIPP shielded container has recently been approved by EPA (with provisions). Although the WIPP shielded container is discussed in the same paragraph, it is not the same container as that proposed for GTCC waste in this EIS.

L6-17 DOE agrees with the commenter that that the WIPP land withdrawal area is surrounded by oil and gas production wells. The oil and gas resources are beneath (about a mile beneath) the horizon of salt used for the repository. In addition, one might predict there are potash reserves in a horizon above the waste. There are two primary ways natural resource attractiveness is considered in demonstrating the safety case for WIPP.

First, the 40 CFR 194 criteria for certification require DOE to set up a system of active and passive institutional controls to preclude post closure human intrusion into or through the repository. The active controls must operate for more than 100 years. The passive controls are intended to communicate the hazards of the site past the active controls period for as long as practicable. Active institutional controls (AIC) include fences and periodic inspections. Passive institutional controls (PICs) are more numerous, and include permanent markers (warning signs, plaques and monuments), awareness triggers (institutional records and archives in multiple locations), and information repositories at the site and at other waste repositories in countries around the world. EPA evaluated the depth and breadth of DOE's proposed system of controls to preclude human intrusion, and determined that it constituted a reasonable effort to minimize the possibility of future releases from human intrusion. Remember that human intrusion is the only pathway for a release from WIPP - total containment is predicted without intrusion.

The second way that nearby natural resource attractiveness is incorporated into the WIPP safety case is that notwithstanding the AIC and PIC measures, human intrusion is assumed to occur in different ways over the regulatory period. The WIPP Performance Assessment (PA) is a probabilistic analysis of the impacts from many different future features events and processes (FEPs). The WIPP PA includes calculations of the amount of radioactive material released during assumed human intrusion (both drilling events and mining events). The probabilistic analysis recognizes the uncertainty in our ability to predict the future. It incorporates all of the FEPs possible and applies probability distributions to the many parameters that must be included in any numeric calculation of risk. Hundreds of parameters, such as the frequency of intrusions, the amount of waste encountered, the size and pressure of an unknown brine reservoir beneath the waste disposal footprint, different drilling practices, etc. are all sampled and the probability of releasing a certain amount of radioactivity is determined over the next 10,000 years. This probability versus amount can then be compared to the release criteria established by EPA in 40 CFR 191. An entirely full WIPP (with the TRU waste inventory allowed by the LWA as amended [P.L. 102-579 as amended by P.L. 104-201]) is shown to comply with the limits by a factor of ten. For the GTCC waste inventory, this same PA system, assuming all the human intrusion as before, demonstrated that WIPP would comply with the disposal standards. Therefore, even with assumed human intrusion (assumed failure of the AIC and PIC measures), WIPP and the additional GTCC inventory, meets the EPA standards.

In summary, natural resource exploration and extraction are considered in WIPP's safety case. While human intrusion is unlikely due to the AIC and PIC measures DOE will implement, the WIPP PA (including the additional GTCC inventory) demonstrates that releases caused by human intrusion would still comply with long-term criteria established by EPA to protect human health in the environment.

2009.¹¹ Thus, there were exceedances of carbon tetrachloride for more than six months before DOE and its contractors were even aware that they had occurred.

DOE and its contractors also originally mis-identified the specific wastes that were causing the rising levels. On November 17, 2009, they informed NMED that "[t]he main contribution of carbon tetrachloride appears to be from waste in filled panels (Panels 3 and 4)."¹² By January 14, 2010, DOE had decided that the primary cause of the emissions was waste in Panel 4 and continuing emplacement of some waste streams in Panel 5.¹³ Yet, despite repeated requests from SRIC that shipments of such high carbon tetrachloride waste streams be suspended, DOE continued shipments of such wastes. Consequently, the running annual average (RAA) of carbon tetrachloride continued to rise. By late March 2010, DOE and its contractors expressed great concern about the problem because if the RAA exceeded 165 ppbv, the permit required that the then open room be closed, even if it were not filled. On March 29, 2010, they asked NMED to immediately grant a temporary authorization to raise the RAA limit by almost four times to 630 ppbv, which NMED granted on April 1. With the issuance of a renewed Hazardous Waste Permit in December 2010, the allowed RRA for carbon tetrachloride is now 960 ppbv. Nonetheless, additional exceedances of carbon tetrachloride continue being released in closed disposal rooms in Panel 5. Thousands of drums with significant amounts of carbon tetrachloride are still to be shipped to WIPP.

But there are at least three important lessons from the carbon tetrachloride situation. First, the fact that VOC monitoring in the underground mine that had been in place for a decade provided erroneous results for months demonstrates a significant operational problem. Second, the fact that a known contaminant (carbon tetrachloride) in a significant amount of waste was not addressed before it became an issue that altered WIPP's operations shows management and operational failures as well as inadequate data in the waste inventory. Third, the necessity of independent regulation was demonstrated, since without the requirements of the Hazardous Waste Permit the problem would not have been detected and without state and public involvement the remedial measures might not have been implemented.

The DEIS must discuss the WIPP experience with hazardous chemicals. The DEIS also must discuss the specific hazardous chemicals, their amounts and concentrations in GTCC waste. The measures needed to prohibit substantial releases of those chemicals at WIPP must be described and analyzed. The monitoring of VOCs in GTCC disposal facilities must be described.

8. The legal requirements are not adequately described and analyzed. The DEIS states:

"Most of the GTCC-like waste consists of TRU waste that may not have been generated from atomic energy defense activities. Disposing of these wastes and GTCC LLRW in WIPP may require a modification of the WIPP LWA to allow

¹¹ December 4, 2009 Letter from James P. Bearzi (NMED) to David Moody and Farok Sharif, p. 1. <http://srirc.org/nuclear/docs/NMED12042009.pdf>

¹² November 17, 2009 Letter from David Moody and M.F. Sharif to James Bearzi, p. 2. <http://srirc.org/nuclear/docs/DOE11172009.pdf>

¹³ January 14, 2010 Letter from David Moody to Don Hancock (SRIC). <http://www.sric.org/nuclear/docs/VOC%20CFCO%20response10-0903-1.pdf>

L6-18 (Cont.)

L6-18

The brine trapped in WIPP salt makes up about 1% of the rock volume. The brine comes in two forms, interstitial and included. Interstitial brine is that trapped in between crystal facies (in between fracture boundaries at microscopic scale). Included brine is inside small cavities called inclusions trapped within the crystals themselves. Inclusions are what you see as small cubical cavities with "bubbles" of air inside. Of course there is hydrated water as well, but it is chemically bound within the minerals. Samples of brine collected from locations just inches apart show different chemical and isotopic composition. Therefore the brine never moved from one location to another. The brine was trapped where it was when that ancient tidal flat dried up 250 million years ago!

With the construction of WIPP, a preferential pathway was opened for water to get inside in the future. This is being addressed through the concept of shaft seals. EPA ruled that the WIPP design for shaft seals will ensure no fresh water enters, and that there will be no release from the repository unless there is assumed human intrusion.

The Performance Assessment (PA) run for the DEIS used a modified version of the current WIPP PA. All WIPP intrusion scenarios were used and the additional 26 rooms were included in these scenarios. Drilling and pressurized brine impacts were included in the analysis. The results of the PA that included the GTCC waste inventory did not exceed the current EPA limits for WIPP.

The discussion of the post-closure compliance analysis in Section 4.3.4.3 was revised to include items taken into consideration with the addition of the GTCC inventory to WIPP.

Unlike the TRU wastes destined for disposal at WIPP, the GTCC inventory does not include organic solids. Under the laws that regulate exposure to hazardous materials, if waste does not contain specific listed chemicals, it is considered hazardous only if it exhibits one or more of four characteristics; flammability, reactivity, corrosivity or toxicity. At WIPP (and presumably at any other disposal alternative), hazardous wastes that are flammable, reactive or corrosive are (would be) prohibited. This prudent policy is primarily for safety during packaging, transportation and emplacement in a final disposal facility. There are no flammable, reactive or corrosive wastes in the GTCC inventory. The remaining characteristic of toxicity can be manifested through two potential exposure pathways: contamination of drinking water or inhalation of airborne contaminants. The exposure hazard at WIPP described in the comment was from organic solid waste streams being received at WIPP. These waste forms were generated from past plutonium production operations where process residues included organic solvents and were solidified primarily by grouting. These organic solids contain significant concentrations of volatile compounds that are toxic above certain concentrations. Because containers with radioactive contents must be vented to preclude flammable hydrogen gas build-up, the filtered vents also served as a release pathway for volatile gases.

While there are no organic solid waste forms in the GTCC inventory, some of the wastes are managed as mixed (radioactive and hazardous) waste. Therefore, the final disposal of the GTCC waste will be permitted for both hazardous and radioactive waste disposal. It is not within the scope of NEPA to establish the monitoring and action level requirements for hazardous materials imposed by a state regulator. It is the same provisions of such a permit that provide assurance that levels of hazardous constituents will not jeopardize worker health and safety, by imposing monitoring and action level requirements. The monitoring requirements for GTCC waste disposal operations will be established in the hazardous waste facility permit when the preferred alternative is selected and authorized. If at a facility with an existing hazardous waste facility permit, the permit will have to be modified. If at a new facility, a permit will have to be issued by the state regulatory authority.

receipt of non-defense wastes and non-transuranic (non-TRU) waste. The total estimated inventory of GTCC LLRW and GTCC like waste, added to the DOE defense TRU waste disposed of or scheduled to be disposed of at WIPP, could exceed the WIPP LWA and the Consultation and Cooperative Agreement RH volume and curie limits for WIPP, as discussed above. The LWA and the regulations at 40 CFR Parts 191 and 194 may also require modification, depending on the specific characteristics of the GTCC LLRW and GTCC-like wastes (see Chapter 13),” at 2-5.

Essentially nothing in that statement is accurate or even consistent with other information in the DEIS. The inventory information is that GTCC waste is not from atomic energy defense activities. Such waste is clearly prohibited by the WIPP LWA. The amount of GTCC waste would exceed the WIPP capacity set by the LWA. The amount, types, and sources of GTCC waste are clearly contrary to the requirements of the Consultation and Cooperation Agreement, which is not only incorporated into the LWA but is also part of a court decision. The EPA regulations and its WIPP certification clearly allow only defense waste in the quantities provided in the LWA.

In addition to those and other changes in the LWA, significant provisions of the WIPP Hazardous Waste Permit (HWP) do not allow GTCC wastes.

The discussion of legal requirements on page 4-77 is less inaccurate and mentions the HWP and the fact that WIPP is not licensed by the NRC. That provision is in another law – PL 96-164, Section 213(a). Moreover, the DEIS does not analyze whether WIPP that was designed and operated without an NRC license could be licensed for GTCC waste, and what the requirements would be and what regulations would have to change.

Thus, the DEIS description and analysis is too inaccurate to adequately inform decisionmakers and the public.

An adequate DEIS must also describe and analyze two other significant matters. First, WIPP’s mission would be dramatically changed by GTCC. WIPP has a specific mission to demonstrate whether the federal government and its contractors, at the cost of billions of dollars: (1) can safely operate WIPP to meet the “start clean, stay clean” standard for up to 175,564 cubic meters (m³) of transuranic (TRU) waste; (2) can safely transport TRU waste through more than 20 states without serious accidents or release of radioactive or hazardous contaminants; (3) can meet commitments to clean up TRU waste at about 20 Department of Energy (DOE) nuclear weapons sites; and (4) can safely close, decontaminate, and decommission the WIPP site, beginning in about 2030 or earlier. Adding GTCC waste to that mission means that some or all aspects of the mission will not be met.

Second, New Mexicans were promised that WIPP would not be a commercial repository and that it would not be the nation’s only repository. Absent that promise, public opposition would have been even greater and government officials might not have supported WIPP. Breaking the promises also would make it more likely that there would be an intensive opposition campaign to GTCC waste at WIPP as occurred with the opposition in Nevada to Yucca Mountain.

L6-19

DOE acknowledges that only defense-generated TRU waste is currently authorized for disposal at the WIPP geologic repository under the WIPP LWA (P.L. 102-579, amended by P.L. 104-201) and that legislation would be required to allow disposal of waste other than TRU waste generated by atomic energy defense activities at WIPP and/or for siting a new facility within the land withdrawal area. It would also be necessary to revise the Agreement for Consultation and Cooperation between Department of Energy and the State of New Mexico for the Waste Isolation Pilot Plant, the WIPP compliance certification with EPA, and the WIPP Hazardous Waste Facility Permit. In addition, follow-on NEPA project-specific review, including further characterization of the waste (e.g., radionuclide inventory and heat loads) as well as the proposed packaging for disposal would have to be conducted.

However, NEPA does not limit an EIS to proposing and evaluating alternatives that are currently authorized. Furthermore, the Agreement for Consultation and Cooperation between Department of Energy and the State of New Mexico for the Waste Isolation Pilot Plant recognizes that the mission of WIPP may change and provides provisions to modify the agreement. For example, the Agreement states: “The parties to this Agreement recognize that future developments including changes to applicable laws (e.g., P.L. 96-164) may make it desirable or necessary for one or both parties to seek to modify this Agreement. Either party to this Agreement may request a review of the terms and conditions.”

DOE acknowledges the TRU waste disposal limitations for WIPP specified in the WIPP LWA and in the Agreement for Consultation and Cooperation between Department of Energy and the State of New Mexico for the Waste Isolation Pilot Plant. Information on these limitations is provided in this EIS (see Section 4.1.1) and was considered in developing the preferred alternative. Based on the GTCC EIS evaluation, disposal of GTCC LLRW and GTCC-like wastes at WIPP would result in minimal environmental impacts on all resource areas evaluated, including human health and transportation. Both the annual dose and the latent cancer fatality (LCF) risk would be zero because there would be no releases to the accessible environment and therefore no radiation doses and LCFs during the first 10,000 years following closure of the WIPP repository.

The WIPP has been certified by the EPA as an acceptable facility for the disposal of defense-generated TRU waste. The physical and chemical characteristics of the GTCC LLRW and GTCC-like wastes proposed for disposal in the WIPP repository are comparable to the TRU wastes currently being disposed of in the repository.

L6-19
(Cont.)

Southwest Research and Information Center, Commenter ID No. L6 (cont'd)

Therefore, while it is appropriate under NEPA to consider WIPP as an alternative, it should not adopted as a disposal option for GTCC wastes.

B. The discussion of "WIPP Vicinity" sites is seriously deficient.

1. The specific proposed locations are not identified. The DEIS states:

"Both the reference locations are located within T22S, R31E. These reference locations were selected primarily for evaluation purposes for this EIS. The actual location or locations would be identified on the basis of follow-on evaluations if and when it is decided to locate a land disposal facility at the WIPP Vicinity." at 11-1.

In southeastern New Mexico, as with other locations, site-specific analysis is necessary for an adequate NEPA analysis and because conditions can be significantly different from place to place. The WIPP site has been moved twice in its history because the actual conditions were not what was expected.

The original WIPP site was moved in 1975 when borehole drilling

"produced unexpected results: rock strata were much higher than expected; beds showed severe distortion, with dips of up to 75 degrees; sections of the upper Castile Formation (the formation below the Salado Formation) were missing, and fractured Castile anhydrite encountered at a depth of 2710 feet contained a pocket of pressurized brine." *WIPP Final Environmental Impact Statement* (DOE/EIS-0026), October 1980, at 2-10.

The waste rooms were relocated in the early 1980s because another pressurized brine reservoir was encountered at WIPP-12, about a mile north of the center of the site. Thus, absent substantial geophysical information that has not been provided, the characteristics of the two reference locations cannot be presumed. Thus, the DEIS does not provide adequate information about either site.

2. Oil and gas resources exist at the two reference locations. What is known is that oil and natural gas resources exist (in varying amounts) throughout this region of the Delaware Basin. The DEIS does not document that no oil and gas resources are in Section 27. The DEIS states: "There is an oil well on Section 35." at 11-5. What the DEIS does not explain is why that well and the likelihood of others does not disqualify those sites. The DEIS does not analyze the impacts of active drilling throughout the reference locations on the performance of the sites for GTCC waste.

3. The legal requirements are not adequately described. The DEIS states:

L6-20 As stated, the specific locations that would be used at each potential site for development of a disposal facility for GTCC LLRW and GTCC-like wastes are not known at this time. The use of "reference locations" was used in the EIS to allow for a quantitative assessment of the impacts that could occur at each site. While some parameters could change within a short distance, most would not. Site-specific information provided by technical staff from various sites that were evaluated was used in these modeling analyses to the extent it was available, and conservative assumptions were used to fill any remaining data gaps. The analysis presented in the EIS is adequate for the comparison of the disposal alternatives evaluated. Fate and transport parameters utilized in the estimations were based on site-specific (e.g., specific to the reference location to the extent available) information and, as such, are considered reasonable for the purpose of the comparison made in the EIS. Once a final decision is made, site-specific NEPA reviews would be conducted as needed.

L6-21 See the response to L6-17.

L6-22 DOE acknowledges the legislative complexity surrounding a modification to the WIPP LWA, but does not believe a more robust discussion of the legislative history of the WIPP LWA is within the scope of this EIS.

L6-19 (Cont.)

L6-20

L6-21

L6-22

Southwest Research and Information Center, Commenter ID No. L6 (cont'd)

"Siting a vault, trench, or borehole facility for GTCC waste inside the WIPP LWA boundary (i.e., Section 27) would be subject to the limits of the WIPP LWA (as discussed for WIPP in Section 4.7), therefore, federal legislation to develop such facilities would be required." at 11-35.

The DEIS should discuss the more than a decade of litigation and proposed land withdrawal legislation as the most relevant example of what is required for such federal legislation. In the case of Section 27, such new legislation could be especially complicated, since it would break the fundamental promises to the State of New Mexico and the public that the LWA strictly limits the use of the site for defense TRU waste.

The DEIS also states:

"Siting a vault, trench, or borehole facility on BLM-administered land outside the WIPP LWB (i.e., Section 35) would require a land withdrawal in accordance with DOI regulations at 40 CFR Part 2300, 'Land Withdrawals'." at 11-36.

Once again, the DEIS should discuss the more than a decade of litigation and proposed land withdrawal legislation as the most relevant example of what is required for such federal legislation. In the case of Section 35, GTCC disposal would require permanent withdrawal by an act of Congress, not by DOI withdrawal authority.

- C. The discussion of Los Alamos National Laboratory (LANL) is seriously deficient.
- 1. The specific location is not identified.

The DEIS states:

"The reference location was selected primarily for evaluation purposes for this EIS. The actual location would be identified on the basis of follow-on evaluations if and when it is decided to locate a land disposal facility at LANL." at 8-1.

The geological setting at LANL is highly complex and variable. The DEIS does not provide adequate site-specific information.

- 2. The location of LANL in a seismic fault zone between a rift valley and a dormant volcano is not the place for radioactive waste that is dangerous for tens of thousands of years. The seismic issues at LANL have affected existing operations at LANL for more than a decade, including reducing activities at facilities such as the Chemistry and Metallurgical Research building. While the DEIS has some discussion of seismic issues at LANL, it does not discuss those actual effects on existing operations. Given that some existing facilities have limited activities because of seismic issues and the proposed Chemistry and Metallurgical Research Replacement-Nuclear Facility is undergoing major design changes as a result of seismic issues, LANL is clearly not a suitable site for GTCC waste disposal. That the DEIS does not discuss that actual history is a serious inadequacy.

L6-23 For the purposes of the EIS analysis DOE believes that the level of details provided describing the geological setting at LANL is adequate for the EIS analysis (see Section 8.1.2).

L6-24 Key parameters evaluated in selection of the preferred alternative include seismic factors (seismicity and volcanism). In addition, the seismic characteristics of the LANL site are in Section 8.1.2.1.4.

L6-22
(Cont.)

L6-23

L6-24

Southwest Research and Information Center, Commenter ID No. L6 (cont'd)

3. LANL's mission has never included GTCC disposal, does not include that mission now, and should not have that future mission.

The only apparent reason to consider LANL for GTCC waste disposal is its current involvement with defense TRU was sealed sources that are supposed to be disposed at WIPP. That wastes is not even included in the DEIS inventory, so that waste provides no basis to include LANL as an alternative site.

Otherwise, LANL's environmental missions relate to cleanup of existing contamination by 2015 under the Consent Order with the State of New Mexico. There is no mission to dispose of wastes subject to independent regulation or NRC licensing.

4. LANL as a GTCC disposal facility is totally contrary to the American Indian Text. That the DEIS contains the American Indian Text is an appropriate recognition of the importance of the LANL site to the Native peoples who have used the site for generations before LANL was created in 1943. But including the text without acting on its substance and meaning would be another example of environmental racism.

The tribes are committed to cleanup of the contamination and their use of their sacred lands. The tribes believe that natural processes – both from plant life and geologic forces – would result in major releases from GTCC disposal. The tribes believe that air pollution is an existing problem, which the current fire problems further validate. The tribes believe that contamination of their water supplies is an existing problem and that additional waste storage or disposal will increase those environmental impacts. Therefore GTCC disposal is totally inappropriate and unacceptable.

D. SRIC is not discussing the technical flaws of sites outside of New Mexico, but expects that DOE will fully consider the comments of those who do point out such flaws.

11. The DEIS is technically flawed because it does not discuss the DOE's history of using trenches, vaults, and boreholes for waste storage and disposal. While the DEIS discusses conceptual designs for trenches, vaults, and boreholes, it does not discuss at all the long DOE history of using such technologies for storage and disposal at various DOE sites.

The DOE sites included in the DEIS have decades of experience of dumping wastes into shallow trenches, boreholes, and vaults. Those practices have resulted in contamination of ground water and soils at all of those locations.

Some of the problems with such practices at INL were discussed in <http://www.ieer.org/reports/poison/pvz.pdf> and in <http://www.ananuclear.org/Portals/0/documents/Water%20Report/waterreportidaho.pdf>.

Some of the problems with such practices at SRS were discussed in <http://www.ieer.org/reports/srs/fullrpt.pdf> and in <http://www.ananuclear.org/Portals/0/documents/Water%20Report/waterreportsavannahriver.pdf>.

L6-25 The disposal methods and sites evaluated in the EIS represent the range of reasonable alternatives for the disposal of GTCC LLRW and GTCC-like wastes. This range is consistent with NEPA implementing regulations in Parts 1500–1508 of Title 40 of the Code of Federal Regulations (40 CFR Parts 1500–1508). In this GTCC EIS, DOE analyzed a range of disposal methods (i.e., geologic repository, near-surface trench, intermediate-depth borehole, and above-grade vault) and federally owned sites (i.e., Hanford Site, INL, LANL, NNSS, SRS, and the WIPP Vicinity, for which two reference locations – one within and one outside the WIPP LWA Boundary – were considered). DOE has determined that it was reasonable to analyze these six sites because they currently have operating radioactive waste disposal facilities, except for the WIPP Vicinity, which is near an operating geologic repository.

L6-26 Text prepared by potentially affected American Indian tribes is included in this EIS. DOE considered this text for Hanford, INL, LANL, and NNSS; however, DOE also needed to ensure consistency in the EIS analyses between the various sites, so that an even comparison could be made between alternatives as required by NEPA. Because of this, it was not possible to fully utilize all of the information provided by the tribal governments in order to perform specific analyses associated with exposure events unique to a given American Indian tribe (such as greater intakes of fish, game, and plants; the use of sweat lodges; and the use of natural pigment paints for traditional ceremonies). Once a decision is made on a specific site location and method, appropriate site-specific NEPA review would be conducted, including appropriate analysis of exposure events unique to the impacted local American Indian tribes.

L6-26 However, the information provided, especially related to cultural resource impacts and historical sites, in these narratives was considered in the identification of the preferred alternative presented in this EIS. The information provided in the narratives for Hanford, INL, LANL, and NNSS was very useful, and DOE appreciates the time and effort expended by the various tribes in supporting this EIS process.

L6-27 A discussion of DOE experience related to use of the trench, vault and boreholes are found in Section 2.9.3.2

Some of the problems with such practices at LANL were discussed in <http://www.ieer.org/reports/lanl/weaponpureport.pdf> and in <http://www.ananuclear.org/Portals/0/documents/Water%20Report/waterreportlosalamos.pdf>.

Some of the problems with such practices at Hanford were discussed in <http://www.ananuclear.org/Portals/0/documents/Water%20Report/waterreporthanford.pdf>.

Some of the problems with such practices at Nevada Test Site were discussed in <http://www.ananuclear.org/Portals/0/documents/Water%20Report/waterreporttestsite.pdf> and in <http://ndep.nv.gov/boff/steward.htm>.

DOE also should have consulted some of its own reports, such as *A Report to Congress on Long-Term Stewardship* (DOE/EM-0563), January 2001. 2 volumes. Volume 2 contains Site Summaries, including on each of the sites considered in the DEIS and dozens of others. This DOE report and others are not mentioned or referenced in the DEIS.

These practices and technologies are relevant to the DEIS in several ways. The DEIS should compare and contrast the performance of the past practices with those expected from the conceptual designs. The DEIS should discuss and analyze the past, current, and future efforts necessary to remediate contamination and how those efforts affect and would be effected by GTCC waste. The DEIS should discuss and analyze the regulatory requirements and actions (including litigation, fines, and penalties) for such past practices and how GTCC disposal would be subjected to similar regulation. The DEIS should analyze the level of expertise that DOE has in handling nuclear and hazardous wastes using such technologies at its sites (including those not being considered for GTCC, such as Fernald). The DEIS should discuss and analyze the credibility that its technologies and practices have with other governmental entities, scientific bodies, and the public, based on its long history.

12. The DEIS is technically flawed because it does include analysis of decommissioning of the disposal facilities.

The DEIS states: "The impact analysis for the decommissioning phase has not been included in this EIS but would be conducted at a later time, as appropriate." at 2-2.

The admitted lack of analysis is another aspect of the DEIS that does not adequately describe the resources required for GTCC disposal, which is an important matter for decisionmakers and the public. The required analysis also would discuss how decommissioning impacts other future use requirements of the sites.

13. The DEIS is technically flawed because there are major inadequacies in the transportation analysis.

The DEIS transportation analysis essentially shows that there are no significant differences among the sites considered. Such an analysis is not credible, and it is not adequate under NEPA.

The large majority of the radioactivity is in activated metals at decommissioned nuclear power plants, which are in large majority located east of the Mississippi River. Thus, the transportation impacts for sites closer to those power plants would be less than for sites in the West.

L6-28 The EIS notes that the decommissioning of a GTCC LLRW disposal facility is part of the proposed action, but because the facility would not be closed and decommissioned until far into the future (after 2083), the impact analysis for the decommissioning phase would be conducted at that time. It is not possible at this time to evaluate with any degree of confidence the environmental impacts from decommissioning a facility that has not yet been selected.

The GTCC LLRW disposal facility would be designed to facilitate future decommissioning consistent with applicable law, guidance, and policies. The appropriate site-specific NEPA review will be conducted in the future as part of the decommissioning plan.

L6-29 The primary radiological transportation risk to the public for any alternative is from the low level of radiation emanating from the transport vehicle. As discussed in Section 5.3.9.1, the collective population risk is a measure of the total risk posed to society as a whole. A comparison of the collective population risk provides a meaningful evaluation of the relative risks between disposal locations, as provided in Tables 2.7 5 and 2.7 6. The magnitude of the collective population risk is primarily determined by the number of routes, the length of each route, the number of shipments along each route, the external dose rate of each shipment, and the population density along a given route. The primary differences between alternatives from the standpoint of transportation are the lengths of the routes as determined by the location of the disposal sites (destination of the shipments). Thus, higher collective population risks are associated with alternatives that require transportation over longer distances. All alternatives involve routes that have similar characteristics, with no significant differences for comparison among alternatives, requiring transportation through a range of rural and urban areas. In addition, the routes used in the analysis are considered representative routes (as discussed in Appendix C, Section C.9.4.1.1), because the actual routes used would be determined in the future. For each disposal site, the routes most affected would be the interstate highways that are in closest proximity to the site.

Calculation of the collective population risk (under routine and accident conditions) is provided in the EIS. While these estimates are conservative, the calculations used expected values where practical (e.g., external shipment dose rates) and provide a reasonable measure for comparison among alternatives, as summarized in Tables 2.7 5 and 2.7 6, and the estimates show that the transportation risks would be small. All alternatives involve routes of hundreds of miles through similar types of rural, suburban, and urban areas. For specific local impacts, Section 5.3.9.2 provides information on potential human health impacts on individuals during normal waste transport along a route. However, the consideration of specific local stakeholder concerns is more appropriate during the final planning stages of a project when actual route selections are finalized, not at the level addressed in this EIS. A generic accident consequence assessment was performed because there is no way to predict the exact location and conditions of an accident, as discussed in C.9.3.3 of the EIS. For all alternatives, potential accidents, even those at the same location, could have impacts that range from negligible to significant depending on the waste involved, the accident severity, and weather conditions. Such an analysis would not help distinguish between alternatives because all alternatives involve routes through or near major population centers. Thus, in general, there are no significant differences among alternatives with respect to transportation impacts.

The additional human health impacts from intermodal transfer and transport of waste from the nearest rail access point to those disposal sites without direct rail access is generally a small percentage of the total risk discussed in Section C.9.5.5 of the EIS. Costs involved in either building a rail spur to a site or the additional cost of intermodal operations would need to be considered if that option was considered further. For the rail option, the use of dedicated trains, if sufficient waste is available for transport at the same time, could reduce transportation risks and costs by minimizing transit times. The current rail analysis therefore bounds what might be expected if dedicated trains were used. In general, transportation costs would be similar across

L6-27
Cont.

L6-28

L6-29

Some sites have railroad access, some sites do not. There is no analysis of the costs and right-of-way and other requirements for constructing railroad access into sites. Thus, the transportation analysis must be different for sites that do not have railroad access.

Some sites are in close proximity to interstate highways, some are not. Again, the transportation impacts are different for sites with interstate highway access. In addition, all truck transportation of GTCC waste should be treated as "highway route controlled quantity" (HRCQ) shipments, as defined in 49 CFR 173.403. The DEIS makes no such commitment and does not provide any analysis of the requirements for such a practice. The DEIS states: "[m]any potential shipments evaluated for this EIS, such as shipments of activated metal from commercial reactors, fall under this category." at C-33. Thus, the DEIS seems to imply that DOE would not treat all GTCC shipments as HRCQ.

Since 98 percent of the radioactivity is in activated metals from decommissioned nuclear power plants, there can be no accurate assessment of the population impacts of transportation, since it is not knowable with the populations will be along transportation routes several decades into the future.

The basis for the accident consequence analysis in the DEIS is not fully and adequately presented. Thus, it is not a credible or adequate analysis.

There is no adequate analysis of the economic impacts of transportation accidents. There is no adequate analysis of the costs of cleanup of releases from any transportation accident. There is no adequate analysis of the short- and long-term costs of a transportation accident in a highly populated area. There is not adequate analysis of the short- and long-term costs of a transportation accident in an area with a significant tourism-based economy.

While the DEIS considers sealed sources a security risk, there is no analysis of the impacts of sabotage of the transportation of sealed sources. There is no analysis of the transportation security requirements for sealed sources. For example, would armed escorts be necessary? It is not a credible or adequate analysis to state that sealed sources are a security risk when they are not being transported, but that they are not a security risk when they are transported.

Virtually all of the GTCC waste shipments would originate from NRC-licensed facilities. None of the disposal sites included in the DEIS are currently NRC licensed. The DEIS does not describe what the regulatory requirements would be for such shipments, nor how they would be met. Based on experience of WIPP, DOE "self-regulation" is not acceptable. There will be prolonged conflicts with states and tribes along possible transportation routes and demands for additional transportation measures will be made. In the case of WIPP, several years of congressional consideration of the Land Withdrawal Act (Public Law 102-579) was necessary and WIPP-specific transportation requirements were legislated. It then requires years of implementation of those measures before shipments begin. Similar processes should be assumed for GTCC wastes, but the DEIS includes no assessment of such a process.

L6-29
(Cont.)

all disposal alternatives. The primary difference would be related to the distances traveled in each case. Thus, the transportation costs will scale with the shipment distances travelled as presented in the EIS. Any decisions made by DOE would take these factors into account during implementation.

The analysis of intentional destructive acts is given in Section 2.7.4.3 of the EIS. This analysis provides a perspective on the risks that the GTCC LLRW and GTCC-like wastes could pose should such an act occur. In general, the risk presented from an intentional destructive act is similar to that from a high-severity transportation accident. The accident consequence assessment (given in Section 5.3.9.3 of the Final EIS) presents the results for transportation accidents that fall into the highest severity category. The severe environment that occurs under such conditions can be considered to be similar to that which could be initially instigated by an act of sabotage. In highly populated areas, where the highest exposures would be anticipated, a rapid response would be expected, minimizing the amount of time available to fully breach a Type B package. Should such shipments be diverted and the radioactive material removed for dispersion, higher exposures could be achieved, and potential impacts could be significant. The economic impact could reach several billions of dollars. The extent of the impacts would depend on the exact location of the release, density of the surrounding population, local meteorology, and emergency response capabilities in the affected area.

There are no definitive studies related to the effects of radioactive waste shipments on local tourism and property values. With an average of only one to two shipments per day over the potential 60 year lifetime of a proposed disposal facility in the case of GTCC LLRW and GTCC-like waste shipments, it is unlikely that there would be any significant impact on tourism and property values.

As stated in Section C.9.4.1.1 of the EIS on route selection, many of the GTCC LLRW and GTCC-like wastes considered in the EIS would meet the definition of a highway route HRCQ (49 CFR 173.403). However, as noted in the discussion, states and Native American tribes have the opportunity to designate "preferred routes" to replace or supplement the interstate highway system. For those wastes not specifically designated as HRCQ, the selection of a route is left to the carrier, but in the case of GTCC LLRW and GTCC-like wastes, additional consultation with transportation stakeholders would occur.

Once an alternative is selected in a ROD for this EIS for implementation, site-specific NEPA reviews would be conducted as needed, including an assessment of specific routing and an accident analysis. This process will include planning that involves all affected transportation stakeholders. DOE does not intend to make any decisions regarding specific waste transportation routes in this EIS.

Southwest Research and Information Center, Commenter ID No. L6 (cont'd)

Planning for transportation routes, inspections, emergency response training, satellite tracking of each shipment, and other aspects started more than a decade before shipments began to WIPP in 1999. The DEIS does not state that similar transportation planning and implementation requirements would occur for GTCC waste shipments. Based on the WIPP experience, the host state and some or all of the states along transportation routes will advocate for such advanced planning and perhaps require additional funding to implement those requirements.

L6-29
(Cont.)

Conclusion

SRIC's comments and those of all other persons must be fully considered. If DOE adequately considers those comments, it will withdraw the DEIS and instead proceed with developing a GTCC PEIS. DOE also will supplement or issue a new Waste Management PEIS that covers wastes for which DOE is responsible in a comprehensive way. Developing and implementing an adequate program for GTCC will be a decades long, technically and politically challenging task. That task must be supported by adequate NEPA documents to assist decisionmakers and the public.

Sincerely,



Don Hancock

Southwest Research and Information Center, Commenter ID No. L6 (cont'd)

ATTACHMENT I

March 24, 2010

Principles for Safeguarding Nuclear Waste at Reactors

The following principles are based on the urgent need to protect the public from the threats posed by the current vulnerable storage of commercial irradiated fuel. The United States does not currently have a national policy for the permanent storage of high-level nuclear waste. The Obama administration has determined that the Yucca Mountain site, which has been mired in bad science and mismanagement, is not an option for geologic storage of nuclear waste. Unfortunately, reprocessing proponents have used this opportunity to promote reprocessing as the solution for managing our nuclear waste. Contrary to their claims, however, reprocessing is extremely expensive, highly polluting, and a proliferation threat, and will actually complicate the management of irradiated fuel. Nor will reprocessing obviate the need for, or "save space" in, a geologic repository.

The United States has a unique opportunity to re-evaluate our nuclear waste management plan. We can make wise decisions about safeguarding radioactive waste or go down the risky, costly, and proliferation prone path towards reprocessing.

The undersigned organizations' support for improving the protection of radioactive waste stored at reactor sites is a matter of security and is in no way an indication that we support nuclear power and the generation of more nuclear waste.

➤ **Require a low-density, open-frame layout for fuel pools:** Fuel pools were originally designed for temporary storage of a limited number of irradiated fuel assemblies in a low density, open frame configuration. As the amount of waste generated has increased beyond the designed capacity, the pools have been reorganized so that the concentration of fuel in the pools is nearly the same as that in operating reactor cores. If water is lost from a densely packed pool as the result of an attack or an accident, cooling by ambient air would likely be insufficient to prevent a fire, resulting in the release of large quantities of radioactivity to the environment. A low density, open-frame arrangement within fuel pools could allow enough air circulation to keep the fuel from catching fire. In order to achieve and maintain this arrangement within the pools, irradiated fuel must be transferred from the pools to dry storage within five years of being discharged from the reactor.

➤ **Establish hardened on-site storage (HOSS):** Irradiated fuel must be stored as safely as possible as close to the site of generation as possible. Waste moved from fuel pools must be safeguarded in hardened, on-site storage (HOSS) facilities. Transporting waste to interim away-from-reactor storage should not be done unless the reactor site is unsuitable for a HOSS facility and the move increases the safety and security of the waste. HOSS facilities must not be regarded as a permanent waste solution, and thus should not be constructed deep underground. The waste must be retrievable, and real-time radiation and heat monitoring at the HOSS facility must be implemented for early detection of radiation releases and overheating. The overall objective of HOSS should be that the amount of releases projected in even severe attacks should be low enough that the storage system would be unattractive as a terrorist target. Design criteria that would correspond to the overall objective must include: Resistance to severe attacks, such as a direct hit by high-explosive or deeply penetrating weapons and munitions or a direct hit by a large aircraft loaded with fuel or a small

Southwest Research and Information Center, Commenter ID No. L6 (cont'd)

aircraft loaded with fuel and/or explosives, without major releases. Placement of individual canisters that makes detection difficult from outside the site boundary.

➤ **Protect fuel pools:** Irradiated fuel must be kept in pools for several years before it can be stored in a dry facility. The pools must be protected to withstand an attack by air, land, or water from a force at least equal in size and coordination to the 9/11 attacks. The security improvements must be approved by a panel of experts independent of the nuclear industry and the Nuclear Regulatory Commission.

➤ **Require periodic review of HOSS facilities and fuel pools:** An annual report consisting of the review of each HOSS facility and fuel pool should be prepared with meaningful participation from public stakeholders, regulators, and utility managers at each site. The report must be made publicly available and may include recommendations for actions to be taken.

➤ **Dedicate funding to local and state governments to independently monitor the sites:** Funding for monitoring the HOSS facilities at each site must be provided to affected local and state governments. The affected public must have the right to fully participate.

➤ **Prohibit reprocessing:** The reprocessing of irradiated fuel has not solved the nuclear waste problem in any country, and actually exacerbates it by creating numerous additional waste streams that must be managed. In addition to being expensive and polluting, reprocessing also increases nuclear weapons proliferation threats.

Southwest Research and Information Center, Commenter ID No. L6 (cont'd)

National

Leonor Tomero, Center for Arms Control and Non-Proliferation
John Issacs, Council for a Liveable World
Kevin Kamps, Beyond Nuclear
Lynn Thorp, Clean Water Action
Erich Pica, Friends of the Earth
Michele Boyd, Physicians for Social Responsibility
Jim Riccio, Greenpeace
Diane Kreiger, Nuclear Peace Age Foundation
Kevin Martin, Peace Action
Tyson Slocum, Public Citizen
Susan Gordon, Alliance for Nuclear Accountability
Arjun Makhijani, Institute for Energy and Environmental Research
Ken Bossong, SUN Day Campaign
Michael Mariotte, Nuclear Information and Resource Service
Anna Aurilio, Environment America
Winona La Duke, Honor the Earth
Dan Becker, Safe Climate Campaign
Dave Hamilton, Sierra Club
Geoffrey Fettus, Natural Resources Defense Council
Ed Lyman, Union of Concerned Scientists
Susan Shaer, Women's Action for New Directions (WAND)

Alaska

Stacy Fritz, No Nukes North

Alabama

Garry Morgan, Bellefonte Efficiency and Sustainability Team, Alabama Chapter of BREDL
Tom Moss, North Alabama Peace Network

Arkansas

Pat Youngdahl, Arkansas WAND

Arizona

Stephen M. Brittle, Don't Waste Arizona
Jack and Felice Cohen-Joppa, Nuclear Resister
Patricia Birnie, GE Stockholder's Alliance
Russell Lowes, SafeEnergyAnalyst.org
Barbara Warren, Arizona Physicians for Social Responsibility

California

Rochelle Becker, Alliance for Nuclear Responsibility CA
David Hartsough, PEACEWORKERS
Jane Williams, California Communities Against Toxics
Roland Valentine, Desert Citizens Against Pollution
Mary Beth Brangan, Ecological Options Network (EON)
Betty Winholz, SAVE THE PARK
Jacqueline Cabasso, Western States Legal Foundation

Southwest Research and Information Center, Commenter ID No. L6 (cont'd)

Molly Johnson, Grandmothers for Peace-San Luis Obispo County Chapter

Linda Seeley, Terra Foundation

Jane Swanson, San Luis Obispo Mothers For Peace Action Committee

Marylia Kelley, Tri-Valley CARES

Michael Welch, Redwood Alliance

Enid Schreiberman, Center for Safe Energy

Jennifer Olarana Viereck, Healing Ourselves and Mother Earth

Dan Hirsch, Committee to Bridge the Gap

Pamela Meidell, Atomic Mirror

Colorado

Bob Kinsey, Colorado Coalition for the Prevention of Nuclear War

Sharyn Cunningham, Colorado Citizens Against Toxic Waste, Inc.

Judith Mohling, Rocky Mountain Peace and Justice Center

Connecticut

Nancy Burton, Connecticut Coalition Against Millstone

Judi Friedman, People's Action for Clean Energy

Sal Mangigli, Connecticut Citizens Action Network, Haddam Chapter

Washington, DC

Louis Clark, Government Accountability Project

Delaware

Alan Muller, Green Delaware

Florida

Bob Krasowski, Florida Alliance for A Clean Environment, The Zero Waste Collier County Group

Georgia

Tom Ferguson, Foundation for A Global Community

Bobbie Paul, Georgia WAND

Glenn Carroll, Nuclear Watch South

Bob Darby, Food Not Bombs, Atlanta

Hawaii

Henry Curtis, Life of the Land

Iowa

Maurcen McCue, PSR Iowa

Idaho

Beatrice Brailsford, Snake River Alliance

Chuck Broschous, Environmental Defense Institute

Illinois

Dave Kraft, Nuclear Energy Information Service

Carolyn Treadway, No New Nukes

Indiana

Grant Smith, Citizens Action Coalition of Indiana

John Blair, ValleyWatch, Inc.

Kansas

Dave Pack, Kansas City Peaceworks

Anne Suellentrop, Kansas City PSR

Southwest Research and Information Center, Commenter ID No. L6 (cont'd)

Kentucky

Mary Davis, Earth Island Institute

Louisiana

Nathalie Walker, Advocates for Environmental Human Rights

Massachusetts

Debbie Grinell, C-10 Research and Education Foundation

Deb Katz, Citizens Awareness Network

Mary Lampert, Pilgrim Watch

Maryland

Dagmar Fabian, Crabshell Alliance

Johanna Neumann, Maryland PIRG

Max Obuszewski, Baltimore Nonviolence Center

Lucy Duff, Peace and Justice Coalition-Prince George's County

Maine

William S. Linnell, Cheaper, Safer Power

Bruce Gagnon, Global Network Against Weapons & Nuclear Power in Space

Michigan

Keith Gunter, Citizens Resistance at Fermi Two

Michael Keegan, Coalition for a Nuclear Free Great Lakes

Georgia Donovan, Izank Walton League-Dwight Lydell Chapter

Terry Miller, Lone Tree Council

Patricia Gillis, Voices for Earth Justice

Alice Hirt, Don't Waste Michigan

Nancy Seibert, IHM Justice, Peace, and Sustainability Office

Lynn Howard Ehrle, International Science Oversight Board-Organic Consumers Association

Kay Cumbow, Citizens for Alternatives to Chemical Contamination

Ronald and Joyce Mason, Swords Into Plowshares Peace Center and Gallery

David Gard, Michigan Environmental Council

Steve Senesi, Kalamazoo Non-Violent Opponents of War

Minnesota

Danene Provencher, West Metro Global Warming Action Group, Inc.

Glady Schmitz, Mankato Area Environmentalists

George Crocker, North American Water Office

Bruce Drew, Prairie Island Coalition

Southwest Research and Information Center, Commenter ID No. L6 (cont'd)

Missouri

Mark Halm, Missourians for Safe Energy
Kat Logan Smith, Missouri Coalition on the Environment

Mississippi

Louie Miller, Mississippi Sierra Club

Montana

Florence Chessin, Missoula Women for Peace, a branch of Women's International League for Peace and Freedom

North Carolina

Lewis Patrie, Western North Carolina Physicians for Social Responsibility

E.M.T O'Nan, Protect All Children's Environment

Avram Friedman, The Canary Coalition

Jim Warren, North Carolina Waste Awareness and Reduction Network

Janet Marsh, Blue Ridge Environmental Defense League

North Dakota

Kandi L. Mossett, Indigenous Environmental Network

Jodie L. White, The Environmental Awareness Committee, Save Our Sacred Earth Campaign

Nebraska

Buffalo Bruce, Western Nebraska Resources Council

Tim Rinne, Nebraskans for Peace

New Hampshire

Will Hopkins, New Hampshire Peace Action

New Jersey

Paula Gotsch, Grandmothers, Mother and More for Energy Safety

Norm Cohen, Coalition for Peace and Justice-UNPLUG Salem Campaign

New Mexico

Mervyn Tilden, Sovereign Dine' Foundation

Janet Greenwald, Citizens for Alternatives to Radioactive Dumping

Joni Arends, Concerned Citizens for Nuclear Safety

Scott Kovac, Nuclear Watch of New Mexico

Greg Mello, Los Alamos Study Group

Don Hancock, Southwest Research and Information Center

Nevada

Judy Treichel, Nevada Nuclear Waste Taskforce

Jim Haber, Nevada Desert Experience

New York

Joanne Hameister, Coalition on West Valley Nuclear Wastes

Anne Rabe, Center for Health, Environment, and Justice

James Rauch, For a Clean Tonawanda Site (FACTS)

Barbara Warren, Citizen's Environmental Coalition

Phillip Musegans, Riverkeeper NY

Tim Judson, Central New York Citizens Awareness Network

Ohio

Chris Trepal, Earth Day Coalition

Terry Lodge, Toledo Coalition for Safe Energy

Sharon Cowdrey, Miamisburg Environmental Safety and Health Network

Oklahoma

Marilyn McCulloch, The Carrie Dickerson Foundation

Southwest Research and Information Center, Commenter ID No. L6 (cont'd)

Oregon

Dona Hippert, Oregon Toxics Alliance
Charles K. Johnson, Center for Energy Research
Nina Bell, Northwest Environmental Advocates
Kelly Campbell, Oregon Physicians for Social Responsibility
Gerry Pollet, Heart of America Northwest

Pennsylvania

David Hughes, Citizen Power
Katherine Dodge, Northwest Pennsylvania, Audobon Society
Gene Stilp, Taxpayers and Ratepayers United
Ernest Fuller, Concerned Citizens for SNEC Safety
Patricia Harner, Philadelphia Physicians for Social Responsibility
Dr. Lewis Cuthbert, Alliance for a Clean Environment

Rhode Island

Sheila Dormandy, Clean Water Action Rhode Island

South Carolina

Susan Corbett, South Carolina Sierra Club
Dr. Finian Taylor, Hilton Head for Peace

South Dakota

Deb McIntyre, South Dakota Peace and Justice Center
Charmaine White Face, Defenders of the Black Hills

Tennessee

Donald B. Clark, Network for Economic and Environmental Responsibility, United Church of Christ
Rev. Charles Lord, Caney Fork Headwaters Association
Rev. Douglas B. Hunt, Interfaith Power & Light
Ralph Hutchinson, Oak Ridge Environmental Peace Alliance
Rev. Walter Stark, Cumberland Countians for Peace and Justice
Ann Harris, We the People, Inc.

Texas

Eliza Brown, SEED Coalition
Mavis Belisle, JustPeace
Gary Stuard, Interfaith Environmental Alliance
Craig Tounet, Austin Physicians for Social Responsibility
Jill Johnston, Southwest Workers Union

Southwest Research and Information Center, Commenter ID No. L6 (cont'd)

Utah

Margene Bullcreek, Ohngo Guadedah Devia
Awareness

Vanessa Pierce, HEAL Utah

Virginia

Scott Sklar, The Stella Group, Inc.

Elena Day, People's Alliance for Clean Energy

Vermont

Arnie Gundersen, Fairwinds Associates, Inc.

Clay Turnbull, New England Coalition on Nuclear
Pollution

Chris Williams, Vermont Citizens Awareness
Network

Margaret Harrington Tamulonis, Women's
International League for Peace

Washington

Tom Carpenter, Hanford Challenge

Wisconsin

Charlie Higley, Citizens Utility Board

Bonnie Urfer and John LaForge, Nukewatch
Wisconsin

Al Gedicks, Wisconsin Resources Protection Council

Judy Miner, Wisconsin Network for Peace and
Justice

West Virginia

Gary Zuckett, West Virginia Citizens Action Group

Wyoming

Mary Woolen, Keep Yellowstone Nuclear Free

Capital Reporting Company

5

1 comments to add after their initial five minutes, we
2 may have some time near the end in order to allow
3 people to add a few final comments. So, with that by
4 way of introduction, let me call on our first speaker,
5 who is Don Hancock, and he will be followed by Yemane
6 Asmerom.

7 MR. HANCOCK: Good evening. Welcome to
8 Albuquerque for the Department of Energy and other
9 people who are here. I'm Don Hancock from Southwest
10 Research and Information Center in Albuquerque, a 40-
11 year-old organization that has worked on a variety of
12 nuclear issues, including nuclear waste issues during
13 most of that time. We provided scoping comments on
14 this document and so, I'm disappointed in looking at
15 the document that our conclusion must be that this
16 Draft EIS is fatally flawed as a matter of law, as a
17 matter of policy, and as a technical matter.

18 From a legal standpoint, the Draft EIS is the
19 wrong document. It does not consider all the
20 reasonable alternatives, as required by the law, and it
21 cannot be used to consider -- continue on to an
22 adequate final EIS. First, it's the wrong document.

866.488.DEPO
www.CapitalReportingCompany.com

T51-1

T51-1

DOE does not agree that a programmatic EIS as described in this comment must be prepared before this EIS is completed. This EIS has been scoped to provide adequate environmental information to support the decision-making process to identify an appropriate site(s) and technology(s) to dispose of a limited amount of GTCC LLRW and GTCC-like waste. If appropriate, DOE would conduct further NEPA review, tiered from this EIS before implementing decisions. DOE tailored the scope of this EIS to ensure the analyses will adequately inform the decisions at issue, including the selection of sites and technologies for the disposal of GTCC and GTCC-like waste. This EIS presents the environmental information needed to adequately inform decision makers regarding many of the questions and points raised in this comment; other questions and points raised remain outside of the scope of this document, as noted below. DOE plans a tiered decision making process in which DOE would conduct further site-specific NEPA reviews before implementing an alternative ultimately selected on the basis of this EIS.

Regarding the types and exact amount of GTCC from existing commercial power plants ultimately requiring disposal, DOE does not agree this is an issue warranting preparation of a PEIS as a prerequisite to this EIS. Nevertheless, considerable attention is given to waste inventories in this EIS, which quantifies and analyzes potential impacts from the range of potential quantities of wastes from commercial power plants as well as from other types of GTCC waste. The EIS is structured to inform potential decisions to employ different technologies and disposal sites from the different types of GTCC and GTCC-like wastes, as is the case under the preferred alternative identified in this Final EIS.

Contrary to points raised in this comment, this EIS also provides substantial attention to inventories and characteristics of GTCC-like wastes and analyzes in detail potential impacts of transportation and disposal options. This EIS also answers the question posed regarding whether GTCC waste could be disposed of in a repository for high-level waste and spent nuclear fuel; the EIS concludes that use of a geologic repository would be a protective and safe method for disposal of the entire inventory of GTCC and GTCC-like wastes evaluated in this EIS (see response to A.2.3 under *Topics of Interest*).

Southwest Research and Information Center, Commenter ID No. T51 (cont'd)

Capital Reporting Company

6

1 Why is it the wrong document? Because, as we stated in
2 our scoping comments, the Department of Energy first
3 must do a programmatic environmental impact statement
4 to address a variety of issues, some of which are not
5 even considered in this draft document.

6 For example, PEIS, a programmatic
7 environmental impact statement should address questions
8 like, "Should a Department of Energy facility be used
9 for commercial waste?" "Should Greater-Than-Class-C
10 waste be disposed of alternatively in a high-level
11 waste or spent nuclear fuel repository?" "What about
12 the options for on-site storage at existing reactor
13 sites for several decades or more?" "What about
14 consolidating GTCC storage at a few locations?" "What
15 about the range of disposal options even more than are
16 considered in the document?" "What about changes in
17 the Nuclear Regulatory Commission regulations that
18 would be required for various disposal options,
19 especially for the existing sites?" And, you were
20 shown those existing Department of Energy sites, none
21 of which have an NRC licensed disposal facility.

22 Regarding the other kinds of waste that they

866.488.DEPO

www.CapitalReportingCompany.com

T51-1
(Cont.)

Southwest Research and Information Center, Commenter ID No. T51 (cont'd)

T51-2 DOE developed this EIS to support a decision on selecting a disposal facility or facilities for GTCC LLRW and GTCC-like waste, to address legislative requirements, to address national security concerns (especially for sealed sources), and to protect public health and safety. The purpose and need for the proposed action is stated in the EIS (Section 1.1). The scope of the EIS is focused on addressing the need for developing a disposal capability for the identified inventory of GTCC LLRW and GTCC-like wastes. The potential security concerns presented by disused sealed sources are also discussed in Section 1.1 of the EIS.

Capital Reporting Company 7

1 want to include, the misnamed GTC-like waste, in 1997,
2 the Department of Energy issued its Waste Management
3 Programmatic Environmental Impact Statement. That's
4 almost 15-years-old. It's time to update that
5 programmatic environmental impact statement to decide
6 what about the Department of Energy waste unrelated to
7 the commercial Greater-Than-Class-C waste. So, that
8 document has to be supplemented to look at the
9 Department of Energy waste before there should be any
10 consideration of consolidating DOE and commercial
11 waste.

12 There's no clear statement of what the need
13 is. You heard Mr. Edelman's presentation saying the
14 need is there's no current -- there is currently no
15 disposal capacity for Greater-Than-Class-C low-level
16 radioactive waste. The same thing, in fact, could be
17 said about there's no disposal -- current disposal
18 capability for spent nuclear fuel. That -- the
19 statement that there isn't current disposal capability
20 is not an adequate statement of need.

21 Again, the National Environmental Policy Act
22 requires that the need, the purpose, be clearly defined

866.488.DEPO
www.CapitalReportingCompany.com

T51-1
(Cont.)

T51-2

Capital Reporting Company

8

1 and stated so the decision makers and the public can
2 understand what the alternatives really are. Again,
3 this is another reason that we should be having a
4 programmatic environmental impact statement not this
5 one.

6 Secondly, the -- according to the federal
7 regulations, the heart of any legally adequate
8 environmental impact statement is consideration of all
9 reasonable alternatives. This document doesn't do
10 that. The Nuclear Waste Policy Act, for example,
11 federal law, says that there is a legal requirement for
12 the Department of Energy to develop a geologic
13 repository for spent nuclear fuel and high-level waste
14 other than WIPP.

15 In any of the presentation, did you hear
16 anything about that legally required facility even
17 being mentioned in this document? No. It's not. It
18 has to be for all reasonable alternatives to be
19 considered.

20 MR. BROWN: Don, you've got about a minute
21 left on this part of your presentation. Thanks.

22 MR. HANCOCK: The only alternatives, as you
866.488.DEPO
www.CapitalReportingCompany.com

T51-2
(Cont.)

T51-3

T51-4

T51-3 The Nuclear Waste Policy Act applied to the disposal of spent nuclear fuel and High Level waste, not GTCC. The disposal methods and sites evaluated in the EIS represent the range of reasonable alternatives for the disposal of GTCC LLRW and GTCC-like wastes. This range is consistent with NEPA implementing regulations in Parts 1500-1508 of Title 40 of the Code of Federal Regulations (40 CFR Parts 1500-1508). In this GTCC EIS, DOE analyzed a range of disposal methods (i.e., geologic repository, near-surface trench, intermediate-depth borehole, and above-grade vault) and federally owned sites (i.e., Hanford Site, INL, LANL, NNSS, SRS, and the WIPP Vicinity, for which two reference locations - one within and one outside the WIPP Land Withdrawal Boundary - were considered). DOE has determined that it was reasonable to analyze these six sites because they currently have operating radioactive waste disposal facilities, except for the WIPP Vicinity, which is near an operating geologic repository.

Final siting of a disposal facility for GTCC LLRW and GTCC-like wastes would involve further NEPA review as needed and be in accordance with applicable laws and regulations and would involve local stakeholder involvement and consent.

T51-4 DOE solicited technical capability statements from commercial vendors that might be interested in constructing and operating a GTCC LLRW disposal facility. Although several commercial vendors expressed interest, no vendors provided specific information on disposal locations and methods that could have been analyzed in the EIS. Hence, this option was analyzed generically. The analysis provided in this EIS could be used to support a decision for disposing of GTCC LLRW and GTCC-like waste in one or more commercial facilities, if such facilities are identified in the future. Additional NEPA reviews would be conducted, as appropriate.

The LLRWPA (P.L. 99-240) assigns DOE responsibility for the disposal of GTCC LLRW generated by NRC and Agreement State licensees. The LLRWPA (P.L. 99-240) specifies that GTCC LLRW, designated a federal responsibility under section 3(b)(1)(D) that results from activities licensed by the NRC, is to be disposed of in an NRC-licensed facility that has been determined to be adequate to protect public health and safety. However, unless specifically provided by law, the NRC does not have authority to license and regulate facilities operated by or on behalf of DOE. Further, the LLRWPA does not limit DOE to using only non-DOE facilities or sites for GTCC LLRW disposal. Accordingly, if DOE selects a facility operated by or on behalf of DOE for disposal of GTCC LLRW for which it is responsible under section 3(b)(1)(D), clarification from Congress would be needed to determine NRC's role in licensing such a facility and related issues. In addition clarification from Congress may be needed on NRC's role if DOE selects a commercial GTCC LLRW disposal facility licensed by an Agreement State rather than by NRC.

Capital Reporting Company

9

1 heard, that are really being seriously considered are
 2 Department of Energy sites. What about commercial
 3 sites for commercial waste? In fact, DOE didn't even
 4 follow its own advance notice of intent, which said,
 5 "They would consider disposal in new or existing DOE or
 6 commercial facilities." They certainly didn't do that.
 7 The generic facilities they talk about are not
 8 adequate.

T51-4
(Cont.)

9 They didn't consider the need for long
 10 Hardened On-site Storage on site. Shockingly, from a
 11 policy standpoint, this document says that for the next
 12 70 years, the term that it purports to cover, the only
 13 geologic repository in the United States will be WIPP.
 14 That is wrong policy and wrong law. So, the conclusion
 15 that they can't go forward, they've got to stop, go
 16 back and start over with a programmatic environmental
 17 impact statement and supplementing the waste management
 18 PEIS is what they need to do.

T51-5

19 The PEIS process, the one that they're doing
 20 now that we've just heard about should end after our
 21 comments. They shouldn't proceed to a final EIS.
 22 Instead, DOE needs to start over. And, they should

T51-6

866.488.DEPO
 www.CapitalReportingCompany.com

- T51-5 The use of HOSS and other approaches for long-term storage of GTCC LLRW and GTCC-like wastes are outside the scope of this EIS because they do not meet the purpose and need for agency action. Consistent with Congressional direction in Section 631 of the Energy Policy Act of 2005 (P.L. 109-58), DOE plans to complete an EIS and a ROD for a permanent disposal facility for this waste, not for long-term storage options. The GTCC EIS evaluates the range of reasonable disposal alternatives and, as also required under NEPA, a No Action Alternative. Under the No Action Alternative, current practices for storing GTCC LLRW and GTCC-like wastes would continue in accordance with current requirements.
- T51-6 The EIS analysis was used to assess the viability of an alternative as well as its relative performance compared to the other alternatives. The preferred alternative was identified based on consideration of many factors and sought to minimize the overall human health risks posed by the proposed GTCC disposal facility.

Southwest Research and Information Center, Commenter ID No. T51 (cont'd)

Capital Reporting Company

10

- 1 conclude and determine that neither New Mexico nor
- 2 other Department of Energy sites should be used for
- 3 disposal of commercial Greater-Than-Class-C waste.

T51-6
(Cont.)

SOUTHWESTERN LOW-LEVEL RADIOACTIVE WASTE COMMISSION
 1731 Howe Avenue #611, Sacramento, California 95825
 Voice: (916) 448-2390
 Fax: (916) 720-0144
 E-mail: swlrwcc@swlrwcc.org
 Website: www.swlrwcc.org



COPY

May 6, 2011

TO: Dr. Steven Chu, Secretary
 U.S. Department of Energy
 1000 Independence Avenue, SW.
 Washington, DC 20585-0119

receive

MAY 16 2011

SUBJECT: Comment on Draft GTCC EIS

Dear Secretary Chu;

The Southwestern Low-Level Radioactive Waste Commission (Commission), established pursuant to the Southwestern Low-Level Radioactive Waste Disposal Compact Consent Act (P.L. 100-712) and charged with the duty of ensuring that low-level radioactive wastes are safely disposed of and managed within the states of Arizona, California, North Dakota and South Dakota, wishes to comment on the Draft GTCC EIS (Draft EIS). We are writing to you because our Commission believes, that, properly addressed, the inclusion of Class B and C low-level radioactive waste in the Draft EIS has potential to significantly respond to the "most significant challenge" identified in the 2010 Radiation Source Protection and Security Task Force Report (Report) to the President and the U.S. Congress- that being access to disposal for disused radioactive sources. Augmenting DOE's efforts to develop a GTCC disposal capability with Congressional approval of the B & C waste pathway would go a long way in solving the problem

It is apparent to our Commission that the Draft EIS does not address/include the disposal of commercial Class B and C waste. The Commission would like to strongly suggest that the DOE take what ever steps are necessary to add commercial Class B and C waste. The Commission is well aware that the Low-Level Radioactive Waste Policy Amendments Act of 1985 limits the DOE's responsibility to the disposal of GTCC waste and makes the states responsible for commercial Class B and C waste. But, the law needs to be changed. The GTCC facility should be used for Class B and C wastes also, since if it can safely dispose of GTCC wastes, it can certainly dispose of Class B and Class C wastes safely. Congress, by changing the law, would enable this to happen. The EIS process whereby DOE must obtain Congressional approval of the GTCC EIS before issuing a Record of Decision in selecting a site for a proposed GTCC facility is a noteworthy opportunity to get Congressional focus/action on this critically important issue.

With the closure of access to the Barnwell, SC, facility on July1, 2008, thirty six States, including our four States, now have no pathway for the disposal of Class B and C waste. All such waste must now be held in storage. The U.S. Nuclear Regulatory Commission (NRC) considers storage less safe than disposal. Storage also has national security implications (see "Report," p.ii). While it is true that the newly licensed WCS facility in Texas will provide access to a disposal pathway for Class B and C waste for Texas and Vermont, there is no guarantee all states will have such access.

Our Commission's position, above, is consistent with other organizations. The Health Physics Society (HPS) first advanced the proposal that the GTCC disposal facility also be used for the disposal of commercial Class B and C waste (September 17, 2007, Letter from HPS to DOE Office of Regulatory Compliance). The American Nuclear Society, in a paper entitled "Disposal of Low-Level Radioactive Waste, Revised February 2009," takes the position of including the disposal of Class B and C waste with GTCC waste. Also, the Chairman of the NRC, in the "Report" confirmed that such challenge requires attention at higher levels for solution. The GTCC EIS process is one way to get the issue before the U.S. Congress and we appreciate your attention to this matter.

Sincerely,

Aubrey Godwin, Chairman
 Southwestern Low-Level Radioactive Waste Commission

L281-1

Southwestern Low-Level Radioactive Waste Commission,
Commenter ID No. L281 (cont'd)

CC: Dr. Gregory B. Jaczko, Chairman
United States Nuclear Regulatory Commission
Washington, DC 20555-0001

Mr. Arnold Edelman
Greater-Than-Class C Low-Level Radioactive Waste EIS
Office of Technical and Regulatory Support (EM-43)
U.S. Department of Energy
1000 Independence Avenue, SW,
Washington, DC 20585-0119

AZ, CA, ND, SD Governors
SWLLRWC Commissioners

Spark of Divinity Mission, Commenter ID No. W47

Abplanalp, Jennifer Marie

From: gtceiswebmaster@anl.gov
Sent: Friday, May 20, 2011 4:09 AM
To: gtceiswebmaster@anl.gov
Subject: Receipt: Greater-Than-Class-C Low-Level Radioactive Waste EIS Comment GTCC10047

Thank you for your comment, Arnold Troeh, Ph.D.,

The comment tracking number that has been assigned to your comment is GTCC10047. Please refer to the comment tracking number in all correspondence relating to this comment.

Comment Date: May 20, 2011 04:08:33AM CDT

Greater-Than-Class-C Low-Level Radioactive Waste EIS Draft Comment: GTCC10047

First Name: Arnold
Middle Initial: N
Last Name: Troeh, Ph.D.
Organization: The Spark of Divinity Mission
Address: 15214 9th Ave. SW.
City: Seattle
State: WA
Zip: 98166-2102
Country: USA
Email: onlytry@comcast.net
Privacy Preference: Don't withhold name or address from public record

Comment Submitted:

Please heed Dkhw'Duw'Absh (Duwamish) Chief Si'ahl's (Seattle) wise admonition when he said, "What happens to Mother Earth happens to Mother Earth's children." She is a living being who has sustained untold abuse, due to the pollution of Her sacred air, land, and waters, through predominantly war and industry. We have a vital symbiotic relationship with Her. When I was teaching on the Yakama Indian reservation in white Swan in 1975 the Hanford Complex was leaking radioactive waste according to Russel Jim a Yakama Tribal Council Member into the Columbia River, and we doubt if much has been done if anything to correct this disastrous problem. The Yakama Tribal Council was really upset about it at that time. So how will that be improved by adding all the radio-active waste in the nation to be disposed of at this location. It is a disaster equal to Fukushima ready to happen.

Questions about submitting comments over the Web? Contact us at: gtceiswebmaster@anl.gov or call the Greater-Than-Class-C Low-Level Radioactive Waste EIS Webmaster at (630) 252-5705.

W47-1 DOE's ROD 78 FR 75913 dated December 13, 2013, stated that DOE has deferred a decision on importing waste from other DOE sites (with limited exceptions as described in the Settlement Agreement with the State of Washington Department of Ecology) for disposal at Hanford at least until WTP is operational.

W47-1

SRS Community ReUse Organization, Commenter ID No. T9

1
2
3
4
5
6
7
8
9
10
11
12
13
14
15
16
17
18
19
20
21
22
23
24
25
26

MR. BROWN: Thank you. Rick McLeod, and then Charles Utley will then follow.

MR. RICK MCLEOD: I'm Rick McLeod, the executive director of the SRS Community ReUse Organization. I'd like to read a letter into the record and then at the conclusion leave a copy for your files. Dear Mr. Edelman, our organization, Savannah River Site Community ReUse Organization, does not support the

1 selection of Savannah River Site as a potential
2 candidate for the disposal of greater-than-class C or
3 greater-than-class C-like waste under the scope of the
4 Draft Environmental Impact Statement. The SRSCRO was
5 the U.S. Department of Energy's designated community
6 re-use organization. We are charged with developing
7 and implementing a comprehensive strategy to diversify
8 the economy of a five-county region in the Central
9 Savannah River area of Georgia and South Carolina. The
10 SRSCRO is governed by a 22-member board of directors
11 composed of business, government, academic leaders from
12 Georgia from South Carolina. Initially its mission was
13 to develop and implement a regional economic
14 development plan utilizing technology-based facilities
15 at Savannah River Site. Today SRSCRO remains focused
16 on the regions of county by supporting new business
17 ventures that create new jobs in our region. The
18 disposal record class-C waste and greater-than-class
19 C-like waste from offsite is not compatible with local
20 and regional manues (phonetic) plans. The SRSCRO
21 believes since disposal of off-site waste as SRS may
22 ultimately affect future industrial recruitment, job
23 creation and overall the common health of the region.
24 Our community has been supporting missions at SRS for
25 over 50 years, a testament to SRS's outstanding record
26 of safety and performance, compliance and contribution

1 to our region and state. While we were confident
 2 that--that SRS current handles the disposal of
 3 low-level radioactive waste generated onsite and in a
 4 technically acceptable and safe manner the disposal of
 5 greater-than-class C waste and greater-than-class
 6 C-like waste at SRS would violate one of the
 7 community's guiding principles, no waste or excess
 8 material should be brought into South Carolina unless
 9 an approved and funded pathway exists for its
 10 processing the shipment to either a customer or an
 11 out-of-state waste disposal facility. It appears to
 12 the SRSCRO the disposal in the geologic repository like
 13 Yucca Mountain and/or the Waste Isolation Pilot Plant,
 14 WIPP, is a more appropriate approach for this type of
 15 waste stream and provides the additional level of
 16 safety, security, reliability to deter and eliminate
 17 any terrorist access to radioactive sealed sources and
 18 such waste. Thank you for allowing us to voice--our
 19 voice to be heard and participate in the Draft EIS
 20 meeting.

T9-1

T9-2

T9-1 The GTCC EIS evaluates the range of reasonable alternatives for the disposal of GTCC LLRW and GTCC-like wastes in compliance with the requirements specified in NEPA, the Low-Level Radioactive Waste Policy Amendments Act (P.L. 99-240), and Section 631 of the Energy Policy Act of 2005 (P.L. 109-58). The GTCC EIS evaluates the potential environmental impacts of the proposed disposal alternatives for GTCC LLRW and GTCC-like wastes, DOE considered all pertinent and important factors including existing regulations, agreements and other requirements in identifying its preferred alternative. The reader is referred to Section 2.9, Factors Considered in the Development of the Preferred Alternative.

T9-2 Based on the GTCC EIS evaluation and WIPP's operating record, DOE believes that the WIPP repository would be a safe location for the disposal of GTCC LLRW and GTCC-like wastes, some of which include long-lived radionuclides. DOE recognizes that the use of WIPP for the disposal of GTCC LLRW and GTCC-like wastes would require modification to existing law. In addition, it would be necessary to revise the Agreement for Consultation and Cooperation between Department of Energy and the State of New Mexico for the Waste Isolation Pilot Plant, the WIPP compliance certification with EPA, and the WIPP Hazardous Waste Facility Permit.

The State of New Mexico has indicated a willingness to accept GTCC LLRW and GTCC-like wastes for disposal at WIPP. Twenty-eight New Mexico State Senators signed a proclamation made in the Fiftieth Legislature, First Session, 2011, stating: "Be it resolved that we, the undersigned, support the opportunity for other potential missions in southeast New Mexico to adequately address the disposal of defense high-level waste, commercial high-level waste, Greater Than Class C LLRW and surplus plutonium waste, as well as the interim storage of spent nuclear fuel." In response to the Draft GTCC EIS, Secretary David Martin, Secretary of the New Mexico Environment Department, sent a letter to DOE on June 27, 2011, stating that "the Department encourages DOE to support the WIPP or WIPP Vicinity proposed locations as the preferred alternatives addressed in the Draft EIS. The geologic repository is the favored alternative being more effective for the enduring time frames for this waste type." In addition, the Governor of New Mexico, in a letter to DOE Secretary Steven Chu on September 1, 2011, stated that the State of New Mexico encourages DOE to support the proposed location of WIPP as the preferred alternative for the disposal of GTCC LLRW and GTCC-like wastes.

The Secretary of Energy determined that a permanent repository for high-level waste and spent nuclear fuel at Yucca Mountain, Nevada, is not a workable option and will not be developed. Therefore, DOE concluded that co-disposal at a Yucca Mountain repository is not a reasonable alternative and has eliminated it from evaluation in this EIS, as described in Section 2.6 of the EIS.



STATE OF IDAHO
DEPARTMENT OF
ENVIRONMENTAL QUALITY

1410 North Hilton • Boise, Idaho 83708 • (208) 373-0502

C.L. "Butch" Otter, Governor
Toni Hardesty, Director

June 24, 2011

Arnold Edelman, EIS Document Manager
Office of Environmental Management
U.S. Department of Energy
Cloverleaf Building, EM-42
1000 Independence Avenue, SW
Washington, DC 20585

Sent via email

Re: Draft Environmental Impact Statement for the Disposal of Greater-Than-Class C (GTCC) Low-Level Radioactive Waste and GTCC-Like Waste

Dear Mr. Edelman:

The Idaho Department of Environmental Quality (DEQ) appreciates the opportunity to review the above titled document and has the following comments in addition to those submitted by Governor Otter at the public hearing held in Idaho Falls on May 11, 2011.

In 1995 the State of Idaho entered into an agreement (1995 Agreement) with the Department of Energy (DOE) and the U.S. Navy to ensure Idaho would not be a dumping ground for out-of-state radioactive waste and to provide requirements and a schedule for the removal of existing wastes from Idaho. The Draft EIS, on page 7-74 in Table 7.5.1, correctly notes that under the 1995 Agreement, Transuranic (TRU) waste brought to Idaho must be treated within 6 months of receipt and shipped out within 6 months of treatment. The Agreement does not allow TRU waste to enter Idaho for permanent disposal. As the Draft EIS indicates, GTCC-like waste includes TRU waste that cannot be brought to Idaho unless it is shipped out within one year of receipt. Accordingly, there is little utility in considering INL as a possible site for disposal of GTCC-like waste which includes TRU waste.

DOE has expended significant resources and effort to successfully implement the intent and requirements of the 1995 Agreement to restrict the importation of radioactive wastes into Idaho and to treat and remove existing wastes. Selecting or even considering INL as a possible disposal location for additional out-of-state radioactive waste undermines that success and the mutual understandings and vision for the INL that Idaho and DOE have reached over the past two decades. Selecting INL for

L2-1

The disposal methods and sites evaluated in the EIS represent the range of reasonable alternatives for the disposal of GTCC LLRW and GTCC-like wastes. This range is consistent with NEPA implementing regulations in Parts 1500–1508 of Title 40 of the Code of Federal Regulations (40 CFR Parts 1500–1508). In this GTCC EIS, DOE analyzed a range of disposal methods (i.e., geologic repository, near-surface trench, intermediate-depth borehole, and above-grade vault) and federally owned sites (i.e., Hanford Site, INL, LANL, NNSS, SRS, and the WIPP Vicinity, for which two reference locations – one within and one outside the WIPP Land Withdrawal Boundary – were considered). DOE has determined that it was reasonable to analyze these six sites because they currently have operating radioactive waste disposal facilities, except for the WIPP Vicinity, which is near an operating geologic repository.

DOE also conducted a generic evaluation of commercial disposal facilities on nonfederal lands in the EIS to order to provide, to the extent possible, information regarding the potential long-term performance of other (nonfederal) locations for siting a GTCC waste land disposal facility.

Final siting of a disposal facility for GTCC LLRW and GTCC-like wastes would involve further NEPA review as needed and be in accordance with applicable laws and regulations and would involve local stakeholder involvement and consent. DOE fully supports the provisions of the 1995 agreement. The agreement was taken into considered in the selection of the preferred alternative.

L2-1

June 24, 2011
Arnold Edelman, EIS Document Manager
Page 2

disposal of additional waste, while continuing to clean up and remove past waste would reverse the progress that has been made and reignite issues that have long been settled. This is especially so as a great deal of the cleanup and removal of the waste at the INL is complete.

DEQ also reiterates that the only disposal method approved by the NRC for GTCC waste is a geological repository – and consideration of other methods is unnecessary and unproductive where that method appears to be responsible and available. The Draft EIS clearly shows the geological repository has low environmental and human health impacts making it a better disposal method than the other alternatives.

For these reasons and those already expressed by Governor Otter, Idaho is not an appropriate site for the disposal of GTCC and GTCC-like waste.

Specific comments regarding the Draft EIS are attached for your consideration.

Sincerely,

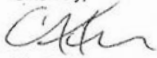

Curt Fransen
Deputy Director

c: David Hensley – Counsel to the Governor
Toni Hardesty – Director, DEQ

Attachment

L2-1
(Cont.)

L2-2

L2-2

DOE agrees that use of a geologic repository would be a protective and safe method for the disposal of the entire inventory of GTCC LLRW and GTCC-like wastes. The GTCC EIS evaluation for the WIPP geologic repository alternative supports this statement. However, the degree of waste isolation provided by a geologic repository may not be necessary for all of the GTCC LLRW and GTCC-like wastes evaluated in the GTCC EIS. The GTCC EIS evaluation indicates that certain wastes (e.g., those containing short-lived radionuclides such as Cs-137 irradiators) could be safely disposed of in properly designed land disposal facilities at sites with suitable characteristics, such as low precipitation rates, high soil distribution coefficients, and sufficient depths to groundwater. Based on the GTCC EIS evaluation, land disposal facilities located in arid climates (e.g., NNSS and WIPP Vicinity) would isolate radionuclides for a sufficient period of time to allow for significant radioactive decay to occur.

While 10 CFR Part 61 identifies one NRC-approved method for GTCC LLRW disposal (disposal in a geologic repository), these regulations also indicate that other disposal methods could be approved. The GTCC EIS evaluates three land disposal methods (i.e., enhanced near-surface trench, intermediate-depth borehole, and above-grade vault). The GTCC EIS evaluation indicates that land disposal methods employed at sites with suitable characteristics would be viable and safe alternatives for the disposal of GTCC LLRW.

ATTACHMENT

Idaho Department of Environmental Quality Comments on Draft Environmental Impact Statement for the Disposal of Greater-Than-Class C (GTCC) Low-Level Radioactive Waste and GTCC-Like Waste (DOE/EIS-0375-D)

Page 2-6, lines 28-35

The key assumption pertaining to the borehole disposal method that an 8 ft diameter borehole can be drilled to a total depth of 130 ft in "unconsolidated to semiconsolidated soils" is not supported in subsequent text. Lines 13-14 (page 7-11) state the first basalt unit appears to occur at a depth of 43 to 57 ft; therefore, up to 87 ft of borehole would have to be drilled in basalt. Lines 26-29 (page 5-5) indicate an alternate drilling method may be employed to drill smaller diameter boreholes in "consolidated materials" (rock) but this alternate drilling method and diameter are not developed for the reference location at the INL. The rationale for not proceeding with assumptions supported by data presented in the report pertaining to the materials (unconsolidated materials versus rock), prescribed borehole depth (130 ft), and diameter (8 ft diameter) is not provided. Such a rationale is needed to support the analysis.

In addition, that assumption the waste would be placed in unconsolidated soils is not conservative for the reference location on the INL since it appears the waste would be placed into basalt. This is significant because retardation of isotopes is assumed to occur within the unconsolidated materials but not within the basalts above the water table. The modeling is not adequately described to ensure the analysis correctly captures the placement of the waste in the appropriate lithology at the reference location on the INL.

Page 2-16, lines 29-34

The assumption that water infiltration rate will decline to 20% of the background infiltration rate after 500 years following facility closure is neither conservative nor supported by the information presented. The "natural background infiltration rate" should be used post closure of the facility.

Page 2-17, lines 17-22

The summary incorrectly states that K_d for the basalts was assumed to be zero and the text refers to "the basalt layer that is present in some parts of INL..." Table E-4 of the main report identifies the values used for the variable represented by K_d . The table shows the basalts layers present above the water table were simulated with a K_d value of zero but the values of K_d assigned in the modeling where the basalt layers occur below the water table have specific

L2-3

The specific locations that would be used at each potential site for development of a disposal facility for GTCC LLRW and GTCC-like wastes are not known at this time. The use of "reference locations" was used in the EIS to allow for a quantitative assessment of the impacts that could occur at each site. While some parameters could change within a short distance, most would not. Site-specific information provided by technical staff from various sites that were evaluated was used in these modeling analyses to the extent it was available, and conservative assumptions were used to fill any remaining data gaps. The analysis presented in the EIS is adequate for the comparison of the disposal alternatives evaluated. Fate and transport parameters utilized in the estimations were based on site-specific (e.g., specific to the reference location to the extent available) information and, as such, are considered reasonable for the purpose of the comparison made in the EIS. In the case of intermediate depth boreholes and enhanced near surface trenches and vaults at INL, the local stratigraphy was accounted for in the modeling calculations. See Table E-3 in Appendix E for the characteristics of the 5 unsaturated zones (layers), which include basalt layers, used in the calculations. However, DOE recognizes that additional project- and site-specific information could be used to inform the implementation of a disposal facility at a given location. This additional information is expected to reduce the uncertainty associated with these types of evaluations to the extent possible. Site-specific information would be evaluated in any site-specific NEPA review that would be conducted based on a ROD for this EIS.

L2-4

The EIS analyses are based on conceptual engineering information and necessitated the use of a number of simplifying assumptions. This approach is consistent with NEPA, which requires such analyses to be made early in the decision-making process. The various land disposal conceptual designs were assumed to be constructed and operated in a comparable manner at each of the various sites. Information on the conceptual engineering designs for the three proposed land disposal methods is provided in Section D.3 of Appendix D in the EIS. By using the same conceptual designs at all of the sites evaluated in the GTCC EIS, except for cases where a design did not apply (e.g., an intermediate-depth borehole at a site with shallow groundwater), the potential impacts (e.g., radionuclides reaching the groundwater) at the different environmental settings could be readily compared.

In performing these evaluations, a number of engineering measures were included in the conceptual facility designs to minimize the likelihood of contaminant migration from the disposal units. No facility design can guarantee that radionuclide migration from the facility would not occur over and beyond a 10,000-year time period. It was assumed that these measures would perform similarly for all conceptual designs, remaining intact for 500 years after the disposal facility closed. After 500 years, the barriers would gradually fail. To account for these engineered features in the modeling calculations, it was assumed that the water infiltration to the top of the waste disposal area would be zero for the first 500 years and then 20% of the natural rate for the area for the remainder of the time period (through 10,000 years). A water infiltration rate of 20% of the natural rate for the area was only used for the disposal area; the natural background infiltration rate was used at the perimeter of the waste disposal units. Again, this approach enables a comparative evaluation of the influence that site-specific environmental factors would have on the potential migration of radionuclides from the disposal facilities and the potential impacts on human health. It should be emphasized that project- and site-specific engineering factors would be incorporated into the actual facility designs of the site or sites selected in a ROD to dispose of GTCC LLRW and GTCC-like wastes.

DOE recognizes that modeling potential releases of radionuclides from the conceptual disposal sites far into the future approximates what might actually occur. Sufficient detail was included in these designs for use in the EIS analyses, consistent with the current stage of this process. Some of the input values may change in the future and could result in higher impacts (such as from increased precipitation at some sites due to climate change), while others could result in lower impacts (due to decreased precipitation).

values ranging from zero (0) to 160 cm³/g. The multiple basalt layers that occur above the water table are assumed to not retard the movement of the simulated contaminants but the interbeds are assigned the same K_d values as the alluvium. The multiple basalt layers below the water table are assigned specific values for simulating the retardation of the contaminants. The text should be corrected to note the existence of multiple layers of basalt that underlie the INL and the text should be expanded to correctly portray the modeling approach used to simulate contaminant transport using multiple values for K_d as defined for the unsaturated zone and for the saturated zone.

Page 5-5, lines 26-29

The assumption that a "more robust drilling technology" could be employed where consolidated materials are present should have been carried forward into the risk analysis since it is highly likely, based on lines 13-14 (page 7-11) that basalt will be encountered before the total projected depth of 130 ft is reached. The text and analysis should be revised to present a more accurate analysis.

Page 5-7, lines 8-9

The assumption that trenches can be excavated to a depth of 36 ft may be optimistic. Test borings are needed to verify the accuracy of this assumption over the area needed for the disposal facility. Such a caveat should be inserted in the text that only one well has been drilled within the boundary of the GTCC reference location and the depth to basalt in that well is not provided. The inference about the depth of the alluvium over the basalt at the reference location is inferred from unidentified wells in the vicinity of the reference location.

Page 5-28, lines 44-46

This section states "Relatively large doses are required to cause acute effects and potential mechanisms for such exposures include direct intrusion into the disposal units or workers being in the immediate vicinity of a large accidental release during operations."

An additional acute exposure pathway should be included for each disposal method considered for the INL reference site. The INL reference site is located in the Snake River Plain, a volcanic province that was created by a series of cataclysmic caldera-forming super-eruptions which started about 15 million years ago. [1]

Volcanic activity within the province in the form of extrusive lava flows has been estimated to have occurred as recently as 2,250 years ago. Volcanic activity within the Snake River Plain is generally considered dormant rather than extinct. If the hazard analysis period extends out 10,000 years, it should address the possibility and potential impacts of such a flow surfacing at or near the site.

DOE believes that 500 years is a realistic time period for the longevity of the types of engineering barriers assumed in the analyses. DOE believes the approach and the assumptions used in the EIS are reasonable for performing the comparative analysis of alternatives required by NEPA. For example, as discussed in Section E.2.2, the assumption of a 20% natural background infiltration rate after 500 years was based on a study at SRS (Phifer et al. 2007) that indicated that after 10,000 years, the closure cap at the F-area would still shed about 80% of the cumulative precipitation falling on it, with an effectiveness that would be greater before 10,000 years, then decrease very slowly after 10,000 years. The approach used in the EIS is more conservative than indicated by this study. Further detail is provided in Appendix E.

L2-5 See response to L2-3.

L2-6 Site-specific environmental factors such as volcanic activity were evaluated in the EIS as appropriate. The results of the evaluation were taken into consideration in identifying the preferred alternative presented in the Final EIS. A discussion of the risk of volcanic activity is included in Section 7.1.2.1.5 of the EIS. This risk is characterized as being the beyond design basis frequency.

L2-5 (Cont.)

L2-6

Page 7-2, Figure 7.1-1

This figure must be replaced. The image is distorted and misrepresents the locations and boundaries for ATR and INTEC. Portions of INTEC are incorrectly shown on both sides of the Big Lost River. One can only assume the reference location for the disposal facility is correctly placed. See the attached image copied from Google Earth that shows the proper locations for ATR and INTEC.

L2-7

L2-7 The figure was replaced in the Final EIS.

Page 7-10, Figure 1.2-1

The figure indicates the "Lava Ridge-Hell's Half Acre Volcanic Rift Zone (40,000 years)". If this is intended to state the time since last eruption it should be 5200 years. The last eruption was 3250 BC ± 150 years [2]

L2-8

L2-8 The values in parenthesis appearing in Figure 7.1.2-1 do not represent the time elapsed since the last eruption. They represent the recurrence interval computed by Hackett et al (2002) by dividing the number of volcanic events into the age range of volcanism.

Page 7-11, lines 13-18

The key assumption pertaining to the viability of the borehole and the trenching methods is that the depth of unconsolidated "soils" is thick enough. Stratigraphic data from nearby wells are used to estimate the thickness of the unconsolidated "soils" at 43 to 57 ft which is much shallower than the assumption for a 130 ft total depth for the boreholes. Additional on-site data are needed to support the assumption that trenches can be dug to a depth of 36 ft across the reference location. Also, smaller diameter boreholes would probably be needed if basalt is encountered at these shallow depths and the area needed would increase in size to maintain the projected spacing between boreholes. It is not clear if data from well USGS 326 is included in the assessment of the depth to basalt or if it was left out of the assessment. The assumption pertaining to the depth of unconsolidated "soils" should be modified to match the site specific data that is available.

L2-9

L2-9 See response to L2-3.

Page 7-12, Figure 7.1.2-2

A companion figure should be added that shows the geologic cross section for the reference location at a scale that allow the thickness of the alluvium to be assessed. This figure provides little useful information particularly regarding the reference location which is not shown on the plan view.

L2-10

L2-10 See response to L2-3.

Page 7-15, lines 34-37

This very brief discussion regarding soils should be augmented with the previously mentioned cross section for the reference area at a scale that will portray the thickness of the alluvium.

L2-11

L2-11 The level of detail presented here is appropriate for the analyses performed. As the long-term modeling analysis uses primarily average DOE site characteristics for many parameters rather than exact measurements at the reference locations, it would not be appropriate to imply more accuracy than is warranted.

Page 7-17, lines 11-14

These lines state "Other surface water bodies within the INL boundaries include natural wetland-like ponds and several man-made percolation and evaporation ponds...." The locations and approximate sizes of these "natural wetland-like ponds" should be included on a figure that demonstrates the locations relative to the reference location.

L2-12

Page 7-18, lines 28-30

The stated thickness of the alluvium at the reference location is "about 9.1 m (30 ft)." This thickness is not consistent with Section 7.1.2.1.3 (page 7-11) where the stated alluvial thickness is reported to be 43 to 57 ft. This inconsistency should be resolved. The conservative thickness should be used for modeling and assessment of the borehole and trenching proposals.

L2-13

Page 7-18, lines 30-36

This description of the thicknesses of the layers of the unsaturated zone should be clarified for the reader to describe both the layers of basalt and the layers of sedimentary interbeds that interrupt the sequence of basalt flows. It is these layers of sedimentary interbeds that are assigned values for K_d where retardation will occur slowing the movement of the contaminants from the trenches, boreholes, or vaults.

L2-14

Page 7-18, lines 43-44

The stated range of depths to ground water is 200 ft to about 900 ft but lines 23-24 (page 7-18) states the thickness of the unsaturated zone is 400 ft to 800 ft. The thickness of the unsaturated zone and the depth to ground water should be the same in this environment. The correct depth to ground water is 200 ft to about 900 ft and the discussion in lines 23-24 should be edited to match the text on the same page.

L2-15

Page 7-19, lines 3-5

The discussion pertaining to perched aquifers should be separated from the discussion about the regional Snake River Plain Aquifer. As presented, the discussion is not complete and the average reader would likely not understand the relevance of perched aquifers that have been found at ATR and other facilities such as INTEC. Multiple perched aquifers have been found at the facilities often separated aerially and vertically from each other. Please expand this discussion regarding the occurrence of perched aquifers and their potential relevance to this proposal for waste disposal.

L2-16

L2-12 As the locations and approximate sizes of the nearby surface water bodies are not expected to be impacted, do not impact the long-term dose calculations, and might not be near the final location of a potential disposal facility if one were selected for INL, adding additional information would not be relevant to any decisions made based on the EIS analysis.

L2-13 Section 7.1.3.2.1 was re-written for consistency.

L2-14 The characteristics of these layers are further described in Table E-3 in Appendix E.

L2-15 The text has been revised for consistency.

L2-16 Based on INL 2011 (Environmental Assessment for the Replacement Capability for Disposal of Remote-Handled Low-Level Radioactive Waste Generated at the Department of Energy's Idaho Site, DOE/EA-1793) there are no permanent perched water zones under the GTCC reference site. Formation of permanent perched water zones is associated with large surface water discharges from industrial facilities. The perched water under the ATR Complex does not underlie the GTCC reference location and therefore perched water zones would not result in a release of contaminants to surface water.

Page 7-19, lines 34-35

The text incorrectly states "Aquifer recharge occurs mainly through the surface of the ESRP from flow in the channel of the Big Lost River and its diversion area to the south." The Big Lost River is not the main source of recharge to the aquifer. Please correct this text.

Page 7-23, lines 38-45

The rationale supporting the conversion of 666 mrem to a direct radiation dose to a site worker at 120 mrem is not clear. Please revise the text to more clearly state the method used to develop the direct radiation dose.

Page 7-51, lines 31-39

The methodology and assumptions used to calculate the peak annual dose under the borehole method is not apparent compared to the other two methods as written. It appears the calculation is based on the travel times for the uranium isotopes that will arrive in the ground water earlier in the borehole method when compared with the other two methods. The text states the risk is driven by the uranium isotopes which will be "slightly higher than the dose resulting from the C-14, Tc-99, and I-129...." Lines 41-43 (same page) refer the reader to Tables 7.2.4-2 and 7.2.4-3 that show the vault and trenches produce higher doses and risk within the 10,000 year time frame. Lines 4-14 (page 7-54) convey the same message regarding the distribution of risk from the three types of disposal. The statements and tables appear to be in conflict. A revision is recommended to more clearly state the arrival times of the noted contaminants and their respective contribution to peak risk which is driven by the later arriving uranium isotopes and not the mobile C-14, Tc-99, and I-129. See the following comment on lines 4-14 (page 7-54) for further discussion regarding the conflicting messages presented between the text and Figures 7.2.4-1 and 7.2.4-2.

Page 7-54, lines 4-14
Page 7-55, Figures 7.2.4-1 and 7.2.4-2

The predicted radiation doses shown on the figures are not described adequately to explain why the arrival times of the isotopes in ground water are shorter for the borehole disposal method than with the trenches or vaults yet the predicted doses are higher for the trenches and vaults. The discussion needs to describe the modeling assumptions that result in the apparent shorter travel times to the ground water but higher doses with the longer travel times.

- L2-17 Text in Section 7.1.3.2.3 was modified to reflect the fact that recharge to the Eastern Snake River Plain aquifer is principally from infiltration of applied irrigation water, infiltration of stream flow from the Big Lost River, and ground-water inflow from adjoining mountain drainage basins.
- L2-18 Based on TLD measurements, if someone were present the entire time over the course of one year at the location with the highest site radiation level, they would receive approximately 666 mrem. Of that 666 mrem, approximately 122 mrem was from natural background radiation for the area. Thus, the dose from site activities would be about 666 – 122 = 544 mrem. If someone, such as a worker, were exposed at that location for 2000 hours per year, rather than the entire 8,766 hours in one year, they would receive a dose of about 544 x 2,000/8,766 = 120 mrem (rounded to 2 significant figures). The text was modified for clarity.
- L2-19 The methodology and assumptions used to calculate the peak doses are the same for the three different disposal methods considered. There is no conflict between the text and the figures. However, to facilitate a better understanding of the results, the text was revised so that the two figures are referenced and explained first before the discussions moves on to cover the information presented in the tables.
- L2-20 Additional discussion of the modeling assumptions and their influence on the dose results was added to Section 7.2.4.2. The travel times for radionuclides to reach the groundwater table are shorter for the borehole disposal method than for the trench and vault disposal methods because the bottom of the boreholes will be located closer to the groundwater table than the bottoms of the trenches and vaults. The peak doses for the borehole method were estimated to be smaller than those for the vault and trench methods because the footprint of a borehole disposal facility would be larger than that of a vault or trench disposal facility. As a result, the distance that the majority of the contamination needs to travel, after arriving at the groundwater table, to reach an offsite well located at 100 m from the edge of the disposal facility, would be greater for the borehole method than that for the vault or trench method (although the leading edge of the contamination for the borehole method would arrive first). The larger disposal area and also the greater distance for a majority of the contamination would result in greater dilution in the groundwater concentrations, and consequently, would yield smaller peak doses.

L2-17

L2-18

L2-19

L2-20

Page 7-67, lines 41-43

This section states that a radiological release from the GTCC reference location could have an impact on the Advanced Test Reactor (ATR) facility, since the ATR is considered historically significant. There is no mention of the potential impact to the Engineering Breeder Reactor I (EBR-I) facility, a National Historic Landmark, which is located approximately four miles to the SSW (generally down gradient) of the proposed GTCC reference location. Please consider adding the potential for impact to the EBR-I site to this section.

Page E-30, Appendix E, Table E-3

Please provide a rationale in a footnote for using a density for "sandy clay/clay" in Unsaturated Zone 1 when the alluvium is described as "coarse-grain unit consisting of predominantly sand and gravel."

Page E-30, Appendix E, Table E-3

The contaminated zone dry bulk density is a soil parameter and is the ratio of the mass of the solid phase of the soil (i.e., dried soil) to its total volume. [3] The typical value used for INL is 1.5. The values for bulk density used elsewhere in appendix E should be reviewed and adjusted to reflect sand, clay, gravel, "fractured Basalt" (instead of basalt) per the discussion in Draft GTCC EIS sections 7.1.3.2 and its sub-sections.

Page E-30, Appendix E, Table E-3

The b-parameter used in the model for the contaminated zone is 5.3 which is a default value in RESRAD corresponding to silty loam. "The soil-specific b parameter is an empirical fitting parameter and, therefore, must be determined experimentally. For each type of soil, the best estimate of b can be obtained by adjusting the best-fit values of each soil to an experimentally determined curve of relative permeability versus saturation, according to the power function model" [4]

$$R_s = (I_r / K_{sat}) (1 / 2b + 3)$$

Where R_s is the saturation ratio (dimensionless), and b is the fitting parameter, called the soil-specific exponential parameter, I_r the downward water infiltration rate and K_{sat} the saturated hydraulic conductivity.

When the b parameter cannot be experimentally determined the values in the following table should be used.

L2-21 The ATR Complex is approximately 0.75 miles from the reference location and the EBR-1 site is located approximately 4 miles to the south-southwest of the reference location. The ATR and EBR-1 sites are over 400 feet above the aquifer and would not be impacted by contaminated groundwater under any conceivable scenario. There are no surface water sources extending between the GTCC reference location and the ATR or the EBR-1 sites. Therefore, radionuclides would not have the possibility of contaminating surface water and then the buildings during operations or post-closure. Therefore, the only exposure source would be from a potential accident via airborne releases from the facility. Based on a credible accident scenario during operation of a potential disposal facility and the prevailing wind direction, air deposition of radionuclides from an accident at the reference location would have little potential to impact the EBR-1 reactor building.

L2-21 L2-22 The density of alluvium was judged to be between those of sandy and clayey soils. Because the measured value for alluvium was not available, the value for sandy clay soil was used. On the other hand, the range of bulk density for different types of soil is small which, in conjunction with the fact that soil bulk density is not a very sensitive parameter, i.e. its influence on the modeling result is small, the use of the density for sandy slay was determined to be acceptable.

L2-22 L2-23 The way RESRAD-OFFSITE was used for groundwater modeling in the EIS deviates from the typical use of the code. The radionuclide release rates from the contaminated zone were pre-calculated and input to the code rather than were calculated by the code using the input parameters of the contaminated zone. Therefore, the soil bulk density of the contaminated zone was not used in the dose modeling. Regarding the soil densities for the unsaturated zones and saturated zone, the input values had been reviewed by INL site representatives before being used in the dose modeling.

L2-23 L2-24 In the EIS modeling, the contaminated zone consists of the waste materials, the waste containers, and the back fill soils. Therefore, the homogeneously contaminated soil assumption associated with a typical contaminated zone for RESRAD-OFFSITE modeling is not applicable. In the EIS modeling, the release rates of radionuclides from the contaminated zone were pre-calculated and input to the code, so the calculation involving a homogeneous contaminated zone was bypassed. Because of this, the input soil-b parameter was not used in the RESRAD-OFFSITE dose calculations and the RESRAD-OFFSITE default value was listed in the table.

Representative Values of Soil-Specific Exponential b Parameter

Texture	Soil-Specific Exponential Parameter, b
Sand	4.05
Loamy sand	4.38
Sandy loam	4.90
Silty loam	5.30
Loam	5.39
Sandy clay loam	7.12
Silty clay loam	7.75
Clay loam	8.52
Sandy clay	10.40
Silty clay	10.40
Clay	11.40

Source: Clapp and Hornberger (1978).

In this case a value ranging from 4.05 to 4.9 should be used instead of the RESRAD default value.

Notes

1. NPS (1991). *Craters of the Moon: National Park Handbook (139)*. Washington D.C.: National Park Service Division of Publications. ISBN 0-912627-44-1.
2. Kuntz, et al., "Radiocarbon Studies of Latest Pleistocene and Holocene Lava Flows of the Snake River Plain, Idaho: Data, Lessons, Interpretations," *Quaternary Research*, February 1986, p. 163.
3. ANL (1993). DATA COLLECTION HANDBOOK TO SUPPORT MODELING IMPACTS OF RADIOACTIVE MATERIAL IN SOIL , Chapter 2, section 2.12
4. ANL (1993). DATA COLLECTION HANDBOOK TO SUPPORT MODELING IMPACTS OF RADIOACTIVE MATERIAL IN SOIL , Chapter 13

State of Idaho, Department of Environmental Quality, Commenter ID No. L2 (cont'd)

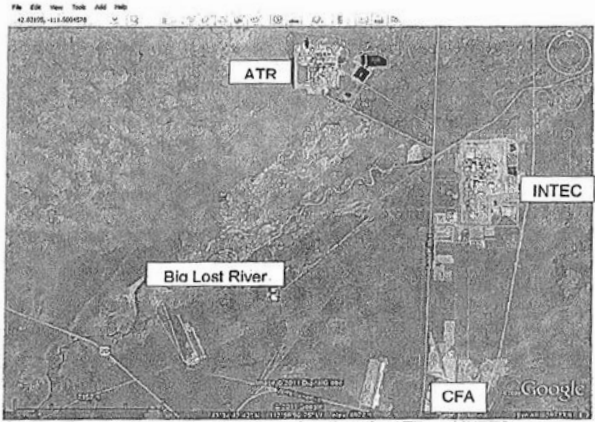

Google Earth image showing the proper locations for ATR and INTEC.

State of Idaho, Governor's Office, Commenter ID No. T18

1
2
3
4
5
6
7
8
9
10
11
12
13
14
15
16
17
18
19
20
21
22
23
24
25

So with that, by introduction, let me
call our first speaker from the Governor's office,
Mike Webster, and he will be followed by Stevan Piet.

MIKE WEBSTER: I think you already introduced
me, didn't you?

MR. BROWN: I did.

MIKE WEBSTER: That's not on the record.

MR. BROWN: You can confirm identification.

1 MIKE WEBSTER: Okay. I'm Mike Webster
2 from -- representing the Governor of the great State
3 of Idaho. And his letter reads:
4 "Dr. Steven Chu, Secretary, U.S.
5 Department of Energy. Regards: Greater-Than-Class C
6 Waste Disposal Draft Environmental Impact Statement.
7 Dear Secretary Chu, as Governor, I write to express
8 my objection to the U.S. Department of Energy's
9 proposal to dispose of Greater-Than-Class C waste or
10 GTCC-like waste generated outside of Idaho in our
11 great state.
12 The Idaho National Laboratory is a
13 preeminent nuclear energy research and engineering
14 facility and a valuable asset to the nation and
15 Idaho. I firmly believe the INL will be a leader in
16 our nation's nuclear renaissance. Proposing the INL
17 as a disposal site for GTCC waste is inconsistent
18 with my vision for the Site and incompatible with its
19 mission to ensure the nation's energies, security
20 with safe, competitive, and sustainable energy
21 systems, and unique national and homeland security
22 capabilities. Idaho embraces this vision for the
23 future of INL and is not willing to risk that future
24 by turning INL into a disposal facility for the
25 off-site waste.

T18-1

T18-1

The disposal methods and sites evaluated in the EIS represent the range of reasonable alternatives for the disposal of GTCC LLRW and GTCC-like wastes. This range is consistent with NEPA implementing regulations in Parts 1500–1508 of Title 40 of the Code of Federal Regulations (40 CFR Parts 1500–1508). In this GTCC EIS, DOE analyzed a range of disposal methods (i.e., geologic repository, near-surface trench, intermediate-depth borehole, and above-grade vault) and federally owned sites (i.e., Hanford Site, INL, LANL, NNSS, SRS, and the WIPP Vicinity, for which two reference locations – one within and one outside the WIPP Land Withdrawal Boundary – were considered). DOE has determined that it was reasonable to analyze these six sites because they currently have operating radioactive waste disposal facilities, except for the WIPP Vicinity, which is near an operating geologic repository.

DOE also conducted a generic evaluation of commercial disposal facilities on nonfederal lands in the EIS to order to provide, to the extent possible, information regarding the potential long-term performance of other (nonfederal) locations for siting a GTCC waste land disposal facility.

Final siting of a disposal facility for GTCC LLRW and GTCC-like wastes would involve further NEPA review as needed and be in accordance with applicable laws and regulations and would involve local stakeholder involvement and consent.

1 The potential selection of the INL for
2 the GTCC waste is contradictory to the DOE's cleanup
3 progress in Idaho. As you know, the INL has been
4 used in the past to store or dispose of radioactive
5 waste that was generated outside of Idaho. Some of
6 that historic waste is similar to the GTCC or
7 GTCC-like waste under consideration in the Draft EIS.

8 The State and DOE resolved years of
9 conflict regarding the historic waste by agreeing to
10 a retrieval and a removal program that had been
11 successfully implemented by DOE. Selecting INL now
12 would be inconsistent with the intent and
13 understandings of the 1995 Settlement Agreement.

14 In the face of our agreements and the
15 great progress DOE has made, it makes no sense to
16 change directions by selecting INL for further
17 disposal of additional out-of-state radioactive
18 waste.

19 The Nuclear Regulatory Commission
20 regards deep geological disposal of GTCC as the most
21 appropriate method. Such repository currently exists
22 in other states and should be selected as the
23 disposable site for this material.

24 Even if alternatives to deep geological
25 disposal, such as trenches, deep bore holes, or

T18-2

T18-3

T18-4

T18-2 DOE is performing environmental restoration activities at INL. The ongoing cleanup effort will continue. DOE fully supports the 1995 Settlement Agreement. In selection of the preferred alternative, exiting agreements were taken into consideration.

T18-3 DOE agrees that use of a geologic repository would be a protective and safe method for the disposal of the entire inventory of GTCC LLRW and GTCC-like wastes. The GTCC EIS evaluation for the WIPP geologic repository alternative supports this statement. However, the degree of waste isolation provided by a geologic repository may not be necessary for all of the GTCC LLRW and GTCC-like wastes evaluated in the GTCC EIS. The GTCC EIS evaluation indicates that certain wastes (e.g., those containing short-lived radionuclides such as Cs-137 irradiators) could be safely disposed of in properly designed land disposal facilities at sites with suitable characteristics, such as low precipitation rates, high soil distribution coefficients, and sufficient depths to groundwater. Based on the GTCC EIS evaluation, land disposal facilities located in arid climates (e.g., NNSS and WIPP Vicinity) would isolate radionuclides for a sufficient period of time to allow for significant radioactive decay to occur.

While 10 CFR Part 61 identifies one NRC-approved method for GTCC LLRW disposal (disposal in a geologic repository), these regulations also indicate that other disposal methods could be approved. The GTCC EIS evaluates three land disposal methods (i.e., enhanced near-surface trench, intermediate-depth borehole, and above-grade vault). The GTCC EIS evaluation indicates that land disposal methods employed at sites with suitable characteristics would be viable and safe alternatives for the disposal of GTCC LLRW.

T18-4 In site evaluation and the selection of the preferred alternative, factors such as geology (basalt) and groundwater (sole source aquifers) were taken into consideration.

1 vaults are deemed acceptable, the INL is located on
2 top of the Snake River Plain Aquifer, the largest
3 fractured basalt aquifer in the country, estimated to
4 have a volume the size of Lake Erie. It is a
5 federally designated sole source aquifer for more
6 than 200,000 people. As such, the INL is not a
7 suitable disposal site when other safer and more
8 appropriate locations are available.

9 I understand the DOE must consider a
10 range of alternatives in this decision-making
11 process; however, the INL is not a viable option for
12 the aforementioned reasons.

13 In Idaho, we are working towards a new
14 tomorrow when it comes to nuclear energy. We want to
15 close the chapter as an off-site disposal facility
16 and continue as a leader in the nuclear renaissance.

17 Additional written comments will be
18 provided by the State, through the Department of
19 Environmental Quality during the public comment
20 period.

21 Please do not hesitate to contact my
22 office at (208)334-2100; or Toni Hardesty, Director
23 of DEQ at (208)373-0502.

24 As always-Idaho, Esto Perpetua, C.L.
25 "Butch" Otter, Governor of Idaho.

T18-4
(Cont.)

State of Idaho, Governor's Office, Commenter ID No. T18 (cont'd)

1 Thank you.
2 MR. BROWN: Thanks very much.
3 Stevan Piet.
4 MIKE WEBSTER: I give this to whom?
5 MR. BROWN: The court reporter. Thank you.
6



C. L. "BUTCH" OTTER
GOVERNOR

May 11, 2011

Dr. Steven Chu
Secretary
U.S. Department of Energy
1000 Independence Ave., SW
Washington, DC 20585

VIA U.S. MAIL & HAND DELIVERY

RE: Greater-Than-Class C Waste Disposal Draft Environmental Impact Statement

Dear Secretary Chu,

As Governor I write to express my objection to the U.S. Department of Energy's (DOE) proposal to dispose of Greater-Than-Class C waste (GTCC) or GTCC-like waste generated outside of Idaho in our great state.

The Idaho National Laboratory (INL) is a pre-eminent nuclear energy research and engineering facility and a valuable asset to the nation and to Idaho. I firmly believe the INL will be a leader in our nation's nuclear renaissance. Proposing the INL as a disposal site for GTCC waste is inconsistent with my vision for the site and incompatible with its mission to "[e]nsure the nation's energy security with safe, competitive, and sustainable energy systems and unique national and homeland security capabilities." Idaho embraces this vision for the future of INL and is not willing to risk that future by turning INL into a disposal facility for off-site waste.

The potential selection of the INL as a disposal site for GTCC waste is contradictory to the DOE's cleanup progress in Idaho. As you know, the INL has been used in the past to store or dispose of radioactive waste that was generated outside of Idaho. Some of that historic waste is similar to the GTCC or GTCC-like waste under consideration in the draft EIS. The State and DOE resolved years of conflict regarding the historic waste by agreeing to a retrieval and removal program plan that is being successfully implemented by DOE. Selecting INL now would be inconsistent with the intent and understandings of the 1995 Settlement Agreement. In the face of our agreements and the great progress DOE has made, it makes no sense to change direction by selecting INL for further disposal of additional out of state radioactive waste.

The Nuclear Regulatory Commission requires deep geological disposal for GTCC as the most appropriate method. Such a repository currently exists in other states and should be selected as the disposal site for this material. Even if alternatives to deep geological disposal such as trenches, deep bore holes or vaults

STATE CAPITOL • BOISE, IDAHO 83720 • (208) 334-2100

L298-1

L298-2

L298-3

L298-4

L298-1 The disposal methods and sites evaluated in the EIS represent the range of reasonable alternatives for the disposal of GTCC LLRW and GTCC-like wastes. This range is consistent with NEPA implementing regulations in Parts 1500–1508 of Title 40 of the Code of Federal Regulations (40 CFR Parts 1500–1508). In this GTCC EIS, DOE analyzed a range of disposal methods (i.e., geologic repository, near-surface trench, intermediate-depth borehole, and above-grade vault) and federally owned sites (i.e., Hanford Site, INL, LANL, NNSS, SRS, and the WIPP Vicinity, for which two reference locations – one within and one outside the WIPP Land Withdrawal Boundary – were considered). DOE has determined that it was reasonable to analyze these six sites because they currently have operating radioactive waste disposal facilities, except for the WIPP Vicinity, which is near an operating geologic repository.

DOE also conducted a generic evaluation of commercial disposal facilities on nonfederal lands in the EIS to order to provide, to the extent possible, information regarding the potential long-term performance of other (nonfederal) locations for siting a GTCC waste land disposal facility.

Final siting of a disposal facility for GTCC LLRW and GTCC-like wastes would involve further NEPA review as needed and be in accordance with applicable laws and regulations and would involve local stakeholder involvement and consent.

L298-2 DOE is performing environmental restoration activities at INL. The ongoing cleanup effort will continue. DOE fully supports the 1995 Settlement Agreement. In selection of the preferred alternative, exiting agreements were taken into consideration.

L298-3 DOE agrees that use of a geologic repository would be a protective and safe method for the disposal of the entire inventory of GTCC LLRW and GTCC-like wastes. The GTCC EIS evaluation for the WIPP geologic repository alternative supports this statement. However, the degree of waste isolation provided by a geologic repository may not be necessary for all of the GTCC LLRW and GTCC-like wastes evaluated in the GTCC EIS. The GTCC EIS evaluation indicates that certain wastes (e.g., those containing short-lived radionuclides such as Cs-137 irradiators) could be safely disposed of in properly designed land disposal facilities at sites with suitable characteristics, such as low precipitation rates, high soil distribution coefficients, and sufficient depths to groundwater. Based on the GTCC EIS evaluation, land disposal facilities located in arid climates (e.g., NNSS and WIPP Vicinity) would isolate radionuclides for a sufficient period of time to allow for significant radioactive decay to occur.

While 10 CFR Part 61 identifies one NRC-approved method for GTCC LLRW disposal (disposal in a geologic repository), these regulations also indicate that other disposal methods could be approved. The GTCC EIS evaluates three land disposal methods (i.e., enhanced near-surface trench, intermediate-depth borehole, and above-grade vault). The GTCC EIS evaluation indicates that land disposal methods employed at sites with suitable characteristics would be viable and safe alternatives for the disposal of GTCC LLRW.

L298-4 In site evaluation and the selection of the preferred alternative, factors such as geology (basalt) and ground water (sole source aquifers) were taken into consideration.

State of Idaho, Governor's Office, Commenter ID No. L298 (cont'd)

basalt aquifer in the country estimated to have a volume the size of Lake Erie. It is a federally designated "sole source" aquifer for more than 200,000 people. As such, the INL is not a suitable disposal site when other safer and more appropriate locations are available.

I understand the DOE must consider a range of alternatives in this decision-making process; however the INL is not a viable option for the aforementioned reasons. In Idaho we are working towards a new tomorrow when it comes to nuclear energy. We want to close the chapter as an off-site disposal facility and continue as a leader in the nuclear renaissance.

Additional written comments will be provided by the State, through the Department of Environmental Quality (DEQ) during the public comment period. Please do not hesitate to contact my office at (208) 334-2100 or Toni Hardesty, Director of DEQ at (208) 373-0502.

As Always-Idaho, "Esto Perpetua"

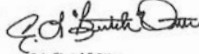

C. L. "Butch" Otter
Governor of Idaho

L298-4
(Cont.)

State of Nevada Agency for Nuclear Projects, Commenter ID No. E45

From: gtcciswebmaster@anl.gov
Sent: Thursday, June 23, 2011 4:45 PM
To: mail_gtccisarchives; gtcciswebmaster@anl.gov; gtccis@anl.gov
Subject: Greater-Than-Class-C Low-Level Radioactive Waste EIS Comment GTCC10381
Attachments: State_of_Nevada_Comments_-_Draft_GTCC_Waste_EIS_GTCC10381.pdf

Thank you for your comment, Joseph Strolin.

The comment tracking number that has been assigned to your comment is GTCC10381. Please refer to the comment tracking number in all correspondence relating to this comment.

Comment Date: June 23, 2011 04:44:25PM CDT

Greater-Than-Class-C Low-Level Radioactive Waste EIS Draft Comment: GTCC10381

First Name: Joseph
Middle Initial: C
Last Name: Strolin
Organization: State of Nevada
Address: Agency for Nuclear Projects
Address 2: Office of the Governor
Address 3: 1761 E. College Parkway, Ste. 118
City: Carson City
State: NV
Zip: 89706
Country: USA
Email: jstrolin@nuc.state.nv.us
Privacy Preference: Don't withhold name or address from public record
Attachment: C:\Documents and Settings\Joe\Desktop\GTCC Draft EIS 2-2011\State of Nevada Comments - Draft GTCC Waste EIS.pdf

Comment Submitted:
Attached are the State of Nevada's comments on DOE's Draft EIS for Disposal of Greater-Than-Class C Low-Level Radioactive Waste and GTCC-Like Waste.

Sincerely,

Joseph C. Strolin
Acting Executive Director
Nevada Agency for Nuclear Projects
Office of the Governor
1761 E. College Parkway, Suite 118
Carson City, Nevada 89706
775-687-3744

State of Nevada Agency for Nuclear Projects, Commenter ID No. E45 (cont'd)

Questions about submitting comments over the Web? Contact us at: gtcciswebmaster@anl.gov or call the Greater-Than-Class-C Low-Level Radioactive Waste EIS Webmaster at (630) 252-5705.

State of Nevada Agency for Nuclear Projects, Commenter ID No. E45 (cont'd)

From: Joe Strolin <jstrolin@nuc.state.nv.us>
Sent: Thursday, June 23, 2011 4:40 PM
To: gtcceis@anl.gov
Subject: State of Nevada Comments on DOE's Draft EIS for Disposal of GTCC Waste
Attachments: State of Nevada Comments - Draft GTCC Waste EIS.pdf

Attached please find the State of Nevada's comments on DOE Draft EIS for Disposal of Greater-Than-Class C Low-Level Radioactive Waste and GTCC-Like Waste. The comments are submitted in response to the notice of availability in the Federal Register of February 25, 2011.

I would appreciate it if you would acknowledge receipt of these comments by replying to this email or by calling my office at 775-687-3744.

Sincerely,

*Joseph C. Strolin, Acting Executive Director
Nevada Agency for Nuclear Projects
Office of the Governor
1761 E. College Parkway, Suite 118
Carson City, Nevada 89706
775-687-3744*

BRIAN SANDOVAL
Governor

STATE OF NEVADA

JOSEPH C. STROLIN
Acting Executive Director



OFFICE OF THE GOVERNOR
AGENCY FOR NUCLEAR PROJECTS
1761 E. College Parkway, Suite 118
Carson City, NV 89706-7954
Telephone (775) 687-3744 • Fax (775) 687-5277
E-mail: owpo@nuc.state.nv.us

June 23, 2011

Mr. Arnold M. Edelman, EIS Document Manager
U.S. Department of Energy, GTCC EIS
Cloverleaf Building, EM-43
1000 Independence Avenue, SW
Washington, DC 20585

RE: State of Nevada Comments on DOE's Draft Environmental Impact Statement for the Disposal of Greater-Than-Class C (GTCC) Low-Level Radioactive Waste and GTCC-Like Waste (DOE/EIS-0375-D)

Dear Mr. Edelman:

Enclosed please find the State of Nevada's comments on DOE's Draft Environmental Impact Statement for the Disposal of Greater-Than-Class C (GTCC) Low-Level Radioactive Waste and GTCC-Like Waste.

If you have questions regarding these comments or would like additional information, please let me know.

Sincerely,

Joseph C. Strolin
Acting Executive Director

JCS/js
Enclosure

cc Marta Adams, Senior Deputy Attorney General
Nevada State Clearinghouse

STATE OF NEVADA COMMENTS
ON DOE'S DRAFT ENVIRONMENTAL IMPACT STATEMENT
FOR THE DISPOSAL OF GREATER-THAN-CLASS C (GTCC) LOW-LEVEL
RADIOACTIVE WASTE AND GTCC-LIKE WASTE (DOE/EIS-0375-D)¹

Submitted by
The Nevada Agency for Nuclear Projects
Office of the Governor
June 23, 2011

1.0 General Comments

1.1 The Nevada Nuclear Security Site (NNSS) as a Potential Disposal Location

In comments on the Notice of Intent (NOI) to prepare an Environmental Impact Statement (EIS) for the disposal of Greater-Than-Class C waste in 2007, the State of Nevada voiced serious reservations about the appropriateness of the Nevada Test Site (since renamed NNSS) as a location for disposal of GTCC waste². In those comments, the State pointed to continuing issues associated with allowable new activities at NNSS, given the site's statutory designation as a "weapons testing site." Those concerns still have not been resolved. In addition, while NNSS has been a site for the disposal of low-level and mixed hazardous and low-level radioactive waste, the nature and characteristics of GTCC wastes and the longer-lived radionuclides they contain pose added and unacceptable long-term risks, given the geophysical conditions at NNSS.

Many of the same conditions that made Yucca Mountain an unsuitable site for long-term geologic isolation of radioactive wastes are also present at the NNSS (i.e., active seismic area; fast groundwater pathways; potential for renewed volcanism; highly corrosive subsurface environment; etc.). In addition, there are serious issues involving the potential for cumulative impacts to the environment from past weapons testing activities (and resulting contamination) and from current and future low-level and mixed-low-level waste disposal activities.

NNSS also poses serious problems with regard to the transportation of GTCC waste and GTCC-like waste from generator and storage sites to any disposal facility that might be located at NNSS. As discussed below, of all the potential disposal locations evaluated in the DEIS, NNSS is by far the most problematic from a transportation standpoint. The fact that transportation factors were not used to discriminate between potential alternative disposal locations, and only overly general cumulative radiation dose calculations were used to compare one site to another with respect to transportation impacts, are major shortcomings of the DEIS.

¹ The Draft Environmental Impact Statement for Greater-Than-Class C (GTCC) Low-Level Radioactive Waste and GTCC-Like Waste is referred to in these comments as the "DEIS".

² Unless otherwise specified, the term "GTCC waste" as used in these comments refers to both GTCC low-level radioactive waste (as defined in the DEIS) and "GTCC-Like" waste.

E45-1

The NNSS was originally created through the issuance of four administrative Public Land Orders by the Secretary of the Interior. Public Land Order 805, dated February 12, 1952, reserved lands for the use of the U.S. Atomic Energy Commission (AEC), DOE's predecessor, as a weapons testing site. Subsequent administrative land withdrawals through 1965 reserved the withdrawn lands for use of the AEC in connection with the NNSS. The 1961 Public Land Order specifically mentioned that it reserved the lands for use of the AEC "in connection with the Nevada Test Site for test facilities, roads, utilities, and safety distances." The Military Lands Withdrawal Act of 1999 withdrew the northwestern area of the NNSS (Pahute Mesa) for exclusive use of DOE. This area had previously been utilized by DOE and its predecessors under a Memorandum of Understanding with the U.S. Air Force.

The U.S. Department of the Interior (DOI) is vested with oversight responsibility to review existing land withdrawals under the Federal Land Policy and Management Act. The DOI suggested in its comments on the 1996 NTS EIS (which included proposals for commercial reuse of the site) that substantial changes in land use at the NTS may require a new land withdrawal. As part of the April 1997 Settlement Agreement resolving State of Nevada litigation regarding radioactive waste disposal at the NTS (State of Nevada v. Peña, U.S. District Court, District of Nevada, 1997), DOE committed to initiate "consultation with the United States Department of the Interior ('DOI') concerning the status of the existing land withdrawals for NTS with regard to low-level waste storage/disposal activities." The consultation process was initiated by DOE with DOI shortly thereafter and was concluded in November 2009, with NNSS's acceptance of custody and control of the approximately 740 acres constituting the NNSS Area 5 Radioactive Waste Management Complex. This facility is part of NNSS's continuing environmental management mission as a disposal facility for low-level waste (LLW) and mixed low-level waste (MLLW). All radioactive waste management at the NNSS is conducted in accordance with applicable federal, state and local regulations.

Site-specific environmental factors such as geophysical conditions were evaluated in the EIS. The results of the evaluation were taken into consideration in identifying the preferred alternative presented in the Final EIS.

E45-1

The State's comments on the 2007 NOI indicated that NNSS was an unacceptable location for disposal of GTCC waste and GTCC-like waste. There is nothing in this DEIS that would alter that assessment.

1.2 The need for NRC Regulation of any GTCC Waste Disposal Activities

The DEIS acknowledges that most of the GTCC waste to be disposed of will be commercial waste generated by current and future Nuclear Regulatory Commission (NRC) licensees, and that, by law, a GTCC waste facility must be regulated/licensed by the NRC. Inclusion of DOE's GTCC-like wastes currently managed under DOE Orders and stored at DOE facilities that operate under DOE Orders requires that these be brought into the NRC regulatory regime. The DEIS does not directly address this issue and, in fact, does not even commit to the NRC licensing and regulation of any disposal facility established pursuant to the Final EIS. NRC licensing is not a simple process, as evidenced by the high-level waste program where the decision was made to co-mingle commercial and defense waste. Major issues and additional regulatory authority matters arise with respect to all of the DOE sites that are under consideration for a GTCC waste facility. The DEIS failed to describe how a NRC-regulated facility can co-exist with a DOE self-regulated facility or an EPA/state-regulated facility such as WIPP, and how the public can be assured that NRC regulatory authority has primacy at the GTCC facility.

Issues of NRC regulation also arise with regard to the transportation of GTCC waste, including the requirement for use of NRC certified shipping containers, requirements involving shipments notifications, NRC transportation safeguards regulations, and others.

1.3 Seriously Deficient Transportation Analysis

The analysis of transportation impacts associated with shipments of GTCC waste and GTCC-like waste in the DEIS is seriously deficient. Most importantly, transportation system characteristics and the effects of waste shipments along specific routes (rail and highway) through specific communities, using specific modes of transport are not used as criteria in evaluating whether identified alternative disposal locations are viable or appropriate. Nor are transportation factors such as these used to compare alternative disposal sites and discriminate among the various sites. Because of the substantial nature of the shipping campaign required for the disposal of GTCC waste, transportation considerations should be a major factor in identifying alternative disposal sites. If that had been done, sites like NNSS, where transportation access is limited and extremely problematic, would have been eliminated from consideration.

Transportation of GTCC waste to any disposal facility located at NNSS would involve unacceptable impacts for the State of Nevada in general and the heavily populated Las Vegas metropolitan area in particular. Since there is no rail access to NNSS, and the cost for constructing such access would be in the neighborhood of \$3 billion (according to DOE's own estimates that were done for the Yucca Mountain project), it is entirely unrealistic to assume that GTCC waste would be shipped via rail to the site. Consequently, all of the waste would have to be moved to the site by truck, requiring 12,600 shipments. Many of these shipments, according to the DEIS, would be "Highway Route-Controlled Quantity" (HRCQ) shipments. By law, HRCQ shipments must use the Interstate highway system and would, of necessity, pass through

E45-2 The disposal methods and sites evaluated in the EIS represent the range of reasonable alternatives for the disposal of GTCC LLRW and GTCC-like wastes. This range is consistent with NEPA implementing regulations in Parts 1500-1508 of Title 40 of the Code of Federal Regulations (40 CFR Parts 1500-1508). In this GTCC EIS, DOE analyzed a range of disposal methods (i.e., geologic repository, near-surface trench, intermediate-depth borehole, and above-grade vault) and federally owned sites (i.e., Hanford Site, INL, LANL, NNSS, SRS, and the WIPP Vicinity, for which two reference locations - one within and one outside the WIPP Land Withdrawal Boundary - were considered). DOE has determined that it was reasonable to analyze these six sites because they currently have operating radioactive waste disposal facilities, except for the WIPP Vicinity, which is near an operating geologic repository.

E45-2 DOE also conducted a generic evaluation of commercial disposal facilities on nonfederal lands in the EIS to order to provide, to the extent possible, information regarding the potential long-term performance of other (nonfederal) locations for siting a GTCC waste land disposal facility.

E45-3 The LLRW PAA (P.L. 99-240) assigns DOE responsibility for the disposal of GTCC LLRW generated by NRC and Agreement State licensees. The LLRW PAA (P.L. 99-240) specifies that GTCC LLRW, designated a federal responsibility under section 3(b)(1)(D) that results from activities licensed by the NRC, is to be disposed of in an NRC-licensed facility that has been determined to be adequate to protect public health and safety. However, unless specifically provided by law, the NRC does not have authority to license and regulate facilities operated by or on behalf of DOE. Further, the LLRW PAA does not limit DOE to using only non-DOE facilities or sites for GTCC LLRW disposal. Accordingly, if DOE selects a facility operated by or on behalf of DOE for disposal of GTCC LLRW for which it is responsible under section 3(b)(1)(D), clarification from Congress would be needed to determine NRC's role in licensing such a facility and related issues. In addition clarification from Congress may be needed on NRC's role if DOE selects a commercial GTCC LLRW disposal facility licensed by an Agreement State rather than by NRC.

E45-4 DOT and the NRC have primary responsibility for federal regulations governing commercial radioactive materials transportation. Non-DOE shipments of GTCC LLRW from commercial sites would be transported by commercial carriers and would be regulated by DOT and the NRC. In addition, DOE shipments by commercial carriers of GTCC LLRW from commercial sites or of GTCC-like waste from DOE sites would be regulated by DOT and NRC.

E45-5 DOE has broad authority under the AEA to regulate all aspects of activities involving radioactive materials that are undertaken by DOE or undertaken on its behalf, including the transportation of radioactive wastes. However, in most cases that do not involve national security, DOE does not exercise its authority to regulate DOE shipments and instead utilizes commercial carriers that undertake shipments of DOE materials under the same terms and conditions as those used for commercial shipments. These shipments are subject to regulation by DOT and the NRC. As a matter of policy, however, even in the limited circumstances where DOE exercises its AEA authority for shipments, DOE requirements mandate that all DOE shipments be undertaken in accordance with the requirements and standards that apply to comparable commercial shipments, unless there is a determination that national security or another critical interest requires different action.

E45-5 Calculation of the collective population risk (under routine and accident conditions) is provided in the EIS. While these estimates are conservative, the calculations used expected values where practical (e.g., external shipment dose rates) and provide a reasonable measure for comparison among alternatives, as summarized in Tables 2.7 5 and 2.7 6, and the estimates show that the transportation risks would be small. All alternatives involve routes of hundreds of miles through similar types of rural, suburban, and urban areas. For specific local impacts, Section 5.3.9.2 provides information on potential human health impacts on individuals during

the most heavily populated portions of Las Vegas and Clark County. Such a shipping campaign would put Las Vegas' tourism-dependent economy at substantial risk in the event of an accident or terrorist attack against a shipment while in transit.

Transportation impacts associated with the disposal of GTCC waste generally, and with respect to NNSC in particular, do not appear to have been adequately addressed in the DEIS. The draft document uses an overly general approach to radiological impact assessment for GTCC waste shipments and ignores the importance of non-radiological factors in defining the true scope and nature of impacts associated with such transportation. Important non-radiological impacts are not used to discriminate among potential disposal locations. Additional issues that should have been covered in the DEIS include, but are not necessarily limited to, differential analyses of impacts associated with various modes of shipment (highway, rail, barge); routing issues and impacts, including the identification of specific preferred and alternative routes from generator/storage sites to proposed disposal locations and the unique characteristics along those routes; property value effects; and risk perception impacts (and their attendant economic consequences) associated with prospective GTCC shipments.

1.4 Lessons from the Failed Federal High-Level Radioactive Waste Program

In going forward with the identification of disposal sites for GTCC waste, DOE should be cognizant of the important lessons to be learned from the failed attempt to site a facility for disposal of high-level radioactive waste and spent nuclear fuel at Yucca Mountain. Such lessons have special relevance with regard to any proposal for siting a GTCC waste disposal facility in general and at NNSC in particular. Any criteria for selecting a disposal location from among various alternatives should reflect the two most important lessons to be gleaned from the failed Yucca Mountain program: (1) that any siting decision must have an impeccable scientific and technical foundation that is fully transparent; and (2) that no facility can or should be forced on an unwilling state.

The scientific and technical justification for any facility means not only that its design and operation be of the highest quality, but also that the geotechnical characteristics of the site can be shown to meet health and safety criteria that, themselves, are sound, scientifically based and objective. The fact that a facility for GTCC waste disposal will be a new, never-before-attempted project (similar to a HLW repository or the WIPP TRU waste facility) makes it imperative that it have the voluntary support of the host state. In this regard, it is not sufficient to garner support from small rural communities that can be readily enticed with promises of economic benefits. Local support alone will not be sufficient to ensure success in a siting program for a facility of this type.

The final EIS should contain (and clearly explain and justify) the specific criteria that will be used to ultimately select a site or sites for GTCC waste disposal. That criteria should include the scientific and technical factors by which sites and the facility-site interface will be evaluated and a requirement that prospective host state approval must be obtained before any siting decision can be finalized.

E45-5 (Cont.)

E45-6

normal waste transport along a route. However, the consideration of specific local stakeholder concerns is more appropriate during the final planning stages of a project when actual route selections are finalized, not at the level addressed in this EIS. A generic accident consequence assessment was performed because there is no way to predict the exact location and conditions of an accident, as discussed in C.9.3.3 of the EIS. For all alternatives, potential accidents, even those at the same location, could have impacts that range from negligible to significant depending on the waste involved, the accident severity, and weather conditions. Such an analysis would not help distinguish between alternatives because all alternatives involve routes through or near major population centers.

The additional human health impacts from intermodal transfer and transport of waste from the nearest rail access point to those disposal sites without direct rail access is generally a small percentage of the total risk discussed in Section C.9.5.5 of the EIS. Costs involved in either building a rail spur to a site or the additional cost of intermodal operations would need to be considered if that option was considered further. For the rail option, the use of dedicated trains, if sufficient waste is available for transport at the same time, could reduce transportation risks and costs by minimizing transit times. The current rail analysis therefore bounds what might be expected if dedicated trains were used. In general, transportation costs would be similar across all disposal alternatives. The primary difference would be related to the distances traveled in each case. Thus, the transportation costs will scale with the shipment distances travelled as presented in the EIS. Any decisions made by DOE would take these factors into account during implementation.

There are no definitive studies related to the effects of radioactive waste shipments on local tourism and property values. With an average of only one to two shipments per day over the potential 60 year lifetime of a proposed disposal facility in the case of GTCC LLRW and GTCC-like waste shipments, it is unlikely that there would be any significant impact on tourism and property values.

As stated in Section C.9.4.1.1 of the EIS on route selection, many of the GTCC LLRW and GTCC-like wastes considered in the EIS would meet the definition of a highway route HRCQ (49 CFR 173.403). However, as noted in the discussion, states and Native American tribes have the opportunity to designate "preferred routes" to replace or supplement the interstate highway system. For those wastes not specifically designated as HRCQ, the selection of a route is left to the carrier, but in the case of GTCC LLRW and GTCC-like wastes, additional consultation with transportation stakeholders would occur.

DOE/NNSA analyzed various radioactive waste shipping routes through and around metropolitan Las Vegas, Nevada, in the NNSC SWEIS. DOE/NNSA continued discussions with the State of Nevada on routing options throughout the preparation of the Final NNSC SWEIS. After taking into consideration the comments and concerns expressed by State, county, and local government officials and the public in general during the review and comment period for the Draft NNSC SWEIS, DOE/NNSA decided to maintain the current highway routing restrictions for shipments of low-level radioactive waste (LLW) and mixed-low level radioactive waste (MLLW), as described in the Waste Acceptance Criteria (WAC) for the site. DOE/NNSA explained this decision in the Final NNSC SWEIS. The unchanged WAC restrictions are to avoid (1) crossing the Colorado River near Hoover Dam and (2) the greater metropolitan Las Vegas interstate system. DOE/NNSA is not considering, nor is it making, changes to the NNSC WAC with regard to routing.

Once an alternative is selected in a ROD for this EIS, implementation will include, as needed and appropriate, NEPA reviews and other analysis (e.g., transportation).

E45-6

The disposal methods and sites evaluated in the EIS represent the range of reasonable alternatives for the disposal of GTCC LLRW and GTCC-like wastes. This range is consistent with NEPA implementing regulations in Parts 1500–1508 of Title 40 of the Code of Federal

State of Nevada Agency for Nuclear Projects, Commenter ID No. E45 (cont'd)

1.5 Definitional Issues

Strictly speaking, most GTCC waste covered by the DEIS is not low-level radioactive waste as that term is widely understood (and reacted to). While GTCC waste may be lower activity waste than spent fuel or high-level waste, its "orphan" situation (i.e., waste that doesn't fit the definition of either LLW or HLW and for which there is no defined disposal path) reflects the difficulty inherent in attempting to define away the problem by appending the term "low-level radioactive waste" to its designation. Originally (and as contained in current regulation), GTCC waste was supposed to be disposed of in a high-level waste repository because GTCC waste contains longer-lived radioactive elements requiring longer-term isolation that would be unacceptable for LLW disposal facilities. The DEIS acknowledges that so-called "GTCC-Like waste" analyzed in the document is similar to non-defense generated TRU waste. The fact that GTCC waste is longer-lived and has a higher activity than LLW cannot be simply defined away by calling it LLW. In the past, GTCC waste was not considered LLW, and it is questionable whether that designation should be used at all. Simply calling the waste "GTCC" and acknowledging its unique characteristics and standing in the waste continuum would be more honest and encourage the more rigorous scrutiny disposal of such material deserves.

2.0 Specific Comments – DEIS Summary and Chapters 1 - 13

2.1 Summary, page S-3: GTCC-like waste

The DEIS states that, "Although GTCC-like waste is not subject to the requirements in the LLRWPA [Low Level Radioactive Waste Policy Amendments Act], DOE also intends to determine a path to disposal that is similarly protective of public health and safety." The DEIS presents no reason why GTCC-like waste should be treated differently than commercial GTCC waste. Disposal of GTCC-like waste should be protective of public health and safety in the same way as GTCC waste that is governed by the LLRWPA and regulated by NRC. DOE indicates in this same paragraph that it does not intend to create a new classification for GTCC-like waste, but that is exactly what the DEIS proposes. DOE should make the commitment that disposal of all GTCC waste will be subject to NRC regulation and that all facilities for GTCC waste disposal will be licensed by the NRC.

2.2 Summary, page S-13: Resource Conservation and Recovery Act (RCRA)

The DEIS assumes that GTCC waste will be treated to render it "nonhazardous" under RCRA. However, the DEIS does not address whether this is even feasible. A more reasonable and realistic approach would be to assume that much of the waste will be mixed hazardous and GTCC, regulated under RCRA as well as other applicable laws and regulations.

2.3 Summary, Table S-3, page S-45: Bounding Analysis of Transportation Impacts

Bounding is a legitimate way to establish the upper and lower boundaries of a possible impact. However, in this case, the extremely simplistic nature of the bounding analysis does not convey the extent of the impacts. The NNSS is not accessible by rail line, a fact mentioned by

Regulations (40 CFR Parts 1500–1508). In this GTCC EIS, DOE analyzed a range of disposal methods (i.e., geologic repository, near-surface trench, intermediate-depth borehole, and above-grade vault) and federally owned sites (i.e., Hanford Site, INL, LANL, NNSS, SRS, and the WIPP Vicinity, for which two reference locations – one within and one outside the WIPP Land Withdrawal Boundary – were considered). DOE has determined that it was reasonable to analyze these six sites because they currently have operating radioactive waste disposal facilities, except for the WIPP Vicinity, which is near an operating geologic repository.

Final siting of a disposal facility for GTCC LLRW and GTCC-like wastes would involve further NEPA review as needed and be in accordance with applicable laws and regulations and would involve local stakeholder involvement and consent.

E45-7 Greater-than-Class C (GTCC) low-level radioactive waste (LLRW) is defined by the U.S. Nuclear Regulatory Commission (NRC) as LLRW that has radionuclide concentrations exceeding the limits for Class C LLRW established in Title 10, Part 61, of the Code of Federal Regulations (10 CFR Part 61),

E45-7

DOE agrees that use of a geologic repository would be a protective and safe method for the disposal of the entire inventory of GTCC LLRW and GTCC-like wastes. However, the degree of waste isolation provided by a geologic repository may not be necessary for all of the GTCC LLRW and GTCC-like wastes evaluated in the GTCC EIS. The GTCC EIS evaluation indicates that certain wastes (e.g., those containing short-lived radionuclides such as Cs-137 irradiators) could be safely disposed of in properly designed land disposal facilities at sites with suitable characteristics, such as low precipitation rates, high soil distribution coefficients, and sufficient depths to groundwater. Based on the GTCC EIS evaluation, land disposal facilities located in arid climates (e.g., NNSS and WIPP Vicinity) would isolate radionuclides for a sufficient period of time to allow for significant radioactive decay to occur.

While 10 CFR Part 61 identifies one NRC-approved method for GTCC LLRW disposal (disposal in a geologic repository), these regulations also indicate that other disposal methods could be approved. The GTCC EIS evaluates three land disposal methods (i.e., enhanced near-surface trench, intermediate-depth borehole, and above-grade vault). The GTCC EIS evaluation indicates that land disposal methods employed at sites with suitable characteristics would be viable and safe alternatives for the disposal of GTCC LLRW.)

E45-8

DOE recognizes that including GTCC-like wastes within the scope of this EIS along with GTCC LLRW may complicate the implementation of GTCC LLRW disposal alternative(s). However, DOE determined that the most efficient approach was to address both types of waste, which have many similar physical and radioactive characteristics, in a single NEPA process.

E45-9

DOE's intent is to facilitate the overall process for addressing the disposal needs of both waste types. Issues associated with potential regulatory changes or NRC licensing would be addressed as necessary to enable implementation.

E45-8 DOE recognizes that including GTCC-like wastes within the scope of this EIS along with GTCC LLRW may complicate the implementation of GTCC LLRW disposal alternative(s). However, DOE determined that the most efficient approach was to address both types of waste, which have many similar physical and radioactive characteristics, in a single NEPA process. DOE's intent is to facilitate the overall process for addressing the disposal needs of both waste types. Issues associated with potential regulatory changes or NRC licensing would be addressed as necessary to enable implementation.

E45-10

E45-9 DOE agrees that some GTCC LLRW and GTCC-like wastes may be characterized as mixed waste (waste containing hazardous chemical constituents in addition to radionuclides). However, currently available waste characterization information is limited, and these wastes only constitute approximately 4% by volume of the Group 1 wastes. Additional information

the GTCC DEIS. Therefore, the section of the DEIS that refers to rail impacts is not valid. The possibility exists that there could be intermodal transportation from two sites nearby, but the numbers of truck shipments to the NNSC will be identical in either the rail or truck scenario. For the NNSC transportation analysis, there is no lower bound possible. There is no bounding analysis. It should be reported this way in the DEIS, and an intermodal alternative, if desired, should be studied. It is important to point out that intermodal operations can substantially change the risks of a transportation program. If DOE is interested in shipping these materials via intermodal, it should assess the risks and inform the affected parties (notably California - Inyo County and San Bernardino County).

Furthermore, the analysis of transportation impacts completely ignores the significant transportation differences among potential disposal sites. The analysis focuses solely on the overly generalized RADTRAN evaluation of radiological impacts as the sole discriminator when major considerations like availability of rail access, proximity to the national rail and interstate highway system, availability of alternate routes, non-radiological impacts to population centers, etc., should have been assessed and used to determine which of the alternative disposal locations would be preferable. The way it appears in the DEIS, there are no substantial differences in transportation impacts among the various possible sites. This is emphatically not the case. In any comprehensive transportation analysis, NNSC would rank at the bottom of potential candidates due to the extremely poor transportation access, lack of rail access, and routes to the facility that impact the state's major population centers and economic sectors.

2.4 Summary, page 49: Cumulative Impacts

The DEIS concludes that "for Alternatives 3 to 5 at the federal sites, the estimated impacts from the GTCC proposed action are not expected to contribute substantially to cumulative impacts for the various resource areas evaluated, with the likely exception of potential human health impacts in the long term." However, with regard to NNSC, this conclusion appears to ignore the fact that thousands of GTCC waste shipments will be added to the thousands of LLW and MLLW shipments on the state's highways due to ongoing LLW and MLLW disposal activities at NNSC. There is no analysis of the cumulative impacts associated with ongoing transportation activities at NNSC and the added impacts from proposed GTCC waste disposal shipments.

2.5 Summary, page 54: Developing a Preferred Alternative

The DEIS notes that existing NRC regulations require GTCC waste to be disposed of in a geologic repository unless alternative proposals are approved by the NRC. The DEIS assumes that alternative methods proposed by DOE (i.e., borehole disposal, trenches, vaults) will be approved by NRC. However, there is no evidence presented in the DEIS to support this assumption.

2.6 Chapter 1, page 1-9: GTCC-like Waste Definition

The text box at the top of the page states that "much of the GTCC-like waste meets the DOE definition of TRU waste." If that is the case, the DEIS needs to explain why GTCC-like

E45-10 (Cont.)

E45-11

E45-12

E45-13

E45-10

would be obtained prior to any disposal, however, and the mixed waste would be rendered nonhazardous before being submitted for disposal. In addition, potential health impacts from hazardous chemicals are expected to be small when compared to radiological risks presented in the EIS (due to the higher volume and activity from the radioactive component of the GTCC LLRW and GTCC-like waste inventory). Any mixed waste in the GTCC EIS inventory would be managed in accordance with federal and state laws and requirements.

Calculation of the collective population risk (under routine and accident conditions) is provided in the EIS. While these estimates are conservative, the calculations used expected values where practical (e.g., external shipment dose rates) and provide a reasonable measure for comparison among alternatives, as summarized in Tables 2.7.5 and 2.7.6, and the estimates show that the transportation risks would be small. All alternatives involve routes of hundreds of miles through similar types of rural, suburban, and urban areas. For specific local impacts, Section 5.3.9.2 provides information on potential human health impacts on individuals during normal waste transport along a route. However, the consideration of specific local stakeholder concerns is more appropriate during the final planning stages of a project when actual route selections are finalized, not at the level addressed in this EIS. A generic accident consequence assessment was performed because there is no way to predict the exact location and conditions of an accident, as discussed in C.9.3.3 of the EIS. For all alternatives, potential accidents, even those at the same location, could have impacts that range from negligible to significant depending on the waste involved, the accident severity, and weather conditions. Such an analysis would not help distinguish between alternatives because all alternatives involve routes through or near major population centers.

The additional human health impacts from intermodal transfer and transport of waste from the nearest rail access point to those disposal sites without direct rail access is generally a small percentage of the total risk discussed in Section C.9.5.5 of the EIS. Costs involved in either building a rail spur to a site or the additional cost of intermodal operations would need to be considered if that option was considered further. For the rail option, the use of dedicated trains, if sufficient waste is available for transport at the same time, could reduce transportation risks and costs by minimizing transit times. The current rail analysis therefore bounds what might be expected if dedicated trains were used. In general, transportation costs would be similar across all disposal alternatives. The primary difference would be related to the distances traveled in each case. Thus, the transportation costs will scale with the shipment distances travelled as presented in the EIS. Any decisions made by DOE would take these factors into account during implementation.

There are no definitive studies related to the effects of radioactive waste shipments on local tourism and property values. With an average of only one to two shipments per day over the potential 60 year lifetime of a proposed disposal facility in the case of GTCC LLRW and GTCC-like waste shipments, it is unlikely that there would be any significant impact on tourism and property values.

As stated in Section C.9.4.1.1 of the EIS on route selection, many of the GTCC LLRW and GTCC-like wastes considered in the EIS would meet the definition of a highway route HRCQ (49 CFR 173.403). However, as noted in the discussion, states and Native American tribes have the opportunity to designate "preferred routes" to replace or supplement the interstate highway system. For those wastes not specifically designated as HRCQ, the selection of a route is left to the carrier, but in the case of GTCC LLRW and GTCC-like wastes, additional consultation with transportation stakeholders would occur.

DOE/NNSA analyzed various radioactive waste shipping routes through and around metropolitan Las Vegas, Nevada, in the Draft NNSC SWEIS. DOE/NNSA continued discussions with the State of Nevada on routing options throughout the preparation of the Final NNSC SWEIS. After taking into consideration the comments and concerns expressed by State, county, and local government officials and the public in general during the review and

State of Nevada Agency for Nuclear Projects, Commenter ID No. E45 (cont'd)

waste is not disposed of as TRU waste. If DOE can define away the problem by classifying this waste as LLW, why instead cannot the waste be defined as TRU waste and disposed of at WIPP?

2.7 Chapter 1, page 1-35: NNSS

The U.S. Air Force, Nellis Air Force Base notes that the potential disposal area at NNSS identified in the DEIS is near a major Nellis training area (R-4806W) that ground parties use for training. The DEIS failed to assess the impacts of overflights or the impacts to the Nellis mission should overflights be prohibited. [Note – this comment was made by Deborah Stockdale, Chief, Asset Management Flight, Nellis Air Force Base and submitted to the Nevada State Clearinghouse.]

2.8 Chapter 1, Lines 24 to 45, page 1-3: Two-Tiered System of Transportation Impacts.

The DEIS confronts two different assessment problems. The first, classified as Group 1, consists of existing GTCC sources whose characteristics, risks, and disposal responsibility are well understood. Group 1 is ready for disposal now and is not subject to a great deal of uncertainty. Group 2 materials, on the other hand, consist primarily of GTCC wastes from West Valley, New York. The future of this waste is uncertain pending Congressional action. The disposition of Group 2 materials cannot be assessed as easily and the size of the future waste stream cannot be known very readily.

The DEIS assessed the uncertainty for Group 2 materials to the degree possible given its current knowledge. However, this assessment muddles the conclusions of the DEIS and makes the DEIS seem more authoritative than it actually is. A different and possibly better approach would have been to assess the impacts of Group 1 materials to the degree possible and then describe the problems facing the disposition of Group 2. The DEIS may have been strengthened or at least become clearer, by discussing the need for congressional leadership in resolving problems with Group 2 materials.

2.9 Chapter 1, Lines 24 to 41, page 1-8: Sealed Sources

The DEIS makes it clear that there are thousands of disused sealed sources all over the country, there are new sources being generated and moved around every year, and all of these sources will have to be managed in the coming decades. The decrease in sealed sources the DEIS indicates past 2030 is due to changes in technology, which seems speculative. The problem is the ongoing creation and management of these wastes and their dispersion throughout the country. While in use, they cannot be centralized.

Centralizing and managing the current inventory of sealed sources is a critical problem. The transportation impact assessment portion should study feasible transportation alternatives for each of the sites for existing inventories of sealed sources, present alternatives for those, and then develop a set of actions for the remaining sealed sources-it won't be much in terms of volume, but it will be important in terms of security and handling.

E45-13
(Cont.)

E45-14

E45-15

comment period for the Draft NNSS SWEIS, DOE/NNSA decided to maintain the current highway routing restrictions for shipments of low-level radioactive waste (LLW) and mixed-low level radioactive waste (MLLW), as described in the Waste Acceptance Criteria (WAC) for the site. DOE/NNSA explained this decision in the Final NNSS SWEIS. The unchanged WAC restrictions are to avoid (1) crossing the Colorado River near Hoover Dam and (2) the greater metropolitan Las Vegas interstate system. DOE/NNSA is not considering, nor is it making, changes to the NNSS WAC with regard to routing.

Once an alternative is selected in a ROD for this EIS, implementation will include, as needed and appropriate, NEPA reviews and other analysis (e.g., transportation).

- E45-11 DOE believes that the analyses presented in the EIS are sufficient to compare the potential cumulative impacts of GTCC LLRW and GTCC-like waste disposal for the sites that were evaluated. While up to 12,600 truck shipments were assessed for transport of the GTCC LLRW and GTCC-like wastes to a proposed disposal facility, these shipments would be spread out over a 60 year time period, with the result that only about one to two shipments a day might be expected at the facility in addition to current traffic. Additional cumulative impact analyses would be conducted in site-specific NEPA reviews, if needed, for the alternative selected in a ROD. Such follow-on analyses would be based on additional site-specific information.
- E45-12 DOE agrees that use of a geologic repository would be a protective and safe method for the disposal of the entire inventory of GTCC LLRW and GTCC-like wastes. The GTCC EIS evaluation for the WIPP geologic repository alternative supports this statement. However, the degree of waste isolation provided by a geologic repository may not be necessary for all of the GTCC LLRW and GTCC-like wastes evaluated in the GTCC EIS. The GTCC EIS evaluation indicates that certain wastes (e.g., those containing short-lived radionuclides such as Cs-137 irradiators) could be safely disposed of in properly designed land disposal facilities at sites with suitable characteristics, such as low precipitation rates, high soil distribution coefficients, and sufficient depths to groundwater. Based on the GTCC EIS evaluation, land disposal facilities located in arid climates (e.g., NNSS and WIPP Vicinity) would isolate radionuclides for a sufficient period of time to allow for significant radioactive decay to occur. While 10 CFR Part 61 identifies one NRC-approved method for GTCC LLRW disposal (disposal in a geologic repository), these regulations also indicate that other disposal methods could be approved. The GTCC EIS evaluates three land disposal methods (i.e., enhanced near-surface trench, intermediate-depth borehole, and above-grade vault). The GTCC EIS evaluation indicates that land disposal methods employed at sites with suitable characteristics would be viable and safe alternatives for the disposal of GTCC LLRW.
- E45-13 There is no current disposal path for GTCC-like waste, much of which meets the definition of DOE TRU waste but was not generated by atomic energy defense activities.
- E45-14 Construction and operation of a disposal facility for GTCC LLRW and GTCC-like wastes will be conducted in accordance with current procedures and agreements in existence at the respective sites. Any changes to these procedures and agreements will be developed in coordination among the agencies participating in the current agreement.
- E45-15 The GTCC LLRW and GTCC-like waste inventory evaluated in the EIS is based on the best available information on the stored and projected GTCC LLRW and GTCC-like wastes from ongoing and planned activities. The estimated 12,000 m³ of GTCC LLRW and GTCC-like wastes is a relatively small volume of waste when compared to other wastes disposed of by DOE. For example, this volume of GTCC LLRW and GTCC-like wastes is only about 20% of the 59,000 m³ of LLRW disposed of at one site (NNSS) in one year (fiscal year 2010). Inclusion of the Group 2 West Valley waste provides a disposal pathway for that waste should it be needed. The current locations of all sealed sources are not known at this time. Follow-on

The problem of public safety discussed in the 2010 Radiation Source Protection and Security Task Force Report centers on the security of sealed sources. The current system of managing sealed sources seems adequate and addresses the public safety needs. The current program argues for the no action alternative. It does not appear to be an urgent requirement.

2.10 Chapter 2, page 2.9: Alternative Considered but not Evaluated in Detail

The DEIS notes that "reference locations" were limited to federal sites and that no specific locations were analyzed for commercial disposal locations. It appears that the entire assessment contained in the DEIS is focused on locating disposal facilities at federal sites, with a "generic" commercial location almost an afterthought. Since most of the GTCC waste is, in fact, commercial waste regulated and licensed by the NRC, it would seem more appropriate for the DEIS to be founded on the assumption that any disposal facility for such waste should be a commercial facility operating under NRC regulation. The fact that no commercial LLW disposal site is currently available for GTCC waste does not mean that one (or more) could not be available in the future if the DEIS concluded that this was the preferred option. After all, none of the federal sites are currently available for GTCC waste disposal, but that didn't hinder the DEIS from including alternate federal sites in the analysis.

2.11 Chapter 2, pages 2-21 to 2-22: Transportation

As noted, the transportation analysis in the DEIS is fundamentally flawed. The overly general assessment of radiological impacts completely ignores the significant diversity in transportation-related factors among alternative disposal locations. In addition, there is no indication that, even in assessing radiological health impacts, the DEIS considered important differentiating characteristics – such as the lack of rail access to NNSS; the added impacts to workers and the public from intermodal operations (the only way to evaluate rail shipments to NNSS) caused by the need to handle waste twice and the incorporation of truck/highway impacts once the waste is removed from trains; and other such factors.

2.12 Chapter 4, pages 4-66 to 4-67: WIPP Transportation Overview

The DEIS states: "The transportation of GTCC LLRW and GTCC-like waste necessary for the disposal of all such waste at WIPP was evaluated." The evaluation appears to have ignored the past 20 years of cooperative planning by DOE and the Western Governors' Association (and other State Regional Groups) for the ongoing shipments of transuranic waste to WIPP. This is a serious omission that should be rectified in the Final EIS. There are many similarities between the current WIPP transuranic waste transportation program and the GTCC transportation program that DOE would be required to develop and implement under the proposed action in this DEIS.

Beginning in the 1980s, the Western Governors' Association (WGA) adopted and reconsidered at three-year intervals, a series of resolutions on waste management generally, and spent nuclear fuel (SNF) and high-level radioactive waste (HLW) transportation in particular. These resolutions were specifically addressed to DOE and emphasized the need for a comprehensive transportation plan that did not take safety for granted.

NEPA activities will be required to look at more specific transportation impacts once management of the sealed sources is better defined.

E45-16 The No Action Alternative is evaluated in Chapter 3 of the EIS, and under this alternative, current practices for storing GTCC LLRW and GTCC-like wastes would continue. These practices are described in Sections 3.2 (GTCC LLRW) and 3.3 (GTCC-like wastes) in the Final EIS. It was necessary to make a number of simplifying assumptions to address the long-term impacts of this alternative, and these are described in Section 3.5. As part of this assessment, it was assumed that these wastes would remain in long-term storage indefinitely, including wastes from the West Valley Site as discussed in Section 3.5.3, and that no maintenance of either the storage facility or waste packages would occur after 100 years. These results indicate that very high radiation doses and cancer risks could occur under this alternative in the long term.

The No Action Alternative is evaluated in sufficient detail in the EIS as required by NEPA. Comparatively high potential radiation doses and cancer risks could occur should this alternative be selected. While a more detailed analysis could reduce the uncertainties associated with estimating these doses and risks, the conclusion of comparatively high impacts would not change for this alternative.

Impacts from accidents or theft/intrusion were not performed for the No Action Alternative because of the large number of potential locations, and in many cases (sealed sources), the current locations of the waste are not known. In general, these impacts would be comparable to those in the accident consequence analyses conducted for facilities and transportation but possibly occur at a higher frequency because of a lower overall level of security.

The No Action Alternative is evaluated in the EIS to provide a baseline for comparison with the action alternatives. This evaluation confirmed the risks posed by these wastes and the need to develop appropriate disposal capability. The potential radiation doses for the No Action Alternative covered a time period of 10,000 years in a manner comparable to that done for the action alternatives. Relatively high impacts could occur shortly after the 100-year institutional control period under this alternative.

E45-17 The Low-Level Radioactive Waste Policy Amendments Act (LLRWPA, P.L. 99-240) assigns DOE responsibility for the disposal of GTCC LLRW generated by NRC and Agreement State licensees. The LLRWPA (P.L. 99-240) does not limit DOE to using only non-DOE facilities or sites for GTCC LLRW disposal. Under NEPA, DOE must evaluate the range of reasonable alternatives for a GTCC LLRW disposal facility. DOE sites represent reasonable alternatives for a GTCC LLRW disposal facility.

E45-18 Calculation of the collective population risk (under routine and accident conditions) is provided in the EIS. While these estimates are conservative, the calculations used expected values where practical (e.g., external shipment dose rates) and provide a reasonable measure for comparison among alternatives, as summarized in Tables 2.7 5 and 2.7 6, and the estimates show that the transportation risks would be small. All alternatives involve routes of hundreds of miles through similar types of rural, suburban, and urban areas. For specific local impacts, Section 5.3.9.2 provides information on potential human health impacts on individuals during normal waste transport along a route. However, the consideration of specific local stakeholder concerns is more appropriate during the final planning stages of a project when actual route selections are finalized, not at the level addressed in this EIS. A generic accident consequence assessment was performed because there is no way to predict the exact location and conditions of an accident, as discussed in C.9.3.3 of the EIS. For all alternatives, potential accidents, even those at the same location, could have impacts that range from negligible to significant depending on the waste involved, the accident severity, and weather conditions. Such an analysis would not help distinguish between alternatives because all alternatives involve routes through or near major population centers.

In this DEIS, DOE should have explicitly examined and endorsed the detailed recommendations of the Western Governors' Association for any future large-scale shipments of radioactive waste to disposal facilities. While these WGA recommendations were primarily addressed to SNF and HLW, they apply equally to the nationwide, multi-decade, GTCC waste disposal program evaluated in this DEIS. In order to develop a safe and effective waste disposal system, WGA recommended that "the federal government must expand its focus beyond siting, and develop, in coordination with states and tribes, a logical and timely transportation program."³ This requires policy commitments from DOE and other federal agencies to:

- Fix the shipping origins and destination points as early as possible;
- Ensure the availability of rail and truck shipping casks;
- Conduct full scale testing of casks for transport of spent nuclear fuel and HLW;
- Prepare a comprehensive transportation plan that includes the analysis of all needed transport safety activities in a single document;
- Develop responsible criteria for selecting shipping routes;
- Develop a sound methodology for evaluating optional mixes of routes and transportation modes; and
- Conduct a thorough review of the risks of terrorism and sabotage against spent fuel and HLW shipments and work with state governments to assume that adequate safeguards are in place prior to shipments occurring.³

The WGA policy resolution also calls on DOE or any other operator of a repository or storage facility to consider specific elements of the WIPP transportation program, including: (1) a safety and public information program similar to that developed with Western states; (2) the WIPP Transportation Safety Program Implementation Guide; (3) the WIPP example of working through its regional cooperative-agreement groups to propose a set of shipping routes to affected states and tribes for their review and comment, resulting in the identification of a set of primary and secondary routes; (4) a tracking system, such as TRANSCOM, capable of notifying the vehicle operator, DOE, states and tribes of current location, potential bad weather and road conditions, and occurrence of incidents; and (5) the responsibility of the generators of spent nuclear fuel and HLW and the federal government, not the states and tribes, to pay for all costs associated with assuring safe transportation, including emergency response, shipment escorts and inspections, and route evaluations. Transportation of GTCC waste should likewise be conducted using such a program.

2.13 Chapter 5, pages 5-18 to 5-91: Assessment Approach and Assumptions (Section 5.2)

The analysis of impacts throughout the DEIS ignores the potential for impacts related to risk, risk perception and the stigmatizing potential of a program and facilities involving large amounts of material identifies as "nuclear" and "radiological". These "special" impacts have the potential to generate significant economic and social consequences such as losses in property values, decreases in tourism and tourism-related revenues, suppression of economic development

³ Western Governors' Association Policy Resolution 08-6, Transportation of Spent Nuclear Fuel and High-Level Radioactive Waste (2008).

The additional human health impacts from intermodal transfer and transport of waste from the nearest rail access point to those disposal sites without direct rail access is generally a small percentage of the total risk discussed in Section C.9.5.5 of the EIS. Costs involved in either building a rail spur to a site or the additional cost of intermodal operations would need to be considered if that option was considered further. For the rail option, the use of dedicated trains, if sufficient waste is available for transport at the same time, could reduce transportation risks and costs by minimizing transit times. The current rail analysis therefore bounds what might be expected if dedicated trains were used. In general, transportation costs would be similar across all disposal alternatives. The primary difference would be related to the distances traveled in each case. Thus, the transportation costs will scale with the shipment distances travelled as presented in the EIS. Any decisions made by DOE would take these factors into account during implementation.

Once an alternative is selected in a ROD for this EIS for implementation, site-specific NEPA reviews would be conducted as needed, including an assessment of specific routing and an accident analysis, including dedicated trains and the potential for multiple railcar accidents if applicable. This process will include planning that involves transportation stakeholders.

E45-19 In the case of WIPP, all routes used in the analysis were in conformance with current WIPP routing guidelines. At this time, any detailed analysis of the specific routes themselves that any shipment could take would not be practical. As discussed in Section C.9.4.1.1, representative shipment routes, including the WIPP routes, were used for the analysis because routes would be selected in the future at the time of shipment based on current road or track conditions. Once the potential disposal site is selected, follow-on analysis would be required, including follow-on NEPA documentation. At that time, depending on the type of shipment, specific preferred and alternative routes could be designated based on public and local, state, and tribal concerns.

Once an alternative is selected in a ROD for this EIS for implementation, DOE will begin the process of developing a transportation plan for the designated disposal facility or facilities. Planning will involve transportation stakeholders such as the WGA and will consider current policies and practices in place for other wastes.

E45-20 The estimated costs associated with the construction and operation of GTCC waste disposal facilities at each of the sites – including costs for direct and indirect labor, equipment, materials, services, and subcontracts – are included in the assessment of each waste management alternative in the EIS. The cost estimates for the land disposal methods are based on a conceptual design of the disposal facility and could increase with actual implementation. Costs shown for WIPP are based on actual costs experienced to date and reflect construction and operation costs of an operating geologic repository. The economic analysis in the EIS addresses the potential economic impacts, including potential impacts resulting from in migration of workers or their families during the construction period, and any consequent impacts on housing, public finances, public service employment, and traffic.

There are no definitive studies related to the effects of radioactive waste shipments on local tourism and property values. With an average of only one to two shipments per day over the potential 60 year lifetime of a proposed disposal facility in the case of GTCC LLRW and GTCC-like waste shipments, it is unlikely that there would be any significant impact on tourism and property values.

due to perceived risks, radiological-related accidents, terrorism/sabotage, etc. While such impacts are not required (by statute or regulation) to be addressed in an EIS, the fact that the GTCC DEIS involves a proposed course of action that spans many decades, impacts potentially wide areas and populations, and deals with waste that the public perceives as highly dangerous more than justifies going the extra mile and evaluating the potential for such "special" impacts in discriminating among possible disposal locations.⁴

2.14 Chapter 9, page 9-52, Lines 10: Absence of Rail Access to NNSS

NNSS not only lacks direct rail access, it is unlikely that NNSS would ever have direct rail access. The 2008 DOE Supplemental EIS for Yucca Mountain estimated that construction of the Caliente rail alignment to the now cancelled repository site would have cost \$2.7 billion or more. Based on that analysis, construction of a rail line to the proposed GTCC disposal area at NNSS would likely cost more than 5-10 times the estimated total cost (\$250-520 million) to construct and operate a disposal facility at NNSS. (GTCC DEIS, page 2-65) The absence of direct rail access to NNSS means that the number of truck shipments in Nevada would not be reduced by intermodal transfer at any receiving location in or near Nevada. Under any intermodal scenario, there would still be 12,600 truck shipments to NNSS.

2.15 Chapter 9, page 9-52, Lines 10-11: Intermodal Access to NNSS via Las Vegas

DOE erroneously suggests that NNSS could receive intermodal shipments of GTCC via Las Vegas, asserting that "the closest access to commercial rail service is in Las Vegas." DOE should drop this sentence in the Final EIS, unless DOE can identify a specific location in Las Vegas where rail shipments of GTCC could be received and transferred to trucks for shipment to NNSS. Moreover, intermodal transfer in Las Vegas would still require 12,600 truck shipments to NNSS.

2.16 Chapter 9, page 9-52, Lines 11-13: Truck shipments through the "Spaghetti Bowl"

The DEIS suggests that, absent being "discouraged" (presumably by the State of Nevada and Clark County), DOE could legally ship LLRW through Las Vegas using the I-15 and US 95 interchange (the "Spaghetti Bowl"). DOE should clarify its position on the legality and advisability of shipping GTCC waste through Las Vegas using the I-15 and US 95 interchange. The policy of avoiding metro Las Vegas and the Spaghetti Bowl for LLW and MLLW shipments to the NNSS is part of an agreement between the State of Nevada and DOE at the secretarial level related to the designation of NNSS (then NTS) as a regional LLW disposal facility in the Record of Decision to the Waste Management Programmatic EIS. Under that agreement, DOE

⁴ Extensive research into the nuclear-related special impacts of a major federal program has been carried out by the State of Nevada in studies that spanned more than a decade. Information on these impacts can be found in the report: A Mountain of Trouble, A Nation at Risk – Report on Impacts of the Proposed Yucca Mountain High-Level Nuclear Waste Program (<http://www.state.nv.us/nucwaste/yucca/impactreport.pdf>).

E45-20 (Cont.)

E45-21

E45-22

E45-23

E45-21

For the purposes of NEPA, the 100% rail transportation analysis was conducted for all sites, including the NNSS, as a reasonable alternative to 100% truck transportation. It is recognized that construction of a rail spur to the NNSS would be required for the 100% rail alternative (e.g., see Section 9.2.9). If a rail spur were not constructed, additional risk would be incurred for intermodal truck shipments for sites without direct rail access as discussed in the EIS.

The additional human health impacts from intermodal transfer and transport of waste from the nearest rail access point to those disposal sites without direct rail access is generally a small percentage of the total risk discussed in Section C.9.5.5 of the EIS. Costs involved in either building a rail spur to a site or the additional cost of intermodal operations would need to be considered if that option was considered further. For the rail option, the use of dedicated trains, if sufficient waste is available for transport at the same time, could reduce transportation risks and costs by minimizing transit times. The current rail analysis therefore bounds what might be expected if dedicated trains were used. In general, transportation costs would be similar across all disposal alternatives. The primary difference would be related to the distances traveled in each case. Thus, the transportation costs will scale with the shipment distances travelled as presented in the EIS. Any decisions made by DOE would take these factors into account during implementation.

While the risks associated with 100% rail shipments would be lower than those associated with 100% truck shipments overall, there would still be approximately 12,600 truck shipments in Nevada to NNSS as pointed out in the comment should an intermodal option be considered.

Once an alternative is selected in a ROD for this EIS for implementation, site-specific NEPA reviews would be conducted as needed, including an assessment of specific routing and an accident analysis, including dedicated trains and the potential for multiple railcar accidents if applicable. This process will include planning that involves transportation stakeholders.

E45-22

DOE does not suggest that NNSS would receive intermodal shipments of GTCC via Las Vegas. As noted on in the text immediately following the quote given in the comment, the text discusses that shipments through Las Vegas have been discouraged and that intermodal shipments would likely pass through either Barstow or Caliente, not Las Vegas.

E45-23

As stated in Section C.9.4.1.1 of the EIS on route selection, many of the GTCC LLRW and GTCC-like wastes considered in the EIS would meet the definition of a highway route HRCQ (49 CFR 173.403). However, as noted in the discussion, states and Native American tribes have the opportunity to designate "preferred routes" to replace or supplement the interstate highway system. For those wastes not specifically designated as HRCQ, the selection of a route is left to the carrier, but in the case of GTCC LLRW and GTCC-like wastes, additional consultation with transportation stakeholders would occur.

DOE/NNSA analyzed various radioactive waste shipping routes through and around metropolitan Las Vegas, Nevada, in the Draft NNSS SWEIS. DOE/NNSA continued discussions with the State of Nevada on routing options throughout the preparation of the Final NNSS SWEIS. After taking into consideration the comments and concerns expressed by State, county, and local government officials and the public in general during the review and comment period for the Draft NNSS SWEIS, DOE/NNSA decided to maintain the current highway routing restrictions for shipments of low-level radioactive waste (LLW) and mixed-low level radioactive waste (MLLW), as described in the Waste Acceptance Criteria (WAC) for the site. DOE/NNSA explained this decision in the Final NNSS SWEIS. The unchanged WAC restrictions are to avoid (1) crossing the Colorado River near Hoover Dam and (2) the greater metropolitan Las Vegas interstate system. DOE/NNSA is not considering, nor is it making, changes to the NNSS WAC with regard to routing.

Once an alternative is selected in a ROD for this EIS, implementation will include, as needed and appropriate, NEPA reviews and other analysis (e.g., transportation).

State of Nevada Agency for Nuclear Projects, Commenter ID No. E45 (cont'd)

- E45-24 The EIS has been corrected to refer to Caliente, NV. Regarding an intermodal facility at Caliente, NV, the EIS states that such a facility was recommended in the past. However, that facility was not built.
- E45-25 See response to E45-23.

agreed to use shipping routes for LLW and MLLW that avoided Metro Las Vegas, the I-15/US 95 interchange, and Hoover Dam (which, at the time, could still be used for such shipments).

E45-23
(Cont.)

2.17 Chapter 9, page 9-52, Lines 13-14: Intermodal facility at "Caliente, New Mexico"

There is no intermodal facility at Caliente, New Mexico. Indeed, there is no Caliente, New Mexico, although there is a small unincorporated community named Ojo Calient in Taos County, New Mexico. The DEIS apparently meant to refer to Caliente, Nevada. Caliente, Nevada is clearly identified as the intended location in the reference (DOE 1999) cited in the DEIS (see comment 2.18).

2.18 Chapter 9, page 9-52, Lines 13-16: Intermodal facility at Caliente, Nevada

E45-24

The DEIS should clearly state that there is, at present, no intermodal facility at Caliente, Nevada, which could be used for GTCC shipments to NNSS. To our knowledge, there are no plans for construction of an intermodal facility at Caliente, Nevada, which could be used for GTCC shipments to NNSS. DOE should drop this reference to intermodal facilities in the Final EIS unless DOE is proposing to construct and operate such a facility at Caliente, Nevada. Moreover, intermodal transfer at Caliente would still require 12,600 truck shipments to NNSS. In addition, it is the position of the State of Nevada that any intermodal transfer facility would be a de facto waste storage facility for commercial, NRC-licensed material and, as such, would require a license from the NRC.

2.19 Chapter 9, page 9-52, Lines 18-20: Route from Caliente to NNSS

The DEIS identifies SR 375, US 6, and US 95 as a potential route from Caliente to NNSS "to avoid Las Vegas." If GTCC waste shipments are considered to be HRCQ shipments, DOE would not be able to use this route under U.S. Department of Transportation regulations governing HRCQ shipments. Such GTCC waste shipments from Caliente would be required to use US 93, I-15, and US 95 through Las Vegas, resulting in significant impacts to the Las Vegas/Clark County area.

E45-25

If DOE believes it can legally use SR 375, US 6, and US 95, for GTCC waste shipments, the Final EIS must evaluate the unique local conditions along the "necessarily longer" route from Caliente to NNSS that could increase the frequency, severity, and consequences of transportation accidents. There are numerous locations along this route where steep grades, sharp curves, critical side slopes, and sheer drop-offs, especially near the summits of mountain passes, could subject shipments to extreme accident impact forces and make emergency response, vehicle and package recovery, and post-accident remediation extremely difficult. Such conditions occur near Oak Springs Summit on US 93 west of Caliente, Hancock Summit on SR 375, Warm Springs Summit on US 6, and numerous locations on US 95 between Tonopah and Mercury. The Final EIS should also examine the impacts of GTCC shipments along this route on the communities of Tonopah, Goldfield, and Beatty. In these communities, schools, public buildings, residences, hotels and other commercial establishments are located in close proximity to the potential GTCC shipment route, often within 25 to 250 feet of the US 93 road shoulder, and in some instances less than 20 feet from the side of the road on which loaded GTCC packages would travel south to

NNSS. There are also environmentally sensitive areas along both potential Caliente to NNSS routes, including the Key Pittman Wildlife Area, Crystal Spring, Ash Springs, and the Pahrangat National Wildlife Refuge.

2.20 Chapter 9, page 9-62: Water Resources (NNSS)

The statement that, "... the potential for mobilization of contaminants to the groundwater [underlying NNSS] from all these sources is negligible because of the arid climate, the extensive depth to groundwater ... and the proven behavior of liquid and vapor fluxes in the vadose zone" is not supported by findings from the failed Yucca Mountain project, where the bomb pulse isotope Chlorine 36 was found hundreds of feet below the surface, indicating that the water infiltration travel time from the surface had to have been in the neighborhood of 50 years, since Chlorine 36 was deposited following bomb tests conducted in the Pacific Ocean in the 1950s. Likewise, radioactive tritium has been found at depth under the NNSS and, more recently, tritium from bomb tests at Paiute Mesa has been detected off site at the western edge of the NNSS boundary. The potential for migration of radionuclides from GTCC waste disposal activities at NNSS is a significant issue and concern, and the conclusion reached in the DEIS is contradicted by findings from other projects and groundwater monitoring efforts.

2.21 Chapter 9, pages 9-65 to 9-66: Post-Closure (NNSS)

The DEIS conclusion that radionuclides are not expected to reach the groundwater table within 100,000 years is unsupported (see comment 2.20).

2.22 Chapter 9, pages 9-68 to 9-70: Socioeconomics (NNSS)

The socioeconomic impact assessment for NNSS contained in the DEIS is seriously incomplete. No effort is made to assess the economic impacts associated with GTCC waste transportation to the site (potentially impacting Nevada's major population areas and economic sectors). Likewise, no attempt was made to assess impacts to property values along shipping routes, impacts to tourism, impacts to economic development from negative perceptions of risk and/or accidents involving GTCC waste, etc. Assessing only the negligible employment effects and relatively minor impacts of project expenditures on area communities misses entirely the potential significant economic and other impacts inherent in a project of this type.

2.23 Chapter 9, page 9-72, lines 26-42: Collective Population Risk

The method of risk analysis used in the DEIS fails to assess the actual impacts that the shipments would have at specific locations along specific routes in Nevada. The DEIS assessment method fails to examine unique local conditions, especially the proximity of buildings to roads and railroads, and actual observed travel speeds and stop times at specific locations along the potential routes in Nevada identified in the DEIS. The aggregate impacts reported in the DEIS tables on pages 9-73 to 9-76 conceal the actual radiological exposures that would likely result from truck shipments at specific locations, such as the intersection of US 6 and US 95 in Tonopah (where truck stop times of 2-5 minutes could be expected), or on US 95 in Goldfield, where trucks may travel at speeds as low as 5 miles per hour around a curve where

E45-26 The GTCC DEIS evaluates three facility options sited in Area 5 on the NNSS: an intermediate-depth borehole disposal facility, an enhanced near-surface trench disposal facility, and an above-ground vault disposal facility. All three disposal facility options involve near-surface disposal in or on thick unsaturated alluvium deposits. The groundwater transport cases cited by the reviewer, Yucca Mountain and Pahute Mesa, involve contaminant sources in fractured rock. The hydrologic and geologic characteristics of Yucca Mountain and Pahute Mesa are entirely different than that Area 5 which is an alluvium-filled valley. No groundwater recharge occurs in alluvium-filled valleys whereas on the higher elevation mesas there is a potential for recharge because of the prevailing higher precipitation rates and higher infiltration rates due to the hydraulic properties of thin alluvium overlaying fractured rock. Consequently, a potential downward pathway for radionuclide transport from the sources located in fractured rock toward the groundwater may exist on the mesas of the NNSS. Whereas in Area 5, there is no groundwater pathway and all radionuclide transport pathways are upward toward the ground surface, including upward liquid and vapor flux, plant uptake, and burrowing animal activity. Therefore, radionuclide migration from sources at Yucca Mountain and Pahute Mesa is not analogous to transport at a GTCC disposal facility in unsaturated alluvium at Area 5.

Extensive site characterization studies have been conducted on the valley-fill alluvium at the NNSS Area 5 Radioactive Waste Management Site that support a conclusion of a negligible potential for transport of contaminants to groundwater. Deep boreholes indicate that thick unsaturated alluvial sediments, more than 200 m thick, are present in Area 5 (Shott et al. 1998). Multiple lines of evidence support a conclusion that percolation of rainwater below the plant root zone, or upper 2 m of alluvium, ceased 10,000 to 15,000 years ago as the climate shifted from cooler and wetter late Pleistocene conditions to the warmer, dryer Holocene conditions (Tyler et al. 1996, Shott et al. 1998, Wolfsberg and Stauffer 2003). Specific evidence supporting negligible deep percolation includes the following:

- Chloride mass-balance studies indicate that percolating rainfall has not reached the uppermost aquifer in the last 20,000 to 120,000 years (Tyler et al. 1996). The large accumulation of stable chloride at the base of the plant root zone indicates that percolation below 2 m ceased 10,000 to 15,000 years ago (Walvoord et al. 2002, Scanlon et al. 2003).
- Age dating of water in the uppermost aquifer using 14C indicates ages from 10,000 to 14,500 years (Tyler et al. 1996). These dates are consistent with recharging ending in the late Pleistocene. Recharge in the Pleistocene was not necessarily spatially uniform and may not have occurred through the alluvial sediments (Tyler et al. 1996).
- Since 1945, atmospheric nuclear testing has increased the 36Cl/35Cl ratio in the atmosphere. Enriched 36Cl/35Cl ratios are not found below a depth of 2 m in Area 5 alluvium, indicating that rainfall has not percolated below this depth since the start of nuclear testing (Tyler et al. 1996).
- Water flow in near-surface Area 5 alluvium is upward due to high evapotranspiration at the surface driven by the arid climate and xerophytic plants. Water potential gradients measured in Area 5 alluvium indicate upward water flow in the upper 35 m of alluvium (Shott et al. 1998). Modeling simulations suggest that the unsaturated alluvium profile has been drying very slowly since the late Pleistocene (Wolfsberg and Stauffer 2003).
- Profiles of heavy isotopes of hydrogen (2H) and oxygen (18O) in soil pore water indicate enrichment in near-surface alluvium and depletion at depth relative to standard mean ocean water. The substantial near-surface enrichment in heavy isotopes indicates persistent evaporative conditions in the shallow vadose zone (Wolfsberg and Stauffer 2003). The depletion in deeper vadose zone pore water indicates the presence of water that infiltrated during a past colder climate (Wolfsberg and Stauffer 2003).

E45-25 (Cont.)

E45-26

E45-27

E45-28

residences are located less than 20 feet from the road shoulder. The Final EIS should consider collective population risk from routine transportation in specific communities along specific routes in Nevada, by considering actual building types and locations, travel speeds and stop times, and actual populations, not only residents, but also children in schools and non-residents in hotels and commercial establishments. The Final EIS should also consider the perceived risk impacts that could result from routine shipments, especially impacts on property values, business location decisions, and tourism along the potential routes in Nevada identified in the DEIS.

2.24 Chapter 9, page 9-77, lines 3-14: Highest Exposed Individuals

The method of risk analysis used in the DEIS fails to assess the actual individual exposures that could result from shipments at specific locations along specific routes in Nevada. The DEIS assessment method uses the RISKIND model default values for individual exposures provided in Table C-6. Actual conditions along potential Nevada shipment routes identified in the DEIS are considerably different and would result in significantly different exposure events and exposures. For example, a location near a pedestrian crosswalk in a school zone, along US 95 in Goldfield, could receive a 30-second exposure at a distance less than 4 meters, from each passing truck. The Final EIS should reexamine the maximum individual exposures from routine transportation, using individual exposure scenarios based on actual conditions at specific locations along specific routes in Nevada.

2.25 Chapter 9, page 9-77, lines 19-25: Accident Consequence Assessment

The DEIS does not provide sufficient information about how the accident consequence assessments were conducted, to allow reviewers to determine the validity of the accident dose risk values presented in the tables on pages 9-73 to 9-76. The discussion in Appendix C, pages C-29 to C-47, does not provide sufficient information about how the accident consequence assessments were conducted, to allow reviewers to determine the validity of the potential accident radiological consequences to populations reported in Table 5.3.9-3, nor to determine the validity of the potential accident radiological consequences to the highest-exposed individuals reported in Table 5.3.9-4. The Final EIS must explain in detail how the analyses were conducted for each type of waste (sealed sources – CH, activated metals – RH, other waste – CH, and other waste – RH) and each mode (rail and truck).

2.26 Chapter 9, page 9-77, lines 19-25: Failure to Evaluate Accident Economic Impacts

The DEIS did not evaluate cleanup costs and other economic impacts, as part of the accident consequence assessments conducted to develop the accident dose risk values presented in the tables on pages 9-73 to 9-76, and the potential accident radiological consequences reported in Tables 5.3.9-3 and 5.3.9-4. Accidents during transport of sealed sources, severe enough to result in a population dose of 4,400 – 15,000 person-rem in an urban area as reported on page 5-86, would release significant amounts of radioactive material, requiring extensive cleanup, remediation, and compensation. Based on analyses of radioactive materials transportation accidents involving similar population doses in urban areas, Nevada believes that severe accidents involving sealed sources could result in adverse economic impacts totaling hundreds of millions of dollars or more. Accidents involving certain other GTCC waste types could also

E45-28
(Cont.)

E45-29

E45-27

E45-30

E45-28

Similar conclusions have been reached by multiple investigators for other arid alluvium-filled valleys in the desert southwest (Prudic 1994, Andraski 1997, Walvoord et al. 2002, Scanlon et al. 2003). These findings support the statement of negligible potential for contaminant transport from a GTCC disposal facility in Area 5 on the NNSS to the groundwater.

Andraski, B.J., 1997. Soil-Water Movement under Natural-Site and Waste-Site Conditions: A Multiple-Year Field Study in the Mojave Desert, Nevada. *Water Resources Research* 33: 1901–1916.

Prudic, D.E., 1994. *Estimates of Percolation Rates and Ages of Water in Unsaturated Sediments at Two Mojave Desert Sites, California-Nevada*. Denver, CO: U.S. Geological Survey, Water-Resources Investigations Report 94-4160.

Scanlon, B.R. K. Keese, R.C. Reedy, J. Simunek, and B.J. Andraski, 2003. Variations in Flow and Transport in Thick Desert Vadose Zones in Response to Paleoclimatic Forcing (0-90 kyr): Field Measurements, Modeling, and Uncertainties. *Water Resources Research* 39: 1179–1197.

Shott, G.J., L.E. Barker, S.E. Rawlinson, M.J. Sully, and B.A. Moore, 1998. *Performance Assessment for the Area 5 Radioactive Waste Management Site at the Nevada Test Site, Nye County, Nevada, Rev. 2.1*. Las Vegas, NV: Bechtel Nevada, DOE/NV/11718--176.

Walvoord, M.A., F.M. Phillips, S.W. Tyler, and P.C. Hartsough, 2003. Deep Arid System Hydrodynamics 2. Application to Paleohydrologic Reconstruction Using Vadose Zone Profiles from the Northern Mojave Desert. *Water Resources Research* 38: 1291–1303.

Wolfsberg, A, and P. Stauffer, 2003. *Vadose Zone Fluid and Solute Flux: Advection and Diffusion at the Area 5 Radioactive Waste Management Site*. Los Alamos, NM: Los Alamos National Laboratory, LA-UR-03-4819.

The estimated costs associated with the construction and operation of GTCC waste disposal facilities at each of the sites – including costs for direct and indirect labor, equipment, materials, services, and subcontracts – are included in the assessment of each waste management alternative in the EIS. The cost estimates for the land disposal methods are based on a conceptual design of the disposal facility and could increase with actual implementation. Costs shown for WIPP are based on actual costs experienced to date and reflect construction and operation costs of an operating geologic repository. The economic analysis in the EIS addresses the potential economic impacts, including potential impacts resulting from migration of workers or their families during the construction period, and any consequent impacts on housing, public finances, public service employment, and traffic.

Costs for institutional controls out to a 10,000 year time frame were not evaluated because the institutional control period was assumed to be for the first 100 years after facility closure. Follow-on site-specific NEPA reviews would take a closer look the implementation and costs of institutional controls.

There are no definitive studies related to the effects of radioactive waste shipments on local tourism and property values. With an average of only one to two shipments per day over the potential 60 year lifetime of a proposed disposal facility in the case of GTCC LLRW and GTCC-like waste shipments, it is unlikely that there would be any significant impact on tourism and property values.

The primary radiological transportation risk to the public for any alternative is from the low level of radiation emanating from the transport vehicle. As discussed in Section 5.3.9.1, the collective population risk is a measure of the total risk posed to society as a whole. A comparison of the collective population risk provides a meaningful evaluation of the relative

release significant amounts of radioactive materials, according to Table 5.3.9.5, and result in adverse economic impacts. The Final EIS must explain in detail the specific source terms released, the extent of contaminated areas requiring cleanup, and the total economic impacts, for each of the severe accident scenarios listed in Table 5.3.9-3 (sealed sources – CH, activated metals – RH, other waste – CH, and other waste – RH, for rail and truck). The Final EIS should also consider the perceived risk impacts that could result from severe accidents involving GTCC shipments, especially impacts on property values, business location decisions, and tourism, along the potential routes in Nevada identified in the DEIS. The Final EIS should also evaluate adverse economic impacts in Nevada resulting from accidents in which no radioactive materials are released.

2.27 Chapter 9, page 9-77, lines 19-25: Failure to Evaluate Acts of Sabotage

The DEIS fails to evaluate the impacts of potential acts of sabotage against shipments of GTCC materials. This failure is particularly serious regarding shipments of sealed sources. Throughout the DEIS, the secure storage and disposal of sealed sources are recognized as a matter of national security concern. Based on analyses of other radioactive materials sabotage events, Nevada believes a successful attack on a sealed source shipment could result in a release of radioactive materials hundreds of times greater than the release resulting from the maximum foreseeable transportation accident. Such an attack in an urban area could result in significant adverse health effects and economic impacts. Certain other shipments, such as contact handled GTCC wastes ("Other Waste –CH"), which contain substantial quantities of dispersible alpha-emitting radionuclides, might also be equally vulnerable to acts of sabotage that could result in significant adverse impacts, especially in urban areas. The Final EIS should evaluate the consequences of successful acts of sabotage against GTCC waste shipments.

2.28 Chapter 9, page 9-81: Summary of Potential Environmental Consequences and Human Health Impacts – Transportation (NNSS)

The summary concludes that "[t]ransporting all waste [to NNSS] by rail would require 5,010 railcar shipments involving 21 million km (13 million mi) of travel." Since there is no rail access to NNSS and no plans to construct such access, it is uncertain how such a conclusion can be supported or on what information such an analysis is based. If the DEIS assumes shipping waste by rail to some intermodal facility, the calculation as to the number of shipments would have to include the truck shipments required to move the waste from the intermodal facility to NNSS. There is no indication that this is factored into the assessment and is a major reason why NNSS is a less-than-ideal site for a GTCC waste disposal facility.

2.29 Chapter 9, page 9-87: Cumulative Impacts (NNSS)

The DEIS concludes that "...the incremental potential impacts from the GTCC proposed action are not expected to contribute substantially to cumulative impacts on the various resource areas evaluated for NNSS." Such a conclusion does not consider the potentially significant cumulative impacts from the simultaneous operations of a large scale LLW and MLLW disposal program at NNSS with the operations of the proposed GTCC waste disposal project. Thousands of LLW and MLLW shipments would be made annually into the NNSS at the same time

E45-30
(Cont.)

E45-31

E45-32

E45-33

risks between disposal locations, as provided in Tables 2.7.5 and 2.7.6. The magnitude of the collective population risk is primarily determined by the number of routes, the length of each route, the number of shipments along each route, the external dose rate of each shipment, and the population density along a given route. The primary differences between alternatives from the standpoint of transportation are the lengths of the routes as determined by the location of the disposal sites (destination of the shipments). Thus, higher collective population risks are associated with alternatives that require transportation over longer distances. All alternatives involve routes that have similar characteristics, with no significant differences for comparison among alternatives, requiring transportation through a range of rural and urban areas. In addition, the routes used in the analysis are considered representative routes (as discussed in Appendix C, Section C.9.4.1.1, because the actual routes used would be determined in the future. For each disposal site, the routes most affected would be the interstate highways that are in closest proximity to the site.

Calculation of the collective population risk (under routine and accident conditions) is provided in the EIS. While these estimates are conservative (i.e., they overestimate the calculated dose), the calculations used expected values where practical (e.g., external shipment dose rates) and provide a reasonable measure for comparison among alternatives, as summarized in Tables 2.7.5 and 2.7.6, and the estimates show that the transportation risks would be small. All alternatives will have some deviation in terms of vehicle speed and receptor distance among others. The overall effect of these types of uncertainties as discussed in Section C.9.5 may cause some deviation in an absolute calculation of risk, but the uniform application of the risk models and input parameters minimizes the relative risks between alternatives.

All alternatives involve routes of hundreds of miles through similar types of rural, suburban, and urban areas. For specific local impacts, Section 5.3.9.2 provides information on potential human health impacts on individuals during normal waste transport along a route. However, the consideration of specific local stakeholder concerns is more appropriate during the final planning stages of a project when actual route selections are finalized, not at the level addressed in this EIS. A generic accident consequence assessment was performed because there is no way to predict the exact location and conditions of an accident, as discussed in Section C.9.3.3 of the EIS. For all alternatives, potential accidents, even those at the same location, could have impacts that range from negligible to significant depending on the waste involved, the accident severity, and weather conditions. Such an analysis would not help distinguish between alternatives because all alternatives involve routes through or near major population centers.

E45-29

Details of the facility accident analysis can be found in Sections 5.3.4.2.1 and C.4.2. All information necessary to duplicate the transportation accident consequence assessment was available in Section 5.3.9.3 of the Draft EIS, with the exception of the source terms used for the contact-handled and remote-handled Other Waste. These latter source terms have been added to Appendix B, Section B.7 of the Final EIS. The accident risk analysis (see Section C.9.3.1) is separate from the accident consequence analysis (see Section C.9.3.3). All relevant data for the accident risk analysis, with the exception of the shipment source terms and route information, are provided in Section C.9.3. Approximately 1,200 routes were considered in this analysis, so it was not considered practical to include this information in the EIS. Such information is readily available by using the TRAGIS routing model, as referenced in Appendix C. Shipment-specific source terms were determined by dividing the origin source inventory by the number of shipments from that site. Site inventories were published in Sandia (2007, 2008), as referenced in Appendix B, which also contains the per-shipment packaging assumptions for each waste type. The shipment-specific source terms were omitted from the EIS for brevity and because of the low estimated impacts.

thousands of GTCC waste shipment would be occurring. Nowhere are impacts to NNSS operations from these activities evaluated. Nor are impacts to communities along LLW, MLLW and GTCC waste shipping routes – many of which would be affected by all these shipments simultaneously – evaluated.

2.30 Chapter 9, page 9-88: Settlement Agreement and Consent Orders for NNSS

The DEIS concludes that no settlement agreement or consent orders would be affected by proposed GTCC waste disposal alternatives for NNSS. This is not entirely accurate. There continue to be unresolved land use issues associated with NNSS that are not adequately addressed in the draft EIS. As Nevada has noted in numerous comments and communications over the years, the original 1952 administrative land withdrawal for the Nevada Test Site (Public Land Order 805) specified its use as a “weapons testing site.” In 1994, the State of Nevada filed a complaint in the U.S. District Court in Las Vegas, alleging that the land withdrawals for NTS do not include waste disposal from offsite sources as an intended use of the land. A settlement agreement signed in April 1997 committed DOE to initiate “consultation with the United States Department of the Interior concerning the status of existing land withdrawals for the NTS with regard to low-level waste storage/disposal activities.” Although DOE has indicated that consultations with the Department of Interior have concluded, the State has continuing concerns about off-site waste disposition, particularly with respect to GTCC and other waste streams, which are subject to NRC regulation. These matters are not addressed in the DEIS.

2.31 Chapter 13, page 13-18, lines 14-21: DOE Self-regulation of Transportation

More than 75 percent of the GTCC shipments evaluated in this DEIS would originate at NRC-licensed facilities, or originate from NRC-licensed activities, yet it is not clear to what extent these shipments would comply with NRC regulations, nor the extent (if any) to which the shipments would be subject to NRC inspections and/or NRC enforcement actions. The Final EIS must clarify how DOE self-regulation of shipments under the Atomic Energy Act would actually operate on a day-to-day basis. The Final EIS should explain how DOE compliance with NRC and DOT regulations would be enforced. Stakeholders are concerned that DOE may exempt itself from DOT and/or NRC requirements and standards “where there is a determination that national security or another critical interest requires different action.” A particular concern is that Federal budget restrictions might influence the degree to which DOE actually achieves “a level of protection that meets or exceeds the level of protection associated with comparable commercial shipments.”

3.0 Specific Comments – Appendices

3.1 Appendix C: Transportation Analysis (and Volume 2, Chapter 9.1.9, Lines 10-20)

The DEIS contains a less rigorous assessment of transportation impacts than it does for other impacts. This is consistent with other DOE EISs, which do not devote adequate attention to important transportation issues.

E45-33
(Cont.)

E45-34

E45-35

E45-36

- E45-30 While cleanup costs could be significant for a severe accident, it is impossible to estimate the economic impacts from a potential radioactive transportation accident without knowing the exact location of such an accident, which is why a generic accident consequence assessment was performed as provided in Section 5.3.9.3. Without knowing the specific details about such items as the affected land use (e.g., agricultural, commercial, retail, residential, etc.), infrastructure (e.g., utilities, transportation), and population levels, any estimate would be speculative. Also, all alternatives would present similar impacts so such an analysis would not provide information that would discriminate between alternatives.
- E45-31 The analysis of intentional destructive acts is given in Section 2.7.4.3 of the EIS. This analysis provides a perspective on the risks that the GTCC LLRW and GTCC-like wastes could pose should such an act occur. In general, the risk presented from an intentional destructive act is similar to that from a high-severity transportation accident. The accident consequence assessment (given in Section 5.3.9.3 of the Final EIS) presents the results for transportation accidents that fall into the highest severity category. The severe environment that occurs under such conditions can be considered to be similar to that which could be initially instigated by an act of sabotage. In highly populated areas, where the highest exposures would be anticipated, a rapid response would be expected, minimizing the amount of time available to fully breach a Type B package. Should such shipments be diverted and the radioactive material removed for dispersion, higher exposures could be achieved, and potential impacts could be significant. The economic impact could reach several billions of dollars. The extent of the impacts would depend on the exact location of the release, density of the surrounding population, local meteorology, and emergency response capabilities in the affected area. In addition, the final transportation routes will not be selected until a ROD for the EIS is issued and follow-up site-specific NEPA review is conducted as needed.
- E45-32 All shipping options to NNSS were considered, including the use of intermodal facilities if rail transport were used. However, shipment of waste to NNSS would likely be via truck transport.

DOE/NNSA analyzed various radioactive waste shipping routes through and around metropolitan Las Vegas, Nevada, in the Draft NNSS SWEIS. DOE/NNSA continued discussions with the State of Nevada on routing options throughout the preparation of the Final NNSS SWEIS. After taking into consideration the comments and concerns expressed by State, county, and local government officials and the public in general during the review and comment period for the Draft NNSS SWEIS, DOE/NNSA decided to maintain the current highway routing restrictions for shipments of low-level radioactive waste (LLW) and mixed-level radioactive waste (MLLW), as described in the Waste Acceptance Criteria (WAC) for the site. DOE/NNSA explained this decision in the Final NNSS SWEIS. The unchanged WAC restrictions are to avoid (1) crossing the Colorado River near Hoover Dam and (2) the greater metropolitan Las Vegas interstate system. DOE/NNSA is not considering, nor is it making, changes to the NNSS WAC with regard to routing.

Once an alternative is selected in a ROD for this EIS, implementation will include, as needed and appropriate, NEPA reviews and other analysis (e.g., transportation).
- E45-33 DOE believes that the analyses presented in the EIS are sufficient to compare the potential cumulative impacts of GTCC LLRW and GTCC-like waste disposal for the sites that were evaluated. In particular, existing concentrations of various radionuclides in contaminated soil and groundwater at the candidate sites were taken into consideration in the selection of the preferred alternative. Also, while up to 12,600 truck shipments were assessed for transport of the GTCC LLRW and GTCC-like wastes to a proposed disposal facility, these shipments would be spread out over a 60 year time period, with the result that only about one to two shipments a day might be expected at the facility in addition to current traffic. Additional cumulative impact analyses would be conducted in site-specific NEPA reviews, if needed, for the alternative selected in a ROD. Such follow-on analyses would be based on additional site-specific information.

There are three transportation alternatives to move GTCC waste. The first is to use exclusively legal-weight truck. The DEIS does not specify, but it is possible to assume that it refers to legal-weight truck, i.e., trucks with a weight below 80,000 pounds. Most of these materials are separable into packages that would enable shipments to fall below the 80,000 pound limit. However, there may also be shipments that could exceed the 80,000 pound limit or may not be divisible in a way that makes it possible to use a legal-weight truck. Examples of these types of materials are: unusual and large reactor parts such as the reactor core shroud, unique defense materials, or prepackaged accumulations of sealed sources where the removal of the sealed sources from the waste package would create a greater burden than shipping via legal-weight truck. Since much of the GTCC waste would be HRCQ shipments, all legal weight and overweight shipments would, of necessity, be routed through Metro Las Vegas and the Spaghetti Bowl (the default route under U.S. DOT regulations).

The second alternative is intermodal shipments. The draft GTCC DEIS does not describe an intermodal shipping scenario in detail. It mentions that two intermodal sites have been studied and identifies them as Barstow, California and Caliente, Nevada (not New Mexico). The DEIS then fails to perform an assessment of intermodal shipping and handling. It indicates that intermodal transportation from either Barstow, California or Caliente, Nevada is possible. However, the DEIS does not indicate which intermodal transportation site was considered. The risks of intermodal shipping and handling are substantially different from direct shipments. The risks at the specific sites and the risks along the routes should be evaluated.

This is particularly true for the extremely rural routes that will be traversed by these shipments. For example, intermodal shipments arriving in Barstow, California will almost certainly travel along California Highway 127 to reach the NNSS. This route is interrupted by seasonal flooding, used by recreational travelers and would require careful study in order to be used for a major shipping campaign. This has a substantial bearing on the risks associated with the shipments. These risks should be considered in the DEIS. The Latent Cancer Fatality numbers and deaths related to accidents contained in the DEIS cannot be properly understood without reference to intermodal handling risks, if indeed that is an option being considered.

The DEIS does not specify which routes the Department of Energy would consider shipping these materials on (i.e., from whatever intermodal facility is postulated to NNSS). The DEIS provides RADTRAN and RISKIND assessments of the routes, but it does not provide maps of the specific routes. There is no detailed description of the selected routes or the risk characteristics along the routes. As with direct truck shipments, the DEIS does not consider that highway routes within Nevada for intermodal shipments of much of the GTCC waste will be severely limited because they would be considered HRCQ shipments. Nor does the DEIS consider the implications of having such HRCQ shipments routed through Metro Las Vegas and the Spaghetti Bowl (which is the default route that must be used under US DOT routing regulations).

The third shipping option is rail. It is not clear what the DEIS means by rail transportation as it relates to the NNSS. There is currently no rail access to the NNSS. Based on work done for the now-defunct Yucca Mountain project, it will require construction of a 319 mile long rail spur. Such construction would last more than 10 years and cost in excess of \$3

E45-36 (Cont.)

E45-34 The NNSS was originally created through the issuance of four administrative Public Land Orders by the Secretary of the Interior. Public Land Order 805, dated February 12, 1952, reserved lands for the use of the U.S. Atomic Energy Commission (AEC), DOE's predecessor, as a weapons testing site. Subsequent administrative land withdrawals through 1965 reserved the withdrawn lands for use of the AEC in connection with the NNSS. The 1961 Public Land Order specifically mentioned that it reserved the lands for use of the AEC "in connection with the Nevada Test Site for test facilities, roads, utilities, and safety distances." The Military Lands Withdrawal Act of 1999 withdrew the northwestern area of the NNSS (Pahute Mesa) for exclusive use of DOE. This area had previously been utilized by DOE and its predecessors under a Memorandum of Understanding with the U.S. Air Force.

The U.S. Department of the Interior (DOI) is vested with oversight responsibility to review existing land withdrawals under the Federal Land Policy and Management Act. The DOI suggested in its comments on the 1996 NTS EIS (which included proposals for commercial reuse of the site) that substantial changes in land use at the NTS may require a new land withdrawal. As part of the April 1997 Settlement Agreement resolving State of Nevada litigation regarding radioactive waste disposal at the NTS (State of Nevada v. Peña, U.S. District Court, District of Nevada, 1997), DOE committed to initiate "consultation with the United States Department of the Interior ('DOI') concerning the status of the existing land withdrawals for NTS with regard to low-level waste storage/disposal activities." The consultation process was initiated by DOE with DOI shortly thereafter and was concluded in November 2009, with NNSS's acceptance of custody and control of the approximately 740 acres constituting the NNSS Area 5 Radioactive Waste Management Complex. This facility is part of NNSS's continuing environmental management mission as a disposal facility for low-level waste (LLW) and mixed low-level waste (MLLW). All radioactive waste management at the NNSS is conducted in accordance with applicable federal, state and local regulations.

E45-35 DOT and the NRC have primary responsibility for federal regulations governing commercial radioactive materials transportation. Non-DOE shipments of GTCC LLRW from commercial sites would be transported by commercial carriers and would be regulated by DOT and the NRC. In addition, DOE shipments by commercial carriers of GTCC LLRW from commercial sites or of GTCC-like waste from DOE sites would be regulated by DOT and NRC.

DOE has broad authority under the AEA to regulate all aspects of activities involving radioactive materials that are undertaken by DOE or undertaken on its behalf, including the transportation of radioactive wastes. However, in most cases that do not involve national security, DOE does not exercise its authority to regulate DOE shipments and instead utilizes commercial carriers that undertake shipments of DOE materials under the same terms and conditions as those used for commercial shipments. These shipments are subject to regulation by DOT and the NRC. As a matter of policy, however, even in the limited circumstances where DOE exercises its AEA authority for shipments, DOE requirements mandate that all DOE shipments be undertaken in accordance with the requirements and standards that apply to comparable commercial shipments, unless there is a determination that national security or another critical interest requires different action.

E45-36 The primary radiological transportation risk to the public for any alternative is from the low level of radiation emanating from the transport vehicle. As discussed in Section 5.3.9.1, the collective population risk is a measure of the total risk posed to society as a whole. A comparison of the collective population risk provides a meaningful evaluation of the relative risks between disposal locations, as provided in Tables 2.7 5 and 2.7 6. The magnitude of the collective population risk is primarily determined by the number of routes, the length of each route, the number of shipments along each route, the external dose rate of each shipment, and the population density along a given route. The primary differences between alternatives from the standpoint of transportation are the lengths of the routes as determined by the location of the disposal sites (destination of the shipments). Thus, higher collective population risks are

billion. Since there is no rail access to NNSS, it is unclear what the DEIS is referring to in the assessment of rail shipments to NNSS. The DEIS should specify how the rail transportation scenario was developed. A rail shipping campaign to a location that has no rail access is unrealistic and should not be used in a bounding assessment.

3.2 Appendix C, pages C-25 to C-26: Transportation Risk Analysis

The methods used to evaluate collective population risk, maximum individual exposures, and accident consequences in the DEIS are too generalized to be of any value in comparative impact assessment of the disposal options and the disposal sites under consideration. The Final EIS should reexamine collective population risk from routine transportation in specific communities along specific routes, by considering actual building types and locations, travel speeds and stop times, and actual populations

The Final EIS should reexamine the maximum individual exposures from routine transportation, using individual exposure scenarios based on actual conditions at specific locations along specific routes. Appendix C, pages C-29 to C-47, does not provide sufficient information about how the accident consequence assessments were conducted, to allow reviewers to determine the validity of the potential accident radiological consequences to populations reported in Table 5.3.9-3, nor to determine the validity of the potential accident radiological consequences to the highest-exposed individuals reported in Table 5.3.9-4. The Final EIS must explain in detail how the analyses were conducted for each type of waste (sealed sources – CH, activated metals – RH, other waste – CH, and other waste – RH) and each mode (rail and truck).

The DEIS fails to evaluate cleanup costs and other economic impacts as part of the accident consequence assessments. The Final EIS must explain in detail the specific source terms released, the extent of contaminated areas requiring cleanup, and the total economic impacts, for each of the severe accident scenarios listed in Table 5.3.9-3.

The DEIS fails to evaluate the impacts of potential acts of sabotage against shipments of GTCC materials. The Final EIS should evaluate the consequences of successful acts of sabotage against GTCC waste shipments.

3.3 Appendix C, page C-33, Lines 5-18: Route Selection for Truck Shipments of GTCC

All truck shipments of GTCC should be treated as "highway route controlled quantity" (HRCQ) of radioactive materials shipments, as defined in 49 CFR 173.403, for purposes of highway route selection. The DEIS is unclear in this regard. The DEIS states, "[m]any potential shipments... such as shipments of activated metal from commercial reactors, fall under this category." The DEIS seems to imply that DOE would not treat all GTCC shipments as HRCQ. Treating some, but not all, GTCC shipments as HRCQ, could result in use of multiple highway routes to each disposal location. This would complicate the process of comparative evaluation of impacts, required under NEPA, and invite unnecessary confusion and controversy. Failure to treat all GTCC shipments as HRCQ for purposes of highway route selection would likely undermine public acceptance on safety and security grounds, especially for shipments through

E45-36
(Cont.)

associated with alternatives that require transportation over longer distances. All alternatives involve routes that have similar characteristics, with no significant differences for comparison among alternatives, requiring transportation through a range of rural and urban areas. In addition, the routes used in the analysis are considered representative routes (as discussed in Appendix C, Section C.9.4.1.1, because the actual routes used would be determined in the future. For each disposal site, the routes most affected would be the interstate highways that are in closest proximity to the site.

Calculation of the collective population risk (under routine and accident conditions) is provided in the EIS. While these estimates are conservative, the calculations used expected values where practical (e.g., external shipment dose rates) and provide a reasonable measure for comparison among alternatives, as summarized in Tables 2.7.5 and 2.7.6, and the estimates show that the transportation risks would be small. All alternatives involve routes of hundreds of miles through similar types of rural, suburban, and urban areas. For specific local impacts, Section 5.3.9.2 provides information on potential human health impacts on individuals during normal waste transport along a route. However, the consideration of specific local stakeholder concerns is more appropriate during the final planning stages of a project when actual route selections are finalized, not at the level addressed in this EIS. A generic accident consequence assessment was performed because there is no way to predict the exact location and conditions of an accident, as discussed in C.9.3.3 of the EIS. For all alternatives, potential accidents, even those at the same location, could have impacts that range from negligible to significant depending on the waste involved, the accident severity, and weather conditions. Such an analysis would not help distinguish between alternatives because all alternatives involve routes through or near major population centers.

The additional human health impacts from intermodal transfer and transport of waste from the nearest rail access point to those disposal sites without direct rail access is generally a small percentage of the total risk discussed in Section C.9.5.5 of the EIS. Costs involved in either building a rail spur to a site or the additional cost of intermodal operations would need to be considered if that option was considered further. For the rail option, the use of dedicated trains, if sufficient waste is available for transport at the same time, could reduce transportation risks and costs by minimizing transit times. The current rail analysis therefore bounds what might be expected if dedicated trains were used. In general, transportation costs would be similar across all disposal alternatives. The primary difference would be related to the distances traveled in each case. Thus, the transportation costs will scale with the shipment distances travelled as presented in the EIS. Any decisions made by DOE would take these factors into account during implementation.

There are no definitive studies related to the effects of radioactive waste shipments on local tourism and property values. With an average of only one to two shipments per day over the potential 60 year lifetime of a proposed disposal facility in the case of GTCC LLRW and GTCC-like waste shipments, it is unlikely that there would be any significant impact on tourism and property values.

As stated in Section C.9.4.1.1 of the EIS on route selection, many of the GTCC LLRW and GTCC-like wastes considered in the EIS would meet the definition of a highway route HRCQ (49 CFR 173.403). However, as noted in the discussion, states and Native American tribes have the opportunity to designate "preferred routes" to replace or supplement the interstate highway system. For those wastes not specifically designated as HRCQ, the selection of a route is left to the carrier, but in the case of GTCC LLRW and GTCC-like wastes, additional consultation with transportation stakeholders would occur. In the case of rail transport, the text was revised to include a reference to the routing regulations in 49CFR172.820(c) regarding the transportation of an HRCQ of material by rail which requires the rail carrier to perform a security and safety risk analysis for any proposed routes.

highly populated areas. However, for NNSS, the use of the HRCQ default route would violate a long-standing agreement between the State of Nevada and DOE requiring shipments of LLW to avoid Metro Las Vegas and the I-15/US 95 interchange.

3.4 Appendix C, page C-33, Lines 30-32: Route Selection for Rail Shipments of GTCC

DOE should reexamine the statement that "DOT has no railroad routing regulations specific to the transportation of radioactive materials. Routes are generally fixed by the location of rail lines, and urban areas cannot be readily bypassed." Rail shipments of activated metals, sealed sources, remote handled wastes, and perhaps all of the GTCC materials evaluated in the DEIS, may be subject to the routing regulations recently adopted by the Department of Transportation's Pipeline and Hazardous Materials Safety Administration (PHMSA) and the Department of Homeland Security's Transportation Security Administration (TSA).

In 2008, regulations [49 CFR Parts 172 & 1580] were jointly promulgated by TSA and PHMSA that would restrict rail shipments of certain hazardous materials, including radioactive materials, through highly populated areas. The new regulations were intended to prevent "catastrophic release or explosion in proximity to densely populated areas, including urban areas and events or venues with large numbers of people in attendance. Also of major concern is the release or explosion of rail cars in close proximity to iconic buildings, landmarks, or environmentally significant areas." Of particular concern, "if terrorists perpetrated an attack against a rail car transporting certain radioactive materials, they could endanger a significant number of people as well as disrupt the supply chain as a result of contamination."

While these rules clearly apply to rail shipments of spent nuclear fuel and high-level radioactive waste, they would likely also apply to rail shipments of activated metals, sealed sources, and other types of GTCC evaluated in the DEIS, especially if such shipments were deemed to be HRCQ shipments. DOE should specifically evaluate the routing implications of the TSA rule, which designates 46 high threat urban areas (HTUAs) in 28 states and the District of Columbia. These regulations [49 CFR Part 1580, Appendix A] subject shipments through these HTUAs to new chain of custody and control and other procedures, such as designation of rail security coordinators and monitoring plans [49 CFR Part 1580, Appendix B]. DOE should also specifically evaluate the implications of the PHMSA regulations for shipments through areas not designated HTUAs, but which exhibit conditions of concern identified in the PHMSA routing regulations, which are designed to protect highly populated areas and iconic locations, through the application of 27 routing risk analysis factors [49 CFR Part 172, Appendix D].

3.5 Appendix C, page C-33, Lines 38-40: Timing of Route Selection for Shipments

DOE must its reconsider its position on the timing of route selection and the role of affected states and tribes. The DEIS states: "At the time of shipment, the route would be selected on the bases [sic] of current road or railroad track conditions, including repairs and traffic conditions." Based on experience with the WIPP transuranic waste shipments, DOE should plan to identify preferred and alternative route options at least 5-7 years in advance of shipments, in consultation with the affected states and tribes.

DOE/NNSA analyzed various radioactive waste shipping routes through and around metropolitan Las Vegas, Nevada, in the Draft NNSS SWEIS. DOE/NNSA continued discussions with the State of Nevada on routing options throughout the preparation of the Final NNSS SWEIS. After taking into consideration the comments and concerns expressed by State, county, and local government officials and the public in general during the review and comment period for the Draft NNSS SWEIS, DOE/NNSA decided to maintain the current highway routing restrictions for shipments of low-level radioactive waste (LLW) and mixed-low level radioactive waste (MLLW), as described in the Waste Acceptance Criteria (WAC) for the site. DOE/NNSA explained this decision in the Final NNSS SWEIS. The unchanged WAC restrictions are to avoid (1) crossing the Colorado River near Hoover Dam and (2) the greater metropolitan Las Vegas interstate system. DOE/NNSA is not considering, nor is it making, changes to the NNSS WAC with regard to routing.

Once an alternative is selected in a ROD for this EIS, implementation will include, as needed and appropriate, NEPA reviews and other analysis (e.g., transportation).

E45-36
(Cont.)

State of Nevada Agency for Nuclear Projects, Commenter ID No. E45 (cont'd)

E45-37 The specific waste forms and packages used to dispose of GTCC LLRW and GTCC-like wastes would be determined in the future as part of the waste acceptance criteria and packaging requirements developed. See the discussion in Section B.5 and C.9.4.2 of the EIS for more information on packaging requirements. All GTCC LLRW and GTCC-like wastes would be packaged and transported in accordance with all applicable federal and state requirements.

3.6 Appendix C, page C-33, Lines 42-45: TRAGIS highway route updates

It is our understanding that the highway data network in TRAGIS has not been recently updated and does not, for example, include the Tillman Bridge over the Colorado River on US Highway 93, which could significantly affect routes in Arizona, California, and Nevada.

3.7 Appendix C, page C-34, Lines 6-7: Use of HRCQ option for modeling highway routes

Use of the HRCQ option to select routes for modeling is inappropriate unless DOE has committed to actually use HRCQ routes for all truck shipments. Otherwise, use of HRCQ routes in risk analysis may systematically underestimate the actual transportation risks, especially regarding routes through highly populated areas.

3.8 Appendix C, page C-34, Lines 18-23: Use of "shortest-route" algorithm for rail shipments

Using the standard assumptions in the model for selection of rail routes, i.e., the "shortest-route" algorithm, does not reflect the impact of the 2008 TSA and PHMSA rail routing regulations cited previously for shipments of certain radioactive materials, which likely apply to some or all of the GTCC materials evaluated in the DEIS.

3.9 Appendix D, page D-2, Lines 8 to 47: General Planning Issues

The DEIS does not include a comprehensive transportation plan. However, the DEIS can recognize the critical importance of a comprehensive transportation plan to stakeholders. DOE has neglected transportation planning in the past. DOE should, however, make a commitment to a process that will result in a systematic approach to transportation planning that will: (1) incorporate stakeholder concerns; (2) effectively manage safety and security issues; and (3) deliver a safe and comprehensive transportation system. The GTCC DEIS fails to acknowledge the size and possible complexity of the transportation program that will be required and the transportation Appendix is only a boilerplate discussion of transportation risk assessment.

3.10 Appendix D, page D-2, Lines 8 to 47: Containers

The DEIS does not make it clear what container would be adopted for sealed sources. Appendix D describes assumptions about the containers, their size and description. It indicates which waste will be placed in which container, but it does not make it clear which container will be used for sealed sources. This is important because these sources are irregularly shaped, in various states of decay, and will require very special kinds of packages. The DEIS also does not address the issue of NRC certification for containers for sealed sources and other types of GTCC waste.

E45-36
(Cont.)

E45-37

State of Nevada Agency for Nuclear Projects, Commenter ID No. E45 (cont'd)

ATTACHMENT
NELLIS AIR FORCE BASE COMMENT



DEPARTMENT OF THE AIR FORCE
99TH CIVIL ENGINEER SQUADRON (ACC)
NELLIS AIR FORCE BASE, NEVADA

Ms Deborah Stockdale
99 CES/CEA
4349 Duffer Dr., Suite 1601
Nellis AFB, NV 89191-7007

MAY 17 2011

Nevada State Clearinghouse
Department of Administration
209 East Musser Street, Room 200
Carson City, NV 89701-4298

Mesdames, Gentlemen,

Thank you for including Nellis Air Force Base (AFB) in the Draft Environmental Impact Statement process for a Facility for Disposal of Greater-Than-Class C (GTCC) Low-Level Radioactive Waste and GTCC-Like Waste at the Nevada National Security Site (formerly known as the Nevada Test Site). Nellis AFB has reviewed the Department of Energy (DOE) Draft Environmental Impact Statement (DEIS), Nevada SAI #E2011-109, and offers the following comment:

The disposal area is near R-4806W and there are ground parties that use that area for training. How will they be affected? Will overflight of aircraft be allowed for the disposal site?

Nellis AFB appreciates the DOE's efforts to address these issues. Should the DOE have any questions or require further assistance, my Action officer for this issue is Mr. Tod Oppenborn, (702) 652-9366.

Sincerely,

DEBORAH STOCKDALE
Chief, Asset Management Flight

Honor the Warfighter

E45-38 This comment was also submitted by the Department of the Air Force separately (see comment response L307-1) and referenced earlier in this comment document (see E45-14).

E45-38

1
2
3
4
5
6
7
8
9
10
11
12
13
14
15
16
17
18
19
20
21
22
23
24
25

MR. BROWN: Okay. Fine.

So Phil Klevorick, I guess, will follow.

You'll follow Steve then.

Steve, proceed.

PUBLIC COMMENTS

MR. FRISHMAN: Thanks. I'm Steve Frishman.

I'm representing the Nevada Agency for Nuclear
Projects. And I'm giving this statement on behalf of
Joe Strolin, the Acting Executive Director of the
agency. He has provided a written statement, and I've
taken the liberty of reducing it to a five-minute
statement, but I'll provide his whole statement, for
the record.

State of Nevada Agency for Nuclear Projects, Commenter ID No. T38 (cont'd)

1 (Reading) The State of Nevada Agency
2 for Nuclear Projects is in the process
3 of reviewing the Department of Energy's
4 Draft Environmental Impact Statement.
5 In addition to these brief preliminary
6 comments, the State will provide more
7 extensive written comments prior to the
8 June 27 deadline.

9 In comments on DOE's Notice of Intent to
10 prepare the EIS for Greater-than-Class C in 2007,
11 Nevada opposed, on both scientific and legal grounds,
12 the use of either the proposed high-level nuclear waste
13 repository --

14 (Reporter request.)

15 MR. BROWN: I'll be liberal on the five
16 minutes, Steve. Go ahead on.

17 MR. FRISHAM: That's the first time I've ever
18 outrun the court reporter.

19 MR. BROWN: Yeah.

20 MR. FRISHAM: In comments on DOE's Notice of
21 Intent to prepare the EIS for Greater-than-Class C in
22 2007, Nevada opposed, on both scientific and legal
23 grounds, the use of either the proposed high-level
24 radioactive waste repository at Yucca Mountain or the
25 Nevada Test Site for Greater-than-Class C disposal.

1 The fact that this Draft EIS explicitly excludes Yucca
2 Mountain as an option is an appropriate acknowledgment
3 of the reality that Yucca Mountain will never be built.

4 The Draft EIS fails to recognize the problems
5 associated with the requirement that any facility
6 chosen for disposal of Greater-than-Class C waste
7 disposal must be licensed and regulated by the U.S.
8 Nuclear Regulatory Commission.

9 While the Draft acknowledges that most of the
10 Greater-than-Class C waste requiring disposal would be
11 commercial waste from NRC-licensed generators, neither
12 Nevada Test Site, nor any of the specific locations
13 identified for potential Greater-than-Class C waste
14 disposal, has an NRC-licensed facility. Inclusion of
15 DOE's Greater-than-Class C-Like waste, currently
16 managed under DOE orders and stored at DOE facilities,
17 requires that these wastes be brought into NRC
18 regulatory regime.

19 This raises considerable waste
20 characterization and security issues. It is by no
21 means clear how or if an NRC-regulated facility can
22 coexist with a DOE self-regulated facility like Nevada
23 Test Site, or in the case of the WIPP facility in New
24 Mexico, an EPA and state-regulated facility, and how
25 the public can be assured that the NRC's regulatory

T38-1 The LLRWPA (P.L. 99-240) assigns DOE responsibility for the disposal of GTCC LLRW generated by NRC and Agreement State licensees. The LLRWPA (P.L. 99-240) specifies that GTCC LLRW, designated a federal responsibility under section 3(b)(1)(D) that results from activities licensed by the NRC, is to be disposed of in an NRC-licensed facility that has been determined to be adequate to protect public health and safety. However, unless specifically provided by law, the NRC does not have authority to license and regulate facilities operated by or on behalf of DOE. Further, the LLRWPA does not limit DOE to using only non-DOE facilities or sites for GTCC LLRW disposal. Accordingly, if DOE selects a facility operated by or on behalf of DOE for disposal of GTCC LLRW for which it is responsible under section 3(b)(1)(D), clarification from Congress would be needed to determine NRC's role in licensing such a facility and related issues. In addition clarification from Congress may be needed on NRC's role if DOE selects a commercial GTCC LLRW disposal facility licensed by an Agreement State rather than by NRC.

T38-2 DOE recognizes that including GTCC-like wastes within the scope of this EIS along with GTCC LLRW may complicate the implementation of GTCC LLRW disposal alternative(s). However, DOE determined that the most efficient approach was to address both types of waste, which have many similar physical and radioactive characteristics, in a single NEPA process. DOE's intent is to facilitate the overall process for addressing the disposal needs of both waste types. Issues associated with potential regulatory changes or NRC licensing would be addressed as necessary to enable implementation.

T38-1

T38-2

10

1 authority will have primacy at a Greater-than-Class C
 2 site.

3 There continues to be unresolved land-use
 4 issues associated with the Nevada Test Site that are
 5 not adequately addressed in the Draft EIS. The
 6 original 1952 administrative land withdrawal for the
 7 Nevada Test Site specified its use as a, quote,
 8 "weapons testing site."

9 In 1994, the State of Nevada filed a
 10 Complaint in the U.S. District Court in Las Vegas,
 11 alleging that the land withdrawals for the Nevada Test
 12 Site do not include waste disposal for offsite sources
 13 as an intended use of the land.

14 A Settlement Agreement signed in April 1997
 15 committed DOE to initiate, quote, "consultation with
 16 the United States Department of the Interior concerning
 17 the status of existing land withdrawals for the NTS
 18 with regard to low-level waste disposal and storage."

19 Although DOE has indicated that consultations
 20 with the Department of the Interior have concluded, the
 21 State has continuing unresolved land withdrawal static
 22 concerns about the use of the site for offsite-
 23 generated waste disposal, including Greater-than-Class
 24 C and Greater-than-Class-C-Like wastes.

25 Transportation impacts associated with the

T38-2
(Cont.)

T38-3

T38-4

T38-3

The NNSS was originally created through the issuance of four administrative Public Land Orders by the Secretary of the Interior. Public Land Order 805, dated February 12, 1952, reserved lands for the use of the U.S. Atomic Energy Commission (AEC), DOE's predecessor, as a weapons testing site. Subsequent administrative land withdrawals through 1965 reserved the withdrawn lands for use of the AEC in connection with the NNSS. The 1961 Public Land Order specifically mentioned that it reserved the lands for use of the AEC "in connection with the Nevada Test Site for test facilities, roads, utilities, and safety distances." The Military Lands Withdrawal Act of 1999 withdrew the northwestern area of the NNSS (Pahute Mesa) for exclusive use of DOE. This area had previously been utilized by DOE and its predecessors under a Memorandum of Understanding with the U.S. Air Force.

The U.S. Department of the Interior (DOI) is vested with oversight responsibility to review existing land withdrawals under the Federal Land Policy and Management Act. The DOI suggested in its comments on the 1996 NTS EIS (which included proposals for commercial reuse of the site) that substantial changes in land use at the NTS may require a new land withdrawal. As part of the April 1997 Settlement Agreement resolving State of Nevada litigation regarding radioactive waste disposal at the NTS (State of Nevada v. Peña, U.S. District Court, District of Nevada, 1997), DOE committed to initiate "consultation with the United States Department of the Interior ('DOI') concerning the status of the existing land withdrawals for NTS with regard to low-level waste storage/disposal activities." The consultation process was initiated by DOE with DOI shortly thereafter and was concluded in November 2009, with NNSS's acceptance of custody and control of the approximately 740 acres constituting the NNSS Area 5 Radioactive Waste Management Complex. This facility is part of NNSS's continuing environmental management mission as a disposal facility for low-level waste (LLW) and mixed low-level waste (MLLW). All radioactive waste management at the NNSS is conducted in accordance with applicable federal, state and local regulations.

T38-4

As stated in Section C.9.4.1.1 of the EIS on route selection, many of the GTCC LLRW and GTCC-like wastes considered in the EIS would meet the definition of a highway route HRCQ (49 CFR 173.403). However, as noted in the discussion, states and Native American tribes have the opportunity to designate "preferred routes" to replace or supplement the interstate highway system. For those wastes not specifically designated as HRCQ, the selection of a route is left to the carrier, but in the case of GTCC LLRW and GTCC-like wastes, additional consultation with transportation stakeholders would occur. For disposal at NNSS, the total number of shipments is estimated to be about 12,600 shipments as stated in Section 9.2.9.1. With an average of only one to two shipments per day over the potential 60 year lifetime of a proposed disposal facility in the case of GTCC LLRW and GTCC-like waste shipments, it is unlikely that there would be any significant impact on any local road traffic or current NNSS operations.

DOE/NSA analyzed various radioactive waste shipping routes through and around metropolitan Las Vegas, Nevada, in the Draft NNSS SWEIS. DOE/NSA continued discussions with the State of Nevada on routing options throughout the preparation of the Final NNSS SWEIS. After taking into consideration the comments and concerns expressed by State, county, and local government officials and the public in general during the review and comment period for the Draft NNSS SWEIS, DOE/NSA decided to maintain the current highway routing restrictions for shipments of low-level radioactive waste (LLW) and mixed-low level radioactive waste (MLLW), as described in the Waste Acceptance Criteria (WAC) for the site. DOE/NSA explained this decision in the Final NNSS SWEIS. The unchanged WAC restrictions are to avoid (1) crossing the Colorado River near Hoover Dam and (2) the greater metropolitan Las Vegas interstate system. DOE/NSA is not considering, nor is it making, changes to the NNSS WAC with regard to routing.

Once an alternative is selected in a ROD for this EIS, implementation will include, as needed and appropriate, NEPA reviews and other analysis (e.g., transportation).

11

1 disposal of the Greater-than-Class C waste, generally
 2 and with respect to Nevada Test Site in particular,
 3 have not been adequately addressed in the Draft EIS.
 4 Since there is no rail access to NTS, it's entirely
 5 unrealistic to assume that Greater-than-Class C waste
 6 could be shipped via rail to the site. Consequently,
 7 all the waste, over 30,000 potential shipments, would
 8 have to be moved to the site by truck.

9 Many of these shipments, according to the
 10 Draft, would be required to use the interstate highway
 11 system, thus pass through the most heavily populated
 12 portions of Las Vegas and Clark County. Such a shipping
 13 campaign would put Las Vegas' tourism-dependent economy
 14 at substantial risk in the event of an accident or
 15 terrorist attack against a shipment while in transit.

16 Initial review of this draft document reveals
 17 nothing that alters the State's view that disposal of
 18 Greater-than-Class C at NTS, regardless of the
 19 alternative method employed, is unacceptable.

20 (Whereupon Exhibit No. 1 was marked for
 21 identification.)

T38-4
(Cont.)

T38-5

T38-5 The disposal methods and sites evaluated in the EIS represent the range of reasonable alternatives for the disposal of GTCC LLRW and GTCC-like wastes. This range is consistent with NEPA implementing regulations in Parts 1500–1508 of Title 40 of the Code of Federal Regulations (40 CFR Parts 1500–1508). In this GTCC EIS, DOE analyzed a range of disposal methods (i.e., geologic repository, near-surface trench, intermediate-depth borehole, and above-grade vault) and federally owned sites (i.e., Hanford Site, INL, LANL, NNSS, SRS, and the WIPP Vicinity, for which two reference locations – one within and one outside the WIPP Land Withdrawal Boundary – were considered). DOE has determined that it was reasonable to analyze these six sites because they currently have operating radioactive waste disposal facilities, except for the WIPP Vicinity, which is near an operating geologic repository.

DOE also conducted a generic evaluation of commercial disposal facilities on nonfederal lands in the EIS to order to provide, to the extent possible, information regarding the potential long-term performance of other (nonfederal) locations for siting a GTCC waste land disposal facility.

Final siting of a disposal facility for GTCC LLRW and GTCC-like wastes would involve further NEPA review as needed and be in accordance with applicable laws and regulations and would involve local stakeholder involvement and consent.



State of New Mexico

Susana Martinez
Governor

September 1, 2011

Secretary Steven Chu
U.S. Department of Energy
Forrestal Building
1000 Independence Ave. SW
Washington, DC 20585
Via fax: 202-586-4403 and U.S. Mail

Re: Science Will Lead New Mexico's Role in Radioactive Waste Management

Dear Dr. Chu:

This letter presents the position of the State of New Mexico regarding the present and future management of radioactive waste in our State and in the Nation. Several recommendations are presented for your consideration.

New Mexico's National Laboratories and the Waste Isolation Pilot Plant

As I am certain you are aware, the Waste Isolation Pilot Plant (WIPP), near Carlsbad, NM, is the only operating facility in the U.S. that permanently disposes defense-related transuranic (TRU) waste. The facility was built for the purpose of isolating waste contaminated with long-lived, mostly alpha-emitting radionuclides left from the research and production of nuclear weapons. These TRU wastes include clothing, tools, mgs, solidified sludge, soil and other trash derived from laboratory and manufacturing operations. WIPP was successfully sited, constructed and operated, with State oversight throughout the process. The WIPP facility operates with a total of 728 employees.

Current operations focus on disposing of defense legacy wastes from Los Alamos National Laboratory (LANL) and from other DOE facilities. New Mexico insists removal of these defense legacy wastes from LANL must remain the highest priority to DOE at WIPP. The agency has become ever more evident as the largest fire in New Mexico's history encroached upon nuclear waste materials stored above ground, approximately 11 years after a previous fire burned significant portions of LANL property. This work is also a necessary precursor for completing the cleanup of all legacy wastes at LANL.

State Capitol • Room 400 • Santa Fe, New Mexico 87501 • 505-476-2200 • fax: 505-476-2216

State of New Mexico, Governor's Office, Commenter ID No. L304 (cont'd)

Dr. Alfredo Armendariz
September 1, 2011
Page 2

Decreases in FY11 operating budgets for WIPP and LANL have decreased the pace of the legacy TRU waste cleanup work at LANL and caused fewer shipments of waste to the WIPP site. These decreases in both funding and shipments have resulted in WIPP implementing a voluntary separation of 51 employees in May 2011. A further reduction of 49 employees may be implemented if the same level of funding is maintained for FY12.

WIPP, with the support of the two New Mexico national laboratories, has safely and efficiently disposed of radioactive waste for the past 12 years. These actions should serve as a model for the President's-Blue Ribbon-Commission-(BRC)-on-how-to-site-and-open-future-repositories-for-the-permanent-disposal-of-radioactive-wastes.

Blue Ribbon Commission Recommendations

The Blue Ribbon Commission on America's Nuclear Future (BRC) came to New Mexico in January 2011 to learn how and why the Federal Government's WIPP facility was successfully sited, constructed and operated. I am delighted to see elements of the WIPP success story liberally spread throughout the Commission's draft report recommendations. When the Blue Ribbon Commission visited Carlsbad early this year, I told them that New Mexico was willing to have a dialogue on other nuclear waste projects within its border as long as the science provided clear and overwhelming assurance of safety and reliability, as it did for WIPP.

The Commission's draft recommendations include "prompt efforts to develop a new permanent geologic disposal facility." As recognized in the other BRC recommendations, New Mexico also believes that any such development must be informed by science and broad local community outreach and support.

Required Future Research

In early June of this year, a management proposal for "Salt Disposal Investigations," describing a field-scale, coupled process heater-test at WIPP, was forwarded from the Department's Carlsbad Field Office to DOE leadership in Washington. This peer reviewed research document proposes an integrated scope of scientific and engineering activities, both in the laboratory and performed underground. The proposed six-year test program could provide key information on thermal, mechanical, and hydrologic responses of salt to elevated thermal conditions. Only comprehensive tests of such maturity can provide the scientifically rigorous proof-of-principle field demonstration for disposal of heat-generating nuclear waste which New Mexico will demand in order to continue the dialogue on other nuclear waste projects within its borders.

The proposed test would be staged in that area of WIPP designated and currently used for non-WIPP related scientific experiments. I recognize that performing the tests at WIPP could be met with skepticism that they only open the door for WIPP expansion and disposal of higher level waste there. That is not New Mexico's intent or goal. Thermal testing of waste disposal in salt must be conducted to guide future options for higher level waste disposal whether in New Mexico, or salt beds elsewhere.

Dr. Alfredo Armendariz
September 1, 2011
Page 3

Consistent with this position, in recent correspondence to the DOE by my Cabinet Secretary for the Environment, New Mexico encourages the DOE to support the proposed location of WIPP as the preferred alternative in the Draft EIS for the disposal of Greater Than Class C (GTCC) Low-Level Radioactive Waste and GTCC-like wastes.

I urge you to provide additional funding for the thermal testing in salt that could lead to a permanent disposal solution for heat-generating nuclear waste in the United States. New Mexico offers the ideal test facilities to demonstrate the scientific and engineering feasibility of emplacing and disposing high level and thermally active nuclear waste in salt formations. A definitive study on the suitability of salt as a disposal medium will move the country forward in its quest to protect human health and the environment over the long term, and if proven feasible, will reduce the potential for a catastrophic event at sites where such material is temporarily stored.

Recommendations

Mr. Secretary, I request that you provide sufficient funding to accelerate the disposal of defense legacy waste from LANL at WIPP in support of completing the LANL cleanup. Again, cleaning up the defense legacy wastes at Los Alamos will be, and must remain, a highest priority to both the State of New Mexico and DOE. In addition, I request that you facilitate discussions with applicable DOE decision makers in Nuclear Energy, Environmental Management and the Office of Science to finalize DOE's proposal for thermal testing of salt, and commit funding at the beginning of fiscal year 2012 for planning and test initiation.

New Mexico continues to recognize the important role that the DOE plays in our state. I look forward to working with you in the pursuit of our mutual goals.

Sincerely,

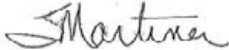

Susana Martinez
Governor

SM/ts

cc: Dave Martin, Secretary, New Mexico Environment Department

Senator Jeff Bingaman

Senator Tom Udall

Senator Dianne Feinstein

L304-1 Based on the GTCC EIS evaluation and WIPP's operating record, DOE believes that the WIPP repository would be a safe location for the disposal of GTCC LLRW and GTCC-like wastes, some of which include long-lived radionuclides. DOE recognizes that the use of WIPP for the disposal of GTCC LLRW and GTCC-like wastes would require modification to existing law. In addition, it would be necessary to revise the Agreement for Consultation and Cooperation between Department of Energy and the State of New Mexico for the Waste Isolation Pilot Plant, the WIPP compliance certification with EPA, and the WIPP Hazardous Waste Facility Permit.

L304-1

State of New Mexico, Governor's Office, Commenter ID No. L304 (cont'd)

Dr. Alfredo Armendariz
September 1, 2011
Page 4

U.S. Congressman Steve Pearce

U.S. Congressman James Clyburn

U.S. Congressman Fred Upton

U.S. Congressman John Shimkus

Daniel B. Poneman, Deputy Secretary of Energy
U.S. Department of Energy

Mr. Thomas D'Agostino, Assistant Secretary, National Nuclear Security Administration
U.S. Department of Energy

Dr. Ines Triay, Assistant Secretary, Environmental Management
U.S. Department of Energy

Dr. Pete Lyons, Assistant Secretary, Nuclear Energy
U.S. Department of Energy

Dr. William F. Brinkman, Director, DOE Office of Science

Vernon D. Asbill, N.M. State Senator

Cadrynn N. Brown, N.M. State Representative

Carlsbad Mayor Dale Janway

State of South Carolina, Governor's Nuclear Advisory Council,
Commenter ID No. W298

From: gtccsiswebmaster@anl.gov
Sent: Friday, June 17, 2011 12:38 PM
To: mail_gtccsisarchives; gtccsiswebmaster@anl.gov; gtccsis@anl.gov
Subject: Greater-Than-Class-C Low-Level Radioactive Waste EIS Comment GTCC10298
Attachments: SC_GNAC_-_GTCC_EIS_Letter_6-15-2011_GTCC10298.pdf

Thank you for your comment, Ben Rusche.

The comment tracking number that has been assigned to your comment is GTCC10298. Please refer to the comment tracking number in all correspondence relating to this comment.

Comment Date: June 17, 2011 12:38:10PM CDT

Greater-Than-Class-C Low-Level Radioactive Waste EIS Draft Comment: GTCC10298

First Name: Ben
Last Name: Rusche
Organization: South Carolina Governor's Nuclear Advisory Council
Address: 1200 Senate Street
Address 2: 408 Wade Hampton Building
City: Columbia
State: SC
Zip: 29201
Country: USA
Email: apowell@energy.sc.gov
Privacy Preference: Don't withhold name or address from public record
Attachment: C:\fakepath\SC GNAC - GTCC EIS Letter 6-15-2011.pdf

Questions about submitting comments over the Web? Contact us at: gtccsiswebmaster@anl.gov or call the Greater-Than-Class-C Low-Level Radioactive Waste EIS Webmaster at (630) 252-5705.

**State of South Carolina, Governor's Nuclear Advisory Council,
Commenter ID No. W298 (cont'd)**

STATE OF SOUTH CAROLINA
Governor's Nuclear Advisory Council
1200 Senate Street, 408 Wade Hampton Building
Columbia, SC 29201
(803)737-8030

BEN RUSCHE, CHAIRMAN
CLAUDE C. CROSS
KAREN PATTERSON
W. GREG KYBERG, SR.
TOM YOUNG

STEVE BYRNE, SR.
CAROLYN HUDSON
DAVID PETERSON
VINCENT VAN BRUNT

June 15, 2011

Mr. Arnold Edelman
Document Manager
Office of Regulatory Compliance (EM-43)
U.S. Department of Energy
1000 Independence Avenue, SW
Washington, DC 20585-0119

Dear Mr. Edelman:

This letter from the South Carolina Governor's Nuclear Advisory Council provides comments on the Draft Environmental Impact Statement for the Disposal of Greater Than Class C (GTCC) Low-Level Radioactive Waste and GTCC-Like Waste (DOE/EIS-0375-D). This Council was formed by statute to advise the Governor on issues relating to nuclear materials and activities in South Carolina.

The subject draft environmental impact statement listed the Savannah River Site (SRS) as a possible alternative for storage of this waste. We strongly disagree with this alternative for the following reasons:

1. It would add to the long-term human health impacts (doses) within 10,000 years which is already much higher than the majority of other alternate locations.
2. The volume of radioactive material at SRS for the foreseeable future needs to be reduced, not added to. And finally,
3. We are opposed to bringing radioactive waste to SRS for disposal because DOE has not demonstrated the ability to execute plans for disposition and disposal of the radioactive materials currently there.

Sincerely,

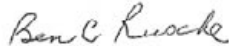

Ben Rusche, Chair
Governor's Nuclear Advisory Council

Cc: Governor Haley
Members of Council
Dr. Dave Moody, DOE-SR Site Manager

W298-1 The disposal methods and sites evaluated in the EIS represent the range of reasonable alternatives for the disposal of GTCC LLRW and GTCC-like wastes. This range is consistent with NEPA implementing regulations in Parts 1500–1508 of Title 40 of the Code of Federal Regulations (40 CFR Parts 1500–1508). In this GTCC EIS, DOE analyzed a range of disposal methods (i.e., geologic repository, near-surface trench, intermediate-depth borehole, and above-grade vault) and federally owned sites (i.e., Hanford Site, INL, LANL, NNSS, SRS, and the WIPP Vicinity, for which two reference locations – one within and one outside the WIPP Land Withdrawal Boundary – were considered). DOE has determined that it was reasonable to analyze these six sites because they currently have operating radioactive waste disposal facilities, except for the WIPP Vicinity, which is near an operating geologic repository.

DOE also conducted a generic evaluation of commercial disposal facilities on nonfederal lands in the EIS in order to provide, to the extent possible, information regarding the potential long-term performance of other (nonfederal) locations for siting a GTCC waste land disposal facility.

Final siting of a disposal facility for GTCC LLRW and GTCC-like wastes would involve further NEPA review as needed and be in accordance with applicable laws and regulations and would involve local stakeholder involvement and consent.

W298-1

State of Washington, Department of Ecology, Commenter ID No. W429

W429-1 Text was revised as suggested.

From: gtceiswebmaster@anl.gov
Sent: Friday, June 24, 2011 11:15 AM
To: gtceiswebmaster@anl.gov
Subject: Receipt: Greater-Than-Class-C Low-Level Radioactive Waste EIS Comment GTCC10429

Thank you for your comment, John Price.

The comment tracking number that has been assigned to your comment is GTCC10429. Please refer to the comment tracking number in all correspondence relating to this comment.

Comment Date: June 24, 2011 11:14:50AM CDT.

Greater-Than-Class-C Low-Level Radioactive Waste EIS Draft Comment: GTCC10429

First Name: John
Middle Initial: B
Last Name: Price
Organization: State of Washington, Dept. of Ecology
Address: 3100 Port of Benton
City: Richland
State: WA
Zip: 99354
Country: USA
Email: John.Price@ecy.wa.gov
Privacy Preference: Don't withhold name or address from public record

Comment Submitted:
American Indian text on top of page 6-69 appears to have typographical omission. It says "The 50-year management time horizon of the CLUP does create permanent land use designations."
Add the word "not" to read:
"The 50-year management time horizon of the CLUP does not create permanent land use designations."

W429-1

Questions about submitting comments over the Web? Contact us at: gtceiswebmaster@anl.gov or call the Greater-Than-Class-C Low-Level Radioactive Waste EIS Webmaster at (630) 252-5705.

State of Washington, Department of Ecology, Commenter ID No. W545

From: gtccoiswebmaster@anl.gov
Sent: Monday, June 27, 2011 4:23 PM
To: mail_gtccoisarchives; gtccoiswebmaster@anl.gov; gtccois@anl.gov
Subject: Greater-Than-Class-C Low-Level Radioactive Waste EIS Comment GTCC10545
Attachments: 11-NWP-64_Comments_on_GTCC_EIC_6-24-11_GTCC10545.pdf

Thank you for your comment, Jane Hedges.

The comment tracking number that has been assigned to your comment is GTCC10545. Please refer to the comment tracking number in all correspondence relating to this comment.

Comment Date: June 27, 2011 04:23:15PM CDT

Greater-Than-Class-C Low-Level Radioactive Waste EIS Draft Comment: GTCC10545

First Name: Jane
Middle Initial: A
Last Name: Hedges
Organization: Washington State Department of Ecology
Address: 3100 Port of Benton Boulevard
City: Richland
State: WA
Zip: 99354
Country: USA
Email: jhed461@ecy.wa.gov
Privacy Preference: Don't withhold name or address from public record
Attachment: Z:\11-NWP-64 Comments on GTCC EIC 6-24-11.pdf

Comment Submitted:
Please see the comments on the letter attached.

Questions about submitting comments over the Web? Contact us at: gtccoiswebmaster@anl.gov or call the Greater-Than-Class-C Low-Level Radioactive Waste EIS Webmaster at (630) 252-5705.



received
JUL - 5 2011

STATE OF WASHINGTON
DEPARTMENT OF ECOLOGY

3100 Port of Benton Blvd • Richland, WA 99154 • (509) 372-7950

711 for Washington Relay Service • Persons with a speech disability can call 877-833-6341

June 27, 2011

11-NWP-064

Arnold Edelman, Document Manager
Greater Than-Class C Low-Level Radioactive Waste EIS
Office of Technical and Regulatory Support (EM-43)
U.S. Department of Energy
1000 Independence Avenue, SW,
Washington, DC 20585-0119

Re: Washington State Department of Ecology (Ecology) Comments on Draft Greater-Than-Class C Low Level Radioactive Waste Environmental Impact Statement (GTCC EIS)

References: See page 3

Dear Mr. Edelman,

As the Washington and Oregon directors said in their letter (Reference 1), the State of Washington remains opposed to any United States Department of Energy (USDOE) plans to dispose of the Greater-than-Class C (GTCC) waste at Hanford. The following comments identify major logic flaws that invalidate the Hanford alternatives in the GTCC EIS.

- I. **GTCC disposal at Hanford does not have the "mission compatibility" used to select candidate disposal sites.** The GTCC EIS page 1-25 states that "The DOE sites evaluated for the land disposal methods were identified on the basis of mission compatibility (i.e., only DOE sites that currently have radioactive waste disposal as part of their ongoing mission were considered)." This statement is contradicted by legal commitments for the Hanford Site:
 - A. As the USDOE announced in the *Federal Register* Volume 74, page 67190 (74 FR 9719), the Hanford Site will not receive waste from off-site until the Waste Treatment and Immobilization Plant (WTP) begins operation. Per the provisions in the United States District Court Consent Decree No. 08-50850-FVS, Appendix A, Milestone A-1, the WTP must achieve initial operations by 12/31/2022. Offsite waste may not come to Hanford before 2023. Therefore, disposal of radioactive waste that originates from off the Hanford site is not part of the ongoing mission for Hanford.
 - B. The Presidential Memorandum dated June 9, 2000 directs the Secretary of Energy to "protect these important values [that are the same in Central Hanford as in the Hanford Reach National Monument] where practical." An ongoing mission to dispose of long-lived radioactive waste is incongruous with protection of the values of a National Monument. Because of the Presidential Memorandum, radioactive waste disposal cannot be part of the ongoing mission of Hanford.
 - C. As noted by Oregon in its comments on this GTCC EIS (reference 4), the proposed disposal of GTCC at Hanford conflicts with (is not compatible with) the Hanford cleanup mission. Therefore, disposal of offsite radioactive waste is not part of the ongoing mission for Hanford.

W545-1 For purposes of the NEPA analysis, Hanford was included. NEPA does not restrict the analysis based on current requirements, legislation or agreements. However, in the selection and implementation of the preferred alternative, these factors were taken into consideration.

The generation or storage of GTCC waste at a specific site was not a consideration in the selection of the site for analysis. A key factor was the existence at or near the reference location (e.g., access roads, utilities, waste storage buildings, etc.) of an existing infrastructure that would support a disposal facility.

The timeline for receipt of GTCC LLRW and GTCC-like waste is not fixed and was assumed in the GTCC EIS to provide a basis for evaluation. As discussed in Section 3.4.2 of the EIS, the actual start date for operations is uncertain at this time. As such, the receipt of waste at the facility is dependent upon, among other things, the alternative or alternatives selected, additional NEPA review as needed, characterization studies, and other actions necessary to initiate and complete construction of a GTCC LLRW and GTCC-like waste disposal facility. Thus, the timeline for the receipt of GTCC LLRW and GTCC-like waste at the disposal facility does not exclude any alternative considered and will be adapted to the alternative(s) selected for implementation.

W545-1

Mr. Arnold Edelman
June 27, 2011
Page 2

Washington does acknowledge the ongoing near-surface disposal of Navy reactor compartments at Hanford. However, the latter disposal was specifically excepted by the moratorium agreed to by USDOE United States District Court Consent Decree No. 08-50850-FVS. We also note the latter disposal has no practical alternative in the near-term.

2. **The GTCC EIS fails to identify a key difference between Hanford and other USDOE sites, that Hanford does not currently store nor generate GTCC or GTCC-like waste.** Table S-2 in the GTCC EIS summary lists some of the candidate disposal sites as current storage or generator locations for GTCC or GTCC-like waste. Hanford is not listed in Table S-2. Proposing to dispose GTCC at Hanford would introduce a new waste category to the Hanford site, which is a key difference from some other candidate sites. The proposal to introduce GTCC waste to the Hanford site is inconsistent with the waste categories already stored at the Hanford site.

3. **The GTCC EIS timeline for receipt of GTCC waste can't be supported at the Hanford Site.** Figure S-6 in the GTCC EIS summary assumed receipt of GTCC waste for disposal in the timeframe from 2019 to 2025. As stated in a preceding comment, the Hanford Site will not receive off-site waste until at least 2022. At that time, several time-consuming elements would be required before off-site waste could potentially be disposed at Hanford:

- Ecology presumes USDOE would designate some or all GTCC and GTCC-like waste as mixed low-level/hazardous waste, and that USDOE would apply for a state dangerous waste management permit. Ecology would not consider such an application until the 2022 commitment date, and would take some time (e.g., 2 to 3 years) to review and approve such a permit. This permit would have to be in place prior to start of construction of a mixed waste disposal facility.
- Also, prior to issuing a Draft permit for a disposal facility a new, current National Environmental Policy Act (NEPA) EIS would be required in order for the state to complete its own State Environmental Policy Act (SEPA) commitments.
- Public meetings and/or public hearings would be required for both USDOE and the State.
- The GTCC EIS states that construction is assumed to require 820 days (3.4 years).

Based on the timing and duration of these elements, receipt of waste could not possibly occur before 2027 or 2028, which is inconsistent with the timeline presented in the GTCC EIS.

4. **Borehole disposal at Hanford is contradicted both within the GTCC EIS, and by Hanford history.**

- A. The State disagrees with USDOE's contention that the depth to groundwater means that only facilities in Nuclear Regulatory Commission (NRC) Region 4 are suitable for burial of wastes because the depth to groundwater is too shallow in the other regions. While depth to groundwater in Central Hanford is 250 to 300 feet below ground surface, the conceptual design of the Intermediate-Depth boreholes would reduce that by 130 feet, to 120 to 170 feet below ground surface. Thus, there is no difference between Intermediate-Depth borehole disposal at Hanford and near-surface disposal in other NRC regions.
- B. Hanford's vadose zone and dry climate may seem like a protective situation however, when waste does migrate, it does so at a greater concentration and is not easily diluted in the groundwater.

W545-2 Depth to groundwater is only one of many factors considered in assessing the suitability of a site for a GTCC disposal facility. Past operational experience with these types of disposal facilities at DOE sites has shown that when properly implemented, they can provide isolation of radioactive waste from the environment for extended time periods. Past problems that have arisen with each option provide additional information to improve the design and performance of future land disposal facilities. Issues related to performance over time would be analyzed in a project-specific analysis to address technical concerns.

W545-1
(Cont.)

W545-2

Mr. Arnold Edelman
June 27, 2011
Page 3

C. The GTCC EIS analyzes intermediate-depth borehole disposal at Hanford as a reference location. Borehole disposal is also analyzed for a hypothetical commercial facility, but only within NRC Region IV "because the depth to groundwater at the other three regions is considered too shallow." The implication is that depth to groundwater at Hanford is adequate for borehole disposal. This is contradicted by impacts from historic waste disposal at Hanford. Hanford's shallow waste disposal cribs were designed for maximum waste retardation and failed. The massive plumes of groundwater contamination at Hanford demonstrate the fatally flawed logic of the GTCC EIS assumption that depth to groundwater makes Hanford a suitable site.

5. Hanford's current risk burden cannot support additional offsite waste disposal.

- A. The State and the public has already noted that offsite waste disposal, as proposed in the Draft Tank Closure & Waste Management EIS, results in significant adverse impacts to the groundwater under the Hanford Site. The State requested that USDOE eliminate disposal of offsite waste at Hanford (Reference 3).
- B. The State is disturbed that USDOE has limited its decisions in the GTCC EIS to the selection of disposal methods and disposal sites without providing in-depth analyses of the impacts. The State urges USDOE to add detailed analyses for each Site to the GTCC EIS.

As the Washington and Oregon Directors stated in Reference 1, we do not support any plans that include the addition of more waste to the Hanford Site and increase cleanup. We stand with the State of Oregon in opposition to any further consideration of Hanford as the disposal site for GTCC and GTCC-like waste.

If you have any questions about our comments, please contact John B. Price of my staff on 509-372-7921.

Sincerely,

Jane A. Hedges
Program Manager
Nuclear Waste Program

jbp/dbm

Reference 1: Letter, Ted Sturdevant, Director, Washington State Department of Ecology and Bob Repine, Acting Director, Oregon Department of Energy, dated May 17, 2011

Reference 2: Letter, Jane A. Hedges, Program Manager, Nuclear Waste Program to Ms. Mary Beth Burandt, dated April 30, 2010

Reference 3: Memorandum by President William J. Clinton, Subject: Memorandum on the Hanford Reach National Monument, June 9, 2000, Weekly Compilation of Presidential Documents, pages Page 1324-1325

Reference 4: Letter, Ken Niles, Oregon Nuclear Safety Division Administrator, dated June 22, 2011

Reference 5: Letter, Jane A. Hedges, Program Manager, to Mary Beth Burandt, US DOE, dated April 30, 2010

cc: See next page

W545-3 The Hanford Site is analyzed as a candidate location for a new GTCC waste disposal facility in the GTCC EIS. DOE is performing environmental restoration activities at the Hanford Site, and the ongoing cleanup efforts at the Hanford Site will continue.

DOE's ROD 78 FR 75913 dated December 13, 2013, stated that DOE has deferred a decision on importing waste from other DOE sites (with limited exceptions as described in the Settlement Agreement with the State of Washington Department of Ecology) for disposal at Hanford at least until WTP is operational.

Chapter 6 in the Final TC&WM EIS cumulative impacts analysis addresses the impacts from past, present and reasonably foreseeable actions in and around the Hanford site.

W545-4 The analysis presented in the GTCC EIS is adequate for the comparison of the disposal alternatives evaluated. Fate and transport parameters utilized in the estimations were based on site-specific (e.g., specific to the reference location to the extent available) information and, as such, are considered reasonable for the purpose of the comparison made in the EIS. As appropriate additional NEPA review would be done as well as public participation as appropriate, before implementation.

W545-2
(Cont.)

W545-3

W545-4

Mr. Arnold Edelman
June 27, 2011
Page 4

cc: Dennis Faulk, EPA
Matt McCormick, USDOE
Scott Samuelson, USDOE
Stuart Harris, CTUIR
Gabe Dohnee, NPT
Russell Jim, YN
Susan Leckband, HAB
Ken Niles, ODOE
Ted Sturdevant, Ecology
Keith Phillips, OFM
Mark Rupp, OFM
Max Power, Oregon Hanford Cleanup Board
Administrative Record:
Environmental Portal
USDOE-ORP Correspondence Control
USDOE-RI. Correspondence Control

**State of Washington, Department of Ecology, and Oregon Department of Energy,
Commenter ID No. L285**

STATE OF WASHINGTON
DEPARTMENT OF ECOLOGY
PO Box 47500 • Olympia, WA 98504-2400 • 360-407-6000
711 for Washington Relay Service • Persons with a speech disability can call 877-833-6341



received
MAY 17 2011

May 17, 2011

Mr. Arnold Edelman, Document Manager
Office of Technical and Regulatory Support (EM-43)
U.S. Department of Energy
1000 Independence Avenue, S.W.
Washington, DC 20585-0119

Re: Draft Environmental Impact Statement (EIS) for the Disposal of Greater-Than-Class C (GTCC) Low-Level Radioactive Waste (LLRW) and GTCC-Like Waste (DOE/EIS-0375D, Draft EIS)

Dear Mr. Edelman:

We are very disappointed that the draft EIS for the Disposal of GTCC and GTCC-like Waste continues to list Hanford as a viable location for the disposal of these highly radioactive wastes. We believed that a thorough analysis would clearly demonstrate that this additional burden of waste would create unacceptable environmental consequences. Rather than focus on analyzing the most appropriate site for disposal of these wastes, the EIS appears to try to preserve every potential option and alternative – to the detriment of the entire process.

L285-1

The states of Washington and Oregon adamantly oppose use of Hanford for disposal of GTCC wastes. Both of our states have been deeply engaged in, and supportive of, cleanup of radioactive and chemically hazardous wastes at Hanford for over 20 years. Adding more waste to the subsurface – especially waste that is highly radioactive and long-lived – is incompatible with the cleanup effort that has come at such a high price and that we all support.

L285-2

Since Hanford cleanup began in 1989, the federal government has spent more than 30 billion taxpayer dollars to try to clean up the extensive environmental injury caused by 45 years of plutonium production. The United States Department of Energy (USDOE) will be cleaning up the existing contamination at Hanford for many decades to come, at a cost of tens of billions of additional dollars. The problems USDOE faces at Hanford are so daunting that no precise estimate is possible.

**State of Washington, Department of Ecology, and Oregon Department of Energy,
Commenter ID No. L285 (cont'd)**

Mr. Arnold Edelman
May 17, 2011
Page 2

Even when the work is complete to the best of our collective ability, extensive contamination of the site is shown in DOE's own analysis in the draft Hanford Tank Closure and Waste Management EIS shows persistent contamination of Hanford groundwater for thousands of years due to waste now in the subsurface.

It is inconceivable to us that USDOE would spend billions of dollars to try to clean up the environmental damage at Hanford, yet ignore that work by proposing to dispose of additional highly radioactive wastes on the site.

Protection of the Columbia River is a core value of the states of Washington and Oregon and the people of the Pacific Northwest. The consideration of Hanford as a disposal site for GTCC wastes is contrary to that value. We strongly urge USDOE to remove Hanford from the list of possible sites for disposal of this waste.

Sincerely,



Ted Sturdevant
Director
Washington State Department of Ecology



Bob Repine
Acting Director
Oregon Department of Energy

cc: Dennis Faulk, EPA
Matthew McCormick, USDOE
Scott Samuelson, USDOE
Stuart Harris, CTUIR
Gabriel Bohnee, NPT
Russell Jim, YN
Susan Leckband, HAB
Ken Niles, ODOE
Ron Skinnarland, Ecology
Oregon Congressional Delegation
Washington Congressional Delegation

cc electronic:

Keith Phillips, Washington Governor's Policy Office
Mark Rupp, Washington Governor's DC Office

L285-3

The disposal methods and sites evaluated in the EIS represent the range of reasonable alternatives for the disposal of GTCC LLRW and GTCC-like wastes. This range is consistent with NEPA implementing regulations in Parts 1500–1508 of Title 40 of the Code of Federal Regulations (40 CFR Parts 1500–1508). In this GTCC EIS, DOE analyzed a range of disposal methods (i.e., geologic repository, near-surface trench, intermediate-depth borehole, and above-grade vault) and federally owned sites (i.e., Hanford Site, INL, LANL, NNSS, SRS, and the WIPP Vicinity, for which two reference locations – one within and one outside the WIPP Land Withdrawal Boundary – were considered). DOE has determined that it was reasonable to analyze these six sites because they currently have operating radioactive waste disposal facilities, except for the WIPP Vicinity, which is near an operating geologic repository.

DOE also conducted a generic evaluation of commercial disposal facilities on nonfederal lands in the EIS to order to provide, to the extent possible, information regarding the potential long-term performance of other (nonfederal) locations for siting a GTCC waste land disposal facility.

Final siting of a disposal facility for GTCC LLRW and GTCC-like wastes would involve further NEPA review as needed and be in accordance with applicable laws and regulations and would involve local stakeholder involvement and consent.

L285-2
(Cont.)

L285-3

**State of Washington, Department of Ecology, and Oregon Department of Energy,
Commenter ID No. T13**

Capital Reporting Company 6

1

2 MR. SKINNARLAND: Yes. I want to thank you all

3 for coming tonight. I'm Ron Skinnarland. I work for the

4 Washington State Department of Ecology, here in the

5 Richland office. And the State of Washington is concerned

6 that there be a safe place to put Greater-Than-Class C

7 waste.

8 I have a letter I'd like to read tonight. It's a

9 joint letter from the head of the Department of Ecology

10 and the head of the Oregon Department of Environmental

11 Quality and I think summarizes our concerns about the

12 potential impact of bringing off-site waste to Hanford for

13 disposal.

14 So, basically, the letter is addressed to

15 Mr. Edelman, and it's about the Greater-Than-Class C EIS.

16 It starts -- I'll just read it.

17 "We are very disappointed that the

18 Draft EIS for the disposal of

19 Greater-than-Class C Waste and

20 Greater-Than-Class-C-Like Waste continues

21 to list Hanford as a viable location for

22 the disposal of these highly radioactive

23 wastes. We believe that a thorough

24 analysis would clearly demonstrate that

25 this additional burden of waste would

866.488.DEPO
www.CapitalReportingCompany.com

T13-1

The EIS analysis is used to assess the viability of an alternative as well as its relative performance compared to the other alternatives. Exclusion of a reasonable alternative from the EIS without first evaluating the site is contrary to a thorough NEPA analysis. All alternatives are retained in the Final EIS because such evaluations are needed to support selection of the preferred alternative. In addition, as discussed in Section 1.4.2, the conceptual disposal facility designs analyzed in the EIS could be modified to perform better in specific locations. Thus, poor performance in the EIS analysis does not necessarily exclude an alternative from consideration.

T13-1

**State of Washington, Department of Ecology, and Oregon Department of Energy,
Commenter ID No. T13 (cont'd)**

Capital Reporting Company

7

1 create unacceptable environmental
2 consequences.
3 "Rather than focusing on analyzing the
4 most appropriate site for disposal of these
5 wastes, the EIS appears to try to preserve
6 every potential option and alternative, to
7 the detriment of the overall process.
8 "The states of Washington and Oregon
9 adamantly oppose use of Hanford for
10 disposal of Greater-Than-Class C Waste.
11 Both of our states are deeply engaged in,
12 and supportive of, cleanup of radioactive
13 and chemically hazardous wastes at Hanford
14 for over 20 years. Adding more waste to
15 the subsurface, especially waste that is
16 highly radioactive and long-lived, is
17 incompatible with the cleanup effort that
18 has come at such a high price and that we
19 all support.
20 "Since the Hanford cleanup began in
21 1989, the federal government has spent more
22 than 30 billion taxpayer dollars to try to
23 clean up the extensive environmental injury
24 caused by 45 years of plutonium production.
25 The United States Department of Energy will

866.488.DEPO
www.CapitalReportingCompany.com

T13-1
(Cont.)

T13-2

T13-2 DOE is performing environmental restoration activities at the Hanford Site. The ongoing cleanup effort will continue. If GTCC LLRW or GTCC-like waste were to be disposed at Hanford, DOE does not anticipate negative impacts to ongoing cleanup activities at this site.

**State of Washington, Department of Ecology, and Oregon Department of Energy,
Commenter ID No. T13 (cont'd)**

Capital Reporting Company

8

1 be cleaning up the existing contamination
2 at Hanford for many decades to come, at a
3 cost of tens of billions of additional
4 dollars.

5 "The problems US DOE faces at Hanford
6 are so daunting that no precise estimate is
7 currently available.

8 "Even when the work is complete to the
9 best of our collective ability, extensive
10 contamination will remain. The Department
11 of Energy's own analysis in the Draft
12 Hanford Tank Closure and Waste Management
13 Environmental Impact Statement shows
14 persistent contamination of Hanford
15 groundwater for thousands of years due to
16 waste now in the subsurface.

17 "So it is inconceivable to us that the
18 Department of Energy would spend billions
19 of dollars to try to clean up the
20 environmental damage at Hanford, yet ignore
21 that work by proposing to dispose of
22 additional highly radioactive wastes on the
23 site.

24 "Protection of the Columbia River is a
25 core value of the states of Washington and

866.488.DEPO
www.CapitalReportingCompany.com

T13-3

The disposal methods and sites evaluated in the EIS represent the range of reasonable alternatives for the disposal of GTCC LLRW and GTCC-like wastes. This range is consistent with NEPA implementing regulations in Parts 1500–1508 of Title 40 of the Code of Federal Regulations (40 CFR Parts 1500–1508). In this GTCC EIS, DOE analyzed a range of disposal methods (i.e., geologic repository, near-surface trench, intermediate-depth borehole, and above-grade vault) and federally owned sites (i.e., Hanford Site, INL, LANL, NNSS, SRS, and the WIPP Vicinity, for which two reference locations – one within and one outside the WIPP Land Withdrawal Boundary – were considered). DOE has determined that it was reasonable to analyze these six sites because they currently have operating radioactive waste disposal facilities, except for the WIPP Vicinity, which is near an operating geologic repository.

DOE also conducted a generic evaluation of commercial disposal facilities on nonfederal lands in the EIS to order to provide, to the extent possible, information regarding the potential long-term performance of other (nonfederal) locations for siting a GTCC waste land disposal facility.

Final siting of a disposal facility for GTCC LLRW and GTCC-like wastes would involve further NEPA review as needed and be in accordance with applicable laws and regulations and would involve local stakeholder involvement and consent.

T13-2
(Cont.)

T13-3

**State of Washington, Department of Ecology, and Oregon Department of Energy,
Commenter ID No. T13 (cont'd)**

Capital Reporting Company

9

1 Oregon and the people of the Pacific
2 Northwest. The consideration of Hanford as
3 a disposal site for Greater-Than-Class C
4 Waste is contrary to that value, and we
5 strongly urge that the Department of Energy
6 remove Hanford from the list of possible
7 waste sites for disposal of this waste."
8 And the letter is signed Ted Sturdevant, Director
9 of the Washington Department of Ecology, and Bob Repine,
10 the Acting Director of Oregon Department of Energy. I
11 have a copy of that.

T13-3
(Cont.)

Sun Rays Mechanical Contractors, Inc., Commenter ID No. L306



**DRAFT ENVIRONMENTAL IMPACT STATEMENT for the
DISPOSAL OF GREATER THAN-CLASS C (GTCC) LOW-LEVEL
RADIOACTIVE WASTE AND GTCC-LIKE WASTE
(DOE/EIS-0375-D)
U.S. Department of Energy**

WRITTEN COMMENT FORM
Must be received on or before June 27, 2011



Mr. X Mrs. ___ Ms. ___ Mr. & Mrs. ___ Dr. ___
Name: James Bruvold, PE
Title: Consulting Engineer
Organization: Sun Rays Mechanical Contractors, Inc
Address: 2120 CR 335
City: Lagosa Springs State: Colorado Zip Code: 81147
Phone: 970-264-5570 E-Mail Address: jbruvold@cfm.org

Comment: Apparently there are abandoned uranium mines in New Mexico that could serve as repositories for portions of this waste. As my business partner Mark Ray testified at Public Hearing in Pasco, WA "put the stuff you don't know what to do with back where you found it" that seems like a good idea to me.

Please use other side if more space is needed.

WITHHOLDING OF PERSONAL INFORMATION: Information you provide on this form may be published as part of the public record for this project, including publication on the Internet. Individual respondents may request confidentiality by checking one of the two boxes below. The DOE will honor such requests to the extent allowed by law. All submission from organizations and businesses, or from individuals identifying themselves as representatives or officials of organizations or businesses, will be available to the public in their entirety.

- Withhold my name and address from the public record.
- Withhold only my address from the public record

Comment forms may be mailed to:
Mr. Arnold Edelman
Document Manager
Office of Regulatory Compliance (EM-43)
U.S. Department of Energy
1000 Independence Avenue, SW
Washington, DC 20585-0119

Comment form may be faxed to:
(301) 903-4303

or sent by electronic mail to:
gtceis@anl.gov

L306-1 The EIS considered the range of reasonable alternatives for disposal of the inventory of GTCC LLRW and GTCC-like wastes identified for inclusion in these analyses. Regarding the use of mined cavities, DOE does not believe it is reasonable to dispose of GTCC LLRW and GTCC like waste in a new mined cavity (other than the existing WIPP facility) because of the potential cost and time it would take to develop such an alternative in comparison to the relatively small amount of waste. With regard to existing mines, no specific mine has been identified as having the proper characteristics for disposal of GTCC LLRW and GTCC-like wastes.

L306-1

J-650

January 2016

Capital Reporting Company 22

1
2
3
4
5
6
7
8
9
10
11

12 MR. BROWN: Jim Bruvold is our speaker now.
13 MR. BRUVOLD: Good evening. My name is James
14 Bruvold. I'm a consulting engineer with Sun Rays
15 Mechanical Contractors.

16 I live in Eugene, Oregon, and I've been attending
17 these meetings for the past year or so, and I've got a
18 pretty good idea of the problems that people are
19 considering here. I think I have a solution that I would
20 like to present.

21 I've been talking to some of the people at the
22 Department of Energy here about it. It's so simple, it's
23 almost stupid. There are fungus that grow on the soil
24 that are actually able to sequester and hold radioactive
25 elements in their bodies, and they use that disintegration

866.488.DEPO
www.CapitalReportingCompany.com

T17-1

Capital Reporting Company

1 energy as a life source.

2 If we were to feed this fungus and culture it in
3 place, perhaps we could find a way of sequestering the
4 leaking waste tanks at the Central Plateau as 110 square
5 miles of contaminated surface area; and the fungus, if
6 they had all the elements they need to survive, they may
7 be able to thrive for hundrede or maybe thousands of
8 years. This may be a long-term solution.

9 So I'm preparing a proposal that I will submit,
10 but I thought I would come here tonight and make a
11 presentation and meet some of the people here, and see
12 what we can do.

13 Mark, would you like to say a few words? I know
14 I was going to get you up here. This is my business
15 partner, Mark Ray. And as this gentleman was saying,
16 that, you know, probably the best place to put it is in a
17 deep hole in the ground that already exists.

18 And where did the uranium come from?

19 MR. RAY: Okay. I worked on the uranium mines in
20 New Mexico. I was on the uranium mines in New Mexico, in
21 the development.

22 There are two holes in New Mexico. One is at
23 Grants, New Mexico, where most of the uranium came from in
24 the first place. It is 3400 feet down. It does have a
25 water problem, but it is a hole already there.

866.488.DEPO
www.CapitalReportingCompany.com

T17-1
(Cont.)

T17-2

T17-2 The EIS considered the range of reasonable alternatives for disposal of the inventory of GTCC LLRW and GTCC-like wastes identified for inclusion in these analyses. Regarding the use of mined cavities, DOE does not believe it is reasonable to dispose of GTCC LLRW and GTCC like waste in a new mined cavity (other than the existing WIPP facility) because of the potential cost and time it would take to develop such an alternative in comparison to the relatively small amount of waste. With regard to existing mines, no specific mine has been identified as having the proper characteristics for disposal of GTCC LLRW and GTCC-like wastes.

Capital Reporting Company

24

1 There is another hole at Crown Point, New Mexico,
2 on the Navajo Reservation, that is 3400 feet that we
3 drilled in 1980 and abandoned it. It's gone. It's there.
4 Conoco -- Phillips-Conoco drilled the hole for a new mine
5 site.

6 I never believed -- I have never been back there,
7 but I don't believe they ever developed this mine site.
8 All they did is drill a 3200-foot hole, 25 feet in
9 diameter, and capped it. It's still there. It's the best
10 place to put it. That's my only thing about it.

11 If you are looking at a waste site, I agree with
12 that woman right there, Yucca Mountain was made for it.
13 They turned it down for who knows -- political reasons.
14 It's in Nevada.

15 But there are places to put this stuff, and the
16 highly radioactive material needs to be buried deep.
17 3400 feet is where this stuff all came from. And at that
18 depth, the material and the rock is now already at --
19 3 percent is the material content of the uranium in that
20 hole at 3400 feet. That's the vein of the -- that's where
21 they mined it all. So that's basically what I wanted to
22 put in.

23 Thank you.

T17-2
(Cont.)

Capital Reporting Company

92

1
2
3
4
5
6
7
8
9
10

11 MR. BROWN: Okay. Kathleen Sanchez is next
12 and David Bacon will follow.

13 MS. SANCHEZ: (Speaking foreign language.)
14 This is an art piece at the Environmental Health and
15 Justice People, our environmental group at Tewa Women
16 United made, and it says you can't bury the truth, and
17 I think it's a very visual way that we have of showing
18 our trust in our Creator that truth can't be buried.
19 You have to speak the truth. You have to live truth,
20 and by being that, you're not able to be cocooned into
21 not doing anything about what's harming your people.

22 And I'm also up here representing, well, Tewa
866.488.DEPO
www.CapitalReportingCompany.com

Capital Reporting Company

93

1 Women United, our women's organization, and our mission
2 is to stop violence against -- all forms of violence
3 against Native women and Mother Earth and to promote
4 peace. We're a 501(c)(3), a women's organization, a
5 women's organization that took up the task of
6 educating, protecting our young mothers and our
7 families from what is seen as the monster or the
8 monster on the hill, and that it's consuming our
9 children.

10 And statistics went out saying that San
11 Idelfonso where I'm from -- that's right where Los
12 Alamos has flopped into our sacred lands -- is now --
13 has an increase of deaths and decrease in births. So
14 something is happening to our ability to promote our
15 way of being and to be present here, and the lab only
16 came up being here less than 65 years, and yet we're
17 already dying because of their business.

18 And talking about the draft EIS, being born
19 here in San Idelfonso, we got to see the beginnings of
20 the Manhattan Project and all through its lifetime what
21 they considered doing, environmental impact statements,
22 and knowing that the people that had worked on draft

866.488.DEPO
www.CapitalReportingCompany.com

Capital Reporting Company

94

1 environmental impact statements or impact statements,
2 being told they cannot talk to the people, that their
3 findings are supposed to be based on papers that were
4 already published or that were in -- that were allowed
5 to be there, so meaning that they're not true EIS
6 statements, and things have happened.

7 And so the draft that we are looking at now is
8 based upon a draft or EIS statements that were false
9 and don't cover present truths. So there are some
10 hidings that are happening about the truth.

11 And sad to say, but the United States has been
12 the last country in 2007 to recognize indigenous
13 peoples as human beings. So up until 2007, we were
14 natural resources, just like our Mother Earth's
15 elements that they use to create the war weapons. And
16 so they disregarded us as disposable people and now
17 signs of that are showing up.

18 And as women and mothers, we know that a lot
19 of the disposal sites, Area G, the plume is spreading
20 and our children are getting sick. Mother Earth is
21 getting sick. The waters are getting contaminated.
22 Our aquifers whose ability to give life started

866.488.DEPO
www.CapitalReportingCompany.com

Tewa Women United, Commenter ID No. T105 (cont'd)

Capital Reporting Company

95

1 millions of years ago, billions of years ago. Yet
2 within that short business of producing weapons, war
3 weaponry and the affiliated chain of that industry is
4 sickening our way of life, our life in general, our
5 life all around on everybody.

6 And Mother Earth, whom we regard as our mother
7 for promoting all life, is sick, sick and dying, and
8 we're also sick and dying because of the nuclear
9 contamination using a natural resources, considered
10 resource, I guess, but a life giver for us in a
11 negative way. So the culture of violence uses our
12 energy, the energy to give life to create a burden on
13 us so that in our dying they can reach out and use the
14 same technology to say they're healing us, which is
15 going round and round, catching your tail in a crazy,
16 crazy way.

17 I don't know. How many minutes?

18 MR. BROWN: You're just about out of time. So
19 if you have one point to make.

20 MS. SANCHEZ: Oh. So I guess what Clarissa
21 asked us to do was think up solutions for energies and
22 how we're going to use it in a positive way instead of

866.488.DEPO
www.CapitalReportingCompany.com

T105-1

T105-1 Stopping the generation of nuclear waste is outside the scope of the GTCC EIS, the scope of which is to evaluate disposal alternatives to enable the selection of a safe alternative or alternatives for the disposal of GTCC LLRW and GTCC-like wastes. The GTCC EIS evaluates the range of reasonable alternatives for the disposal of GTCC LLRW and GTCC-like wastes in compliance with the requirements specified in NEPA, the Low-Level Radioactive Waste Policy Amendments Act (P.L. 99-240), and Section 631 of the Energy Policy Act of 2005 (P.L. 109-58). The GTCC EIS evaluates the potential environmental impacts of the proposed disposal alternatives for GTCC LLRW and GTCC-like wastes. Based on the evaluation, DOE has determined that there are safe and secure alternatives for the disposal of GTCC LLRW and GTCC-like wastes. The GTCC EIS provides information that supports this determination, and, as discussed in Section 1.1, Purpose and Need for Agency Action, DOE is responsible for the disposal of GTCC LLRW and GTCC-like wastes.

Tewa Women United, Commenter ID No. T105 (cont'd)

Capital Reporting Company

96

1 a negative way, and so using radioactivity that is
2 natural in an unhealthy way is sickening, and we're
3 dying from it. So let's stop that madness now.
4 So "gooda" (phonetic).

T105-1
(Cont.)

Toiyabe Chapter, Sierra Club, Commenter ID No. T42

24

1

2

3 MS. FELDMAN: Sure. I'm sorry it wasn't

4 clear when I signed in.

5 MR. BROWN: Sure.

6 MS. FELDMAN: My last name is Feldman, F, as

7 in Frank, E-L-D-M-A-N.

8 MR. BROWN: Okay. Great. And Shila Z.

9 will be following you.

10 Thanks. Go ahead.

11 MS. FELDMAN: I represent the Toiyabe Chapter

12 of the Sierra Club.

13 The Toiyabe Chapter of the Sierra Club has

14 over 5,000 members in Nevada and Eastern California. We

15 are all deeply concerned about how nuclear waste is

16 managed, and we want to make these following points.

17 First, the EIS process seems to be premature. The

18 majority of the Greater-than-Class C waste will not

19 exist for at least another 20 years. Planning ahead is

20 good, but this seems to be an extreme.

21 Also, it would be prudent to first receive

22 the recommendations of the Blue Ribbon Commission, as

23 Judy just mentioned, and evaluate them as possible

24 alternatives. The Commission has not yet announced

25 when to expect the recommendations. Their first

T42-1

T42-1 The scope of this EIS is adequate to inform decision-making for the disposal of GTCC LLRW and GTCC-like waste. Sufficient information is available to support the current decision-making process to identify (an) appropriate site(s) and method(s) to dispose of the limited amount of GTCC LLRW and GTCC-like waste identified in the EIS.

DOE believes that this EIS process is not premature and is in compliance with NEPA. On the basis of an assumed starting date of 2019 for disposal operations, more than half (about 6,700 m³ [240,000 ft³]) of the total GTCC LLRW and GTCC-like waste inventory of 12,000 m³ [420,000 ft³]) is projected to be available for disposal between 2019 and 2030. An additional 2,000 m³ (71,000 ft³) would become available for disposal between 2031 and 2035. This information is presented in Figure 3.4.2-1. DOE believes this EIS is timely, especially given the length of time necessary to develop a GTCC waste disposal facility.

Toivabe Chapter, Sierra Club, Commenter ID No. T42 (cont'd)

1 report, but not their final report, is required to be
2 published in the next month, June of
3 2011.

4 Second, DOE should consider Hardened On-Site
5 Storage option, a HOSS option. HOSS is similar to one
6 of the disposal concepts, vaults, that DOE is
7 considering. Except HOSS is for safe and risk-free
8 storage, not final and irretrievable disposal.
9 Materials could be accessed from a HOSS system in
10 managed ways at later times.

11 HOSS could also be used to store spent
12 nuclear fuel, a kind of high-level nuclear waste, as
13 well as Greater-than-Class C waste, at the reactor site
14 where it's generated.

15 HOSS also minimizes transportation risks to
16 move nuclear waste from multiple generation sites that
17 are mostly east of the Mississippi to select few
18 disposal sites that are all west of the Mississippi.

19 We'd also like to mention that there's no
20 rail to the Nevada National Security Site, and routing
21 would need to go through Las Vegas. We consider that a
22 huge risk and not adequately represented by the
23 information as presented in the Draft EIS.

24 Inst, we'd like to mention that the best
25 solution for nuclear waste management is not to create

T42-2 The use of HOSS and other approaches for long-term storage of GTCC LLRW and GTCC-like wastes are outside the scope of this EIS because they do not meet the purpose and need for agency action. Consistent with Congressional direction in Section 631 of the Energy Policy Act of 2005 (P.L. 109-58), DOE plans to complete an EIS and a ROD for a permanent disposal facility for this waste, not for long-term storage options. The GTCC EIS evaluates the range of reasonable disposal alternatives and, as also required under NEPA, a No Action Alternative. Under the No Action Alternative, current practices for storing GTCC LLRW and GTCC-like wastes would continue in accordance with current requirements.

T42-3 DOE agrees that there is no direct rail access to NNSS.

DOE/NNSA analyzed various radioactive waste shipping routes through and around metropolitan Las Vegas, Nevada, in the Draft NNSS SWEIS. DOE/NNSA continued discussions with the State of Nevada on routing options throughout the preparation of the Final NNSS SWEIS. After taking into consideration the comments and concerns expressed by State, county, and local government officials and the public in general during the review and comment period for the Draft NNSS SWEIS, DOE/NNSA decided to maintain the current highway routing restrictions for shipments of low-level radioactive waste (LLW) and mixed-level radioactive waste (MLLW), as described in the Waste Acceptance Criteria (WAC) for the site. DOE/NNSA explained this decision in the Final NNSS SWEIS. The unchanged WAC restrictions are to avoid (1) crossing the Colorado River near Hoover Dam and (2) the greater metropolitan Las Vegas interstate system. DOE/NNSA is not considering, nor is it making, changes to the NNSS WAC with regard to routing.

T42-2

T42-4 Stopping the generation of nuclear waste is outside the scope of the GTCC EIS, the scope of which is to evaluate disposal alternatives to enable the selection of a safe alternative or alternatives for the disposal of GTCC LLRW and GTCC-like wastes. The GTCC EIS evaluates the range of reasonable alternatives for the disposal of GTCC LLRW and GTCC-like wastes in compliance with the requirements specified in NEPA, the Low-Level Radioactive Waste Policy Amendments Act (P.L. 99-240), and Section 631 of the Energy Policy Act of 2005 (P.L. 109 58). The GTCC EIS evaluates the potential environmental impacts of the proposed disposal alternatives for GTCC LLRW and GTCC-like wastes. Based on the evaluation, DOE has determined that there are safe and secure alternatives for the disposal of GTCC LLRW and GTCC-like wastes. The GTCC EIS provides information that supports this determination, and, as discussed in Section 1.1, Purpose and Need for Agency Action, DOE is responsible for the disposal of GTCC LLRW and GTCC-like wastes.

T42-3

T42-4

Toiyabe Chapter, Sierra Club, Commenter ID No. T42 (cont'd)

26

1 it. The Draft EIS needs to evaluate an alternative
2 where no new reactors are built. In that scenario,
3 most of the Greater-than-Class C waste would be
4 eliminated and not created.
5 Thank you.

T42-4
(Cont.)

Tri-Valley CAREs, Commenter ID No. L91

Jun 27 11:07:09p

Tri-Valley CAREs

925-443-1077

p. 2

Tri-Valley CAREs

Communities Against a Radioactive Environment

2582 Old First Street, Livermore, CA 94551 • (925) 443-7148 • www.trivalleycares.org



Peace Justice Environment
since 1983

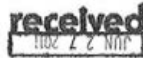

June 27, 2011

Arnold Edelman, EIS Document Manager
Office of Environmental Management
U.S. Department of Energy
Cloverleaf Building, EM-43
1000 Independence Avenue, SW
Washington, DC 20585

Sent via fax:
Fax: 301-905-7238

Tri-Valley CAREs' Comments on the EIS on Disposal of Greater-Than-Class C Low-Level Radioactive Waste and GTCC-Like Waste

Tri-Valley CAREs submits these comments on the Draft Environmental Impact Statement (DEIS) on the Disposal of Greater-Than-Class C (GTCC) Low-Level Radioactive Waste and GTCC-Like Waste (DOE/EIS-0375-D). As explained herein, the DEIS fails to provide an accurate, complete or legally adequate analysis as is required by the National Environmental Policy Act (NEPA).

Tri-Valley CAREs was founded in 1983 in Livermore, California by concerned neighbors living around the Lawrence Livermore National Laboratory. Tri-Valley CAREs monitors nuclear weapons and environmental clean-up activities throughout the US nuclear weapons complex on behalf of its 5,600 members. Tri-Valley CAREs has worked for decades with its partners in the Alliance for Nuclear Accountability to develop and promote a rational U.S. policy for the most safe and secure nuclear waste management. We seek options that will have the least impact on the world's communities with the legacy of deadly contamination from the nuclear age. Tri-Valley CAREs also seeks to eliminate waste, fraud and abuse from the oversight and management of facilities that make up the nuclear weapons complex.

The purpose of NEPA is to ensure that every federal agency prepare a full Environmental Impact Statement (EIS) for major federal actions significantly affecting the quality of the human

L91-1

The scope of this EIS is adequate to inform decision-making for the disposal of GTCC LLRW and GTCC-like waste. Sufficient information is available to support the current decision-making process to identify (an) appropriate site(s) and method(s) to dispose of the limited amount of GTCC LLRW and GTCC-like waste identified in the EIS.

DOE believes that this EIS process is in compliance with NEPA. All relevant potential exposure pathways were considered in the analyses presented in the EIS. These analyses addressed a range of reasonable scenarios and estimated the potential impacts on all environmental resources consistent with NEPA requirements.

DOE developed this EIS to support a decision on selecting a disposal facility or facilities for GTCC LLRW and GTCC-like waste, to address legislative requirements, to address national security concerns (especially for sealed sources), and to protect public health and safety. The purpose and need for the proposed action, as discussed above, is stated in the EIS (Section 1.1). The scope of the EIS is focused on addressing the need for developing a disposal capability for the identified inventory of GTCC LLRW and GTCC-like wastes. DOE plans a tiered decision-making process, in which DOE would conduct further site-specific NEPA reviews before implementing an alternative ultimately selected on the basis of this EIS.

L91-1

J-662

January 2016

Tri-Valley CAREs - L91

Tri-Valley CAREs, Commenter ID No. L91 (cont'd)

Jun 27 11:07:10p Tri-Valley CAREs 925-443-1077 p.3

environment. An EIS must provide a "full and fair discussion of significant environmental impacts and shall inform the decision-makers and the public of the reasonable alternatives that would avoid or minimize adverse impacts or enhance the quality of the human environment."¹²

As described below, the DEIS fails to provide an adequate purpose and need statement, fails to include an adequate analysis of reasonable alternatives, and improperly segments the proposed action from other connected actions. For these reasons, the DEIS must be significantly revised and recirculated for public review and comment.

I. The Purpose and Need Statement Omits Critical Reasons for the Proposed Action

An EIS must explain the underlying purpose and need to which the lead agency is responding in proposing the alternatives including the proposed action. 40 CFR § 1502.13. A federal agency may describe the purpose and need in any way that meets the statutory authority.

The DEIS ignores the legal requirement to study a deep geologic disposal site. Yucca Mountain was never a scientifically sound disposal site and now the Obama Administration has taken it off the table. There is a legal requirement to develop a deep geological disposal facility for placement of nuclear waste in the long term. The Department of Energy should study whether a realistic deep geological disposal site is feasible. Let us be clear however, Tri-Valley CAREs is only advocating that deep geologic disposal be studied in compliance with federal law. Tri-Valley CAREs is not advocating that DOE rush to put these wastes in the ground. As described below, Tri-Valley CAREs is advocating for a combination of waste minimization and Hardened On Site Storage as the only ethically and scientifically defensible proposal that has been developed to date.

Moreover, the Waste Isolation Pilot Project (WIPP) must not be considered for GTCC waste disposal. The only repository alternative considered in the DEIS is WIPP, even though federal and New Mexico laws clearly prohibit commercial waste, including GTCC. By law, WIPP's mission is limited to 175,564 cubic meters of transuranic waste from nuclear weapons. That's less than 5,000,000 curies of radioactivity. GTCC waste would contain 30 times more radioactivity than planned for WIPP and would eliminate the ban on commercial waste. The DOE should revise the DEIS to describe the need for the proposed action that includes options other than the WIPP.

II. The EIS Fails to Include an Adequate Analysis of Reasonable Alternatives

The twin functions of the Environmental Impact Statement (EIS) are to "require that agencies take a 'hard look' at environmental consequences, and provide for broad dissemination of relevant environmental information." See *Robertson v. Methow Valley*, 490 US 332, 350 (1989). The discussion of alternatives is the legally required heart of any EIS. 40 CFR § 1502.14. The legally adequate EIS must "[r]igorously explore and objectively evaluate all reasonable alternatives, and for alternatives which were eliminated from detailed study, briefly discuss the reasons for their having been eliminated." 40 CFR § 1502.14(a).

a. Hardened On Site Storage is a Reasonable Alternative That Must be Rigorously Explored and Objectively Evaluated in a Revised EIS

¹² 42 U.S.C. §332; 40 CFR 1501.
¹³ 40 CFR 1502.1.

L91-2 In accordance with the LLRWPA (P.L. 99-240), the federal government (DOE) is responsible for the disposal of GTCC LLRW. DOE developed this EIS to support a decision on selecting a disposal facility or facilities for GTCC LLRW and GTCC-like waste, to address legislative requirements, to address national security concerns (especially for sealed sources), and to protect public health and safety. The purpose and need for the proposed action, as discussed above, is stated in the EIS (Section 1.1). The scope of the EIS is focused on addressing the need for developing a disposal capability for the identified inventory of GTCC LLRW and GTCC-like wastes.

L91-3 The EIS considered the range of reasonable alternatives for the disposal of the GTCC waste inventory, including disposal in a deep geologic repository. DOE did not evaluate developing a geologic repository exclusively for disposal of GTCC LLRW and GTCC-like wastes because DOE determined that such an alternative is not reasonable due to the time and cost associated with siting a deep geologic repository and the relatively small volume of GTCC LLRW and GTCC-like wastes identified in the GTCC EIS. DOE believes that the results presented in this EIS for the WIPP geologic repository alternative are indicative of the high degree of waste isolation that would be provided by disposal in a geologic repository. DOE has included analysis of generic commercial facilities in the event that a facility could become available in the future. In that case, before making a decision to use a commercial facility, DOE would conduct further NEPA reviews, as appropriate.

L91-4 DOE advocates waste minimization measures when available and practical and would expect that appropriate measures would be taken prior to actual disposal. However, the use of HOSS and other approaches for long-term storage of GTCC LLRW and GTCC-like wastes are outside the scope of this EIS because they do not meet the purpose and need for agency action. Consistent with Congressional direction in Section 631 of the Energy Policy Act of 2005 (P.L. 109-58), DOE plans to complete an EIS and a ROD for a permanent disposal facility for this waste, not for long-term storage options. The GTCC EIS evaluates the range of reasonable disposal alternatives and, as also required under NEPA, a No Action Alternative. Under the No Action Alternative, current practices for storing GTCC LLRW and GTCC-like wastes would continue in accordance with current requirements.

L91-5 Disposal of GTCC LLRW and GTCC-like wastes at WIPP or the WIPP Vicinity site is included in the range of reasonable alternatives and is evaluated in this EIS. DOE acknowledges that only defense-generated TRU waste is currently authorized for disposal at the WIPP geologic repository under the WIPP LWA as amended (P.L. 102-579 as amended by P.L. 104-201) and that legislation would be required to allow disposal of waste other than TRU waste generated by atomic energy defense activities at WIPP and/or for siting a new facility within the land withdrawal area. It would also be necessary to revise the *Agreement for Consultation and Cooperation between Department of Energy and the State of New Mexico for the Waste Isolation Pilot Plant*, the WIPP compliance certification with EPA, and the WIPP Hazardous Waste Facility Permit. In addition, site-specific NEPA reviews would be conducted as needed, including further characterization of the waste (e.g., radionuclide inventory and heat loads) as well as the proposed packaging for disposal. However, NEPA does not limit an EIS to proposing and evaluating alternatives that are currently authorized. Furthermore, the Agreement for Consultation and Cooperation between Department of Energy and the State of New Mexico for the Waste Isolation Pilot Plant recognizes that the mission of WIPP may change and provides provisions to modify the agreement. For example, the Agreement states: "The parties to this Agreement recognize that future developments including changes to applicable laws (e.g., Public Law [P.L.] 96-164) may make it desirable or necessary for one or both parties to seek to modify this Agreement. Either party to this Agreement may request a review of the terms and conditions."

J-663

January 2016

Final GTCC EIS

Appendix I: Comment Response Document

Tri-Valley CAREs, Commenter ID No. L91 (cont'd)

Jun 27 11:07:10p Tri-Valley CAREs 925-443-1077 p.4

The DEIS rejects "Hardened On-Site Storage" (HOSS) in which GTCC waste and irradiated spent fuel would remain at commercial nuclear power plants in long-term storage so that they can be monitored and are protected from aircraft crashes or terrorist attacks. HOSS involves securing the waste in a reinforced concrete cylinder near the site where it was produced. This avoids many harms, including expensive and dangerous waste transportation.

DOE's reason for rejecting HOSS is that it is "not a permanent disposal facility." This is not a credible reason for rejecting this alternative because it fails to acknowledge that no one has developed a "permanent" method for storing this waste to date. All containment designs have shown that the radioactive waste would leak at some time in the future. Keeping the waste in HOSS is a safe form of storage and would reduce the risk of accidents or a terrorist attack while scientists work to develop safe and secure methods of permanent disposal. HOSS is more protective of human health and the environment than any of DOE's current dumping practices and the alternatives presented in the DEIS. HOSS is a reasonable alternative that must be rigorously explored and objectively evaluated in a revised EIS. In addition to HOSS for already-generated waste, part of a future solution, of course, must be drastically minimizing the generation of those wastes.

b. The DEIS Must Be Revised to Include a Geologic Disposal Alternative Pursuant to the Nuclear Waste Policy Act of 1982

The DEIS also does not include consideration of any geologic disposal facility, except WIPP, even though for almost thirty years federal law (Nuclear Waste Policy Act of 1982) has required development of one or more other repositories. 42 U.S.C. § 10101. The Nuclear Regulatory Commission has determined that spent nuclear fuel can stay at commercial reactors for up to 100 years. So GTCC could also remain at those sites for at least that time period.

c. The Alternatives in the DEIS Are Not Reasonable and Violate State Laws

The DEIS focuses on storing GTCC at existing Department of Energy sites. Most of these properties are currently undergoing multi-million or multi-billion dollar clean-up projects and some of them have legal agreements with host states not to accept new waste.

Moreover, the legal requirement for another repository still exists, yet the alternative of putting the GTCC waste into that repository is not even mentioned. The GTCC EIS disregards the Nuclear Waste Policy Act, which requires DOE to site and operate at least one geologic repository other than WIPP. Since 1987, the only place considered has been Yucca Mountain, Nev. As mentioned, that flawed site has been terminated by the Obama administration, and appropriately has been dropped from consideration in the GTCC EIS. Yet, the alternatives evaluated in the DEIS are unreasonable and at least in part illegal. These alternatives should be rejected and a new DEIS must be circulated that provides a reasonable range of alternatives.

DOE should not proceed with a final GTCC EIS, but instead should develop a new DEIS that includes HOSS facilities as the best solution for GTCC wastes for decades to come and outlines a credible plan to study geologic disposal site(s) to dispose of GTCC waste. Further, skipping the generation of new GTCC wastes is a reasonable and feasible alternative that can change the calculus regarding what to do with these wastes. This also must be fully explored in a new EIS.

III. The DEIS Improperly Segments the Proposed Action from Other Connected Actions

DOE should develop a national waste management strategy for different waste types. Such a strategy is needed to integrate the management of these wastes as opposed to the apparent piecemeal

L91-7

L91-6 See response to L91-1.

L91-7

The use of HOSS and other approaches for long-term storage of GTCC LLRW and GTCC-like wastes are outside the scope of this EIS because they do not meet the purpose and need for agency action. Consistent with Congressional direction in Section 631 of the Energy Policy Act of 2005 (P.L. 109-58), DOE plans to complete an EIS and a ROD for a permanent disposal facility for this waste, not for long-term storage options. The GTCC EIS evaluates the range of reasonable disposal alternatives and, as also required under NEPA, a No Action Alternative. Under the No Action Alternative, current practices for storing GTCC LLRW and GTCC-like wastes would continue in accordance with current requirements.

L91-8

L91-8 Development of a geologic repository for disposal of spent nuclear fuel and high-level waste is outside the scope of this EIS.

L91-9

L91-9

The disposal methods and sites evaluated in the EIS represent the range of reasonable alternatives for the disposal of GTCC LLRW and GTCC-like wastes. This range is consistent with NEPA implementing regulations in Parts 1500-1508 of Title 40 of the Code of Federal Regulations (40 CFR Parts 1500-1508). In this GTCC EIS, DOE analyzed a range of disposal methods (i.e., geologic repository, near-surface trench, intermediate-depth borehole, and above-grade vault) and federally owned sites (i.e., Hanford Site, INL, LANL, NNS, SRS, and the WIPP Vicinity, for which two reference locations – one within and one outside the WIPP Land Withdrawal Boundary – were considered). DOE has determined that it was reasonable to analyze these six sites because they currently have operating radioactive waste disposal facilities, except for the WIPP Vicinity, which is near an operating geologic repository.

L91-11

L91-12

DOE also conducted a generic evaluation of commercial disposal facilities on nonfederal lands in the EIS to order to provide, to the extent possible, information regarding the potential long-term performance of other (nonfederal) locations for siting a GTCC waste land disposal facility.

L91-13

Final siting of a disposal facility for GTCC LLRW and GTCC-like wastes would involve further site-specific NEPA review as appropriate and be in accordance with applicable laws, regulations and agreements, and would involve local stakeholder involvement the DOE sites. The ongoing cleanup effort will continue.

L91-10 See response to L91-3.

J-664

January 2016

Tri-Valley CAREs, Commenter ID No. L91 (cont'd)

Jun 27 11:07:11p

Tri-Valley CAREs

925-443-1077

p. 5

approach that is currently being used by the Department. Such a strategy, moreover, should be assessed through programmatic and site-specific NEPA processes. This is particularly important when considering the disposal of long-lived radioactive wastes which are not suitable for shallow land burial.

Connected actions are those actions that are "closely related" and "should be discussed" in the same NEPA document. Under NEPA, actions are connected if they: (1) Automatically trigger other actions which may require environmental impact statements; cannot or will not proceed unless other actions are taken previously or simultaneously. In *Bluc Mountains Biodiversity Project v. Blackwood*, 161 F.3d 1208, 1215 (9th Cir.1998), the Ninth Circuit held that five potential logging projects in the same watershed were cumulative and had to be evaluated in a single EIS, where they were reasonably foreseeable and "developed as part of a comprehensive forest recovery strategy." Similarly, in *Thomas v. Peterson*, 753 F.2d 754, 758 (9th Cir.1985), the court held that a logging project and a road to facilitate the logging had to be considered in a single EIS because "the timber sales could not proceed without the road, and the road would not be built but for the contemplated timber sales." The various nuclear waste disposal projects are interrelated and interdependent and will not proceed in a vacuum. These programs are improperly segmented in violation of NEPA.

V. Conclusion

Due to the significant revisions that are required to correct the legal deficiencies in the NEPA analysis, the DEIS must be revised and recirculated for public review and comment. We thank you for considering these comments and look forward to the further NEPA review and analysis that is clearly warranted before these major federal actions can proceed.

Sincerely,

/s/
Loulena Miles,
Attorney and Board Member, Tri-Valley CAREs

and

/s/
Marylin Kelley
Executive Director
Tri-Valley CAREs

L91-13
(Cont.)

L91-11 The use of HOSS and other approaches for long-term storage of GTCC LLRW and GTCC-like wastes are outside the scope of this EIS because they do not meet the purpose and need for agency action. Consistent with Congressional direction in Section 631 of the Energy Policy Act of 2005 (P.L. 109-58), DOE plans to complete an EIS and a ROD for a permanent disposal facility for this waste, not for long-term storage options. The GTCC EIS evaluates the range of reasonable disposal alternatives and, as also required under NEPA, a No Action Alternative. Under the No Action Alternative, current practices for storing GTCC LLRW and GTCC-like wastes would continue in accordance with current requirements.

The action alternatives evaluated in the GTCC EIS did not include interim storage of GTCC LLRW and GTCC-like wastes until a geologic repository for spent nuclear fuel and high-level radioactive waste becomes available because such interim storage is outside the scope of the GTCC EIS. The purpose of the GTCC EIS is to evaluate the range of reasonable alternatives for the safe and secure disposal of GTCC LLRW and GTCC-like wastes. The No Action Alternative evaluates continued storage of GTCC LLRW and GTCC-like wastes consistent with ongoing practices.

L91-12 Stopping the generation of nuclear waste is outside the scope of the GTCC EIS, the scope of which is to evaluate disposal alternatives to enable the selection of a safe alternative or alternatives for the disposal of GTCC LLRW and GTCC-like wastes. The GTCC EIS evaluates the range of reasonable alternatives for the disposal of GTCC LLRW and GTCC-like wastes in compliance with the requirements specified in NEPA, the Low-Level Radioactive Waste Policy Amendments Act (P.L. 99-240), and Section 631 of the Energy Policy Act of 2005 (P.L. 109 58). The GTCC EIS evaluates the potential environmental impacts of the proposed disposal alternatives for GTCC LLRW and GTCC-like wastes. Based on the evaluation, DOE has determined that there are safe and secure alternatives for the disposal of GTCC LLRW and GTCC-like wastes. The GTCC EIS provides information that supports this determination, and, as discussed in Section 1.1, Purpose and Need for Agency Action, DOE is responsible for the disposal of GTCC LLRW and GTCC-like wastes.

L91-13 DOE disagrees that its waste management strategies are "piecemeal" and that its waste disposal projects are improperly segmented. DOE's Programmatic Waste Management Environmental Impact Statement (WM PEIS, DOE-0200, May 1997), addressed its complex-wide waste management activities across the nation for five waste types: LLW, MLLW, HLW, TRU Waste, and Non-Wastewater Hazardous Waste. The WM PEIS did not consider commercial GTCC, however it recognized that DOE is responsible for such waste under the LLRWPA, and as such DOE would be developing strategies for such waste. The actions evaluated in the WM PEIS did not "trigger" actions related to GTCC waste, nor do the disposal alternatives evaluated in this Final GTCC waste "trigger" actions considered in the WM PEIS. DOE is not contemplating a change in its disposal decisions under the WM PEIS. DOE does intend to make site-specific disposal decisions under this Final GTCC EIS. In the absence of available commercial facilities for GTCC waste disposal as explained in Section S.2.6.8 of the EIS summary, DOE evaluated DOE sites suitable to host such disposal facilities, and these sites were all considered in the WM PEIS.

Tri-Valley CAREs, Commenter ID No. W555

From: gtccsiswebmaster@anl.gov
Sent: Monday, June 27, 2011 7:55 PM
To: gtccsiswebmaster@anl.gov
Subject: Receipt: Greater-Than-Class-C Low-Level Radioactive Waste EIS Comment GTCC10555

Thank you for your comment, Marylia Kelley.

The comment tracking number that has been assigned to your comment is GTCC10555. Please refer to the comment tracking number in all correspondence relating to this comment.

Comment Date: June 27, 2011 07:54:40PM CDT

Greater-Than-Class-C Low-Level Radioactive Waste EIS Draft Comment: GTCC10555

First Name: Marylia
Last Name: Kelley
Organization: Tri-Valley CAREs
City: Livermore
State: CA
Zip: 94550
Country: USA
Privacy Preference: Don't withhold name or address from public record

Comment Submitted:
June 27, 2011
Arnold Edelman, EIS Document Manager
Office of Environmental Management
U.S. Department of Energy
Cloverleaf Building, FM-43
1000 Independence Avenue, SW
Washington, DC 20585

Sent via fax:
Fax: 301-903-7238

Tri-Valley CAREs' Comments on the EIS on Disposal of Greater-Than-Class C Low-Level Radioactive Waste and GTCC-Like Waste

Tri-Valley CAREs submits these comments on the Draft Environmental Impact Statement (DEIS) on the Disposal of Greater-Than-Class C (GTCC) Low-Level Radioactive Waste and GTCC-Like Waste (DOE/EIS-0375-D). As explained herein, the DEIS fails to provide an accurate, complete or legally adequate analysis as is required by the National Environmental Policy Act (NEPA).

Tri-Valley CAREs was founded in 1983 in Livermore, California by concerned neighbors living around the Lawrence Livermore National Laboratory. Tri-Valley CAREs monitors nuclear weapons and environmental clean-up activities throughout the US nuclear weapons complex on behalf of its 5,600 members. Tri-Valley CAREs has worked for decades

W555-1 The scope of this EIS is adequate to inform decision-making for the disposal of GTCC LLRW and GTCC-like waste. Sufficient information is available to support the current decision-making process to identify (an) appropriate site(s) and method(s) to dispose of the limited amount of GTCC LLRW and GTCC-like waste identified in the EIS.

DOE believes that this EIS process is in compliance with NEPA. All relevant potential exposure pathways were considered in the analyses presented in the EIS. These analyses addressed a range of reasonable scenarios and estimated the potential impacts on all environmental resources consistent with NEPA requirements.

DOE developed this EIS to support a decision on selecting a disposal facility or facilities for GTCC LLRW and GTCC-like waste, to address legislative requirements, to address national security concerns (especially for sealed sources), and to protect public health and safety. The purpose and need for the proposed action, as discussed above, is stated in the EIS (Section 1.1). The scope of the EIS is focused on addressing the need for developing a disposal capability for the identified inventory of GTCC LLRW and GTCC-like wastes. DOE plans a tiered decision-making process, in which DOE would conduct further site-specific NEPA reviews before implementing an alternative ultimately selected on the basis of this EIS.

W555-1

Tri-Valley CAREs, Commenter ID No. W555 (cont'd)

with its partners in the Alliance for Nuclear Accountability to develop and promote a rational U.S. policy for the most safe and secure nuclear waste management. We seek options that will have the least impact on the world's communities with the legacy of deadly contamination from the nuclear age. Tri-Valley CAREs also seeks to eliminate waste, fraud and abuse from the oversight and management of facilities that make up the nuclear weapons complex.

The purpose of NEPA is to ensure that every federal agency prepare a full Environmental Impact Statement (EIS) for major federal actions significantly affecting the quality of the human environment. An EIS must provide a "full and fair discussion of significant environmental impacts and shall inform the decision-makers and the public of the reasonable alternatives that would avoid or minimize adverse impacts or enhance the quality of the human environment."

As described below, the DEIS fails to provide an adequate purpose and need statement, fails to include an adequate analysis of reasonable alternatives, and improperly segments the proposed action from other connected actions. For these reasons, the DEIS must be significantly revised and recirculated for public review and comment.

I. The Purpose and Need Statement Omits Critical Reasons for the Proposed Action

An EIS must explain the underlying purpose and need to which the lead agency is responding in proposing the alternatives including the proposed action. 40 CFR § 1502.13. A federal agency may describe the purpose and need in any way that meets the statutory authority.

The DEIS ignores the legal requirement to study a deep geologic disposal site. Yucca Mountain was never a scientifically sound disposal site and now the Obama Administration has taken it off the table. There is a legal requirement to develop a deep geological disposal facility for placement of nuclear waste in the long term. The Department of Energy should study whether a realistic deep geological disposal site is feasible. Let us be clear however, Tri-Valley CAREs is only advocating that deep geologic disposal be studied in compliance with federal law. Tri-Valley CAREs is not advocating that DOE rush to put these wastes in the ground. As described below, Tri-Valley CAREs is advocating for a combination of waste minimization and Hardened On Site Storage as the only ethically and scientifically defensible proposal that has been developed to date.

Moreover, the Waste Isolation Pilot Project (WIPP) must not be considered for GTCC waste disposal. The only repository alternative considered in the DEIS is WIPP, even though federal and New Mexico laws clearly prohibit commercial waste, including GTCC. By law, WIPP's mission is limited to 175,564 cubic meters of transuranic waste from nuclear weapons. That's less than 5,000,000 curies of radioactivity. GTCC waste would contain 30 times more radioactivity than planned for WIPP and would eliminate the ban on commercial waste. The DOE should revise the DEIS to describe the need for the proposed action that includes options other than the WIPP.

II. The EIS Fails to Include an Adequate Analysis of Reasonable Alternatives

The twin functions of the Environmental Impact Statement (EIS) are to "require that agencies take a 'hard look' at environmental consequences, and provide for broad dissemination of relevant environmental information." See *Robertson v. Methow Valley*, 490 US 332, 350 (1989). The discussion of alternatives is the legally required heart of any EIS. 40 CFR § 1502.14. The legally adequate EIS must "[r]igorously explore and objectively evaluate all reasonable alternatives, and for alternatives which were eliminated from detailed study, briefly discuss the reasons for their having been eliminated." 40 CFR § 1502.14(a).

a. Hardened On Site Storage is a Reasonable Alternative That Must be Rigorously Explored and Objectively Evaluated in a Revised EIS

The DEIS rejects "Hardened On-Site Storage" (HOSS) in which GTCC waste and irradiated spent fuel would remain at commercial nuclear power plants in long-term storage so that they can be monitored and are protected from aircraft crashes or terrorist attacks. HOSS involves securing the waste in a reinforced concrete cylinder near the site where it was produced. This avoids many harms, including expensive and dangerous waste transportation.

W555-2 DOE developed this EIS to support a decision on selecting a disposal facility or facilities for GTCC LLRW and GTCC-like waste, to address legislative requirements, to address national security concerns (especially for sealed sources), and to protect public health and safety. The purpose and need for the proposed action, as discussed above, is stated in the EIS (Section 1.1). The scope of the EIS is focused on addressing the need for developing a disposal capability for the identified inventory of GTCC LLRW and GTCC-like wastes.

W555-3 The EIS considered the range of reasonable alternatives for the disposal of the GTCC waste inventory, including disposal in a deep geologic repository. The Secretary of Energy determined that a permanent repository for high-level waste and spent nuclear fuel at Yucca Mountain, Nevada, is not a workable option and will not be developed. Therefore, DOE concluded that co-disposal at a Yucca Mountain repository is not a reasonable alternative and has eliminated it from evaluation in this EIS, as described in Section 2.6 of the EIS.

DOE did not evaluate developing a geologic repository exclusively for disposal of GTCC LLRW and GTCC-like wastes because DOE determined that such an alternative is not reasonable due to the time and cost associated with siting a deep geologic repository and the relatively small volume of GTCC LLRW and GTCC-like wastes identified in the GTCC EIS. DOE believes that the results presented in this EIS for the WIPP geologic repository alternative are indicative of the high degree of waste isolation that would be provided by disposal in a geologic repository. DOE has included analysis of generic commercial facilities in the event that a facility could become available in the future. In that case, before making a decision to use a commercial facility, DOE would conduct further NEPA reviews, as appropriate.

DOE recognizes that disposal of GTCC LLRW and GTCC-like wastes in the WIPP geologic repository would require modification to existing law. In addition, it may be necessary to revise the Agreement for Consultation and Cooperation between Department of Energy and the State of New Mexico for the Waste Isolation Pilot Plant, the WIPP compliance certification with the EPA, and the WIPP Hazardous Waste Facility Permit.

W555-4 DOE advocates waste minimization measures when available and practical and would expect that appropriate measures would be taken prior to actual disposal. However, the use of HOSS and other approaches for long-term storage of GTCC LLRW and GTCC-like wastes are outside the scope of this EIS because they do not meet the purpose and need for agency action. Consistent with Congressional direction in Section 631 of the Energy Policy Act of 2005 (P.L. 109-58), DOE plans to complete an EIS and a ROD for a permanent disposal facility for this waste, not for long-term storage options. The GTCC EIS evaluates the range of reasonable disposal alternatives and, as also required under NEPA, a No Action Alternative. Under the No Action Alternative, current practices for storing GTCC LLRW and GTCC-like wastes would continue in accordance with current requirements.

W555-5 Disposal of GTCC LLRW and GTCC-like wastes at WIPP or the WIPP Vicinity site is included in the range of reasonable alternatives and is evaluated in this EIS. DOE acknowledges that only defense-generated TRU waste is currently authorized for disposal at the WIPP geologic repository under the WIPP LWA as amended (P.L. 102-579 as amended by P.L. 104-201) and that legislation would be required to allow disposal of waste other than TRU waste generated by atomic energy defense activities at WIPP and/or for siting a new facility within the land withdrawal area. However, NEPA does not limit an EIS to proposing and evaluating alternatives that are currently authorized. Also, the Agreement for Consultation and Cooperation between Department of Energy and the State of New Mexico for the Waste Isolation Pilot Plant recognizes that the mission of WIPP may change and provides provisions to modify the agreement. For example, the Agreement states: "The parties to this Agreement recognize that future developments including changes to applicable laws (e.g., Public Law [P.L.] 96-164) may make it desirable or necessary for one or both parties to seek to modify this Agreement. Either party to this Agreement may request a review of the terms and conditions."

W555-2

W555-3

W555-4

W555-5

W555-6

W555-7

Tri-Valley CAREs, Commenter ID No. W555 (cont'd)

DOE's reason for rejecting HOSS is that it is "not a permanent disposal facility." This is not a credible reason for rejecting this alternative because it fails to acknowledge that no one has developed a "permanent" method for storing this waste to date. All containment designs have shown that the radioactive waste would leak at some time in the future. Keeping the waste in HOSS is a safe form of storage and would reduce the risk of accidents or a terrorist attack while scientists work to develop safe and secure methods of permanent disposal. HOSS is more protective of human health and the environment than any of DOE's current dumping practices and the alternatives presented in the DEIS. HOSS is a reasonable alternative that must be rigorously explored and objectively evaluated in a revised EIS. In addition to HOSS for already-generated waste, part of a future solution, of course, must be drastically minimizing the generation of those wastes.

W555-7
(Cont.)

b. The DEIS Must Be Revised to Include a Geologic Disposal Alternative Pursuant to the Nuclear Waste Policy Act of 1982

The DEIS also does not include consideration of any geologic disposal facility, except WIPP, even though for almost thirty years federal law (Nuclear Waste Policy Act of 1982) has required development of one or more other repositories. 42 U.S.C. § 10101. The Nuclear Regulatory Commission has determined that spent nuclear fuel can stay at commercial reactors for up to 100 years. So GTCC could also remain at those sites for at least that time period.

W555-8

c. The Alternatives in the DEIS Are Not Reasonable and Violate State Laws

The DEIS focuses on storing GTCC at existing Department of Energy sites. Most of these properties are currently undergoing multi-million or multi-billion dollar clean-up projects and some of them have legal agreements with host states not to accept new waste.

W555-9

Moreover, the legal requirement for another repository still exists, yet the alternative of putting the GTCC waste into that repository is not even mentioned. The GTCC EIS disregards the Nuclear Waste Policy Act, which requires DOE to site and operate at least one geologic repository other than WIPP. Since 1987, the only place considered has been Yucca Mountain, Nev. As mentioned, that flawed site has been terminated by the Obama administration, and appropriately has been dropped from consideration in the GTCC EIS. Yet, the alternatives evaluated in the DEIS are unreasonable and at least in part illegal. These alternatives should be rejected and a new DEIS must be circulated that provides a reasonable range of alternatives.

W555-10

DOE should not proceed with a final GTCC EIS, but instead should develop a new DEIS that includes HOSS facilities as the best solution for GTCC wastes for decades to come and outlines a credible plan to study geologic disposal site(s) to dispose of GTCC waste. Further, stopping the generation of new GTCC wastes is a reasonable and feasible alternative that can change the calculus regarding what to do with these wastes. This also must be fully explored in a new EIS.

W555-11

W555-12

III. The DEIS Improperly Segments the Proposed Action from Other Connected Actions

DOE should develop a national waste management strategy for different waste types. Such a strategy is needed to integrate the management of these wastes as opposed to the apparent piecemeal approach that is currently being used by the Department. Such a strategy, moreover, should be assessed through programmatic and site-specific NEPA processes. This is particularly important when considering the disposal of long-lived radioactive wastes which are not suitable for shallow land burial.

Connected actions are those actions that are "closely related" and "should be discussed" in the same NEPA document. Under NEPA, actions are connected if they: (i) automatically trigger other actions which may require environmental impact statements; cannot or will not proceed unless other actions are taken previously or simultaneously. In *Blue Mountains Biodiversity Project v. Blackwood*, 161 F.3d 1208, 1215 (9th Cir.1998), the Ninth Circuit held that five potential logging projects in the same watershed were cumulative and had to be evaluated in a single EIS, where they were reasonably foreseeable and "developed as part of a comprehensive forest recovery strategy." Similarly, in *Thomas*

W555-13

DOE acknowledges the TRU waste disposal limitations for WIPP specified in the WIPP LWA as amended (P.L. 102-579 as amended by P.L. 104-201) and in the Agreement for Consultation and Cooperation between Department of Energy and the State of New Mexico for the Waste Isolation Pilot Plant. Information on these limitations is provided in this EIS (see Section 4.1.1) and was considered in developing the preferred alternative. Based on the GTCC EIS evaluation, disposal of GTCC LLRW and GTCC-like wastes at WIPP would result in minimal environmental impacts for all resource areas evaluated, including human health and transportation. Both the annual dose and the latent cancer fatality (LCF) risk would be zero because there would be no releases to the accessible environment and therefore no radiation doses and LCFs during the first 10,000 years following closure of the WIPP repository. DOE recognizes that the use of WIPP for the disposal of GTCC LLRW and GTCC-like wastes would require legislative changes and site-specific NEPA reviews would be conducted as needed, including further characterization of the waste (e.g., radionuclide inventory and heat loads), as well as the proposed packaging for disposal.

W555-6 See response to W555-1.

W555-7 The use of HOSS and other approaches for long-term storage of GTCC LLRW and GTCC-like wastes are outside the scope of this EIS because they do not meet the purpose and need for agency action. Consistent with Congressional direction in Section 631 of the Energy Policy Act of 2005 (P.L. 109-58), DOE plans to complete an EIS and a ROD for a permanent disposal facility for this waste, not for long-term storage options. The GTCC EIS evaluates the range of reasonable disposal alternatives and, as also required under NEPA, a No Action Alternative. Under the No Action Alternative, current practices for storing GTCC LLRW and GTCC-like wastes would continue in accordance with current requirements.

W555-8 The Nuclear Waste Policy Act of 1982 applies to the disposal of spent fuel and high level waste, not GTCC LLRW. The action alternatives evaluated in the GTCC EIS did not include interim storage of GTCC LLRW and GTCC-like wastes until a geologic repository for spent nuclear fuel and high-level radioactive waste becomes available because such interim storage is outside the scope of the GTCC EIS. The purpose of the GTCC EIS is to evaluate the range of reasonable alternatives for the safe and secure disposal of GTCC LLRW and GTCC-like wastes. The No Action Alternative evaluates continued storage of GTCC LLRW and GTCC-like wastes consistent with ongoing practices.

W555-9 The disposal methods and sites evaluated in the EIS represent the range of reasonable alternatives for the disposal of GTCC LLRW and GTCC-like wastes. This range is consistent with NEPA implementing regulations in Parts 1500–1508 of Title 40 of the Code of Federal Regulations (40 CFR Parts 1500–1508). In this GTCC EIS, DOE analyzed a range of disposal methods (i.e., geologic repository, near-surface trench, intermediate-depth borehole, and above-grade vault) and federally owned sites (i.e., Hanford Site, INL, LANL, NNSS, SRS, and the WIPP Vicinity, for which two reference locations – one within and one outside the WIPP Land Withdrawal Boundary – were considered). DOE has determined that it was reasonable to analyze these six sites because they currently have operating radioactive waste disposal facilities, except for the WIPP Vicinity, which is near an operating geologic repository.

DOE also conducted a generic evaluation of commercial disposal facilities on nonfederal lands in the EIS to order to provide, to the extent possible, information regarding the potential long-term performance of other (nonfederal) locations for siting a GTCC waste land disposal facility.

Final siting of a disposal facility for GTCC LLRW and GTCC-like wastes would involve further site-specific NEPA review as appropriate and be in accordance with applicable laws, regulations and agreements, and would involve local stakeholder involvement the DOE sites. The ongoing cleanup effort will continue.

Tri-Valley CAREs, Commenter ID No. W555 (cont'd)

v. Peterson, 753 F.2d 754, 758 (9th Cir.1985), the court held that a logging project and a road to facilitate the logging had to be considered in a single EIS because "the timber sales could not proceed without the road, and the road would not be built but for the contemplated timber sales." The various nuclear waste disposal projects are interrelated and interdependent and will not proceed in a vacuum. These programs are improperly segmented in violation of NEPA.

V. Conclusion

Due to the significant revisions that are required to correct the legal deficiencies in the NEPA analysis, the DEIS must be revised and recirculated for public review and comment. We thank you for considering these comments and look forward to the further NEPA review and analysis that is clearly warranted before these major federal actions can proceed.

Sincerely,

/s/
Loulena Miles,
Attorney and Board Member, Tri-Valley CAREs

and

/s/
Marylia Kelley
Executive Director
Tri-Valley CAREs

Questions about submitting comments over the Web? Contact us at: gtcciswebmaster@anl.gov or call the Greater-Than-Class-C Low-Level Radioactive Waste EIS Webmaster at (630) 252-5705.

W555-13
(Cont.)

W555-10 See response to W555-3.

W555-11 The use of HOSS and other approaches for long-term storage of GTCC LLRW and GTCC-like wastes are outside the scope of this EIS because they do not meet the purpose and need for agency action. Consistent with Congressional direction in Section 631 of the Energy Policy Act of 2005 (P.L. 109-58), DOE plans to complete an EIS and a ROD for a permanent disposal facility for this waste, not for long-term storage options. The GTCC EIS evaluates the range of reasonable disposal alternatives and, as also required under NEPA, a No Action Alternative. Under the No Action Alternative, current practices for storing GTCC LLRW and GTCC-like wastes would continue in accordance with current requirements.

The action alternatives evaluated in the GTCC EIS did not include interim storage of GTCC LLRW and GTCC-like wastes until a geologic repository for spent nuclear fuel and high-level radioactive waste becomes available because such interim storage is outside the scope of the GTCC EIS. The purpose of the GTCC EIS is to evaluate the range of reasonable alternatives for the safe and secure disposal of GTCC LLRW and GTCC-like wastes. The No Action Alternative evaluates continued storage of GTCC LLRW and GTCC-like wastes consistent with ongoing practices.

W555-12 Stopping the generation of nuclear waste is outside the scope of the GTCC EIS, the scope of which is to evaluate disposal alternatives to enable the selection of a safe alternative or alternatives for the disposal of GTCC LLRW and GTCC-like wastes. The GTCC EIS evaluates the range of reasonable alternatives for the disposal of GTCC LLRW and GTCC-like wastes in compliance with the requirements specified in NEPA, Low-Level Radioactive Waste Policy Amendments Act (P.L. 99-240), and Section 631 of the Energy Policy Act of 2005 (P.L. 109-58). The GTCC EIS evaluates the potential environmental impacts of the proposed disposal alternatives for GTCC LLRW and GTCC-like wastes. Based on the evaluation, DOE has determined that there are safe and secure alternatives for the disposal of GTCC LLRW and GTCC-like wastes. The GTCC EIS provides information that supports this determination, and, as discussed in Section 1.1, Purpose and Need for Agency Action, DOE is responsible for the disposal of GTCC LLRW and GTCC-like wastes.

W555-13 DOE disagrees that its waste management strategies are "piecemeal" and that its waste disposal projects are improperly segmented. DOE's Programmatic Waste Management Environmental Impact Statement (WM PEIS, DOE-0200, May 1997), addressed its complex-wide waste management activities across the nation for five waste types: LLW, MLLW, HLW, TRU Waste, and Non-Wastewater Hazardous Waste. The WM PEIS did not consider commercial GTCC, however it recognized that DOE is responsible for such waste under the LLRWPA, and as such DOE would be developing strategies for such waste. The actions evaluated in the WM PEIS did not "trigger" actions related to GTCC waste, nor do the disposal alternatives evaluated in this Final GTCC waste "trigger" actions considered in the WM PEIS. DOE is not contemplating a change in its disposal decisions under the WM PEIS. DOE does intend to make site-specific disposal decisions under this Final GTCC EIS. In the absence of available commercial facilities for GTCC waste disposal as explained in Section S.2.6.8 of the EIS summary, DOE evaluated DOE sites suitable to host such disposal facilities, and these sites were all considered in the WM PEIS.



UNITED STATES ENVIRONMENTAL PROTECTION AGENCY
WASHINGTON, D.C. 20460

JUN 27 2011

Arnold Edelman, EIS Document Manager
Office of Environmental Management
U.S. Department of Energy
Cloverleaf Building, EM-43
1000 Independence Avenue, SW
Washington, DC 20585-0119

OFFICE OF
ENFORCEMENT AND
COMPLIANCE ASSURANCE

Dear Mr. Edelman:

In accordance with our responsibilities under Section 309 of the Clean Air Act and the National Environmental Policy Act, the Environmental Protection Agency (EPA) has reviewed the Department of Energy's Draft Environmental Impact Statement (EIS) for the Disposal of Greater-Than-Class C (GTCC) Low-Level Radioactive Waste (LLRW) and GTCC-Like Waste (CEQ 20110048). Our general comments are highlighted below with detailed comments enclosed for your consideration.

GTCC LLRW is radioactive waste that is generated by the Nuclear Regulatory Commission (NRC) or Agreement States licensees containing radionuclide concentrations in excess of the limits for Class C LLRW as identified in NRC regulations 10 CFR 61.55. For the purposes of this EIS, GTCC-like waste is DOE owned or generated LLRW and non-defense-generated transuranic radioactive waste that have characteristics similar to those of GTCC LLRW and for which there may not be a path for disposal. The Low-Level Radioactive Waste Policy Act of 1985 (amending the original 1980 Act) assigned the responsibility for the disposal of GTCC LLRW to the Federal Government; the Energy Policy Act of 2005 further assigned this responsibility to the Department of Energy (DOE).

DOE is proposing to construct and operate a new facility or facilities, or use an existing facility for the disposal of GTCC LLRW and DOE GTCC-like waste. The draft EIS analyzes impacts that would be associated with the construction, operation, and long-term management of a facility for the disposal of this waste. One disposal alternative considered is a geologic repository which was evaluated at the Waste Isolation Pilot Plant (WIPP), in New Mexico. The other alternative methods evaluated include an intermediate-depth borehole, an enhanced near-surface trench, and an above-grade vault. Each of these disposal methods were evaluated at the following locations: Hanford Site, Washington; Idaho National Laboratory (INL) Site, Idaho; Nevada National Security Site (NNSS), Nevada; and the Savannah River Site, South Carolina. The conceptual designs described in the draft EIS incorporate a number of engineering enhancements beyond those typically used in designs of LLRW disposal facilities. In addition, post-closure performance calculations were performed for long time frames (10,000 years or

Internet Address (URL) • <http://www.epa.gov>
Recycled/Recyclable • Printed with Vegetable Oil Based Inks on 100% Postconsumer, Process Chlorine Free Recycled Paper

longer to determine peak annual doses) commensurate with the need to protect the general public for up to 10,000 years.

The draft EIS does not identify a preferred alternative. Instead, a preferred alternative will be determined after consultation with Congress, consistent with Section 631 of the Energy Policy Act of 2005 and then identified in the final EIS. The draft EIS acknowledges that once the site has been identified, a follow-on site-specific NEPA evaluation and documentation will be needed to ensure proper land use planning, assure protection of local ecological and cultural resources, and account for local variations by hydrology and geology to minimize potential waste migration.

EPA has worked closely with DOE as a cooperating agency and most of our concerns have been addressed through this process. However some clarification regarding the technical bases for the assumption of parameter values leading to faster transport of radionuclides in the subsurface and their relation to current disposal practices is recommended. For example, it may be useful to provide additional discussion of the performance history of the options so that the strengths and weaknesses and the expected degree of reliability for each alternative can be more readily assessed. Regarding the borehole disposal alternative, it may also be useful to discuss how site-specific impacts on the stability of the geologic formation from the installation of 930 boreholes to a maximum depth of 1,000 feet will be assessed. Depth and spacing of boreholes may need to be adjusted, as well as additional measures implemented to enhance stability. Flow of water through the deeper formations will also need to be evaluated.

In addition, the draft EIS has identified existing agreements (pages 1-31, 6-111, and 7-74) concerning the Hanford and INL sites. According to these agreements no, or limited amounts of, waste will be disposed of at these sites. More specifically:

- EPA has concerns with the potential selection of the Hanford site. The proposed site for the GTCC disposal facility at Hanford is close to the "200 Area." According to DOE's recent analyses in the Tank Closure and Waste Management EIS, this area has very high radionuclide and chemical contamination levels in the vadose zone, which can potentially lead to groundwater contamination well above drinking water standards. The primary contaminants of concern include Technetium-99 (Tc-99) and Iodine 129 (I-129), which are highly soluble in water. Disposal of additional waste near the 200 Area could exacerbate that contamination, especially in the event that the GTCC waste facility cover and engineered barriers fail in the longer term, allowing leaching to take place and radionuclide and chemical contamination to spread to surrounding soils and eventually to groundwater and the Columbia River. Current cleanup goals for the area include limiting additional contaminant releases to surface soils and the vadose zone and development of effective technologies to remove or immobilize the appropriate amount of existing contamination. Thus, the proposed disposal of GTCC waste does not appear to be consistent with the ongoing cleanup effort, given the amount of radionuclides already present in the area. As the draft EIS indicates, one means of mitigating that existing contamination impact would be for DOE to limit disposal of off-site waste streams to Hanford, at least waste containing Tc-99 and I-129 (p. 6-111). If this site is selected,

L94-1 A preferred alternative is not required to be included in a Draft EIS. The Council on Environmental Quality regulations in 40 CFR 1502.14(e) specify that the section on alternatives in an EIS shall identify the agency's preferred alternative or alternatives, if one or more exists, in the Draft EIS and identify such alternative(s) in the Final EIS unless another law prohibits the expression of such a preference; that is, a preferred alternative shall be identified in the Draft EIS if one exists. If no preferred alternative has been identified at the Draft EIS stage, a preferred alternative need not be included. By the time the Final EIS is filed, 40 CFR 1502.14(e) presumes the existence of a preferred alternative and requires its identification in the Final EIS unless another law prohibits the expression of such a preference.

DOE did not have a preferred alternative at the time of issuance of the Draft EIS because of the complex nature of the proposed action and the potential implications for disposal of GTCC LLRW and GTCC-like wastes. For public comment, the Draft EIS presented considerations for developing a preferred alternative in the Summary (in Section S.6) and in Section 2.9. As required by 40 CFR 1502.14(e), the Final EIS contains a preferred alternative for the disposal of GTCC LLRW and GTCC-like wastes (see Section 2.10). In developing the preferred alternative, DOE took into consideration public comments on the Draft EIS, public EIS scoping comments, and other factors identified in Sections S.6 and 2.9 of the EIS.

L94-2 The fate and transport of radionuclides in the subsurface is dependent on a number of factors many of which exhibit a wide range of values for the sites evaluated in this EIS. The evaluation in the GTCC EIS made use of site-specific fate and transport values provided by each site and therefore, the evaluation results should distinguish each site relative to potential fate and transport of the nuclides in the GTCC LLRW and GTCC-like waste inventory. However, the designs were intended to allow comparisons among sites and as such, the same input values were assumed for all the sites to evaluate performance of the land disposal facilities over a 10,000 year period. These assumptions address aspects such as longevity of the engineered barriers (disposal facility covers, liners) and effectiveness of grouting materials placed to solidify the waste keeping them in place. Appendix E of this EIS presents a detailed discussion of the evaluation and assumptions.

The conceptual nature of these configurations takes into account the characteristics of all of the disposal sites for which they were considered, but their designs (e.g., depth and spacing of boreholes) could be altered or enhanced, as necessary, to provide an optimal solution at a specific location. Note that the depth of boreholes evaluated was 130 ft (40 m), not 1,000 ft, which would make a significant difference in terms of stability relative to borehole spacing. As discussed in Section 1.4.2, the conceptual disposal facility designs analyzed in the EIS could be modified to perform better in specific locations. At any potential site identified in a ROD, DOE would conduct additional studies to confirm the most suitable location of the facility, most optimal technology, and other factors which would involve site-specific NEPA as appropriate.

L94-3 DOE has considered cumulative impacts at the Hanford Site in this GTCC EIS. The disposal of GTCC LLRW and GTCC-like waste at the Hanford Site could result in environmental impacts that may warrant mitigation for Tc-99 and I-129 through limiting receipt of these waste streams (see Table 6.2.4.2 and Figure 6.2.4.1 in this EIS).

DOE's ROD 78 FR 75913 dated December 13, 2013, stated that DOE has deferred a decision on importing waste from other DOE sites (with limited exceptions as described in the Settlement Agreement with the State of Washington Department of Ecology) for disposal at Hanford at least until WTP is operational.

U.S. Environmental Protection Agency, Commenter ID No. L94 (cont'd)

contamination impact would be for DOE to limit disposal of off-site waste streams to Hanford, at least waste containing Te-99 and I-129 (p. 6-111). If this site is selected, EPA recommends that the final EIS include information addressing groundwater contamination remedial activities that would meet Washington State Model Toxics Control Act (MTCA), EPA, and tribal standards for drinking and surface water quality.

- EPA also has significant concerns with the potential selection of the INL site. At the INL site, the proposed GTCC facility would be near the existing Advanced Test Reactor Complex and the Big Lost River, and would also be located over the Snake River Plain Aquifer. This aquifer is the sole source of drinking water for nearly 200,000 people in southeast and south central Idaho (p. 7-18). Past waste disposal practices at INL have created plumes of radiochemical contamination within the aquifer. We are also concerned with the transport characteristics of this site. As presented, the assumptions of parameter values lead to a faster transport of radionuclides in the subsurface. As a result, they far exceed the values of the other alternatives. For this reason, as noted in the detailed comments attached, the technical bases that were assumed in the analysis of this site and their relation to current disposal practices should be clarified in the final EIS.

Based on the above information and issues associated with the disposal alternatives presented, we have rated the action alternatives as Environmental Concerns/Insufficient Information (EC-2), (see enclosed "Summary of EPA Rating System"). The "EC" rating is based on the potential for adverse impacts to surface water and groundwater resources. The "2" rating is based on the need to present information to fully assess the environmental impacts from the proposed action.

We appreciate the opportunity to review and comment on this document. If you have any further questions you may contact me at (202) 564-5400. You may also call my staff point of contact, Marthea Rountree. She can be reached at (202) 564-7141.

Sincerely,

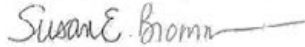

Susan E. Dromm
Director
Office of Federal Activities

Enclosures (2): Detailed Comments
Summary of EPA Rating System

L94-4

The INL site analysis, as was the case for the other DOE sites, used site-specific information provided by technical staff to the extent it was available, and conservative assumptions were used to fill any remaining data gaps. The analysis presented in the EIS is adequate for the comparison of the disposal alternatives evaluated. As provided in Appendix E, fate and transport parameters utilized in the estimations were based on site-specific (information and, as such, are considered reasonable for the purpose of the comparison made in the EIS. However, DOE recognizes that additional project- and site-specific information would be necessary to inform the implementation of a disposal facility at a given location at INL.

L94-3
(Cont.)

L94-4

Environmental Protection Agency
Draft Environmental Impact Statement
Detailed Comments
Disposal of Greater-Than-Class C (GTCC) Low-Level Radioactive Waste
and GTCC-Like Waste (DOE/EIS-0375-D)

General

Because construction of the waste disposal facility would disturb more than one acre (up to 110 acres), the project will require a National Pollutant Discharge Elimination System permit for construction activities. For this reason, DOE should consider use of Low Impact Development (LID) techniques during construction activities to reduce stormwater impacts, including contaminated runoff and sediments that would discharge to local streams.

Chapter 1 – Introduction

Waste Inventory:

In estimating the inventory of waste, the draft EIS does not appear to address the potential application of the "waste incidental to reprocessing" (WIR) process at West Valley. The WIR process allows DOE to re-consider whether waste previously considered to be high-level waste can be re-categorized as low-level waste or transuranic waste (TRU). The draft EIS takes an appropriately conservative approach by assuming that any waste exhumed from the NRC- and State-licensed Disposal Areas (NDA/SDA) at the West Valley site will be GTCC or "GTCC-like" waste. However, it should treat the potential application of the WIR process at West Valley in a manner consistent with the *Final Environmental Impact Statement for Decommissioning and/or Long-Term Stewardship at the West Valley Demonstration Project and Western New York Nuclear Service Center* (West Valley EIS, DOE/EIS-0226).

Table 3-20 of the West Valley EIS estimates that application of the WIR process could result in generation of an additional 160 cubic meters of low-level waste and 150 cubic meters of TRU waste from current site activities (not including implementation of alternatives in the EIS). Table 4-47 estimates that, if the Sitewide Removal Alternative is selected as the Phase 2 decommissioning alternative, an additional 210 cubic meters of low-level waste and 280 cubic meters of TRU waste could be generated. Thus, application of the WIR process could result in generation of an additional 370 cubic meters of low-level waste and 330 cubic meters of TRU waste. The combined volume of 700 cubic meters represents approximately 6% of the waste volume considered in the draft EIS. Volumes of high-level waste would be reduced by corresponding amounts.

The West Valley site is unusual in the sense that waste resulting from the reprocessing activities could be considered either DOE-origin or commercial-origin, and DOE-origin waste may not be attributable to defense activities. If the assumption is that any WIR

L94-5 Once a ROD is issued, the design of a new facility or the use of an existing facility will address specific regulatory requirements, (e.g., need for an NPDES permit) and will also incorporate sustainable design and use of low impact development techniques during construction to reduce impacts (Refer to Section 1.3).

L94-6 GTCC EIS includes an estimate of potential GTCC LLRW and GTCC-like wastes at the West Valley Site including WIR. This information was provided by the DOE West Valley Site Office as referenced in the *Supplement to Greater-Than-Class C (GTCC) Low-Level Radioactive Waste and GTCC-Like Waste Inventory Reports ANL/EVS/R-10/1, Oct. 2010* (as shown in the data call reference, Bohan, C., 2008a, *GTCC Data Call – Updated Table and Report*, email with attachments). Consistent with the *Final Environmental Impact Statement for Decommissioning and/or Long-Term Stewardship at the West Valley Demonstration Project and Western New York Nuclear Service Center* (DOE/EIS-0226), the GTCC EIS assumes TRU waste resulting from a future WIR determination is included in the GTCC EIS inventory as that waste is assumed to be non-defense in origin for the purposes of the GTCC EIS analysis. LLW resulting from a future WIR determination is not included in the GTCC EIS inventory because there would be an existing disposal path. As indicated in Table B-3 in Appendix B of the GTCC EIS, the estimated volume of West Valley waste analyzed in the GTCC EIS is less than those presented in the Final EIS for the West Valley Site because the GTCC EIS assumes volume reduction prior to disposal.

Characterization information for the GTCC LLRW and GTCC-like wastes currently in storage at the West Valley Site is sufficient for the analysis conducted for the GTCC EIS. The inventory of GTCC LLRW for the West Valley Site that may be generated in the future could increase or decrease from the amount assumed in the GTCC EIS, based on the decisions made regarding the disposition of portions of the site, updated characterization information (including the WIR process), and compliance with applicable regulatory requirements.

L94-5

L94-6

waste would be non-GTCC low-level waste or defense-origin TRU, in which case it can be accepted at the WIPP, this should be clearly stated. The final EIS should explain how the WIR process is taken into account in deriving waste estimates for the West Valley site.

Disposal Alternatives:

It may be useful to provide additional discussion of the performance history of the options so that the reader can more readily assess the strength and weakness of each option and what degree of reliability may be expected. As indicated on page 1-23, the vault design is similar to one employed at SRS. However, there is no information for the reader to judge whether it has performed as desired. How do the "enhanced" trench designs compare to those in use at other sites, and in particular to those known to have failed?

Regarding the borehole disposal alternative, it may also be useful to discuss how site-specific impacts on the stability of the geologic formation from the installation of 930 boreholes to a maximum depth of 1000 feet will be assessed. Depth and spacing of boreholes may need to be adjusted, as well as additional measures implemented to enhance stability. Flow of water through the deeper formations will also need to be evaluated.

Chapter 3 – No Action Alternative

West Valley Site:

In evaluating the No Action Alternative, the draft EIS does not appear to address the implications of GTCC and TRU waste remaining at the West Valley site as a result of selection of the Sitewide Close-in-Place Alternative for Phase 2 of site decommissioning. The West Valley EIS estimates that the Sitewide Removal Alternative will generate 4,200 cubic meters of GTCC low-level waste and 1,000 cubic meters of TRU waste (Section 2.4.1.5). However, Phase 1 of the Phased Decisionmaking Alternative is estimated to generate only 710 cubic meters of TRU waste and no GTCC waste (Section 2.4.3.6). This implies that 4,200 cubic meters of GTCC low-level waste and 290 cubic meters of TRU waste will remain at the site if the Sitewide Removal Alternative is not selected for Phase 2 (the Sitewide Close-in-Place Alternative is estimated to generate negligible volumes of GTCC and TRU waste). Further, low-level waste in excess of 1 million cubic meters will also remain on site, some of which could be DOE-origin "GTCC-like" low-level waste.

The draft EIS estimates that exhumation of the NDA and SDA at West Valley will generate 4,300 cubic meters of GTCC low-level waste and GTCC-like waste (page 1-46). This appears to account for all of the GTCC low-level waste that could remain at the site, as only 31 cubic meters is estimated to be GTCC-like waste (page 1-19). Page 1-19 further states that, of the approximately 2,200 cubic meters of GTCC-like waste originating at West Valley, about 44% is in Group 2 (yet to be generated). It appears

L94-7 The three land disposal facility conceptual designs (above-grade vault, enhanced near-surface trench, and intermediate-depth borehole) were selected as being representative of a range of land disposal configurations (varying degrees of waste consolidation and geometry) that could be employed for the disposal of the GTCC LLRW and GTCC-like waste inventory. As discussed in Section 1.4.2, each concept has its roots in practice at DOE sites. The same vault, borehole, and trench characteristics were considered for the disposal sites evaluated in order to compare the performance of each site's natural hydrological, geological, and meteorological properties relative to contaminant fate and transport once any engineered barriers would begin to fail.

The conceptual nature of these configurations takes into account the characteristics of all of the disposal sites for which they were considered, but their designs (e.g., width, depth, cover depth, reinforced containment) could be altered or enhanced, as necessary, to provide an optimal solution at a specific location. As an example, the cover depth could be adjusted to ensure that roots from vegetation would not compromise the top of the engineered barrier. In addition, the dimensions of the generic land disposal units (e.g., trench - width and depth, borehole - diameter and depth, vault - width, depth, and height) were selected based on similar existing facilities, existing equipment and methods for construction, and optimized (maximized waste volume disposed of for a given disposal unit volume; simple waste handling procedures to minimize exposure) for the types of waste packages considered. All designs could also accommodate different disposal packages (existing and proposed) with minor variations in their dimensions, but the EIS analyses would remain relevant for each option considered.

For example, if borehole disposal at NNSS became a preferred alternative, any capacity in the existing boreholes would have been considered in follow-up studies. For an above-grade vault with a 5 m cover, long-term impacts from the above-grade vault as determined by modeling for the EIS would be expected to be similar to those for a vault set lower with respect to grade, including with the top of the vault at or below grade, except in the case where the bottom of the waste confinement was closer to the groundwater table. For any disposal option, the bottom of any disposal unit would not be located at or below the water table to exclude the chance of groundwater migration into the disposal unit. Actual implementation of a disposal option at a specific location at a given site may have to be modified (i.e., the depth of a trench or a borehole may need to be reduced to avoid groundwater issues).

Past operational experience with these types of disposal facilities at DOE sites has shown that when properly implemented, they can provide isolation of radioactive waste from the environment for extended time periods. Past problems that have arisen with each option provide additional information to improve the design and performance of future land disposal facilities. Issues related to performance over time would be analyzed in a project-specific analysis to address technical and long-term concerns.

Note that the depth of boreholes evaluated was 130 ft (40 m), not 1,000 ft, which would make a significant difference in terms of stability relative to borehole spacing.

L94-8 The detailed implications of GTCC and TRU waste remaining at the West Valley site as a result of selection of the Sitewide Close in Place Alternative will be addressed under the Phase 2 site decommissioning study. Also, the impacts of storing TRU waste at West Valley are discussed in detail in the *Final Environmental Impact Statement for Decommissioning and/or Long-Term Stewardship at the West Valley Demonstration Project and Western New York Nuclear Service Center* (DOE/EIS-0226). Analysis done for the GTCC EIS indicate that the impacts of the No-Action alternative for NRC Region I (i.e., high dose estimates) is a direct reflection of the assumption that waste would remain at West Valley (Refer to Section 3.5). Any further consideration of possible future actions at West Valley and the uncertainties associated with its waste inventory would be speculative at this time. Even though it is beyond the scope of this GTCC EIS, the comment is noted.

L94-6 (Cont.)

L94-7

L94-8

then that all of the GTCC-like waste from decommissioning at West Valley will be TRU waste, which will not be generated by exhumation of the NDA and SDA.

Applicable regulations for disposal of GTCC low-level and TRU waste assume a greater degree of isolation than is provided by conventional near-surface disposal facilities like the NDA and SDA (10 CFR Part 61 and 40 CFR Part 191, respectively), as have the alternatives analyzed in the draft EIS. Recognizing that the decision on final decommissioning of the NDA and SDA will not be made before the final EIS is issued, the final EIS should address the long-term implications of leaving waste on site, with reference to the West Valley EIS as appropriate. The final EIS should also identify where and in what form TRU materials would remain at the West Valley site.

Chapter 4 – WIPP

Regulatory Structure:

Section 4.7 indicates that statutory changes would be necessary to allow disposal of waste other than defense-origin TRU waste at WIPP. It also recognizes the potential involvement of both EPA and NRC as regulatory authorities for underground disposal operations. This situation is further complicated by the fact that the waste considered in the draft EIS is itself covered under multiple regulations. The discussion on page 4-11 contrasts the requirements of 10 CFR Part 61 and 40 CFR Part 191 in pointing out that magnesium oxide (MgO) is placed on defense-origin TRU waste to satisfy the assurance requirements of 40 CFR Part 191, with the implication that this would not be necessary for GTCC disposal. However, non-defense TRU would still be subject to 40 CFR Part 191 and its assurance requirements. The final EIS should discuss how DOE views this overlap in regulation and how it proposes the overlap be addressed should disposal at WIPP be the preferred alternative.

Transportation:

Transportation impacts at WIPP need to be clarified and reconciled with Table 5.3.9-3, which shows radiological impacts to the public from severe transportation accidents. Because all remote-handled (RH) waste shipped to WIPP is assumed to be packaged in shielded containers to allow disposal as contact-handled (CH) waste, and fewer shielded containers can be included in any one shipment, there are more shipments overall than assumed for the other land disposal sites. It is clear that the larger number of shipments results in a proportionately greater number of miles travelled and therefore a greater number of accidents. It is also clear that shipping RH waste in shielded containers reduces the external exposure to those living or working along the transportation route, compared to the shipments of RH waste to the other land disposal sites.

However, impacts to the public should be similar for shipments of CH waste to WIPP or the other land disposal sites. In fact, page 4-72 (addressing impacts of transportation to WIPP) refers the reader to Section 5.3.9 for "transportation impacts for CH shipments." Page 5-85 notes that, for severe accidents, "estimated population doses and associated latent cancer fatalities (LCFs) were higher for the sealed sources and Other Waste-CH

L94-8 (Cont.)

L94-9

L94-10

L94-9

DOE acknowledges that the WIPP LWA as amended (P.L. 102-579 as amended by P.L. 104-201) limits disposal at WIPP to defense generated TRU waste. The use of WIPP was included as an alternative in the EIS because the use of this repository for GTCC LLRW and GTCC-like wastes is a reasonable approach. To protect public health and the environment, DOE intends to dispose of GTCC-like waste on the basis of its radiological and physical characteristics. It is recognized that WIPP cannot be used for the GTCC LLRW and GTCC-like waste inventory addressed in the EIS under current law. However, GTCC LLRW and GTCC-like wastes having characteristics similar to those of the defense-generated TRU wastes that are currently being disposed of at WIPP would be expected to be managed in a manner that is generally comparable to that used for defense-generated TRU wastes, to comply with 10 CFR Part 61 to ensure the health and safety of the general public for the long term.

Although WIPP is not currently authorized to dispose of GTCC LLRW and GTCC-like wastes, NEPA does not preclude DOE from considering WIPP as a reasonable alternative for disposing of GTCC LLRW and GTCC-like wastes. The need for legislative modifications to enable WIPP to be used for the disposal of GTCC LLRW and GTCC-like wastes is identified and discussed in the EIS.

L94-10

Direct comparison of the accident risks in Tables 4.3.9-1/4.3.9-2 with the accident consequences in Table 5.3.9.3-3 is not meaningful because the accident risks in Tables 4.3.9-1/4.3.9-2 include factors related to the distance traveled, accident probabilities, release fractions, and weather conditions as discussed in Appendix C, Sections C.9.3.1 and C.9.4.3.

Text has been added to Section 5.3.9.3 to clarify that the accident consequence impacts presented in Tables 5.3.9-3 and 5.3.9-4 correspond to shipments bound for near-surface disposal facilities and that impacts for similar shipments going to WIPP (activated metal shipments and remote-handled Other Waste packaged as contact-handled shipments) would be approximately a factor of three smaller because the packages assumed for the WIPP shipments have approximately one-third the capacity of those assumed for the near-surface disposal facility shipments.

Dose rates for rail shipments are approximately double those for truck shipments when using the same type of shipping containers as discussed further in Section C.9.4.4 and shown in Table C-9. However, AMCs would be shipped in Type B casks such as the 3-60B truck cask or the NAC UMS rail cask (see Table B-9 and discussion in Section B.1.5.2). The NAC UMS rail cask is approximately twice the size of the 3-60B truck cask. As identified in Table B-10, only one AMC could be accommodated in a truck cask and about four in a rail cask. Thus, while the rail cask may contain more AMCs, the dose rate could be approximately double that for the truck cask because of the relative sizes of the truck and rail casks, the loading configuration within the rail cask and the heavier shielding. A similar argument can be made for shipment of the h-SAMCs.

than for the activated metals and Other Waste-RH because they had higher amounts of alpha-emitting radionuclides, which are more of an inhalation (internal) hazard." Tables B-11 and B-12 indicate that the same number of shipments and same type of packaging are projected for the sealed source and Other Waste-CH categories, regardless of their destination. This suggests that the projected impacts of a similarly severe accident should also be comparable, if not identical.

Comparison of the "accident" column in Tables 4.3.9-1 and 4.3.9-2, which show population risks from transportation to WIPP by truck and rail, respectively, with Table 5.3.9-3 does not show consistency in either projected dose or risk for the CH waste categories. Table 5.3.9-3 shows that projected LCPs for sealed sources are generally higher than 1, with collective doses generally above 1,000 person-rem. The "accident" figures in Tables are all well below 0.1.

Several points should be clarified for the final EIS, including the meaning of the "accident" column in Tables 4.3.9-1 and 4.3.9-2 and the applicability of Table 5.3.9-3 to transportation to WIPP. Further, the statements on page 4-67 and 5-83 that "[d]ose rates for rail shipments are approximately double those for truck shipments because rail shipments are assumed to have twice the number of waste packages as corresponding truck shipments" is incorrect, particularly as it applies to shipments to WIPP. As shown in Table B-10, activated metal canisters (AMCs) and half-shielded activated metal canisters (h-SAMCs) have ratios of rail:truck of 4:1 and 3:1, respectively. These waste packages make up a significant proportion of the overall transportation. As a result, as shown in Tables B-11 and B-12, the rail:truck ratio for the other land disposal sites is about 2.5:1, while the ratio for shipments to WIPP is nearly 3:1 (because h-SAMCs are used for other types of RH waste as well as activated metals).

Waste Generation Period:

On page 4-1, line 26, it is assumed that the underground facilities will remain functional during the period projected for disposal of GTCC waste. This needs further explanation. The projected period ranges between the years 2019 and 2083 and it would be helpful to know the basis and details of the assumptions made for functionality. The properties of salt, creep rate, and the rate of deterioration should be included. It would also be helpful to mention what precautionary measures would be undertaken to maintain functionality if WIPP is selected as the site for GTCC disposal. The influence of creep closure is visible in the drift areas which have been open more than 30 years. This is a function of age of the structure and requires secondary or tertiary support to remain operational.

For completeness and better understanding of the operation procedure (which influences the EIS) the following topics should be considered in section 4.1.3.

- Mining method – the Room and Pillar type of mining method is used in WIPP underground. This has the advantage of safety and keeping the excavations open for longer period. The lower mining ratio is an important issue to consider for stability.

L94-11 As discussed in Section 4.1.4.1, a conceptual location within WIPP was analyzed as a potential alternative. The exact locations and orientations of these rooms would be determined on the basis of mining engineering, safety, and other factors should this alternative be selected. Therefore, a detailed discussion of the mining method and mining ratio and its effects are not required in this EIS and are not significant factors in the EIS impacts analyses. In addition, the proposed change for panels 9 and 10 has not been approved by the EPA or the NMED and should not be included in the EIS. The current certified baseline is what is described in the EIS.

The DOE has always maintained that borehole plugs, panel closures and shaft seals are engineered barriers that meet the definition of 40 CFR 194.44. This position is stated in the CCA Section 3.3. It is the EPA who determined that panel closure shaft seals and borehole plugs are not engineered barriers in their compliance determination for 40 CFR 194. EPA stated in CARD 44, "For compliance with this requirement [40 CFR 194.44], EPA did not evaluate panel seals, shaft seals or borehole plugs. EPA considered these items to be features of the disposal system design and evaluated them in that context." The text in the EIS is correct as written.

The DRZ is discussed in Section 4.1.3. The clay seams and marker beds are assumed to be fractured within the DRZ such that they have the same properties as the DRZ in the PA grid above and below the excavations (but not MB138). The properties of the DRZ are assumed to be homogeneous. The DRZ is considered differently for the panel closures and in a different way again for the shaft seals. The impact of the clay seams and the anhydrite fracture model on the DRZ was not discussed because it was considered beyond the scope of the EIS.

The October 2014 EPA Final Rule on the DOE proposed panel closure redesign was documented in the federal register notice (Volume 79, No. 195, Wednesday October 8, 2014) and based on the EPA technical review of the proposed panel closure redesign, EPA concluded that WIPP would continue to comply with the long term (i.e., 10,000 year compliance time frame after final facility closure) radioactive release standards. However, the primary purpose of a panel closure design is to meet the NMED, WIPP Hazardous Waste Facility Permit closure requirements for the operational period (prior to final facility closure). A panel closure is designed to provide assurance in terms of Resource Conservation Recovery Act (40 CFR 264.110 Subpart G – Closure and Post Closure), that the limit for the migration of hazardous constituents, volatile organic compounds (VOCs), during the operational time frame will be met at the point of compliance, which is the WIPP Land Withdrawal boundary. NMED will have to determine, through a well-defined regulatory review process (i.e., 40 CFR 270.42), the adequacy of a panel closure redesign to meet the primary panel closure design criteria which is to prevent the migration of hazardous VOCs in the air pathway in concentrations above health-based levels beyond the WIPP Land Withdrawal boundary during the operational time frame. NMED will first need to approve the adequacy of the panel closure redesign prior to implementation.

L94-10 (Cont.)

L94-11

U.S. Environmental Protection Agency, Commenter ID No. L94 (cont'd)

- Reference to the dimension of the excavations and shape of the opening should be provided. This is a factor for safety and can influence environmental and human impacts.
- In addition, a very brief mention about the nature of the support system can be added here for consideration of safety.
- The proposed changes regarding the Panels 9 and 10 need to be mentioned here and the statements on line 15-17 should be clarified.
- In the WIPP certification, MgO is the only design feature actually claimed by DOE as an engineered barrier; while the other engineered features described in lines 34-44 could potentially act as engineered barriers, they are not identified as such by DOE.
- A mention about the extent and influence of the existing fractures and clay layers in the disturbed rock zone (DRZ) would be helpful.

Geology and Soils:

In Section 4.2.2, Geology is limited to stratigraphy and physiography. A thorough investigation of geological and hydrological issues is required in selection of a potential site for disposal. Although stratigraphy is an important aspect of geology, suitability of a site primarily depends upon the lithologic characteristics, which include strength of the materials and other physical characteristics. A brief mention of these (shear strength, etc.) should be included in the final EIS.

In describing the Salado Formation on page 4-22, the final EIS should include the non-homogeneities which are important issues for waste disposal. The anhydrite layers – Master beds should be mentioned. The weak clay zones for shearing are a factor for stability.

Chapter 5 – Elements Common to Alternatives 3, 4, and 5

Page 5-29 of the draft EIS indicates that EPA's Federal Guidance Reports 11 and 12 contain dose conversion factors based on International Commission on Radiological Protection (ICRP) Publications 26 and 30. The draft EIS also states that dose conversion factors (DCFs) developed by ICRP in Publication 72 were used for the current analyses. The final EIS should highlight that EPA has included DCFs based on ICRP 72 in its CD supplement to Federal Guidance Report No. 13, *Cancer Risk Coefficients for Environmental Exposure to Radionuclides*, which can be found at <http://www.epa.gov/radiation/federal/techdocs.html>.

Chapter 7 – INL

Transport Characteristics:

Although Table E-4 indicates that the selection of distribution coefficient (K_d) values at INL was based on site-specific recommendations, some attention should be given to how this conservative assumption compares to the disposal practices at the Radioactive Waste Management Complex (RWMC). Near-surface disposal is being performed at the

L94-12 The analysis of lithologic characteristics is an activity that would normally be performed after site selection. In the case of an operating facility such as WIPP, this type of characterization is available in its Compliance Certification Application (<http://www.wipp.energy.gov/library/CRA/BaselineTool/Documents/CRA%20-%202004/Chapters/Chapter%202.pdf>).

Text has been added to section 4.2.2.1.3 related to the Salado Formation.

L94-13 Text was added to Section 5.2.4.3 to reflect the availability of the dose conversion factors based on ICRP 72.

L94-14 The three land disposal facility conceptual designs (above-grade vault, enhanced near-surface trench, and intermediate-depth borehole) were selected as being representative of a range of land disposal configurations (varying degrees of waste consolidation and geometry) that could be employed for the disposal of the GTCC LLRW and GTCC-like waste inventory. As discussed in Section 1.4.2, each concept has its roots in practice at DOE sites. The same vault, borehole, and trench characteristics were considered for the disposal sites evaluated in order to compare the performance of each site's natural hydrological, geological, and meteorological properties relative to contaminant fate and transport once any engineered barriers would begin to fail. The INL site analysis, as was the case for the other DOE sites, used site-specific information provided by technical staff to the extent it was available, and conservative assumptions were used to fill any remaining data gaps.

If INL were identified as a host site in a ROD for GTCC disposal, a thorough investigation of current practices at the RWMC would be used to customize the disposal technology to a specified location on the site. Such an investigation would involve site-specific NEPA as appropriate.

L94-11
(Cont.)

L94-12

L94-13

L94-14

RWMC. The final EIS should address the similarity of technology used at the RWMC to the borehole, trench, and vault technologies evaluated in the EIS, and should also compare the K_d assumption to the values used to authorize disposal at the RWMC. The draft EIS indicates that tritium and strontium plumes are present in the area of the reference location, but attributes these to past practices of disposal of liquids. This comparison will help the reader evaluate whether the magnitude of the projected doses are reflective of INL as a whole, or the reference location in particular.

Projected Peak Doses:

Some explanation should be provided as to why the projected doses from C-14, Tc-99, and I-129 should be significantly lower for the borehole technology as compared to the trench and vault. The draft EIS notes that these radionuclides will reach the designated receptor sooner because the disposal facility is constructed deeper, and therefore is closer to the ground water. However, this does not necessarily explain why in Figure 7.2.4-1 the peaks for the trench and vault technologies are steep and sharp, while the peak for the borehole technology is shorter and more spread over time. This pattern is also noted at other sites (e.g., Figure 8.2.4-1 for LANL). A possible explanation is that the depth and diameter of the borehole only allows a slower release of radionuclides from the upper portion of the borehole, whereas both the trench and vault are more amenable to an overall flushing of radionuclides once failure and infiltration occur. This would suggest that the borehole peak would be more spread over time, as radionuclides gradually make their way into the ground water. The final EIS should address this finding.

L94-14
(Cont.)

L94-15

L94-15 Additional discussion of the modeling assumptions and their influence on the dose results was added to Section 7.2.4.2. The travel times for radionuclides to reach the groundwater table are shorter for the borehole disposal method than for the trench and vault disposal methods because the bottom of the boreholes will be located closer to the groundwater table than the bottoms of the trenches and vaults. The peak doses for the borehole method were estimated to be smaller than those for the vault and trench methods because the footprint of a borehole disposal facility would be larger than that of a vault or trench disposal facility. As a result, the distance that the majority of the contamination needs to travel, after arriving at the groundwater table, to reach an offsite well located at 100 m from the edge of the disposal facility, would be greater for the borehole method than that for the vault or trench method (although the leading edge of the contamination for the borehole method would arrive first). The larger disposal area and also the greater distance for a majority of the contamination would result in greater dilution in the groundwater concentrations, and consequently, would yield smaller peak doses.

SUMMARY OF EPA RATING SYSTEM

Rating the Environmental Impact of the Action

- **LO (Lack of Objections)** The review has not identified any potential environmental impacts requiring substantive changes to the preferred alternative. The review may have discussed opportunities for application of mitigation measures that could be accomplished with no more than minor changes to the proposed action.
- **EC (Environmental Concerns)** The review has identified environmental impacts that should be avoided in order to fully protect the environment. Corrective measures may require changes to the preferred alternative or application of mitigation measures that can reduce the environmental impact.
- **EO (Environmental Objections)** The review has identified significant environmental impacts that should be avoided in order to adequately protect the environment. Corrective measures may require substantial changes to the preferred alternative or consideration of some other project alternative (including the no action alternative or a new alternative). The basis for environmental objections can include situations:
 1. Where an action might violate or be inconsistent with achievement or maintenance of a national environmental standard;
 2. Where the Federal agency violates its own substantive environmental requirements that relate to EPA's areas of jurisdiction or expertise;
 3. Where there is a violation of an EPA policy declaration;
 4. Where there are no applicable standards or where applicable standards will not be violated but there is potential for significant environmental degradation that could be corrected by project modification or other feasible alternatives; or
 5. Where proceeding with the proposed action would set a precedent for future actions that collectively could result in significant environmental impacts.
- **EU (Environmentally Unsatisfactory)** The review has identified adverse environmental impacts that are of sufficient magnitude that EPA believes the proposed action must not proceed as proposed. The basis for an environmentally unsatisfactory determination consists of identification of environmentally objectionable impacts as defined above and one or more of the following conditions:
 1. The potential violation of or inconsistency with a national environmental standard is substantive and/or will occur on a long-term basis;
 2. There are no applicable standards but the severity, duration, or geographical scope of the impacts associated with the proposed action warrant special attention; or
 3. The potential environmental impacts resulting from the proposed action are of national importance because of the threat to national environmental resources or to environmental policies.

Adequacy of the Impact Statement

- **Category 1 (Adequate)** The draft EIS adequately sets forth the environmental impact(s) of the preferred alternative and those of the alternatives reasonably available to the project or action. No further analysis or data collection is necessary, but the reviewer may suggest the addition of clarifying language or information.
- **Category 2 (Insufficient Information)** The draft EIS does not contain sufficient information to fully assess environmental impacts that should be avoided in order to fully protect the environment, or the reviewer has identified new reasonably available alternatives that are within the spectrum of alternatives analyzed in the draft EIS, which could reduce the environmental impacts of the proposal. The identified additional information, data, analyses, or discussion should be included in the final EIS.
- **Category 3 (Inadequate)** The draft EIS does not adequately assess the potentially significant environmental impacts of the proposal, or the reviewer has identified new, reasonably available, alternatives that are outside of the spectrum of alternatives analyzed in the draft EIS, which should be analyzed in order to reduce the potentially significant environmental impacts. The identified additional information, data, analyses, or discussions are of such a magnitude that they should have full public review at a draft stage. This rating indicates EPA's belief that the draft EIS does not meet the purposes of NEPA and/or the Section 309 review, and thus should be formally revised and made available for public comment in a supplemental or revised draft EIS.



UNITED STATES
NUCLEAR REGULATORY COMMISSION
WASHINGTON, D.C. 20555-0001

July 11, 2011

Mr. Arnold Edelman, EIS Document Manager
U.S. Department of Energy
GTCC EIS
Cloverleaf Building, EM-43
1000 Independence Ave. SW
Washington, DC 20585

SUBJECT: COMMENTS ON THE DRAFT ENVIRONMENTAL IMPACT STATEMENT FOR
THE DISPOSAL OF GREATER-THAN-CLASS C (GTCC) LOW-LEVEL
RADIOACTIVE WASTE AND GTCC-LIKE WASTE

On February 25, 2011, the U.S. Department of Energy (DOE) published a notice in the *Federal Register* (76 FR 10574) announcing the availability of the "Draft Environmental Impact Statement (DEIS) for the Disposal of Greater-Than-Class C (GTCC) Low-Level Radioactive Waste and GTCC-Like Waste" for public review and comment. As a commenting agency, the U.S. Nuclear Regulatory Commission (NRC) offers the enclosed remarks for consideration by DOE. At a later date, the NRC will also submit its perspective on the four topics identified in the February 16, 2011 letter from Ms. Christine Geles to Mr. Larry W. Camper.

In the interim, NRC staff will remain available to answer any questions related to the Commission's regulations, guidance, and other regulatory concerns. The NRC appreciates the opportunity to provide comments on the DEIS. Should you have any questions, please contact Janelle Jessio, my staff representative, at (301) 415-6776.

Sincerely,

Andrew Percinka, Deputy Director
Environmental Protection
and Performance Assessment Directorate
Division of Waste Management
and Environmental Protection
Office of Federal and State Materials
and Environmental Management Programs

U.S. Nuclear Regulatory Commission, Commenter ID No. L8 (cont'd)

U.S. Nuclear Regulatory Commission—General Comments on the Draft Environmental Impact Statement for the Disposal of Greater Than Class C (GTCC) Low Level Radioactive Waste and GTCC-Like Waste

The U.S. Nuclear Regulatory Commission (NRC) is cognizant of its potential role as the licensing authority for the U.S. Department of Energy's (DOE) greater-than-class C (GTCC) low-level radioactive waste (LLW) disposal facility. For this reason, the NRC has elected to participate as a commenting agency for DOE's Draft Environmental Impact Statement (DEIS) for the disposal of GTCC and GTCC-like LLW. Recognizing this role, the NRC identified several general issues as well as a number of section-specific issues in the DEIS. Some comments relate to the adequacy of technical information which NRC may need to make a licensing decision while others address the need for additional information or further clarification. Most of these comments are offered as examples and this document should not be considered an exhaustive list of information needed to support a license application and its review.

NRC Non-Section-Specific Comments

- 1) The document contains a large number of assumptions for which no basis is provided. This compromises the rigor of the impact analyses. Going forward, a thorough basis should be provided for all assumptions and conclusions.
- 2) The GTCC DEIS discusses disposal of both GTCC waste generated by NRC licensees and "GTCC-like" waste generated by DOE. Section 3(b)(2) of the Low Level Radioactive Waste Policy Amendments Act of 1985 (LLRWPA) requires that all Section 3(b)(1)(D) waste that results from NRC licensed activities be disposed of in a facility licensed by the NRC. This section does not grant NRC the authority to license and regulate disposal of DOE generated or owned GTCC-like waste. If DOE decides to operate a facility that disposes of both DOE and commercially generated waste, NRC would license the portion of the facility that handles commercially generated waste. However, the specific issues associated with licensing a combined facility will depend on the preferred alternative selected by DOE.
- 3) DOE should consider including an evaluation of the most likely combination of the alternatives, as well as their impacts, in the Final Environmental Impact Statement documenting selection of an alternative.
- 4) A discussion of impacts from "Intentional Destructive Acts" should be included for all of the alternatives. If this discussion is not added, DOE should explain why this discussion is not necessary for the alternatives where the discussion is omitted.
- 5) In the DEIS, accidents are discussed for each of the proposed alternatives with the exception of the "No Action" Alternative. A discussion of accidents for the "No Action" Alternative should be included or a justification for why it's not needed should be provided.
- 6) A detailed description and evaluation of the potential environmental impacts should be presented for each affected resource.

Enclosure

L8-1

The EIS analyses are based on conceptual engineering information and necessitated the use of a number of simplifying assumptions. This approach is consistent with NEPA, which requires such analyses to be made early in the decision-making process. The various land disposal conceptual designs were assumed to be constructed and operated in a comparable manner at each of the various sites. Information on the conceptual engineering designs for the three proposed land disposal methods is provided in Section D.3 of Appendix D in the EIS. By using the same conceptual designs at all of the sites evaluated in the GTCC EIS, except for cases where a design did not apply (e.g., an intermediate-depth borehole at a site with shallow groundwater), the potential impacts (e.g., radionuclides reaching the groundwater) at the different environmental settings could be readily compared.

In performing these evaluations, a number of engineering measures were included in the conceptual facility designs to minimize the likelihood of contaminant migration from the disposal units. No facility design can guarantee that radionuclide migration from the facility would not occur over and beyond a 10,000-year time period. It was assumed that these measures would perform similarly for all conceptual designs, remaining intact for 500 years after the disposal facility closed. After 500 years, the barriers would gradually fail. To account for these engineered features in the modeling calculations, it was assumed that the water infiltration to the top of the waste disposal area would be zero for the first 500 years and then 20% of the natural rate for the area for the remainder of the time period (through 10,000 years). A water infiltration rate of 20% of the natural rate for the area was only used for the disposal area; the natural background infiltration rate was used at the perimeter of the waste disposal units. Again, this approach enables a comparative evaluation of the influence that site-specific environmental factors would have on the potential migration of radionuclides from the disposal facilities and the potential impacts on human health. It should be emphasized that project- and site-specific engineering factors would be incorporated into the actual facility designs of the site or sites selected in a ROD to dispose of GTCC LLRW and GTCC-like wastes.

DOE recognizes that modeling potential releases of radionuclides from the conceptual disposal sites far into the future approximates what might actually occur. Sufficient detail was included in these designs for use in the EIS analyses, consistent with the current stage of this process. Some of the input values may change in the future and could result in higher impacts (such as from increased precipitation at some sites due to climate change), while others could result in lower impacts (due to decreased precipitation).

DOE believes that 500 years is a reasonable time period for the longevity of the types of engineering barriers assumed in the analyses. DOE believes the approach and the assumptions used in the EIS are reasonable for performing the comparative analysis of alternatives required by NEPA. For example, as discussed in Section E.2.2, the assumption of a 20% natural background infiltration rate after 500 years was based on a study at SRS (Phifer et al. 2007) that indicated that after 10,000 years, the closure cap at the F-area would still shed about 80% of the cumulative precipitation falling on it, with an effectiveness that would be greater before 10,000 years, then decrease very slowly after 10,000 years. The approach used in the EIS is more conservative than indicated by this study.

L8-2

DOE recognizes that including GTCC-like wastes within the scope of this EIS along with GTCC LLRW may complicate the implementation of GTCC LLRW disposal alternative(s). However, DOE determined that the most efficient approach was to address both types of waste, which have many similar physical and radioactive characteristics, in a single NEPA process. DOE's intent is to facilitate the overall process for addressing the disposal needs of both waste types. DOE acknowledges that the LLRWPA (P.L. 99-240) specifies that GTCC LLRW, designated a federal responsibility under section 3(b)(1)(D) that results from activities licensed by the NRC, is to be disposed of in an NRC-licensed facility that has been determined to be adequate to protect public health and safety. However, unless specifically provided by law, the NRC does not have authority to license and regulate facilities operated by or on behalf of DOE. Further, the LLRWPA does not limit DOE to using only non-DOE facilities or sites for

U.S. Nuclear Regulatory Commission, Commenter ID No. L8 (cont'd)

- 7) A brief discussion of mitigation for the long-term impacts of the "No Action" Alternative should be provided.
- 8) A discussion of both: (1) impacts of an alternative on climate change; and (2) impacts of climate change on an alternative should be provided for all of the alternatives, including the "No Action" Alternative. Additionally, this evaluation should use the same parameters for each alternative. If the same parameters are not used, a basis for that decision should be provided.
- 9) For each alternative, a brief description of transportation routes and modes for conveying construction materials to the facility should be included.

NRC Section-Specific Comments

- 1) DOE EIS:
Section 1.4.2.3.1, Page 1-23: "Wastes would be contained in packages designed to retain their integrity for an extended time period, and these wastes would be carefully emplaced into the trenches."

Section 5.1.4.3, Page 5-18: "For wastes like activated metals and sealed sources, which mostly contain radionuclides with shorter half-lives, this EIS does not assume grouting would be required because of the waste form."

NRC Comment:
Waste container and packaging are an important part of disposal, but little information is presented. Table 5.1-3 on pages 5-3 to 5-4 lists the container type, but additional information should be included in the assessments of the alternatives including composition of the container materials, container thickness, and the potential physical and chemical processes that could affect contaminant release. Since the release rate at the source term is usually a significant component of any assessment, specific information should be included on the contents of the containers, in addition to the waste. "Other Waste" will be embedded in mortar, but it is not clear that the activated metals and sealed sources will be embedded in a sandy backfill or mortar, or if waste will be the only material within the containers.
- 2) DOE EIS:
Section 1.4.2.3.2, Page 1-23. The above-grade vault design is "... similar to a belowground vault option for LLRW disposal (Denson et al. 1997) that was previously investigated by the U.S. Army Corps of Engineers (USACE). A similar concrete vault structure is currently in use for the below-grade disposal of higher-activity LLRW at SRS (MMCS et al. 1994)."

NRC Comment:
A brief rationale should be given for excluding the below-ground vault design.

- L8-3 DOE evaluated each of the proposed sites and methods individually including the entire inventory of GTCC LLRW and GTCC-like waste. This approach bounded the analysis by presenting the maximum environmental consequences of the proposed action. The potential environmental consequences of the preferred alternative are also presented in the Final EIS (Section 2.10). The preferred alternative includes a combination of waste types and methods.
- L8-4 The analysis of intentional destructive acts is given in Section 2.7.4.3 of the EIS. This analysis provides a perspective on the risks that the GTCC LLRW and GTCC-like wastes could pose should such an act occur. In general, the risk presented from an intentional destructive act is similar to that from a high-severity transportation accident. The accident consequence assessment (given in Section 5.3.9.3 of the Final EIS) presents the results for transportation accidents that fall into the highest severity category. The severe environment that occurs under such conditions can be considered to be similar to that which could be initially instigated by an act of sabotage. In highly populated areas, where the highest exposures would be anticipated, a rapid response would be expected, minimizing the amount of time available to fully breach a Type B package. Should such shipments be diverted and the radioactive material removed for dispersion, higher exposures could be achieved, and potential impacts could be significant. The economic impact could reach several billions of dollars. The extent of the impacts would depend on the exact location of the release, density of the surrounding population, local meteorology, and emergency response capabilities in the affected area. In addition, the final transportation routes will not be selected until a ROD for the EIS is issued and follow-up site-specific NEPA review is conducted as needed.
- L8-5 Impacts from accidents or theft/intrusion were not performed for the No Action Alternative because, as stated in Chapter 3 of the GTCC EIS, GTCC LLRW was assumed to be managed consistent with the existing NRC licenses. In general, these impacts would be comparable to those in the accident consequence analyses conducted for facilities and transportation but possibly occur at a higher frequency because of a lower overall level of security.
- L8-6 All relevant potential exposure pathways were considered in the analyses presented in the EIS. These analyses addressed a range of reasonable scenarios and estimated the potential impacts on all environmental resources consistent with NEPA requirements. For the human health assessment, the focus was on the groundwater pathway, since this is the most likely manner in which someone could be exposed to the radioactive contaminants in the GTCC LLRW and GTCC-like wastes in the distant future. As discussed in Section 2.7.4.2, the hypothetical resident farmer scenario was only used to provide estimates for comparing the various sites evaluated. Reasonably foreseeable future scenarios at the sites evaluated may be different from the hypothetical resident farmer scenario considered in the GTCC EIS. Follow-on site-specific NEPA review would be conducted by using additional site-specific information, if available. This information could include sensitive subpopulations and specific pathways of exposure for American Indians. In a similar fashion, additional cumulative impacts analyses would be conducted by using additional site-specific information when the location selected for a GTCC LLRW and GTCC-like waste disposal facility was determined. All environmental resources areas discussed in Chapter 2 and listed in Figure 2-1 were included in the evaluation.
- L8-7 The No Action Alternative is evaluated in detail in the EIS as required by NEPA (Chapter 3). A mitigation plan is not required under the No Action Alternative. The long-term storage of GTCC LLRW is subject to NRC and Agreement state requirements.

U.S. Nuclear Regulatory Commission, Commenter ID No. L8 (cont'd)

- 3) DOE DEIS:
Section 1.5.2, Page 1-44: "Data on the GTCC LLRW that might be generated by the concentration and consolidation of Class B and Class C LLRW are difficult to ascertain at this time because of the speculative nature of these events. The uncertainty that would be introduced in the EIS process by including this potential volume is not warranted."
- NRC Comment:
It would be helpful to include additional details supporting the determination that a discussion of the concentration of Class B and C LLRW is not warranted.
- 4) DOE DEIS:
Section 1.8, Pg 1-48 (Tribal Consultation): In the DEIS, only 14 American Indian tribal governments for four of the sites being analyzed were consulted.
- NRC Comment:
Consultations with American Indian tribal governments were limited in that they were not conducted for SNRS, WIPP vicinity, or the other generic regional locations. Justification should be provided in the DEIS as to why consultations were only conducted for the four sites: Hanford, INL, LANL, and NNGS.
- 5) DOE DEIS:
Section 2.0, Page 2-2: "The impact analysis for the decommissioning phase has not been included in this EIS but would be conducted at a later time, as appropriate."
- NRC Comment:
A comparison of decommissioning impacts would be useful in selecting an alternative. For example, an additional 4,300 m³ (150,000 ft³) of GTCC LLRW and GTCC-like wastes could be generated by the exhumation of the Nuclear Decommissioning Authority and State-Licensed Disposal Area at the site as part of future decommissioning activities. Exhumation would be an action within the scope of Alternatives 2, 3, 4, and 5, and as such, should be part of the assessment and included in the impact discussions for these alternatives. This would apply to all "Other Waste" that requires exhumation and transportation to a potential GTCC facility. The "No Action" Alternative would not require such an assessment.
- 6) DOE DEIS:
Section 2.6, Page 2-9: "[T]he NOI for the GTCC EIS also identified the Oak Ridge Reservation (ORR) as a site to be evaluated for potential disposal of GTCC waste by using a land disposal method because of its ongoing waste disposal mission. However, disposal of radioactive waste at the ORR is currently limited to only CERCLA wastes. Through further reviews conducted by the Low-Level Waste Disposal Facility Federal Review Group, DOE determined that the site is not appropriate for disposal of LLRW containing high concentrations of long-lived radionuclides (such as those found in GTCC waste), especially those with high mobility in the subsurface environment. For this reason, DOE concluded that the Oak Ridge Reservation is not a reasonable disposal site alternative and has eliminated it from detailed evaluation in this EIS."

L8-12

L8-13

L8-14

L8-15

L8-8 The GTCC EIS analyzed the CO₂ emissions of the action alternatives in Chapters 4 and 5 and found them to be negligible for both construction and operations. As such, a separate, similar analysis of the No Action Alternative would not provide a significantly improved understanding. The impacts of climate change were considered in the evaluation of the resource areas evaluated, and the same parameters (e.g., precipitation, geology, seismic, etc.) were used for each alternative for the long-term modeling. DOE recognizes that modeling potential releases of radionuclides from the conceptual disposal sites far into the future approximates what might actually occur. Sufficient detail was included in these designs for use in the EIS analyses, consistent with the current stage of this process. Some of the input values may change in the future and could result in higher impacts (such as from increased precipitation at some sites due to climate change), while others could result in lower impacts (due to decreased precipitation).

L8-9 A discussion of the transportation aspects of the proposed action are included in Chapter 5.2.9 of the GTCC EIS. The transportation mode used for conveying construction materials to the facility is anticipated to be by truck. Due to the nature of the facility, the types and quantities of materials are small. Follow-on analysis will be conducted once a final decision is made and a site and method is selected for implementation.

L8-10 Information on waste forms and waste packages and containers is provided in the EIS to allow for a comparative analysis of alternatives for transportation and waste disposal. Treatment of the wastes prior to disposal is outside the scope of the EIS. Such treatment is assumed to be addressed prior to receipt of the waste at the GTCC LLRW and GTCC-like waste disposal facility. DOE agrees that it is important to immobilize long-lived radionuclides such as Tc-99 and I-129 prior to disposal. Solidification techniques (e.g., use of grout) are expected to immobilize certain wastes in the GTCC LLRW and GTCC-like waste inventory. If needed, the actual stabilization methods used will depend, in part, on the waste stream, packaging, and final disposal facility design. DOE considers the assumptions used for waste form stability (see Appendix B) to be reasonable for purposes of the comparative analysis provided in the EIS.

The waste characteristics and physical form would have to meet the disposal facility waste acceptance criteria. It is expected that these waste acceptance criteria would identify requirements (such as allowable concentrations) for individual radionuclides, including Tc-99 and I-129. The specific waste forms and packages used to dispose of GTCC LLRW and GTCC-like wastes would be determined in the future as part of the waste acceptance criteria and packaging requirements developed. See the discussion in Section B.5 and C.9.4.2 of the EIS for more information on packaging requirements. All GTCC LLRW and GTCC-like wastes would be packaged and transported in accordance with all applicable federal and state requirements, and waste disposal activities would be conducted in accordance with appropriate requirements.

L8-11 The three land disposal facility conceptual designs (above-grade vault, enhanced near-surface trench, and intermediate-depth borehole) were selected as being representative of a range of land disposal configurations (varying degrees of waste consolidation and geometry) that could be employed for the disposal of the GTCC LLRW and GTCC-like waste inventory. As discussed in Section 1.4.2, each concept has its roots in practice at DOE sites. The same vault, borehole, and trench characteristics were considered for the disposal sites evaluated in order to compare the performance of each site's natural hydrological, geological, and meteorological properties relative to contaminant fate and transport once any engineered barriers would begin to fail.

The conceptual nature of these configurations takes into account the characteristics of all of the disposal sites for which they were considered, but their designs (e.g., width, depth, cover depth, reinforced containment) could be altered or enhanced, as necessary, to provide an optimal

U.S. Nuclear Regulatory Commission, Commenter ID No. L8 (cont'd)

<p>NRC Comment: The FEIS should state specifically what technical basis makes the ORR site inappropriate for disposal of GTCC waste, especially for those wastes with highly mobile isotopes in the subsurface environment.</p> <p>7) DOE DEIS: Section 2.7.4.2, Page 2-17. "The key input parameters that influenced the long-term human health results are the precipitation rates and the soil distribution coefficients (K_d) assumed in the calculations."</p> <p>NRC Comment: The K_d should be included as a parameter in the sensitivity analyses.</p> <p>8) DOE DEIS Section 2.7.12, Page 2-23. "DOE did not evaluate the cumulative impacts of the no action alternative, since such an evaluation would involve making speculative assumptions about environmental conditions and future activities at the many locations where the GTCC LLRW and GTCC-like waste could be stored."</p> <p>NRC Comment: Because of its generic nature, the DEIS contains numerous assumptions that could be described as speculative but the DEIS came to conclusions on impacts for alternatives other than the no-action alternative. Therefore, it is unclear why the DEIS could not also make reasonable (non-speculative) assumptions on future environmental conditions and activities in order to evaluate the no-action alternative.</p> <p>9) DOE DEIS: Section 2.8.4, Page 2-58. "Because the soil distribution coefficients are used to calculate the radionuclide release rates for sealed sources, it is assumed that the radionuclides would be released to the surrounding soil immediately upon contact with water. This approach is assumed to be conservative, and it adds a large uncertainty to the results presented in this EIS."</p> <p>NRC Comment: A conceptual model of contaminant fate and transport should be presented for each alternative. Assumptions could then be compared to the conceptual model, and large uncertainties would not need to be added to the results. For example, reduced water infiltration rate for only the waste disposal area is assumed to be conservative within the DEIS because with a higher water infiltration rate outside the waste disposal area, the transport time needed for radionuclides to reach the underlying groundwater table after they have been released from the waste disposal area would be shortened. However, a conceptual model may point out that the engineered cover casts a large water shadow so that the higher water infiltration rate outside of the waste disposal area flows past the area of concern and is not significant.</p>	<p>L8-15 (Cont.)</p> <p>L8-16</p> <p>L8-12</p> <p>L8-17</p> <p>L8-13</p> <p>L8-18</p> <p>L8-14</p> <p>L8-15</p>
--	---

solution at a specific location. As an example, the cover depth could be adjusted to ensure that roots from vegetation would not compromise the top of the engineered barrier. In addition, the dimensions of the generic land disposal units (e.g., trench - width and depth, borehole - diameter and depth, vault - width, depth, and height) were selected based on similar existing facilities, existing equipment and methods for construction, and optimized (maximized waste volume disposed of for a given disposal unit volume; simple waste handling procedures to minimize exposure) for the types of waste packages considered. All designs could also accommodate different disposal packages (existing and proposed) with minor variations in their dimensions, but the EIS analyses would remain relevant for each option considered.

For an above-grade vault with a 5 m cover as an example, long-term impacts from the above-grade vault as determined by modeling for the EIS would be expected to be similar to those for a vault set lower with respect to grade, including with the top of the vault at or below grade, except in the case where the bottom of the waste confinement was closer to the groundwater table.

Class B and C wastes are not GTCC LLRW and are out of scope for this EIS. The possible concentration of these wastes to form additional GTCC LLRW is too speculative at this time as stated in the text and is not required for consideration under NEPA.

DOE solicited input from various sources to identify American Indian tribes that would be interested in engaging in tribal consultation with DOE on the proposed action discussed in the GTCC EIS. This engagement began in 2007 at the October State and Tribal Government Working Group meeting in Snowbird, Utah. As a follow-up to that meeting, DOE, in 2008, sent out letters to tribal government officials communicating DOE's interest in consulting with tribal nations on the GTCC EIS. However, no tribal group came forward, and DOE was not able to identify any interested tribal group affiliated with WIPP or the Savannah River Site. The approach used to engage American Indian tribes is further described in the EIS under Section 1.8 on tribal consultation for the GTCC EIS.

The EIS notes that the decommissioning of a GTCC waste disposal facility is part of the proposed action, but because the facility would not be closed and decommissioned until far into the future (after 2083), the impact analysis for the decommissioning phase would be conducted at that time. It is not possible at this time to evaluate with any degree of confidence the environmental impacts from decommissioning a facility that has not yet been selected.

The GTCC waste disposal facility would be designed to facilitate future decommissioning consistent with applicable law, guidance, and policies. The appropriate site-specific NEPA review will be conducted in the future as part of the decommissioning plan.

The impacts of decommissioning of the existing disposal sites at West Valley are not within the scope of this EIS. This GTCC EIS addresses the potential environmental impacts associated with the proposed development, operation, and long-term management of a disposal facility or facilities for GTCC low-level radioactive waste (LLRW) and DOE GTCC-like waste.

Based on further reviews conducted by the DOE Low-Level Waste Disposal Facility Federal Review Group, DOE determined that the site is not appropriate for disposal of LLRW containing high concentrations of long-lived radionuclides (such as those found in GTCC waste), especially those with high mobility in the subsurface environment. For this reason, DOE concluded that the Oak Ridge Reservation is not a reasonable disposal site alternative and has eliminated it from detailed evaluation in this EIS.

10) DOE DEIS:
 Section 2.9.2, Page 2-61: "Use of boreholes or a geologic repository might require more waste handling to make the physical size of the waste manageable than use of trenches or vaults. The need for treatment could result in greater worker doses."
 DOE DEIS, Appendix B, Page B-7, Table B-3, Footnote d: "Because of the assumed volume reduction, the volumes presented in this GTCC EIS are less than those presented in the Final EIS for the West Valley Site (DOE 2010a)."
 NRC Comment:
 This is an incomplete evaluation of worker dose. Waste handling by workers for the borehole and geologic repository alternative should be evaluated or at least discussed in the worker impact sections. If there is additional volume reduction as stated on page B-7 that involves worker handling, the process of this reduction should be described and discussed, and the impact to workers included in the assessment.

11) DOE DEIS:
 Section 2.9.3, Page 2-64: "If post-closure care is not maintained, vaults could pose a greater potential for radiological exposures to the public (Rao et al. 1992; Kozak et al. 1993). Consequently, maintenance of institutional controls is considered particularly important for this technology to achieve post-closure safety. Long term post-closure care requirements for the trench, borehole, and deep geologic methods should be less than those for an above-grade vault (USACE Waterways Experiment Station 1984)."
 NRC Comment:
 10 CFR 61.59 states that a NRC licensed disposal facility may not rely upon institutional controls for longer than 100 years. The level of information presented regarding this design option does not appear to support this alternative under the regulation. To support any future decision, DOE needs to provide additional information that supports the satisfactory behavior of above-ground vaults beyond the institutional control period. In addition, availability of suitable borrow areas needed to build shove-grade vaults was not addressed.

12) DOE DEIS:
 Section 3.5.1.2, Page 3-20: "For the long term evaluation of the No Action Alternative in this EIS, the following assumptions apply: (1) maintenance activities at these storage facilities would not be conducted after the active institutional control period (i.e., after 100 years), (2) the storage containers would start to degrade to the extent that potential radionuclide releases could occur, (3) these radionuclides would then reach the groundwater and move down gradient off-site, and (4) a hypothetical individual would use and consume this contaminated groundwater in the future. These assumptions were made to allow for an assessment of the potential human health impacts in the future; they do not imply that such a situation is reasonable or likely to occur."

L8-19

L8-20

L8-21

L8-16 The stability of one of the waste forms (i.e., the grout material for Other Waste) was evaluated in the sensitivity analysis by varying the effective retardation period of the release of radionuclides. There are many parameters that could affect the modeling results that could be addressed in a sensitivity analysis. However, the essential effects of many of these parameters are the same (i.e., affecting when and how much water would enter the waste containers and contact the waste materials). In the GTCC EIS, both the influence of the water infiltration rate and the influence of when water would enter the waste containers on the dose results were addressed.

L8-17 Modeling results can be very sensitive to some factors, such as the Kd for a given radionuclide. Kd values were provided by the sites for the GTCC EIS analyses. More extensive and detailed sensitivity analysis may need to be conducted during the implementation phase for a GTCC LLRW and GTCC-like waste disposal facility, based on more specific information on the engineering designs of the disposal facilities and their influence on the integrity of waste packages, waste containers, barrier materials, and the surrounding native soil (e.g., location-specific Kd values); however, the analysis provided in the EIS is sufficient to inform site and technology selection decisions.

L8-18 The No Action Alternative is evaluated in Chapter 3 of the EIS, and under this alternative, current practices for storing GTCC LLRW and GTCC-like wastes would continue. These practices are described in Sections 3.2 (GTCC LLRW) and 3.3 (GTCC-like wastes) in the Final EIS. It was necessary to make a number of simplifying assumptions to address the long-term impacts of this alternative, and these are described in Section 3.5. As part of this assessment, it was assumed that these wastes would remain in long-term storage indefinitely, including wastes from the West Valley Site as discussed in Section 3.5.3, and that no maintenance of either the storage facility or waste packages would occur after 100 years. These results indicate that very high radiation doses and cancer risks could occur under this alternative in the long term.

L8-19 The No Action Alternative is evaluated in the EIS to provide a baseline for comparison with the action alternatives. This evaluation confirmed the risks posed by these wastes and the need to develop appropriate disposal capability. The potential radiation doses for the No Action Alternative covered a time period of 10,000 years in a manner comparable to that done for the action alternatives. Relatively high impacts could occur shortly after the 100-year institutional control period under this alternative.

L8-20 The same conceptual model was applied to all of the land-based disposal methods. Details of the model can be found in Section E.2 of the EIS.

L8-21 Operations such as the packaging and loading of shipments fall under the responsibility of the shipping organization and would be covered by the respective organization's operating procedures, safety measures, and NEPA activities, as appropriate. Also, packaging and loading of the GTCC LLRW and GTCC-like wastes at each generator location would be the same for all alternative disposal sites, with the exception of remote-handled waste at WIPP.

L8-22 The EIS assumes that the disposal facility may not rely upon institutional controls for longer than 100 years. Detailed facility designs for the selected disposal method alternative will be developed as part of the project specific analysis.

The availability of soils/borrow areas is dependent in part on the amount of material needed. If the vault design had been selected for use, additional details regarding the available borrow areas would have been identified based on a site-specific design that could require more or less material as identified for the conceptual designs presented in the EIS.

U.S. Nuclear Regulatory Commission, Commenter ID No. L8 (cont'd)

Section 5.2.4.2 Alternatives 3, 4, and 5 (pg. 5-20): "The human health impacts associated with the waste handling, transportation, and disposal of GTCC LLRW and GTCC-like wastes are analyzed for all aspects associated with managing these wastes, from the point of generation, to the transportation of wastes to the disposal site, to the placement of wastes in the disposal facility, and to the long-term management of the disposal facility. That is, this evaluation includes an assessment of potential environmental impacts for both the operational phase and post-closure phase of actions at the disposal sites."

Section 5.2.4.3 Alternatives 3, 4, and 5 (pg. 5-28): "Following completion of the useful life of the disposal facility, it would be decommissioned in accordance with applicable requirements at the time. A long-term monitoring and maintenance period would follow site decommissioning to ensure that the disposal facility was adequately containing the disposed wastes."

NRC Comment:
In determining the long-term impacts of the "No Action" Alternative, the DEIS assumes that there are no institutional controls. It is not clear that the same assumption is used for the other alternatives. Please clarify whether no institutional controls for long term impacts are assumed for all of the alternatives and if they are not, please provide a justification.

13) DOE DEIS:
Section 3.5, Page 3-10: "Under the No Action Alternative, it is assumed that the current facility operations at the storage and generator sites would continue for the short term and result in minimal impacts on most resource areas (e.g., air quality, geology, water resources, ecological resources, socioeconomic, land use, transportation, and cultural resources)."

NRC Comment:
A basis for the assumption that the "No Action" Alternative would have minimal impacts on the stated resource areas should be provided. Specific information regarding these impacts should be available since these facilities are currently operating.

14) DOE DEIS:
Section 3.5, Page 3-11: "For purposes of analysis of the long-term impacts, wastes from the GTCC inventory that are assumed to be generated within a given NRC region are assumed to be stored at a single facility in that region, and this storage facility is assumed to have a footprint of 300 x 300 m (1,000 x 1,000 ft). It is recognized that these simplifying assumptions do not represent the current situation, and GTCC wastes are currently stored throughout the region at a number of locations. However, this approach is assumed to be reasonable for estimating the potential radiation doses and LCF risks to address the long-term impacts associated with the No Action Alternative."

L8-21 The EIS states in Section 3.1 for the No Action Alternative that the EIS "assumed that the stored waste would be actively managed for 100 years after all the waste was generated and placed in storage." For the other alternatives, the discussion on the application of institutional controls is found in Section 5.6 of the EIS. For the GTCC waste disposal facility or facilities, it is expected that both active and passive institutional controls would be implemented and relied on to allow the facility to perform adequately with respect to protection from inadvertent human intruders.

L8-22 The No Action Alternative is evaluated in Chapter 3 of the EIS, and under this alternative, current practices for storing GTCC LLRW and GTCC-like wastes would continue. These practices are described in Sections 3.2 (GTCC LLRW) and 3.3 (GTCC-like wastes) in the Final EIS. It was necessary to make a number of simplifying assumptions to address the long-term impacts of this alternative, and these are described in Section 3.5. As part of this assessment, it was assumed that these wastes would remain in long-term storage indefinitely, including wastes from the West Valley Site as discussed in Section 3.5.3, and that no maintenance of either the storage facility or waste packages would occur after 100 years. These results indicate that very high radiation doses and cancer risks could occur under this alternative in the long term.

The No Action Alternative is evaluated in sufficient detail in the EIS as required by NEPA. Comparatively high potential radiation doses and cancer risks could occur should this alternative be selected. While a more detailed analysis could reduce the uncertainties associated with estimating these doses and risks, the conclusion of comparatively high impacts would not change for this alternative.

Impacts from accidents or theft/intrusion were not performed for the No Action Alternative because of the large number of potential locations, and in many cases (sealed sources), the current locations of the waste are not known. In general, these impacts would be comparable to those in the accident consequence analyses conducted for facilities and transportation but possibly occur at a higher frequency because of a lower overall level of security.

The No Action Alternative is evaluated in the EIS to provide a baseline for comparison with the action alternatives. This evaluation confirmed the risks posed by these wastes and the need to develop appropriate disposal capability. The potential radiation doses for the No Action Alternative covered a time period of 10,000 years in a manner comparable to that done for the action alternatives. Relatively high impacts could occur shortly after the 100-year institutional control period under this alternative.

L8-23 The 300 x 300 m footprint assumption was based on the volume of waste of one NRC Region to be stored, including area for storage of the waste itself and an attendant facility. For comparison purposes, it is less than half the area assumed for the proposed vault disposal facility (420 x 610 m) for the entire waste inventory as discussed in Section D.4.3.

The single site assumption was based on a composite of different sites obtained using a similar approach as used previously in the No Action alternative evaluation for Yucca Mountain.

L8-21
(Cont.)

L8-22

L8-23

U.S. Nuclear Regulatory Commission, Commenter ID No. L8 (cont'd)

NRC Comment:
A basis for the estimated footprint should be provided. Also, additional details are necessary to demonstrate why this "single site" assumption is reasonable.

15) DOE DEIS:
Section 4.3.4.3, Page 4-60. "The post-closure impacts of disposing of the GTCC LLRW and GTCC-like wastes were evaluated in the EIS in the same manner as was done for TRU wastes (i.e., by developing complementary cumulative distribution functions (CCDFs) based on performance assessments) (Sandia 2006c.d: 2010a). The post-closure impacts are limited to the potential radiation doses from the release of radionuclides from waste packages at WIPP and from their subsequent migration to groundwater."

NRC Comment:
The analyses performed by Sandia Laboratories for Alternative 2 (disposal at WIPP, page 4-61) should be integrated into the EIS. The uncertainty produced by using a different computer code and possibly a different analysis methodology should also be discussed (i.e. page E-30).

16) DOE DEIS:
Section 5.2, Pages 5-16 to 5-19. "The generic commercial disposal locations are not evaluated for the environmental resource areas discussed in this section because each of the four regions encompasses a very large area for which a meaningful evaluation of the resource area is not possible. However, human health impacts for the long term are estimated by using region-specific input parameters. This estimate was done in order to provide information that could be used to distinguish the four regions from one another."

NRC Comment:
The assessments for the generic commercial regional (L-IV) sites and the "No Action" Alternative are too generic to support an informed decision on an approach for disposing of GTCC wastes. Comparison of results with other sites using site-specific data is unrealistic. For instance, an effective site evaluation would require important parameters such as the depth to groundwater and the unsaturated zone thickness. However, in the DEIS these depths were averaged over areas too large to be of any real value. Results are very dependent on characteristics of the specific sites. The resulting impact analyses are therefore too generic to allow for a useful comparison.

17) DOE DEIS:
Section 5.3.1.2, Page 5-47. "In addition, this Section 5.3.1.2 provides a qualitative assessment of the potential effects of global climate change on the proposed land disposal (borehole, trench, and vault) facilities for the long term, as discussed below."

NRC Comment:
Climate change could affect the results included in the assessments. Currently, the prognoses of future climate states and changes are uncertain. It is precarious to rely on one document (Karl et al. 2006) to characterize future climate conditions in different regions of the United States. A more comprehensive assessment should include

L8-24 The modeling approaches used in the EIS to address the WIPP repository and the land disposal alternatives were selected to best accommodate the unique differences of these two types of facilities. That is, the same modeling approach as that used previously to support the disposal of defense-generated TRU wastes at WIPP was also used for the GTCC LLRW and GTCC-like wastes (i.e., the development of complementary cumulative distribution functions based on performance assessments). This approach was used in the EIS, given the similarity of the GTCC LLRW and GTCC-like wastes to the defense-generated TRU wastes already being safely disposed of in this repository.

L8-23
(Cont.)

In contrast, the land-based disposal concepts were well-suited to be assessed by using the RESRAD-OFFSITE computer code. This computer code is quite flexible and has algorithms for addressing radionuclide decay and ingrowth during transit, which is a very important consideration for the long-lived radionuclides in the GTCC LLRW and GTCC-like wastes, some of which are in very long decay series. This flexibility allowed for its use at all sites (other than WIPP), facilitating comparisons between the three land-based disposal methods at the various sites.

L8-24

There is no need to integrate the modeling effort at WIPP with the RESRAD-OFFSITE analyses in the EIS. The modeling approaches used for these two sets of analyses address the unique circumstances of WIPP (a deep geologic repository) with the land-based disposal concepts. DOE believes that the analyses in the EIS are sufficient to inform decision-making and allow for the identification of a preferred alternative.

L8-25

Section 4.3.4.3 of the EIS has been revised to update the Sandia analysis and to provide a more complete description of the scenarios considered in the analysis.

L8-25

In the absence of specific commercial sites, DOE evaluated generic commercial facilities in the EIS to allow DOE to make a determination regarding disposal of GTCC LLRW and GTCC-like waste in such a facility. Should one or more commercial facilities be identified at a later time, DOE may conduct further NEPA reviews, as appropriate. See Section 12.1 of the EIS for the approach used in analyzing the generic sites.

L8-26

L8-26

DOE recognizes that modeling potential releases of radionuclides from the conceptual disposal sites far into the future approximates what might actually occur. Sufficient detail was included in these designs for use in the EIS analyses, consistent with the current stage of this process. Some of the input values may change in the future and could result in higher impacts (such as from increased precipitation at some sites due to climate change), while others could result in lower impacts (due to decreased precipitation).

A limited sensitivity analysis was conducted to obtain an idea of the uncertainties involved in the long-term post-closure human health estimates as described in Appendix E, Section E.6. The sensitivity analysis did include an analysis of the infiltration rate.

sensitivity analyses with varying climate-sensitive parameters (e.g., infiltration rates, erosion rates, water table fluctuations, etc).

18) DOE DEIS:
Section 5.5, Page 5-93: *"The inadvertent human intruder scenario is not evaluated quantitatively for Alternatives 3 to 5 because the NRC had already incorporated the inadvertent human intruder protection concept in its classification system of LLW as Class A, B, C, or GTCC. The NRC had already determined that for waste classified as GTCC, conventional near-surface land disposal is generally not protective of an inadvertent human intruder."*

NRC Comment:
10 CFR 61.42 states that the disposal facility must ensure the protection of inadvertent intruders. A quantitative evaluation as part of the licensing process would normally be required to demonstrate that this performance objective is being met and should be included in the FEIS.

19) DOE DEIS:
Chapters 6-11. Most of the federal sites considered in the DEIS are relatively large areas or regions. Because site factors can vary significantly, potential environmental impacts can also vary significantly.

NRC Comment:
Both the precision of the reference location being described as well as the site characteristics need to be improved.

In addition, the NRC has the following specific concerns about the "reference sites" associated with the alternatives selected by DOE for analysis in the DEIS:

- i. Nevada National Security Site: The reference location is near a dry lake bed. 10 CFR 61.50(a)(5) states that, "The disposal site must be generally well drained and free of areas of flooding or frequent ponding." If the precipitation rate increases in the future, this area might experience more flooding.
- ii. Idaho National Laboratory: The reference location appears to lie within the Big Lost River Flood Plain. 10 CFR 61.50(a)(5) states that, "Waste disposal shall not take place in a 100-year flood plain, coastal high-hazard area or wetland".
- iii. Hanford Site: The reference location appears to be an area where the Ringold Formation is absent, yet the parameter values cited in Table E-5 on pages E-30 through E-39 included the Ringold formation.
- iv. Savannah River Site: The reference location description is inconsistent throughout Chapter 10. The reference location shown in Fig. 10.1.1 and Fig. 10.1.2-2 is positioned to the northeast of the locations shown in the figures presented later in the chapter.

L8-26
(Cont.)

L8-27

L8-28

L8-27 DOE agrees that the GTCC waste disposal facility must ensure the protection of a hypothetical future inadvertent human intruder, especially for the wastes disposed of in an enhanced near surface trench. In the conceptual design for the trench disposal facility, the trenches are about 3 m (10 ft.) wide, 11 m (36 ft.) deep, and 100 m (330 ft.) long. The GTCC waste disposal placement is assumed to be about 5 to 10 m (16 to 33 ft.) below ground surface.

On the basis of the depth of waste disposal, DOE believes that the only reasonable potential for intrusion is from a future drilling event, such as drilling for a well. The likelihood of inadvertent intrusion from a drilling event would be very low for a GTCC waste trench disposal facility because of (1) the narrow width of the trench, (2) the use of intruder barriers, (3) the remoteness of the sites, (4) DOE's commitment to long-term institutional control, (5) site conditions such as the general lack of easily accessible resources and the great depth to groundwater, and (6) waste form stability. On the basis of these considerations, DOE did not include a quantitative analysis of inadvertent human intruder in the EIS. Further evaluations would be conducted in site-specific NEPA reviews in the future as warranted.

Potential inadvertent human intrusion into WIPP is addressed in the documentation supporting its current operations. Inclusion of GTCC LLRW and GTCC-like wastes with the wastes already planned for disposal in this repository would not be expected to change the results associated with this hypothetical intrusion event.

The FEIS is not intended to be used as part of the licensing process. A quantitative evaluation would be developed and included in any formal licensing request.

L8-28 The reference location is considered to have characteristics representative of the actual location that could be used for waste disposal purposes. Once a decision is made on specific site and method, a project specific analysis will be conducted. As stated in section 1.4.3 these evaluations are intended to serve as a starting point for each of the sites being considered. If a site or sites were selected for possible implementation of a land disposal method or methods, a follow-on site-specific NEPA evaluation and documentation, as appropriate, along with further optimization by a selection study, would be conducted to identify the location or locations within a given site that would be considered the best ones to accommodate the land disposal method(s).

As for the locations selected at the DOE sites –

- i) The GTCC reference location at the NNSS is located within Area 5 (Section 9.1). The reference location was selected primarily for evaluation purposes for this EIS. The actual location would be identified on the basis of follow on evaluations if and when it is decided to locate a land disposal facility at NNSS and would be in compliance with applicable federal, state, and DOE requirements.
- ii) The GTCC reference location at INL is not located within the 100-yr floodplain as shown in Section 7.2.3.1.
- iii) As discussed in Section 6.1.2.1.3, the Ringold formation is absent under the north and northeast parts of the 200 East Area at the Hanford Site. However, the GTCC reference location is south of the 200 East Area, and as discussed "Sediments include the upper Miocene to Pliocene Ringold Formation".
- iv) The reference location at the Savannah River Site in Figure 10.1.2-2 was adjusted to be consistent with Figure 10.1-1 and the other figures in the chapter.

U.S. Nuclear Regulatory Commission, Commenter ID No. L8 (cont'd)

20) DOE DEIS:
Section 4.3.1.2.1 (Page 4-52): In the DEIS, it was assumed that "only the two noisiest pieces of equipment would operate simultaneously in order to estimate noise levels."

NRC Comment:
The noise impacts analysis methodology presented are not complete. The referenced assumption is not presented as a part of the noise impacts analysis methodology described in Appendix C. Throughout Appendix C, the methodologies presented should be complete for each resource area including methodologies for analyzing noise impacts.

21) DOE DEIS:
Section E.1, Page E-3. DOE selected RESRAD-OFFSITE for use in this DEIS because of its ability to address radioactive decay and in growth of progeny radionuclides(s).

NRC Comment:
In the DEIS, it was not demonstrated that this is a significant process affecting the results. The potential disadvantages of RESRAD-OFFSITE include: no source term discretization for different designs and no container failure-release rate simulation. Diffusion, colloidal transport (corrosion products), and chemical forms were not modeled. The advantages and disadvantages of RESRAD-OFFSITE and other suitable codes should be addressed in the FEIS. Subsequently, the rationale for choosing a particular numerical code should be documented.

22) DOE DEIS:
Section E.2.7, Page E-10: "For purposes of analysis in this EIS, it is assumed that the engineered barriers would begin to degrade and fail 500 years after the closure of the disposal facility. This assumption is considered to be conservative (i.e., yield greater impacts) since the integrity of the engineered barriers is expected to last longer than 500 years. Many of the radionuclides in the GTCC LLRW and GTCC-like wastes have very long half-lives, so this 500-year time period would not result in an appreciable reduction in the total hazard associated with these wastes as a result of radioactive decay."

NRC Comment:
No infiltration for 500 years is a very significant technical assumption and is non-conservative. The infiltration rate is one of the most important parameter inputs and affects the impact analyses in a significant way. Although the expectations are that the engineered barrier will last for a very long time, an effective performance rate of 100 percent over a 500 year period has not yet been demonstrated. Relatively little information is provided on the covers to be used for the borehole and trench alternatives, and how they are expected to maintain their high rate of performance over the long-term. In addition, many of the radionuclides in the GTCC wastes have shorter half-lives so that a complete immobilization of 500 years could make a difference. Because the numerical simulation runs used to support the DEIS are deterministic, this assumption should be well-documented and include a sound technical basis.

L8-29 An adequate description of the methodologies for the resource areas considered in the EIS are presented in Section 5.2 and Appendix C. However, a more comprehensive description of the methodology used to evaluate noise impacts has been added to Appendix C.

L8-30 The modeling with the RESRAD-OFFSITE code utilized a specific feature of the code. That is, the leach rates of radionuclides were calculated separately and entered as input values to the code for subsequent transport modeling through the unsaturated zones and the groundwater aquifer. In the process of calculating leach rates to input into the RESRAD-OFFSITE code, the influence of the waste forms was considered. For activated metals, a constant release fraction was assumed, reflecting that the imbedded radionuclides in the metal would not dissolve in water until the metal was corroded. For Other Wastes, the release rates were calculated by considering the retardation provided by grouting; therefore, measured Kd values of radionuclides in cementitious materials as available in published literature were used for the release calculations. For sealed sources, because the waste forms can vary greatly, the release rates were calculated by assuming the waste forms would behave like soils and would not provide extra protection against leaching. The consideration for releases from activated metals was similar to a dissolution mechanism. The consideration for releases from sealed sources was similar to a surface rinse mechanism. The consideration for releases from Other Waste was similar to a surface rinse mechanism, but with non-zero Kds for the waste form.

The integrity of waste packages, waste containers, and barrier materials over time was not specifically modeled in the RESRAD-OFFSITE code. Their performance over time depends on the engineering designs of the disposal facility. Compared with the analysis time frame that extends to 10,000 (or possibly up to 100,000) years into the future, the integrity periods of the waste packages, waste containers, and barrier materials are relatively short. Therefore, in the GTCC EIS, the integrity periods are evaluated as one single parameter, which is assumed to be 500 years in the analysis. To study the influence of this assumption, a sensitivity analysis was conducted. This approach provides a perspective on performance for the long term.

The RESRAD-OFFSITE code, like all codes, has limitations. This code was selected for the GTCC EIS analysis because of its manageable number of input parameters, its comprehensive transport analysis for radionuclides in the unsaturated zones and saturated zone, and its flexibility in accepting radionuclide release rates calculated outside the RESRAD-OFFSITE framework. Furthermore, the RESRAD-OFFSITE code has been benchmarked with other computer codes. The results obtained from the code are considered to be technically sound estimates.

L8-31 DOE believes that 500 years is a realistic time period for the longevity of the types of engineering barriers assumed in the analyses. DOE believes the approach and the assumptions used in the EIS are reasonable for performing the comparative analysis of alternatives required by NEPA. For example, as discussed in Section E.2.2, the assumption of a 20% natural background infiltration rate after 500 years was based on a study at SRS (Phifer et al. 2007) that indicated that after 10,000 years, the closure cap at the F-area would still shed about 80% of the cumulative precipitation falling on it, with an effectiveness that would be greater before 10,000 years, then decrease very slowly after 10,000 years. The approach used in the EIS is more conservative than indicated by this study.

23) DOE DEIS:

Section E.2.2, Page E-11: "It is assumed that the water infiltration rate into the top of waste disposal facility would be zero for the first 500 years following closure, and then it would be 20% of the natural rate. This approach is meant to account for the reduction in the integrity of the cover and other engineering barriers as they begin to degrade and fail. This value was used for all future times extending to 10,000 years and longer (to obtain peak annual doses)."

NRC Comment:

Excluding 80 percent of the assumed infiltration from 500 years until 10,000 years after closure is a very significant and non-conservative assumption. Although the expectations are that the engineered barrier will last for a very long time, an effective performance rate of 80 percent over a 9600 year period has not yet been demonstrated. The infiltration rate is one of the most important parameter inputs and affects the impact analyses in a significant way. Because the numerical simulation runs used to support the DCIG are deterministic this assumption should be well-documented and include a sound technical basis.

24) DOE DEIS:

Section E.2.3, Page E-11: "The radionuclide release fraction for activated metals was taken to be $1.19 \times 10^{-1} \text{yr}$ in this analysis. This value is assumed to be reasonable for stainless-steel waste forms for the purpose of this comparative analysis on the basis of rates observed in corrosion experiments on stainless-steel coupons conducted at INEL (INL 2006; Adler-Filton et al. 2004). However, if the environmental conditions surrounding a specific waste were not controlled and were more conducive to causing corrosion, or if the metal making up a specific waste was more conducive to corrosion, the release fractions could be higher than those used here."

NRC Comment:

Important input values, such as waste form release fractions, should be supported by a strong technical basis and included as performance measures in the sensitivity analyses.

25) DOE DEIS:

Section E.2.3, Page E-12: "The solidification provided by mixing the Other Waste with a stabilizing agent would also reduce the leaching of radionuclides. However, the reduction in leaching might not last over a long period of time, when the nature of the stabilizing agent would change in the environment or the integrity of the stabilizing agent would deteriorate. In this analysis, the effectiveness of solidification in terms of leaching reduction is assumed to last for 500 years following facility closure; after that, the retention of radionuclides by the stabilizing agent is assumed to be the same as that of the surrounding backfill soils."

Section E.2.3, Page E-13: "Note that these values are based on specific assumptions regarding the type of cement used and would need to be reconsidered on the basis of the actual cements that could be used in a specific situation. Maintaining local reducing conditions can be an important consideration in designing the final system for specific wastes containing significant amounts of nickel, technetium, and uranium isotopes."

L8-32

DOE recognizes that modeling potential releases of radionuclides from the conceptual disposal sites far into the future approximates what might actually occur. Sufficient detail was included in these designs for use in the EIS analyses, consistent with the current stage of this process. DOE agrees that it is important to immobilize long-lived radionuclides such as Tc-99 and I-129 prior to disposal. Solidification techniques (e.g., use of grout) are expected to immobilize certain wastes in the GTCC LLRW and GTCC-like waste inventory. If needed, the actual stabilization methods used will depend, in part, on the waste stream, packaging, and final disposal facility design. DOE considers the assumptions used for waste form stability (i.e., activated metal corrosion and grout performance, see Appendix B) to be reasonable for purposes of the comparative analysis provided in the EIS.

L8-31
(Cont.)

L8-32

NRC Comment:
The DEIS's assumption of 500 year effectiveness of "Other Waste" solidification in terms of leaching is a very significant and non-conservative assumption. Although the expectations are that the cementitious material will remain with minimum cracks and virtually intact for a very long time, an effective performance rate of 100 percent over a 500 year period has not yet been demonstrated. Considering that the numerical simulation runs are deterministic, this assumption should have a well-documented and sound technical basis.

26) DOE DEIS:
Section E.8, Page E-70: Three variables were used to perform sensitivity analysis: increased infiltration rates after 500 years, longer periods of grout effectiveness, and greater distances to the receptor. No analyses were performed on infiltration occurring before 500 years on grout degrading before 500 years. The distance to the receptor is set by regulation and not an ideal parameter to use for sensitivity analyses. Although the draft EIS states that precipitation rates and soil distribution coefficients (K_d) are key input parameters, K_d s are not included in the sensitivity analyses.

NRC Comment:
The draft EIS does not demonstrate what the most significant parameters are nor does it provide insights on how contaminants move through the man-made and natural systems. Furthermore, sensitivity analyses should provide insight into how the disposal system works in concert with the environment and should identify those input parameters that are the major contributors to the variation or uncertainty in the calculated dose.

27) DOE DEIS:
Appendix E, Tables on RESRAD-OFFSITE input parameter values, Page E-30: "Choose a small value [erosion rate] so that the buried waste would remain covered within the time frame considered (i.e., would yield more conservative groundwater results because there would be no losses through surface runoff and erosion)." (page E-43)

NRC Comment:
This low erosion rate assumption lacks a technical basis and assumes that the engineered cover remains intact for a longer period of time. This assumption also excludes the possibility of waste being exposed at the surface by geomorphic processes.

28) DOE DEIS:
Appendix E, Table E-18: The evaluation of the WIPP vicinity site appears to use less conservative parameters than other site locations.

NRC Comment:
i. Similar distribution coefficients are used for all sites except WIPP vicinity site (see Table E-14). For example, while most sites have a zero K_d value for Iodine, the WIPP vicinity has 1; while most sites have a zero K_d value for Technetium, the WIPP vicinity has 0.1.

L8-32
(Cont.)

L8-33

L8-34

L8-35

L8-33 The stability of one of the waste forms (i.e., the grout material for Other Waste) was evaluated in the sensitivity analysis by varying the effective retardation period of the release of radionuclides. There are many parameters that could affect the modeling results that could be addressed in a sensitivity analysis. However, the essential effects of many of these parameters are the same (i.e., affecting when and how much water would enter the waste containers and contact the waste materials). In the GTCC EIS, both the influence of the water infiltration rate and the influence of when water would enter the waste containers on the dose results were addressed.

Modeling results can be very sensitive to some factors, such as the K_d for a given radionuclide. Care was taken to use average site values for such input parameters for comparison among alternatives. More extensive and detailed sensitivity analysis may need to be conducted during the implementation phase for a GTCC LLRW and GTCC-like waste disposal facility, based on more specific information on the engineering designs of the disposal facilities and their influence on the integrity of waste packages, waste containers, barrier materials, and the surrounding native soil (e.g., location-specific K_d values); however, the analysis provided in the EIS is sufficient to inform site and technology selection decisions.

L8-34 DOE recognizes that modeling potential releases of radionuclides from the conceptual disposal sites far into the future approximates what might actually occur. Sufficient detail was included in these designs for use in the EIS analyses, consistent with the current stage of this process and was applied across all alternatives. Some of the input values may change in the future and could result in higher impacts. Follow-on site-specific evaluations would also be performed based on a final decision for disposal of GTCC LLRW and GTCC-like waste.

L8-35 i) The K_d values selected for the WIPP Vicinity are generic values for sandy soils which, along with siltstones, are the primary components of the Dewey Lake Formation in which the groundwater aquifer of concern is located. In general, the generic K_d values for siltstones are greater than those for sandy soils. Therefore, the use of K_d values for sandy soils should be conservative because it would yield higher groundwater concentrations and subsequently, higher radiation doses.

ii) The water in the Dewey Lake Formation is a perched aquifer not considered fit for human consumption (see Section 4.2.3.2.2) although it is considered suitable for livestock consumption. Thus, the analysis using RESRAD-OFFSITE used a water source considered to be consistent with what would be used for human consumption.

iii) While the NRC Lea County EIS did not consider impacts from the WIPP site, the GTCC EIS does. Therefore, cumulative impacts are expected to be small from combined operations of the proposed GTCC disposal facility and the enrichment plant at the Lea County site.

U.S. Nuclear Regulatory Commission, Commenter ID No. L8 (cont'd)

- ii. Additional inconsistency exists in the unsaturated zone thickness. Page 4-29, lines 30-32, state that, "The saturated zone, which makes up the middle portion of the Dewey Lake, occurs at depths of about 50 to 80 m (164 to 262 ft)," while RESRAD-OFFSITE input value uses a depth of 153 m (Table E-13, page E-45).
- iii. Section 11.4 on page 11-35 incorrectly applies concluding results of the 2005 NRC Lea County EIS to the cumulative impacts for the WiPP Vicinity site. The Lea County site was much further away and did not consider impacts from the WiPP site.

L8-35
(Cont.)

U.S. Senator Jeff Merkley's Office, Commenter ID No. T122

Capital Reporting Company

9

1
2
3
4
5
6
7
8
9
10
11
12
13
14
15
16
17
18
19
20
21
22
23
24
25

MR. BROWN: Thank you.

Marc Siegel is next, with Senator Merkley's office, and Ken Niles will follow Marc.

MR. SIEGEL: Thank you. I'm Marc Siegel with the office of U.S. Senator Jeff Merkley. I would like to take this opportunity to say a few words on behalf of Oregon Senator Jeff Merkley.

Tonight is an important opportunity for the Pacific Northwest and Oregonians to let their voices be heard about the future of Hanford. The people of the Pacific Northwest have had the opportunity over the years to witness the complications of politics and bureaucracy in dealing with nuclear waste and the problems that are created when waste is poorly handled.

This region will be dealing with the reality of Hanford's nuclear waste legacy for many decades as we work to protect our communities and our environment. And that future shouldn't include transporting more dangerous waste through our communities for permanent storage at Hanford. The current timeline for

866.488.DEPO
www.CapitalReportingCompany.com

- T122-1 DOE's ROD 78 FR 75913 dated December 13, 2013, stated that DOE has deferred a decision on importing waste from other DOE sites (with limited exceptions as described in the Settlement Agreement with the State of Washington Department of Ecology) for disposal at Hanford at least until WTP is operational.
- T122-2 DOE is performing environmental restoration activities at the Hanford Site. The ongoing cleanup effort will continue.

T122-1
T122-2

J-693

January 2016

Capital Reporting Company

10

1 cleaning up the existing contamination at Hanford is
2 decades away, and we can't afford to start talk about
3 bringing more waste into the region.

4 Senator Merkley recognizes that there aren't
5 many good options that exist today for storing
6 nuclear waste, but given the history of waste storage
7 at Hanford and the contamination it has caused, he
8 does not believe Hanford is an appropriate location
9 for additional permanent waste storage. The
10 environmental health of the Pacific Northwest and the
11 Columbia River are closely linked to Hanford nuclear
12 site, and this region looks forward to a toxic-free
13 Hanford site.

14 Again, on behalf of Senator Merkley, thank you
15 for letting me say a few words about this issue.

T122-2
(Cont.)

T122-3

U.S. Senator Ron Wyden

For Immediate Release:
May 19, 2011

Contact: Tom Towslee (503) 326-7525

Wyden Statement at Public Hearing on Hanford Cleanup

Portland OR – Senator Ron Wyden (D-Ore.) issued the following statement (through staff) at today's public hearing in Portland on the U.S. Department of Energy's draft environmental impact statement for cleaning up storage tanks and managing waste at the Hanford Nuclear Reservation:

"The U.S. Department of Energy is once again coming to Oregon to solicit public comment on yet another version of its misguided effort to solve the nuclear waste problem by bringing more hazardous material to Hanford. I have opposed using the Hanford Nuclear Reservation as a dumping ground for the nation's nuclear waste every time the Department of Energy brings it up. I oppose it again today. The stated goal of DOE is to clean up Hanford, yet it continues to propose adding more waste and wasting more money on studies to bring in more hazardous waste."

"DOE has been working on Hanford cleanup for more than 20 years, and at best, they probably have another 35 years to go. I think it's time to point out the obvious -- Hanford cannot be cleaned up by adding more waste. Hanford, with its 40 miles of unlined trenches, sits along 50 miles of the Columbia River, which is the lifeline of the Pacific Northwest economy. That is a formula for disaster. Bringing more radioactive waste from across the country to Hanford is only going to increase the odds of that disaster or, at worst, make it inevitable."

"It is not just the disposal of waste at Hanford that puts the public at risk. It's also transporting it on public highways. When a semi truck loaded with radioactive waste jackknifed on I-84 near La Grande in December 2008, it brought into sharp focus the serious questions about whether the Department of Energy can adequately protect the environment and the safety of other travelers and communities. The proposal to bring Greater Than Class C waste (GTCC), which could add more than 12,000 more truckloads of radioactive waste on its way to Hanford will only add to that risk."

"As those of us living downstream from Hanford know only too well, the United States faces a daunting challenge of figuring out what to do with nuclear waste from nuclear weapons and from our existing generation of nuclear power plants. But as we also know, bringing more waste to Hanford, at a time when DOE is missing almost every major milestone in cleaning up that site, does not inspire confidence. I have said many times, 'Hanford should not be turned into a 'national sacrifice zone.' I am not satisfied with the progress to date, I am absolutely opposed to bringing more waste to Hanford, and I am not supportive of adding more truckloads of waste going thru the Columbia River Gorge to take it there."

###

L300-1 DOE's ROD 78 FR 75913 dated December 13, 2013, stated that DOE has deferred a decision on importing waste from other DOE sites (with limited exceptions as described in the Settlement Agreement with the State of Washington Department of Ecology) for disposal at Hanford at least until WTP is operational.

However, regardless of where the GTCC waste disposal facility is ultimately located, a relatively small amount of GTCC LLRW and GTCC-like wastes may be transported through the Columbia River Gorge on their way to the disposal facility. The waste would be generated within the states of Oregon and Washington and would include actinide sealed sources and Cs-137 irradiators from local medical institutions, research facilities, universities, and other NRC and Agreement State licensees.

DOE is performing environmental restoration activities at the Hanford Site. The ongoing cleanup effort will continue.

L300-2 Refer to the L300-1 response regarding a discussion on ongoing cleanup activities at the Hanford site.

L300-3 Refer to the L300-1 response regarding a discussion on the importation of wastes from other DOE sites.

If DOE decides to implement its preferred alternative for the TC&WM EIS, GTCC LLRW and GTCC-like wastes would not be shipped through the Columbia River Gorge for disposal at the Hanford Site until the waste treatment plant is operational. However, regardless of where the GTCC waste disposal facility is ultimately located, a relatively small amount of GTCC LLRW and GTCC-like wastes may be transported through the Columbia River Gorge on their way to the disposal facility. The waste would be generated within the states of Oregon and Washington and would include actinide sealed sources and Cs-137 irradiators from local medical institutions, research facilities, universities, and other NRC and Agreement State licensees.

The transportation of radioactive waste will meet or exceed DOT and NRC regulatory requirements that promote the protection of human health and the environment. These regulations include requirements for radioactive materials packaging, marking, labeling, placarding, shipping papers, and highway routing. The waste shipments would be on preferred routes, which are interstate highways or alternative routes designated by a state routing agency in accordance with DOT regulations (49 CFR Part 397, Subpart D). The GTCC LLRW and GTCC-like wastes would be shipped in approved waste packages and transportation casks. The robust nature of these casks limits the potential release of radioactive and chemically hazardous material under the severest of accident conditions. It is unlikely that the transportation of GTCC LLRW and GTCC-like wastes to any of the alternative sites evaluated in the EIS would cause an additional fatality as a result of radiation from either incident-free transportation or postulated transportation accidents.

The EIS evaluated the transportation impacts from the shipments that would be required to dispose of all of the GTCC LLRW and GTCC-like wastes at the various disposal sites. The EIS addressed the collective population risks during routine conditions and accidents, the radiological risks to the highest exposed individuals during routine conditions, and the consequences to individuals and populations as a result of transportation accidents, including those that could release radioactive or hazardous chemical materials. About 12,600 shipments would be required to transport all of the GTCC LLRW and GTCC-like wastes to the Hanford Site for disposal. This would result in about 50 million km (30 million mi) of highway travel, with no expected LCFs. One fatality directly related to an accident might occur (see Section 6.2.9.1).

L300-4 See response to L300-3.

UU Ministry for Earth, Commenter ID No. W493

From: gtcciswebmaster@anl.gov
Sent: Sunday, June 26, 2011 12:18 PM
To: gtcciswebmaster@anl.gov
Subject: Receipt: Greater-Than-Class-C Low-Level Radioactive Waste EIS Comment GTCC10493

Thank you for your comment, Sabrina Harle.

The comment tracking number that has been assigned to your comment is GTCC10493. Please refer to the comment tracking number in all correspondence relating to this comment.

Comment Date: June 26, 2011 12:18:14PM CDT

Greater-Than-Class-C Low-Level Radioactive Waste EIS Draft Comment: GTCC10493

First Name: Sabrina
 Middle Initial: L
 Last Name: Harle
 Organization: UU Ministry for Earth
 Address: 1034 SW 13th Avenue
 City: Portland
 State: OR
 Zip: 97205-1705
 Country: USA
 Email: sabbylou@gmail.com
 Privacy Preference: Don't withhold name or address from public record

Comment Submitted:

Please do not allow any more waste to be dumped at Hanford. We cannot afford to have such deadly poison on our Oregon roads, leaking into our ground water supply, contaminating the Columbia River Gorge or the risk to the thousands of drivers in Oregon, should an accident occur.

It's time to CLEAN UP Hanford, not add to the waste dumped there. Real clean up efforts can only start when we stop producing such waste, and start finding safer ways of disposing the waste we do have... in DEEP underground tanks, fit for such nastiness. bringing in truckloads from elsewhere is not keeping our state safe.

I implore you, pleas do NOT allow this to happen.

Thank you.

Very seriously concerned,

Sabrina Louise

Questions about submitting comments over the Web? Contact us at: gtcciswebmaster@anl.gov or call the Greater-Than-Class-C Low-Level Radioactive Waste EIS Webmaster at (630) 252-5705.

W493-1 DOE's ROD 78 FR 75913 dated December 13, 2013, stated that DOE has deferred a decision on importing waste from other DOE sites (with limited exceptions as described in the Settlement Agreement with the State of Washington Department of Ecology) for disposal at Hanford at least until WTP is operational.

However, regardless of where the GTCC waste disposal facility is ultimately located, a relatively small amount of GTCC LLRW and GTCC-like wastes may be transported through the Columbia River Gorge on their way to the disposal facility. The waste would be generated within the states of Oregon and Washington and would include actinide sealed sources and Cs-137 irradiators from local medical institutions, research facilities, universities, and other NRC and Agreement State licensees.

The transportation of radioactive waste will meet or exceed DOT and NRC regulatory requirements that promote the protection of human health and the environment. These regulations include requirements for radioactive materials packaging, marking, labeling, placarding, shipping papers, and highway routing. The waste shipments would be on preferred routes, which are interstate highways or alternative routes designated by a state routing agency in accordance with DOT regulations (49 CFR Part 397, Subpart D). The GTCC LLRW and GTCC-like wastes would be shipped in approved waste packages and transportation casks. The robust nature of these casks limits the potential release of radioactive and chemically hazardous material under the severest of accident conditions. It is unlikely that the transportation of GTCC LLRW and GTCC-like wastes to any of the alternative sites evaluated in the EIS would cause an additional fatality as a result of radiation from either incident-free transportation or postulated transportation accidents.

The EIS evaluated the transportation impacts from the shipments that would be required to dispose of all of the GTCC LLRW and GTCC-like wastes at the various disposal sites. The EIS addressed the collective population risks during routine conditions and accidents, the radiological risks to the highest exposed individuals during routine conditions, and the consequences to individuals and populations as a result of transportation accidents, including those that could release radioactive or hazardous chemical materials. About 12,600 shipments would be required to transport all of the GTCC LLRW and GTCC-like wastes to the Hanford Site for disposal. This would result in about 50 million km (30 million mi) of highway travel, with no expected LCFs. One fatality directly related to an accident might occur (see Section 6.2.9.1).

DOE's standard operating procedure for transportation of radioactive waste is developed and continually revised to ensure that the utmost protection of public health and the environment is achieved and that the risk of a traffic accident is minimized. For example, DOE has established a comprehensive emergency management program (Transportation Emergency Preparedness Program or TEPP) that provides detailed, hazard specific planning and preparedness measures to minimize the health impacts from accidents involving loss of control over radioactive material or toxic chemicals. DOE's TEPP was established to ensure that its contractors and state, tribal, and local emergency responders are prepared to respond promptly, efficiently, and effectively to accidents involving DOE shipments of radioactive materials.

If an accident that involved a release of radioactive material to the environment occurred, it would be remediated promptly in accordance with these procedures. These measures would help DOE minimize and mitigate any impacts on the environment.

W493-2 DOE is performing environmental restoration activities at the Hanford Site. The ongoing cleanup effort will continue.

- W493-3 Stopping the generation of nuclear waste is outside the scope of the GTCC EIS, the scope of which is to evaluate disposal alternatives to enable the selection of a safe alternative or alternatives for the disposal of GTCC LLRW and GTCC-like wastes. The GTCC EIS evaluates the range of reasonable alternatives for the disposal of GTCC LLRW and GTCC-like wastes in compliance with the requirements specified in NEPA, the Low-Level Radioactive Waste Policy Amendments Act (P.L. 99-240), and Section 631 of the Energy Policy Act of 2005 (P.L. 109-58). The GTCC EIS evaluates the potential environmental impacts of the proposed disposal alternatives for GTCC LLRW and GTCC-like wastes. Based on the evaluation, DOE has determined that there are safe and secure alternatives for the disposal of GTCC LLRW and GTCC-like wastes. The GTCC EIS provides information that supports this determination, and, as discussed in Section 1.1, Purpose and Need for Agency Action, DOE is responsible for the disposal of GTCC LLRW and GTCC-like wastes.
- W493-4 The EIS considered the range of reasonable alternatives for disposal of the inventory of GTCC LLRW and GTCC-like wastes identified for inclusion in these analyses. DOE has included analysis of generic commercial facilities in the event that a facility could become available in the future. In that case, before making a decision to use a commercial facility, DOE would conduct further NEPA reviews, as appropriate.
- W493-5 DOE's ROD 78 FR 75913 dated December 13, 2013, stated that DOE has deferred a decision on importing waste from other DOE sites (with limited exceptions as described in the Settlement Agreement with the State of Washington Department of Ecology) for disposal at Hanford at least until WTP is operational.

Valley Interfaith Project, Commenter ID No. W267

From: gtcciswebmaster@anl.gov
Sent: Thursday, June 16, 2011 3:06 PM
To: gtcciswebmaster@anl.gov
Subject: Receipt: Greater-Than-Class-C Low-Level Radioactive Waste EIS Comment GTCC10267

Thank you for your comment, Patricia Orlinski.

The comment tracking number that has been assigned to your comment is GTCC10267. Please refer to the comment tracking number in all correspondence relating to this comment.

Comment Date: June 16, 2011 03:05:29PM CDT

Greater-Than-Class-C Low-Level Radioactive Waste EIS Draft Comment: GTCC10267

First Name: Patricia
Last Name: Orlinski
Organization: Valley Interfaith Project
Address: 10511 W. Kingswood Circle
Address 2: na
City: Sun City
State: AZ
Zip: 85351-2246
Country: USA
Email: bikerpat@mindspring.com
Privacy Preference: Don't withhold name or address from public record

Comment Submitted:

Please remove the Hanford Nuclear Reservation from the U.S. Department of Energy's list of candidate sites for a permanent nuclear waste dump site to store radioactive materials coming from across the United States. Hanford is the wrong place to transport and dispose of more highly dangerous radioactive material.

W267-1

Hanford is already the most contaminated site in the Western Hemisphere and the Department of Energy is already engaged in one of the largest and most complex cleanup projects in U.S. history at Hanford. The number one priority should be to stop waste from leaking into the Columbia River and clean up the existing waste at Hanford. No new nuclear waste should be stored at Hanford.

W267-2

Even more than this, we must discontinue the use of nuclear power. There are other choices that are not as hazardous to all living things. Certainly bringing waste from nuclear sites anywhere near a waterway like the Columbia River is reckless and irresponsible.

W267-3

Questions about submitting comments over the Web? Contact us at: gtcciswebmaster@anl.gov or call the Greater-Than-Class-C Low-Level Radioactive Waste EIS Webmaster at (630) 252-5705.

- W267-1 DOE's ROD 78 FR 75913 dated December 13, 2013, stated that DOE has deferred a decision on importing waste from other DOE sites (with limited exceptions as described in the Settlement Agreement with the State of Washington Department of Ecology) for disposal at Hanford at least until WTP is operational.
- W267-2 DOE is performing environmental restoration activities at the Hanford Site. The ongoing cleanup effort will continue.
- W267-3 Stopping the generation of nuclear waste is outside the scope of the GTCC EIS, the scope of which is to evaluate disposal alternatives to enable the selection of a safe alternative or alternatives for the disposal of GTCC LLRW and GTCC-like wastes. The GTCC EIS evaluates the range of reasonable alternatives for the disposal of GTCC LLRW and GTCC-like wastes in compliance with the requirements specified in NEPA, the Low-Level Radioactive Waste Policy Amendments Act (P.L. 99-240), and Section 631 of the Energy Policy Act of 2005 (P.L. 109-58). The GTCC EIS evaluates the potential environmental impacts of the proposed disposal alternatives for GTCC LLRW and GTCC-like wastes. Based on the evaluation, DOE has determined that there are safe and secure alternatives for the disposal of GTCC LLRW and GTCC-like wastes. The GTCC EIS provides information that supports this determination, and, as discussed in Section 1.1, Purpose and Need for Agency Action, DOE is responsible for the disposal of GTCC LLRW and GTCC-like wastes.

Valley Interfaith Project, Commenter ID No. W418

From: gtceiswebmaster@anl.gov
Sent: Friday, June 24, 2011 12:10 AM
To: gtceiswebmaster@anl.gov
Subject: Receipt: Greater-Than-Class-C Low-Level Radioactive Waste EIS Comment GTCC10418

Thank you for your comment, Patricia Orlinski.

The comment tracking number that has been assigned to your comment is GTCC10418. Please refer to the comment tracking number in all correspondence relating to this comment.

Comment Date: June 24, 2011 12:10:21AM CDT

Greater-Than-Class-C Low-Level Radioactive Waste EIS Draft Comment: GTCC10418

First Name: Patricia
Last Name: Orlinski
Organization: Valley Interfaith Project
Address: 10511 W. Kingswood Circle
Address 2: na
Address 3: 10511 W. Kingswood Circle
City: Sun City
State: AZ
Zip: 85351-2246
Country: USA
Email: bikerpat@mindspring.com
Privacy Preference: Don't withhold name or address from public record

Comment Submitted:

Nuclear waste is the greatest problem related to the use of nuclear power. There is no way to eliminate the waste created by nuclear fusion. No one wants to have the waste in their "back yard," yet the waste is there from 100 nuclear plants, and will continue to have waste from these plants. We must stop using poison generating forms of electric power. We have other choices and of energy that do not leave these toxic elements behind.

Questions about submitting comments over the Web? Contact us at: gtceiswebmaster@anl.gov or call the Greater-Than-Class-C Low-Level Radioactive Waste EIS Webmaster at (630) 252-5705.

W418-1 Stopping the generation of nuclear waste is outside the scope of the GTCC EIS, the scope of which is to evaluate disposal alternatives to enable the selection of a safe alternative or alternatives for the disposal of GTCC LLRW and GTCC-like wastes. The GTCC EIS evaluates the range of reasonable alternatives for the disposal of GTCC LLRW and GTCC-like wastes in compliance with the requirements specified in NEPA, the Low-Level Radioactive Waste Policy Amendments Act (P.L. 99-240), and Section 631 of the Energy Policy Act of 2005 (P.L. 109-58). The GTCC EIS evaluates the potential environmental impacts of the proposed disposal alternatives for GTCC LLRW and GTCC-like wastes. Based on the evaluation, DOE has determined that there are safe and secure alternatives for the disposal of GTCC LLRW and GTCC-like wastes. The GTCC EIS provides information that supports this determination, and, as discussed in Section 1.1, Purpose and Need for Agency Action, DOE is responsible for the disposal of GTCC LLRW and GTCC-like wastes.

W418-1

Washington State, Department of Health, Commenter ID No. T12

Capital Reporting Company

5

- 1
- 2
- 3
- 4
- 5
- 6
- 7
- 8
- 9
- 10
- 11
- 12
- 13
- 14
- 15
- 16
- 17
- 18
- 19
- 20
- 21
- 22

MR. MURPHY: Thank you. Sean Murphy, Washington State Department of Health.
Short message to the DOE. We hope you guys work hard on this. There's licensees in the State of Washington that are the caretakers of this material, and it's just sitting there waiting for something to happen to it. So please continue your good work on the EIS and select something. Thanks.

T12-1

T12-1 Comment noted.

Waste Control Specialists, LLC, Commenter ID No. E41

From: Jeff Skov <jskov@VALHINET>
Sent: Monday, June 27, 2011 3:27 PM
To: gtceis@anl.gov
Cc: Scott Kirk
Subject: WCS Comments on DOE's DEIS for Disposal of GTCC LLRW and GTCC-Like Waste
Attachments: WCS_GTCC_Comment_Ltr_06_24_11_FINAL.pdf

Waste Control Specialists LLC (WCS) is pleased to submit the attached comments on the U.S. Department of Energy's (DOE's) Draft Environmental Impact Statement (DEIS) for the disposal of Greater-Than-Class C (GTCC) low-level radioactive waste and GTCC-like waste as requested in the Department's Federal Register Notice of February 25, 2011, 76 Fed. Reg. 10574.

A hard-copy is being sent via registered mail this afternoon.

Please contact me if you have questions or desire additional information.

Jeffrey M. Skov
Vice President, Licensing and Regulatory Affairs
Waste Control Specialists LLC
5430 LBJ Freeway, Suite 1700
Dallas, Texas 75240

972-448-1483 (office)
972-448-1419 (fax)
jskov@valhinet.net

The information transmitted is intended only for the person or entity to which it is addressed and may contain confidential and/or privileged material. Any review, retransmission, dissemination or other use of, or taking of any action in reliance upon, this information by persons or entities other than the intended recipient is prohibited. If you received this in error, please contact the sender and delete the material from any computer.

received
JUN 27 2011

**WASTE CONTROL
SPECIALISTS LLC**

June 27, 2011

Mr. Arnold M. Edelman
EIS Document Manager
U.S. Department of Energy
GTCC EIS, Cloverleaf Building, EM-43
1000 Independence Avenue, SW
Washington, DC 20585

- References:
- (1) Texas Radioactive Material License No. R04100, Amendment 07
 - (2) Federal Register, U.S. Department of Energy, *Notice of Availability of the Draft Environmental Impact Statement for the Disposal of Greater-Than-Class C (GTCC) Low-Level Radioactive Waste and GTCC-Like Waste, and Notice of Public Hearings*, Vol. 76, No. 38, pp. 10574-10577, February 25, 2011
 - (3) Federal Register, U.S. Nuclear Regulatory Commission, *Public Workshop to Discuss Low-Level Radioactive Waste Management*, Vol. 76, No. 39, pp. 10810-10811, February 28, 2011
 - (4) Federal Register, U.S. Nuclear Regulatory Commission, *Notice of Public Meeting and Request for Comments on the Potential Revision of the Branch Technical Position on Concentration Averaging and Encapsulation*, Vol. 76, No. 17, pp. 4739-4741, January 26, 2011

Subject: Comments from Waste Control Specialists LLC Regarding the U.S. Department of Energy's Draft Environmental Impact Statement for the Disposal of Greater-Than-Class C Low-Level Radioactive Waste and GTCC-Like Waste

Dear Mr. Edelman:

In accordance with Reference 2, Waste Control Specialists LLC (WCS) is pleased to provide comments on the subject Draft Environmental Impact Statement (DEIS), which provides an analysis of options and alternatives for disposing of Greater-Than-Class C (GTCC) and GTCC-like Low-Level Radioactive Waste (LLW). As discussed in the

Corporate
5430 LBJ Freeway, Ste. 1700
Three Lincoln Centre
Dallas, TX 75240
Ph. 972.715.9800
Fx. 972.448.1419

Facility
P.O. Box 1129
Andrews, TX 79714
Ph. 888.789.2783
Fx. 505-394-3427

Waste Control Specialists, LLC, Commenter ID No. E41 (cont'd)

Arnold M. Edelman
June 27, 2011
Page 2 of 5

DEIS, WCS is currently storing certain GTCC waste at our licensed and secure facility located in Andrews County, Texas. In addition, WCS is currently constructing an enhanced near-surface shallow land disposal facility that is licensed to dispose of Class A, B, and C LLW. Once operational, this facility will be authorized to serve the disposal needs of generators in the Texas Compact (Texas and Vermont, including non-regional waste approved for importation) and the U.S. Department of Energy (DOE).

ALTERNATIVES CONSIDERED

DOE is proposing to construct and operate a new facility or facilities, or use an existing facility or facilities, for the disposal of GTCC LLW and DOE GTCC-like waste. The disposal methods that were evaluated to assess the long-term adequacy of such a facility include burial in a geologic repository, an intermediate-depth borehole facility, an enhanced near-surface trench, and an above-grade vault. The locations for disposal include seven facilities owned by DOE, as well as generic commercial sites in four regions of the U.S. DOE also analyzed a "No Action Alternative" as part of this DEIS.

DOE did not specify a preferred alternative, but identified factors that would be considered to select a preferred alternative or alternatives for inclusion in the Final EIS. The factors listed include the waste type characteristics, such as the radionuclide inventory and waste form stability, disposal method considerations (including protection of an inadvertent intruder), and disposal location considerations.

DISCUSSION

WCS will only comment on two of the alternatives presented in the DEIS: Alternative 1, the No Action Alternative, and Alternative 4, Enhanced Near-Surface Trench disposal.

Alternative 1: WCS believes that the "No Action Alternative" of continuing to store GTCC and GTCC-like LLW across the U.S. is not a long-term solution. These types of radioactive wastes will continue to pose not only a radiological risk to public safety and the environment, but also to national security. WCS believes that the best long-term solution is permanent disposal of this waste in the geologic repository located at the Waste Isolation Pilot Plant located near Carlsbad, New Mexico (Alternative 2), an intermediate borehole facility (Alternative 3), or an enhanced near-surface disposal facility (Alternative 4), or a combination thereof.

Alternative 4: WCS has licensed (see Reference 1) and is currently constructing the nation's first disposal facility¹ developed under the Low-Level Radioactive Waste Policy Act of 1980, as amended in 1985. The characteristics of the site's geology and climate, a state-of-the-art engineering design, and stringent regulatory requirements will ensure that public health and the environment will be protected for tens of thousands of years.

¹ WCS is also the only facility authorized to dispose of Class A, B, and C LLW mixed with hazardous waste regulated under the Resource Conservation and Recovery Act in the U.S.

E41-1 DOE agrees that use of a geologic repository would be a protective and safe method for the disposal of the entire inventory of GTCC LLRW and GTCC-like wastes. The GTCC EIS evaluation for the WIPP geologic repository alternative supports this statement. However, the degree of waste isolation provided by a geologic repository may not be necessary for all of the GTCC LLRW and GTCC-like wastes evaluated in the GTCC EIS.

The GTCC EIS evaluation indicates that certain wastes (e.g., those containing short-lived radionuclides such as Cs-137 irradiators) could be safely disposed of in properly designed land disposal facilities at sites with suitable characteristics, such as low precipitation rates, high soil distribution coefficients, and sufficient depths to groundwater. Based on the GTCC EIS evaluation, land disposal facilities located in arid climates (e.g., NNSS and WIPP Vicinity) would isolate radionuclides for a sufficient period of time to allow for significant radioactive decay to occur.

E41-2 Site characteristics similar to those found at WCS (e.g., soil, geology, precipitation) were considered in the EIS analyses. The major considerations for developing a preferred alternative are presented in Section 2.9.

E41-1

E41-2

Waste Control Specialists, LLC, Commenter ID No. E41 (cont'd)

Arnold M. Edelman
June 27, 2011
Page 3 of 5

Under Alternative 4 (Enhanced Near-Surface Trench), DOE analyzed the performance of disposal of GTCC LLW and DOE GTCC-like waste in a near-surface trench located in the U.S. Nuclear Regulatory Commission's (NRC's) Regions 2 and 4. The design of the disposal facility analyzed included trenches approximately 3-m (10-ft) wide, 11-m (36-ft) deep, and 100-m (33-ft) long. The GTCC waste disposal placement was estimated to be 5 to 10 m (15 to 30 ft) below grade surface. Use of a reinforced concrete layer was included as an engineered barrier that would be placed on top of the waste and backfill would be added to raise the trench elevation to grade. The reinforced concrete layer would serve as shielding to reduce the levels of radiation during facility operations and to deter inadvertent drilling during the post-closure period.

Many of the design features described in Alternative 4 are similar to those that are being used to construct both the Texas Compact Waste Disposal Facility (CWF) and the Federal Facility Waste Disposal Facility (FWF) in Andrews County, Texas.

For example, the CWF and FWF design features include placing waste inside of reinforced concrete canisters, a one-foot concrete base, geomembrane liners, leachate collection system, a 3-ft compacted clay liner, and a 40-foot cover system that will provide additional barriers to prevent inadvertent intrusion into the waste. Class A, B, and C LLW will be placed at a depth of at least 10 m (30 ft) and backfill will be used to raise elevation back to surface grade.

Pursuant to Title 30 of the Texas Administrative Code (TAC), Section 336.709, *Technical and Environmental Analyses*, WCS was required to demonstrate that the site characteristics and design were suitable to protect the general population from releases of radioactivity for a minimum period of 1,000 years after closure or the period when peak dose occurs, whichever is longer. The analysis that was approved by the Texas Commission on Environmental Quality successfully demonstrated that a peak dose of less than 10 millirems per year was estimated to occur at approximately 36,000 years into the future.

Based on the geological characteristics and engineering design of our enhanced near-surface disposal facility, WCS believes that Alternative 4 will provide a viable solution for the disposition of some types of GTCC LLW and DOE GTCC-like waste. Therefore, WCS encourages the DOE to evaluate and consider WCS' site characteristics and the design of its enhanced near-surface disposal facility when determining the preferred alternative in the Final EIS.

Continued Coordination with the U.S. Nuclear Regulatory Commission

WCS commends DOE for including NRC as a commenting agency on this EIS and for coordinating with NRC to hold a public workshop (Reference 3) to discuss low-level radioactive waste management issues. The NRC's role is extremely important in the process since they have been designated as the regulatory authority for a GTCC disposal

E41-3 Comment noted. DOE agrees that the willingness of the host community is an important factor when selecting the preferred alternative.

E41-2
(Cont.)

E41-3

Waste Control Specialists, LLC, Commenter ID No. E41 (cont'd)

Arnold M. Edelman
June 27, 2011
Page 4 of 5

facility. At the workshop, DOE, NRC, and other stakeholders discussed possible changes to Title 10 of the U.S. Code of Federal Regulations, Part 61 (10 CFR 61), *Licensing Requirements for Land Disposal of Radioactive Waste*. WCS believes that these early discussions were very helpful to identify potential technical issues that could affect the manner in which Class A, B, C, GTCC, and DOE GTCC-like wastes are regulated.

NRC promulgated 10 CFR 61 as a final rule in 1982. This regulation established the framework to ensure that occupational workers, the general public, and the environment would be protected against potential releases of radioactive materials from facilities licensed to dispose of LLW. It also established the numerical concentrations that would be used to define Class A, B, C, and GTCC LLW.

Recently NRC has initiated efforts to revise 10 CFR 61. Some stakeholders have encouraged NRC to abandon the waste classification defined in 10 CFR 61 completely and bring the nation's LLW management system into alignment with that established by the International Atomic Energy Agency. Other stakeholders have suggested that NRC revise the classification tables in 10 CFR 61.55 using more recent and up-to-date biokinetic and dosimetric models developed by the International Commission on Radiological Protection. In either case, the boundary could shift relative to whether the responsibility for the disposal of an existing waste stream rests with the States (as is currently the case for commercial Class A, B, and C LLW) or with the federal government (as is currently the case for GTCC waste). That is, the ramifications of such a shift could result in transferring the responsibility for the disposal of certain, more problematic wastes from the States to the federal government.

In the NRC's recently issued preliminary proposed rule on site-specific analyses for demonstrating compliance with 10 CFR 61 Subpart C performance objectives (see 76 Fed. Reg. 24831 dated May 3, 2011), they propose a 20,000 year period of performance. This timeframe is longer than the initial period of performance for a high-level waste repository. A well designed and sited LLW repository, such as the WCS facility, could meet the same performance standards as required for high-level waste, including the longer term second period of performance, and thus be equally protective of public health and safety and the environment for ultimate disposition of GTCC waste.

NRC is also revising the 1995 Branch Technical Position on Concentration Averaging and Encapsulation (BTP). This guidance was initially issued to the licensed community to address the manner in which 10 CFR 61 should be interpreted and implemented across the U.S. The BTP provided direction for determining whether certain types of waste, such as sealed sources, could be classified as Class C LLW suitable for disposal licensed under 10 CFR 61. On the other hand, licensees were encouraged to classify radioactive wastes as GTCC LLW if the concentrations exceeded those specified in the BTP. Those waste streams, classified as GTCC, were not generally suitable for shallow land disposal and would thereby become the responsibility of the federal government.

E41-3
(Cont.)

Waste Control Specialists, LLC, Commenter ID No. E41 (cont'd)

Arnold M. Edelman
June 27, 2011
Page 5 of 5

WCS encourages DOE to continue the coordinating efforts to revise both 10 CFR 61 and the BTP as a means to determine which waste streams could be safely disposed of at traditional shallow land disposal facilities or by any one (or combination thereof) of the disposal alternatives analyzed as part of the Final EIS.

Site Selection Should Favor Strong Community Support

In addition to the impacts to human health and the environment, selection of the preferred alternative should weigh heavily on the level of stakeholder support provided by regional and local communities that are willing to host such a disposal facility. The successful licensing of the WCS disposal facilities in Andrews County, Texas, would not have occurred without the tremendous support from the regional and local communities. The stakeholders supporting the licensing efforts are familiar with both the potential risk and benefits that the nuclear industry brings to our communities located across the Permian Basin of western Texas and southeastern New Mexico.

In closing, WCS commends DOE for achieving this important milestone that is urgently needed not only for public safety and environmental protection, but for reasons of national security. WCS requests that a copy of all correspondence regarding this matter be submitted directly to my attention by fax (575-394-3427) or email (skirk@valhi.net).

Thank you for your consideration of this submission.

Sincerely,



J. Scott Kirk, CHP
Vice President, Licensing, Corporate Compliance & Radiation Safety Officer

cc: Rodney Baltzer, WCS
William P. Dornsife, P.E., WCS
Jeffrey M. Skov, WCS
Linda Beach, P.E., WCS
Tom Jones, WCS

E41-3
(Cont.)

West Valley Citizen Task Force, Commenter ID No. L275



THE WEST VALLEY CITIZEN TASK FORCE

May 6, 2011

Greater-Than-Class C Low-Level Radioactive Waste EIS
Office of Technical and Regulatory Support (EM-43)
U.S. Department of Energy
1000 Independence Avenue, SW.
Washington, DC 20585-0119



MAY 23 2011

RE: Comments of the West Valley Citizen Task Force on the
Greater-Than-Class C Low-Level Radioactive Waste EIS

The West Valley Citizen Task Force (CTF) urges the Department of Energy (DOE) and the United States Congress to act in a timely manner in the identification of a preferred alternative for the disposal of Greater-Than-Class C (GTCC) Low Level Radioactive Waste and GTCC-like waste. The CTF is encouraged by the approach and time line that the Department of Energy is pursuing in their accumulation and analysis of public comments on this Draft EIS. We find it distressing that, while the West Valley site does have GTCC and GTCC-like waste, (Table S-2, pg. S-19) the closest public hearing will be in Washington, DC. We also question the exclusion of the Seneca Nation as a participating tribal government (S.1.5, pgs. 5 & 7).

There are several factors that we believe are of significant importance when identifying a preferred alternative. The CTF supports the complete deactivation and decommissioning of the West Valley Demonstration Project site. It is our belief that all waste should be removed and the site should be available for public reuse. The removal of GTCC LLRW and GTCC-like waste will be another step in that direction.

The CTF urges the DOE to carefully examine the comments received from the public and stakeholders. We also believe that cost should not be the driving factor in the preferred alternative decision. The CTF urges that an independent cost analysis be conducted before an alternative is chosen. Public safety, average dose, and long term impact should be weighed more heavily than any cost factor. We also suggest that all relevant studies be completed prior to recommending an alternative to the Congress. With the recent devastation in Japan due to seismic activity, we urge that all alternatives and sites be subject to the most rigid of standards.

West Valley Citizen Task Force
c/o The Logue Group
PO Box 270270 - West Hartford, CT 06127
860-521-9122

L275-1 DOE's goal with regard to its public participation process is to be able to disseminate the information to the public so that input from the interested public can be obtained to inform the Final EIS. To this end, nine public hearings at venues accessible to the interested public for the various disposal sites evaluated in the EIS were conducted. Notices were placed in various local newspapers to announce the public hearings before and during the scheduled hearings.

L275-2 DOE initiated consultation and communication with the 14 participating American Indian tribes that have cultural or historical ties to the DOE sites analyzed in the EIS. These interactions are summarized in Section 1.8 of the EIS, and they included several meetings, workshops, and the development of tribal narratives that were included in the EIS. In addition to including tribal narratives related to the four sites in the EIS, DOE inquired about tribal interests with regard to the WIPP/WIPP Vicinity and SRS. No tribes came forward in response to the inquiries regarding these two locations. It was not necessary to consult with American Indian tribes with regard to the generic regional locations, since the specific locations of the potential disposal facilities (and the affected tribes) were not known.

DOE will continue to consult with the site-affiliated American Indian tribes, as appropriate, during implementation of the selected alternative.

L275-3 Recommendations were taken into consideration, as appropriate, in the selection of the preferred alternative.

L275-1

L275-2

L275-3

West Valley Citizen Task Force, Commenter ID No. L275 (cont'd)

The DOE has suggested five alternatives for the disposal of GTCC waste (S.2.5). Each of these alternatives was evaluated on eleven separate criteria (S.2.8, pg. S-37). There was also a mention of regional commercial disposal sites, although no specific vendor or site has yet to be identified. Upon examination of the five alternatives, the West Valley CTF strongly supports Alternative 2, WIPP Geologic Repository as the preferred alternative. Our selection of this alternative is based on the data presented in Table S-3, comparisons of potential impacts. Public safety and environmental impact must be primary considerations for any alternative. Table S-3, pg. S-41 supports our belief that the WIPP alternative would offer the lowest worker dose and lowest Latent Cancer Fatality (LCF) risk (Table S-4; pg. S-47). The WIPP site would also have zero long term annual dose and LCF risk (Table S-3; pg. S-42), although we would urge DOE to conduct studies to accurately determine the impact, if any, to individuals and nearby populations from a waste handling accident at the site.

The WIPP site would be preferred by the CTF due to the very low impacts that disposal would have on habitat and wildlife as well as other ecological resources compared to the other alternatives (Table S-3, pg. S-43). The siting at WIPP is also preferred due to the existing facility and stable environmental footprint need to dispose of additional waste at the site (S.2.5.2; Figure S-8, pgs. S-20, 21).

Transportation to the WIPP repository is an obstacle and a point of concern for the CTF. We would recommend that studies be conducted to lower the projected impacts of shipping waste to the site. The CTF strongly encourages the use of rail transportation as opposed to trucking materials. Fewer trips would be necessary, resulting in the chance for fewer accidents or exposures (Table S-3; pg. S-45).

In summation, the West Valley CTF strongly supports the creation of a disposal site for GTCC and GTCC-like wastes. We urge the DOE and the Congress to move judiciously, but as quickly as possible, in the identification of such a disposal site. The CTF supports the WIPP Geologic Repository as the preferred alternative for such a site based on the points discussed in the preceding paragraphs.

Sincerely,

Deborah A. ... *Christy C. ...*
P. ... *...*
... *...* *...*
Ray ... *Eric W. ...*

L275-4 Based on the GTCC EIS evaluation and WIPP's operating record, DOE believes that the WIPP repository would be a safe location for the disposal of GTCC LLRW and GTCC-like wastes, some of which include long-lived radionuclides. DOE recognizes that the use of WIPP for the disposal of GTCC LLRW and GTCC-like wastes would require modification to existing law. In addition, it would be necessary to revise the Agreement for Consultation and Cooperation between the Department of Energy and the State of New Mexico for the Waste Isolation Pilot Plant, the WIPP compliance certification with EPA, and the WIPP Hazardous Waste Facility Permit.

The State of New Mexico has indicated a willingness to accept GTCC LLRW and GTCC-like wastes for disposal at WIPP. Twenty-eight New Mexico State Senators signed a proclamation made in the Fiftieth Legislature, First Session, 2011, stating: "Be it resolved that we, the undersigned, support the opportunity for other potential missions in southeast New Mexico to adequately address the disposal of defense high-level waste, commercial high-level waste, Greater Than Class C LLRW and surplus plutonium waste, as well as the interim storage of spent nuclear fuel." In response to the Draft GTCC EIS, Secretary David Martin, Secretary of the New Mexico Environment Department, sent a letter to DOE on June 27, 2011, stating that "the Department encourages DOE to support the WIPP or WIPP Vicinity proposed locations as the preferred alternatives addressed in the Draft EIS. The geologic repository is the favored alternative being more effective for the enduring time frames for this waste type." In addition, the Governor of New Mexico, in a letter to DOE Secretary Steven Chu on September 1, 2011, stated that the State of New Mexico encourages DOE to support the proposed location of WIPP as the preferred alternative for the disposal of GTCC LLRW and GTCC-like wastes.

L275-5 Follow-on site-specific project studies will further evaluate transportation options for the preferred alternative and will involve transportation stakeholders.

L275-6 See Response L275-4.

Western Governors' Association, Commenter ID No. L99 (W327)

From: gtcciswebmaster@anl.gov
Sent: Monday, June 20, 2011 4:19 PM
To: mail_gtccisarchives; gtcciswebmaster@anl.gov; gtccis@anl.gov
Subject: Greater-Than-Class-C Low-Level Radioactive Waste EIS Comment GTCC10327
Attachments: GTCC_EIS_comments_Final_Draft_2_GTCC10327.pdf

Thank you for your comment, Western Governors'.

The comment tracking number that has been assigned to your comment is GTCC10327. Please refer to the comment tracking number in all correspondence relating to this comment.

Comment Date: June 20, 2011 04:19:09PM CDT

Greater-Than-Class-C Low-Level Radioactive Waste EIS Draft Comment: GTCC10327

First Name: Western
Last Name: Governors'
Organization: Western Governors' Association
Address: 1600 Broadway, Suite 1700
City: Denver
State: CO
Zip: 80202
Country: USA
Email: tmccammon@westgov.org
Privacy Preference: Don't withhold name or address from public record
Attachment: C:\fakepath\GTCC EIS comments Final Draft_2_.pdf

Comment Submitted:

On behalf of Western Governors, we appreciate the opportunity to comment on the U.S. Department of Energy's (DOE) Draft Environmental Impact Statement (EIS) for Disposal of Greater-Than-Class C (GTCC) Low-Level Radioactive Waste and GTCC-Like Waste (DOE/EIS-0375-D), issued in February 2011. Attached are the WGA comments.

If you have any questions, please contact Jennifer Salisbury jsalisbury@westgov.org, ph: 303-623-9378

Thank you,
Toni McCammon, Office Manager
WGA

Questions about submitting comments over the Web? Contact us at: gtcciswebmaster@anl.gov or call the Greater-Than-Class-C Low-Level Radioactive Waste EIS Webmaster at (630) 252-5705.



WESTERN GOVERNORS' ASSOCIATION

C.L. "Butch" Otter
Governor of Idaho
Chairman

Christine O. Gregoire
Governor of Washington
Vice Chair

Pam O. Inmann
Executive Director

Headquarters:
1600 Broadway
Suite 1700
Denver, CO 80202
303-623-9378
Fax 303-534-7309

Washington, D.C. Office:
400 N. Capitol Street, N.W.
Suite 388
Washington, D.C. 20001

202-624-5402
Fax 202-624-7707

www.westgov.org

June 20, 2011

Arnold Edelman, EIS Document Manager
Office of Environmental Management
U.S. Department of Energy
Cloverleaf Building, EM-43
1000 Independence Avenue, SW
Washington, DC 20585

Dear Mr. Edelman,

On behalf of Western Governors, we appreciate the opportunity to comment on the U.S. Department of Energy's (DOE) "Draft Environmental Impact Statement (EIS) for Disposal of Greater-Than-Class C (GTCC) Low-Level Radioactive Waste and GTCC-Like Waste (DOE/EIS-0375-D), issued in February 2011. Western states have a long history of working together regionally and with the Department of Energy on issues related to the transportation, storage and disposal of radioactive waste. Our review of the Draft EIS leads us to conclude that it should be revised and reissued as a draft, as opposed to proceeding directly to a final EIS. To support this request, we would offer the following observations and recommendations on behalf of the Western Governors' Association (WGA):

I. Emphasis on Western and Department of Energy Sites

We have continually and emphatically noted in the past that western states shoulder a disproportionate and unfair burden in supporting the operation and cleanup of the nation's atomic weapons complex. Once again, states in the West are being considered for six of the seven possible sites for the disposal of GTCC and GTCC-like waste. DOE sites are prominently considered despite a lack of congressional direction that this be the case.

Western DOE sites already have extensive waste cleanup missions and enforceable cleanup agreements, and major challenges remain in meeting these commitments. Many of these sites are focused on cleanup and removal of waste under agreements with host states, not on additional disposal. Bringing in new wastes for disposal is not necessarily compatible with a site's cleanup mission. In some cases it would result in imposing a sizeable additional burden on a site or sites that already face groundwater and other contamination problems well into the future.

In addition, none of the DOE sites under consideration in the draft EIS contain an NRC-licensed or regulated facility for disposal of LLW or GTCC waste. Disposal of commercial waste at a DOE facility must be

L99-1

The scope of this EIS is adequate to inform decision-making for the disposal of GTCC LLRW and GTCC-like waste. Sufficient information is available to support the current decision-making process to identify (an) appropriate site(s) and method(s) to dispose of the limited amount of GTCC LLRW and GTCC-like waste identified in the EIS.

DOE believes that this EIS process is not premature and is in compliance with NEPA. On the basis of an assumed starting date of 2019 for disposal operations, more than half (about 6,700 m³ [240,000 ft³] of the total GTCC LLRW and GTCC-like waste inventory of 12,000 m³ [420,000 ft³]) is projected to be available for disposal between 2019 and 2030. An additional 2,000 m³ (71,000 ft³) would become available for disposal between 2031 and 2035. This information is presented in Figure 3.4.2-1. DOE believes this EIS is timely, especially given the length of time necessary to develop a GTCC waste disposal facility.

DOE developed this EIS to support a decision on selecting a disposal facility or facilities for GTCC LLRW and GTCC-like waste, to address legislative requirements, to address national security concerns (especially for sealed sources), and to protect public health and safety. The purpose and need for the proposed action, as discussed above, is stated in the EIS (Section 1.1). The scope of the EIS is focused on addressing the need for developing a disposal capability for the identified inventory of GTCC LLRW and GTCC-like wastes. DOE plans a tiered decision-making process, in which DOE would conduct further site-specific NEPA reviews before implementing an alternative ultimately selected on the basis of this EIS.

L99-2

The GTCC EIS evaluates the range of reasonable alternatives for the disposal of GTCC LLRW and GTCC-like wastes in compliance with the requirements specified in NEPA, LLRWPA, and Section 631 of the Energy Policy Act of 2005 (P.L. 109 58). The GTCC EIS evaluates the potential environmental impacts of the proposed disposal alternatives for GTCC LLRW and GTCC-like wastes. Based on the evaluation, DOE has determined that there are safe and secure alternatives for the disposal of GTCC LLRW and GTCC-like wastes. The GTCC EIS provides information that supports this determination, and, as discussed in Section 1.1, Purpose and Need for Agency Action, DOE is responsible for the disposal of GTCC LLRW and GTCC-like wastes.

L99-1

L99-2

L99-3

DOE is performing environmental restoration activities at the Hanford Site, INL, LANL, NNSS, and SRS. The ongoing cleanup efforts at these sites will continue. If GTCC LLRW or GTCC-like waste were to be disposed at Hanford, DOE does not anticipate negative impacts to ongoing cleanup activities at this site.

L99-3

L99-4

The LLRWPA (P.L. 99-240) assigns DOE responsibility for the disposal of GTCC LLRW generated by NRC and Agreement State licensees. The LLRWPA (P.L. 99-240) specifies that GTCC LLRW, designated a federal responsibility under section 3(b)(1)(D) that results from activities licensed by the NRC, is to be disposed of in an NRC-licensed facility that has been determined to be adequate to protect public health and safety. However, unless specifically provided by law, the NRC does not have authority to license and regulate facilities operated by or on behalf of DOE. Further, the LLRWPA does not limit DOE to using only non-DOE facilities or sites for GTCC LLRW disposal. Accordingly, if DOE selects a facility operated by or on behalf of DOE for disposal of GTCC LLRW for which it is responsible under section 3(b)(1)(D), clarification from Congress would be needed to determine NRC's role in licensing such a facility and related issues. In addition clarification from Congress may be needed on NRC's role if DOE selects a commercial GTCC LLRW disposal facility licensed by an Agreement State rather than by NRC.

L99-4

Western Governors' Association, Commenter ID No. L99 (W327) (cont'd)

Arnold Edelman
June 20, 2011
Page 2

licensed or regulated by NRC. The Draft EIS does not address DOE's plans for obtaining an NRC license for disposal of commercial GTCC waste on a DOE facility.

Recommendation: Potential sites considered by DOE reflect factors other than presumed DOE siting convenience. As noted above, it does not follow from congressional direction that likely disposal alternatives should be DOE sites with other, current cleanup missions. Siting criteria should include:

- disposal suitability (e.g. trenches for disposal of activated metals);
- minimization of cross-country transport;
- avoidance of potential conflict with other current DOE cleanup missions; and
- NRC licensing of disposal facilities.

Not only should these factors be considered in identifying alternative sites, they also should be addressed with more specificity in impact assessments and siting decisions.

In addition, with respect to GTCC waste, we recommend DOE follow Western Governors' position on centralized storage of spent nuclear fuel and high-level waste: if deemed necessary, such waste shall be located within a state only with the written consent of the Governor (WGA 09-5, Policy #2). We recommend that a similar policy apply to the disposal of GTCC or GTCC-like waste in a Western state.

Further, we recommend that the principles of volunteerism and consent also be applied. Past experience suggests that departure from these principles creates strife and costly delays, without reliably delivering needed sites.

2. Identification of Alternatives

It is not clear why each disposal method (boreholes, enhanced trenches, above-ground vaults) is considered for disposal of all types of GTCC and GTCC-like wastes. The EIS indicates that some disposal methods are more appropriate for some waste types than for others, and that each disposal method is suboptimal for at least one of the major waste types. Yet there is no attempt to match each major waste type with its most appropriate disposal method.

In addition, it appears that the EIS authors went to great effort to ensure that most options presented in scoping this EIS remained as viable choices, even though a cursory examination clearly demonstrates some of the options at several of the proposed sites are less than ideal. We expect that when this document is revised, many of the proposed options will have been eliminated from further consideration.

Recommendation: We recommend either a fuller explanation as to why each major GTCC waste type should *not* be matched with its most appropriate disposal method(s) or an assessment of alternatives that do match waste types with their most appropriate disposal methods. In general, the alternatives assessed should reflect realistic and implementable alternatives for DOE action. The alternatives DOE has assessed so far do not appear to meet that criterion.

L99-5 The analysis presented in the GTTC EIS is adequate for the comparison of the disposal alternatives evaluated. Fate and transport parameters utilized in the estimations were based on site-specific (e.g., specific to the reference location to the extent available) information and, as such, are considered reasonable for the purpose of the comparison made in the EIS. As appropriate additional NEPA review including public participation would be done, before implementation.

DOE is performing environmental restoration activities at the Hanford Site, INL, LANL, NNSS, and SRS. The ongoing cleanup efforts at these sites will continue.

L99-6 The EIS analysis is used to assess the viability of an alternative as well as its relative performance compared to the other alternatives. Exclusion of a reasonable alternative from the EIS without first evaluating the site is contrary to a thorough NEPA analysis. All alternatives are retained in the Final EIS because such evaluations are needed to support selection of the preferred alternative. In addition, as discussed in Section 1.4.2, the conceptual disposal facility designs analyzed in the EIS could be modified to perform better in specific locations.

L99-4
(Cont.)

L99-5

L99-6

Arnold Edelman
June 20, 2011
Page 3

3. Transportation Impacts and Access to Rail

Using RADTRAN and RISKIND, the EIS estimates routine and accident-related radiological risks. Using the tables in sections 6.1.9 (Hanford) and 10.1.9 (SRS), one can calculate that a shipment campaign for disposal at Hanford would require 10,000 truck shipment miles (59 percent of which would consist of activated metals), while sites closer to the shipment origins could require as few as 3,800 truck shipment miles. Risks associated with the transportation of radioactive waste are directly related to the number of shipments and distance transported. However, no DOE site is eliminated or even properly evaluated on the grounds that it would require a substantial number of long-distance, cross-country shipments (a total of 33,700 truck shipments or 11,800 rail shipments).

Given this potentially large discrepancy among sites, it is important that the EIS evaluate and compare the transportation impacts in relation to each disposal alternative, including but not limited to routing and emergency preparedness impacts of a large shipment campaign, costs (packaging, operations, emergency preparedness and response) to both state and federal governments, etc. Such assessments should compare impacts for each modal (rail vs. truck) alternative, as well as each site. Several of the considered sites lack direct access to the national rail system, which could make them suboptimal for the disposal of activated metals, which are not easily or efficiently transported by truck.

Recommendation: We recommend that the EIS substantially improve and integrate the assessment of transportation impacts, including the costs of transportation packaging, operations and emergency response associated with transport of different GTCC waste types over different distances. Given substantial costs required for providing rail access where it does not already exist, access to the national rail system also should be factored into cost estimates as appropriate. We recommend that the EIS also assess the handling and packaging costs at origin sites, and discuss who is expected to pay these costs.

We recommend and expect that any transportation program for GTCC or GTCC-like material would be modeled after the Waste Isolation Pilot Program (WIPP) transportation safety program, which is purposefully extra-regulatory and was developed in cooperation with affected states. Additionally, it is expected that any shipment campaign be supported by financial assistance to states for emergency response training and meeting shipment safety protocols similar to those used for shipments to WIPP.

4. Characterization of Other Wastes

It is unclear in the Draft EIS whether all current GTCC and GTCC-like wastes have been characterized to determine their radiological or hazardous components and the requisite packaging for transport and disposal. The EIS does not appear to address the need to characterize "other" GTCC and GTCC-like wastes. "Other" wastes comprise 58% of the projected GTCC and GTCC-like inventory. The EIS assumes that 45% must be remote handled (packaging, transport, and disposal), while 55% may be contact handled.

Recommendation: The revised EIS should describe how DOE has characterized or will characterize current and prospective GTCC and GTCC-like wastes to determine the most

L99-7

Calculation of the collective population risk (under routine and accident conditions) is provided in the EIS. While these estimates are conservative, the calculations used expected values where practical (e.g., external shipment dose rates) and provide a reasonable measure for comparison among alternatives, as summarized in Tables 2.7 5 and 2.7 6, and the estimates show that the transportation risks would be small. All alternatives involve routes of hundreds of miles through similar types of rural, suburban, and urban areas. For specific local impacts, Section 5.3.9.2 provides information on potential human health impacts on individuals during normal waste transport along a route. However, the consideration of specific local stakeholder concerns is more appropriate during the final planning stages of a project when actual route selections are finalized, not at the level addressed in this EIS. A generic accident consequence assessment was performed because there is no way to predict the exact location and conditions of an accident, as discussed in C.9.3.3 of the EIS. For all alternatives, potential accidents, even those at the same location, could have impacts that range from negligible to significant depending on the waste involved, the accident severity, and weather conditions. Such an analysis would not help distinguish between alternatives because all alternatives involve routes through or near major population centers.

The additional human health impacts from intermodal transfer and transport of waste from the nearest rail access point to those disposal sites without direct rail access is generally a small percentage of the total risk discussed in Section C.9.5.5 of the EIS. Costs involved in either building a rail spur to a site or the additional cost of intermodal operations would need to be considered if that option was considered further. For the rail option, the use of dedicated trains, if sufficient waste is available for transport at the same time, could reduce transportation risks and costs by minimizing transit times. The current rail analysis therefore bounds what might be expected if dedicated trains were used. In general, transportation costs would be similar across all disposal alternatives. The primary difference would be related to the distances traveled in each case. Thus, the transportation costs will scale with the shipment distances travelled as presented in the EIS. Any decisions made by DOE would take these factors into account during implementation.

Once an alternative is selected in a ROD for this EIS for implementation, site-specific NEPA reviews would be conducted as needed, including an assessment of specific routing and an accident analysis, including dedicated trains and the potential for multiple railcar accidents if applicable. This process will include planning that involves transportation stakeholders.

L99-8

The GTCC LLRW and GTCC-like waste inventory evaluated in the EIS is based on the best available information on the stored and projected GTCC LLRW and GTCC-like wastes from ongoing and planned activities. Although characterization information for some of the GTCC LLRW and GTCC-like wastes is limited, DOE believes that sufficient data are available to allow for a comparative analysis of various approaches to dispose of these wastes in the EIS. Adequate data are generally available for the radioactive constituents, but comparable data for chemical constituents are generally lacking. DOE believes that the data presented in the EIS are sufficient to make comparative analyses between and among sites.

Information on waste forms and waste packages and containers is provided in the EIS to allow for a comparative analysis of alternatives for transportation and waste disposal. Treatment of the wastes prior to disposal is outside the scope of the EIS. Such treatment is assumed to be addressed prior to receipt of the waste at the GTCC LLRW and GTCC-like waste disposal facility. DOE agrees that it is important to immobilize long-lived radionuclides such as Tc-99 and I-129 prior to disposal. Solidification techniques (e.g., use of grout) are expected to immobilize certain wastes in the GTCC LLRW and GTCC-like waste inventory. If needed, the actual stabilization methods used will depend, in part, on the waste stream, packaging, and final disposal facility design. DOE considers the assumptions used for waste form stability (see Appendix B) to be reasonable for purposes of the comparative analysis provided in the EIS.

L99-7

L99-8

Arnold Edelman
June 20, 2011
Page 4

appropriate packaging, and how this characterization informs choices of packaging, transport and disposal methods.

5. Consideration of the Regional Low-level Waste Compacts

Due to the lack of information provided on characterization of waste, it is unclear whether the disposal of GTCC and GTCC-like wastes fall under the jurisdiction of the regional low-level waste compacts as authorized by Congress.

Recommendation: The EIS should account for all applicable oversight and regulatory authorities as it evaluates individual sites.

6. Summary Recommendation: Revise the Draft EIS

The Draft EIS should be revised and reissued to address the comments above and as summarized below:

- The matching of GTCC waste types with disposal alternatives should be reconsidered and more fully explained.
- The selection of alternative sites should be reconsidered and explained in terms of their current uses, missions and regulatory constraints.
- Alternative sites should be linked with waste type/disposal options and evaluated in terms of siting criteria identified above.
- The DOE commitment to the siting principles of volunteerism and consent and, regarding any Western sites, to WGA Policy resolutions should be discussed and explained.
- The analysis of transportation impacts should be developed to consider routing, route preparation and emergency response; and the minimization of transportation impacts, particularly regarding activated metals, should be considered in the identification and selection of site alternatives.
- The GTCC waste characterization process should be discussed and the implications for packaging, packaging costs and transportation options should be explained.
- The implications of regional low-level waste compacts for GTCC waste disposal and requirements for NRC certification should be considered and explained.

Thank you again for the opportunity to review the EIS and we appreciate your attention to our comments and recommendations.

Sincerely,

C.L. "Butch" Otter
Governor of Idaho
Chairman

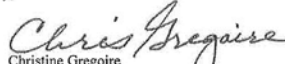
Christine Gregoire
Governor of Washington
Vice Chair

L99-8
(Cont.)

L99-9

L99-9

L99-6
(Cont.)

L99-5
(Cont.)

L99-6
(Cont.)

L99-5
(Cont.)

L99-7
(Cont.)

L99-8
(Cont.)

L99-9
(Cont.)

The waste characteristics and physical form would have to meet the disposal facility waste acceptance criteria. It is expected that these waste acceptance criteria would identify requirements (such as allowable concentrations) for individual radionuclides, including Tc-99 and I-129. The specific waste forms and packages used to dispose of GTCC LLRW and GTCC-like wastes would be determined in the future as part of the waste acceptance criteria and packaging requirements developed. See the discussion in Section B.5 and C.9.4.2 of the EIS for more information on packaging requirements. All GTCC LLRW and GTCC-like wastes would be packaged and transported in accordance with all applicable federal and state requirements, and waste disposal activities would be conducted in accordance with appropriate requirements.

The LLRW PAA (P.L. 99-240) assigns DOE responsibility for the disposal of GTCC LLRW generated by NRC and Agreement State licensees. The LLRW PAA (P.L. 99-240) specifies that GTCC LLRW, designated a federal responsibility under section 3(b)(1)(D) that results from activities licensed by the NRC, is to be disposed of in an NRC-licensed facility that has been determined to be adequate to protect public health and safety. However, unless specifically provided by law, the NRC does not have authority to license and regulate facilities operated by or on behalf of DOE. Further, the LLRW PAA does not limit DOE to using only non-DOE facilities or sites for GTCC LLRW disposal. Accordingly, if DOE selects a facility operated by or on behalf of DOE for disposal of GTCC LLRW for which it is responsible under section 3(b)(1)(D), clarification from Congress would be needed to determine NRC's role in licensing such a facility and related issues. In addition clarification from Congress may be needed on NRC's role if DOE selects a commercial GTCC LLRW disposal facility licensed by an Agreement State rather than by NRC.

Whiteaker Community Council, Commenter ID No. T173

Capital Reporting Company

45

1
2
3
4
5
6
7
8
9
10
11
12
13
14
15
16
17
18
19
20
21

MR. BROWN: Louisa. Eva Kronin will follow you.

MS. HAMACHEK: I'm Louisa Hamachek from Eugene,
and I'm the chair of the Whiteaker Community Council,
our neighborhood association, and we have agreed that
we oppose the transportation of nuclear waste through
our neighborhood. Our neighborhood has a smaller
highway. We're about a mile and a half from I-5. We
have a smaller highway that is the one chosen as the
detour route if there's an accident on I-5, which
means that the nuclear trucks would come through our
neighborhood. And we have decided to oppose that and
not allow any nuclear waste trucks to come through
our neighborhood.

T173-1

T173-1 Some shipments of GTCC waste may be subject to DOT regulations for Highway Route Controlled Quantities. As such under 49 CFR 172.403, GTCC waste can only be transported on State approved routes that minimize radiological risks. The preferred route for such materials is on the interstate system. In the event of an accident, the detour route must be approved by the state. Given the location of Whiteaker in Eugene, OR., a very limited number of GTCC waste shipments would be routed via Interstate 5 to any of the disposal sites analyzed in the GTCC EIS.

Women for a Better World, Commenter ID No. W21

From: gtceiswebmaster@anl.gov
Sent: Sunday, May 15, 2011 12:58 PM
To: gtceiswebmaster@anl.gov
Subject: Receipt: Greater-Than-Class-C Low-Level Radioactive Waste EIS Comment GTCC10021

Thank you for your comment, Stephanie Hiller.

The comment tracking number that has been assigned to your comment is GTCC10021. Please refer to the comment tracking number in all correspondence relating to this comment.

Comment Date: May 15, 2011 12:57:51PM CDT

Greater-Than-Class-C Low-Level Radioactive Waste EIS Draft Comment: GTCC10021

First Name: Stephanie
Last Name: Hiller
Organization: Women for a Better World
Address: 1500 Pacheco Street #111
City: Santa Fe
State: NM
Zip: 87505
Country: USA
Email: hiller.stephanie@gmail.com
Privacy Preference: Don't withhold name or address from public record

Comment Submitted:

I realize that in these hearings and comments DOE and associated agencies prefer rational arguments based on evidence and presented in as scientific a manner as possible. But I am going to try to appeal to your hearts.

Truth is more a matter of the heart than of the brain, and it's time we accepted the rule of heart instead of the tricky machinations of our intellects so easily made to serve our craven hunger for money, conquest of land, and domination of whoever has the misfortune to stand in the way of our relentless movement across the planet, heedless of the destruction in our wake.

Today Fukushima and yesterday Three Mile Island and Chernobyl. Downwinders of the Nevada Test Site and Alamogordo. Neighbors in the vicinity of leaking nuclear plants in the United States and other countries. The fate of uranium miners, soldiers too close to nuclear tests, and others. All show that the spread of radioactive materials throughout our planet is killing us. Cancer rates have risen exponentially since the making of the first bomb. Victims of depleted uranium bombing are giving birth to hideously deformed children. Radiation is wrecking our immune systems and our genome, wasting and polluting essential but diminishing natural resources like soil and water effectively forever, and for what?

We are not deluded about the "environmental benefits" of nuclear power. The nuclear reactor process has proven to be too dangerous for humans to handle. No adequate form of disposal has been found for the waste. We don't need it and we don't want it. We do not want our state to become a National Sacrifice Zone for the nuclear industry. We want you to stop producing that waste, and then we will consider supporting you in exercising the highest possible caution in storing the nearly one million tons of waste you have already created.

W21-1

Stopping the generation of nuclear waste is outside the scope of the GTCC EIS, the scope of which is to evaluate disposal alternatives to enable the selection of a safe alternative or alternatives for the disposal of GTCC LLRW and GTCC-like wastes. The GTCC EIS evaluates the range of reasonable alternatives for the disposal of GTCC LLRW and GTCC-like wastes in compliance with the requirements specified in NEPA, the Low-Level Radioactive Waste Policy Amendments Act (P.L. 99-240), and Section 631 of the Energy Policy Act of 2005 (P.L. 109-58). The GTCC EIS evaluates the potential environmental impacts of the proposed disposal alternatives for GTCC LLRW and GTCC-like wastes. Based on the evaluation, DOE has determined that there are safe and secure alternatives for the disposal of GTCC LLRW and GTCC-like wastes. The GTCC EIS provides information that supports this determination, and, as discussed in Section 1.1, Purpose and Need for Agency Action, DOE is responsible for the disposal of GTCC LLRW and GTCC-like wastes.

W21-1

Women for a Better World, Commenter ID No. W21 (cont'd)

Thank you.

Questions about submitting comments over the Web? Contact us at: gtcciswebmaster@anl.gov or call the Greater-Than-Class-C Low-Level Radioactive Waste EIS Webmaster at (630) 252-5705.

Capital Reporting Company

32

1

2

3

4

5

6

7

8

9

10

11

12

13

14

15

16

17

18

19

MR. BROWN: Thank you. Georgia is next.
Kenneth Hodge is after her.

20

21

22

23

24

25

MS. PINKEL: I'm Georgia Pinkel, and the
co-convener of the Women's International League for
Peace and Freedom, Portland branch. And, of course,
my branch, as well as national and international,
supports you in this effort to stop the further

866.488.DEPO
www.CapitalReportingCompany.com

Women's International League for Peace and Freedom, Commenter ID No. T116
(cont'd)

Capital Reporting Company

33

1 pollution of our area.

2 For those that have the little book that they
3 were handing out, on page S16 it shows you where all
4 of that nuclear waste is going to come from. It's
5 all east of the Mississippi. It seems to me we ought
6 to set our scientists to find a way to neutralize it
7 where it sits instead of hauling it all around the
8 countryside. We're opposed to the trucks or the
9 trains. We are dismayed that Hanford is still
10 polluted, and we have had very little effective
11 cleanup in spite of the amount of money that has been
12 spent.

13 I think I'll leave you just with this idea. Oh,
14 besides this (pointing to her shirt.) My shirt says,
15 Democracy is not a spectator sport. You guys know
16 that. We need to let everybody know that, and we
17 need to work towards the situation where public
18 opinion becomes public policy. We need to take back
19 our sovereignty and to make them listen to what we
20 are saying and to believe us.

21 So WIL says, indeed, the only sane approach is
22 to cease production of nuclear weapons and nuclear
23 power plants and to begin dismantling both for the
24 welfare of the entire earth.

25 Thank you.

866.488.DEPO
www.CapitalReportingCompany.com

T116-1

T116-2

T116-1 The EIS considered the range of reasonable alternatives for disposal of the inventory of GTCC LLRW and GTCC-like wastes identified for inclusion in these analyses. The development of treatment methods was considered to be outside the scope of the EIS.

T116-2 Stopping the generation of nuclear waste from nuclear power production and the production of nuclear weapons are outside the scope of this EIS, which is to evaluate disposal alternatives to enable the selection of a safe alternative or alternatives for the disposal of GTCC LLRW and GTCC-like waste.

Woodstock Neighborhood Association, Commenter ID No. W266

From: gtceiswebmaster@anl.gov
Sent: Thursday, June 16, 2011 2:59 PM
To: gtceiswebmaster@anl.gov
Subject: Receipt: Greater-Than-Class-C Low-Level Radioactive Waste EIS Comment GTCC10266

Thank you for your comment, Lonnie Port.

The comment tracking number that has been assigned to your comment is GTCC10266. Please refer to the comment tracking number in all correspondence relating to this comment.

Comment Date: June 16, 2011 02:59:12PM CDT

Greater-Than-Class-C Low-Level Radioactive Waste EIS Draft Comment: GTCC10266

First Name: Lonnie
Middle Initial: L
Last Name: Port
Organization: Woodstock Neighborhood Association
Address: 5905 SE 43rd
City: Portland
State: OR
Zip: 97206
Country: USA
Email: lonniewna@hotmail.com
Privacy Preference: Don't withhold name or address from public record

Comment Submitted:
Secretary Chu and Mr. Edelman:

Please remove the Hanford Nuclear Reservation from the U.S. Department of Energy's list of candidate sites for a permanent nuclear waste dump site to store radioactive materials coming from across the United States. Hanford is the wrong place to transport and dispose of more highly dangerous radioactive material.

Hanford is already the most contaminated site in the Western Hemisphere and the Department of Energy is already engaged in one of the largest and most complex cleanup projects in U.S. history at Hanford. The number one priority should be to stop waste from leaking into the Columbia River and clean up the existing waste at Hanford. No new nuclear waste should be stored at Hanford.

This proposal means that thousands of trucks with dangerous radioactive waste would be traveling along interstate routes, passing through our cities and the Columbia River Gorge National Scenic Area. I-84 travels the length of the Gorge and is often within a few feet of homes, schools, critical wildlife habitat and the Columbia River. The risk of an accident is simply too great, and the environmental and human health costs are unacceptable.

The Draft Environmental Impact Statement (DEIS) fails to consider the risks involved in transporting these waste materials to Hanford. The DEIS does not include a 2008 USDOE study that estimated 800 adult cancer deaths would occur due to ambient radiation from the transport vehicles alone. Nor does the DEIS include the unimaginable number of deaths and environmental damage resulting from a truck accident, an earthquake or an intentional attack.

W266-1 The disposal methods and sites evaluated in the EIS represent the range of reasonable alternatives for the disposal of GTCC LLRW and GTCC-like wastes. This range is consistent with NEPA implementing regulations in Parts 1500–1508 of Title 40 of the Code of Federal Regulations (40 CFR Parts 1500–1508). In this GTCC EIS, DOE analyzed a range of disposal methods (i.e., geologic repository, near-surface trench, intermediate-depth borehole, and above-grade vault) and federally owned sites (i.e., Hanford Site, INL, LANL, NNSS, SRS, and the WIPP Vicinity, for which two reference locations – one within and one outside the WIPP Land Withdrawal Boundary – were considered). DOE has determined that it was reasonable to analyze these six sites because they currently have operating radioactive waste disposal facilities, except for the WIPP Vicinity, which is near an operating geologic repository.

DOE also conducted a generic evaluation of commercial disposal facilities on nonfederal lands in the EIS to order to provide, to the extent possible, information regarding the potential long-term performance of other (nonfederal) locations for siting a GTCC waste land disposal facility.

Final siting of a disposal facility for GTCC LLRW and GTCC-like wastes would involve further NEPA review as needed and be in accordance with applicable laws and regulations and would involve local stakeholder involvement and consent.

W266-2 DOE is performing environmental restoration activities at the Hanford Site. The ongoing cleanup effort will continue.

W266-3 DOE's ROD 78 FR 75913 dated December 13, 2013, stated that DOE has deferred a decision on importing waste from other DOE sites (with limited exceptions as described in the Settlement Agreement with the State of Washington Department of Ecology) for disposal at Hanford at least until WTP is operational.

However, regardless of where the GTCC waste disposal facility is ultimately located, a relatively small amount of GTCC LLRW and GTCC-like wastes may be transported through the Columbia River Gorge on their way to the disposal facility. The waste would be generated within the states of Oregon and Washington and would include actinide sealed sources and Cs-137 irradiators from local medical institutions, research facilities, universities, and other NRC and Agreement State licensees.

The transportation of radioactive waste will meet or exceed DOT and NRC regulatory requirements that promote the protection of human health and the environment. These regulations include requirements for radioactive materials packaging, marking, labeling, placarding, shipping papers, and highway routing. The waste shipments would be on preferred routes, which are interstate highways or alternative routes designated by a state routing agency in accordance with DOT regulations (49 CFR Part 397, Subpart D). The GTCC LLRW and GTCC-like wastes would be shipped in approved waste packages and transportation casks. The robust nature of these casks limits the potential release of radioactive and chemically hazardous material under the severest of accident conditions. It is unlikely that the transportation of GTCC LLRW and GTCC-like wastes to any of the alternative sites evaluated in the EIS would cause an additional fatality as a result of radiation from either incident-free transportation or postulated transportation accidents.

The EIS evaluated the transportation impacts from the shipments that would be required to dispose of all of the GTCC LLRW and GTCC-like wastes at the various disposal sites. The EIS addressed the collective population risks during routine conditions and accidents, the radiological risks to the highest exposed individuals during routine conditions, and the

Woodstock Neighborhood Association, Commenter ID No. W266 (cont'd)

Finally, on the 25th Anniversary of the Columbia River Gorge National Scenic Area Act, we should celebrate the past and future protection of the Columbia Gorge--not propose more dangers to this national treasure.

I am joined in opposition to transporting more nuclear waste to Hanford by Friends of the Columbia Gorge, Heart of America Northwest, Columbia Riverkeeper, 17 Oregon legislators, Congressman Earl Blumenauer, U.S. Senator Merkley, U.S. Senator Wyden and many others.

Thank you for your time and consideration.

Lonnie Port
Portland, Oregon
Board Member of the Woodstock Neighborhood Association

Questions about submitting comments over the Web? Contact us at: gtcciswebmaster@anl.gov or call the Greater-Than-Class-C Low-Level Radioactive Waste EIS Webmaster at (630) 252-5705.

2

consequences to individuals and populations as a result of transportation accidents, including those that could release radioactive or hazardous chemical materials. About 12,600 shipments would be required to transport all of the GTCC LLRW and GTCC-like wastes to the Hanford Site for disposal. This would result in about 50 million km (30 million mi) of highway travel, with no expected LCFs. One fatality directly related to an accident might occur (see Section 6.2.9.1).

The EIS also evaluated the impact of intentional destructive acts that could occur during waste handling, transportation, and disposal (see Section 2.7.4.3 of the EIS). The potential for such destructive acts is low. DOE sites considered in the EIS are secured, and the packaging for the GTCC LLRW and GTCC-like wastes would be robust. The GTCC LLRW and GTCC-like wastes are not readily dispersible, and the impacts from any attempts to disperse these materials during transportation (such as the impacts from an explosive blast) would be greater than the impacts from any potential release of radioactivity. Impacts from severe natural phenomena, such as earthquakes and tornados, would not be expected to be significant, given that the GTCC LLRW and GTCC-like wastes are largely not dispersible and given the robust nature of the waste packages and containers.

DOE's standard operating procedure for transportation of radioactive waste is developed and continually revised to ensure that the utmost protection of public health and the environment is achieved and that the risk of a traffic accident is minimized. For example, DOE has established a comprehensive emergency management program (Transportation Emergency Preparedness Program or TEPP) that provides detailed, hazard specific planning and preparedness measures to minimize the health impacts from accidents involving loss of control over radioactive material or toxic chemicals. DOE's TEPP was established to ensure that its contractors and state, tribal, and local emergency responders are prepared to respond promptly, efficiently, and effectively to accidents involving DOE shipments of radioactive materials.

If an accident that involved a release of radioactive material to the environment occurred, it would be remediated promptly in accordance with these procedures. These measures would help DOE minimize and mitigate any impacts on the environment.

A number of commenters indicated they believed shipping offsite waste would result in 800 LCFs. This value for transportation risk does not exist in this GTCC EIS. DOE believes that the value of approximately 800 LCFs, cited in the public comments, is from the results provided in the *Draft Global Nuclear Energy Partnership Programmatic Environmental Impact Statement* (GNEP PEIS) regarding transportation of spent nuclear fuel (SNF) and HLW. This value represents the maximum impacts associated with 50 years of transportation activities supporting the operations of all existing U.S. commercial light-water reactors if they all were replaced with high-temperature, gas-cooled reactors. The GNEP PEIS was canceled by DOE on June 29, 2009 (74 FR 31017).

Yakama Nation Environmental Restoration Waste Management Program,
Commenter ID No. L293

From: gtceiswebmaster@anl.gov
Sent: Monday, June 27, 2011 4:15 PM
To: mail_gtceisarchives; gtceiswebmaster@anl.gov; gtceis@anl.gov
Subject: Greater-Than-Class-C Low-Level Radioactive Waste EIS Comment GTCC10543
Attachments: 6-27-2011_Yakama_Nation_Comment_Package_GTCC_EIS_GTCC10543.pdf

Thank you for your comment, Russell Jim.

The comment tracking number that has been assigned to your comment is GTCC10543. Please refer to the comment tracking number in all correspondence relating to this comment.

Comment Date: June 27, 2011 04:15:24PM CDT

Greater-Than-Class-C Low-Level Radioactive Waste EIS Draft Comment: GTCC10543

First Name: Russell
Last Name: Jim
Organization: Yakama Nation Environmental Restoration Waste Management Program
Address: P.O. Box 151
City: Toppenish
State: WA
Zip: 98948
Country: USA
Email: rjim@vnerwm.com
Privacy Preference: Don't withhold name or address from public record
Attachment: C:\fakepath\6-27-2011_Yakama_Nation_Comment_Package_GTCC_EIS.pdf

Questions about submitting comments over the Web? Contact us at: gtceiswebmaster@anl.gov or call the Greater-Than-Class-C Low-Level Radioactive Waste EIS Webmaster at (630) 252-5705.

Yakama Nation Environmental Restoration Waste Management Program,
Commenter ID No. L293 (cont'd)



Confederated Tribes and Bands
of the Yakama Nation

Established by the
Treaty of June 9, 1855

June 21, 2011

Arnold Edelman, EIS Document Manager
Office of Environmental Management
U.S. Department of Energy
Cloverleaf Building, EM-43
1000 Independence Avenue, SW
Washington, DC 20585

Dear Mr. Edelman,

This letter summarizes the Yakama Nation's comments and concerns regarding the proposed action alternatives presented in the Draft Environmental Impact Statement for the Disposal of Greater-Than-Class C (GTCC) Low-Level Radioactive Waste and GTCC-Like Waste (DOE/EIS-0375-D). Our review of the Draft GTCC EIS has found that it is deficient in a number of areas, and will require substantial revisions. Key elements must be thoroughly redone in order for the revised Draft GTCC EIS to be considered technically and legally adequate. We have provided a detailed evaluation of the elements in the attachments that accompany this letter.

The Yakama Nation's vision for the cleanup and closure of the Hanford Site is based on several important principles:

- Recognition of the Yakama Treaty of 1855 as an applicable federal requirement.
- Compliance with Yakama Nation treaty rights, including full access to cultural and natural resources within the ceded land and aboriginal territory, including on the Hanford Site.
- Protection of Yakama Nation tribal members' health and the environment by reducing contamination to levels that are safe under any exposure scenario and for all tribal uses.
- Implementation of permanent cleanup actions that do not rely on the use of long-term institutional controls, stewardship, or surface barriers to prevent exposure to dangerous radionuclides, hazardous chemicals, or other substances.

The key issues or deficiencies in the Draft GTCC EIS include, but are not limited to, the following:

- The Hanford Site is not an appropriate location for the disposal of any additional off-site nuclear waste of any classification for a number of reasons, including the site's proximity to the Columbia River and the high hydraulic conductivity of Hanford soils, the presence of extensive contamination throughout site soils and groundwater, and the direct conflict with

Post Office Box 151, Fort Road, Toppenish, WA 98948 (509) 865-5121

L293-1

As discussed in Section 1.4.3, the consideration of Hanford as well as the other sites is based on mission compatibility (i.e., only DOE sites that currently have radioactive waste disposal facilities). These DOE sites have supporting infrastructure already in place that might be useful for future potential GTCC waste disposal activities. Other factors considered were sufficient depth to groundwater, not be located in a 100 year floodplain or in wetlands, consistent with current land use plans and have a low probability for erosion, mass wasting, faulting, folding, and seismic activity that would occur often enough and to a large enough extent that the facility's performance would be affected.

DOE's ROD 78 FR 75913 dated December 13, 2013, stated that DOE has deferred a decision on importing waste from other DOE sites (with limited exceptions as described in the Settlement Agreement with the State of Washington Department of Ecology) for disposal at Hanford at least until WTP is operational.

DOE is performing environmental restoration activities at the Hanford Site. The ongoing cleanup effort will continue.

Regarding the Yakama Nation's perspectives about tribal treaty rights allowing unrestricted access at Hanford, DOE respectfully disagrees. This EIS presents relevant and essential information important to the evaluation of potential environmental impacts, consistent with NEPA's primary goal of full disclosure to the public as well as agency decision makers. This includes discussion of the history of the settlement of Hanford and the treaties entered into between tribal nations and the U.S. government. There is substantial documentation indicating that the tribes understood at the time these treaties were signed that the lands were no longer "unclaimed" when they were claimed for the purposes of the white settlers' activities. DOE is not aware of any judicially recognized mechanisms that would allow these lands to revert to "unclaimed" status merely through the process of being acquired by the federal government. The portion of Hanford that remained in the public domain in 1943, as well as all the acquired lands, were closed to all access initially under authority of the War Powers Act and then under authority of the AEA. It is therefore DOE's position that the Hanford lands are neither "open" nor "unclaimed." However, the Yakama Nation are active participants in decisions regarding Hanford and their concerns have been considered by DOE in the development of this GTCC EIS.

L293-1

Yakama Nation Environmental Restoration Waste Management Program,
Commenter ID No. L293 (cont'd)

ongoing site cleanup activities that have cost tens of billions of dollars over the past 20 years.

- The cumulative impacts analysis for the Hanford Site fails to account for the extensive, and in many cases severe contamination already in place. The levels of contamination observed means that addition of any new waste will push already unacceptable exceedances of applicable or relevant and appropriate requirements even higher.
- Greater-Than-Class-C waste poses a serious threat to human health and the environment, and should be disposed of in accordance with the requirements set by the Nuclear Regulatory Commission in 10 CFR 61, in a deep geologic repository. While the WIPP facility is considered, the Draft GTCC does not consider a new deep geologic repository for disposal of the identified source term. This alternative should be included and evaluated.
- The proposed action alternatives incorporate a large number of unrealistic and unreasonable assumptions in order to meet performance requirements. Evaluation of many of these assumptions demonstrates that the alternatives would not be able to meet even the most basic performance criteria for disposal of the wastes.
- The proposed action alternatives presented in the Draft GTCC EIS rely heavily on the use of institutional controls to reduce exposure to disposed waste. Such designs do not respect Treaty Rights or federal trust responsibilities, and are not realistic over the timeframes required for GTCC waste to decay to safe levels.
- The supporting analysis for the proposed action alternatives is deficient. In particular the sensitivity analysis fails to evaluate any parameters under circumstances worse than the USDOE's base case, which is itself unrealistic.

The Yakama Nation does not support inclusion of the Hanford Site as a candidate location for the construction of a new GTCC waste disposal facility. A preliminary analysis should have resulted in this site's disqualification from further consideration. Furthermore, the Yakama Nation does not support the importation of new, highly radioactive, and long-lived waste to the site for shallow disposal.

The selection of any alternative that includes the importation of additional waste to the Hanford Site would result in substantial violations of federal environmental standards (including drinking water standards) over a broad geographic area for a period of thousands of years, and would increase already severe threats to the Columbia River, a resource of cultural, regional, and national importance.

The presence of high levels of contamination has already resulted in Yakama tribal members being unable to fully exercise their Treaty-reserved rights at the Hanford Site. Implementation of the proposed action alternatives would constitute further violation of these rights. In the event that Hanford remains a location under consideration, the Yakama Nation has provided extensive comments regarding necessary revisions to the proposed action alternatives; however, these comments should not be construed in any way as an acceptance of the proposal to develop, operate, and manage a new disposal facility at the Hanford Site.

L293-1
(Cont.)

L293-2

L293-3

L293-4

L293-5

L293-6

L293-7

L293-2 DOE has considered cumulative impacts at the Hanford Site in this GTCC EIS. The disposal of GTCC LLRW and GTCC-like waste at the Hanford Site could result in environmental impacts that may warrant mitigation for Tc-99 and I-129 through limiting receipt of these waste streams (see Table 6.2.4.2 and Figure 6.2.4.1 in this EIS).

DOE's ROD 78 FR 75913 dated December 13, 2013, stated that DOE has deferred a decision on importing waste from other DOE sites (with limited exceptions as described in the Settlement Agreement with the State of Washington Department of Ecology) for disposal at Hanford at least until WTP is operational.

L293-3 DOE did not evaluate developing a geologic repository exclusively for disposal of GTCC LLRW and GTCC-like wastes because DOE determined that such an alternative is not reasonable due to the time and cost associated with siting a deep geologic repository and the relatively small volume of GTCC LLRW and GTCC-like wastes identified in the GTCC EIS. DOE believes that the results presented in this EIS for the WIPP geologic repository alternative are indicative of the high degree of waste isolation that would be provided by disposal in a geologic repository. DOE has included analysis of generic commercial facilities in the event that a facility could become available in the future. In that case, before making a decision to use a commercial facility, DOE would conduct further NEPA reviews, as appropriate.

DOE agrees that use of a geologic repository would be a protective and safe method for the disposal of the entire inventory of GTCC LLRW and GTCC-like wastes. The GTCC EIS evaluation for the WIPP geologic repository alternative supports this statement. However, the degree of waste isolation provided by a geologic repository may not be necessary for all of the GTCC LLRW and GTCC-like wastes evaluated in the GTCC EIS.

While 10 CFR Part 61 identifies one NRC-approved method for GTCC LLRW disposal (disposal in a geologic repository), these regulations also indicate that other disposal methods could be approved. The GTCC EIS evaluates three land disposal methods (i.e., enhanced near-surface trench, intermediate-depth borehole, and above-grade vault).

The GTCC EIS evaluation indicates that certain wastes (e.g., those containing short-lived radionuclides such as Cs-137 irradiators) could be safely disposed of in properly designed land disposal facilities at sites with suitable characteristics, such as low precipitation rates, high soil distribution coefficients, and sufficient depths to groundwater. Based on the GTCC EIS evaluation, land disposal facilities located in arid climates (e.g., NNSS and WIPP Vicinity) would isolate radionuclides for a sufficient period of time to allow for significant radioactive decay to occur. The GTCC EIS evaluation also indicates that land disposal methods employed at sites with suitable characteristics would be viable and safe alternatives for the disposal of GTCC LLRW.

L293-4 The EIS analysis is used to assess the viability of an alternative as well as its relative performance compared to the other alternatives. Exclusion of a reasonable alternative from the EIS without first evaluating the site is contrary to a thorough NEPA analysis. All alternatives are retained in the Final EIS because such evaluations are needed to support selection of the preferred alternative. In addition, as discussed in Section 1.4.2, the conceptual disposal facility designs analyzed in the EIS could be modified to perform better in specific locations. Thus, poor performance in the EIS analysis does not necessarily exclude an alternative from consideration.

In performing these evaluations, a number of engineering measures were included in the conceptual facility designs to minimize the likelihood of contaminant migration from the disposal units. No facility design can guarantee that radionuclide migration from the facility would not occur over and beyond a 10,000-year time period. It was assumed that these

Yakama Nation Environmental Restoration Waste Management Program,
Commenter ID No. L293 (cont'd)

We request that you revise the Draft GTCC EIS to correct the deficiencies that have been identified and described in this letter and the accompanying comments. We also request that a revised Draft GTCC EIS that identifies a preferred alternative be circulated for public review and comment.

Sincerely,



Harry Smiskin, Chairman, Yakama Tribal Council

cc/enc: Moses Squeochs, General Council Chairman
Donald Isadore, Jr., Yakama Tribal Council
Warren Spencer, Jr., Yakama Tribal Council
Sam Jim, Sr., Yakama Tribal Council
Phil Rigdon, YN DNR Deputy Director
Russell Jim, Manager, ERWM Program

L293-8

measures would perform similarly for all conceptual designs, remaining intact for 500 years after the disposal facility closed. After 500 years, the barriers would gradually fail. To account for these engineered features in the modeling calculations, it was assumed that the water infiltration to the top of the waste disposal area would be zero for the first 500 years and then 20% of the natural rate for the area for the remainder of the time period (through 10,000 years). A water infiltration rate of 20% of the natural rate for the area was only used for the disposal area; the natural background infiltration rate was used at the perimeter of the waste disposal units. Again, this approach enables a comparative evaluation of the influence that site-specific environmental factors would have on the potential migration of radionuclides from the disposal facilities and the potential impacts on human health. It should be emphasized that project- and site-specific engineering factors would be incorporated into the actual facility designs of the site or sites selected in a ROD to dispose of GTCC LLRW and GTCC-like wastes.

DOE recognizes that modeling potential releases of radionuclides from the conceptual disposal sites far into the future approximates what might actually occur. Sufficient detail was included in these designs for use in the EIS analyses, consistent with the current stage of this process. Some of the input values may change in the future and could result in higher impacts (such as from increased precipitation at some sites due to climate change), while others could result in lower impacts (due to decreased precipitation).

L293-5 DOE appreciates the input provided by the Santa Clara Pueblo, the Pueblo de San Ildefonso, and the Confederated Tribes and Bands of the Yakama Nation on the EIS, both in the tribal narratives and in comments on the Draft EIS. This input was considered by DOE in identifying the preferred alternative.

In the EIS, it was assumed that institutional controls of the land disposal units would be maintained for 100 years and that corrective measure could be implemented during this time period to ensure that the engineered barriers lasted for at least 500 years. This assumption is consistent with the institutional control time frame given in both NRC and DOE requirements and was determined to be a reasonable approach for assessing the long-term performance of the disposal units in the EIS.

In evaluating the performance of the proposed land disposal facilities, a number of engineering measures were assumed in the conceptual facility designs to minimize infiltration of water into the wastes and thereby minimize contaminant migration from the disposal units. These measures would also limit exposure pathways, such as the ingestion of plants having very long roots. It was assumed in this EIS that these measures would remain intact for 500 years after the disposal facility closed. Any defects identified in the disposal facilities were assumed to be corrected during the 100-year institutional control period, so that the 500-year time period would be met.

While this time period of 500 years may not be long enough to be of relevance to various American Indian tribes, it was determined to be a reasonable basis to use for comparing the merits of various land-disposal concepts and sites in the EIS and to allow for the selection of a preferred alternative.

L293-6 The stability of one of the waste forms (i.e., the grout material for Other Waste) was evaluated in the sensitivity analysis by varying the effective retardation period of the release of radionuclides. There are many parameters that could affect the modeling results that could be addressed in a sensitivity analysis. However, the essential effects of many of these parameters are the same (i.e., affecting when and how much water would enter the waste containers and contact the waste materials). In the GTCC EIS, both the influence of the water infiltration rate and the influence of when water would enter the waste containers on the dose results were addressed.

Yakama Nation Environmental Restoration Waste Management Program,
Commenter ID No. L293 (cont'd)

Attachment 1

**Yakama Nation ERWM Program General Comments on the
Draft Environmental Impact Statement for the Disposal of Greater-Than-Class C (GTCC)
Low-Level Radioactive Waste and GTCC-Like Waste (DOE/EIS-0375-D)**

This Attachment 1 presents the Yakama Nation Environmental Restoration and Waste Management (ERWM) Program's general comments on the U.S. Department of Energy's (USDOE) Draft Environmental Impact Statement for the Disposal of Greater-Than-Class C (GTCC) Low-Level Radioactive Waste and GTCC-Like Waste (referred to here as the Draft GTCC EIS). The general comments presented here summarize the major issues and concerns identified by ERWM on behalf of the Yakama Nation. Attachment 2 presents targeted comments keyed to specific sections or pages of the Draft GTCC EIS. Attachment 3 provides additional detailed comments prepared by the Institute for Energy and Environmental Research (IEER).

ERWM finds that all of the proposed action alternatives are deficient in numerous ways. Primarily, the proposed action alternatives do not comply with environmental regulations or important criteria such as the federal drinking water standards. Furthermore, the proposed action alternatives will result in unacceptable environmental consequences. It is our position that the Draft GTCC EIS must be thoroughly reanalyzed and reevaluated. A revised EIS that addresses the issues and deficiencies identified by the Yakama Nation in its letter, to which this document is an attachment, should be released for public review. The key issues and deficiencies are expanded upon below.

Comment 1. Hanford should not be considered for construction of a GTCC waste disposal facility.

Comment 1a. The Hanford Site is not appropriate for the disposal of additional nuclear waste.

The Hanford Site was evaluated in 1942 as a location on which to build a massive wartime industrial production facility. The features that were found attractive at that time included access to abundant clean water in the Columbia River; loose gravelly and sandy soils covering much of the site; the presence of large quantities of electrical power; access to railroads; significant tracts of land that remained undeveloped; and the relative ease with which the land could be condemned, its residents evicted, and the property withdrawn from the public domain (Gerber, 2002).

L293-9

Modeling results can be very sensitive to some factors, such as the Kd for a given radionuclide. Care was taken to use average site values for such input parameters for comparison among alternatives. More extensive and detailed sensitivity analysis may need to be conducted during the implementation phase for a GTCC LLRW and GTCC-like waste disposal facility, based on more specific information on the engineering designs of the disposal facilities and their influence on the integrity of waste packages, waste containers, barrier materials, and the surrounding native soil (e.g., location-specific Kd values); however, the analysis provided in the EIS is sufficient to inform site and technology selection decisions.

L293-7 DOE's ROD 78 FR 75913 dated December 13, 2013, stated that DOE has deferred a decision on importing waste from other DOE sites (with limited exceptions as described in the Settlement Agreement with the State of Washington Department of Ecology) for disposal at Hanford at least until WTP is operational.

L293-8 A preferred alternative is not required to be included in a Draft EIS. The Council on Environmental Quality regulations in 40 CFR 1502.14(e) specify that the section on alternatives in an EIS shall identify the agency's preferred alternative or alternatives, if one or more exists, in the Draft EIS and identify such alternative(s) in the Final EIS unless another law prohibits the expression of such a preference; that is, a preferred alternative shall be identified in the Draft EIS if one exists. If no preferred alternative has been identified at the Draft EIS stage, a preferred alternative need not be included. By the time the Final EIS is filed, 40 CFR 1502.14(e) presumes the existence of a preferred alternative and requires its identification in the Final EIS unless another law prohibits the expression of such a preference.

DOE did not have a preferred alternative at the time of issuance of the Draft EIS because of the complex nature of the proposed action and the potential implications for disposal of GTCC LLRW and GTCC-like wastes. To seek public input on how to identify a preferred alternative for inclusion in the Final EIS, the Draft EIS presented considerations for developing a preferred alternative in the Summary (in Section S.6) and in Section 2.9. As required by 40 CFR 1502.14(e), the Final EIS contains a preferred alternative for the disposal of GTCC LLRW and GTCC-like wastes (see Section 2.10). In developing the preferred alternative, DOE took into consideration public comments on the Draft EIS, public EIS scoping comments, and other factors identified in Sections S.6 and 2.9 of the EIS.

The publication by the EPA of a NOA of the Final EIS in the Federal Register initiated a 30-day public availability or "waiting" period. While the availability period is not a formal public comment period, the public can comment on the Final EIS, including the preferred alternative, prior to final agency action. Comments received will be addressed by DOE in a ROD.

As required by the Energy Policy Act of 2005, (P.L. 109-58), DOE must submit a Report to Congress that includes the alternatives considered in the EIS and await Congressional action before making a final decision regarding which alternative(s) to implement. The Report to Congress will be made available to the public on the GTCC EIS website (<http://www.gtcceis.anl.gov/>).

L293-9 See response to L293-1.

Yakama Nation Environmental Restoration Waste Management Program,
Commenter ID No. L293 (cont'd)

Yakama Nation ERWM Program GTCC EIS Comments
Attachment 1
Page 2

With the exception of the relatively large expanse of land that remains empty under federal control, *none* of the characteristics described above is considered desirable for the purposes of disposing of long-lived, dangerous radioactive waste. Many of these characteristics, such as proximity to the Columbia River and the high hydraulic conductivity of Hanford soils (i.e., loose gravelly and sandy) are *undesirable* when disposing of nuclear waste.

In the 1980s, during the federal government's search for a location to construct a high-level waste repository, the Hanford Site was found to have several questionable site features, including high geothermal gradients, rapid groundwater flow rates, unusually high shear stresses in bedrock basalt, and local seismicity that made the site unsuitable for repository construction (White, 1983). Regardless of these characteristics, the status of the Hanford Site as a solely federally held, pre-existing facility that was already substantially contaminated with nuclear waste proved attractive enough that it was included on the short list for consideration as the site of a high-level waste repository.

Based on the analyses and supporting documentation provided by the Draft GTCC EIS, it appears that the Hanford Site's inclusion as an area under consideration for construction of a GTCC low-level radioactive waste (LLRW) disposal facility is not based on advantageous site characteristics or on sound technical analysis, but rather on political expediency and present site status that includes high levels of pre-existing contamination. While the urgencies associated with World War II and the relative lack of knowledge regarding the dangers, toxicity, environmental behavior, and lasting legacy of nuclear waste may not have provided sufficient reason to reconsider construction of the Hanford Site in 1942, we can apply significantly more information and collective knowledge today when evaluating the site as a location for future disposal of highly radioactive and long-lived nuclear waste.

The past activities at the Hanford Site have resulted in extensive contamination throughout site soils and groundwater, making the addition of new waste to the site unacceptable from both a moral and regulatory perspective. Furthermore, the importation of new waste to Hanford is directly contrary to the goals and actions of site cleanup activities that have cost tens of billions of dollars over the past 20 years. Finally, the importation of new waste to the Hanford Site is not compatible with Yakama Nation treaty rights.

Recommendation 1a. The Hanford Site should be removed from consideration in the revised Draft GTCC EIS. The Hanford Site should not be considered further as an appropriate location for the disposal of additional off-site nuclear waste¹.

Comment 1b. The Hanford Site is geologically unsuitable for GTCC waste disposal.

¹ Comments that propose revisions to Hanford Site-related content in the Draft GTCC EIS have been included in the event that Hanford remains under consideration, against ERWM's recommendation. Inclusion of revision comments regarding the Hanford Site should not be construed in any way to imply, implicitly or otherwise, that the Hanford Site is an acceptable location for disposal of nuclear waste.

GTCC FINAL Narrative_Altch1_05-22-11.docx

L293-10 The site-specific environmental factors – seismicity, volcanism, and flooding – were evaluated in the EIS as appropriate. The results of the evaluation were taken into consideration in identifying the preferred alternative presented in the Final EIS.

L293-9
(Cont.)

L293-10

Yakama Nation Environmental Restoration Waste Management Program,
Commenter ID No. L293 (cont'd)

Yakama Nation ERWM Program GTCC EIS Comments
 Attachment 1
 Page 3

Nuclear Regulatory Commission (NRC) licensing requirements for land disposal facilities (10 CFR 61) require that for a site to be considered suitable for near-surface disposal, it must be devoid of tectonic processes such as faulting, folding, seismic activity, or volcanism. The Hanford Site is located within the seismically active Pasco Basin within the larger Yakima Fold Belt, where tectonic compression continues to the present day (Reidel et al., 1993; Bakun et al., 2002).

Earthquakes in the Hanford region have been calculated to have magnitudes as large as 6.8 (intensity magnitude, M_i ; the moment magnitude, M_w , was 6.5 to 7.0 at 95 percent confidence) (Bakun et al., 2002). The potential for earthquakes with magnitudes greater than 7.1 has been identified through local paleoseismic studies (West et al., 1996). In 1872, shaking from a magnitude 6.8 earthquake resulted in "damage intensities [of Modified Mercalli Intensity VI^2] that extended west throughout the now densely populated Puget Sound basin and southeast to beyond the Hanford Nuclear Reactor Site" (Stover and Coffman, 1993). The event triggered many landslides within the Columbia River Gorge and resulted in other subsidence in the area.

Hanford was regularly swept by massive glacial outburst flooding from Glacial Lake Missoula in the recent geologic past. These floods deposited the glaciofluvial sedimentary units that currently mantle the site bedrock (Fecht and Marceau, 2006), which the proposed action alternatives would use for permanent disposal.

Further, the Grand Coulee Dam (constructed 1933–1942) is approximately 200 miles upstream of the Hanford Site on the Columbia River. While the Draft GTCC EIS briefly considers the extent of a probable maximum flood in the Columbia River and potential 25 percent and 50 percent failure of Grand Coulee Dam, no analysis was made of the effects of a 100 percent dam failure or glacial outburst flooding of the site.

Such events should be considered in the site selection process given the timescale over which GTCC and GTCC-like waste will remain dangerous. Large erosive events such as those that could result from glacial outburst flooding or wholesale failure of dams on the Columbia River could remove a significant portion of the overburden used to isolate the disposed waste. Volcanic damming of the Columbia River or the upstream pooling of water that occurs during glacial outburst flooding could result in complete submersion of the disposal facility³. The USDOE presumes that the rate of waste migration is directly proportional to the infiltration rates,

² *...[T]he Modified Mercalli Intensity Scale...[is] composed of 12 increasing levels of intensity that range from imperceptible shaking to catastrophic destruction...The lower numbers of the intensity scale generally deal with the manner in which the earthquake is felt by people. The higher numbers of the scale are based on observed structural damage...[An abbreviated description of Level VI intensity is:] Felt by all, many frightened. Some heavy furniture moved; a few instances of fallen plaster. Damage slight⁴ (USGS 2011b).

³ Pooling of water at elevations that exceed those observed at the Central Plateau has been recorded in the geologic record through deposition of the Touchet Beds, which were described by Newcomb et al. (1972).

L293-10
 (Cont.)

Yakama Nation Environmental Restoration Waste Management Program,
Commenter ID No. L293 (cont'd)

Yakama Nation ERWM Program GTCC EIS Comments
Attachment 1
Page 4

which means that such an event could result in large-scale mobilization of wastes over a very short period, invalidating many of the assumptions used to control the dose to exposed individuals outside the disposal facility.

Recommendation 1b. The revised Draft GTCC EIS should acknowledge and address the risks described in this Attachment 1 and the relevant references. Any further analysis performed for the Hanford Site should evaluate scenarios in detail that include:

- 100 percent failure of Grand Coulee Dam and lower Columbia River dams
- Volcanic damming of the Columbia River and flooding of the Hanford Site
- Glacial outburst flooding at the Hanford Site

Comment 2. GTCC waste should be disposed of in a deep geologic repository.

In accordance with NRC regulation 10 CFR 61, GTCC waste must be disposed of in a deep geologic repository unless alternative methods of disposal are proposed to and approved by the NRC. This regulation was enacted in due deference to the danger posed by the high activity, long half-lives, and high biologic quality factors of the wastes that fall into the GTCC classification. The proposed action alternatives included in the Draft GTCC EIS do not adequately isolate and contain the wastes, protect the public, or limit public exposure sufficiently to meet the requirements in 10 CFR 61.

The proposed action alternatives are clearly deficient when evaluated in the context of the highly variable and frequently suboptimal conditions imposed by the real world, as opposed to the static and favorable conditions used in the Draft GTCC EIS to evaluate the alternatives' performance. Attachment 3 provides an alternative analysis of the proposed action alternatives. The alternative analysis demonstrates using *the same information provided in the Draft GTCC EIS* that the proposed action alternatives fail to meet regulatory compliance using the unaltered RESRAD-OFFSITE modeling software. Although appropriate documentation was not provided in the Draft GTCC EIS, it appears that the USDOE chose to modify the existing, accepted software in order to achieve an acceptable level of performance from the proposed action alternatives. This approach is not acceptable and must not be used in the revised Draft GTCC EIS or for the purposes of comparing the proposed action alternatives.

The USDOE has justified its failure to include an alternative for a new deep geologic repository on the premise that the total waste volume does not justify construction of a new facility. While this claim could be acceptable when considered in a vacuum, significant evidence suggests that a new deep geologic repository is required for the nation's nuclear waste and that constructing one should therefore be seriously considered. This evidence includes the Blue Ribbon Commission on America's Nuclear Future's consideration of a deep geologic repository for defense-related high-level waste, as well as the presence of many other orphan wastes that are

GTCC FINAL Narrative_Attch1_09-22-11.docx

L293-11 See response to L293-3.

L293-10
(Cont.)

L293-11

Yakama Nation Environmental Restoration Waste Management Program,
Commenter ID No. L293 (cont'd)

Yakama Nation ERWM Program GTCC EIS Comments
Attachment 1
Page 5

not addressed in the Draft GTCC EIS, such as the large amounts of depleted or recycled uranium that are also unsuitable for shallow land disposal (see Attachment 3 for additional discussion of orphan source terms).

Finally, the justification applied by the USDOE in rejecting consideration of a new deep geologic repository ignores that such a facility, if built to appropriate standards, could be used for disposal of other highly radioactive and long-lived wastes. This is the same logic that is applied to *justify* the inclusion of the Waste Isolation Pilot Project (WIPP) facility for disposal of GTCC waste.

Recommendation 2. The revised Draft GTCC EIS should include an alternative for construction of a new deep geologic repository of appropriate size and specifications to meet all NRC 10 CFR 61 requirements for the identified source term, as well as other orphan wastes that have not yet been addressed. The new deep geologic repository alternative should be identified as the preferred alternative.

Comment 3. Transuranic waste should be disposed of in accordance with regulatory requirements regardless of origin.

Waste inventory information provided in Appendix B of the Draft GTCC EIS identifies 402,000 curies of radioactivity that are attributable to transuranic (TRU) radionuclides. The estimated total volume of all the waste destined for disposal is approximately 12,000 cubic meters. Assuming that the entire waste volume has the density of solid rock⁴, there is still enough TRU-derived activity to contaminate every cubic meter of waste proposed in the Draft GTCC EIS to more than 100 times the level specified in the Environmental Radiation Protection Standards (40 CFR 191). The Draft GTCC EIS identifies "about 56 percent of the entire waste inventory...[as meeting] the USDOE definition of TRU waste" (p. 3-18). This suggests that the aforementioned waste contains *at least* 100 times the transuranic radionuclide activity required for deep geologic disposal.

The origin of the TRU radionuclides addressed by the Draft GTCC EIS should be irrelevant when considering disposal alternatives, especially given that the USDOE has now assumed responsibility for the waste's disposal. The long half-lives and high biologic quality factor associated with transuranic waste justify the stringent disposal requirements described in 40 CFR 191. It is not acceptable to use the Draft GTCC EIS as an opportunity to improperly dispose of these dangerous wastes.

⁴ Density of rock is approximately 2,800 kg/m³. While the assumption that the entire inventory has the density of solid rock is not realistic, any correction for a more appropriate lower unit weight will only increase the concentration of transuranics per gram.

GTCC FINAL Narrative_Atch1_06-22-11.docx

L293-12 DOE recognizes that including GTCC-like wastes within the scope of this EIS along with GTCC LLRW may complicate the implementation of GTCC LLRW disposal alternative(s). However, DOE determined that the most efficient approach was to address both types of waste, which have many similar physical and radioactive characteristics, in a single NEPA process. DOE's intent is to facilitate the overall process for addressing the disposal needs of both waste types. Issues associated with potential regulatory changes or NRC licensing would be addressed as necessary to enable implementation.

DOE agrees that use of a geologic repository would be a protective and safe method for the disposal of the entire inventory of GTCC LLRW and GTCC-like wastes. The GTCC EIS evaluation for the WIPP geologic repository alternative supports this statement. However, the degree of waste isolation provided by a geologic repository may not be necessary for all of the GTCC LLRW and GTCC-like wastes evaluated in the GTCC EIS. The GTCC EIS evaluation indicates that certain wastes (e.g., those containing short-lived radionuclides such as Cs-137 irradiators) could be safely disposed of in properly designed land disposal facilities at sites with suitable characteristics, such as low precipitation rates, high soil distribution coefficients, and sufficient depths to groundwater. Based on the GTCC EIS evaluation, land disposal facilities located in arid climates (e.g., NNSS and WIPP Vicinity) would isolate radionuclides for a sufficient period of time to allow for significant radioactive decay to occur.

While 10 CFR Part 61 identifies one NRC-approved method for GTCC LLRW disposal (disposal in a geologic repository), these regulations also indicate that other disposal methods could be approved. The GTCC EIS evaluates three land disposal methods (i.e., enhanced near-surface trench, intermediate-depth borehole, and above-grade vault). The GTCC EIS evaluation indicates that land disposal methods employed at sites with suitable characteristics would be viable and safe alternatives for the disposal of GTCC LLRW.

L293-11
(Cont.)

L293-12

Yakama Nation Environmental Restoration Waste Management Program,
Commenter ID No. L293 (cont'd)

Yakama Nation ERWM Program GTCC EIS Comments
Attachment 1
Page 6

The Draft GTCC EIS indicates that 56 percent of the entire waste inventory is derived from cleanup operations at the West Valley Site, New York, and that much of this waste meets the USDOE definition of TRU waste. Importation of waste from the West Valley Site is directly contrary to the goals and objectives of more than 20 years of cleanup work performed at the Hanford Site. The intent of the West Valley Demonstration Project Act (P.L. 96-368), which charged the USDOE with responsibility for cleaning up the West Valley Site, was not that the USDOE would simply move dangerously contaminated waste to an alternative federally held site with a larger pre-existing inventory of waste. The existing level of contamination at the Hanford Site does not provide justification for importation of additional waste; on the contrary, it should be treated as a strong deterrent.

Recommendation 3. The revised Draft GTCC EIS should not consider waste that meets the definition of transuranic waste and transuranic-like waste for inclusion in any of the Draft GTCC EIS action alternatives or other alternatives that utilize shallow land burial. These wastes should be disposed of in a deep geologic repository.

The revised Draft GTCC EIS should include an alternative for construction of a new deep geologic repository that meets the disposal requirements for transuranic waste, including transuranic waste from the West Valley Site.

Comment 4. The evaluation of cumulative impacts at Hanford is deficient.

The cumulative impacts analysis in the Draft GTCC EIS does not take into consideration the total inventory of pre-existing radioactive waste at the Hanford Site. The Draft GTCC EIS must consider all waste that is excluded or not discussed in the Tank Closure and Waste Management (TCWM) EIS (USDOE, 2009). Existing contamination at the site is the result of extensive waste disposal activities during plutonium production that included liquid waste discharges into open bottom cribs and trenches; leakage from waste tanks in the Central Plateau; operation of the US Ecology Low-Level Radioactive Waste Dump; and cleanup activities performed at the site. Importation of additional waste to the Hanford Site contravenes the efforts that have been pursued by the USDOE, the Washington State Department of Ecology, and the U.S. Environmental Protection Agency (USEPA) for the past 20 years to stabilize and remove radioactive contamination at the Hanford Site at a cost of tens of billions of dollars.

The high concentrations of technetium-99 (Tc-99) and iodine-129 (I-129) expected to be in Hanford groundwater (350,000 and 697 picocuries per liter [pCi/L], respectively) as a result of waste disposal activities identified in the TCWM EIS for Alternative Combination 1 will significantly exceed compliance with USEPA groundwater maximum contaminant levels (MCLs). In the case of beta-emitting radionuclides, exceedances of the drinking water MCL range in magnitude from 700 times (in the case of I-129 alone) to more than 1,000 times (I-129 and Tc-99 together) the allowable limit.

GTCC FINAL Narrative_Atch1_05-22-11.docx

L293-13 See response to L293-2.

L293-12
(Cont.)

L293-13

J-730

January 2016

Yakama Nation Environmental Restoration Waste Management Program,
Commenter ID No. L293 (cont'd)

Yakama Nation ERWM Program GTCC EIS Comments
Attachment 1
Page 7

While the USDOE has found it prudent in the Draft GTCC EIS to suggest not adding waste that includes significant Tc-99 or I-129, such a measure would require the construction of multiple disposal facilities and ignores the reality that many other radionuclides are already present in the Hanford subsurface and groundwater including, but not limited to, strontium-90, cesium-137, and tritium. The addition of any beta-emitting radionuclide, or radionuclides with intermediate or long-lived beta-emitting daughter products, would ultimately result in even greater exceedances of applicable regulations, since all beta-emitters contribute toward a common MCL.

High levels of contamination are not confined only to beta-emitting radionuclides. As was the case with I-129 and Tc-99, the TCWM EIS estimates that uranium groundwater contamination will greatly exceed the applicable MCL of 30 pCi/L, even before the addition of the new wastes identified in the Draft GTCC EIS. However, the Draft GTCC EIS fails to acknowledge that such an exceedance would already exist and does not suggest limiting the amount of uranium brought to the Hanford Site.

Finally, the Draft GTCC EIS fails to acknowledge and evaluate the significant concentrations of transuranic radionuclides already disposed of in the US Ecology site, the high concentrations of plutonium that are expected to reach the river corridor, and the large amounts of transuranics buried or discharged on the Hanford Site prior to 1970 (see Attachment 3 for additional detail). The Draft GTCC EIS *does*, however, propose to import more of all of these substances to the Hanford Site under the proposed action alternatives.

Recommendation 4. The cumulative impacts analyses provided in the Draft GTCC EIS are so deficient that they should be discarded and redone in their entirety for the revised Draft GTCC EIS to take into full account the existing contamination as well as contamination that will result from future cleanup and disposal activities.

Comment 5. The Draft GTCC EIS analysis of proposed action alternatives is deficient.

Comment 5a. Analysis of proposed action alternatives incorporates numerous unrealistic assumptions in order to "meet" performance requirements.

The Draft GTCC EIS analysis of the performance of the proposed action alternatives incorporates multiple simplifying assumptions, some stated explicitly and others implied. Many of these assumptions are not well justified and are generally unrealistic. Selected assumptions made in the Draft GTCC EIS are outlined below to provide some context for additional comments that follow. Flawed assumptions used in analysis of the proposed action alternatives include the following:

- Surface barriers will function flawlessly, preventing all infiltration into the waste interval for a minimum of 500 years.

GTCC FINAL Narrative_Abch1_06-22-11.docx

L293-14 The EIS analyses are based on conceptual engineering information and necessitated the use of a number of simplifying assumptions. This approach is consistent with NEPA, which requires such analyses to be made early in the decision-making process. The various land disposal conceptual designs were assumed to be constructed and operated in a comparable manner at each of the various sites. Information on the conceptual engineering designs for the three proposed land disposal methods is provided in Section D.3 of Appendix D in the EIS. By using the same conceptual designs at all of the sites evaluated in the GTCC EIS, except for cases where a design did not apply (e.g., an intermediate-depth borehole at a site with shallow groundwater), the potential impacts (e.g., radionuclides reaching the groundwater) at the different environmental settings could be readily compared.

In performing these evaluations, a number of engineering measures were included in the conceptual facility designs to minimize the likelihood of contaminant migration from the disposal units. No facility design can guarantee that radionuclide migration from the facility would not occur over and beyond a 10,000-year time period. It was assumed that these measures would perform similarly for all conceptual designs, remaining intact for 500 years after the disposal facility closed. After 500 years, the barriers would gradually fail. To account for these engineered features in the modeling calculations, it was assumed that the water infiltration to the top of the waste disposal area would be zero for the first 500 years and then 20% of the natural rate for the area for the remainder of the time period (through 10,000 years). A water infiltration rate of 20% of the natural rate for the area was only used for the disposal area; the natural background infiltration rate was used at the perimeter of the waste disposal units. Again, this approach enables a comparative evaluation of the influence that site-specific environmental factors would have on the potential migration of radionuclides from the disposal facilities and the potential impacts on human health. It should be emphasized that project- and site-specific engineering factors would be incorporated into the actual facility designs of the site or sites selected in a ROD to dispose of GTCC LLRW and GTCC-like wastes.

DOE recognizes that modeling potential releases of radionuclides from the conceptual disposal sites far into the future approximates what might actually occur. Sufficient detail was included in these designs for use in the EIS analyses, consistent with the current stage of this process. Some of the input values may change in the future and could result in higher impacts (such as from increased precipitation at some sites due to climate change), while others could result in lower impacts (due to decreased precipitation).

DOE believes that 500 years is a realistic time period for the longevity of the types of engineering barriers assumed in the analyses. DOE believes the approach and the assumptions used in the EIS are reasonable for performing the comparative analysis of alternatives required by NEPA. For example, as discussed in Section E.2.2, the assumption of a 20% natural background infiltration rate after 500 years was based on a study at SRS (Phifer et al. 2007) that indicated that after 10,000 years, the closure cap at the F-area would still shed about 80% of the cumulative precipitation falling on it, with an effectiveness that would be greater before 10,000 years, then decrease very slowly after 10,000 years. The approach used in the EIS is more conservative than indicated by this study.

Estimated radiation doses and LCFs were calculated for each site and disposal concept for 10,000 years, and if the peak impact did not occur during this time frame, the analysis was extended out to 100,000 years. DOE believes that the assumptions made to support the long-term modeling calculations for the groundwater pathway are reasonable and enable a comparative evaluation of the impacts between alternatives. The results of the evaluation presented in the EIS are sufficient to inform the selection of sites and methods for disposal. Site-specific NEPA reviews would be conducted as needed.

L293-13
(Cont.)

L293-14

Yakama Nation Environmental Restoration Waste Management Program,
Commenter ID No. L293 (cont'd)

Yakama Nation ERWM Program GTCC EIS Comments
 Attachment 1
 Page 8

- Surface barriers will not become degraded as a result of environmental weathering or human or biological activity for a minimum of 500 years.
- Eroded or otherwise degraded barriers will maintain a minimum of 80 percent effectiveness at preventing infiltration into buried waste.
- Stabilizing grout or other forms of waste "improvement" will experience no degradation for a minimum of 500 years.
- Erosion rates at the site and of the engineered barriers will not exceed 0.01 millimeters per year for more than 10,000 years⁵.
- Infiltration rates at the disposal site will not change at all over the next 10,000 or 100,000 years, and there will be no overland flow or irrigation at the site⁶.
- Resident farmers or other occupants will never occupy, or otherwise disturb, land directly over the waste site, even with complete loss of institutional controls and memory.
- All three near-surface disposal alternatives are of equal integrity despite differences in disposal depth, construction materials, waste concentration, and barrier use.
- Groundwater elevations will not change appreciably within the next 10,000 or 100,000 years.
- Waste will be leached only by precipitation that infiltrates straight down from within the disposal facility boundary. At no time during the next 100,000 years will the buried waste encounter lateral groundwater flow.
- Infiltration of precipitation surrounding the disposal facility is *completely uncontaminated*, and therefore dilutes any contaminated water that emanates from the facility.
- At no time in the next 100,000 years will a surface water exposure pathway develop within the disposal facility.

L293-14
 (Cont.)

⁵ This erosion rate is extremely low by geologic standards and rarely seen outside of very low-denudation environments acting on very strong or resilient rocks (Bierman and Turner, 1994; Brook et al., 1995), neither of which apply to surface barriers at Hanford.

⁶ The assumed infiltration rate for the Hanford Site is 1 millimeter per year; this value is lower than the infiltration rate observed on the site at present. The Draft GTCC EIS acknowledges that a change of ± 10 percent in precipitation is possible at the candidate sites. However, no discussion is included that describes the corresponding change in infiltration rate. Infiltration may increase significantly with a modest change in precipitation as a result of cooler temperatures (Musgrove and Schrag, 2006). Other complications that were not considered include precipitation falling as snow, which also increases infiltration relative to total precipitation, and deep root penetration into surface barriers, which would also enhance surface infiltration.

Yakama Nation Environmental Restoration Waste Management Program,
Commenter ID No. L293 (cont'd)

Yakama Nation ERWM Program GTCC EIS Comments
Attachment 1
Page 9

Many of these assumptions are demonstrably false, such as the assumed erosion rate, restriction of infiltration to vertical flow, and cleanliness of the site soils. Other assumptions such as the presumption of barrier and grout performance generally contradict both published research and in some cases common sense (such as in the case of institutional controls). This is discussed in greater detail below.

Recommendation 5a. Analysis performed to support action alternatives in the revised Draft GTCC EIS must use realistic assumptions that accurately reflect environmental variables and human behavior.

Comment 5b. Assumptions of barrier integrity and performance are unrealistic and poorly justified.

All of the proposed action alternatives presented in the Draft GTCC EIS rely on surface barriers in order to meet basic performance criteria in the first 10,000 years following facility closure. This is in part a reflection of the USDOE's assumption that the release of radionuclides from disposed GTCC and GTCC-like waste is directly proportional to the infiltration rate of water through the waste (p. 6-91; Appendix E).

The Draft GTCC EIS characterizes the assumptions of barrier and waste stabilization performance as "conservative because the engineered systems (including the disposal facility cover) [will] last longer than 500 years even in the absence of active maintenance measures" (Appendix E). No substantive documentation is offered to support this assertion. However, such assumptions are not conservative and are not consistent with published research.

Degradation of surface barriers that can reasonably be expected to occur and that could lead to decreased performance include damage from desiccation, freezing, and thawing; differential settlement; deep root penetration by trees or other vegetation; and burrowing by terrestrial mammals, insects, or birds. Research by Smith et al. (1997) found that even without direct human intrusion or vandalism, natural biologic activity may significantly compromise barrier integrity through animal burrowing activity and root intrusion. As part of their conclusions, Smith et al. suggested that monitoring and maintenance of capped, inactive, hazardous waste burial sites should be continued *indefinitely* and not end after the period mandated by regulatory requirements.

In fact, long-term performance problems associated with surface barriers are hardly unusual. In a case study performed in Wenatchee, Washington, Benson and Khire (1997) found that after just two years of observation, cumulative percolation into a test clay barrier had increased from 1 to 3 centimeters as a result of extensive cracking associated with desiccation⁷.

⁷ Wenatchee is approximately 70 miles north-northwest of the Hanford Central Plateau and shares climate characteristics as well as orographic patterns with the Hanford Site.

L293-15 See response to L293-14.

L293-14
(Cont.)

L293-15

Yakama Nation Environmental Restoration Waste Management Program,
Commenter ID No. L293 (cont'd)

Yakama Nation ERWM Program GTCC EIS Comments
Attachment 1
Page 10

The National Research Council's *Assessment of the Performance of Engineered Waste Containment Barriers* provided an example in which 22 of 77 test pads in active landfills did not achieve their goal hydraulic conductivity when tested (National Research Council, 2007). The report went on to reiterate that clay barriers are generally acknowledged to be susceptible to *significant increases* in conductivity as a result of desiccation cracking, differential settlement, lateral spreading, freezing, thawing, and root penetration.

The National Research Council published a report titled *Long-Term Institutional Management of U.S. Department of Energy Legacy Waste Sites* (2000) that addressed the USDOE's use of barriers as a tool for isolating and containing waste. This report drew a number of conclusions, including the following:

- "Physical barrier systems [that] keep hazardous wastes in isolation will require their own ongoing support from [an] institutional management system." (emphasis added)
- "Without constant attention, stewardship measures imposed today are not likely to remain effective for as long as residual contamination presents risks."
- "Given that decisions that affect sites' futures are often made under conditions of considerable uncertainty, the best decision strategy overall...takes seriously the prospects that failures of engineered barriers, institutional controls and other stewardship measures in the future could have ramifications that a good steward would want to avoid."

The USDOE's assumptions in the Draft GTCC EIS are all but mutually exclusive with the conclusions presented above. Analysis offered in the Draft GTCC EIS assumes only the most optimal barrier performance in conjunction with extensive cooperation from the surrounding environment and future human populace. This is not a conservative approach and should not be represented as such. Analysis by the IEER determined that the performance of barriers did not significantly affect the overall performance of proposed action alternatives at the Hanford Site (see Attachment 3). However, this does not excuse reliance on barrier performance, particularly at other sites or at a future Hanford Site with a significantly different climate.

Recommendation 5b. The revised Draft GTCC EIS should present action alternatives that do not rely on surface barriers to maintain their long-term integrity. The revised action alternatives should be capable of meeting performance requirements without depending heavily on assumed climate, environmental conditions, and human behavior.

Comment 5c. Use of institutional controls in action alternatives is unclear, inconsistent, and unrealistic.

GTCC FINAL Narrative_Attch1_05-22-11.docx

L293-16 In evaluating the performance of the proposed land disposal facilities, a number of engineering measures were assumed in the conceptual facility designs to minimize infiltration of water into the wastes and thereby minimize contaminant migration from the disposal units. Monitoring and maintenance of the land disposal units were assumed to be for 100 years, and corrective measures could be implemented during this time period to ensure that the engineered barriers lasted for at least 500 years. This is consistent with the institutional control time frame given in both NRC and DOE requirements and was determined to be a reasonable approach for assessing the long-term performance of the disposal units.

It was assumed that after 500 years, the barriers would gradually fail. To account for these measures in the modeling calculations, it was assumed that the water infiltration to the top of the waste disposal area would be zero for the first 500 years and then 20% of the natural rate for the area for the remainder of the assessment time period (10,000 years). A water infiltration rate of 20% of the natural rate for the area was used only for the waste disposal area; the natural background infiltration rate was used at and beyond the perimeter of the waste disposal units.

Additional assumptions were used for a number of parameters, including the distance to a nearby hypothetical receptor (100 m or 330 ft. from the edge of the disposal facility). The analyses in the EIS indicate that a near-surface trench facility at NNSS and the WIPP Vicinity can be safely used (e.g., estimates indicated no dose to a hypothetical nearby receptor at 10,000 years).

DOE agrees that the GTCC waste disposal facility must ensure the protection of a hypothetical future inadvertent human intruder. In the conceptual design for the trench disposal facility, the trenches are about 3 m (10 ft.) wide, 11 m (36 ft.) deep, and 100 m (330 ft.) long. The GTCC waste disposal placement is assumed to be about 5 to 10 m (16 to 33 ft.) below ground surface.

On the basis of the depth of waste disposal, DOE believes that the only reasonable potential for intrusion into a trench is from a future drilling event, such as drilling for a water well. The likelihood of inadvertent intrusion from a drilling event would be very low for a GTCC trench disposal facility at the reference locations evaluated because of (1) the narrow width of the trench, (2) the use of intruder barriers, (3) the remoteness of the sites, (4) DOE's commitment to long-term institutional control at these sites, (5) site conditions such as the general lack of easily accessible resources and the great depth to groundwater, and (6) waste form stability. On the basis of these considerations, DOE did not include a quantitative analysis of an inadvertent human intruder in this EIS. Site-specific NEPA reviews would be conducted as needed.

L293-15
(Cont.)

L293-16

J-734

January 2016

Final GTCC EIS

Appendix I: Comment Response Document

Yakama Nation Environmental Restoration Waste Management Program,
Commenter ID No. L293 (cont'd)

Yakama Nation ERWM Program GTCC EIS Comments
Attachment 1
Page 11

The Draft GTCC EIS states that protection against inadvertent human intrusion will be accomplished in part by "design features [including] institutional controls" (p. 5-95) that would be maintained "as long as necessary to perform their intended protective purposes" (p. 5-96). However, in the same section, the USDOE implies that active institutional controls would be discontinued 100 years after site closure despite the fact that "it would take several millennia for many of the long-lived radionuclides to decay to low levels." These statements are not internally consistent. It is not possible to maintain institutional controls as long as is necessary, while simultaneously *not* maintaining the same controls as long as is necessary on the basis that the prescribed time period is simply too long. If active institutional controls cannot be maintained for the time period required to ensure that the disposal site is safe for unrestricted access, *then the disposal method used should not rely on institutional controls.*

The Draft GTCC EIS's inconsistent application of and presumed effectiveness of institutional controls recur repeatedly throughout the document, including in the following statement made to justify the parameters used to calculate exposure:

...the long-term human health impacts are addressed by considering the future radiation dose and LCF risk to a hypothetical individual who resides 100 m (330 ft) from the edge of the disposal facility and develops a farm. This resident farmer scenario is assumed to be conservative (i.e., one that overestimates the expected dose and LCF risk) because it assumes a total loss of institutional control and institutional memory with regard to the disposal facility.

The Draft GTCC EIS does not elaborate on how exposed individuals over multiple generations are capable of avoiding—consistently, without fail, and by a margin of *at least 100 meters*—the disposal facility of which they have no knowledge or memory. This statement is not internally consistent and appears to simultaneously concede that any institutional control will ultimately fail, while also remaining effective. This rationale is illogical and unacceptable.

The Yakama Nation ERWM Program has previously commented on the USDOE's reliance on institutional controls (Yakama Nation ERWM Program, 2010). Those comments noted that institutional controls could not be assumed to remain effective over long periods of time and that they also conflict with Yakama Nation treaty rights.

No government in history has existed for as long as 10,000 years, let alone 100,000. It is unreasonable to assume that measures such as federal ownership of the disposal site and land designations will provide any form of protection against future intrusion. Other similarly passive controls such as unmaintained "fences, signs and other markers" are not expected to provide better protection over such an extended time period.

L293-16
(Cont.)

GTCC FINAL Narrative_Attch1_06-22-11.docx

Yakama Nation Environmental Restoration Waste Management Program,
Commenter ID No. L293 (cont'd)

Yakama Nation ERWM Program GTCC EIS Comments
Attachment 1
Page 12

Recommendation 5c. *The revised Draft GTCC EIS should provide alternatives that do not rely on institutional controls to limit doses and achieve an acceptable level of performance within the 10,000-year period required. Any alternative proposed for the Hanford Site must respect Yakama Nation treaty rights and be compatible with clean closure requirements on the site.*

Discussion of institutional controls in the revised Draft GTCC EIS must be internally consistent and include the following:

- **Specific, detailed information on the length of active maintenance.**
- **Detailed information for long-term monitoring and maintenance or the lack thereof.**
- **Clearly stated, consistent, and realistic assumptions of the long-term efficacy of the passive institutional controls.**
- **Plans, or lack thereof, for ensuring the stability of long-term institutional controls through multiple successive governments, so that the site remains isolated for the requisite 10,000 years.**

Comment 5d. *Direct intrusion into the disposal facility and facility barriers should be evaluated in detail.*

The Draft GTCC EIS acknowledges that "the NRC [has] already determined that for waste classified as GTCC, conventional near-surface land disposal is generally not protective of an inadvertent intruder." The USDOE found this to be sufficient justification for not considering the scenario in any quantitative form for the proposed action alternatives.

However, an intruder in the disposal facility poses serious problems to much of the analysis provided in the Draft GTCC EIS. Intrusion into the disposal facility clearly could result in significant dismantling of the many carefully laid assumptions that have already been identified. Direct physical intrusion into the facility may result in:

- Significantly reduced distances at which exposure to waste and contaminated groundwater occur (which was specifically not evaluated in the Draft GTCC EIS).
- Surface irrigation that dramatically increases infiltration into waste disposal intervals.
- Waste or contaminated backfill that is brought to the surface, allowing for direct ingestion and other exposure pathways.
- Deconstruction of cover by resident farmers to access the clay or other earthen materials for use in lining irrigation ditches or other building purposes.
- Residences that require dug-out foundations or basements being built directly on top of the barrier.

GTCC FINAL Narrative_Abbot1_09-22-11.docx

L293-17 DOE agrees that the GTCC waste disposal facility must ensure the protection of a hypothetical future inadvertent human intruder, especially for the wastes disposed of in an enhanced near surface trench. In the conceptual design for the trench disposal facility, the trenches are about 3 m (10 ft.) wide, 11 m (36 ft.) deep, and 100 m (330 ft.) long. The GTCC waste disposal placement is assumed to be about 5 to 10 m (16 to 33 ft.) below ground surface.

On the basis of the depth of waste disposal, DOE believes that the only reasonable potential for intrusion is from a future drilling event, such as drilling for a well. The likelihood of inadvertent intrusion from a drilling event would be very low for a GTCC waste trench disposal facility because of (1) the narrow width of the trench, (2) the use of intruder barriers, (3) the remoteness of the sites, (4) DOE's commitment to long-term institutional control, (5) site conditions such as the general lack of easily accessible resources and the great depth to groundwater, and (6) waste form stability. On the basis of these considerations, DOE did not include a quantitative analysis of inadvertent human intruder in the EIS. Site-specific NEPA reviews would be conducted as needed.

L293-16
(Cont.)

L293-17

Yakama Nation Environmental Restoration Waste Management Program,
Commenter ID No. L293 (cont'd)

Yakama Nation ERWM Program GTCC EIS Comments
Attachment 1
Page 13

- Regrading or large-scale earthwork associated with redevelopment, conversion to farmland, or other changes in land use that significantly reduce the overburden above the waste interval.
- Intentional intrusion to remove waste under the misconception that it is valuable.

Exposure to an inadvertent or intentional intruder could be significantly higher than any of the estimates provided in the Draft GTCC EIS, which are based on many best-case assumptions and limited exposure pathways. Furthermore, the activities of an intruder clearly have the potential to significantly increase off-site doses. These consequences should not be ignored or downplayed simply as a matter of convenience.

Recommendation 5d. The revised Draft GTCC EIS must incorporate an extensive quantitative evaluation of intentional and unintentional intrusion into any disposal facility related to the proposed action alternatives.

Comment 5e. Performance assessment of the proposed action alternatives cannot be verified and appears to significantly underpredict future doses.

Analysis performed by IEER using the same parameters as those provided in the Draft GTCC EIS was unable to replicate the reported doses using RESRAD-OFFSITE. Calculations performed for trench and borehole disposal delivered significantly higher doses (trenches: 300 millirem; boreholes: 177 millirem) than those reported in the Draft GTCC EIS.

Because the vault dose reported in the Draft GTCC EIS was similar to the trench dose, it is reasonable to assume that the vault dose is also incorrect. The USDOE acknowledges that some modifications to RESRAD-OFFSITE were made, but does not provide adequate information to account for the large differences between doses predicted in the Draft GTCC EIS and those calculated by IEER. Please refer to Attachment 3 for additional information on this comment.

Recommendation 5e. Calculation of exposure that results from a proposed action alternative disposal facility should be redone. Additional, detailed information should be incorporated into the revised Draft GTCC EIS so that the USDOE calculations can be replicated and examined in appropriate detail.

Comment 5f. Sensitivity analysis performed for the proposed action alternatives is abnormal, unusual, and non-conservative.

The sensitivity analysis performed for the Draft GTCC EIS proposed action alternative-derived doses does not follow normal protocols that evaluate scenarios both better and worse than the base case provided. Rather, the USDOE has adopted the stance that the base case (including, and heavily relying upon, the assumptions noted above) is the *worst-case scenario* and that parameters affecting proposed action alternative performance can *only improve*. This is

GTCC FINAL Narrative_Atch1_06-22-11.docx

L293-18 The modeling with the RESRAD-OFFSITE code utilized a specific feature of the code. That is, the leach rates of radionuclides were calculated separately and entered as input values to the code for subsequent transport modeling through the unsaturated zones and the groundwater aquifer. In the process of calculating leach rates to input into the RESRAD-OFFSITE code, the influence of the waste forms was considered. For activated metals, a constant release fraction was assumed, reflecting that the imbedded radionuclides in the metal would not dissolve in water until the metal was corroded. For Other Wastes, the release rates were calculated by considering the retardation provided by grouting; therefore, measured Kd values of radionuclides in cementitious materials as available in published literature were used for the release calculations. For sealed sources, because the waste forms can vary greatly, the release rates were calculated by assuming the waste forms would behave like soils and would not provide extra protection against leaching. The consideration for releases from activated metals was similar to a dissolution mechanism. The consideration for releases from sealed sources was similar to a surface rinse mechanism. The consideration for releases from Other Waste was similar to a surface rinse mechanism, but with non-zero Kds for the waste form.

The integrity of waste packages, waste containers, and barrier materials over time was not specifically modeled in the RESRAD-OFFSITE code. Their performance over time depends on the engineering designs of the disposal facility. Compared with the analysis time frame that extends to 10,000 (or possibly up to 100,000) years into the future, the integrity periods of the waste packages, waste containers, and barrier materials are relatively short. Therefore, in the GTCC EIS, the integrity periods are evaluated as one single parameter, which is assumed to be 500 years in the analysis. To study the influence of this assumption, a sensitivity analysis was conducted. This approach provides a perspective on performance for the long term.

DOE believes that sufficient information has been provided in the EIS to enable third parties to independently verify the results presented.

L293-19 See response to L293-6.

L293-17
(Cont.)

L293-18

L293-19

J-737

January 2016

Yakama Nation Environmental Restoration Waste Management Program,
Commenter ID No. L293 (cont'd)

Yakama Nation ERWM Program GTCC EIS Comments
Attachment 1
Page 14

unrealistic and scientifically unsupportable even when using appropriate base-case parameters. Taking into consideration the assumptions and parameters provided in the base case, the sensitivity analysis included in the Draft GTCC EIS is meaningless.

A more appropriate sensitivity analysis performed by IEER using parameters less favorable than the USDOE's base case found that doses delivered by a proposed action alternative disposal facility could be substantially larger than those provided in the Draft GTCC EIS. The analysis also identifies significantly reduced travel times to groundwater and reasonable parameters that could result in total removal of surface barriers within 5,000 years. These analyses are discussed in greater detail in Attachment 3.

Recommendation 5f. In the revised Draft GTCC EIS, sensitivity analysis must evaluate facility performance using realistic parameters. The analysis must evaluate scenarios that are less favorable than the USDOE-provided base case.

Sensitivity analysis should also evaluate scenarios in which unrealistic assumptions previously discussed, such as consistent low rates of erosion and infiltration for 10,000 years, are replaced with higher or increasing rates.

Comment 6. The Draft GTCC EIS must comply with federal and state environmental laws.

The Low-Level Radioactive Waste Policy Amendments Act of 1985 states that GTCC waste is to be disposed of in an NRC-licensed facility that has been determined to be adequate to protect public health and safety. NRC regulations state that GTCC waste is generally not acceptable for near-surface disposal and must be disposed of in a deep geologic repository unless alternative methods of disposal are proposed to and approved by the NRC.

Recommendation 6. The revised Draft GTCC EIS must explain how the selection of a USDOE-operated facility will meet the requirements for NRC licensing and regulation and how such a facility will be determined to adequately protect public health and safety.

Comment 7. The Draft GTCC EIS must recognize Yakama Nation treaty rights.

The Treaty of 1855 between the United States and the Yakama Nation (12 Stat. 951) is not mentioned in the Draft GTCC EIS. Under that treaty, the United States has accepted a trust responsibility to ensure that the Yakama people and resources are not harmed by federal actions.

GTCC FINAL Narrative_Atch1_09-22-11.docx

L293-20 The LLRWPA (P.L. 99-240) assigns DOE responsibility for the disposal of GTCC LLRW generated by NRC and Agreement State licensees. The LLRWPA (P.L. 99-240) specifies that GTCC LLRW, designated a federal responsibility under section 3(b)(1)(D) that results from activities licensed by the NRC, is to be disposed of in an NRC-licensed facility that has been determined to be adequate to protect public health and safety. However, unless specifically provided by law, the NRC does not have authority to license and regulate facilities operated by or on behalf of DOE. Further, the LLRWPA does not limit DOE to using only non-DOE facilities or sites for GTCC LLRW disposal. Accordingly, if DOE selects a facility operated by or on behalf of DOE for disposal of GTCC LLRW for which it is responsible under section 3(b)(1)(D), clarification from Congress would be needed to determine NRC's role in licensing such a facility and related issues. In addition clarification from Congress may be needed on NRC's role if DOE selects a commercial GTCC LLRW disposal facility licensed by an Agreement State rather than by NRC.

L293-21 The text within brackets has been incorporated into the GTCC EIS (Section 6.1.10): [DOE's relationship with American Indian tribes is based on treaties, statutes, and DOE directives. Representatives of the United States negotiated treaties with leaders of various Columbia Plateau American Indian tribes and bands in June 1855 at Camp Stevens in the Walla Walla Valley. The negotiations resulted in three treaties, one with the 14 tribes and bands of the group that would become the Confederated Tribes and Bands of the Yakama Nation, one with the 3 tribes that would become the Confederated Tribes of the Umatilla Indian Reservation, and one with the Nez Perce Tribe. The U.S. Senate ratified the treaties in 1859. The negotiated treaties are as follows:

- Treaty with the Walla Walla, Cayuse, etc., Tribes (June 9, 1855; 12 Stat. 945);
- Treaty with the Yakama Nation (June 9, 1855; 12 Stat. 951); and
- Treaty with the Nez Perce Tribe (June 11, 1855; 12 Stat. 957).

The Confederated Tribes and Bands of the Yakama Nation of the Yakama Reservation, the Confederated Tribes of the Umatilla Indian Reservation, and the Nez Perce Tribe of Idaho are federally recognized tribes that are eligible for funding and services from the U.S. Bureau of Indian Affairs by virtue of their status as Indian tribes (68 FR 68180, December 5, 2003).

The terms of the three preceding treaties are similar. Each of the three tribal organizations agreed to cede large blocks of land to the United States. Hanford is within the ceded lands. The treaties reserved to the tribes certain lands for their exclusive use (the three reservations). The treaties also secured to the tribes certain rights and privileges to continue traditional activities outside the reservations. These included (1) the right to fish at usual and accustomed places in common with citizens of the United States and (2) the privileges of hunting, gathering roots and berries, and pasturing horses and cattle on open and unclaimed lands. No portion of the Hanford Site constitutes open and unclaimed land.]

Regarding the Yakama Nation's perspectives about tribal treaty rights allowing unrestricted access at Hanford, DOE respectfully disagrees. This EIS presents relevant and essential information important to the evaluation of potential environmental impacts, consistent with NEPA's primary goal of full disclosure to the public as well as agency decision makers. This includes discussion of the history of the settlement of Hanford and the treaties entered into between tribal nations and the U.S. government. There is substantial documentation indicating that the tribes understood at the time these treaties were signed that the lands were no longer "unclaimed" when they were claimed for the purposes of the white settlers' activities.

DOE is not aware of any judicially recognized mechanisms that would allow these lands to revert to "unclaimed" status merely through the process of being acquired by the federal government. The portion of Hanford that remained in the public domain in 1943, as well as all

L293-19
(Cont.)

L293-20

L293-21

Yakama Nation Environmental Restoration Waste Management Program,
Commenter ID No. L293 (cont'd)

Yakama Nation ERWM Program GTCC EIS Comments
Attachment 1
Page 15

The treaty supports protection of natural and cultural resources for the Yakama Nation. The Draft GTCC EIS incorrectly includes trust responsibility and treaty rights under the umbrella of environmental justice, which implies that all treaty rights have been appropriately considered in accordance with the National Environmental Policy Act and other federal laws, which is not the case. Considering tribal views and perspectives is very different from full and fair consideration of tribal treaty rights and federal trust responsibility.

Recommendation 7. The revised Draft GTCC EIS must recognize the Treaty of 1855 as a requirement that applies to the proposed action alternatives. Potential impacts to treaty-reserved rights and resources should be identified and evaluated in the revised Draft GTCC EIS. Any action alternative included in the Final GTCC EIS should adequately address tribal exposures based on full access to treaty-reserved resources, and should be consistent with the USDOE's American Indian Policy.

Comment 8. The Draft GTCC EIS does not appropriately address cultural and natural resources at the Hanford Site.

Comment 8a. Evaluation of cultural and natural resources is incomplete.

The Draft GTCC EIS frequently uses language that suggests cultural resources in the Draft GTCC EIS reference area have been thoroughly surveyed and evaluated. However, the locations identified have not been professionally surveyed for cultural resources, and the subsurface has not been evaluated. Many of the surveys that have been performed were spatially restricted, were associated with local projects, and did discover physical cultural resources. It is reasonable to expect that significant cultural resources may be present in the Draft GTCC EIS reference area and surrounding the Central Plateau of the Hanford Site (known as the 200 Area), but that those resources are as-yet undiscovered.

As in the TCWM EIS, the Draft GTCC EIS places heavy emphasis on physical objects and artifacts that can be positively identified as of Native American origin. However, there are many other cultural and natural resources that the USDOE does not (and cannot) assign a value to. These resources include the cultural significance of sacred sites within the Hanford Site boundaries and along the Columbia River, as well as protection of all natural resources, including surface waters, groundwater, geologic resources, air, plants, fish, and wildlife within usual and accustomed places.

Recommendation 8a. The revised Draft GTCC EIS should acknowledge that significant cultural resources exist within the reference area for the Hanford Site and that the full extent of impacts to these resources has not been evaluated in detail. The revised Draft GTCC EIS should provide appropriate detail that identifies the cultural resource surveys to date, including their spatial extent and the activities conducted.

GTCC FINAL Narrative_Attch1_06-22-11.docx

the acquired lands, were closed to all access initially under authority of the War Powers Act and then under authority of the AEA. It is therefore DOE's position that the Hanford lands are neither "open" nor "unclaimed."

L293-22 As required by NEPA, the Final EIS (Appendix G) evaluates the potential impacts of the proposed action on cultural and natural resources at the various DOE sites in sufficient detail to assess the potential impacts of the proposed alternatives. DOE recognizes that development of a disposal facility for GTCC LLRW and GTCC-like wastes would require that future land uses be restricted at and near the site for the protection of the general public. This action could affect areas that may be important to American Indian tribes.

DOE considered the text provided by the participating affiliated American Indian tribes for each of DOE sites evaluated in selection of the preferred alternative. Information provided by the tribal governments associated with exposure pathways unique to American Indian tribes (e.g., greater intakes of fish, game, and plants; use of sweat lodges; use of natural pigment paints for traditional ceremonies) would be evaluated in site-specific NEPA reviews for the alternative(s) selected in a ROD for this EIS.

L293-21
(Cont.)

L293-22

Yakama Nation Environmental Restoration Waste Management Program,
Commenter ID No. L293 (cont'd)

Yakama Nation ERWM Program GTCC EIS Comments
Attachment 1
Page 16

Comment 8b. The Draft GTCC EIS does not appropriately address Tribal Cultural Properties.

The Rattlesnake Mountain and Gable Mountain Gable Butte Cultural District are eligible Traditional Cultural Properties (TCP). The Draft GTCC EIS understates the significance of these sites to the Yakama Nation and other native tribes. This status should be recognized and incorporated into the revised Draft GTCC EIS.

Recommendation 8b. The Cultural Resources section in the revised Draft GTCC EIS should acknowledge and discuss the presence of TCPs in the vicinity of the reference area. The revised Draft GTCC EIS should acknowledge the impact that construction of a new facility will have on TCP visual resources, TCP access, and levels of contamination at TCPs.

L293-22
(Cont.)

Yakama Nation Environmental Restoration Waste Management Program,
Commenter ID No. L293 (cont'd)

Yakama Nation ERWM Program GTCC EIS Comments
Attachment 1
Page 17

References

- Bakun, W., R. Haugerud, M. Hopper and R. Ludwin. 2002. *The December 1872 Washington State Earthquake*. Bulletin of the Seismological Society of America, v. 92, n.8, pp. 3239-3258. December.
- Benson, C. and M. Khire. 1997. *Earthen Material in Surface Barriers*. Barrier Technologies for Environmental Management: Summary of a Workshop. Committee on Remediation of Buried and Tank Wastes, National Research Council. 188 pages.
- Bierman, P. and J. Turner. 1994. *¹⁰Be and ²⁶Al Evidence for exceptionally low rates of Australian bedrock erosion and the likely existence of pre-Pleistocene Landscapes*. Quaternary Research, vol. 44, pages 378-382.
- Brook E., E. Brown, M. Kurz, R. Ackert, G. Raisbeck and F. Yiou. 1995. *Constraints on age, erosion, and uplift of Neogene glacial deposits in the Transantarctic Mountains determined from in situ cosmogenic ¹⁰Be and ²⁶Al*. Geology, vol. 23, no. 12, pages 1063-1066.
- Environmental Radiation Protection Standards for Management and Disposal of Spent Nuclear Fuel, High-Level and Transuranic Radioactive Wastes. Code of Federal Regulations - Title 40, Part 191. 50 FR 38084, September 19, 1985; 58 FR 66414 December 20, 1993.
- Fecht, K. and T. Marceau. 2006. *Late Pleistocene- and Holocene-Age Columbia River Sediments and Bedforms: Hanford Reach Area, Washington; Part 2*. WCH-46. Washington Closure Hanford. March.
- Gerber, M. 2002. *On the Home Front; The Cold War Legacy of the Hanford Nuclear Site*. University of Nebraska Press, Lincoln and London. 363 pages.
- Licensing Requirements for Land Disposal of Radioactive Waste. Code of Federal Regulations Part 61. 47 FR 57463, December 27, 1982; 49 FR 9405 March 12, 1984.
- Musgrove, M. and D.P. Schrag. 2006. *Climate Change at Yucca Mountain: Lessons from Earth History, in Uncertainty Underground: Yucca Mountain and the Nation's High-Level Nuclear Waste*. Edited by Allison M. Macfarlane and Rodney C. Ewing. The MIT Press, Cambridge, Massachusetts, pages 149-162.
- National Research Council. 2000. *Long-Term Institutional Management of U.S. Department of Energy Legacy Waste Sites. Commission of Geosciences, Environment and Resources*. National Academies Press, N.W. Washington, DC.
- National Research Council. 2007. *Assessment of the Performance of Engineered Waste Containment Barriers*. National Academy of the Sciences. 134 pages.

GTCC FINAL Narrative_Attch1_06-22-11.docx

J-741

January 2016

Yakama Nation Environmental Restoration Waste Management Program,
Commenter ID No. L293 (cont'd)

Yakama Nation ERWM Program GTCC EIS Comments
Attachment 1
Page 18

Newcomb, R., J. Strand and J. Frank. 1972. *Geology and Ground-Water Characteristics of the Hanford Reservation of the U.S. Atomic Energy Commission, Washington*. Geological Survey Professional Paper 717. United States Government Printing Office, Washington.

Public Law 96-368 [S.2443]; October 1 1980. West Valley Project Demonstration Act.

Reidel, S., N. Campbell, K. Fecht and K. Lindsey. 1993. *Late Cenozoic Structure and Stratigraphy of South Central Washington* (WHC-SA-1764-FP). Prepared for the U.S. Department of Energy Office of Environmental Restoration and Waste Management.

Smith, E., R. Luxmoore, and G. Suter. 1997. *Natural Physical and Biological Processes Compromise the Long Term Performance of Compacted Soil Caps*. Barrier Technologies for Environmental Management: Summary of a Workshop. Committee on Remediation of Buried and Tank Wastes, National Research Council. 188 pages.

Stover, C. and J. Coffman. 1993. *Seismicity of the United States, 1568-1989 (Revised)*. United States Geological Survey Professional Paper 1527. United States Government Printing Office, Washington.

U.S. Department of Energy (USDOE). 2009. *Draft Tank Closure and Waste Management Environmental Impact Statement for the Hanford Site, Richland, Washington* (DOE/EIS-0391). Prepared by the U.S. Department of Energy, October.

U.S. Environmental Protection Agency (USEPA). 1988. *Federal Guidance Report Number 11. Limiting Values of Radionuclide Intake and Air Concentration and Dose Conversion Factors for Inhalation, Submersion and Ingestion* (EPA-520/1-88-020). Prepared by the Office of Radiation Programs, U.S. Environmental Protection Agency.

U.S. Environmental Protection Agency (USEPA). 1999. *Consideration of Cumulative Impacts in EPA Review of NEPA Documents*. EPA 315-R-99-002.

U.S. Geological Survey (USGS). 2011a. *Earthquake Hazards Program*. Available online: http://earthquake.usgs.gov/earthquakes/states/events/1872_12_15.php. Accessed 5/12/2011.

U.S. Geological Survey (USGS). 2011b. *Earthquake Hazards Program: The Modified Mercalli Intensity Scale*. Available online: <http://earthquake.usgs.gov/learn/topics/mercalli.php>. Accessed June 16, 2011.

West, M., F. Ashland, A. Busacca, G. Berger and M. Shaffer. 1996. *Late Quaternary deformation, Saddle Mountains anticline, south central Washington*. *Geology*, v. 24, no.12, p 1123-1126; 5 figures. December.

GTCC FINAL Narrative_Attch1_06-22-11.docx

J-742

January 2016

Yakama Nation Environmental Restoration Waste Management Program,
Commenter ID No. L293 (cont'd)

Yakama Nation ERWM Program GTCC EIS Comments
Attachment 1
Page 19

White, D. 1983. *Background Paper for Assessment of Basalt Lava Flows (BWIP)*, Washington. *Supplement to a Study of the Isolation System for Geologic Disposal of Radioactive Wastes*. National Academy Press, Washington D.C. Republished with permission as an Appendix to *Heat, High Water and Rock Instability at Hanford* by Makhijani A., and K. Tucker. 1985. Health and Energy Institute, Washington D.C.

Yakama Nation ERWM Program. *Letter to David A. Brockman, U.S. Department of Energy*. March 19.

GTCC FINAL Narrative_Altch1_06-22-11.docx

L293-23 The Low-Level Radioactive Waste Policy Amendments Act (P.L. 99-240) assigns DOE responsibility for the disposal of GTCC LLRW generated by NRC and Agreement State licensees. GTCC-like waste was also included in our analysis to address waste owned or generated by DOE that has similar characteristics to GTCC LLRW which can be disposed of in a similar manner.

The GTCC LLRW and GTCC-like waste inventory evaluated in the EIS is based on the best available information on the stored and projected GTCC LLRW and GTCC-like wastes from ongoing and planned activities. The estimated 12,000 m³ of GTCC LLRW and GTCC-like wastes is a relatively small volume of waste when compared to other wastes disposed of by DOE. For example, this volume of GTCC LLRW and GTCC-like wastes is only about 20% of the 59,000 m³ of LLRW disposed of at one site (NNSS) in one year (fiscal year 2010). DOE canceled the *Draft Global Nuclear Energy Partnership Programmatic Environmental Impact Statement* (GNEP PEIS) (74 FR 31017); therefore, the generation of additional GTCC LLRW under GNEP is not included in the GTCC EIS inventory. In addition, the inventory includes wastes expected to be generated during the production of Mo-99 for medical applications from two potential generators. While the potential generator(s) of this waste may change, the estimated characteristics and volumes are representative of the amounts expected to supply the demand for the Mo-99. DOE believes that expanding the inventory to include potential GTCC LLRW and GTCC-like wastes from undefined or unplanned future activities would introduce excessive uncertainty in the EIS evaluations. DOE believes that the inventory included in the GTCC EIS is reasonable for the purposes of the NEPA process and that it provides a supportable basis for conducting the EIS evaluation and the identification of the preferred alternative in the Final EIS. In the future, should additional waste be identified, appropriate NEPA review would be conducted to reflect these changes and also changes that would be needed to the existing infrastructure or the identification of additional disposal sites.

Although characterization information for some of the GTCC LLRW and GTCC-like wastes is limited, DOE believes that sufficient data are available to allow for a comparative analysis of various approaches to dispose of these wastes in the EIS. Adequate data are generally available for the radioactive constituents, but comparable data for chemical constituents are generally lacking. DOE believes that the data presented in the EIS are sufficient to make comparative analyses between and among sites.

Depleted uranium is not included in the GTCC LLRW waste inventory because this material is not GTCC LLRW. Likewise, Class B and C wastes are not GTCC LLRW and are out of scope for this EIS.

L293-24 Future waste that will be generated from the cleanup the West Valley Site does make up a large proportion of the GTCC inventory, especially if a decision is made to exhume the waste from the West Valley site State-licensed Disposal Area and the NRC licensed Disposal Area. Follow on analysis would be conducted to determine characteristics of this waste and any final packaging configurations. Based on the current analysis of this waste, it would be subject to disposal in a deep geologic repository (Table 2.10-1)

DOE agrees that use of a geologic repository would be a protective and safe method for the disposal of the entire inventory of GTCC LLRW and GTCC-like wastes. The GTCC EIS evaluation for the WIPP geologic repository alternative supports this statement. However, the degree of waste isolation provided by a geologic repository may not be necessary for all of the GTCC LLRW and GTCC-like wastes evaluated in the GTCC EIS. The GTCC EIS evaluation indicates that certain wastes (e.g., those containing short-lived radionuclides such as Cs-137 irradiators) could be safely disposed of in properly designed land disposal facilities at sites with suitable characteristics, such as low precipitation rates, high soil distribution coefficients, and sufficient depths to groundwater. Based on the GTCC EIS evaluation, land disposal facilities located in arid climates (e.g., NNSS and WIPP Vicinity) would isolate radionuclides for a sufficient period of time to allow for significant radioactive decay to occur.

**Yakama Nation Environmental Restoration Waste Management Program,
Commenter ID No. L293 (cont'd)**

ID No.	Section	Subsection	Page	Figure, Map or Table Number	Topic	Comment
1	1	1.1	1-2	NA	ES Contents	Further clarification is requested on the purposes and need to which USDOE is responding. Although there is currently no disposal capability for other GTCC low-level radioactive waste (LLRW) or GTCC-like waste, there is also no path to disposal for a vast quantity of waste. USDOE should perform a comprehensive National Environmental Policy Act (NEPA) analysis for developing additional disposal capability for all its waste under a GTCC LLRW.
2	1	1.1	1-4	NA	West Valley Waste	The West Valley Site status accounts for 88 percent of the total waste described in the EIS. It is not responsible for cleanup of the one site responsible for such a large percentage of the materials. Cleanup of the West Valley Site should not simply consist of transferring the waste to the near surface of the Hanford Site or some other location. The waste from West Valley should be disposed of in a deep geologic repository in accordance with applicable federal regulations (10 CFR 61, 40 CFR 191).
3	1	1.4.1.3	1-19	NA	GTCC Waste Type	This statement that West Valley-related waste does not meet the requirements for disposal at the Yucca Indian Reservation (WIPR) facility is outdated because it implies that the waste is somehow different from other types of GTCC and GTCC-like waste. The statement is misleading because it implies that the waste is somehow different from other types of GTCC and GTCC-like waste. The statement is outdated because it implies that the waste is somehow different from other types of GTCC and GTCC-like waste. Further review the text of the Draft GTCC EIS Introduction to more clearly state that disposal of all the waste at the WIPR facility is a viable alternative.
4	1	1.4.2	1-20	NA	Action Alternatives	1) GTCC of status. The primary emphasis is to support the stability of spent isolation of wastes in a safer, having long-term impact, not to be a waste management alternative. The primary emphasis is to support the stability of spent isolation of wastes in a safer, having long-term impact, not to be a waste management alternative. The primary emphasis is to support the stability of spent isolation of wastes in a safer, having long-term impact, not to be a waste management alternative. Review the Draft GTCC EIS to specifically identify what long-term storage benefits are achieved using near-surface disposal and how they compare to deep geologic disposal.
5	1	1.4.2	1-21	NA	Surface Site Institutional Controls	All the conceptual designs for the land disposal alternative require a surface barrier and a key element to prevent future surface barrier to not prevent redistribution and the potential spread of contamination from burning events. Review the Draft GTCC EIS to determine whether the proposed alternative is not dependent on surface barriers to maintain isolation of wastes. Include in the revised text acknowledgement that any surface barrier is likely to experience significant degradation over time as a result of fire events.
6	1	1.4.2.1	1-21	NA	Deep Geologic Disposal	This will require of content for being geologic disposal in a deep geologic repository and advanced to the Draft GTCC EIS. Further, WIPP evaluates disposal in a deep geologic repository from a conceptual point of view that does not emphasize the existing legal requirements for WIPP disposal.
7	1	1.4.2.2	1-22	NA	Action Alternatives	Both sites and trenches as shown are open at the bottom, allowing any leachate to migrate directly to the underlying geologic material. The surface barrier is formed from a thin layer of soil through the waste zone on the waste table. It is also well established that geologic disposal is the preferred option for the waste. Review the Draft GTCC EIS to determine how the existing barrier is designed to prevent migration of waste. The revised GTCC EIS should evaluate the potential for migration of waste from the surface barrier to the underlying geologic material. The revised GTCC EIS should evaluate the potential for migration of waste from the surface barrier to the underlying geologic material. The revised GTCC EIS should evaluate the potential for migration of waste from the surface barrier to the underlying geologic material. The revised GTCC EIS should evaluate the potential for migration of waste from the surface barrier to the underlying geologic material.

Yakama Nation EIS/RA Program General Comments on the Draft Environmental Impact Statement for the Disposal of Greater Than-Class C (GTCC) Low-Level Radioactive Waste and GTCC-Like Waste (COEIS-0315-0)

Attachment 2

- L293-23
- L293-24
- L293-25
- L293-26
- L293-27
- L293-28
- L293-29

Yakama Nation Environmental Restoration Waste Management Program,
Commenter ID No. L293 (cont'd)

- While 10 CFR Part 61 identifies one NRC-approved method for GTCC LLRW disposal (disposal in a geologic repository), these regulations also indicate that other disposal methods could be approved. The GTCC EIS evaluates three land disposal methods (i.e., enhanced near-surface trench, intermediate-depth borehole, and above-grade vault). The GTCC EIS evaluation indicates that land disposal methods employed at sites with suitable characteristics would be viable and safe alternatives for the disposal of GTCC LLRW.
- L293-25 The discussion in Section 1.4.1.3 to which the comment refers, is referring to the entire GTCC-like Group 1 Other Waste category, not just that from West Valley [i.e., “Much of the waste in this category is expected to meet the DOE definition for TRU waste (i.e., waste that contains more than 100 nCi/g of alpha-emitting TRU radionuclides with half-lives longer than 20 years). This TRU waste may not meet the waste acceptance criteria for disposal at WIPP as defense-generated TRU waste...]
- L293-26 While 10 CFR Part 61 identifies one NRC-approved method for GTCC LLRW disposal (disposal in a geologic repository), these regulations also indicate that other disposal methods could be approved. The GTCC EIS evaluates three land disposal methods (i.e., enhanced near-surface trench, intermediate-depth borehole, and above-grade vault). The GTCC EIS evaluation indicates that land disposal methods employed at sites with suitable characteristics would be viable and safe alternatives for the disposal of GTCC LLRW.
- L293-27 The three land disposal facility conceptual designs (above-grade vault, enhanced near-surface trench, and intermediate-depth borehole) were selected as being representative of a range of land disposal configurations (varying degrees of waste consolidation and geometry) that could be employed for the disposal of the GTCC LLRW and GTCC-like waste inventory. As discussed in Section 1.4.2, each concept has been used to some degree in the United States or other countries. The same vault, borehole, and trench characteristics were considered for the disposal sites evaluated in order to compare the performance of each site’s natural hydrological, geological, and meteorological properties relative to contaminant fate and transport once any engineered barriers would begin to fail.

The conceptual nature of these configurations takes into account the characteristics of all of the disposal sites for which they were considered, but their designs (e.g., width, depth, cover depth, reinforced containment) could be altered or enhanced, as necessary, to provide an optimal solution at a specific location. As an example, the cover depth could be adjusted to ensure that roots from vegetation would not compromise the top of the engineered barrier. In addition, the dimensions of the generic land disposal units (e.g., trench - width and depth, borehole – diameter and depth, vault – width, depth, and height) were selected based on similar existing facilities, existing equipment and methods for construction, and optimized (maximized waste volume disposed of for a given disposal unit volume; simple waste handling procedures to minimize exposure) for the types of waste packages considered. All designs could also accommodate different disposal packages (existing and proposed) with minor variations in their dimensions, but the EIS analyses would remain relevant for each option considered.

For example, if borehole disposal at NNSS became a preferred alternative, any capacity in the existing boreholes would have been considered in follow-up studies. For an above-grade vault with a 5 m cover, long-term impacts from the above-grade vault as determined by modeling for the EIS would be expected to be similar to those for a vault set lower with respect to grade, including with the top of the vault at or below grade, except in the case where the bottom of the waste confinement was closer to the groundwater table. For any disposal option, the bottom of any disposal unit would not be located at or below the water table to exclude the chance of groundwater migration into the disposal unit. Actual implementation of a disposal option at a specific location at a given site may have to be modified (i.e., the depth of a trench or a borehole may need to be reduced to avoid groundwater issues).

Yakama Nation Environmental Restoration Waste Management Program,
Commenter ID No. L293 (cont'd)

Past operational experience with these types of disposal facilities at DOE sites has shown that when properly implemented, they can provide isolation of radioactive waste from the environment for extended time periods. Past problems that have arisen with each option provide additional information to improve the design and performance of future land disposal facilities. Issues related to performance over time would be analyzed in a project-specific analysis to address technical and long-term concerns.

- L293-28 DOE agrees that use of a geologic repository would be a protective and safe method for the disposal of the entire inventory of GTCC LLRW and GTCC-like wastes. The GTCC EIS evaluation for the WIPP geologic repository alternative supports this statement. However, the degree of waste isolation provided by a geologic repository may not be necessary for all of the GTCC LLRW and GTCC-like wastes evaluated in the GTCC EIS. The GTCC EIS evaluation indicates that certain wastes (e.g., those containing short-lived radionuclides such as Cs-137 irradiators) could be safely disposed of in properly designed land disposal facilities at sites with suitable characteristics, such as low precipitation rates, high soil distribution coefficients, and sufficient depths to groundwater. Based on the GTCC EIS evaluation, land disposal facilities located in arid climates (e.g., NNSS and WIPP Vicinity) would isolate radionuclides for a sufficient period of time to allow for significant radioactive decay to occur.

While 10 CFR Part 61 identifies one NRC-approved method for GTCC LLRW disposal (disposal in a geologic repository), these regulations also indicate that other disposal methods could be approved. The GTCC EIS evaluates three land disposal methods (i.e., enhanced near-surface trench, intermediate-depth borehole, and above-grade vault). The GTCC EIS evaluation indicates that land disposal methods employed at sites with suitable characteristics would be viable and safe alternatives for the disposal of GTCC LLRW.

- L293-29 The specific locations that would be used at each potential site for development of a disposal facility for GTCC LLRW and GTCC-like wastes are not known at this time. The use of "reference locations" was used in the EIS to allow for a quantitative assessment of the impacts that could occur at each site. While some parameters could change within a short distance, most would not. The RESRAD-OFFSITE computer code was used to model the migration of radionuclides from the GTCC LLRW and GTCC-like wastes placed into the conceptual disposal facility designs for the three land disposal methods (not all three methods were evaluated for each site). Site-specific information provided by technical staff from various sites that were evaluated was used in these modeling analyses to the extent it was available, and conservative assumptions were used to fill any remaining data gaps. While the computer model was largely developed to support environmental restoration activities, it has a number of features that make it a good choice for use in this EIS. The analysis presented in the EIS is adequate for the comparison of the disposal alternatives evaluated. Fate and transport parameters utilized in the estimations were based on site-specific (e.g., specific to the reference location to the extent available) information and, as such, are considered reasonable for the purpose of the comparison made in the EIS. However, DOE recognizes that additional project- and site-specific information, such as the actual depth to groundwater over the entire disposal area, could be used to inform the implementation of a disposal facility at a given location. This additional information is expected to reduce the uncertainty associated with these types of evaluations to the extent possible. Site-specific information would be evaluated in any site-specific NEPA review that would be conducted based on a ROD for this EIS.

- L293-30 See response to L293-27.
- L293-31 The land disposal construction phasing/sequencing is discussed in Section 5.1.4.1 of the EIS.
- L293-32 The EIS analyses are based on conceptual engineering information and necessitated the use of a number of simplifying assumptions. This approach is consistent with NEPA, which requires such analyses to be made early in the decision-making process. The various land disposal conceptual designs were assumed to be constructed and operated in a comparable manner at each of the various sites. Information on the conceptual engineering designs for the three proposed land disposal methods is provided in Section D.3 of Appendix D in the EIS.

In performing these evaluations, a number of engineering measures were included in the conceptual facility designs to minimize the likelihood of contaminant migration from the disposal units. No facility design can guarantee that radionuclide migration from the facility would not occur over and beyond a 10,000-year time period. It was assumed that these measures would perform similarly for all conceptual designs, remaining intact for 500 years after the disposal facility closed. After 500 years, the barriers would gradually fail. To account for these engineered features in the modeling calculations, it was assumed that the water infiltration to the top of the waste disposal area would be zero for the first 500 years and then 20% of the natural rate for the area for the remainder of the time period (through 10,000 years). A water infiltration rate of 20% of the natural rate for the area was only used for the disposal area; the natural background infiltration rate was used at the perimeter of the waste disposal units.

DOE recognizes that modeling potential releases of radionuclides from the conceptual disposal sites far into the future approximates what might actually occur. Sufficient detail was included in these designs for use in the EIS analyses, consistent with the current stage of this process. Some of the input values may change in the future and could result in higher impacts (such as from increased precipitation at some sites due to climate change), while others could result in lower impacts (due to decreased precipitation). For additional information, see Section J.2.7.

- L293-33 The amount of shielding used in the near-surface vault construction is estimated to be sufficient to reduce external exposure outside of the facility walls to below contact-handled levels (<200 mrem/h) at the surface and near background levels above the vault cover.
- L293-34 Site-specific environmental factors, such as flooding, were evaluated in the EIS as appropriate. The results of the evaluation were taken into consideration in identifying the preferred alternative presented in the Final EIS.
- L293-35 As required by NEPA, the Final EIS evaluates the potential impacts of the proposed action on cultural and natural resources at the various DOE sites in sufficient detail to assess the potential impacts of the proposed alternatives. DOE recognizes that development of a disposal facility for GTCC LLRW and GTCC-like wastes would require that future land uses be restricted at and near the site for the protection of the general public. This action could affect areas that may be important to American Indian tribes.

DOE considered the text provided by the participating affiliated American Indian tribes (Appendix G) for each of the DOE sites evaluated in selection of the preferred alternative. Information provided by the tribal governments associated with exposure pathways unique to American Indian tribes (e.g., greater intakes of fish, game, and plants; use of sweat lodges; use of natural pigment paints for traditional ceremonies) would be evaluated in site-specific NEPA review for the alternative(s) selected in a ROD for this EIS.

**Yakama Nation Environmental Restoration Waste Management Program,
Commenter ID No. L293 (cont'd)**

ID No.	Section	Subsection	Page	Figure, Map, or Table Number	Topic	Comment
3	1	1.4.2.2	1-22	NA	Action Alternatives	Provide additional detail regarding waste placement, such as how operations will ensure that waste will be stored upright and secured during loading.
3	1	1.4.2.3.1	1-22	NA	Action Alternatives	The approach to land disposal construction phasing/sequencing should be included in Section 5 of the Draft GTCC EIS. Construction sequencing information is scattered throughout the EIS in a disorganized fashion that requires the reader to hunt through several pages to obtain the relevant information. Revise the Draft GTCC EIS so that all site information is compiled in at least one location for review.
10	1	1.4.2.3.2	1-23	NA	Action Alternatives	The aboveground waste alternative will not contain waste for 10,000 years without active institutional controls. Revise the Draft GTCC EIS to provide action alternatives that do not include the vault alternative.
11	1	1.4.2.3.2	1-24	NA	Action Alternatives	Revise the Draft GTCC EIS to provide estimates of how much gamma radiation would be attenuated by shielding incorporated into the vault.
12	1	1.4.3	1-25	NA	Historical Site	Use of the proposed near-surface disposal design location is not reasonable. The location of the site should not be within the flood plain or in an area that is subject to seismic activity. The location of the site should not be in an area that is subject to geological cultural loading or other similar events. A waste disposal facility should not be located where such events could potentially damage the facility.
13	1	1.4.3	1-26	NA	Cultural Resources	Historic cultural and natural resources have not been adequately addressed as part of the Draft GTCC EIS, and the included information is not sufficient to support the EIS. The EIS should include information regarding cultural resources that are located on or near the disposal facility at the historical site.
14	1	1.5.1	1-40	Figures 1.5-1	EIS Comments	It is incorrectly implied that the Draft GTCC EIS provides sufficient information for a comparative analysis of proposed action alternatives to allow selection of a preferred alternative. Site-specific evaluations are needed for a meaningful assessment of human health impacts before a GTCC waste land disposal alternative(s) or facility can be selected as the preferred alternative. Furthermore, public participation in the EIS process has been significantly curtailed without identification of a preferred alternative in the Draft GTCC EIS because there will not be an opportunity for public comment on the preferred alternative if it is not identified until the Final EIS is issued. The USDOE should release a revised Draft GTCC EIS with an identified preferred alternative.
15	1	1.5.1	1-41	NA	Historical Site	A thorough analysis to support GTCC waste disposal decisionmaking should have clearly demonstrated that historical land is a viable location for disposal of GTCC wastes. Disposal of GTCC wastes would be incorporation with efforts to clean up selective environmental consequences. Revise the Draft GTCC EIS so that historical land is not included as a candidate site for construction of a disposal facility.
16	1	1.5.1	1-41	NA	Deep Geologic Disposal	The Nuclear Regulatory Commission (NRC) cannot approve GTCC LLRW land disposal alternatives that violate production and/or disposal of GTCC LLRW and GTCC-like waste in a deep geologic repository is the only method that would ensure isolation of radioactive waste from the environment. Revise the Draft GTCC EIS to clearly distinguish a deep geologic repository as the preferred alternative.

Yakama Nation Environmental Program GTCC EIS Comments
Response Document
Page 2

- L293-30
- L293-31
- L293-32
- L293-33
- L293-34
- L293-35
- L293-36
- L293-37
- L293-38

Yakama Nation Environmental Restoration Waste Management Program,
Commenter ID No. L293 (cont'd)

L293-36 The specific locations that would be used at each potential site for development of a disposal facility for GTCC LLRW and GTCC-like wastes are not known at this time. The use of “reference locations” was used in the EIS to allow for a quantitative assessment of the impacts that could occur at each site. While some parameters could change within a short distance, most would not. Site-specific information provided by technical staff from various sites that were evaluated was used in these modeling analyses to the extent it was available, and conservative assumptions were used to fill any remaining data gaps. The analysis presented in the EIS is adequate for the comparison of the disposal alternatives evaluated. Fate and transport parameters utilized in the estimations were based on site-specific (e.g., specific to the reference location to the extent available) information and, as such, are considered reasonable for the purpose of the comparison made in the EIS.

A preferred alternative is not required to be included in a Draft EIS. The Council on Environmental Quality regulations in 40 CFR 1502.14(e) specify that the section on alternatives in an EIS shall identify the agency’s preferred alternative or alternatives, if one or more exists, in the Draft EIS and identify such alternative(s) in the Final EIS unless another law prohibits the expression of such a preference; that is, a preferred alternative shall be identified in the Draft EIS if one exists. If no preferred alternative has been identified at the Draft EIS stage, a preferred alternative need not be included. By the time the Final EIS is filed, 40 CFR 1502.14(e) presumes the existence of a preferred alternative and requires its identification in the Final EIS unless another law prohibits the expression of such a preference.

DOE did not have a preferred alternative at the time of issuance of the Draft EIS because of the complex nature of the proposed action and the potential implications for disposal of GTCC LLRW and GTCC-like wastes. To seek public input on how to identify a preferred alternative for inclusion in the Final EIS, the Draft EIS presented considerations for developing a preferred alternative in the Summary (in Section S.6) and in Section 2.9. As required by 40 CFR 1502.14(e), the Final EIS contains a preferred alternative for the disposal of GTCC LLRW and GTCC-like wastes (see Section 2.10). In developing the preferred alternative, DOE took into consideration public comments on the Draft EIS, public EIS scoping comments, and other factors identified in Sections S.6 and 2.9 of the EIS.

The publication by the EPA of a NOA of the Final EIS in the Federal Register initiated a 30-day public availability or “waiting” period. While the availability period is not a formal public comment period, the public can comment on the Final EIS, including the preferred alternative, prior to final agency action. Comments received will be addressed by DOE in a ROD. As required by the Energy Policy Act of 2005 (P.L. 109-58), DOE must submit a Report to Congress that includes the alternatives considered in the EIS and await Congressional action before making a final decision regarding which alternative(s) to implement. The Report to Congress will be made available to the public on the GTCC EIS website (<http://www.gtceis.anl.gov/>).

L293-37 DOE is performing environmental restoration activities at the Hanford Site. The ongoing cleanup effort will continue.

The EIS analysis is used to assess the viability of an alternative as well as its relative performance compared to the other alternatives. Exclusion of a reasonable alternative from the EIS without first evaluating the site is contrary to a thorough NEPA analysis. All alternatives are retained in the Final EIS because such evaluations are needed to support selection of the preferred alternative. In addition, as discussed in Section 1.4.2, the conceptual disposal facility designs analyzed in the EIS could be modified to perform better in specific locations. Thus, poor performance in the EIS analysis does not necessarily exclude an alternative from consideration.

DOE's ROD 78 FR 75913 dated December 13, 2013, stated that DOE has deferred a decision on importing waste from other DOE sites (with limited exceptions as described in the Settlement Agreement with the State of Washington Department of Ecology) for disposal at Hanford at least until WTP is operational.

L293-38 See response to L293-28.

L293-39 The EIS analyses are based on conceptual engineering information and necessitated the use of a number of simplifying assumptions. This approach is consistent with NEPA, which requires such analyses to be made early in the decision-making process. The various land disposal conceptual designs were assumed to be constructed and operated in a comparable manner at each of the various sites. Information on the conceptual engineering designs for the three proposed land disposal methods is provided in Section D.3 of Appendix D in the EIS. By using the same conceptual designs at all of the sites evaluated in the GTCC EIS, except for cases where a design did not apply (e.g., an intermediate-depth borehole at a site with shallow groundwater), the potential impacts (e.g., radionuclides reaching the groundwater) at the different environmental settings could be readily compared.

DOE recognizes that modeling potential releases of radionuclides from the conceptual disposal sites far into the future approximates what might actually occur. Sufficient detail was included in these designs for use in the EIS analyses, consistent with the current stage of this process. Some of the input values may change in the future and could result in higher impacts (such as from increased precipitation at some sites due to climate change), while others could result in lower impacts (due to decreased precipitation).

Estimated radiation doses and LCFs were calculated for each site and disposal concept for 10,000 years, and if the peak impact did not occur during this time frame, the analysis was extended out to 100,000 years. DOE believes that the assumptions made to support the long-term modeling calculations for the groundwater pathway are reasonable and enable a comparative evaluation of the impacts between alternatives. The results of the evaluation presented in the EIS are sufficient to inform the selection of sites and methods for disposal. Site-specific NEPA reviews would be conducted as needed.

The EIS analysis is used to assess the viability of an alternative as well as its relative performance compared to the other alternatives. Exclusion of a reasonable alternative from the EIS without first evaluating the site is contrary to a thorough NEPA analysis. All alternatives are retained in the Final EIS because such evaluations are needed to support selection of the preferred alternative. In addition, as discussed in Section 1.4.2, the conceptual disposal facility designs analyzed in the EIS could be modified to perform better in specific locations. Thus, poor performance in the EIS analysis does not necessarily exclude an alternative from consideration.

L293-40 The EIS considered the range of reasonable alternatives for the disposal of the GTCC waste inventory, including disposal in a deep geologic repository. DOE did not evaluate developing a geologic repository exclusively for disposal of GTCC LLRW and GTCC-like wastes because DOE determined that such an alternative is not reasonable due to the time and cost associated with siting a deep geologic repository and the relatively small volume of GTCC LLRW and GTCC-like wastes identified in the GTCC EIS. DOE believes that the results presented in this EIS for the WIPP geologic repository alternative are indicative of the high degree of waste isolation that would be provided by disposal in a geologic repository. DOE has included analysis of generic commercial facilities in the event that a facility could become available in the future. In that case, before making a decision to use a commercial facility, DOE would conduct further NEPA reviews, as appropriate.

**Yakama Nation Environmental Restoration Waste Management Program,
Commenter ID No. L293 (cont'd)**

ID No.	Section	Subsection	Page	Figure, Map or Table Number	Type	Comment
17	1	1.5.1	1-42	NA	Long-Term Impacts	The impact on groundwater beyond 10,000 years are not considered for comparison of proposed disposal sites as the land impurities. Review the Draft GTCC EIS to consider long-term impacts to groundwater beyond 10,000 years to the point of maximum dose rate. Review the Draft GTCC EIS to ensure that action alternatives at proposed disposal sites can be compared. Provide additional analysis (USDOE M 435.1-1) requirements. Action alternatives that cannot meet the long-term requirement for waste consideration should be removed from the Draft GTCC EIS.
18	1	1.5.2	1-43	NA	Deep Geologic Disposal	The EIS Notices of intent (22 FR 44035) indicates a deep geologic repository other than WIPP will not be evaluated. Data is concerns related to surface, cost, and waste volume. However, it has not been a quarter-century since Section 301(b)(1)(D) of the Low-Level Radioisotope Waste Policy Amendment Act of 1988 (LLRWPA) designated federal responsibility for disposal of GTCC LLRW. Waste disposal is a federal responsibility under the LLRWPA. The LLRWPA requires that the LLRWPA be implemented by USDOE. USDOE is to ensure GTCC LLRW generation bear disposal costs (USDOE 1987, page 7-2) should be included. There also remains a tremendous burden of USDOE waste (other than GTCC LLRW) waste with no path to disposal that has not been, but should be, removed from the Draft GTCC EIS. Review the Draft GTCC EIS to ensure that the analysis at multiple, appropriate candidate sites.
19	1	1.5.2	1-43	NA	EIS Contents	Review the Draft GTCC EIS to verify that Congressional direction in section 631 of the Energy Policy Act of 2001 does not require an EIS and a Record of Decision (ROD) for a permanent disposal facility for GTCC-like waste. Review the inconsistency that the No Action alternative is a de facto evaluation. It is not.
20	1	1.5.2	1-44	NA	Waste Volume	Review the Draft GTCC EIS to acknowledge the direct relationship between the proposed volume of GTCC LLRW and the EIS score evaluating potential environmental impacts using various disposal options. Implementation of the steps identified by USDOE to ensure commercial operations would provide an incentive for waste reduction and wider medium environmental impact through pollution prevention.
21	1	1.5.2	1-44	NA	Long-Term Impacts	This section contains information that is dependent on land use designations and institutional controls in violation of 10 CFR 61. The scenario undertaken exceeded data and CER risk and is not based on conservative assumptions as indicated. Review the Draft GTCC EIS regarding the statement and all other statements that indicate the resident farmer scenario is based off data is a conservative estimate.
22	1	1.5.2	1-45	NA	Hanford Site	Site-specific evaluations that consider resident populations are needed for an adequate comparison of land disposal impacts. Address any of the sites can be selected for the preferred alternative. Review the Draft GTCC EIS to acknowledge that informed decisions require that the specific characteristics and conditions of each site be evaluated in addition and that this information has not yet been provided, making the analysis a subjective response.
23	2	NA	2-1	NA	EIS Contents	Site-specific evaluations that consider resident populations are needed for an adequate comparison of land disposal impacts. Address any of the sites can be selected for the preferred alternative. Review the Draft GTCC EIS to acknowledge that informed decisions require that the specific characteristics and conditions of each site be evaluated in addition and that this information has not yet been provided, making the analysis a subjective response.
24	2	NA	2-1	NA	GTCC Waste Type	Review the Draft GTCC EIS to define what the special processing and design will be for the GTCC LLRW waste if near-surface disposal is selected. In particular, describe in detail any volume reduction that is performed and the limits on activity per unit volume that will be removed.

Yakama Nation EISWMP Program GTCC EIS Comments
Attachment 2
Page 3

L293-39
L293-40
L293-41
L293-42
L293-43
L293-44
L293-45
L293-46

Yakama Nation Environmental Restoration Waste Management Program,
Commenter ID No. L293 (cont'd)

L293-41 Section 631 b (1) of the Energy Policy Act of 2005 (P.L. 109-58) requires the Secretary of Energy to submit a report to Congress containing an estimate of the cost and proposed schedule to complete an EIS and ROD for a permanent disposal facility for GTCC waste.

The No Action Alternative is evaluated in Chapter 3 of the Final EIS, and under this alternative, current practices for storing GTCC LLRW and GTCC-like wastes would continue. These practices are described in Sections 3.2 (GTCC LLRW) and 3.3 (GTCC-like wastes) in the Final EIS. It was necessary to make a number of simplifying assumptions to address the long-term impacts of this alternative, and these are described in Section 3.5.

As part of this assessment, it was assumed that these wastes would remain in long-term storage indefinitely, including wastes from the West Valley Site as discussed in Section 3.5.3, and that no maintenance of either the storage facility or waste packages would occur after 100 years. These results indicate that very high radiation doses and cancer risks could occur under this alternative in the long term.

The No Action Alternative is evaluated in the EIS to provide a baseline for comparison with the action alternatives. This evaluation confirmed the risks posed by these wastes and the need to develop appropriate disposal capability. The potential radiation doses for the No Action Alternative covered a time period of 10,000 years in a manner comparable to that done for the action alternatives. Relatively high impacts could occur shortly after the 100-year institutional control period under this alternative.

L293-42 The GTCC LLRW and GTCC-like waste inventory evaluated in the EIS is based on the best available information on the stored and projected GTCC LLRW and GTCC-like wastes from ongoing and planned activities. The estimated 12,000 m³ of GTCC LLRW and GTCC-like wastes is a relatively small volume of waste when compared to other wastes disposed of by DOE. For example, this volume of GTCC LLRW and GTCC-like wastes is only about 20% of the 59,000 m³ of LLRW disposed of at one site (NNS) in one year (fiscal year 2010). DOE canceled the *Draft Global Nuclear Energy Partnership Programmatic Environmental Impact Statement* (GNEP PEIS) (74 FR 31017); therefore, the generation of additional GTCC LLRW under GNEP is not included in the GTCC EIS inventory. In addition, the inventory includes wastes expected to be generated during the production of Mo-99 for medical applications from two potential generators. While the potential generator(s) of this waste may change, the estimated characteristics and volumes are representative of the amounts expected to supply the demand for the Mo-99. DOE believes that expanding the inventory to include potential GTCC LLRW and GTCC-like wastes from undefined or unplanned future activities would introduce excessive uncertainty in the EIS evaluations. DOE believes that the inventory included in the GTCC EIS is reasonable for the purposes of the NEPA process and that it provides a supportable basis for conducting the EIS evaluation and the identification of the preferred alternative in the Final EIS. In the future, should additional waste be identified, appropriate NEPA review would be conducted to reflect these changes and also changes that would be needed to the existing infrastructure or the identification of additional disposal sites.

Although characterization information for some of the GTCC LLRW and GTCC-like wastes is limited, DOE believes that sufficient data are available to allow for a comparative analysis of various approaches to dispose of these wastes in the EIS. Adequate data are generally available for the radioactive constituents, but comparable data for chemical constituents are generally lacking. DOE believes that the data presented in the EIS are sufficient to make comparative analyses between and among sites.

Depleted uranium is not included in the GTCC LLRW waste inventory because this material is not GTCC LLRW. Likewise, Class B and C wastes are not GTCC LLRW and are out of scope for this EIS.

DOE's Report to Congress required by Section 631 of the Energy Policy Act, 2005 (P.L. 109-58), will identify options for ensuring that the beneficiaries of the activities resulting in the generation of GTCC LLRW bear all reasonable costs of disposing of such wastes.

L293-43 The resident farmer scenario is not dependent on land use designations or institutional controls. As discussed in Section 2.7.4.2, the hypothetical resident farmer scenario was only used to provide estimates for comparing the various sites evaluated; however, this scenario may not be consistent with the reasonably foreseeable future scenario at some of the sites evaluated. Site-specific NEPA reviews would be conducted as needed.

L293-44 All relevant potential exposure pathways were considered in the analyses presented in the EIS. These analyses addressed a range of reasonable scenarios and estimated the potential impacts on all environmental resources consistent with NEPA requirements. For the human health assessment, the focus was on the groundwater pathway, since this is the most likely manner in which someone could be exposed to the radioactive contaminants in the GTCC LLRW and GTCC-like wastes in the distant future. Site-specific NEPA reviews would be conducted as needed. This information could include sensitive subpopulations and specific pathways of exposure for American Indians.

L293-45 DOE developed this EIS to support a decision on selecting a disposal facility or facilities for GTCC LLRW and GTCC-like waste, to address legislative requirements, to address national security concerns (especially for sealed sources), and to protect public health and safety. The purpose and need for the proposed action, as discussed above, is stated in the EIS (Section 1.1). The scope of the EIS is focused on addressing the need for developing a disposal capability for the identified inventory of GTCC LLRW and GTCC-like wastes.

As required by the Energy Policy Act of 2005, (P.L. 109-58), DOE must submit a Report to Congress that includes the alternatives considered in the EIS and await Congressional action before making a final decision regarding which alternative(s) to implement. The Report to Congress will be made available to the public on the GTCC EIS website (<http://www.gtcceis.anl.gov/>).

L293-46 Information on waste forms and waste packages and containers is provided in the EIS to allow for a comparative analysis of alternatives for transportation and waste disposal. Treatment of the wastes prior to disposal is outside the scope of the EIS. Such treatment is assumed to be addressed prior to receipt of the waste at the GTCC LLRW and GTCC-like waste disposal facility. DOE agrees that it is important to immobilize long-lived radionuclides such as Tc-99 and I-129 prior to disposal. Solidification techniques (e.g., use of grout) are expected to immobilize certain wastes in the GTCC LLRW and GTCC-like waste inventory. If needed, the actual stabilization methods used will depend, in part, on the waste stream, packaging, and final disposal facility design. DOE considers the assumptions used for waste form stability (see Appendix B) to be reasonable for purposes of the comparative analysis provided in the EIS.

The waste characteristics and physical form would have to meet the disposal facility waste acceptance criteria. It is expected that these waste acceptance criteria would identify requirements (such as allowable concentrations) for individual radionuclides, including Tc-99 and I-129. The specific waste forms and packages used to dispose of GTCC LLRW and GTCC-like wastes would be determined in the future as part of the waste acceptance criteria and packaging requirements developed.

L293-47 Detailed information related to the potential impacts on the various resource areas are provided in the individual site chapters as well as in Chapter 5 (Common elements for Alternatives 3,4, and 5) and Appendix D (Conceptual Disposal Facility Design), and Appendix E (Evaluation of Long-Term Human Health Impacts). All relevant potential exposure pathways and resources

**Yakama Nation Environmental Restoration Waste Management Program,
Commenter ID No. L293 (cont'd)**

ID No.	Section	Subsection	Page	Figure Number	Topic	Comment
25	2	NA	2-2	Figure 2-1	EIS Contents	There are no quantitative data provided to support the claim that "estimated potential impacts would probably be small overall or could be avoided, minimized, or mitigated to an acceptable level." Substantive comments on the EIS are provided in the comments section of the EIS. See previous comments regarding the list of a preferred alternative in the Draft GTCC EIS. Review the Draft GTCC EIS to identify additional information and analysis of the various options to demonstrate that potential impacts are bounded.
26	2	NA	2-3	NA	EIS Contents	See previous comments regarding the list of a preferred alternative in the Draft GTCC EIS. Review the Draft GTCC EIS to identify additional information and analysis of the various options to demonstrate that potential impacts are bounded.
27	2	2.1	2-4	NA	Long-Term Impacts	The No Action alternative has the potential to cause significant long-term environmental degradation by the EIS's quantitative estimates of impacts on the environment. The evaluation of long-term impacts does not consider surface runoff and particulate air emissions/moistures even though storage of GTCC wastes is at the ground surface. Proper evaluation of the impact of the No Action alternative requires that the EIS consider the impacts of long-term impacts. Review the Draft GTCC EIS analysis of the No Action alternative to demonstrate that potential long-term impacts are bounded.
28	2	2.3	2-8	NA	Action Alternatives	The Draft GTCC EIS should identify the minimum acceptable depth to groundwater for each of the trenches, and verify to the best of your ability that alternative benefits could be used for GTCC waste. If the waste is deeper of less than 30 meters below ground surface, it would be considered near-surface disposal. Review the Draft GTCC EIS to acknowledge this distinction and describe additional engineering and design measures that would be required for such an action.
29	2	2.3	2-8	NA	Action Alternatives	The Draft GTCC EIS should identify the minimum acceptable depth to groundwater for each of the trenches, and verify to the best of your ability that alternative benefits could be used for GTCC waste. If the waste is deeper of less than 30 meters below ground surface, it would be considered near-surface disposal. Review the Draft GTCC EIS to acknowledge this distinction and describe additional engineering and design measures that would be required for such an action.
30	2	2.3	2-8	NA	Handoff Site	A thorough analysis to support GTCC waste disposal decision-making should clearly demonstrate that Handoff is not a viable location for disposal of these highly radioactive and long-lived wastes. See previous comments regarding disposal of additional waste at Handoff. Review the Draft GTCC EIS so that Handoff is no longer a candidate site for disposal of GTCC waste.
31	2	2.4	2-9	NA	Handoff Site	One Ridge was established as a candidate site because it had appropriate for disposal of LLRW including high concentrations of long-lived radionuclides. However, the EIS does not provide sufficient information to support the claim that the site is suitable for disposal of GTCC waste. This information is required to support the claim that the site is suitable for disposal of GTCC waste. This information is required to support the claim that the site is suitable for disposal of GTCC waste. This information is required to support the claim that the site is suitable for disposal of GTCC waste.
32	2	2.7.1	2-10	NA	Short-Term Impacts	The impacts to air quality during the construction phase at the Handoff Site should be of particular concern. Using the reference area the potential to create additional risks that the Draft GTCC EIS does not sufficiently address.
33	2	2.7.2	2-11	NA	Long-Term Impacts	Surface erosion and land-use-related controls are not appropriate for handling wastes that will remain dangerous on the site for the life of the waste. The EIS does not provide sufficient information to support the claim that the site is suitable for disposal of GTCC waste. This information is required to support the claim that the site is suitable for disposal of GTCC waste. This information is required to support the claim that the site is suitable for disposal of GTCC waste.

Yakama Nation Environmental Restoration Waste Management Program
Appendix I
Page 4

L293-47

L293-48

L293-49

L293-50

L293-51

L293-52

L293-53

L293-54

L293-55

Yakama Nation Environmental Restoration Waste Management Program,
Commenter ID No. L293 (cont'd)

L293-48 A preferred alternative is not required to be included in a Draft EIS. The Council on Environmental Quality regulations in 40 CFR 1502.14(e) specify that the section on alternatives in an EIS shall identify the agency's preferred alternative or alternatives, if one or more exists, in the Draft EIS and identify such alternative(s) in the Final EIS unless another law prohibits the expression of such a preference; that is, a preferred alternative shall be identified in the Draft EIS if one exists.

If no preferred alternative has been identified at the Draft EIS stage, a preferred alternative need not be included. By the time the Final EIS is filed, 40 CFR 1502.14(e) presumes the existence of a preferred alternative and requires its identification in the Final EIS unless another law prohibits the expression of such a preference.

DOE did not have a preferred alternative at the time of issuance of the Draft EIS because of the complex nature of the proposed action and the potential implications for disposal of GTCC LLRW and GTCC-like wastes. To seek public input on how to identify a preferred alternative for inclusion in the Final EIS, the Draft EIS presented considerations for developing a preferred alternative in the Summary (in Section S.6) and in Section 2.9. As required by 40 CFR 1502.14(e), the Final EIS contains a preferred alternative for the disposal of GTCC LLRW and GTCC-like wastes (see Section 2.10). In developing the preferred alternative, DOE took into consideration public comments on the Draft EIS, public EIS scoping comments, and other factors identified in Sections S.6 and 2.9 of the EIS.

The publication by the EPA of a NOA of the Final EIS in the Federal Register initiated a 30-day public availability or "waiting" period. While the availability period is not a formal public comment period, the public can comment on the Final EIS, including the preferred alternative, prior to final agency action. Comments received will be addressed by DOE in a ROD. As required by the Energy Policy Act of 2005 (P.L. 109-58), DOE must submit a Report to Congress that includes the alternatives considered in the EIS and await Congressional action before making a final decision regarding which alternative(s) to implement. The Report to Congress will be made available to the public on the GTCC EIS website (<http://www.gtcceis.anl.gov/>).

DOE agrees that use of a geologic repository would be a protective and safe method for the disposal of the entire inventory of GTCC LLRW and GTCC-like wastes. The GTCC EIS evaluation for the WIPP geologic repository alternative supports this statement. However, the degree of waste isolation provided by a geologic repository may not be necessary for all of the GTCC LLRW and GTCC-like wastes evaluated in the GTCC EIS. The GTCC EIS evaluation indicates that certain wastes (e.g., those containing short-lived radionuclides such as Cs-137 irradiators) could be safely disposed of in properly designed land disposal facilities at sites with suitable characteristics, such as low precipitation rates, high soil distribution coefficients, and sufficient depths to groundwater. Based on the GTCC EIS evaluation, land disposal facilities located in arid climates (e.g., NNSS and WIPP Vicinity) would isolate radionuclides for a sufficient period of time to allow for significant radioactive decay to occur.

While 10 CFR Part 61 identifies one NRC-approved method for GTCC LLRW disposal (disposal in a geologic repository), these regulations also indicate that other disposal methods could be approved. The GTCC EIS evaluates three land disposal methods (i.e., enhanced near-surface trench, intermediate-depth borehole, and above-grade vault). The GTCC EIS evaluation indicates that land disposal methods employed at sites with suitable characteristics would be viable and safe alternatives for the disposal of GTCC LLRW.

Yakama Nation Environmental Restoration Waste Management Program,
Commenter ID No. L293 (cont'd)

- L293-49 The No Action Alternative is evaluated in Chapter 3 of the EIS, and under this alternative, current practice for storing GTCC LLRW and GTCC-like wastes would continue. These practices are described in Sections 3.2 (GTCC LLRW) and 3.3 (GTCC-like wastes) in the Final EIS. It was necessary to make a number of simplifying assumptions to address the long-term impacts of this alternative, and these are described in Section 3.5. As part of this assessment, it was assumed that these wastes would remain in long-term storage indefinitely, including wastes from the West Valley Site as discussed in Section 3.5.3, and that no maintenance of either the storage facility or waste packages would occur after 100 years. These results indicate that very high radiation doses and cancer risks could occur under this alternative in the long term.
- The No Action Alternative is evaluated in the EIS to provide a baseline for comparison with the action alternatives. This evaluation confirmed the risks posed by these wastes and the need to develop appropriate disposal capability. The potential radiation doses for the No Action Alternative covered a time period of 10,000 years in a manner comparable to that done for the action alternatives. Relatively high impacts could occur shortly after the 100-year institutional control period under this alternative.
- L293-50 See response to L293-29.
- L293-51 The text states “The borehole method entails emplacement of waste in boreholes at depths below 30 m” and “The conceptual design evaluated in this EIS employs boreholes that are 2.4 m (8 ft.) in diameter and 40-m (130-ft.) deep.” Waste can still be buried in shallower boreholes (less than 40 m) and still keep the waste below 30 m (at intermediate depths, not near-surface).
- L293-52 The EIS analysis is used to assess the viability of an alternative as well as its relative performance compared to the other alternatives. Exclusion of a reasonable alternative from the EIS without first evaluating the site is contrary to a thorough NEPA analysis. All alternatives are retained in the Final EIS because such evaluations are needed to support selection of the preferred alternative. In addition, as discussed in Section 1.4.2, the conceptual disposal facility designs analyzed in the EIS could be modified to perform better in specific locations. Thus, poor performance in the EIS analysis does not necessarily exclude an alternative from consideration.
- L293-53 Disposal of LLRW at Oak Ridge Reservation (ORR) is currently limited to only CERCLA (Comprehensive Environmental Response, Compensation, and Liability Act) waste. Based on reviews conducted by the Low-Level Waste Disposal Facility Federal Review Group, DOE determined the site is not appropriate for disposal of LLRW containing high concentrations of long-lived radionuclides (such as those found in GTCC LLRW and GTCC-like wastes), especially those with high mobility in the subsurface environment. For this reason, DOE concluded that the ORR is not a reasonable disposal site alternative and eliminated it from detailed evaluation. Hanford, on the other hand, exhibits different soil and depth to groundwater characteristics that do not exclude it from being considered in the GTCC EIS evaluation.
- L293-54 Potential air quality impacts at Hanford were evaluated sufficiently in Section 6.2.1 in the EIS. It is not expected that the disposal facility would be constructed in contaminated soil.
- L293-55 DOE agrees that use of a geologic repository would be a protective and safe method for the disposal of the entire inventory of GTCC LLRW and GTCC-like wastes. The GTCC EIS evaluation for the WIPP geologic repository alternative supports this statement. However, the degree of waste isolation provided by a geologic repository may not be necessary for all of the GTCC LLRW and GTCC-like wastes evaluated in the GTCC EIS. The GTCC EIS evaluation indicates that certain wastes (e.g., those containing short-lived radionuclides such as Cs-137 irradiators) could be safely disposed of in properly designed land disposal facilities at

sites with suitable characteristics, such as low precipitation rates, high soil distribution coefficients, and sufficient depths to groundwater. Based on the GTCC EIS evaluation, land disposal facilities located in arid climates (e.g., NNSS and WIPP Vicinity) would isolate radionuclides for a sufficient period of time to allow for significant radioactive decay to occur.

While 10 CFR Part 61 identifies one NRC-approved method for GTCC LLRW disposal (disposal in a geologic repository), these regulations also indicate that other disposal methods could be approved. The GTCC EIS evaluates three land disposal methods (i.e., enhanced near-surface trench, intermediate-depth borehole, and above-grade vault). The GTCC EIS evaluation indicates that land disposal methods employed at sites with suitable characteristics would be viable and safe alternatives for the disposal of GTCC LLRW.

DOE agrees that the GTCC waste disposal facility must ensure the protection of a hypothetical future inadvertent human intruder, especially for the wastes disposed of in an enhanced near surface trench or vault.

On the basis of the depth of waste disposal, DOE believes that the only reasonable potential for intrusion is from a future drilling event, such as drilling for a well. The likelihood of inadvertent intrusion from a drilling event would be very low for a GTCC near-surface disposal facility because of (1) the use of intruder barriers, (2) the remoteness of the sites, (3) DOE's commitment to long-term institutional control, (4) site conditions such as the general lack of easily accessible resources and the great depth to groundwater, and (5) waste form stability. On the basis of these considerations, DOE did not include a quantitative analysis of inadvertent human intruder in the EIS. Site-specific NEPA reviews would be conducted as needed.

- L293-56 See response to L293-2.
- L293-57 Site-specific environmental factors, such as erosion rates, runoff coefficient, slope length and steepness, cover and management and soil erodability, were evaluated in the EIS as appropriate (Refer to Table E-3 (INL), E-5 (Hanford), E-7, (LANL), E-9 (NNSS) and E-13 (WIPP)). The results of the evaluation were taken into consideration in identifying the preferred alternative presented in the Final EIS.
- L293-58 The erosion rates used for Hanford were selected to be conservative (i.e., higher than expected) to produce results that would not underestimate potential impacts. Appendix E in the EIS covers the model input parameters used for Hanford and the other sites evaluated.
- L293-59 The use of water during construction would not occur over emplaced GTCC or GTCC-like waste other than minor amounts for used for re-vegetation of any final ground cover. The volume of water anticipated for construction is small (maximum of about 0.4% of the annual water use at the 200 East Area) as discussed in Section 6.2.3.1. Such an increase is not expected to have an appreciable effect on existing contamination in the vadose zone.
- L293-60 See response to L293-2.
- L293-61 All relevant potential exposure pathways were considered in the analyses presented in the EIS, including impacts from surface runoff (Refer to Appendix E). These analyses addressed a range of reasonable scenarios and estimated the potential impacts on all environmental resources consistent with NEPA requirements. Site-specific NEPA reviews would be conducted as needed.
- L293-62 See response to L293-2.

**Yakama Nation Environmental Restoration Waste Management Program,
Commenter ID No. L293 (cont'd)**

ID No.	Section	Subsection	Page	Figure, Map or Table Number	Topic	Comment
34	2	2.7.2	241	NA	Long-Term Impacts	The statement "the land currently used for storage would continue to be used" does not address the long-term use of the Hanford storage tanks not designed for long-term use. Century to the EIS's claim: Alternative 1-5's implementation at Hanford could have significant impacts. Refer to previous comments regarding subsurface contamination in the Hanford reference area and comments regarding future cumulative impacts. Review the Draft GTCC EIS in accordance with these comments.
35	2	2.7.2	242	NA	Environmental Variables	Assuming that the erosion rate will always be that in watersheds that is not responsible for the erosion of adjacent, very large runoff events are known to result in significant erosion that may not be apparent in short-term observations. Additional information needed to be taken into account, particularly at more arid locations such as Hanford. Review the Draft GTCC EIS to better understand the erosion rates used in the EIS. The erosion rates used in the EIS should be based on the actual erosion rates that are observed in the region or a given region to these adjustments can be accounted for.
36	2	2.7.2	242	NA	Environmental Variables	It is not realistic to assume that very low erosion rates observed on a newly constructed barrier can be maintained beyond 100 years. Review the Draft GTCC EIS to evaluate a variable or increasing erosion rate over time to reflect the impact of barrier degradation.
37	2	2.7.3	242	NA	Short-Term Impacts	The impact rate was read from spreading the identified volume of water (rain) and allowing the water to infiltrate as significant. This is not a realistic assumption. The impact rate should be based on the actual infiltration rate of the Hanford reference area, which according to the Draft GTCC EIS is proportional to infiltration.
38	2	2.7.3	242	NA	Long-Term Impacts	Potential risks to the aquifer are not sufficiently addressed. The groundwater under the reference area is already significantly contaminated. See comments in Attachment 1 regarding Hanford cumulative impacts.
39	2	2.7.3	242	NA	Long-Term Impacts	Potential long-term impacts from surface runoff were not evaluated. Given that waste is stored at or near the ground surface in the Hanford, trench, and vault alternatives, and given that institutional controls are not reliable beyond 100 years, failure to evaluate long-term impacts from surface runoff is inappropriate. Review the Draft GTCC EIS to include the surface water pathway for exposure.
40	2	2.7.3	243	NA	Long-Term Impacts	The Draft GTCC EIS identifies significant impacts to Hanford groundwater including large doses of 1,120, 70-90, 10,280, and other radionuclides. Several of the radionuclides that reach groundwater after the first 10,000 years are transuranic. It is not reasonable to add more contaminants to Hanford groundwater in the form of waste. Refer to the comments in Attachment 1 regarding cumulative impacts and more comments on the Draft GTCC EIS. Review the Draft GTCC EIS to include the impact of the Hanford EIS to the impact of a GTCC waste facility.
41	2	2.7.4.1	243	NA	Short-Term Impacts	Review the Draft GTCC EIS to identify the dose that a Native American cultural resource specialist will receive during excavation activities.
42	2	2.7.4.1	243	NA	Long-Term Impacts	The EIS's risk assessment did not include all relevant pathways for exposure. Post-closure exposure pathways should reasonably include surface water, groundwater, and ingestion, and vapor inhalation. Read and review the Yakama Nation Exposure Scenario (October 2007) and incorporate the exposure pathways identified there to the risk analysis presented in the revised GTCC Draft EIS.
43	2	2.7.4.2	244	Table 2.7.3	Action Alternatives	Because current storage of GTCC wastes is at the ground surface and institutional controls are not viable beyond 100 years (10 CFR 61.1), it is essential to conduct quantitative evaluation of the impacts of the no action alternative using the runoff rate estimate of the proposed disposal alternatives.

Yakama Nation Environmental Restoration Waste Management Program: GTCC EIS Commenter ID No. L293
Attachment 2
Page 5

- L293-58
- L293-59
- L293-60
- L293-61
- L293-62
- L293-63
- L293-64
- L293-65

Yakama Nation Environmental Restoration Waste Management Program,
Commenter ID No. L293 (cont'd)

L293-63 All relevant potential exposure pathways were considered in the analyses presented in the EIS. These analyses addressed a range of reasonable scenarios and estimated the potential impacts on all environmental resources consistent with NEPA requirements. For the human health assessment, the focus was on the groundwater pathway, since this is the most likely manner in which someone could be exposed to the radioactive contaminants in the GTCC LLRW and GTCC-like wastes in the distant future. As discussed in Section 2.7.4.2 of the EIS, the hypothetical resident farmer scenario was only used to provide estimates for comparing the various sites evaluated; however, this scenario may not be consistent with the reasonably foreseeable future scenario at some of the sites evaluated. Site-specific NEPA reviews would be conducted as needed. This information could include sensitive subpopulations and specific pathways of exposure for American Indians.

L293-64 See response to L293-63.

L293-65 The No Action Alternative is evaluated in Chapter 3 of the EIS, and under this alternative, current practices for storing GTCC LLRW and GTCC-like wastes would continue. These practices are described in Sections 3.2 (GTCC LLRW) and 3.3 (GTCC-like wastes) in the Final EIS. It was necessary to make a number of simplifying assumptions to address the long-term impacts of this alternative, and these are described in Section 3.5. As discussed, airborne releases were considered to be negligible. As part of this assessment, it was assumed that these wastes would remain in long-term storage indefinitely, including wastes from the West Valley Site as discussed in Section 3.5.3, and that no maintenance of either the storage facility or waste packages would occur after 100 years. These results indicate that very high radiation doses and cancer risks could occur under this alternative in the long term.

The No Action Alternative is evaluated in sufficient detail in the EIS as required by NEPA. Comparatively high potential radiation doses and cancer risks could occur should this alternative be selected. While a more detailed analysis could reduce the uncertainties associated with estimating these doses and risks, the conclusion of comparatively high impacts would not change for this alternative.

The No Action Alternative is evaluated in the EIS to provide a baseline for comparison with the action alternatives. This evaluation confirmed the risks posed by these wastes and the need to develop appropriate disposal capability. The potential radiation doses for the No Action Alternative covered a time period of 10,000 years in a manner comparable to that done for the action alternatives. Relatively high impacts could occur shortly after the 100-year institutional control period under this alternative.

- L293-66 See response to L293-21.
- L293-67 DOE agrees that the GTCC waste disposal facility must ensure the protection of a hypothetical future inadvertent human intruder, especially for the wastes disposed of in an enhanced near surface trench. In the conceptual design for the trench disposal facility, the trenches are about 3 m (10 ft.) wide, 11 m (36 ft.) deep, and 100 m (330 ft.) long. The GTCC waste disposal placement is assumed to be about 5 to 10 m (16 to 33 ft.) below ground surface.

On the basis of the depth of waste disposal, DOE believes that the only reasonable potential for intrusion is from a future drilling event, such as drilling for a well. The likelihood of inadvertent intrusion from a drilling event would be very low for a GTCC waste trench disposal facility because of (1) the narrow width of the trench, (2) the use of intruder barriers, (3) the remoteness of the sites, (4) DOE's commitment to long-term institutional control, (5) site conditions such as the general lack of easily accessible resources and the great depth to groundwater, and (6) waste form stability. On the basis of these considerations, DOE did not include a quantitative analysis of inadvertent human intruder in the EIS. Site-specific NEPA reviews would be conducted as needed.

Potential inadvertent human intrusion into WIPP is addressed in the documentation supporting its current operations. Inclusion of GTCC LLRW and GTCC-like wastes with the wastes already planned for disposal in this repository would not be expected to change the results associated with this hypothetical intrusion event.

- L293-68 See response to L293-67.
- L293-69 All relevant potential exposure pathways were considered in the analyses presented in the EIS. These analyses addressed a range of reasonable scenarios and estimated the potential impacts on all environmental resources consistent with NEPA requirements. For the human health assessment, the focus was on the groundwater pathway, since this is the most likely manner in which someone could be exposed to the radioactive contaminants in the GTCC LLRW and GTCC-like wastes in the distant future. Locations closer than the 100 m (330 ft.) evaluated would result in higher dose and cancer risk estimates. The 100 m (30 ft.) distance was used to be consistent with the minimum buffer zone distance surrounding a DOE LLRW disposal site identified in DOE Manual 435.1-1 Radioactive Waste Management Manual. As discussed in Section 2.7.4.2 of the EIS, the hypothetical resident farmer scenario was only used to provide estimates for comparing the various sites evaluated; however, this scenario may not be consistent with the reasonably foreseeable future scenario at some of the sites evaluated. Site-specific NEPA reviews would be conducted as needed. This information could include sensitive subpopulations and specific pathways of exposure for American Indians. In a similar fashion, additional cumulative impacts analyses would be conducted by using additional site-specific information when the location selected for a GTCC LLRW and GTCC-like waste disposal facility was determined.

DOE has considered cumulative impacts at the Hanford Site in this GTCC EIS. The disposal of GTCC LLRW and GTCC-like waste at the Hanford Site could result in environmental impacts that may warrant mitigation for Tc-99 and I-129 through limiting receipt of these waste streams (see Table 6.2.4.2 and Figure 6.2.4.1 in this EIS).

DOE's ROD 78 FR 75913 dated December 13, 2013, stated that DOE has deferred a decision on importing waste from other DOE sites (with limited exceptions as described in the Settlement Agreement with the State of Washington Department of Ecology) for disposal at Hanford at least until WTP is operational.

ID No.	Section	Subsection	Page	Figure, Map, or Table Number	Topic	Comment
44	2	27.4.2	2-9	NA	Surface Exposure to Institutional Controls	Refer to the comments in Attachment 1 regarding land use and site occupation following loss of institutional controls. Post-closure occurrence is not considered any closer to the facility than 100 meters from the boundary. This is not a reasonable assumption since a fish at least and secondarily wastes sent to land and gather on open lands such as the Hanford Site. Revise the Draft GTCC EIS to incorporate the requirements of the Treaty of 1855, and provide additional alternatives that do not conflict with the rights granted by the Treaty of 1855.
45	2	27.4.2	2-9	NA	Human Exposure	It is unacceptable to assume that the resident farmer scenario is a conservative estimate. By assuming a high level of institutional controls and institutional memory of the facility, unintentional or intentional intrusion into the waste site is very likely. Revise the Draft GTCC EIS to include a detailed institutional intruder scenario for any near-surface proposed action alternative.
46	2	27.4.2	2-9	NA	Human Exposure	The paragraph continues the first paragraph on this page, which states that all institutional controls will be lost. Corollary use of institutional controls and residual memory alone for much more routine and destructive scenarios than a resident farmer who does not come closer to the facility than 100 meters from the boundary. The concept that a farmer or future resident could reside on a nearby site is a very poor assumption. It is not likely that any person would be present at the site after the facility is closed. The proposed scenario may be more appropriate for a well-drained field. The provided scenario is not conservative and should not be identified as such. Revise the Draft GTCC EIS to include significantly more detailed and damaging scenarios that include direct occupational, facility-related damage to surface barriers, and dramatically increased infiltration such as may occur as a result of irrigation within the facility boundary.
47	2	27.4.2	2-9	NA	Long-Term Impacts	The draft does not take into account the cumulative impacts at the Hanford Site. Please refer to comments in Attachment 1 regarding cumulative impacts in the Hanford Site. Revise the Draft GTCC EIS to include all relevant cumulative impacts from the Hanford Site, including the Triuk, Clowen, and Neelon Management (TCMN) EIS (USDOL, 2009) and should include the exposure pathways identified in the Yakama Nation Exposure Scenario (Reddy, 2007). Revise the Draft GTCC EIS to include all pre-existing contamination at the Hanford Site in the cumulative impact analysis.
48	2	27.4.2	2-9	NA	Human Exposure	The advertisement that the surface level impact mechanism is not subject to the Hanford, trench, and vent alternatives is technically unjustified. See previous comments about the need to include the surface water exposure pathway in the revised Draft GTCC EIS.
49	2	27.4.2	2-9	NA	Human Exposure	Underlying assumptions here and throughout the Draft GTCC EIS reflect systematic overestimation of land use designations and institutional controls to reduce estimated long-term exposures. Revise the Draft GTCC EIS to acknowledge in the section that describes the Hanford Site that the Hanford Site is a complex of sites with a variety of uses and activities. Provide a more detailed description of site-specific uses and LCF risk. Remove speculation on the likelihood of the resident farmer scenario occurring at individual sites and delete the reference to Hanford as an example.
50	2	27.4.2	2-9	NA	Surface Exposure to Institutional Controls	The effectiveness of stabilization agents such as gravel to reduce the leaching of Cs-137/W-37 has not been established, and such agents may be retroequivalent when compared to the long half-lives of these radionuclides. Revise the Draft GTCC EIS to include the effectiveness of stabilization agents and the performance over very long periods of time has not been evaluated using a scientifically rigorous methodology.

L293-66

L293-67

L293-68

L293-69

L293-70

L293-71

L293-72

Yakama Nation Environmental Program GTCC EIS Comments
 Commenter: American Indian
 Page: 8

**Yakama Nation Environmental Restoration Waste Management Program,
 Commenter ID No. L293 (cont'd)**

Yakama Nation Environmental Restoration Waste Management Program,
Commenter ID No. L293 (cont'd)

L293-70 All relevant potential exposure pathways were considered in the analyses presented in the EIS. These analyses addressed a range of reasonable scenarios and estimated the potential impacts on all environmental resources consistent with NEPA requirements. For the human health assessment, the focus was on the groundwater pathway, since this is the most likely manner in which someone could be exposed to the radioactive contaminants in the GTCC LLRW and GTCC-like wastes in the distant future. As discussed in Section 2.7.4.2 of the EIS, the hypothetical resident farmer scenario was only used to provide estimates for comparing the various sites evaluated; however, this scenario may not be consistent with the reasonably foreseeable future scenario at some of the sites evaluated. Site-specific NEPA reviews would be conducted as needed.

L293-71 In evaluating the performance of the proposed land disposal facilities, a number of engineering measures were assumed in the conceptual facility designs to minimize infiltration of water into the wastes and thereby minimize contaminant migration from the disposal units. Monitoring and maintenance of the land disposal units were assumed to be for 100 years, and corrective measures could be implemented during this time period to ensure that the engineered barriers lasted for at least 500 years. This is consistent with the institutional control time frame given in both NRC and DOE requirements and was determined to be a reasonable approach for assessing the long-term performance of the disposal units.

It was assumed that after 500 years, the barriers would gradually fail. To account for these measures in the modeling calculations, it was assumed that the water infiltration to the top of the waste disposal area would be zero for the first 500 years and then 20% of the natural rate for the area for the remainder of the assessment time period (10,000 years). A water infiltration rate of 20% of the natural rate for the area was used only for the waste disposal area; the natural background infiltration rate was used at and beyond the perimeter of the waste disposal units.

Additional assumptions were used for a number of parameters, including the distance to a nearby hypothetical receptor (100 m or 330 ft. from the edge of the disposal facility). The analyses in the EIS indicate that a near-surface trench facility at NNSS and the WIPP Vicinity can be safely used (e.g., estimates indicated no dose to a hypothetical nearby receptor at 10,000 years).

DOE agrees that the GTCC waste disposal facility must ensure the protection of a hypothetical future inadvertent human intruder. In the conceptual design for the trench disposal facility, the trenches are about 3 m (10 ft.) wide, 11 m (36 ft.) deep, and 100 m (330 ft.) long. The GTCC waste disposal placement is assumed to be about 5 to 10 m (16 to 33 ft.) below ground surface.

On the basis of the depth of waste disposal, DOE believes that the only reasonable potential for intrusion into a trench is from a future drilling event, such as drilling for a water well. The likelihood of inadvertent intrusion from a drilling event would be very low for a GTCC trench disposal facility at the reference locations evaluated because of (1) the narrow width of the trench, (2) the use of intruder barriers, (3) the remoteness of the sites, (4) DOE's commitment to long-term institutional control at these sites, (5) site conditions such as the general lack of easily accessible resources and the great depth to groundwater, and (6) waste form stability. On the basis of these considerations, DOE did not include a quantitative analysis of an inadvertent human intruder in this EIS. Site-specific NEPA reviews would be conducted as needed.

Issues associated with potential inadvertent human intrusion into WIPP have been addressed in the documentation supporting its current operations. Disposal of the GTCC LLRW and GTCC-like waste inventory in addition to the wastes already planned for disposal in this repository would not be expected to change the results associated with this hypothetical event.

All relevant potential exposure pathways were considered in the analyses presented in the EIS. These analyses addressed a range of reasonable scenarios and estimated the potential impacts on all environmental resources consistent with NEPA requirements. For the human health assessment, the focus was on the groundwater pathway, since this is the most likely manner in which someone could be exposed to the radioactive contaminants in the GTCC LLRW and GTCC-like wastes in the distant future. As discussed in Section 2.7.4.2, the hypothetical resident farmer scenario was only used to provide estimates for comparing the various sites evaluated; however, this scenario may not be consistent with the reasonably foreseeable future scenario at some of the sites evaluated. Site-specific NEPA reviews would be conducted as needed.

L293-72 Information on waste forms and waste packages and containers is provided throughout the EIS to allow for a comparative analysis of alternatives for transportation and waste disposal. Treatment of the wastes prior to disposal is outside the scope of the EIS. Such treatment is assumed to be addressed prior to receipt of the waste at the GTCC LLRW and GTCC-like waste disposal facility. DOE agrees that it is important to immobilize long-lived radionuclides such as Tc-99 and I-129 prior to disposal. Solidification techniques (e.g., use of g rout) are expected to immobilize certain wastes in the GTCC LLRW and GTCC-like waste inventory. If needed, the actual stabilization methods used will depend, in part, on the waste stream, packaging, and final disposal facility design. DOE considers the assumptions used for waste form stability (see Appendix B) to be reasonable for purposes of the comparative analysis provided in the EIS.

L293-73 The minimum distance of 100 m is adequate for the analyses conducted in this EIS. The 100 m distance was used to be consistent with the minimum buffer zone distance surrounding a DOE LLRW disposal site identified in DOE Manual 435.1-1, Radioactive Waste Management Manual. As discussed in Section 2.7.4.2 of the EIS, the hypothetical resident farmer scenario was only used to provide estimates for comparing the various sites evaluated; however, this scenario may not be consistent with the reasonably foreseeable future scenario at some of the sites evaluated. Site-specific NEPA reviews would be conducted as needed.

L293-74 The assumption of a 20% natural background infiltration rate after 500 years was based on a study at SRS (Phifer et al. 2007) that indicated that after 10,000 years, the closure cap at the F-area would still shed about 80% of the cumulative precipitation falling on it, with an effectiveness that would be greater before 10,000 years, then decrease very slowly after 10,000 years. The approach used in the EIS is more conservative than indicated by this study.

A limited sensitivity analysis was conducted to obtain an idea of the uncertainties involved in the long-term post-closure human health estimates as described in Appendix E, Section E.6. The sensitivity analysis did include an analysis of the infiltration rate.

L293-75 All relevant potential exposure pathways were considered in the analyses presented in the EIS. These analyses addressed a range of reasonable scenarios and estimated the potential impacts on all environmental resources consistent with NEPA requirements. The specific locations that would be used at each potential site for development of a disposal facility for GTCC LLRW and GTCC-like wastes are not known at this time. The use of "reference locations" was used in the EIS to allow for a quantitative assessment of the impacts that could occur at each site. While some parameters could change within a short distance, most would not. Site-specific information provided by technical staff from various sites that were evaluated was used in these modeling analyses to the extent it was available, and conservative assumptions were used to fill any remaining data gaps. The analysis presented in the EIS is adequate for the comparison of the disposal alternatives evaluated. Fate and transport parameters utilized in the estimations were based on site-specific (e.g., specific to the reference location to the extent available) information and, as such, are considered reasonable for the purpose of the comparison made in the EIS. However, DOE recognizes that additional project- and site-specific information, such as the actual depth to groundwater over the entire disposal

**Yakama Nation Environmental Restoration Waste Management Program,
Commenter ID No. L293 (cont'd)**

ID No.	Section	Subsection	Page	Topic, Area or Risk Number	Type	Comment
51	2	2.7.4.2	2-16	NA	Long-Term Impacts	The final proposed finding that DOE meets the minimum distance by the design and construction of LLRW performance assessment conducted under the Radioactive Waste Management Manual (RSDBE M 435.1-1). Review the link to explain that "93 meter buffer" zone may be used if adequate justification is provided" (RSDBE M 435.1-1).
52	2	2.7.4.2	2-16	NA	Environmental Violations	The assumption that the infiltration rate will be 20 percent of the "natural rate" over the waste area has not been shown to apply at the site. The assumption that the infiltration rate will be 20 percent of the "natural rate" over the waste area has not been shown to apply at the site. The assumption that the infiltration rate will be 20 percent of the "natural rate" over the waste area has not been shown to apply at the site. The assumption that the infiltration rate will be 20 percent of the "natural rate" over the waste area has not been shown to apply at the site.
53	2	2.7.8	2-21	NA	Long-Term Impacts	The DOE GTCC EIS must consider the full range of impacts associated with proposed land disposal to ensure protection of local ecological and cultural resources. A disposal facility and site would produce use of the land at any time for other purposes by the local community. The DOE GTCC EIS must consider the full range of impacts associated with proposed land disposal to ensure protection of local ecological and cultural resources. A disposal facility and site would produce use of the land at any time for other purposes by the local community.
54	2	2.7.12	2-23	NA	Long-Term Impacts	Review the Draft GTCC EIS to verify that the level of cumulative impacts analysis should be commensurate with potential impacts. Review the Draft GTCC EIS to verify that the level of cumulative impacts analysis should be commensurate with potential impacts.
56	2	2.7.12	2-24	NA	Surface Institutional Controls	Clarify that the Draft GTCC EIS uses the resident farmer scenario only for comparative purposes and that subsequent NEPA analyses would have to consider applicable exposure pathways unique to specific sites for a more meaningful evaluation. See previous comment and comments in Attachment 1 regarding use of the resident farmer scenario and reliance on institutional controls and surface controls. Review the Draft GTCC EIS in accordance with these comments.
56	2	2.8.4	2-28	NA	Behavioral Institutional Controls	Assessors' study for the resident farmer scenario reflect systematic overreliance on current land use designations and institutional controls to reduce estimated long-term exposure. See previous comment on use of the resident farmer scenario and reliance on institutional controls. Review the Draft GTCC EIS in accordance with these comments.
57	2	2.8.4	2-28	NA	Human Exposure	Review the text to explain the rationale the resident farmer scenario "we note our current land use designations and institutional controls, any further design considerations or site-specific modeling must consider exposure pathways unique to specific sites for a meaningful evaluation of the expected dose and LCR risk."
59	2	2.9	2-29	NA	Human Exposure	In citing 10 CFR 61, the text incorrectly implies that special considerations may warrant more studies approved for all current and future disposal sites. The text incorrectly implies that special considerations may warrant more studies approved for all current and future disposal sites. The text incorrectly implies that special considerations may warrant more studies approved for all current and future disposal sites.

- L293-73
- L293-74
- L293-75
- L293-76
- L293-77
- L293-78
- L293-79
- L293-80
- L293-81

area, could be used to inform the implementation of a disposal facility at a given location. This additional information is expected to reduce the uncertainty associated with these types of evaluations to the extent possible. Site-specific information would be evaluated in any site-specific NEPA review that would be conducted based on a ROD for this EIS.

- L293-76 As required by NEPA, all impact analyses not just for cumulative impacts, in the EIS are commensurate with the potential significance of the impact. Cumulative impacts were evaluated in Sections 4.5, 5.3.12, 6.4, 7.4, 8.4, 9.4, 10.4, and 11.4 in the EIS and were summarized in Section 2.7.12.
- L293-77 As stated in Section 2.7.4.2 of the EIS, “The use of the resident farmer scenario is intended to provide estimates for comparing the various sites evaluated; however, this scenario may not be consistent with the reasonably foreseeable future scenario at some of the sites evaluated (e.g., Hanford Site).” Additional text was appended to this statement – “Subsequent NEPA analysis would use additional site-specific information, if available, for the evaluation of potential impacts should a site be selected for a GTCC disposal facility.”
- L293-78 All relevant potential exposure pathways were considered in the analyses presented in the EIS. These analyses addressed a range of reasonable scenarios and estimated the potential impacts on all environmental resources consistent with NEPA requirements. For the human health assessment, the focus was on the groundwater pathway, since this is the most likely manner in which someone could be exposed to the radioactive contaminants in the GTCC LLRW and GTCC-like wastes in the distant future. Locations closer than the 100 m (330 ft.) evaluated would result in higher dose and cancer risk estimates. The 100 m (30 ft.) distance was used to be consistent with the minimum buffer zone distance surrounding a DOE LLRW disposal site identified in DOE Manual 435.1-1, Radioactive Waste Management Manual. As discussed in Section 2.7.4.2 in the EIS, the hypothetical resident farmer scenario was only used to provide estimates for comparing the various sites evaluated; however, this scenario may not be consistent with the reasonably foreseeable future scenario at some of the sites evaluated. Site-specific NEPA reviews would be conducted as needed. This information could include sensitive subpopulations and specific pathways of exposure for American Indians.
- L293-79 See response to L293-78.
- L293-80 See response to L293-28.
- L293-81 As stated in Section 2.9 of the EIS, DOE is concerned with the protection of human health, during construction and operation of the facility, as well as in the long-term after facility closure.
- L293-82 The No Action Alternative is evaluated in sufficient detail in the EIS as required by NEPA. Comparatively high potential radiation doses and cancer risks could occur should this alternative be selected. While a more detailed analysis could reduce the uncertainties associated with estimating these doses and risks, the conclusion of comparatively high impacts would not change for this alternative. The comment recommendation was taken into consideration, as appropriate, in the selection of the preferred alternative.
- L293-83 See response to L293-67.

**Yakama Nation Environmental Restoration Waste Management Program,
Commenter ID No. L293 (cont’d)**

ID No.	Section	Subsection	Page	Figure Map or Table Number	Title	Comment
60	2	2.9	2-59	NA	Human Exposure	Although several evaluators of the No Action alternative found that the use of a worst-case scenario for a final disposal alternative, even in conjunction with other action alternatives.
61	2	2.9.3.1	2-62	NA	Surface Institutional Controls	Institutional control can be effective in reducing the potential for inadvertent intrusion and potential intruder exposure. However, institutional controls are effective only insofar as they are in place. U.S. Nuclear Regulatory Commission, 1987). Review the Draft EIS to ensure that institutional controls are being implemented and are being maintained. Review the Draft EIS to ensure that institutional controls are being implemented and are being maintained. Review the Draft EIS to ensure that institutional controls are being implemented and are being maintained. Review the Draft EIS to ensure that institutional controls are being implemented and are being maintained.
62	2	2.9.3.3	2-63	NA	Surface Institutional Controls	Review the Draft EIS to ensure that institutional controls are being implemented and are being maintained. Review the Draft EIS to ensure that institutional controls are being implemented and are being maintained. Review the Draft EIS to ensure that institutional controls are being implemented and are being maintained. Review the Draft EIS to ensure that institutional controls are being implemented and are being maintained.
63	2	2.9.4.2	2-67	NA	Cultural Resources	Cultural resources include much more than simply Traditional Cultural Properties (TCP). As the Draft GTCC EIS has defined it, the entire Hanford Site, including the Hanford Reach of the Columbia River, is a TCP because the entire area has traditional cultural and religious significance to the Yakama people.
64	2	2.9.4.3	2-67	NA	EIS Contents	The Draft EIS did not recognize in the Draft GTCC EIS for actions at Hanford. Review the Draft GTCC EIS to recognize the Treaty of 1855. Review the Draft GTCC EIS to recognize the Treaty of 1855. Review the Draft GTCC EIS to recognize the Treaty of 1855. Review the Draft GTCC EIS to recognize the Treaty of 1855.
65	5	NA	NA	NA	Action Alternatives	Review the Draft GTCC EIS to provide more information on the Standard Waste Box (SWB). Include information on dimensions, materials, and location beyond the SWB description.
66	5	5.1.1	5-5	NA	Action Alternatives	Review the Draft GTCC EIS to provide additional information regarding how the baseline scenario was selected.
67	5	5.1.3	5-12	NA	Action Alternatives	Review the Draft GTCC EIS to identify the source of the additional information cover. The Draft GTCC EIS has already acknowledged that the cumulative work on the Hanford Site has created a “soil deficit,” making the source of this material a significant issue.
68	5	5.1.4.3	5-18	NA	Action Alternatives	The assumption that the radioactive land disposal facilities are all of equal integrity is not valid, nor any analysis presented based on the assumption that the radioactive land disposal facilities are all of equal integrity. The Draft GTCC EIS should consider the fact that the radioactive land disposal facilities are not of equal integrity. The Draft GTCC EIS should consider the fact that the radioactive land disposal facilities are not of equal integrity. The Draft GTCC EIS should consider the fact that the radioactive land disposal facilities are not of equal integrity.

Yakama Nation Environmental Restoration Waste Management Program GTCC EIS Comments
Appendix I
Page 8

- L293-82
- L293-83
- L293-84
- L293-85
- L293-86
- L293-87
- L293-88
- L293-89
- L293-90

Yakama Nation Environmental Restoration Waste Management Program,
Commenter ID No. L293 (cont'd)

- L293-84 The three land disposal facility conceptual designs (above-grade vault, enhanced near-surface trench, and intermediate-depth borehole) were selected as being representative of a range of land disposal configurations (varying degrees of waste consolidation and geometry) that could be employed for the disposal of the GTCC LLRW and GTCC-like waste inventory. As discussed in Section 1.4.2 of the EIS, each concept has been used to some degree in the United States or other countries. The same vault, borehole, and trench characteristics were considered for the disposal sites evaluated in order to compare the performance of each site's natural hydrological, geological, and meteorological properties relative to contaminant fate and transport once any engineered barriers would begin to fail. It should be emphasized that project- and site-specific engineering factors would be incorporated into the actual facility designs of the site or sites selected in a ROD to dispose of GTCC LLRW and GTCC-like wastes.
- L293-85 As required by NEPA, the EIS evaluates the potential impacts of the proposed action on cultural resources at the various DOE sites in sufficient detail to assess the potential impacts of the proposed alternatives. DOE recognizes that development of a disposal facility for GTCC LLRW and GTCC-like wastes would require that future land uses be restricted at and near the site for the protection of the general public. This action could affect areas that may be important to American Indian tribes.
- DOE considered the text provided by the participating affiliated American Indian tribes for each of DOE sites evaluated in selection of the preferred alternative. Information provided by the tribal governments associated with exposure pathways unique to American Indian tribes (e.g., greater intakes of fish, game, and plants; use of sweat lodges; use of natural pigment paints for traditional ceremonies) would be evaluated in site-specific NEPA analyses for the alternative(s) selected in a ROD for this EIS.
- L293-86 See response to L293-21.
- L293-87 Information on waste forms and waste packages and containers, including the SWB, is provided in the EIS to allow for a comparative analysis of alternatives for transportation and waste disposal. See the discussion in Section B.5 and C.9.4.2 of the EIS for more information on packaging and requirements. All GTCC LLRW and GTCC-like wastes would be packaged and transported in accordance with all applicable federal and state requirements, and waste disposal activities would be conducted in accordance with appropriate requirements.
- L293-88 The three land disposal facility conceptual designs (above-grade vault, enhanced near-surface trench, and intermediate-depth borehole) were selected as being representative of a range of land disposal configurations (varying degrees of waste consolidation and geometry) that could be employed for the disposal of the GTCC LLRW and GTCC-like waste inventory. As discussed in Section 1.4.2 of the EIS, each concept has been used to some degree in the United States or other countries. Section 1.4.2.2 discusses the selected borehole diameter. The same vault, borehole, and trench characteristics were considered for the disposal sites evaluated in order to compare the performance of each site's natural hydrological, geological, and meteorological properties relative to contaminant fate and transport once any engineered barriers would begin to fail.

Yakama Nation Environmental Restoration Waste Management Program,
Commenter ID No. L293 (cont'd)

- L293-89 The amount of additional soil that might be required for the implementation of a near-surface vault facility would depend on the site-specific implementation. Site-specific NEPA reviews would be conducted as needed.
- L293-90 The three land disposal facility conceptual designs (above-grade vault, enhanced near-surface trench, and intermediate-depth borehole) were selected as being representative of a range of land disposal configurations (varying degrees of waste consolidation and geometry) that could be employed for the disposal of the GTCC LLRW and GTCC-like waste inventory. As discussed in Section 1.4.2 of the EIS, each concept has been used to some degree in the United States or other countries. The same vault, borehole, and trench characteristics were considered for the disposal sites evaluated in order to compare the performance of each site's natural hydrological, geological, and meteorological properties relative to contaminant fate and transport once any engineered barriers would begin to fail.

The conceptual nature of these configurations takes into account the characteristics of all of the disposal sites for which they were considered, but their designs (e.g., width, depth, cover depth, reinforced containment) could be altered or enhanced, as necessary, to provide an optimal solution at a specific location. As an example, the cover depth could be adjusted to ensure that roots from vegetation would not compromise the top of the engineered barrier. In addition, the dimensions of the generic land disposal units (e.g., trench - width and depth, borehole - diameter and depth, vault - width, depth, and height) were selected based on similar existing facilities, existing equipment and methods for construction, and optimized (maximized waste volume disposed of for a given disposal unit volume; simple waste handling procedures to minimize exposure) for the types of waste packages considered. All designs could also accommodate different disposal packages (existing and proposed) with minor variations in their dimensions, but the EIS analyses would remain relevant for each option considered. Such characteristics as depth of disposal, waste concentrations, and disposal unit geometry were specifically accounted for in the EIS analysis.

For example, if borehole disposal at NNSS became a preferred alternative, any capacity in the existing boreholes would have been considered in follow-up studies. For an above-grade vault with a 5 m cover, long-term impacts from the above-grade vault as determined by modeling for the EIS would be expected to be similar to those for a vault set lower with respect to grade, including with the top of the vault at or below grade, except in the case where the bottom of the waste confinement was closer to the groundwater table. For any disposal option, the bottom of any disposal unit would not be located at or below the water table to exclude the chance of groundwater migration into the disposal unit. Actual implementation of a disposal option at a specific location at a given site may have to be modified (i.e., the depth of a trench or a borehole may need to be reduced to avoid groundwater issues).

Past operational experience with these types of disposal facilities at DOE sites has shown that when properly implemented, they can provide isolation of radioactive waste from the environment for extended time periods. Past problems that have arisen with each option provide additional information to improve the design and performance of future land disposal facilities. Issues related to performance over time would be analyzed in a project-specific analysis to address technical and long-term cultural concerns (e.g., tribal issues).

- L293-91 Additional construction details would not provide any information that would help to discriminate between alternatives because construction of a particular disposal unit is expected to be similar for each site. Also, borehole casings would not be expected to be contaminated as all waste emplacements would involve packages without external contamination. Should such contamination occur, it would be handled according to a specific site's procedures for handling radioactively contaminated material.
- L293-92 The amount of additional soil that might be required for the implementation of a near-surface vault facility would depend on the site-specific implementation. Site-specific NEPA reviews would be conducted as needed.
- L293-93 DOE agrees that some GTCC LLRW and GTCC-like wastes may be characterized as mixed waste (waste containing hazardous chemical constituents in addition to radionuclides). However, currently available waste characterization information is limited, and these wastes only constitute approximately 4% by volume of the Group 1 wastes as discussed in Section 1.4.1 of the EIS. Additional information would be obtained prior to any disposal, however, and the mixed waste would be rendered nonhazardous before being submitted for disposal. In addition, potential health impacts from hazardous chemicals are expected to be small when compared to radiological risks presented in the EIS (due to the higher volume and activity from the radioactive component of the GTCC LLRW and GTCC-like waste inventory). Any mixed waste in the GTCC EIS inventory would be managed in accordance with federal and state laws and requirements.
- L293-94 See response to L293-67.
- L293-95 DOE believes that the simplified approach for estimating the effectiveness of the facility containment system is reasonable for the comparative analyses given in the EIS. It is not possible at this time to provide specific information on the expected monitoring and maintenance program to be used for the land disposal methods. Information on the facility designs is limited to conceptual descriptions of these facilities as given in Appendix D of the EIS. The monitoring and maintenance program would be tailored to the actual design of the disposal facility and would be developed during the implementation phase for a GTCC waste disposal facility.
- The types of activities that would be expected to occur during the post-closure phase of a GTCC waste disposal facility would include: visually inspecting cover systems and security fences; monitoring the nearby air, soil, surface water, and groundwater; and repairing any defects in the facility, including cracks or holes in the soil cover. A detailed program would be developed to ensure that the wastes remained safely contained within the disposal unit for as long as possible.
- L293-96 The difference between neutral and stable weather conditions is discussed in footnote 'b' in Table 5.3.9-3 of the EIS. The overall impact from severe weather conditions such as tornadoes would result in further dilution of air concentrations and generally reduce overall population exposure estimates.
- L293-97 The resource values listed in Table D-9 are the correct values. The values for trench construction in Table 5.3.2-1 were revised to reflect the correct values.
- L293-98 See response to L293-78
- L293-99 All relevant potential exposure pathways were considered in the analyses presented in the EIS. These analyses addressed a range of reasonable scenarios and estimated the potential impacts on all environmental resources consistent with NEPA requirements. The assessment of impacts from accidents occurring hundreds to thousands of years into the future was considered too speculative to include because of the large uncertainty associated with estimating future land use and population patterns.

**Yakama Nation Environmental Restoration Waste Management Program,
Commenter ID No. L293 (cont'd)**

ID No.	Section	Subsection	Page	Figure, Map or Table Number	Topic	Comment
69	5	5.1.1	55	NA	Action Alternatives	Revise the Draft GTCC EIS to provide additional construction details, including how radiologically contaminated equipment such as the borehole casing will be handled, stored, and disposed of.
70	5	5.2.2	534	NA	Action Alternatives	The next alternative will have significant impacts to geologic and soil resources. Revise the Draft GTCC EIS to evaluate impacts to geologic and soil resources for all alternatives in greater detail than is currently provided.
71	5	5.2.2	NA	NA	Human Exposure	Revise the Draft GTCC EIS to provide a more detailed assessment of human exposure to radionuclides that make up the radionuclide inventory, such as radon, radon progeny, radon decay products, radon daughters, and radon progeny decay products. Revise the Draft GTCC EIS to provide a more detailed assessment of human exposure to radionuclides that make up the radionuclide inventory, such as radon, radon progeny, radon decay products, radon daughters, and radon progeny decay products.
72	5	5.2.2	536	NA	Human Exposure	Revise the assessment of human health in the Draft GTCC EIS to qualitatively evaluate hazardous and infectious contamination. This is a potential concern because of the large volume of waste that will be disposed of in the near-surface vaults. It is particularly important to evaluate the potential for contamination of the near-surface vaults and the potential for contamination of the near-surface vaults.
73	5	5.2.3	536	NA	Long-Term Impacts	Revise the Draft GTCC EIS to identify a long-term monitoring and maintenance program that would follow site decommissioning to ensure that the disposal facility is adequately maintained. The monitoring program should demonstrate that the facility will meet the CFR 61 requirements.
74	5	5.2.3	541	NA	Action Alternatives	The Draft GTCC EIS states that the effects of two alternative conditions were considered: "winds and salts." Revise the Draft GTCC EIS to provide a more detailed assessment of the potential for contamination of the near-surface vaults and the potential for contamination of the near-surface vaults.
75	5	5.3	549	Table 5.3.2-1	Short-Term Impacts	The above presented in Table 5.3.2-1 do not match the values provided in Appendix D. Long additional data requirements for city estimates and provide additional justification for these estimates.
76	5	5.3.4	551	NA	Short-Term Impacts	Evaluation of potential impacts on workers and the general public does not constitute a complete analysis. Further is part of the "Yakama Nation's waste and radioactive waste management and remediation program" as required by the Treaty of 1855. The Yakama Nation must be considered a potentially exposed "worker" group in the short term and long term. The unique exposure pathways for the Yakama Nation must be considered, such as high exposure rates for surface water, groundwater, air, and soil. The Yakama Nation must be considered a potentially exposed "worker" group in the short term and long term. The unique exposure pathways for the Yakama Nation must be considered, such as high exposure rates for surface water, groundwater, air, and soil. The Yakama Nation must be considered a potentially exposed "worker" group in the short term and long term. The unique exposure pathways for the Yakama Nation must be considered, such as high exposure rates for surface water, groundwater, air, and soil.
77	5	5.3.4	560	NA	Short-Term Impacts	Exposure estimates showing a hypothetical accident radiological release are not complete. In addition to external radiation from the release, there are also potential for internal exposure from ingestion of contaminated food and water. The exposure estimates should be updated to include these potential exposure pathways. The exposure estimates should be updated to include these potential exposure pathways. The exposure estimates should be updated to include these potential exposure pathways.
78	5	5.3.4.3	563	NA	Surface Interstitial Contaminants	The assumption that individuals will not move closer than 100 meters from the facility boundary is not justified and is not valid. The Draft GTCC EIS should evaluate exposure to an individual at the center of the disposal facility following closure of the site as part of the disposal facility as part of the exposure scenario.

Yakama Nation ERMW Program GTCC EIS Comments
Respondent
Page 8

- L293-91
L293-92
L293-93
L293-94
L293-95
L293-96
L293-97
L293-98
L293-99

L293-100 DOE agrees that the GTCC waste disposal facility must ensure the protection of a hypothetical future inadvertent human intruder. On the basis of the depth of waste disposal, DOE believes that the only reasonable potential for intrusion is from a future drilling event, such as drilling for a well. The likelihood of inadvertent intrusion from a drilling event would be very low because of: (1) the use of intruder barriers, (2) the remoteness of the sites, (3) DOE's commitment to long-term institutional control, (4) site conditions such as the general lack of easily accessible resources and the great depth to groundwater, and (5) waste form stability. On the basis of these considerations, DOE did not include a quantitative analysis of inadvertent human intruder in the EIS. Site-specific NEPA reviews would be conducted as needed.

Potential inadvertent human intrusion into WIPP is addressed in the documentation supporting its current operations. Inclusion of GTCC LLRW and GTCC-like wastes with the wastes already planned for disposal in this repository would not be expected to change the results associated with this hypothetical intrusion event.

L293-101 The EIS analyses are based on conceptual engineering information and necessitated the use of a number of simplifying assumptions. This approach is consistent with NEPA, which requires such analyses to be made early in the decision-making process. The various land disposal conceptual designs were assumed to be constructed and operated in a comparable manner at each of the various sites. Information on the conceptual engineering designs for the three proposed land disposal methods is provided in Section D.3 of Appendix D in the EIS.

By using the same conceptual designs at all of the sites evaluated in the GTCC EIS, except for cases where a design did not apply (e.g., an intermediate-depth borehole at a site with shallow groundwater), the potential impacts (e.g., radionuclides reaching the groundwater) at the different environmental settings could be readily compared.

In performing these evaluations, a number of engineering measures were included in the conceptual facility designs to minimize the likelihood of contaminant migration from the disposal units. No facility design can guarantee that radionuclide migration from the facility would not occur over and beyond a 10,000-year time period. It was assumed that these measures would perform similarly for all conceptual designs, remaining intact for 500 years after the disposal facility closed. After 500 years, the barriers would gradually fail. To account for these engineered features in the modeling calculations, it was assumed that the water infiltration to the top of the waste disposal area would be zero for the first 500 years and then 20% of the natural rate for the area for the remainder of the time period (through 10,000 years). A water infiltration rate of 20% of the natural rate for the area was only used for the disposal area; the natural background infiltration rate was used at the perimeter of the waste disposal units. Again, this approach enables a comparative evaluation of the influence that site-specific environmental factors would have on the potential migration of radionuclides from the disposal facilities and the potential impacts on human health. It should be emphasized that project- and site-specific engineering factors would be incorporated into the actual facility designs of the site or sites selected in a ROD to dispose of GTCC LLRW and GTCC-like wastes.

Estimated radiation doses and LCFs were calculated for each site and disposal concept for 10,000 years, and if the peak impact did not occur during this time frame, the analysis was extended out to 100,000 years. DOE believes that the assumptions made to support the long-term modeling calculations for the groundwater pathway are reasonable and enable a comparative evaluation of the impacts between alternatives. The results of the evaluation presented in the EIS are sufficient to inform the selection of sites and methods for disposal. Site-specific NEPA reviews would be conducted as needed.

**Yakama Nation Environmental Restoration Waste Management Program,
Commenter ID No. L293 (cont'd)**

ID No.	Section	Subsection	Page	Figure, Map or Table Number	Topic	Comment
79	5	5.3.4.3	5-43	NA	Surface Barrier/Institutional Controls	It is speculative to assume that engineering controls combined with natural features will ensure long-term stability of the disposal facility. Site-specific engineering analyses of surface barriers and institutional controls. Review the Draft GTCC EIS to ensure that these controls are addressed.
80	5	5.3.4	5-44	NA	Human Exposure	Chief water use of contaminated groundwater associated with leaching were evaluated. The evaluation should include not only the water use of contaminated groundwater, but also direct contact and inhalation of water vapors wafting and for a resident farmer who is Native American, Steve Lodge use.
81	5	5.3.4.3	5-44	NA	Human Exposure	Field to include a surface water exposure pathway for a resident farmer either at the edge of or on the disposal facility. It is not justified and not representative of the site. Review the Draft GTCC EIS to include a surface water exposure pathway in the predictive dose assessment beginning 100 years after closure of the facility.
82	5	5.3.4.3	5-45	NA	Human Exposure	Review the Draft GTCC EIS to discuss the reduction of the hypothetical resident farmer from the facility boundary, including accurate modeling. Specifically, it should be evaluated at 50 and 100 years from the release, not 100 years from the start of the release. The facility should not allow increasing resident distance from the point of release. Similarly, review the Draft GTCC EIS to include scenarios with greater rates of infiltration, larger changes in temperature, and higher rates of erosion when evaluating near-surface disposal alternatives.
83	5	5.3.4.3	5-45	NA	Surface Barrier/Institutional Controls	It is unknown whether controls will remain 100 percent effective for 500 years and 40 percent effective for 10,000 years without intervention for the long-term remediation and maintenance program. Review the Draft GTCC EIS to provide additional strength justification for the long-term viability. Commenters that they are very skeptical in terms of the United States.
84	5	5.3.4.3	5-46	NA	Human Exposure	The paragraph beginning at the 37 page: "The human health impacts to the hypothetical resident farmer given in the EIS are based on the assumption that the disposal facility will remain intact for 10,000 years. The human health impacts that are calculated in the Draft GTCC EIS are based on many unjustified and unreasonable assumptions that it is reasonable to compare them as a means of evaluating performance of each near-surface disposal alternative. The additional information that is needed to support the analysis of disposal alternatives, but is not provided or discussed in any of the near-surface alternatives. No technical measures are proposed or discussed for any of the near-surface alternatives. Enhancements, these statements are not supported by other portions of the Draft GTCC EIS that describe design features such as high as 2,000-megawatt residual from near-surface disposal alternatives or by Appendix E, which states: "Given the unknown behavior of the engineered barriers and waste conditions over a very long period of time, estimates of the peak annual radiation doses and LCF risks to human health are very difficult to predict." Review the Draft GTCC EIS to accurately reflect the large degree of uncertainty associated with the performance of the near-surface alternatives. Review the performance statement of each alternative to that realistic performance criteria are used. Remove or revise the statement: "The near-surface disposal alternatives can be engineered to perform at a level that is very low." (Given the unknown behavior of the engineered barriers and waste conditions over a very long period of time, estimates of the peak annual radiation doses and LCF risks to human health are very difficult to predict.)

Yakama Nation Environmental Restoration Waste Management Program
Appendix I
Page 10

L293-101
L293-102
L293-103
L293-104
L293-105
L293-106

Yakama Nation Environmental Restoration Waste Management Program,
Commenter ID No. L293 (cont'd)

L293-102 As discussed in Section 5.3.4.3 of the EIS, contaminated groundwater was assumed to be used for drinking and irrigation of crops, leading to the ingestion of contaminated foodstuffs. All relevant potential exposure pathways were considered in the analyses presented in the EIS. These analyses addressed a range of reasonable scenarios and estimated the potential impacts on all environmental resources consistent with NEPA requirements. For the human health assessment, the focus was on the groundwater pathway, since this is the most likely manner in which someone could be exposed to the radioactive contaminants in the GTCC LLRW and GTCC-like wastes in the distant future. As discussed in Section 2.7.4.2 of the EIS, the hypothetical resident farmer scenario was only used to provide estimates for comparing the various sites evaluated; however, this scenario may not be consistent with the reasonably foreseeable future scenario at some of the sites evaluated. Site-specific NEPA reviews would be conducted as needed. This information could include sensitive subpopulations and specific pathways of exposure for American Indians.

L293-103 The surface water pathway was not analyzed quantitatively in the EIS for the reasons summarized in Appendix E – “Releases to surface water would only occur once the entire engineered cover over the disposed wastes had eroded away. Because of the thick cover layer and the use of very robust engineering techniques to construct it, it was assumed for the analyses in the EIS that the buried GTCC wastes would always be overlain by some cover material through 10,000 years, eliminating surface water runoff as a potential exposure mechanism for the action alternatives.

Even if releases to surface water were to occur, it is not expected that these releases would be significant or result in higher peak annual doses or latent cancer facility (LCF) risks than would releases to groundwater. The disposal facility and waste containers are assumed to maintain their integrity for at least 500 years, and this factor would allow many of the shorter-lived radionuclides to decay to innocuous levels prior to any releases to the environment. In addition, it is expected that releases to surface water would be much more diluted in the environment (such as in a river or lake) before being ingested by the hypothetical receptor than would comparable releases to groundwater (in which case the hypothetical receptor would extract water for use from a well). Because of this smaller amount of dilution, the groundwater pathway would likely be much more significant than the surface water pathway.”

L293-104 All relevant potential exposure pathways were considered in the analyses presented in the EIS, including impacts from erosion. These analyses addressed a range of reasonable scenarios and estimated the potential impacts on all environmental resources consistent with NEPA requirements. For the human health assessment, the focus was on the groundwater pathway, since this is the most likely manner in which someone could be exposed to the radioactive contaminants in the GTCC LLRW and GTCC-like wastes in the distant future. Locations closer than the 100 m (330 ft.) evaluated would result in higher dose and cancer risk estimates. The 100 m (30 ft.) distance was used to be consistent with the minimum buffer zone distance surrounding a DOE LLRW disposal site identified in DOE Manual 435.1-1, Radioactive Waste Management Manual. As discussed in Section 2.7.4.2 in the EIS, the hypothetical resident farmer scenario was only used to provide estimates for comparing the various sites evaluated; however, this scenario may not be consistent with the reasonably foreseeable future scenario at some of the sites evaluated.

In addition, a sensitivity analysis was also conducted to assess the impacts of infiltration rates of 50 and 100%. Details of the analysis are presented in Appendix E, Section E.6 of the EIS. Site-specific NEPA reviews would be conducted as needed.

Yakama Nation Environmental Restoration Waste Management Program,
Commenter ID No. L293 (cont'd)

L293-105 See response to L293-95.

The types of activities that would be expected to occur during the post-closure phase of a GTCC waste disposal facility would include visually inspecting cover systems and security fences; monitoring the nearby air, soil, surface water, and groundwater; and repairing any defects in the facility, including cracks or holes in the soil cover. A detailed program would be developed to ensure that the wastes remained safely contained within the disposal unit for as long as possible.

L293-106 The EIS analyses are based on conceptual engineering information and necessitated the use of a number of simplifying assumptions. This approach is consistent with NEPA, which requires such analyses to be made early in the decision-making process. The various land disposal conceptual designs were assumed to be constructed and operated in a comparable manner at each of the various sites.

Information on the conceptual engineering designs for the three proposed land disposal methods is provided in Section D.3 of Appendix D in the EIS. By using the same conceptual designs at all of the sites evaluated in the GTCC EIS, except for cases where a design did not apply (e.g., an intermediate-depth borehole at a site with shallow groundwater), the potential impacts (e.g., radionuclides reaching the groundwater) at the different environmental settings could be readily compared.

In performing these evaluations, a number of engineering measures were included in the conceptual facility designs to minimize the likelihood of contaminant migration from the disposal units. No facility design can guarantee that radionuclide migration from the facility would not occur over and beyond a 10,000-year time period. It was assumed that these measures would perform similarly for all conceptual designs, remaining intact for 500 years after the disposal facility closed. After 500 years, the barriers would gradually fail. To account for these engineered features in the modeling calculations, it was assumed that the water infiltration to the top of the waste disposal area would be zero for the first 500 years and then 20% of the natural rate for the area for the remainder of the time period (through 10,000 years). A water infiltration rate of 20% of the natural rate for the area was only used for the disposal area; the natural background infiltration rate was used at the perimeter of the waste disposal units. Again, this approach enables a comparative evaluation of the influence that site-specific environmental factors would have on the potential migration of radionuclides from the disposal facilities and the potential impacts on human health. It should be emphasized that project- and site-specific engineering factors would be incorporated into the actual facility designs of the site or sites selected in a ROD to dispose of GTCC LLRW and GTCC-like wastes.

DOE recognizes that modeling potential releases of radionuclides from the conceptual disposal sites far into the future approximates what might actually occur. Sufficient detail was included in these designs for use in the EIS analyses, consistent with the current stage of this process. Some of the input values may change in the future and could result in higher impacts (such as from increased precipitation at some sites due to climate change), while others could result in lower impacts (due to decreased precipitation).

Estimated radiation doses and LCFs were calculated for each site and disposal concept for 10,000 years, and if the peak impact did not occur during this time frame, the analysis was extended out to 100,000 years. DOE believes that the assumptions made to support the long-term modeling calculations for the groundwater pathway are reasonable and enable a comparative evaluation of the impacts between alternatives. The results of the evaluation presented in the EIS are sufficient to inform the selection of sites and methods for disposal. Site-specific NEPA reviews would be conducted as needed.

- L293-107 See response to L293-93.
- L293-108 The hazardous waste that could be generated during construction of a near-surface disposal facility could include typical industrial construction wastes such as liquids – used oil, grease, and organic solvents – and solids – batteries, mercury construction lights, cleaning materials (e.g., wipes), and solids generated during the cleanup of spills (e.g. absorbents, contaminated soil). At the time of construction, such wastes would be identified and properly disposed of according to their waste characteristics and the appropriate local, state, and federal regulations.
- L293-109 Same response as above for L293-108.
- L293-110 DOE believes that the analyses presented in the EIS are sufficient to compare the potential cumulative impacts of GTCC LLRW and GTCC-like waste disposal for the sites that were evaluated. In particular, existing concentrations of various radionuclides in contaminated soil and groundwater at the candidate sites were taken into consideration in the selection of the preferred alternative. Also, while up to 12,600 truck shipments were assessed for transport of the GTCC LLRW and GTCC-like wastes to a proposed disposal facility, these shipments would be spread out over a 60 year time period, with the result that only about one to two shipments a day might be expected at the facility in addition to current traffic. Additional cumulative impact analyses would be conducted in site-specific NEPA reviews, if needed, for the alternative selected in a ROD. Such follow-on reviews would be based on additional site-specific information.
- L293-111 See response to L293-67.
- L293-112 The EIS analysis assumes 100 years of institutional control after closure of a GTCC disposal facility, but that control period could be for a longer time period. As discussed in Section 2.9, the exposure to an inadvertent intruder is to be limited even after the period of active institutional control.
- The depth of disposal (5 m from the ground surface to the top of the disposal unit) for the proposed vault facility is the same as that for the trench. With reinforced concrete sides, the vault may be less vulnerable to inadvertent intrusion than for the proposed trench design and also less vulnerable to erosion and subsequent exposure to surface water.
- DOE agrees that the GTCC waste disposal facility must ensure the protection of a hypothetical future inadvertent human intruder, especially for the wastes disposed of in an enhanced near surface trench. In the conceptual design for the trench disposal facility, the trenches are about 3 m (10 ft.) wide, 11 m (36 ft.) deep, and 100 m (330 ft.) long. The GTCC waste disposal placement is assumed to be about 5 to 10 m (16 to 33 ft.) below ground surface.
- On the basis of the depth of waste disposal, DOE believes that the only reasonable potential for intrusion is from a future drilling event, such as drilling for a well. The likelihood of inadvertent intrusion from a drilling event would be very low for a GTCC waste trench disposal facility because of: (1) the narrow width of the trench, (2) the use of intruder barriers, (3) the remoteness of the sites, (4) DOE’s commitment to long-term institutional control, (5) site conditions such as the general lack of easily accessible resources and the great depth to groundwater, and (6) waste form stability. On the basis of these considerations, DOE did not include a quantitative analysis of inadvertent human intruder in the EIS. Site-specific NEPA reviews would be conducted as needed.
- L293-113 See response to L293-95.

**Yakama Nation Environmental Restoration Waste Management Program,
Commenter ID No. L293 (cont’d)**

ID No.	Section	Subsection	Page	Figure, Table or Table Number	Type	Comment	
85	5	5.3.11	597	NA	GTCC Waste Type	This section does not identify potential Resource Conservation and Recovery Act (RCRA) hazardous waste. Review the Draft GTCC EIS to identify potential RCRA hazardous wastes and associated volumes. Identify characteristic waste and/or listed waste. Include physical, chemical, and waste type descriptors, address how the wastes would be managed and disposed of in accordance with state and federal requirements.	L293-107
86	5	5.3.11	599	Table 5.3.11-1	GTCC Waste Type	This table indicates that approximately 18 to 182 cubic yards of hazardous waste ("solids") will be generated by the three gully as RCRA wastes, and provide management and disposal information on how disposal actions will comply with RCRA.	L293-108
87	5	5.3.11	599	Table 5.3.11-2	GTCC Waste Type	Hazardous hazardous liquid and solid wastes would be "sent off-site for treatment, recovery, and disposal at RCRA-approved treatment, storage, and disposal facility (TSDF) or other RCRA-approved treatment, storage, and disposal of more detailed information on how these RCRA wastes would be generated, managed, and disposed of according to RCRA requirements. Also provide information on RCRA permitting for these wastes.	L293-109
88	5	5.3.12	592	NA	Long-Term Impacts	Review the Draft GTCC EIS to explain that, although the impacts of various disposal alternatives may appear minor when viewed individually, these impacts may be significant when viewed collectively in the context of a site's other past, present, and foreseeable impacts. Also explain that any additional impacts are unacceptable if the cumulative impacts at a site already exceed regulatory limits. Review the Draft GTCC EIS to explain how the impacts of RCRA wastes are addressed in detail.	L293-110
89	5	5.3	593	NA	Human Exposure	Review the Draft GTCC EIS to explain how the impacts of RCRA wastes are addressed in detail.	L293-111
90	5	5.6	595	NA	Surface Burial/ Institutional Controls	Review the Draft GTCC EIS to explain how the impacts of RCRA wastes are addressed in detail.	L293-112
91	5	5.6	595	NA	Surface Burial/ Institutional Controls	According to 10 CFR 61, institutional controls include an environmental monitoring program, but no such plan is presented in this section of the report. Review the Draft GTCC EIS to include a long-term environmental monitoring plan.	L293-113
92	5	5.6	595	NA	Surface Burial/ Institutional Controls	Based upon the topic presented in this table, two types of waste will be disposed of within the three disposal options: waste that will be disposed of in a trench and waste that will be disposed of in a vault. Review the Draft GTCC EIS to explain how the impacts of RCRA wastes are addressed in detail. The institutional control period to much more than 100 years after closure" given that the waste would be hazardous for 10,000 years. This justification provided is flawed. Waste that is categorized for 10,000 or more years should be disposed of in a deep geologic repository because it remains dangerous over that time by definition. Review the Draft GTCC EIS to describe and evaluate the requirements for waste segregation and identify disposal in a deep geologic repository as the preferred alternative.	L293-114

Yakama Nation ERM/WMP Program GTCC EIS Comments
Attachment 2
Page 11

- L293-114 DOE agrees that use of a geologic repository would be a protective and safe method for the disposal of the entire inventory of GTCC LLRW and GTCC-like wastes. The GTCC EIS evaluation for the WIPP geologic repository alternative supports this statement. However, the degree of waste isolation provided by a geologic repository may not be necessary for all of the GTCC LLRW and GTCC-like wastes evaluated in the GTCC EIS. The GTCC EIS evaluation indicates that certain wastes (e.g., those containing short-lived radionuclides such as Cs-137 irradiators) could be safely disposed of in properly designed land disposal facilities at sites with suitable characteristics, such as low precipitation rates, high soil distribution coefficients, and sufficient depths to groundwater. Based on the GTCC EIS evaluation, land disposal facilities located in arid climates (e.g., NNSS and WIPP Vicinity) would isolate radionuclides for a sufficient period of time to allow for significant radioactive decay to occur.
- L293-115 The site-specific environmental factors identified – seismic activity, subsurface movement, proximity to the Columbia River, and high levels of contamination – were considered in the EIS. The results of the evaluation were taken into consideration in identifying the preferred alternative presented in the Final EIS.
- DOE is performing environmental restoration activities at the Hanford Site. The ongoing cleanup effort will continue.
- The EIS analysis is used to assess the viability of an alternative as well as its relative performance compared to the other alternatives. Exclusion of a reasonable alternative from the EIS without first evaluating the site is contrary to a thorough NEPA analysis. All alternatives are retained in the Final EIS because such evaluations are needed to support selection of the preferred alternative. In addition, as discussed in Section 1.4.2, the conceptual disposal facility designs analyzed in the EIS could be modified to perform better in specific locations. Thus, poor performance in the EIS analysis does not necessarily exclude an alternative from consideration.
- L293-116 See response to L293-21.
- L293-117 Other toxic pollutants releases are a composite of calculated estimates of toxic air pollutants, excluding ammonia, from the 200-East and 200-West Areas tank farms, 200 Area Effluent Treatment Facility, Central Waste Complex, T Plant Complex, and Waste Receiving and Processing Facility. As referenced, further information on the composition of the other toxic pollutants can be found in Poston, T.M., et al. (editors), 2007, Hanford Site Environmental Report for Calendar Year 2006, prepared by Pacific Northwest National Laboratory, Richland, Wash., for U.S. Department of Energy, Sept.
- L293-118 See response to L293-29.
- L293-119 The use of “reference locations” was used in the EIS to allow for a quantitative assessment of the impacts that could occur at each site. While some parameters could change within a short distance, most would not. The RESRAD-OFFSITE computer code was used to model the migration of radionuclides from the GTCC LLRW and GTCC-like wastes placed into the conceptual disposal facility designs for the three land disposal methods (not all three methods were evaluated for each site). Site-specific information provided by technical staff from various sites that were evaluated was used in these modeling analyses to the extent it was available, and conservative assumptions were used to fill any remaining data gaps. While the computer model was largely developed to support environmental restoration activities, it has a number of features that make it a good choice for use in this EIS. The analysis presented in the EIS is adequate for the comparison of the disposal alternatives evaluated.
- L293-120 Same response as above for L293-119.

Yakama Nation Environmental Restoration Waste Management Program,
Commenter ID No. L293 (cont’d)

ID No.	Section	Subsection	Page	Figure, Map, or Table Number	Topic	Comment
104	6	6.1.21.4	6-22	NA	Environmental Variables	
103	6	6.1.21.4	6-22	NA	Environmental Variables	
102	6	6.1.21.3	6-8	NA	Environmental Variables	
101	6	6.1.21	6-14	NA	Environmental Variables	
100	6	6.1.13	6-0	NA	Environmental Variables	
99	6	6.1.12	NA	NA	Environmental Variables	
98	6	6.1.11	NA	NA	Environmental Variables	
97	6	6.1.11	6-3	NA	Environmental Variables	
96	6	6.1	6-1	NA	Environmental Variables	
95	6	NA	NA	Table 6.1.1-2	Human Exposure	
94	6	NA	6-1	NA	EIS Contents	
93	6	NA	6-1	NA	Hanford Site	
92	6	NA	Table 6.1.1-2		Human Exposure	
91	6	6.1.11	6-3		Environmental Variables	
90	6	6.1.11	NA		Environmental Variables	
89	6	6.1.12	NA		Environmental Variables	
88	6	6.1.11	NA		Environmental Variables	
87	6	6.1.11	6-3		Environmental Variables	
86	6	6.1	6-1		Environmental Variables	
85	6	NA	NA	Table 6.1.1-2	Human Exposure	
84	6	NA	6-1	NA	EIS Contents	
83	6	NA	6-1	NA	Hanford Site	
82	6	NA	Table 6.1.1-2		Human Exposure	
81	6	6.1.11	6-3		Environmental Variables	
80	6	6.1.11	NA		Environmental Variables	
79	6	6.1.12	NA		Environmental Variables	
78	6	6.1.11	NA		Environmental Variables	
77	6	6.1.11	6-3		Environmental Variables	
76	6	6.1	6-1		Environmental Variables	
75	6	NA	NA	Table 6.1.1-2	Human Exposure	
74	6	NA	6-1	NA	EIS Contents	
73	6	NA	6-1	NA	Hanford Site	
72	6	NA	Table 6.1.1-2		Human Exposure	
71	6	6.1.11	6-3		Environmental Variables	
70	6	6.1.11	NA		Environmental Variables	
69	6	6.1.12	NA		Environmental Variables	
68	6	6.1.11	NA		Environmental Variables	
67	6	6.1.11	6-3		Environmental Variables	
66	6	6.1	6-1		Environmental Variables	
65	6	NA	NA	Table 6.1.1-2	Human Exposure	
64	6	NA	6-1	NA	EIS Contents	
63	6	NA	6-1	NA	Hanford Site	
62	6	NA	Table 6.1.1-2		Human Exposure	
61	6	6.1.11	6-3		Environmental Variables	
60	6	6.1.11	NA		Environmental Variables	
59	6	6.1.12	NA		Environmental Variables	
58	6	6.1.11	NA		Environmental Variables	
57	6	6.1.11	6-3		Environmental Variables	
56	6	6.1	6-1		Environmental Variables	
55	6	NA	NA	Table 6.1.1-2	Human Exposure	
54	6	NA	6-1	NA	EIS Contents	
53	6	NA	6-1	NA	Hanford Site	
52	6	NA	Table 6.1.1-2		Human Exposure	
51	6	6.1.11	6-3		Environmental Variables	
50	6	6.1.11	NA		Environmental Variables	
49	6	6.1.12	NA		Environmental Variables	
48	6	6.1.11	NA		Environmental Variables	
47	6	6.1.11	6-3		Environmental Variables	
46	6	6.1	6-1		Environmental Variables	
45	6	NA	NA	Table 6.1.1-2	Human Exposure	
44	6	NA	6-1	NA	EIS Contents	
43	6	NA	6-1	NA	Hanford Site	
42	6	NA	Table 6.1.1-2		Human Exposure	
41	6	6.1.11	6-3		Environmental Variables	
40	6	6.1.11	NA		Environmental Variables	
39	6	6.1.12	NA		Environmental Variables	
38	6	6.1.11	NA		Environmental Variables	
37	6	6.1.11	6-3		Environmental Variables	
36	6	6.1	6-1		Environmental Variables	
35	6	NA	NA	Table 6.1.1-2	Human Exposure	
34	6	NA	6-1	NA	EIS Contents	
33	6	NA	6-1	NA	Hanford Site	
32	6	NA	Table 6.1.1-2		Human Exposure	
31	6	6.1.11	6-3		Environmental Variables	
30	6	6.1.11	NA		Environmental Variables	
29	6	6.1.12	NA		Environmental Variables	
28	6	6.1.11	NA		Environmental Variables	
27	6	6.1.11	6-3		Environmental Variables	
26	6	6.1	6-1		Environmental Variables	
25	6	NA	NA	Table 6.1.1-2	Human Exposure	
24	6	NA	6-1	NA	EIS Contents	
23	6	NA	6-1	NA	Hanford Site	
22	6	NA	Table 6.1.1-2		Human Exposure	
21	6	6.1.11	6-3		Environmental Variables	
20	6	6.1.11	NA		Environmental Variables	
19	6	6.1.12	NA		Environmental Variables	
18	6	6.1.11	NA		Environmental Variables	
17	6	6.1.11	6-3		Environmental Variables	
16	6	6.1	6-1		Environmental Variables	
15	6	NA	NA	Table 6.1.1-2	Human Exposure	
14	6	NA	6-1	NA	EIS Contents	
13	6	NA	6-1	NA	Hanford Site	
12	6	NA	Table 6.1.1-2		Human Exposure	
11	6	6.1.11	6-3		Environmental Variables	
10	6	6.1.11	NA		Environmental Variables	
9	6	6.1.12	NA		Environmental Variables	
8	6	6.1.11	NA		Environmental Variables	
7	6	6.1.11	6-3		Environmental Variables	
6	6	6.1	6-1		Environmental Variables	
5	6	NA	NA	Table 6.1.1-2	Human Exposure	
4	6	NA	6-1	NA	EIS Contents	
3	6	NA	6-1	NA	Hanford Site	
2	6	NA	Table 6.1.1-2		Human Exposure	
1	6	6.1.11	6-3		Environmental Variables	

Yakama Nation Environmental Restoration Waste Management Program
 Commenter ID No. L293
 Page 12

L293-115
 L293-116
 L293-117
 L293-118
 L293-119
 L293-120
 L293-121
 L293-122
 L293-123
 L293-124
 L293-125
 L293-126

- L293-121 The reference is provided in the text.
- L293-122 Ten years of data is sufficient for the purposes of the EIS and provides the current baseline needed for evaluation. Site remediation efforts have also been on-going over this period of time.
- L293-123 The site-specific environmental factors identified in the comment were evaluated in the EIS as appropriate in Sections 6.1.2 and 6.1.3. The results of the evaluation were taken into consideration in identifying the preferred alternative presented in the Final EIS.
- L293-124 See response to L293-118.
- L293-125 The seismic activity in the area surrounding the Hanford Site was evaluated in the EIS as appropriate in Section 6.1.2.1.4. The results of the evaluation were taken into consideration in identifying the preferred alternative presented in the Final EIS.
- L293-126 See response to L293-125.
- L293-127 In the TC&WM 2012 EIS “Probabilistic seismic hazard analyses are used to determine ground motions expected from multiple earthquake sources, which are then used to design or evaluate facilities at Hanford. On the basis of the most recent site-specific seismic analyses, it is estimated that an earthquake producing a horizontal (ground) acceleration of 0.10 g at Hanford would be experienced on average every 500 years (annual probability of occurrence of 1 in 500). An earthquake producing a peak horizontal (ground) acceleration of 0.2 g is calculated to have an annual probability of occurrence of 1 in 2,500, which is in approximate agreement with the national seismic hazard maps produced by USGS (Duncan 2007:4.46). As stated in DOE Order 420.1B, Change 1, DOE requires nuclear and nonnuclear facilities to be designed, constructed, and operated so that the public, workers, and environment are protected from adverse impacts of natural phenomena hazards, including earthquakes. A site-specific ground response model developed for the WTP being constructed at Hanford stipulated increased ground motions for the design basis of this facility by up to 40 percent to be more conservative (Duncan 2007:4.46).”
- L293-128 See response to L293-125.
- L293-129 The American Indian Text box in Section 6.1.3.1.1 of the EIS discusses the importance of the Columbia River to the Indian People, and Section 6.1.3.1.3 discusses the importance of the designation of the Columbia River as “salmon and trout spawning, noncore rearing, and migration.”
- L293-130 Radionuclides in the Columbia River originating from Hanford are discussed in Section 6.1.3.1.3 in the EIS (e.g. “These constituents are known to be entering the river from contaminated groundwater beneath the Hanford Site.”).
- L293-131 See response to L293-118.
- L293-132 Depleted uranium is not included in the GTCC LLRW waste inventory because this material is not GTCC LLRW.
- L293-133 See response to L293-78.
- L293-134 See response to L293-78.
- L293-135 See response to L293-78.

**Yakama Nation Environmental Restoration Waste Management Program,
Commenter ID No. L293 (cont’d)**

ID No.	Section	Subsection	Page	From Nutzer Table Number	Topic	Comment	
105	6	6.1.21.4	6-22	NA	Environmental Variables	The seismic analysis used in the Hanford Site NEPA characterization (Duncan et al., 2007) did not determine the ability of Hanford facilities to withstand seismic hazards, as the Draft GTCC EIS asserts. The 1998 Hanford Seismic Hazard Analysis and Corrosy (Hanford Corrosy, 1998) simply estimated the probability of seismic activity for use in facility design and evaluation at the specific Hanford area. The 2007 Hanford Seismic Hazard Analysis and Corrosy (Hanford Corrosy, 2007) provides a more detailed seismic hazard analysis for the entire Hanford site. The previous comment regarding seismic activity at the reactor site. Revise the Draft GTCC EIS in accordance with these comments.	L293-127
106	6	6.1.21.4	6-22	NA	Environmental Variables	The 1998 Hanford Seismic Hazard Analysis (Geomatics Consultants, 1998) referenced in the Hanford Site NEPA characterization (Duncan et al., 2007) assessed “the current state of scientific knowledge about the seismic potential and earthquake ground motion characteristics of the Hanford region. A supplemental seismic study is needed to evaluate the appropriateness of the assumptions used in the 1998 Hanford Seismic Hazard Analysis and Corrosy (Hanford Corrosy, 1998) Revise the Draft GTCC EIS to include the additional evaluation.	L293-128
107	6	6.1.31.1	6-39	NA	Environmental Variables	Revise the Draft GTCC EIS by adding to this paragraph that the Columbia River supports numerous natural resources, including spawning and rearing areas for salmon, steelhead, sturgeon, and other migratory and resident fish species, and is of major cultural importance to numerous Indian tribes.	L293-129
108	6	6.1.31.3	6-35	NA	Environmental Variables	Revise the Draft GTCC EIS by adding to this paragraph the fact that groundwater contaminated with many of the same radionuclides is currently discharged to the Columbia River.	L293-130
109	6	6.1.32.3	6-40	NA	Long-Term Impacts	Revise the Draft GTCC EIS to address potential future changes in groundwater recharge rates that result from changes in precipitation (hydrology) and evaporation (hydrology) at the site.	L293-131
110	6	6.1.4	6-43	NA	Human Exposure	Revise this as the physical chemical and radiological characteristics of a uranium radionuclide and should be included with the physical chemical and radiological characteristics of depleted uranium and other waste underlines as GTCC or GTCC-like waste. GTCC EIS to include depleted uranium and other waste underlines as GTCC or GTCC-like waste and perform a thorough evaluation of both radiologic and chemical exposure that results from disposal activities.	L293-132
111	6	6.1.4	6-44	Table 6.1.4.1	Human Exposure	Native Americans are not given consideration as a unique potentially exposed receptor group. Estimating exposure and radiation dose to Native Americans is not possible because of the lack of information on their unique exposure parameters, such as those identified in the Yakama Nation Exposure Scenario (Incidell, 2007). Revise the Draft GTCC EIS to include Native Americans as a separate and unique group of receptors.	L293-133
112	6	6.1.4	6-44	Table 6.1.4.1	Human Exposure	Exposure pathways listed in this table are not complete. In addition to external radiation, inhalation, and ingestion of water, dusts, and soil, the Draft GTCC EIS to include Native Americans as a separate and unique group of receptors. Revise the Draft GTCC EIS to include these pathways.	L293-134
113	6	6.1.4	6-45	NA	Human Exposure	Exposure appears to be based on very specific data sets from past monitoring. Although the characterization is not adequate without the use of these data sets, the use of these data sets to estimate exposure is not appropriate. Revise the Draft GTCC EIS to estimate future exposure, such as done in the TOWA EIS (USDOE, 2009), based on projected total groundwater contamination that will result from plumes migrating from the Central Plume and proposed waste disposal actions.	L293-135
114	6	6.1.4	6-47	NA	Cultural Resources	Because there is no narrative associated with this (or any) Native American text box, it is unclear how the four categories of goods and services provided by an undisturbed environment and that contribute to human health are evaluated in the Draft GTCC EIS. Revise the Draft GTCC EIS to clearly state how (and where in the document) impacts to these important categories are evaluated in the EIS.	L293-136

Yakama Nation EIS/WMP Program GTCC EIS Comments
Commenter ID: L293
Page: 13

DOE respects the unique and special relationship between American Indian tribal governments and the Government of the United States. For this reason, DOE has presented and considered tribal views and perspectives throughout the GTCC EIS (and not on one page or section) to ensure full and fair consideration of tribal rights and concerns before making decisions or implementing programs that could affect tribes.

All relevant potential exposure pathways were considered in the analyses presented in the EIS. These analyses addressed a range of reasonable scenarios and estimated the potential impacts on all environmental resources consistent with NEPA requirements. For the human health assessment, the focus was on the groundwater pathway, since this is the most likely manner in which someone could be exposed to the radioactive contaminants in the GTCC LLRW and GTCC-like wastes in the distant future. Locations closer than the 100 m (330 ft.) evaluated would result in higher dose and cancer risk estimates. The 100 m (30 ft.) distance was used to be consistent with the minimum buffer zone distance surrounding a DOE LLRW disposal site identified in DOE Manual 435.1 1, Radioactive Waste Management Manual. As discussed in Section 2.7.4.2 in the EIS, the hypothetical resident farmer scenario was only used to provide estimates for comparing the various sites evaluated; however, this scenario may not be consistent with the reasonably foreseeable future scenario at some of the sites evaluated. Site-specific NEPA reviews would be conducted as needed. This information could include sensitive subpopulations and specific pathways of exposure for American Indians.

More than 8,000 years of prehistoric human activity in the largely arid environment of the middle Columbia River region have left extensive archaeological deposits along the river shores. Well-watered areas inland from the river also show evidence of concentrated human activity, and recent surveys have indicated transient use of arid lowlands for hunting. These cultural sites were occupied continuously or intermittently over substantial timespans. For this reason, a single location may contain evidence of use during both the prehistoric and historic periods, and thus the number of — occupational — could prove substantially greater than the number of identified sites (Neitzel 2005).

To date, approximately 32,630 hectares (80,640 acres) of Hanford and adjacent areas have been surveyed for archaeological resources. Approximately 1,550 cultural resource sites and isolated finds and 531 buildings and structures have been documented. 49 cultural resource sites are listed in the National Register. Most of these sites are associated with the American Indian landscape and are part of six archaeological districts situated on the shores and islands of the Columbia River. To protect resources, the National Historic Preservation Act (16 U.S.C. 470 et seq.), Section 304, and the Archaeological Resources Protection Act (16 U.S.C. 470aa et seq.), Section 9, require agencies to withhold from public disclosure information on the location and character of cultural resources (Duncan 2007).

Prehistoric period sites common to Hanford include remains of numerous pit house villages, various types of open campsites, spirit quest monuments (rock cairns), hunting camps, game drive complexes, quarries in mountains and rocky bluffs, hunting and kill sites in lowland stabilized dunes, and small temporary camps near perennial sources of water away from the river (Duncan 2007:4.120).

Although development and amateur artifact collectors have disturbed many prehistoric resources throughout the region, restricted public access imposed at Hanford has resulted in less destruction than in many other areas (Duncan 2007:4.120). Destruction from other causes is also slight.

The text was revised as suggested.

L293-136

L293-137

L293-138

ID No.	Section	Subsection	Page	Figure, Map, or Table Number	Topic	Comment
115	6	6.1.10	6-72	NA	Cultural Resources	Provide a reference for stating that humans have been present on the Hanford site for approximately 8,000 years. Other sources state that there has been human presence at this site for 11,000 years. In addition, the timeframe during which there has been human presence on the site is not representative of the site. Therefore, it is suggested to state that "historic use of the area began 11,000 years ago." Revise the Draft GTCC EIS to specify that the information presented is only for archaeological use.
116	6	6.1.10	6-72	NA	EIS Contents	Revise the Draft GTCC EIS to include the full name of the Yavapai Nation as the Confederated Tribes and Bands of the Yavapai Nation (the Yavapai Nation) in the title of the Yavapai Nation. Revise the Draft GTCC EIS to include the full name of the Confederated Tribes and Bands of the Yavapai Nation in the title of the Yavapai Nation. Revise the Draft GTCC EIS to include the full name of the Confederated Tribes and Bands of the Yavapai Nation in the title of the Yavapai Nation. Revise the Draft GTCC EIS to include the full name of the Confederated Tribes and Bands of the Yavapai Nation in the title of the Yavapai Nation.
117	6	6.1.10	6-73	NA	Cultural Resources	The entire Hanford site, including the Central Plant and 200 Areas, is rich in culturally important sites, many of which are not readily apparent. Physical features that can be easily identified using normal archaeological survey methods. Several sites may be seen as such as the site of the Hanford site. Revise the Draft GTCC EIS to include the full name of the Confederated Tribes and Bands of the Yavapai Nation in the title of the Yavapai Nation. Revise the Draft GTCC EIS to include the full name of the Confederated Tribes and Bands of the Yavapai Nation in the title of the Yavapai Nation.
118	6	6.2.1	6-77	NA	Human Exposure	Revise the Draft GTCC EIS exposure pathways to include contaminated dust.
119	6	6.2.1	6-77	NA	Long-Term Impacts	Revise the Draft GTCC EIS to include that the radioactive soils of the site and land are particularly susceptible to injury from disturbance, have long recovery times, and have high potential for contamination by invasive weeds.
120	6	6.2.3	6-82	NA	Short-Term Impacts	Revise the Draft GTCC EIS by substantially increasing the section to address the potential effects of releases of air within on the movement of current and possible future contaminated plumes. The proposed section would appear to have the potential to increase the risk of the release of the contaminants from the site. Revise the Draft GTCC EIS to include the full name of the Confederated Tribes and Bands of the Yavapai Nation in the title of the Yavapai Nation.
121	6	6.2.4	6-83	NA	Human Exposure	See previous comments regarding inclusion of Yavapai, Yavapai members and Native Americans as a unique receptor group. Revise the Draft GTCC EIS to include the full name of the Confederated Tribes and Bands of the Yavapai Nation in the title of the Yavapai Nation.
122	6	6.2.4	6-85	Table 6.2.4-1	Human Exposure	Revise the Draft GTCC EIS to include the full name of the Confederated Tribes and Bands of the Yavapai Nation in the title of the Yavapai Nation. Revise the Draft GTCC EIS to include the full name of the Confederated Tribes and Bands of the Yavapai Nation in the title of the Yavapai Nation.
123	6	6.2.4	6-86	NA	Human Exposure	The resident farmer scenario and other human health evaluations not related to worker health are based on a distance of 100 meters from the disposal area boundary. See previous comments regarding appropriate exposure scenarios, distances from the disposal area boundary, and contaminant concentration. Revise the Draft GTCC EIS to appropriately reflect the risk posed by the facility following evaluation of the site as a hypothetical accident scenario or historical site.
124	6	6.2.4	6-87	Table 6.2.4-2 and 3	Long-Term Impacts	It is unclear how the draft EIS is calculating the potential for contamination from the GTCC waste inventory. It is unclear how the draft EIS is calculating the potential for contamination from the GTCC waste inventory. It is unclear how the draft EIS is calculating the potential for contamination from the GTCC waste inventory. It is unclear how the draft EIS is calculating the potential for contamination from the GTCC waste inventory.
125	6	6.2.4	6-89	NA	Human Exposure	The description of soil and hazardous waste management is vague. The same individual's jaundice (weakened) is included for all the other potential disposal sites. Revise the Draft GTCC EIS to provide detailed descriptions of waste generated (both hazardous and non-hazardous) at each site, as well as regulatory requirements, management to comply with those requirements, and disposal options to incorporate those comments.
126	6	6.2.11	6-103	NA	GTCC Waste Type	Revise the Draft GTCC EIS to include the full name of the Confederated Tribes and Bands of the Yavapai Nation in the title of the Yavapai Nation.

Yavapai Nation Environmental Program GTCC EIS Document
 Appendix I
 Page 14

L293-137
 L293-138
 L293-139
 L293-140
 L293-141
 L293-142
 L293-143
 L293-144
 L293-145
 L293-146
 L293-147
 L293-148

**Yakama Nation Environmental Restoration Waste Management Program,
 Commenter ID No. L293 (cont'd)**

Yakama Nation Environmental Restoration Waste Management Program,
Commenter ID No. L293 (cont'd)

- L293-139 As required by NEPA, the EIS evaluates the potential impacts of the proposed action on cultural resources at the various DOE sites in sufficient detail to assess the potential impacts of the proposed alternatives. DOE recognizes that development of a disposal facility for GTCC LLRW and GTCC-like wastes would require that future land uses be restricted at and near the site for the protection of the general public. This action could affect areas that may be important to American Indian tribes. Text was added to Section 6.1.10 of the EIS describing the concept of traditional cultural properties and those associated with the Hanford Site.
- L293-140 Existing site-specific contamination was considered where appropriate. Additional information concerning air monitoring and air releases in the 200 west area was added to Section 6.1.1.2. All relevant potential exposure pathways were considered in the analyses presented in the EIS. These analyses addressed a range of reasonable scenarios and estimated the potential impacts on all environmental resources consistent with NEPA requirements. For the human health assessment, the focus was on the groundwater pathway, since this is the most likely manner in which someone could be exposed to the radioactive contaminants in the GTCC LLRW and GTCC-like wastes in the distant future. As discussed in Section 2.7.4.2 of the EIS, the hypothetical resident farmer scenario was only used to provide estimates for comparing the various sites evaluated; however, this scenario may not be consistent with the reasonably foreseeable future scenario at some of the sites evaluated. Site-specific NEPA reviews would be conducted as needed.
- L293-141 Section 6.2.5 of the EIS discusses the need to quickly revegetate disturbed land at Hanford so that non-native species do not become established.
- L293-142 The water use during construction of a potential disposal facility at the Hanford Site was evaluated in the EIS as appropriate. The results of the evaluation were taken into consideration in identifying the preferred alternative presented in the Final EIS. Information on water use and consumption from the construction and operation of a GTCC Disposal facility is found in Appendix D 6.1 and D 6.2 of the EIS.
- L293-143 See response to L293-78.
- L293-144 The potential for flooding at the Hanford Site was evaluated in the EIS as appropriate in Section 6.1.3.1.1. The results of the evaluation were taken into consideration in identifying the preferred alternative presented in the Final EIS.
- L293-145 See response to L293-78.
- L293-146 See response to L293-2.
- L293-147 See response to L293-78.
- L293-148 The hazardous waste that could be generated during construction of a near-surface disposal facility could include typical industrial construction wastes such as liquids – used oil, grease, and organic solvents – and solids – batteries, mercury construction lights, cleaning materials (e.g., wipes), and solids generated during the cleanup of spills (e.g. absorbents, contaminated soil). At the time of construction, such wastes would be identified and properly disposed of according to their waste characteristics and the appropriate local, state, and federal regulations.

L293-149 All relevant potential exposure pathways were considered in the analyses presented in the EIS. These analyses addressed a range of reasonable scenarios and estimated the potential impacts on all environmental resources consistent with NEPA requirements. For the human health assessment, the focus was on the groundwater pathway, since this is the most likely manner in which someone could be exposed to the radioactive contaminants in the GTCC LLRW and GTCC-like wastes in the distant future. Locations closer than the 100 m (330 ft.) evaluated would result in higher dose and cancer risk estimates. The 100 m (30 ft.) distance was used to be consistent with the minimum buffer zone distance surrounding a DOE LLRW disposal site identified in DOE Manual 435.1 1, Radioactive Waste Management Manual. As discussed in Section 2.7.4.2 of the EIS, the hypothetical resident farmer scenario was only used to provide estimates for comparing the various sites evaluated; however, this scenario may not be consistent with the reasonably foreseeable future scenario at some of the sites evaluated. Site-specific NEPA reviews would be conducted as needed. This information could include sensitive subpopulations and specific pathways of exposure for American Indians.

This EIS presents relevant and essential information important to the evaluation of potential environmental impacts, consistent with NEPA's primary goal of full disclosure to the public as well as agency decision makers. This includes discussion of the history of the settlement of Hanford and the treaties entered into between tribal nations and the U.S. government. There is substantial documentation indicating that the tribes understood at the time these treaties were signed that the lands were no longer "unclaimed" when they were claimed for the purposes of the white settlers' activities. DOE is not aware of any judicially recognized mechanisms that would allow these lands to revert to "unclaimed" status merely through the process of being acquired by the federal government. The portion of Hanford that remained in the public domain in 1943, as well as all the acquired lands, were closed to all access initially under authority of the War Powers Act and then under authority of the AEA. It is therefore DOE's position that the Hanford lands are neither "open" nor "unclaimed."

L293-150 See response to L293-2.

L293-151 See response to L293-118.

L293-152 See response to L293-2.

L293-153 See response to L293-2.

L293-154 See response to L293-21.

L293-155 The alternatives suggested for evaluation are not within the reasonable range of alternatives for disposal of GTCC LLRW and GTCC-like wastes. Evaluation of additional generic sites would not provide further benefit in the decision to provide a disposal pathway for GTCC LLRW and GTCC-like waste and is considered outside the scope of the EIS.

**Yakama Nation Environmental Restoration Waste Management Program,
Commenter ID No. L293 (cont'd)**

ID No.	Section	Subsection	Page	Figure, Table or Title Number	Topic	Comment
127	6	6.3	6-104	NA	Human Exposure	It is recommended to evaluate potential impacts only to workers and the general public. Hanford is a part of the Yakama Nation's usual and accustomed use lands, to which unrestricted access is guaranteed by the Treaty of 1855. The Yakama Nation must be consulted regarding the potential impacts of proposed disposal alternatives on the health, safety, and subsistence uses of natural resources. Review the Draft GTCC EIS to incorporate these pathways and doses as outlined in the Yakama Nation Exposure Scenario (Revised, 2007).
128	6	6.3	6-105	NA	Human Exposure	It is important to explain that the dose estimates presented in the summary will occur in addition to doses from already-existing radionuclides that have been released from the Hanford Site. The summary should also include information on the potential for additional releases and doses that will be incurred from the proposed disposal alternatives. Review the Draft GTCC EIS in accordance with these comments.
129	6	6.4.1.1	6-107	NA	Long-Term Impacts	Disposal units waste sites located in the reference area may involve disturbing contaminated sediments at depths greater than 100 meters below the water table. The Draft GTCC EIS should incorporate all existing contaminations and estimate releases at the Hanford Site at the estimate of cumulative impacts on the site to include the potential for future releases and one of PUBLIC's priority field activities: dredging, filling, and other activities of the BIC.
130	6	6.4.2	6-109	NA	Long-Term Impacts	This text should be revised to clarify that post-disposal impacts presented in Section 6.4.2.3 indicate that post-disposal impacts for the land disposal alternatives (low-level, trench, and vault basins) would contribute to overall cumulative impacts from past, present, and reasonably foreseeable future actions at Hanford. The level of cumulative impact analysis should be commensurate with potential impacts from the proposed disposal alternatives. The cumulative impacts analysis should be revised to include the potential for cumulative impacts at Hanford would first require a comprehensive cumulative risk assessment for the entire site, which has not yet been conducted. A complete cumulative impacts analysis could then provide an understanding of whether the proposed alternatives for disposal of GTCC LLRW and GTCC-like wastes are consistent with the requirements of the National Environmental Policy Act (NEPA). The cumulative impacts of proposed alternatives combined with other USDOE action (e.g., on-site waste disposal) should be documented. In addition, planned and unannounced visits by JSDOE in conjunction with Department of Interior inspections on land use in the reference area may result in cumulative impacts that have not been fully assessed. Review the Draft GTCC EIS to incorporate these analyses.
131	6	6.4.2	NA	NA	Long-Term Impacts	Cumulative impacts evaluated in this section are not accurate and do not account for all impacts at the Hanford Site. Review the Draft GTCC EIS to include all additional impacts provided in the TOWNS EIS (JSDOE, 2009), such as the operation of the waste treatment and storage facility, the proposed disposal alternatives, and the potential for cumulative impacts from the US Ecology, LLRW disposal facility, and existing contamination associated with former Central Plateau waste disposal practices. See previous comments regarding complete assessment of cumulative impacts at the Hanford Site.
132	6	6.5	6-111	NA	ESG Comments	There is no mention of treaty rights in this section. Review the Draft GTCC EIS to incorporate treaty rights.
133	12	NA	12-1	NA	ESG Comments	Review the Draft GTCC EIS to provide estimates of resource impacts for generic sites that are not included in the current draft. Provide a description of when the evaluation will be conducted, what will be included, and how the information will be available for public review.

Yakama Nation Environmental Program GTCC EIS Comments
Attachment 2
Page 15

L293-149

L293-150

L293-151

L293-152

L293-153

L293-154

L293-155

L293-156 See response to L293-78.

L293-157 The EIS analyses are based on conceptual engineering information and necessitated the use of a number of simplifying assumptions. This approach is consistent with NEPA, which requires such analyses to be made early in the decision-making process. The various land disposal conceptual designs were assumed to be constructed and operated in a comparable manner at each of the various sites. Information on the conceptual engineering designs for the three proposed land disposal methods is provided in Section D.3 of Appendix D in the EIS. By using the same conceptual designs at all of the sites evaluated in the GTCC EIS, except for cases where a design did not apply (e.g., an intermediate-depth borehole at a site with shallow groundwater), the potential impacts (e.g., radionuclides reaching the groundwater) at the different environmental settings could be readily compared.

In performing these evaluations, a number of engineering measures were included in the conceptual facility designs to minimize the likelihood of contaminant migration from the disposal units. No facility design can guarantee that radionuclide migration from the facility would not occur over and beyond a 10,000-year time period. It was assumed that these measures would perform similarly for all conceptual designs, remaining intact for 500 years after the disposal facility closed. After 500 years, the barriers would gradually fail.

To account for these engineered features in the modeling calculations, it was assumed that the water infiltration to the top of the waste disposal area would be zero for the first 500 years and then 20% of the natural rate for the area for the remainder of the time period (through 10,000 years). A water infiltration rate of 20% of the natural rate for the area was only used for the disposal area; the natural background infiltration rate was used at the perimeter of the waste disposal units. Again, this approach enables a comparative evaluation of the influence that site-specific environmental factors would have on the potential migration of radionuclides from the disposal facilities and the potential impacts on human health. It should be emphasized that project- and site-specific engineering factors would be incorporated into the actual facility designs of the site or sites selected in a ROD to dispose of GTCC LLRW and GTCC-like wastes.

DOE believes that 500 years is a realistic time period for the longevity of the types of engineering barriers assumed in the analyses. DOE believes the approach and the assumptions used in the EIS are reasonable for performing the comparative analysis of alternatives required by NEPA. For example, as discussed in Section E.2.2, the assumption of a 20% natural background infiltration rate after 500 years was based on a study at SRS (Phifer et al. 2007) that indicated that after 10,000 years, the closure cap at the F-area would still shed about 80% of the cumulative precipitation falling on it, with an effectiveness that would be greater before 10,000 years, then decrease very slowly after 10,000 years. The approach used in the EIS is more conservative than indicated by this study.

L293-158 See response to L293-95.

L293-159 While radionuclide releases are not anticipated during operation of the proposed disposal facility, the generic facility would be expected to have contingency plans similar to the existing federal sites. Emergency response plans and procedures, based on further review should a decision be made to build such a facility, would be in place before the receipt of any radioactive waste.

L293-160 See response to L293-67.

**Yakama Nation Environmental Restoration Waste Management Program,
Commenter ID No. L293 (cont'd)**

ID No.	Section	Subsection	Page	Figure Map or Table Number	Topic	Comment
134	12	12.1	123.1	NA	Human Exposure	It is inappropriate to evaluate potential impacts only to workers and the general public. Stress Region IV (western sites) shows for all located near Native Americans. The Draft GTCC EIS should include a table listing the number of workers, their estimated dose and cancer risk, including high exposure rates for surface water consumption, fish, game, and other participating wildlife use, and other critical and subsistence uses of natural resources.
135	12	12.1	123.3	NA	Soil/Groundwater Contaminant Exposure	It is not realistic or appropriate to assume that engineered cover and earth conditions will not begin to degrade until after 500 years. Site performance should be modeled in a more realistic manner in the EIS to provide alternatives that do not depend on surface barriers and optimistic assumptions to meet performance requirements.
136	12	12.2	123.3	NA	Human Exposure	Table 12-1, for all the radionuclides included in the waste packages would contain the radionuclide maxima and bounding maximum values for each radionuclide. The Draft GTCC EIS repeatedly states that nonradiating radionuclides would be included, however, it would be incorrect and confusing to provide more specific information about waste modeling would be implemented, how often it would be conducted, and how long it would be conducted. The Draft GTCC EIS to provide more specific information about waste modeling would be implemented, how often it would be conducted, and how long it would be conducted. The Draft GTCC EIS to provide more specific information about waste modeling would be implemented, how often it would be conducted, and how long it would be conducted. The Draft GTCC EIS to provide more specific information about waste modeling would be implemented, how often it would be conducted, and how long it would be conducted.
137	12	12.2	123.3	NA	Soil/Groundwater Contaminant Exposure	Revise the Draft GTCC EIS to give examples of the types of engineering controls that would be used in the event of contaminant releases. Describe in detail how they fit into the proposed controls will control and reduce these releases. Provide examples of how they would be implemented. Describe how they would be implemented. Describe how they would be implemented. Describe how they would be implemented.
138	12	12.3	124	NA	Human Exposure	See previous comments regarding identical radionuclide scenarios and post-closure exposure scenarios that should be included. Revise the Draft GTCC EIS to include these scenarios and exposures.
139	12	12.3	124	NA	Soil/Groundwater Contaminant Exposure	Revise the Draft GTCC EIS to provide specific corrective actions that would be taken if water was found to be infiltrating within the first 500 years of closure. See previous comments regarding identical radionuclide scenarios and post-closure exposure scenarios that should be included. Revise the Draft GTCC EIS to include these scenarios and exposures.
140	12	12.3	124	NA	Environmental Variables	See previous comments regarding underlying assumptions used to estimate releases from this proposed disposal facility in the first 500 years of closure. Revise the Draft GTCC EIS to provide realistic assumptions based on environmental parameters that are not optimal for the site. Revise the Draft GTCC EIS to provide realistic assumptions based on environmental parameters that are not optimal for the site. Revise the Draft GTCC EIS to provide realistic assumptions based on environmental parameters that are not optimal for the site.
141	13	13.3	132	NA	EIS Contents	The NRC's study rights are not acknowledged in this section. Revise the Draft GTCC EIS to acknowledge the Yakama Nation's study rights.
142	13	13.3.1	133	NA	EIS Contents	Revise Section 13 of the Draft GTCC EIS to include the Treaty of 1855 (25 Stat. 651) as a requirement to be considered in the EIS process.
143	13	13.4	133	NA	EIS Contents	Executive Orders that may be violated by the Draft GTCC EIS include EO-11514 (Protection and Enhancement of Environmental Quality), EO-11735 (Coordination and Cooperation with Indian Tribal Governments), EO-13045 (Review of Executive Orders, Regulations, and Proposed Rules), and EO-13176 (Improving Governmental Decision Making and Transparency). Revise the Draft GTCC EIS to be consistent with these Executive Orders.

Yakama Nation Environmental Restoration Waste Management Program
Appendix I: Comment Response Document
Page 16

L293-156
L293-157
L293-158
L293-159
L293-160
L293-161
L293-162
L293-163
L293-164
L293-165

Yakama Nation Environmental Restoration Waste Management Program,
Commenter ID No. L293 (cont'd)

L293-161 Site-specific NEPA reviews would be conducted as needed once an alternative is selected to tailor the proposed disposal facility to the selected site. The types of activities that would be expected to occur during the post-closure phase of a GTCC waste disposal facility would include visually inspecting cover systems and security fences; monitoring the nearby air, soil, surface water, and groundwater; and repairing any defects in the facility, including cracks or holes in the soil cover. A detailed program would be developed to ensure that the wastes remained safely contained within the disposal unit for as long as possible.

L293-162 The EIS analyses are based on conceptual engineering information and necessitated the use of a number of simplifying assumptions. This approach is consistent with NEPA, which requires such analyses to be made early in the decision-making process. The various land disposal conceptual designs were assumed to be constructed and operated in a comparable manner at each of the various sites. Information on the conceptual engineering designs for the three proposed land disposal methods is provided in Section D.3 of Appendix D in the EIS. By using the same conceptual designs at all of the sites evaluated in the GTCC EIS, except for cases where a design did not apply (e.g., an intermediate-depth borehole at a site with shallow groundwater), the potential impacts (e.g., radionuclides reaching the groundwater) at the different environmental settings could be readily compared.

In performing these evaluations, a number of engineering measures were included in the conceptual facility designs to minimize the likelihood of contaminant migration from the disposal units. No facility design can guarantee that radionuclide migration from the facility would not occur over and beyond a 10,000-year time period. It was assumed that these measures would perform similarly for all conceptual designs, remaining intact for 500 years after the disposal facility closed. After 500 years, the barriers would gradually fail. To account for these engineered features in the modeling calculations, it was assumed that the water infiltration to the top of the waste disposal area would be zero for the first 500 years and then 20% of the natural rate for the area for the remainder of the time period (through 10,000 years). A water infiltration rate of 20% of the natural rate for the area was only used for the disposal area; the natural background infiltration rate was used at the perimeter of the waste disposal units. Again, this approach enables a comparative evaluation of the influence that site-specific environmental factors would have on the potential migration of radionuclides from the disposal facilities and the potential impacts on human health. It should be emphasized that project- and site-specific engineering factors would be incorporated into the actual facility designs of the site or sites selected in a ROD to dispose of GTCC LLRW and GTCC-like wastes.

DOE recognizes that modeling potential releases of radionuclides from the conceptual disposal sites far into the future approximates what might actually occur. Sufficient detail was included in these designs for use in the EIS analyses, consistent with the current stage of this process. Some of the input values may change in the future and could result in higher impacts (such as from increased precipitation at some sites due to climate change), while others could result in lower impacts (due to decreased precipitation).

DOE believes that 500 years is a realistic time period for the longevity of the types of engineering barriers assumed in the analyses. DOE believes the approach and the assumptions used in the EIS are reasonable for performing the comparative analysis of alternatives required by NEPA. For example, as discussed in Section E.2.2, the assumption of a 20% natural background infiltration rate after 500 years was based on a study at SRS (Phifer et al. 2007) that indicated that after 10,000 years, the closure cap at the F-area would still shed about 80% of the cumulative precipitation falling on it, with an effectiveness that would be greater before 10,000 years, then decrease very slowly after 10,000 years. The approach used in the EIS is more conservative than indicated by this study.

L293-163 See response to L293-21.

L293-164 See response to L293-21.

L293-165 Many of these Executive Orders apply to implementation activities. The construction and operation of a GTCC disposal facility will be done in accordance with existing federal, state, and local laws and regulations, including Presidential Executive Orders.

L293-166 The GTCC LLRW and GTCC-like waste inventory evaluated in the EIS is based on the best available information on the stored and projected GTCC LLRW and GTCC-like wastes from ongoing and planned activities. The estimated 12,000 m³ of GTCC LLRW and GTCC-like wastes is a relatively small volume of waste when compared to other wastes disposed of by DOE. For example, this volume of GTCC LLRW and GTCC-like wastes is only about 20% of the 59,000 m³ of LLRW disposed of at one site (NNSS) in one year (fiscal year 2010). DOE canceled the *Draft Global Nuclear Energy Partnership Programmatic Environmental Impact Statement* (GNEP PEIS) (74 FR 31017); therefore, the generation of additional GTCC LLRW under GNEP is not included in the GTCC EIS inventory. In addition, the inventory includes wastes expected to be generated during the production of Mo-99 for medical applications from two potential generators. While the potential generator(s) of this waste may change, the estimated characteristics and volumes are representative of the amounts expected to supply the demand for the Mo-99. DOE believes that expanding the inventory to include potential GTCC LLRW and GTCC-like wastes from undefined or unplanned future activities would introduce excessive uncertainty in the EIS evaluations. DOE believes that the inventory included in the GTCC EIS is reasonable for the purposes of the NEPA process and that it provides a supportable basis for conducting the EIS evaluation and the identification of the preferred alternative in the Final EIS. In the future, should additional waste be identified, appropriate NEPA review would be conducted to reflect these changes and also changes that would be needed to the existing infrastructure or the identification of additional disposal sites.

L293-167 DOE does not anticipate constructing any new facilities in contaminated areas. Site surveys will be conducted prior to the start of any construction activities.

L293-168 Site-specific environmental factors were evaluated in the EIS as appropriate in Section 6.1.3.23. The results of the evaluation were taken into consideration in identifying the preferred alternative presented in the Final EIS. Once a decision is made concerning the selection of a site and disposal methods for GTCC LLRW, additional site-specific NEPA and other review will be conducted to evaluate soils, sediments, seismic, geologic and other factors.

L293-169 See response to L293-2.

L293-170 Details of the facility accident analysis can be found in Sections 5.3.4.2.1 and 6.2.4.1 in the EIS regarding Hanford. Only a small subset of potential accident impacts are analyzed because such impacts are dependent on the severity of the accident, the amount of material released, how readily the material can be dispersed, the weather conditions (wind direction and speed) at the time of the accident, and the land use of the affected area. Human health impacts were bounded, but such socioeconomic impacts are not as readily quantified. As shown in the accident analysis, the potential human health accident impacts do not vary significantly among the potential sites because all sites are in relatively remote areas. Likewise, the potential socioeconomic impacts are not expected to vary significantly among sites and would not be a discriminator when selecting the preferred alternative.

L293-171 All relevant potential exposure pathways were considered in the analyses presented in the EIS. These analyses addressed a range of reasonable scenarios and estimated the potential impacts on all environmental resources consistent with NEPA requirements. A transportation accident involving dispersal of radioactive material into a water body would be an extremely rare event and is not considered credible for the transportation risk analysis conducted for this EIS.

**Yakama Nation Environmental Restoration Waste Management Program,
Commenter ID No. L293 (cont'd)**

ID No.	Section	Subsection	Page	Figure, Table or Table Number	Type	Comment
144	Appendix B	NA	NA	NA	EIS Comments	The Draft GTCC EIS inadequately focuses uncertainties in the waste volumes and accordingly that any require storage. Of particular concern is the potential for future incremental activities to be included in the Draft GTCC EIS. It seems likely that any facility developed to accept the wastes identified in the Draft GTCC EIS will be the first choice for future incremental activities to be included in the Draft GTCC EIS. Whether the Draft GTCC EIS is better focused on the wastes that might be generated in the future, whether the facility is expected to be available to handle all such wastes that might be generated in the future, this section does not deal with the resulting air contamination from construction in contaminated soils and sediments. See previous comments on this topic.
145	Appendix C	C1	C1	NA	Environmental Variables	See previous comments regarding soil and sediments at the Hanford Site and revise the Draft GTCC EIS in accordance with these comments. There are reliable emissions in the case of the Hanford Site, such as the problem that elastic steel pipes on the ground and water resources.
146	Appendix C	C2	C-2	NA	Environmental Variables	See previous comments regarding soil and sediments at the Hanford Site and revise the Draft GTCC EIS in accordance with these comments. There are reliable emissions in the case of the Hanford Site, such as the problem that elastic steel pipes on the ground and water resources.
147	Appendix C	C3	C-3	NA	Environmental Variables	See previous comments regarding soil and sediments at the Hanford Site and revise the Draft GTCC EIS in accordance with these comments. There are reliable emissions in the case of the Hanford Site, such as the problem that elastic steel pipes on the ground and water resources.
148	Appendix C	C3	C-30	NA	Human Exposure	This section does not consider the implications of a catastrophic accident/release. At the Hanford Site, there is a real possibility of a catastrophic accident/release. The risk of a catastrophic accident/release is not considered beyond 100 years. The risk of a catastrophic accident/release is not considered beyond 100 years. The risk of a catastrophic accident/release is not considered beyond 100 years. The risk of a catastrophic accident/release is not considered beyond 100 years.
149	Appendix C	C3.1	C-29	NA	Human Exposure	The risk of a catastrophic accident/release is not considered beyond 100 years. The risk of a catastrophic accident/release is not considered beyond 100 years. The risk of a catastrophic accident/release is not considered beyond 100 years. The risk of a catastrophic accident/release is not considered beyond 100 years.
150	Appendix C	E1	E-3	NA	Human Exposure	See previous comments regarding soil and sediments at the Hanford Site and revise the Draft GTCC EIS in accordance with these comments. There are reliable emissions in the case of the Hanford Site, such as the problem that elastic steel pipes on the ground and water resources.
151	Appendix E	E1	E-6	NA	Human Exposure	See previous comments regarding soil and sediments at the Hanford Site and revise the Draft GTCC EIS in accordance with these comments. There are reliable emissions in the case of the Hanford Site, such as the problem that elastic steel pipes on the ground and water resources.
152	Appendix E	E.1	E-6	NA	Human Exposure	See previous comments regarding soil and sediments at the Hanford Site and revise the Draft GTCC EIS in accordance with these comments. There are reliable emissions in the case of the Hanford Site, such as the problem that elastic steel pipes on the ground and water resources.
153	Appendix E	E.1	E-6	NA	Human Exposure	See previous comments regarding soil and sediments at the Hanford Site and revise the Draft GTCC EIS in accordance with these comments. There are reliable emissions in the case of the Hanford Site, such as the problem that elastic steel pipes on the ground and water resources.
154	Appendix E	E.1	E-6	NA	Human Exposure	See previous comments regarding soil and sediments at the Hanford Site and revise the Draft GTCC EIS in accordance with these comments. There are reliable emissions in the case of the Hanford Site, such as the problem that elastic steel pipes on the ground and water resources.

- L293-166
- L293-167
- L293-168
- L293-169
- L293-170
- L293-171
- L293-172
- L293-173
- L293-174
- L293-175
- L293-176

**Yakama Nation Environmental Restoration Waste Management Program,
Commenter ID No. L293 (cont'd)**

ID No.	Section	Subsection	Page	Figure, Map, or Table Number	Topic	Comment
155	Appendix E	E.21	E4	NA	Human Exposure	The assumption that the resident farmer scenario at desert site is conservative because it presumes farming would not be possible due to low rainfall is clearly false, given that the entire area is surrounded by irrigated farms. Clarify the ability to farm does not depend on rainfall alone. Revise the Draft GTCC EIS to remove the statement and all other site land regimes than with wet that acknowledge (1) that the area is not a desert and (2) that there is no empirical way to determine the amount of rainfall. Site-specific comments on the topic.
156	Appendix E	E.22	E4	E-2	Human Exposure	While conceivably straightforward, this section and the associated figure do not account for the feedback loops that link types of land cover and contamination has been noted to follow. Numerous accounts of radionuclides preferentially accumulated in water have been documented in river and terrestrial ecology. Revise the Draft GTCC EIS to acknowledge and incorporate this feedback. Because current storage of GTCC wastes is at the ground surface and radiological controls are not relied upon for more than 100 years, evaluation of long-term human health impacts of the No Action alternative should consider surface runoff and airborne releases (including particulates) of radionuclides from the site. The No Action alternative should consider the potential for radionuclide migration to groundwater and other receptors. Site-specific comments on the topic are provided in the Draft GTCC EIS to incorporate these pathways.
157	Appendix E	E.3	E-13	NA	Human Exposure	The information provided for radionuclide transfer from waste to vegetation rates measured at Hanford. A comparison estimate of radionuclide transfer from waste to vegetation has been found to be 10 times higher. The radionuclide transfer rate in the Draft GTCC EIS significantly underestimates the potential for radionuclide transfer from waste to vegetation. In addition, the radionuclide transfer rate may change significantly over time as a result of climate change and lower temperatures. The minimum 10,000-year period over which the disposal facility must isolate wastes requires that higher rates be considered in the analysis. Revise the Draft GTCC EIS to evaluate higher radionuclide rates at the waste site. Site-specific comments regarding precipitation and irrigation rates used to analyze the Hanford Site. Revise the Draft GTCC EIS to evaluate precipitation and irrigation rates that would result from significant climate change in the next 10,000 to 100,000 years.
158	Appendix E	E.4	E-69	Table E-15	Environmental Variables	
159	Appendix E	E.4	E-69	Table E-15	Environmental Variables	

Yakama Nation Environmental Program GTCC EIS Comments
Appendix I
Page 18

L293-177
L293-178
L293-179
L293-180
L293-181

L293-172 See response to L293-67.

L293-173 The surface water pathway was not analyzed quantitatively in the EIS for the reasons summarized in Appendix E – “Releases to surface water would only occur once the entire engineered cover over the disposed wastes had eroded away. Because of the thick cover layer and the use of very robust engineering techniques to construct it, it was assumed for the analyses in the EIS that the buried GTCC wastes would always be overlain by some cover material through 10,000 years, eliminating surface water runoff as a potential exposure mechanism for the action alternatives.

Even if releases to surface water were to occur, it is not expected that these releases would be significant or result in higher peak annual doses or latent cancer fatality (LCF) risks than would releases to groundwater. The disposal facility and waste containers are assumed to maintain their integrity for at least 500 years, and this factor would allow many of the shorter-lived radionuclides to decay to innocuous levels prior to any releases to the environment. In addition, it is expected that releases to surface water would be much more diluted in the environment (such as in a river or lake) before being ingested by the hypothetical receptor than would comparable releases to groundwater (in which case the hypothetical receptor would extract water for use from a well). Because of this smaller amount of dilution, the groundwater pathway would likely be much more significant than the surface water pathway.”

L293-174 See response to L293-95.

L293-175 See response to L293-2.

L293-176 All relevant potential exposure pathways were considered in the analyses presented in the EIS, including impacts from surface runoff and airborne emissions. These analyses addressed a range of reasonable scenarios and estimated the potential impacts on all environmental resources consistent with NEPA requirements. For the human health assessment, the focus was on the groundwater pathway, since this is the most likely manner in which someone could be exposed to the radioactive contaminants in the GTCC LLRW and GTCC-like wastes in the distant future. Locations closer than the 100 m (330 ft.) evaluated would result in higher dose and cancer risk estimates. The 100 m (30 ft.) distance was used to be consistent with the minimum buffer zone distance surrounding a DOE LLRW disposal site identified in DOE Manual 435.1 ,1 Radioactive Waste Management Manual. As discussed in Section 2.7.4.2 in the EIS, the hypothetical resident farmer scenario was only used to provide estimates for comparing the various sites evaluated; however, this scenario may not be consistent with the reasonably foreseeable future scenario at some of the sites evaluated. Site-specific NEPA reviews would be conducted as needed.

L293-177 All relevant potential exposure pathways were considered in the analyses presented in the EIS, including impacts from surface runoff and airborne emissions. These analyses addressed a range of reasonable scenarios and estimated the potential impacts on all environmental resources consistent with NEPA requirements. For the human health assessment, the focus was on the groundwater pathway, since this is the most likely manner in which someone could be exposed to the radioactive contaminants in the GTCC LLRW and GTCC-like wastes in the distant future. As discussed in Section 2.7.4.2 in the EIS, the hypothetical resident farmer scenario was only used to provide estimates for comparing the various sites evaluated; however, this scenario may not be consistent with the reasonably foreseeable future scenario at some of the sites evaluated. Site-specific NEPA reviews would be conducted as needed.

L293-178 See response to L293-177.

L293-179 See response to L293-65.

L293-180 See response to L293-29.

L293-181 DOE recognizes that modeling potential releases of radionuclides from the conceptual disposal sites far into the future approximates what might actually occur. Sufficient detail was included in the conceptual disposal facility designs for use in the EIS analyses, consistent with the current stage of this process. Some of the input values may change in the future and could result in higher impacts (such as from increased precipitation at some sites due to climate change), while others could result in lower impacts (due to decreased precipitation).

Yakama Nation EIS/IA Program
GTCC EIS Comments
Appendix I
Page 18

References List

- CEQ. 1987. *Considering Cumulative Effects under the National Environmental Policy Act*. National Environmental Policy Act Website. Available online: <http://www.nepa.doe.gov/nepa/ceq/ceq.html>. Accessed 6/12/2011.
- Cheney, J. & Berk, M. Chermans, R. Fowler, B. Pitt, P. Handelson, E. Kennedy, G. Lind, T. Pirova, M. Sureshensky, N. Scott, S. Spahr, A. Sweney, and P. Thoma. 2007. *Hanford Site National Environmental Policy Act (NEPA) Characterization* (PNWL-4415 Rev. 10). September.
- Energy Policy Act. 2005. *Energy Policy Act of 2005* §931. Public Law 109-58, August 8. Available online: <http://dojreferrals.energy.gov/olaw/olaw050805.pdf>. Accessed 6/12/2011.
- Geonetric Consultants. 1993. *Probabilistic Seismic Hazard Analysis, DOE Hanford Site, Washington* (WMC-SD-W226A111022 Rev. 0). Prepared for Westinghouse Hanford Company. December.
- RCQ/FH Inc. (Roclab). 2007. *Yakama Nation Exposure Scenario for Hanford Site Risk Assessment*. Richland, Washington. Prepared for the Yakama Nation EIS/IA Program. September.
- U.S. Department of Energy (USDOE). 1987. *Recommendations for Management of Greater-Than-Class-C Low-Level Radioactive Waste* DCE/NE-0077. February. Available online: http://www.doe.gov/officeofenvironment/DOE_MRS/RTZ.pdf
- U.S. Department of Energy (USDOE). 2008. *Draft Tank Closure and Waste Management Environmental Impact Statement for the Hanford Site, Richland, Washington* (DOE/EIS-0291). Prepared by the U.S. Department of Energy. October.
- U.S. Environmental Protection Agency (USEPA). 1993. *Consideration of Cumulative Impacts in EPA Review of NEPA Documents*. EPA 315-R-99-002. May. Available online: <http://www.epa.gov/ceq/comments/considerationofcumulativeimpacts.pdf>. Accessed 6/12/2011.
- U.S. Nuclear Regulatory Commission. 1981. *Draft Environmental Impact Statement on 10 CFR Part 61 Licensing Requirements for Land Disposal of Radioactive Wastes* NUREG-0782, Volume 21. September.

Yakama Nation Environmental Restoration Waste Management Program,
Commenter ID No. L293 (cont'd)

Yakama Nation Environmental Restoration Waste Management Program,
Commenter ID No. L293 (cont'd)

L293-182 See response to L293-24.



INSTITUTE FOR ENERGY AND ENVIRONMENTAL RESEARCH

6935 Laurel Avenue, Suite 201
Takoma Park, MD 20912

Phone: (301) 270-5500
FAX: (301) 270-3029
e-mail: ieer@ieer.org
<http://www.ieer.org>

Attachment 3

Comments of the Institute for Energy and Environmental Research on the
Department of Energy's
Draft Environmental Impact Statement for the Disposal of Greater-Than-Class C (GTCC) Low-Level Radioactive Waste and GTCC-Like Waste (DOE/EIS-0375-D), published in February 2011
9 June 2011
Prepared for Ridolfi, Inc., by
The Institute for Energy and Environmental Research

These comments on the *Draft Environmental Impact Statement for the Disposal of Greater-Than-Class C (GTCC) Low-Level Radioactive Waste and GTCC-Like Waste (DOE/EIS-0375-D)*, published by the Department of Energy (DOE) in February 2011, were prepared by the Institute for Energy and Environmental Research under contract to Ridolfi, Inc. This Draft GTCC EIS is referred to in the comments below as "Draft EIS." IEER had submitted comments to the DOE on its draft implementation (or scoping) plan in September 2007.¹

Overview and Recommendations for a Revised Draft EIS

Our analysis indicates that the Draft EIS is very incomplete and in many respects scientifically ill-founded. These points are called out explicitly in the discussion below. As a result we have concluded that it is necessary to re-do the draft and republish a Draft EIS for public comment. The recommendations below for a revision indicate the breadth and depth of the scientific and regulatory gaps and problems with the Draft EIS. They are based on the analysis and review of the EIS below (including Appendix A).

Section A Recommendations: DOE's responses to some public comments on scope (with four subsections)

A revised draft EIS should be published that includes a deep geologic repository alternative other than WIPP.

L293-182

¹Arjun Makhijani. *Comments of the Institute for Energy and Environmental Research on the Department of Energy's Notice of Intent to Prepare an Environmental Impact Statement for the Disposal of Greater-Than-Class-C Low-Level Radioactive Waste, Federal Register*, Institute for Energy and Environmental Research, September 21, 2007, on the Web at <http://www.ieer.org/comments/gtccnoi.pdf>. Hereafter Makhijani 2007.

Yakama Nation Environmental Restoration Waste Management Program,
Commenter ID No. L293 (cont'd)

The EIS should include an alternative that combines hardened on site storage of commercial reactor decommissioning GTCC for 30 to 60 years combined with disposal.

A revised draft EIS should be published that explicitly addresses cancer risks to children and especially female children, to estimate whether the proposed disposal methods meet the standards for public health protection in existing regulations, notably Subpart C of 10 CFR 61.² In light of Executive Order 13045, the DOE should also consider non-cancer risks in utero and non-cancer risks to children.

A revised draft EIS should be published that explicitly includes depleted uranium from enrichment plants as GTCC-like waste. This should include both existing stocks of DU at DOE sites as well as stocks of DU anticipated from the centrifuge enrichment plant that has been licensed and operating in New Mexico and the one likely to be operational in the future in Idaho.

Section B Recommendation: Standards to be applied for performance assessment

The DOE should apply the criteria of 10 CFR 61.41 for assessing whether a site and disposal method meets minimal disposal criteria. It is essential to calculate organ doses and to do so for the age and gender that would be the most exposed for a given set of environmental conditions. For CERCLA sites, like Hanford, ARARs, including radionuclide drinking water MCLs and a lifetime cancer risk of at most one in 10,000, need to be maintained. The DOE should also take treaty compliance into account through use of appropriate scenarios and by assuming that institutional controls will end when DOE site cleanup is completed. Sites and disposal methods that do not meet these criteria should be ruled out. Hanford does not meet the criteria for any disposal method and should be ruled out as a disposal site for GTCC and GTCC-like waste. The Draft EIS should be reissued for public comment with the changes in this set of recommendations since the failure to use the appropriate standards and ARARs as reference points is a fundamental analytical and legal problem. The Draft EIS as it stands gives the false impression that the choices of sites and disposal approaches are much wider than they are if reasonable existing health and environmental standards are applied.

Section C Recommendations: Source terms that are not, but should be, included in a revised Draft EIS

Recommendation: The DOE should reissue a Draft GTCC EIS for public comment with the following source terms included:

1. Depleted uranium from enrichment plants
2. Recycled uranium, including the recycled uranium in the DOE complex and that generated from operations at West Valley
3. Hanford reactor graphite moderator blocks

² United States. Nuclear Regulatory Commission. *Code of Federal Regulations. Title 10 – Energy; Chapter 1 – Nuclear Regulatory Commission; Part 61 – Licensing Requirements for Land Disposal of Radioactive Waste.* 1-1-11 Edition. Washington, DC: Office of the Federal Register, National Archives and Records Administration; U.S. Government Printing Office, 2011. On the Web at <http://www.gpo.gov/fdsys/pkg/CFR-2011-title10-vol2/pdf/CFR-2011-title10-vol2-part61.pdf>.

L293-183 The use of HOSS and other approaches for long-term storage of GTCC LLRW and GTCC-like wastes are outside the scope of this EIS because they do not meet the purpose and need for agency action. Consistent with Congressional direction in Section 631 of the Energy Policy Act of 2005 (P.L. 109-58), DOE plans to complete an EIS and a ROD for a permanent disposal facility for this waste, not for long-term storage options. The GTCC EIS evaluates the range of reasonable disposal alternatives and, as also required under NEPA, a No Action Alternative. Under the No Action Alternative, current practices for storing GTCC LLRW and GTCC-like wastes would continue in accordance with current requirements.

L293-184 Disposition of the GTCC LLRW and GTCC-like wastes will be handled in a manner that is protective of human health and the environment and in compliance with applicable requirements and regulations. Doses to workers and the public will be minimized to the extent practical. The methodology used to estimate the radiological human health impacts in the EIS is based on standard practices that are subject to revision as our understanding of the effects of radiation on humans evolves (e.g., effects on children vs. adults and/or consideration of organ dose vs. total effective dose). The same methodology is used in the evaluation of all alternatives; thus, any modification of this methodology would not affect the comparisons among alternatives and the identification of the preferred alternative.

L293-185 See response to L293-132.

L293-186 The EIS analysis is used to assess the viability of an alternative as well as its relative performance compared to the other alternatives. The three land disposal facility conceptual designs (above-grade vault, enhanced near-surface trench, and intermediate-depth borehole) were selected as being representative of a range of land disposal configurations (varying degrees of waste consolidation and geometry) that could be employed for the disposal of the GTCC LLRW and GTCC-like waste inventory. As discussed in Section 1.4.2 of the EIS, each concept has been used to some degree in the United States or other countries. The same vault, borehole, and trench characteristics were considered for the disposal sites evaluated in order to compare the performance of each site's natural hydrological, geological, and meteorological properties relative to contaminant fate and transport once any engineered barriers would begin to fail. It should be emphasized that project- and site-specific engineering factors would be incorporated into the actual facility designs of the site or sites selected in a ROD to dispose of GTCC LLRW and GTCC-like wastes. Thus, comparison against specific performance criteria is premature at this time. In addition, as discussed in Section 1.4.2, the conceptual disposal facility designs analyzed in the EIS could be modified to perform better in specific locations.

L293-187 The wastes cited in the comment are not included in the GTCC LLRW waste inventory because these materials are not GTCC LLRW.

Yakama Nation Environmental Restoration Waste Management Program,
Commenter ID No. L293 (cont'd)

4. The plutonium-containing waste that was buried as transuranic waste at the US Ecology commercial low-level waste site prior to 1970.
5. Buried transuranic waste and plutonium containing waste in trenches and cribs at Hanford
6. "Immobilized Low Activity Waste" resulting from the high-level waste processing and vitrification work planned at Hanford.
7. High-level waste tanks when they are removed from the Hanford Site after the waste is removed for vitrification.
8. Soil around the high-level waste tanks that contains high-level waste that leaked from dozens of the tanks over the decades.

L293-187
(Cont.)

Section D Recommendations: Health and Environmental Impact

Recommendations

The present Draft EIS does not meet the minimum standards of transparency that would allow an independent verification of the DOE's estimates. Nor does it meet the minimum tests of estimating health and environmental impacts that would give credence to the results that claim that public health would be protected in the trench, vault, or borehole scenarios. It is also far too limited in considering a single geologic repository site, WIPP, that is limited by law to only defense transuranic waste. In other words, the Draft EIS does not meet the test of scientific integrity and a reasonable range of alternative as required by NEPA. The DOE should publish a revised Draft EIS with the following changes in the scenarios:

1. All base case scenarios should assume a complete loss of institutional control. Therefore all resident farmer and tribal scenarios should assume that there will be people residing on the disposal site rather than away from it. These residents would therefore use water from the site below the disposal layer for domestic, agricultural, and cultural purposes.
2. The revised Draft EIS should incorporate the fact of pre-existing contamination on DOE sites when it models disposal at such sites.
3. The revised Draft EIS should have at least one scenario in which the cover is completely eroded away (on the order of 1mm/year of erosion) in order to assess the effect of disposal on surface water and aquatic food contamination. Besides RESRAD default consumption, the Yakama lifestyle scenario should also be evaluated in this case.
4. The revised draft EIS should provide sound, scientific technical justification for key parameters such as the lifetime of grout and infiltration rate as well as possible future rainfall and climate variations. There has been ample work in these areas that is not reflected in the Draft EIS at present.
5. The revised Draft EIS should have a normal sensitivity analysis in which parameter variation results in dose estimates on both sides (higher and lower) of the base case.
6. A realistic assessment of the trench, vault, and borehole disposal options shows that the basic health protection and dose limits would be violated by large margins. These methods are unsuitable for disposal of GTCC and GTCC-like waste and should be explicitly rejected when the Draft EIS is revised. We

L293-188

L293-189

L293-190

L293-191

L293-192

L293-193

- L293-188 On the basis of the depth of waste disposal, DOE believes that the only reasonable potential for intrusion is from a future drilling event, such as drilling for a well. The likelihood of inadvertent intrusion from a drilling event would be very low for a GTCC near-surface disposal facility because of (1) the use of intruder barriers, (2) the remoteness of the sites, (3) DOE's commitment to long-term institutional control, (4) site conditions such as the general lack of easily accessible resources and the great depth to groundwater, and (5) waste form stability. On the basis of these considerations, DOE did not include a quantitative evaluation of this scenario in the EIS. Site-specific NEPA reviews would be conducted as needed.
- L293-189 Where significant, pre-existing contamination is considered under cumulative impacts. Pre-existing contamination at Hanford was evaluated in Section 6.4.2.
- L293-190 See responses to L293-57 and L293-135.
- L293-191 See responses to L293-42 and L293-14.
- L293-192 See response to L293-6.
- L293-193 While 10 CFR Part 61 identifies one NRC-approved method for GTCC LLRW disposal (disposal in a geologic repository), these regulations also indicate that other disposal methods could be approved. The GTCC EIS evaluates three land disposal methods (i.e., enhanced near-surface trench, intermediate-depth borehole, and above-grade vault). The GTCC EIS evaluation indicates that land disposal methods employed at sites with suitable characteristics would be viable and safe alternatives for the disposal of GTCC LLRW.

Yakama Nation Environmental Restoration Waste Management Program,
Commenter ID No. L293 (cont'd)

understand that Congress is to have its say about a preferred alternative when the Final EIS is published. But that should not prevent the DOE from clearly pointing out that some methods of disposal violate existing regulations and in the case of DOE Superfund sites, ARARs, not to speak of tribal treaty rights.

7. The doses to a resident farmer are far higher when realistic scenarios about loss of institutional control and memory are evaluated (rather than the DOE's assumption of a permanent knowledge of the site boundary). The DOE should include an onsite farmer using irrigation water from the disposal site in its trench, vault, and borehole scenarios.
8. The DOE's recognition that offsite wastes containing Tc-99 and I-129 should not be brought to Hanford for disposal should lead it to the conclusion that no GTCC or GTCC-like wastes should be brought to Hanford for a variety of reasons, including the need to develop more than one site if they are, the exacerbation of contamination at Hanford from other wastes that would be brought in, the need, in fact to remove existing wastes from Hanford in order to meet drinking water standards and other ARARs, etc.
9. The DOE should calculate organ as well as total body effective doses. This will enable an evaluation of the degree to which disposal methods comply with dose limits in existing regulations such as the drinking water standards (40 CFR 141.66) and the low-level waste rule (10 CFR 61 Subpart C).
10. The DOE should consider at least one deep geologic repository other than WIPP as one of the alternatives.

L293-193
(Cont.)

L293-194

L293-195

L293-196

L293-197

L293-194 See response to L293-98.

L293-195 See response to L293-2.

L293-196 See response to L293-180.

L293-197 See response to L293-24.

L293-198 This section is an elaboration on the preceding comments, L293-178 through L293-193. The responses to the preceding comments adequately address issues raised in this section. More detailed information on specific issues can also be found in the responses to comments L293-1 through L293-177.

A. DOE's responses to some public comments on scope

The DOE has not given a satisfactory response to a number of public comments regarding the scope and nature of the alternatives to be considered and the manner in which they should be evaluated. The response to some of the key comments on the scope is non-responsive enough to warrant revision of the draft and republication of a new draft for public comment.

1. *The DOE has considered no alternative for deep geologic disposal other than the Waste Isolation Pilot Plant (WIPP)*

Section 1.5.2 of the Draft EIS³ states that

DOE does not plan to evaluate an additional deep geologic repository facility because siting another deep geologic repository facility for GTCC LLRW and GTCC-like waste would be impractical due to the cost and time involved and the relatively small volume of GTCC LLRW and GTCC-like waste.

WIPP is presently restricted by law to defense transuranic waste. Yet, almost all the radioactivity in the source term, as defined by DOE in the Draft EIS, is commercial GTCC. There is no guarantee that Congress would enact a law to accommodate GTCC and GTCC-like waste at WIPP. A number of commenters, including IEER, had asked that WIPP be ruled out, in part for this reason. We understand that the DOE can ask for the law to be changed and that Congressional action will be required prior to

L293-198

³ Draft EIS Section 1.5.2 (pp. 1-43 to 1-45) is called: Comments Determined to be Outside EIS Scope.

Yakama Nation Environmental Restoration Waste Management Program,
Commenter ID No. L293 (cont'd)

actual final selection of a preferred alternative. However, it is essential that a repository other than WIPP also be evaluated, since WIPP is restricted by law to defense waste and since deep geologic disposal is the option with the lowest long-term radiological impacts. Moreover, the DOE did not compare the cost and time for creating a new repository with that of expanding WIPP. Finally, the Blue Ribbon Commission on America's Nuclear Future (BRC) may consider an option of a repository for defense high-level waste separate from a commercial spent fuel repository. While WIPP may eventually be considered for such a mission, we note that the BRC is not going to recommend any specific sites for any waste. A new site would therefore also be among the options for defense high-level waste. That site could also accommodate GTCC and GTCC-like waste, a number of other "orphan" wastes, like large amounts of depleted uranium from enrichment plants and recycled uranium from the nuclear weapons complex (see below). Congressional action would be required in all of these cases.

Recommendation: A revised draft EIS should be published that includes a deep geologic repository alternative other than WIPP.

2. *The DOE has rejected Hardened On Site Storage (HOSS) of GTCC without an adequate analysis.*

In Section 1.5.2 (p. 1-43) of the Draft EIS, the DOE states that it did not consider HOSS because the GTCC EIS process is about "permanent disposal" and on site storage does "not meet the purpose and need for agency action." While we recognize that HOSS is not a permanent disposal option, HOSS could be a complement to permanent disposal, especially for commercial GTCC generated by the decommissioning of reactors, which accounts for about 98 percent of the radioactivity considered in the Draft EIS. Onsite storage of reactor decommissioning GTCC for 60 years would greatly decrease the total amount of radioactivity relative to that estimated by the DOE at disposal time (six years after reactor shut down). This is because the vast majority of the radioactivity in reactor decommissioning GTCC consists of relatively short-lived radionuclides such as manganese-54, iron-55, cobalt-60, and others. At the end of 60 years of storage after reactor shut down, this portion of the radioactivity would have decayed away almost totally.⁴ Much of it also decays after the six years of storage assumed by the DOE. However, the radioactivity remaining at 60 years after storage is only about 11 percent of that at six years. That remaining at 30 years is about 15 percent of that at six years after reactor shutdown.⁴ This decrease in radioactivity would therefore also greatly reduce the largest source of decay heat in the overall GTCC and GTCC-like source term that the DOE has considered in the Draft EIS. It would also greatly reduce the total GTCC and GTCC-like source term to be disposed of.

Onsite storage of commercial GTCC from reactor decommissioning would add little to the cost of the decommissioning of reactor sites, in view of the cancellation of the Yucca Mountain Project. Commercial spent fuel will likely have to be stored on site for decades. While the BRC is considering an option of consolidated storage, the practical failure of the Private Fuel Storage Project in Utah⁵ to

⁴ Calculated by applying the decay constants of the eight most important radionuclides (carbon-14, manganese-54, iron-55, nickel-59, nickel-63, cobalt-60, molybdenum-93, and niobium-94) to the inventory at 6 years and 60 years. See Appendix C (begins at pdf p. 254) of J. Schelling, C. D. Leigh, et al., *Supporting Nuclear Utility Inventory Estimates for the Greater-Than-Class-C Low-Level Radioactive Waste Environmental Impact Statement Evaluations*. This document is available as Appendix H (begins at pdf p. 226) in *Basis Inventory for Greater-than-Class-C Low-Level Radioactive Waste Environmental Impact Evaluations, Rev 1*, Sandia National Laboratories, May 2008, on the Web at http://www.gtccels.anl.gov/documents/docs/Task_3_2_Revision_1_FINAL.pdf. Also see Table 4 (p. 16) of this main document.

⁵ The project failed in practice to create a storage site even though the federal legal formalities of obtaining a license from the Nuclear Regulatory Commission were successfully completed.

L293-198
(Cont.)

Yakama Nation Environmental Restoration Waste Management Program,
Commenter ID No. L293 (cont'd)

actually open even after obtaining a license from the Nuclear Regulatory Commission (NRC) is an indication that onsite storage of spent fuel is the most likely outcome for the foreseeable future. Even if the storage period is not 60 years, a storage period of just half that would still eliminate by decay almost 94 percent of the radioactivity in the entire GTCC and GTCC-like source term.

Finally, the DOE needs to evaluate the cost impact of a combined onsite storage approach for 30 to 60 years followed by disposal with the option of no onsite storage beyond the six years delay between reactor shutdown and waste disposal now envisioned in the Draft EIS.

Recommendation: The EIS should include an alternative that combines hardened on site storage of commercial reactor decommissioning GTCC for 30 to 60 years combined with disposal.

3. *The Draft EIS has essentially dismissed without analysis the comments made on the implementation plan that it should address the issue of doses and cancer risks to women and children and risks during in utero exposure (p. 1-44 to 1-45). The Draft EIS has also not considered non-cancer risks in utero and to children.*

IEER had made the following recommendation in its comments on the implementation plan:

The BEIR VII report of the National Research Council concluded that females face a much higher overall risk than males and that children face higher risks than adults. The risk factors for cancer incidence, by sex and age, published in BEIR VII should be used to estimate risks in the GTCC EIS. Non-cancer risks considered in the BEIR VII report should also be evaluated. If any EPA guidance is used it should be EPA Federal Guidance Report 13, and not Federal Guidance Report 11.

We note here that external dose risk factors FGR 13 (and FGR 12) are explicitly based on Reference Man, a hypothetical young "Caucasian" male. The EIS should explicitly reject this model. Dose estimates should be made for the most vulnerable – that is, those most at risk for a given exposure. It is critical in this area therefore to use the BEIR VII report especially for external dose estimates, since it does not suffer from this limitation.

Recommendation: Radiation dose calculations should include separate estimates of doses to males and females in various ages groups from infant on up. Cancer risks should be based on the results of the BEIR VII report. All cancer risks should consider incidence as well as mortality. Non-cancer risks should also be considered.⁶

The Draft EIS contains what is essentially a non-response and continues to use Reference Man:

The concerns with regard to the increased sensitivity of various elements of the population are noted. The EIS presents a comparative analysis of the potential radiation doses and LCF [latent cancer fatalities] risks to members of the general public (as represented by an adult receptor) from use of the various disposal alternatives presented in the NOI. As such, the level of detail requested here is not necessary for the purposes of this EIS, and the hazards associated with management of these wastes are

⁶ Makhijani 2007 p. 10

L293-198
(Cont.)

**Yakama Nation Environmental Restoration Waste Management Program,
 Commenter ID No. L293 (cont'd)**

presented in terms of the annual dose and LCF risk to a potentially exposed adult receptor.

The estimates for dose and LCF risk were based on a resident farmer receptor, which is considered a conservative scenario that accounts for the largest number of pathways of potential exposure. The primary pathway of concern, however, is the ingestion of groundwater potentially contaminated with radionuclides released from wastes at the proposed disposal facility. The estimated dose and LCF risk to an adult receptor presented in the EIS are considered conservative (relative to any other potential receptor) because the ingestion rate assumed for water intake is the 90th percentile value for the general public recommended by the EPA (i.e., two liters per day for 365 days per year) (EPA 2000).

Follow-on NEPA evaluations will be conducted, as needed, to assess potential human health impacts on a site-specific basis (accounting for sensitive populations as applicable) when a disposal site or location is identified.

The continued use of an adult male resident farmer is not responsive to the comment at all. The comment that the DOE is using a 90th percentile value for water intake does not compensate for the added doses and risks faced by children even when lower intakes for the latter are taken into account. For instance, the table below shows that the risks for infants and five-year old female children are considerably higher than female 30-year-olds even when lower intakes by children are taken into account. For instance, the risk of breast cancer for a female child is more than 20 times greater than for an adult female, for the same level of environmental contamination. The differential between female children and men is even greater than shown in Table 1.

Table 1: Lifetime cancer incidence risk for exposure at stated age, fluid ingestion, females only (fluid intakes adjusted for age)

Cancer	Radionuclide	Infant Risk/Bq	Age 5 Risk/Bq	Age 30 Risk/Bq	Overall Risk Ratio Infant/Age 30 (Note 1)	Overall Risk Ratio Age 5/Age 30 (Note 1)
Leukemia	Sr-90	2.79E-08	3.06E-09	1.13E-09	6.2	1.7
Breast	Sr-90	1.38E-09	2.60E-10	1.68E-11	20.6	10.0
Thyroid	I-131	2.32E-07	8.63E-08	1.77E-09	32.8	12.2

Notes: 1. Fluid intakes for females assumed as follows: infant = 350 cc per day, 5-year old = 900 cc/day; 30-year-old = 1,400 cc/day. The fluid intake figures for children were computed at 50 cc/day/kilogram of weight, using mean weights for the United States. These are total fluid intakes, including, but not limited to, water. 2. Bq = Becquerel.

Source: Adapted from Makhijani, Smith, and Thorne, *Science for the Vulnerable*, Institute for Energy and Environmental Research, 2006, p. 40, on the web at <http://www.ieer.org/campaign/report.pdf>.

The DOE and all federal agencies are required to take into account the higher sensitivity of children. Indeed, the explicit failure to do so and the explicit reliance on an adult receptor are arguably in violation of the Executive Order on Children. Specifically, Executive Order 13045, *Protection of Children From Environmental Health Risks and Safety Risks*, states:⁷

⁷ William J. Clinton, "Executive Order 13045 – Protection of Children From Environmental Health Risks and Safety Risks," *Federal Register*, v. 62, no. 78 (April 23, 1997), pp. 19883-19888. On the Web at <http://www.epa.gov/fedrgstr/eo/eo13045.pdf>, p. 19885. Emphasis added.

L293-198
(Cont.)

Yakama Nation Environmental Restoration Waste Management Program,
Commenter ID No. L293 (cont'd)

A growing body of scientific knowledge demonstrates that children may suffer disproportionately from environmental health risks and safety risks. These risks arise because: children's neurological, immunological, digestive, and other bodily systems are still developing; children eat more food, drink more fluids, and breathe more air in proportion to their body weight than adults; children's size and weight may diminish their protection from standard safety features; and children's behavior patterns may make them more susceptible to accidents because they are less able to protect themselves. Therefore, to the extent permitted by law and appropriate, and consistent with the agency's mission, each Federal agency:

(a) shall make it a high priority to identify and assess environmental health risks and safety risks that may disproportionately affect children;

and

(b) shall ensure that its policies, programs, activities, and standards address disproportionate risks to children that result from environmental health risks or safety risks.

It is clear from the phrases in we have put in bold in the above quote that the DOE is both required to identify risks that disproportionately affect children and to ensure that its programs and actions address any disproportionate risks. It is also clear from Table 1 above that disproportionate risks to children do exist, even when female children are compared to female adults. The difference is much greater when female children are compared to male adults. As a result, the Draft EIS's failure to explicitly estimate doses and risks to children fails to even minimally meet the requirements of Executive Order 13045.

L293-198
(Cont.)

Recommendation: A revised draft EIS should be published that explicitly addresses cancer risks to children and especially female children, to estimate whether the proposed disposal methods meet the standards for public health protection in existing regulations, notably Subpart C of 10 CFR 61.⁸ In light of Executive Order 13045, the DOE should also consider non-cancer risks in utero and non-cancer risks to children.

4. *The Draft EIS has not included depleted uranium from enrichment plants in its source term.*

IEER provided an extensive factual, regulatory, and analytical basis in its comments on the implementation plan that depleted uranium from enrichment plants should be included as part of the GTCC and GTCC-like source term for this EIS. IEER also provided analysis indicating that the DU from enrichment plants was unsuitable for shallow land burial, which could not meet 10 CFR 61 Subpart C

⁸ United States. Nuclear Regulatory Commission. *Code of Federal Regulations. Title 10 – Energy: Chapter I – Nuclear Regulatory Commission; Part 61 – Licensing Requirements for Land Disposal of Radioactive Waste. 1-1-11 Edition.* Washington, DC: Office of the Federal Register, National Archives and Records Administration; U.S. Government Printing Office, 2011. On the Web at <http://www.gpo.gov/fdsys/pkg/CFR-2011-title10-vol2/pdf/CFR-2011-title10-vol2-part61.pdf>.

Yakama Nation Environmental Restoration Waste Management Program,
Commenter ID No. L293 (cont'd)

health protection criteria.⁹ The Draft EIS has not addressed any of the substance of the comments, in effect ignoring them altogether.

Further, the analysis provided by IEER clearly fits into DOE's own definition of GTCC-like waste in the Draft EIS:

GTCC-like waste refers to radioactive waste that is owned or generated by DOE and has characteristics sufficiently similar to those of GTCC LLRW such that a common disposal approach may be appropriate. GTCC-like waste consists of LLRW and potential non-defense-generated TRU waste that has no identified path for disposal. The use of the term "GTCC-like" is not intended to and does not create a new DOE classification of radioactive waste.¹⁰

The vast majority of DU from the three gaseous diffusion plants was generated by the DOE and is owned by it. IEER showed that it has characteristics sufficiently similar to GTCC for it to be disposed of in the same manner. For instance, its long-lived alpha-emitting specific activity is well over 100 nanocuries per gram, which is the threshold for GTCC in 10 CFR 61.55. It has no identified path for disposal at the present time. The DOE was required by law to address comments substantively. This comment is a very important one in terms of the scope of the GTCC EIS, the health impact of GTCC and GTCC-like low-level waste, and cost. It is therefore imperative that DOE revise and republish its Draft EIS for public comment to include DU from past, existing, and proposed enrichment plants for technical, environmental, and legal considerations.

Recommendation: A revised draft EIS should be published that explicitly includes depleted uranium from enrichment plants as GTCC-like EIS. This should include both existing stocks of DU at DOE sites as well as stocks of DU anticipated from the centrifuge enrichment plant that has been licensed and operating in New Mexico and the one likely to be operational in the future in Idaho.

B. Standards to be applied for performance assessment

The DOE is charged with the responsibility for providing alternatives for disposal of GTCC (and GTCC-like) waste under the general framework of the NRC's low-level waste rule 10 CFR 61.

In 10 CFR Part 61, "Licensing Requirements for Land Disposal of Radioactive Waste," the NRC classifies LLRW into four classes (Classes A, B, and C, and GTCC LLRW) on the basis of the concentrations of short-lived and long-lived radionuclides (10 CFR 61.55). By controlling isotope concentrations in each class, the NRC regulations seek to control potential radiation exposures to future receptors, including inadvertent human intruders (e.g., a water well driller) after the period of active institutional control has ended. The NRC states in 10 CFR 61.55 that GTCC LLRW is not "generally acceptable" for near-surface disposal, although the NRC recognizes in 10 CFR 61.7(b)(5) that "there may be some instances where waste with concentrations greater than permitted for Class C

⁹ Makhijani 2007 pp. 3 to 8

¹⁰ Draft EIS v. 1, p. 1-1

L293-198
(Cont.)

Yakama Nation Environmental Restoration Waste Management Program,
Commenter ID No. L293 (cont'd)

waste would be acceptable for near surface disposal with special processing or design."¹¹

What is "acceptable" and "not acceptable" for disposal under 10 CFR 61 is primarily defined by whether the disposal meets the health protection criteria specified in terms of maximum dose in 10 CFR 61 Subpart C, which states in part:

§ 61.40 General requirement.

Land disposal facilities must be sited, designed, operated, closed, and controlled after closure so that reasonable assurance exists that exposures to humans are within the limits established in the performance objectives in §§ 61.41 through 61.44.

§ 61.41 Protection of the general population from releases of radioactivity.

Concentrations of radioactive material which may be released to the general environment in ground water, surface water, air, soil, plants, or animals must not result in an annual dose exceeding an equivalent of 25 millirems to the whole body, 75 millirems to the thyroid, and 25 millirems to any other organ of any member of the public. Reasonable effort should be made to maintain releases of radioactivity in effluents to the general environment as low as is reasonably achievable.

The rule also requires that the health of inadvertent intruders also be protected but does not explicitly provide a dose limit:

§ 61.42 Protection of individuals from inadvertent intrusion.

Design, operation, and closure of the land disposal facility must ensure protection of any individual inadvertently intruding into the disposal site and occupying the site or contacting the waste at any time after active institutional controls over the disposal site are removed.

It is important to note that no time limit for the protection of the health of the public is specified in 10 CFR 61.

All disposal of low-level waste under 10 CFR 61, whatever its class, must meet these health protection criteria. Despite these very clear rules, the Draft EIS does not use 10 CFR 61 Subpart C as the basic criterion for deciding whether a disposal method is acceptable. For instance, while 10 CFR 61.41 requires the calculation of organ doses, the Draft EIS does not provide any estimates of organ doses. It does not eliminate options that exceed 10 CFR 61.41 dose limits even in terms of whole body effective dose equivalents.

Further, at sites such as Hanford, which are Superfund (CERCLA) sites, the DOE is required to meet other regulatory criteria that go under the collective rubric of Applicable or Relevant and Appropriate Requirements (ARARs). These include groundwater protection to drinking water standards and Superfund standards that limit the cancer risk from residual contamination to the range of 10^{-4} to 10^{-6} , that is, between one in ten thousand and one in a million.¹²

¹¹ Draft EIS v. 1, p. 2-59

¹² The CERCLA (or Superfund) remediation standard is at 40 CFR 300.430. <http://edocket.access.gpo.gov/cfr/2010/julatr/pdf/40cfr300.430.pdf>. The risk limit is specified at 40 CFR

Yakama Nation Environmental Restoration Waste Management Program,
Commenter ID No. L293 (cont'd)

The Draft EIS does not discuss ARARs for CERCLA sites. Specifically, the EPA defines a 15 millirem per year dose as being acceptable, even though it acknowledges that it exceeds the 10^{-4} lifetime cancer risk specified in the CERCLA regulation.²³ However, the EPA's risk coefficient of 0.000575 fatal cancers per rem for low-level radiation²⁴ equals a dose limit of about 3 millirem per year to meet the 10^{-4} risk limit. None of the approaches for disposal studied for Hanford meet this 3 millirem/year criterion of 10^{-4} lifetime cancer risk even if it is interpreted as fatal cancer risk and not cancer incidence risk and even if the DOE's estimates of doses are accepted. Specifically, the DOE calculates the annual doses for borehole, trench, and vault disposal as 4.8, 48, and 49 millirem respectively. As is shown in Appendix A and also discussed below, the borehole result is an artifact of selecting a resident 100 meters away from the site boundary, even thousands of years into the future, effectively assuming institutional control for unprecedented periods against historical evidence, against the assumption of maximum institutional control of 100 years in 10 CFR 61, and against the best prevailing scientific judgment that institutional control should not be assumed for more than about 100 years. Specifically, 10 CFR 61.59(b) specifies that "institutional controls may not be relied upon for more than 100 years following transfer of control of the disposal site to the owner." Placing a resident farmer on the site itself, since institutional control cannot be assumed for thousands of years, is the appropriate approach to estimating long-term doses and health effects. The DOE has not done this for any scenario. The doses in such a case would be much higher, as illustrated in Section III of Appendix A.

Finally, it is essential to take treaty compliance issues into account. An assumption of institutional control for thousands of years does not fulfill this criterion.

Recommendations: The DOE should apply the criteria of 10 CFR 61.41 for assessing whether a site and disposal method meets minimal disposal criteria. It is essential to calculate organ doses and to do so for the age and gender that would be the most exposed for a given set of environmental conditions. For CERCLA sites, like Hanford, ARARs, including radionuclide drinking water MCLs and a lifetime cancer risk of at most one in 10,000, need to be maintained. The DOE should also take treaty compliance into account through use of appropriate scenarios and by assuming that institutional controls will end when DOE site cleanup is completed. Sites and disposal methods that do not meet these criteria should be ruled out. Hanford does not meet the criteria for any disposal method and should be ruled out as a disposal site for GTCC and GTCC-like waste. The Draft EIS should be reissued for public comment with the changes in this set of recommendations since the failure to use the appropriate standards and ARARs as reference points is a fundamental analytical and legal problem. The Draft EIS as it stands gives the false impression that the choices of sites and disposal approaches are much wider than they are if reasonable existing health and environmental standards are applied.

L293-198
(Cont.)

300.430(e)(2)(i)(A)(2).) It should be noted that the range is for the combination of chemicals and radionuclides. It is discussed here assuming no carcinogenic chemicals are present.

²³ Stephen D. Luftig (Office of Emergency and Remedial Response) and Larry Weinstock (Office of Radiation and Indoor Air). *Establishment of Cleanup Levels for CERCLA Sites with Radioactive Contamination*. (OSWER No. 9200.4-18) Washington, D.C.: Environmental Protection Agency, Office of Solid Waste and Emergency Response, August 22, 1997. On the Web at <http://www.epa.gov/superfund/health/contaminants/radiation/pdfs/radguide.pdf>.

²⁴ Keith F. Eckerman, Richard W. Leggett, Christopher B. Nelson, Jerome S. Puskin, Allan C.B. Richardson. *Cancer Risk Coefficients for Environmental Exposure to Radionuclides: Radionuclide-Specific Lifetime Radiogenic Cancer Risk Coefficients for the U.S. Population, Based on Age-Dependent Intake, Dosimetry, and Risk Models*. (Federal Guidance Report No. 13) (EPA 402-R-99-001) Oak Ridge, TN: Oak Ridge National Laboratory; Washington, DC: Office of Radiation and Indoor Air, United States Environmental Protection Agency, September 1999, on the web at <http://www.epa.gov/radiation/docs/federal/402-r-99-001.pdf>, p.179.

Yakama Nation Environmental Restoration Waste Management Program,
Commenter ID No. L293 (cont'd)

C. Source terms that are not, but should be, included in a revised Draft EIS

A number of source terms that should be included in the GTCC-like definition because they do not meet the health criteria of 10 CFR 61 or other ARARs for Hanford:

1. Depleted uranium from enrichment plants,
2. Recycled uranium, including the recycled uranium in the DOE complex and that generated from operations at West Valley,
3. Hanford reactor graphite moderator blocks,
4. The plutonium-containing waste that was buried as transuranic waste at the US Ecology commercial low-level waste site prior to 1970,
5. Buried transuranic waste and plutonium containing waste in trenches and cribs at Hanford,
6. "Immobilized Low Activity Waste" resulting from the high-level waste processing and vitrification work planned at Hanford,
7. High-level waste tanks when they are removed from the Hanford Site after the waste is removed for vitrification,
8. Soil around the high-level waste tanks that contains high-level waste that leaked from dozens of the tanks over the decades.

At present DOE plans to dispose of source terms numbers 3 to 8 in the list above in shallow land burial facilities on the Hanford Central Plateau, notably the Integrated Disposal Facility (East and/or West) and the Environmental Restoration Disposal Facility (ERDF) or to leave them in place where they are now. Yet, the DOE's own calculations show that its plans for the disposal of existing Hanford wastes related to remediation, as well as waste migration from past disposal practices, will result in violation of the drinking water levels by hundreds or even thousands of times to periods extending out hundreds or even thousands of years. While we recognize that variances from CERCLA ARARs are possible, such variances would result in a violation of the treaty rights of the Yakama Nation to unrestricted exercise of hunting, fishing, and gathering and other activities on the area now taken up by DOE Hanford facilities. Moreover, the DOE has not shown that retrievable storage of remediation wastes from Hanford with future disposal in a suitable deep geologic repository is not an option. Variances should not be given when there are viable alternatives to meet the ARARs. Indeed, given the threats to the most important surface water resource in the Northwest, deep disposal may well be the most attractive option, especially in combination with retrieval and similar disposal of wastes that have been disposed of in the past in ways that would not be acceptable today (such as discharge of plutonium-laden liquids to cribs and trenches). When there are not viable technologies available, a research and development program should be initiated.

We have already discussed the reasons for not disposing of the wastes listed in items 6 to 8 in the above list in IEER comments on the Tank Closure and Waste Management Draft EIS for the Hanford Site¹⁵ and will not repeat them here. The rationale for including the other items in the GTCC EIS and designating them for deep geologic disposal is outlined here.

¹⁵ See Attachment 3 to the letter from Harry Smislin, Chairman, Yakama Tribal Council to David A. Brockman, Manager, Richland Operations Office, U.S. Department of Energy and Mary Beth Burandt, Document Manager, Office of River Protection, U.S. Department of Energy, March 19, 2010.

L293-198
(Cont.)

Yakama Nation Environmental Restoration Waste Management Program,
Commenter ID No. L293 (cont'd)

1. Depleted uranium

This is covered extensively in the IEER's comments on the implementation plan cited above. None of the facts or analysis have changed. The Draft EIS ignored both the facts and the analysis. The only thing that has changed is that the source term is likely to be bigger, since a new enrichment plant had begun operating since those comments were sent and at least one other new plant will be built. Table 2 shows the expected source term for depleted uranium from enrichment plants:

Table 2: Depleted uranium source term from past and future enrichment plant operations

	Current/Projected	Metric tons	Cubic meters	Curies
DOE complex	Current	5.58E+05	6.72E+04	1.90E+05
LES (NM)	Projected	3.09E+05	3.72E+04	1.05E+05
Areva (ID)	Projected	3.46E+05	4.16E+04	1.17E+05
Total	Current and Projected	1.21E+06	1.46E+05	4.12E+05

Source: Estimated by IEER from various sources.

2. Recycled Uranium

Recycled uranium has a higher specific activity than depleted uranium. It can range from 400 nanocuries per gram to over 1,000 nanocuries per gram depending on the enrichment level of the uranium (from depleted to slightly enriched). There are about 250,000 metric tons (13,200 cubic meters) of recycled uranium in various degrees of enrichments located at various sites of the DOE complex.¹⁸ If the average activity is assumed to be 1,000 nanocuries per gram, then the number of curies is 250,000, which is somewhat greater than the historical source term of 190,000 curies for depleted uranium from the three DOE complex gaseous diffusion enrichment plants (see the first row of numbers in Table 2 above). The same scientifically based arguments made above for classifying depleted uranium as TRU waste hold *a fortiori* for recycled uranium (RU). That is to say, the specific activity for long-lived alpha-emitting radionuclides of RU is higher and, in addition, recycled uranium contains transuranic radionuclides (mainly plutonium isotopes and neptunium-237) and fission products (mainly technetium-99) that add to its radiotoxicity.

3. Hanford single pass reactor graphite moderator blocks

The DOE has proposed to dispose of the graphite moderator blocks of the single pass reactors in the shallow land disposal sites on the Hanford Central Plateau. This is entirely inappropriate for regulatory and environmental reasons.

About 5,700 cubic meters of graphite moderator blocks from the eight plutonium producing plants contain, all together, 37,000 curies of carbon-14. IEER's calculation shows that this waste is slightly under GTCC in terms of its concentration of radioactivity per cubic meter of waste. Yet, if buried at

¹⁸ United States. Department of Energy. *A Preliminary Review of the Flow and Characteristics of Recycled Uranium throughout the DOE Complex 1952-1999, Project Overview and Field Site Reports.* (F-001-001) DOE, March 2001. p. 8.

L293-198
(Cont.)

Yakama Nation Environmental Restoration Waste Management Program,
Commenter ID No. L293 (cont'd)

Hanford and the carbon-14 reaches the groundwater, its concentration would well exceed the drinking water standards. The DOE's own estimate of carbon-14 contamination due to its disposal practices at ERDF is that the peak concentration will reach 1.3 million picocuries per liter about 520 years from now at the ERDF boundary.¹⁷ The drinking water standard is 2,000 picocuries per liter by DOE's calculation.¹⁸ Hence, according to DOE's own calculation the drinking water limit would be exceeded by 650 times 520 years from the present – well after the loss of institutional control. Moreover, the concentrations would be much greater than the drinking water limit for considerable periods before and after the estimated peak in about the year 2630.

A significant portion of the carbon-14 would likely be oxidized over the long-term since shallow land burial implies oxidizing conditions. If only half of the total is oxidized, about 18,500 curies of carbon-14 dioxide would be released to the atmosphere. This would be larger than the entire carbon-14 source term from all existing reactors from a geologic repository permitted under 40 CFR 191, the EPA rule that applies to all geologic repositories except Yucca Mountain. The permitted amount is 100 curies per 1,000 metric tons of heavy metal. Roughly 100,000 to 120,000 metric tons are to be expected from the operation of existing commercial reactors, which would mean a maximum permitted release of 10,000 to 12,000 curies of carbon-14 in the form of carbon-14 dioxide.

Indeed, it is important to remember in this context that a large, possibly central, part of the reason that Congress asked the National Academies to create a special standard for Yucca Mountain is because the EPA Science Advisory Board concluded that an oxidizing repository environment (like Yucca Mountain) may release carbon-14 in excess of the allowable one-tenth of the EPA estimated inventory and, by implication, that such a repository may not meet the carbon-14 emission part of 40 CFR 191.¹⁹

While it is difficult to calculate the emissions of carbon-14 from spent fuel disposed of in a deep geologic repository due to the many complex barriers to release and the complex physical and chemical pathways between the disposal location in an engineered deep geologic repository and the atmosphere, it is much less complicated to understand that a substantial fraction of the carbon-14 disposed of in shallow land burial under oxidizing conditions would be oxidized and released relatively rapidly to the atmosphere. Assuming half of the graphite block inventory is released, the total release to the atmosphere would be 18,500 curies. This would result in very small individual radiation doses – on the

L293-198
(Cont.)

¹⁷ United States. Department of Energy. *Remedial Investigation and Feasibility Study Report for the Environmental Restoration Disposal Facility.* (DOE/RL 93-99 rev.1) Richland, WA: DOE Richland Operations Office, October 1994. On the Web at

http://www5.hanford.gov/pdw/fisd/AR/FSD0001/FSD0047/D196061256/D196061256_58632036_76907_802.pdf. Table 4-10 (pp. 4T-10c to 4T-10d)

¹⁸ Drinking water standards for man-made beta and photon emitters, except tritium and strontium-90 are calculated assuming a 4 millirem per year maximum organ or whole body effective dose equivalent (whichever is greater) and a 2 liter daily intake of water by an adult. A list of "Benchmark Concentrations," which are equivalent to federal primary drinking water maximum contaminant levels (MCLs), is given in TC&WM Draft EIS Table O-4 (Appendix O, v. 2, p. O-31). The concentrations are derived from the drinking water annual dose limit of 4 mrem for man-made beta and photon emitters (except tritium and strontium-90) as specified in 40 CFR 141.66.

¹⁹ The Science Advisory Board concluded that the uncertainties in modeling the release were very large and that the release could range from essentially zero to the entire inventory of C-14. The inventory itself was deemed to be somewhat uncertain. The EPA's estimate of inventory was 1 curie per metric ton. (United States. Environmental Protection Agency, Science Advisory Board, *An SAB Report : Review of Gaseous Release of Carbon-14 : Review, by the Radiation Advisory Committee, of the Release of Carbon-14 in Gaseous Form from High-Level Waste Disposal*, (EPA-SAB-RAC-93-010) EPA, April 1993. Hereafter cited as SAB 1993.)

Yakama Nation Environmental Restoration Waste Management Program,
Commenter ID No. L293 (cont'd)

order of ten microrem per person per year²⁰) since the carbon-14 dioxide would be dispersed throughout the troposphere. Some of it would remain in the air and some would mix into the oceans. The collective doses to the global population over 10,000 years (less than two half lives of carbon-14) would be high.

Using the parameter of 400 person-rem per curie of carbon-14 dioxide (used by the EPA Science Advisory Board in its estimates²¹) the cumulative dose over 10,000 years would be on the order of 7.4 million rem. The BEIR VII risk factor for cancer incidence is 1.1 cancers per 1,000 person-rem of population dose. This means that 7.4 million person-rem would lead to more than 8,000 cancers globally. This is a very tiny fractional increase in the cancer rate that would not be detectable by any known technique; nonetheless it is a cumulatively large absolute number due to the long-half life of carbon-14 (5,730 years) and the fact that carbon-14 dioxide is chemically identical to non-radioactive ordinary carbon dioxide and as such is taken up by plants for their growth. About half of these cancers – over 4,000 – can be expected to be fatal.

In addition, the lifetime cancer incidence risk from drinking water contaminated with carbon-14 to 1.3 million picocuries per liter to a resident farmer would be about 1 in 10. That is, about 10 percent of a population of resident farmers would get cancer from consuming the water on site over a lifetime, without even taking into account the non-cancer risks associated with the fact the carbon-14 became organically bound and part of the food chain if the water is used for irrigation. One of every two such cancers would be fatal. According to the scaling factors developed by Argonne National Laboratory for the Draft EIS, the dose (and hence risk) from carbon-14 would more than double when all other pathways, including food grown with contaminated water, are taken into account. Note that Argonne assumed that just half the food came from the site, instead of all of it.²² Overall therefore, one in every five people living a quasi-resident farmer lifestyle. All together, the lifetime cancer incidence risk to a resident farmer from both drinking water and diet would be more than one in five – over 2,000 times higher than the maximum allowable cancer risk of 10⁻⁴ under CERCLA. It would be more than 1,000 times the maximum CERCLA risk if that risk is interpreted as fatal cancer risk and not cancer incidence risk.

Finally, the Wigner energy stored in the graphite blocks could be released during handling, processing, and transport and cause a fire. This will require particular care regardless of the option chosen for disposal. But it causes a special problem for shallow land burial. Specifically, the low-level waste rule stipulates at 10 CFR 61.56(a)(6) that "[w]aste must not be pyrophoric. Pyrophoric materials contained in waste shall be treated, prepared, and packaged to be nonflammable." The DOE has no proposed method to make the graphite nonflammable before disposal.

In sum, a number of scientific, regulatory, environmental, and health considerations lead to the conclusion that the disposal of Hanford graphite moderator blocks in shallow land facilities, including vaults and boreholes, would be inappropriate. It is therefore reasonable and appropriate to consider the Hanford graphite moderator blocks as GTCC-like waste and to prepare them for deep geologic

²⁰ SAB 1993 p. 21 (where the dose is given as 0.01 mrem = 10 microrem).

²¹ SAB 1993 p. 21

²² Argonne National Laboratory, Environmental Science Division, *Post-Closure Performance Analysis of the Conceptual Disposal Facility Designs at the Sites Considered for the Great-than-Class-C Environmental Impact Statement*, (ANL/EVS/R-10/8), ANL, October 2010, on the Web at http://www.gtcceis.anl.gov/documents/docs/ANL_EVS_R-10_8.pdf. See Appendix C, p. 150 and Table C-1.

L293-198
(Cont.)

Yakama Nation Environmental Restoration Waste Management Program,
Commenter ID No. L293 (cont'd)

disposal where the fractional release of carbon-14 would be very small or even essentially zero if the site is well-selected.

4. The plutonium-containing waste that was buried as transuranic waste at the US Ecology commercial low-level waste site prior to 1970.

Prior to 1970 plutonium containing wastes were disposed of as low-level waste without particular regard to the specific activity of the transuranic alpha-emitting radionuclides in them. In 1970s the category of TRU waste was defined as that containing more than 10 nanocuries per gram of long-lived alpha-emitting radionuclides. The limit of 10 was raised to 100 in the 1980s.

One of the problems with US Ecology waste containing significant concentrations of transuranic radionuclides is that the batches of waste with concentrations more than 100 nanocuries per gram can no longer be segregated from those below that limit. Hence, one reasonable approach is to recover the entire TRU buried waste from the US Ecology site and treat it as TRU waste to be disposed of in a geologic repository. Since this is waste in a commercial site, it would then be an additional type of GTCC-like waste at least for the portion that was more than 100 nanocuries per gram. Since it is not now segregable, it should all be treated as TRU waste for recovery and deep geological disposal, especially since it will exacerbate the violation of drinking water limits and other ARARs at the site due to the other transuranic wastes disposed of on site in the early decades.

Specifically, the issue of transuranic contamination of the groundwater on the Central Plateau and in the longer term, the River Corridor, due to US Ecology operations, should not be seen in isolation from the other transuranic waste that the DOE treats as already disposed of or the plans of the DOE described in the Tank Closure and Waste Management Draft EIS (cited here as TC&WM Draft EIS). That EIS shows that the plutonium contamination from non-tank sources will contaminate water to greater than the drinking water limit far into the future. The drinking water limit for plutonium-239 is 15 picocuries per liter, in the absence of other alpha-emitting radionuclides such as radium-226 and americium-241.

In the TC&WM Draft EIS, the DOE estimated that the peak concentration of plutonium in the River Corridor would occur in the year 2983 – that is more than eight centuries from the present; that level would be 4,250 picocuries per liter,²³ or more than 280 times the drinking water standard. The plutonium would be migrating from the Central Plateau, where the US Ecology site is located with its estimated 140 kilograms of plutonium.²⁴ In addition, other radionuclides like iodine-129 and strontium-90 would also exceed the drinking water limit for considerable periods.

These facts point to a very different remediation approach for Hanford than assuming buried plutonium contaminated wastes to be already disposed of and therefore requiring no further action. The designation of US Ecology plutonium wastes as transuranic wastes should be an integral part of the evaluation of a strategy that approaches the Hanford Site as one that would be released for unrestricted use after completion of remediation, with such use being defined so as to include and respect the Yakama Nation's treaty rights. We understand that the US Ecology site would eventually revert to the

²³ TC&WM Draft EIS v. 2, Appendix U, Table U-2.

²⁴ All alpha-emitting isotopes. Calculated from Table 2.D of Department of Health, *Commercial Low-Level Waste Disposal Site, Richland, Washington: Final Environmental Impact Statement*, Volume I, (DOH Publication 320-031) Richland, WA, Washington State Department of Health and Department of Ecology, May 28, 2004, on the Web at <http://www.doh.wa.gov/ehp/rp/waste/vol1.pdf>. Hereafter referred to as DOH EIS 2004.

L293-198
(Cont.)

Yakama Nation Environmental Restoration Waste Management Program,
Commenter ID No. L293 (cont'd)

State of Washington after operations are finished as per the procedure specified in 10 CFR 61. But this should provide all the more incentive to the State to negotiate an understanding with the DOE that transuranic wastes, broadly defined, at the US Ecology site would be recovered for disposal offsite as GTCC-like waste.

5. Buried transuranic waste and plutonium containing waste in trenches and cribs at Hanford

The DOE considers the pre-1970 waste, whether solid or liquid, discharged or buried at the Hanford Site to be permanently disposed of. Some of it, especially in liquid form, has migrated to the vadose zone and the DOE considers that it would be too difficult to retrieve it. However, this waste is, by DOE's own calculation, going to contribute to massive contamination of the groundwater at the site for centuries. While some parts of the problem are indeed difficult, this is a matter for determined research and development rather than resignation to a highly contaminated future that would violate Yakama Nation treaty rights, among other things.

The source term for pre-1970 buried and discharged plutonium-contaminated waste at Hanford is quite large. About 362 kilograms of solid waste containing plutonium was buried at Hanford, of which the DOE itself has classified about 343 kilograms as being contained in transuranic waste that has plutonium concentrations of more than 100 nanocuries per gram.²⁵

Before 1970, liquid waste containing transuranic elements was directly dumped into the soil. According to the Appendix S of the Draft Tank Closure EIS the amount of plutonium-239 and plutonium-240 is about 200 kg.²⁶

All told, about 543 kilograms of plutonium in defense transuranic waste was disposed of prior to 1970 that should now be recognized (and in the case of 343 kilograms of plutonium in the pre-1970 solid waste is recognized) as TRU waste by the DOE. A critical question is: why does the DOE consider this waste as already disposed of without a serious assessment of the technology needed to recover it and dispose it of according to present law and regulation, which requires repository disposal for defense TRU waste? A second and related question is: why is the DOE recovering the TRU waste from Pit 9 at Idaho, given that (i) there is also a large amount at Hanford, which, moreover, appears to be migrating faster than that at Idaho, and (ii) that the Hanford waste is in much closer proximity to a critical surface water resource, the Columbia River?

L293-198
(Cont.)

²⁵ See Table 4-1 of W. O. Greenhalgh, *Pre-1970 Buried Transuranic Solid Waste at the Hanford Site*. (WHC-SD-WM-ES-325, Rev.0) Westinghouse Hanford Company, May 23, 1995, on the Web at <http://www.iaea.org/inis/collection/NCLCollectionStore/Public/27/002/27002757.pdf>. Note: this does not include post-1970 TRU waste or US Ecology TRU waste or TRU liquid discharges. Nineteen kg of the 362 kg total in buried plutonium was omitted because it was not identified as TRU waste in the data. Hence the total TRU solid and liquid pre-1970 waste TRU source term is (362-19)+200 = 543 kilograms.

²⁶ TC&WM Draft EIS, v. 2, Appendix S, total compiled from Tables S-35b to S-60b.

Yakama Nation Environmental Restoration Waste Management Program,
Commenter ID No. L293 (cont'd)

Recommendation: The DOE should reissue a Draft GTCC EIS for public comment with the following source terms included:

1. Depleted uranium from enrichment plants
2. Recycled uranium, including the recycled uranium in the DOE complex and that generated from operations at West Valley
3. Hanford reactor graphite moderator blocks
4. The plutonium-containing waste that was buried as transuranic waste at the US Ecology commercial low-level waste site prior to 1970.
5. Buried transuranic waste and plutonium containing waste in trenches and cribs at Hanford
6. "Immobilized Low Activity Waste" resulting from the high-level waste processing and vitrification work planned at Hanford.
7. High-level waste tanks when they are removed from the Hanford Site after the waste is removed for vitrification.
8. Soil around the high-level waste tanks that contains high-level waste that leaked from dozens of the tanks over the decades.

D. Health and Environmental Impact

IEER carried out some verification calculations of radiation dose using the DOE's assumptions for a resident farmer 100 meters from the site. We did so using DOE's assumptions as well as more realistic assumptions for parameters relating to the site, using the same software, RESRAD-OFFSITE. IEER also performed some calculations for an onsite resident staying over the disposal site after a complete loss of institutional control and institutional memory. These calculations are shown in Appendix A. The analysis is summarized here in order to connect the analysis to the other comments and to provide a summary basis for the recommendations for a revised Draft EIS. Please refer to Appendix A for more details.

1. DOE's scenario assumptions

The DOE has a number of assumptions that artificially make doses via all but the water pathway disappear and go down to zero. For instance, the DOE assumes an erosion rate of only 0.01 millimeters per year – just four-tenths of an inch in a thousand years. This means that the DOE is effectively assuming that the five-meter cover for the waste will remain functionally intact for hundreds of thousands of years – despite the rain, snow, run off, and winds. Further the DOE makes non-conservative assumptions about infiltration, and hence the amount of water that travels through the waste layer. And, in one of the most surprising and unrealistic of assumptions, the DOE assumes that infiltration of water from any place other than above the GTCC disposal site would be across clean soil so that all other infiltration would dilute water contamination. Given that the proposed Hanford disposal site is on the Central Plateau, at about the core zone boundary, this assumption shows a shocking disregard of the extensive contamination of the Central Plateau from past disposal practices such as discharges into trenches and cribs, and leaks of high-level wastes from the tanks over the decades. It is essential for the DOE to take existing contamination as well as contamination from its proposed cleanup and disposal activities in the core zone into account when estimating the water contamination for a resident farmer 100 meters from the GTCC disposal site.

L293-198
(Cont.)

Yakama Nation Environmental Restoration Waste Management Program,
Commenter ID No. L293 (cont'd)

Assuming that a resident farmer will be at least 100 meters away from the GTCC disposal site boundary thousands of years into the future rests on the notion that the site boundary will be known in some way at that time. This implies some form of institutional control for thousands of years, which is completely unrealistic and contrary to scientific advice and understanding that has been given to the DOE, including by the National Academies. Specifically, the National Research Council has explicitly commented on this in regard to DOE cleanup plans. The same would apply to GTCC disposal. In a report on long-term management, the Council concluded as follows:

The Committee on Remediation of Buried and Tank Wastes finds that much regarding DOE's intended reliance on long-term stewardship is at this point problematic....

[...]

Other things being equal, **contaminant reduction is preferred to contaminant isolation and imposition of stewardship measures whose risk of failure is high.**

[...]

*The committee believes that the working assumption of DOE planners must be that many contamination isolation barriers and stewardship measures at sites where wastes are left in place will eventually fail, and that much of our current knowledge of the long-term behavior of wastes in environmental media may eventually be proven wrong. Planning and implementation at these sites must proceed in ways that are cognizant of this potential fallibility and uncertainty.*²⁷

The DOE has ignored this by assuming that a resident farmer will be at least 100 meters from the site in all scenarios. The DOE has not done even a single case that assumes a failure of controls and loss of institutional memory, thus dismissing the advice that it should assume that stewardship measures "will eventually fail." But, surprisingly, it implicitly claims that in adopting the 100-meter distance from the site boundary it is actually following this advice:

Under Alternatives 3 to 5, the long-term human health impacts are addressed by considering the future radiation dose and LCF risk to a hypothetical individual who resides 100 m (330 ft) from the edge of the disposal facility and develops a farm. **This resident farmer scenario is assumed to be conservative (i.e., one that overestimates the expected dose and LCF risk) because it assumes a total loss of institutional control and institutional memory with regard to the disposal facility and because the radiation doses and LCF risks estimated to occur to this individual would likely never occur.**²⁸

This statement is internally contradictory. How can a person know to set up their home at least 100 meters from the disposal site in every case if there is a total loss not only of control but also of institutional memory? A total loss of control and memory requires an assumption that a future resident farmer or tribal member will actually live on the disposal site with their families, since they will have no way of knowing where the site boundary was located in the distant past. Therefore the DOE's claim that an assumption that a resident farmer will be at least 100 meters

²⁷ National Research Council, Board on Radioactive Waste Management, Commission on Geosciences, Environment, and Resources, *Long-Term Institutional Management of U.S. Department of Energy Legacy Waste Sites*, Washington, DC: National Academy Press, 2000, on the Web at http://www.nap.edu/catalog.php?record_id=9949, pp. 3 and 5. Original italics; bold added.

²⁸ Draft EIS v. 1, p. 2-15, emphasis added.

Yakama Nation Environmental Restoration Waste Management Program,
Commenter ID No. L293 (cont'd)

away is consistent with a complete loss of institutional control and memory is incorrect and scientifically unsupportable. Moreover, it is not conservative, as shown in Appendix A.

The DOE does not provide adequate technical justification for key parameter choices such as infiltration rate through the waste layer and the lifetime of the engineered barriers even though the former is rather low (resulting in lower dose estimates) and the latter, at 500 years, is rather high, also resulting in lower dose estimates than more realistic assumptions.

2. Verification of DOE's dose estimates for trench disposal method at the Hanford Site

The specific scenario that IEER tried to reproduce was the trench disposal method at Hanford with default parameters as used in the Draft EIS, which estimates a peak dose of 48 mrem/year; the largest component is Remote Handled (RH) Other Waste category, whose peak dose the DOE estimates at 39 mrem per year. The scenario is the DOE's base case with the resident farmer being 100 meters from the site using all the other assumptions as well, so far as they are specified in the Draft EIS.

Figure 1 shows the results of IEER's verification calculations using the DOE assumptions so far as we could determine them from the Draft EIS (see Appendix A for more details).

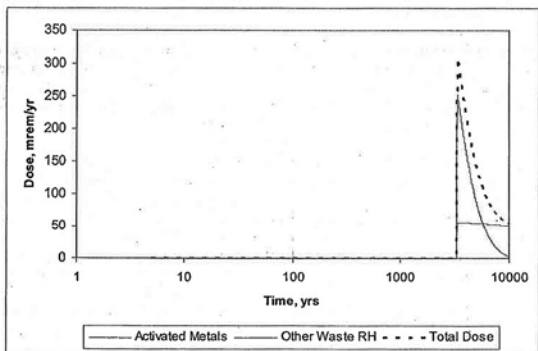

Figure 1: IEER's modeling results for trench disposal of GTCC and GTCC-like waste in a trench at Hanford

As can be seen from Figure 1, IEER's peak dose estimate using the DOE's parameters so far as they could be determined is about 300 millirem per year. The activated metals dose is about 50 millirem and the Other Waste - RH dose is about 250 millirem. The total peak dose is about six times the DOE's estimate of 48 millirem noted above. Figure 2 below shows the results of DOE's trench disposal modeling in more detail.

L293-198
(Cont.)

Yakama Nation Environmental Restoration Waste Management Program,
Commenter ID No. L293 (cont'd)

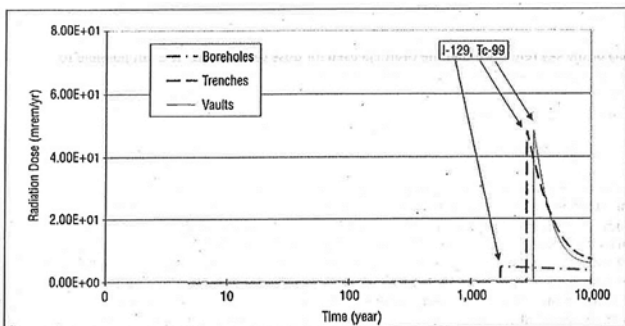

Figure 2: The DOE's modeling results for trench disposal of GTCC and GTCC-like waste in a trench at Hanford
Source: Figure 6.2.4-1 in Draft GTCC EIS (Volume 1)

Further, it should be noted that the vast majority of the dose results from iodine-129 and technetium-99. The water pathway is the only one considered (both direct use and indirect doses via agriculture) and those doses are dominated by I-129 and Tc-99. This is a critical result that has considerable implications for the total body effective dose equivalent used by the DOE to the exclusion of organ dose estimation. This is discussed below when the sensitivity analysis is considered.

The most important conclusions from this verification exercise are:

- The DOE's peak dose estimates for the first 10,000 year period appear to be significant underestimates.²⁹
- Both the DOE peak dose estimate and the IEER peak dose estimate are considerably higher than the allowable maximum limit under 10 CFR 61 Subpart C, the NRC's low-level waste dose limit, even for the non-conservative assumptions used in this scenario.³⁰ Hence, they indicate that trench disposal is unsuitable. Since the vault disposal doses are very similar (49 mrem/yr peak), that approach is also unsuitable.³¹

The reasons for the large differences in results are unclear. One reason may be that the DOE has not used the standard RESRAD-OFFSITE model but rather modified it in a three-step process

²⁹ On the other hand, the DOE's peak dose estimates for the period between 10,000 and 100,000 years are larger than those of IEER. See Appendix A.

³⁰ "Non-conservative" is used here in the sense that it does not adequately represent public health protection and that doses tend to be underestimates relative to realistic as well as conservative assumptions. "Conservative" would be designed to give a great deal of confidence that radiation doses and health impacts would likely be below those estimated.

³¹ We comment on the borehole method below.

L293-198
(Cont.)

Yakama Nation Environmental Restoration Waste Management Program,
Commenter ID No. L293 (cont'd)

for estimating non-drinking water doses; the reasons that the DOE used this estimation process are unclear to us. Further, the properties of the agricultural areas are not specified either in the Draft EIS or the key reference that the Draft EIS used for dose calculations. It is not possible to properly analyze and verify the DOE's calculations without key input parameters. Further, we have reasons to be skeptical, because much of the approach and several of DOE's assumptions are clearly non-conservative.

3. Sensitivity analysis

The DOE has done a very abnormal, unusual, and non-conservative sensitivity analysis. A normal sensitivity analysis varies the base case parameters on both sides – that is, in ways that would give an optimistic picture and a pessimistic picture in terms of health and environmental outcomes and reflect a realistic range for the possible variation in parameters in the future. A normal sensitivity analysis is also a useful way of exploring the possibility that key assumptions may be wrong in ways that might worsen the health outcomes. This is in keeping with the basic spirit of the National Research Council recommendation that it is important to understand what may occur in technical and institutional barriers fail in the long term and if key assumptions are wrong.

In contrast, the Draft EIS effectively treats the base case as the worst case in its sensitivity analysis even though it contains non-conservative and in some cases dubious and internally inconsistent assumptions. For instance, a normal sensitivity analysis would assume that a farmer might live closer to the site boundary than 100 meters or even within the site boundaries; it would also include a scenario in which a farmer lived farther away. The Draft EIS only considers that case in which a farmer would live farther away. Similarly, for the durability of performance (no infiltration for 500 years and durability of grout for 500 years), the DOE assumes that the performance quality will extend out much farther in time -2,000 to 5,000 years – but makes no provision for failure in a much shorter time. These assumptions not only did not conform to normal sensitivity analysis practice, they also fly in the face of available facts of barrier performance degradation. There are very large uncertainties with respect to the performance of grout, which can and has deteriorated rapidly under certain conditions. Experiments under adverse conditions of large surface to volume ratios done at Oak Ridge National Laboratory, for instance, showed a release fraction of strontium-90 from grout between 3.9% and over 50% in only 80 days.³²

More details on Draft EIS approach to sensitivity analysis can be found in Appendix A.

IEER performed its own sensitivity analysis to test the effect of erosion (1 mm per year at the upper limit was assumed), climate, and other parameters, using variations both higher and lower than the base case. For instance, the infiltration rate was doubled from 20 to 40% and also halved to 10%. However, the resident farmer was still assumed to be 100 meters outside

³² As discussed and cited in Brice Smith, *What the DOE Knows it Doesn't Know about Grout: Serious Doubts Remain About the Durability of Concrete Proposed to Immobilize High-Level Nuclear Waste in the Tank Farms at the Savannah River Site and other DOE Sites*, Institute for Energy and Environmental Research, Takoma Park, Maryland updated October 18, 2004, p. 3. On the web at <http://www.ieer.org/reports/srs/grout.pdf>. The conditions of the experiment would likely be more adverse than in subsurface disposal, but then 80 days is less than 0.1 percent of the time for which DOE assumes complete barrier integrity.

Yakama Nation Environmental Restoration Waste Management Program,
Commenter ID No. L293 (cont'd)

the site, so some comparison would be possible when other technical parameters were varied. The results of the sensitivity analysis regarding distance from the site boundary to the well are shown in Figure 3.

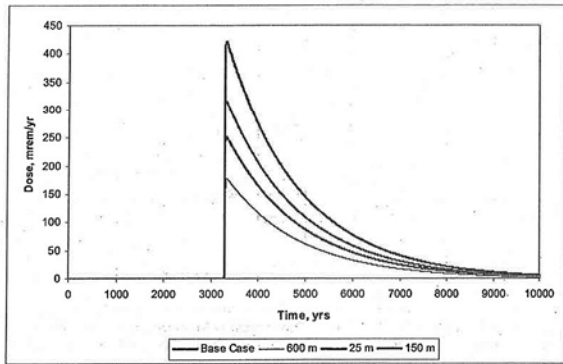

Figure 3: Total Dose for the Different Distances to the Well (Note: Base case distance to the well is 300 m, which is in between the case of very close (25 m) to the site boundary and 600 m).

It is clear that the variation of a single parameter increases the dose from the most important component of the waste in terms of peak dose (Other Waste - RH) from about 250 mrem/year to over 400 mrem per year.

When all parameters are varied the upper limit of dose increases by about a factor of four for total dose and by more than a factor of four for the Other Waste - RH category. See Figure 4 below and Appendix A for more details.

L293-198
(Cont.)

Yakama Nation Environmental Restoration Waste Management Program,
Commenter ID No. L293 (cont'd)

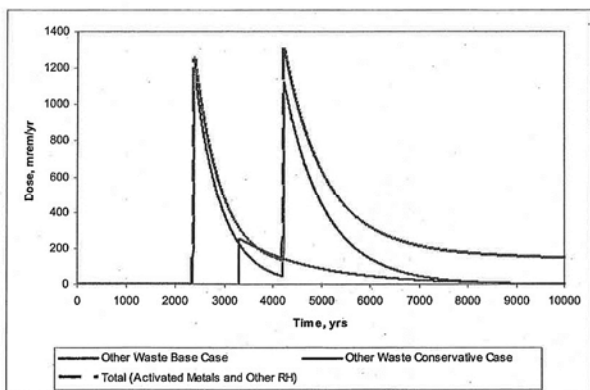

Figure 4: Base Case and Conservative Case for the Other Waste - RH category. (Note: The green line represents the total of activated metals and Other Waste - RH. The red line is Other Waste - RH alone)

Finally, a sensitivity test could be done by estimating organ dose in addition to whole body effective dose. 10 CFR 61 limits the dose to the most exposed organ or to the whole body to 25 mrem/year (except for 75 mrem to the thyroid). For instance, a total body effective dose of 20 millirem, under the limit, from iodine-129 translates into about 400 mrem/year to the thyroid, which would be an unacceptably high dose. It is essential that the revised Draft EIS consider organ as well as total body effective doses. This is because organ dose is essential to determining compliance with radiation protection regulations and with some CERCLA ARARs, such as drinking water standards.

4. Cover erosion scenario

The choice of an extremely low erosion rate in the Draft EIS rules out air and surface water doses, because there is a substantial cover on the waste in all the scenarios. A more conservative erosion rate of 1 mm/year is reasonable for a semi-arid area like Hanford and should be considered. IEER modeled this to evaluate the significance of cover erosion. It turns out that the erosion parameter is especially significant for Hanford and for the Yakama Nation.

An erosion rate of 1 mm/year results in the 5-meter thick trench cover being completely eroded in 5,000 years. Hence, at that point, rain and snow contact the waste, some of which gets washed off into surface water. This means that the dose from the aquatic food pathway is significantly increased. Figure 5 shows the results for the cover erosion scenario. The red line shows the dose from Other Waste RH and the green line shows the total dose. Note that even though the other parameters, such as infiltration have been maintained the same as in the base case IEER model, there is a second peak dose, after the cover erodes, of about 1,600 mrem/year at somewhat over 5,000 years after disposal;

L293-198
(Cont.)

**Yakama Nation Environmental Restoration Waste Management Program,
 Commenter ID No. L293 (cont'd)**

L293
 67/106

this is much greater than the first peak, which occurs due to groundwater use. The main reason for the higher second peak is the dose from consuming surface water and aquatic food from surface water sources.

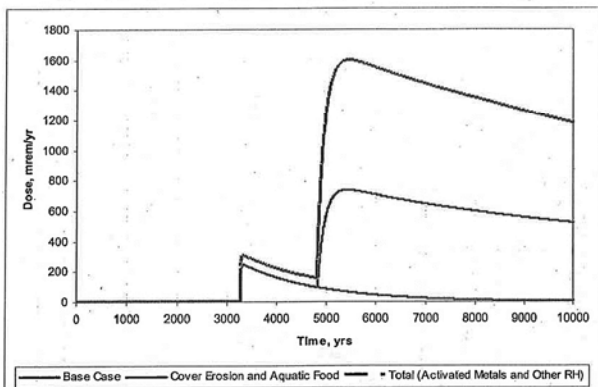

Figure 5. Base Case and Cover Erosion and Aquatic Food Scenario for the Other Waste RH Category (red line). The green line shows dose for the total source term (other waste plus activated metals)

Further, the major contributors to the second peak are the transuranic radionuclides Cm-245, Pu-239, and Pu-240. This is completely different from the Tc-99 and I-129 doses, which are important in the earlier peak.

It should also be noted that the aquatic pathways doses estimated here use the standard RESRAD parameters, which include only 5.4 kilograms of fish consumption per year. The Yakama scenario developed by the Yakama Nation and Ridolfi, Inc., has vastly different and higher fish consumption. At 150 grams per day on average, fish consumption in a traditional Yakama diet would be ten times higher than the RESRAD default value. Similarly other consumption parameters, such as meat and plants, are also different.³³

5. Borehole disposal and the resident farmer scenario

IEER also tested the case of borehole disposal in several variations with a farmer living at the site boundary, using water that has passed next to the waste, but not over it, and finally using water that has passed through the waste. Infiltration rates were also varied. Figure 6 shows the results. The lowest peak dose was 177 mrem/year about 2,650 years in the future while the

³³ Ridolfi, Inc., *Yakama Nation Exposure Scenario for Hanford Site Risk Assessment, Richland, Washington*, Yakama Nation ERWM Program, September 2007, Figure 8.

L293-198
 (Cont.)

**Yakama Nation Environmental Restoration Waste Management Program,
Commenter ID No. L293 (cont'd)**

case of using irrigation from the site had two peaks – one of 5,050 mrem/year 235 years in the future due to I-129 and Tc-99 and one at 6,431 mrem/year 372 years into the future due to uranium isotopes. For context, the Draft EIS's estimate of peak dose due to borehole disposal was just 4.8 mrem/year – 37 times lower than the lowest borehole estimate when institutional controls are relaxed and more than 1,300 times lower when there is total loss of institutional control and memory.

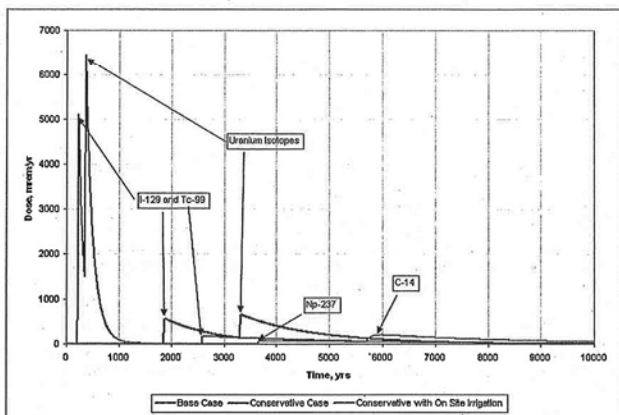

Figure 6: Borehole Land Disposal Alternative for the Group 1 Stored Other Waste - RH Category

Note that the highest dose in the irrigation scenario case is due to uranium – a strong reminder that large amounts of uranium are unsuitable for disposal even in boreholes as much as 40 m deep. So long as the disposal is relatively shallow and water is available beneath the disposal, the method is likely to be a problem from the point of view of a resident farmer and loss of institutional control.

5. Iodine-129 and Technetium-99 at Hanford

We appreciate that DOE acknowledges pre-existing contamination at Hanford by iodine-129 and technetium-99 and the difficulties that this entails for disposal of GTCC and GTCC-like waste at Hanford:

A potential long-term impact from the GTCC proposed action would be the groundwater radionuclide concentrations that could result if the integrity of the facility did not remain intact in the distant future. The human health evaluation for the post-closure phase of the proposed action indicates that a dose of up to 48 mrem/yr (trench disposal

L293-198
(Cont.)

Yakama Nation Environmental Restoration Waste Management Program,
Commenter ID No. L293 (cont'd)

method) or 49 mrem/yr (vault method) could be incurred by the hypothetical resident farmer assumed to be located 100 m (330 ft) from the edge of the disposal facility. It is estimated that the dose to the hypothetical receptor would be about 10 times lower if the borehole disposal method was used. These doses were calculated to occur about 1,800 years (borehole method), 3,300 years (vault method), and 2,900 years (trench method) after failure of the cover and engineered barriers, which are assumed to retain their integrity for 500 years following the closure of the disposal facility.

These doses would be primarily associated with GTCC-like RH waste, and the primary radionuclide contributors within 10,000 years would be Tc-99 and I-129. The Hanford TC&WM EIS (DOE 2009) cumulative estimates for Alternative Combination 1 indicate that the peak concentrations for Tc-99 and I-129 would be about 350,000 pCi/L [almost 400 times the drinking water limit] and 697 pCi/L [almost 700 times the drinking water limit], respectively, 2,000 to 3,000 years in the future. The GTCC EIS estimates of the peak concentrations for Tc-99 and I-129 corresponding to the highest dose given above (49 mrem/yr) are about 10,000 pCi/L and 100 pCi/L; these concentrations would occur at approximately the same time as the time reported in the Hanford TC&WM EIS. As stated in the Hanford TC&WM EIS (DOE 2009), when the impacts of technetium-99 from past leaks and cribs and trenches (ditches) are combined, DOE believes it may not be prudent to add significant additional technetium-99 to the existing environment. Therefore, one means of mitigating this impact would be for DOE to limit disposal of off-site waste streams containing iodine-129 or technetium-99 at Hanford. Finally, follow-on NEPA evaluations and documents prepared to support any further considerations of siting a new borehole, trench, or vault disposal facility at Hanford would provide more detailed analyses of site-specific issues, including cumulative impacts.³⁴

This is an important acknowledgement that waste containing Tc-99 and I-129 should not be brought to Hanford. Yet it is far too limited in the following ways:

- It does not acknowledge that borehole disposal could result in high doses if institutional control is truly lost.
- It does not acknowledge that at 49 mrem/year total body effective dose equivalent, the drinking water limit would be exceeded by more than 100 times (combined Tc-99 and I-129).³⁵ By implication, even the borehole disposal dose of 4.8 mrem/year estimated by the DOE would violate the drinking water limit by more than 10 times, presuming the dose comes mainly from Tc-99 and I-129, as is true of the trench disposal case.
- It does not take other radionuclides into account. For instance, we showed above that with onsite irrigation, the peak borehole disposal dose would be from uranium and it would be more than 1,300 times the dose estimated for borehole disposal calculated for Hanford in the Draft EIS.
- It does not take into account the contamination of the site by a vast array of other radionuclides, like plutonium-239/240 and strontium-90, which would also greatly exceed standards far into the future, even though the peak doses may not coincide.

³⁴ Draft EIS v. 1, pp. 6-110 and 6-111

³⁵ The drinking water limit for Tc-99, when present alone, is 900 pCi/L and for I-129, when present alone is 1 pCi/L hence, 10,000 pCi/L of Tc-99 is 11 times the drinking water limit and 100 pCi/L for I-129 is 100 times the limit. When both are present the limit is exceeded by $100 \times 11 = 111$ times.

L293-198
(Cont.)

Yakama Nation Environmental Restoration Waste Management Program,
Commenter ID No. L293 (cont'd)

Coincidence of the peak dose is not the only important criterion. Indeed, when all radionuclides are taken into account, the overall timing of the peak dose might change.

- The above quote does not explicitly acknowledge that if GTCC-like wastes containing I-129 and Tc-99 are not brought to Hanford but other GTCC and GTCC-like wastes are, two disposal sites would have to be developed.

Recommendations

The present Draft EIS does not meet the minimum standards of transparency that would allow an independent verification of the DOE's estimates. Nor does it meet the minimum tests of estimating health and environmental impacts that would give credence to the results that claim that public health would be protected in the trench, vault, or borehole scenarios. It is also far too limited in considering a single geologic repository site, WIPP, that is limited by law to only defense transuranic waste. In other words, the Draft EIS does not meet the test of scientific integrity and a reasonable range of alternative as required by NEPA. The DOE should publish a revised Draft EIS with the following changes in the scenarios:

1. All base case scenarios should assume a complete loss of institutional control. Therefore all resident farmer and tribal scenarios should assume that there will be people residing on the disposal site rather than away from it. These residents would therefore use water from the site below the disposal layer for domestic, agricultural, and cultural purposes.
2. The revised Draft EIS should incorporate the fact of pre-existing contamination on DOE sites when it models disposal at such sites.
3. The revised Draft EIS should have at least one scenario in which the cover is completely eroded away (on the order of 1mm/year of erosion) in order to assess the effect of disposal on surface water and aquatic food contamination. Besides RESRAD default consumption, the Yakama lifestyle scenario should also be evaluated in this case.
4. The revised draft EIS should provide sound, scientific technical justification for key parameters such as the lifetime of grout and infiltration rate as well as possible future rainfall and climate variations. There has been ample work in these areas that is not reflected in the Draft EIS at present.
5. The revised Draft EIS should have a normal sensitivity analysis in which parameter variation results in dose estimates on both sides (higher and lower) of the base case.
6. A realistic assessment of the trench, vault, and borehole disposal options shows that the basic health protection and dose limits would be violated by large margins. These methods are unsuitable for disposal of GTCC and GTCC-like waste and should be explicitly rejected when the Draft EIS is revised. We understand that Congress is to have its say about a preferred alternative when the Final EIS is published. But that should not prevent the DOE from clearly pointing out that some methods of disposal violate existing regulations and in the case of DOE Superfund sites, ARARs, not to speak of tribal treaty rights.
7. The doses to a resident farmer are far higher when realistic scenarios about loss of institutional control and memory are evaluated (rather than the DOE's assumption of a permanent knowledge of the site boundary). The DOE should include an onsite farmer

L293-198
(Cont.)

Yakama Nation Environmental Restoration Waste Management Program,
Commenter ID No. L293 (cont'd)

using irrigation water from the disposal site in its trench, vault, and borehole disposal scenarios.

8. The DOE's recognition that offsite wastes containing Tc-99 and I-129 should not be brought to Hanford for disposal should lead it to the conclusion that no GTCC or GTCC-like wastes should be brought to Hanford for a variety of reasons, including the need to develop more than one site if they are, the exacerbation of contamination at Hanford from other wastes that would be brought in, the need, in fact to remove existing wastes from Hanford in order to meet drinking water standards and other ARARs, etc.
9. The DOE should calculate organ as well as total body effective doses. This will enable an evaluation of the degree to which disposal methods comply with dose limits in existing regulations such as the drinking water standards (40 CFR 141.66) and the low-level waste rule (10 CFR 61 Subpart C).
10. The DOE should consider at least one deep geologic repository other than WIPP as one of the alternatives.

L293-198
(Cont.)

Yakama Nation Environmental Restoration Waste Management Program,
Commenter ID No. L293 (cont'd)

Comments of the Institute for Energy and Environmental Research on the Department of Energy's
*Draft Environmental Impact Statement for the Disposal of Greater-Than-Class C (GTCC) Low-Level
Radioactive Waste and GTCC-Like Waste*
(DOE/EIS-0375-D), published in February 2011

8 JUNE 2011

APPENDIX A

ELENA KALININA

Yakama Nation Environmental Restoration Waste Management Program,
Commenter ID No. L293 (cont'd)

SECTION I

**KEY POINTS IN THIS PRELIMINARY REVIEW OF THE POST-CLOSURE HUMAN HEALTH IMPACTS
EVALUATION PRESENTED IN DRAFT GTCC EIS**

The main goal of the preliminary review was to identify the key technical issues related to the post-closure human health impacts evaluation presented in the draft EIS. In addition to this review IEER has commissioned an independent RESRAD-OFFSITE modeling which was performed to provide more detailed evaluation of some of these issues. The results of this modeling are provided in a Section II of this Appendix.

The following materials were reviewed as a part of this work:

- Summary of the Draft GTCC EIS
- Chapter 3 of the Draft GTCC EIS (Alternative 1: No Action)
- Chapter 5 of the Draft GTCC EIS (Evaluation Elements Common to Alternatives 3, 4, and 5).
- Chapter 6 of the Draft GTCC EIS (Hanford Site: Affected Environment and Consequences of Alternatives 3, 4, and 5).
- Appendix E of the Draft GTCC EIS (Evaluation of Long-Term Human Health Impacts for the No Action Alternative and the Land Disposal Alternatives, specifically subsections on RESRAD-OFFSITE, Simulation Approaches, Inputs, Results, and Sensitivity Analysis)
- User's Manual for RESRAD-OFFSITE, Version 2
- ANL 2010, *Post-Closure Performance Analysis of the Conceptual Disposal Facility Designs at the Sites Considered for the Great-than-Class-C Environmental Impact Statement*, ANL/EVS/R-10/8.

Note that RESRAD-OFFSITE computer code was used in the Draft GTCC EIS to evaluate human health impacts related to all the land disposal alternatives. However, the assumptions, mathematical formulation, and numerical implementation related to this evaluation are not all explicitly described in the Draft GTCC EIS. Because of this, the RESRAD-OFFSITE user's manual that contains all this information was included in the review.

Key Technical Issues Related to the Post-Closure Human Health Impacts Evaluation for the Land Disposal Alternatives

The key issues identified during the preliminary review are considered below.

Infiltration Rate

The infiltration rate is one of the most important parameters affecting the long-term waste disposal performance. Even a very limited sensitivity analysis conducted in the draft EIS demonstrated that the peak total dose to the residential farmer is roughly proportional to the infiltration rate. Yet, the base case assumes that the infiltration through the waste will be 20% of the ambient infiltration rate during all the 10,000 year period. Also, the infiltration rate is constant and is equal to the present day ambient infiltration rate for both, 10,000 year period and 100,000 year period.

The justification provided in the draft EIS for assuming that the infiltration rate will be 20% of the ambient infiltration is "based on a study at the SRS that indicated that after 10,000 years, the closure cap at the F-area would still shed about 80% of the cumulative precipitation falling on it, with a higher degree of

L293-199 An analysis of this study presented by the Institute for Energy and Environmental Research on behalf of the Yakama Nation is outside the scope of the GTCC EIS.

L293-199

Yakama Nation Environmental Restoration Waste Management Program,
Commenter ID No. L293 (cont'd)

effectiveness occurring before 10,000 years (Phifer et al. 2007).³⁶ This justification is not sufficient. As it is discussed below, the sensitivity analysis does not address this issue because it is limited in its applications.

Maintaining the present day infiltration rate constant for 10,000 years is not a conservative assumption. For instance, extensive long-term climate change studies were performed for the Yucca Mountain project. The following assumptions were made for the Yucca Mountain site:

The first climate stage is a continuation of current present-day climate conditions from present day to approximately 400 to 600 years into the future.

The second climate stage begins approximately 400 to 600 years from present day and is characterized as a monsoon climate with wetter summers relative to present-day climate. The monsoon climate is predicted to last between 900 to 1,400 years.

The third climate stage begins between 1,300 and 2,000 years from present day and is characterized as a glacial-transition climate with cooler air temperatures and on average higher annual precipitation relative to present-day climate. The duration of the glacial-transition climate is estimated to be 10,000 years. Similar assumptions should be applicable to the other sites, especially Hanford. Consequently, the infiltration rate for most of the 10,000 year period will be greater than the present-day infiltration rate. This consideration should be included in the human health impact analysis.

Human Intrusion

Direct physical intrusion, such as by a future inadvertent intruder into the disposal facility after the site closure, is not analyzed quantitatively in the draft EIS. Consequently, the human health analysis does not include the potential impacts from the inadvertent intrusion. Direct intrusion into the waste disposal units was qualitatively considered in Chapter 5.5 of the draft EIS. However, this qualitative approach is not sufficient for justifying exclusion of the inadvertent intruder scenario.

Sensitivity Analysis

The human health impacts were evaluated deterministically for each land disposal alternative. The deterministic dose and risk values were calculated using RESRAD-OFFSITE computer code.

A simplified sensitivity analysis was performed to evaluate potential impacts from the uncertainty in the major parameters. Three parameters were addressed in this sensitivity analysis: (1) the water infiltration rate through the disposal facility cover after 500 years following closure of the facility, (2) the effectiveness of the stabilizing agent (grout) used for Other Waste, and (3) the distance to the assumed hypothetical receptor. These three parameters address issues related to disposal facility design, waste form stability, and site selection.³⁷ Ten combinations (ten cases) of these parameters were considered.

The applicability of this sensitivity analysis is limited due to the reasons discussed below.

The sensitivity analysis considered a less conservative effective period for the grout (2,000 yrs and 5,000 yrs) than the one used in the base case (500 yrs).

³⁶ ANL 2010 p. 26

³⁷ ANL 2010 p. 154

L293-199
(Cont.)

Yakama Nation Environmental Restoration Waste Management Program,
Commenter ID No. L293 (cont'd)

The sensitivity analysis considered a less conservative exposure distance to the resident farmer from the edge of the disposal facility (300 m and 500 m) than the one used in the base case (100 m).

Note, that a common practice is to consider more conservative parameter values in the sensitivity analysis than the ones used in the base case. This is because the major concern is how much worse, not how much better, it can get. This is especially important in this case because neither the grout effective period nor the distance to the resident farmer used in the base case represent the worst case scenario. 500 yrs for the grout performance and 100 m for the exposure distance are not conservative assumptions. It is not clear why a resident farmer location could not have been on the edge of the disposal facility. No data are provided in support of 500 year grout performance.

The sensitivity analysis considered only two sites. The SRS site represented a site in the Eastern United States (a humid site). The WIPP Vicinity site represented a site in the Western United States (an arid site). The WIPP Vicinity site does not represent the Western sites because the infiltration rate at this site is a few orders of magnitude lower than at the other western sites and as a result none of contaminants reach the groundwater table in either 10,000 or 100,000 years.

Only the trench disposal alternative was considered in the sensitivity analysis. The results do not necessarily apply to the other alternatives.

Very strong limitations are also imposed by considering only Other Waste CH [contact handled] type. As it was noted in the draft EIS "[b]ecause the radionuclide mix for each waste type (i.e., activated metals, sealed sources, and Other Waste) is different, the peak annual doses and LCF risks for each waste type do not necessarily occur at the same time. In addition, the peak annual doses and LCF risks for the entire GTCC waste inventory considered as a whole could be different from those for the individual waste types." (p. 5-66)

Note that the doses associated with the Other Waste CH type are the smallest ones. Much higher doses and LCF risks result either from the Other Waste RH [remote handled] type or for the activated metals, depending on the land disposal alternative. It would make more sense to consider the Other Waste RH type in the sensitivity analysis because it is the major contributor to the doses and LCF risks in the case of the trench disposal.

The sensitivity analysis should have been considered for each site, for each land disposal alternative, and for each waste category and should have used the conservative parameters values in order to be applicable to the different conditions considered in the draft EIS.

As a result, the following statements made in the draft EIS needs additional justification: "The results of the sensitivity analysis for this waste type and disposal method at these two sites can be used to infer conclusions about different waste streams disposed of at other alternate sites by using the three land disposal methods. This analysis also gives some indication of the level of conservatism in the results, which is useful information for the decision-making process." (p. E-21)

Finally, the sensitivity analysis did not consider other parameters that might be of importance, such as radionuclide partition coefficients, irrigation rates, consumption factors, and other. These parameters were considered in IEER's independent modeling described in Section II of this Appendix. The radionuclide partition coefficients (K_d s) and consumption factors were found to be of a great importance to the land disposal performance as described in Section II of this Appendix.

L293-199
(Cont.)

Yakama Nation Environmental Restoration Waste Management Program,
Commenter ID No. L293 (cont'd)

Infiltration along the Length of the Offsite Transport

The conceptual model used in the human health impact evaluation assumes that there is infiltration of clean water along the length of the offsite transport. The clean infiltration water dilutes the contaminant plume at the offsite locations and results in smaller doses and LCF risks, as noted in the draft EIS: "In addition, because of the extra dilution by clean water coming down from the ground surface, the potential radiation dose would also be lower than that in the Base Case." (p. E-22)

The impacts from assuming clean infiltration water are described in the draft EIS as: "The radiation dose incurred by the hypothetical resident farmer considered for post closure impact analyses would decrease with increasing exposure distance, as demonstrated by the results for the Base Case and Cases IX and X (see also Figure E-9). As mentioned before, this result would occur because additional dilution of radionuclide concentrations in groundwater would result from the additional transport distance toward the location of the off-site well. As the distance would increase from 100 m (330 ft) to 500 m (1,600 ft), the maximum annual radiation dose would decrease by more than 70%." (p. E-27)

Note that this assumption is not adequate for this analysis because a significant portion of the offsite soils might be contaminated with the radionuclides deposited from contaminated irrigation water and from the surface runoff and dust originated from the contaminated site. Consequently, the infiltration water leaching through the contaminated offsite soils will be contaminated as well. RESRAD-OFFSITE only partially addresses this problem by considering the additional impacts from contaminated offsite soils. RESRAD-OFFSITE does not consider leaching of radionuclides from the contaminated offsite soils into the groundwater.

The exposure pathways associated with the use of contaminated groundwater implemented in RESRAD-OFFSITE are shown in Figure 1. The red arrow is added to the original figure presented in the draft EIS to demonstrate the missing link (irrigation recycling) between the contaminated offsite soil and the groundwater.

L293-199
(Cont.)

**Yakama Nation Environmental Restoration Waste Management Program,
 Commenter ID No. L293 (cont'd)**

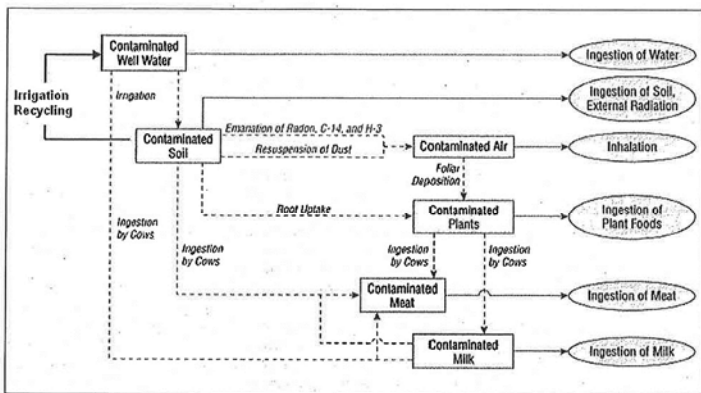

NOTE: This figure was reproduced from Figure E-2 (v. 2, p. E-9) in draft GTCC EIS. The red arrow and text box were added to the original figure.

Figure 1. Exposure Pathways Associated with the Use of Contaminated Groundwater

In summary, both the treatment of the offsite contaminated soils in RESRAD-OFFSITE and the assumption of clean infiltration water along the offsite transport made in the draft EIS, are not conservative and lead to underestimating potential doses and LCF risks.

Toxic Chemicals

The human health impact analysis presented in the draft EIS does not address potential toxic chemical releases from the wastes; it is limited to radioactive constituents only. The toxic chemicals have to be identified for each waste type and some analysis of the potential impacts associated with these chemicals should be performed and presented.

Exposure Distance

A hypothetical individual is assumed to move near the site and reside in a house located 100 m from the edge of the disposal facility. This location was selected "because it is the minimum distance identified in Manual DOE M 435.1-1 (DOE 1999a) for the location of the buffer zone surrounding a DOE LLRW disposal site at which compliance with dose standards needs to be demonstrated." (p. 5-63) On the other hand, it is stated in the draft EIS that "The resident farmer scenario is assumed to be conservative (i.e., one that overestimates the expected dose and LCF risk) because it assumes a total loss of institutional control and institutional memory with regard to the disposal facility." (p. 2-24) The two citations provided above are in contradiction with each other. The location of the residential farmer should not be limited to off site in the case of a total loss of institutional control and institutional memory.

L293-199
(Cont.)

Yakama Nation Environmental Restoration Waste Management Program,
Commenter ID No. L293 (cont'd)

As it was demonstrated in the draft EIS and confirmed by IEER's independent modeling, the closer the exposure location, the higher the doses and LCF risks. Either a base case or a sensitivity analysis should have considered closer locations (immediately at the fence or even on site).

Engineered Barrier Performance

As it is described in the draft EIS "the engineering barriers incorporated in the disposal facility would keep percolating water out of the waste units for 500 years following closure of the disposal facility" and [a]fter 500 years, the integrity of the barriers and waste containers would begin to degrade, allowing for water infiltration into the top of the disposal units at 20% of the natural infiltration rate for the area." The same assumption is used for the grout: "A stabilizing agent (grout) would be used to solidify the Other Waste type, and this grout would maintain its effectiveness for 500 years." (p. E-20)

At the same time, it is pointed out in the draft EIS that the "[d]ata on the performance of waste packages and engineering barriers over an extended time period are limited. ... How and when the waste packages and engineering barriers would begin to degrade and how this degradation would progress over time are very difficult to determine." (p. 5-64)

No justification for the performance period of 500 years is provided in the draft EIS. Instead, even longer performance periods of 2,000 years and 5,000 years are considered in the sensitivity analysis.

As was concluded based on IEER's independent modeling results, the engineering barrier performance has little impact on the land disposal performance in the Hanford Site specific conditions. However, this may not be the case for the other sites.

Human Health Impact Results for the 100,000 Year Period

The human health impact evaluation was extended to 100,000 years in the post-closure analysis for the Hanford Site. The results of this analysis demonstrated that a second peak dose (mostly associated with uranium isotopes) occurs around 21,000 years.

IEER's independent modeling demonstrated that the time of peak dose associated with uranium isotopes can occur significantly earlier (around 4,200 years) if uranium K_d is 0.06 mL/g in both unsaturated layers and the saturated zone and if the ambient infiltration rate is 5 mm/yr. The base case considered in the draft EIS assumed uranium K_d of 0.6 mL/g in the first unsaturated layer and saturated zone and uranium K_d of 0.06 mL/g in the second unsaturated layer. The base case ambient infiltration was 3.5 mm/yr. Both, lower K_d and higher ambient infiltration rate are plausible conditions and should have been considered in the draft EIS either in the base case or sensitivity analysis.

Cover Erosion and Aquatic Food Pathway

The base case scenario as implemented in the draft EIS assumes that the cover will not completely erode either in 10,000 or 100,000 years. The base case also does not consider aquatic food consumption. IEER's independent modeling demonstrated that if the cover erodes during the 10,000 year of simulation, it will result in a significant total dose mainly due to the aquatic food consumption. The major contributors to the total dose will be plutonium isotopes and curium-245 transported from the contaminated zone to the surface water body by the surface water.

L293-199
(Cont.)

Yakama Nation Environmental Restoration Waste Management Program,
Commenter ID No. L293 (cont'd)

Justifications for excluding cover erosion and aquatic food pathway are not provided in the draft EIS.

Modeling Approach

The human impact analysis for all sites and all land disposal alternatives was conducted using RESRAD-OFFSITE computer code. Consequently, the assumptions incorporated in this code were inherited by this analysis.

RESRAD-OFFSITE does not allow for modeling of multiple contaminated zones with different release rates. As a result, each waste type was modeled separately using a simplified approach. In this approach, all the wastes included in the specific waste category type (i.e. GTCC Group 1 Projected Activated Metals category) were consolidated in the middle of the disposal facility. The area occupied by the wastes was calculated as the sum of the areas occupied by the disposal units required to store these wastes. The waste thickness was assumed to be equal to the thickness of the overall waste interval used in each disposal alternative. The waste was uniformly distributed within the volume defined by the waste area and waste thickness. A homogeneous waste cover was assumed at the top of the waste with the cover depth equal to the depth of the top of the waste interval used in each disposal alternative.

As a result, the conceptual representation used in the modeling is significantly simplified with regard to the conceptual design of a corresponding land disposal alternative as shown in the draft EIS. It does not account for the combined effects from the different contaminant plumes originating from the different waste sources either in time or in space.

Also, this simplified conceptualization results in the distance of 175 to 225 m (depending on the consolidated source area) between the down-gradient edge of the wastes and the facility fence. The groundwater well was assumed to be 100 m from the fence (275 to 325 m from the wastes) in the draft EIS. The additional distances to the well considered in the sensitivity analysis (Appendix E of the draft EIS) were 300 m and 500 m. According to the conceptual design, the actual distance to the fence can be 50 m for some contaminated sources.

L293-199
(Cont.)

Key Technical Issues Related to the Post-Closure Human Health Impacts Evaluation for the No Action Alternative in Region IV

The long-term human health impacts for the No Action alternative were evaluated using a similar approach as the one used for the land disposal alternatives. It was assumed that all the wastes generated in a specific region will be stored in this region indefinitely. For the modeling purpose, each waste category was considered separately. The waste was consolidated in the center of the 300 m by 300 m disposal facility.

No Action alternative differs from the land disposal alternatives by the following assumptions. No Action alternative assumes that there are neither engineered barriers nor a cover and that the wastes are placed on the ground surface. The DOE No Action alternative does not include atmospheric transport; only the groundwater pathway is considered. The waste inventory represents only the inventory generated in the region considered, not the overall waste inventory. The other conceptual assumptions are the same as in the land disposal alternatives.

The main key technical issues associated with No Action alternative are described below with the focus on Region IV. Note that the key technical issues associated with the land disposal alternatives are also applicable to the No Action alternative because a similar modeling approach and conceptualization were used.

Yakama Nation Environmental Restoration Waste Management Program,
Commenter ID No. L293 (cont'd)

Airborne Releases and Surface Water Runoff

Airborne releases and surface water runoff were excluded from the evaluation of the long-term human health impacts from the No Action alternative. Note that airborne release (gases and water vapor) was included in the evaluation of the land disposal alternatives even though the land disposal facilities provide better waste isolation than the No Action alternative.

The airborne pathway was excluded because "dispersion of any released radionuclides by the wind would greatly decrease the air concentrations." (p. 3-11) This justification is not sufficient for excluding the airborne releases.

The surface water runoff was excluded because "the storage sites would probably have berms or other engineered features to minimize water runoff from the site." (p. E-3) This contradicts the main assumption concerning the total loss of institutional control 100 years after the facility closure.

Both, airborne releases and surface water runoff have to be included in the analysis of the No Action alternative because the wastes are assumed to be stored on the ground surface without any engineered barriers and covers. It is especially important in this alternative because the wastes become available for release 100 years from the facility closure, which is significantly earlier than it was assumed in the land disposal alternatives (500 years after the closure).

Based on IEER's independent modeling analysis performed for the land disposal alternatives, the contaminant transport via surface water runoff might significantly contribute to the total dose.

Infiltration Rate

The infiltration rate on the top of the wastes in the case of No Action alternative is equal to the ambient infiltration rate because there are no engineered barriers in place. This assumption makes the infiltration rate especially important.

The infiltration rate assumed for Region IV was 1 mm/yr. Note that it is 3.5 times lower than the ambient infiltration used for the Hanford Site (3.5 mm/yr). The mean annual present day infiltration rate estimated for the area above the proposed repository at the Yucca Mountain is 15 mm/yr. The mean annual infiltration rates estimated for the monsoon and glacial transition climate are 28 mm/yr and 29.3 mm/yr respectively. While there are some areas in Region IV with infiltration rates below 1 mm/yr (for example, some areas at the Nevada National Security Site (NNSS)), the infiltration of 1 mm/yr is not representative for many other areas in Region IV, including the Hanford Site.

Because the ambient infiltration rate used for Region IV analysis was very low, none of the radionuclides reached the groundwater table in 10,000 years. This resulted in 0 dose because the groundwater pathway was the only exposure considered: "It is estimated that there would be no groundwater dose within 10,000 years for a generic commercial facility located in Region IV because the radioactive contamination would not reach the groundwater table in 10,000 years as a result of the arid conditions at this location." (p. E-19)

Yet, this conclusion of zero dose does not even apply to a generic disposal facility if it is located at Hanford.

Human Health Impact Results for the 100,000 Year Period

L293-199
(Cont.)

Yakama Nation Environmental Restoration Waste Management Program,
Commenter ID No. L293 (cont'd)

The results of the human health impact evaluation for the period of 100,000 years for Region IV reported in the draft EIS indicate that uranium isotopes and plutonium-238 reach the groundwater well around 40,000 years (Figure 3.5-7 in draft EIS). The uranium isotopes were shown to reach the groundwater well in 21,000 years for the land disposal alternatives considered for Hanford. Note that radionuclide leaching rates are significantly slower in the land disposal alternatives because only 20% of the ambient infiltration is assumed to pass through the wastes. IEER's independent modeling of the trench disposal alternative demonstrated that the uranium isotopes may reach groundwater at Hanford in 4,200 years if a more conservative uranium partition coefficient and ambient infiltration rate are used. Consequently, under the No Action alternative, the breakthrough time might be even smaller. This raises another question regarding the applicability of the generic facility in Region IV No Action alternative results to the Hanford Site.

L293-199
(Cont.)

Yakama Nation Environmental Restoration Waste Management Program,
Commenter ID No. L293 (cont'd)

SECTION II

**RESULTS OF RESRAD-OFFSITE MODELING OF THE TRENCH LAND DISPOSAL
ALTERNATIVE FOR THE HANFORD SITE**

This report presents the results of an independent modeling performed to simulate trench land disposal alternative at the Hanford Site. The first objective of this modeling was to supplement a very limited sensitivity analysis conducted as a part of the draft EIS. The second objective was to modify the conceptual assumptions and parameters used in EIS to better represent the Hanford specific site conditions. A modeling approach similar to the one used in the draft EIS was implemented. Using an identical approach would probably be more consistent. However, this was not an option due to the lack of the detailed information needed for this implementation either in the draft EIS or the supporting references.

As a first step in this study, a test base case RESRAD-OFFSITE model was developed in an attempt to reproduce the results reported in the draft EIS. This model represents an interpretation of the conceptual approach and data described in the draft EIS and ANL 2010. This base case model was then modified to conduct sensitivity study and to consider additional parameters and scenarios.

The major results discussed in the draft EIS are the estimated peak annual doses from the use of contaminated groundwater within 10,000 years of disposal. These results for the Hanford Site are presented in Table 6.2.4-2 of the draft EIS. The peak annual doses were estimated for each of the following conditions:

- Land disposal alternative: borehole, vault, and trench
- Waste group: Group 1 stored, Group 1 projected, and Group 2 projected
- Waste category: GTCC and GTCC-like
- Waste type: activated metals, sealed sources, other waste CH, and other waste RH

L293-199
(Cont.)

Because each combination was considered separately, there are 24 individual peak annual doses (3 waste groups x 2 waste categories x 4 waste types) for each land disposal alternative. The total dose versus time for each alternative was calculated as the sum of the individual dose histories and the peak total dose was derived based on this calculation. Note that because the peak times of the individual doses may be different from each other, the peak time of the total dose does not necessarily coincide with any individual peak time and the total peak dose may be smaller than the sum of the individual peak doses.

The total annual doses versus time for the borehole, vault, and trench disposal alternatives are presented in Figure 4-9 (ANL 2010) for the period of simulation of 10,000 yrs and in Figure 4-10 for the period of simulation of 100,000 years.

The results presented in the draft EIS indicate that the vault and trench land disposal alternatives are very similar with regard to the individual peak annual doses, total peak annual doses, and the peak total dose timing. The borehole land disposal alternative has significantly smaller estimated individual doses and total dose than the trench and vault alternatives. Based on these results, we concluded that considering trench land disposal alternative in the independent modeling would be sufficient to represent the case with the highest total dose.

Two cases were selected for modeling. The first case considers the GTCC-like other waste RH in Group 1 stored waste. This case has the DOE's highest peak dose estimate among all the other individual doses (48 mrem/yr). In the second case, the DOE considers the GTCC activated metals in Group 1 projected waste.

Yakama Nation Environmental Restoration Waste Management Program,
Commenter ID No. L293 (cont'd)

The DOE estimates the second highest peak dose in this case (5 mrem/yr). All the other peak doses are significantly smaller (0 to 2.5 mrem/yr).³⁸

Modeling Approach

Same simplified modeling approach was used for each case presented in Table 6.2.4-2 in the draft EIS. In this approach, all the wastes included in the specific case were consolidated in the middle of the disposal facility. The area occupied by the wastes was calculated as the sum of the areas occupied by the disposal units required to store these wastes. Table 5.1-3 in the draft EIS shows the number of the disposal units for each waste type. Table 4-2 in ANL 2010 shows the corresponding consolidated waste areas.

For example, 2.1 trenches are required to dispose of the GTCC-like other waste RH in Group 1 stored waste category (2,500 55-gallon drums). The trench horizontal dimensions are 3 m wide and 100 m long (Figure 1). Consequently, the consolidated waste area is $3\text{ m} \times 100\text{ m} \times 2\text{ trenches} = 600\text{ m}^2$. The contaminated area is assumed to be a square. The waste thickness was assumed to be equal to the thickness of the overall waste interval used in each disposal alternative. This thickness was equal to 5.6 m for the trench alternative. The waste was uniformly distributed within the volume defined by the waste area and waste thickness. A homogeneous waste cover was assumed at the top of the waste with the cover depth equal to the depth of the top of the waste interval used in each disposal alternative. This depth was equal to 5 m in the trench alternative.

As a result, the conceptual representation used in modeling is significantly simplified with regard to the conceptual design shown in Figures 1 and 2. It is not clear either from draft EIS or ANL 2010 whether the facility area was assumed to be a square as well or whether the actual proposed dimensions were used. For example, in the case of the trench alternative the facility is 550m by 330m. The same area can be represented with a square with the side of 426 m. The square shape was assumed in the independent modeling to be consistent with the square shape contaminated zone (Figure 3).

This conceptualization results in the distance of 175 (source area 2,600 m²) to 225 m (source area 0.1 m²) between the down gradient edge of the wastes and the facility fence. The groundwater well was assumed to be 100 m from the fence (275 to 325 m from the wastes) in the draft EIS. The additional distances to the well considered in the sensitivity analysis (Appendix E of the draft EIS) were 300 m and 500 m. According to the conceptual design shown in Figure 1, the actual distance to the fence can be 50 m for some contaminated sources.

L293-199
(Cont.)

³⁸ Draft EIS, Vol. 1, Table 6.2.4.2, p. 6-87

Yakama Nation Environmental Restoration Waste Management Program,
Commenter ID No. L293 (cont'd)

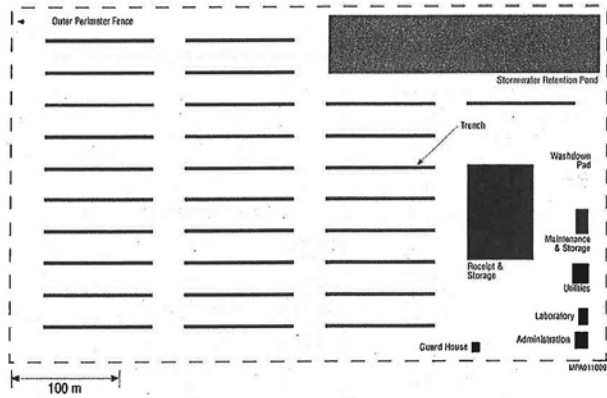

NOTE: This figure was reproduced from Figure D-12 in Draft GTCC EIS (Volume 2)

Figure 1. Layout of a Conceptual Trench Disposal Facility

The following assumptions were used in the modeling (as inferred from the draft EIS):

- All agricultural areas and the dwelling site are located outside the facility fence.
- The wastes are intact for 500 years while engineering barriers are in place.
- The water starts infiltrating onto the wastes at 500 years after the facility closure.
- The infiltration rate on the top of the wastes is 20% of the ambient infiltration rate during all the period of simulation (either 10,000 on 100,000 years).
- The ambient infiltration is equal to the present-day infiltration and remains constant during all period of simulation.
- The infiltration rate at the bottom of the waste is equal to the ambient infiltration rate.
- The cover does not erode to the top of the waste during all the period of simulation. Consequently, the contaminant transport via runoff from the contaminated source is not considered.
- The contaminants are released from the wastes to the groundwater based on the contaminant-specific leaching rates.
- Because the cover does not erode to the top of the wastes, the contaminant releases from the wastes to the atmosphere are considered only for gases formed by carbon-14, tritium, and radon.
- There is no surface water (pond) on the site and consumption of the contaminated fish is not considered.
- There is no irrigation within the facility. Only the agricultural areas outside of the facility fence are irrigated.
- Only 50% of the food comes from the contaminated areas.
- Farmer spends 50% of time indoors and 25% outdoors. The remaining 25% of time is spent outside of the contaminated areas.

L293-199
(Cont.)

Yakama Nation Environmental Restoration Waste Management Program,
Commenter ID No. L293 (cont'd)

- The dose conversion factors are for an adult.

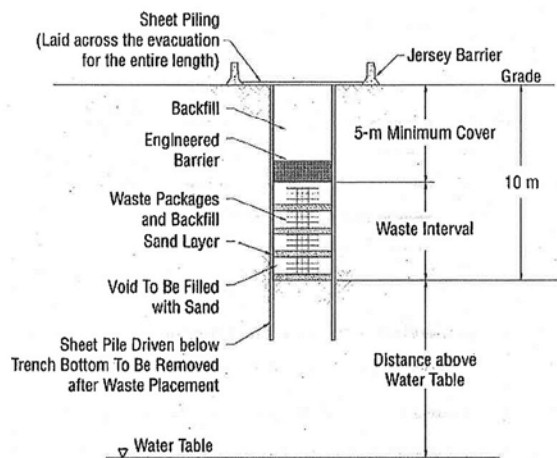

L293-199
(Cont.)

NOTE: This figure was reproduced from Figure D-1 in Draft GTCC EIS (Volume 2)

Figure 2. Cross Section of a Conceptual Trench Disposal Unit

Section II

Demo 4.4

Yakama Nation Environmental Restoration Waste Management Program,
Commenter ID No. L293 (cont'd)

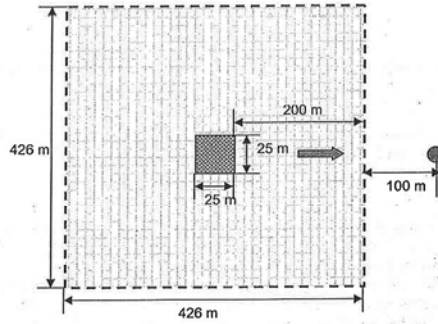

NOTE: The source dimensions corresponds to the GTCC-like other waste RH Group1 stored category. The facility dimensions corresponds to the trench disposal alternative.

Figure 3. Conceptual representation of the contaminated site used in RESRAD-OFFSITE modeling.

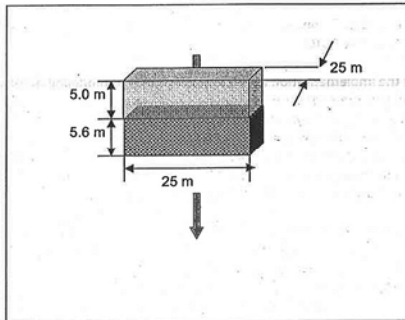

NOTE: The small blue arrow represents the infiltration into the waste (20% of ambient infiltration). The large blue arrow represents the ambient infiltration.

Figure 4. Conceptual representation of the contaminated zone used in RESRAD-OFFSITE modeling.

L293-199
(Cont.)

Yakama Nation Environmental Restoration Waste Management Program,
Commenter ID No. L293 (cont'd)

The radionuclide-specific leaching rate r_i (or release fraction) was calculated as:

$$r_i = \frac{I}{\theta_{ca} B_0 R_{ca,i}} \quad R_i = 1 + \frac{\rho_b K_{d,i}}{\theta_{ca}} \quad (1)$$

where I is infiltration rate on the top of the wastes, B_0 is the initial thickness of the contaminated zone, and R_i is the radionuclide-specific retardation factor (equal to 1 for non sorbing radionuclides), ρ_b is the contaminated zone bulk density, θ_{ca} is the moisture content of the contaminated zone, and $K_{d,i}$ is the radionuclide-specific partition coefficient.

Note that Equation (1) is not provided either in draft EIS or ANL 2010. ANL 2010 provides radionuclide-specific release fractions for activated metals (Table 4-5), sealed sources (Table 4-8), and other waste (Table 4-11). Equation (1) is from RESRAD-ONSITE. It was used to check the release rates in ANL-2010. The same release rates were obtained with $I=0.000$ m/yr (20% of ambient infiltration rate of 0.0035 m/yr), $\rho_b=1.8$ g/cm³, $B_0=5.6$ m, $\theta_{ca}=0.2$, and radionuclide-specific $K_{d,i}$ values for soil (same as the $K_{d,i}$ values for the upper unsaturated zone layer in Table 4-17) and for cementitious system (Table E-1 in draft EIS). In the case of activated metals, all the release rates calculated using equation (1) greater than 1.19×10^{-5} 1/yr were substituted with the release rate of 1.19×10^{-5} 1/yr, which corresponds to the corrosion rate of metals.

As it follows from Equation (1), the release rates need to be recalculated if a different infiltration rate I , or different K_d values, or different contaminated zone parameters (bulk density, thickness, and moisture content) are used.

Two conditions regarding the modeling approach remain unclear due to the limited information presented in this regard in the draft EIS and ANL 2010.

The first condition concerns the implementation of release rates used for modeling other waste. It is stated in the ANL 2010 and draft EIS that the releases were simulated using the rates calculated based on the K_d s in cementitious system during the first 500 years (these are very small releases). After 500 years it was assumed that the cement degraded and the release rates based on the soil K_d s were used. This is not clear because RESRAD-OFFSITE uses constant with time release rates. Only one rate for each radionuclide can be specified. In the independent modeling, it was assumed that no release occurs during the first 500 years. The released rates in Table 4-8 based on soil K_d s (Table 4-17) were used after this time.

The second condition concerns the calculation of the total dose. As it is described in the ANL 2010, the total doses were calculated by following a three-step procedure. The first step of the procedure was to calculate the radiation dose from the drinking water pathway for individual radionuclides contained in the waste materials. In the second step, the radiation dose associated with the drinking water pathway was scaled to obtain the radiation dose associated with all the groundwater-related pathways. The all-pathway dose summed across all radionuclides contained in the waste material yielded the final dose results. The scaling factor is the ratio of radiation dose associated with all groundwater-related pathways to the radiation dose associated with only the drinking water pathway. The scaling factors were developed for each radionuclide in Appendix C of ANL-2010. It is not clear why the three step procedure was necessary when RESRAD-OFFSITE is capable of calculating all the water related doses, including drinking water pathway in one run. All the applicable exposure pathways were considered together in the independent modeling instead of using a three-step approach.

L293-199
(Cont.)

Yakama Nation Environmental Restoration Waste Management Program,
Commenter ID No. L293 (cont'd)

Modeling Parameters

A number of parameters are required for the modeling. Some of these parameters are included either in draft EIS or ANL 2010, some of them required additional calculations.

Initial Radionuclide Concentrations in Contaminated Zone

These initial concentrations are not provided in the draft EIS or ANL 2010. These concentrations were calculated as follows.

The radionuclide inventories were taken from Table B-5 for the case of GTCC-like other waste RH, group 1 stored category. The radionuclide inventories were taken from Table B-6 for the case of GTCC activated metals, group 1 projected category.

The first-order decay equation was used to calculate radionuclide inventories after 500 years during which the engineered barriers were assumed to be in place. For the sake of simplicity, the ingrowth was not accounted for.

The radionuclide concentrations were calculated based on this inventory, contaminated zone volume, and contaminated zone bulk density.

Radionuclide Release Rates and K_d

These parameters were specified as described above.

Infiltration Rate

The infiltration rate is calculated internally in RESRAD-OFFSIE based on evaporation coefficient, runoff coefficient, irrigation rate, and precipitation. These coefficients were specified the same as in Table E-5 in the draft EIS to get an ambient infiltration rate of 0.0035 m/yr.

Cover Erosion Rate

The cover erosion rate is calculated internally in RESRAD-OFFSIE based on the rainfall and runoff factor, soil erodibility factor, slope length-steepness factor, crop/cover management factor, supporting practice factor, and soil bulk density. These coefficients were specified the same as in Table E-5 in the draft EIS to get an erosion rate of 1×10^{-5} m/yr (0.1 m eroded by the end of 10,000 year simulation period or 1 m eroded by the end of 100,000 year simulation period).

Unsaturated and Saturated Zone Properties

These properties were defined based on the data in Table E-5 in the draft EIS.

Agricultural Areas Properties

The properties of the agricultural areas are described in ANL 2010. However, the locations of these areas are not specified. It is only stated that they are outside of the facility fence. The grazing area and the pasture area are assumed to be 10,000 m² with irrigation rate of 0.1 m/yr. The fruit, grain, and non-leafy vegetables area and leafy vegetables area are assumed to be 1,000 m² with the irrigation rate of 0.2 m/yr.

L293-199
(Cont.)

Yakama Nation Environmental Restoration Waste Management Program,
Commenter ID No. L293 (cont'd)

The data on the dwelling site area and irrigation rate are not provided. The dwelling site used in the independent modeling was set equal to 625 m² and the irrigation was assumed to be 0.

Consumption Fractions

All consumption fraction were set equal to 0.5.

Occupancy Parameters

The occupancy parameters were specified in accordance with the once used in EIS: 50% of time spent indoors, 25% time spent outdoors, 0.05% time spent outside in each of the agricultural area and dwelling site.

Well Pumping Rate

Well pumping rate was set equal to 2,500 m³/yr. If the user-specified pumping rate is smaller than the total water demand including drinking water, household water and irrigation, RESRAD changes the pumping rate to set it equal to the annual water demand.

The water demand as defined based on the parameters described in EIS is 2,678 m³/yr. To get the pumping rate of 2,500 m³/yr, the irrigation rate of the grazing and pasture areas in the independent modeling was set equal to 0.0907 m/yr to make the total water demand go down to 2,493 m³/yr. It is not clear how this problem was managed in the EIS.

L293-199
(Cont.)

Default Parameters

The default RESRAD-OFFSITE parameters were used for the radionuclide-specific transfer factors, air transport parameters, inhalation, life stock intake, plant factors, and ingestion rates (except drinking water intake of 730 L/d).

Surface Water Parameters

No surface water parameters are provided in EIS because these are only required if the aquatic foods pathway is used. This pathway was excluded from the calculations in EIS.

Site Layout

Site layout used in the independent modeling is shown in Figure 5. The surface water pond was defined because it was used in one of the runs. The location of the well is 300 m from the down gradient edge of the contaminated zone. This location corresponds to the base case. Other locations were considered in the sensitivity analysis.

Yakama Nation Environmental Restoration Waste Management Program,
Commenter ID No. L293 (cont'd)

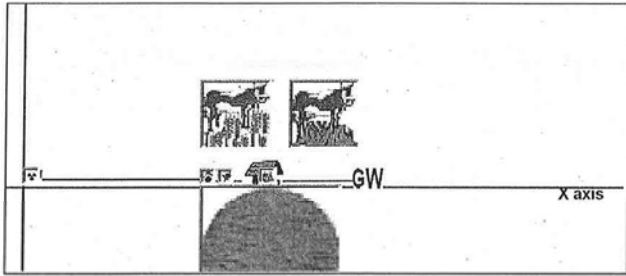

Figure 5. Site Layout Considered in the Independent Modeling

The cross section through the contaminated zone used in the independent modeling is shown in Figure 6.

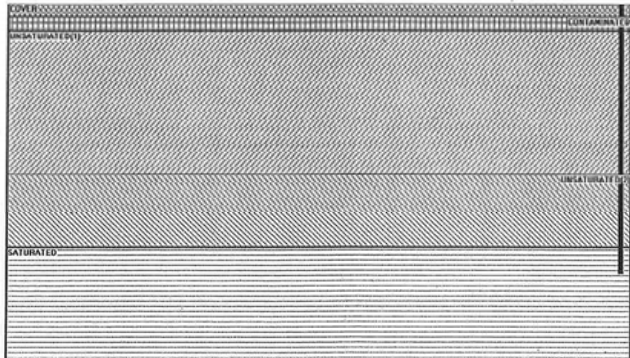

Figure 6. Contaminated Zone Cross Section Considered in the Independent Modeling

Base Case Test Runs

The base case was developed in an attempt to reproduce the results presented in the draft EIS (Table 6.24-2). Two cases were considered: (1) GTCC-like other waste RH, Group 1 stored category and (2) activated metals, Group 1 projected category.

L293-199
(Cont.)

Yakama Nation Environmental Restoration Waste Management Program,
Commenter ID No. L293 (cont'd)

As it was discussed above, the intent was to use the same modeling approach and parameters as in the draft EIS. However, because not everything was clear about the approach and not all parameters were provided, some differences may exist between the independent modeling set up and the set up used in the draft EIS.

The results of the independent modeling are presented in Figures 7 and 8. The results from the draft EIS are reproduced in Figure 9 and 10.

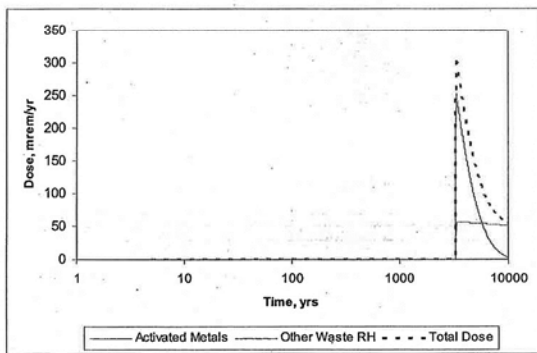

Figure 7. Base Case Independent Modeling Results for the 10,000 Year Simulation Period.

L293-199
(Cont.)

Yakama Nation Environmental Restoration Waste Management Program,
Commenter ID No. L293 (cont'd)

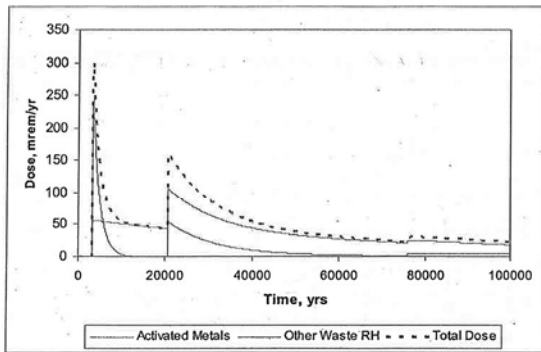
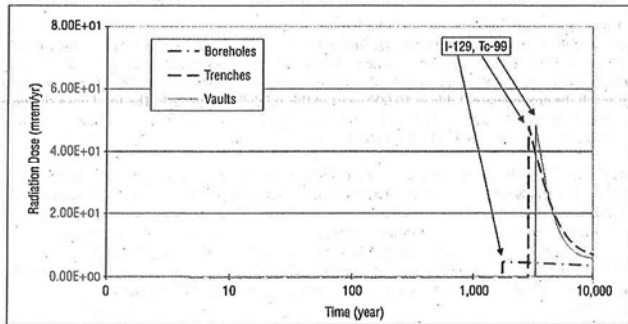

Figure 8. Base Case Independent Modeling Results for the 100,000 Year Simulation Period.



NOTE: This figure was reproduced from Figure 6.2.4-1 in Draft GTCC EIS (Volume 1)

Figure 9. Draft EIS Modeling Results for the 10,000 Year Simulation Period.

L293-199
(Cont.)

**Yakama Nation Environmental Restoration Waste Management Program,
Commenter ID No. L293 (cont'd)**

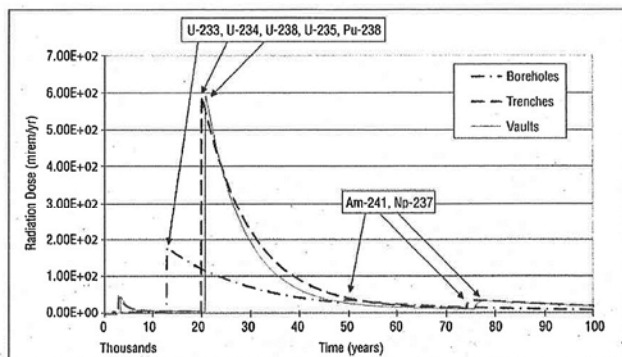

NOTE: This figure was reproduced from Figure 6.2.4-2 in Draft GTCC EIS (Volume 1)
Figure 10. Draft EIS Modeling Results for the 100,000 Year Simulation Period.

The peak doses during the 10,000 year period obtained in the independent modeling are 250 mrem/yr (other waste) and 56 mrem/yr (activated metals). The peak time is 3,300 years for both types of waste. This is because the dose is associated with non-sorbing radionuclides – I-129 and Tc-99 in the other waste case and Tc-99 in the activated metals case. All the other radionuclides have partition coefficient greater than 0 and do not reach the groundwater table in 10,000 years in this modeling approach. The total dose shown in Figures 7 and 8 represents the sum of the doses from two categories. The other categories have very small contributions based on the data in the draft EIS (Table 6.2.4-2).

The peak dose timing coincides with the peak time obtained in the draft EIS. However, the peak doses in the draft EIS are noticeably smaller – 39 mrem/yr in the case of other waste and 5 mrem/yr in the case of activated metals. The major contributors are the same – I-129 and Tc-99. The same peak dose timing suggests that the unsaturated and saturated zone transport parameters are the same in both models. The difference in doses may be related to the differences in the release rates and exposure parameters. However, this can only be established by comparing actual RESRAD-OFFSITE input files. As it was discussed above, an attempt was made to use the same parameters as in the draft EIS, but the actual input files are not available to us.

The peak doses during the period of time from 10,000 years to 100,000 years obtained in the independent modeling are 50 mrem/yr (other waste) and 103 mrem/yr (activated metals). The peak time is 21,100 years for both types of waste. The major contributors to these doses are U-233 in the case of the other waste and U-233 and Tc-99 in the case of activated metals. Uranium has low K_d values (0.6 mL/g in the 1st unsaturated layer and saturated zone and 0.06 mL/g in the 2nd unsaturated layer) and it reaches the groundwater table in 21,000 years. None of the other radionuclides reach the groundwater table within the 100,000 years.

L293-199
(Cont.)

Yakama Nation Environmental Restoration Waste Management Program,
Commenter ID No. L293 (cont'd)

The peak dose timing during 10,000 to 100,000 year period coincides with the peak time obtained in the draft EIS. However, the total peak doses in the draft EIS is larger (600 mrem/yr). The major contributors are the same as in the independent modeling.

In summary, under the base case conditions assumed in the draft EIS for the Hanford Site the only two radionuclides that reach groundwater table within 10,000 year simulation period are I-129 and Tc-99. These are long-lived radionuclides with 0 K_d s and retardation factor of 1. The time of travel of these radionuclides to the well is around 3,300 years. Because the time of travel to the well is inversely proportional to the retardation factor, only the radionuclides with retardation factors smaller than 3 will reach the well in 10,000 years (~3,300x3). The retardation factor is smaller than 3 when a radionuclide K_d is smaller than 0.23 mL/g, assuming the waste specific bulk density and moisture content used in the draft EIS. Among all the radionuclides present in the wastes, the only radionuclide with K_d smaller than 0.23 mL/g is uranium. However, as it was discussed above, this K_d is only considered for the 2nd layer in the unsaturated zone. The uranium K_d s in the 1st unsaturated layer and in the saturated zone are 0.6 mL/g. Uranium and neptunium isotopes reach the groundwater in about 21,000 years from the beginning of simulation. All the other radionuclides do not reach the well within 100,000 years. Because all the radionuclides that reach the groundwater well within either 10,000 years or 100,000 years are long-lived, the only effect of the engineered barriers under the Hanford specific conditions is in delaying the timing of the peak dose, the dose magnitude remains the same.

Sensitivity Analysis

The sensitivity analysis considered only the "other waste" category. The same conclusions should be applicable to the other waste category.

The following parameters were studied in the sensitivity analysis:

- Leaching rates (infiltration rate at the top of the wastes in the case of non sorbing contaminants)
- Ambient infiltration rate
- Irrigation rates at the agricultural areas
- Distance to the groundwater well
- Fraction of food from contaminated areas
- Well pumping rate
- Depth of aquifer contributing to pumping
- Uranium K_d

The parameters that had small impact on the peak dose (within the parameter ranges considered) were: irrigation rate of grazing area and pasture area, well pumping rate, and the depth of aquifer contributing to pumping. The other parameters have either noticeable or significant impact on the total doses.

Figure 11 shows the impacts from using 2 times higher and 2 times lower leaching rate for I-129 and Tc-99. Because I-129 and Tc-99 are non-sorbing radionuclides (with retardation factor of 1), this is the same as to change infiltration rate at the top of the waste (Equation 1). A two-times higher infiltration rate represents 40% of the ambient infiltration case and two times lower infiltration rate represents 10% ambient infiltration case. The maximum dose related to I-129 increases 2 times when 2 times higher infiltration rate is used. Same is true for Tc-99. The increase in the total dose is smaller than 2 times because only one leaching rate was varied at the time (either I-129 or Tc-99).

L293-199
(Cont.)

**Yakama Nation Environmental Restoration Waste Management Program,
 Commenter ID No. L293 (cont'd)**

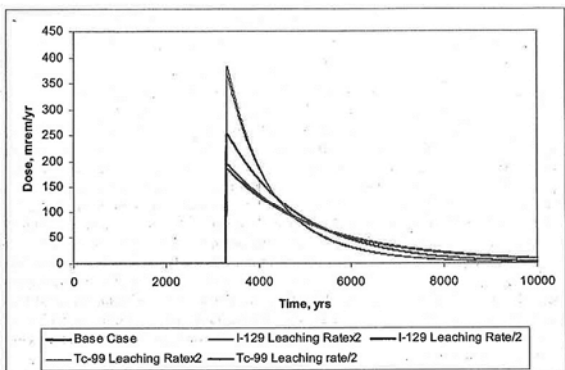

NOTE: Base case leaching rates are 6.31×10^{-4} 1/yr for both I-129 and Tc-99.
 Figure 11. Total Dose for the Different Leaching Rates

The impacts from the different distances to the groundwater well are shown in Figure 12. The dose increases 1.5 times due when the distance to the well is 2 times smaller and decreases 1.5 when it is 2 times greater.

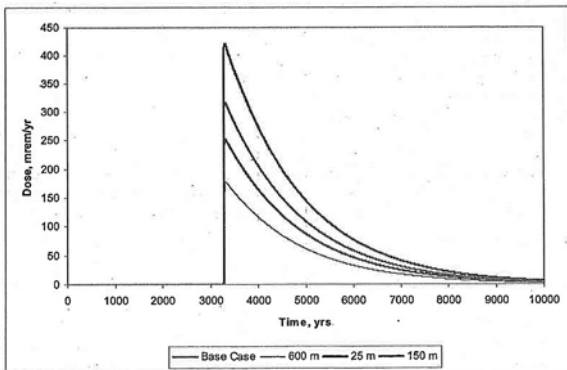

NOTE: Base case distance to the well is 300 m.
 Figure 12. Total Dose for the Different Distances to the Well

L293-199
 (Cont.)

Yakama Nation Environmental Restoration Waste Management Program,
Commenter ID No. L293 (cont'd)

Figure 13 shows the impacts from the different ambient infiltration rates. When the ambient infiltration rate is 5 mm/yr, the peak dose is higher and it occurs about 1,000 years earlier. The peak dose is higher because the radionuclide release rates are higher (20% of 5 mm/yr instead of 20% of 3.5 mm/yr as in the base case). The peak occurs earlier because the travel time is faster under the higher infiltration conditions.

Note that the uranium isotopes do not reach the water table within the 10,000 year period in the base case. This is also true for the case with ambient infiltration of 5 mm/yr. Note that the uranium K_d s were set equal to 0.6 mL/g in the 1st layer of the unsaturated zone and in the saturated zone and to 0.06 mL/g in the 2nd layer of the unsaturated zone. The red line in Figure 13 shows the case with the ambient infiltration of 5 mm/yr in which uranium isotopes were assigned K_d of 0.06 mL/g in the unsaturated and saturated zone. In this situation uranium isotopes reach the groundwater table within 10,000 years and result in the second peak around 4,200 years.

Figure 14 shows the impacts due to the different consumption fractions. When 100% of food comes from contaminated areas (2 times more than in the base case), the total dose increases 1.6 times.

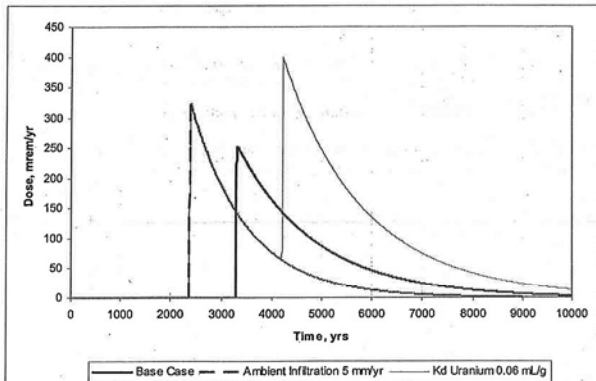

NOTE: Base case ambient infiltration is 3.5 mm/yr, uranium K_d is 0.6 mL/g in 1st UZ layer and SZ
 Figure 13. Total Dose for the Different Ambient Infiltration Rates and Uranium Partition Coefficients

L293-199
 (Cont.)

Yakama Nation Environmental Restoration Waste Management Program,
Commenter ID No. L293 (cont'd)

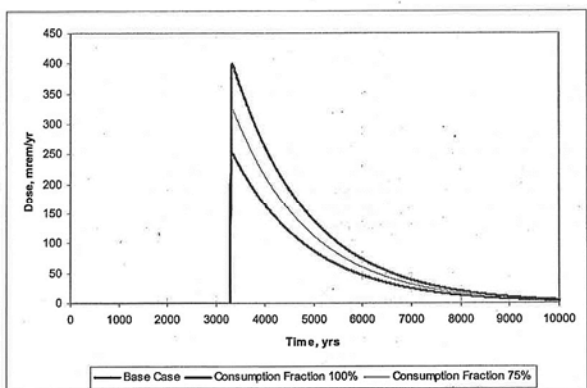

NOTE: Base case consumption fraction is 0.5.
Figure 14. Total Dose for the Different Consumption Fractions

Figure 15 shows the impacts from the irrigation rate of the fruit, grain, and non-leafy vegetables. The impacts are smaller than in the previous cases, but still noticeable.

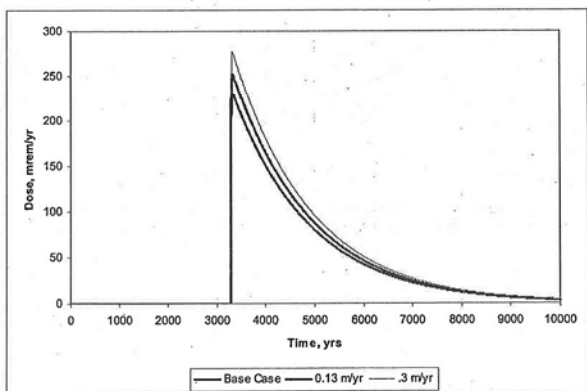

NOTE: Base case irrigation rate is 0.2 m/yr
Figure 15. Total Dose for the Different Irrigation Rates of Fruits, Grains and Non-Leafy Vegetables.

L293-199
(Cont.)

Yakama Nation Environmental Restoration Waste Management Program,
Commenter ID No. L293 (cont'd)

A conservative case was developed to demonstrate the potential impacts from all the sensitive parameters on the total dose both for the other RH waste and for the activated metals categories. The conservative case uses the ambient infiltration of 5 mm/yr. 40% of the infiltration is assumed at the top of the waste. Uranium K_d is 0.06 mL/g in both, unsaturated and saturated zones. Irrigation rate of the fruits, grains, and non-leafy vegetables is 0.3 m/yr. The fraction of food from contaminated areas is 75%. The distance to the well is 200 m (next to the fence). Note that some of these parameters are below the potential maximum values.

Figure 16 compares the base case to the conservative case for the other waste RH category. Figure 17 compares the base case to the conservative case for the activated metals category. The total dose (activated metal and other waste RH) is plotted in both figures as well. In both cases, the peak doses in conservative case are more than 4 times higher.

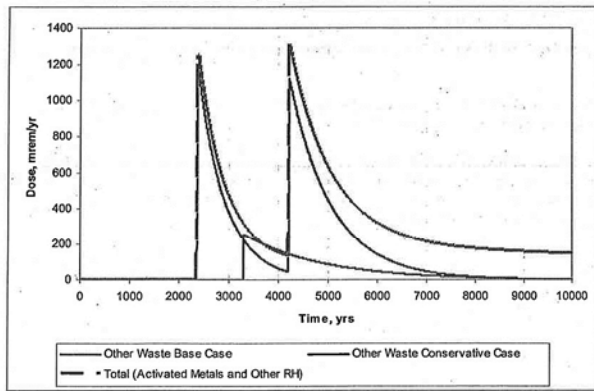

Figure 16. Base Case and Conservative Case for the Other Waste RH Category

L293-199
(Cont.)

Yakama Nation Environmental Restoration Waste Management Program,
Commenter ID No. L293 (cont'd)

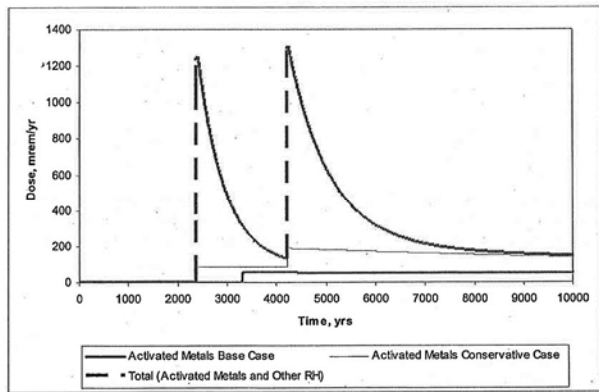

Figure 17. Base Case and Conservative Case for the Activated Metals Category

The contributions of the major exposure pathways for the base case and the conservative case for the other waste RH category are shown in Figures 18 and 19.

In both cases, the major contributors are drinking water ingestion and plant food (contaminated with irrigated water) pathways. Ingestion of milk and meat plays less significant role. The significance of drinking water and plant food changes with time as shown in Figure 19 when uranium isotopes reach the groundwater well around the simulation year 4,200.

L293-199
(Cont.)

**Yakama Nation Environmental Restoration Waste Management Program,
Commenter ID No. L293 (cont'd)**

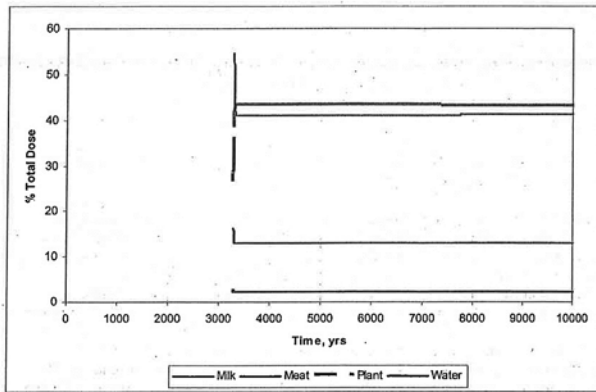

Figure 18. Major Pathway Contributions for the Base Case

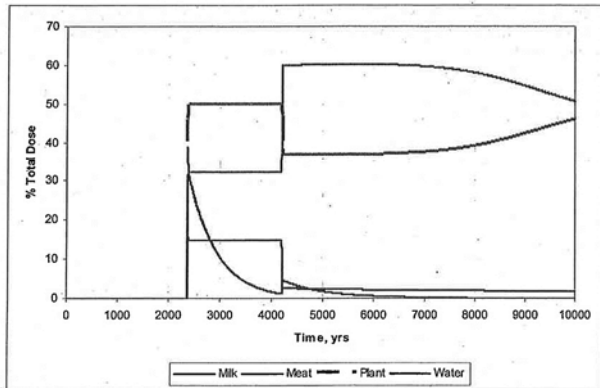

Figure 19. Major Pathway Contributions for the Conservative Case

The conservative case was developed as a demonstration that reasonably conservative parameters below the potential upper bounds still result in a large increase in estimated dose. We note specifically that Figure 16 to 19 show that the drinking water dose in the base case, using DOE parameters, is on the order

L293-199
(Cont.)

Yakama Nation Environmental Restoration Waste Management Program,
Commenter ID No. L293 (cont'd)

of 100 mrem per year at the peak, with a similar dose from plants. In the sensitivity test, the peak drinking water is about seven times higher, at about 700 mrem/year, and the plant peak dose is about six times higher at about 600 mrem/year. The peak drinking water and plant doses occur at different times. Nonetheless, the total peak dose in the conservative case developed above is almost six times higher than the base case estimate, which uses the parameters selected by the DOE.

Additional Scenario

An additional scenario was developed to evaluate the significance of the cover erosion and aquatic food consumption that were not addressed in the base case.

As it was discussed earlier (under the modeling parameters), the cover erosion rate is calculated internally in RESRAD-OFFSITE based on the rainfall and runoff factor, soil erodibility factor, slope length-steepness factor, crop/cover management factor, supporting practice factor, and soil bulk density. These coefficients were specified the same as in Table E-5 in the draft EIS. The only exception was the crop/cover management factor that was adjusted to get the cover erosion rate of 1×10^{-3} m/yr, compared to an erosion rate of 10^{-5} m/yr used by DOE. This erosion rate results in the total cover disappearance in 5,000 years.

The aquatic food pathway was activated with the default RESRAD-OFFSITE parameters. The other modeling parameters were the same as in the base case, except the default runoff coefficient of 0.2 was used. The evaporation coefficient was adjusted accordingly to maintain the ambient infiltration rate of 3.5 mm/yr.

The results of this scenario are shown in Figures 20 and 21 for the other waste RH category and activated metals category respectively. The total dose (the sum of activated metals and other waste RH doses) are also plotted in these figures.

L293-199
(Cont.)

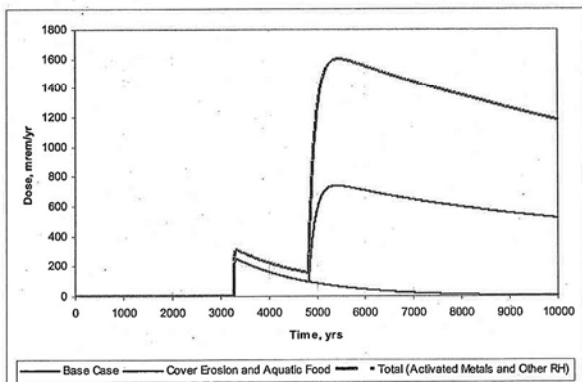

Figure 20. Base Case and Cover Erosion and Aquatic Food Scenario for the Other Waste Category (red line). The green line shows dose for the total source term (other waste plus activated metals)

Yakama Nation Environmental Restoration Waste Management Program,
Commenter ID No. L293 (cont'd)

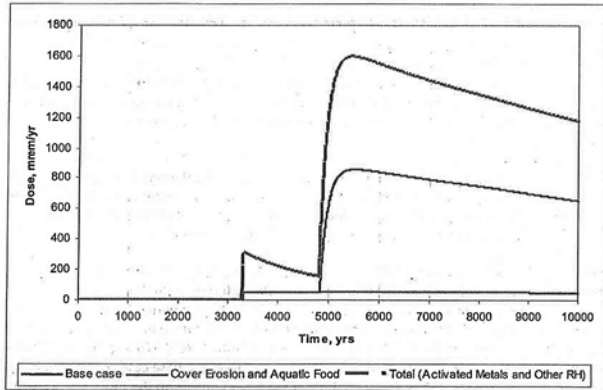

Figure 21. Base Case and Cover Erosion and Aquatic Food Scenario for the Activated Metals Category (red line). The green line shows dose for the total source term (other waste plus activated metals)

As can be seen from these figures, the cover erosion and aquatic food scenario significantly affects the total dose. In both cases, there is a second dose peak, which is 6.5 times higher than the 1st peak. The differences begin to surface when the cover starts to disappear (around year 5,000). At this moment the waste becomes exposed at the surface and is a subject of the surface water transport. The major contributors to the second peak are Cm-245, Pu-239, and Pu-240. The major pathway is the aquatic pathway.

Summary

One of the goals of this report was to attempt to reproduce the major results for the Hanford Site reported by DOE in the draft EIS. Two cases for the trench land disposal alternatives with the highest peak doses (Group 1 GTCC-like Stored Other Waste RH and Group 1 Projected GTCC Activated Metals) were selected for this purpose. An extensive review of the draft EIS and its major supporting reference (ANL 2010) was conducted to identify all the data required to do the simulations with the RESRAD-OFFSITE computer code and to clarify the modeling approach used in the draft EIS. Not all the data were found in these two documents and some of the statements in the draft EIS made regarding the modeling approach remain unclear.

The peak doses calculated for the selected two cases are different (higher for the peak dose within the 10,000 year period and lower for the peak dose within 10,000 to 100,000 year period) than the once estimated in the draft EIS. The major contributors and the timing of the peak doses are very similar to the ones in the draft EIS. The only way to resolve these differences would be to directly compare the RESRAD-

L293-199
(Cont.)

Yakama Nation Environmental Restoration Waste Management Program,
Commenter ID No. L293 (cont'd)

OFFSITE input files used in the draft EIS for these 2 cases with the input files developed as a part of this independent modeling.

Under the base case conditions assumed in the draft EIS for the Hanford Site the only radionuclides that reach the groundwater well within 10,000 years are I-129 and Tc-99, which are non-sorbing radionuclides with K_d equal to 0 (retardation factor equal to 1). The only radionuclides that reach the groundwater well within 100,000 years are isotopes of uranium and Np-237 with relatively low K_d s (retardation factor ranging from 1.5 to 23.5). Because these radionuclides are long-lived, the only effect of the engineered barriers under the Hanford specific conditions is in delaying the timing of the peak dose, the dose magnitude remains the same.

Another goal of this work was to conduct a sensitivity analysis in addition to the one included in the draft EIS. A number of parameters was considered in this additional study. The parameters that had small impact on the peak dose (within the parameter ranges considered) were: irrigation rate of grazing area and pasture area, well pumping rate, and the depth of aquifer contributing to pumping.

The infiltration rate and partition coefficients (K_d s) have the highest impact on the total dose. The radionuclide-specific dose is directly proportional to the ratio of the infiltration on the top of the waste and radionuclide specific retardation factor. The peak total dose within 10,000 year period is directly proportional to the infiltration rate on the top of the waste because in Hanford specific conditions the only contributors to the total dose during this period are non-sorbing radionuclides (I-129 and Tc-99). Because the infiltration on the top of the waste is defined as a percentage (20% in the base case considered in the draft EIS) of the ambient infiltration, the ambient infiltration has great impacts on the total dose as well.

The other parameters that have pronounced impacts on the total dose are: distance to the well; irrigation rate of fruits, grains, and non-leafy vegetables; and consumption fraction. Using more conservative than in the base case values for the sensitive parameters result in 5 time increase in the peak total dose.

Finally, one additional scenario was developed to evaluate the significance of the cover erosion and aquatic food consumption that were not addressed in the base case considered in the draft EIS. The cover erosion resulted in the surface water transport of highly sorbing radionuclides that were immobile in the base case scenario. These radionuclides (Cm-245, Pu-239, and Pu-240) were accumulated in the surface water body and resulted in the high total dose within the 10,000 year period related to the aquatic food consumption.

Conclusions

The ambient infiltration rate and the percentage of the ambient infiltration rate applied to the waste top are the most important parameters affecting the performance of all land disposal alternatives. These parameters should be re-evaluated for the Hanford Site. The possibility of a colder and wetter future climate should be considered when defining the ambient infiltration as well as a possible irrigation within the facility limits. A better justification should be provided for using 20% of ambient infiltration rate at the top of the waste.

The radionuclide partition coefficients (and corresponding retardation factors) are the other parameters of a great importance. These parameters were not studied in the sensitivity analysis included in the draft EIS. For the Hanford specific conditions, the partition coefficients of uranium and neptunium are of major concern.

L293-199
(Cont.)

Yakama Nation Environmental Restoration Waste Management Program,
Commenter ID No. L293 (cont'd)

The consumption fraction of 0.5 used in the draft EIS needs to be justified. The higher consumption fraction leads to a higher total dose because the food injection contributes 50% or more to the total dose.

The distance from the down-gradient edge of the waste to the facility fence used in the draft EIS was from 175 to 225 m. The well was placed 100 m from the fence. This translates in to the distance to the well of 275 to 325 m. Using of this distance needs to be justified. The actual facility design may result in the distance to the well as small as 50 m if located just outside of the facility fence. The closer location will result in a higher dose.

The base case scenario should consider cover erosion and aquatic food pathway because they may greatly affect the land disposal performance.

L293-199
(Cont.)

SECTION III

DEEP BOREHOLE LAND DISPOSAL ALTERNATIVE

The same approach that was used for simulating the trench land disposal alternative was implemented to simulate the deep borehole alternative. The GTCC-like Group 1 Stored Other Waste RH was considered in the simulation for the same reasons it was used in the trench simulations.

The radionuclide inventory at the beginning of simulation is the same as in the trench case. The radionuclide concentrations are different because the consolidated waste area and waste thickness are different for the borehole alternative – 270 m² and 10 m respectively (Table 4-2 in ANL 2010).

The radionuclide release rates in the borehole alternative are different from the trench one due to the different waste thickness (Equation 1). The values from Table 4-7 in ANL 2010 were used.

The thickness of the first unsaturated layer is 20 m smaller in the borehole alternative than in the trench alternative because the borehole waste interval is deeper.

The other parameters were kept the same as in the trench base case with the exception of the well which was placed on the down gradient edge of the waste. A different layout was used for agricultural areas and dwelling site, but their layout does not affect the contaminant concentrations in the well.

Three cases were considered. The first case is called Base Case. This case corresponds to the trench base case, but with the well next to the waste instead of 100 m away from the facility boundary.

The second case uses the more conservative ambient infiltration of 5 mm/yr (instead of 3.5 mm/yr) and more conservative percentage of infiltration applied at the waste top (40% instead of 20%). Also, the uranium isotope K_d s are assumed to be 0.06 mL/g in both, unsaturated layers and in the saturated zone. The ingestion fraction is 0.75 for all food types.

The third case uses the same parameters as the second case, except it assumes the irrigation of 0.2 m/yr on the top of the contaminated zone. The irrigation is incorporated by increasing the ambient infiltration rate to 50 mm/yr.

The results of these simulations are shown in Figure 22. The peak dose in the base case is 177 mrem/yr at 2,650 years and it is related to I-129 and Tc-99. The other radionuclides do not reach the ground water well in 10,000 years.

There are two total dose peaks in the second case. The first peak at 1,939 years (550 mrem/yr) is related to I-129 and Tc-99 and the second peak at 3,400 years (647 mrem/yr) is related mainly to the uranium isotopes.

There are 4 peaks in the third case. The first peak at 235 years (5,050 mrem/yr) is related to I-129 and Tc-99. The second peak at 372 years (6,431 mrem/yr) is related mainly to uranium isotopes. The third peak at 3,707 years (62 mrem/yr) is related to Np-237. The fourth peak at 5,897 years (195 mrem/yr) is related to Np-237.

L293-199
(Cont.)

Yakama Nation Environmental Restoration Waste Management Program,
Commenter ID No. L293 (cont'd)

Note that the infiltration rate and radionuclide specific partition coefficient have the greatest impacts on the total dose. The distance to the well is of less importance because the radionuclide transport in the saturated zone is significantly faster than in the unsaturated zone.

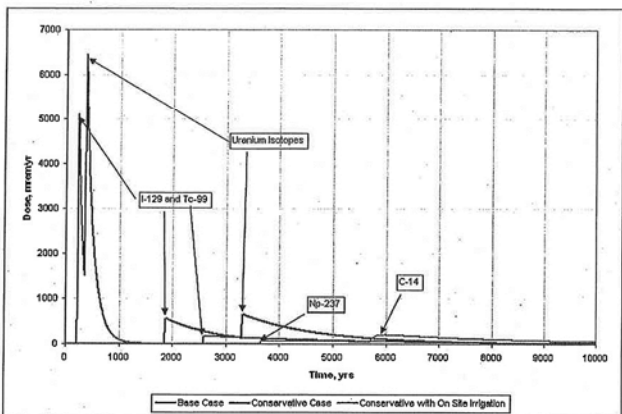

Figure 22. Borehole Land Disposal Alternative for the Group 1 GTCC-Like Stored Other Waste - RH Category

L293-199
(Cont.)