

1
2
3
4
5
6
7
8
9
10
11
12
13
14
15
16

APPENDIX K:
HYDROPOWER SYSTEMS TECHNICAL INFORMATION AND ANALYSIS

1
2
3
4
5
6
7
8
9
10
11
12
13
14
15

This page intentionally left blank

APPENDIX K:

HYDROPOWER SYSTEMS TECHNICAL INFORMATION AND ANALYSIS

This appendix provides details on three analyses that are related to hydropower system electricity production, powerplant capacity, costs, and electricity service charge rates and that are conducted for the Glen Canyon Dam Long-Term Experiment and Management Plan (LTEMP) Draft Environmental Impact Statement (DEIS). The first analysis (presented in Section K.1) evaluated the impacts of changes in Glen Canyon Dam operations associated with LTEMP alternatives on the economic value of the powerplant’s capacity and energy production. The impacts were measured in terms of changes in the value of regional power system capacity (the power system comprised of Western’s long-term firm (LTF) customers) and overall system-level electricity production costs (the entire Western Interconnection). The second analysis (presented in Section K.2) studied how system resources and operations under LTEMP alternatives affect the wholesale electricity rates paid by utility entities that receive federal preference power produced by Glen Canyon Dam. The third analysis (presented in Section K.3) studied the effects of alternatives on electricity rates paid by retail customers.

K.1 ECONOMIC VALUE OF GLEN CANYON DAM POWERPLANT CAPACITY AND ENERGY PRODUCTION

This first analysis studied the impacts of changes in Glen Canyon Dam Powerplant operations associated with LTEMP alternatives on the economic value of its capacity and energy production. Power system impacts are measured in terms of increases in capacity expansion expenditures and overall electricity production costs that would result from changing current Glen Canyon Dam operating criteria to different operating criteria as defined under LTEMP alternatives.

K.1.1 Power Systems Background

The Glen Canyon Dam Powerplant generates large amounts of energy that yield economic benefits to the grid. It also provides the grid with firm capacity that contributes to system reliability. Argonne National Laboratory (Argonne) staff conducted a power systems analysis of Glen Canyon Dam’s economic benefits under each of the main alternatives defined by the LTEMP DEIS. These alternative-specific operating criteria are summarized in Table 2-1 of the DEIS.

The total water release volume from Lake Powell during each water year (WY) is nearly identical under all alternatives (see Section 4.2). However, at varying restriction levels, alternative criteria define the daily and hourly operational flexibility at Glen Canyon Dam, and affect Lake Powell reservoir elevations and monthly water release volumes. LTEMP alternatives also differ in their inclusion of various experimental releases such as high flow experiments

1 (HFEs) and trout management flows (TMFs). The frequencies of these experimental releases
2 differ among the alternatives.
3

4 Glen Canyon Dam energy production serves the electricity demands (loads) of a dynamic
5 system that responds to its operations. Therefore, economic impacts of changes in Glen Canyon
6 Dam operations are measured for the system as a whole. Some of the responses to changes in
7 Glen Canyon Dam operating criteria, such as system unit dispatch adjustments, would occur very
8 quickly. System dispatch refers to the amount of generation that each powerplant unit produces
9 over time to match system loads plus system energy losses. In contrast, other system responses
10 are much slower. For example, Glen Canyon Dam operating criteria affect its maximum output
11 at times of peak load, and therefore system-wide capacity expansion pathways; that is, the timing
12 and type of new units that will be built in the future. This methodology measures the spectrum of
13 system economic impacts from hourly time intervals to multi-year processes.
14

15 The system modeled consists of 11 hydropower plants (including the Glen Canyon Dam
16 Powerplant) marketed and scheduled by the Colorado River Storage Project (CRSP)
17 Management Center of the Western Area Power Administration (Western), the loads of all LTF
18 power customers, and the resources owned and operated by the eight LTF power customers that
19 have the largest allocations of capacity and energy (see Section K.1.3.2 for more detail). The
20 combined loads and resources of these entities are referred to at the Salt Lake City Area
21 Integrated Projects (SLCA/IP) market system.
22

23 Each aspect of an LTEMP alternative affects the economic value of this system. This
24 analysis focuses on the total differences in the economic value of SLCA/IP federal hydropower
25 resource among alternatives benchmarked to existing operating criteria (Alternative A, the no
26 action alternative). This difference is referred to as the economic cost of an alternative and is
27 quantified as the net present value (NPV) of the cost that would be accrued during the 20-year
28 LTEMP period. System interactions with the broader Western Interconnection are also
29 represented. It should be noted that this is an economic analysis that measures the net cost
30 difference for the system as a whole, not a financial analysis of individual entities (e.g., a utility
31 company) that operate within the system.
32

33 Operating criteria impact power economics because they affect the timing and routing of
34 water releases through the dam. From a system dispatch perspective, power produced by
35 Glen Canyon Dam yields the highest economic benefits when the limited amount of water
36 released during a WY is routed through the powerplant's generating turbines to produce power
37 during seasons of the year and times of the day when it displaces either energy generation or
38 demand curtailment from expensive grid resources. For example, Glen Canyon Dam has a high
39 economic value when the energy it produces either reduces or eliminates the operation of a
40 generating unit with a high production cost. On the other hand, it has a much lower value when it
41 displaces lower-cost power generation.
42

43 During most HFEs, water release rates from Glen Canyon Dam are greater than the
44 maximum flow rate of the powerplant's turbines. Therefore, some water is released through the
45 dam's hollow jet tubes, bypassing powerplant turbines. Non-power water releases such as these
46 produce no electricity and therefore yield no energy value. Because water is limited, the bypass

1 water reduces the overall economic value of power because this water could have otherwise been
2 stored in Lake Powell and released to produce energy at another time to displace the dispatch of
3 more costly system resources.
4

5 Glen Canyon Dam capacity also has considerable value because the powerplant can
6 generate power during times of peak demand. Without the Glen Canyon Dam Powerplant, other
7 resources would need to be constructed or acquired in order to ensure that the system had
8 adequate generating capabilities available to reliably meet system loads. The Glen Canyon Dam
9 power resource therefore avoids investments and fixed operating and maintenance (O&M) costs.
10 Alternative operating criteria affect peak Glen Canyon Dam Powerplant operations and therefore
11 the amount of capacity the system can rely upon to meet system peak loads.
12

13 The methodology used for power systems analysis mimics decisions that could be made
14 by system entities based on contractual and financial considerations that affect economic
15 outcomes. For example, the borrowing rate for capital may impact both capacity expansion
16 decisions and therefore economic outcomes. Economic costs include the following components:
17 (1) energy production costs for the entire system and (2) capital investment plus fixed O&M
18 costs for constructing and operating units built for system capacity expansion. Energy production
19 costs are comprised of fuel expenditures, variable O&M costs, and unit startup expenses. All
20 costs are estimated over the 20-year LTEMP period starting at the beginning of calendar year
21 (CY) 2015 and extending through the end of CY 2034. To be consistent with the analyses
22 performed for other resource areas, the start of the study period was adjusted to CY 2015. Please
23 refer to Section K.1.9 for a description of how the adjustment was made. Emphasis is placed on
24 accurately estimating the cost of an alternative compared to Alternative A in terms of both
25 economic ranking and the relative magnitude of cost differences. Therefore, costs such as fixed
26 O&M costs are not computed for existing units that remain unchanged across all alternatives.
27
28

29 **K.1.2 Glen Canyon Dam, Reservoir, and Powerplant Background**

30

31 Glen Canyon Dam is a U.S. federal resource that was built by the Bureau of Reclamation
32 (Reclamation) between 1956 and 1964 as part of the CRSP that was authorized by the Colorado
33 River Storage Project Act on April 11, 1956. The Act authorized the Secretary of the Interior to
34 develop the water resources of the Upper Colorado River Basin by constructing, operating, and
35 maintaining the CRSP and other participating reclamation projects. The dam is a 710-foot-high
36 concrete arch structure with a crest length of 1,560 ft, containing 4,901,000 yd³ of concrete. The
37 thickness of the dam at the crest is 25 ft, and its maximum base thickness is 300 ft. The reservoir
38 formed by the dam, Lake Powell, has a total water storage capacity of 27 million acre-feet (maf),
39 with an active capacity of approximately 20.9 maf when full. Under normal water surface
40 elevation levels, the reservoir has a length of 186 mi and a surface area of 161,390 ac. The dam
41 controls a drainage basin approximately 108,355 mi² (Harpman and Rosekrans 1996).
42

43 Currently, there are eight generating units at Glen Canyon Powerplant with a total
44 sustained operating capacity of approximately 1,320 megawatts (MW). The first two Glen
45 Canyon units began generating power in September 1964, and the eighth and final unit came
46 online in February 1966, as recorded in Power Operations and Maintenance Form 59 (Form

1 PO&M-59). When water is released from the reservoir through power plant turbines, the energy
2 generated serves the electricity demands of consumers located in the SLCA/IP market system.
3

4 Lake Powell was filled for the first time in 1980, when it reached a maximum reservoir
5 water elevation of 3,700.6 feet (ft). Displacing power generation and associated air emissions
6 mainly from powerplants that burn fossil fuels such as coal, oil, and natural gas, the average
7 annual gross electricity generation from the Glen Canyon Dam Powerplant between CY 1980
8 and 2013 was about 4,716.5 GWh. This statistic does not include generation production for years
9 prior to 1980, because a portion of water inflows into Lake Powell were used to fill the reservoir
10 prior to that time. From 1980 through 2013, annual generation has varied by more than a factor
11 of 2.6. Generation was at a low of 3,299 GWh in CY 2005 and at a high of 8,703 GWh in CY
12 1984. The high level of annual generation variability of the Glen Canyon Dam Powerplant since
13 1980 is mainly attributable to variations in Lake Powell inflow levels, which are strongly
14 influenced by precipitation. Hydropower variability and uncertainty reduce its value because at
15 times these resources have reduced energy production and peak output capabilities. Therefore,
16 other resources need to be made available to serve system loads and reliability requirements.
17

18 Operational limitations at Glen Canyon Dam were minimal from 1964 through May
19 1990. Minimum releases from Lake Powell were 1,000 cfs from Labor Day to Easter and
20 3,000 cfs during the rest of the year. These minimums are only a small fraction, approximately
21 3% to 9%, of the physical maximum turbine flow rate of 33,000 cfs at full reservoir. There were
22 no institutional limitations on maximum flow rates, hourly ramping, or daily changes in flow.
23 The relatively low minimum release rate requirement, combined with limits that were only
24 constrained by the physical powerplant and dam characteristics, allowed for flexible operations
25 that maximized the economic or financial value of hydropower generation.
26

27 Many interested parties became increasingly concerned about the effects of rapid changes
28 in Glen Canyon Dam water releases on the downstream riverine environment, including the
29 impacts they could have on endangered species. Legislation was introduced in Congress in 1990
30 addressing dam operations after the Glen Canyon Environmental Studies Program published its
31 report in 1987 describing the impacts of dam operation on the national and recreational resources
32 of the Grand Canyon. Reclamation began to restrict operations on June 1, 1990, when it
33 conducted research discharges as part of the Glen Canyon Environmental Studies. Numerous test
34 flows were conducted during a 14-month period that concluded at the end of July 1991. The
35 purpose of these research releases was to collect and analyze data at different flow levels in order
36 to investigate the effects of flow patterns on the riverine environment downstream of Glen
37 Canyon Dam. Interim flow operating constraints were imposed at Glen Canyon Dam on
38 August 1, 1991, and were in effect until February 1997, when new operational rules and project
39 management goals were adopted to comply with the 1996 Glen Canyon Dam Environmental
40 Impact Statement Record of Decision (ROD).
41

42 The 1996 ROD requires releases from Lake Powell to be at least 8,000 cfs between the
43 hours of 7:00 a.m. and 7:00 p.m., and 5,000 cfs or more during all other hours of the day. The
44 maximum allowable release is limited to 25,000 cfs. In very high release months, the maximum
45 limit can be exceeded, but the release rate must be constant during the entire month. The
46 1996 ROD operating criteria also limits release fluctuations during all rolling 24-hour periods.

1 The fluctuation level permitted depends on the amount of water that will be released from Glen
2 Canyon Dam during a month. The allowable daily fluctuation is 5,000 cfs/24 hours when the
3 monthly scheduled water release is less than or equal to 600 kaf. Daily fluctuations are restricted
4 to 6,000 cfs/24 hours for those months in which the scheduled release is equal to or greater than
5 600 kaf but less than 800 kaf, and at 8,000 cfs/24 hours for months with releases equal to or
6 greater than 800 kaf. Finally, the 1996 ROD operating criteria also limited the rate at which Lake
7 Powell water release are allowed to ramp up and down. The maximum ramp rate is 4,000 cfs/hr
8 when increasing, and 1,500 cfs/hr when decreasing. Operating criteria reduced the flexibility of
9 operations, diminished dispatchers' ability to respond to market price signals, and decreased the
10 economic power benefits of the Glen Canyon Dam. Between 1997 and 2005, this decrease in
11 economic benefit was estimated to range from \$38 million to \$50 million per year (in 2009\$)
12 (Veselka et al. 2010). This range may not be indicative of future economic costs due to a number
13 of factors including changes in power market structures and utility fuel prices.
14

15 The 1996 ROD operating criteria include "emergency exception criteria" that recognize
16 the fact that the Glen Canyon Dam Powerplant is an important grid resource. When emergency
17 exception criteria are invoked, normal operations are suspended until the emergency has ended
18 or Western has been cleared of its North American Electric Reliability Corporation (NERC)
19 emergency operation responsibilities. Emergency exception criteria allow Glen Canyon Dam to
20 dispatch up to all of its available capacity at Glen Canyon Powerplant, depending on the severity
21 of the system emergency, by rapidly increasing generation output in response to events such as
22 insufficient system generating capacity, transmission system problems, and system restoration.
23

24 In addition, Glen Canyon Dam generators provide system regulation to Western as the
25 operator of the Western Area Colorado Missouri (WACM) balancing authority (BA) area. The
26 Glen Canyon Dam Powerplant responds to a regulation signal developed and electronically
27 transmitted to the dam by Western for continuous response to power system load and frequency
28 changes. Western is required to react to moment-by-moment changes in system frequency, time
29 error, and tie-line loading within the WACM BA via powerplant automatic generation control
30 (AGC) equipment at Glen Canyon Dam and some of the other SLCA/IP federal hydropower
31 plants to adjust the power output of the generators to match variations in system load in
32 accordance with prescribed NERC criteria. The degree to which Western responds to these
33 system changes is computed by an area control error (ACE) equation.
34

35 The ACE signal that is sent to Glen Canyon Dam adds to or subtracts from the existing
36 scheduled hourly generation set point. Therefore, at any instant in time, the powerplant is
37 typically producing more or less power than the current hourly scheduled set point. Deviations
38 from the set point typically fluctuate from negative to positive values many times during any
39 hour. However, the resulting output from Glen Canyon generators on average approximates the
40 hourly scheduled level. Because post-ROD operating criteria specify release restrictions in terms
41 of hourly average levels, Glen Canyon Dam can provide regulation services while scheduling set
42 point levels at minimum and maximum allowable flow limits. It can also ramp set points within
43 up and down limitations (see <http://www.wapa.gov/crsp/planprojectscrsp/gcopswhite.html>).
44

1 The 1996 ROD operating criteria currently restrict Glen Canyon Dam operations in terms
2 of both the operational range of water releases and the rate at which water releases are permitted
3 to change over time. It also provides the operating criteria for Alternative A.
4

6 **K.1.3 Power Systems Geographic Scope**

7

8 The Glen Canyon Dam Powerplant is part of a large dynamic power grid that responds to
9 its operations. It is also a component of Western's SLCA/IP, which is comprised of 11 federal
10 hydropower facilities marketed and scheduled by the CRSP Management Center. Western
11 markets these facilities as a bundled resource. Therefore, power economic impact analyses are
12 based on a systems approach that measures the collective responses of system components to
13 changes in Glen Canyon Dam operating rules and experimental releases. The focus area is on
14 SLCA/IP federal hydropower resources, and the utilities operated by Western's SLCA/IP LTF
15 power customers. For the purpose of this appendix, this primary impact area is referred to as the
16 SLCA/IP market system (or SLCA/IP system). However, as described in more detail below, the
17 methodology also recognizes that this system does not operate in isolation. Instead, it interacts
18 with the much larger Western Interconnection power grid.
19

20 The power systems method uses a three-tiered approach. All simulate the system on an
21 hourly basis over the 20-year LTEMP period. The top tier models the loads and resources of the
22 entire Western Interconnection to gain a broad perspective on the future development of the
23 larger overall system. Both Western Interconnection system capacity expansion and economic
24 system dispatch are modeled.
25

26 The middle tier models SLCA/IP LTF customer utility loads and resources along with
27 future Western Interconnection interactions via non-firm bilateral energy transaction. It also
28 projects SLCA/IP market system future capacity additions, determines day-ahead unit
29 commitments, and performs economic dispatch. It focuses on SLCA/IP customer resources at a
30 higher level of fidelity than the Western Interconnection tier. The top and middle tiers both rely
31 on projections found in the *Annual Energy Outlook* (EIA 2014) published by the U.S. Energy
32 Information Administration (EIA). The *Annual Energy Outlook* uses an even broader perspective
33 that incorporates overall U.S. and global macroeconomic drivers into the projection of
34 U.S. energy futures.
35

36 The bottom tier focuses on SLCA/IP federal hydropower resources. It models the long-
37 term management and routing of water resources within the Colorado River Basin, including
38 those river reaches below Glen Canyon Dam. Future water management is compliant with all
39 applicable laws and water rights. Given this projection of long-term water management,
40 simulation of powerplant dispatch is performed based on market price drivers projected by the
41 Western Interconnection tier and key physical and institutional constraints on reservoir
42 operations and powerplant dispatch. Hourly dispatch is subject to numerous physical and
43 institutional constraints, including those specified under an LTEMP alternative.
44

45 The top tier represents a large geographical area, but at a relatively low level of fidelity.
46 Increasing attention to detail and accuracy is paid as the geographical coverage becomes more

1 focused. By using this approach, power systems comparative analyses are able to determine how
2 changes in Glen Canyon Dam Powerplant operations affect its economic value. This top-down
3 modeling approach is further described below. More details about the selection of the power
4 system’s geographical scope and detail are provided in Attachment K-1.
5
6

7 **K.1.3.1 Top Tier: General Western Interconnection Perspective Modeling**

8

9 North America is comprised of two major and three minor alternating-current power
10 grids. The Western Interconnection is the major power grid that stretches from Western Canada
11 south to Baja California in Mexico, and eastward from the Pacific Ocean to the Rockies and the
12 Great Plains. All of the electric utilities in the Western Interconnection are electrically tied
13 together during normal system conditions and operate at a synchronized frequency that averages
14 60 Hz. The Western Electricity Coordinating Council (WECC) region of NERC facilitates
15 regional transmission expansion planning for the interconnection, and the Western Governors’
16 Association acts as a state/provincial steering committee. These entities work collaboratively to
17 develop long-term electricity supply futures, estimate transmission requirements, and prepare
18 long-term interconnection-wide transmission plans (see [http://energy.gov/oe/services/electricity-
19 policy-coordination-and-implementation/transmission-planning/recovery-act-0](http://energy.gov/oe/services/electricity-policy-coordination-and-implementation/transmission-planning/recovery-act-0)).
20

21 Argonne power system analysts modeled the long-term capacity expansion, unit
22 commitments, and hourly unit dispatch of Western Interconnection resources using the
23 AURORAxmp model (referred to as AURORA). The Western Interconnection topology and
24 supporting model inputs were provided by EPIS, Inc., the AURORA model developers. A
25 depiction of this topology is shown in Figure K.1-1. Each “bubble” in the diagram roughly
26 represents groups of utilities, single BAs, or combinations of BAs. Bidirectional limits on the
27 links that connect bubbles restrict network energy transfers. User-defined limits can vary hourly.
28 The location of SLCA/IP federal hydropower resources in the AURORA Western
29 Interconnection topology is indicated in the figure. The Glen Canyon Dam Powerplant is labeled
30 “GC,” and the Flaming Gorge and Fontenelle Powerplants are labeled “FG” and “FN,”
31 respectively. The location of powerplants in the Wayne D. Aspinall Cascade and all other
32 SLCA/IP hydropower plants is labeled “Aspinall & Others.”
33

34 The primary driver of many variables that define Western Interconnection future
35 developments were based on projections published in EIA’s 2014 *Annual Energy Outlook*
36 (hereafter 2014 AEO; EIA 2014) for the reference scenario that was released in April 2014.
37 Model results are consistent with state integrated resource plans (IRPs). A more detailed
38 description of AURORA is provided in Section K.1.5.9.
39

40 In addition to estimating the capacity expansion pathways and system production costs,
41 AURORA also projects future locational marginal prices (LMPs) throughout the Western
42 Interconnection. The LMPs measure the incremental cost to serve an additional 1 MW of load at
43 a specific point in the grid; that is, the cost to change the dispatch of system resources to serve a
44 slightly higher load. This typically involves increasing the power generation at one of more units
45 or reducing loads via a demand response management (DSM) agreement.
46

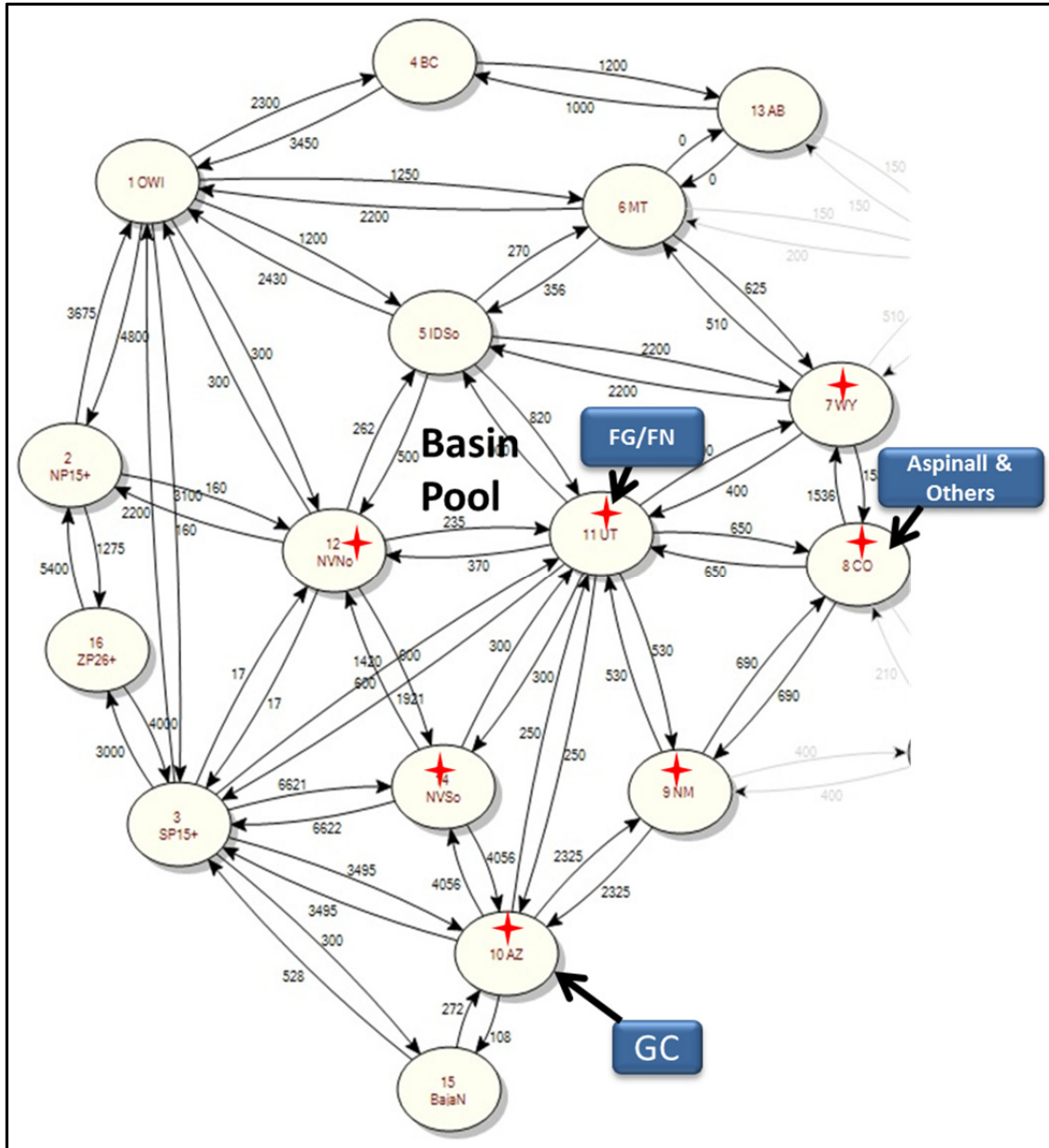

1

2 **FIGURE K.1-1 Network Topology Used by the AURORA Western Interconnection**
 3 **Model**

4
 5

6 AURORA Western Interconnection projections of hourly LMPs at the Palo Verde
 7 marketing hub are used by the LTF customer and Western SLCA/IP federal resource tiers
 8 (i.e., middle and bottom tiers). This hub was selected as a representative point for LTEMP EIS
 9 modeling because prices at this location are often used by schedulers at the Western’s Montrose
 10 Energy Management and Marketing Office (EMMO) as a benchmark for short-term bilateral
 11 transactions. Palo Verde hub prices have also been used extensively in the past for other
 12 economic and financial analyses of SLCA/IP hydropower resources (see <http://www.usbr.gov/lc/region/programs/strategies/FEIS/AppO.pdf> and <http://www.usbr.gov/uc/envdocs/eis/>)

1 AspinallEIS/Vol2-Appdx-D.pdf). As discussed in Attachment K-1, investigations by Argonne
2 indicate that alternative operations at Glen Canyon Dam will have a negligible impact on
3 Western Interconnection LMP levels and patterns outside of the SLCA/IP market system, and are
4 therefore assumed to be static (i.e., given values) and identical under all alternatives.
5

6 LTEMP alternatives will have a relatively small impact on bilateral market interactions
7 between the SLCA/IP market system and the rest of the Western Interconnection; that is, a
8 maximum decrease of about 4.3% for power sales and decrease of 1.4% for power purchases.
9 The use of LMPs to measure the economic impact of changes in Western Interconnection
10 transactions yields a very good approximation because the LMP represents the system resource
11 cost to serve the marginal load at a specific point. Therefore, a SLCA/IP market system sale to
12 the Western Interconnection displaces higher cost generation in the interconnection. Likewise, a
13 power purchase by the SLCA/IP market system displaces higher cost generation in the SLCA/IP
14 system by increasing production in the interconnection at a cost that approximately equals the
15 LMP at the Palo Verde hub minus transmission costs.
16
17

18 **K.1.3.2 Middle Tier: LTF Customer Utility Systems**

19
20 The primary focus of the power systems analysis is the SLCA/IP federal hydropower
21 resources and the utilities operated by its LTF power customers. The SLCA/IP federal
22 hydropower resources that the CRSP Management Office markets and the Montrose EMMO
23 schedules are described in more detail in Section K.1.3.3. This section describes the
24 approximately 138 customer entities that have SLCA/IP LTF contractual agreements
25 with Western.
26

27 Western sells power to wholesale power customers on both a firm and non-firm basis,
28 including cities and towns, rural electric cooperatives, public utility and irrigation districts,
29 federal and state agencies, investor-owned utilities, power marketers, and American Indian
30 Tribes (Tribes). In total, these entities provide retail electric service to millions of consumers in
31 the Western Interconnection. However, others are end-use customers, including federal and state
32 agencies, and irrigation districts that use power directly for their own purposes. Various laws,
33 including the Reclamation Project Act of 1939 and the Federal Power Act, require Western to
34 give preference to certain types of nonprofit organizations seeking to purchase federal power.
35 Those entitled to preference status include cities and towns, state and federal agencies, irrigation
36 districts, public utility districts, rural electric cooperatives, and Tribes (see
37 <https://www.wapa.gov/About/Pages/customers.aspx>).
38

39 For economic analysis purposes, the system modeled in the middle tier includes LTF
40 customers that are categorized as either large or small. Accounting for about 75% of Western's
41 LTF energy and capacity sales, the eight largest customers, in terms of capacity and energy
42 allocation, are Deseret Generation and Transmission Cooperative (Deseret), the Navajo Tribal
43 Utility Authority (NTUA), Salt River Project (SRP), Utah Associated Municipal Power Systems
44 (UAMPS), Utah Municipal Power Agency (UMPA), Platte River Power Authority (PRPA), Tri-
45 State Generation and Transmission Association (Tri-State), and Colorado Springs Utilities
46 (CSU). Except for NTUA, all large LTF customers own and operate generating resources. About

1 130 remaining customers were aggregated for the analysis into two “small customer” entities
2 accounting for the remaining 25% of LTF sales. Individually, each small customer receives less
3 than 2.5% of Western’s total SLCA/IP LTF capacity and energy sales. Last, Western has LTF
4 contracts to serve project use loads such as pumping for irrigation. Serving these loads has the
5 highest priority for delivery.
6

7 In CY 2013, the eight large SLCA/IP LTF power customers owned and contracted for the
8 use of specific physical resources. Based on data contained in EIA Form-860 and information
9 obtained from both IRPs and the EPIS AURORA database, the total firm capacity of these
10 resources was approximately 12,670 MW. As discussed in more detail in Section K.1.7.5, firm
11 capacity in this power systems study is based on the maximum output level that a resource is
12 expected to reliably produce during the time of peak demand. For some generating units, the firm
13 capacity is significantly different from the nameplate capacity.
14

15 As shown in Figure K.1-2, over 50% of this capacity is owned by SRP and another 19%
16 is owned by Tri-State. The remaining six large customers account for the remainder. In addition
17 to these supply resources and the aforementioned SLCA/IP LTF contracts, additional firm
18 capacity for is secured through other federal power purchases from Western’s Loveland Area
19 Projects and the Desert Southwest Offices and through non-federal power contracts. In addition,
20 DSM measures are credited as firm capacity resources. Based on data contained in Federal
21 Energy Regulatory Commission (FERC) Form-714 and utility IRPs, these resources and non-
22 firm energy transactions were used to serve combined service territory loads of almost 61 TWh
23 in CY 2013.
24
25

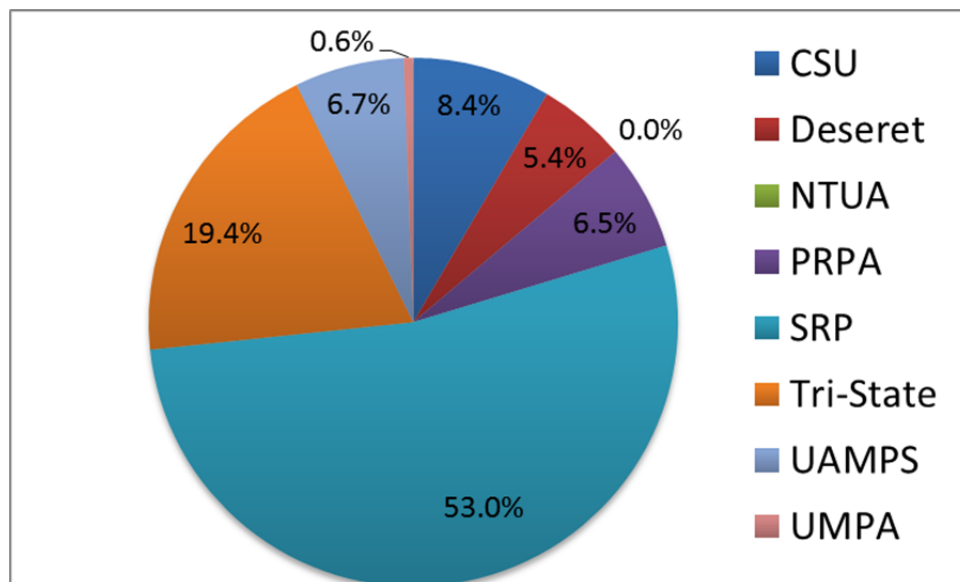

26
27 **FIGURE K.1-2 SLCA/IP LTF Customer Capacity Ownership Percentages**
28
29

1 Figure K.1-3 shows a simplified topology for the SLCA/IP market systems that was used
 2 by the AURORA model. It contains both large and small LTF customers. Where applicable,
 3 bubbles for large customers (shown as Pool A in Figure K.1-3) contain both loads and resources.
 4 Depending on the customer's location, loads and resources are designated as east or west
 5 regional entities. In the figure, small customer and project use bubbles only contain loads that
 6 have been aggregated by location. Energy flows among entities via system linkages. Some links
 7 have limitations and/or associated costs. More details about the SLCA/IP market system
 8 topology are described in Section K.1.6.

9
 10 It should be noted that the Glen Canyon Dam Powerplant and all other federal
 11 hydropower plants are modeled as resources that are directly available to Western's customers.
 12 In reality, energy and capacity from these resources are sold by the CRSP Management Center to
 13 customers through LTF contracts. Argonne staff, in consultation with Western, Reclamation, and
 14 the NPS, decided not to include a representation of these contracts in the modeling process
 15 because the vast majority of the SLCA/IP federal resource ultimately serves LTF customer loads
 16 and capacity needs. Financial complications associated with covering short-term and hourly long
 17 and short energy positions would have made the modeling process significantly more expensive
 18 and time consuming. It was also judged to have little impact on the assessment of the relative
 19 impacts of LTEMP alternatives. Given the time and budget constraints, it was decided that the
 20 more direct approach of modeling hydropower resources was sufficient.

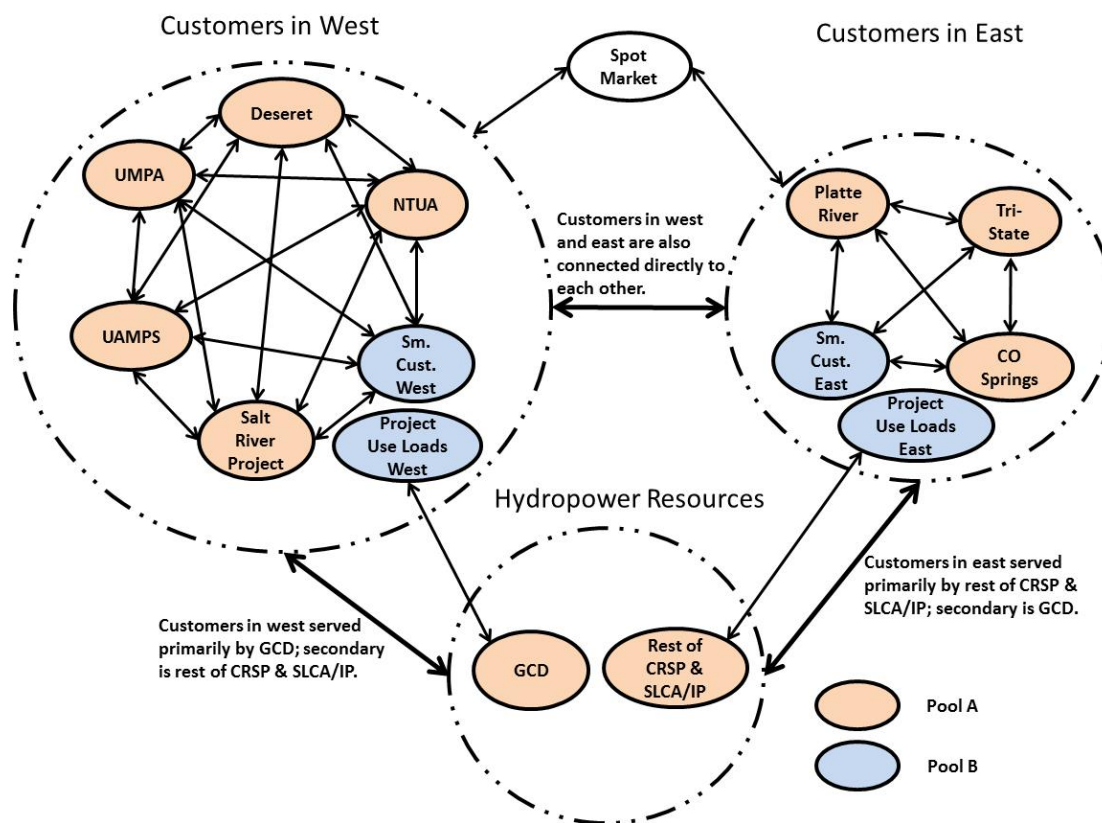

23
 24 **FIGURE K.1-3 Simplified Network Topology of the SLCA/IP Market System**

1 Power systems modeling of the SLCA/IP market system assumes a very high level of
2 cooperation and coordination among Western and its LTF power customers. Capacity expansion
3 planning, unit commitment schedules, and least-cost hourly dispatch for the entire system were
4 based on a “single operator/decision maker” model. This is a higher level of cooperation and
5 coordination than what actually occurs. However, Western and its customers do cooperate on a
6 number of different levels. For example, several large LTF customers jointly own capacity of
7 some of the same facilities. They also buy and sell energy through long-term, day-ahead, and
8 hour-ahead bilateral agreements using various market signals. The SLCA/IP market system
9 topology also includes energy transfer costs that dampen power transfers relative to a “single-
10 decision maker” model that does not incur these costs.

11
12 The AURORA topology of the SLCA/IP market system does not model physical
13 transmission constraints. It does, however, limit flows on some links between bubbles. Energy
14 flows on links connecting SLCA/IP federal hydropower resources to LTF customer loads are
15 limited by contract rate of delivery (CROD) allocations (Western 2015). CROD is the firm
16 capacity the CRSP Management Center agrees to have available for delivery. It may or may not
17 be accompanied by energy supplied by Western (see [https://www.wapa.gov/crsp/opsmaintcrsp/
18 dictionary.htm#c](https://www.wapa.gov/crsp/opsmaintcrsp/dictionary.htm#c)). When not all of the CROD is being utilized for Western power deliveries, a
19 customer can use the remainder to schedule the delivery of other energy transactions. In addition,
20 5% of the energy that flows on these links is lost between the point of injection and the delivery
21 point. This represents EMMO current transmission losses for SLCA/IP federal hydropower
22 deliveries. Under wet hydrological conditions in which SLCA/IP total federal hydropower
23 generation exceeds the total CROD, the excess energy flows on links that represent shorter term
24 Western energy transactions with its LTF customers.

25
26 Regardless of the amount of firm capacity that is available from SLCA/IP federal
27 hydropower resources, Western’s CROD is assumed to be identical under all alternatives.
28 Currently, some customers voluntarily use the difference between the CROD and sustainable
29 hydropower (SHP) on Western’s transmission system for customer displacement power (CDP).
30 The SHP is the minimum amount of power and energy the EMMO must deliver to its LTF
31 customers regardless of SLCA/IP federal hydropower conditions. The CDP replacement option
32 is specified under an amendment to the SLCA/IP firm electric service contract to accommodate
33 replacement power decisions. Therefore, it is assumed that any loss in firm capacity under an
34 alternative will free up transmission capacity for CDP transactions (Loftin et al. 1998).

35
36 Transfers of energy among LTF customers are virtually unconstrained, which may at
37 times lead to an overestimation of the amount of energy transfers among LTF customer utilities.
38 However, there are significant on- and off-peak costs for energy flows on lines that connect
39 customers to each other. These costs tend to dampen bulk power transactions among the bubbles.
40 Information from Western regarding hourly transmission rates for five of Western’s large
41 customers and six other investor-owned utilities in the surrounding area (Wicks 2014) was used
42 to set transfer costs on links between any two firm electric service customers to \$6.5/MWh and
43 \$3.5/MWh for peak and off-peak, respectively.

1 Lastly, it is assumed that new capacity built as a result of any losses at Glen Canyon Dam
2 will be located near load centers freeing up transmission at peak times between remotely located
3 Glen Canyon Dam and major loads. This would also result in a somewhat lower energy loss on
4 the transmission lines since more heavily loaded lines during peak hours have higher losses than
5 during cooler off-peak periods. For example, lost capacity from SRP would be built near the
6 Phoenix load center. This will free up transmission between Glen Canyon Dam and Phoenix.
7 These potential advantages were not quantified in this analysis.
8

9 Assumptions and simplifications associated with the topology and representation of the
10 SLCA/IP market system may produce modeling errors in some situations. However, the intent of
11 the power systems analysis is to perform a comparative economic study to identify the relative
12 ranking and magnitude of alternative impacts using Alternative A as a benchmark. Because these
13 inaccuracies are present in the evaluation of all alternatives, errors in differences among
14 alternatives may be somewhat muted. Despite the simplifying assumptions and potential
15 inaccuracies, the AURORA dispatch model does provide reasonable results for LTEMP power
16 systems analyses. As discussed in more detail in Section K.1.6.2, a 2013 benchmark analysis of
17 utility-level generation by fuel type for the eight large customers modeled by AURORA were
18 very similar to values reported by each utility in EIA Form-923. This result gave Argonne
19 modelers some degree of assurance that, from a production cost standpoint, the modeling
20 approach captured the essence of the dispatch.
21
22

23 **K.1.3.3 Bottom Tier: Western SLCA/IP Hydropower Resources**

24
25 Of the three analysis tiers, the bottom tier is modeled at the finest level of granularity. It
26 simulates the hourly operation of Western's 11 SLCA/IP powerplants that are marketed and
27 scheduled by the CRSP Management Center. For this study, six of these facilities are classified
28 as large plants. The largest is at Glen Canyon Dam. Its powerplant consists of eight generating
29 units with a combined capacity of about 1,320 MW. As shown in Figure K.1-4, Glen Canyon
30 Dam accounts for about 72% of Western's total SLCA/IP federal hydropower nameplate
31 capacity. Other SLCA/IP federal hydropower plants in the system that are classified as large
32 SLCA/IP federal hydropower facilities include powerplants contained in the CRSP and the
33 Seedskaadee Project. All large plants except Fontenelle are in the CRSP. The Blue Mesa
34 Powerplant has two generators, the total capacity of which is 86.4 MW. Located 12 mi
35 downstream from Blue Mesa on the Gunnison River, the Morrow Point Power Plant has two
36 units with a combined capacity of 165 MW; another 6 mi farther downstream, the Crystal
37 Powerplant has an installed capacity of approximately 32 MW from one unit. Blue Mesa,
38 Morrow Point, and Crystal are part of the Wayne D. Aspinall Cascade (also referred to as the
39 Aspinall Cascade). The Fontenelle Powerplant has a nameplate capacity of 10 MW and it is the
40 only powerplant associated with the Seedskaadee Project. Flaming Gorge Dam is located on the
41 Green River downstream of Fontenelle Dam. The Flaming Gorge Powerplant has three
42 generating units. Each unit has a nameplate capacity of 50.65 MW for a total of approximately
43 152 MW. However, because of turbine limitations, the operable capability of the powerplant is
44 approximately 141 MW.
45
46

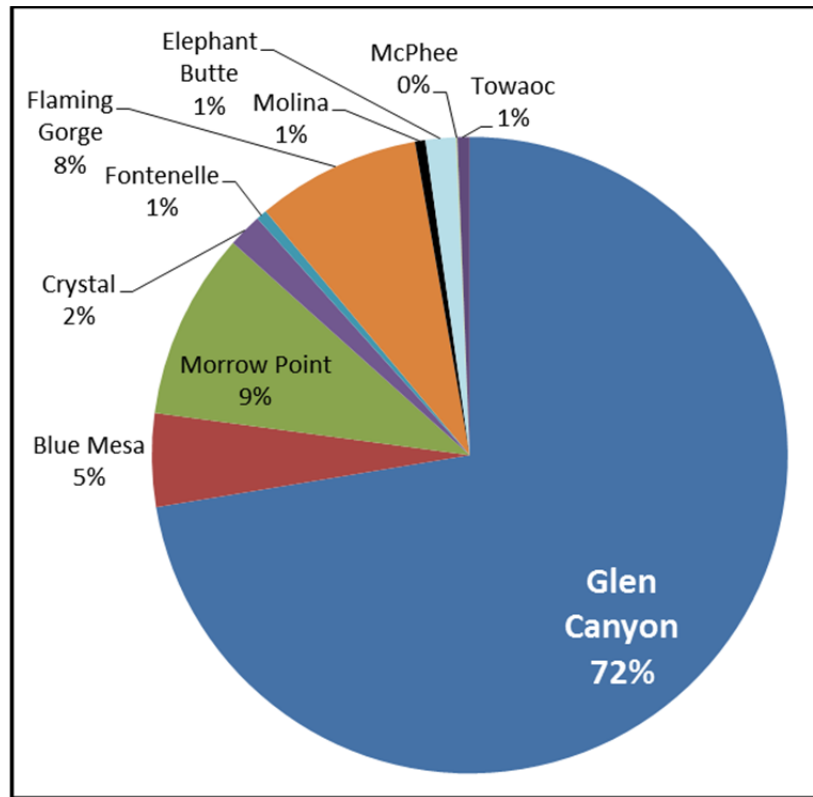

FIGURE K.1-4 Percent of SLCA/IP Federal Hydropower Nameplate Capacity by Facility

The SLCA/IP hydropower facilities that are classified as small include the Upper and Lower Molina complex in the Collbran Project with a combined nameplate capacity of 13.5 MW, the Elephant Butte Powerplant in the Rio Grande Project with 28 MW, and in the Dolores Project, the McPhee and Towaoc Powerplants with total of 11.5 MW. Combined, these small facilities account for less than 3% of Western’s SLCA/IP hydropower resources.

Modeled hourly energy production from federal hydropower resources are input into the SLCA/IP market system as a time series of power injections and from bubbles indicated in Figure K.1-3 as “Hydropower Resources.” As discussed in more detail in Section K.1.5, both the middle and bottom tier models use a consistent set of LMP projected by the Western Interconnection model (top tier).

K.1.4 Overview of Power Systems Methods

The Argonne team of power system analysts and modelers developed a collection of tools that are linked together to evaluate the economic costs of LTEMP EIS alternatives. The processes by which these tools were used and information flows among them are summarized in this section. The next section describes each tool in more detail, and the ones that follow provide more information on model input data and applications.

1 Incorporating all aspects of the three tiers discussed earlier, Figure K.1-5 shows the
2 modeling sequence and data flows for the power systems analysis. Using Western
3 Interconnection topology depicted in Figure K.1-1, the AURORA model models the top tier.
4 Palo Verde market hub LMPs produced for CY 2013 are calibrated to closely match observed
5 levels. LMP calibration factors are discussed in more detail in Attachment K-2 and are applied to
6 future years through the end of the study period.

7
8 The bottom tier, which represents Western’s SLCA/IP federal hydropower plants, is
9 modeled next. Due to the complexities of SLCA/IP hydropower operating criteria and mandates
10 unrelated to power production, AURORA could not directly model either the firm capacity or the
11 hourly operations of the larger and more complex SLCA/IP federal hydropower resources.
12 Therefore, the Colorado River Simulation System (CRSS) model, the Sand Budget Model
13 (SBM), a simplified version of the Generation and Transmission Maximization (referred to as
14 GTMax-Lite) model, and spreadsheet tools were used to project powerplant-specific hourly
15 production levels over the study period at a level of detail sufficient for estimating power
16 economic impacts that would potentially occur from alternative Glen Canyon Dam operations.

17
18 The CRSS model developed by Reclamation models the future operations of water-
19 related resources on the Colorado River. Power systems analysis utilized 21 CRSS projected
20 monthly hydrological futures for large Western SLCA/IP federal hydropower plants including
21 Glen Canyon Dam. Separate CRSS model runs are made for each alternative, resulting in unique
22 projections of monthly reservoir elevation and water volume releases for Glen Canyon Dam. The
23 monthly operations of all other SLCA/IP dams are unaffected by an alternative.

24
25 A simplified version of the Generation and Transmission Maximization model (called
26 GTMax-Lite) developed by Argonne optimizes the economic value of hourly energy produced
27 by both Glen Canyon Dam and all other large SLCA/IP federal hydropower facilities. The
28 dispatch depends on unit availability as simulated by an outage model, LTEMP EIS operating
29 criteria, SBM monthly water releases, and a time series of energy market prices.

30
31 For each alternative, the GTMax-Lite configuration that represents Glen Canyon Dam
32 was run for all traces under two different conditions. The first condition assumes that no
33 distinctive release events such as HFES will occur in the future; that is, CRSS monthly results
34 and Western Interconnection calibrated LMPs drive hourly SLCA/IP operations. No TMFs or
35 HFE are conducted in this first set of model runs. Using these initial results from CRSS and
36 GTMax-Lite, the Reclamation SBM schedules various HFES that differ in terms of peak water
37 release rate, duration, and timing. The SBM also reallocates CRSS monthly water release
38 volumes among the months of a single WY in order to enable higher water releases during
39 months with experiments. Due to the reallocation of monthly water releases and the scheduled
40 TMFs and HFES, the GTMax-Lite model that represents Glen Canyon Dam must be run a second
41 time using the SBM results. It is this second GTMax-Lite run that is used for Glen Canyon Dam
42 for all power systems economic analyses.

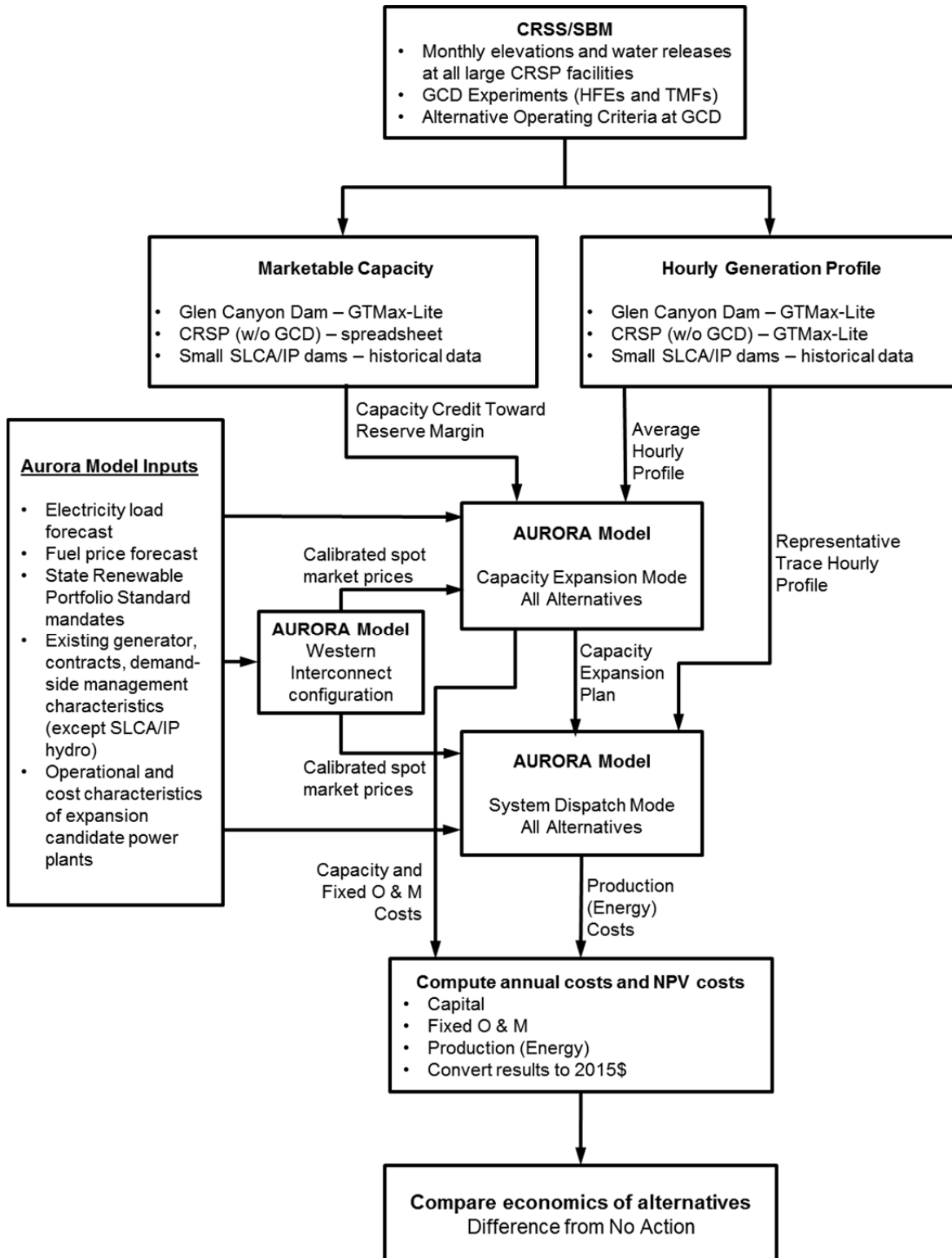

1
2
3

FIGURE K.1-5 Flow Diagram of the Power Systems Methodology Used in the LTEMP DEIS

1 A second configuration of GTMax-Lite configuration simulates the operation of other
2 large SLCA/IP powerplants. It also uses input data from the CRSS model and calibrated Western
3 Interconnection LMPs. The Glen Canyon Dam LTEMP DEIS alternative operating criteria and
4 experimental releases conducted at Glen Canyon Dam do not impact the operations of these
5 upstream resources; therefore, the SBM does not consider these resources in the determination of
6 when HFE events will occur. GTMax-Lite optimization for these plants was performed for a
7 condition that represents an average hydrological condition as projected by CRSS and for the
8 CRSS projection, also known as a trace, which was judged by Argonne staff to be
9 “representative” of the 21 projections. The selection of this representative trace is described in
10 Attachment K-3.

11
12 The firm capacity of Western’s SLCA/IP federal hydropower resources is computed by
13 spreadsheet tools that estimate the maximum potential output of these resources during the time
14 of peak system load. Depending on an alternative’s operating criteria, the maximum output level
15 at the Glen Canyon Dam Powerplant is suppressed. For example, flat flow alternatives are
16 associated with relatively low firm capacity levels, while higher firm capacity levels are attained
17 under less stringent operating criteria such as under Alternative B. As described in more detail in
18 Sections K.1.5 and K.1.7, determination of Glen Canyon Dam Powerplant capacity is based on
19 GTMax-Lite hourly results for all 21 projected futures. Other large SLCA/IP hydropower plant
20 firm capacities are based on CRSS projected futures and power equations that estimate
21 maximum output levels.

22
23 The middle tier is modeled by the SLCA/IP market system configuration of AURORA.
24 This configuration contains all of the loads and resources that are in the utilities operated by
25 SLCA/IP LTF wholesale customers and a point that represents a connection to the rest of the
26 Western Interconnection. At this interconnection point, energy is bought and sold at the
27 calibrated Palo Verde market hub price. Hour-by-hour energy injections into the system from
28 Western’s hydropower resources are prescribed as determined by GTMax-Lite.

29
30 For each alternative, AURORA was used for two major purposes: (1) to determine the
31 cost of capacity expansion pathway over time during the study period for the SLCA/IP market
32 system; and (2) to compute production costs associated with a least-cost unit commitment and
33 system dispatch for a given expansion pathway and a single representative hydrology future or
34 trace. Therefore, AURORA is run in two modes. The first, or “expansion,” mode is used to
35 determine the type of technologies that will be built in the SLCA/IP market system and the time
36 when system capabilities will be expanded. It also considers scheduling the retirement of existing
37 generating units. The second, or “dispatch,” mode determines unit commitments and performs a
38 system dispatch of a static set of both existing and new resources. This static resource set was
39 determined by previous AURORA capacity expansion runs.

40
41 As shown in Figure K.1-5, calibrated market prices are used by both the capacity
42 expansion and system dispatch modes for all alternatives. However, the AURORA capacity
43 expansion model runs use the hourly energy production from Western’s SLCA/IP hydropower
44 resources, based on an average hydropower condition, while AURORA dispatch runs use
45 generation level projected by the representative trace.

1 Results of the AURORA dispatch model consist of costs to produce the electrical energy
2 to meet the system load demand. Production costs are the sum of powerplant fuel costs, variable
3 O&M costs, unit startup costs, and the cost of power purchased from the spot market minus spot
4 market sales revenues. Results from the AURORA expansion and dispatch models (namely
5 capital, fixed O&M, and production or energy costs) were combined to determine the total
6 annual costs for each alternative. The NPV stream of costs was also calculated to facilitate
7 comparisons among alternatives. This single lump-sum value was based on a discount rate of
8 3.375%, a rate that is used by Reclamation for cost-benefit studies of projects. The use of this
9 discount rate was in part based on information contained in Attachment K-4, which was provided
10 by Reclamation staff. At the recommendation of Western staff, a second discount rate of 1.4%
11 was used in a sensitivity study.
12
13

14 **K.1.5 Description of Individual Power System Models**

15
16 As described in the previous section, Argonne used several tools and models of varying
17 levels of detail and complexity to estimate the economics of LTEMP DEIS alternatives.
18 Additional information on each of these tools and models, along with a description of other
19 supporting algorithms, is provided below.
20
21

22 **K.1.5.1 Colorado River Simulation System Model (Bottom Tier)**

23
24 The CRSS model was developed by Reclamation to model future operations of water-
25 related resources on the Colorado River, including both the upper and lower portions of the
26 basin. The Glen Canyon Dam is the lowest reservoir in the upper basin. For the LTEMP EIS,
27 CRSS projected 105 monthly hydrological futures over a 48-year time period from 2013 through
28 2060, inclusive. Each future or trace is based on a historical time series of hydrological
29 conditions. Power system analyses utilize the first 21 years of CRSS projections of reservoir
30 elevations and water release volumes for CRSP and the Seedskaadee project; that is, the set of
31 large plants. Of the 105 traces projected by CRSS, a common set of 21 was used by all DEIS
32 research areas including power systems analyses.
33

34 For the initial structured decision-making exercises, all of the simulation cases included
35 three separate options for sediment conditions (high, moderate, and low), effectively multiplying
36 the number of simulations required by a factor of three. Once the detailed results were generated,
37 the three sets of findings were assigned relative weightings in order to combine and condense the
38 findings into weighted averages. For expediency in the power systems analysis, all of the
39 simulation runs will be based on a single sediment option (the moderate case, also designated
40 “s2” in previous treatments), which was weighted by 63.1% for combining the detailed results.
41 This greatly reduces the number of cases to be examined, and based on previous findings it does
42 not affect comparisons or conclusions regarding impacts of the alternatives.
43

44 Separate CRSS model runs are made for each alternative, resulting in a unique projection
45 of monthly reservoir elevation and water volume releases for Glen Canyon Dam. However,
46 monthly operations of all other SLCA/IP dams are identical under all alternatives. Therefore,

1 operations for all Large SLCA/IP federal hydropower plant model runs of GTMax-Lite used
2 CRSS results for the Alternative A. In addition, Reclamation staff determined that LTEMP DEIS
3 alternatives have negligible impacts on reservoir, and hence, power operations in the Lower
4 Colorado River Basin, including those at Hoover Dam. Therefore, operations downstream of
5 Glen Canyon Dam were not included in power systems analyses.
6
7

8 **K.1.5.2 Representative Trace Tool (Bottom Tier)** 9

10 The Representative Trace Tool contains supplemental software written by Argonne
11 specifically for the LTEMP DEIS. It assists in the selection of a single hydrological trace for the
12 detailed hourly dispatch of Western’s large SLCA/IP hydropower plants. The trace chosen best
13 meets a set of criteria for being “representative.” The representative trace must have annual
14 variations in hydrological conditions at Glen Canyon Dam that are similar to the hydrological
15 distribution of the entire population of the 21 common trace set for sediment condition 2. The
16 mean Glen Canyon Dam annual water release of the representative trace must also be
17 approximately equal to the mean of all 21 traces. For consistency, the selected trace is also
18 applied to the other five large SLCA/IP federal hydropower plants.
19
20

21 **K.1.5.3 Hydropower Outage Model (Bottom Tier)** 22

23 The Hydropower Outage model and supporting spreadsheets are used to simulate unit
24 outages at all six large SLCA/IP federal hydropower powerplants. This includes both scheduled
25 outages and forced outages that are caused by random mechanical and electrical events.
26 Designed and written by Argonne, a methodology was developed to incorporate the number,
27 cause, and duration of forced outages that may potentially occur during the 20-year study period.
28 The model uses a random number generator to simulate the timing and cause of forced outages
29 using data contained in the NERC Generating Availability Data System (GADS). Several
30 instances of the model were run. The time series of random outage selected for LTEMP analyzes
31 was the one that closely matched GADS statistical averages. The outage methodology is
32 discussed in more detail later in Section K.1.7.3 and in Attachment K-5. The same time sequence
33 of representative outages was used under all alternatives.
34

35 Reclamation provided Argonne with maintenance schedules over the study period for
36 large SLCA/IP facilities. The timing and length of outages at large SLCA/IP powerplants is in
37 general the same under all DEIS alternatives. However, during HFEs and TMFs, it was assumed
38 that a scheduled maintenance outage would not be conducted.
39
40

41 **K.1.5.4 Generation and Transmission Maximization-Lite (Bottom Tier)** 42

43 GTMax-Lite is a simplified version of the full GTMax model. Both were developed by
44 Argonne. GTMax-Lite has limited scope and data requirements compared to the full version of
45 GTMax. The two versions of GTMax-Lite used for the LTEMP DEIS represent only the physical
46 characteristics of hydropower plants, downstream flow requirements, and both water release and

1 reservoir operating criteria. The primary modeling objective of the lite version is to maximize the
2 economic value of hydropower resources. This differs from the full GTMax model, in which the
3 full model represents other factors such as customer power delivery requests sent to the EMMO,
4 short-term purchase and sale commitments, and non-economic EMMO dispatch goals and
5 guidelines. Although full GTMax and GTMax-Lite differ, they share many of the same features
6 and in general produce similar generation patterns and estimates of hydropower economic value.
7

8 The GTMax-Lite model configuration used for LTEMP power systems analyses
9 optimizes the economic value of hourly energy produced at both Glen Canyon Dam and all other
10 large SLCA/IP federal hydropower facilities. Operations depend on both unit availability as
11 simulated by the outage model and a set of operating criteria. For the LTEMP DEIS, two
12 configurations of the model were constructed. One represents the operation of only Glen Canyon
13 Dam, and the other optimizes the operation of the remaining large hydropower facilities.
14

15 GTMax-Lite was used because many thousands of weekly runs with hourly time steps
16 need to be performed rapidly. It was customized to address a specific problem by tailoring the
17 objective function, the input and output routines, and the model constraints to be consistent with
18 LTEMP modeling needs; that is, it models federal hydropower resources without LTF
19 contractual obligations. Multiple model runs and data handling are controlled by a Microsoft
20 Excel® spreadsheet, and the objective function is optimized using the Lingo software, which
21 simultaneously identifies the best pattern of hourly energy production over time that satisfies all
22 operational constraints.
23
24

25 **Glen Canyon Dam Configuration**

26
27 The Glen Canyon Dam GTMax-Lite model was run thousands of times in support of the
28 structure decision analysis (SDA) process. This includes nearly 1,000 LTEMP scenario
29 optimizations (combinations of 15 alternatives, 21 hydrology traces [based on 105 years of
30 historical data], and three sediment traces) that optimize water releases (each run consisting of
31 180,000 hours of Glen Canyon Dam flows). The GTMax-Lite hourly water release results are
32 used by analysts of each resource area, such as sediment, fish, recreation, and riparian
33 vegetation. Analyses of power systems economics leverages the outputs produced by this
34 process.
35

36 Initial SDA exercises used all of the simulation cases, including three separate options for
37 sediment conditions (high, moderate, and low), effectively multiplying the number of
38 simulations required by a factor of three. Once the detailed results were generated, the three sets
39 of findings were assigned relative weightings in order to combine and condense them into
40 weighted averages. For expediency in the power systems analysis, all of the simulation runs were
41 based on a single sediment option (the moderate case), which was weighted by 63.1% for
42 combining the detailed results. It should be noted that for any given hydrology, variations in
43 sediment level had only minor impacts on SDA power outcomes. This greatly reduces the
44 number of cases to be examined and, based on previous findings, does not affect comparisons or
45 conclusions regarding impacts of the alternatives.
46

1 GTMax-Lite simulated operations at Glen Canyon Dam were made for all 21 projected
2 hydrological futures over the entire study period. As described below, all runs were performed
3 twice. The Glen Canyon Dam configuration uses hourly AURORA calibrated prices projected by
4 the Western Interconnection configuration to maximize the economic power value of operations
5 during representative 1-week periods for each month during the study period. Hourly prices input
6 into the model are average values based on weekday, Saturday, and Sunday/holiday Palo Verde
7 hub LMP projections. Model results for hourly Glen Canyon Dam generation are greatly
8 influenced by the hourly LMP profile, a weekly water release requirement, Lake Powell
9 Reservoir elevation, and LTEMP alternative operating criteria.

10
11 To achieve more accurate/realistic results, both GTMax-Lite configurations explicitly
12 model scheduled and forced outages. Reclamation provided a maintenance schedule for all six
13 CRSP facilities over the study period (Clayton 2013). A methodology was developed to
14 incorporate the number, cause, and duration of forced outages that would be expected during the
15 study period. Data on forced outages for hydroelectric turbines were obtained from GADS,
16 which is a database of operating data on electric generating equipment maintained by the NERC.
17 This information was input into an algorithm that produced a plausible series of random outages
18 for units at the Glen Canyon Dam Powerplant. For large SLCA/IP federal hydropower facilities,
19 based on the cause of forced outages and associated average down times using data contained in
20 the NERC GADS for hydropower plants that had capacities greater than 30 MW.

21
22 Market prices input to LTEMP power system models represent the economic value of
23 hydropower generation at hourly intervals. These prices directly influence the generation
24 schedule produced by the models when optimizing SLCA/IP hydropower resources. To the
25 extent possible, the GTMax-Lite model uses its limited-energy/water resource stored in a
26 reservoir (i.e., Lake Powell at the Glen Canyon Dam) to first generate electricity during on-peak
27 hours when it has the highest economic value. Any remaining energy is scheduled during lower-
28 priced hours.

29
30 Model-generated operations comply with any operating constraints and downstream flow
31 targets placed upon the hydropower system for environmental or institutional reasons. Operating
32 constraints include limits on water release up- and down-ramp rates, limits on reservoir water
33 release rate changes over a rolling 24-hour period, ancillary service requirements, and others.

34
35 Figure K.1-6 illustrates a typical Glen Canyon Dam GTMax-Lite result for a 24-hour
36 period. The green bars represent hourly Glen Canyon Dam Powerplant production, the total of
37 which is highly influenced by the mandated monthly water release volume. The light green line
38 shows hourly market prices. In general, energy production is the highest when it has the most
39 value. Note that the production levels are such that the total of hourly generation multiplied by
40 the market price (i.e., energy production value) over the day is as large as possible. The
41 production pattern adheres to all operating criteria such that the power output pattern complies
42 with minimum and maximum flow rate constraints, ramp-rate limits, and daily change
43 restrictions. Also note in this example that some of the constraints are binding. In this case, the
44 minimum and maximum generations do not bind the solution; that is, generation levels do not
45 operate at either of these levels. Generation pattern is bound or limited by daily change and both
46 up and down hourly ramp rate constraints. However, when more water is released for power

1 generation, the maximum limit becomes binding because peak generation levels are possible
 2 within the daily change constraint. On the other hand, when hydropower generation is low, the
 3 minimum constraint becomes binding. Therefore, hydropower conditions often dictate when a
 4 constraint is either binding or not binding.

6 More operational flexibility at Glen Canyon Dam always translates into higher or equal
 7 economic value. For example, if there was no daily change constraint, powerplant output in
 8 Figure K.1-6 would have been at the minimum during the nighttime, when prices are lower, and
 9 ramped up over a few more hours to reach the maximum output level when prices are the
 10 highest. A further relaxation of operating criteria by removing hourly ramping constraints,
 11 lowering the minimum, and increasing the maximum would have resulted in a higher
 12 concentration of Glen Canyon Dam generation in the hours with the highest demand. The daily
 13 maximum generation level would have also been higher. Therefore, limits not only constrain the
 14 economic value of energy, but also impact the maximum output that Glen Canyon Dam produces
 15 during system peak loads and therefore reduce its firm capacity.

17 The Glen Canyon Dam version of GTMax-Lite compresses the full 8760 hours per year
 18 into 12 “typical week” periods of 168 hours for each month. Outputs include hourly turbine and
 19 non-turbine water release and power generation schedules for a series of representative 1-week
 20 time periods (i.e., sequence of 168-hour time periods) that maximize the economic value of
 21 hydropower energy resources. The Glen Canyon Dam GTMax-Lite configuration utilizes a
 22 “wrap” technique that significantly reduces model end-effects associated with running typical
 23
 24

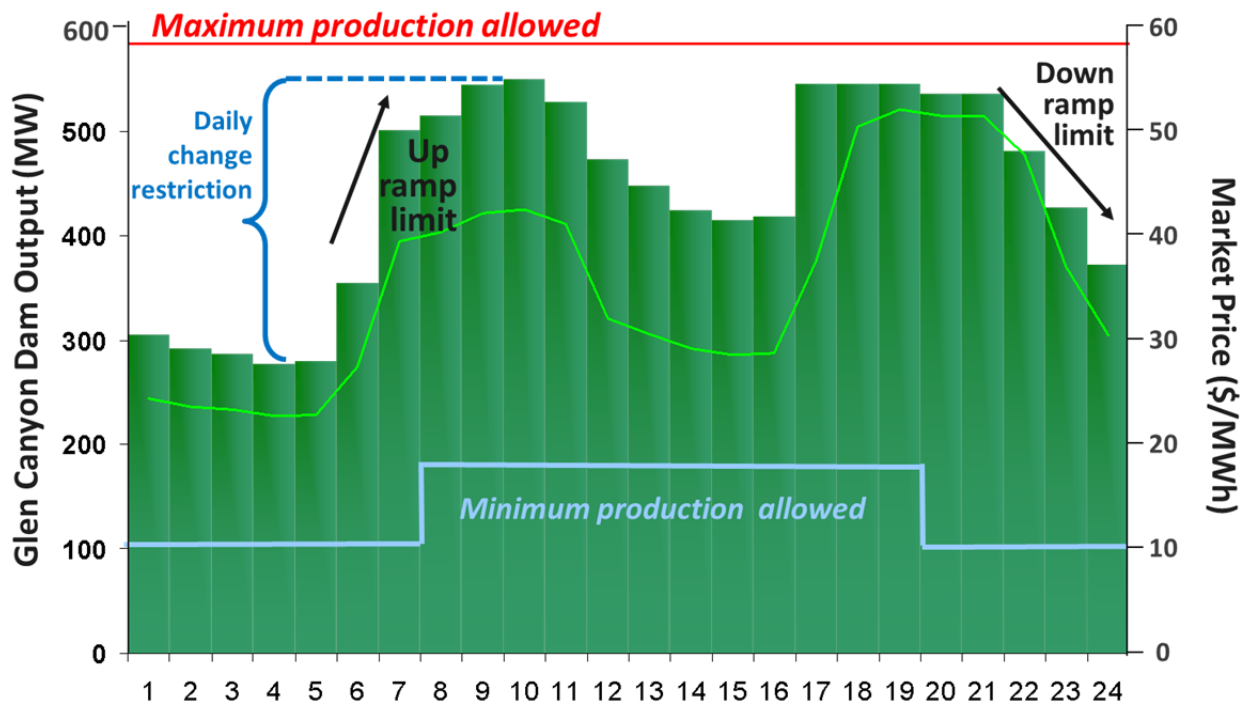

25
 26 **FIGURE K.1-6 Illustration of a Typical GTMax-Lite Result for a 24-Hour Period**

1 weeks. The technique essentially connects the modeled beginning hours to those at the end of the
2 optimized week. Because the model mathematically repeats the same weekly pattern infinitely,
3 ending model solutions are positioned such that it is starting in a good position for operations
4 during the following week.

5
6 Because the GTMax-Lite model only simulates operations for one representative week in
7 each month, the results are repeated to reflect full months of hourly operations for each year of
8 the study. This is accomplished by assigning the typical water and generation release pattern
9 estimate by GTMax-Lite for specific day types to each day of the month. For example, the
10 Sunday optimized pattern is assigned to all Sundays and holidays that occur in a month. It should
11 also be noted that GTMax-Lite is provided with the number of day types that occur in each
12 simulated month. Using this information, GTMax-Lite produces a weekly result such that the
13 repeated daily results over a month release the exact amount of specified monthly water release.

14
15 The GTMax-Lite configuration that represents Glen Canyon Dam was run under two
16 different of assumptions. The first assumes that no distinctive release events such as HFEs will
17 occur in the future, in which case CRSS data are used to drive operations. This information was
18 input into the SBM in order for the model to schedule HFEs and adjust CRSS monthly water
19 release volumes and Glen Canyon Dam reservoir elevations. This intermediate solution was only
20 used by the SBM.

21
22 For a second run of the Glen Canyon Dam GTMax-Lite model, it is assumed that HFEs
23 will occur as scheduled by the SBM. The LTEMP DEIS defines several different types of HFE,
24 each with a unique specified hourly water release pattern. GTMax-Lite models operations when
25 an HFE is *not* scheduled. A separate routine is used to compute Glen Canyon Dam Powerplant
26 generation based on the prescribed HFE water release pattern. This pattern depends on the type
27 of HFE that would be conducted. Under most HFEs, there are time periods when water release
28 requirements exceed the combined maximum flow rate of Glen Canyon Dam Powerplant
29 turbines. Therefore, the routine tracks both turbine water and non-turbine water releases. It also
30 computes power production levels based on Lake Powell's water elevation. During days in a
31 month in which an HFE is not scheduled, Glen Canyon Dam hourly generation simulated by
32 GTMax-Lite accounts for the SBM monthly water release volume, the amount of water that was
33 released during the HFE, and the number of normal operating days (i.e., day without the HFE) in
34 the month.

35 36 37 **Other Large Federal SLCA/IP Hydropower Resources Configuration**

38
39 Because Western markets power from combined SLCA/IP facilities, of which Glen
40 Canyon Dam is the single largest component, a second GTMax-Lite configuration was
41 developed. It represents the remaining CRSP hydropower powerplants, including Blue Mesa,
42 Morrow Point, Crystal, and Flaming Gorge, and the Fontenelle Powerplant of the Seedskadee
43 Project. Although Fontenelle is not technically part of CRSP, it is included in this configuration
44 because it is operated as a cascade with Flaming Gorge and the CRSS model projects both
45 monthly reservoir elevations and releases for these facilities. This GTMax-Lite configuration and

its key operating constraints, shown in Figure K.1-7 below, were developed specifically for the LTEMP DEIS.

GTMax-Lite is a scaled-down version of the full GTMax model. Both represent all the physical CRSP and Seedskadee powerplants and downstream flows at gages in the Green River. However, the lite version omits the representation of SLCA/IP firm contracts. Instead, large SLCA/IP hydropower plant operations are driven directly by electricity market price signals—not contracts. This streamlined process involves far fewer model operator steps and solves the problem considerably faster than the full GTMax model. The GTMax-Lite configuration that represents these five large SLCA/IP powerplants was run once for an average hydrological condition to support AURORA capacity expansion model runs, and a second time using the representative trace to support SLCA/IP detailed system dispatch runs. It optimizes operations during all hours of the study period, based on input data from the CRSS model and AURORA Western Interconnection calibrated market prices for the Palo Verde market hub. LTEMP DEIS alternative and experimental releases conducted at Glen Canyon Dam, such as HFEs and TMFs, do not affect the operations of these five upstream resources. Therefore, this configuration uses CRSS results for Alternative A. Therefore, the SBM did not adjust CRSS results.

As shown in the figure, GTMax-Lite contains two water cascades. The first consists of the Fontenelle and Flaming Gorge Reservoirs and the second consists of the Aspinall Cascade, which includes the Blue Mesa, Morrow Point, and Crystal reservoirs. Operationally, reservoirs in

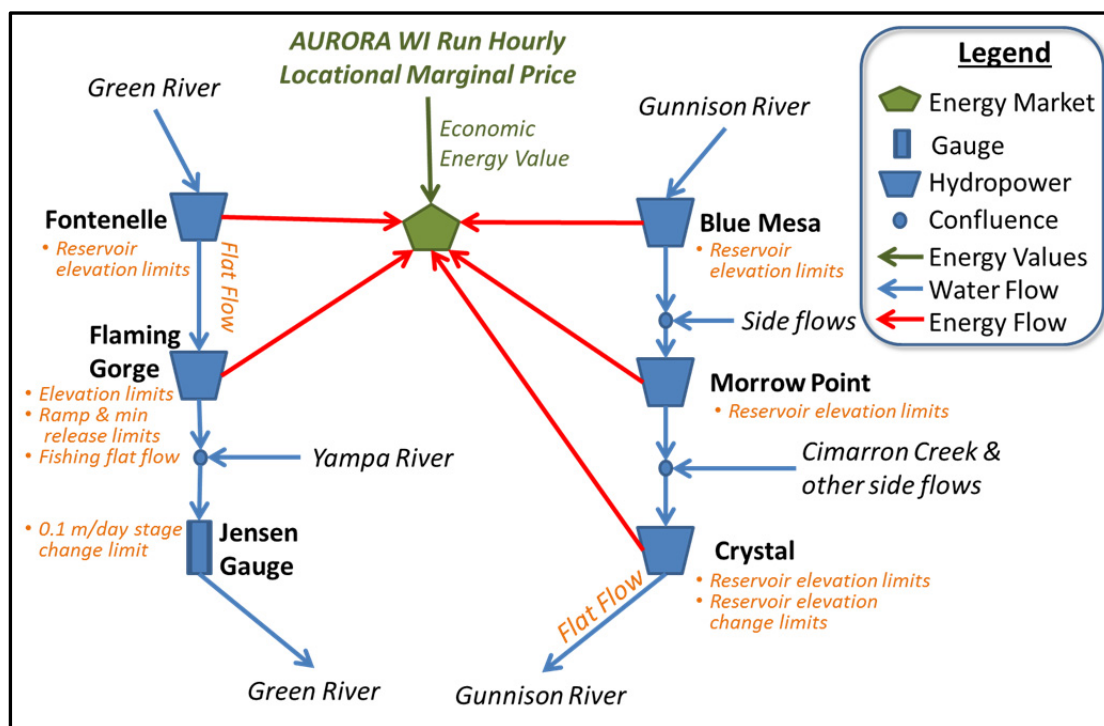

FIGURE K.1-7 GTMax-Lite Network Topology for the Large SLCA/IP Hydropower Resources Other Than Glen Canyon Dam

1 the first cascade are very loosely connected, but reservoirs in the Aspinall Cascade are very
2 tightly coupled.

3
4 Monthly releases and reservoir elevations were obtained from CRSS model results for
5 Alternative A. CRSS also provides information about water inflows into reservoirs, side flows
6 that occur between connected reservoirs, and reservoir evaporation. Other inputs included
7 operating constraints placed on the facilities, such as restrictions on water release ramp rates and
8 flow requirements at the Jensen Gage downstream of Flaming Gorge. The objective function
9 simultaneously maximizes the economic value of the hydropower resource at these five large
10 facilities. The output is an hourly schedule of water releases and electric generation that
11 maximizes the economic value of hydropower resources within the bounds of all operating
12 constraints.

13
14 Operating constraints include maximum and minimum limits imposed on all reservoirs
15 and a complex set of restrictions at the Crystal Reservoir that bound the rate of elevation changes
16 over time. In order to ensure that water releases do not violate reservoir operating constraints, the
17 GTMax-Lite model computes hourly water mass balances and reservoir elevations using
18 reservoir elevation-volume functions. Water balancing equations account for water inflows, side
19 flows, evaporation, upstream reservoir water releases, and all releases from the reservoir of
20 interest.

21
22 Flows at the Jensen Gage are restricted to daily stage changes of 0.1 meters/day. Because
23 gage flows are directly affected by upstream water releases from the Flaming Gorge Reservoir,
24 GTMax-Lite models gage flows that comply with the daily gage constraint. To optimize Flaming
25 Gorge operations, water travel time distribution (WTTD) functions are used to estimate the time
26 it takes water to flow through Green River reaches, and the attenuation of releases as water
27 travels downstream. For this study, two reaches are defined. The first is from the Flaming Gorge
28 Dam to the confluence of the Green and Yampa Rivers and the second is from this confluence
29 down to the gage. Although WTTD can vary by hydrological condition, for this study a typical
30 WTTD function was derived from Streamflow Synthesis and Reservoir Regulation (SSARR)
31 model outputs. SSARR was written by the Army Corps of Engineers. In general, it takes about
32 24 hours for the first fractional amount (less than 1%) of a Flaming Gorge release to reach the
33 gage. Typically, all of the water passes the gage 48 hours after the release. Gage readings are
34 computed using a function that relates the flow rate at the gage to the gage stage. Yampa River
35 water flows into the Green River are based on historical monthly data. Based on historical
36 records, for this study a monthly 50% flow exceedance was input into GTMax-Lite.

37
38 The temporal modeling methods used by GTMax-Lite for the five large hydropower
39 plants differ from the Glen Canyon Dam configuration because it simulates operations for all
40 hours during every study period day. It was structured and configured differently from Glen
41 Canyon Dam GTMax-Lite because the operating constraints at powerplants and reservoirs in the
42 Aspinall Cascade are fundamentally different from those at Glen Canyon Dam. The imposition
43 of gage constraints at Jensen is also unique. The five-plant configuration of GTMax-Lite needs
44 to be run far fewer times than the Glen Canyon Dam configuration, and therefore it is
45 computationally more affordable to model all days.

As shown in Figure K.1-8, time in the five large plant configuration of GTMax-Lite is separated into three periods that include history, primary optimization, and extension. The historical period is required because operations in the past affect future operation. These include operations in the Aspinall Cascade that constrain Crystal Reservoir elevation changes over 1-day and 3-day periods. In addition, operations at the Flaming Gorge Dam need to comply with gage flow constraints. Note that the water travel time from the Dam to the gage is about 2 days. For the first model run, actual historical operations are input into the model. However, for all subsequent optimizations, “history” is obtained from the previous model run. For this study, hourly results for the last 3 days of the primary optimization period are used.

To reduce model end effects and place operations at the end of the simulated period in a good position for the following days, a 1-week extension period is included in each model run. This differs from Glen Canyon Dam GTMax-Lite model runs that apply the previously described wrap technique to reduce model end effects. Results for the extension period are not used by AURORA or in any economic calculations. Instead, results for the extension period are erased and replaced with primary optimization period results from a subsequent model run.

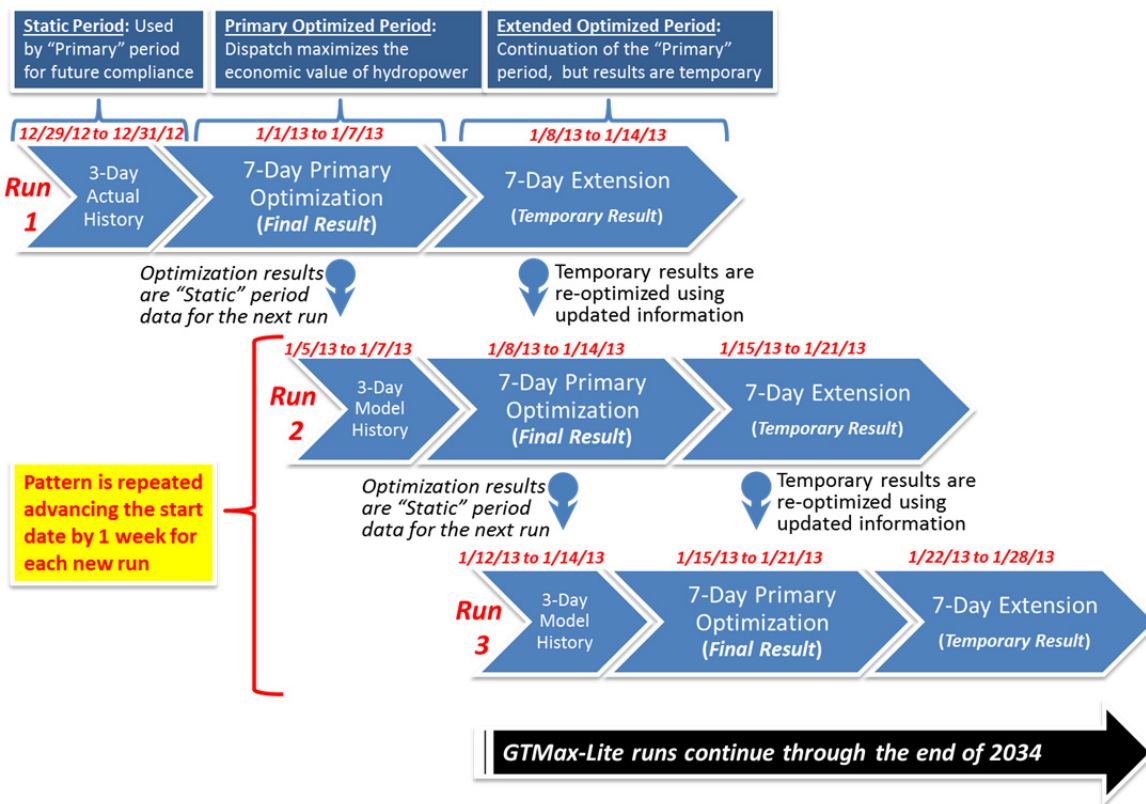

FIGURE K.1-8 Illustration of Temporal Modeling Method Used in the GTMax-Lite Five Large SLCA/IP Plant Configuration

1 **K.1.5.5 Sand Budget Model (Bottom Tier)**
2

3 The Reclamation SBM schedules various HFEs that differ in terms of peak water release
4 rate, duration, and timing. It uses results from the CRSS model and the intermediate Glen
5 Canyon Dam GTMax-Lite solution. The model is run for each alternative using alternative
6 specific triggers to schedule future HFEs under all 21 hydrological futures and three sediment
7 futures.
8

9 SBM maintains the annual WY release volumes specified by CRSS, but reallocates
10 monthly volumes in order to enable higher water releases during months with experiments. Due
11 to the reallocation of water releases, the Glen Canyon Dam GTMax-Lite model is run a second
12 time using the SBM results. It is this second GTMax-Lite run that is used for all economic
13 analyses.
14

15 **K.1.5.6 Large SLCA/IP Powerplant Spreadsheets (Bridges Bottom and
16 Middle Tiers)**
17

18 Several spreadsheets were written by Argonne in support of the LTEMP DEIS power
19 system analyses. These large SLCA/IP powerplant spreadsheets perform the following functions:
20

- 21 • Create alternative-specific hourly Glen Canyon Dam generation input data for
22 the SLCA/IP market system configuration of AURORA. One set of
23 generation data contains average hourly values computed from GTMax-Lite
24 results for the 21 SBM traces. These values are used for SLCA/IP capacity
25 expansion simulations. The second set of Glen Canyon Dam generation is
26 based on GTMax-Lite results for the representative trace and used for
27 AURORA dispatch model runs.
28
- 29 • Determine the amount of Glen Canyon Dam capacity will be reserved and
30 available for ancillary services for each day of the simulation period. If these
31 services cannot be entirely fulfilled by the Glen Canyon Dam Powerplant, the
32 amount that needs to be supplied by Aspinall Cascade powerplants is
33 computed. Computations for Glen Canyon Dam and the Aspinall Cascade are
34 performed for each alternative.
35
- 36 • Find and store the maximum daily generation level contained in Glen Canyon
37 Dam GTMax-Lite outputs for all alternatives and traces. These data are used
38 by the Firm Capacity Spreadsheet that computes aggregate firm capacity level
39 for SLCA/IP federal hydropower resources.
40
- 41 • Create alternative-specific hourly generation input data for AURORA that
42 represents the five large SLCA/IP powerplants. One set of generation data is
43 based on GTMax-Lite that models these five large plants based on average
44 monthly releases and reservoir information that is derived from CRSS trace
45 results. These values are used for SLCA/IP capacity expansion simulations.
46

1 The second set of large SLCA/IP hydropower generation values is based on
2 GTMax-Lite results for the representative trace and used for AURORA
3 dispatch model runs.

- 4
5 • Determine the maximum potential output level from the five large SLCA/IP
6 powerplants. Maximum output levels are computed for all combinations of
7 unit outages at each powerplant based on operating criteria, turbine capacities,
8 forebay elevation, tailwater elevation calculations, and water-to-power
9 conversion factors as a function of head. Except for minor adjustments that
10 account for Aspinall spinning reserve and regulation service duties, maximum
11 output levels are identical across all alternatives. Based on user-defined risk
12 level, spreadsheet results are also used by the Firm Capacity Spreadsheet to
13 set the aggregate firm capacity level for Western’s SLCA/IP federal
14 hydropower resources.

15 16 17 **K.1.5.7 Small SLCA/IP Powerplant Spreadsheet (Bridges Bottom and** 18 **Middle Tiers)**

19
20 The capacity and dispatch of relatively small SLCA/IP federal hydropower resources
21 including Deer Creek, Elephant Butte, Towaoc, McPhee, and Molina are estimated using the
22 Small SLCA/IP Powerplant spreadsheet. Estimates of future hourly plant-level generation are on
23 based on historical Form PO&M-59 data and powerplant duty cycle (i.e., baseload or peaking).
24 This spreadsheet is also used to estimate maximum output levels for use in computations of
25 Western’s SLCA/IP hydropower firm capacity. The same hourly generation and maximum
26 output values are used for all alternatives for both AURORA capacity expansion and dispatch
27 model runs.

28 29 30 **K.1.5.8 Loads Shaping Algorithm (Middle Tier)**

31
32 In order to project hourly customer loads for LTF large and small customers, Argonne
33 analyzed several years of historical load data for the eight large customers that was contained in
34 the FERC Form-714. Normalized loads for CY 2006 were selected to serve as a representative
35 profile and used as the basis for projecting future chronological hourly loads for all LTF
36 customers. The basis for selecting this year is described in more detail in Section K.1.6.3.
37 Normalized profiles cannot simply be multiplied by a constant value (e.g., monthly peak load) to
38 scale loads for a future year, because load factors are projected to change over time. Therefore,
39 the Loads Shaping Algorithm is used to compute hourly scaling factors that, when applied to the
40 normalized profile, produce a time series of chronological hourly loads that simultaneously
41 match both a projected monthly peak load and monthly total load.

42
43 The Loads Shaping Algorithm uses a quadratic programming technique that minimizes
44 differences between a normalized load duration curve (LDC) constructed from historical data
45 and a reshaped LDC generated by the model. Figure K.1-9 shows the original LDC, constructed
46 from historical loads for one of the large customers and the reshaped LDC. The reshaped curve is

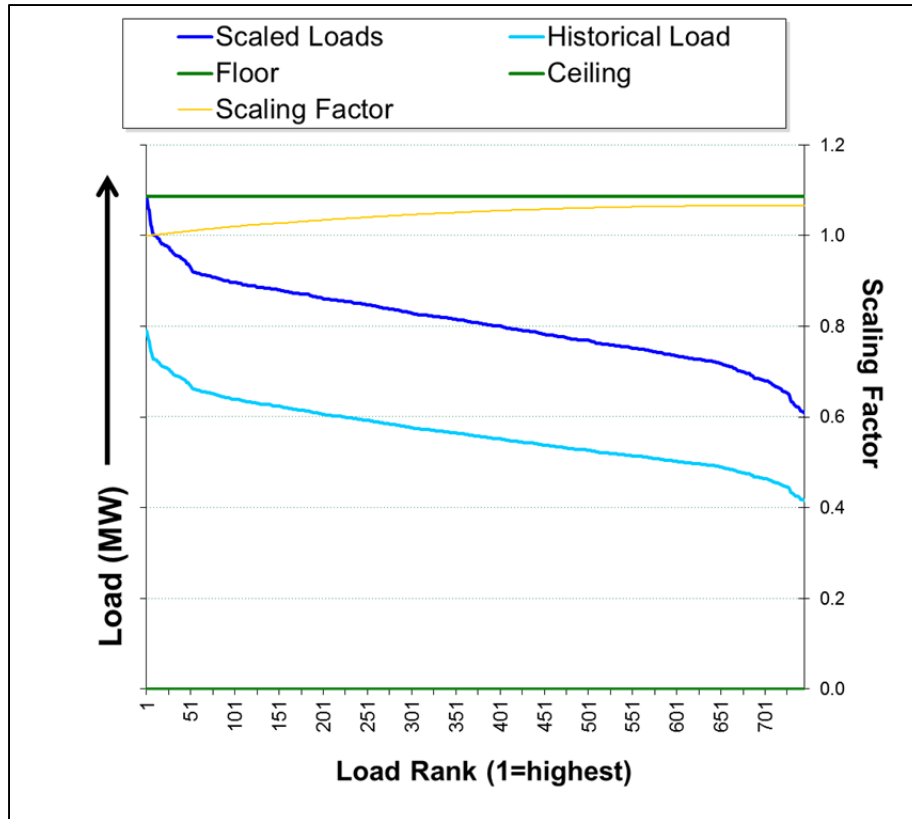
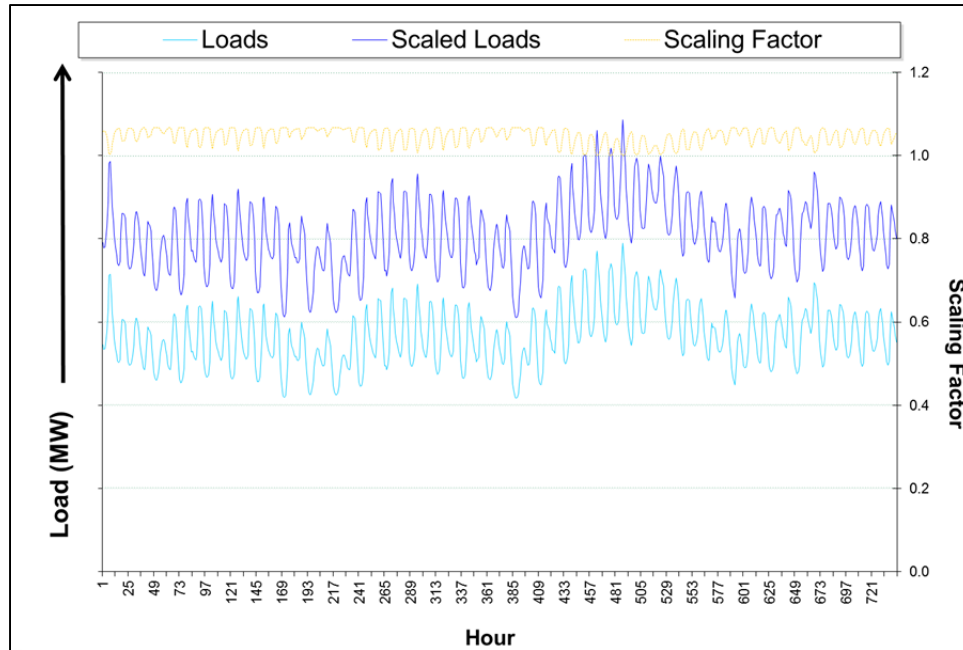

FIGURE K.1-9 Example of the Load Scaling Algorithm LDC

consistent with a projected monthly load factor. Upper and lower load constraints may be specified by the user to bind the model’s solution. For each point in the LDC, a scaling factor, shown on the secondary y-axis, is then computed as the ratio of the reshaped load to the original load. Finally, the algorithm constructs a scaled chronological hourly profile based on the load scaling factors and an associated original hourly load. The end product, as shown in Figure K.1-10, is a chronological load time series that exactly matches the monthly projected peak and total load.

K.1.5.9 AURORA (Top and Middle Tiers)

The AURORA model is at the core of the methodology used to identify SLCA/IP federal hydropower interactions with the power grid. It was developed by EPIS, Inc., and it is used by utilities throughout the United States to model capacity expansion pathways, simulate unit commitments, and perform hourly unit dispatch. Based on information contained in the EPIS, Inc., Web page (http://epis.com/AURORA_xmp/long_term_expansion.php), one of the primary uses of AURORA is for lifecycle analysis and resource capacity expansion optimization studies.



1

2

3

4

5

6

FIGURE K.1-10 Example of the Load Scaling Algorithm Chronological Hourly Loads

7

8

9

10

11

AURORA uses hourly demands and individual resource-operating characteristics in a transmission-constrained, chronological dispatch algorithm. This algorithm also models the deployment of curtailments at market price trigger points. LMPs projections are made in user-defined market bubbles over long-term planning horizons. For the LTEMP DEIS, it computes LMPS at each of the bubble shown in Figure K.1-1.

12

13

14

15

16

17

18

19

20

21

A recursive modeling process identifies the set of resources among existing and potential future resources with the highest and lowest market values to produce economically consistent capacity expansion and retirement schedules. Based on the NPV of hourly market prices, it chooses to build one or more technologies contained in a user-defined list of new resource candidates. AURORA compares those values to existing resources in an iterative process to create a capacity expansion path of new units over time. The end result is a coordinated forecast of capacity expansion schedules for multiple market areas that meet planning reserve margin targets. State renewable portfolio standards (RPSs) under the future conditions are also simulated and incorporated into the expansion pathway.

22

23

24

25

26

27

28

29

Capital investment decisions made in AURORA use levelized capital investment costs that spread the cost of building a new unit into payments that are made at set time intervals (i.e., weekly, monthly, annually) over the book life of the project, similar to home mortgage payments. In this study, these payments are made and accounted for from the time a new unit comes online through the end of the LTEMP study period. This reduces modeling end-effects because new units contained in the AURORA expansion path will operate long beyond the end of the LTEMP period. For example, if a new unit is brought online during the last year in the study, only 1 year of capital payments are included in the economic cost calculations, not the

1 entire cost of the project. This reduces issues associated with evaluating technologies that have
2 disparate capital costs and operational characteristics on timelines that do not cover the entire life
3 of the candidate resources.

4
5 This levelized cost methodology is equivalent to incurring all capital cost expenditures
6 when the unit comes online and later receiving a salvage value payment at the end of the study
7 period. The salvage value represents the economic value of the resource at the end the study.
8 This approach is used in the Wien Automatic System Planning (WASP) Package. Developed in
9 1972 by the Tennessee Valley Authority and the Oak Ridge National Laboratory, it has long
10 been in continuous use by many utilities around the world for power generation expansion
11 planning. When using the WASP sinking fund depreciation accounting method, WASP
12 mathematics are equivalent to NPV results used by Argonne in this study (IAEA 1980).

13
14 For the LTEMP DEIS, AURORA is used in the order listed below for the following
15 purposes:

- 16
17 1. Project Palo Verde market hub prices/LMPs (top tier),
- 18
19 2. Determine construction schedules for new units in the SLCA/IP market
20 system (middle tier), and
- 21
22 3. Simulate unit commitments and perform SLCA/IP market system dispatch
23 (middle tier).

24
25 Modeling for the top tier is performed once—the results are used across all LTEMP DEIS
26 alternatives. The middle tier of AURORA is run for each alternative.

27
28 AURORA is first used to project future hourly energy market prices throughout the
29 Western Interconnection during the study period; that is, for top tier modeling. Without
30 alteration, it uses a Western Interconnection topology and dataset that were provided by EPIS. It
31 should be noted that EPIS derived model input data for load growth, utility fuel price projections,
32 and the cost and performance for new candidate units for system capacity expansion based
33 primarily on information contained in EIA's 2014 AEO (EIA 2014).

34
35 For the LTEMP DEIS, LMPs at the Palo Verde marketing hub were selected as a
36 representative hourly time series. These market prices are the primary economic driver that shape
37 SLCA/IP hydropower operations in both versions of the GTMax-Lite model and the Small
38 SLCA/IP Power Plant Spreadsheet. The same price set was used for all alternatives. As discussed
39 in Attachment K-1, Argonne assumes that alternative operations at Glen Canyon Dam will have
40 a negligible impact on Western Interconnection LMPs outside of the SLCA/IP market system.

41
42 The second purpose of the AURORA model was to project system capacity expansion
43 paths and unit retirement schedules for utilities in the SLCA/IP market system based on the
44 assumption that customers will engage in cooperative agreements that are mutually beneficial;
45 that is, middle tier modeling. It uses detailed unit-level information about existing powerplant
46 units owned and operated by Western and its LTF customers. The model also includes

1 information about candidate units that could be built in the future. Projected power demands
2 consist of Western project use loads (which are described later) and loads for SLCA/IP LTF
3 customers as described above. Capacity is constructed such that the reserve margin of the
4 aggregate eight large customers never drops below 15%.

5
6 The firm capacity credit assigned to SLCA/IP federal hydropower resources in AURORA
7 is estimated by the Western Firm Capacity Spreadsheet. The firm capacity logic used in this tool
8 is in part based on a risk level consistent with a dry (i.e., low) hydropower condition such that
9 the CRSP Management Center and the EMMO will be able to meet its LTF contractual capacity
10 obligations with SLCA/IP federal hydropower resources 90% of the time. This is consistent with
11 the level of risk to which Western has been exposed in the past.

12
13 SLCA/IP utility system energy transactions with the rest of the Western Interconnection
14 are assumed to be priced at levels projected by the AURORA Western Interconnection model
15 run. For the purpose of determining capacity expansion paths, it was assumed that the SLCA/IP
16 market system would only make power purchases. This assumption was made to ensure that the
17 SLCA/IP market system would not construct capacity on a speculative basis for the purpose of
18 selling energy to the Western Interconnection; that is, it constructs capacity primarily for internal
19 purposes. Because the Western Interconnection prices tend to be more expensive than production
20 costs in the SLCA/IP market system, purchases from the Western Interconnection tend to be
21 small. However, the Western Interconnection energy was made available for purchase in
22 situations where internal SLCA/IP production costs became expensive. In addition, reserve
23 margin requirements were configured to exclude Western Interconnection purchases as a source
24 of firm capacity. Therefore, the SLCA/IP market system is prevented from leaning on the
25 Western Interconnection for capacity during times of peak load.

26
27 The third purpose of the AURORA model was to perform a detailed dispatch analysis of
28 the SLCA/IP market system which consists of the SLCA/IP hydropower facilities and Western's
29 SLCA/IP LTF customers. Resources available for hourly dispatch are based on a previous
30 capacity expansion run made by AURORA.

31 32 33 **K.1.5.10 LMP Calibration Spreadsheet (Top Tier)**

34
35 Spot market prices were modeled for CY 2013 through CY 2033 by the Western
36 Interconnection AURORA model. Prices from the first year of this run, 2013, were compared
37 against actual day-ahead market (DAM) prices published by the Intercontinental Exchange (ICE)
38 and the California Independent System Operator to determine model accuracy. The Palo Verde
39 market hub was chosen for the LTEMP analysis to represent prices for the spot market in the
40 AURORA network topology because it is a major hub relatively close to Glen Canyon Dam and
41 is often used as the benchmark price for Western energy transactions.

42
43 In general, AURORA prices differed significantly from both ICE and California
44 independent system operator day-ahead market (CAISO DAM) historical prices for 2013.
45 Therefore, the LMP Calibration Spreadsheet was written to scale AURORA hourly LMPs to
46 more closely match actual nominal values in terms of 2013 dollars. The ICE publishes day-ahead

1 weighted average peak, off-peak, and Sunday off-peak electricity prices for each day. Sunday
2 off-peak hours are the 16 daytime hours that have the highest loads; they correspond to the
3 16 hours classified as peak in the other 6 days of the week. Hourly prices generated by the
4 AURORA model were subdivided into seven categories: holiday, Sunday daytime, Sunday
5 nighttime, Saturday peak, Saturday off-peak, weekday peak, and weekday off-peak.
6 AURORA 2013 monthly averages were computed for each category and compared against the
7 monthly average ICE prices in these categories.
8

9 A scalar (ratio of the ICE to AURORA prices) was generated for each month and each
10 category. Prices generated by the AURORA model were generally lower than the ICE prices.
11 Prices in off-peak hours were lower by about 5 to 15%, and prices in peak hours were lower by
12 as much as 20 to 50%. To adjust prices, both AURORA 2013 and projected LMPs for Palo
13 Verde were multiplied by the aforementioned scalar.
14

15 LMPs at the Palo Verde hub were projected by applying AURORA model price growth
16 rates to the calibrated 2013 price. Future spot market prices are difficult to accurately forecast
17 because they are dependent on many factors, each of which cannot be projected with certainty.
18 Therefore, many future scenarios are possible. For the power systems analysis, the 2014 AEO
19 (EIA 2014) reference case was used to supply AURORA with variable inputs that drive future
20 prices. One of the most important of these is natural gas prices. Figure K.1-11 shows a very
21 strong correlation between historical on and off-peak prices at the Palo Verde hub and natural
22 gas prices. This correlation is due the fact that the resources that are on the margin (i.e., last ones
23 dispatch and determine the LMP) frequently burn natural gas. This strong correlation is expected
24 to continue in the future. AURORA model results support this expectation. Figure K.1-12 shows
25 that the 2014 AEO (EIA 2014) forecasted annual average delivered natural gas price to increase
26 in the future. By 2033, natural gas prices are expected to be about 83% more expensive than
27 prices in 2013. Calibrated LMPs follow this same basic trend. By 2033, Palo Verde price
28 projections, which are based on the aforementioned methodology, are expected to increase by
29 78%. Factors that lead to a slightly slower growth in LMPs include the emergence of more-
30 efficient gas-fired electricity generating technologies that burn less fuel per MWh of fuel
31 consumed and a projected increase in the penetration of variable energy resources (VERs).
32
33

34 **K.1.5.11 Firm Capacity Spreadsheet (Bridges Bottom and Middle Tiers)**

35

36 The Firm Capacity Spreadsheet uses maximum daily output levels from the Large and
37 Small SLCA/IP Powerplant spreadsheets and an assumed risk preference to estimate the amount
38 of firm capacity that is available to the SLCA/IP market system for credit toward the system
39 reserve margin. It also applies outage results produced by the Hydropower Outage model the five
40 large SLCA/IP federal hydropower plants. GTMax-Lite runs of Glen Canyon Dam incorporate
41 outages into estimated daily peak powerplant operations under all 21 hydrological traces.
42
43

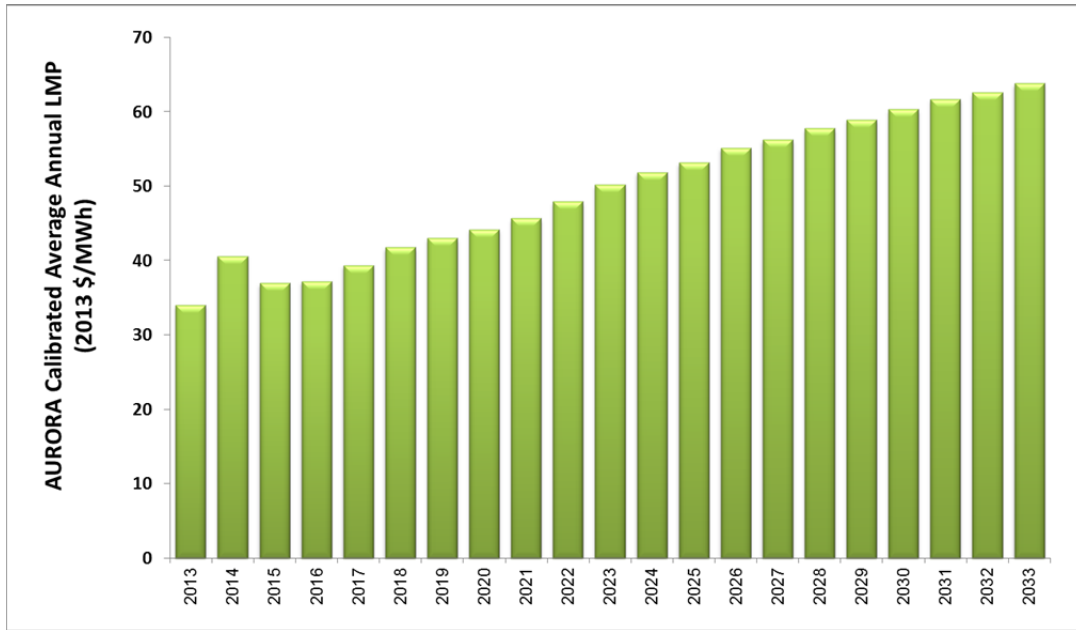

1
2
3
4
5

FIGURE K.1-11 Projected Annual Average Calibrated AURORA LMPs at the Palo Verde Market Hub

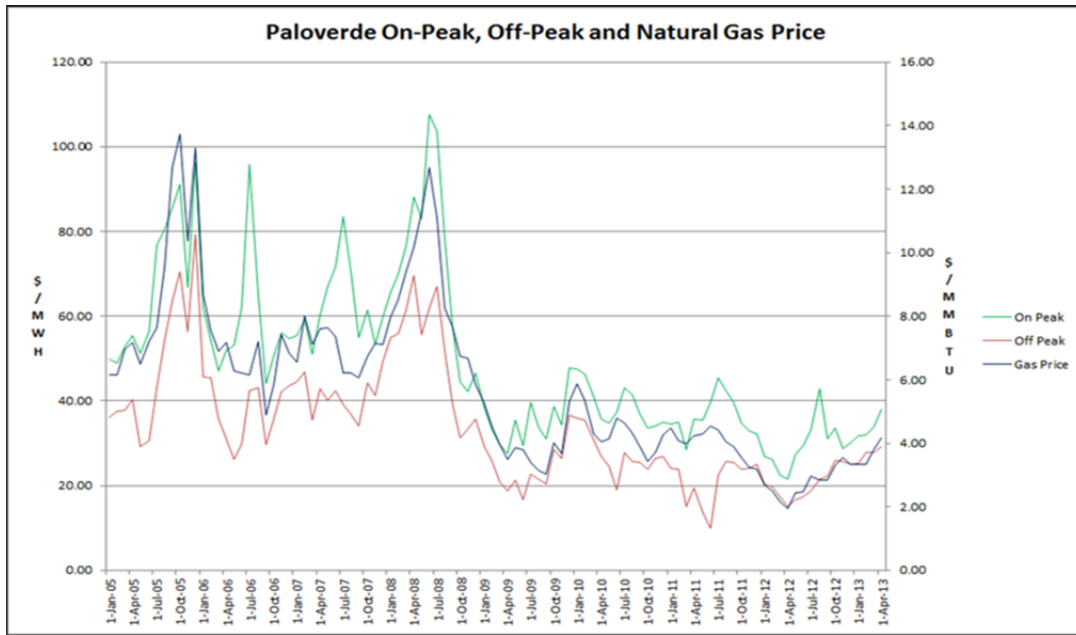

6
7
8
9
10

FIGURE K.1-12 Historical Palo Verde On- and Off-Peak Electricity Prices Compared to Natural Gas Prices

1 In addition to outages, the spreadsheet incorporates a large number of factors in the
2 determination of firm capacity. As explained in more detail in Section K.1.7, these factors
3 include the following:

- 4
- 5 • The time of the year the system peak load is projected to occur;
- 6
- 7 • The probability distribution of the coincidental hydropower peak output
8 potential from SLCA/IP hydropower facilities that consist of all SLCA/IP
9 large and small federal hydropower plants as computed by Glen Canyon Dam
10 GTMax-Lite and the Large SLCA/IP Powerplant Spreadsheet tools;
- 11
- 12 • Projected ancillary service obligations;
- 13
- 14 • Projected capacity levels that will be reserved to for project use obligations;
- 15
- 16 • Expected future system transmission losses; and
- 17
- 18 • The risk tolerance level associated with SLCA/IP federal hydropower having
19 a lower production capability than the declared firm capacity level during the
20 time of the system peak load.
- 21

22 Firm capacity results vary significantly by alternative and are sensitive to both
23 assumptions regarding the selected risk tolerance level and the month in which the peak load is
24 projected to occur in the future. For the LTEMP DEIS, the capacity that is available to the
25 SLCA/IP market system is a fixed amount over the entire study period. Spreadsheet firm
26 capacity results are input into the AURORA SLCA/IP market system runs that simulate capacity
27 expansion.

30 **K.1.6 SLCA/IP Market System, Data Sources, and Model**

31

32 The power systems methodology assesses the economic impacts of changes in Glen
33 Canyon Dam Powerplant operations at the systems level using the three-tiered approach briefly
34 described in the Power Systems Geographic Scope section. The middle tier represents SLCA/IP
35 federal hydropower resources marketed and scheduled the CRSP Management Center and all of
36 the utility systems that receive LTF SLCA/IP energy and capacity.

37

38 Previous sections described federal hydropower resources and hourly prescribed energy
39 injections into the SLCA/IP market system based on GTMax-Lite model results. This section
40 provides additional information about modeling the loads and resources of CRSP Management
41 Center LTF power customers. There are approximately 129 LTF SLCA/IP wholesale customer
42 entities that are categorized as either large or small. Accounting for about 75% of Western's LTF
43 energy and capacity sales, the eight largest customers are Deseret, the Navajo NTUA, SRP,
44 UAMPS, UMPA, PRPA, Tri-State, and CSU. Except for NTUA, all large LTF customers own
45 and operate generating resources. There are about 130 remaining customers, which are
46 aggregated into east and west "small customer" entities, accounting for the remaining 25% LTF

1 sales. Energy received by a few customers under Western LTF contracts are used to serve project
 2 use loads such as pumping for irrigation. Figure K.1-3 shows a simplified topology for the
 3 SLCA/IP systems that was used by the AURORA model to simulate the capacity expansion
 4 pathways and dispatch under each alternative. The following sections describe key model input
 5 and modeling assumptions for the SLCA/IP system.

6
 7 The AURORA model is used to simulate unit commitment scheduling, for resources
 8 dispatch, and for capacity expansion in the SLCA/IP market system. Details on model inputs for
 9 initial historical conditions and for simulating future operations are provided below.

10
 11
 12 **K.1.6.1 Historical Data Sources**

13
 14 The first year simulated by AURORA is CY 2013. It set initial model conditions based
 15 on historical information and serves as a starting point for modeling the future. A considerable
 16 amount of data is needed for AURORA to model SLCA/IP market system operations including
 17 hourly load data, characteristics of existing powerplants, and firm hydropower contracts that
 18 Western’s customers have with offices other than the CRSP Management Center. Primary data
 19 sources for this information include the following:

- 20
- 21 • EPIS—AURORA database containing general/default power systems data;
- 22
- 23 • EIA—existing powerplant ownership, capacity, technology type, primary
- 24 mover, historical delivered fuel prices, plant fuel consumption, historical
- 25 annual generation;
- 26
- 27

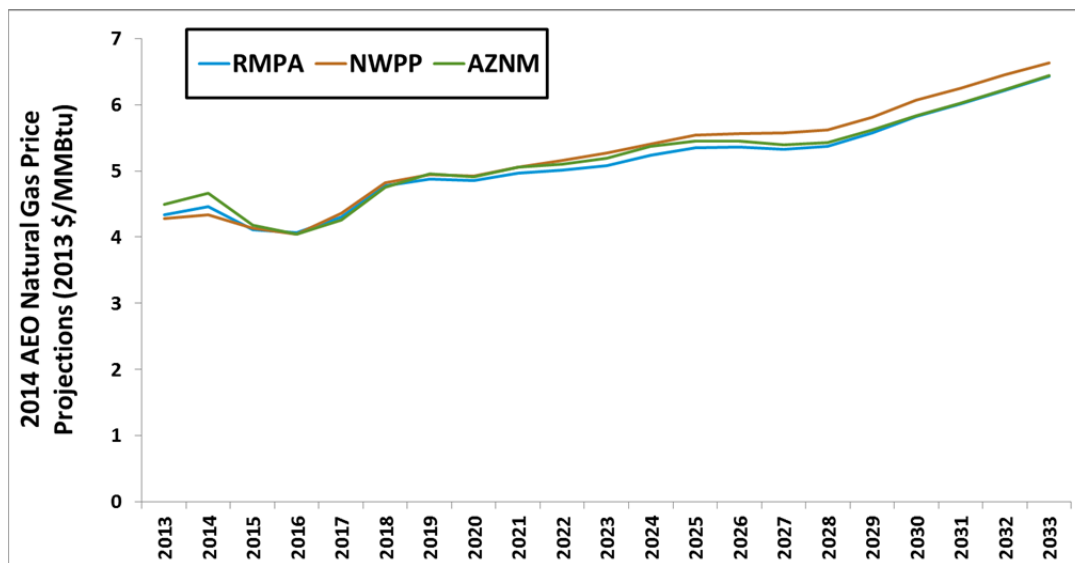

28
 29 **FIGURE K.1-13 2014 AEO (EIA 2014) Projected Delivered Utility Natural Gas**
 30 **Prices**
 31

- 1
- 2 • ICE and CAISO Web sites—sources of historical day-ahead peak and off-
- 3 peak electricity prices;
- 4
- 5 • NERC—power plant maintenance and forced outage characteristics from
- 6 GADS,
- 7
- 8 • FERC—historical hourly load data for utilities and BAs;
- 9
- 10 • Large customer IRPs—a report filed by each of Western’s customers and
- 11 contains characteristics of existing power plants, utility system loads, and
- 12 DSM programs; and
- 13
- 14 • Western—data and information on hydropower contracts from the CRSP
- 15 Management Center and other regional offices from which Western
- 16 customers’ receives federal hydropower and detailed information on federal
- 17 hydropower plant and WACM BA operations, including factors related to
- 18 ancillary services and the transmission system.
- 19

20 The AURORA model uses a database constructed by EPIS that contains Western
21 Interconnection-wide powerplant characteristics, fuel price projections, and hourly load profiles.
22 These data were compared to the aforementioned data sources to verify their accuracy and
23 consistency. Because the methodology calls for Western’s eight large customers to be modeled
24 in detail, Argonne staff constructed hourly load profiles for SLCA/IP system entities and
25 carefully examined power plant characteristics data contained in the AURORA inventory and
26 benchmark them against data on powerplant characteristics compiled by EIA.

27

28

29 **Historical 2013 Loads**

30

31 SLCA/IP market system loads were generated for three types of LTF customers: large,
32 small, and project use. Project use loads are based on information provided by CRSP
33 Management Center staff. These loads are aggregated into east and west groups and are assumed
34 to be constant over each month. Project use loads are projected to increase over the study period,
35 but are relatively small, ranging from a total project use monthly peak load of 4.15 to 51.42 MW.
36 Project use loads are higher in the summer and lower in the winter.

37

38 The power systems modeling effort began at a time when historical FERC Form-714 load
39 data for CY 2013 were not yet available. Argonne staff therefore constructed a time series of
40 CY 2013 hourly loads for each of the eight large customers and for each of the two small
41 customers groups classified as east and west.

42

43 Loads for 2013 were constructed by the Loads Shaping Algorithm. For the eight large
44 customers, the algorithm scaled representative nominal hourly shapes to CY 2013 levels such
45 that hourly loads were consistent with projected monthly peak and total load targets. As
46 described previously, CY 2006 hourly load profiles were used as the basis for constructing these

1 nominalized shapes. CY 2013 load targets were based primarily on information contained in
2 large customer IRPs.

3
4 Aggregate small customer loads in the west were based on the UAMPS load profiles that
5 was scaled to match 2013 small customer energy data used for retail rate analyses. UAMPS
6 projected growth rates were also applied to the west small customer group. An identical method
7 was used for the small customer group in the east, except in this case load profiles and growth
8 rates for CSU were scaled to match small customer energy targets.

9
10 Although Western almost exclusively sells LTF capacity and energy to utilities in its
11 service territory, special arrangements were made to enable Tribal entities to receive SLCA/IP
12 federal hydropower capacity and energy. For 48 Tribes that do not operate their own electric
13 utilities, Western made an administrative change to allow them to receive an allocation of power
14 and the associated financial benefits. In this benefit crediting arrangement, Western delivers the
15 Tribe's allocation to their electric service supplier. Because the SLCA/IP rate is lower than the
16 supplier's production cost, the supplier provides the Tribe with a payment that is equal to the
17 Tribe's electric allocation from Western multiplied by the difference in rates. The payment
18 received by the Tribe is the financial equivalent of a direct delivery of electricity. Through this
19 arrangement, Tribes ultimately receive the same services, pay the same rates for both capacity
20 and energy, and abide by the same terms as all other customers. For power systems economic
21 modeling, these financial transactions are not explicitly simulated because the effects on overall
22 system-level economics are insignificant and not appreciably different among alternatives.

23 24 25 **2013 Powerplant Characteristics and Fuel Prices**

26
27 Recent data (from 2012 and 2013) on thermal power plant characteristics were obtained
28 from EIA Form-860. This information was coupled with monthly cost and quality fuel deliveries
29 from EIA Form-923 to estimate delivered 2013 fuel prices for each of the thermal powerplants in
30 the unit inventory of Western's large customers. Fuel prices for 2013 are typically used.
31 However, when this information is not available, 2012 prices are used as a surrogate. AURORA
32 model generating unit capacity levels vary by month, with generally higher capacities in the
33 winter than in summer months.

34
35 In AURORA, delivered fuel prices are not directly assigned to each powerplant in its
36 database. Instead, AURORA applies unit-specific fuel price multipliers to a common price.
37 Henry Hub is used as a price reference point for natural gas, and state-level coal prices are used
38 as coal reference points. The EPIS-supplied representation of the Western Interconnection uses
39 actual and projected monthly natural gas prices at Henry Hub for the year 2010 in terms of
40 nominal 2010 dollars. For power systems analysis, AURORA unit-level delivered natural gas
41 prices are converted to 2013 dollars. Prices at points of delivery are typically higher than the
42 Henry Hub price. Therefore, prices are adjusted to account for delivery costs by applying unit-
43 specific price multipliers in the model. Natural gas prices for 2013 are based on plant delivery
44 costs reported in FERC Form-923. Similarly, 2013 coal prices in 2013 nominal dollars are
45 computed in AURORA by applying unit-level multipliers to state-level prices.

1 Natural gas prices in AURORA differ by month; generally, prices are higher in the winter
2 as compared to the spring and autumn. These same seasonal trends were used for the LTEMP
3 power systems study. No seasonal changes in coal or distillate fuel prices were assumed; that is,
4 coal and distillate fuel prices are constant throughout 2013.

5
6 Only one small oil-fired unit is owned by Western's large customers. It is rarely
7 dispatched. No adjustments were made to the EPIS default nuclear fuel price. Only one nuclear
8 plant is partially owned by SRP. It is dispatched as a base load unit, and production levels do not
9 vary significantly among alternatives. Therefore, production cost differences for this plant do not
10 have a significant bearing on economic cost differences among alternatives.

11 12 13 **O&M Costs for Existing and Committed Units**

14
15 Real variable O&M costs for existing units and ones that are committed to be constructed
16 are held static at 2013 levels throughout the study period.

17
18 Fixed O&M costs only factor into LTEMP DEIS economic calculations for capacity
19 expansion units because the retirement schedule of existing units and online dates for committed
20 units do not change among alternatives; therefore the economic difference of these "fixed" costs
21 between Alternative A, which serves as a reference point, and other alternatives is equal to zero.

22 23 24 **2013 Unit-Level Heat Rates**

25
26 Documentation in the AURORA model acknowledges shortcomings in the default heat
27 rate data in the EPIS-provided database. It recommends that EIA sources of historical generation
28 data, like Form-923, be consulted to confirm plant-specific heat rates. This information was
29 coupled with monthly powerplant generation and the cost and quality fuel deliveries from EIA
30 Form-923 to generate heat rates and delivered fuel prices for each of the thermal powerplants in
31 the unit inventory of Western's large customers. AURORA default heat rates differed by as
32 much as 60% from levels calculated from current EIA data. Therefore, in this analysis heat rates
33 calculated from EIA data replaced AURORA default values. However, EIA data was not
34 reported for some thermal powerplants; in those cases, default AURORA values or surrogate
35 values based on similar type plants were used. Some differences were also found when
36 comparing AURORA default delivered fuel prices with those calculated from recent EIA data.
37 When discrepancies were found, calculated fuel prices were used in this analysis. However,
38 AURORA defaults were used for plants that either had no EIA data or where fuel prices were
39 outside of a reasonable range.

40 41 42 **2013 Firm Power Contracts**

43
44 The eight large SLCA/IP power utilities both buy and sell power under various LTF
45 contracts. As described previously, contracts between the CRSP Management Center and its LTF
46 customers are not directly modeled. Instead, power systems economic analyses assume that

1 federal SLCA/IP hydropower plants are supply resources for meeting SLCA/IP system
2 (i.e., large and small customer utility) loads. In addition to SLCA/IP capacity and energy, some
3 customers also receive federal hydropower from other regional offices within the Western
4 organization. Information on these non-SLCA/IP LTF contracts was supplied by Western. These
5 contracts are modeled in AURORA as virtual hydropower plants, the operation of which is
6 constrained by contract monthly minimum and maximum hourly contract limits and total
7 monthly energy bounds.

8
9 In addition to federal contracts, some customers have contracts with entities that are
10 either within the modeled SLCA/IP system and/or other Western Interconnection entities that are
11 outside of the SLCA/IP market system. Information on these contracts was ascertained from
12 customer IRPs. Details on these non-federal firm contracts were typically not available.
13 Therefore, Argonne power system modelers created simple representations of these contracts in
14 AURORA using the information that was available in the IRPs. Contracts are modeled in
15 AURORA as virtual thermal power plants with operating limits.

16 17 18 **2013 Renewable Energy Resources (Water, Wind, and Solar)**

19
20 The AURORA model also includes a representation of existing renewable energy
21 resources. These resources include SLCA/IP system non-federal hydropower and wind and solar
22 Variable Energy Resources (VERs) that produce power and serve system loads. Non-federal
23 hydropower plant resources were modeled as AURORA hydropower plants based on the
24 operating characteristics of the resource (i.e., run-of-river or peaking). For 2013 operations,
25 monthly generation levels were benchmarked to actual levels recorded in EIA Form-923. Power
26 production from VERS is represented as a fixed time series of hourly power injections into the
27 grid using locational profiles provided by EPIS in the AURORA Western Interconnection
28 database.

29 30 31 **K.1.6.2 AURORA Model Dispatch Results for 2013**

32
33 Initial model AURORA model runs of CY 2013 produced results that significantly
34 differed from historical monthly generation levels. Model runs were mainly driven by EPIS input
35 data that was supplied with the model. However, after system representation and input data
36 refinements were made, the model results more closely mimicked historical production patterns.
37 Figure K.1-14 shows that the 2013 AURORA generation profile by fuel type for Western's eight
38 large LTF customers is similar to actual 2013 levels as found in EIA Form-923. Generation for
39 hydropower plants by LTF customer utilities exactly match prescribed historical levels.

40 41 42 **K.1.6.3 SLCA/IP Market System Projections**

43
44 SLCA/IP market system supply and demand attributes, time value of money assumptions,
45 and projections driving variables such as load growth, delivered utility fuel prices, and new unit
46 technology characteristics play a major role in the development of the system and LTEMP DEIS

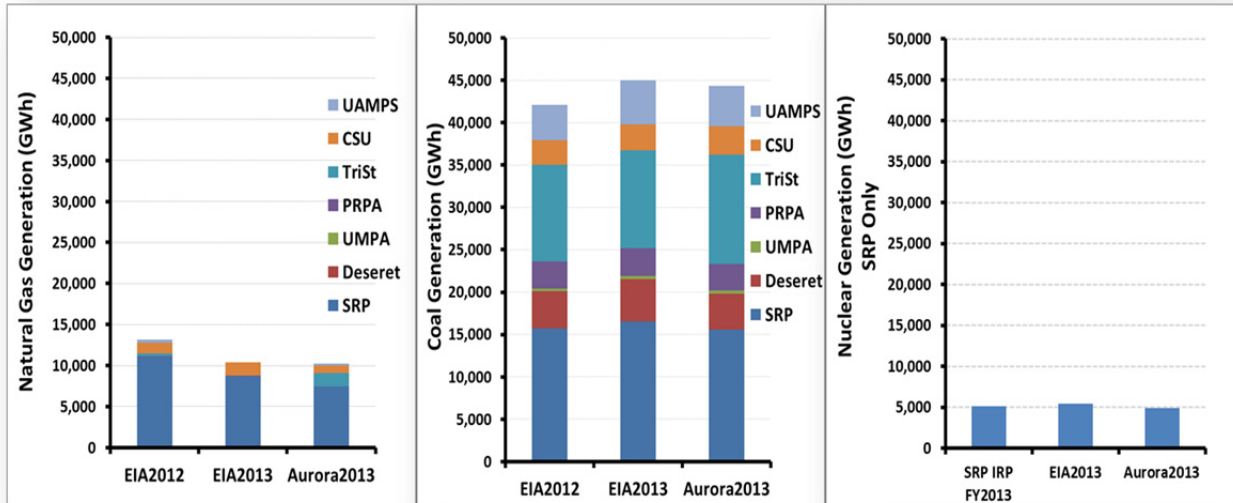

FIGURE K.1-14 Comparison of Modeled and Actual Annual Aggregated Generation Levels (from the EIA) for Natural Gas, Coal, and Nuclear Powerplants under the No Action Alternative

power system results. Projected future developments in the SLCA/IP market system rely on several information sources that include the following:

- Large customer IRPs—future fossil, and VER power plant additions and DSM initiatives;
- EIA announced (or committed) new unit additions, 2014 AEO (EIA 2014) candidate technology characteristics, utility fuel price, and load projections as driven by broader forces such as overall U.S. and global macroeconomic developments;
- State RPS—future RPS requirements; and
- Western—changes in project use loads and outlooks for future ancillary service requirements.

Western LTF customers are required to submit IRPs in order to receive federal hydropower capacity and energy. Information contained in these IRPs was used as a principal source of model inputs for future developments in terms of load growth and resource capacity expansion. However, not all IRPs cover the entire timeframe of the LTEMP DEIS study period. Therefore, projections found in the 2014 AEO (EIA 2014) were used to supplement LTF customer IRPs and provide projections that were based on a common and consistent basis.

1 **Load Growth Projections**
2

3 This section will describe in detail how the hourly loads for the eight large customers and
4 the two groups of aggregate small customers were developed for the years in the LTEMP study
5 period. As noted earlier, small customers were aggregated into an east group or bubble and a
6 west group or bubble.
7

8 Developing hourly loads was a three-step process. First, historical hourly load data was
9 gathered for each utility to be modeled. Second, a historical year was selected that best
10 represented the load profiles of all years for which data was collected. The year selected had the
11 best matches to both the average weekly load factor and the average annual load factor across all
12 years. Third, the Hourly Load Forecast Algorithm was used to generate hourly load profiles for
13 all future years for each utility. The model scaled hourly loads so they followed the profile of the
14 representative year and at the same time also match forecasted monthly peak and total monthly
15 energy for each utility modeled.
16

17 To find the representative historical year, hourly loads were collected from each large
18 customer for the years 2006 to 2009. The data were compiled by FERC in Form-714 and are
19 publicly available via software downloaded from the FERC Web site (available at
20 <http://www.ferc.gov/docs-filing/forms/form-714/view-soft.asp>). These years were chosen
21 because they were the only recent set of years for which complete annual datasets were available
22 for all eight customers. Data for 2010, 2011, and 2012 were not available for NTUA and Deseret.
23 We could only choose a year for which data was available for all utilities. For more details on
24 load data collection see Attachment K-7.
25
26

27 **Small Customer Loads.** As noted earlier, small customers were aggregated into an east
28 bubble and a west bubble. Staff from Western assisted Argonne in classifying whether small
29 customers should be placed into the east or west bubble. In general, small customers in Colorado,
30 New Mexico, and Wyoming were put into the east bubble, while small customers in Arizona,
31 Nevada, and Utah were put into the west bubble. Small customer load shapes were based on the
32 representative year from one of the eight large customers. For small customers in the east bubble,
33 the profile from CSU was used; for small customers in the west bubble, UAMPS was used.
34 UAMPS is in the western part of the CRSP Management Center customer territory and is
35 comprised of many cooperating small customers. Therefore, it was judged that UAMPS load
36 shape was representative of small customers in the west bubble. CSU is a relatively small
37 municipal utility in the eastern part of Western's service territory; therefore, its load shape was
38 used to represent small customers in the east bubble. These load shapes were scaled to match
39 their estimated historical total load based on information that was collected for the retail rate
40 payer analysis described in Section K.3.
41
42

43 **Representative Load Shape.** After collecting the historical data, total hourly
44 coincidental loads were computed for the eight large utilities for the 2006 through 2009 time
45 period. A weekly load factor (WLF) was calculated for each week in each year for which FERC
46 Form-714 data were available. An average weekly load factor (AWLF) across all years was also

1 calculated. Then the sum of the squared differences (SSD) between the WLF and the AWLF was
2 calculated using the equation $SSD(WLF) = \sum (WLF - AWLF)^2$. A similar calculation was
3 performed to find the SSD between the annual load factor (ALF) for each year and average
4 annual load factor (AALF) across all years or $SSD(ALF) = \sum (ALF - AALF)^2$. The sum of the
5 squared differences for both the WLF and ALF were then summed. CY 2006 had the smallest
6 sum and was therefore selected as the representative year for all customer loads. Using a
7 common year for all utilities correctly captures load diversity among the utilities, including those
8 resulting from large-scale weather patterns.

9
10 After selecting the representative year, the Hourly Load Forecast Algorithm was used to
11 generate hourly load profiles for future years for each of the eight large LTF utilities and for each
12 small customer bubble. Inputs into the algorithm were the utility's hourly load profile for the
13 representative year and the forecasted monthly peak load and energy for each future year. Based
14 on the data that were available, a load forecast was generated using a customized method for
15 each utility. The following describes the method used to generate each load forecast.

16 17 18 ***Salt River Project***

- 19
20 1. Historical hourly load profile for 2006 was used. The monthly peak loads and
21 energy were based on the ratios of monthly peak to annual peak and monthly
22 energy to total annual energy from 2006.
- 23
24 2. Total annual energy for 2012 was specified in the 2013 IRP (SRP et al. 2012).
25 From 2013 to 2033, the annual energy was assumed to grow at the same
26 annual rate as the total electricity sales forecast for the Southwest region of
27 the Western Electricity Coordinating Council in the 2014 AEO (namely,
28 Table 91 in EIA 2014).
- 29
30 3. Annual peak loads for 2012 to 2016 were specified in the 2013 IRP
31 (SRP et al. 2012). From 2017 to 2033, the peak load was assumed to grow at
32 the same annual rate as used for the total annual energy shown above (namely,
33 the data from Table 91 of the early release of EIA 2014).

34 35 36 ***Navajo Tribal Utility Authority***

- 37
38 1. The historical hourly load profile for 2006 was used. The monthly peak loads
39 and energy were based on the ratios of monthly peak to annual peak and
40 monthly energy to total annual energy from 2006.
- 41
42 2. Annual peak loads and energy for 2012 to 2030 were obtained from the
43 October 2012 IRP (NTUA 2012).
- 44
45 3. Annual peak loads and energy for 2031 to 2033 were calculated using the
46 same growth rate as 2030.

1 **UMPA**

- 2
- 3 1. The historical hourly load profile for 2006 was used. The monthly peak loads
4 and energy were based on the ratios of monthly peak to annual peak and
5 monthly energy to total annual energy from 2006.
 - 6
 - 7 2. Annual peak loads and energy for 2012 to 2033 were obtained from the IRP
8 5-year plan (UMPA 2013).
 - 9

10 **UAMPS**

- 11
- 12
 - 13 1. The historical hourly load profile for 2006 was used. The monthly peak loads
14 and energy were based on the ratios of monthly peak to annual peak and
15 monthly energy to total annual energy from 2006.
 - 16
 - 17 2. UAMPS staff provided historical monthly energy and peak demand data for
18 2011 to 2013 (Anderson 2014).
 - 19
 - 20 3. There were no growth forecasts in the UAMPS IRP (UAMPS 2013), so the
21 same growth rates were assumed for annual peak and energy as those
22 provided in the UMPA IRP for 2014 to 2033. Members of UAMPS were
23 assumed to have similar energy demand profiles as members of UMPA.
 - 24
 - 25

26 **Deseret**

- 27
- 28 1. The historical hourly load profile for 2006 was used. The monthly peak loads
29 and energy were based on the ratios of monthly peak to annual peak and
30 monthly energy to total annual energy from 2006.
 - 31
 - 32 2. Annual peak loads and energy for 2012 to 2018 were obtained from the IRP
33 update (Deseret 2012).
 - 34
 - 35 3. From 2019 to 2033, the annual peak load and energy were assumed to grow at
36 the same rate as the total electricity sales forecast for the Rocky Mountain
37 region of the Western Electricity Coordinating Council in the 2014 AEO
38 (namely, Table 94, in EIA 2014).
 - 39
 - 40

41 **Tri-State Generation and Transmission Association**

- 42
- 43 1. The historical hourly load profile for 2006 was used. The monthly peak loads
44 and energy were based on the ratios of monthly peak to annual peak and
45 monthly energy to total annual energy from 2006.
 - 46

- 1 2. Annual peak loads and energy for 2012 to 2029 were obtained from the IRP
2 (Tri-State 2010).
- 3
- 4 3. Annual peak loads and energy for 2030 to 2033 were assumed to grow at the
5 same rate as 2029.
- 6
- 7

8 ***Colorado Springs Utility***

- 9
- 10 1. The historical hourly load profile for 2006 was used. The monthly peak loads
11 and energy were based on the ratios of monthly peak to annual peak and
12 monthly energy to total annual energy from 2006.
- 13
- 14 2. Annual peak loads and energy for 2012 to 2031 were obtained from the IRP
15 (CSU 2012).
- 16
- 17 3. Annual peak loads and energy for 2032 to 2033 were assumed to grow at the
18 same rate as 2031.
- 19
- 20

21 ***Platte River Power Authority***

- 22
- 23 1. The historical hourly load profile for 2006 was used. The monthly peak loads
24 and energy were based on the ratios of monthly peak to annual peak and
25 monthly energy to total annual energy from 2006.
- 26
- 27 2. Annual peak loads and energy for 2012 to 2020 were obtained from the IRP
28 (PRPA undated).
- 29
- 30 3. Annual peak loads and energy for 2021 to 2033 were assumed to grow at the
31 5-year average growth rate from 2016 to 2020.
- 32
- 33

34 ***Small Customer—West***

- 35
- 36 1. The historical 2006 hourly load profile for UAMPS selected as representing
37 small customers in this bubble.
- 38
- 39 2. Data was collected for 2012 on retail energy sales from EIA Form-861 and
40 summed for all small customers in this bubble.
- 41
- 42 3. The annual load factor for UAMPS was assumed to be representative of this
43 small customer group. The annual peak load for 2012 was computed from the
44 retail energy sales in 2012 and the UAMPS load factor.
- 45

- 1 4. Annual peak loads and energy for 2013 to 2033 were assumed to grow at the
2 same rate as for UAMPS.
- 3
- 4 5. The monthly peak loads and energy were based on the ratios of monthly peak
5 to annual peak and monthly energy to total annual energy from the 2006
6 UAMPS load profile.
- 7
- 8

9 ***Small Customer—East***

- 10
- 11 1. The historical 2006 hourly load profile for CSU selected as representing small
12 customers in this bubble.
- 13
- 14 2. Data for 2012 was collected on retail energy sales from EIA Form-861 and
15 summed for all small customers in this bubble.
- 16
- 17 3. The annual load factor for CSU was assumed to be representative of this small
18 customer group. The annual peak load for 2012 was computed from the retail
19 energy sales in 2012 and the CSU load factor.
- 20
- 21 4. Annual peak loads and energy for 2013 to 2033 were assumed to grow at the
22 same rate as for CSU.
- 23
- 24 5. The monthly peak loads and energy were based on the ratios of monthly peak
25 to annual peak and monthly energy to total annual energy from the 2006 CSU
26 load profile.
- 27

28 Figures K.1-15 and K.1-16 show stacked bar charts of customer non-coincidental
29 monthly peak load and total monthly load projections, respectively. As described in sections that
30 follow, projections of the eight large customer system summer peak load is particularly
31 significant. Any reduction in Glen Canyon Dam Powerplant capacity as a result of more
32 stringent operating criteria does not incur an economic cost until all of the excess capacity in the
33 system is fully depleted. The year in which this occurs is heavily dependent on large customer
34 utility system load growth. Attachment K-6 contains more detailed results for individual large
35 customers and for the two aggregate small customer bubbles.

36

37

38 **Capacity Expansion Candidate Unit Characteristics**

39

40 To reliably meet the forecasted increases in electricity demand and to replace
41 powerplants that will be retired during the study period, new powerplants will be constructed in
42 the SLCA/IP market system.

43

44 Argonne staff used the AURORA model to create system capacity expansion paths and
45 unit retirement schedules for utilities in the SLCA/IP system for each of the DEIS alternatives.
46 As described previously, AURORA uses detailed unit-level information about existing and

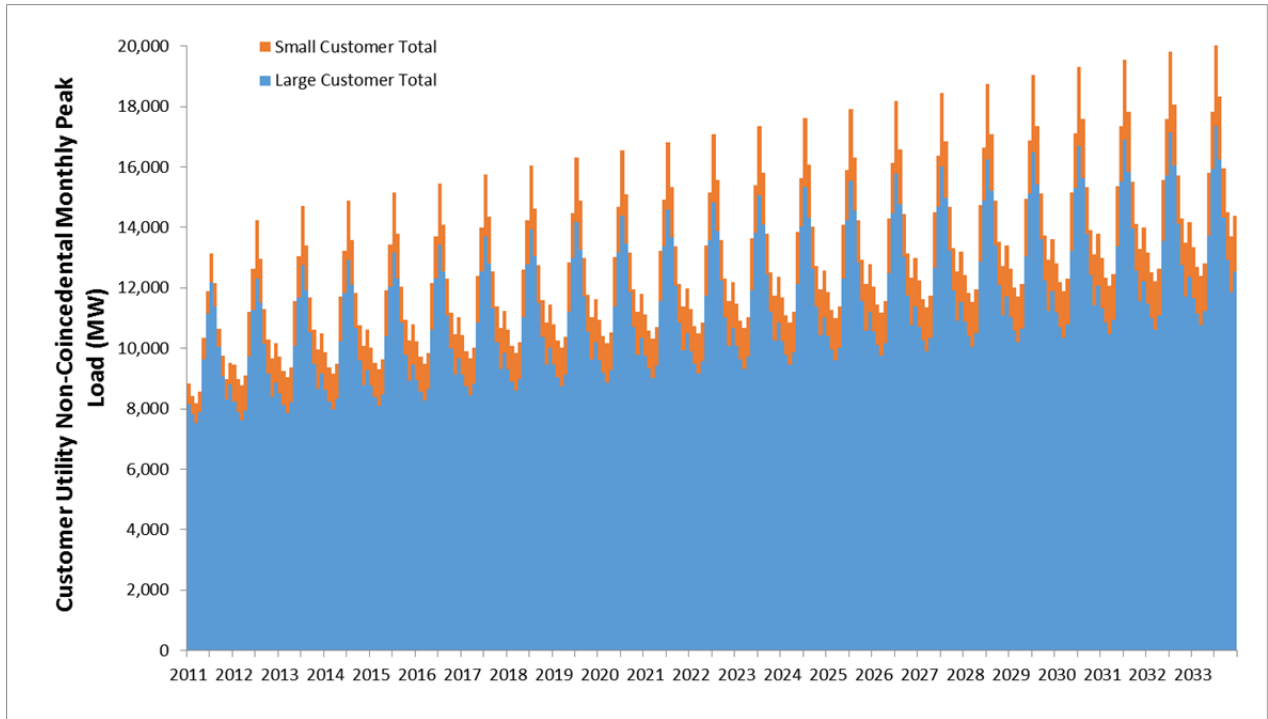

1

2 **FIGURE K.1-15 Total Non-coincidental Peak Loads for the SLCA/IP Market System**

3

4

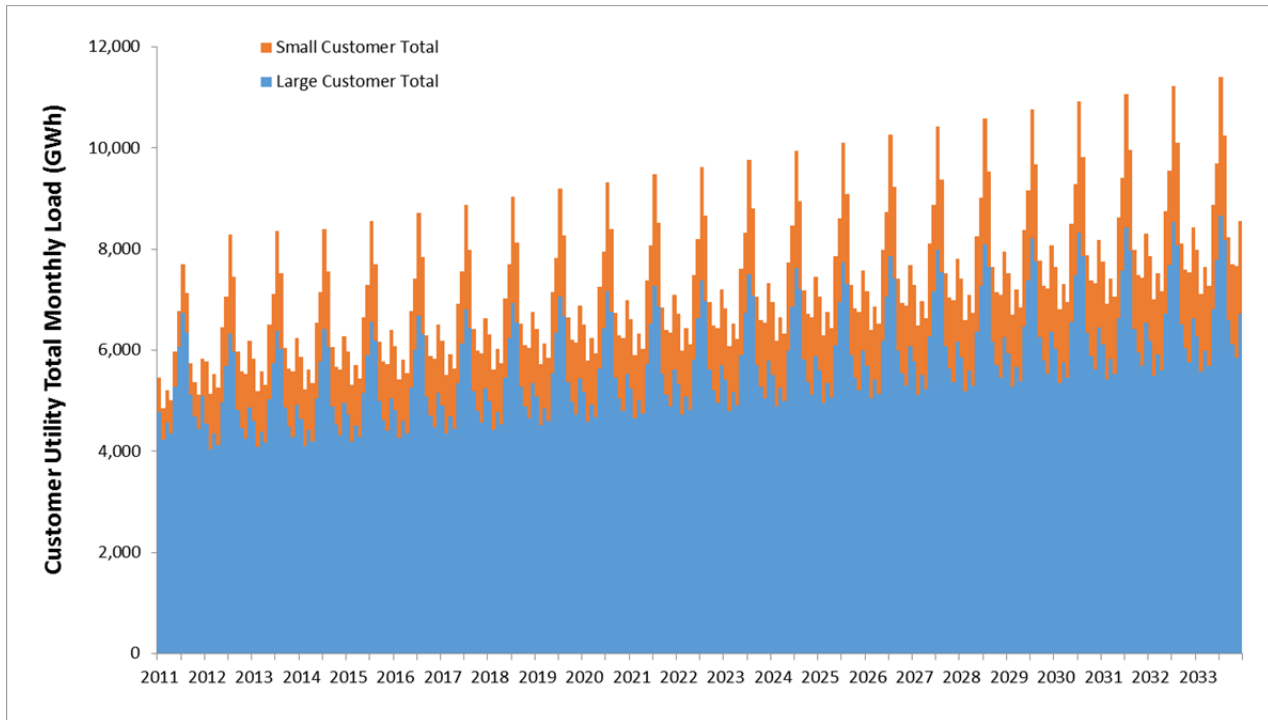

5

6 **FIGURE K.1-16 Total Monthly Loads for the SLCA/IP Market System**

7

1 committed generating units owned and operated by Western’s LTF customers. The model also
2 includes information about candidate units that could be built in the future. The type and number
3 of new technologies added over time was determined by Argonne staff by tunneling AURORA
4 model capacity expansion runs. In this context, “tunneling” refers to restricting the number of
5 possible model solutions to a smaller set of capacity expansion possibilities (e.g., restricting the
6 number of possible new gas-turbines built in a specific year and location [i.e., bubble], to one to
7 three units instead of the model default of zero to unlimited new units). This technique is often
8 used in capacity expansion planning when the number of combination of expansion technologies
9 is otherwise enormous. It often requires multiple iterative model runs as the user explores
10 different tunnel boundaries such that the solution is not bounded by the user-defined limits.
11 Capacity is constructed such that the capacity reserve margin of the aggregate eight large
12 customers never drops below 15%. Table K.1-1 shows the cost, in terms of 2013 dollars, and
13 performance characteristics of a suite of candidate plants from which the AURORA model could
14 choose to expand capacity of the power system.

15
16 Expansion candidates were selected from the suite of new central station electricity
17 generating technologies in the 2014 AEO (EIA 2014). The suite includes conventional and
18 advanced thermal units and renewables. Performance characteristics in the table include unit
19 capacity, heat rate, and fuel type, and cost characteristics include capital costs, fixed and variable
20 O&M costs, book life of the unit, and number of years it takes to construct. Costs are shown as a
21 range because Western’s customers are located in three different geographic regions identified
22 by the EIA 2014 AEO (EIA 2014) electricity market module; each has powerplant-specific labor
23 multipliers. Different labor multipliers were factored into the powerplant costs from EIA
24 depending upon where the plant would be located. Labor costs vary by region where the plant is
25 constructed; a regional multipliers table is located on the EIA Website
26 (<http://www.eia.gov/forecasts/capitalcost>).

27
28 Overnight capital expenses and fixed O&M costs are based on 2014 AEO (EIA 2014)
29 data and expressed in 2012 dollars. AEO documentation indicates that these costs are applicable
30 to new units built in 2014 and later. It is assumed that these costs will not change in real terms;
31 therefore, capital costs for a specific technology in real terms do not change as a function of
32 online date. The AEO cost values were converted to 2013 dollars using the “Powerplants”
33 index contained in the “Bureau of Reclamation Construction Cost Trends” table
34 (Reclamation undated). The values for January were used because it was assumed that new
35 plants came online at the beginning of the year. Fixed O&M costs were converted to 2013
36 nominal dollars using this same table, except in this case the “Powerplant Accessory elect. &
37 misc. equip” index was used. Variable O&M costs for new construction are converted to 2013
38 nominal dollars based on the producer price index (PPI) for “Electric power transmission,
39 control, and distribution energy production” (series ID code pcu22112-22112-) (BLS undated).

40
41 In the AEO, capital costs are shown as an “overnight” cost, which is an estimate of the
42 cost at which a powerplant could be constructed assuming that the entire process from planning
43 through completion could be accomplished in a single day. However, in reality a plant takes
44 several years to construct. Money borrowed or committed to a project during its construction
45 must be repaid with interest. The term for this expenditure is allowance for funds during
46 construction (AFUDC). Because capital costs from the 2014 AEO (EIA 2014) for expansion

1 **TABLE K.1-1 Cost and Performance Characteristics of Capacity Expansion Candidates**

| Expansion Candidate Technology | Capacity (MW) | Heat Rate (Btu/kWh) | Fuel Type | Unit Book Life (yr) | Construction Lead Time (yr) | AFUDC (% of overnight cost) | Levelized Capital Cost (2013\$/MW/yr) | | Fixed O&M Cost (2013\$/MW/yr) | | Variable O&M Cost (2013\$/MWh) | |
|----------------------------------------|---------------|---------------------|-------------|---------------------|-----------------------------|-----------------------------|---------------------------------------|---------|-------------------------------|--------|--------------------------------|-------|
| | | | | | | | Min | Max | Min | Max | Min | Max |
| Scrubbed Pulverized Coal | 600 | 8,800 | Coal | 30 | 4 | 9.83 | 194,080 | 197,146 | 31,491 | 31,982 | 4.51 | 4.59 |
| Integrated Gasification Combined Cycle | 550 | 8,700 | Coal | 30 | 4 | 9.83 | 250,755 | 253,980 | 52,015 | 52,684 | 7.31 | 7.40 |
| Conventional Combined Cycle | 300 | 7,050 | Natural Gas | 30 | 3 | 7.26 | 59,953 | 60,429 | 13,456 | 13,563 | 3.68 | 3.71 |
| Advanced Combined Cycle | 400 | 6,430 | Natural Gas | 30 | 3 | 7.26 | 66,931 | 67,407 | 15,708 | 15,825 | 3.34 | 3.37 |
| Conventional Combustion Turbine | 120 | 10,850 | Natural Gas | 30 | 2 | 4.76 | 62,438 | 62,755 | 7,544 | 7,578 | 15.87 | 15.95 |
| Advanced Combustion Turbine | 230 | 9,750 | Natural Gas | 30 | 2 | 4.76 | 43,722 | 44,304 | 7,297 | 7,392 | 10.75 | 10.89 |
| Advanced Nuclear | 2,236 | 10,452 | Uranium | 30 | 6 | 15.19 | 385,516 | 386,997 | 94,873 | 95,243 | 2.18 | 2.19 |
| Wind | 50 | 0 | Wind | 30 | 3 | 7.26 | 105,631 | 106,900 | 40,996 | 41,350 | 0.00 | 0.00 |
| Solar Thermal | 50 | 0 | Solar | 30 | 3 | 7.26 | 240,921 | 253,715 | 65,452 | 68,112 | 0.00 | 0.00 |
| Photovoltaic | 50 | 0 | Solar | 30 | 2 | 4.76 | 217,553 | 225,801 | 24,055 | 24,966 | 0.00 | 0.00 |

Source: Reclamation (undated)

K-51

2
3

1 candidates were overnight costs, they did not include AFUDC. Therefore, these additional
2 expenditures were added to the overnight capital cost before the capital costs are leveled.
3 Calculation of AFUDC assumes that a certain percent of the total overnight cost is borrowed at
4 regular intervals during construction. The time series of expenditures is often referred to as an
5 “S curve” of capital spending. The time series of expenditures from the S curve coupled with the
6 interest rate of the borrowed money and the time period over which it is borrowed yields the
7 amount of interest paid per dollar or as the amount of AFUDC as a percent of the overnight cost.
8

9 AFUDC is estimated for each technology using a spreadsheet model. For this study, a
10 Weibull distribution was used to represent the S curve of capital spending and the interest rate
11 assumed was 4.28%. Table K.1-1 shows the amount of AFUDC as a percent of the overnight
12 cost. It estimates interest payments monthly using a blended average of long-term taxable and
13 municipal bond rates, which are estimated using information from several sources including the
14 following:

- 15 1. WM Financial Strategies (undated)
- 16 2. Bloomberg Business (undated)
- 17 3. BondsOnline (undated)

18
19
20
21
22 Assumed construction times used for the study period were also obtained from the 2014
23 AEO (EIA 2014). The average projected bond rate in real terms (i.e., actual quoted levels less
24 projected inflation) is expected to vary slightly over time. As a simplification, an annual average
25 bond rate of 4.28% was used regardless of when construction begins. This is the average rate
26 over the 2017 through 2033 time period. It should be noted that during this time period the
27 weighted average annual bond rate fluctuates between 4.16% in 2033 and 4.39% in 2019; that is,
28 a range of only 0.23%.

29
30 It should be noted that in order for the power systems analysis to be consistent with other
31 LTEMP resource study areas, the analysis period and assumed implementation date of all
32 alternatives is assumed to occur retroactively. Therefore, in order to best capture the economic
33 impacts of an alternative, capacity replacement for lost Glen Canyon Dam Powerplant capacity
34 may be brought online in the model sooner than what may be physically possible.
35

36 Capital costs used for this analysis are similar to those recommended by Energy and
37 Environmental Economics, Inc. (E3), for WECC 10- and 20-year planning studies (E3 2014).
38 Similar to this study, E3 used AEO new powerplant construction cost information as the basis for
39 its recommendations to WECC. However, E3 used data from the 2013 AEO, while this analysis
40 used more recent data contained in the 2014 AEO (EIA 2014). The costs between the two
41 sources were slightly different. Overnight capital costs for the two key technologies selected by
42 AURORA for SLCA/IP market system expansion are somewhat lower in the 2014 AEO
43 (EIA 2014) compared to the 2013 AEO; costs are 5.2% less for advanced combustion turbines
44 and 7.6% less for advanced natural gas combined cycle plants.
45

1 E3 also used a method similar to that used in this study by adjusting overnight capital
2 costs to account for additional expenditures like AFUDC. The AFUDC multipliers applied by
3 Argonne are slightly greater than those used by E3. For example, Argonne used an IDC
4 multiplier of 1.0476 for advanced combustion turbines, while E3 used a multiplier of 1.035. For
5 advanced natural gas combined cycle technologies, Argonne used a multiplier of 1.0983 while
6 E3 used a multiplier of 1.068.
7

8 Finally, the levelized cost of capital plus fixed O&M cost used in Reclamation's (2007a)
9 *Colorado River Interim Guidelines for Lower Basin Shortages and Coordinated Operations for*
10 *Lake Powell and Lake Mead* (a.k.a. Interim Guidelines EIS) is consistent with levels used in this
11 study. For a natural gas combined cycle plant, the total cost presented in that EIS was
12 \$75,800/MW-yr (in 2007\$; i.e., approximately \$83,400/MW-yr in 2013\$). In comparison, this
13 study uses a levelized capital cost of capital plus fixed O&M that, depending on location, ranges
14 between \$82,639/MW-yr and \$83,232/MW-yr. No other technologies were considered in the
15 Interim Guidelines EIS; therefore, a comparison cannot be made for the combustion turbine
16 technology.
17

18 In an email response (James 2014) sent to LTEMP co-lead agencies following the
19 March/April 2014 Stakeholder Workshop, the Colorado River Energy Distributors Association
20 (CREDA) suggested using capital cost data from a document published by the Electric Power
21 Research Institute (EPRI 2013). In this document, the overnight capital cost of a natural gas-fired
22 combined cycle plant was shown to have a range of 900 to 1,150 \$/kW (in 2011\$); the lower cost
23 unit used wet cooling and the higher cost dry cooling. The wet cooling value was similar to the
24 value from the 2014 AEO (EIA 2014), which also assumed wet cooling. When AFUDC was
25 added, the cost range became 1,025 to 1,325 \$/kW, which equates to an AFUDC multiplier of
26 about 15% above the overnight cost. This multiplier is substantially more than AFUDC
27 multipliers used by either Argonne or the E3 report. The EPRI report did not provide a rationale
28 for using such a high multiplier. The discount rate assumed by the EPRI study was also greater
29 than the one used by Argonne (i.e., 5% vs. 4.28%, respectively).
30

31 CREDA supplied their own capital cost estimate for a natural gas-fired combined cycle
32 plant because they felt that the EPRI data did not fully account for higher elevations and harsher
33 ambient conditions that exist in CREDA member service regions. The capital cost given by
34 CREDA ranged from 1,130 to 1,426 \$/kW. It was assumed that AFUDC was included in these
35 capital costs, but assumptions about calculating the AFUDC were not given. Therefore, we were
36 unable to compare Argonne's and E3's assumptions to CREDA's.
37

38 CREDA also supplied an estimate of levelized cost for the natural gas-fired combined
39 cycle plant; the cost range was 108,000 to 132,000 \$/MW-yr. Although CREDA did not state the
40 exact discount rate used to determine the levelized cost, they did acknowledge it was greater than
41 5%. However, based on the capital cost range in units of \$/kW that CREDA supplied, their
42 discount rate would be approximately 6.25%, which is substantially higher than the discount rate
43 used by Argonne.
44
45

Generating Unit Operating Cost and Fuel Price Projections

This section will describe how fixed O&M costs of expansion candidates generating plants were projected into the future and will also describe how fuel prices for both existing and new generating plants were projected.

Variable O&M Costs for Existing and Committed Units.

The AURORA model default database currently contains unit-level estimates of variable O&M costs for the year 2010 in terms of nominal 2010 dollars. These costs are converted to 2013 nominal dollars based on the PPI for “Electric power transmission, control, and distribution energy production” (series ID code pcu22112-22112-) (BLS undated). This equates to an increase in nominal cost of approximately 6.9%, which is reflected in AURORA inputs, thereby affecting unit-level total power production cost.

TABLE K.1-2 Cumulative Annual Percent Increase in Natural Gas Prices at the Henry Hub

| Year | Percent Increase |
|------|------------------|
| 2014 | 3.7 |
| 2015 | 3.9 |
| 2016 | 14.9 |
| 2017 | 22.2 |
| 2018 | 33.2 |
| 2019 | 29.3 |
| 2020 | 21.5 |
| 2021 | 29.5 |
| 2022 | 33.9 |
| 2023 | 37.6 |
| 2024 | 42.1 |
| 2025 | 45.3 |
| 2026 | 48.8 |
| 2027 | 52.3 |
| 2028 | 55.3 |
| 2029 | 60.4 |
| 2030 | 67.5 |
| 2031 | 71.3 |
| 2032 | 76.5 |
| 2033 | 82.8 |

Future Natural Gas Prices for Existing Units.

Unit delivery multipliers are adjusted for future time periods to be consistent with anticipated real price projection changes forecasted regionally by the 2014 AEO (EIA 2014). The cumulative percent increase in natural gas prices are provided in Table K.1-2. Note that all multipliers in the table are relative to the 2013 price.

Future Natural Gas Prices for New Expansion Units.

Future natural gas prices for new units constructed by AURORA model expansion plans are specified by bubble and duty cycle. These prices are linked to the absolute real 2013 price levels and price changes over time that are consistent with the 2014 AEO (EIA 2014) prices shown in Figure K.1-17. Prices can also vary by technology type. The 2014 AEO (EIA 2014) price projections are specified in terms of 2012 dollars. These were converted to 2013 dollars using the GNP IPD based on the GNP IPD for January 2013 relative to January 2012 GNP IPD (see <http://research.stlouisfed.org/fred2/data/GDPDEF.txt>).

Natural gas prices in AURORA differ by month; generally, prices are higher in the winter as compared to the summer. In the AURORA EPIS default database, this monthly price pattern is most distinct (i.e., relatively large price range during the year) in early forecast years and gradually diminishes over time. These same seasonal trends were used for the LTEMP power systems study.

Future Coal Prices for Existing Units. AURORA base coal prices are entered at the state level and change annually. Unit delivery coal price multipliers are adjusted for future time

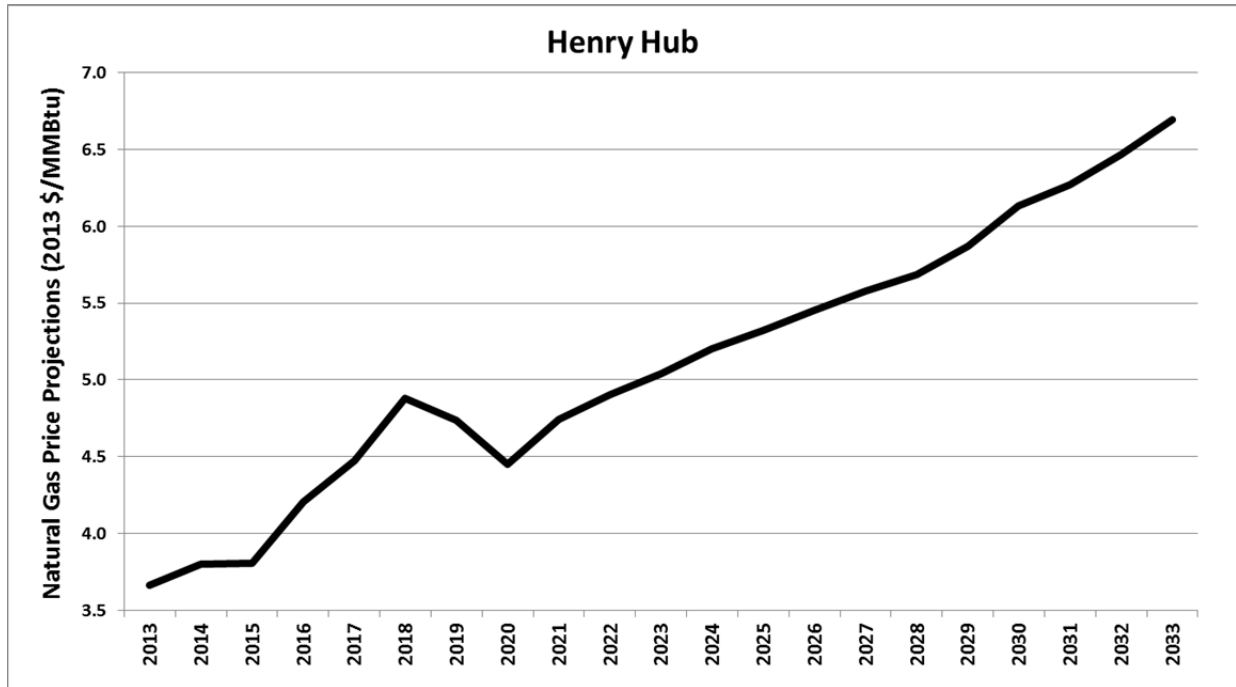

1

2 **FIGURE K.1-17 Projected 2014 AEO (EIA 2014) Natural Gas Prices at the Henry Hub**

3

4

5

6

7

8

9

10

11

12

13

14

15

16

17

18

19

20

21

22

23

24

25

26

27

periods to be consistent with anticipated real price projection changes forecasted regionally by the 2014 AEO (EIA 2014) electricity market module shown in Figure K.1-18. Regional multipliers are shown in Table K.1-3 below.

Multipliers are applied at the unit level, depending on the state in which it resides. Therefore, as shown in Figure K.1-18, states were paired with the AEO regions. Because Wyoming is split between two regions, an average of the two was used.

Future Coal Prices for New Expansion Units. Future coal prices for new units constructed by the AURORA model expansion plan are specified by bubble (i.e., large customer) and duty cycle. These are consistent with absolute real-price levels and changes over time projected by 2014 AEO (EIA 2014), as shown in Figure K.1-19. The 2014 AEO (EIA 2014) price projections are specified in terms of 2012 dollars which are converted to 2013 dollars using the GNP IPD.

Future Distillate Fuel Oil for Existing Units. Future delivered price multipliers are adjusted for future time periods to be consistent with anticipated real price projection changes forecasted regionally by the 2014 AEO (EIA 2014). Regional multipliers are shown in Table K.1-4.

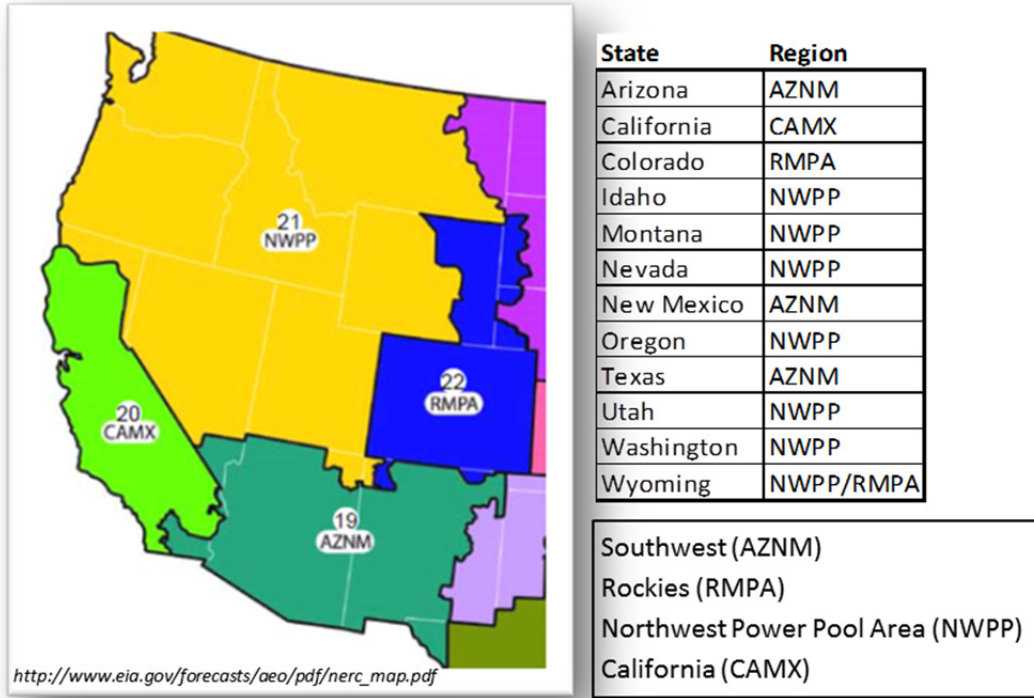

1

FIGURE K.1-18 2014 AEO (EIA 2014) Electricity Market Module Regions and the Mapping of States to Regions

2

3

4

5

6

Future Nuclear Fuel Price for Existing Units. EPIS-supplied nuclear fuel prices and projections were used for power systems modeling. As previously noted, there is only one nuclear plant in the SLCA/IP market system whose production levels do not vary significantly among alternatives.

7

8

9

10

11

Renewable Resource Projections

12

13

Future renewable resource additions are built by the model such that each utility complies with minimum requirements specified in state RPSs. Each utility fulfills the requirements specified by the state(s) where the utility serves load. If a state where a utility has load requires that 20% of the electric energy be satisfied by renewables, then the utility must have sufficient renewable capacity to serve 20% of its electric generation in the state. In cases such as Tri-State, which has loads in more than one state, RPS compliance is attained within each state. One simplification is that a utility employs a single type of renewable generation to serve future load in each state (namely, solar for Arizona and New Mexico and wind for Utah and Colorado). Any renewable generation source that a utility currently utilizes is credited toward meeting a future RPS goal.

14

15

16

17

18

19

20

21

22

23

24

25

26

27

1 **TABLE K.1-3 Cumulative Annual Percent Increase in Regional Coal Prices**

| Region | Year | | | | | | | | | | | | | | | | | | | |
|--------|------|------|------|------|------|------|------|------|------|------|------|------|------|------|------|------|------|------|------|------|
| | 2014 | 2015 | 2016 | 2017 | 2018 | 2019 | 2020 | 2021 | 2022 | 2023 | 2024 | 2025 | 2026 | 2027 | 2028 | 2029 | 2030 | 2031 | 2032 | 2033 |
| RMPA | -1.6 | 2.7 | 6.5 | 8.8 | 11.6 | 13.7 | 15.8 | 17.7 | 20.0 | 22.1 | 24.4 | 26.8 | 28.7 | 30.3 | 29.3 | 30.0 | 30.1 | 30.9 | 31.7 | 33.8 |
| NWPP | 0.6 | 4.5 | 10.0 | 11.9 | 14.7 | 17.1 | 19.4 | 20.5 | 23.0 | 26.4 | 28.7 | 31.2 | 33.2 | 35.1 | 32.6 | 32.3 | 31.2 | 31.5 | 30.6 | 34.4 |
| AZNM | -1.7 | 5.1 | 8.6 | 11.6 | 8.9 | 9.2 | 9.6 | 10.8 | 12.2 | 13.7 | 14.7 | 15.9 | 16.8 | 17.6 | 18.1 | 19.2 | 20.2 | 21.3 | 22.3 | 23.3 |
| CAMX | -4.0 | 2.7 | 4.3 | 5.8 | 7.8 | 9.6 | 11.6 | 13.1 | 15.1 | 17.0 | 19.1 | 21.2 | 22.7 | 23.9 | 24.9 | 26.9 | 28.7 | 30.5 | 31.8 | 33.1 |

2
3

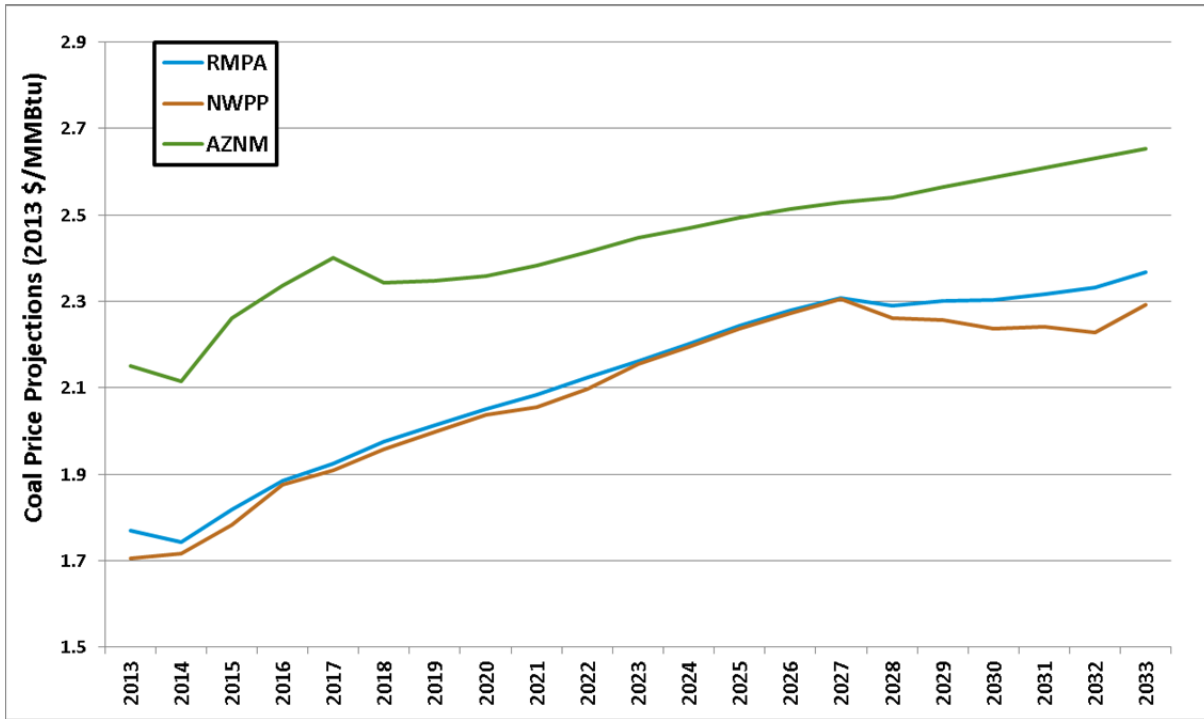

1

FIGURE K.1-19 Projected AEO 2014 (EIA 2014) Coal Prices by Electricity Market Module Region

2
3
4
5

K.1.7 Glen Canyon Dam Powerplant Capacity Cost and Benefit Methodology

6

The difference between the firm capacity level of Alternative A and the firm capacity level under a specific alternative is the amount of additional capacity that will eventually need to be built. It is referred to as lost Glen Canyon Dam capacity and will be replaced at some point in the future by one or more entities in the SLCA/IP market system, which consists of Western and the utilities operated by its LTF customers. The economic costs of this lost firm capacity is based on the capital and fixed O&M costs that would be expended to construct and operate new units that replace it. The amount of replacement capacity that would need to be built is dependent on several factors, including the level of current and committed system resources, future annual system peak loads, and system reliability criteria. Economic impacts are measured for the system as a whole, where system-wide capacity expansion pathways are simulated and associated costs are computed for each alternative. A time series of costs differences relative to Alternative A is then computed and expressed as a single NPV for each alternative. Capacity replacement costs include capital investment for new capacity plus fixed O&M costs for operating the newly constructed units.

7
8
9
10
11
12
13
14
15
16
17
18
19
20
21
22
23
24

1 **TABLE K.1-4 Cumulative Annual Percent Increase in Regional Distillate Fuel Prices**

| Region | Year | | | | | | | | | | | | | | | | | | | |
|---------|------|-------|-------|-------|-------|-------|------|------|------|------|------|------|------|------|------|------|------|------|------|------|
| | 2014 | 2015 | 2016 | 2017 | 2018 | 2019 | 2020 | 2021 | 2022 | 2023 | 2024 | 2025 | 2026 | 2027 | 2028 | 2029 | 2030 | 2031 | 2032 | 2033 |
| RMPA | -5.6 | -10.2 | -13.0 | -13.9 | -13.0 | -11.1 | -9.3 | -7.3 | -5.2 | -3.3 | -1.5 | 0.3 | 1.7 | 3.5 | 4.9 | 6.4 | 7.6 | 9.0 | 10.6 | 12.2 |
| NWPP | -5.6 | -10.4 | -13.3 | -14.2 | -13.2 | -11.3 | -9.5 | -7.5 | -5.3 | -3.5 | -1.5 | 0.3 | 1.8 | 3.4 | 4.8 | 6.4 | 7.6 | 9.0 | 10.6 | 12.2 |
| AZNM | -5.6 | -10.2 | -13.0 | -13.9 | -13.0 | -11.1 | -9.3 | -7.3 | -5.2 | -3.3 | -1.5 | 0.3 | 1.7 | 3.5 | 4.9 | 6.4 | 7.6 | 9.0 | 10.6 | 12.2 |
| CAMX | -5.6 | -10.4 | -13.1 | -14.0 | -13.1 | -11.2 | -9.4 | -7.4 | -5.3 | -3.4 | -1.5 | 0.3 | 1.8 | 3.5 | 4.8 | 6.4 | 7.6 | 9.0 | 10.6 | 12.2 |
| NWPP/RM | -5.6 | -10.3 | -13.1 | -14.0 | -13.1 | -11.2 | -9.4 | -7.4 | -5.3 | -3.4 | -1.5 | 0.3 | 1.7 | 3.4 | 4.8 | 6.4 | 7.6 | 9.0 | 10.6 | 12.2 |

2
3

1 **K.1.7.1 Treatment of Glen Canyon Dam Capital and Fixed O&M Costs**
2

3 The Glen Canyon Dam and Powerplant was constructed between June 1960 and
4 September 1966. Preceding the construction of the dam, diversion tunnels were dug and a coffer
5 dam was built upstream to divert water from the main dam construction site (see
6 <http://www.usbr.gov/uc/rm/crsp/gc/history.html>). All of the capital costs to build the dam and
7 powerplant were incurred in past. Therefore, the economic costs of these past expenditures are
8 treated as sunk investments under all alternatives; that is, economic costs for building the dam
9 and powerplant are set equal to zero because past expenditures cannot be altered. Furthermore, it
10 is assumed that any additional capital investment in the dam and powerplant that will be incurred
11 in the future is unaffected by an alternative. It therefore follows that capital investment
12 differences among alternatives is also zero. Similarly, Glen Canyon Dam fixed O&M costs are
13 assumed to be unaffected by all of the alternatives. It is also assumed that the total physical
14 1,320 MW of nameplate capacity at Glen Canyon Dam is identical under all LTEMP DEIS
15 alternatives and that the capacity of all powerplant units will not change over the study period.
16

17 Past Glen Canyon Dam construction costs and interest expenses are paid by Western
18 SLCA/IP LTF customers through Western's firm energy and capacity rates. Revenues from the
19 sale of CRSP power are deposited in the U.S. Treasury. These power revenues also pay for
20 irrigation assistance, O&M costs, salinity control, and environmental programs through
21 Western's firm energy and capacity rate. CRSP power revenues have funded over \$298 million
22 of costs associated with environmental programs in the Grand Canyon. Since 2000, Glen Canyon
23 Dam environmental experiments recommended through the Glen Canyon Dam Adaptive
24 Management Program cost an additional \$44.3 million (see <http://www.gcdamp.gov/faq.html>).
25 Firm power customer rates are assumed to have no impact on the economic costs of LTEMP
26 DEIS alternatives. However, as discussed in the Wholesale Rate section, energy and capacity
27 rates have a financial impact on Western's CRSP Management Center Office, the EMMO, and
28 firm customer finances.
29
30

31 **K.1.7.2 Western's SLCA/IP LTF Obligations and Glen Canyon Dam**
32 **Replacement Capacity**
33

34 Although construction expenditures that occurred a long time ago are assumed to be a
35 sunk economic cost, Glen Canyon Dam Powerplant capacity and energy currently reap economic
36 benefits for the electric utility sector. The economic benefits of Glen Canyon Dam capacity will
37 continue far into the future at a level that, in part, depends on the operating criteria that govern
38 future power operations. Under most hydrological conditions, current operating criteria and those
39 specified by LTEMP DEIS alternatives affect the ability of Western staff to schedule and
40 Reclamation powerplant operators to deploy the entire Glen Canyon Dam nameplate capacity at
41 times of peak system load. This deployment level differs by alternative. Therefore, the firm
42 capacity of the Glen Canyon Dam Powerplant is less than its physical nameplate capacity.
43

44 Currently, Glen Canyon Dam capacity primarily benefits SLCA/IP LTF customers.
45 Through its marketing program, Western currently sells customers bundled SLCA/IP federal
46 hydropower resources, not individual plants. For power systems analysis, firm capacity is

1 therefore determined for the entire system, based on the coincidental sum of maximum daily
2 energy outputs from all SLCA/IP federal hydropower facilities and other factors such as those
3 described in the Firm Capacity Spreadsheet section (Section K.1.5.11). For the LTEMP DEIS,
4 Argonne conducted a study of Western's SHP commitment levels over the last 10 years; the
5 study is described later in this appendix, in the Firm Capacity Risk Level section. The study
6 found that capacity has historically been marketed such that 90% of the time Western's
7 11 SLCA/IP federal hydropower plants had sufficient maximum operating capabilities to meet
8 customers' total peak requests for energy within the bounds specified by SLCA/IP LTF
9 contracts. This same 90% level is used to determine the firm capacity under all of the
10 alternatives. However, in the future Western may choose to market capacity at either a higher or
11 a lower risk level.

12
13 Operating criteria differ by alternative in terms of the distribution of monthly water
14 release volumes during a WY and the level of operating flexibility that is allowed at Glen
15 Canyon Dam. Both affect the maximum output level that the Glen Canyon Dam Powerplant is
16 allowed to deliver during times of SLCA/IP market system peak load. The difference between
17 the Alternative A capacity and the capacity under another specific alternative is the amount of
18 additional capacity that will eventually need to be built above the Alternative A capacity
19 expansion plan. This lost capacity will be replaced at some point in the future by one or more
20 large SLCA/IP LTF customer utilities. For the purposes of economic impacts, it is assumed that
21 the identification of the entities that replaces this lost capacity is inconsequential. As stated
22 previously, this is an economic analysis that measures the net cost difference for the system as a
23 whole, not a financial analysis of individual entities (e.g., a utility company) that operate within
24 the system.

25
26 The wholesale rate and retail rate studies that are presented in Sections K.2 and K.3,
27 respectively, discuss potential impacts on individual entities within the SLCA/IP market system.
28 The wholesale rate study also discusses rates under a scenario in which Western replaces lost
29 capacity, as well as another scenario in which Western makes capacity and energy obligations
30 based on the chronological capabilities of SLCA/IP federal hydropower resources. The latter
31 scenario requires that SLCA/IP LTF customers replace the lost capacity.

32 33 34 **K.1.7.3 Western SLCA/IP Firm Hydropower Capacity**

35
36 Argonne used several tools and models of varying levels of detail and complexity to
37 estimate SLCA/IP federal hydropower plant firm capacity levels; that is, the maximum power
38 output that system operators can usually, but not always, rely upon to meet peak loads. Argonne
39 also developed capacity expansion paths for each alternative and associated costs for the
40 SLCA/IP market system. An expansion path describes the timing and type of new units that will
41 be built in the future. It is based on a host of factors such as CRSP Management Center firm
42 capacity, the system capacity reserve margin goal, projected fuel prices, the characteristics of
43 existing powerplants, and peak load growth.

44
45 Firm capacity is based on the coincidental sum of maximum daily energy outputs for all
46 SLCA/IP federal hydropower facilities. The method used varies by powerplant size and

1 operating criteria. Figure K.1-20 lists SLCA/IP federal hydropower facilities grouped by size.
 2 The figure also provides information on the models, parameters, and data used for estimating
 3 firm capacity.
 4

5 The entire physical capacity of SLCA/IP federal hydropower resources is not available to
 6 meet LTF customer loads. Instead capacity is reserved for other purposes. As shown in
 7 Figure K.1-21, some of these purposes include capacity set aside to serve project use loads such
 8 as pumping for irrigation, replacing transmission losses, providing spinning reserves, and
 9 performing regulation services. A more detailed description of these components is provided
 10 next.
 11

12 From an operational standpoint, the capacity that is reserved for these purposes is known
 13 with a relatively high degree of certainty. However, at any single point in the future, the impacts
 14 of unit outages, reservoir elevation, and enviromental operating critera on hydropower resource
 15 capacity are highly variable and cannot be predicted without forecast error. Therefore, SLCA/IP
 16 federal hydropower resources are exposed to risks because the future of both reservoir conditions
 17 and the operating state of generating units are not known with certainty. This risk level is directly
 18 related the amount of firm capacity that is assumed (that is, the lower the amount of firm
 19 capacity, the lower the risk). The power systems methodology uses a probabilistic approach to
 20 quantify this risk.
 21
 22

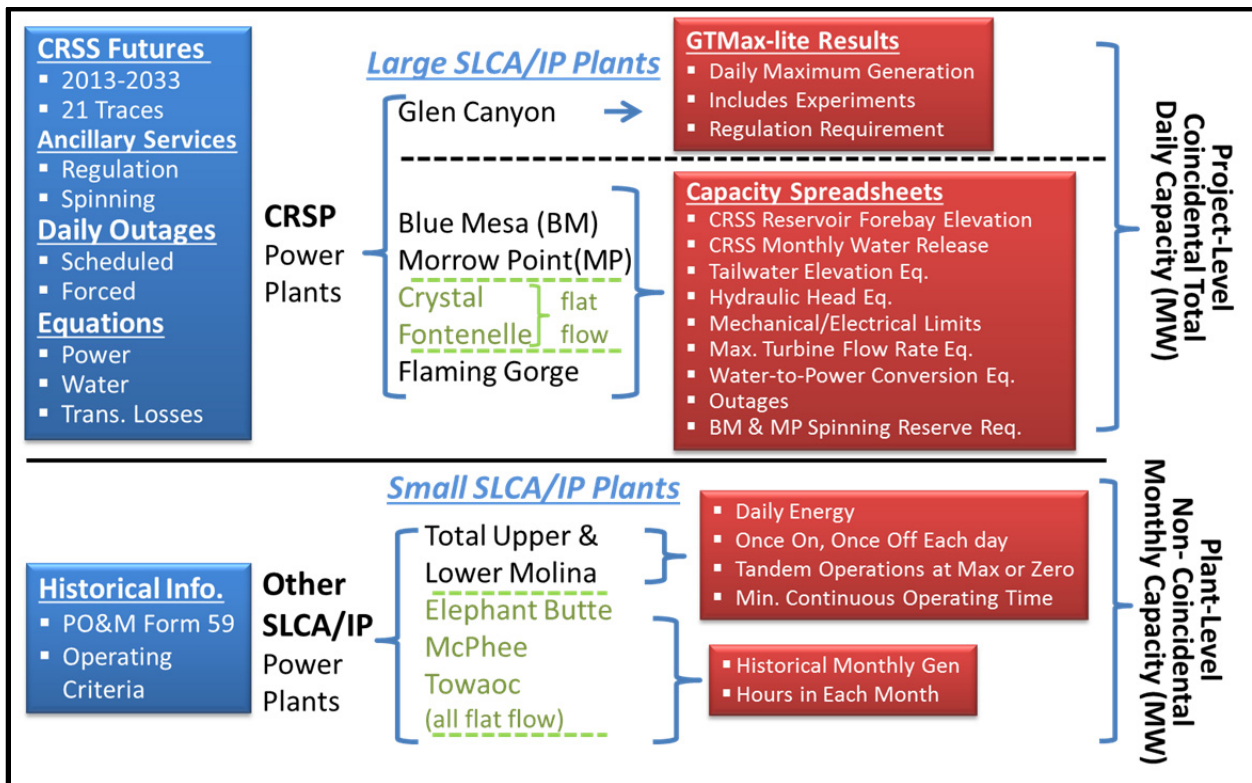

23

24 **FIGURE K.1-20 Western SLCA/IP Hydropower Powerplants**

25

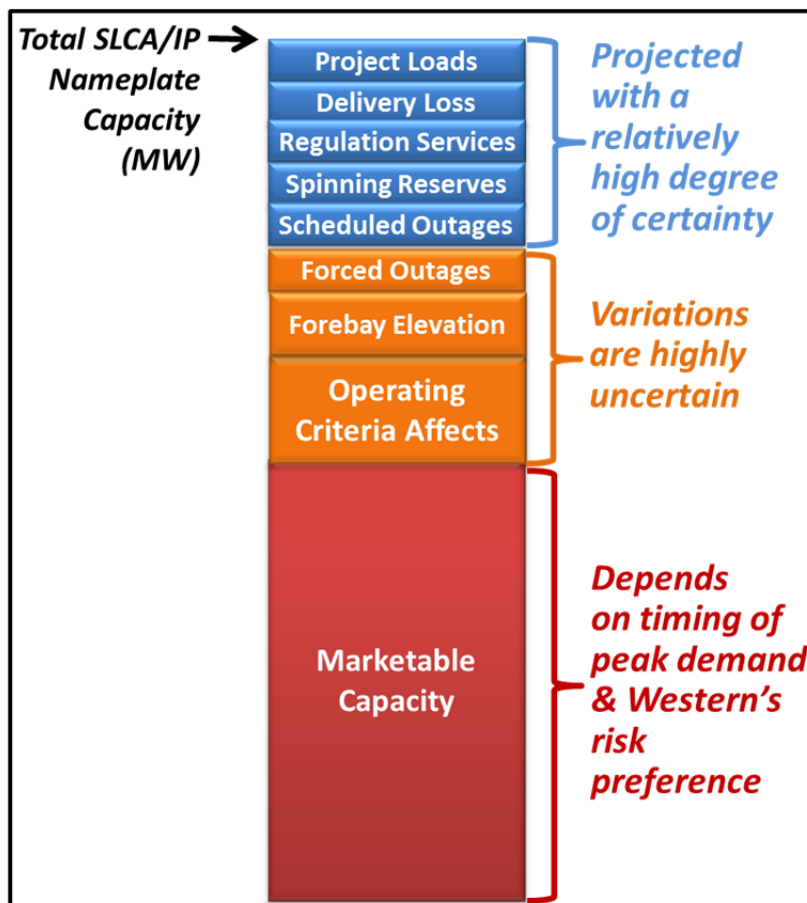

FIGURE K.1-21 SLCA/IP Federal Hydropower Capacity Uses and Variability Factors

Project Use Loads

Western has an obligation to serve project use loads such as pumping for irrigation. These loads are also given a high priority in LTEMP power system models; that is, these loads must be satisfied before other SLCA/IP market system loads are served. Summary data that describes project use obligations was obtained from the CRSP Management Center. These obligations were transformed into hourly “flat” load vectors. During the study period, one new project use load will come online: the Navajo-Gallup Water Supply Project. From discussions with CRSP Management Center staff, it was determined that there would be additional project use loads from this project of 5 MW load in 2018, 2023, 2024, and 2029, for a total increase of 20 MW. Loads are assumed to be identical for both capacity and energy economic analyses. In addition, these loads are assumed to be unaffected by alternative.

Delivery Losses

Energy is lost in the process of transporting energy from SLCA/IP federal hydropower generation points to points of energy delivery. Under current accounting practices, which were established after system consolidation measures were implemented, transmission system losses are set to 5% (Scheid 2015). Therefore, it is assumed that marketable capacity that is delivered to customers is reduced by this same percentage. For example, when the Fontenelle Powerplant produces its maximum output of 10 MW, it is assumed that only 9.5 MW is delivered to demand points; that is, for accounting purposes, 0.5 MW is lost during the transmission process.

Ancillary Services

As part of its power pool agreements, Western has an obligation to provide ancillary services. SLCA/IP resources provide regulation reserves and fast spinning reserves. As shown in Table K.1-5, both of these ancillary services are projected to increase by up to 80 MW. The maximum requirement is reached in 2025 for regulation reserves and in 2030 for fast spinning reserves. A total of 160 MW of ancillary will then be maintained from 2030 into the foreseeable future. Estimates of future ancillary service levels were provided by Reclamation based on a discussion with Western staff in May 2013.

Figure K.1-22 shows how the methodology used for this study explicitly reduces the operating range of plants that provide one or more ancillary services. A plant’s hourly maximum output is reduced by the level of regulation service and spinning reserve provided. In addition, when providing regulation services, the minimum generation level is also increased by the level of regulation service provided. Note that under current power pooling agreements, a powerplant simultaneously provides identical levels of up and down regulation. Based on discussions with power system operators, the priority for ancillary services provided by SLCA/IP federal hydropower resources is as follows. The first priority is to serve both regulation services and spinning reserves at Glen Canyon Dam. However, if the Glen Canyon Dam Powerplant has insufficient capacity to serve both or doing so would increase Glen Canyon Dam non-power water releases, spinning reserves will be off-loaded to powerplants located in the Aspinall Cascade and, if absolutely necessary, followed by regulation services.

TABLE K.1-5 Assumed Ancillary Services Provided by SLCA/IP Hydropower Facilities from 2013 to 2030

| Year | Ancillary Services (MW) | | |
|-------|-------------------------|---------------------|-------|
| | Fast Spinning Reserves | Regulation Reserves | Total |
| 2013 | 43 | 60 | 103 |
| 2014 | 45 | 62 | 107 |
| 2015 | 47 | 63 | 111 |
| 2016 | 50 | 65 | 115 |
| 2017 | 52 | 67 | 118 |
| 2018 | 54 | 68 | 122 |
| 2019 | 56 | 70 | 126 |
| 2020 | 58 | 72 | 130 |
| 2021 | 60 | 73 | 134 |
| 2022 | 63 | 75 | 138 |
| 2023 | 65 | 77 | 141 |
| 2024 | 67 | 78 | 145 |
| 2025 | 69 | 80 | 149 |
| 2026 | 71 | 80 | 151 |
| 2027 | 73 | 80 | 153 |
| 2028 | 76 | 80 | 156 |
| 2029 | 78 | 80 | 158 |
| 2030+ | 80 | 80 | 160 |

1 When Glen Canyon Dam serves regulation services,
 2 it instantaneously fluctuates above and below a fixed
 3 generation set point. For example, when the hourly set point
 4 is 500 MW and regulation services is 60 MW, generation
 5 will go to a minimum of 440 MW when regulating down
 6 and go up to a maximum of 560 MW when regulating up.
 7 Based on conversations with EMMO staff, the net energy
 8 generated to provide regulation over a 1-hour time period is
 9 very close to zero; that is, instantaneous fluctuations in
 10 generation above and below the generation set point sum to
 11 zero. In the example above, 500 MWh of generation would
 12 be generated during the hour.

13
 14 Because water release restrictions at Glen Canyon
 15 Dam are specified in terms of average hourly flow rates, and
 16 not instantaneous limits, regulation services can continue to
 17 be provided when releases are at an environmental flow rate
 18 limit. For example, a powerplant’s generation can be set for
 19 an hour to a level that exactly releases the minimum water
 20 flow rate requirement. When providing regulation services
 21 during this hour, instantaneous flow rate will sometimes be
 22 lower than the environmental “hourly rate” minimum
 23 (regulating down), but these low flows will be offset by
 24 instances when it is higher than the minimum flow (regulating up).

25
 26 Regulation services will affect the operating range at Glen Canyon Dam. The sum of the
 27 regulation service plus the operational set point cannot exceed the physical maximum MW
 28 output of the *entire* powerplant. The maximum physical output of the plant is dependent on the
 29 number of units that are operational and Lake Powell’s water elevation. At the other extreme, the
 30 set point operation minus regulation service cannot be less the minimum operating limit of a
 31 *single* Glen Canyon Dam unit.

32
 33 Spinning reserves only affect the maximum set point at Glen Canyon Dam. Under normal
 34 operating conditions, this spare or reserved capacity is not utilized. However, events such as a
 35 unit forced outage or downed power lines may result in a sudden grid energy imbalance; that is,
 36 there is not enough energy production to serve load. To overcome this deficiency, spinning
 37 reserves are deployed and one or more powerplants increase output to return the system to a
 38 balanced state as quickly as possible.

39
 40 When spinning reserves are deployed at Glen Canyon Dam, the powerplant very quickly
 41 ramps up production by a maximum of 60 MW. Under these conditions, the water release up-
 42 ramp is allowed to exceed environmental operating limits. Glen Canyon Dam “emergency
 43 exception criteria,” which are stipulated under all alternatives, allows Glen Canyon Dam to
 44 operate outside of minimum and maximum flow limits, daily changes constraints, and both
 45 maximum hourly up- and down-ramp rates in the event of a power system emergency (e.g., grid
 46 energy imbalance events). However, similar to regulation services, the set point generation level

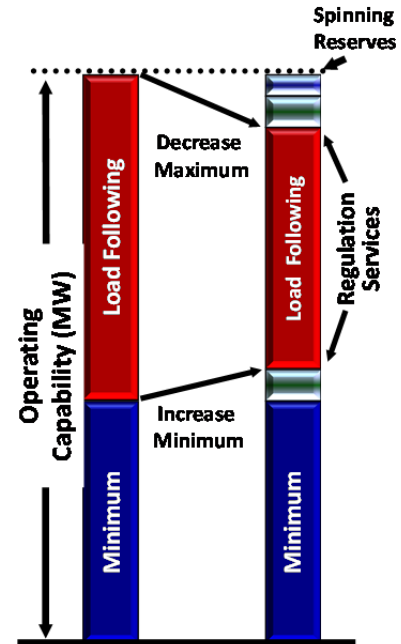

FIGURE K.1-22 Reductions in Operating Range when Providing Ancillary Services

1 plus the spinning reserve service cannot exceed the physical maximum MW output of the *entire*
2 plant. As shown in Figure K.1-22, when both ancillary services are being served, the sum of set
3 point, regulation, and spinning reserves cannot exceed then maximum output capability of the
4 plant.

5
6 The economic cost of providing ancillary services at Glen Canyon Dam varies by
7 alternative, such that the greater the operational flexibility is, the higher the cost of serving
8 regulation and spinning reserves will be. Under flat flow alternatives, ancillary services do not
9 typically affect the operating range because there is no flexibility in the system. On the other
10 hand, ancillary services at times bind (i.e., lower) the maximum output level at Glen Canyon
11 Dam. These binding events occur when the monthly water release volume allows for a relatively
12 large daily operating range and a higher base flow. Glen Canyon Dam unit outages and lower
13 reservoir elevations exacerbate the economic impacts of this constraint by essentially lowering
14 the maximum physical output of the plant.

15
16 The time series of ancillary service projections shown in Table K.1-5 will be used in
17 GTMax-Lite model runs that determine differences in capacity and energy value among LTEMP
18 DEIS alternatives. However, in December 2014, Western indicated that ancillary services were
19 no longer expected to increase as anticipated in May 2013. Glen Canyon Dam currently supplies
20 a total of 67 MW of ancillary services, and this is not expected to increase during the LTEMP
21 study period. Therefore, a sensitivity study was performed to determine how firm capacity levels
22 will change if a different ancillary services schedule is used. The sensitivity study and results are
23 reported in Section K.1.10.8.

24 25 26 **Outage**

27
28 All of the SLCA/IP hydropower resources undergo both scheduled and forced unit
29 outages, during which times a unit either produces no output or produces at a level that is lower
30 than its full capability; that is, the capacity is temporarily de-rated. Maintenance is normally
31 performed during a scheduled outage, while forced outages typically occur at random, and are
32 precipitated by the failure of one or more unit/plant components.

33
34 For the LTEMP study, the Reclamation provided Argonne with unit-level maintenance
35 schedules for the six largest SLCA/IP facilities over the study period. When a unit is taken out of
36 service for maintenance, the maximum output of that unit is set to zero in all pertinent modeling
37 processes, including both versions of GTMax-Lite and spreadsheet tools that estimate maximum
38 physical output levels at large SLCA/IP hydropower resources other than Glen Canyon Dam.

39
40 To represent unit forced outages at large SLCA/IP powerplants, a methodology was
41 developed to incorporate the number, cause, and duration of forced outages that may potentially
42 occur during the study period. Data on forced outages for hydroelectric turbines were obtained
43 from the GADS. This database is maintained by NERC and contains operating information on
44 electric generating equipment. GADS data were input into an algorithm that produces a plausible
45 series of random outages for units at the Glen Canyon Dam Powerplant. Using a different set of
46 random draws for each run, the forced outage model performed numerous simulations. The run

1 that produced the most representative time series of outages in terms of matching overall GADS
2 statistical averages was selected. It should be noted that the forced outage model only represents
3 full unit outages. It therefore does not directly represent partial outages. However, the model
4 uses equivalent outage statistics that implicitly account for these types of outages. For example,
5 if a unit is de-rated by 25% over a 6-month time period, the equivalent outage rate would be
6 12.5%. Details of the forced outage algorithm and methodology are described in
7 Attachment K-5.
8

9 Scheduled and forced outages are not explicitly modeled for small SLCA/IP federal
10 hydropower resources. However, outages are reflected in the model to the extent that unit down
11 time is reflected in Form PO&M-59 data, which is ultimately used to model small federal
12 hydropower facilities. For example, if the McPhee unit was down for an entire month, a zero
13 generation level would be reported by Form PO&M-59 for that month, which would affect the
14 results produced by the Small SLCA/IP Powerplant Spreadsheet model. Although this
15 methodology is not the most accurate modeling approach, it should be noted that the total small
16 facilities capacity is less than 3% of the entire SLCA/IP federal hydropower capacity. Therefore,
17 modeling errors were judged by Argonne staff to be negligible.
18
19

20 **Maximum Power Plant Output, Forebay Elevations, and Monthly Releases**

21

22 The surface water elevation in a reservoir affects both hydropower maximum possible
23 output level and the amount of water that needs to be released through a turbine to produce a unit
24 (MWh) of energy. For the large SLCA/IP hydropower resources, end of the month reservoir
25 elevations, also referred to as forebay elevations, were projected using Reclamation's CRSS and
26 the SBM models.
27

28 Because DEIS alternative operating criteria affect monthly Glen Canyon Dam water
29 releases, and therefore Lake Powell water elevations, CRSS and SBM make separate projections
30 for each alternative. Future hydrology conditions are not known with certainty; therefore, the
31 CRSS model projected 105 possible outcomes at the end of each month throughout a 2013
32 through 2060 time period, inclusive. Although 48 years of monthly outcomes were projected,
33 only the first 21 calendar years (20 water years) were used for analysis in the DEIS. Each
34 outcome, also known as a "trace," is based on a unique historical series of hydrological
35 conditions. Therefore, hydrological conditions are deterministic and it is extremely unlikely that
36 any one trace will ever be repeated. Of these 105 traces, a common set of 21 was used by all
37 DEIS research areas.
38

39 Using this information, the GTMax-Lite model is used to optimize the hourly operations
40 of the Glen Canyon Dam such that it maximizes the economic value of energy. As described
41 previously, GDC GTMax-Lite runs were performed twice. The first provides input to the SBM
42 and the second run accommodates experimental releases using altered SBM monthly water
43 release volumes and reservoir elevations. Hourly operations are projected over the entire time
44 period for all 21 traces for each alternative. Daily maximum daily generation levels from
45 Glen Canyon Dam GTMax-Lite output for all alternatives and traces are stored for use by the
46 Firm Capacity Spreadsheet.

1 The maximum monthly physical output levels for the other five large SLCA/IP
2 hydropower resources were computed over the entire study period for all 21 CRSS traces. Each
3 powerplant's maximum possible output level is based on the following set of conditions, limits,
4 and equations;

- 5
- 6 1. Mechanical/electrical turbine capacity limit;
- 7
- 8 2. Unit operating status (either operating or out of service);
- 9
- 10 3. Reservoir elevation as a function of water storage;
- 11
- 12 4. Maximum turbine water release as a function of head (forebay minus tailwater
13 elevations);
- 14
- 15 5. Tail-water elevation as a function of maximum flow rate; and
- 16
- 17 6. The water-to-power conversion factor that is a function of reservoir forebay
18 elevation.
- 19

20 In order to solve for the above set of relationships, an iterative process is used to
21 converge all interdependent relationships to a consistent set of values. Interdependencies occur
22 because the tailwater elevation is a function of the turbine flow and the turbine flow is a function
23 of the system head, which is the difference between the tailwater and reservoir forebay
24 elevations. In addition, the total turbine flow rate, and therefore tailwater and head, depend on
25 the number of units that are operating. End-of-month reservoir forebay elevation levels that are
26 used in the dispatch process for the other five large SLCA/IP hydropower plants are obtained
27 from the CRSS model.

28

29 The physical maximum output level for the small SLCA/IP federal hydropower plants
30 was set to the nameplate capacity. However, for small run-of-river hydropower plants, historical
31 maximum output levels are based on the MWh of energy that a plant produced during a month
32 divided by the number of hours that occurred during the month. The maximum output is
33 typically achieved only at the Molina units.

34

35

36 **Operating Criteria Effects on the Maximum Output Level**

37

38 In addition to physical limitations, operations at all SLCA/IP hydropower plants are
39 required to remain within a set of institutional and environmental limitations. For power systems
40 analysis, SLCA/IP modeled operations are restricted by three types of limitations. These include
41 (1) reservoir operating restrictions, (2) reservoir water release constraints, and (3) downstream
42 gage stage and water flow limitations. Each of these affects the maximum daily output level.
43 Depending on the situation, operating criteria do not allow a powerplant to reach its maximum
44 physical output potential.

1 **Glen Canyon Dam.** The impact of operating criteria on Glen Canyon Dam maximum
2 output levels is both complex and situational, involving not only the criteria, but also other
3 factors such as the ancillary service requirements, monthly water release volumes, Lake Powell
4 Reservoir elevation, and the number of operational units. End-of-month Lake Powell Reservoirs
5 were obtained from the SBM.
6

7 To provide accurate estimates of the operating criteria on Glen Canyon Dam maximum
8 output levels, Argonne optimized its hourly dispatch using a configuration of the GTMax-Lite
9 model that only models Glen Canyon Dam. The GTMax-Lite model incorporates all
10 environmental constraints imposed on Glen Canyon Dam from the current operating regime,
11 such as restrictions on reservoir water release up/down ramp rates, minimum and maximum
12 hourly release rates, and flow rate changes over a rolling 24-hour period. It also includes a
13 projected maintenance schedule provided by Reclamation and a set of random unit forced
14 outages. When physically possible and economically advantageous, the Glen Canyon Dam
15 Powerplant also has ancillary service requirements, which, as discussed above, can impact Glen
16 Canyon Dam's operational range.
17

18 For Glen Canyon Dam, the daily capacity level is set to the maximum output level that
19 was modeled each day by GTMax-Lite. Although all operating criteria at Glen Canyon Dam
20 potentially affect the maximum output potential, the daily change constraints in combination
21 with water availability typically are the most binding. In addition to the aforementioned
22 operating criteria, HFEs also affect capacity.
23
24

25 **Aspinall Cascade: Blue Mesa, Morrow Point, and Crystal Dams.** The Aspinall
26 Cascade is operated as a tightly coupled, multipurpose system with a total nameplate capacity of
27 approximately 283.4 MW. Plants in the cascade include Blue Mesa, Morrow Point, and Crystal.
28 At the top of the cascade (i.e., highest elevation), the Blue Mesa Powerplant operates in a
29 peaking mode. Located 12 mi downstream from Blue Mesa, the Morrow Point Power Dam is in
30 the middle of the cascade. When four boats operate in the Morrow Point Reservoir, there is a
31 minimum reservoir elevation requirement of 7,151 ft. In addition, the Morrow Point Reservoir
32 cannot be drawn down by more than 3 ft per rolling 24-hour period if the surface elevation is
33 below an elevation of 7,144 ft. When four boats are not operating, the minimum reservoir
34 elevation is 7,125 ft.
35

36 The Crystal Powerplant is at the bottom of the cascade. In addition to functioning as a
37 power generation unit, its operations stabilize the flow of water through Gunnison National Park.
38 The flat flow requirement precludes it from rapidly changing its power output from one hour to
39 the next. Operating criteria for the Crystal Reservoir are season specific. During the wet season
40 (March 1 to June 30), the operating criteria limit reservoir drawdown to no more than 4 ft in a
41 24-hour rolling period, 5 ft over a 48-hour rolling period, or 6 ft over a 72-hour rolling period,
42 and so on. In addition, once an elevation of 6,748 ft is reached, the reservoir level may not drop
43 by more than 0.5 ft per 24-hour rolling period. During the remainder of the year, there is a
44 10-ft-per-24-hr-period fluctuation limit, with a maximum 3-day drawdown of 15 ft. If the
45 reservoir elevation is below 6,733 ft, there is a 5-ft-per-24-hr-period drawdown limit, with a
46 maximum drawdown of 20 ft per 7-day period.

1 Cascade reservoir restrictions can at times affect the hourly dispatch of powerplant units.
2 However, for the LTEMP DEIS, it is assumed that these operating criteria do not affect the
3 maximum output level that can be achieved at the Blue Mesa and Morrow Point. Generation at
4 both of these powerplants can be ramped up or down from a zero output level to maximum
5 capability in a matter of minutes without adverse effects on the power equipment. In addition,
6 the plants are scheduled in advance, so reservoirs can usually accommodate water releases
7 associated peak powerplant output levels without violating reservoir operating criteria.
8 Therefore, it is assumed that Blue Mesa and Morrow Point maximum output levels are limited
9 only by the reservoir level and the number of units that are in service as described in the Forebay
10 Elevation section above.

11
12 The Crystal Dam however has a flat flow requirement that precludes it from rapidly
13 changing its power output from one hour to the next. Therefore, the maximum output level from
14 this plant is assumed to equal the monthly generation at the plant divided by the number of hours
15 in the month.

16
17
18 **Green River: Fontenelle Dam and Flaming Gorge Dam.** The Fontenelle Powerplant
19 also releases water at a constant rate (or flat flow), and output levels are nearly constant during
20 daily operations. Therefore, maximum output level from this plant is assumed to equal the
21 monthly generation at the plant divided by the number of hours in the month.

22
23 Operations at Flaming Gorge Dam are subject to set of complex limitations that affect
24 maximum daily capacities. These include a minimum flow rate of 800 cfs, a maximum up-ramp
25 rate of 800 cfs/hr, and a down-ramp rate limit of 1,000 cfs/hr. Water releases are further
26 constrained to a constant rate (i.e., flat flow) in the summertime during the hours of the day when
27 people are likely to be fishing below the dam. In keeping with current practices, the computation
28 of Flaming Gorge capacity assumes the following:

- 29
30 1. The daily water release volume is the same for all days of a month;
31
32 2. The hourly water release pattern is identical each day of the week;
33
34 3. There is a one-hump release pattern during the summer; and
35
36 4. There is flat flow in summer between the hours of 6:00 AM and 7:00 PM
37 (i.e., a duration of 13 hours every day).
38

39 The trapezoidal methodology utilized in the Large Plant Capacity Spreadsheet is
40 illustrated in Figure K.1-23. It applies simple geometric equations to estimate Flaming Gorge
41 base and peaking capacities using daily water release volumes and reservoir elevations derived
42 from CRSS model results. The base capacity is computed by multiplying the 800 cfs minimum
43 flow requirement by a water-to-power conversion factor that is a function of hydraulic head. It
44 requires a significant volume of base load water to be released each day (i.e., constant 800 cfs
45 release over a 24-hour period).
46

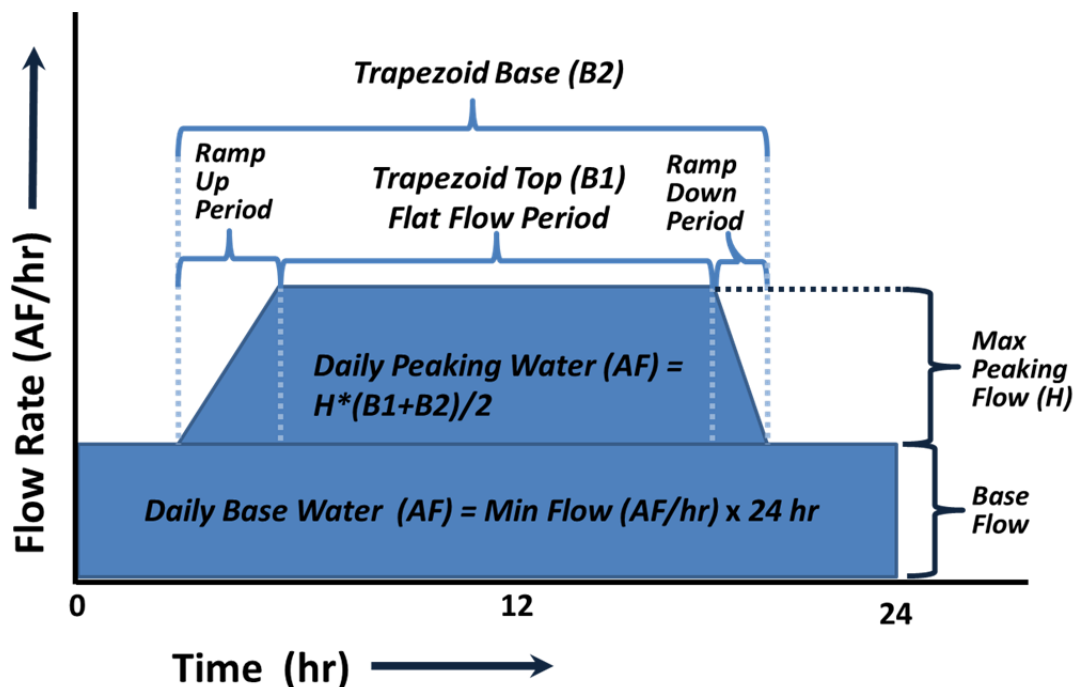

$$\text{Daily Peaking Water (AF)} + \text{Daily Base Water (AF)} = \text{CRSS Monthly Water (AF)} / \text{Days in a Month}$$

FIGURE K.1-23 Illustration of the Trapezoidal Method Used to Compute Capacity at Flaming Gorge Dam

The water volume that remains after sustaining the daily base release is used to estimate peaking capacity as the height of a trapezoid. The length of the top of the trapezoid is 13 hours (i.e., fishing duration) and length of its bottom/base is equal to 13 hours plus the up and down ramping times. As shown in Figure K.1-24, these ramping times increase as a function of peaking water volume and subjected to a total time limit of 11 hours (i.e., 24 hours less the 13 hour flat flow period).

Furthermore, the sum of the base load and peaking capacities cannot exceed the total physical turbine flow limit multiplied by the water-to-power conversion factor, as described in more detail in the Forebay Elevation section; both the maximum turbine flow limit and the power conversion factor are a function of the hydraulic head. The total turbine water release, and therefore the maximum output level, is reduced when turbines are taken offline due to a scheduled or forced unit outage at Flaming Gorge. The results of performing trapezoidal computations over a large range of daily water volumes are shown in Figure K.1-25. This relationship between daily water volume and maximum turbine flow rate is fairly accurately described by a sixth order polynomial. Multiplying the maximum flow rate by the water to power conversion factor yields a capacity estimate.

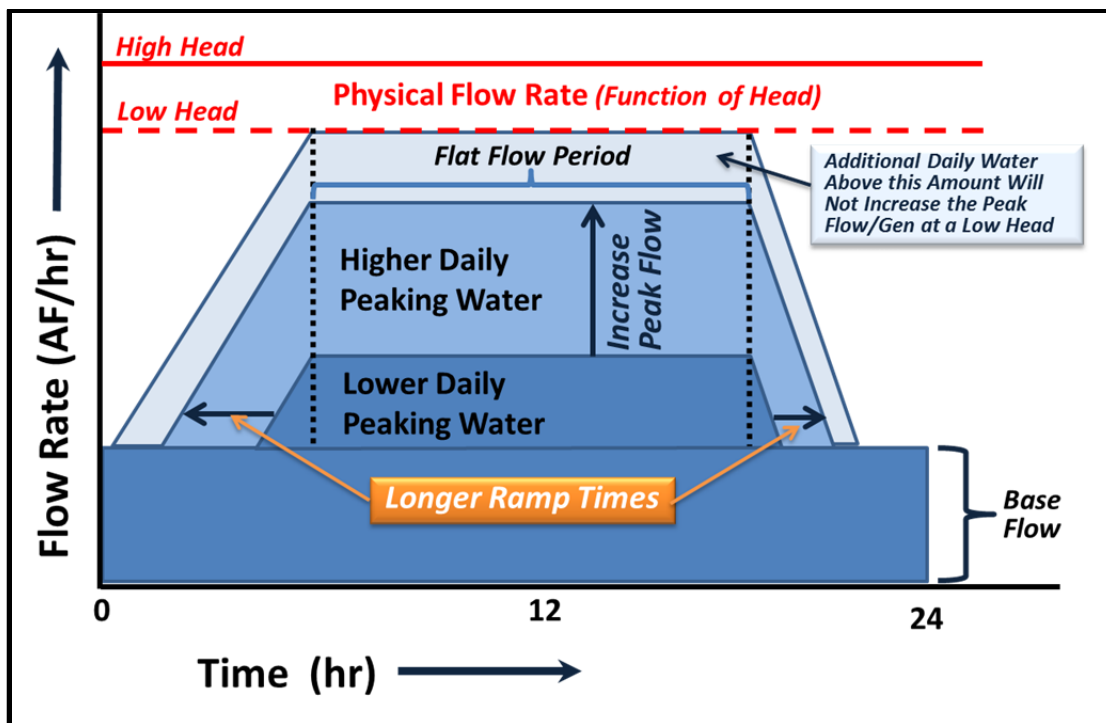

1
 2 **FIGURE K.1-24 Illustration of Ramping Time Increase as a Function of Increasing**
 3 **Water Volumes at Flaming Gorge Dam**
 4
 5

6 To protect endangered native fish in the Green River basin, the U.S. Fish and Wildlife
 7 Service released a biological opinion (FWS 1992) designed to protect the Colorado Squawfish
 8 and Razorback Sucker. The overall intent of the opinion was to structure releases from the
 9 Flaming Gorge reservoir so that they resemble natural hydrograph and water temperature
 10 conditions. A final set of restrictions was implemented in WY 2006 following completion of a
 11 final EIS on the operation of Flaming Gorge Dam (Reclamation 2005) and issuance of its ROD
 12 (Reclamation 2006) in February 2006.
 13

14 High spring release volumes are being structured to enhance river flows during spring
 15 spawning periods. Flow volumes include full powerplant output (approximately 4,500 cfs or
 16 141 MW) to full plant output plus bypass tubes and spillways combined. The high release period
 17 could be held for as long as 4 weeks. The actual volume and duration of release from Flaming
 18 Gorge is determined by the river volume desired on the Green River below the Jensen
 19 measurement gage at Jensen (or Jensen Gage) and inflow support from the Yampa River. The
 20 high spring release is patterned around the peak runoff period, which varies each year based on
 21 weather conditions and endangered fish spawning activities. High peak spring releases transfer
 22 water that historically was released during summer and winter peak months to spring months.
 23 This shifting of water among months of the year is factored into CRSS model runs that provide
 24 input data into the Large Plant Capacity Spreadsheet.
 25

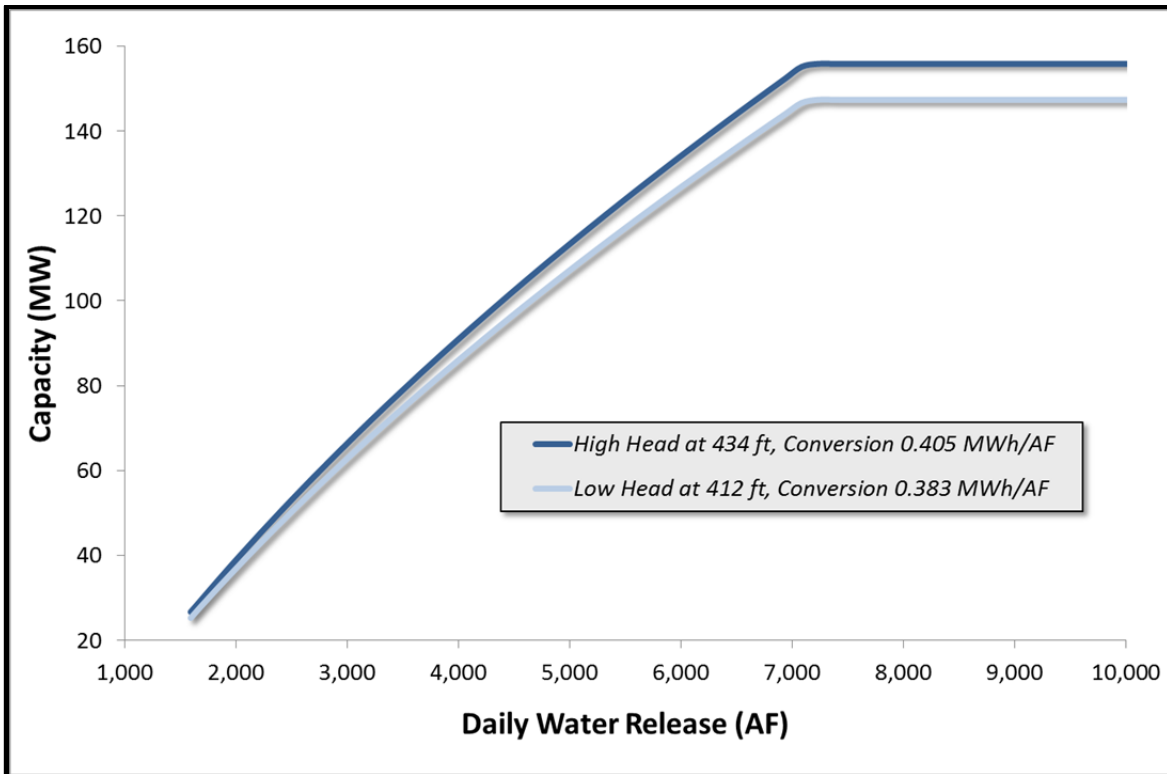

1

2

FIGURE K.1-25 Capacity Values at Flaming Gorge Dam Calculated over a Wide Range of Daily Water Releases Using the Trapezoidal Method

3

4

5

6

After the high spring release is completed, flows on the Green River below the Jensen Gage are held to an average of 1,600 cfs, if possible. The gage is about 94 mi downstream of the reservoir, receiving water not only from Flaming Gorge but also from the uncontrolled Yampa River, which joins the Green River approximately 65 mi downstream of the dam. This means that releases from the Flaming Gorge power plant are held to a minimum of 800 cfs (25 MW) until a time when the combined average flows on the Green and Yampa rivers below Jensen fall below the desired level of 1,600 cfs average. This powerplant restriction can last from 3 to 8 weeks, depending on snowpack conditions.

14

15

Flaming Gorge operations must also be patterned such that daily stage readings at the Jensen Gage do not fluctuate by more than 0.1 m. These stage readings are a function of hourly water releases from Flaming Gorge, inflows into the Green River from the Yampa River (105 km [65 mi] downstream of the dam), downstream flow rate attenuations, and water travel times. Although the influence of Jensen Gage constraints are not factored into the capacity estimate, at low daily water release volumes the daily range of Jensen Gage flow rates are also low.

21

22

23

Small SLCA/IP Resources. Relatively small SLCA/IP hydropower plants including Towaoc, McPhee, Elephant Butte, Upper Molina, and Lower Molina power plants. In total, these facilities contribute a relatively small amount of capacity and all but the Molina power plants are

24

25

1 flat flow facilities. Powerplant capacities for small powerplants are computed in a spreadsheet
2 based on historical monthly generation data as archived in Form PO&M-59. For the small
3 powerplants that are run at flat flow, the firm capacity credit is primarily a function of monthly
4 estimates of total energy production divided by the number of hours in a month.
5

6 However, Molina powerplants are dispatchable and operated in unison. The spreadsheet
7 algorithm evenly divides Form PO&M-59 monthly generation among all days in the month. The
8 spreadsheet then operates Molina at maximum output continuously until the entire daily
9 generation is exhausted; that is, the units start and stops once per day and no power is produced
10 in any other hours. The block of operating hours is based on market prices such that the
11 economic value of Molina resources is maximized.
12
13

14 ***Risk-Based Firm Capacity Operating Criteria***

15
16 As discussed previously, numerous factors influence the amount of firm capacity that is
17 credited toward reserve margin computations for SLCA/IP system. Two of these factors are
18 discussed in this section. These include (1) the month when system peak load occurs and (2) the
19 percentage of time that the entire firm capacity or more will be available to meet the system peak
20 load.
21
22

23 **System Peak Load Month.** The month in which the system peak load occurs and upon
24 which firm capacity calculations would be based was debated and ultimately jointly decided
25 upon by staff from Reclamation, Western, National Park Service (NPS), and Argonne. August
26 was chosen as the month when the system peak load occurs. This decision was made after
27 examining historical FERC Form-714 data for CY 2006 through CY 2012, inclusive. Hourly
28 load data were available for all eight large customer utilities. However, NTUA and Deseret data
29 was only available for the first 4 of the 7 years. No hourly load data were available for any of the
30 small LTF customers.
31

32 An examination of large LTF customer historical peak loads over this time period
33 showed that individual customer peaks almost always occurred during the summer. A few
34 exceptions occurred. CSU experienced one annual peak load in April 2006 and another peak in
35 December 2009. In addition, NTUA, which has the lowest peak load of the eight large
36 customers, experiences its peak load in either December or January. Figure K.1-26 shows that
37 the NTUA peak load is about 1% of the non-coincidental sum of the eight large customer
38 average annual historical peak loads. The sum of these annual non-coincidental peaks changed
39 very little during the 2006 to 2012 time period, and averaged approximately 11,800 to
40 11,900 MW.
41

42 When the peak occurs in the summertime, it almost always occurs in either July or
43 August. Only CSU experienced a different summer peak; it occurred in June of 2012 and was
44 merely 2 MW greater than the highest load in July. A close examination of when the peak
45 occurred also revealed that, for several utilities, there was no clear pattern of which month the
46 peak occurs in. For example, SRP, which accounts for a majority of the non-coincidental total,

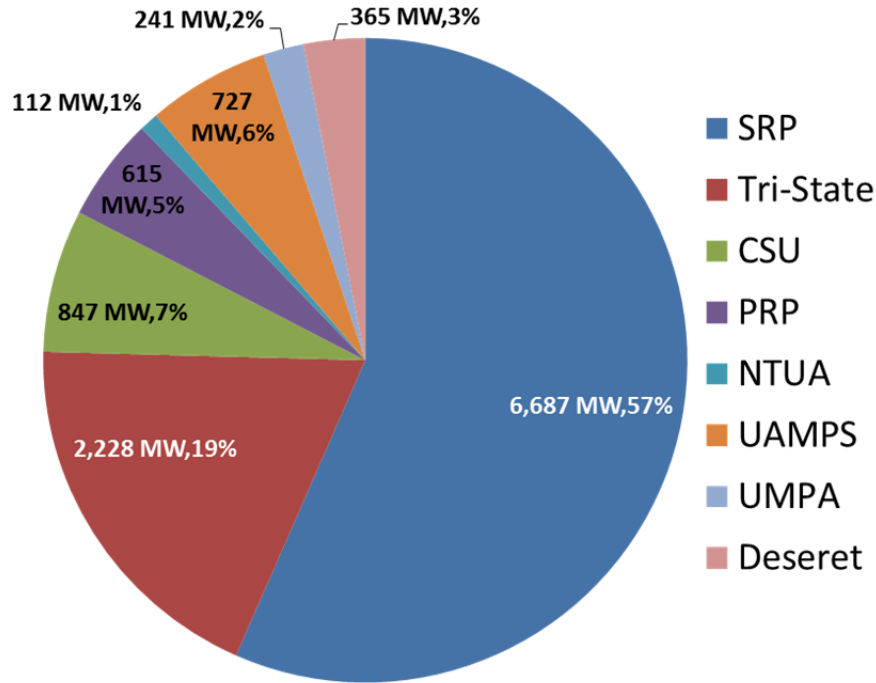
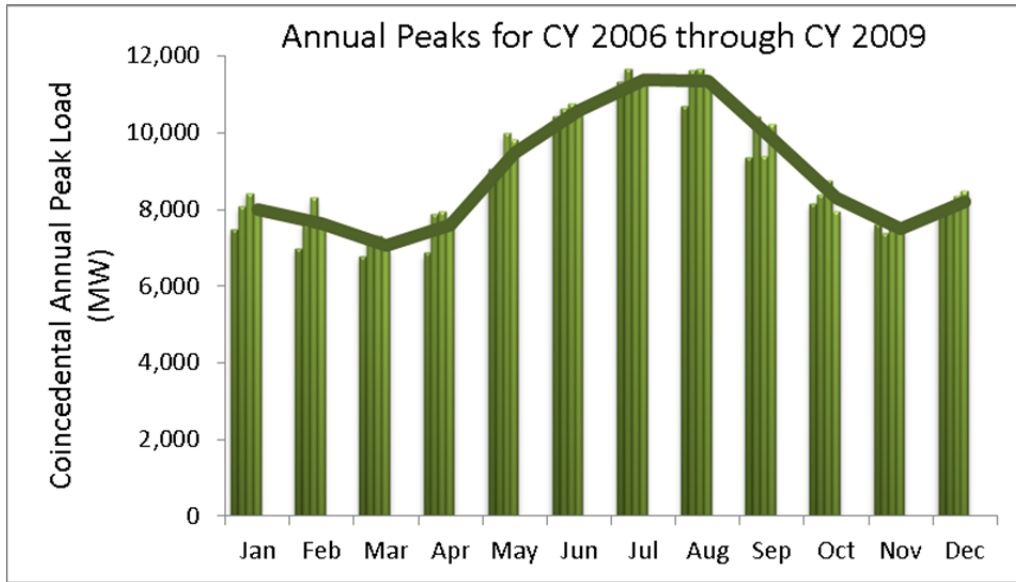

FIGURE K.1-26 Average Historical Non-coincidental Annual Peak Loads (in MW) for the Eight Large Customers and Percentages Relative to the Total

experienced 3 years during which the annual peak occurred in July and 3 years during which the peak occurred in August. In 2007, the maximum load in July equaled the maximum in August. In addition, July and August maximum loads tend to be very similar across all systems.

Coincidental annual peak loads were also examined. The coincidental peak was determined by first summing up the available loads for the eight large customers on an hourly basis and then identifying the month in which the maximum total hourly load occurred. Results of this exercise also showed that, historically, July and August both had very similar maximum loads. Figure K.1-27 shows annual coincidental monthly maximum loads for 4 years (CY 2006 through CY 2009), based on data for all eight large SLCA/IP customers. In chronological order, the bars show annual peaks and the line shows the average. Figure K.1-28 shows the same information, except it is for an additional 3 years (CY 2010 through CY 2012) and is based on only six utilities. Information is presented in two separate figures because all load data were not available for all 7 years. As mentioned previously, FERC hourly data were not available for NTUA and Deseret during this time period. It should be noted that, for CY 2011 and CY 2012, the August peaks were markedly higher than those in July. The representative load profile for the large customers has a coincidental peak load of about 12,370 MW.



1
2
3
4
5

FIGURE K.1-27 Historical Coincidental Annual and Average Peak Loads for the Eight Large Customers during the CY 2006 through CY 2009 Time Period

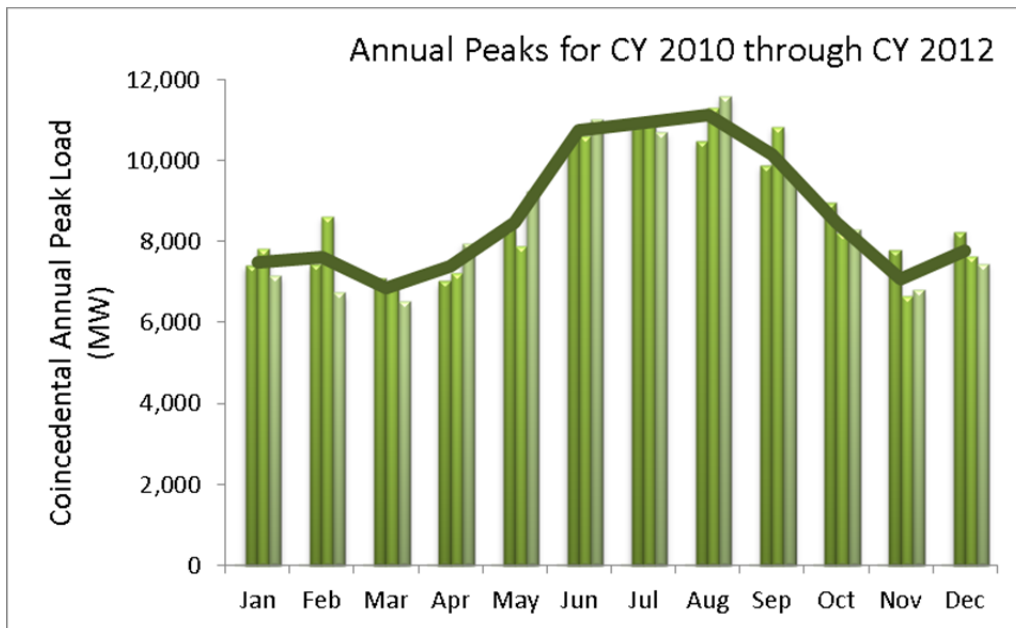

6
7
8
9
10

FIGURE K.1-28 Historical Coincidental Annual and Average Peak Loads for Six Large Customers during the CY 2010 through CY 2012 Time Period

1 **Firm Capacity Risk Level.** Assumptions regarding the level of risk that would be used
2 in the LTEMP power systems analyses to determine firm capacity levels under each alternative
3 were debated and jointly decided upon by staff from Reclamation, Western, NPS, and Argonne.
4 Again, historical information was used to help in the decision-making process. However, unlike
5 the process that was used to determine the timing of the peak load, which primarily relied on
6 historical data, these methods also required the use of modeling tools—most of which were
7 previously described in the Modeling Tools section.
8

9 Under terms of the SLCA/IP 2004 LTF contracts, Western’s CRSP Management Center
10 Office is obligated to provide its LTF customers with a minimum capacity level (SHP). The SHP
11 level must be supplied regardless of the state or condition of SLCA/IP hydropower resources.
12 These non-contingent contracts became effective on October 1, 2004, and will continue to be
13 binding until September 30, 2024. When SLCA/IP resources are incapable of fulfilling
14 Western’s entire obligation, Western must make power purchases to cover any shortfalls.
15 Therefore, Western is exposed to market risks because the future of both reservoir conditions and
16 the operating state of generating units are not known with certainty. Argonne conducted an
17 analysis to roughly approximate risk levels to which Western is exposed under its current SHP
18 obligation. For this analysis, risk exposure is measured as the probability that Western will not
19 be able to meet its daily SHP obligations during peak summer load months. Argonne staff
20 estimate this probability by computing daily SLCA/IP hydropower powerplant capacity under
21 many possible hydrological futures while accounting for the impacts of unit-level outages and
22 environmental operating limits. This analysis is merely a retrospective study of Western’s SHP
23 level using current hydrological data. The methodology used in this analysis was not necessarily
24 used by Western to determine its current SHP obligations.
25

26 SLCA/IP hydropower facilities span a large range of powerplant sizes and operational
27 flexibility. For this analysis, Western’s SLCA/IP hydropower resources are divided by size as
28 shown in Figure K.1-20.
29

30 The capacity from the Western SLCA/IP system is estimated using the models and
31 method shown in Figure K.1-29, which leverages LTEMP tools and methods. A brief overview
32 of capacity computations is as follows:
33

- 34 1. Glen Canyon Dam Powerplant resource capacity under many plausible futures
35 is based on Reclamation’s CRSS and SBM models, along with maximum
36 daily production levels projected by the Argonne GTMax-Lite model;
37
- 38 2. Other CRSP and Fontenelle daily capacities under many plausible futures are
39 estimated by the Large Powerplant spreadsheets that compute unit-level
40 maximum output based on CRSS model results and unit-level outages;
41
- 42 3. Flaming Gorge capacity is further reduced under most hydrological conditions
43 because operating criteria and other agreements further constrain its maximum
44 daily output; and
45

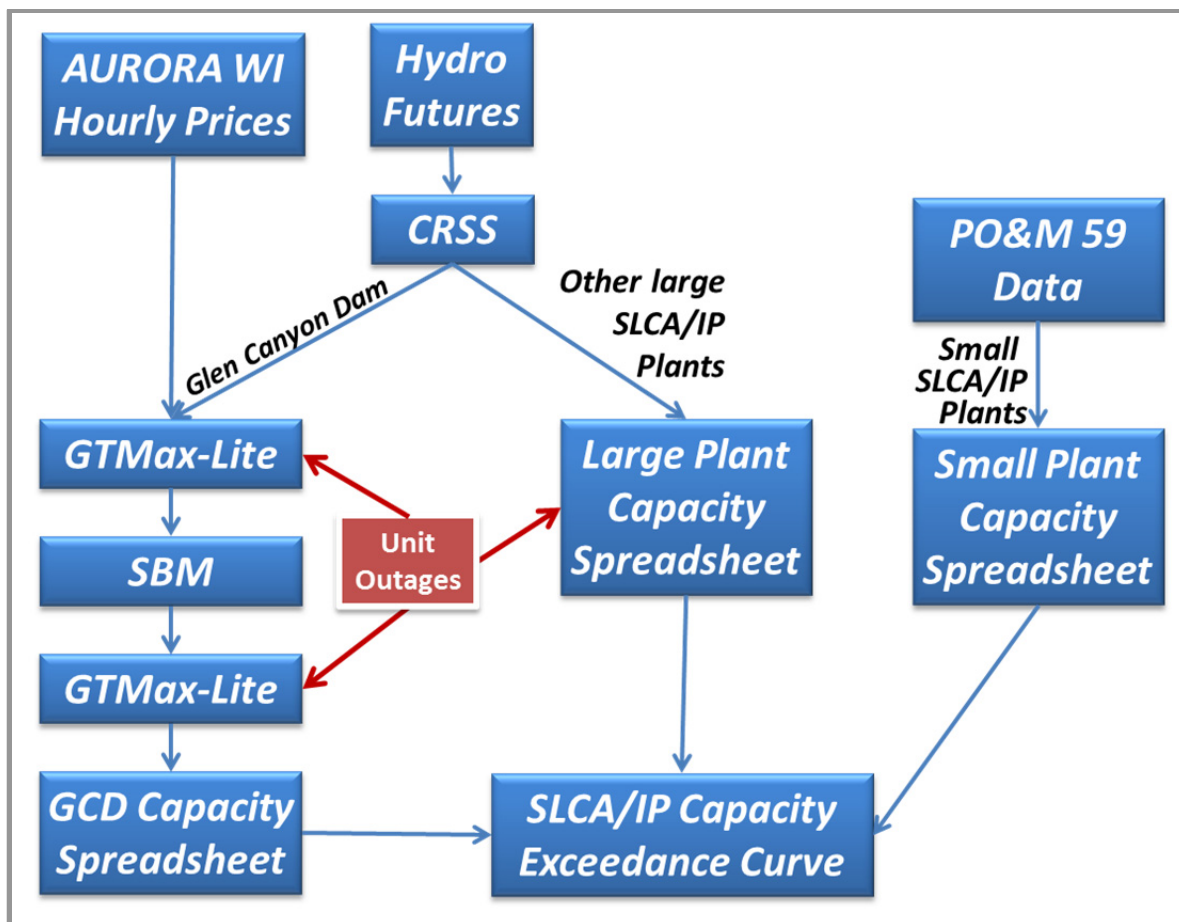

FIGURE K.1-29 SLCA/IP Models Used for Estimating SHP Capacity

4. For the remaining SLCA/IP resources (i.e., Towaoc, McPhee, Elephant Butte, Upper Molina, and Lower Molina), monthly capacity computations are based on historical monthly operating information contained in Form PO&M-59.

After trace-specific time series of plant-level capacities are computed, the Firm Capacity Spreadsheet creates SLCA/IP hydropower capacity exceedance curves. For each day in a month, the routine totals the daily coincidental peak capacities of all large powerplants. To this sum the routine adds monthly capacities for all small powerplants and subtracts capacity that is reserved for other purposes as described in previous sections.

After a time series of plant-level capacities was computed for all facilities and all traces over the 20-year study period, the data were processed further in a separate routine to determine exceedance levels for the peak loads months of July and August. For each day in a month, the routine totals the daily coincidental peak capacities for both Glen Canyon Dam and the other large SLCA/IP federal facilities for 21 hydrology traces over the 20-year study period. The resulting values are used to create SLCA/IP hydropower marketable capacity exceedance curves.

1 Western's current sustainable hydropower (SHP) commitment level was located
2 on these exceedance curves to determine how much of the time SLCA/IP resources
3 would be able to meet all of Western's current contractual and operating obligations. SHP
4 is the minimum aggregate level of LTF capacity and energy that will be provided by
5 Western to all SLCA/IP customers through the contract period, regardless of the
6 hydropower condition. The location of the Western's SHP commitment on the
7 exceedance curve will determine the level of capacity risk to which Western is currently
8 exposed.
9

10 From Western's data over at least the last 10 years, its SHP commitment for July has
11 been about 750 MW. As shown on the SLCA/IP capacity exceedance curve in Figure K.1-30,
12 this level is exceeded about 89.5% of the time; in other words, there is a 10.5% probability that
13 Western will need to make purchases to fulfill its entire SHP. In August the risk is somewhat
14 lower. Figure K.1-31 shows that Western has enough SLCA/IP hydropower capacity to meet its
15 SHP capacity obligation of 721.4 MW about 91% of the time. Therefore, Western's current
16 capacity risk is at about the 90% exceedance level.
17
18

19 **K.1.7.4 Firm Capacity Curves for LTEMP Power Systems Analyses for the Peak** 20 **Month of August** 21

22 Similar to the above assessment of risk for the CRSP Management Center, exceedance
23 curves were constructed to analyze risk levels associated with firm capacity used for SLCA/IP
24 system reserve margin calculations. The left panel of Figure K.1-32 shows the marketable
25 capacity for the seven primary alternatives at exceedance levels ranging from 10% to 99% for
26
27

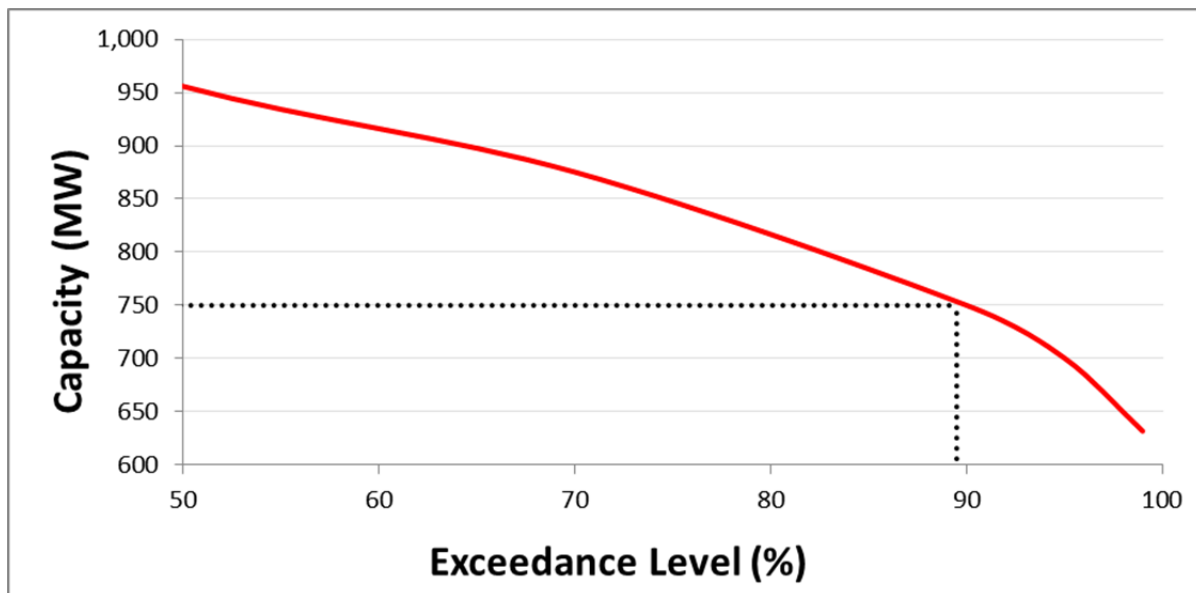

28
29 **FIGURE K.1-30 Historical SHP Capacity Obligation and Western Estimated Risk Level**
30 **in July**

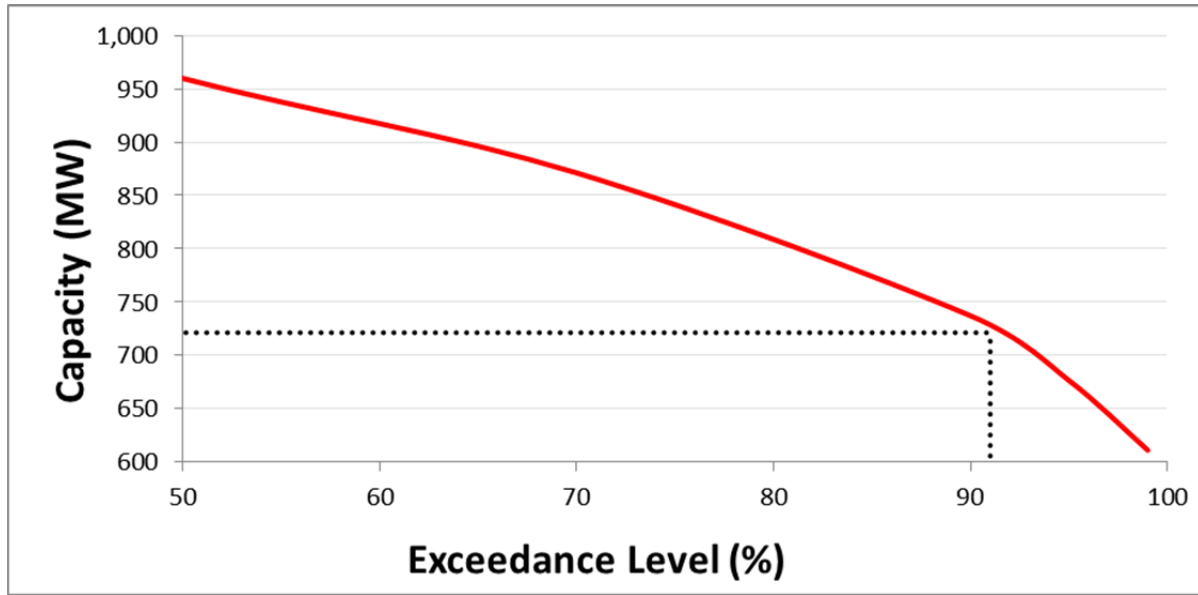

FIGURE K.1-31 Historical SHP Capacity Obligation and Western Estimated Risk Level in August

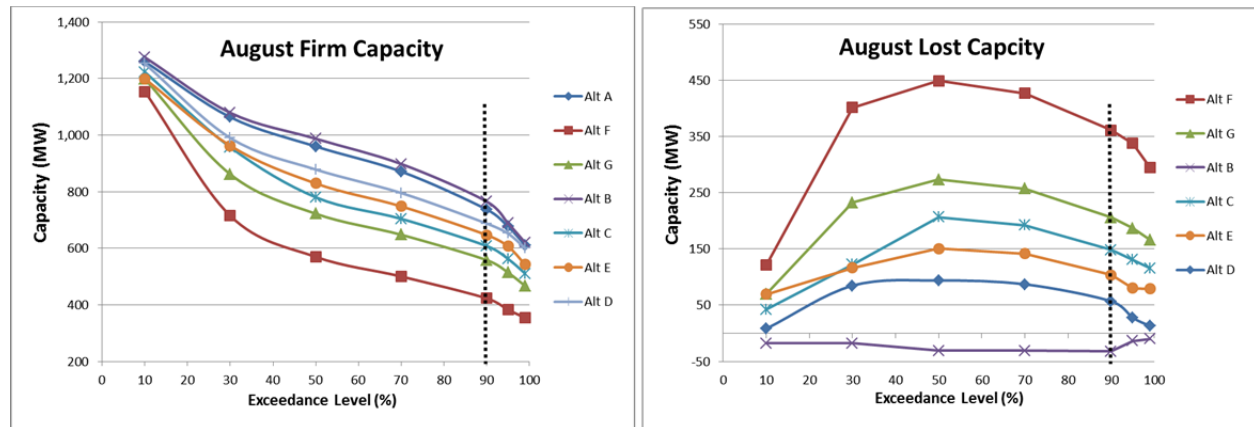

FIGURE K.1-32 Comparison of Firm Marketable Capacity Determinations across Alternatives, Exceedance Levels, and Summer Peak Months

combined SLCA/IP federal hydropower resources. These results assume that the peak system load will occur in August. All alternatives have less firm capacity at all exceedance levels than Alternative A, except for Alternative B, but this is expected because it has the least restrictive environmental constraints of any alternative.

Under the assumption that the peak load occurs in August, the right panel of Figure K.1-32 shows the difference in firm capacity compared to Alternative A. The graphs show that the greatest difference in capacity occurs at the 50% exceedance level and the smallest at the 99% exceedance level. Based on the current CRSP Management Center risk exposure of

1 10%, the determination of firm capacity for all LTEMP alternatives will also be based on this
2 risk level. Note that the results reported in Chapter 4 of the main document also assume a 10%
3 risk level (90% exceedance level) for a peak load that is anticipated to occur in August.
4

5 However, Western CRSP Management Center staff point out that Western has no
6 obligation to use this criteria when setting future LTF capacity offers to its preference customers.
7 Western staff also noted that other offices within the Western organization use different criteria to
8 establish marketable capacity levels. For example, the Desert Southwest (DSW) Office sells its
9 entire available Hoover Dam Powerplant capacity to its customers, and this capacity varies over
10 time. As the Hoover Dam Power Resource changes, DSW staff modifies its commitment level
11 accordingly. Therefore, Argonne staff encouraged a sensitivity analysis that uses a range of
12 exceedance levels. The results of the analysis are presented in Section K.1.10.4.
13

14 The power systems methodology assumes that lost Glen Canyon Dam Powerplant
15 capacity replacement costs due to more stringent operating criteria under an alternative will be
16 assessed at the systems level.
17

18 Capital costs to build the dam and powerplant were incurred in past. Therefore, the
19 economic costs of these past expenditures are treated as sunk investments under all alternatives;
20 that is, economic costs for building the dam and powerplant are set equal to zero because past
21 expenditures cannot be altered. Furthermore, it is assumed that any additional capital investment
22 in the dam and powerplant that will be incurred in the future is unaffected by an alternative. It
23 therefore follows that capital investment differences among alternatives is also zero. Similarly,
24 Glen Canyon Dam fixed O&M costs are assumed to be unaffected by any of the alternatives. It is
25 also assumed that the total physical 1,320 MW of nameplate capacity at Glen Canyon Dam is
26 identical under all LTEMP DEIS alternatives and that the capacity of all powerplant units will
27 not change over the study period.
28

29 Capital costs only factor into LTEMP DEIS economic calculations for capacity
30 expansion units because the retirement schedule of existing units and the online date of
31 committed units does not change among alternatives; therefore, the economic cost difference
32 between Alternative A and other alternatives is equal to zero. Fixed O&M costs only factor into
33 LTEMP DEIS economic calculations for capacity expansion units because the retirement
34 schedule of existing units and online dates for committed units do not change among
35 alternatives; therefore, the economic difference of these “fixed” costs between Alternative A,
36 which serves as a reference point, and other alternatives is equal to zero.
37
38

39 **K.1.7.5 AURORA Capacity Expansion Reserve Margin Targets and** 40 **Capacity Additions** 41

42 The AURORA model was used as a tool to aid power system modelers and analysts at
43 Argonne in finding reasonable capacity expansion plans for each LTEMP alternative using the
44 topology previously shown in Figure K.1-3 and described in Section K.1.5.9. This section
45 provides more details on how it was used for capacity expansion. The network topology shown
46 in Figure K.1-3 consists of two power pools. Pool A is made up of all SLCA/IP hydropower

1 resources and Western’s eight large customers. Pool B consists of the aggregate of Western’s
2 small customers and all project use loads.

3
4 The network was modeled as two power pools for the purpose of calculating a system
5 reserve margin. Western’s eight large customers and hydropower resources were put into Pool A
6 because these customers (except for NTUA) satisfy their loads from a combination of their own
7 generation, generation owned jointly with another large customer(s), Western firm hydropower
8 allocations, bilateral contracts, and market purchases. Customers in Pool B have no generation
9 and serve loads only through Western firm hydropower allocations, bilateral contracts, and
10 market purchases. It is assumed that customers in Pool A would satisfy their combined reserve
11 margin by constructing new generation. Customers in Pool B would satisfy their reserve margin
12 by making individual purchases from large Pool A customers and from the Western
13 Interconnection market transactions.

14
15 The model builds new units when the capacity reserve margin of the aggregate SLCA/IP
16 system, which includes Western and all of its LTF customers, would otherwise drop below 15%.
17 Based on a review of utility IRPs in the Western Interconnection, it was found that a 15% reserve
18 margin is a typical capacity expansion goal. This value was therefore used as a reserve margin
19 goal for the LTEMP power systems analysis.

20
21 Capacity that is credited toward the reserve margin frequently differs from the rated
22 nameplate capacity, because the maximum output from the powerplant may differ from the rated
23 level. For example, a high atmospheric temperature typically reduced the maximum output from
24 gas-turbine technologies. Therefore, the firm capacity that is used in the reserve margin
25 calculation is less than the nameplate capacity if the system peak load is expected to occur during
26 a hot summer afternoon. The firm capacity that is given to VERs can be very complicated. It is
27 often based on system-level reliability calculations that determine an equivalent “100% reliable”
28 capacity that yields the same loss-of-load probability as the VER.

29
30 The power system analysis uses an estimate of firm capacity for all existing and new
31 units instead of the nameplate capacity. In some cases, this requires that sometimes the
32 nameplate capacity is significantly derated. For example, it is assumed that the firm capacity
33 credit of new solar and wind farms is only 10% of the nameplate capacity. This is the default
34 used by AURORA. The firm capacity of Western’s SLCA/IP hydropower resources that is
35 credited toward this system reserve margin was described in Section K.1.7.4. In addition, as
36 noted previously, only the daily capacity of Glen Canyon Dam differs among alternatives.

37
38 Figure K.1-33 provides a simplified illustration of the impact of the firm capacity credit
39 at Glen Canyon Dam on the timing of new construction to meet future loads and the reserve
40 margin target. Two cases are shown in this example for illustrative purposes only. Under Case 1,
41 Glen Canyon Dam has a larger firm capacity and Case 2 has a smaller credit. The orange line
42 shows the annual coincidental peak load for the system. Because Western's firm allocation is
43 non-contingent, that capacity amount can be subtracted from the system peak load before
44 calculating the reserve margin. The reserve margin is then applied to that resulting curve to
45 obtain a revised load curve that includes the required reserve margin. This curve is then
46 compared with the capacity in Pool A to determine where they intersect. The year in which they

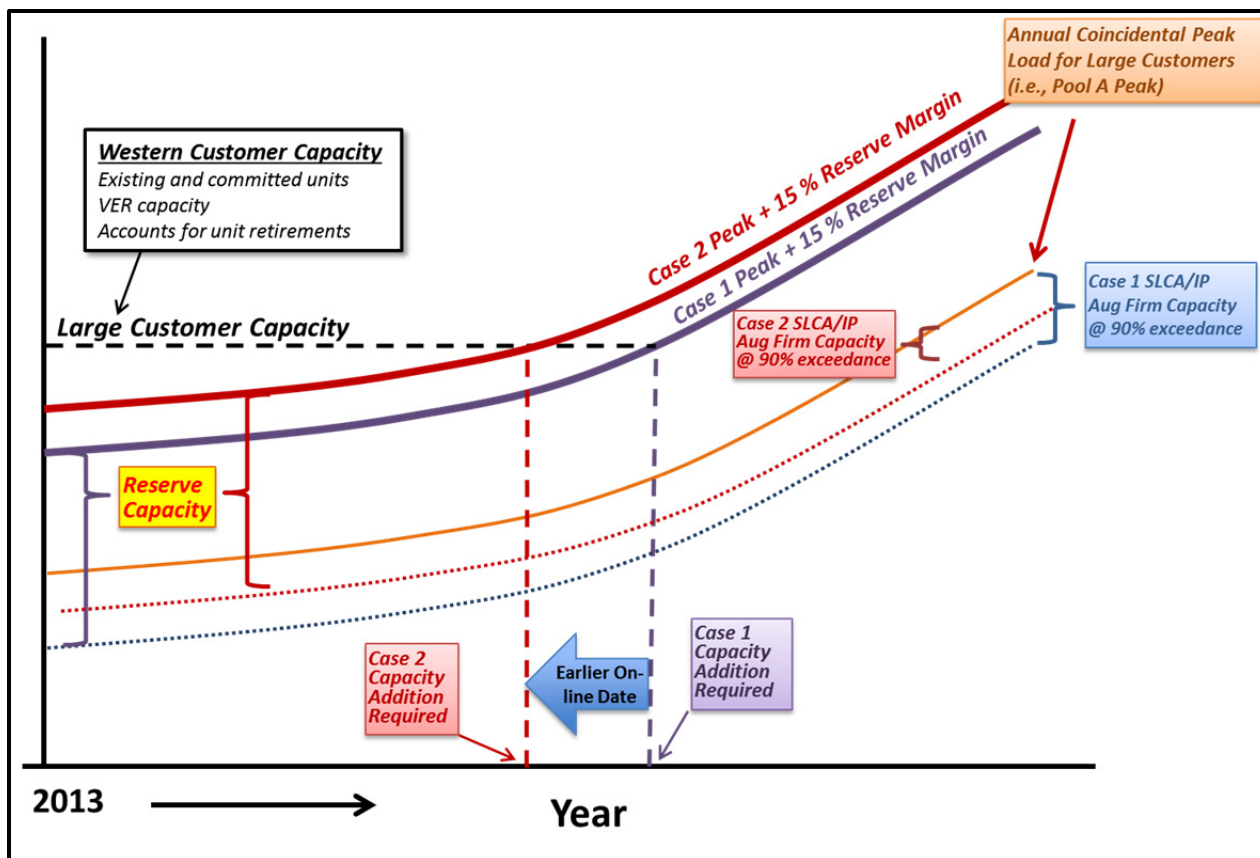

FIGURE K.1-33 Timing of Capacity Additions in AURORA

intersect is when new capacity is needed to meet the reserve margin. The graph shows that Case 2 needs new capacity before Case 1 because Western’s firm capacity credit under Case A is smaller.

To reliably serve projected load growth, fossil and non-fossil generation units are constructed by AURORA. AURORA also sheds load at specified market price trigger points.

Capacity shortfalls that remain after complying with state RPSs are resolved by building new electric generating units from a list of candidates. The cost and characteristics of candidate technologies for future capacity expansion that were used for power systems analysis were provided in Table K.1-1. These technologies and associated attributes and costs were based for data found in EIA’s 2014 AEO (EIA 2014).

The AURORA capacity expansion feature was used to guide the selection of a plausible capacity expansion plan for the SLCA/IP system. The methodology utilized models the expansion path for an aggregate eight large customer pool labeled “Pool A” in Figure K.1-3. The expansion plan determined under each alternative meets a 15% target reserve margin for pool A (large customers and SLCA/IP federal hydropower resources) plus additional capacity to replace lost Glen Canyon capacity that is allocated to small customers. Under an alternative, large

1 customers therefore replace the entire lost capacity even though only a portion (i.e., about 75%
2 under current SLCA/IP LTF capacity allocations) of this lost capacity would contractually affect
3 these larger utilities. Because small customers would most likely not build capacity in the future,
4 it was assumed the lost capacity allocated to these small utilities (i.e., about 25%) would be
5 replaced via the capacity expansion pathways of the aggregate eight large systems (Pool A).
6 Small customers pay for this capacity by purchasing it from the large customers via LTF
7 contracts.
8

9 The methodology implicitly assumes that a capacity shortfall in one customer utility
10 system could be temporarily fulfilled by another utility that has excess. Conceptually, this could
11 be achieved via a short-term firm bilateral capacity contract between the two systems, thereby
12 delaying a physical capacity addition by the utility that is “short” capacity. The sharing of
13 capacity resources differs from an approach in which the capacity requirements and goals of each
14 large customer are met individually. Under the joint system model, new units are only
15 constructed when the aggregate system is short. Because the methodology used in the analysis
16 focuses on the economics of the entire system, financial transactions among individual utilities,
17 such as short-term firm capacity purchases and sales, are not computed.
18

19 Although Western customers have a history of mutually beneficial arrangements, the
20 “joint system” model assumes a level of cooperation and coordination that currently does not
21 exist. Currently, there are no centralized energy or capacity markets in the region of the Western
22 Interconnection where SLCA/IP federal hydropower resources and Western’s LTF customers are
23 located. Capacity expansion decisions and energy transactions in this area are done
24 autonomously to meet the objectives of each independent utility. In addition, each utility has
25 limited information about the entire grid and the independent actions/decisions made by other
26 entities in the system. This is different than that used in the AURORA model, which makes units
27 commitments and dispatches units with “perfect” information about the entire system to optimize
28 a system-wide objective. AURORA also builds new powerplants to meet the pool-level reserve
29 margins, not to serve the objectives of each independent utility. Because a utility may add
30 capacity instead of making a short-term firm capacity purchase, this methodology will tend to
31 underestimate capacity expansion costs under all alternatives. However, inaccuracies associated
32 with cost differences among alternatives are most likely lower.
33

34 As discussed previously, new units are constructed when the capacity reserve margin of
35 the aggregate system would otherwise drop below 15%. Additions are made in unit capacity
36 increments resulting in a plan that has a “lumpy” reserve margin time series. The reserve margin
37 requirement (i.e., modeled as a “hard” constraint) also produces a solution that almost always
38 exceeds the 15% target. These relatively small excess capacities that fluctuate over time are
39 beneficial to the system dispatch and production-cost economics. Although most analyses would
40 assume that this excess capacity has no value, it could potentially be sold to a neighboring utility
41 outside the SLCA/IP marketing area, thereby reducing expansion costs. A simple post-model
42 sensitivity study was performed that assumed this capacity could be sold. The results of the study
43 are reported later in this appendix.
44

45 Depending on AURORA model parameters and run settings, the expansion plans
46 suggested by AURORA can be considerably different for Alternative A and in many instances

1 add significantly more generating units than the number required to maintain a 15% reserve
2 margin. This in part stems from the fact that the optimization problem AURORA attempts to
3 solve is extremely difficult to find. After discussion with EPIS staff and examinations of
4 expansion results, Argonne concluded that new capacity addition decisions made by the model
5 are based on financial objects rather than a single global economic objective. AURORA builds a
6 new unit if it is financially attractive. The end result is a realistic expansion path. However,
7 solutions that focus on local unit additions that are financially viable based on the NPV of costs
8 and revenues over the study period result in expansion pathways that often differ from the one
9 that costs the least over the entire multi-utility system.

10
11 Given the size of the modeled SLCA/IP area, the focus/capabilities of AURORA, and
12 Argonne staff skill level in the use of the model, finding the global least-cost economic solution
13 for Alternative A is intractable; that is, Argonne could not mathematically prove that any one of
14 the many solutions produced by AURORA was the global least-cost solution. It was also judged
15 that the mathematical optimum path would most likely not be found within a reasonable amount
16 of time and effort (i.e., several weeks or months). Given this modeling limitation, however, the
17 technologies selected by AURORA consistently indicated that combustion turbines (CTs) and
18 natural gas-fired combined cycle units will be constructed in the future. This solution is
19 consistent with available IRPs that Argonne reviewed for SLCA/IP large customers and several
20 large systems (typically investor-owned utilities) that neighbor the SLCA/IP marketing area. A
21 summary of these IRPs is shown in Table K.1-6 (see Table 2 of Attachment K-9 for additional
22 information). More detailed information about these IRPs are provided in Attachment K-9.

23
24 It should be noted that the methodology only represents SLCA/IP physical assets and
25 production levels. It does not reflect changes in SLCA/IP contract that may be implemented in
26 October 1, 2024, or financial implications as they affect Western and individual customers. This
27 topic will be discussed in the Wholesale Rate Analysis section.

28 29 30 **K.1.7.6 Dispatch Performed by AURORA Model Capacity Expansion Runs**

31
32 The methodology used represents all of SLCA/IP hydropower energy assets in the
33 AURORA model to measure the economics of changes in Glen Canyon Dam operating criteria.
34 GTMax-Lite and customized small SLCA/IP resource spreadsheet results provide AURORA
35 with alternative-specific SLCA/IP dispatch and an hourly schedule of energy injections into the
36 power grid. By doing so, AURORA recognizes the basic role of hydropower resources as they
37 affect the dispatch of the SLCA/IP system and energy transactions with the Western
38 Interconnection.

39
40 Due to the complexities of SLCA/IP hydropower operating criteria and non-power
41 considerations, AURORA could not model the dispatch of these resources at the level of detail
42 required for this study. Instead, powerplant-specific hourly production levels were projected over
43 the study period using the previously discussed two GTMax-Lite model configurations and the
44 Small SLCA/IP Powerplants Spreadsheet. Energy injections into the system from Glen Canyon
45 Dam are based on average hourly GTMax-Lite results over all 21 hydrology traces from the
46 SBM. Hourly energy injections from all other large SLCA/IP resources are based on

1 **TABLE K.1-6 Summary of Utility IRPS for Four Large SLCA/IP Customers and Other Large**
 2 **Utilities in Areas Neighboring the SLCA/IP System**

| Utility | Utility Type | Type of Generation Added | When Added | Capacity Added (MW) |
|----------------------------|------------------|---------------------------|--------------|------------------------------|
| Public Service of CO | Investor | Gas Turbines | 2018 to 2022 | 1,211 |
| | Owned | Combined Cycle | 2023 to 2032 | 1,929 |
| Public Service of NM | Investor | Gas Turbines | 2016 to 2033 | 736 |
| | Owned | Solar PV | 2015 to 2022 | 283 |
| Rocky Mountain Power | Investor | Combined Cycle | 2014, 2024 | 645, 423 |
| | Owned | Wind | 2024 | 432 |
| Arizona Public Service | Investor | Natural Gas (unspecified) | 2019 to 2029 | 4,200 |
| | Owned | Renewable (unspecified) | 2019 to 2029 | 425 |
| Tucson Elect. Power | Investor | Natural Gas (unspecified) | 2015 to 2028 | 1,214 |
| | Owned | Renewable (unspecified) | 2014 to 2028 | 529 |
| Nevada Power Company | Investor | Combined Cycle | 2018 to 2024 | 3,813 |
| | Owned | Gas Turbines | 2023 to 2032 | 2,043 |
| | | Solar PV | 2016 to 2021 | 50 |
| Sierra Pacific Power | Investor | Gas Turbines | 2023 to 2029 | 1,975 |
| | Owned | Combined Cycle | 2025 | 571 |
| Platte River Power | Western Customer | Gas Turbines | 2021 | Unspecified |
| Colorado Springs Utilities | Western Customer | Gas Turbines | 2029 to 2031 | 39 |
| | | Renewable (unspecified) | 2018 to 2029 | 20 |
| Tri-State G & T Assn. | Western Customer | Combined Cycle | 2019 to 2026 | 1,176 |
| | | Renewable (unspecified) | 2016 to 2027 | 350 |
| Salt River Project | Western Customer | Natural Gas (unspecified) | FY2018+ | Projected 581-MW gap in 2017 |
| | | | | |

3
 4
 5 GTMax-Lite results, which use average monthly hydrological conditions over the 21 hydrology
 6 traces produced by CRSS. Last, energy injections from small SLCA/IP hydropower plants are
 7 based on average historical conditions reported in Form PO&M-59.
 8

9 Annual CY energy generation for Glen Canyon Dam and all other SLCA/IP hydropower
 10 resources combined are shown in Figure K.1-34 under Alternative A. Annual generation from
 11 the Glen Canyon Dam Powerplant averages about 4,114 GWh, and ranges from about
 12 3,665 GWh to 4,338.2 GWh. The lowest generation value occurs in 2013 due to low initial
 13 reservoir elevations that were observed at the end of CY 2012. That is, because the simulation
 14 starts out at a point in time when the Glen Canyon Dam reservoir is low, water releases tend to
 15 be less since more water is retained in the reservoir in an attempt to increase the water storage
 16 level. On average, Glen Canyon Dam is expected to account for about 72% of the total annual
 17 SLCA/IP hydropower generation. Because annual WY releases are nearly the same under all
 18 alternatives, total CY annual generation levels for all alternatives are within about 1.7% of
 19 Alternative A. Those alternatives that have more HFEs tend to have somewhat lower annual
 20 average generation levels. This topic will be discussed in more detail in Section K.1.10.
 21

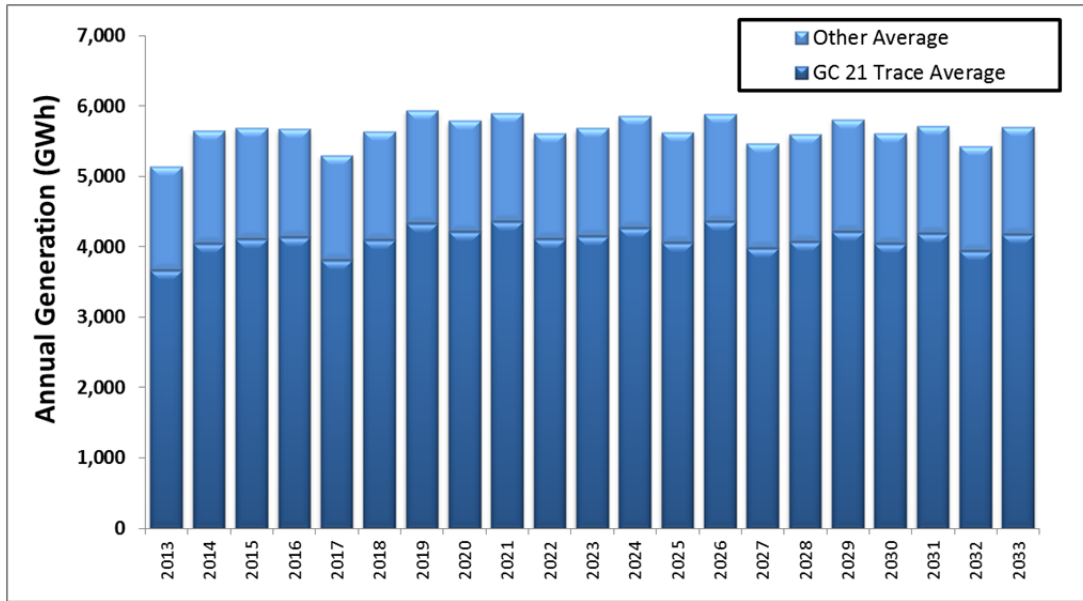

1

FIGURE K.1-34 Annual Average Hydropower Generation for the Glen Canyon Dam Powerplant and the Aggregate Generation for all other SLCA/IP Resources

2

3

4

5

6

7

8

9

10

11

12

13

14

Although annual Glen Canyon Dam generation levels are similar among alternatives, the monthly distribution of generation within a year is substantially different among alternatives. Projected monthly generation produced by other SLCA/IP hydropower resources is essentially identical under all alternatives. Figure K.1-35 shows that alternatives such as Alternatives A and B have high Glen Canyon Dam average daily generation levels during the peak summer months when marginal energy production costs are relatively expensive. These energy levels produce higher economic values than those with lower summertime generation levels, such as Alternative F.

15

16

17

18

19

Interactions between all entities in the SLCA/IP marketing area and the rest of the Western Interconnection are represented by a single point where non-firm hourly energy transactions occur. This point, labeled “Spot Market” in Figure K.1-3, contains an inelastic time vector of market prices for system energy purchase and sales.

20

21

22

23

24

25

26

27

28

29

30

Power transfers between utilities and the Western Interconnection node incur a charge that varies by on-peak and off-peak periods. All purchases and sales that a customer makes incur an additional transfer cost that also varies by on-peak and off-peak periods. The eight large customer utilities and small customers only purchase energy from the spot market node; spot sales are not possible. This assumption was made to ensure that the SLCA/IP system would not construct capacity on a speculative basis for the purpose of selling energy to the Western Interconnection; that is, it constructs capacity primarily for internal purposes. Because the Western Interconnection prices tend to be more expensive than production costs in the SLCA/IP system, purchases from the Western Interconnection tend to be small. However, the Western Interconnection energy was made available for purchase by the SLCA/IP systems in situations where internal production costs became expensive. In addition, reserve margin requirements

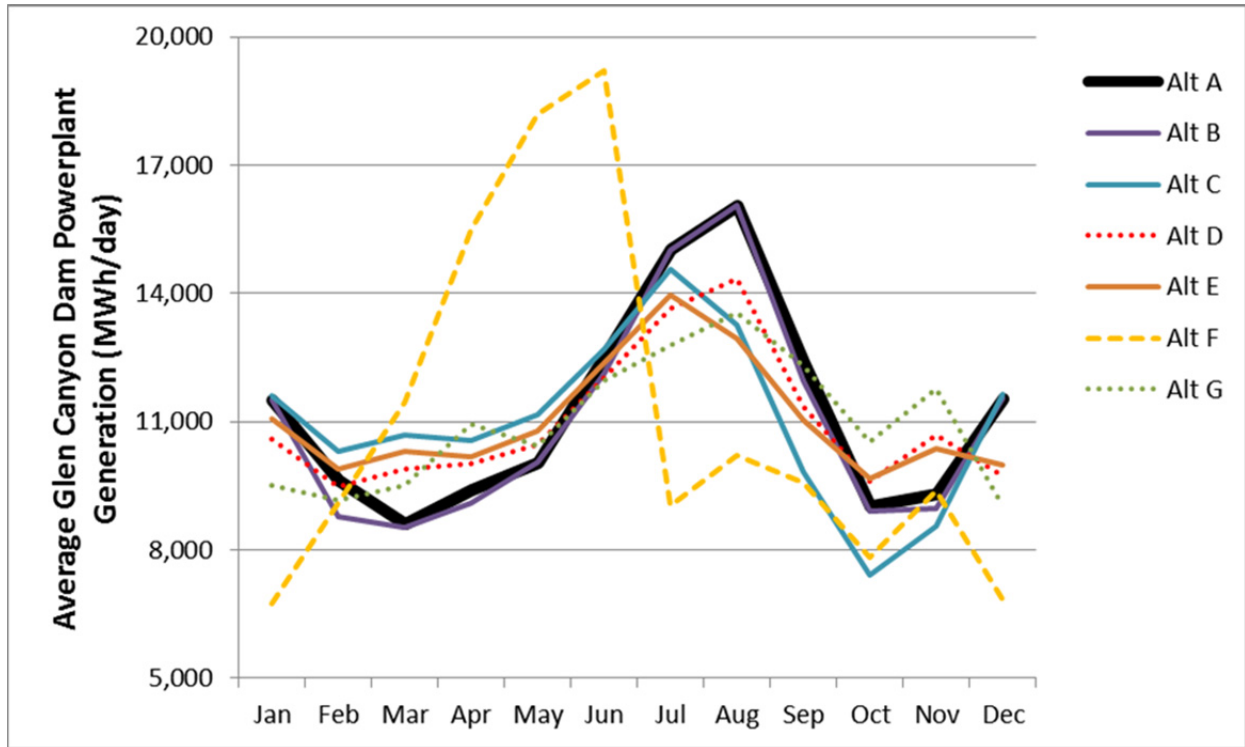

1

2

FIGURE K.1-35 Average Daily Glen Canyon Dam Powerplant Hydropower Generations by Month Based on the Average of All 21 CRSS/SBM Hydrology Traces

3

4

5

6

were configured to exclude Western Interconnection purchases as a source of firm capacity. Therefore, the SLCA/IP system is prevented from leaning on the Western Interconnection for capacity during times of peak load.

8

9

10

Depending on the customer's location, loads and resources are designated as east or west regional entities. Energy flows among entities via system linkages. Some links have limitations and/or associated costs. Energy flows on links connecting SLCA/IP resources to Western's customer loads. Limits on energy transfers on those links represent customer CROD allocations. Under hydrological conditions in which SLCA/IP total generation exceeds the total CROD, the excess energy flows on links that represent Western's shorter-term energy transactions with its LTF customers.

17

18

Very small cost premiums are placed on some connections to represent Western's service priorities and to roughly approximate energy flows. Energy generated by Glen Canyon Dam is transmitted to loads in the following priority order: (1) project use in the west region, (2) project use in the east region, (3) LTF customers in the west region, and (4) LTF customers in the east region. The higher the priority, the lower the power delivery cost; that is, the lower the assigned link cost. Energy flow priorities for other SLCA/IP resources mirror the Glen Canyon Dam pattern. The priority order for SLCA/IP resources other than Glen Canyon Dam is (1) project use in the east region, (2) project use in the west region, (3) LTF customers in the east region, and (4) LTF customers in the west region.

26

1 Figure K.1-3 also shows that an LTF customer has direct connections to all other LTF
2 customers in the region where it resides. Energy transfers may also occur among customers
3 located in different regions. In addition, “ballpark” energy transactions among LTF customers
4 incur an energy transfer cost that varies by on-peak and off-peak periods. Power transmission
5 costs of \$3.5/MWh during off-peak hours and \$6.5/MWh during on-peak hours was based on
6 historical information provided by Western. Off-peak hours include all day on Sundays and
7 holidays and 8 hours each night during all other days.

8
9 The AURORA topology/configuration assumes a very high level of cooperation and
10 coordination among Western and its customers when modeling system dispatch. More
11 specifically, given the transfer limits and costs discussed above, the model determines a unit
12 commitment schedule and least-cost hourly dispatch for the entire SLCA/IP marketing area as if
13 it were under the control of a single operator. This is a higher level of cooperation and
14 coordination than what actually occurs. However, Western and its customers do buy and sell
15 energy via both day-ahead and hour-ahead bilateral agreements using market signals, insights,
16 and data such as that provided by ICE as a guide. The AURORA topology also includes energy
17 transfer costs among LTF customers that dampen power transfers relative to a “single-owner”
18 model that does not incur these costs.

21 **K.1.7.7 Rationale for the Selection of Hydrology Conditions Used for Capacity** 22 **Expansion Runs**

23
24 The low hydropower condition of 90% exceedance used to select SLCA/IP hydropower
25 capacity credits is fairly conservative because the system is slow to respond to capacity
26 shortfalls. New units take a relatively long time (years) to plan/engineer, permit, construct, test,
27 and eventually bring online. Therefore, if insufficient capacity is built, the system may
28 experience years of unacceptably high reliability risks when hydrology/hydropower capacity is
29 low.

30
31 On the other hand, average energy conditions are used for power injections into the grid
32 for capacity expansion modeling because the system quickly adapts to various hydrological
33 situations through system dispatch and short-term energy transactions (e.g., purchases when
34 hydropower energy production is below normal). Although it does not provide an exact estimate
35 of energy economics, given all of the other uncertainties involved with long-term projections, an
36 average hydrological condition provides a good approximation of the *relative* economics among
37 the enormous number of capacity expansion pathways that are theoretically possible for the
38 SLCA/IP study area.

39 40 41 **K.1.8 Glen Canyon Dam Energy Economic Benefits Methodology**

42
43 The Glen Canyon Dam Powerplant generates large amount of energy that yields
44 significant economic benefits to the grid. It serves SLCA/IP market system demands and this
45 system responds/reacts to its powerplant operations. Therefore, the economic impacts of changes
46 in Glen Canyon Dam operations are measured for the system as a whole by computing SLCA/IP

1 market system operating costs. On the production side, costs include energy production costs that
2 are comprised of fuel expenditures, variable O&M costs, and unit startup expenses. Costs are
3 also incurred to deploy price-sensitive loads. The AURORA model run in dispatch mode was
4 used to estimate production levels and associated costs for each generating unit and DSM
5 program in the SLCA/IP market system during the study period.
6

7 AURORA dispatch mode computations are based on a given set of resources, as
8 previously determined by AURORA runs that were made in capacity expansion mode. Hourly
9 SLCA/IP federal hydropower production input into AURORA is based on GTMax-Lite runs for
10 Glen Canyon Dam and the other five large hydropower plants. These runs adhere to all physical
11 and institutional operating criteria, including those needed to supply project use loads and fulfil
12 ancillary service requirements. Energy costs for each LTEMP alternative are computed as the
13 difference between the AURORA dispatch results for Alternative A and another alternative.
14

15 The LTEMP DEIS affects the system-level operating costs and therefore energy
16 economics because operating criteria bind the timing and routing of water releases through Glen
17 Canyon Dam. From a system dispatch perspective, power produced by the Glen Canyon Dam
18 Powerplant yields the highest economic benefits when the limited amount of water it releases
19 during a WY is routed through the powerplant's generating turbines to produce power that either
20 displaces energy generation or demands curtailment from expensive grid resources. For example,
21 Glen Canyon Dam has a high economic value when the energy it produces reduces or eliminates
22 the operation of an old, inefficient gas turbine with high production costs. On the other hand, it
23 has a much lower value when it displaces low-cost power generation. As discussed earlier, LMPs
24 that are specified at the Western Interconnection spot market node interface represents Western
25 Interconnection marginal cost production savings when it purchases power from the SLCA/IP
26 market system. On the other hand, when the SLCA/IP market system buys from the Western
27 Interconnection, operating costs of the system are reduced, but it pays for the purchase at the
28 LMP price. For the LTEMP DEIS, these prices were determined by the Western Interconnection
29 model run and a scaling algorithm applied to the Palo Verde market hub. Purchases are only
30 made when the LMP is less expensive than the incremental cost of both power production and
31 DSM deployment.
32

33 The average annual energy produced by the Glen Canyon Dam Powerplant varies by less
34 than 2% among alternatives. However, at varying levels of stringency, alternative criteria bind
35 the daily and hourly operational flexibility at Glen Canyon Dam and affect both Lake Powell
36 monthly reservoir elevations and Glen Canyon Dam monthly water release volumes. One of the
37 primary differences between the AURORA dispatch in capacity expansion mode and when
38 AURORA is run in dispatch mode is the hydrological information used for SLCA/IP federal
39 hydropower conditions. When run in dispatch mode, the AURORA model uses GTMax-Lite
40 results for Glen Canyon Dam and the other five large SLCA/IP federal hydropower plants, based
41 on hydrological information for the representative trace. As shown in Figure K.1-36, average
42 annual SLCA/IP federal hydropower plant generation for the representative hydrology trace
43 (i.e., trace 14) used for economic dispatch runs is significantly different from that used for
44 AURORA capacity expansion runs, shown in Figure K.1-33. It should be noted that there is
45 significantly more generation volatility in Glen Canyon Dam Powerplant energy production used
46 for economic dispatch runs. The lowest annual Glen Canyon Dam generation level using trace 14

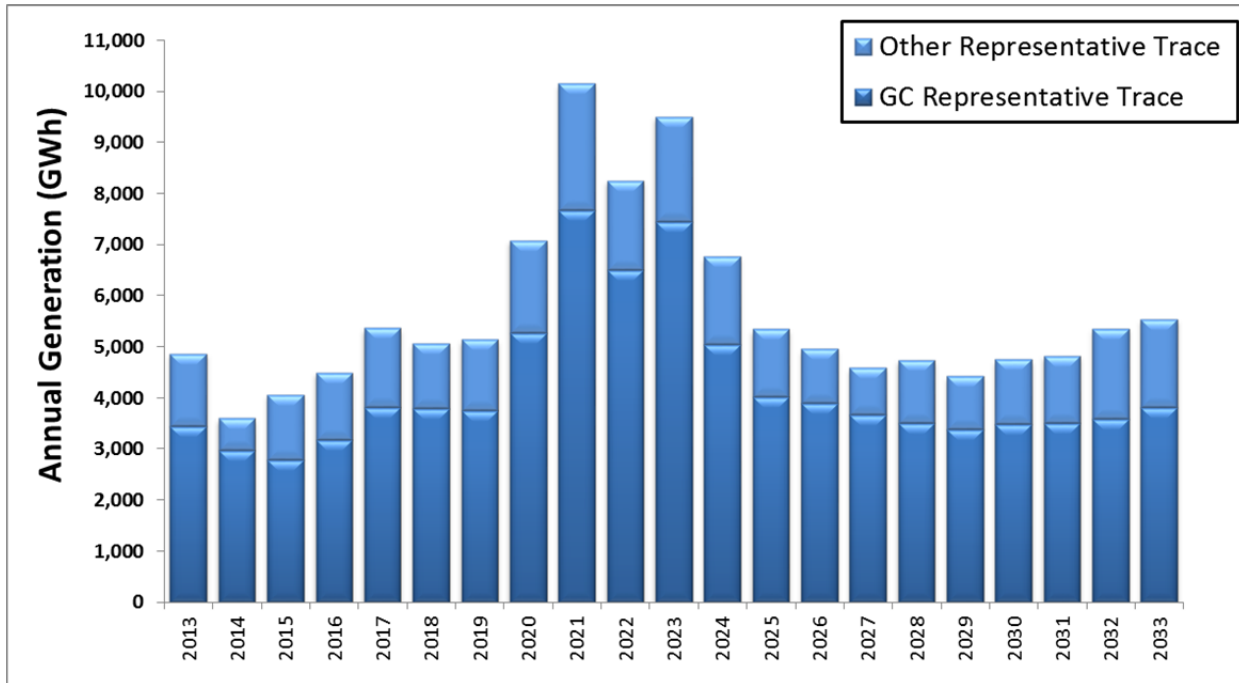

1

2 **FIGURE K.1-36 Average Annual Glen Canyon Dam Powerplant Generation for the**
 3 **Representative CRSS/SBM Hydrology Trace**

4
5

6 is 2,781 GWh, which occurs in CY 2015. Generation under that same trace is 7,677 GWh in
 7 CY 2021; therefore, those years differ by a factor of about 2.7. This is consistent with historical
 8 volatility levels. As described in Section K.1.2, Glen Canyon Dam Powerplant annual generation
 9 varied by a factor of 2.6 between CY 1980 and CY 2013.

10

11 Trace 14 average daily generation over the LTEMP period produced by the Glen Canyon
 12 Dam Powerplant by month is shown in Figure K.1-37. These values are similar to the ones used
 13 for the AURORA capacity expansion runs shown in Figure K.1-34. It is one of the attributes of
 14 trace 14 that make it “representative.”

15

16 As described in more detail in Section K.1.10, the combination of LTEMP operating
 17 criteria, Glen Canyon Dam monthly water releases volumes, SLCA/IP market system loads, and
 18 spot market LMPs drive DEIS differences in economic dispatch cost among alternatives. The
 19 system-level dispatch methodology for computing energy economic costs captures the following
 20 key aspects of DEIS alternative operating criteria:

21

- 22 • Marginal dispatch costs at a location to serve loads increase as the system
 23 load-level increases. Resources with low costs are dispatched first. As the load
 24 increases, more expensive resources are dispatched to balance the supply and
 25 demand.
- 26 • The Glen Canyon Dam energy value is based on SLCA/IP market system cost
 27 reduction as a consequence of powerplant energy injections into the grid.

28

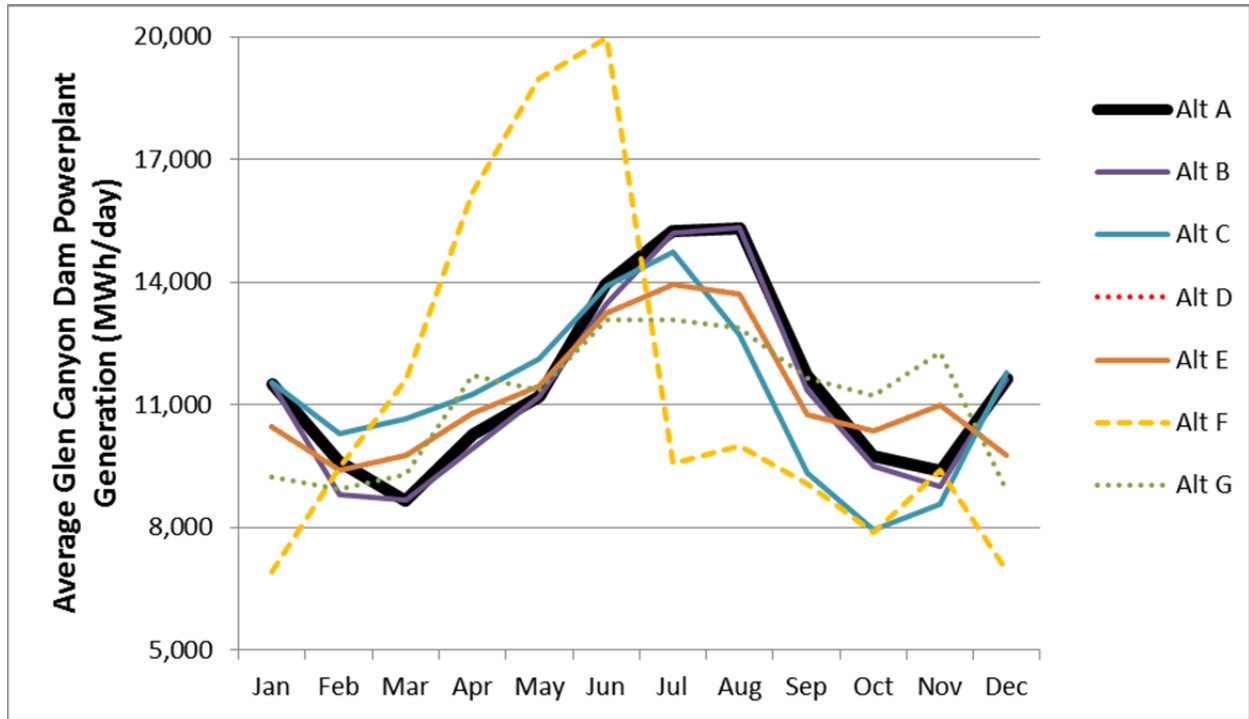

1
 2 **FIGURE K.1-37 Representative Trace Average Daily Glen Canyon Dam Powerplant Generations**
 3 **by Month**

- 4
 5
 6 • Over short-term operations such as daily and weekly dispatch, energy
 7 economic differences among alternatives are highly dependent on operational
 8 flexibility allowed under the alternative and the marginal production cost and
 9 LMP spread between off- and on-peak periods. If costs and prices are always
 10 the same, operational criteria would have minimal impacts.
 11
 12 • On an annual timeframe, energy economic differences among alternatives are
 13 dependent on the correlation of monthly water release volumes to monthly
 14 marginal production costs and LMP. Alternatives with a positive correlation
 15 have a much higher energy economic value than those with a negative
 16 correlation. The larger the monthly price and cost spreads, the greater the
 17 economic cost of the alternative. If costs and prices are always the same,
 18 monthly water release volumes would have minimal impacts.
 19
 20 • Unlike daily, weekly, and monthly economic differences that are a function of
 21 price/cost spreads, economic differences from HFEs are a function of absolute
 22 energy price/cost levels. Some water bypasses the turbines because the
 23 required HFE flow rate can exceed the turbines' maximum flow capability.
 24 Water that bypasses the turbines does not generate electricity for sale to
 25 customers and therefore has zero power value.
 26
 27

1 **K.1.9 Net Present Value Calculations and Study Period Adjustments**
2

3 As described in previous sections, all costs input into GTMax-Lite and AURORA are
4 expressed in 2013 dollars. For many of these inputs, this required that input values reported in
5 the literature be converted to 2013 dollars. For example, the cost of candidate technologies for
6 new construction was expressed in terms of 2012 dollars. The index used for dollar conversion is
7 application specific. Attachment K-10 provides more information on the dollar year conversion
8 process.
9

10 By expressing all present and future cost inputs in terms of real dollars, the effects of
11 inflation are removed from all AURORA model calculations. Therefore, for each year all costs
12 projected by the model are measured on a common and consistent basis. However, LTEMP
13 DEIS alternatives incur different levels of cost at different times over the study period.
14 Therefore, to account for the time value of money in which the present worth of money is
15 typically, but not necessarily, higher today than the same amount of money in the future, the
16 NPV of all costs are calculated to facilitate a common point in time for cost comparisons among
17 alternatives. The process of discounting is used to make costs that occur at different points in
18 time commensurate with each other.
19

20 The NPV computation takes a chronological stream of values over time and discounts
21 each one to a specified point in time based on a defined discount rate. These values are then
22 summed. Although the mechanics of the discounting process are very straightforward, the
23 magnitude of the discount rate greatly influences the degree to which future costs and benefits
24 “count” in the decision. As a result, the choice of discount rate is the subject of much debate. For
25 the LTEMP DEIS, NPV calculations are based on a discount rate of 3.375%. The use of this
26 discount rate was in part based on information contained in Attachment K-4, which was provided
27 by Reclamation staff. At the recommendation of Western staff, a second discount rate of
28 1.4% was used in a sensitivity study.
29

30 Because of discounting, the NPV calculation places more importance on near-term
31 economic costs as compared to those that occur in the more distant future. For example, a dollar
32 cost incurred during the first year of the study period has a \$1 NPV impact. However, at a
33 3.375% discount rate, the same dollar impact in the 20th year of the analysis has only a
34 \$0.5322 impact (i.e., slightly more than half) on the NPV. The selection of the representative
35 trace does not consider the discount effect on NPV outcomes. It may be important, however,
36 because the energy costs of an alternative are sensitive to hydrological conditions. The selected
37 representative hydrology trace starts out dry, becomes very wet in the middle of the period, and
38 by the last few years it returns to a dry condition. All other factors constant, the NPV calculation
39 would yield a different value if the sequence of dry, average, and wet hydrological conditions
40 differed from trace 14. A sensitivity analysis of the impacts of the sequence of hydrological
41 conditions on DEIS energy NPVs would help quantify the range of possible outcomes.
42

43 All detailed model calculations were made and expressed in 2013 dollars. This was in
44 part due to CRSS and SBM, which used the beginning of CY 2013 as a starting point. Cost was
45 computed over the 20-year length of the long-term experiment: a period that begins at the start of
46 CY 2013 and ends at midnight on the last day of CY 2032. However, to be consistent with other

1 DEIS disciplines, the power system analysis period was directed by project co-leads to cover
2 CY 2015 through CY 2034 and express all costs in terms of 2015 dollars. The request was made
3 at a point in the modeling process when all model runs, computations, and most aspects of the
4 analysis had been completed. It was therefore necessary to make adjustments to the CY 2013 to
5 CY 2032 results. The power systems team and co-leads agreed that the following adjustments
6 were reasonable given time and budget constraints.

- 7
8 1. All energy costs were shifted by 2 years. That is, CY 2013 energy costs were
9 assumed to take place in CY 2015 using trace 14 hydrology for CY 2013,
10 energy costs in CY 2014 were assume to occur in CY 2016, and so on.
11
- 12 2. The energy costs were then adjusted to account for real changes in energy
13 prices over time. This was accomplished in a two-step process. First, an
14 energy price index benchmarked to 2013 dollars was computed. The index is
15 based on the yearly average energy cost to serve load from the AURORA
16 SLCA/IP market systems model. This index was then applied to the shifted
17 energy costs from step 1 for all years. For example, because energy prices in
18 real 2013 dollars decreased during CY 2013 to CY 2015 timeframe (according
19 to AURORA and in actuality), the costs are adjusted downward using the
20 AURORA-generated energy price index. The end result is chronological
21 annual costs from CY 2015 through CY 2034 in beginning year 2013 dollars.
22
- 23 3. The energy cost time series is then converted to 2015 dollars using a general
24 price index. For this analysis, the seasonally adjusted GNP IPD was applied to
25 the 2013 dollars (see Table 1 in Attachment K-10).
26
- 27 4. The capital cost dollar for new unit construction from the EIA's 2014 AEO
28 (EIA 2014) expressed in nominal 2012 was adjusted to beginning year 2015
29 dollars using the "Powerplants" index contained in Reclamation (undated).
30 Fixed O&M costs were converted to 2015 dollars used the same table, except
31 that the "Powerplant Accessory elect. & misc. equip" index was used.
32
- 33 5. No adjustments were made to the online dates of new units constructed to the
34 study period, because the capacity reserve margin was greater than 15% in
35 2015 under all alternatives. However, because the analysis period is shifted,
36 there were no AURORA capital or fixed O&M cost computations for the last
37 2 years. Therefore, average cost values over the last 5 years of the AURORA
38 model run were assumed for CY 2033 and CY 2044.
39
- 40 6. The stream of all future costs are discounted to beginning year 2015 at an
41 annual discount rate (i.e., 3.375%) specified by the Reclamation for cost-
42 benefit studies of projects.
43

44 A final EIS and ROD will not be completed until after WY 2015. The reader should
45 recognize that the economic analysis for electrical power systems is sensitive to the years that are
46 modeled. Currently, the region affected by a change in the operation of Glen Canyon Dam is in

1 “capacity surplus.” This means that generating capacity in the affected region currently exceeds
2 peak electrical demand more than is necessary to achieve an acceptable level of reliability.
3 However, a growing regional economy and population will soon cause electrical demand to catch
4 up to supply. Depending on the actual ROD implementation date, the SLCA/IP market system
5 and the Western Interconnection may need to build additional capacity above committed levels
6 before completion of the ROD.
7
8

9 **K.1.10 Power Systems Results**

10
11 This section details the results of the power systems analysis, focusing primarily on total
12 SLCA/IP market system costs under each alternative relative to Alternative A. It also describes
13 the sensitivity studies that were performed to test the robustness of model results and analysis
14 conclusions. One set of sensitivity studies was on the risk preference or exceedance level that is
15 used to determine SLCA/IP federal hydropower firm capacity. The results in the main DEIS
16 were based on a 90% exceedance level. This section presents power system results for
17 exceedance levels of 50% and 99% to reflect the possibility of Western considering different risk
18 levels in future marketing efforts.
19

20 Another sensitivity study was performed on discount rate. The discount rate used in the
21 main EIS was 3.375% because the Bureau of Reclamation is required to employ an
22 administratively determined discount rate known as the federal plan formulation and evaluation
23 rate, when undertaking economic analyses of water resource and related matters pursuant to
24 42 U.S.C. 1962d-17. The plan formulation and evaluation rate for fiscal year (FY) 2015 is
25 3.375% (Reclamation 2014a,b). This section will show how power system results will change if
26 a lower discount rate, namely, 1.4%, is used. This value was used to explore a “real” interest rate
27 based on treasury notes and bonds, as determined by the Office of Management and Budget in
28 Circular A-94 Appendix C.
29

30 Two other sensitivity studies were also performed. One studied the sensitivity of the
31 baseline capacity expansion pathway used in Alternative A to different assumptions about the
32 candidate plants that would be constructed. AURORA invariably chose a combination of
33 advanced combustion turbines and advanced combined cycle plants as the preferred expansion
34 path. However, to test the sensitivity of the results to different expansion pathways, we ran the
35 AURORA model for two extreme expansion pathways for Alternative A: one allowed
36 construction of only advanced combustion turbines, and the other only natural gas combined cycle
37 plants.
38

39 The next study determined the sensitivity of the AURORA results to the choice of
40 hydrological conditions. The results of another hydrological condition were compared against the
41 results of the representative trace (i.e., trace 14).
42

43 Finally, as described in Section K.1.7.3, ancillary services are no longer expected to
44 increase as much and as rapidly as assumed in GTMax-Lite model runs. Therefore, a sensitivity
45 study was performed to determine whether and by how much power system results would change
46 if current ancillary service projection had been used. The results of the sensitivity study showed

1 that ancillary services assumptions under a range of plausible futures have little to no effect on
 2 firm capacity and energy value for the LTEMP alternatives (see Section K.1.10.8 for further
 3 detail).

4
 5
 6 **K.1.10.1 Main Drivers of Differences among Alternatives**
 7

8 Among all alternatives, annual water release volumes differ by less than 1% and the total
 9 volume of water released from Glen Canyon Dam over the 20-year LTEMP period is nearly
 10 identical. Therefore, the economic cost of an LTEMP alternative is not caused by changes in
 11 long-term water release volumes, but rather from altering the routing and timing of water
 12 releases during monthly, daily, and hourly timeframes within a year.
 13

14 Figure K.1-38 shows monthly average daily generation produced by water releases that
 15 are routed through the powerplant’s turbines. Each alternative has a unique monthly water
 16 release pattern. For example, as compared to Alternative A, Alternative F turbine releases are
 17 much higher during March, April, May, and June and much lower during July and August. When
 18 water/generation is shifted from a month that has higher system production costs to a month with
 19 lower costs, the economic value of power produced by the Glen Canyon Dam Powerplant is
 20 reduced. Ultimately, this generation shift increases costs to the SLCA/IP market system, and
 21 therefore the cost of the alternative, because more expensive generation serves system electricity
 22 demand. Figure K.1-39 shows the average daily minimum, maximum, average, and range of
 23 electricity market prices by month forecasted for the Palo Verde market hub during the 20-year
 24 LTEMP period. In general, the more generation is produced in months with high electricity
 25 prices, the lower the alternative’s cost will be relative to Alternative A. This allocation of limited
 26 water resources allows Glen Canyon Dam to serve system loads when the power it generates has
 27 the highest value.
 28
 29

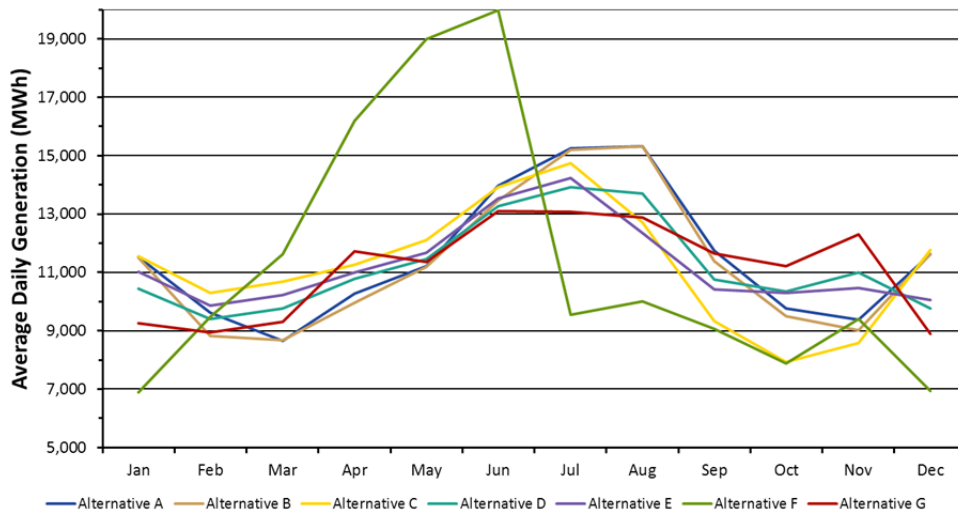

30
 31 **FIGURE K.1-38 Average Daily Generation by Month for Each Alternative**
 32

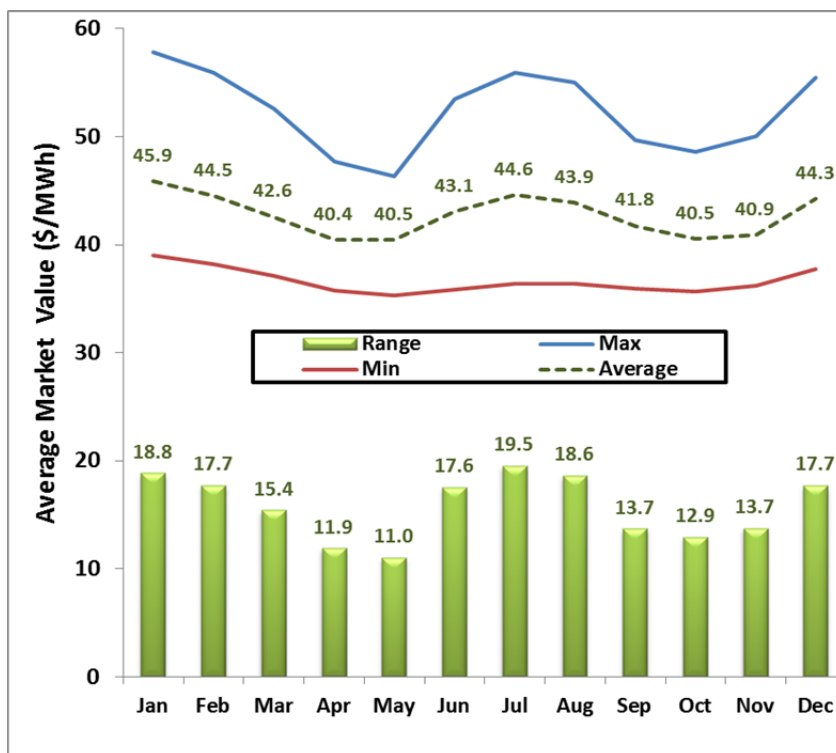

FIGURE K.1-39 Palo Verde Average Daily Electricity Market Price Statistics by Month during the 20-Year LTEMP Period

Alternatives also impact the daily profile of water releases. Changes in operating criteria, such as maximum and minimum release restrictions and mandates that limit water release changes over time, result in very different release patterns during most days. For example, except when transitioning between months or when HFEs are being conducted, Alternatives F and G require water releases from Glen Canyon Dam to be at a constant rate during each month. In contrast, other alternatives allow powerplant operators to change water release levels during a day in response to market price signals and system marginal production cost patterns. Alternatives that allow for only a small range between maximum and minimum releases and permit only minimal changes in water releases over time decrease the value of Glen Canyon Dam power production by shifting water releases from high price peak hours to low price off-peak hours. Figure K.1-40 shows typical Western Interconnection hourly electricity price patterns for winter and summer and the price spread between peak and off-peak hours.

Finally, alternatives affect the routing of water releases from the dam. Water is typically released through one or more of Glen Canyon Dam's eight turbines to produce electricity. However, depending on the pressure exerted by the water elevation in Lake Powell, only a limited amount of water can flow through turbines during an hour. In addition, the generating capacity of a unit indirectly limits the flow of water through it. Therefore, whenever a water release is required to exceed the combined flow capabilities of the generating units that are in operation, some of the water is released through hollow jet tubes and spillways. These non-power releases produce no energy and are referred to as spilled water. Each alternative has a

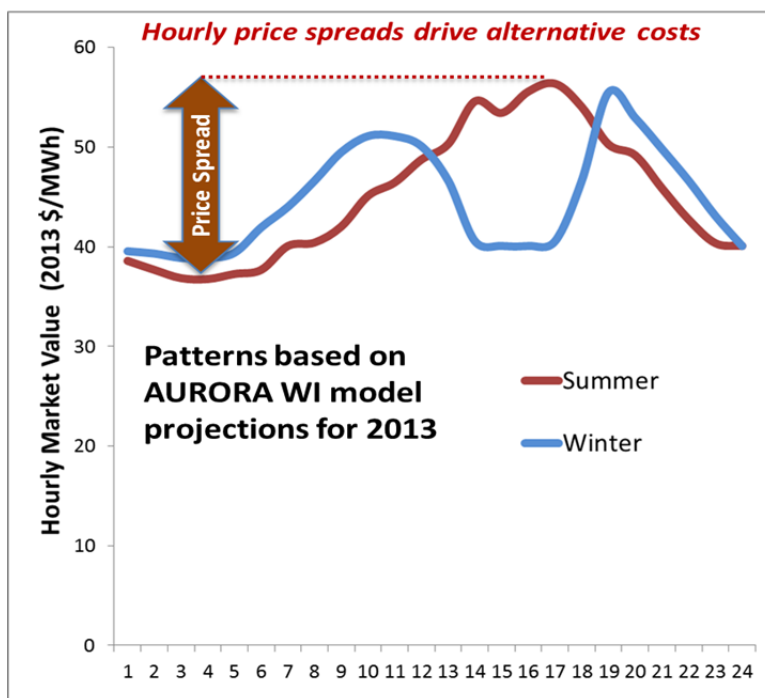
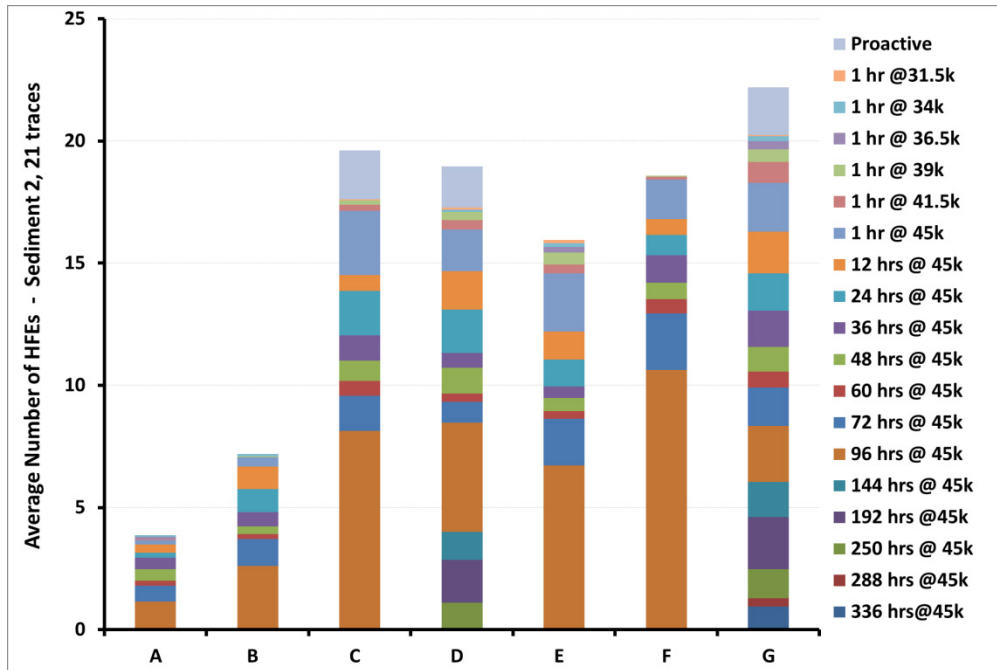

FIGURE K.1-40 Typical Hourly Winter/Summer Price Patterns in the Western United States

1
2
3
4
5
6
7
8
9
10
11
12
13
14
15
16
17
18
19
20
21
22
23
24
25

unique set of HFE specifications that affect the frequency and duration of Glen Canyon Dam water spill volumes. Figures K.1-41 and K.1-42 show the average number of HFEs and the average amount of water spilled by alternative over the LTEMP period, respectively. Averages shown are based on all 21 hydrology traces of sediment trace 2 and disaggregated by type of HFE. Alternative G has the highest number of HFEs; Alternatives C, D, E, and F have somewhat fewer HFEs; and Alternatives A and B have by far the fewest HFEs. Similarly, the greatest average volume of spilled water occurs under Alternatives D and G; a lower amount of water is spilled under Alternatives C, E, and F; and again by far the least water is spilled under Alternatives A and B.

Water is also spilled during very low (i.e., dry) hydropower conditions when the water elevation in Lake Powell is below the minimum turbine water intake level. During those times, it is assumed that all of the water released from Glen Canyon Dam produces no electricity until the water level rises to the minimum intake level. Figure K.1-43 shows the average annual number of hours, by alternative, the Lake Powell elevation is below the minimum penstock intake over the 20-year study period for all 21 traces of sediment trace 2. Alternative G averages the greatest number of hours when the elevation is too low, resulting in an average of 8.5 hours over the 8,760-hour year, or 0.1% of the time; Alternatives A, B, C, D and E have somewhat fewer hours; and Alternative F has no hours when the elevation is too low to produce electricity.



1
2
3
4
5

FIGURE K.1-41 Average Number of HFEs by Alternative for All 21 Hydrology Traces of Sediment Trace 2

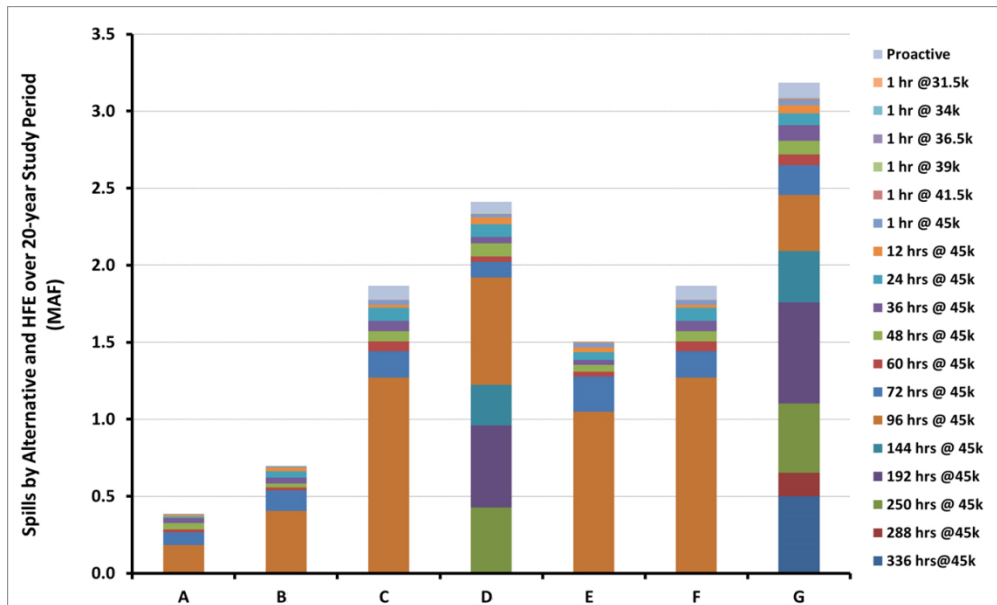

6
7
8
9
10

FIGURE K.1-42 Average Amount of Water Spilled by Alternative for All 21 Hydrology Traces of Sediment Trace 2

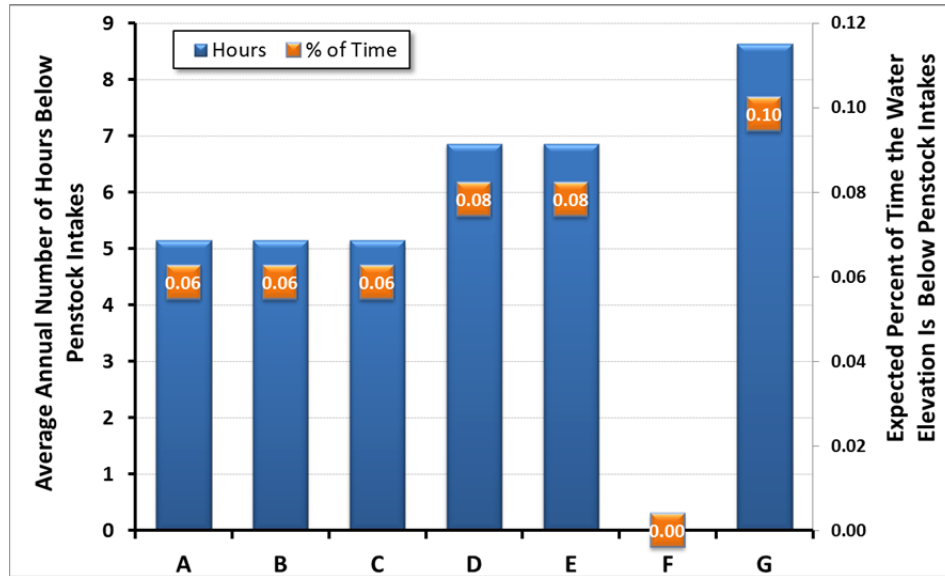

FIGURE K.1-43 Average Annual Number of Hours the Lake Powell Elevation Is below the Penstock Intake by Alternative for All 21 Hydrology Traces of Sediment Trace 2

Figure K.1-43 also shows that the percentage of time the reservoir at Glen Canyon Dam is expected to be below the penstock is very small (i.e., at most about one hourly occurrence out of every 1,000 hours). However, most of these occurrences are concentrated in fairly long, continuous periods of time. For example, under Alternative G, all hours with elevations below the penstocks occur during a continuous 3-month period starting in January 2018, under hydrology trace 19, and during the entire month of April 2024, under hydrology trace 8. Therefore, the risk of encountering zero generation periods is small, but when it does occur, the economic implications are very costly.

Finally, water spills can also occur as a result of inflow forecast error. High reservoir conditions in combination with unanticipated large water inflow volumes into Lake Powell will result in a spill if there is inadequate spare reservoir capacity to accommodate all of the water inflows minus maximum turbine flow rates.

K.1.10.2 Capacity Expansion Modeling

Capacity expansion plans for each alternative during the study period are determined by running the AURORA model in capacity expansion mode. The plans specify the type of technology built, unit capacity, and the year a new unit begins operation. The model also computed the annual capacity investment and O&M costs for all new units built over the study period except those previously committed and contained in the unit inventory. As noted in section K.1.6.3, the AURORA model was given a wide selection of technologies from which to choose for future capacity additions, including conventional and advanced natural gas combustion turbines, conventional and advanced gas/oil combined cycle units, scrubbed and

1 pulverized coal units, integrated gasification combined cycle units, nuclear units, wind farms,
 2 and solar thermal and photovoltaic projects.

3
 4 The firm SLCA/IP federal hydropower capacity input to the AURORA expansion model
 5 is credited toward meeting the system reserve margin. The quantity input depends on the
 6 combined operating capabilities of these resources at the time of the system peak demand, and on
 7 a defined exceedance level. Table K.1-7 shows marketable capacity by alternative at the 90%
 8 exceedance level (i.e., a 10% risk of having a lower peak operating capability than the specified
 9 firm level at the time of system peak load). The table also shows the difference in firm capacity
 10 compared to Alternative A (referred to as lost capacity). Except for Alternative B, which has
 11 28.1 MW more firm capacity than Alternative A, all other alternatives provide approximately
 12 50 MW to 314 MW less firm capacity—that is, a reduction that ranges from 6.7 to 42.6%
 13 relative to Alternative A.

14
 15 A retrospective study performed by Argonne on marketable capacity offered by CRSP
 16 Management Center over the last 10 years shows that it markets capacity at a 90% exceedance
 17 level. That is, Western has enough SLCA/IP federal hydropower resource capacity to meet its
 18 obligation 90% of the time. Therefore, the baseline LTEMP analysis used the same exceedance
 19 level to determine SLCA/IP federal hydropower firm capacity. However, in the future Western
 20 may choose another exceedance level to determine marketable capacity. Results are presented
 21 later in Section K.1.10.4 for exceedance levels of 50% and 99%; this range will bracket the risk
 22 preference level that the CRSP Management Center will likely, but not necessarily, choose to use
 23 when determining future LTF capacity commitment levels.

24
 25
 26 **TABLE K.1-7 SLCA/IP Marketable Capacity at the 90% Exceedance Level**

| Capacity Type | Alternative A (No Action) | Alternative B | Alternative C | Alternative D (Preferred Alternative) | Alternative E | Alternative F | Alternative G |
|-----------------------------------------|---------------------------------------------|--------------------------|---------------------------|---------------------------------------|---------------------------|---------------------------|---------------------------|
| SLCA/IP Firm Capacity (MW) ^a | 737.2 (no change from current condition) | 765.3 (3.8% increase) | 608.1 (17.5% decrease) | 687.6 (6.7% decrease) | 647.0 (12.2% decrease) | 423.1 (42.6% decrease) | 558.2 (24.2% decrease) |
| SLCA/IP Lost Capacity (MW) ^b | Not applicable | -28.1 | 129.1 | 49.6 | 90.2 | 314.1 | 179.0 |

^a Marketable capacity is calculated based on all 21 hydrology traces with median sediment input (sediment trace 2), which has the highest likelihood of occurrence. It is calculated at the 90% exceedance level, using August as the peak load month. That is, combined SLCA/IP federal hydropower resources are able to attain peak output at the firm capacity level or higher 90% of the time during the August peak load.

^b Lost capacity is the difference between the marketable capacity in Alternative A and the marketable capacity of another alternative; it represents the capacity that would need to be replaced somewhere in the power system if that alternative was implemented.

27
 28
 29

1 The AURORA expansion model only selected natural gas-fired technologies in its
2 SLCA/IP market system plan to meet future demand; no other thermal or renewable technologies
3 were chosen. Wind and solar plants were added in the expansion pathway, but only to meet the
4 state RPS requirements as described in Section K.1.6.3. The natural gas-fired technologies
5 chosen by AURORA were the 400-MW advanced combined cycle unit and 230-MW advanced
6 combustion turbine.

7
8 The expansion pathway chosen by AURORA was consistent with projections made in the
9 2014 AEO (EIA 2014), and with expansion plans reported in IRPs developed by utilities in the
10 region. Figure K.1-44 shows the 2014 AEO projects of cumulative capacity additions for the
11 three geographic regions in the Western Interconnection for the next 20 years. In the future, the
12 AEO projects only renewable generation; natural gas combined cycle plants and combustion
13 turbines; and distributed peaking generation, which is most often fueled by natural gas.

14
15 As noted in Section K.1.6.3, Argonne conducted a survey of the current IRPs available on
16 the websites (which typically had publication dates of either 2013 or 2014) of Western’s
17 customers and investor-owned utilities in the geographic and “electrical” area of Western’s
18 customers to determine the timing and type of resources these utilities were planning to meet
19 future electric demand. The results of that survey were shown in Table K.1-6. As in the
20 2014 AEO (EIA 2014), utilities are forecasting that future capacity additions to their systems
21 will consist of renewables (mainly wind and solar) and natural gas-fired combined-cycle plants
22 and combustion turbines. A conclusion that can be drawn from Table K.1-6 is that because new
23 generators are forecasted to come online in the very near term (the next 2 to 3 years) there will
24 be little or no excess capacity in the region that would be available to replace capacity lost at
25 Glen Canyon Dam at the time when the ROD is issued.

26
27 Figure K.1-45 shows the cumulative capacity additions selected by the AURORA
28 expansion model for Alternative A (combustion turbines are labeled CT and natural gas
29 combined-cycle units are labeled NGCC). Because units are built in large increments, capacity
30 expansion is often said to be “lumpy.” The green line in the figure shows the amount of capacity
31 in excess of the 15% reserve margin. Due to the lumpy expansion path, some years significantly
32 exceed the 15% reserve margin target, while others have just enough to satisfy the reserve
33 margin. However, the capacity above the reserve margin could be sold to utilities that are short
34 of capacity at the market price, thereby reducing the total net cost to the SLCA/IP market system.
35 Sales of excess capacity will be explored and quantified in the analysis of alternatives.

36
37 It should be noted that the first capacity addition under Alternative A comes online in
38 2018 under the current joint system analysis. Therefore, there will be very little or no excess
39 capacity when operational changes at Glen Canyon Dam could possibly be implemented.
40 Furthermore, lost capacity would need to be replaced soon after the ROD.

41
42 Although CRSP Management Center LTF customers typically engage in economical firm
43 capacity and energy transactions, the joint planning approach assumes a higher level of
44 coordination and cooperation among LTF customers than may currently exist. Results shown in
45 Figure K.1-45 are based on a methodology that projects the expansion plan for the combined

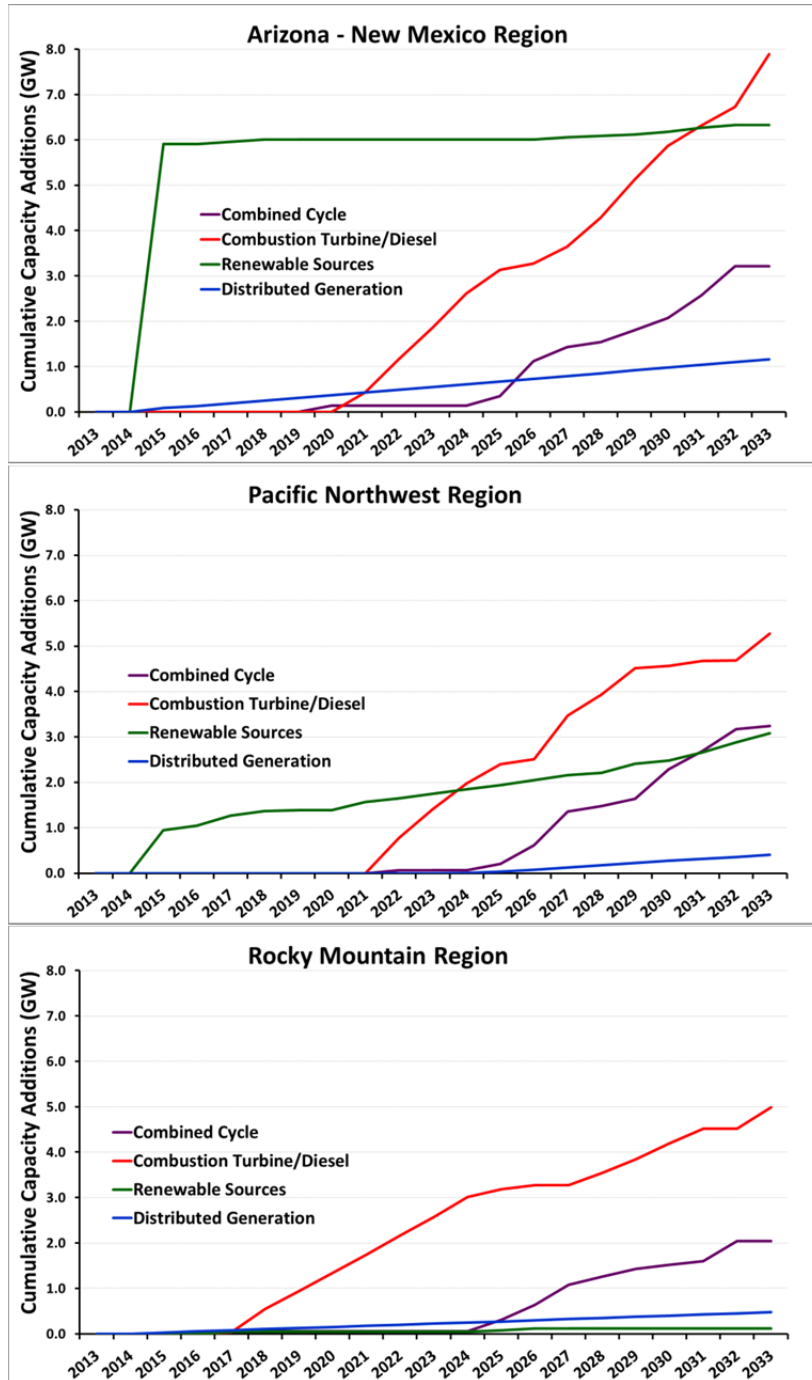

FIGURE K.1-44 2014 Annual Energy Outlook Projections of Capacity Additions in the Western Interconnection over the LTEMP Period

1

2

3

4

5

6

7

8

9

1 **TABLE K.1-8 Difference in Cumulative Capacity Additions of Each Alternative Relative to**
 2 **Alternative A (90% Exceedance Level)**

| Year | Additional Capacity (MW) Needed Relative to Alternative A | | | | | | |
|--------------|-----------------------------------------------------------|-------------------------------------------|-------------------------------------------|-------------------------------------------|-------------------------------------------|---------------|---------------|
| | Alternative A Expansion (MW) | Alternative B, Long-Term Strategy 1 | Alternative C, Long-Term Strategy 1 | Alternative D, Long-Term Strategy 4 | Alternative E, Long-Term Strategy 1 | Alternative F | Alternative G |
| 2013 | 0 | 0 | 0 | 0 | 0 | 0 | 0 |
| 2014 | 0 | 0 | 0 | 0 | 0 | 0 | 0 |
| 2015 | 0 | 0 | 0 | 0 | 0 | 0 | 0 |
| 2016 | 0 | 0 | 0 | 0 | 0 | 0 | 0 |
| 2017 | 0 | 0 | 0 | 0 | 0 | 230 | 0 |
| 2018 | 230 | 0 | 230 | 0 | 0 | 460 | 230 |
| 2019 | 630 | 0 | 230 | 0 | 0 | 460 | 230 |
| 2020 | 1,030 | 0 | 230 | 0 | 0 | 460 | 230 |
| 2021 | 1,030 | 0 | 230 | 230 | 230 | 460 | 230 |
| 2022 | 1,430 | 0 | 230 | 230 | 230 | 460 | 230 |
| 2023 | 1,830 | 0 | 230 | 230 | 230 | 460 | 230 |
| 2024 | 2,060 | 0 | 230 | 0 | 0 | 460 | 230 |
| 2025 | 2,290 | 0 | 230 | 0 | 0 | 460 | 230 |
| 2026 | 2,520 | 0 | 230 | 0 | 230 | 460 | 230 |
| 2027 | 2,750 | 0 | 230 | 230 | 230 | 460 | 230 |
| 2028 | 2,980 | 0 | 230 | 230 | 230 | 460 | 230 |
| 2029 | 3,440 | -230 | 0 | 0 | 0 | 230 | 230 |
| 2030 | 3,670 | 0 | 0 | 0 | 0 | 230 | 230 |
| 2031 | 3,900 | 0 | 0 | 0 | 0 | 230 | 230 |
| 2032 | 4,590 | 0 | 230 | 230 | 230 | 460 | 230 |
| 2033 | 4,820 | 0 | 230 | 230 | 230 | 460 | 230 |
| Average | | -11 | 142 | 77 | 88 | 329 | 175 |
| GC Reduction | | -28 | 129 | 49 | 90 | 314 | 179 |
| Difference | | 17 | 13 | 28 | -2 | 15 | -4 |

3
 4
 5 system in which the costs and benefits of new generating resources would be shared among both
 6 large and small customers. This approach has a number of advantages related to modeling
 7 efficiency while representing the general system response to changes in Glen Canyon Dam firm
 8 capacity. This joint planning approach indicates that numerous units would be constructed by the
 9 system. For example, by 2034, 14 new advanced combustion turbines and four advanced
 10 combined cycle units would be constructed under Alternative A (see Table K.1-9). Each unit
 11 could be operated by an individual utility or as a joint dispatch, whatever arrangement is more
 12 advantageous. If technical or institutional barriers did not allow joint unit dispatch, a new unit
 13 could be built by a single owner/operator. Furthermore, if the new unit created excess capacity in
 14 the owner's utility, it may be able sell capacity from other system resources that are more
 15 conducive to joint dispatch. Alternatively, the capacity-long system could sell the excess without
 16 specifying the individual supply resource.

17

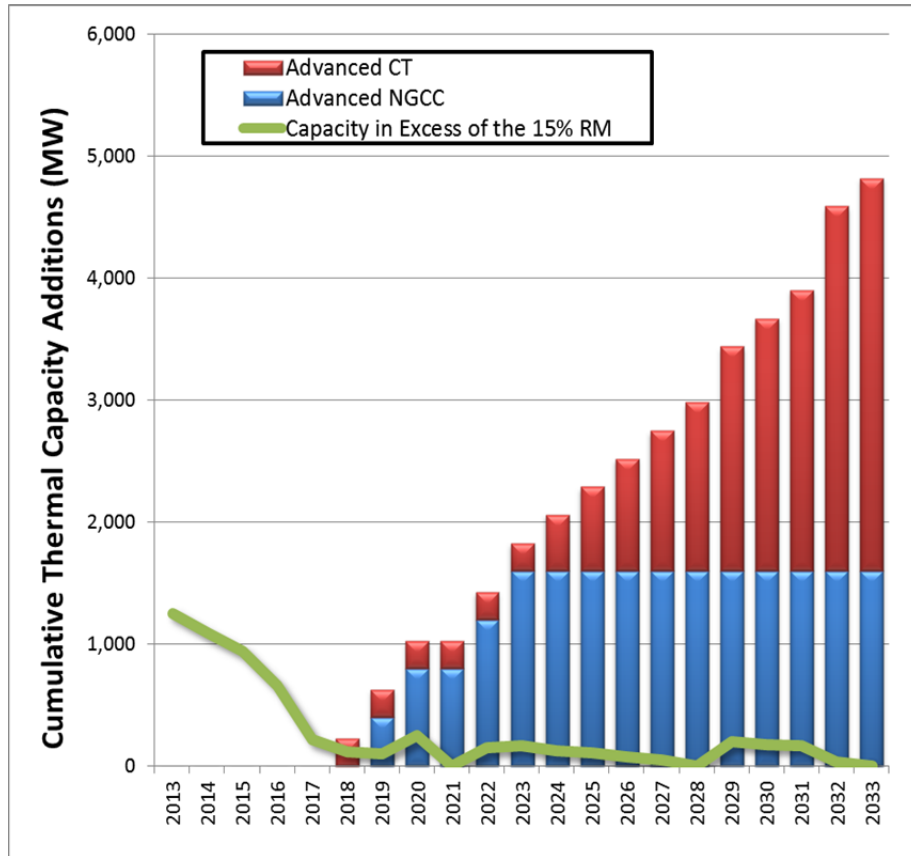

1

FIGURE K.1-45 Cumulative Capacity Additions for Alternative A (90% Exceedance Level)

2

3

4

5

6

7

8

9

10

11

12

13

14

15

16

17

18

19

20

21

22

23

The cost of capacity replacement in general would be higher if each individual utility were modeled as isolated entities (i.e., without mutually beneficial arrangements), which is how new units would actually be constructed. This model solution would, in many respects, be uneconomical and unrealistic because each utility that is capacity short would need to either (1) build a relatively large efficient unit to replace its allocation of the lost capacity, which in most cases is very small, or (2) build a very small unit that is typically less efficient and, because of economies of scale, is more costly per kilowatt of installed capacity to construct. Utilities that are capacity long may not need to construct any replacement capacity. The capacity expansion plan would also be very lumpy.

The capacity expansion pathway for Alternative A will replace existing powerplant capacity that will retire in the future and meet forecasted increases in electricity demand in the SLCA/IP market system. The expansion pathways for all other alternatives are a modification of this pathway. Differences in firm capacity among alternatives were evaluated in terms of the amount and timing of new generating units constructed in the future. All alternatives except Alternative B have a decrease in firm capacity compared to Alternative A. Alternatives that have less firm capacity would be expected to install capacity earlier and/or install more capacity than Alternative A. Conversely, Alternative B would be expected to have a delay in capacity additions

1 compared to Alternative A. Table K.1-9 compares the
 2 capacity expansion pathways for Alternatives A and F.
 3 Alternative F has the most lost capacity of all
 4 alternatives.

6 Table K.1-9 shows that Alternative F installs
 7 combustion turbines (labeled CT1, CT2, etc.) 1 to
 8 7 years earlier than Alternative A. By the end of the
 9 LTEMP period Alternative F also installs more
 10 capacity, two more combustion turbines. Because the
 11 number and timing of natural gas combined cycle units
 12 (labeled NGCC1, NGCC2, etc.) is identical under both
 13 alternatives, lost Glen Canyon Dam capacity is replaced
 14 exclusively by advanced combustion turbines. This
 15 accelerated capacity addition schedule occurs because
 16 Alternative F has 314 MW less SLCA/IP federal
 17 hydropower firm capacity than Alternative A.

19 Table K.1-8 shows a comparison of capacity
 20 additions for all alternatives. This table lists the
 21 cumulative additional capacity for Alternative A and
 22 then shows the difference in cumulative capacity
 23 between it and the other alternatives. The difference
 24 represents the capacity that is constructed to replace lost
 25 Glen Canyon Dam capacity. Note that the replacement
 26 capacity in the table are -230 MW, 230 MW, or 460
 27 MW; capacity changes occur in increments of an
 28 advanced combustion turbine unit. At the bottom of the table are values showing the average
 29 annual amount of replacement capacity, the lost firm capacity, and the difference between those
 30 two values. As expected, the average annual amount of lost capacity and capacity replacement is
 31 very close.

33 Under Alternative A, an estimated 4,820 MW of new capacity is built in the SLCA/IP
 34 market system. Capacity additions are phased in over time, such that a minimum 15% capacity
 35 reserve margin is attained in each year of the 20-year LTEMP period. Under alternatives with
 36 less SLCA/IP federal firm capacity, more new generating capacity must be built and the capacity
 37 must also be built sooner. Like Alternative A, Alternative B adds 4,820 MW of new capacity by
 38 CY 2034; however, because Alternative B has slightly more firm capacity, one new generating
 39 unit would be constructed a year later than under Alternative A. All other alternatives have less
 40 firm capacity than Alternative A. Under Alternatives C, D, E, and G, 5,050 MW of new capacity
 41 additions would be required by CY 2034; this amounts to one more combustion turbine than
 42 Alternative A, which is an increase in capacity of 4.8%. Under Alternative F, 5,280 MW of new
 43 capacity is built by CY 2034, which is two more combustion turbines than Alternative A. This
 44 amounts to an increase in capacity of 9.5%.

**TABLE K.1-9 Comparison of the
 Amount and Timing of New Capacity
 Additions for Alternatives A and F
 (90% Exceedance Level)**

| On-Line Date | New Additions | |
|-----------------|---------------|---------------|
| | Alternative A | Alternative F |
| 2014 | | |
| 2015 | | |
| 2016 | | |
| 2017 | | CT1 |
| 2018 | CT1 | CT2 & CT3 |
| 2019 | NGCC1 | NGCC1 |
| 2020 | NGCC2 | NGCC2 |
| 2021 | | |
| 2022 | NGCC3 | NGCC3 |
| 2023 | NGCC4 | NGCC4 |
| 2024 | CT2 | CT4 |
| 2025 | CT3 | CT5 |
| 2026 | CT4 | CT6 |
| 2027 | CT5 | CT7 |
| 2028 | CT6 | CT8 |
| 2029 | CT7 & CT8 | CT9 |
| 2030 | CT9 | CT10 |
| 2031 | CT10 | CT11 |
| 2032 | CT11-CT13 | CT12-CT13 |
| 2033 | CT14 | CT16 |

1 In addition, it is noteworthy that because capacity is built in discrete sizes/increments that
2 do not match the amount of lost capacity, system expansion differences among the alternatives
3 do not typically match the amount of lost capacity. In some years, the replacement capacity is
4 larger than the lost capacity, while in other years it is smaller. Again, this result shows the
5 “lumpiness” of capacity expansion, which allows for possible sale of capacity above the 15%
6 reserve margin to be sold at market price to reduce the total cost of an alternative.
7
8

9 **K.1.10.3 Economic Impacts**

10
11 When the capacity expansion pathways were determined for each alternative, the
12 AURORA model was run in dispatch mode to simulate the operation of the system for every
13 hour in the entire study period for hydrological trace 14, which is the representative trace.
14 Selection of the representative trace was discussed in Section K.1.5.2, and Attachment K-3 of
15 this appendix describes in detail how that trace was chosen.
16

17 The AURORA dispatch model computes all SLCA/IP market system costs associated
18 with the production of electrical energy to meet the system load and to generate additional
19 energy for power sales to the spot market. Production costs are the sum of powerplant fuel costs,
20 variable O&M costs, and cost of power purchased from the spot market. Revenues from the
21 power sales to the spot market are subtracted from these costs to compute the net economic cost.
22 This technique was used to compute the production costs of serving only SLCA/IP market load.
23 Results from the AURORA expansion and dispatch models (i.e., capital, fixed O&M, and
24 production or energy costs) are combined to determine the total annual costs for each alternative.
25 The net present value stream of costs is also calculated to facilitate comparison of each
26 alternative to Alternative A. This single lump-sum value is based on a discount rate of 3.375%, a
27 rate used by Reclamation for cost-benefit studies of projects pursuant to U.S.C. 1962d-17.
28

29 The total economic impacts at the 90% exceedance level by alternative are summarized
30 in Table K.1-10. Costs are disaggregated by system-wide net production cost, which was
31 obtained from AURORA dispatch model simulations, and by capital costs and fixed O&M costs,
32 which were both obtained from AURORA expansion model simulations. This table also includes
33 calculating a benefit from the sale of excess capacity above that required to satisfy the reserve
34 margin. This benefit would reduce the total cost of each alternative.
35

36 All alternatives except for Alternative B have less firm SLCA/IP federal hydropower
37 capacity than Alternative A. Therefore, the NPV of capital and fixed O&M costs are higher than
38 under Alternative A. Alternative B had the same total amount of new capacity at the end of the
39 LTEMP study period as Alternative A, but the construction of one combustion turbine was
40 delayed by a year due to its slightly higher firm SLCA/IP federal hydropower capacity, which
41 resulted in slightly lower capital and fixed O&M costs. Although Alternatives C, D, E, and G
42 have the same amount of new capacity at the end of the LTEMP study period, they have different
43 NPVs for capacity and fixed O&M because of the difference in the timing of the installation of
44 the new capacity. The differences in timing are found in Table K.1-8.
45

1 **TABLE K.1-10 Total Economic Impacts by Alternative at the 90% Exceedance Level**

| Economic Impact Measure | Alternative A (No Action Alternative) | Alternative B | Alternative C | Alternative D (Preferred Alternative) | Alternative E | Alternative F | Alternative G |
|----------------------------------------------------------------------|-----------------------------------------------|---------------------------------------------|----------------------------|------------------------------------------|----------------------------|---------------------------|----------------------------|
| System-level generating capacity additions (MW) ^a | 4,820 (no change from current condition) | 4,820 (no change from current condition) | 5,050 (4.8% increase) | 5,050 (4.8% increase) | 5,050 (4.8% increase) | 5,280 (9.5% increase) | 5,050 (4.8% increase) |
| SLCA/IP system-wide production cost (\$million) ^b | 34,228 (no change from current condition) | 34,221 (0.02% decrease) | 34,255 (0.08% increase) | 34,270 (0.1% increase) | 34,249 (0.06% increase) | 34,373 (0.4% increase) | 34,345 (0.3% increase) |
| SLCA/IP Capital cost (\$million) for capacity expansion ^b | 1,643 (no change from current condition) | 1,635 (0.5% decrease) | 1,746 (6.3% increase) | 1,696 (3.2% increase) | 1,703 (3.7% increase) | 1,882 (14.5% increase) | 1,769 (7.7% increase) |
| Fixed O&M cost (\$million) for capacity expansion ^b | 345 (no change from current condition) | 344 (0.3% decrease) | 363 (5.2% increase) | 354 (2.6% increase) | 355 (2.9% increase) | 385 (11.6% increase) | 366 (6.1% increase) |
| Total cost (\$million) ^b | 36,216 (no change from current condition) | 36,200 (0.04% decrease) | 36,364 (0.41% increase) | 36,320 (0.29% increase) | 36,307 (0.25% increase) | 36,640 (1.2% increase) | 36,480 (0.73% increase) |
| Difference in Total Costs (\$million) Relative to No Action | Not applicable | -16 | 148 | 104 | 91 | 424 | 264 |
| Rank (lowest to highest total cost) | 2 | 1 | 5 | 4 | 3 | 7 | 6 |
| Potential capacity sales (\$million) ^b | 86 | 99 | 99 | 106 | 82 | 105 | 85 |
| Adjusted total cost (\$million) ^b | 36,130 (No change from current conditions) | 36,101 (0.08% decrease) | 36,265 (0.37% increase) | 36,214 (0.23% increase) | 36,225 (0.26% increase) | 36,535 (1.1% increase) | 36,395 (0.73% increase) |

TABLE K.1-10 (Cont.)

| Economic Impact Measure | Alternative A (No Action) | Alternative B | Alternative C | Alternative D | Alternative E | Alternative F | Alternative G |
|----------------------------------------------------------------------|---------------------------|---------------|---------------|---------------|---------------|---------------|---------------|
| Difference in Adjusted Total Costs (\$million) Relative to No Action | Not applicable | -29 | 135 | 84 | 95 | 405 | 265 |
| Adjusted Rank (lowest to highest total cost) | 2 | 1 | 5 | 3 | 4 | 7 | 6 |

^a Additional generation capacity required under the LTEMP alternatives for Western’s customers over the 20-year LTEMP period to not only meet future load demand and replace unit retirements but also account for loss/gain in capacity at Glen Canyon Dam due to the alternative operating constraints.

^b Net present value (\$million 2015) of costs to meet total system electric demand over 20-year study period for all SLCA/IP customers under representative trace. Discount rate is 3.375%.

1
2
3
4
5
6
7
8
9
10
11
12
13
14
15
16
17
18
19
20
21
22
23
24
25
26

Table K.1-10 also shows the amount of potential sale of excess capacity of generating units constructed by Western’s customers above that mandated by the reserve margin. As a result of the lumpy nature of capacity additions, there are short periods of time (i.e., typically less than 2 years) in which slightly more system capacity is built than is needed to meet the reserve margin target. It is assumed this small amount of capacity (i.e., less than the size of one generating unit) may have some value and could be sold to entities outside of the SLCA/IP system. Sales of this excess capacity lower the total cost of all alternatives, but do not substantially affect their relative ranking from lowest to highest cost alternative. If alternatives are ranked based on the difference in adjusted total cost, the order of alternatives from lowest to highest cost is as follows: Alternative B, Alternative A, Alternative D, Alternative E, Alternative C, Alternative G, and Alternative F. If the potential for sale of excess capacity is not factored into the total alternative cost, then the ranking of alternatives changes only slightly; Alternatives E and D change places in the ranking. All other alternatives remain in the same order.

Cost of Experimental Releases

LTEMP alternatives and associated long-term strategies are composed of operating criteria and several experimental elements, as shown in Table 4.1-1. Economic evaluations presented for the Structured Decision Analysis (SDA) (Appendix C) and detailed power systems analysis (Section 4.13 and Section K.1) bundle all of the costs associated with an alternative (including operational changes and experiments) into a single value (NPV). This section provides estimates of the “unbundled” economic cost of several types of experiments.

1 These estimates are computed by comparing the estimated effects of long-term strategies
2 of alternatives that differ only in inclusion of a particular experiment.¹ The one element that
3 differs between the two alternatives is the element for which the economic impacts are measured.
4 For example, to measure the economic cost of low summer flows, two long-term strategies for
5 Alternative D are compared (D1 and D4). Both have identical operating criteria and the same
6 experimental elements except that under long-term strategy D1 low summer flows are included
7 in the second 10 years of the LTEMP period, while under long-term strategy D4 low summer
8 flows would not be conducted. Subtracting NPV results for D4 from D1 yields the NPV cost of
9 conducting the experiments over the 20-year LTEMP period. Using this methodology, the
10 approximate cost of conducting different types of experimental elements can be “unbundled”
11 from the total aggregate costs previously reported.

12
13 Although the SDA modeling results do not include all possible combinations of operating
14 criteria and experiments, a general estimate of the relative costs of each type of experiment can
15 be gained by comparing selected pairs of SDA NPV model results as described in the example
16 above. Using information provided in Table 4.1-1, the following pairs of alternatives were
17 selected to approximate costs associated with individual experimental elements:

- 18
19 1. Low summer flows
 - 20 a. Long-term strategies D4 (without low summer flows) and D1 (with low
21 summer flows)
 - 22 b. Long-term strategies E3 (without low summer flows) and E5 (with low
23 summer flows)
- 24 2. TMFs
 - 25 a. Long-term strategies D3 (without TMFs) and D1 (with TMFs)
 - 26 b. Long-term strategies E3 (without TMFs) and E6 (with TMFs)
- 27 3. Steady weekend flows for macroinvertebrate production
 - 28 a. Long-term strategies D1 (without steady weekend flows) and D2 (with
29 steady weekend flows)
- 30 4. Fall HFE
 - 31 a. Long-term strategies C3 (without HFEs) and C4 (with HFEs)
 - 32 b. Long-term strategies E3 (without HFEs) and E4 (with HFEs)

33
34 Consistent with both the SDA and detailed power system results, costs for each
35 experiment are computed for both Glen Canyon Dam Powerplant energy production and
36 replacement capacity. Figures 12 and 13 in Appendix C show annual average energy and
37 capacity costs for four experimental elements described above. These estimates are based on
38 21 hydrology traces over the 20-year LTEMP study period. Note that the cost of a single element
39 type differs by alternative pairing. For example, the annual average NPV energy costs difference
40 between long-term strategies E3 and E5 is bigger than the difference between long-term
41 strategies D4 and D1. In this case, the difference is due to several factors including interactions
42 among the experimental element that is being measured (i.e., low summer flows), and both the

¹ Mechanical trout removal is not included in the comparison of elements because it not a factor in estimates of either SDA or power systems costs.

1 operating criteria and other experiments. Note that both E3 and E5 do not include other
2 experiments while both long-term strategies D4 and D1 include TMFs and different types of
3 HFES. It is therefore apparent that operating criteria and other experiments have an impact on the
4 incremental cost of conducting a specific experiment.
5

6 As discussed in more detail below, the cost of conducting an experiment is dependent not
7 only on the water release specifications of the experiment but also the frequency of the
8 experiments and the length of time that it takes to conduct an individual experiment. For
9 example, the energy cost to conduct each steady weekend flow experiment is relatively low,
10 while it is much more costly to conduct an individual low summer flow. However, as shown in
11 the following discussion, steady weekend flows are much more costly than low summer flows
12 because of the high frequency of steady weekend flows throughout the 20-year LTEMP period.
13 Approximately seventeen 2-day steady flows would take place every year under the former
14 scenario while on average over all 21 traces less than one low summer flow 92-day experiment is
15 expected over the entire 20-year LTEMP period under the latter scenario.
16

17 Capital costs for experimental elements display a pattern that is distinctly different from
18 energy costs. For example, among the experimental elements, fall HFES are the most expensive
19 while replacement capital costs are zero. Because these HFES are conducted exclusively during
20 the month of November, there are small impacts on Glen Canyon Dam Powerplant maximum
21 output levels in August when firm capacity is measured. This is especially the case under dry
22 hydrological conditions (e.g., 90% exceedance) under Alternative C and Alternative E operating
23 criteria. There are also no firm capacity cost impacts associated with TMFs because these are
24 conducted in May, June, and July and require no water reallocation among months of the year.
25

26 The following sections discuss in more detail each experimental element in terms of the
27 cost to conduct an individual experiment, the frequency of experiments, and duration of each
28 experiment.
29
30

31 **Cost of Low Summer Flows.** The average annual energy cost for low summer flow
32 experiments is approximately \$0.10 million for the long-term strategy D1 to long-term
33 strategy D4 comparison (i.e., \$1.97 million over 20 years) and about \$0.17 million for the long-
34 term strategy E3 to long-term strategy E5 comparison (i.e., \$3.36 million over 20 years). These
35 values are the difference in the averages of the annualized NPV of hydropower generation
36 between long-term strategies D1 and D4 and long-term strategies E3 and E5, as computed from
37 Figure C-12 of Appendix C. These costs are relatively low compared to both steady weekend
38 flows and HFES. This outcome is due to the timing and infrequent occurrence of low summer
39 flow experiments. Among all 21 hydrology traces over the 20-year LTEMP period (i.e., 20×21
40 = 420 outcomes), only 15 low summer flow experiments were triggered; that is, on average there
41 is only a 71.4% chance ($15/21 \times 100$) that a single low summer flow will be conducted during
42 the entire 20-year LTEMP period. On an annual basis, the chance that a low summer flow will be
43 conducted is only 3.6% ($15/420 \times 100$). Furthermore, all low summer flows occur during the last
44 10 years of the LTEMP period. Because the NPV calculation uses an annual discount rate, a low
45 summer flow experiment in a later year has a lower weight in the NPV calculation compared to
46 the same experiment conducted in an earlier year. Based on the total energy cost of a low

1 summer flow experiment and the frequency of occurrence, the average NPV energy cost of a
2 single low summer flow experiment is about \$2.76 million for Alternative D and about
3 \$4.70 million for Alternative E. Because a low summer flow experiment takes place during the
4 entire months of June, July, and August (92 days), the average daily NPV cost to conduct a low
5 summer flow experiment is about \$30,000 for Alternative D and about \$51,000 for
6 Alternative E.

7
8 The average annual capacity replacement costs for low summer flows are approximately
9 \$1.25 million based on the long-term strategy D1 to long-term strategy D4 comparison
10 (\$24.94 million over 20 years) and about \$0.99 million based on the long-term strategy E3 to
11 long-term strategy E5 comparison (\$19.77 million over 20 years). These values are the
12 difference in the averages of the annualized NPV of hydropower capacity between long-term
13 strategies D1 and D4 and long-term strategies E3 and E5, as computed from Figure C-13 of
14 Appendix C. Because low summer flow experiments directly impact operations in the critical
15 peak load month of August by reducing both monthly water release volumes and operational
16 flexibility, there is an impact on firm capacity estimates and therefore the cost of lost capacity at
17 the Glen Canyon Dam Powerplant. Based on the total capital cost of the low summer flow
18 experiment and the frequency of occurrence, the average NPV capital cost of a single experiment
19 is about \$34.92 million for long-term strategies D1–D4 and about \$27.67 million for
20 Alternative E; that is, an average daily NPV costs of about \$380,000 for long-term
21 strategies D1–D4 and about \$301,000 for long-term strategies E3–E5. Adding the low summer
22 flow costs for energy and capacity yields a per experiment cost of \$37.68 million and
23 \$32.37 million for Alternatives D and E, respectively.

24
25 In WY 2000, a low summer steady flow experiment was conducted and the financial
26 energy cost of this experiment was estimated to be about \$25 million in nominal dollars
27 (Veselka et al. 2011). Because the low summer steady flow was a one-time experiment, it was
28 assumed that there were no firm capacity impacts. The WY 2000 low summer steady flow
29 experiment was several times more expensive than the projected energy costs of the low summer
30 flow experiments considered for the LTEMP period, for which costs were estimated to be
31 \$2.76 million and \$4.70 million for Alternatives D and E, respectively. Although both have
32 similar-sounding names and are conducted in the summertime, there are several factors that
33 make the historical low summer steady flow distinctly different from low summer flows under
34 LTEMP. These include but are not limited to following:

- 35
36 1. The WY 2000 low summer steady flow lasted 6 months. In contrast, the low
37 summer flow is only 3 months long.
38
39 2. The WY 2000 low summer steady flow had zero operational flexibility,
40 whereby water and therefore power plant output was almost always constant.
41 There is comparatively more operating flexibility allowed under the LTEMP
42 low summer flow.
43
44 3. During WY 2000, energy prices were driven by the California market, which
45 at that time experienced extraordinary price spikes due to the market design
46 structure in place at that time (e.g., the average on-peak price in August was

1 approximately \$114.29/MWh) and daily price spreads between on- and off-
2 peak periods were up to \$90/MWh.

- 3
4 4. The WY 2000 low summer steady flow required two “spike flows” (the
5 predecessor of HFEs) in the spring and fall.
6

7
8 **Cost of Trout Management Flows.** The average annual energy costs of TMFs² are
9 approximately \$175,000 for the long-term strategy D1 to long-term strategy D3 comparison (i.e.,
10 \$3.49 million over 20 years) and about \$48,900 for the long-term strategy E3 to long-term
11 strategy E6 comparison (i.e., \$0.98 million over 20 years). These values are the difference in the
12 averages of the annualized NPV of hydropower generation between long-term strategies D1 and
13 D3 and long-term strategies E3 and E6, as computed from values in Figure C-12 of Appendix C.
14 Like low summer flows, these costs are relatively low compared to both the steady weekend flow
15 and the HFE experiments. The average number of TMFs conducted in a trace for Alternatives D
16 and E is 3.48 and 2.38, respectively. On an annual basis, the chances that a TMF will be
17 conducted for Alternatives D and E are 17.4% (3.48 per 20 years) and 11.9% (2.38 per 20 years),
18 respectively. Based on the total energy cost of a TMF and the frequency of occurrence, the
19 average NPV energy cost of a single TMF is about \$1.0 million for Alternative D and about
20 \$410,000 for Alternative E. Because a TMF takes place for a period of 5 days in May, June, and
21 July, or a total of 15 days, the average daily NPV cost to conduct a TMF is almost \$67,000 for
22 Alternative D and about \$27,400 for Alternative E.
23

24 There is no capacity replacement cost for TMFs because these experiments only occur in
25 the months of May, June, and July, and water is only reallocated within the same month to
26 conduct the experiments; there is no water reallocation among other months of the year.
27 Therefore, there is no capacity impact in the month of August when firm capacity is measured.
28

29
30 **Cost of Steady Weekend Flows.** The average annual energy cost for the steady
31 weekend flows is approximately \$533,000 (i.e., \$10.6 million over 20 years). This value is the
32 difference in the averages of the annualized NPV of hydropower generation between long-term
33 strategies D2 and D1, as computed from values in Figure C-12 of Appendix C. As noted earlier,
34 this is the highest cost of all experimental elements because of the large number of steady
35 weekend flows conducted each year (i.e., there are approximately seventeen 2-day steady
36 weekend flow experiments annually). Steady weekend flows are conducted each weekend in the
37 months of May through August. Based on the total energy cost of a steady weekend flow and
38 their frequency of occurrence, the average NPV energy cost of a single steady weekend flow is
39 about \$31,400 (\$533,000/17). Each steady weekend flow lasts 2 days, so the average daily NPV
40 cost of a steady weekend flow is about \$15,700.

2 Trout management flows consist of repeated cycles of high and low flows over a season (see Section 2.2.3.2 for a description of TMFs). The modeling conducted for the LTEMP considered three cycles, one each in May, June, and July. In the cost of experiment analysis, a TMF experiment is assumed to be a single three-cycle implementation.

1 The average annual capacity replacement cost for steady weekend flows is about
2 \$4.2 million (i.e., \$84 million over 20 years). This value is the difference in the averages of the
3 annualized NPV of hydropower capacity between long-term strategies D2 and D1, as computed
4 in Figure C-13 of Appendix C. Based on the total capital cost of the steady weekend flows and
5 their frequency of occurrence, the average NPV capital cost of a single experiment is about
6 \$247,000 (\$4.2 million/17), or an average daily cost of almost \$124,000. Adding the costs for
7 both energy and capacity yields a per-experiment cost of over \$278,000.

8
9
10 **Cost of Fall High Flow Experiments.** The average annual energy cost for the fall HFEs
11 is approximately \$1.25 million for the long-term strategy C3 to long-term strategy C4
12 comparison (i.e., \$24.98 million over 20 years) and about \$1.23 million for the long-term
13 strategy E3 to long-term strategy E4 comparison (i.e., \$24.54 million over 20 years). These
14 values are the difference in the averages of the annualized NPV of hydropower generation
15 between long-term strategies C3 and C4 and long-term strategies E3 and E4, as computed from
16 values in Figure C-12 of Appendix C. These costs are relatively high compared to the energy
17 cost for other experiments. This outcome is due to the frequent occurrences of fall HFEs and the
18 high energy cost associated with conducting each individual fall HFE. On an annual average
19 basis, 19.6 HFE experiments per hydrology trace (nearly every November during the 20-year
20 LTEMP period) are conducted under long-term strategy C4 and 16.0 HFE experiments (80% of
21 Novembers; $16/20 \times 100$) are conducted under long-term strategy E4. Based on the total energy
22 cost of the fall HFEs and the frequency of occurrence, the average NPV energy cost of a single
23 fall HFE is about \$1.27 million for Alternative C and about \$1.53 million for Alternative E.

24
25 The number of days it takes to conduct a fall HFE experiment varies based on the type of
26 HFE. An HFE can last from 2 to 16 days, including the up and down ramping periods. On
27 average, a fall HFE lasts about 4.7 days under long-term strategy C4 and 4.6 days under long-
28 term strategy E4. Therefore, the average daily NPV costs to conduct a fall HFE experiment in
29 November is about \$271,000 for Alternative C and about \$337,000 for Alternative E. As
30 discussed previously, there is no lost capacity cost associated with a fall HFE because November
31 HFEs have little to no impact on maximum output levels at the Glen Canyon Dam Powerplant in
32 August (i.e., the month with the highest peak load).

33
34 The cost for an individual HFE computed in this analysis is somewhat lower than the
35 estimated cost of the fall HFE conducted in WY 2014, which ranged from \$2.44 million to
36 \$2.59 million (Graziano et al. 2015). Several factors contributed to the higher historical costs and
37 include (1) WY 2014 HFE was a longer 6-day event; (2) costs were not discounted; and (3) the
38 WY 2014 HFE study was a financial analysis.

39
40
41 **Experimental Element Summary.** Table K.1-11 summarizes the results of the pairwise
42 comparison of alternatives to determine the costs of individual experiments.

1 **TABLE K.1-11 Estimated Cost of LTEMP Experiments**

| Experimental Element and Pair | Average NPV Cost over 20 Years (\$ million) | | | Average NPV Cost Per Experiment (\$ million) | | | Average Daily NPV Cost (\$ million) | | |
|----------------------------------------------------------|------------------------------------------------|----------|-------|-------------------------------------------------|----------|-------|----------------------------------------|----------|-------|
| | Energy | Capacity | Total | Energy | Capacity | Total | Energy | Capacity | Total |
| Low summer flows (long-term strategies D4, D1) | 1.97 | 24.94 | 26.92 | 2.76 | 34.92 | 37.68 | 0.03 | 0.38 | 0.41 |
| Low summer flows (long-term strategies E3, E5) | 3.36 | 19.77 | 23.13 | 4.70 | 27.67 | 32.37 | 0.05 | 0.30 | 0.35 |
| TMFs (long-term strategies D3, D1) | 3.49 | 0.00 | 3.49 | 1.00 | 0.00 | 1.00 | 0.067 | 0.00 | 0.067 |
| TMFs long-term strategies (E3, E6) | 0.98 | 0.00 | 0.98 | 0.41 | 0.00 | 0.41 | 0.027 | 0.00 | 0.027 |
| Steady weekend flows (long-term strategies D1, D2) | 10.6 | 84.0 | 94.6 | 0.031 | 0.247 | 0.278 | 0.016 | 0.124 | 0.14 |
| Fall HFEs (long- term strategies C3, C4) | 24.98 | 0.00 | 24.98 | 1.27 | 0.00 | 1.27 | 0.27 | 0.00 | 0.27 |
| Fall HFEs (long- term strategies E3, E4) | 24.54 | 0.00 | 24.54 | 1.53 | 0.00 | 1.53 | 0.34 | 0.00 | 0.34 |

2
3
4 **K.1.10.4 Sensitivity of Results to Exceedance Level**

5
6 One sensitivity study investigated the effect of exceedance level on results. The previous
7 section discussed results at the 90% exceedance level. This section will show results at the 50%
8 and 99% exceedance levels and discuss how they compare to each other and to results at the 90%
9 exceedance level. Table K.1-12 shows at each exceedance level and alternative the firm capacity,
10 the capacity replacement requirement, and the system-level capacity additions at the end of the
11 LTEMP study period.

12
13 Table K.1-12 shows that, compared the 90% exceedance level, the 99% exceedance level
14 results in a lower firm capacity and the 50% exceedance level results in a higher firm capacity. A
15 higher exceedance level means SLCA/IP federal hydropower resources will be able to supply the
16 system with all of the computed firm capacity more often than when a lower exceedance level is
17 used. In addition, in the 50 to 99% exceedance range, the higher the exceedance level, the lower
18 the firm capacity difference among alternatives. Therefore, the higher the exceedance level, the
19 smaller the difference in in capital and fixed O&M costs among alternatives.

20
21 The AURORA model was run both in capacity expansion and dispatch mode to
22 determine the NPV costs of the new expansion pathways and the production costs for the 50%
23 and 99% exceedance levels for the representative trace. Figures K.1-46, K.1-47, and K.1-48
24 show results for the 50%, 90%, and 99% exceedance levels, respectively. These figures also
25 show the difference in cost between various alternatives and Alternative A for each of the three

1 **TABLE K.1-12 Comparison of Marketable Capacity, Replacement Capacity, and Capacity**
2 **Additions by Exceedance Level**

| Capacity Type | Alternative A (No Action Alternative) | Alternative B | Alternative C | Alternative D (Preferred Alternative) | Alternative E | Alternative F | Alternative G |
|--------------------------------------------------------------|---------------------------------------------|---------------------------------------------|---------------------------------------------|---------------------------------------------|---------------------------------------------|---------------------------|---------------------------|
| 99% Exceedance Level | | | | | | | |
| SLCA/IP Marketable Capacity (MW) ^a | 611.2 (no change from current condition) | 619.9 (1.4% increase) | 510.7 (16.4% decrease) | 599.8 (1.8% decrease) | 542.2 (11.3% decrease) | 354.5 (42.0% decrease) | 466.8 (23.6% decrease) |
| SLCA/IP Replacement Capacity (MW) ^b | Not applicable | -8.8 | 100.5 | 11.3 | 68.9 | 256.7 | 144.3 |
| System-Level Generating Capacity Additions (MW) ^c | 5,050 (no change from current condition) | 5,050 (no change from current condition) | 5,050 (no change from current condition) | 5,050 (no change from current condition) | 5,050 (no change from current condition) | 5,280 (4.6% increase) | 5,280 (4.6% increase) |
| 90% Exceedance Level | | | | | | | |
| SLCA/IP Firm Capacity (MW) ^a | 737.2 (no change from current condition) | 765.3 (3.8% increase) | 608.1 (17.5% decrease) | 687.6 (6.7% decrease) | 647.0 (12.2% decrease) | 423.1 (42.6% decrease) | 558.2 (24.2% decrease) |
| SLCA/IP Lost Capacity (MW) ^b | Not applicable | -28.1 | 129.1 | 49.6 | 90.2 | 314.1 | 179.0 |
| System-Level Generating Capacity Additions (MW) ^c | 4,820 (no change from current condition) | 4,820 (no change from current condition) | 5,050 (4.8% increase) | 5,050 (4.8% increase) | 5,050 (4.8% increase) | 5,280 (9.5% increase) | 5,050 (4.8% increase) |
| 50% Exceedance Level | | | | | | | |
| SLCA/IP Firm Capacity (MW) ^a | 959.9 (no change from current condition) | 987.0 (2.8% increase) | 780.2 (18.7% decrease) | 878.3 (8.5% decrease) | 829.1 (13.6% decrease) | 569.6 (59.3% decrease) | 722.1 (24.8% decrease) |
| Lost Capacity (MW) ^b | Not applicable | -27.2 | 179.7 | 81.6 | 130.8 | 390.3 | 237.8 |
| System-Level Generating Capacity Additions (MW) ^c | 4,820 (no change from current condition) | 4,590 (4.8% decrease) | 5,050 (4.8% increase) | 4,820 (no change from current condition) | 4,820 (no change from current condition) | 5,280 (9.5% increase) | 5,050 (4.8% increase) |

Footnotes on next page.

TABLE K.1-12 (Cont.)

- a Additional generation capacity required under the LTEMP alternatives for Western’s customers over the 20-year LTEMP period to not only meet future load demand and replace unit retirements but also account for loss/gain in capacity at Glen Canyon Dam due to the alternative operating constraints.
- b Lost capacity is the difference between the marketable capacity in Alternative A and the marketable capacity of another alternative; it represents the capacity that would need to be replaced somewhere in the power system if that alternative was implemented.
- c Additional generation capacity required under the LTEMP alternatives for Western’s customers over the 20-year LTEMP period to not only meet future load demand but also account for loss/gain in capacity at Glen Canyon Dam due to the alternative operating constraints

1
2

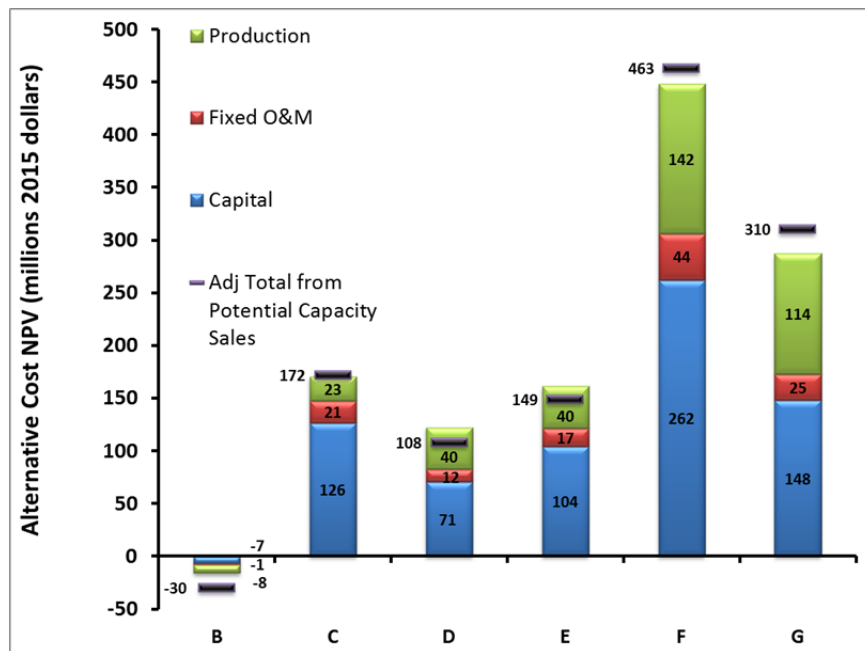

3

FIGURE K.1-46 Cost Difference of Alternatives Compared to Alternative A at 50% Exceedance Level and 3.375% Discount Rate

4
5
6
7

8 components that comprise the total cost of the alternative: capital, fixed O&M, and production or
 9 energy. The black bar for each alternative shows the total cost of the alternative if excess
 10 capacity above the amount required to satisfy the reserve margin is sold to the market. This sale
 11 of excess capacity could either raise or lower the total alternative cost compared to
 12 Alternative A. Results shown in all three figures are based on a 3.375% discount rate. The
 13 relative ranking of alternatives for these two sensitivity analyses are similar to the 90%
 14 exceedance level (that is, in order from highest to lowest, Alternatives B, A, D, E, C, F, and G).
 15 In addition, this ranking is identical whether excess firm capacity is either sold or not sold.

16

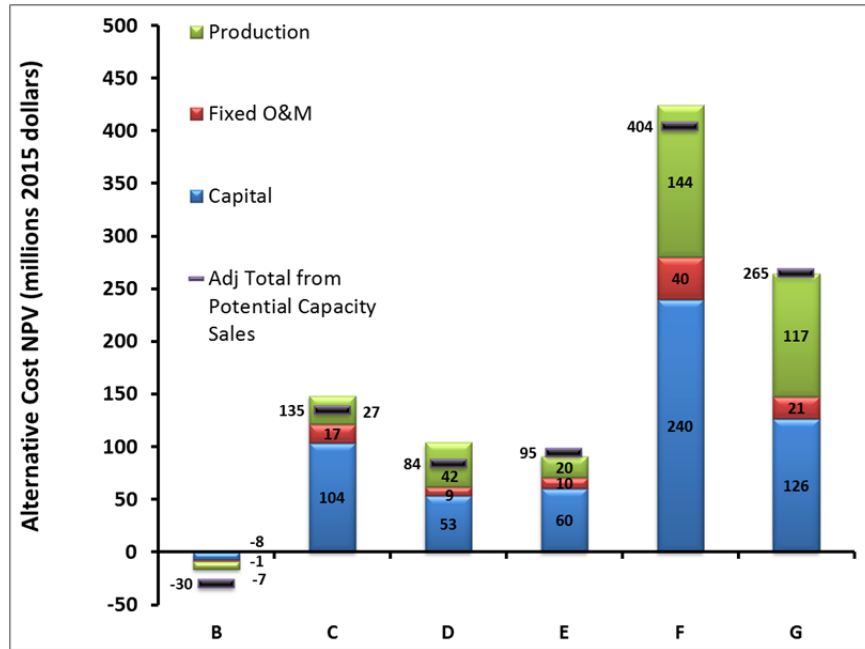

1
2
3
4
5

FIGURE K.1-47 Cost Difference of Alternatives Compared to Alternative A at 90% Exceedance Level and 3.375% Discount Rate

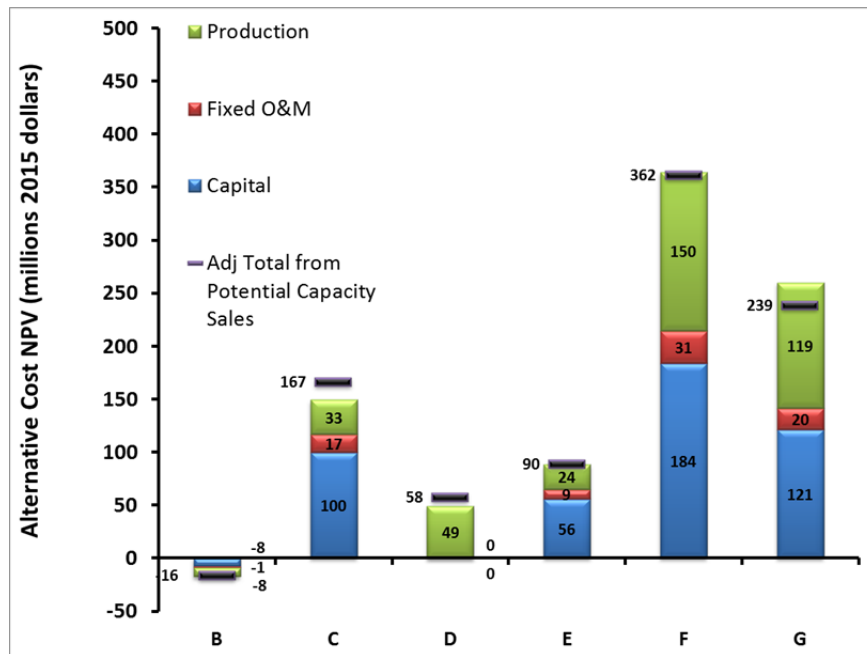

6
7
8
9
10
11

FIGURE K.1-48 Cost Difference of Alternatives Compared to Alternative A at 99% Exceedance Level and 3.375% Discount Rate

1 The figures show that as the exceedance level increases the difference in the cost of each
2 component and the total cost compared to Alternative A decreases. The alternative cost
3 differences are smaller because the difference in firm SLCA/IP federal hydropower capacity
4 between the various alternatives and Alternative A is lower as the exceedance level increases.
5 Because a smaller amount of new capacity is needed to replace capacity lost at Glen Canyon
6 Dam compared to Alternative A, each cost component and the total cost of the alternative is
7 reduced.
8

9 At all exceedance levels, the cost of Alternatives F and G, which both have steady flow
10 operating requirements, have the highest costs of all alternatives because they have the lowest
11 firm capacity and no operational flexibility. Therefore, both require the largest amount of new
12 capacity additions to replace lost Glen Canyon Dam capacity. Alternative F is the highest cost
13 because, unlike Alternative G, it has very high monthly water releases at a time of the year
14 (i.e., spring) with relatively low marginal production costs, and low releases during the high-
15 production-cost summer months of July and August. In contrast, Alternative B is always the
16 lowest cost alternative because it has a higher firm capacity than Alternative A and slightly more
17 operational flexibility. The other three alternatives also have approximately the same ranking
18 across all three exceedance levels.
19

20 Note that in Figure K.1-48 (the 99% exceedance level), the capital and fixed O&M cost
21 differences between Alternatives A and D are zero. This occurs because the capacity expansion
22 schedule is identical in both alternatives; that is, the amount and type of capacity is brought
23 online at exactly the same time. Table K.1-12 has examples of other alternatives that have the
24 same amount of capacity additions at the end of the LTEMP period as Alternative A, but still
25 have a difference in the capital and fixed O&M costs compared to Alternative A. This occurs
26 because of the difference in timing of capacity additions. This result again illustrates the lumpy
27 nature of capacity expansion due to the fact that plants used for capacity expansion have a
28 discrete size; thus, adding one or a combination of several may exceed the capacity needed to
29 just fulfill the reserve margin requirement.
30

31 Finally, the cost differences between an alternative and Alternative A are a very small
32 percent of the total cost of the alternative across this wide range of exceedance levels. For
33 example, Alternative F is the highest cost alternative at all three exceedance levels. At the 50%
34 exceedance level, Alternative F costs more about \$448 million more than Alternative A.
35 However, this difference is only about 1.2% of the total cost of Alternative A, which is about
36 \$36.2 billion. This total cost excludes static expenditures that are not tracked because they are
37 identical under all alternatives. These static expenditures include, but are not limited to, fixed
38 O&M costs for existing powerplants and both transmission and distribution costs. If these other
39 costs were included, the percent difference relative to the total cost of Alternative A would be
40 lower than the aforementioned 1.2%.
41
42

43 **K.1.10.5 Sensitivity of Results to Discount Rate** 44

45 Up to this point NPVs have been calculated using an annual discount rate of 3.375%,
46 which is a rate used by Reclamation for project cost-benefit studies. The LTEMP hydropower

1 subject matter expert team that helped guide this power systems study expressed concern that the
 2 3.375% rate appears to be too high under current economic conditions. Therefore, a real annual
 3 discount rate of 1.4% was used for the sensitivity study. That value was obtained from the Office
 4 of Management and Budget Circular A-94, Appendix C (available at
 5 https://www.whitehouse.gov/omb/circulars_a094/a94_appx-c). That rate is the real interest rate
 6 on treasury notes and bonds with a maturity of 30 years.

7
 8 Figure K.1-49 shows the 20-year NPV cost differences between each alternative and
 9 Alternative A for the representative trace at the 90% exceedance level using the 1.4% real
 10 discount rate. This figure should be compared to Figure K.1-47, which is the same exceedance
 11 level but for the baseline discount rate. When using a lower discount rate, the NPV costs of
 12 alternatives relative to Alternative A are larger because costs at the end of the study period have
 13 a larger contribution to the NPV. Note that the NPV cost difference between Alternatives F and
 14 A is approximately a half billion dollars (\$508 million, if adjustment for potential excess
 15 capacity sales is not included). However, the relative ranking of alternatives from lowest to
 16 highest cost, and relative percent difference from Alternative A do not change for these two
 17 discount rates. Alternative B is the lowest cost alternative, followed by Alternatives A, D, E, C,
 18 G, and F. If it is assumed that excess capacity will be sold to an entity outside of the SLCA/IP
 19 market system, then Alternatives D and E change places in the alternative ranking.

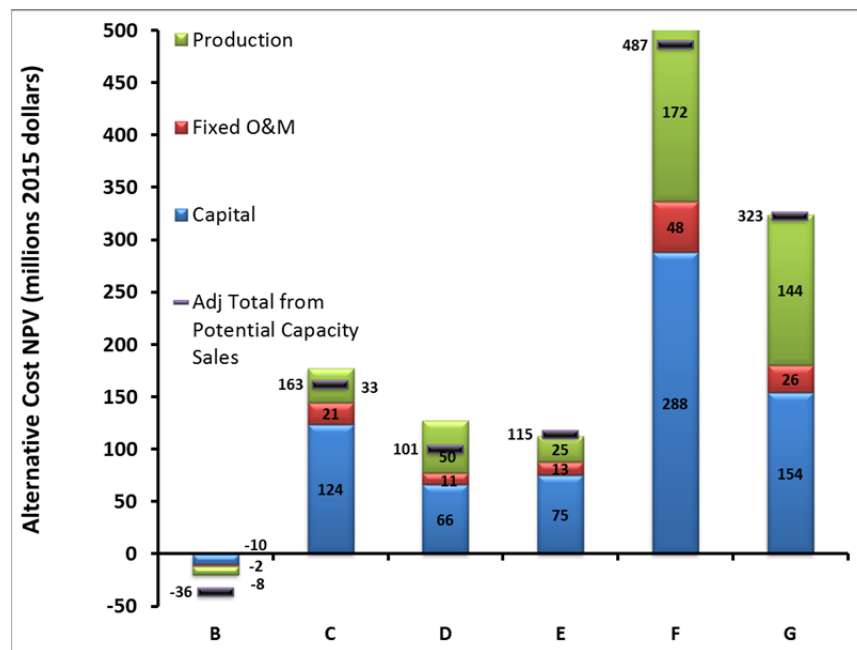

FIGURE K.1-49 Cost Difference of Alternatives Compared to Alternative A at 90% Exceedance Level and 1.4% Discount Rate

1 **K.1.10.6 Sensitivity of Results to the Base Capacity Expansion Path**
2

3 The new generating unit additions projected by the AURORA capacity expansion model
4 run for Alternative A represents a reasonable and plausible outlook that is consistent with utility
5 IRPs in the region and the 2014 AEO (EIA 2014) projections. However, as stated earlier, the
6 AURORA model bases capacity expansion decisions more on local financial objectives than on
7 economic ones. Argonne power systems analysts also discovered that small changes in some
8 AURORA inputs would lead to substantial changes in capacity expansion pathways. This model
9 behavior leads to uncertainty about the impact of Alternative A's expansion pathway on the final
10 results and about the conclusions that could ultimately be made about power systems economic
11 impacts.
12

13 Although pathways were different, it became apparent that the advanced combustion
14 turbines and advanced combined cycle units were the two expansion candidates used almost
15 exclusively by AURORA for new future additions. Therefore, additional model runs were made
16 to measure the sensitivity of the base capacity expansion pathway on economic outcomes. Two
17 extreme Alternative A pathways were tested. Both were based on a 90% exceedance level and a
18 3.375% discount rate. One pathway built exclusively advanced combustion turbines and the
19 second pathway build only the advanced combined cycle plants. Under both pathways,
20 combustion turbines replaced lost capacity at Glen Canyon Dam for all other alternatives.
21 Results for these two extreme pathways are shown in Figures K.1-50 and K.1-51.
22

23 For both pathways, the comparative results show the same basic pattern as all of the
24 previously discussed results. Alternative ranking is basically the same. However, under the
25 advanced combustion turbine base expansion pathway, costs (stacked bars) are noticeably higher
26 for Alternatives D and E as compared to the primary assumption set reported in Chapter 4
27 (i.e., mixed technology expansion, 90% exceedance, and a 3.375% discount rate shown in
28 Figure K.1-47). Also under the advanced combined cycle base expansion pathway, costs for
29 Alternatives C, D, and E are somewhat lower. This is due primarily to the lumpy nature of
30 capacity additions. If excess capacity can be sold, the effects of this lumpy behavior are
31 significantly reduced. Note that for each alternative the black bars for the three base expansion
32 pathways are very similar.
33

34 **K.1.10.7 Sensitivity of Results to the Assumed Future Hydrological Conditions**
35

36 Hydrology trace 14 in combination with sediment trace 2, which was the most probably
37 sediment condition, was used as the representative trace. However, as noted earlier, the impacts
38 of an alternative are dependent on the hydrological conditions. Therefore, the timing of dry,
39 average, and wet hydrological condition is important because discounting in the NPV
40 computation gives a higher weight to near-term costs as compared to costs that are incurred in
41 the more distant future.
42
43
44

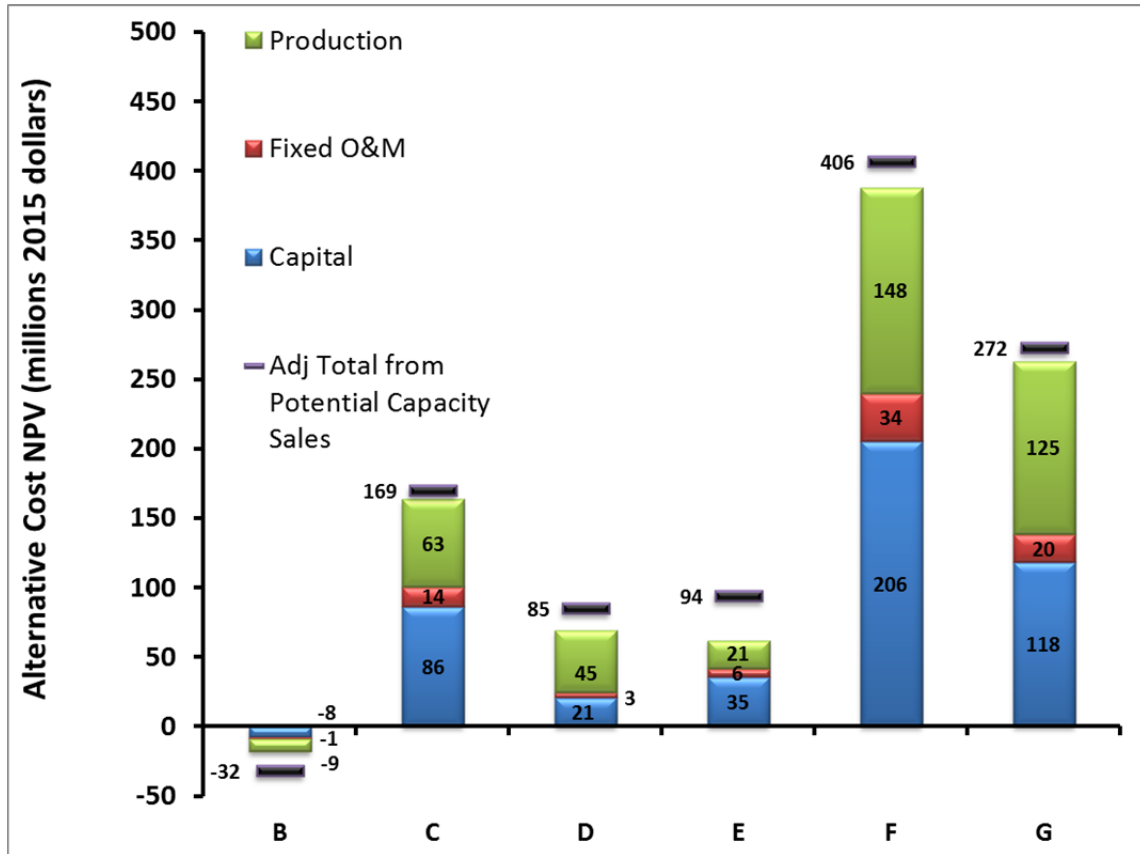

1

FIGURE K.1-50 Cost Difference of Alternatives Compared to Alternative A at 90% Exceedance Level and 3.375% Discount Rate, Assuming All Alternative A New Capacity Additions Are Advanced Combustion Turbines

2
3
4
5
6

This section is intended to provide insights into the economic results' sensitivity to the selected hydrological condition. Ideally, all possible combinations of the 21 hydrology traces and three sediment traces would be simulated with the AURORA model in dispatch mode over the 20-year study period. However, such an effort would be very time consuming. As a simplification, only one other hydrological condition was run. For each hour of the LTEMP study period, this condition uses the average hourly generation from all 21 traces under sediment trace 2 as projected by GTMax-Lite runs of Glen Canyon Dam. Results for this average hydropower condition are shown in Figure K.1-52.

7
8
9
10
11
12
13
14
15

Note that all capital and fixed O&M costs in Figure K.1-52, as shown by the blue and red bars, respectively, are identical to those shown in Figure K.1-47 for the primary assumption set. This occurs because capacity expansion decisions are made under uncertainty. For this power systems study, the expansion pathway for each alternative is based on a set of 21 plausible future hydrological conditions. It is also assumed that once the firm capacity level is determined and input into the AURORA model to determine an alternative-specific expansion path, the firm capacity level does not change regardless of the sequence of actual hydrological conditions that occur in the future. Therefore, the representative trace and the average trace use identical

16
17
18
19
20
21
22
23

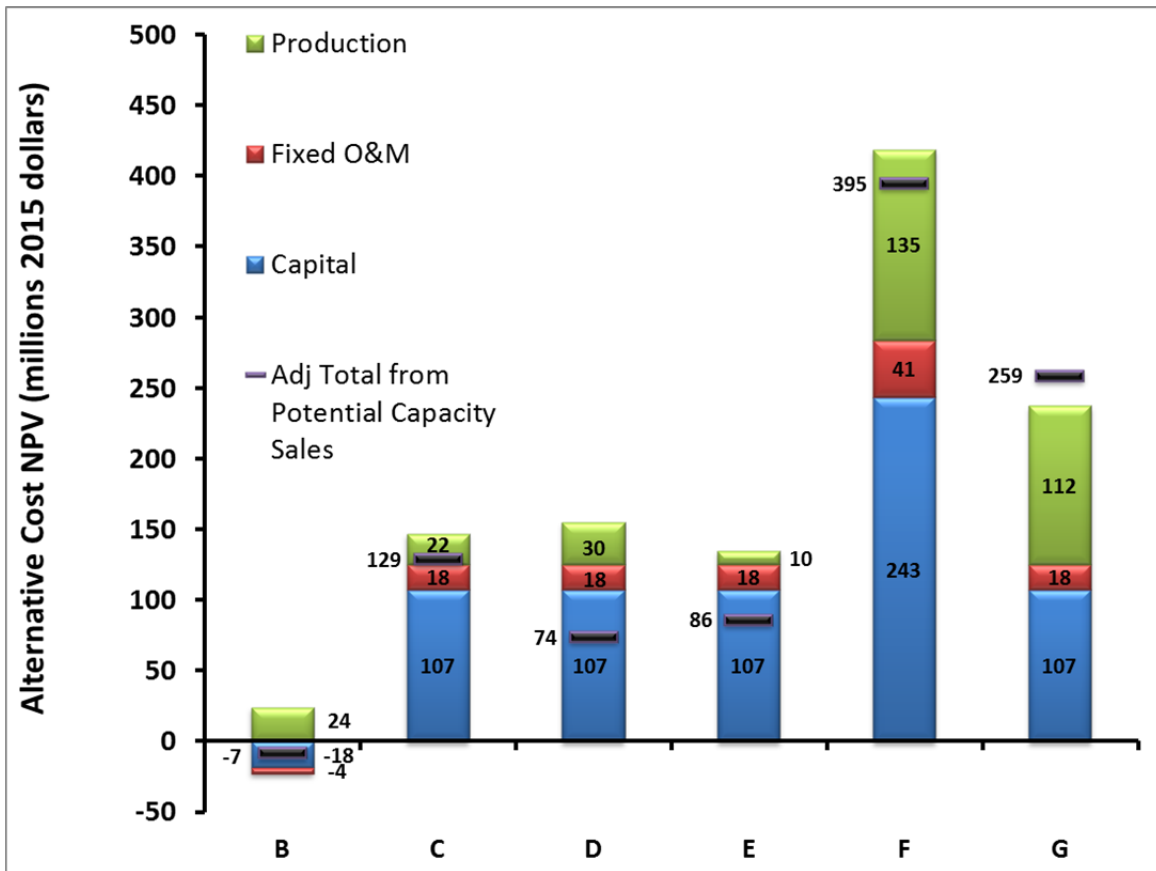

FIGURE K.1-51 Cost Difference of Alternatives Compared to Alternative A at 90% Exceedance Level and 3.375% Discount Rate, Assuming All Alternative A New Capacity Additions Are Advanced Combined Cycle

capacity expansion pathways. If other hydropower conditions were run, each one would use this fixed expansion path.

Although capital and fixed O&M costs are identical, production costs (green bars) are slightly different. This does not provide definitive proof that the selected trace does not have a substantial impact on economic outcomes, but it does show that the representative trace—which has a sequence of dry, average, wet, average, and dry conditions over the study period—produces a result that is very similar to a sequence of average hydropower conditions.

K.1.10.8 Sensitivity of Results to Changes in Ancillary Services

A sensitivity study was performed on the effect changes in ancillary services (AS), which is the sum of regulation and fast spinning reserves, would have on the value of energy and firm capacity from Glen Canyon Dam. It was performed because assumptions about ancillary service requirements changed from when the GTMax-Lite model was run for the swing-weighting exercise in March 2014 (swing-weighting described in Appendix C). For this modeling, ancillary

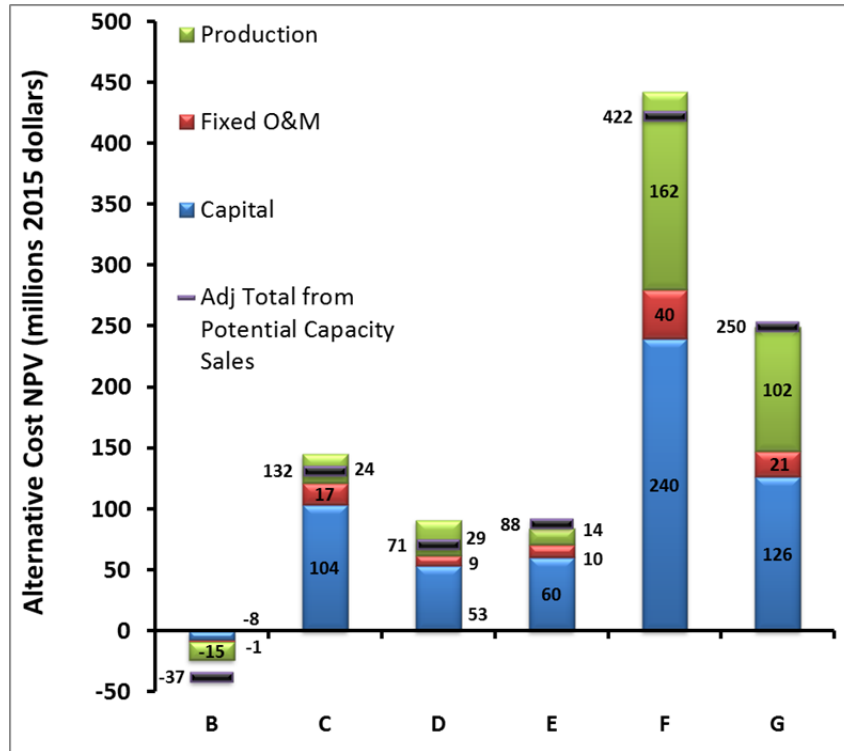

FIGURE K.1-52 Cost Difference of Alternatives Compared to Alternative A at 90% Exceedance Level and 3.375% Discount Rate Assuming Average Hydropower Conditions

service requirements at Glen Canyon Dam were projected to be 103 MW in 2013 and then to increase to 160 MW by 2030. This case was called the high AS scenario. However, subsequent to this modeling, a second scenario was determined by Western to be more likely (i.e., ancillary service requirements would remain at the same levels that exist today). Glen Canyon Dam currently supplies 67 MW of ancillary services and Western currently expects this not to increase during the LTEMP study period. This case was called the current AS scenario. This section reports the results of the study.

Using a lower ancillary service requirement will affect Glen Canyon Dam dispatch, firm capacity levels, and economic evaluations. In addition, alternatives that allow higher operational flexibility may be affected more than ones with very stringent limitations. Therefore, a sensitivity analysis was conducted to evaluate the magnitude of change that would occur in model results if the current AS scenario had been used.

Because it would have been very costly to repeat the entire analysis with current ancillary service requirements, the sensitivity analysis used a simpler methodology to gage differences in firm capacity and energy economics among Alternatives A, D, and F under two disparate ancillary service market assumptions. If differences in the marketable capacity and energy for these three alternatives were dissimilar under the two AS cases, a second phase analysis would be performed.

1 Alternatives A, D, and F were chosen because they span a wide range of firm capacities
 2 that the LTEMP alternatives exhibit. Alternative A is the current operating regime and has the
 3 second highest firm capacity; Alternative F is a steady flow alternative and has the lowest
 4 marketable capacity; and Alternative D represents a mid-range firm capacity level. To expedite
 5 the analysis, end-of-month elevations and monthly release values from the CRSS model for just
 6 trace 14 (i.e., the representative hydrology trace) was analyzed. Monthly releases input to the
 7 Glen Canyon Dam GTMax-Lite model were not adjusted for experiments (either HFEs or TMFs)
 8 because CRSS results did not account for them. Experiments are only added by the SBM and are
 9 assumed to have relatively small impacts on firm capacity at exceedance levels over 50%.

10
 11 The GTMax-Lite model was run and results were stored for hourly generation over the
 12 entire study period. Firm capacity for several exceedance levels above 50% under the three
 13 alternatives were then estimated for both sets of ancillary service values. The value of generation
 14 was determined by multiplying hourly generation levels by corresponding hourly Palo Verde
 15 LMPs. Hourly values were then summed to determine the total economic energy value. Next,
 16 differences in firm capacity and energy value among the three alternatives were computed and
 17 results from the ancillary services cases were compared.

18
 19 Ancillary services sensitivity analysis results are shown in Tables K.1-13 through K.1-15
 20 below. Table K.1-13 shows the capacity at exceedance levels ranging from 0 to 100% for the
 21 three alternatives and the two ancillary service scenarios. At capacity exceedance levels of
 22 interest for the LTEMP analysis (namely, 50% to 99%), the capacity differs by less than 5%
 23 between the two ancillary services scenarios.

24
 25
 26 **TABLE K.1-13 Firm SLCA/IP Federal Hydropower Capacity (MW) at Various**
 27 **Exceedance Levels at Glen Canyon Dam by Alternative and Ancillary Service Scenarios**

| Exceedance | Alternative A (No Action Alternative) | | Alternative D (Preferred Alternative) | | Alternative F | |
|------------|---------------------------------------|---------|---------------------------------------|---------|---------------|---------|
| | Current AS | High AS | Current AS | High AS | Current AS | High AS |
| 100 | 519 | 495 | 458 | 458 | 191 | 191 |
| 99 | 519 | 495 | 458 | 458 | 191 | 191 |
| 90 | 550 | 549 | 484 | 481 | 212 | 212 |
| 80 | 575 | 575 | 525 | 511 | 232 | 232 |
| 70 | 630 | 623 | 546 | 544 | 241 | 241 |
| 60 | 647 | 647 | 564 | 564 | 251 | 251 |
| 50 | 673 | 673 | 591 | 584 | 259 | 259 |
| 40 | 694 | 694 | 595 | 595 | 267 | 267 |
| 30 | 716 | 716 | 620 | 607 | 276 | 276 |
| 20 | 890 | 830 | 887 | 827 | 692 | 692 |
| 10 | 975 | 967 | 987 | 967 | 985 | 985 |
| 1 | 1097 | 1097 | 1097 | 1097 | 1097 | 1097 |
| 0 | 1097 | 1097 | 1097 | 1097 | 1097 | 1097 |

28
 29

1 Table K.1-14 shows capacity (MW), energy (GWh), spills (GWh), and the NPV of all
 2 cost components for the 3 alternatives. The capacity shown in Tables K.1-14 and K.1-15 is at the
 3 90% exceedance level; it shows that there is a very small difference (less than 0.8%) in the
 4 capacity and energy, in terms of MW and GWh, respectively, between the high AS and current
 5 AS scenarios for Alternatives A and D. There is no difference between the ancillary service
 6 scenarios for Alternative F. The difference in total NPV between the two scenarios for
 7 Alternatives A and D is also very small; namely, \$2.86 million (0.08%) for Alternative A and
 8 \$4.71 million (0.14%) for D. There is no difference between the ancillary services scenarios for
 9 Alternative F.

10
 11 Table K.1-15 compares the differences in firm capacity and energy in Alternatives D
 12 and F relative to Alternative A for both ancillary services scenarios. Again, the ancillary services
 13 scenario has only a very minor effect on the relative difference between each alternative and
 14 Alternative A.

15
 16 These results show very little difference among ancillary services scenarios. The primary
 17 reason for this is that under all three alternatives operating criteria do not allow the Glen Canyon
 18 Dam Powerplant to utilize a significant amount of its capacity under most hydropower
 19 conditions; that is, the criteria almost always restrict the maximum Glen Canyon Dam output to a
 20 level that is significantly below the physical maximum capacity. This gap between maximum
 21 output and physical capacity can be used for ancillary services because all alternatives allow
 22 exception criteria and restrict hourly average flow rates, but not instantaneous rates. For
 23 example, under Alternatives A and D, daily change specifications typically limit maximum
 24 output levels far (more than 160 MW) below the maximum physical output of the plant.
 25 Therefore, ancillary services requirements do not usually bind operations. Note that the power
 26 systems analysis did not evaluate the value of any unused capacity (i.e., the differences between
 27 the physical powerplant capacity minus the sum of generation plus ancillary services).
 28
 29

30 **TABLE K.1-14 Comparison of Capacity and Energy Values at Glen Canyon Dam by Alternative**
 31 **and Ancillary Services Scenarios at the 90% Exceedance Level**

| Ancillary Service Scenario and Alternative | Capacity (MW) | Energy (GWh) | Spills (GWh) | NPV (\$millions) | | | Increase in Value Compared to Current AS |
|-----------------------------------------------|------------------|-----------------|-----------------|------------------|----------|----------|---------------------------------------------------|
| | | | | Capacity | Energy | Total | |
| High AS Scenario | | | | | | | |
| Alternative A | 548.9 | 88,754 | 1,824 | 422.77 | 3,054.06 | 3,476.82 | Not Applicable |
| Alternative D | 480.7 | 88,790 | 1,556 | 370.29 | 3,043.41 | 3,413.70 | Not Applicable |
| Alternative F | 212.3 | 88,081 | 1,918 | 163.53 | 2,916.39 | 3,079.92 | Not Applicable |
| Current AS Scenario | | | | | | | |
| Alternative A | 550.3 | 88,757 | 1,821 | 423.87 | 3,055.81 | 3,479.68 | 2.86 |
| Alternative D | 484.2 | 88,792 | 1,555 | 372.95 | 3,045.39 | 3,418.34 | 4.64 |
| Alternative F | 212.3 | 88,081 | 1,918 | 163.53 | 2,916.39 | 3,079.92 | 0.00 |

1
2

TABLE K.1-15 Difference Relative to Alternative A (value of Alternative A minus value of alternative)

| Strategy | Capacity (MW) | Energy (GWh) | Spills (GWh) | NPV (\$millions) | | |
|----------------------------------|---------------|--------------|--------------|------------------|--------|--------|
| | | | | Capacity | Energy | Total |
| High AS Scenario | | | | | | |
| Alternative D | 68.13 | -36.64 | 267.90 | 52.48 | 10.64 | 63.12 |
| Alternative F | 336.55 | 672.59 | -93.50 | 259.23 | 137.67 | 396.90 |
| Current AS Scenario | | | | | | |
| Alternative D | 66.10 | -34.67 | 265.93 | 50.92 | 10.42 | 61.34 |
| Alternative F | 337.98 | 676.04 | -96.95 | 260.33 | 139.42 | 399.76 |
| Difference (Current–High) | | | | | | |
| Alternative D | -2.02 | 1.97 | -1.97 | -1.56 | -0.22 | -1.78 |
| Alternative F | 1.43 | 3.45 | -3.45 | 1.10 | 1.76 | 2.86 |

3
4
5
6
7
8
9

Based on insights gained from this study, it was concluded that ancillary services assumptions under a range of plausible futures have little to no effect on firm capacity and energy value for the LTEMP alternatives. Therefore, it was not necessary to conduct more detailed analyses on ancillary services.

10
11
12

K.1.10.9 Summary of Economic Ranking

13
14
15
16
17
18
19
20
21
22

Power systems analysis results show that there are three distinct groups of outcomes. Alternatives A and B are clearly the most favorable for hydropower economics, while Alternatives F and G are the least favorable. Alternatives C, D, and E rank between these two extremes. As shown in Table K.1-16, the ranking of alternatives is very consistent regardless of changes in assumptions that were made in the sensitivity runs. Alternatives D and E switched ranking under only two sets of assumptions. This order switch between the third and fourth rank is mainly attributed to the lumpy nature of capacity expansion paths. Among the sensitivity analyses conducted the discount rate assumption had the largest impact on absolute economic costs, but in terms of percent changes in total system costs that were tracked, it had negligible effects.

23
24
25
26
27
28
29
30

It is noteworthy that as the exceedance level increased from 50% to 99% the cost of the alternatives decreased, but the rankings did not change except for the aforementioned switching of Alternatives D and E. Although cost differences among alternatives decrease, higher exceedance levels increase overall SLCA/IP market system costs for all alternatives; however, system reliability improves with higher exceedance levels since there is more capacity built in the system.

1 **TABLE K.1-16 Summary of Economic Rankings for Baseline and All Sensitivity Scenarios**

| | | Assumptions | | | Alternative Rank (lowest to highest total cost) | | | | | | |
|-------------------------|-----------------------------|----------------------|---------------------------|----------------------|----------------------------------------------------|---|---|---|---|---|---|
| Exceedance Level (%) | Excess Capacity Sales | Hydrology | Base Expansion Path | Discount Rate (%) | A | B | C | D | E | F | G |
| | | | | | | | | | | | |
| 90 | Yes | Representative Trace | CT & NGCC | 3.375 | 2 | 1 | 5 | 3 | 4 | 7 | 6 |
| 50 | No | Representative Trace | CT & NGCC | 3.375 | 2 | 1 | 5 | 3 | 4 | 7 | 6 |
| 50 | Yes | Representative Trace | CT & NGCC | 3.375 | 2 | 1 | 5 | 3 | 4 | 7 | 6 |
| 99 | No | Representative Trace | CT & NGCC | 3.375 | 2 | 1 | 5 | 3 | 4 | 7 | 6 |
| 99 | Yes | Representative Trace | CT & NGCC | 3.375 | 2 | 1 | 5 | 3 | 4 | 7 | 6 |
| 90 | No | Representative Trace | CT & NGCC | 1.4 | 2 | 1 | 5 | 4 | 3 | 7 | 6 |
| 90 | Yes | Representative Trace | CT & NGCC | 1.4 | 2 | 1 | 5 | 3 | 4 | 7 | 6 |
| 90 | No | Average Hydropower | CT & NGCC | 3.375 | 2 | 1 | 5 | 3 | 4 | 7 | 6 |
| 90 | Yes | Average Hydropower | CT & NGCC | 3.375 | 2 | 1 | 5 | 3 | 4 | 7 | 6 |
| 90 | No | Representative Trace | CT | 3.375 | 2 | 1 | 5 | 3 | 4 | 7 | 6 |
| 90 | Yes | Representative Trace | CT | 3.375 | 2 | 1 | 5 | 3 | 4 | 7 | 6 |
| 90 | No | Representative Trace | NGCC | 3.375 | 2 | 1 | 5 | 3 | 4 | 7 | 6 |
| 90 | Yes | Representative Trace | NGCC | 3.375 | 2 | 1 | 5 | 3 | 4 | 7 | 6 |

2
 3
 4 Last, the rankings of alternatives are also in general agreement with those found in the
 5 structured decision analysis (SDA). The SDA report shows that the value of GCD hydropower
 6 production is the highest under Alternative B followed closely by Alternative A. Alternatives F
 7 and G have the least value, respectively, and the remaining alternatives are between these
 8 bookends.

9
 10
 11 **K.2 WESTERN’S SLCA/IP FIRM ELECTRIC SERVICE RATE IMPACTS³**

12
 13 The SLCA/IP firm electric service (FES) rate is the price paid per unit of product sold by
 14 Western’s CRSP Management Center to its SLCA/IP FES customers. Two SLCA/IP
 15 commodities are sold, namely firm capacity and firm energy. Each has a separate price. This
 16 section documents the methods and calculations used to determine the impact of the LTEMP
 17 DEIS alternatives on the SLCA/IP capacity and energy rates.⁴ The analysis was performed by
 18 Western CRSP Management Center staff with assistance from Argonne.
 19

³ New terms and acronyms used in this section are defined at first use, and definitions of those terms are provided at the end of the section.

⁴ The term “rate” will be used rather than “price.” This is the standard convention for wholesale electrical commodities. Rate is the price charged for an energy unit, whether capacity or energy. Rate is often used to describe wholesale prices because it is the price of wholesale units and not necessarily the units used for retail sales.

1 The analysis in this section begins with the calculations of economic impact performed
2 and described in Section K.1. Section K.1 describes the economic impact on electrical power
3 production, which is the impact—measured in dollars—on the economy. It includes the system
4 cost of changing the timing and routing of water releases at Glen Canyon Dam. It also includes
5 the expense of constructing (or savings resulting from forgoing construction of) additional
6 electrical generators because of changes in firm SLCA/IP hydropower capacity.
7

8 Several calculations were performed to determine the impact of the LTEMP DEIS
9 alternatives on the SLCA/IP rates. Three rates were calculated for each of the seven alternatives:
10 (1) a firm energy rate, (2) a firm capacity rate, and (3) a composite rate. This section describes
11 the methods and assumptions used to determine these financial rate impacts.
12

13 This analysis is a financial study. It uses the economic estimates described in Section K.1
14 as input values to conduct a financial analysis. Because existing FES contracts are firm
15 obligations to deliver electrical power, the economic impact described in Section K.1 will affect
16 the SLCA/IP rates through the period specified under contract. This analysis describes how the
17 economic impacts are “stepped down,” through changes in the SLCA/IP rate, to utilities that
18 purchase Glen Canyon Dam electrical power. The analysis assumes that Western’s contractual
19 obligation to deliver power to its current FES customers remains unchanged from current levels
20 through the end of the marketing period.
21

22 23 **K.2.1 Relationship between the Economic Impacts of LTEMP Alternatives** 24 **and Impacts on SLCA/IP FES Rates** 25

26 It is important that this analysis of the impacts of LTEMP alternatives on SLCA/IP FES
27 rates be compatible with the economic analysis of the impacts of alternatives on Glen Canyon
28 Dam power production and value (as presented in Section K.1). Economic impacts are changes
29 in the value of power systems resources. The power system economic analysis described in
30 Section K.1 determines the economic loss (or gain) of changing the operation of Glen Canyon
31 Dam. The economic information resulting from the analysis presented in Section K.1 is used as
32 input values for the SLCA/IP rate analysis. This financial analysis is a “step down” from the
33 economic analysis described in Section K.1. It demonstrates how the economic impact of
34 alternative-specific differences in Glen Canyon Dam electric power generation affects the per
35 unit cost of electricity to FES customers through changes in the SLCA/IP rate.
36
37

38 **K.2.2 Temporal Scope of the Analysis and Input Data** 39

40 The SLCA/IP rate analysis is a 20-year analysis encompassing the CY 2015 through
41 CY 2034 time period. It is assumed that the SLCA/IP rate associated with the alternative does
42 not change throughout the power repayment study (PRS) repayment period, which extends
43 beyond CY 2034.
44

45 As explained in Section K.2.3, the SLCA/IP rate is required to be sufficient to repay
46 authorized irrigation projects, which have construction and repayment periods that extend for

1 another 50 years. Therefore, although the analysis includes LTEMP EIS alternative-specific
2 costs that differ by alternative over the 20-year time frame of the LTEMP EIS, the rate study
3 continues with other operations and repayment expenses for many years thereafter.

4
5 Rate changes as a result of alternative operating criteria for Glen Canyon Dam impact all
6 FES customers.⁵

7
8 Data described in Section K.1 are key input data for the SLCA/IP rate impact analysis.
9 These data include:

- 10
11 • The hourly SLCA/IP electrical production under each alternative for the
12 representative 20-year trace⁶ that is simulated by both the GTMax-Lite model
13 and the Small SLCA/IP Powerplant Spreadsheet that is produced for the
14 economic impact analysis;
- 15
16 • The hourly FES customer requests for energy under the terms of their
17 contractual agreements with Western; and
- 18
19 • The estimated capacity cost for each alternative that is set equal to the
20 AURORA model's capacity expansion plan multiplied by the technology-
21 specific levelized cost of capital plus annual fixed O&M expenses.

22 23 24 **K.2.3 SLCA/IP Rate Setting**

25
26 A typical regulated electrical utility sets a rate based on a “test year” using a formula that
27 recoups its estimated operations expenses and allows a fair return on its capital investment. For
28 electrical utilities regulated by State Commissions, their rates are reviewed and approved by the
29 Commission. This approach is quite different from the ratesetting process required of Western.

30
31 Western sets SLCA/IP rates in order to repay all costs associated with power generation.
32 Western must establish power rates sufficient to recover operating, maintenance, and purchase
33 power expenses. In addition, Western sets rates in order to repay the federal government's
34 investment in building these generation and transmission facilities within 50 years. Outside of
35 the 50-year repayment period, this is similar to a regulated electrical utility. The biggest
36 difference lies in the requirement that Western's rates must also be set to cover certain non-
37 power costs Congress has assigned to power users to repay. These are authorized irrigation costs
38 in excess of water users' ability to repay. For the CRSP, authorized irrigation projects have
39 repayment periods that extend for another 50 years. Western must demonstrate to the Federal
40 Electrical Regulatory Commission (FERC) that its SLCA/IP rate is set appropriately to make
41 required repayment of all authorized projects. Even though FERC approves a SLCA/IP rate that

5 “FES customers” and “SLCA/IP LTF customers” are used synonymously.

6 The basis for selection of a representative trace is described in Attachment K-3 of Appendix K.

1 expires in 5 years, it is a rate that has been demonstrated to make all required repayment of all
2 authorized projects.

3
4 Another approach to this analysis would be to add LTEMP EIS alternative-specific
5 expenses for 5 years, estimate a SLCA/IP rate based on that, do it again for another 5 years, and
6 again and again. The LTEMP EIS alternative-specific impact would then show four SLCA/IP
7 rates that cover the 20-year temporal scope of the EIS. We could then do a net present value
8 calculation to 2015. This approach would have made the SLCA/IP rate analysis more
9 comparable to the approach used in Sections K.1 and K.3. This would be a straight-forward
10 calculation for a regulated utility that uses a “test year” to set rates. The expenses related to a
11 “test year” would be available for each of the 20 years included in the LTEMP EIS time frame
12 from the analysis in Section K.1. As explained in the previous paragraph, this approach would be
13 significantly different from Western’s required method of setting SLCA/IP rates. In addition, the
14 schedule for completion of this analysis did not allow for the added time required.

15 16 17 **K.2.4 Calculation of Net Electrical Energy Expense**

18
19 Figure K.2-1 illustrates the method used to determine the yearly expense of electrical
20 energy over the 20-year study period.

21 22 23 **K.2.4.1 SLCA/IP Electrical Production**

24
25 Data on the combined amounts of electrical energy produced by all of the SLCA/IP
26 federal hydropower plants under each alternative were generated for the economic analysis
27 described in Section K.1, and were used as input to the SLCA/IP wholesale rate analysis. The
28 data are hourly over the 20-year study period. There is one set of these hourly data for each
29 LTEMP DEIS alternative.

30 31 32 **K.2.4.2 Sustainable Hydropower (SHP) and Available Hydropower (AHP) 33 Capacity and Energy**

34
35 Western’s Energy Management and Marketing Office (EMMO) schedules electrical
36 capacity and energy to serve FES customer energy requests. Each FES customer requests energy
37 according to the terms and conditions of CRSP Management Center FES contracts. An FES
38 customer can schedule an amount of energy to be delivered up to a specified capacity amount.
39 This is known as the SHP capacity.⁷ SLCA/IP FES customers also have a monthly amount of
40 electrical energy that Western is obligated to deliver. A customer schedules the monthly
41 allocation of electrical energy within the capacity limit mentioned above. This is known as the

⁷ Specific descriptions of the terms and conditions of FES contracts will not be discussed here. The abbreviated descriptions provided here are intended only to explain the process of calculating the impact of the LTEMP DEIS alternatives on the SLCA/IP wholesale rate.

1 SHP energy allocation. Both capacity and energy amounts differ by customer and by month.
 2 Table K.2-1 shows CRSP Management Center current total SHP contractual obligations and
 3 project use required deliveries by month.
 4

5 Because SLCA/IP FES customers are allowed to schedule SHP energy according to their
 6 individual needs, the hourly shaping of energy differs from day to day and from customer to
 7 customer. Therefore, it is necessary to estimate the aggregate daily shape of electrical energy
 8 schedules submitted to the EMMO by all FES customers. Western used average weekday,
 9 Saturday, and Sunday shapes for each month of WY 2014 to represent these schedules. When a
 10 holiday occurs, the load shape for Sunday is used. These SHP loads are provided in
 11 Table K.2-2.⁸ In addition, the EMMO must serve project use loads that vary over time. Western
 12 used WY 2014 data, rather than averaging several years of loads or projecting different load
 13 shapes for future years, because the SHP daily shape does not differ substantially from year to
 14 year.
 15
 16

17 **TABLE K.2-1 SHP Contractual Obligations and Project Use Required Deliveries by Month**

| Month | Firm Electric Service | | | Project Use | | Total | |
|-------|-----------------------|--------------|------------------------|---------------|--------------|---------------|--------------|
| | Capacity (kW) | Energy (kWh) | CROD ^a (kW) | Capacity (kW) | Energy (kWh) | Capacity (kW) | Energy (kWh) |
| Jan. | 863,726 | 463,462,717 | 1,403,777 | 7,639 | 4,200,824 | 871,365 | 467,663,541 |
| Feb. | 851,326 | 409,824,542 | 1,403,777 | 7,639 | 4,200,824 | 858,965 | 414,025,365 |
| Mar. | 765,761 | 422,665,276 | 1,403,777 | 42,539 | 21,916,824 | 808,300 | 444,582,100 |
| April | 638,196 | 365,283,663 | 1,317,779 | 52,634 | 23,184,158 | 690,830 | 388,467,820 |
| May | 623,515 | 378,216,775 | 1,317,779 | 52,634 | 23,184,158 | 676,149 | 401,400,933 |
| June | 646,035 | 397,635,769 | 1,317,779 | 52,634 | 23,184,158 | 698,669 | 420,819,927 |
| July | 740,916 | 434,536,678 | 1,317,779 | 52,634 | 23,184,158 | 793,550 | 457,720,836 |
| Aug. | 714,683 | 437,867,014 | 1,317,779 | 52,634 | 23,184,158 | 767,317 | 461,051,172 |
| Sept. | 618,576 | 380,082,095 | 1,317,779 | 52,634 | 23,184,158 | 671,210 | 403,266,253 |
| Oct. | 739,646 | 398,608,181 | 1,403,777 | 42,539 | 21,916,824 | 782,185 | 420,525,004 |
| Nov. | 775,589 | 408,041,232 | 1,403,777 | 7,639 | 4,200,824 | 783,228 | 412,242,055 |
| Dec. | 869,160 | 455,561,848 | 1,403,777 | 7,639 | 4,200,824 | 876,799 | 459,762,672 |

^a CROD = Contract Rate of Delivery

18
 19
 20

⁸ In some situations, it is difficult to separate customer SHP and project use loads that are submitted to Western's EMMO. For this analysis, it is conservatively assumed that the loads in Table K.2-2 are only SHP loads even though small amounts of project use loads are included. This assumption will have minimal impact on the results, since the same hourly loads are used for all alternatives.

1 **TABLE K.2-2 SHP Hourly Load Shapes by Month and Type of Day**

| Month | Day of the Week | Hour of Day | | | | | | | | | | | | | | | | | | | | | | | |
|-------|-----------------|-------------|-----|-----|-----|-----|-----|-----|-----|-----|-----|-----|-----|-----|-----|-----|-----|-----|-----|-----|-----|-----|-----|-----|-----|
| | | 1 | 2 | 3 | 4 | 5 | 6 | 7 | 8 | 9 | 10 | 11 | 12 | 13 | 14 | 15 | 16 | 17 | 18 | 19 | 20 | 21 | 22 | 23 | 24 |
| Oct. | Wkday | 275 | 271 | 267 | 279 | 320 | 454 | 594 | 596 | 673 | 695 | 714 | 707 | 717 | 713 | 720 | 727 | 734 | 742 | 748 | 750 | 729 | 656 | 451 | 366 |
| | Sat. | 294 | 288 | 282 | 280 | 297 | 417 | 539 | 538 | 625 | 653 | 676 | 671 | 680 | 672 | 676 | 686 | 691 | 701 | 707 | 711 | 701 | 640 | 427 | 352 |
| | Sun. | 272 | 290 | 275 | 269 | 287 | 384 | 467 | 459 | 494 | 518 | 562 | 581 | 588 | 590 | 599 | 620 | 632 | 643 | 652 | 658 | 627 | 558 | 382 | 340 |
| Nov. | Wkday | 354 | 295 | 287 | 291 | 363 | 460 | 643 | 676 | 676 | 697 | 689 | 677 | 665 | 657 | 656 | 680 | 721 | 773 | 780 | 776 | 770 | 734 | 507 | 441 |
| | Sat. | 351 | 299 | 290 | 294 | 363 | 449 | 580 | 617 | 639 | 677 | 672 | 666 | 654 | 647 | 644 | 665 | 702 | 758 | 767 | 762 | 753 | 707 | 504 | 433 |
| | Sun. | 314 | 270 | 268 | 267 | 331 | 391 | 490 | 518 | 525 | 525 | 525 | 510 | 506 | 509 | 543 | 591 | 673 | 702 | 699 | 696 | 648 | 426 | 399 | |
| Dec. | Wkday | 346 | 325 | 319 | 322 | 391 | 525 | 698 | 794 | 785 | 764 | 760 | 740 | 721 | 676 | 665 | 676 | 719 | 836 | 853 | 849 | 833 | 791 | 612 | 506 |
| | Sat. | 356 | 342 | 332 | 334 | 386 | 496 | 654 | 751 | 747 | 735 | 738 | 722 | 704 | 662 | 643 | 652 | 707 | 823 | 839 | 835 | 820 | 776 | 601 | 489 |
| | Sun. | 324 | 307 | 309 | 297 | 347 | 448 | 568 | 602 | 586 | 565 | 570 | 551 | 537 | 511 | 509 | 521 | 586 | 698 | 765 | 764 | 752 | 712 | 490 | 453 |
| Jan. | Wkday | 375 | 358 | 351 | 379 | 445 | 586 | 771 | 810 | 810 | 784 | 749 | 735 | 714 | 698 | 692 | 689 | 724 | 845 | 854 | 850 | 833 | 793 | 565 | 441 |
| | Sat. | 376 | 381 | 375 | 398 | 435 | 516 | 691 | 710 | 725 | 714 | 691 | 680 | 662 | 648 | 639 | 641 | 677 | 822 | 835 | 831 | 788 | 750 | 559 | 430 |
| | Sun. | 356 | 343 | 343 | 340 | 400 | 449 | 548 | 562 | 582 | 559 | 536 | 523 | 514 | 504 | 501 | 511 | 567 | 688 | 723 | 721 | 683 | 629 | 457 | 394 |
| Feb. | Wkday | 360 | 346 | 340 | 343 | 374 | 481 | 769 | 793 | 805 | 806 | 740 | 711 | 691 | 677 | 624 | 633 | 664 | 838 | 861 | 860 | 843 | 807 | 608 | 464 |
| | Sat. | 363 | 361 | 353 | 352 | 356 | 425 | 684 | 725 | 729 | 736 | 676 | 652 | 636 | 621 | 576 | 587 | 616 | 780 | 813 | 815 | 777 | 745 | 624 | 446 |
| | Sun. | 341 | 338 | 344 | 333 | 334 | 379 | 557 | 558 | 569 | 576 | 520 | 504 | 490 | 473 | 470 | 489 | 531 | 693 | 777 | 780 | 739 | 637 | 532 | 360 |
| Mar. | Wkday | 348 | 334 | 334 | 359 | 465 | 585 | 671 | 704 | 726 | 723 | 711 | 703 | 698 | 689 | 685 | 689 | 698 | 744 | 765 | 770 | 733 | 641 | 523 | 411 |
| | Sat. | 367 | 354 | 351 | 368 | 450 | 531 | 609 | 625 | 682 | 685 | 677 | 670 | 667 | 653 | 645 | 646 | 664 | 715 | 747 | 746 | 719 | 643 | 513 | 425 |
| | Sun. | 347 | 342 | 346 | 353 | 413 | 479 | 535 | 541 | 558 | 552 | 536 | 537 | 539 | 527 | 525 | 536 | 562 | 622 | 658 | 660 | 661 | 586 | 462 | 409 |
| Apr. | Wkday | 307 | 299 | 296 | 342 | 396 | 501 | 548 | 589 | 601 | 604 | 632 | 640 | 646 | 633 | 632 | 629 | 630 | 636 | 649 | 653 | 633 | 600 | 510 | 415 |
| | Sat. | 318 | 309 | 304 | 328 | 363 | 471 | 529 | 562 | 581 | 587 | 615 | 618 | 623 | 609 | 611 | 613 | 613 | 619 | 635 | 641 | 618 | 585 | 497 | 409 |
| | Sun. | 301 | 299 | 293 | 305 | 328 | 406 | 428 | 460 | 479 | 486 | 490 | 504 | 517 | 532 | 541 | 548 | 554 | 560 | 573 | 587 | 570 | 538 | 446 | 386 |
| May | Wkday | 379 | 339 | 335 | 345 | 412 | 513 | 552 | 593 | 609 | 630 | 632 | 641 | 640 | 637 | 633 | 642 | 644 | 657 | 647 | 645 | 641 | 615 | 528 | 452 |
| | Sat. | 392 | 358 | 348 | 354 | 397 | 488 | 510 | 523 | 560 | 595 | 600 | 607 | 607 | 607 | 605 | 619 | 622 | 639 | 636 | 638 | 631 | 602 | 524 | 467 |
| | Sun. | 373 | 333 | 323 | 326 | 368 | 449 | 463 | 469 | 480 | 506 | 557 | 580 | 582 | 584 | 584 | 589 | 593 | 613 | 609 | 612 | 604 | 573 | 509 | 413 |
| Jun. | Wkday | 475 | 435 | 398 | 422 | 438 | 519 | 605 | 634 | 672 | 681 | 681 | 685 | 691 | 691 | 691 | 696 | 695 | 692 | 682 | 681 | 673 | 666 | 632 | 511 |
| | Sat. | 474 | 442 | 420 | 404 | 401 | 473 | 549 | 606 | 640 | 658 | 667 | 675 | 679 | 680 | 681 | 687 | 686 | 681 | 675 | 675 | 662 | 648 | 626 | 507 |
| | Sun. | 410 | 395 | 410 | 403 | 375 | 396 | 446 | 457 | 471 | 501 | 521 | 571 | 576 | 592 | 599 | 612 | 608 | 604 | 599 | 607 | 594 | 572 | 548 | 491 |
| Jul. | Wkday | 478 | 428 | 425 | 421 | 443 | 553 | 582 | 617 | 649 | 675 | 685 | 711 | 747 | 751 | 752 | 756 | 755 | 771 | 762 | 761 | 736 | 693 | 609 | 554 |
| | Sat. | 489 | 443 | 428 | 423 | 441 | 520 | 562 | 576 | 605 | 653 | 669 | 700 | 738 | 739 | 741 | 745 | 743 | 758 | 754 | 748 | 723 | 678 | 598 | 532 |
| | Sun. | 449 | 418 | 442 | 438 | 442 | 509 | 526 | 526 | 542 | 610 | 624 | 635 | 683 | 702 | 707 | 710 | 708 | 721 | 714 | 695 | 671 | 629 | 577 | 528 |
| Aug. | Wkday | 499 | 433 | 413 | 412 | 438 | 531 | 644 | 678 | 667 | 679 | 696 | 727 | 763 | 764 | 768 | 766 | 761 | 757 | 745 | 736 | 700 | 663 | 571 | |
| | Sat. | 490 | 446 | 431 | 414 | 429 | 510 | 594 | 638 | 631 | 640 | 662 | 680 | 720 | 760 | 762 | 767 | 764 | 759 | 753 | 740 | 728 | 691 | 656 | 572 |
| | Sun. | 472 | 402 | 425 | 421 | 402 | 424 | 484 | 491 | 511 | 552 | 616 | 633 | 677 | 683 | 683 | 686 | 687 | 688 | 683 | 674 | 665 | 609 | 589 | 561 |
| Sep. | Wkday | 428 | 394 | 391 | 399 | 440 | 500 | 549 | 576 | 608 | 616 | 621 | 623 | 637 | 663 | 666 | 668 | 667 | 663 | 661 | 657 | 652 | 646 | 577 | 512 |
| | Sat. | 446 | 392 | 382 | 378 | 408 | 467 | 502 | 548 | 594 | 605 | 612 | 613 | 628 | 652 | 653 | 656 | 654 | 653 | 653 | 648 | 639 | 629 | 567 | 501 |
| | Sun. | 400 | 383 | 375 | 375 | 395 | 436 | 471 | 476 | 492 | 521 | 564 | 605 | 620 | 638 | 640 | 643 | 653 | 650 | 649 | 645 | 641 | 629 | 546 | 478 |

K-133

1 When seasonal SLCA/IP federal hydropower resources are significantly greater than
2 combined SHP commitments and project use loads plus the energy required to cover delivery
3 losses,⁹ the CRSP Management Center offers its FES customers capacity and/or energy above
4 the SHP levels. These additional offers plus SHP are referred to as available hydropower (AHP).
5 The methodology applied for the wholesale rate analysis offers a seasonal AHP, which is
6 distributed monthly. The seasons that met the AHP offer criteria were largely a function of
7 hydrological condition rather than of the alternative. Each of the seven alternatives had the same
8 number of seasons that met the AHP criteria. The alternatives differed, however, in the amount
9 of AHP that was offered.

10
11 Based on the sequence of hydrological conditions contained in the representative trace,
12 AHP offers were calculated for any season that met the 20% excess AHP offer criterion; that is,
13 an AHP offer is made only if hydropower resources in a season are at least 20% greater than the
14 seasonal SHP level.

15
16 Western is required under its FES contracts to provide AHP, by season, when available.
17 However, the contracts do not specify how much energy above SHP is required to make a
18 seasonal AHP offer. There are no set criteria for offering AHP. It is the current practice of the
19 CRSP Management Center to review and release information for the upcoming season and
20 decide whether to offer AHP. CRSP Management Center power marketing managers confer with
21 EMMO managers and consider anticipated release information, market prices, the amount of
22 anticipated energy and capacity above SHP, and other factors in making an AHP offer for the
23 upcoming season.

24
25 For the purposes of completing this analysis, CRSP Management Center managers and
26 staff that are involved in the seasonal determinations were surveyed to establish a criterion based
27 on past practices. The 20% trigger represents a reasonable amount of additional available
28 hydropower that could be efficiently and equitably offered to Western's more than 135
29 customers. Offers to FES customers are made prior to the beginning of the season.¹⁰ If the
30 predicted energy production above AHP levels did not occur, and an AHP offer was made, the
31 resulting short position must be resolved by energy market purchases. When available seasonal
32 hydropower is less than 20% it is assumed that the excess energy would be offered to the market.
33 The 20% trigger used for this analysis is for modeling purposes only and does not represent an
34 established policy or practice.

35
36 The amount of AHP offered in a particular month was the smaller of the percent energy
37 above the SHP energy and the percent capacity above the SHP capacity. Once this was
38 determined, the SLCA/IP hourly energy delivery obligation (i.e., SHP load) was scaled by the

⁹ Energy delivery losses were conservatively set equal to 8.5% of the total SLCA/IP hourly federal hydropower generation when computing FES rates and seasonal customer offers above AHP levels. This level is consistent with historical levels used for ratemaking, but somewhat higher than the 5% loss rate used for power systems economic analyses presented in Section K.1.

¹⁰ SLCA/IP power is marketing in two seasons: the "summer" season is April through September, the "winter" season is October through March.

1 appropriate percentage for each hour in the months that offer seasonal AHP. Project use loads
2 were not adjusted.

3
4 AHP is sold to SLCA/IP FES customers at the FES energy rate. Since the FES energy
5 rate is typically lower than the hourly spot market price, the addition of AHP tends to reduce
6 CRSP Management Center revenues when compared to selling this excess (or long) energy to the
7 spot market. There is typically a relatively minor (if any) financial impact on Western from
8 offering AHP capacity. All SLCA/IP FES customers are billed monthly for the CROD capacity
9 allocation, regardless of the particular SHP or AHP capacity allocation for the month. However,
10 there is a financial impact on Western when SHP capacity offers exceed the amount available
11 from SLCA/IP federal hydropower resources (due to, for example, the aforementioned forecast
12 error), because Western must purchase capacity to fill the deficit.

13
14 Seasonal SLCA/IP federal hydropower generation is almost always either above or below
15 the SHP obligation. The logic that is used to model this energy imbalance is shown in
16 Figure K.2-1. If generation is below the SHP obligation, it is assumed that Western will be a net
17 seasonal power purchaser and cover the short energy position via the spot market at spot market
18 prices.¹¹ If generation is above the SHP obligation, the excess seasonal energy is sold to the spot
19 market at spot market prices, unless it is a season in which the AHP offer criteria are met, in
20 which case the seasonal excess energy is sold to SLCA/IP customers at the FES energy rate.

21
22 Although Western may be short during a specific season, on an hourly basis it may
23 produce SLCA/IP federal hydropower in excess of FES SHP loads (i.e., FES customer energy
24 requests). For example, during the middle of the night, under a steady flow alternative, loads
25 may be less than generation. Likewise, there are some hours when hydropower resources
26 produce less energy than loads when there is excess seasonal energy. Therefore, the wholesale
27 rate analysis uses a methodology in which long and short positions along with associated costs
28 and revenues are computed hourly under each alternative. Spot prices are the same scaled
29 AURORA Western Interconnection LMPs at the Palo Verde hub that are used for power system
30 economic analyses.

31 32 33 **K.2.5 Calculation of Capacity Expenses and Total Net Costs**

34
35 In addition to the annual net expense related to electrical energy for each alternative,
36 Western will have a cost related to electrical capacity purchases or, in the case of Alternative B,
37

¹¹ Western's CRSP Management Center has several decades of experience with the vicissitudes of hydrological conditions in the Colorado River basin. There have been years in which electrical production from the SLCA/IP was inadequate to meet SHP commitment levels. Western once hedged its risk of dealing with this condition by making a long-term capacity and energy purchase. Outside of one instance, Western's firming purchases have only been on the day-ahead market or for a season when conditions were forecasted to require this.

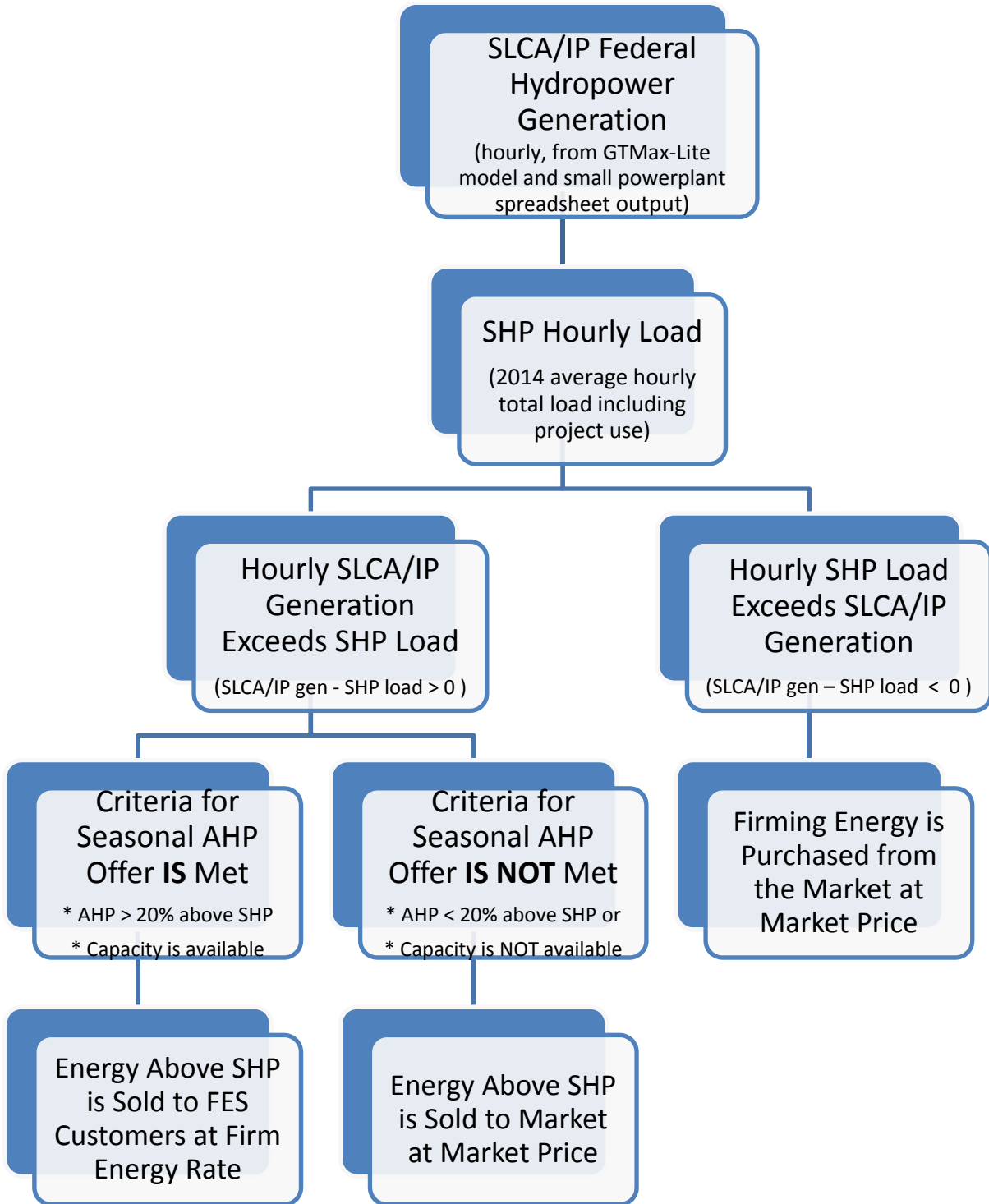

1
2
3

FIGURE K.2-1 Determination of Energy Hourly Expense or Revenue

1 capacity cost avoided.¹² As explained in Section K.2.1, an important requirement of this
 2 SLCA/IP wholesale rate analysis is to maintain compatibility with the economic analysis
 3 presented in Section K.1. The AURORA capacity expansion module applied in the analysis
 4 indicated that additional capacity facilities (construction of new generation) would be required
 5 over the 20-year LTEMP period. Table K.2-3 contains the same costs that were used in the
 6 power systems economic analysis described in Section K.1. It shows the capacity expense
 7 required over the 20-year period for each alternative.
 8

9 The net energy expense for each alternative is computed as described above and
 10 illustrated in Figure K.2-2. Added to this figure is the capacity cost, by year, for each alternative.
 11 The sum of these two numbers is the total Western expense that is incorporated into the
 12 computation of wholesale rates (Figure K.2-2).
 13
 14

15 **TABLE K.2-3 Total Levelized Capital and Fixed O&M Cost (million 2015\$) for System Capacity**
 16 **Expansion by Alternative and Year**

| Year | Alternative A (No Action Alternative) | Alternative B | Alternative C | Alternative D (Preferred Alternative) | Alternative E | Alternative F | Alternative G |
|------|------------------------------------------------|------------------|------------------|------------------------------------------------|------------------|------------------|------------------|
| 2015 | 0.0 | 0.0 | 0.0 | 0.0 | 0.0 | 0.0 | 0.0 |
| 2016 | 0.0 | 0.0 | 0.0 | 0.0 | 0.0 | 0.0 | 0.0 |
| 2017 | 0.0 | 0.0 | 0.0 | 0.0 | 0.0 | 12.2 | 0.0 |
| 2018 | 12.2 | 12.2 | 24.5 | 12.2 | 12.2 | 36.7 | 24.5 |
| 2019 | 46.7 | 46.7 | 58.9 | 46.7 | 46.7 | 71.2 | 58.9 |
| 2020 | 81.1 | 81.1 | 93.4 | 81.1 | 81.1 | 105.6 | 93.4 |
| 2021 | 81.1 | 81.1 | 93.4 | 93.4 | 93.4 | 105.6 | 93.4 |
| 2022 | 115.6 | 115.6 | 127.8 | 127.8 | 127.8 | 140.1 | 127.8 |
| 2023 | 150.0 | 150.0 | 162.2 | 162.2 | 162.2 | 174.5 | 162.2 |
| 2024 | 162.2 | 162.2 | 174.5 | 162.2 | 162.2 | 186.7 | 174.5 |
| 2025 | 174.5 | 174.5 | 186.7 | 174.5 | 174.5 | 199.0 | 186.7 |
| 2026 | 186.7 | 186.7 | 199.0 | 186.7 | 199.0 | 211.2 | 199.0 |
| 2027 | 199.0 | 199.0 | 211.2 | 211.2 | 211.2 | 223.5 | 211.2 |
| 2028 | 211.2 | 211.2 | 223.5 | 223.5 | 223.5 | 235.7 | 223.5 |
| 2029 | 235.7 | 223.5 | 235.7 | 235.7 | 235.7 | 248.0 | 248.0 |
| 2030 | 248.0 | 248.0 | 248.0 | 248.0 | 248.0 | 260.2 | 260.2 |
| 2031 | 260.2 | 260.2 | 260.2 | 260.2 | 260.2 | 272.5 | 272.5 |
| 2032 | 297.0 | 297.0 | 309.2 | 309.2 | 309.2 | 321.5 | 309.2 |
| 2033 | 309.2 | 309.2 | 321.5 | 321.5 | 321.5 | 333.7 | 321.5 |
| 2034 | 270.0 | 267.6 | 274.9 | 274.9 | 274.9 | 287.2 | 282.3 |

17

¹² Capacity in this context is LTF capacity that Western must acquire as a result of a reduction in Glen Canyon Powerplant output that is caused by a change in operating criteria specified under an LTEMP alternative. It is distinctly different from the short-term capacity discussed in the previous section that is dependent on natural short-term hydrological variability.

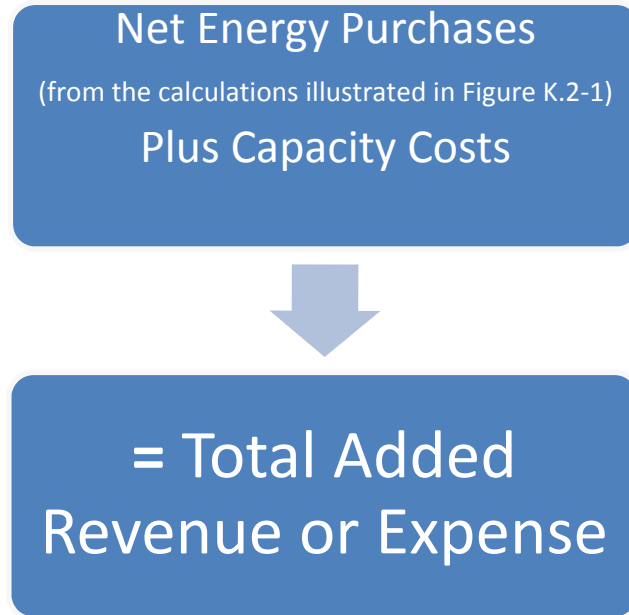

FIGURE K.2-2 Determination of Total Net Expense or Revenue by Year for Each Alternative

Table K.2-3 is a reproduction of a table from Section K.1. It is the estimated expense of capacity construction under each alternative. Alternative A includes capacity expenses, not because of a changed operation at Glen Canyon Dam or a change in SLCA/IP commitment levels by Western, but because of growth in electrical demand and the need for SLCA/IP customers to have to build new generating units to meet growing electrical demand. Based on the analysis described in Section K.1, existing generating units are sufficient to meet electrical demand until 2017.

The difference between the capacity expenses under Alternative A and the other alternatives is a function of how the LTEMP EIS alternatives affect the available capacity at Glen Canyon Dam. Differences in capacity expenses from Alternative A are a result of implementing the alternative. Table K.2-4 shows the differences in capacity expenses from Alternative A. The numbers in Table K.2-4 (differences from Alternative A) were used in this analysis. Notice that no capacity expense is required until 2018 under all alternatives except for Alternative F, which requires a capacity expense in 2017.

1 **TABLE K.2-4 Total Levelized Capital and Fixed O&M Cost (in millions of 2015\$) for System**
 2 **Capacity Expansion by Alternative and Year Expressed as the Difference from Alternative A**

| Total Levelized Capital and Fixed O&M Cost (millions 2015\$)—Difference from Alternative A | | | | | | |
|-----------------------------------------------------------------------------------------------|------------------|------------------|------------------|------------------|------------------|------------------|
| Year | Alternative B | Alternative C | Alternative D | Alternative E | Alternative F | Alternative G |
| 2015 | 0 | 0 | 0 | 0 | 0 | 0 |
| 2016 | 0 | 0 | 0 | 0 | 0 | 0 |
| 2017 | 0 | 0 | 0 | 0 | 12.2 | 0 |
| 2018 | 0 | 12.3 | 0 | 0 | 24.5 | 12.3 |
| 2019 | 0 | 12.2 | 0 | 0 | 24.5 | 12.2 |
| 2020 | 0 | 12.3 | 0 | 0 | 24.5 | 12.3 |
| 2021 | 0 | 12.3 | 12.3 | 12.3 | 24.5 | 12.3 |
| 2022 | 0 | 12.2 | 12.2 | 12.2 | 24.5 | 12.2 |
| 2023 | 0 | 12.2 | 12.2 | 12.2 | 24.5 | 12.2 |
| 2024 | 0 | 12.3 | 0 | 0 | 24.5 | 12.3 |
| 2025 | 0 | 12.2 | 0 | 0 | 24.5 | 12.2 |
| 2026 | 0 | 12.3 | 0 | 12.3 | 24.5 | 12.3 |
| 2027 | 0 | 12.2 | 12.2 | 12.2 | 24.5 | 12.2 |
| 2028 | 0 | 12.3 | 12.3 | 12.3 | 24.5 | 12.3 |
| 2029 | -12.2 | 0 | 0 | 0 | 12.3 | 12.3 |
| 2030 | 0 | 0 | 0 | 0 | 12.2 | 12.2 |
| 2031 | 0 | 0 | 0 | 0 | 12.3 | 12.3 |
| 2032 | 0 | 12.2 | 12.2 | 12.2 | 24.5 | 12.2 |
| 2033 | 0 | 12.3 | 12.3 | 12.3 | 24.5 | 12.3 |
| 2034 | -2.4 | 4.9 | 4.9 | 4.9 | 17.2 | 12.3 |

3
4
5
6
7
8
9
10
11
12
13
14
15
16

K.2.6 Western Replacement Resources

Using AURORA capacity expansion path modeling, the power systems analysis identified lost Glen Canyon Dam Powerplant capacity that would result from alternative-specific differences in operations and changed system capacity expansion paths. However, Western’s FES power obligations are unaltered over the time period of this analysis, at least through FY 2024. Therefore, it is assumed for this analysis that Western purchases this capacity and incurs capacity firming costs.

When capacity in the region is in short supply, Western’s firming purchases either include a capacity premium or Western makes a capacity purchase. For this analysis, it is assumed that Western purchases the electrical capacity projected by the AURORA capacity

1 expansion module. The capacity expenses included in this analysis are the differences from those
2 for Alternative A.¹³

3
4 Western’s purchase of electrical power to meet contractual obligations is a common
5 occurrence. It is quite typical for Western to make these purchases during drier years with low
6 release targets. Even in average years, Western purchases firming energy on some days or for
7 some hours. Typically, Western purchases electrical energy on an hourly basis for the days or
8 months ahead. However, Western’s CRSP Management Center has also purchased firming
9 energy for a future season or year. Western has also once contracted for electrical power and
10 energy over a multi-year period.

11
12 It is also assumed that, when electrical capacity in the region is in short supply, utilities
13 that buy electricity at a price that covers the average cost, including the cost of capital and fixed
14 O&M. For this analysis, it is assumed that Western purchases the capacity needed to make up for
15 losses in capacity that results from alternative-specific changes in Glen Canyon Dam operations
16 (i.e., the difference between FES capacity and the alternative-specific SLCA/IP federal
17 hydropower firm capacity that is based on a 90% exceedance level).

18
19 Electrical capacity additions by Western’s FES customers are required under
20 Alternative A over the 20-year analysis period, with existing SLCA/IP contractual obligations in
21 place. These additions are required because of growth in electrical demand. However, if there is
22 a change in the operation of Glen Canyon Dam that reduces the powerplant’s firm capacity—as
23 would occur under most of the LTEMP alternatives—additions to electrical capacity would be
24 required.¹⁴ The assumption used for this analysis is that Western purchases the capacity
25 identified as the amount lost under each alternative, costing the amounts specified in
26 Table K.2-3. The differences in total costs include levelized capital and fixed O&M between
27 each alternative and Alternative A.

28
29 To be clear, Table K.2-3 is a duplication of the power economic analysis (Section K.1).
30 Western would not incur the capacity expansion costs for Alternative A. Added capacity costs
31 needed for load growth in Alternative A are not included. Only the differences in capacity costs
32 between Alternative A and the other alternatives are included in the analysis.

33 34 35 **K.2.7 Post-2024 Marketing Period**

36
37 Western markets SLCA/IP electrical power under firm, long-term contracts. Under these
38 contracts, Western is required to deliver this electrical power to federal points of delivery
39 regardless of hydrological conditions or changes in the operational criteria of the SLCA/IP
40 hydropower plants. The current FES marketing contracts expire on September 30, 2024. For the

¹³ See Section K.1 for details on the generation types, years in which construction occurs, and pricing assumptions.

¹⁴ This is not the case for Alternative B. Under Alternative B, Glen Canyon Dam marketable capacity is increased over that of Alternative A. Fewer capacity additions are required.

1 period following 2024, Western is currently engaged in developing a marketing plan. This
2 requires a formal public process in compliance with applicable federal law.

3
4 For the purpose of completing this analysis, certain assumptions had to be made. First, it
5 was assumed that Western will continue with its current SLCA/IP obligations until the current
6 marketing period ends and the existing contracts expire.¹⁵ This requires that Western deliver the
7 same amount of electrical power and energy to SLCA/IP customers until the end of FY 2024,
8 regardless of the alternative analyzed. Second, recognizing that there is a period of uncertainty
9 between 2025 and 2034, net firming expenses for the post-2024 time period were analyzed under
10 two sets of assumptions. These are as follows:

- 11
- 12 • A continuation of existing SLCA/IP FES contract commitments between
13 FY 2025 and FY 2034 (no change); and
 - 14
 - 15 • A reduction in SLCA/IP FES contract commitments so that net firming
16 expenses are equal to \$0 between FY 2025 and FY 2034. This means, for the
17 numbers included in the SLCA/IP power repayment study, zero dollars of
18 firming expense and zero additional dollars of revenue from market sale or
19 from AHP sales (resource available).
 - 20

21 These two assumptions constitute “bookends” regarding the outcomes possible in the
22 development of the post-2024 marketing plan.¹⁶

23
24 These bookends are for modeling purposes only. They represent a very broad range of
25 possible FES obligations of electrical power in the post-2024 marketing period.

26
27 Obligations of electrical capacity under the current marketing plan were based on a 90%
28 exceedance level (i.e., the amount of hydropower capacity available 90% of the time). This level
29 of marketable capacity is consistent with marketing plans established by other Western regional
30 offices. In establishing power obligations for the post-2024 marketing period, Western will
31 consider the capacity and energy available from the SLCA/IP units including those at the Glen
32 Canyon Dam Powerplant and will establish, through a public process, an appropriate and
33 reasonable amount of marketable capacity and energy to provide to FES customers. The range of

¹⁵ There is a provision in the existing SLCA/IP contracts to modify the FES obligations upon a 5-year notice to SLCA/IP customers. However, considering the probable timing of new operating criteria for the Glen Canyon Dam following the completion of the LTEMP DEIS and the issuance of a ROD, a 5-year notice would not be significantly different than the end of the current marketing period.

¹⁶ Western could choose a post-2024 SLCA/IP FES obligation of electric power that exceeds its current obligation. However, prior to completion of the required public process it would be difficult to determine what the higher obligation would be that could be considered a reasonable bookend. Moreover, the time-frame available to complete this analysis required that the analysis be simplified. The assumption that the post-2024 SLCA/IP FES obligation continues existing commitments was easier to accomplish since much of the data related to this assumption was produced in Section K.1.

1 SLCA/IP impacts described for these bookends will almost certainly encompass the actual rate
2 impact, once the post-2024 marketing plan is completed.

3
4 It should be noted that the establishment of these bookends is not an attempt to predict or
5 to anticipate Western's choice prior to the conclusion of the required public process. This is an
6 analysis, not a description of policy or attempt to predict Western's post-2024 marketing plan.
7 This set of bookends is intended to reflect the range of reasonable possibilities. It is reasonable
8 that Western would continue existing commitment levels to ensure continued customer access to
9 the transmission associated with the energy. Moreover, it is also reasonable to believe that
10 Western would establish post-2024 marketing plan commitments that exactly follow the power
11 resource available at the SLCA/IP power system.

14 **K.2.8 Power Repayment Studies to Determine Rate Impacts**

15
16 Western sets rates as low as possible consistent with sound business principles to repay
17 the federal government's investment in generation and transmission facilities in addition to
18 specific non-power costs that power users are legislatively required by Congress to repay, such
19 as irrigation costs that are beyond the irrigators' ability to repay. Sales of federal electric power
20 and transmission repay all costs (including interest) associated with generating and delivering the
21 power. Western prepares a PRS for each specific power project to ensure the rates are sufficient
22 to recover expenses, including O&M, transmission, interest, replacement/upgraded equipment,
23 purchased power, and wheeling. The PRS consists of two parts: historical data and future
24 forecasted data. The historical data is a record of project repayment from the beginning of the
25 project to the most recent year for which audited financial data are available. The first future year
26 in the PRS is the first year for which forecasts, rather than actual data, are used. The last future
27 year in the PRS must cover the final year allowed for repayment of historical investment.

28
29 Although the tool used to calculate the PRS has changed many times in the past, the
30 principles underlying project repayment have not. These principles are summarized in
31 U.S. Department of Energy (DOE) Order RA 6120.2 that governs project repayment and
32 financial reporting for the DOE Power Marketing Administrations. In addition to Order
33 RA 6120.2, Western's PRSs must meet the Federal Energy Regulatory Commission's rate filing
34 requirements and procedures in 18 CFR Part 300.

37 **K.2.8.1 PRS Expenses**

38
39 All annual costs that are to be repaid by power customers must be included in the PRS.
40 These costs include O&M, purchased power, transmission and other expenses, and interest
41 expense. Interest expense is calculated by multiplying each investment's prior year unpaid
42 balance by the appropriate interest rate.

43
44 Tables K.2-5 and K.2-6 show the total net purchase power costs for each year for each
45 alternative. These tables show net purchase power expenses only. They do not include other
46 O&M expenses, interest or principle payments. Positive numbers indicate net purchase power

1 **TABLE K.2-5 Total Net Purchase Power Expenses (thousand 2015\$) by Year and Alternative for**
 2 **the Continuous Current Obligations Scenario^a**

| Year | Alternative A (No Action Alternative) | Alternative B | Alternative C | Alternative D (Preferred Alternative) | Alternative E | Alternative F | Alternative G |
|------|------------------------------------------------|------------------|------------------|------------------------------------------------|------------------|------------------|------------------|
| 2015 | 31,200 | 29,800 | 35,300 | 32,000 | 31,600 | 44,100 | 34,800 |
| 2016 | 96,900 | 95,200 | 93,500 | 98,300 | 96,800 | 104,200 | 98,800 |
| 2017 | 68,600 | 68,800 | 70,500 | 69,700 | 70,300 | 89,920 | 73,800 |
| 2018 | 49,500 | 74,100 | 68,320 | 54,200 | 51,500 | 87,930 | 72,020 |
| 2019 | 17,700 | 13,300 | 30,820 | 22,900 | 18,000 | 49,730 | 38,220 |
| 2020 | 34,700 | 33,000 | 48,220 | 37,100 | 35,700 | 69,930 | 53,020 |
| 2021 | 31,400 | 29,900 | 48,420 | 47,920 | 46,920 | 70,630 | 52,620 |
| 2022 | 4,350 | 3,650 | 13,020 | 14,750 | 15,400 | 26,780 | 16,570 |
| 2023 | -82,550 | -79,810 | -63,220 | -67,640 | -67,550 | -59,290 | -66,150 |
| 2024 | -36,580 | -33,010 | -6,710 | -43,190 | -41,360 | -20,400 | -36,130 |
| 2025 | -70,810 | -69,840 | -55,780 | -64,110 | -70,420 | -47,120 | -59,360 |
| 2026 | 11,480 | 11,990 | 24,340 | 9,370 | 24,860 | 45,600 | 11,620 |
| 2027 | 29,400 | 29,900 | 46,320 | 53,320 | 45,120 | 68,830 | 62,320 |
| 2028 | 52,200 | 50,100 | 69,820 | 69,820 | 68,920 | 89,930 | 80,920 |
| 2029 | 75,000 | 60,680 | 76,800 | 77,000 | 76,100 | 99,620 | 97,220 |
| 2030 | 66,800 | 66,000 | 67,700 | 67,700 | 66,800 | 91,120 | 86,620 |
| 2031 | 89,100 | 89,900 | 95,300 | 94,600 | 93,400 | 115,420 | 120,720 |
| 2032 | 70,900 | 70,200 | 84,320 | 84,120 | 83,420 | 108,630 | 91,520 |
| 2033 | 67,800 | 66,500 | 84,820 | 84,920 | 84,020 | 107,730 | 91,720 |
| 2034 | 35,900 | 31,240 | 48,130 | 46,830 | 46,230 | 71,540 | 72,020 |

^a These numbers are compared to a condition in which generation is just equal to SHP obligations. Positive numbers indicate net firming purchases. Negative numbers indicate revenues collected above a condition in which generation is just equal to SHP obligations.

3
 4
 5 expenses. Negative numbers indicate that generation from SLCA/IP power plants is sufficient to
 6 meet SHP obligations and include additional sales of electricity to FES customers (AHP) or
 7 additional sales to the market. The numbers in these tables are net purchase power expenses
 8 compared to a condition in which electrical generation is just sufficient to meet SHP obligations
 9 without firming expenses and without sales of surplus electricity to FES customers or to the
 10 market. Note that the negative numbers occur in the years 2023-2025 and carry across all the
 11 alternatives in these years. These are the wettest years of the representative trace used for this
 12 analysis..

13
 14 Table K.2-5 is purchase power for the scenario in which the existing SLCA/IP
 15 commitment levels for energy and capacity are maintained. Table K.2-5 is purchase power for
 16 the scenario in which Western reduces its commitment levels, post-2024, to just the amount of
 17
 18

1 **TABLE K.2-6 Total Net Purchase Power Expenses by Year and Alternative for the**
 2 **Reduced Obligations to Match Resource Scenario^{a, b}**

| Year | Alternative A (No Action Alternative) | Alternative B | Alternative C | Alternative D (Preferred Alternative) | Alternative E | Alternative F | Alternative G |
|------|---------------------------------------|---------------|---------------|---------------------------------------|---------------|---------------|---------------|
| 2015 | 31,200 | 29,800 | 35,300 | 32,000 | 31,600 | 44,100 | 34,800 |
| 2016 | 96,900 | 95,200 | 93,500 | 98,300 | 96,800 | 104,200 | 98,800 |
| 2017 | 68,600 | 68,800 | 70,500 | 69,700 | 70,300 | 89,920 | 73,800 |
| 2018 | 49,500 | 74,100 | 68,320 | 54,200 | 51,500 | 87,930 | 72,020 |
| 2019 | 17,700 | 13,300 | 30,820 | 22,900 | 18,000 | 49,730 | 38,220 |
| 2020 | 34,700 | 33,000 | 48,220 | 37,100 | 35,700 | 69,930 | 53,020 |
| 2021 | 31,400 | 29,900 | 48,420 | 47,920 | 46,920 | 70,630 | 52,620 |
| 2022 | 4,350 | 3,650 | 13,020 | 14,750 | 15,400 | 26,780 | 16,570 |
| 2023 | -82,550 | -79,810 | -63,220 | -67,640 | -67,550 | -59,290 | -66,150 |
| 2024 | -36,580 | -33,010 | -6,710 | -43,190 | -41,360 | -20,400 | -36,130 |
| 2025 | 0 | 0 | 0 | 0 | 0 | 0 | 0 |
| 2026 | 0 | 0 | 0 | 0 | 0 | 0 | 0 |
| 2027 | 0 | 0 | 0 | 0 | 0 | 0 | 0 |
| 2028 | 0 | 0 | 0 | 0 | 0 | 0 | 0 |
| 2029 | 0 | 0 | 0 | 0 | 0 | 0 | 0 |
| 2030 | 0 | 0 | 0 | 0 | 0 | 0 | 0 |
| 2031 | 0 | 0 | 0 | 0 | 0 | 0 | 0 |
| 2032 | 0 | 0 | 0 | 0 | 0 | 0 | 0 |
| 2033 | 0 | 0 | 0 | 0 | 0 | 0 | 0 |
| 2034 | 0 | 0 | 0 | 0 | 0 | 0 | 0 |

^a These numbers are compared to a condition in which generation is just equal to SHP obligations. Positive numbers indicate net firming purchases. Negative numbers indicate revenues collected above a condition in which generation is just equal to SHP obligations.

^b Zeroes indicate that no purchase power expenses are required to firm to contract obligations. Other expenses; operations, maintenance, repayment of investment and interest payments continue.

3
 4
 5 energy and capacity provided by the resource. These data were developed as described above
 6 and include the following:

- 7
- 8 • Purchase power expense net of additions to revenue from the sale of AHP, and
- 9
- 10 • Cost of capacity including capital and fixed O&M expenses relative to
- 11 Alternative A.
- 12
- 13

14 **K.2.8.2 PRS Revenue Distribution**

15
 16 The CRSP Management Center uses a balloon payment methodology for repayment of
 17 project costs. This means that principal payments for capital costs are not due until the end of

1 their repayment period. For example, if an investment has a repayment period of 50 years, the
2 total principal payment can be made in the 50th year. The revenue distribution described in this
3 section, and the PRS calculations described in the next section, pertain to the balloon payment
4 methodology.
5

6 Within the PRS, electrical power revenues within the year must first be applied to the
7 annual O&M costs. Interest expense is considered an operational cost, but it is the last in priority.
8 After all annual costs are paid, capital costs must be repaid in the following order: (1) required
9 principal payments, (2) deficits, and then (3) the highest interest-bearing investment. Required
10 payments are payments on those investments that still have an unpaid balance at the end of their
11 repayment period.
12

13 **K.2.8.3 The SLCA/IP PRS**

14 The SLCA/IP PRS includes the revenue requirements for the CRSP, Collbran, and Rio
15 Grande projects, which were integrated for marketing and ratemaking purposes on October 1,
16 1987, in addition to two participating projects of the SLCA/IP system that have power facilities,
17 the Dolores and the Seedska-dee Projects. The CRSP Management Center forecasts 5 years of
18 firming purchased power in the PRS. This reflects the firming purchase power requirements
19 between projected generation and FES contract obligations. For the remaining future years, a
20 forecast of \$4 million per year is projected to cover operational purchase power costs for the
21 EMMO located in Montrose, Colorado.
22

23 Western used the FY 2015 preliminary SLCA/IP PRS as the template to calculate the rate
24 impacts for all the alternatives. The generation, project use, energy, and capacity values for each
25 alternative were updated in the PRS, and the rate was computed for each alternative. The rate-
26 setting period in the PRS is determined by calculating the revenue requirement from the first
27 future year through the year with the highest revenue requirement, which is referred to as the
28 pinch-point year. For this rate analysis, the first future year used in the template is FY 2018. The
29 pinch point used in the template is FY 2025 and is driven by a multi-million dollar Aid-to-
30 Participating-Projects required payment due that year. Consequently, the rate-setting period for
31 the template, from the first future year to the pinch point, is FY 2018 through FY 2025. The
32 revenue requirements are recovered through a 50/50 split between the energy and capacity rates.
33 Three rates calculated in the PRS are energy, capacity, and composite.
34

35 The energy rate is the rate that sets forth the charges for energy. It is expressed in
36 mills/kWh and is applied to each kilowatt-hour delivered to an FES customer. The energy rate is
37 estimated by a rates specialist and manually entered in the PRS, and a study is run to determine if
38 the rate is sufficient to cover costs without creating a deficit. If the study produces a deficit
39 balance, a new rate is entered into the PRS and the study is run again. The estimated rate is
40 increased until the study no longer produces a deficit.
41
42
43
44

1 The capacity rate is the rate that sets forth the charges for capacity. It is expressed in
2 \$/kW-month and applied to each kilowatt of the CROD. The formula for the capacity rate is
3 linked to the energy rate and is simultaneously updated to ensure the revenue requirement is
4 recovered through a 50/50 split between the capacity and energy rates.¹⁷

5
6 The composite rate is the rate for firm power, which is the total annual revenue
7 requirement for capacity and energy divided by the total annual energy sales. It is expressed in
8 mills/kWh and used for comparison purposes only. The composite rate is calculated after the
9 energy rate is computed and the rate-setting period is established. The composite rate, in
10 mills/kWh, is calculated as the ratio of the total revenue required during rate-setting period to the
11 total projected sales during the rate-setting period.

12 13 14 **K.2.8.4 Standard PRS Rate-Setting Method Versus the Method Used in This** 15 **Analysis**

16
17 In order to accurately compute the impact of each alternative in terms of energy and
18 capacity rates, projected power purchases for the entire rate-setting period of 2015 through 2034
19 were used. This deviates from Western's normal 5-year forecast in order to accurately capture
20 each alternative's rate impacts. Table K.2-4 shows power purchase costs, assuming that current
21 FES obligations would continue after FY 2024, and Table K.2-5 shows results for the marketing
22 structure that would incur zero firming expenses after 2024. Table K.2-6 shows the SLCA/IP rate
23 impact for each alternative.

24 25 26 **K.2.9 Results**

27
28 Table K.2-6 shows the estimated SLCA/IP energy and capacity rates by alternative. This
29 reflects Western's current method of billing. SLCA/IP FES customers are billed monthly for the
30 amount of energy used and for their capacity allocation. A composite rate is an index number
31 that includes the energy and capacity rates together and may be useful for comparison purposes.

32
33 Table K.2-7 shows that there is a significant difference between the "bookend"
34 assumptions. Comparing the composite rate, the No Change condition results in higher SLCA/IP
35 rates across all alternatives compared to the Resource Available condition. For the No Change
36 condition, the highest rate occurs under Alternative G (38.75 mills/kWh). The lowest SLCA/IP

¹⁷ The production of hydropower that Western markets requires the construction of a dam and water storage. The fuel for these hydropower facilities is water, which is costless. Under the law, Western is required to set "cost-based" rates. If Western used marginal cost to set capacity and energy rates, the energy rate would be zero or near zero. It has been Western's practice to set FES rates so that 50% of the revenues collected through the sale of power are through the capacity rate and 50% of the revenues collected are through the energy rate. Other Federal power marketing agencies use different rate-setting strategies, but their rates are also required to be cost-based. The "50/50 split" is not a legal requirement, but, rather, a common Western practice.

1 **TABLE K.2-7 SLCA/IP Rate Impact by Alternative**

| | Alternative A (No Action Alternative) | | Alternative B | | Alternative C | | Alternative D (Preferred Alternative) | | Alternative E | | Alternative F | | Alternative G | |
|-------------------------------|---------------------------------------------|-----------------|---------------|-------|---------------|-------|---------------------------------------------|-------|---------------|-------|---------------|-------|---------------|-------|
| | NC ^a | RA ^b | NC | RA | NC | RA | NC | RA | NC | RA | NC | RA | NC | RA |
| | | | | | | | | | | | | | | |
| Pinch-Point FY | 2031 | 2055 | 2031 | 2055 | 2031 | 2055 | 2031 | 2055 | 2031 | 2055 | 2025 | 2057 | 2031 | 2055 |
| Composite (mills/kWh) | 32.64 | 25.19 | 32.69 | 25.07 | 33.77 | 25.65 | 33.65 | 25.22 | 33.41 | 25.16 | 37.79 | 27.53 | 38.75 | 26.65 |
| Energy (mills/kWh) | 13.52 | 13.40 | 13.54 | 13.22 | 13.99 | 14.55 | 13.94 | 13.78 | 13.84 | 14.01 | 15.67 | 16.86 | 16.07 | 15.22 |
| Capacity (\$/kW- month) | 5.74 | 5.69 | 5.75 | 5.62 | 5.94 | 6.18 | 5.92 | 5.85 | 5.88 | 5.95 | 6.66 | 7.16 | 6.83 | 6.50 |

^a NC = No change from current FES commitment levels.

^b RA = Resource available. Commitment level equals available SLCA/IP federal hydropower resource.

2
 3
 4 rate occurs under Alternative A (32.64 mills/kWh), although Alternative B is almost the same
 5 rate (32.69 mills/kWh). The range is 6.11 mills/kWh, with Alternative G producing a rate that is
 6 19% higher than Alternative A (the no action alternative). The Resource Available condition
 7 produces similar results. The lowest SLCA/IP rate occurs under Alternative B (25.07
 8 mills/kWh), almost identical to Alternative A (25.19 mills/kWh). Under this condition, the
 9 highest SLCA/IP rate occurs under Alternative F (27.53 mills/kWh). The range is smaller under
 10 this condition with Alternative F producing a rate that is 2.46 mills/kWh or 10% higher than
 11 Alternative B.

12
 13 It is worth noting that under either of the post-2024 “bookend” conditions, Alternatives
 14 A, B, C, D, and E produce similar SLCA/IP rates. Alternatives F and G produce significantly
 15 higher SLCA/IP rates.

16
 17 As described previously, the no change and resource available bookends are used for
 18 modeling purposes only and do not represent estimates or indications of the post-2024
 19 commitment levels that may result from the public process. Alternative impacts on SLCA/IP
 20 rates illustrated in Table K.2-7 are good indications of the rank order of the alternatives and the
 21 direction of impacts (positive or negative), and they encompass the range of the actual future rate
 22 impacts once the post-2024 marketing plan has been implemented. For the final LTEMP EIS,
 23 assumptions concerning post-2024 commitment levels may be revised to duplicate the range
 24 examined in the economic analysis described in Section K.1. This would be a SLCA/IP capacity
 25 obligation based on the 99th, 90th, and 50th percentile exceedance levels. The resulting range
 26 will likely be somewhat narrower than the results of the bookend analysis presented in this draft.
 27

1 **K.2.9.1 Pinch-Point Year**
2

3 Table K.2-7 includes pinch-point year information. The pinch point is the year in which
4 the largest revenue requirement occurs in the future and is influential in setting the SLCA/IP rate.
5

6 There were three common pinch points that occurred when determining alternative-
7 specific rates:
8

- 9 • 2025, caused by a required Aid-to-Participating-Projects Payment (Duchesne);
- 10 • 2031, caused by purchase power expense; and
- 11 • 2055, caused by a required Aid-to-Participating-Projects Payment (Starvation
12 Reservoir).
- 13
- 14
- 15

16 As described in Section K.2.3, Western’s SLCA/IP rates are set to assure repayment of
17 all authorized water projects. In the current PRS, repayment of existing projects and repayment
18 of yet-to-be constructed water projects will be completed in 50 years. The pinch-point is the year
19 in which the largest future revenue requirement occurs. These pinch-points occur when a large
20 water project – or “block” of a large water project – requires a repayment. After this pinch-point
21 year, revenues are sufficient to complete repayment of remaining water projects. Therefore, it is
22 said that the pinch-point year drives the rate.
23

24 Higher purchase power requirements require increasing the revenue requirement in the
25 pinch-point year. Because the amount of purchase power is not consistent across alternatives,
26 neither is the revenue requirement. The pinch-point year varies among alternatives because of the
27 variation of purchase power amounts by alternative. It is not possible to use a consistent pinch-
28 point year because each alternative produces different annual revenue requirements, and
29 therefore a different schedule for completing repayment. The only way to have a consistent
30 pinch-point year is to have consistent revenue requirements across each alternative.¹⁸ With a
31 fixed rate, the lower the purchase power, the more revenue available for discretionary repayment
32 of investments which reduces annual interest and ultimately the annual revenue requirements.
33 Conversely, increases in purchase power reduce the amount available for repayment on
34 investment which leads to higher interest payments and subsequently, higher annual revenue
35 requirements.
36
37
38

¹⁸ One could argue that the SLCA/IP rate analysis should “force” the SLCA/IP rate to have the same pinch-point year for each alternative so that the impact of the alternatives is a more “apples to apples” comparison. This was considered as an approach, but it was decided that forcing such a condition would require a significant change in the rate-setting process. Moreover, it may be useful to the reader to know how alternatives differ in terms of their effect on setting a pinch-point year.

1 **K.2.10 Definitions Used in Section K.2**

2
3 **Available Hydropower (AHP):** The amount of SLCA/IP electrical energy and/or capacity
4 available to FES customers for either the summer or winter seasons. This is designated for each
5 month of the season.

6
7 **Aid to Participating Projects:** This is the part of an authorized irrigation/water project that is
8 assigned to power for repayment. There is an assigned amount in the PRS for each authorized
9 project.

10
11 **Composite Rate:** This is not a rate that is used for billing purposes. It is for comparisons. One
12 takes the capacity rate and the energy rate, assumes a load factor and calculates the average rate
13 per kilowatt-hour.

14
15 **Contract Rate of Delivery (CROD):** the amount of capacity allocated to an FES customer, by
16 season, for the marketing period. It represents the “ceiling” obligation. An FES customer can
17 utilize AHP capacity up to this amount.

18
19 **Colorado River Storage Project (CRSP):** Federal hydropower facilities in the Upper Colorado
20 River Basin including Glen Canyon, Flaming Gorge, Fontenelle and the Aspinall Units.

21
22 **CRSP Management Center:** Western’s Colorado River Storage Project Management Center.
23 This is the Western office that has the responsibility for marketing the SLCA/IP power resources
24 and for setting SLCA/IP FES rates.

25
26 **Federal Energy Regulatory Commission (FERC):** A federal commission that regulates the
27 interstate transmission of electricity, natural gas, and oil. FERC also reviews proposals to build
28 liquefied natural gas terminals and interstate natural gas pipelines as well as licensing
29 hydropower projects. The FERC has limited jurisdiction over Western’s rates, but must ensure
30 that Western’s project rates are sufficient to repay authorized projects.

31
32 **Load Factor:** A proportion of average energy used over a specified time period compared to
33 peak demand for the same time period.

34
35 **No Change Scenario (NC):** This scenario represents a post-2024 condition where Western
36 continues its current obligations to provide capacity and energy from the SLCA/IP resources.

37
38 **Pinch Point Year:** In setting the SLCA/IP FES rate, this is the year in which the highest
39 payment obligation exists. It is said to “drive” the rate.

40
41 **Project Use:** Electrical capacity and energy reserved to power authorized water projects.

42
43 **Power Repayment Study (PRS):** this is the name of the model used by Western to set rates.
44 PRS models are project specific.

1 **Resources Available Scenario (RA):** This scenario represents a post-2024 condition where
2 Western reduces its current commitment of SLCA/IP energy and capacity to exactly match the
3 production of power from the SLCA/IP resources.
4

5 **Sustainable Hydropower (SHP):** The amount of SLCA/IP electrical energy and capacity
6 available to FES customers over the course of the marketing plan. This is the “firm” commitment
7 that Western, in low release conditions, must firm up. There is an SHP capacity and energy
8 amount for each month of the season.
9

10 **Salt Lake City Area Integrated Projects (SLCA/IP):** The Collbran, Rio Grande, and the
11 Colorado River Storage Projects were integrated by Western in 1986 for marketing and rate-
12 setting purposes.
13
14

15 **K.3 IMPACTS ON RETAIL ELECTRICITY RATES**

16

17 This section documents effects of Glen Canyon Dam Long-Term Experimental and
18 Management Plan (LTEMP) alternatives on retail electricity rates and bills. Retail rate impacts
19 measure how LTEMP alternatives affect electricity bills paid by household and business
20 consumers who buy electricity from utility systems that directly or indirectly receive power from
21 the Salt Lake City Area Integrated Projects (SLCA/IP) through Western Area Power
22 Administration (Western). These impacts are documented in three sections that first explain the
23 methodological approach then summarize results and finally present the impacts.
24
25

26 **K.3.1 Analysis Approach**

27

28 Retail rate and residential bill impacts are derived from the power systems analysis
29 (described in Section K.1), SLCA/IP allocations, and publicly available retail rate and sales data
30 using various allocation formulas. The foundation of the analysis is a database of retail sales,
31 retail rates, and SLCA/IP energy allocations for utility systems that are given preference in
32 power allocation from the SLCA/IP (referred to here as preference power). Rate impacts are
33 based on the assumption that the capital, operating, and administrative costs of Glen Canyon
34 Dam do not substantively change under different LTEMP alternatives when the energy output
35 from the dam changes. Because these operating and administrative costs are not affected by the
36 LTEMP alternatives, rate impacts result from changes in the cost associated with replacing
37 capacity and/or energy with changes in dam operations. The wholesale power costs associated
38 with changes in dam operations are labeled “grid costs” and include costs of replacement
39 capacity, changed production costs (fuel costs, purchased power costs, and variable operation
40 and maintenance [O&M] costs), and differential fixed O&M costs. Using the retail data along
41 with aggregate grid costs, the retail rate impacts of the LTEMP alternatives were determined for
42 the vast majority of municipal, cooperative, and other entities that directly or indirectly receive
43 preference power from SLCA/IP. A separate analysis was made for American Indian Tribes
44 using SLCA/IP allocations to the Tribes combined with contract price data for special
45 arrangements that are made with Tribes for SLCA/IP energy and capacity. The special contract

1 arrangements imply that rate impacts for Tribes are generally greater than the rate impacts for
2 non-Tribal systems. This analysis is presented in Section K.4.

3
4 The primary output from the rate impact analysis is a set of figures and tables that present
5 the percent increase or decrease in electric rates and the changes in monthly electricity bills paid
6 by residential consumers of municipal utilities, cooperative distribution utilities, Tribal
7 authorities, and irrigation districts. (Retail consumers include businesses households and other
8 institutions, while residential only includes households.) The rate impacts of different LTEMP
9 alternatives are presented relative to Alternative A (the no action alternative). Rate impacts were
10 estimated for all of the utility systems that have available retail energy sales data published by
11 the Energy Information Agency (EIA) and incorporated more than 90% of entities that receive
12 power from the SLCA/IP in terms of energy allocation. Entities for which rate impacts cannot be
13 measured directly because of a lack of publicly available data include direct retail consumers
14 such as military bases, universities, and the DOE Albuquerque office. In addition to computing
15 rate impacts for companies with available data from the EIA, retail rate impacts for American
16 Indian Tribes were calculated. This calculation used data from utility systems that serve the
17 Tribes at a retail level combined with the effects of net benefit contracts between the Tribes and
18 wholesale utility systems that directly compensate for wholesale power. Contracts between
19 Tribes and wholesale systems to provide benefits are termed net benefit contracts. This analysis
20 is presented in Section K.4.

21
22 Four primary tasks were undertaken to compute the rate impacts on retail consumers.
23 These tasks were:

- 24
25 1. Compiling retail energy sales (\$), rate (\$/MWh), and residential bill (\$/month)
26 data for each utility system directly or indirectly receiving an allocation of
27 SLCA/IP federal preference power;
- 28
29 2. Computing year-by-year grid costs under LTEMP alternatives from the power
30 systems analysis and analyzing how the capital cost of new capacity is
31 translated into retail revenue requirements (the capital recovery factor or
32 carrying charge rate);
- 33
34 3. Allocating the aggregate grid cost impacts under LTEMP alternatives to
35 individual retail utility systems; and,
- 36
37 4. Presenting the disparate retail rate and residential bill impacts over time for
38 different systems.

39
40 Three information sources, as illustrated in Figure K.3-1, were used to compute the rate
41 impacts of LTEMP alternatives. The first set of inputs for the analysis was a database of sales,
42 rates, and SLCA/IP allocations for utility systems that receive federal preference power from the
43 SLCA/IP. The second set of inputs consisted of the aggregate grid cost combined data from the
44 power systems analysis with capital recovery charge analysis that represents the wholesale power
45 costs. The third set was macroeconomic data from the Energy Information Administration (EIA)
46 (EIA 2015b,c). These inputs were used to determine the relative rate impacts for individual

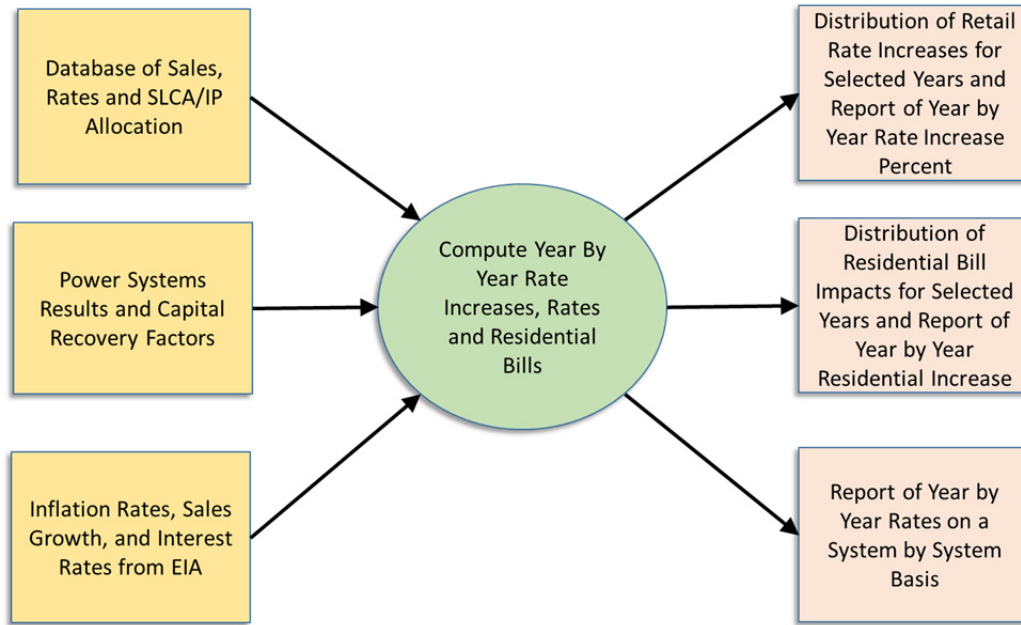

1
2 **FIGURE K.3-1 Flowchart Diagram of Rate Impact Analysis Process**

3
4
5 systems from different LTEMP alternatives. Varying impacts on individual systems were largely
6 driven by (1) the amount of preference power allocated to each system relative to the total
7 generation resources of the system, and (2) the current retail rate, which influences the
8 percentage change calculation (a higher rate results in a smaller percent change).
9

10 Explanations of analytical methods for determining rate impacts are organized around
11 Figure K.3-1. The next three sections explain the data input items listed on the left side of
12 Figure K.3-1. Section K.3.1.4 describes details of the calculation process referenced in the
13 middle of Figure K.3-1, and Sections K.3.2 and K.3.3 describe the rate impacts that are cited on
14 the right side of the figure. Additional description of the process to compute rate impacts for
15 American Indian Tribes appears in Section K.4.
16
17

18 **K.3.1.1 Database of Sales, Rates, and SLCA/IP Allocation for Retail Utility Systems**

19
20 The explanation of the database is separated into two parts that address: (1) how a list of
21 utility systems that receive federal preference power from SLCA/IP and distribute power to retail
22 residential, commercial, industrial and other consumers was compiled; and (2) how retail
23 statistics are gathered for utility distribution systems from Form EIA-861 detailed data files
24 (EIA 2015a).
25
26
27

List of Utility Systems that Distribute Power to Retail Consumers

Developing the database for retail rate analysis involved arranging a list of utility systems that sell electricity on a retail basis and that directly or indirectly receive SLCA/IP federal preference power allocations. The starting point for this list is tabulating utility systems that receive federal preference power from SLCA/IP. Western provided this information in a spreadsheet of allocations for the period October 1, 2008, through September 30, 2024 (Osiek 2014). The allocation data included information for 154 different systems that receive separate preference power allocations.

Some of the utility systems listed in the Allocation Report do not sell power on a retail basis to residential and business retail consumers. Five systems including (1) the Wyoming Municipal Power Agency (WMPA), (2) the Utah Municipal Power Agency (UMPA), (3) the Platte River Power Authority (Platte River), (4) the Colorado River Commission of Nevada (CRCN), and (5) Tri-State Generation and Transmission Cooperative (Tri-State) receive preference power allocations from SLCA/IP and then re-allocate power to distribution systems. Table K.3-1 shows that these five indirect systems comprise 47% of the total SLCA/IP federal preference power. Deseret Generation and Transmission Cooperative and the Utah Associated Municipal Power Systems are not included in the five indirect allocation entities because for these two systems, each of their member distribution systems receives distinct direct allocations.

For the systems with indirect allocation listed in Table K.3-1, it is necessary to compile retail sales and rate data on all of the individual systems that sell power to retail consumers because the larger wholesale systems do not sell to retail consumers. A list of retail entities that are members of indirect retail systems (e.g., distribution cooperatives [co-ops] that are members of Tri-State) have been obtained from Websites for the five indirect allocation utility systems (CRCN 2015; Platte River Power Authority 2015; Tri-State 2015; UMPA 2015; WMPA 2015).

TABLE K.3-1 Energy Allocations for Systems Receiving Indirect SLCA/IP Allocations

| System | Annual SLCA Energy Allocation (MWh) | Percent of Total Allocation |
|-------------------------------------------|-------------------------------------|-----------------------------|
| Systems Receiving Indirect Allocation | | |
| Wyoming Municipal Power Agency | 24,753 | 0.50% |
| Utah Municipal Power Agency | 290,604 | 5.87% |
| Platte River Power Authority | 502,467 | 10.15% |
| Colorado River Commission of Nevada | 88,212 | 1.78% |
| Tri-State Generation and Transmission | 1,424,012 | 28.76% |
| Subtotal Systems with Indirect Allocation | 2,330,048 | 47.05% |
| Systems Receiving Direct Allocation | 2,621,739 | 52.95% |
| Total Energy Allocation | 4,951,787 | 100.00% |

1 After including the retail systems that are members of indirect allocation utilities, the total
 2 number of retail utility systems in the database increases from 154 to 226.

3
 4
 5 **Retail Statistics for Distribution Utility Systems from the Form EIA-861 Database**

6
 7 Rate impact calculations for each entity required data for residential and nonresidential
 8 sales revenues and sales quantity. The primary source for the existing retail rates and retail
 9 residential, commercial, industrial, and other energy sales is the Form EIA-861 database
 10 (EIA 2015a). Data for direct retail consumers such as military bases and most American Indian
 11 Tribes are not included in the EIA database. After adjusting for complications associated with
 12 differences in system names, historical data availability, and systems the operate in multiple
 13 states, 91% of the preference power can be associated with retail sales data available in the EIA
 14 861 database as shown in Table K.3-2. Additional data for American Indian Tribes is derived
 15 from utility companies that serve the Tribal Reservation along with wholesale utility systems that
 16 are the SLCA/IP benefit crediting partners (see Section K.4). Tribal entities that provide data to
 17 the EIA 861 database (representing the figure of 44.19% in Table K.3-2) included Ak-Chin,
 18 Tohono O’odham Reservation, and the Navajo Tribal Utility Authority. These three systems
 19 operate their own utilities and do not have special contracting arrangements to secure their
 20 SLCA/IP allocation. After accounting for special net benefit contracts used by Tribal Authorities
 21 combined with retail utilities that serve the Tribes, the coverage of Tribes is 100%.

22
 23
 24 **TABLE K.3-2 Coverage of Retail Information from EIA Database Relative to SLCA/IP Preference**
 25 **Power Allocation^a**

| System | SLCA Annual Energy Allocation (MWh) | Percent of Total Energy Allocation | SLCA Energy with Retail Sales | Percent of Energy With Retail Sales |
|---------------------------------------------|----------------------------------------------|------------------------------------------|-------------------------------------|-------------------------------------------|
| WMPA, UAMPS, UMPA, CRCN, Platte River | 1,231,926 | 24.87 | 1,229,054 | 99.77 |
| Tri-State, Deseret | 1,840,470 | 37.15 | 1,840,470 | 100.00 |
| Co-ops not Included in Larger Entities | 210,951 | 4.26 | 210,951 | 100.00 |
| Electric Districts and Irrigation Districts | 123,588 | 2.49 | 108,401 | 87.71 |
| Municipalities not in JAAs (including SRP) | 921,408 | 18.60 | 921,408 | 100.00 |
| Military Bases | 70,550 | 1.42 | 0 | 0.00 |
| Tribal Authorities | 464,030 | 9.37 | 205,051 | 44.19 |
| Universities and DOE Office | 91,401 | 1.84 | 0 | 0.00 |
| Total | 4,954,323 | 100.00 | 4,515,334 | 91.14 |

^a Note: CRCN = Colorado River Commission of Nevada; JAA = Joint Action Agency; SRP = Salt River Project; UAMPS = Utah Associated Municipal Power Systems; UMPA = Utah Municipal Power Agency; WMPA = Wyoming Municipal Power Agency.

26
 27
 28

K.3.1.2 Incorporation of Power Systems Analysis and Capital Recovery Factors

The second category of information input to the rate impact analysis shown in Figure K.3-1 is projected grid cost data derived from the power systems analysis and capital recovery factors. The amount of annual aggregate capacity (in MW) that is added on an annual basis, the total annual variable production cost, and the fixed O&M costs for new capacity are obtained from the power systems analysis described in Section K.1. The amount of capacity that needs to be added under each LTEMP alternative due to changes in operations is converted to revenue requirements using a carrying charge analysis combined with the projected cost of constructing new generating plants.

To integrate power systems analysis with the rate impact calculations, selected results are summed together over the different systems that are simulated. Aggregating data from the power systems analysis across the large systems that were modeled and then allocating those costs to individual systems means that, in terms of the rate impact analysis, there is no difference in treatment between the small systems and the other eight utilities modeled in the power systems analysis. Equations used to convert the generation cost and capacity expansion data to aggregate grid cost impacts are listed below, where t represents the annual period, i represents the LTEMP alternative, and c represents the capacity type. The summation is over the new capacity type:

$$\text{Capacity Cost}_{t,i} = \sum \text{New Capacity}_{t,i,c} \times \text{Capacity Cost}_{t,i,c} \times \text{Carrying Charge Rate}_t,$$

$$\text{Fixed O\&M}_{t,i} = \sum \text{Accumulated Capacity}_{t,i,c} \times \text{Fixed O\&M Cost/kW-yr}_c, \text{ and}$$

$$\text{Grid Cost}_{t,i} = \text{Production Cost}_{t,i} + \text{Capacity Cost}_{t,i} + \text{Fixed O\&M}_{t,i}.$$

Carrying Charge Factors Applied to New Capacity That Account for Ownership and Financing Structures of Municipal and Cooperative Systems

Rate impacts cannot be directly calculated from outputs generated by the power systems analysis because of the manner in which plants are financed. The annual cost of new capacity that is charged to consumers is established from dollar amounts that are paid to bondholders who lend money for constructing a new plant. Annual funds collected to compensate for the cost of building new capacity is termed the “capital recovery factor” or the “carrying charge rate.” A detailed analysis has been made of carrying charges for individual municipal and cooperative systems as part of the rate impact analysis. The carrying charges used data from financial reports and derived revenue requirements from changes in the quantity of generating capacity. The analysis includes effects of municipally financed debt, debt service requirements, the tenor of debt, and other assumptions including the interest rate. Some of the considerations in deriving the carrying charge analysis include:

- The carrying charge for purposes of the rate impact depends on the debt structure used to finance the investment. If the bond repayment period is not the same as the plant life and/or the bond repayment does not increase with inflation (both of which are generally true) then the capital recovery for

1 purposes of the rate impact analysis is different than the economic carrying
2 charge used in the power system analysis;

- 3
- 4 • The carrying charge for rate impact analysis does not reflect differences in
5 risks associated with generating alternatives that are borne by consumers (for
6 example, the capacity from Glen Canyon Dam already exists, while the
7 ultimate cost of capacity from new generation plants has uncertain capital and
8 operating costs);
- 9
- 10 • The carrying charge for rate impact analysis is affected by the debt service
11 coverage and other specific features of bonds issued to finance construction
12 for municipal and cooperative systems;
- 13
- 14 • The year-by-year carrying charge measured using actual interest rates relevant
15 for measuring rate impacts is flat over the prospective tenor of the debt (by
16 contrast, the real carrying charge used in economic analysis in the initial year
17 of the plant life is lower than subsequent years);
- 18
- 19 • The carrying charge for generation and transmission cooperatives may be
20 affected by patronage capital that is generally part of the financing of a new
21 powerplant;
- 22
- 23 • The interest rate used in the calculation of carrying charges for rate impact
24 analysis should reflect the credit rating and the tax status of entities that will
25 finance the new construction; and
- 26
- 27 • The interest rate used for the carrying charge analysis changes over time when
28 interest rates change (as projected by the EIA).
- 29

30 The carrying charge rates implemented in the rate impact analysis are shown on
31 Figure F.3-2. The carrying charges applied in the rate impact simulation are a weighted average
32 of the carrying charges for taxable (e.g., co-op) and municipal financing. The weighted average
33 is derived from the energy allocations for (1) systems that issue taxable debt (co-ops and
34 irrigation districts), and (2) systems for which the interest is exempt from federal income taxes
35 (municipal systems). The weighted average carrying charge that converts one-time capital costs
36 for construction of new capacity into projected annual revenue requirements begins at a level of
37 7.03% in 2015 and eventually increases to 8.50% (the middle line in Figure K.3-2). By contrast,
38 if the same interest rate and inflation assumptions were applied to computing economic carrying
39 charges, the real capital recovery factor would only be 4.38% in 2014. This higher carrying
40 charge increases measured rate impacts.

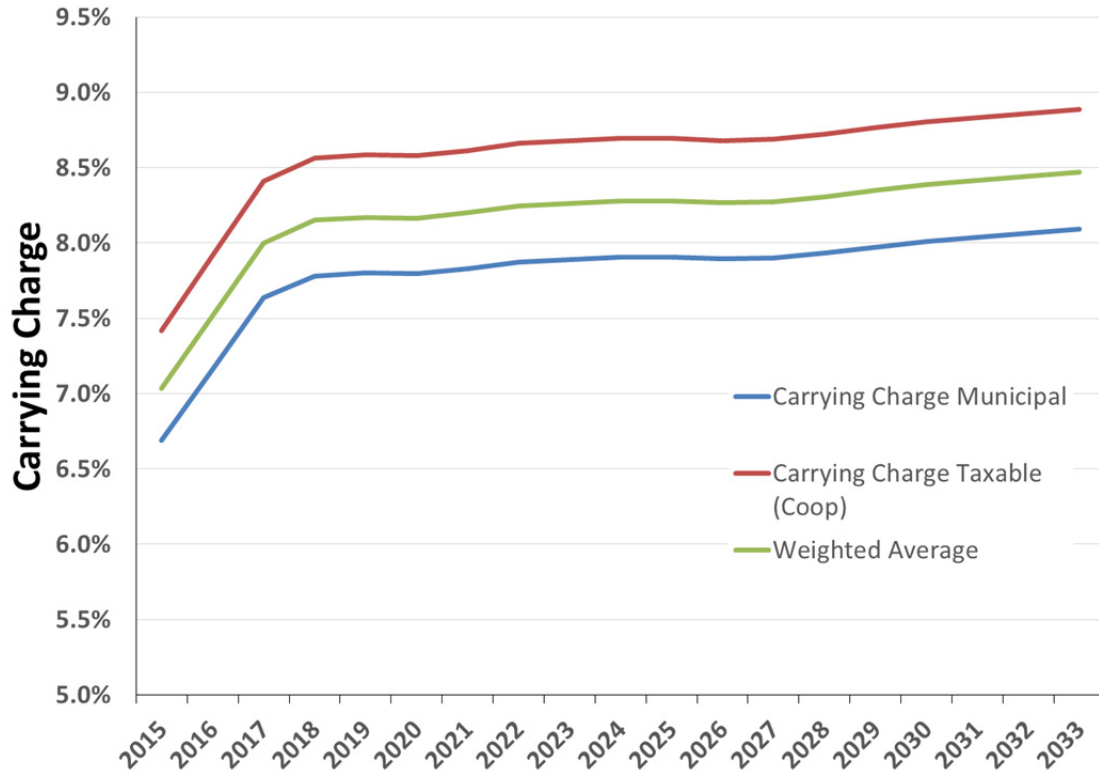

FIGURE K.3-2 Projected Carrying Charge Rates Used in Rate Impact Analysis

K.3.1.3 Inflation Rates, Sales Growth, and Interest Rates from EIA

The third set of input data presented on the left side of Figure K.3-1 consists of general macroeconomic variables that drive the prospective level of base retail rates for each utility system. Macroeconomic factors include the expected level of electricity rates and the expected level of retail sales growth in the southwest region, as well as future interest rates for the municipal and cooperative systems. Data for these items has been derived from information provided in EIA regional forecasts presented in the 2015 Annual Energy Outlook (EIA 2015b). Projections from the EIA annual outlook (EIA 2015c) are also used for macroeconomic data including prospective inflation rates and interest rates.

K.3.1.4 Calculation Process for Computing Rate and Bill Impacts

The middle of Figure K.3-1 represents calculations made for computing rate impacts after the inputs are established. The computations of rate impacts for individual systems involve a series of allocations under each LTEMP alternative. Figure K.3-3 shows three allocation procedures that were part of calculating rate impacts. The first allocation involved attributing total grid cost to individual utility systems using SLCA/IP allocation data (shown in red in Figure K.3-3). For the indirect allocation systems defined in “List of Utility Systems that Distribute Power to Retail Consumers” above, a second allocation involved attributing SLCA/IP

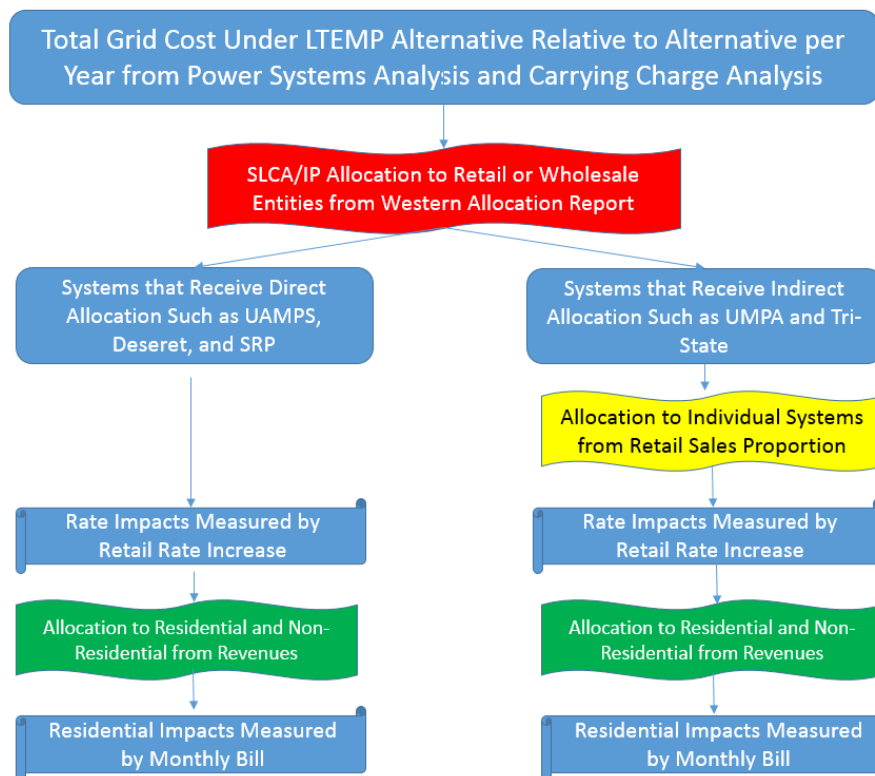

FIGURE K.3-3 Flowchart Diagram of Allocation Process

power from the Generation and Transmission Cooperative or the Joint Action Agency to individual members (shown in yellow in Figure K.3-2). These two allocations define impacts measured by the percent change in retail rates. The only allocation that involves assumptions with respect to utility-specific ratemaking processes is the computation of residential bill impacts. To compute the residential bill impact, costs must be allocated between residential and nonresidential consumers (shown in green in Figure K.3-2). For this allocation, the assumption is made that capacity and energy costs are allocated in the same proportion as existing overall rates.

Then next five sections describe the allocation process used to compute the rate impacts. The first section explains why wholesale rates were not needed in the allocation process and how the aggregate grid cost impacts can be compared to SLCA/IP wholesale revenues. The second section describes the allocation of aggregate grid costs to different systems, and the third section describes the allocation process for indirect systems. The fourth section explains the allocation process for residential rates, and the final section demonstrates the process with a case study.

Using Grid Costs Rather than SLCA/IP Wholesale Rates for Computing Retail Rate Impacts

A fundamental concept underlying the rate impact analysis is that rate impacts of LTEMP alternatives occur because of differences in alternatives with regard to capacity that is lost and

1 energy that must be purchased during different periods, not Western's cost structure. Western
2 must collect the same amount of revenue to cover its costs under all of the LTEMP alternatives,
3 even though marketable capacity has declined and timing of energy production has changed. For
4 LTEMP alternatives that increase grid cost relative to Alternative A, retail consumers must in
5 one way or another pay for replacing capacity and more expensive energy. This implies that rate
6 impacts can be computed directly from grid costs rather than Western wholesale tariffs. For
7 benchmarking purposes, the average annual real grid cost impacts are presented relative to the
8 dollar amount of revenues collected by Western presented in Section K.3.2.2. Wholesale grid
9 costs used as the basis for computing rate impacts are also compared to the aggregate wholesale
10 amounts that would be paid under projected SLCA/IP rates described in Section K.2. This
11 analysis is described in detail in Section K.3.6, where the aggregate incremental grid cost for
12 each alternative is compared to the aggregate wholesale power cost that would be paid under
13 wholesale SLCA/IP rates computed in Section K.2. Table K.3-15 (presented in Section K.3.6)
14 demonstrates that for LTEMP alternatives other than Alternative G, the SLCA/IP wholesale rates
15 would result in lower measured impacts than the aggregate grid costs.

16
17 The fact that retail rate impacts can be computed without separate calculations of
18 Western wholesale rates can be demonstrated with a hypothetical example of three rate
19 calculation approaches, the first of which does not include wholesale rate calculations, while the
20 second and third apply different possible changes in wholesale tariffs that result from various
21 LTEMP alternatives. All three of the wholesale rate techniques result in the same retail rate
22 impact. The first method does not require measurement of SLCA/IP wholesale rates and is
23 consistent with the approach illustrated in Figure K.3-3. Using this approach, rate impacts are
24 computed by directly allocating grid costs under different LTEMP alternatives. The second
25 method assumes that Western increases wholesale capacity charges to cover the fixed costs
26 associated with lower amounts of capacity from changes in Glen Canyon Dam operations. This
27 method assumes that the utility systems themselves procure the capacity and energy to make up
28 for the changes in dam operations. The total amount of wholesale revenues received by Western
29 does not change in this second method, and the utility systems themselves incur the increased
30 grid costs in this scenario. Because Western's revenues do not change and utilities procure the
31 capacity and energy deficits created from the LTEMP alternatives, the second scenario produces
32 the same revenues as the first method, in which wholesale rates are not considered. The third
33 approach assumes that Western, instead of the utility systems, procures the deficient capacity and
34 energy. This means the grid cost impacts are included in the Western wholesale rates and, from
35 the perspective of the utility systems, the capacity quantity does not change. The same amount of
36 capacity and energy must be procured by Western as would be procured by the individual utility
37 systems. Ultimately, SLCA/IP rates change in different LTEMP alternatives to cover changes in
38 the cost of capacity and energy.

39 40 41 **Allocation of Aggregate Grid Costs to Retail Systems**

42
43 The primary allocation formula applied to compute rate impacts involves allocating total
44 grid costs to different systems using the annual SLCA/IP energy as reported in Osiek (2015).
45 This allocation process, illustrated in red in Figure K.3-3, is represented by the following

1 equation (recall that retail rates include rates to residential, business, and other consumers served
2 by the utility system):

$$\begin{aligned} & \text{Retail Change for Individual System Relative to Alternative A (\$)} = \\ & \quad \frac{[\text{SLCA/IP Energy Allocation to Individual System (MWH)} / \\ & \quad \text{Aggregate SLCA/IP Energy Allocation to All Systems (MWH)}] \times \\ & \text{Aggregate Grid Cost Impact of LTEMP Alternative Relative to Alternative A (\$).} \end{aligned}$$

9 SLCA/IP energy allocation in the above formula is applied by summing the summer and winter
10 energy allocation for each system listed in Osiek (2015). The actual allocation that determines
11 the amount each system pays for SLCA/IP power involves both energy and capacity and is
12 differentiated by season. This raises the question of whether summer capacity, winter capacity,
13 summer energy, and winter energy should be applied in a more complex allocation process. The
14 question is resolved because the allocation shares to individual systems would be virtually
15 identical if either the capacity or energy allocation were used. This is demonstrated by the fact
16 that the annual load factor in SLCA/IP allocations is similar across different systems. If the load
17 factor across systems is the same, then allocation of total grid costs using either capacity or
18 energy will result in the same percentage of aggregate grid cost being attributed to each
19 individual system. The similarity of annual load factors (average hourly energy for the winter
20 and summer divided by the average summer and winter capacity) is illustrated in Figure K.3-4.
21 Because the load factor is nearly identical for almost all distribution systems in Figure K.3-4, the
22 use of capacity or energy does not influence the allocation process.

23
24 Given total retail revenues attributed to individual systems, the calculation of percent
25 change in retail rates from LTEMP alternatives can be represented by the two formulas shown
26 below. In these formulas, t is a subscript for the year and i represents the individual system. The
27 term $\text{Retail Change}_{t,i}$ shown in the equation is the result of equation presented at the beginning of
28 this section.

$$\text{Rate Change Percent}_{t,i} = \text{Retail Change}_{t,i} / \text{Retail \$ Revenue under Alternative } A_{t,i}$$

31
32 Retail Revenue under Alternative $A_{t,i}$ comes from retail revenue for each individual system that
33 is part of the database. Increases in retail revenues from sales growth and from price increases
34 after the base period are calculated from the EIA energy outlook for the Southwest region as
35 represented by the following equation:

$$\begin{aligned} \text{Retail Rate (\$/MWh) under Alternative } A_{t,i} &= \text{Retail Rate under Alternative } A_{t-1,i} \times \\ & (1 + \text{Electricity Price Inflation from EIA}_t) \times (1 + \text{Sales Growth from EIA}_t). \end{aligned}$$

39 40 41 **SLCA/IP Energy for Indirect Allocation Systems**

42
43 The second allocation issue highlighted in Figure K.3-3 involves allocation of SLCA/IP
44 energy and capacity to individual retail entities from systems that receive indirect allocations.
45 For the indirect allocation systems other than Tri-State (WMPA, UMPA, Platte River, and
46 CRCN), the allocation of SLCA/IP energy to individual member utility systems is made on the

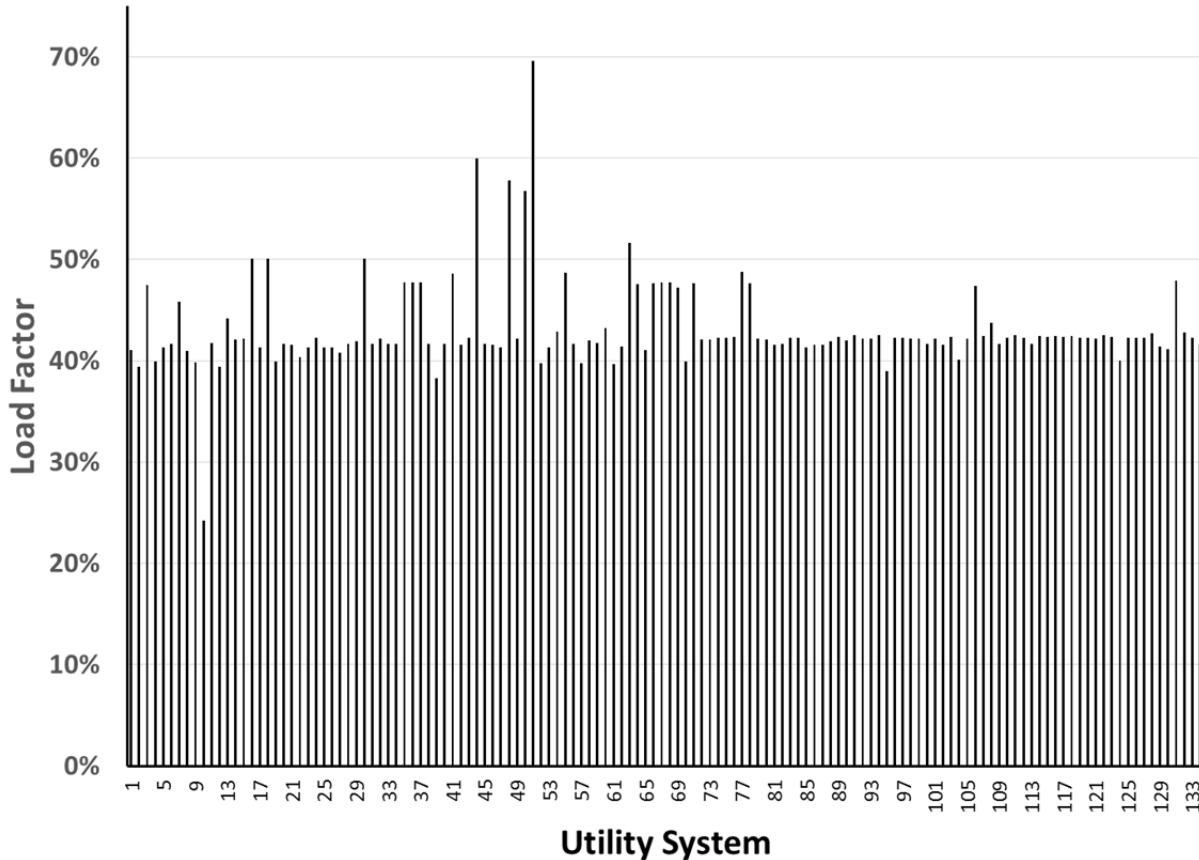

FIGURE K.3-4 Load Factors of SLCA/IP Power (Source: Osiek 2015)

basis of the retail sales proportion. Retail sales of the individual member system is divided by aggregate retail sales accumulated for the wholesale system (e.g., WMPA). The percentage of retail sales is multiplied by the aggregate SLCA/IP allocation to the large system reported in Osiek (2015). For Tri-State, the same general process was used, with the exception that distribution cooperatives in Nebraska are not assumed to receive any SLCA/IP preference power and are not included in the aggregate sales calculation. The method for allocating SLCA/IP energy to individual distribution systems that are part of the larger indirect allocation systems can be represented by the following equation:

$$\text{Allocation of SLCA/IP to Distribution Entity (MWh)} = \frac{[\text{Annual Retail Sales of Distribution Entity (MWh)} / \text{Total Aggregate Retail Sales of Distribution Systems in Group (MWh)}] \times \text{Total SLCA/IP Allocation to Group (MWh)}}{1}$$

Allocation Process from Computing Residential Bill Impacts

The final allocation process illustrated in Figure K.3-3 is the allocation of overall retail revenues (residential and non-residential revenues) to residential consumers and computation of

1 residential bills. Calculation of residential bills involves two steps. The first step is to allocate a
2 portion of the total retail increase for the system to residential consumers. This allocation is made
3 with the ratio of residential revenues to total retail revenues for each system. Using the
4 residential revenue percent, the dollar amount of change in residential revenue under LTEMP
5 alternatives relative to Alternative A can be represented by the following equation:

$$6 \quad \text{Residential Revenue Change } \$_{t,i} = \text{Change in Grid Cost}_{t,i} \times \text{Residential Percent}_i.$$

7
8
9 The second step is computing the monthly residential bill change from residential
10 revenue change. The change in monthly residential bill relative to Alternative A is computed by
11 dividing the total residential revenue change by projected residential consumers and then by 12.
12 The number of residential consumers is projected through dividing the overall sales growth by 2
13 (implicitly assuming half of the growth is from increased use per customer). Calculation of
14 monthly residential bills relative to the Alternative A is demonstrated in the equations below:

$$15 \quad \text{Residential \$ Bill Increase}_{t,i} = \text{Residential \$ Increase}_{t,i} / \text{Residential Customers}_{it} / 12,$$

16
17
18 where:

$$19 \quad \text{Residential Customers}_{it} = \text{Residential Customers}_{i,t-1} \times (1 + \text{Sales Growth EIA}_t/2).$$

20 21 22 23 **Case Study Illustration of the Allocation Process**

24
25 The process of calculating rate impacts can be demonstrated by considering a case study.
26 Tri-State is used to show how aggregate grid costs are allocated to determine rate impacts and
27 why wholesale rates are not necessary in computing retail rate impacts. To demonstrate how rate
28 changes are established, the grid cost impact under Alternative F in the highest impact year is
29 used. On an aggregate basis, grid costs in this case increase by \$41 million (in real 2015 dollars)
30 relative to Alternative A. Tri-State members had retail revenues of \$1.476 billion (computed
31 from aggregating revenues for the Tri-State systems excluding the Nebraska members using the
32 database).²⁰ Tri-State energy allocations represent 29.0% of the total SLCA/IP (derived from the
33 allocation report and recorded in the database). The amount of grid cost increase allocated to Tri-
34 State can be computed as 29.0% multiplied by the aggregate grid cost change of \$41 million, or
35 \$11.89 million. Note this calculation is made without any wholesale rate calculations. This
36 calculation implies that the increase in average retail rates for Alternative F in the high-impact
37 year across Tri-State member systems is \$11.89 million/\$1,476 billion = 0.81%.

38
39 The same retail rate calculation can be made by first computing impacts on SLCA/IP
40 wholesale rates. Using the current capacity and energy allocations, Western revenues collected
41 from SLCA/IP power are current published rates multiplied by aggregate allocations. Total
42 revenues from multiplying capacity charges by total SLCA/IP capacity and energy charges by

²⁰ By comparison, Tri-State's wholesale revenues were \$1.019 billion in 2013, as reported in its Financial Report (Tri-State 2015).

1 total SLCA/IP energy sum to approximately \$143 million. The total increase in wholesale rates
2 would then be 28.67%, or \$41 million/\$143 million, if Western did not change capacity and
3 energy allocations in the SLCA/IP tariff. Tri-State payments for wholesale power without the
4 increase are the Tri-State allocation percent multiplied by total SLCA/IP revenues or $29.0\% \times$
5 $\$143 \text{ million} = \41.47 million . For Tri-State, the increase in wholesale costs is $28.67\% \times$
6 $\$41.47 \text{ million} = \11.89 million . Thus, the wholesale cost increase is the same whether it is
7 calculated directly from aggregate grid costs as in the last paragraph or whether it is computed
8 using wholesale rates as in this paragraph, and the \$143 million of revenues collected from
9 wholesale rates is not necessary for computing retail rate impacts. The wholesale impact of
10 \$11.89 million translates into the same retail impact of 0.81% discussed above. The example
11 demonstrates that a large wholesale rate increase of 28.87% translates to a much smaller retail
12 rate impact.

15 **Rate Impact Measurement for American Indian Tribes**

16
17 A detailed retail rate impact analysis has been prepared for American Indian Tribes. The
18 analytical approach and results are described in Section K.4.

21 **K.3.2 Results**

22
23 Retail rate and residential bill changes are affected by the aggregate grid costs that occur
24 under the various LTEMP alternatives relative to Alternative A. Once grid cost changes are
25 established (that correspond to SLCA/IP wholesale rate changes), differential retail rate changes
26 experienced by individual systems are affected by the amount of power that a system receives
27 from SLCA/IP relative to total generation resource requirements of the system. The ratio of
28 SLCA/IP allocation to retail sales for a particular system is termed the “preference ratio.”
29 Measurement of aggregate grid cost and the effect of SLCA/IP allocation guide presentation of
30 the rate analysis in this section. The first part measures the aggregate grid cost change relative to
31 wholesale revenues that are currently collected for SLCA/IP capacity and energy. Second,
32 differential retail rates for individual systems are explained in the context of the preference ratio.

35 **K.3.2.1 Grid Cost Changes Relative to Western Wholesale Revenues**

36
37 Retail rate impacts of LTEMP alternatives relative to Alternative A are relatively small
38 for individual utility systems. This is because grid cost impacts are spread over a wide consumer
39 base and because SLCA/IP is only one out of a multitude of generating resources for the retail
40 utility systems. Given the small rate impacts on retail systems, changes in annual grid costs
41 relative to the total SLCA/IP revenues are introduced to provide a benchmark for comparing
42 LTEMP alternatives. Table K.3-3 presents the average annual real grid cost increases per year
43 from 2015 through 2035 (the LTEMP period) for LTEMP alternatives relative to Alternative A.
44 (Grid costs that include capacity costs and production costs are defined in Section K.3.1.)
45 Table K.3-3 shows that using the benchmark of wholesale revenues collected for SLCA/IP
46 federal preference power, the increase in annual real grid costs divided by current wholesale

1 **TABLE K.3-3 Average Annual Grid Cost Relative to SLCA/IP Wholesale Revenues Relative**
 2 **to Alternative A**

| Alternative | Average Annual Grid Cost Increase Relative to Alternative A (in thousands of 2015\$) | Western Revenues from SLCA/IP Capacity and Energy Charges (in thousands of 2015\$) | Percentage Change Relative to Western Revenues | Average Capacity Differential Relative to Alternative A After 2017 (MW) | Maximum Capacity Differential in Single Year Relative to Alternative A (MW) |
|-------------|--------------------------------------------------------------------------------------|------------------------------------------------------------------------------------|------------------------------------------------|-------------------------------------------------------------------------|-----------------------------------------------------------------------------|
| A | | 143,000 | 0.00% | | - |
| B | (976) | 143,000 | -0.68% | (13.53) | (230.00) |
| C | 9,820 | 143,000 | 6.87% | 189.41 | 230.00 |
| D | 6,831 | 143,000 | 4.78% | 121.76 | 230.00 |
| E | 6,392 | 143,000 | 4.47% | 135.29 | 230.00 |
| F | 28,751 | 143,000 | 20.11% | 392.35 | 460.00 |
| G | 17,218 | 143,000 | 12.04% | 230.00 | 230.00 |

3
 4
 5 revenues is as much as 20% for Alternative F. The grid cost increase is between 4% and 5% of
 6 current SLCA/IP wholesale revenues for Alternatives E and D. Capacity differences between the
 7 respective LTEMP alternatives and Alternative A, presented as the capital recovery of capacity
 8 costs, are the most important drivers of grid cost changes. The average annual capacity that is
 9 constructed under Alternative A that corresponds to the two right-most columns in Table K.3-3
 10 is 2,701 MW.

11
 12
 13 **K.3.2.2 Retail Rate Changes for Individual Systems and SLCA/IP Power Relative**
 14 **to Total Resources**

15
 16 Variation among retail rate changes for individual utility systems under different LTEMP
 17 alternatives are driven in large part by the ratio of SLCA/IP energy allocation compared to the
 18 total generation resources required for the system. Using the database described in
 19 Section K.2.1.2, the proportion of SLCA/IP power to total resources can be measured by
 20 computing the ratio of SLCA/IP annual energy allocation to total retail sales. If this preference
 21 ratio is low for a retail utility system, then even a relatively large increase in SLCA/IP costs will
 22 probably have a small rate impact. Figure K.3-5 displays the range in preference ratios for
 23 individual systems, together with the size of the systems, in a scatter plot. The size of the system
 24 on the x-axis is represented by annual retail sales. The y-axis of the graph demonstrates that the
 25 range in preference ratio varies from less than 1% to more than 60% for different systems in the
 26 database. Points in the upper left corner of Figure K.3-5 demonstrate that most of the systems
 27 with high preference ratios are small. This is likely due to the history of allocations for
 28 preference power. If a system was small when it originally received a preference power
 29 allocation, but has subsequently grown large, it will have a relatively lower ratio of SLCA/IP
 30 allocation to retail sales (sales have increased and the SLCA/IP allocation has remained the
 31 same). On the other hand, if a system has not grown much since the original allocation was made

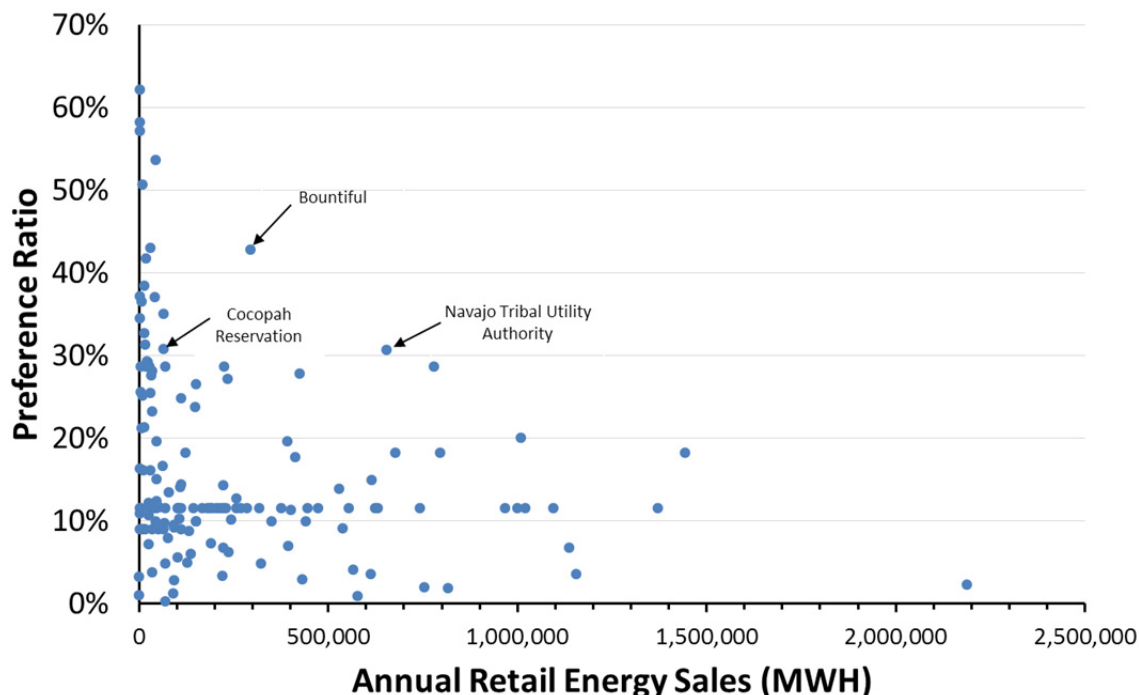

FIGURE K.3-5 Scatter Plot of Preference Ratio and Annual Retail Sales

(i.e., it is a small system with relatively low retail sales), the preference ratio could remain relatively high.

Two of the Tribes that provide data to the EIA 861 database are highlighted in Figure K.3-5 as background for the rate impacts that are discussed in Section K.3.4.²¹ The Navajo Tribal Utility Authority represents a large proportion (about 40%) of the SLCA/IP allocation to Tribes.²² Figure K.3-5 shows that the Tribes with EIA data do have relatively high preference ratios. The only other utility system with a relatively high preference ratio that is not a very small system is the City of Bountiful, a member of UAMPS (highlighted in Figure K.3-5).

The relationship between the preference ratio and rate changes for individual systems is demonstrated by scatter plots of the percentage retail rate change and the preference ratio. In the scatter plots, the retail rate change is measured relative to Alternative A, implying that a scatter plot for Alternative A is not meaningful. Figure K.3-6 presents scatter plots of the preference ratio and the percent rate change relative to Alternative A for Alternatives B through G. In

²¹ Fifty-three different Tribal entities receive capacity and energy allocations from SLCA/IP, representing 8.85% of the total energy allocation. Because the Tribes do not report sales and revenues as part of Form EIA-861 database, accessing sufficient data to make individual rate impact assessments was not possible. Instead, the analysis focused on two Tribal systems: Navajo Tribal Utility Authority and the Cocopah Reservation.

²² Retail data for the Navajo Tribal Utility Authority was derived from its Integrated Resource Plant (IRP) and Website (<https://ww2.wapa.gov/sites/western/es/irp/Documents/NTUA2012.pdf>) rather than from the EIA-861.

1 displaying the scatter plots for each LTEMP alternative relative to Alternative A, a single year is
2 selected so that each system represents a single point. In each panel of Figure K.3-6, the year
3 shown is the year with the highest rate impact for the respective LTEMP scenario. Because the
4 highest rate changes do not occur in the same year for the various LTEMP alternatives, as
5 explained in Section K.3.3.2, the scatter plots use different years.

6
7 The scatter plots shown in Figure K.3-6 demonstrate that much of the rate impact on
8 individual systems is driven by the preference ratio. For each of the panels in Figure K.3-6, a
9 regression equation of the percent retail rate change versus the preference ratio is displayed. The
10 R^2 statistic displayed on each of the panels is 0.87. This indicates that 87% of the variation in
11 percentage rate change can be explained by variation in the preference ratio. The 13% of
12 variation in percentage retail rate changes that is not explained by the preference ratio represents
13 other factors that include the level of retail rates, the load factor of the system, distribution costs,
14 and the capacity and energy costs paid for non SLCA/IP power.

15
16 Scatter plots displayed in Figure K.3-6 have differently scaled y-axes. The y-axes
17 represent the range in possible rate changes for the respective LTEMP alternative in the year
18 with the highest (absolute value) percent change. The upper end of the y-axis therefore
19 represents the absolute maximum retail rate percent increase for the LTEMP alternative across
20 systems. Finally, regression equations are presented in each panel of Figure K.3-6 that shows the
21 relationship between the preference ratio and the percent retail rate change in the year with the
22 maximum change for each LTEMP alternative. These regression equations can be used to
23 approximate rate impacts for systems that are not included in the database, as explained in the
24 next section.

25 26 27 **K.3.2.3 Using Regression Equations to Approximate Retail Rate Changes for** 28 **Systems Not Included in the Database** 29

30 For small Tribal systems and other entities that do provide retail sales and rate data to the
31 EIA, the rate impacts can be approximated using the regression equations shown in Figure K.3-6.
32 To compute rate impacts for systems that are not directly evaluated in the database, the
33 preference ratio should be computed first through dividing annual SLCA/IP energy allocations
34 by the retail electricity usage of consumers for the system. This preference ratio can then be
35 multiplied by the coefficient shown in each of the panels of Figure K.3-6. For example, under
36 Alternative F in the high-impact year, the coefficient is 0.074. If the ratio of SLCA/IP energy to
37 total energy consumption is 50% for an entity such as a U.S. Air Force base or for a Tribe that
38 does not report to the EIA, the estimated rate increase would be 3.7% ($0.074 \times 50\%$).

39 40 41 **K.3.3 Summary of Impacts** 42

43 Retail rate and residential bill impacts under the LTEMP alternatives were compiled for
44 147 different utility systems during the LTEMP period, 2015 to 2035, on an annual basis. The
45 retail rate impacts and the residential bill impacts under Alternatives B–G are presented relative
46 to Alternative A. Due to the large number of retail utility systems that receive federal preference

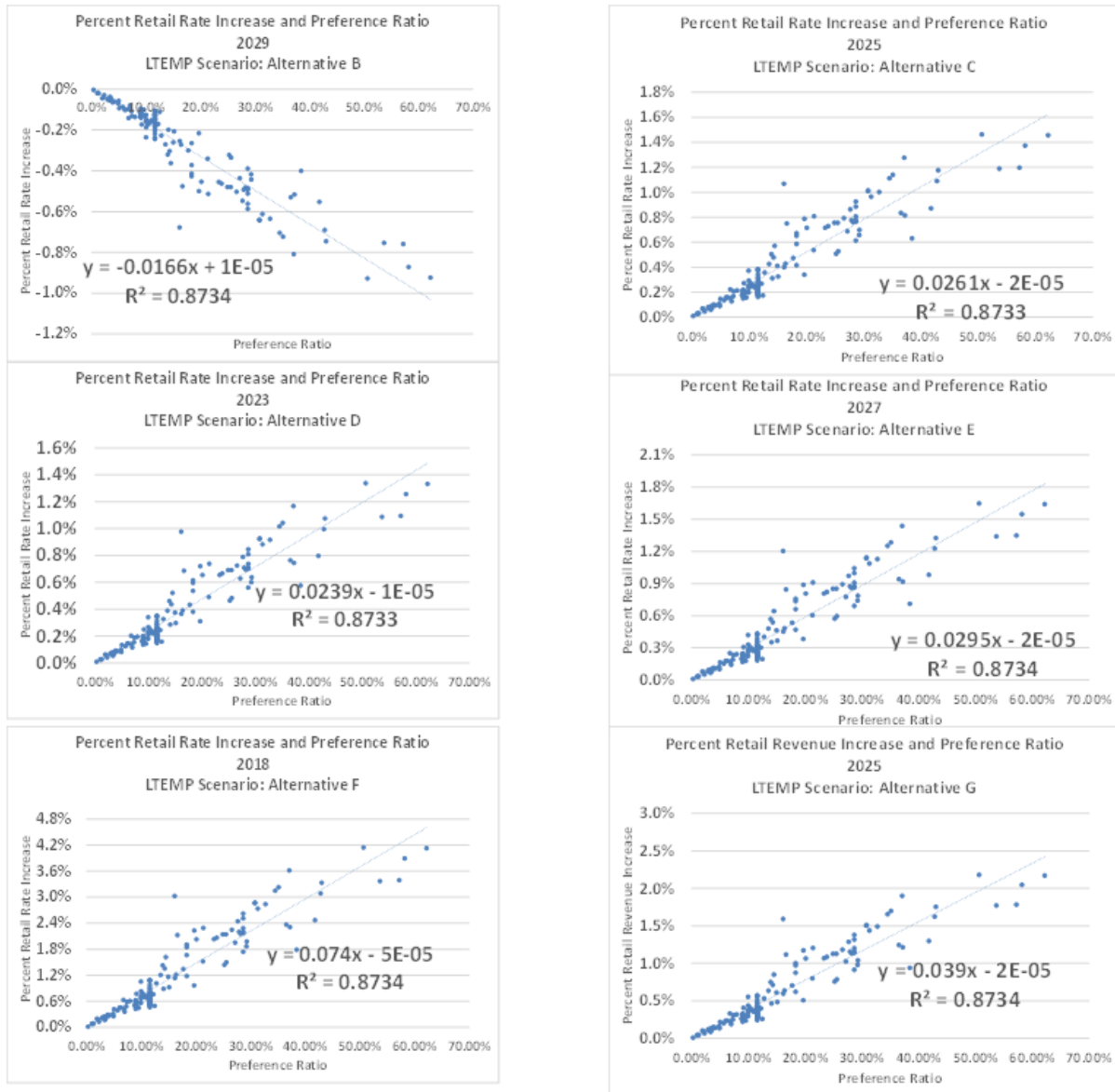

1

2 **FIGURE K.3-6 Scatter Plots of Percent Retail Rate Change and the Preference Ratio**

3

4

5

power and the number of LTEMP alternatives, various different techniques were used to summarize the rate impact results.

6

7

8

Rate and bill impacts are presented in four parts. First, the aggregate impacts are averaged across all systems and across the entire LTEMP period. Second, the impacts of LTEMP alternatives are presented on a year-by-year basis averaged across all systems. This section also includes a summary comparison of maximum-impact-year rate and bill impacts across different LTEMP alternatives. Third, rate and bill impacts for specific utility systems are listed under different LTEMP alternatives and the impacts under each LTEMP alternative are discussed. Fourth, the rate impacts on small systems and Tribes are explained.

9

10

11

12

13

14

K.3.3.1 Average Rate Impacts under LTEMP Alternatives over the 20-Year LTEMP Period

To demonstrate the general magnitude of rate impacts and evaluate the relative impact of different LTEMP alternatives on retail electricity rates, impacts are presented in terms of average impacts across utility systems and the LTEMP period. Before introducing the rate and bill impacts for Alternatives B, C, D, E, F, and G relative to Alternative A, retail rates and residential bills for Alternative A are described. The retail rates and residential bills under Alternative A provide a benchmark for gauging impacts of other alternatives. For example, a monthly residential bill increase of \$1.00 under a particular LTEMP alternative relative to Alternative A can be evaluated relative to the average and median monthly residential bills in Alternative A.

Figures K.3-7 and K.3-8 display retail rates in \$/MWh and residential bills in \$/month under Alternative A. Note that none of the tables and figures in this section include the impacts on Tribes that have special net benefit contracts. Rate impacts for Tribes with net benefit contracts are addressed in Section K.3.4.2. Figure K.3-7 shows the distribution of retail rates across the utility systems. Retail rates are computed by dividing retail revenues collected from residential, business and other consumers by retail sales for the consumers. Rates and bills are represented in Figures K.3-7 and K.3-8 with distribution analyses. The increments on the x-axis demonstrate the highest and lowest ranges for rates and bills across different systems. The average and the median statistics, as well as the ranges, are shown in the graph titles. The range in retail rates under Alternative A varies from \$55/MWh to \$177/MWh, with an average rate of \$104/MWh. The level of retail rates influences the reported rate increase percent in subsequent presentation of rate impacts. For example, a lower retail rate for a particular system results in a higher percent increase, all else being equal, because the allocated aggregated cost increase is

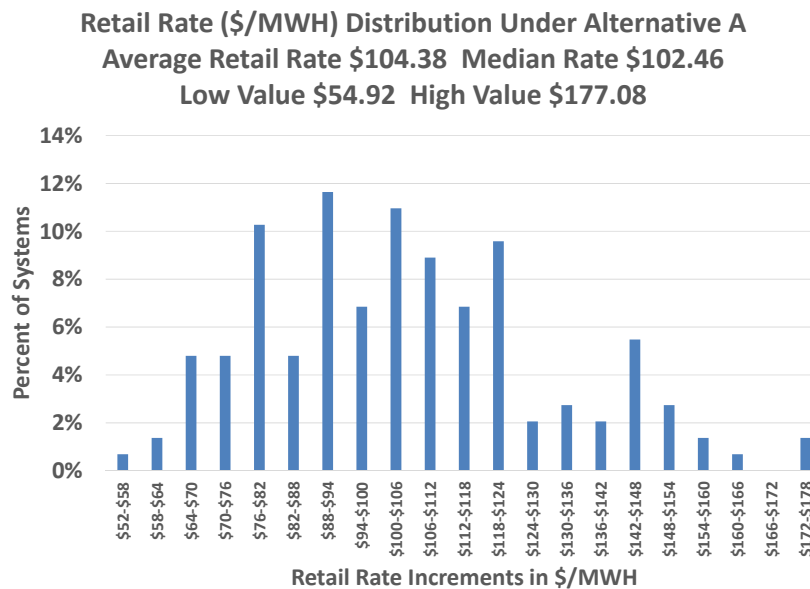

FIGURE K.3-7 Retail Rate Distribution under Alternative A

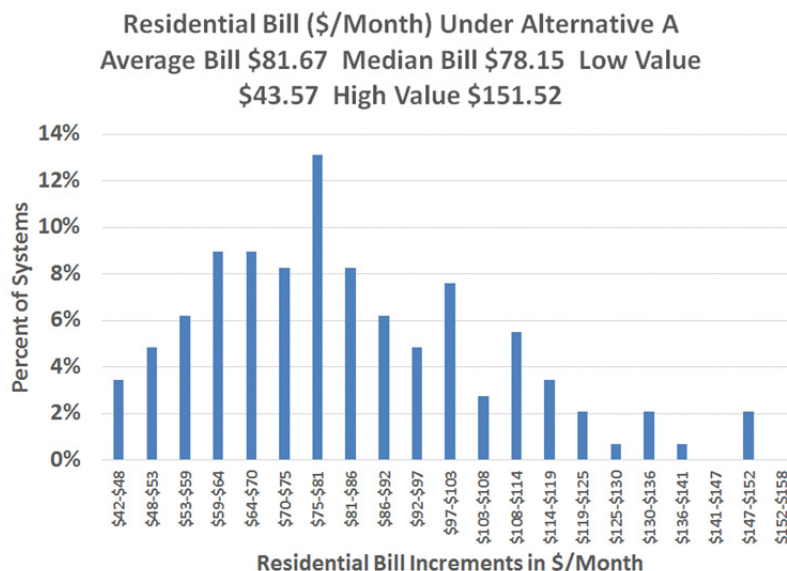
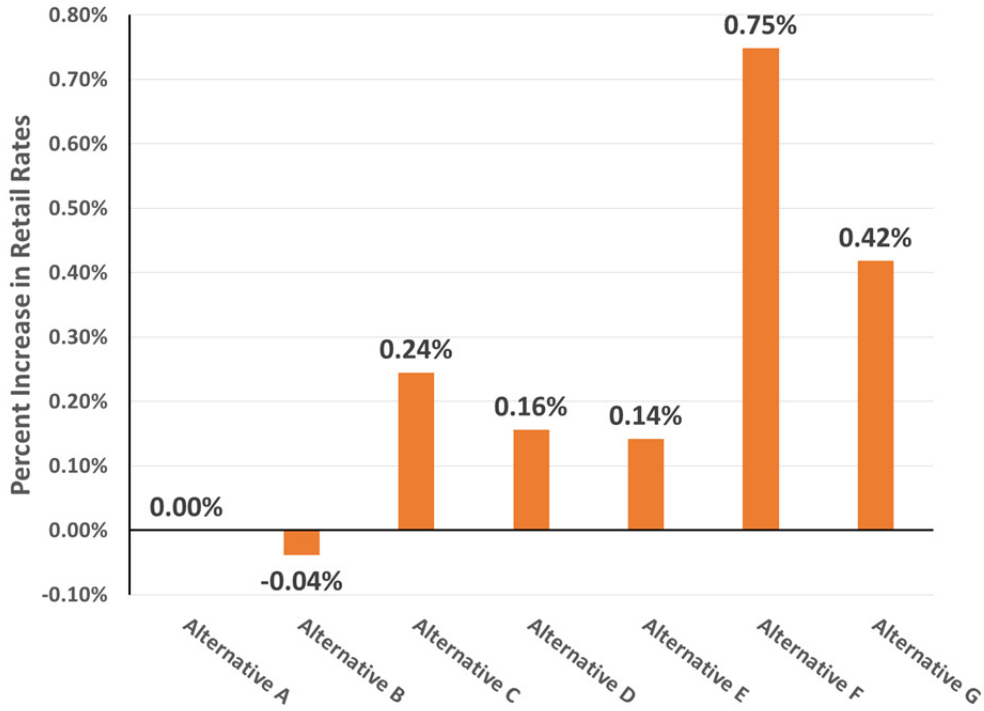

FIGURE K.3-8 Monthly Residential Bill Distribution under Alternative A

divided by the retail rate. On the other hand, a lower retail rate does not influence the residential bill calculation because bill impacts are measured on an absolute basis.

Figure K.3-8 presents monthly residential bills that are calculated by dividing annual residential revenues of a system by the number of residential consumers and then dividing the product by 12. Average monthly bills under Alternative A range between \$44 and \$151 per month, with an average of \$82 per month. This implies that an increase of \$1 from an LTEMP alternative other than Alternative A results in a typical percent increase in monthly bills of somewhat more than 1%.

Figures K.3-9 and K.3-10 illustrate the average impacts on retail rate changes and on monthly residential bills across different systems relative to Alternative A. Residential bill impacts in Figure K.3-10 and in the rest of the subsequent rate impact presentation are measured in real 2015 dollars. The graphs in Figures K.3-9 and K.3-10 display averages across systems that are not weighted by the size of the systems. This means that a small system with less than 1,000 consumers is given the same weight as a large system with hundreds of thousands of customers (such as SRP). Because rate impacts tend to be greater for small systems, evaluating impacts using averages weighted by the sales size results in lower increases (about half of the unweighted average). Weighted average impacts are discussed in Section K.3.3.3 and presented in Table K.3-4. Figure K.3-9 demonstrates that even the most extreme LTEMP alternative in terms of changing dam operations (Alternative F) results in rate changes for retail consumers below 1%. Under Alternative F, there is an average rate increase of 0.75% relative to Alternative A. Figure K.3-10 shows that the highest average residential bill impact is 69 cents per month. Alternatives E and D have much lower retail rate impacts that are approximately 20% of the rate impact under Alternative F. (Note that individual rate impacts on particular systems can be higher than the average impacts.)



1
2
3
4
5

FIGURE K.3-9 Average Retail Rate Impacts under LTEMP Alternatives Relative to Alternative A

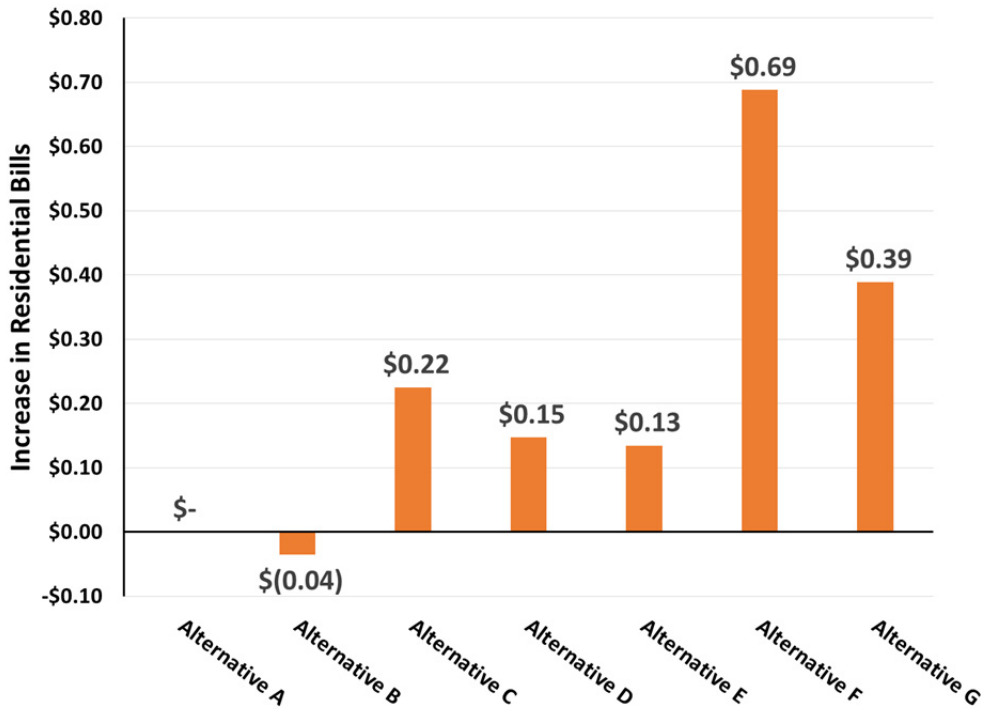

6
7
8

FIGURE K.3-10 Average Residential Bill Impacts under LTEMP alternatives Relative to Alternative A

K.3.3.2 Average Year-by-Year Rate Impacts

Rate impacts presented in the previous paragraphs, which average rate and bill changes across the entire LTEMP period, mask the year-to-year rate impacts. Impacts in a single year can be different than average impacts across years because of the manner in which capacity changes occur and the effects of dam operations on production costs. Maximum rate impacts in a single year may be of concern to stakeholders. Therefore, the average annual retail rate and bill impacts from year to year are presented in this section. Figures K.3-11 and K.3-12 show the year-by-year averages for the overall retail percent changes and residential bill changes under different LTEMP alternatives. Year-by-year impacts for LTEMP alternatives are measured relative to Alternative A and the averages are not weighted by system size. Figure K.3-11 demonstrates that in terms of average percent changes in retail rates across all of the utility systems, the changes are not constant from year to year. Retail rate impacts from Alternative F are above the other alternatives, except in 2 of the years. The largest percent changes other than under Alternative F are under Alternative G, which has relatively constant changes over the LTEMP period. The third-highest rate impacts are from Alternative C; these are constant until 2028, after which the impacts decline. Alternatives D and E have varying impacts from year to year that are driven by differences in construction of new capacity. Alternative B has impacts below zero (bill reductions relative to Alternative A), except in 2034, when construction of new capacity is accelerated relative to Alternative A. All of the tables and figures in this section include the

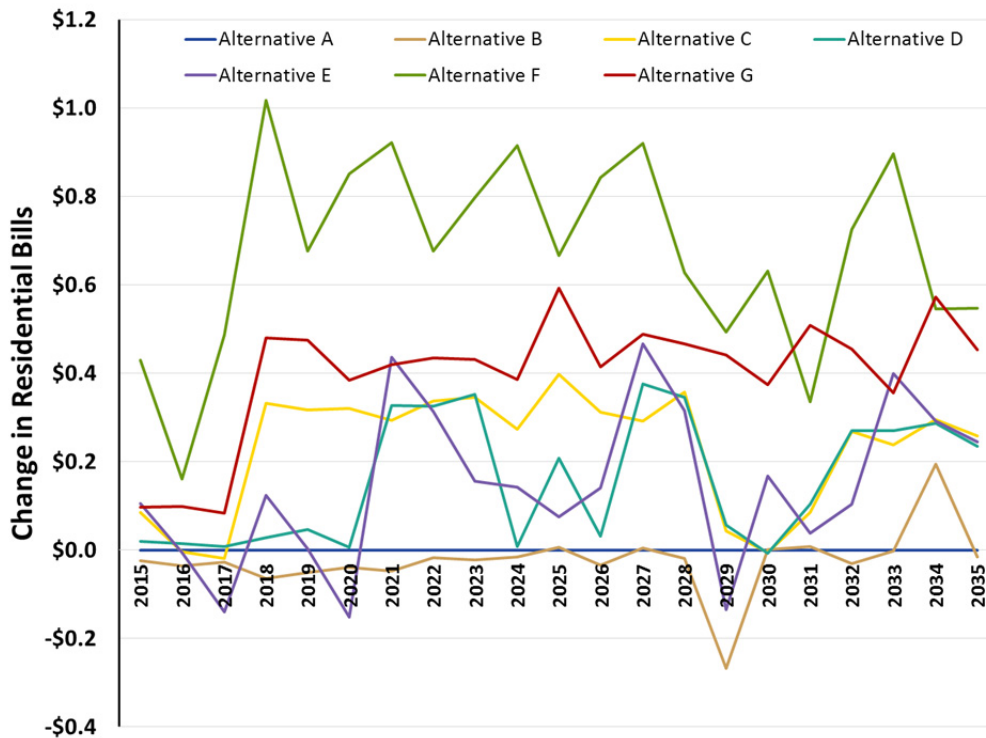

FIGURE K.3-11 Average Retail Percent Revenue Increase Relative to Alternative A

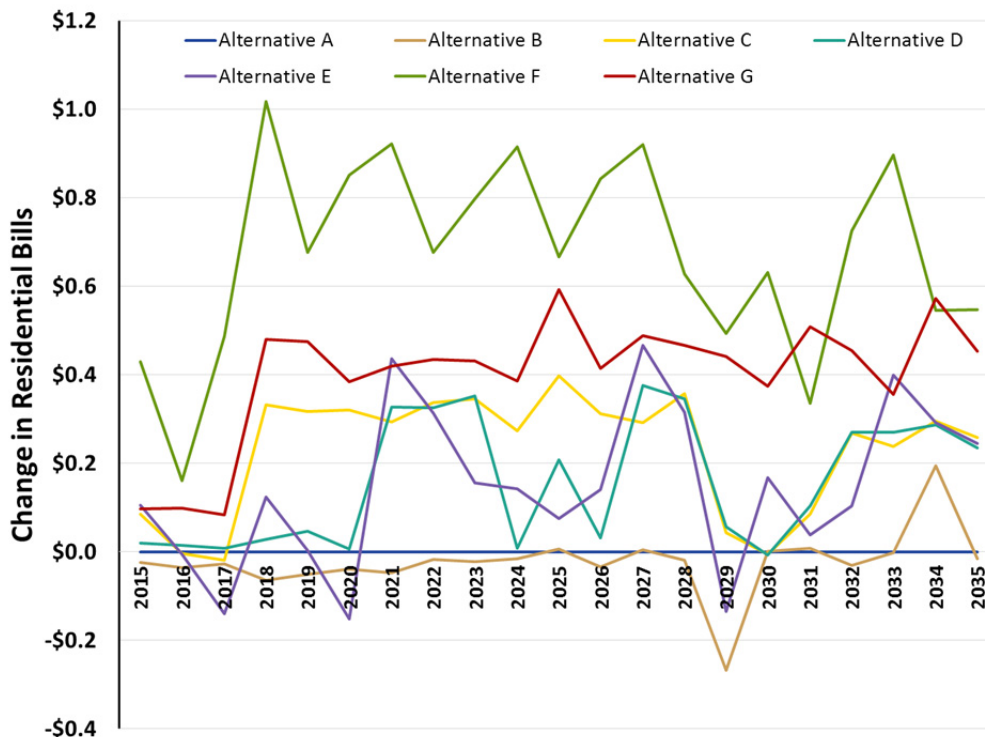

FIGURE K.3-12 Average Monthly Residential Bill Changes Relative to Alternative A

Ak-Chin, Tohono O’odham Reservation, and Navajo Tribal Utility Authority Tribes but do not include the impacts on Tribes that have special net benefit contracts. Rate impacts for Tribes with net benefit contracts are addressed in Section K.3.4.2.

Figure K.3-12 shows that in terms of monthly bill changes from year to year, the annual patterns are similar to the trends in retail bill changes. The highest monthly bill impact in a single year is just above \$1.00 per month under Alternative F, relative to Alternative A in 2018. The year 2018 for Alternative F is termed the maximum impact year. For Alternative G, the maximum residential monthly impact is just below 60 cents per month in the year 2025. Impacts for the maximum year are presented in Table K.3-4. Figure K.3-11 also demonstrates that monthly bill impacts are more variable from year to year under Alternative E than other LTEMP alternatives. Alternative E has bill changes below zero in the years 2017, 2020, and 2029. The bill impacts are higher for Alternative E than Alternative D, but Alternative D does not have any impacts that are below zero.

Maximum and average rate and bill impacts are recorded in Table K.3-4, which summarizes the average impacts across systems in the maximum impact year and over the LTEMP period. Unlike the impacts presented up to this point, Table K.3-4 also presents the averages and maximum impacts using an alternative weighting method where the size of different systems is considered. The weighting method places a higher weight on larger systems

1 by multiplying all of the impacts by the ratio of retail sales for a system to aggregate retail sales
2 across all systems. When averages are weighted by sales, the rate and bill impacts are
3 approximately half of the amount without weighting. For example, the maximum monthly bill
4 impact of \$1.02 per month under Alternative F in 2018 is reduced to 50 cents when small
5 systems are given lower weight and larger systems are given higher weight. The large reduction
6 in impacts from weighting by sales comes about in part because SRP and the City of Colorado
7 Springs have low rate impacts and a very high level of sales relative to other systems. The sales
8 of these two systems alone represent 45% of the total sales for all systems in the analysis. When
9 weighting by sales, the weighting calculation shown in Table K.3-4 excludes SRP and the City
10 of Colorado Springs in the aggregate sales tabulation.

11
12 In addition to displaying average impacts across years and average rate impacts in the
13 maximum change year, median impacts are also shown in Table K.3-4. Median statistics show
14 the rate or bill change for which 50% of companies are above the value and 50% are below the
15 value. The median values are less affected by extreme high values or low values and result in
16 lower observed impacts because a few systems with high rate impacts skew the averages. The
17 top half of Table K.3-4 shows data on an unweighted basis that have been shown above. The
18 lower half shows weighted averages, including the median. The top part of Table K.3-4
19 demonstrates that the maximum impact is lower when measured by the median instead of the
20 average. For example, under Alternative F, the maximum residential bill impact of \$1.02 that is
21 averaged for all systems is more than 20% less (78 cents) when the median is used to measure
22 the typical impact. The impact is further reduced when the impacts are weighted by sales size, as
23 shown at the bottom of the table. Weighting by sales reduces the measured rate impact. For
24 example, under Alternative G, the average retail rate increase is reduced from 0.64% to 0.50%
25 when the average is weighted by adjusted sales size. When the median sales weighted statistic is
26 measured, the number for the maximum year under Alternative G falls to 0.39%.

27 28 29 **K.3.3.3 Individual System Impacts and Summary Descriptions of LTEMP** 30 **Alternatives**

31
32 This section addresses individual rate and bill impacts on particular systems rather than
33 presenting results in terms of averages. Detailed rate impacts on selected individual utilities are
34 presented separately for systems that experience relatively large and relatively small impacts.
35 Four tables, Table K.3-5 through Table K.3-8, demonstrate the large and small individual
36 impacts on different systems. The tables show the year with the maximum retail rate and
37 monthly bill impact for each alternative relative to Alternative A. Using the lists of systems with
38 the highest rate impacts and the graphs and tables from previous sections, each alternative is
39 summarized.

40 41 42 **Lists of Individual Systems with Largest and Smallest Impacts**

43
44 Table K.3-5 lists the 30 systems with the largest percentage retail rate impact (in absolute
45 value) for the LTEMP alternatives. Given the aggregate grid cost change from an LTEMP
46 alternative, the retail rate impact for a particular system depends on the SLCA/IP energy

1 **TABLE K.3-4 Summary Table of Comparative Values**

| Impact | Alternative A (No Action Alternative) | Alternative B | Alternative C | Alternative D (Preferred Alternative) | Alternative E | Alternative F | Alternative G |
|------------------------------------------------------------------|---------------------------------------------|------------------|------------------|------------------------------------------------|------------------|------------------|------------------|
| Percent change in average grid cost relative to Western revenues | No Change | -0.68 | 6.87 | 4.78 | 4.47 | 20.11 | 12.04 |
| No Weighting by size | | | | | | | |
| Percent change in retail rates (average across years) | No Change | -0.04 | 0.25 | 0.15 | 0.14 | 0.75 | 0.42 |
| Average percent change in retail rates (maximum impact year) | No Change | -0.27 | 0.43 | 0.39 | 0.50 | 1.21 | 0.64 |
| Median percent change in retail rates (maximum impact year) | No Change | -0.20 | 0.27 | 0.25 | 0.30 | 0.76 | 0.40 |
| Change in monthly residential bill (average across years) | No Change | -\$0.04 | \$0.22 | \$0.15 | \$0.13 | \$0.69 | \$0.39 |
| Average change in monthly residential bill (maximum impact year) | No Change | -\$0.27 | \$0.40 | \$0.38 | \$0.47 | \$1.02 | \$0.59 |
| Median change in monthly residential bill (maximum impact year) | No Change | -\$0.23 | \$0.31 | \$0.27 | \$0.09 | \$0.78 | \$0.46 |
| Weighting by size with adjustments for SRP and Colorado Springs | | | | | | | |
| Percent change in retail rates (average across years) | No Change | -0.03 | 0.19 | 0.12 | 0.11 | 0.59 | 0.33 |
| Percent change in retail rates (maximum impact year) | No Change | -0.21 | 0.34 | 0.31 | 0.39 | 0.96 | 0.50 |
| Median percent change in retail rates (maximum impact year) | No Change | -0.19 | 0.26 | 0.24 | 0.30 | 0.75 | 0.39 |
| Change in monthly residential bill (average across years) | No Change | -\$0.03 | \$0.18 | \$0.12 | \$0.11 | \$0.56 | \$0.32 |
| Change in monthly residential bill (maximum impact year) | No Change | -\$0.25 | \$0.32 | \$0.31 | \$0.38 | \$0.83 | \$0.48 |
| Change in monthly residential bill (average across years) | No Change | -\$0.22 | \$0.31 | \$0.27 | \$0.10 | \$0.79 | \$0.46 |

K-174

2
3

1 **TABLE K.3-5 Individual Systems with the Largest Percent Retail Rate Impacts Relative to Alternative A**

| Number | Utility System | Preference Ratio | Number of Residential Consumers | Percent Rate Impact Relative to Alternative A | | | | | |
|--------|------------------------------|------------------|---------------------------------|-----------------------------------------------|--------------------|--------------------|--------------------|--------------------|--------------------|
| | | | | Alternative B 2029 | Alternative C 2025 | Alternative D 2023 | Alternative E 2027 | Alternative F 2020 | Alternative G 2025 |
| 1 | Beaver (UAMPS) | 25.51 | 1,500 | -0.48 | 0.76 | 0.69 | 0.85 | 2.14 | 1.13 |
| 2 | Ephraim (UAMPS) | 28.19 | 1,731 | -0.48 | 0.76 | 0.70 | 0.86 | 2.15 | 1.13 |
| 3 | Manti (UMPA) | 28.65 | 1,274 | -0.49 | 0.77 | 0.70 | 0.86 | 2.17 | 1.14 |
| 4 | Murray (UAMPS) | 27.89 | 13,977 | -0.49 | 0.78 | 0.71 | 0.88 | 2.20 | 1.16 |
| 5 | Spanish Fork (UMPA) | 28.65 | 9,712 | -0.49 | 0.78 | 0.71 | 0.88 | 2.20 | 1.16 |
| 6 | Dixie Escalante R.E.A. | 19.68 | 13,831 | -0.50 | 0.79 | 0.72 | 0.89 | 2.23 | 1.17 |
| 7 | Brigham City | 26.57 | 6,643 | -0.50 | 0.79 | 0.73 | 0.89 | 2.25 | 1.18 |
| 8 | Provo (UMPA) | 28.65 | 31,204 | -0.51 | 0.81 | 0.74 | 0.91 | 2.29 | 1.20 |
| 9 | Ocotillo I.D. | 21.36 | 19 | -0.51 | 0.81 | 0.74 | 0.91 | 2.29 | 1.21 |
| 10 | Paragonah (UAMPS) | 37.22 | 250 | -0.52 | 0.82 | 0.75 | 0.92 | 2.31 | 1.22 |
| 11 | Fairview (UAMPS) | 36.53 | 714 | -0.53 | 0.84 | 0.76 | 0.94 | 2.37 | 1.25 |
| 12 | Flowell E.A., Inc. (Deseret) | 27.66 | 194 | -0.55 | 0.86 | 0.79 | 0.97 | 2.44 | 1.29 |
| 13 | Morgan (UAMPS) | 41.79 | 1,429 | -0.55 | 0.87 | 0.80 | 0.98 | 2.47 | 1.30 |
| 14 | Levan (UMPA) | 28.65 | 317 | -0.56 | 0.89 | 0.81 | 1.00 | 2.51 | 1.32 |
| 15 | Nephi (UMPA) | 28.65 | 1,890 | -0.59 | 0.93 | 0.85 | 1.04 | 2.62 | 1.38 |
| 16 | Parowan (UAMPS) | 31.33 | 1,237 | -0.61 | 0.97 | 0.88 | 1.09 | 2.73 | 1.44 |
| 17 | Monroe (UAMPS) | 32.73 | 916 | -0.63 | 1.00 | 0.92 | 1.13 | 2.84 | 1.49 |
| 18 | Navajo Tribal Authority | 30.75 | 32,727 | -0.64 | 1.01 | 0.92 | 1.14 | 2.86 | 1.51 |
| 19 | Cocopah Reservation | 30.83 | 3,334 | -0.64 | 1.01 | 0.93 | 1.14 | 2.87 | 1.51 |
| 20 | Helper | 16.10 | 1,020 | -0.68 | 1.07 | 0.98 | 1.20 | 3.03 | 1.59 |
| 21 | Bountiful (UAMPS) | 42.82 | 15,295 | -0.69 | 1.09 | 1.00 | 1.23 | 3.09 | 1.62 |
| 22 | Oak City (UAMPS) | 34.51 | 260 | -0.70 | 1.11 | 1.02 | 1.25 | 3.15 | 1.66 |
| 23 | Gunnison | 35.12 | 3,348 | -0.72 | 1.14 | 1.04 | 1.29 | 3.23 | 1.70 |
| 24 | Ak-Chin Municipal | 43.03 | 282 | -0.75 | 1.18 | 1.08 | 1.33 | 3.33 | 1.75 |
| 25 | Truth or Consequences | 53.69 | 3,572 | -0.75 | 1.19 | 1.09 | 1.34 | 3.37 | 1.77 |
| 26 | Holden (UAMPS) | 57.22 | 215 | -0.76 | 1.20 | 1.09 | 1.35 | 3.39 | 1.78 |
| 27 | Maricopa MWCD | 37.09 | NA ^a | -0.81 | 1.28 | 1.17 | 1.44 | 3.62 | 1.90 |

K-175

2
3

1 **TABLE K.3-5 (Cont.)**

| Number | Utility System | Preference Ratio | Number of Residential Consumers | Percent Rate Impact Relative to Alternative A | | | | | |
|--------|--------------------|------------------|---------------------------------|-----------------------------------------------|--------------------|--------------------|--------------------|--------------------|--------------------|
| | | | | Alternative B 2029 | Alternative C 2025 | Alternative D 2023 | Alternative E 2027 | Alternative F 2020 | Alternative G 2025 |
| 28 | Kanosh (UAMPS) | 58.20 | 284 | -0.87 | 1.37 | 1.26 | 1.55 | 3.89 | 2.05 |
| 29 | Meadow (UAMPS) | 62.22 | 158 | -0.92 | 1.46 | 1.33 | 1.64 | 4.13 | 2.17 |
| 30 | Enterprise (UAMPS) | 50.65 | 517 | -0.93 | 1.46 | 1.34 | 1.65 | 4.14 | 2.18 |

^a NA = Not applicable (i.e., the system does not sell to residential consumers).

2

3

1 **TABLE K.3-6 Individual Systems with the Smallest Percent Retail Rate Impacts Relative to Alternative A**

| No | Utility System | Preference Ratio | Number of Residential Consumers | Percent Rate Impact Relative to Alternative A | | | | | |
|----|-----------------------------|------------------|---------------------------------|-----------------------------------------------|--------------------|--------------------|--------------------|--------------------|--------------------|
| | | | | Alternative B 2029 | Alternative C 2025 | Alternative D 2023 | Alternative E 2027 | Alternative F 2020 | Alternative G 2025 |
| 1 | Frederick | 0.26 | 3,453 | 0.00 | 0.01 | 0.01 | 0.01 | 0.01 | 0.01 |
| 2 | Salt River Project | 1.09 | 867,846 | -0.02 | 0.03 | 0.02 | 0.03 | 0.08 | 0.04 |
| 3 | Los Alamos County | 0.98 | 7,792 | -0.02 | 0.03 | 0.03 | 0.03 | 0.09 | 0.05 |
| 4 | Wellton-Mohawk I.D. | 1.24 | 2,768 | -0.02 | 0.03 | 0.03 | 0.04 | 0.09 | 0.05 |
| 5 | Intermountain R.E.A. | 2.27 | 130,075 | -0.03 | 0.05 | 0.04 | 0.05 | 0.13 | 0.07 |
| 6 | Grand Valley E.C. | 3.33 | 14,021 | -0.04 | 0.06 | 0.05 | 0.07 | 0.17 | 0.09 |
| 7 | Central Valley E.C., Inc. | 2.04 | 5,180 | -0.04 | 0.07 | 0.06 | 0.07 | 0.19 | 0.10 |
| 8 | Lea County E.C., Inc. | 1.89 | 6,759 | -0.04 | 0.07 | 0.06 | 0.08 | 0.20 | 0.10 |
| 9 | ELECTRICAL DISTRICT 3 | 3.54 | 19,561 | -0.05 | 0.07 | 0.07 | 0.08 | 0.21 | 0.11 |
| 10 | Washington (UAMPS) | 2.89 | 5,578 | -0.05 | 0.07 | 0.07 | 0.08 | 0.21 | 0.11 |
| 11 | Farmers E.C., Inc. | 2.93 | 9,739 | -0.05 | 0.08 | 0.07 | 0.09 | 0.23 | 0.12 |
| 12 | Colorado Springs Utilities | 3.29 | 180,928 | -0.05 | 0.09 | 0.08 | 0.10 | 0.24 | 0.13 |
| 13 | Holy Cross E.A. | 3.59 | 45,196 | -0.06 | 0.09 | 0.08 | 0.10 | 0.25 | 0.13 |
| 14 | Safford | 4.91 | 3,378 | -0.06 | 0.09 | 0.08 | 0.10 | 0.25 | 0.13 |
| 15 | Yampa Valley Rural | 4.15 | 21,670 | -0.06 | 0.10 | 0.09 | 0.11 | 0.27 | 0.14 |
| 16 | Santa Clara (UAMPS) | 3.84 | 1,973 | -0.06 | 0.10 | 0.09 | 0.11 | 0.29 | 0.15 |
| 17 | Mesa (APPA) | 4.85 | 13,257 | -0.07 | 0.11 | 0.10 | 0.12 | 0.31 | 0.16 |
| 18 | Navopache E.C., Inc. | 6.96 | 34,867 | -0.08 | 0.13 | 0.12 | 0.14 | 0.36 | 0.19 |
| 19 | Torrington (WMPA) | 5.66 | 3,163 | -0.09 | 0.14 | 0.12 | 0.15 | 0.39 | 0.20 |
| 20 | Glenwood Springs | 5.00 | 4,779 | -0.09 | 0.15 | 0.13 | 0.17 | 0.42 | 0.22 |
| 21 | Fort Laramie (WMPA) | 8.98 | 210 | -0.10 | 0.15 | 0.14 | 0.17 | 0.43 | 0.22 |
| 22 | Gallup | 6.83 | 8,509 | -0.10 | 0.15 | 0.14 | 0.17 | 0.43 | 0.23 |
| 23 | Lamar Utilities Board | 9.53 | 4,219 | -0.10 | 0.16 | 0.14 | 0.18 | 0.45 | 0.24 |
| 24 | Lehi (UAMPS) | 6.26 | 14,146 | -0.10 | 0.16 | 0.15 | 0.18 | 0.45 | 0.24 |
| 25 | Kaysville (UAMPS) | 6.01 | 7,929 | -0.10 | 0.16 | 0.15 | 0.18 | 0.45 | 0.24 |
| 26 | Sierra Electric Cooperative | 11.56 | 3,595 | -0.10 | 0.16 | 0.15 | 0.18 | 0.46 | 0.24 |
| 27 | Tohono O'odham | 9.20 | 3,036 | -0.11 | 0.17 | 0.15 | 0.19 | 0.47 | 0.25 |
| 28 | Thatcher | 7.26 | 1,072 | -0.11 | 0.17 | 0.15 | 0.19 | 0.48 | 0.25 |
| 29 | Raton | 12.46 | 3,645 | -0.11 | 0.17 | 0.16 | 0.20 | 0.49 | 0.26 |
| 30 | Sangre de Cristo Electric | 11.56 | 10,756 | -0.11 | 0.18 | 0.16 | 0.20 | 0.50 | 0.26 |

K-177

1 allocation, the preference ratio, and the current retail rate. None of these three items change with
2 different operations of the dam. This means the ranking of systems does not change under
3 different alternatives and lists of systems with the largest and smallest impact can be presented
4 on a single table. The percentage rate impact is shown under the letter of the respective
5 alternative. The year of the maximum impact for which the retail rate impact is displayed is
6 shown below the alternative title. Table K.3-6 displays the 30 systems with the smallest
7 percentage retail rate impact in a similar format. The size of systems as measured by the number
8 of residential consumers and the preference ratio is presented for each system. The year for
9 which the impact is measured is also shown on Table K.3-5.

10
11 Many of the entities that experience the largest impacts are part of the UAMPS system
12 and have a high ratio of preference power to sales. The systems with the highest rate impacts
13 generally are relatively small, such as the City of Enterprise (with 517 consumers). The systems
14 that experience the smallest impact are often large systems and have relatively low preference
15 power ratios.

16
17 Tables K.3-7 and K.3-8 list the systems with the highest and lowest residential monthly
18 retail bill impacts in a similar format to the percent retail rate change tables. As with
19 Tables K.3-5 and K.3-6, the impacts are shown for Alternatives B–G relative to Alternative A.
20 The ranking of residential bill impacts is not the same as the rank of the retail percent increase.
21 One of the reasons for differences in ranking is due to residential use variation among individual
22 systems. Systems with lower residential use have a higher bill impact because grid costs are
23 spread over a smaller base, all else being equal. Differences in residential usage are evidenced by
24 the fact that the median average usage across the different systems is 730 kWh per month, while
25 the maximum use for a single system is 1,680 kWh per month, and the system with the lowest
26 annual residential usage is 391 kWh per month.²³ The ranking of retail percent impacts and
27 monthly residential bill impacts also differs because residential bills are measured in absolute
28 rather than in percentage terms. If two utility systems have the same overall percentage rate
29 increase, but one system has a higher level of prices and higher residential bills, that system will
30 have a higher residential bill impact relative to the percentage impact. For example, Ak-Chin has
31 a higher ranking for bill impacts than for retail rate change impacts. This utility system has a
32 small number of residential customers and a relatively high level of consumer bills. In 2012, the
33 average monthly bill of Ak-Chin was about \$140, which is 69% higher than the average bill
34 across all systems of \$84 per month.

35 36 37 **K.3.4 Impacts on Small Systems**

38
39 Two groups of utilities that are allocated a large fraction of their generation resources
40 from SLCA/IP projects are Tribes and some small utilities, implying that the rate and bill
41 impacts on these two groups tend to be relatively large. Impacts on small systems are presented
42 separately in this section. Impacts on Tribes are presented in Section K.4.

43

²³ These figures are averages for a system and do not account for the distribution of usage within the systems.

1 **TABLE K.3-7 Individual Systems with the Largest Monthly Residential Bill Impacts Relative to Alternative A**

| No | Utility System | Preference Ratio | Number of Residential Consumers | Monthly Bill Impact (2015 \$) Relative to Alternative A | | | | | |
|----|----------------------------------------|------------------|---------------------------------|---------------------------------------------------------|--------------------|--------------------|--------------------|--------------------|--------------------|
| | | | | Alternative B 2029 | Alternative C 2025 | Alternative D 2023 | Alternative E 2027 | Alternative F 2020 | Alternative G 2025 |
| 1 | Bridger Valley E.A., Inc. | 23.82 | 5,262 | -0.43 | 0.63 | 0.56 | 0.74 | 1.62 | 0.94 |
| 2 | Murray (UAMPS) | 27.89 | 13,977 | -0.43 | 0.63 | 0.56 | 0.74 | 1.62 | 0.95 |
| 3 | Paragonah (UAMPS) | 37.22 | 250 | -0.43 | 0.64 | 0.56 | 0.75 | 1.63 | 0.95 |
| 4 | Provo (UMPA) | 28.65 | 31,204 | -0.43 | 0.64 | 0.57 | 0.75 | 1.63 | 0.95 |
| 5 | Gunnison | 35.12 | 3,348 | -0.46 | 0.69 | 0.61 | 0.81 | 1.76 | 1.03 |
| 6 | Monroe (UAMPS) | 32.73 | 916 | -0.46 | 0.69 | 0.61 | 0.81 | 1.76 | 1.03 |
| 7 | Salem (UMPA) | 28.65 | 1,793 | -0.47 | 0.70 | 0.62 | 0.82 | 1.79 | 1.04 |
| 8 | Parowan (UAMPS) | 31.33 | 1,237 | -0.47 | 0.70 | 0.62 | 0.82 | 1.79 | 1.04 |
| 9 | Nephi (UMPA) | 28.65 | 1,890 | -0.49 | 0.73 | 0.65 | 0.85 | 1.86 | 1.09 |
| 10 | Spanish Fork (UMPA) | 28.65 | 9,712 | -0.49 | 0.73 | 0.65 | 0.86 | 1.88 | 1.10 |
| 11 | Truth or Consequences | 53.69 | 3,572 | -0.50 | 0.74 | 0.66 | 0.87 | 1.90 | 1.11 |
| 12 | Garkane Power Assn., Inc. | 27.18 | 10,520 | -0.50 | 0.75 | 0.66 | 0.87 | 1.91 | 1.11 |
| 13 | Manti (UMPA) | 28.65 | 1,274 | -0.50 | 0.75 | 0.66 | 0.88 | 1.92 | 1.12 |
| 14 | Page (AZ) + | 24.91 | 3,492 | -0.51 | 0.76 | 0.67 | 0.89 | 1.94 | 1.13 |
| 15 | Morgan (UAMPS) | 41.79 | 1,429 | -0.52 | 0.78 | 0.69 | 0.91 | 1.99 | 1.16 |
| 16 | Dixie Escalante R.E.A., Inc. | 19.68 | 13,831 | -0.53 | 0.79 | 0.70 | 0.93 | 2.02 | 1.18 |
| 17 | Willwood | 16.37 | 49 | -0.55 | 0.81 | 0.72 | 0.95 | 2.07 | 1.21 |
| 18 | Levan (UMPA) | 28.65 | 317 | -0.55 | 0.82 | 0.72 | 0.96 | 2.09 | 1.22 |
| 19 | Holyoke | 29.24 | 937 | -0.55 | 0.82 | 0.73 | 0.96 | 2.09 | 1.22 |
| 20 | Electrical District 3 (APPA) | 14.49 | 975 | -0.56 | 0.82 | 0.73 | 0.97 | 2.11 | 1.23 |
| 21 | Oak City (UAMPS) | 34.51 | 260 | -0.57 | 0.84 | 0.74 | 0.98 | 2.15 | 1.25 |
| 22 | Kanosh (UAMPS) | 58.20 | 284 | -0.61 | 0.90 | 0.80 | 1.05 | 2.30 | 1.34 |
| 23 | Ocotillo I.D. | 21.36 | 19 | -0.66 | 0.98 | 0.87 | 1.15 | 2.52 | 1.47 |
| 24 | Electrical District 3, Maricopa County | 16.62 | 93 | -0.71 | 1.05 | 0.93 | 1.23 | 2.69 | 1.57 |
| 25 | Bountiful (UAMPS) | 42.82 | 15,295 | -0.76 | 1.13 | 1.01 | 1.33 | 2.90 | 1.69 |
| 26 | Meadow (UAMPS) | 62.22 | 158 | -0.78 | 1.15 | 1.02 | 1.35 | 2.95 | 1.72 |
| 27 | Holden (UAMPS) | 57.22 | 215 | -0.78 | 1.16 | 1.03 | 1.36 | 2.96 | 1.72 |
| 28 | Enterprise (UAMPS) | 50.65 | 517 | -0.84 | 1.24 | 1.10 | 1.46 | 3.18 | 1.86 |
| 29 | Flowell E.A., Inc. (Deseret) | 27.66 | 194 | -0.92 | 1.37 | 1.22 | 1.61 | 3.51 | 2.05 |
| 30 | Ak-Chin Municipal | 43.03 | 282 | -1.39 | 2.07 | 1.83 | 2.42 | 5.29 | 3.08 |

K-179

1 **TABLE K.3-8 Individual Systems with the Smallest Monthly Residential Bill Impacts Relative to Alternative A**

| No | Utility System | Preference Ratio | Number of Residential Consumers | Monthly Bill Impact (2015 \$) Relative to Alternative A | | | | | |
|----|----------------------------|------------------|---------------------------------|---------------------------------------------------------|--------------------|--------------------|--------------------|--------------------|--------------------|
| | | | | Alternative B 2029 | Alternative C 2025 | Alternative D 2023 | Alternative E 2027 | Alternative F 2020 | Alternative G 2025 |
| 1 | Maricopa County | 37.09 | NA ^a | 0.00 | 0.00 | 0.00 | 0.00 | 0.00 | 0.00 |
| 2 | Frederick | 0.26 | 3,453 | 0.00 | 0.01 | 0.01 | 0.01 | 0.02 | 0.01 |
| 3 | Los Alamos County | 0.98 | 7,792 | -0.02 | 0.02 | 0.02 | 0.03 | 0.06 | 0.03 |
| 4 | Wellton-Mohawk I.D. | 1.24 | 2,768 | -0.03 | 0.04 | 0.03 | 0.05 | 0.10 | 0.06 |
| 5 | Salt River Project | 1.09 | 867,846 | -0.03 | 0.04 | 0.04 | 0.05 | 0.11 | 0.06 |
| 6 | Intermountain R.E.A. | 2.27 | 130,075 | -0.04 | 0.06 | 0.05 | 0.07 | 0.16 | 0.09 |
| 7 | Washington (UAMPS) | 2.89 | 5,578 | -0.04 | 0.07 | 0.06 | 0.08 | 0.17 | 0.10 |
| 8 | Lea County E.C., Inc. | 1.89 | 6,759 | -0.05 | 0.07 | 0.06 | 0.08 | 0.17 | 0.10 |
| 9 | Central Valley E.C., Inc. | 2.04 | 5,180 | -0.05 | 0.07 | 0.06 | 0.08 | 0.18 | 0.11 |
| 10 | Farmers E.C., Inc. | 2.93 | 9,739 | -0.05 | 0.08 | 0.07 | 0.09 | 0.20 | 0.12 |
| 11 | Colorado Springs Utilities | 3.29 | 180,928 | -0.06 | 0.08 | 0.07 | 0.10 | 0.21 | 0.12 |
| 12 | Grand Valley E.C. | 3.33 | 14,021 | -0.06 | 0.09 | 0.08 | 0.10 | 0.22 | 0.13 |
| 13 | Glenwood Springs | 5.00 | 4,779 | -0.07 | 0.10 | 0.09 | 0.11 | 0.25 | 0.15 |
| 14 | Yampa Valley Rural | 4.15 | 21,670 | -0.07 | 0.10 | 0.09 | 0.12 | 0.25 | 0.15 |
| 15 | Gallup | 6.83 | 8,509 | -0.07 | 0.10 | 0.09 | 0.12 | 0.27 | 0.16 |
| 16 | Navopache E.C., Inc. | 6.96 | 34,867 | -0.08 | 0.11 | 0.10 | 0.13 | 0.29 | 0.17 |
| 17 | Safford | 4.91 | 3,378 | -0.08 | 0.12 | 0.10 | 0.14 | 0.30 | 0.17 |
| 18 | Torrington (WMPA) | 5.66 | 3,163 | -0.08 | 0.12 | 0.11 | 0.14 | 0.31 | 0.18 |
| 19 | Holy Cross E.A. | 3.59 | 45,196 | -0.08 | 0.12 | 0.11 | 0.14 | 0.31 | 0.18 |
| 20 | Fort Laramie (WMPA) | 8.98 | 210 | -0.09 | 0.13 | 0.11 | 0.15 | 0.33 | 0.19 |
| 21 | Price | 7.93 | 4,460 | -0.09 | 0.13 | 0.11 | 0.15 | 0.33 | 0.19 |
| 22 | Mesa (APPA) | 4.85 | 13,257 | -0.09 | 0.13 | 0.12 | 0.15 | 0.33 | 0.19 |
| 23 | Santa Clara (UAMPS) | 3.84 | 1,973 | -0.09 | 0.14 | 0.12 | 0.16 | 0.35 | 0.20 |
| 24 | ELECTRICAL DISTRICT 3 | 3.54 | 19,561 | -0.09 | 0.14 | 0.12 | 0.16 | 0.36 | 0.21 |
| 25 | Lusk (WMPA) | 8.98 | 931 | -0.09 | 0.14 | 0.12 | 0.16 | 0.36 | 0.21 |
| 26 | Mora-San Miguel | 11.56 | 10,575 | -0.10 | 0.15 | 0.13 | 0.18 | 0.38 | 0.22 |
| 27 | Lehi (UAMPS) | 6.26 | 14,146 | -0.10 | 0.15 | 0.13 | 0.18 | 0.38 | 0.22 |
| 28 | Farmington | 6.73 | 34,037 | -0.10 | 0.15 | 0.14 | 0.18 | 0.39 | 0.23 |
| 29 | Cody (WMPA) | 8.98 | 5,894 | -0.10 | 0.15 | 0.14 | 0.18 | 0.39 | 0.23 |
| 30 | Kit Carson Electric | 11.56 | 24,309 | -0.11 | 0.17 | 0.15 | 0.19 | 0.42 | 0.25 |

^a NA = Not applicable.

To demonstrate the effect of system size on rate impacts, statistics were computed for the 20 systems with the largest impact and the 20 systems with the smallest impacts. Table K.3-9 demonstrates that, as measured by the number of residential consumers, the average size of systems with the largest rate impacts (1,680 consumers) is much smaller than the typical size of utility systems. Without adjusting for SRP and Colorado Springs, utilities with the smallest rate impacts are on average 38 times the size of the systems that have the largest rate impacts. When the two large systems are removed, the systems with the smallest impacts are still about 10 times larger than the systems with the largest percent rate increases.

The comparatively high retail rate increases on some small utility systems under the LTEMP alternatives are shown in Table K.3-10. This table shows average retail rate impacts under different alternatives relative to Alternative A for the selected groups of utility systems. In comparing rate impacts, the maximum impact year is used. The 20 systems with the largest impact have an average rate increase that is 2.52 times the average rate increase percent across all systems. On the other hand, the 20 systems with the smallest impact have an average rate increase that is a small fraction of the average rate increase for the entire population of systems. Finally, Table K.3-10 illustrates that the preference ratio is highly correlated to the rate increase.

K.3.5 Alternative-Specific Impacts

K.3.5.1 Alternative A

Under Alternative A, SLCA/IP marketable capacity is 737.2 MW using an assumed water flow rate that is low enough that one can be 90% confident that the rate will be exceeded. Average annual daily generation and hydropower value at Glen Canyon Dam and SLCA/IP

TABLE K.3-9 Size and Preference Ratio for Utility Systems with Large Rate Impacts

| Statistics for Impact Analysis on Small Systems | | | | | |
|--------------------------------------------------------|---------------------------------------|--------------------------|------------------------------------------------|---------------------|-----------------------------------------------|
| Group of System | Rate Impact Relative to Average | Residential Customers | Size Relative to Large Impact Systems | Preference Ratio | Preference Ratio Relative to Average |
| Utilities with Largest Rate Impact ^a | 2.52 | 1,680 | 1.00 | 38.83% | 2.36 |
| Utilities with Smallest Impact ^b | 0.18 | 69,099 | 41.13 | 3.24% | 0.20 |
| Utilities with Smallest Impact Excluding SRP and CS | 0.20 | 17,096 | 10.18 | 3.81% | 0.23 |
| Average of All Systems | 1.00 | 16,567.69 | 9.86 | 16.43% | 1.00 |

^a Includes 20 systems with largest impact except Tribes.

^b Includes 20 systems with smallest rate impact.

1
2

TABLE K.3-10 Rate Impacts for Selected Groups in Maximum Impact Year

| Alternative | Largest Retail Rate Change Group in Maximum Impact Year (%) | Smallest Retail Rate Change Group in Maximum Impact Year (%) | Average Retail Rate Change Across All Systems in Maximum Impact Year (%) | Rate Impact for Largest Group/Average Rate Impact (\$) |
|-------------|-------------------------------------------------------------|--------------------------------------------------------------|--------------------------------------------------------------------------|--------------------------------------------------------|
| A | 0.00 | 0.00 | 0.00 | – |
| B | -0.56 | -0.09 | -0.27 | 2.08 |
| C | 1.08 | 0.09 | 0.43 | 2.52 |
| D | 0.98 | 0.07 | 0.39 | 2.52 |
| E | 1.21 | 0.09 | 0.50 | 2.44 |
| F | 3.05 | 0.22 | 1.21 | 2.52 |
| G | 1.60 | 0.12 | 0.64 | 2.52 |

3
4

marketable capacity would not change under Alternative A. Rate impacts for each LTEMP Alternative are computed relative to this alternative, meaning that the difference between two cases must be used to evaluate the change in rates.

8
9

Retail rates and residential bills are computed for Alternative A using inflation rates and sales growth from EIA forecasts. Production costs, fixed operation and maintenance costs associated with new capacity, and the cost of new capacity from Alternative A are used as the basis for evaluating aggregate grid cost impacts for the other LTEMP scenarios.

13
14

K.3.5.2 Alternative B

16
17

Under Alternative B, rates and bills would be lower than under all other alternatives. Production costs are lower under Alternative B than under Alternative A, and there is a minor difference in the amount of capacity added for 1 year. Although the total amount of capacity added over the 20-year LTEMP period is the same as in Alternative A, a 1-year delay in constructing a new natural-gas-fired combustion turbine is projected in the power systems analysis for the year 2029. This delay in capacity additions and the difference in production cost accounts for the slightly lower annual average grid cost for Alternative B compared to Alternative A. The difference in annual grid costs averages \$976 thousand per year (real 2015\$).

25
26

When the annual grid cost reduction is translated to impacts on electric bills, the average retail rate decrease over the LTEMP period is -0.039%. The maximum rate decrease occurs in the year of the capacity deferral, 2029. The percent decrease in this year with the deferred capacity (the maximum impact year) is -0.27%. Table K.3-5 shows that the individual systems with the maximum impact have decreases that range between -0.48% and -0.93%. The average

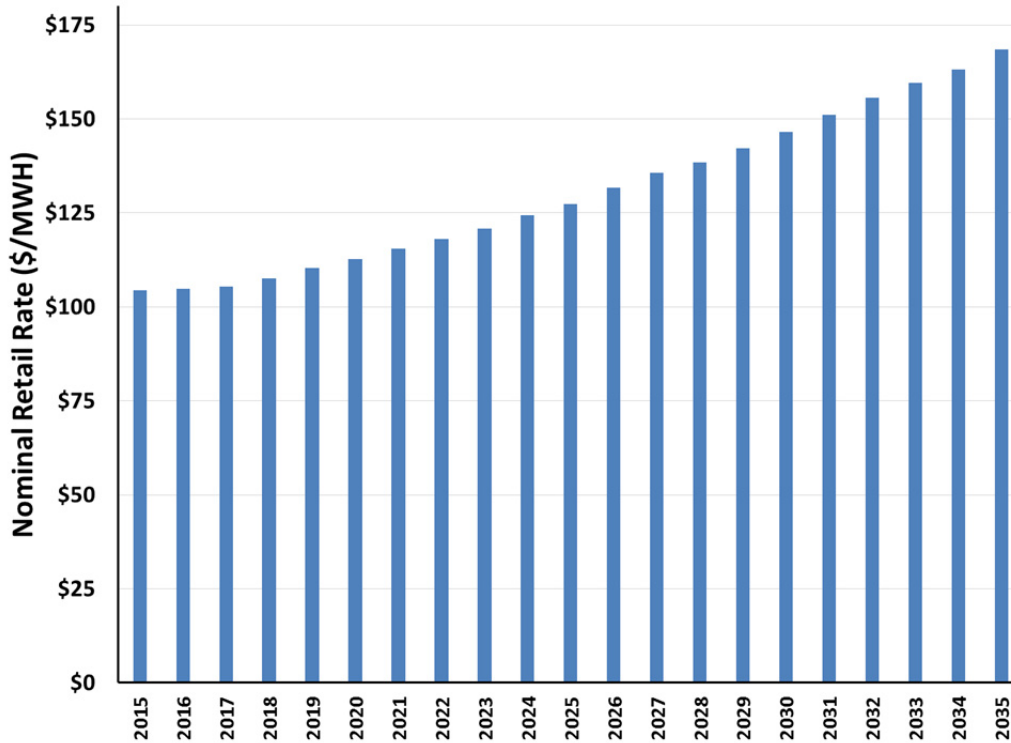

FIGURE K.3-13 Retail Rates under Alternative A

decrease in monthly residential bills over the LTEMP period is 4 cents per month, while the decrease in 2029 is 27 cents per month.

K.3.5.3 Alternative C

Retail rate increases under Alternative C relative to Alternative A are primarily driven by an increase in capacity of 230 MW that occurs for most years after 2018. This capacity increase is more than the reduction in marketable capacity of 129.1 MW. Replacement of the lost capacity and increased production costs results in varying grid cost impacts over the LTEMP period. Average grid impacts in real 2015 dollars are \$9.8 million per year relative to Alternative A. These impacts are less than under Alternative F and Alternative G, but more than under Alternatives D, E, or B. The increase of \$9.8 million in grid costs represents an increase of 6.87% relative to the annual wholesale revenues currently collected from SLCA/IP capacity and energy charges. When the wholesale grid cost of 6.87% is converted into retail rates, the averages across all systems and years range from a low of 0% to a high of 0.428% in 2025. The average percent retail rate increase across all systems for the LTEMP period is 0.245%. For the year 2025, which is the year with the maximum percent rate impact shown in Table K.3-5, individual systems experience percentage impacts ranging from less than 0% up to 1.46%.

1 Monthly residential bill impacts under Alternative C relative to Alternative A range from
2 0 to 40 cents for the LTEMP period. The average increase in residential bills is 22 cents per
3 month. Detailed residential bill impacts under Alternative C for the maximum year are shown in
4 Table K.3-6. Residential bill impacts in the highest impact year (2025) are not much higher than
5 the results from Alternative D discussed in the next section. However, the average impacts under
6 Alternative C are 43% greater than the impacts under Alternative D. For the maximum impact
7 year 2025, the range in residential bill impacts ranges between approximately \$0 (4 cents for
8 SRP consumers) and \$2.07 per month (Ak-Chin Electric Municipal).
9

10 **K.3.5.4 Alternative D**

11
12
13 Retail rate increases under Alternative D relative to Alternative A are primarily driven by
14 a reduction in capacity of 230 MW in most years. Replacement of capacity and increased
15 production costs result in varying grid cost impacts on a year-by-year basis. Average grid
16 impacts in real 2015 dollars are \$6.8 million per year. When translated to retail rates, the impacts
17 as an unweighted average across all systems range from 0% to a high of 0.391% in 2023. The
18 average retail rate increase across all systems for the LTEMP period is 0.156%. For the
19 maximum impact year 2023, individual systems experience percentage impacts ranging from 0%
20 to 1.38%, as shown in Tables K.3-5 and K.3-6. The maximum impact retail rate increase is lower
21 for Alternative D than for any other alternative analyzed except Alternatives B and A.
22

23 The impacts measured in terms of residential bills for individual systems in the maximum
24 impact year are shown in Tables K.3-6 and K.3-7. Residential bill impacts under Alternative D
25 relative to Alternative A, measured in 2015 dollars per month, range from 0 to 38 cents over the
26 LTEMP period. The bill increase of 38 cents per month in the high-impact year is less than the
27 bill increase in the high-impact year of 47 cents under Alternative E. The average increase in
28 residential bills over the LTEMP period is 15 cents per month. For the year 2023, with the
29 maximum bill impact, the range in residential bill impacts is between 0 and \$1.83 per month.
30

31 **K.3.5.5 Alternative E**

32
33
34 Retail rate increases under Alternative E relative to Alternative A are primarily driven by
35 an increase in capacity of 230 MW that occurs in 10 out of the 20 years of the evaluation, the
36 average of which is more than the reduction in marketable capacity change of 90.21 MW.
37 Replacement of the lost capacity and increased production costs results in varying grid cost
38 impacts over the LTEMP period, some of which are lower than rates and bills under
39 Alternative A. Average grid impacts are \$6.4 million per year, which is lower than any of the
40 LTEMP alternatives except Alternatives A and B. When the grid cost is converted into retail
41 rates, the average across all systems and years range from changes that are below zero in years
42 with no capacity change, to a high of 0.497% in 2027. The average percent retail rate increase
43 across all systems for the years 2015 to 2035 is 0.142%. When compared to Alternative D, the
44 average increase across the LTEMP period is slightly less, but the impact in the maximum year
45 is slightly more. For the year 2027, which is the year with the highest rate impact, individual
46 systems experience percentage impacts ranging from 0.03% (SRP) to 1.65% (City of Enterprise).

1 Residential bill impacts under Alternative E relative to Alternative A range from amounts
2 that are below zero to 47 cents over the LTEMP period. The average increase is 13 cents per
3 month. For the year 2027 with the maximum bill impact, the range in residential bill impacts is
4 between 5 (SRP) and \$2.42 per month (Ak-Chin Municipal Electric).
5
6

7 **K.3.5.6 Alternative F**

8

9 Retail rate increases under Alternative F relative to Alternative A are driven by increases
10 in capacity of either 230 MW or 460 MW in various years, as well as varying amounts of
11 production cost increases. The increase in capacity compares to the reduction in marketable
12 capacity of 314 MW. The average grid cost increase under Alternative F is \$28.7 million per
13 year. This is much higher than any of the other LTEMP alternatives and equates to 20.11% of the
14 \$143 million in SLCA/IP wholesale revenues. The average retail rate increase reaches a high of
15 1.21% in 2018 and the average percent retail rate increase over the LTEMP period is 0.75%.
16 When compared to the next highest impact scenario, Alternative G, the average impact is almost
17 double. For the year 2018, the year with the maximum rate impact, individual systems
18 experience percentage impacts ranging from 0.08% (SRP) to 4.14% (City of Enterprise, a
19 member of UAMPS), as shown in Tables K.3-5 and K.3-6.
20

21 Residential bills under Alternative F that result from the grid cost increases are higher
22 than bills under Alternative A in all years and are \$1.02 in the maximum impact year. The
23 average increase in residential bills over the LTEMP period is 69 cents per month. For the year
24 2018, with the maximum bill impact, the range in residential bill impacts is between 11 cents
25 (SRP) and \$5.29 (Ak-Chin Municipal Electric) per month.
26
27

28 **K.3.5.7 Alternative G**

29

30 Retail rate increases under Alternative G relative to the Alternative A are driven by an
31 increase in capacity of 230 MW that occurs from the year 2018 forward, as well as production
32 cost increases. The increase in capacity of 230 MW is more than the reduction in marketable
33 capacity of 179 MW. Average grid cost increases by \$17.2 million per year, which is higher than
34 any of the LTEMP alternatives except Alternative F. The average retail rate increase across all
35 systems and years is above zero in all years and reaches a high of 0.638% in 2025. Across the
36 LTEMP period and all systems, the rate increase is 0.418%. When compared to Alternative C,
37 the average increase is almost double and the impact in the maximum year is also higher because
38 of higher production costs. For the year 2025, which is the year with the highest rate impact in
39 this scenario, individual systems experience percentage impacts ranging from 0.04% (SRP) to
40 2.18% (City of Enterprise).
41

42 Residential bill impacts under Alternative G have a high of 59 cents, while the average
43 increase in residential bills is 39 cents per month over the LTEMP period. For the year 2025,
44 with the maximum bill impact, the range in residential bill impacts is between 6 cents (SRP) and
45 \$3.08 (Ak-Chin Municipal Electric) per month as shown in Tables K.3-7 and K.3-8.
46

1 **K.4 FINANCIAL IMPACTS OF LTEMP ALTERNATIVES ON AMERICAN INDIAN**
2 **TRIBES**

3
4 The purpose of this section is to estimate the financial impact of LTEMP alternatives on
5 American Indian Tribes that receive an allocation of SLCA/IP electrical power. This section also
6 compares the estimated financial impacts on these Tribes to the estimated financial impacts on
7 other Western FES customers in the SLCA/IP marketing area to see how Tribal financial impacts
8 compare with the financial impacts on others.
9

10 Western's post-2004 marketing plan purposely provided SLCA/IP power allocations to
11 over 50 Tribes in its marketing area who historically had not been able to receive the financial
12 benefits of federal hydropower. Western normally requires its customers to operate electric
13 utilities, and most Tribes do not meet that requirement. Tribes are preference power customers,
14 but historically have been underrepresented in Western's customer base. In order to encourage
15 widespread use of federal hydropower, Western made administrative changes to allow numerous
16 Tribes to receive an allocation of power and the associated financial benefits. Western developed
17 a resource pool of sufficient size to target an allocation of 65% of total Tribal electrical use to
18 eligible Tribes.²⁴ There are 57 Tribes or Tribal entities who currently receive an allocation of
19 SLCA/IP power (directly or indirectly) from Western.
20

21 The impact of the alternatives ranges from almost no impact to over \$3 million in
22 financial costs for the Tribes, with the average financial impact of all the alternatives being
23 \$1.345 million per year. Tribes may be financially impacted in three ways by the LTEMP
24 alternatives:
25

- 26 • Tribes that operate their own utilities may see a change in the rate they pay for
27 SLCA/IP power.
- 28
- 29 • Tribes that do not operate their own electric utility and have entered into
30 benefit crediting arrangements with another utility to take their allocation, and
31 instead receive an economic benefit from that utility, may see a change in the
32 economic benefit, essentially a change in payment received from that other
33 utility.
- 34
- 35 • Tribes that have entered into an economic benefit with a utility that also
36 receives SLCA/IP power may see their economic benefit crediting payments
37 change and may experience changes in the retail rates charged to Tribal
38 members.
39

40 There are currently 57 Tribes and Tribal entities that received a power allocation from the
41 SLCA/IP resources. The analysis in this report assumes that each of these Tribes will continue to

²⁴ The final allocation of SLCA/IP power to Tribes was less than the 65% target. In addition, Western adjusted the target allocation to account for Tribes whose reservations were in electrical service areas served by existing SLCA/IP FES customers.

1 receive its current allocation under each alternative of the LTEMP DEIS. Nine of these Tribes
2 operate electric utilities and receive power directly from Western. The remaining 48 Tribes are
3 not electrical utilities but still receive the benefits of federal hydropower through benefit
4 crediting arrangements with SLCA/IP customers or other electric utilities.

5
6 The purpose of benefit crediting is to provide a Tribe with the financial benefits
7 associated with SLCA/IP power—a low-cost capacity and energy resource. This benefit is
8 usually provided to the Tribe by an electrical service provider (supplier) that serves the area in
9 which the Tribe is located. The benefit received by the Tribe is in lieu of a direct delivery of
10 power by Western. It is intended to be the financial equivalent of a direct delivery. Because the
11 SLCA/IP rate is generally lower than the supplier’s production cost of electrical power, the
12 difference between these costs is considered the benefit per megawatt-hour received by the
13 Tribe. This cost difference is multiplied by the Tribe’s megawatt-hour allocation of SLCA/IP
14 power. The product of these two numbers is the dollar benefit to the Tribe for an SLCA/IP
15 allocation. The supplier provides the Tribe with a dollar benefit. The equation used to determine
16 the benefit is similar to the following:

17
18
$$\textit{Benefit} = \textit{SLCA/IP Allocation} \times (\textit{Supplier rate} - \textit{SLCA/IP rate}) \quad (\text{Eq. 1})$$

19
20 Where:

- 21
22 Benefit = the financial benefit received by the Tribe from the electric service
23 provider (\$),
24 SLCA/IP Allocation = SLCA/IP allocation to the Tribe in the post-2004 marketing period
25 (MWh),
26 Supplier rate = average production cost (i.e., large customer retail rate) or purchase
27 cost of the electrical supplier (\$/MWh), and
28 SLCA/IP rate = the composite SLCA/IP FES rate (\$/MWh).
29
30

31 **K.4.1 Contractual Requirements for Calculating and Delivering Benefits to Tribes**

32
33 In order to accommodate the post-2004 allocations of SLCA/IP electrical power to
34 Tribes, Western contracted with seven electrical wholesale utility customers (suppliers) to
35 establish benefit crediting arrangements, which would allow the Tribes that did not operate
36 electric utilities to benefit from a federal hydropower allocation. Western and the individual
37 Tribes made arrangements with one of the following entities:

- 38
39
 - Public Service Company of New Mexico,
 - 40 • Navajo Tribal Utility Authority,
 - 41 • Page Electric Utility,
 - 42 • Tri-State Generation and Transmission Association,
 - 43 • Salt River Project,
 - 44 • Aha Macav, or
 - 45 • Deseret Generation and Transmission.

46

1 Each of these suppliers calculates the financial benefit of a Tribe's SLCA/IP power
2 allocation according to language in three-party contracts among Western, the supplier, and the
3 Tribe. The contractual language varies somewhat for each supplier. Below is an excerpt from
4 Western's contract with Public Service Company of New Mexico (PNM) and a Pueblo in New
5 Mexico:

6
7 "7.2 The Economic Benefit shall be calculated each month as follows:
8 Economic Benefit (\$) = (Cost A - Cost B)* (kWh scheduled and delivered
9 as the Tribal Allocation). The values of A and B and the method for
10 determining the amount of energy delivered by Western to PNM by month
11 for the Economic Benefit of the Tribe are set forth in Exhibit A attached
12 hereto.

13
14 "7.2.1 Cost A is PNM's weighted average generation cost for the Pueblos
15 in PNM's service area as delineated in Exhibit A. Cost A shall be
16 revised as required by PNM to reflect changes in retail generation
17 costs as set forth in Exhibit A attached hereto.

18
19 "7.2.2 Cost B is the cost of the Tribal Allocation as delineated in
20 Exhibit A attached hereto. Cost B shall be revised as required by
21 Western to reflect changes in power supply costs as set forth in
22 Exhibit A attached hereto."

23
24 Essentially, the benefit each Tribe receives is the difference between the market value of
25 electrical energy and the SLCA/IP wholesale rate multiplied by the Tribe's SLCA/IP allocation.
26 These benefit crediting arrangements are intended to capture the approximate benefit a Tribe
27 would receive from an allocation of SLCA/IP power if it were able to receive it directly to serve
28 its own electric load.

31 **K.4.2 Calculation of Tribal Benefit Baseline under Alternative A (No Action Alternative)**

32
33 Attachment K-11 lists the Tribes that receive an allocation of SLCA/IP electrical power,
34 the amount of electrical capacity and energy the Tribe is currently allocated (by season), and the
35 utility that serves the Tribal reservation or Tribal lands.

36
37 The Tribal benefit was calculated for Alternative A. Note that this benefit calculation
38 differs somewhat from the benefit currently received by the Tribe for two reasons:

- 39
- 40 • The SLCA/IP rate developed by Western for Alternative A is marginally
41 higher than the actual current SLCA/IP rate.
 - 42
 - 43 • The electrical rate of the supplier is estimated in several cases. Western's
44 contracts may refer to "average generation cost" or to the "Class A rate," but
45 the rate of the supplier is typically not quantitatively specified in the contract

1 language. Therefore, the published rates for the seven suppliers that best
2 conformed to the current contract description were used.

3
4 With these data, the calculation of the Tribal economic benefit was determined by
5 inputting the relevant rates and Tribal allocations into Equation 1. It includes both capacity and
6 energy components. This calculation was performed for each Tribe that has entered into a benefit
7 crediting contract. This was not done for the nine Tribes that operate utilities; they do not receive
8 a benefit credit because they directly receive an SLCA/IP allocation.

9
10
11 **K.4.3 Calculation of Change in Tribal Benefit as a Result of LTEMP EIS Alternatives**

12
13 Figure K.4-1 illustrates the method that was used for evaluating the impacts of LTEMP
14 alternatives on the benefit for each Tribe.

15
16 The power economic impacts for the DEIS are described in Section K.1. Western used
17 these data to estimate the SLCA/IP FES rate for each alternative. The method used the results
18 that are described in Section K.2. The financial benefit was computed for each Tribe for each
19 alternative using the estimated SLCA/IP rate for each alternative, the estimated supplier's rate,
20 and the Tribal allocations listed in Attachment K-11.

21
22 A simplifying assumption was used in this analysis. The Tribal allocations used for the
23 analysis (and listed in Attachment K-11) are SLCA/IP commitment levels from the current
24 marketing plan. This plan expires at the end of FY 2024. It was assumed that these commitment
25 levels would continue through the LTEMP period, which extends through 2035. It should be
26 emphasized that this is an analysis, not a description of policy or attempt to predict Western's
27 post-2024 marketing plan. Although it is a reasonable assumption for the purposes of this
28 analysis that Western will continue existing commitment levels after 2024, the reader should not
29 assume that Western will or will not maintain these levels when the new marketing plan is
30 finalized.

31
32
33 **K.4.4 Impacts on Tribes through a Change in the Retail Rate of the Electrical Supplier to
34 Tribal Lands**

35
36 In addition to the economic impact of the LTEMP alternatives on Tribal benefits, some
37 Tribes receive retail electric service from suppliers (such as rural cooperatives) that are SLCA/IP
38 customers themselves. This means that Tribal households and commercial establishments on
39 Tribal lands could pay a different retail rate for their electricity. If an alternative operating
40 criterion at Glen Canyon Dam causes a change in the SLCA/IP rate, a utility supplying retail
41 service to a Tribe could change its retail rate for electricity as a result of that alternative. Tribal
42 members and commercial establishments on Tribal lands (households and businesses) could
43 incur a change in their electrical utility bills as a result.

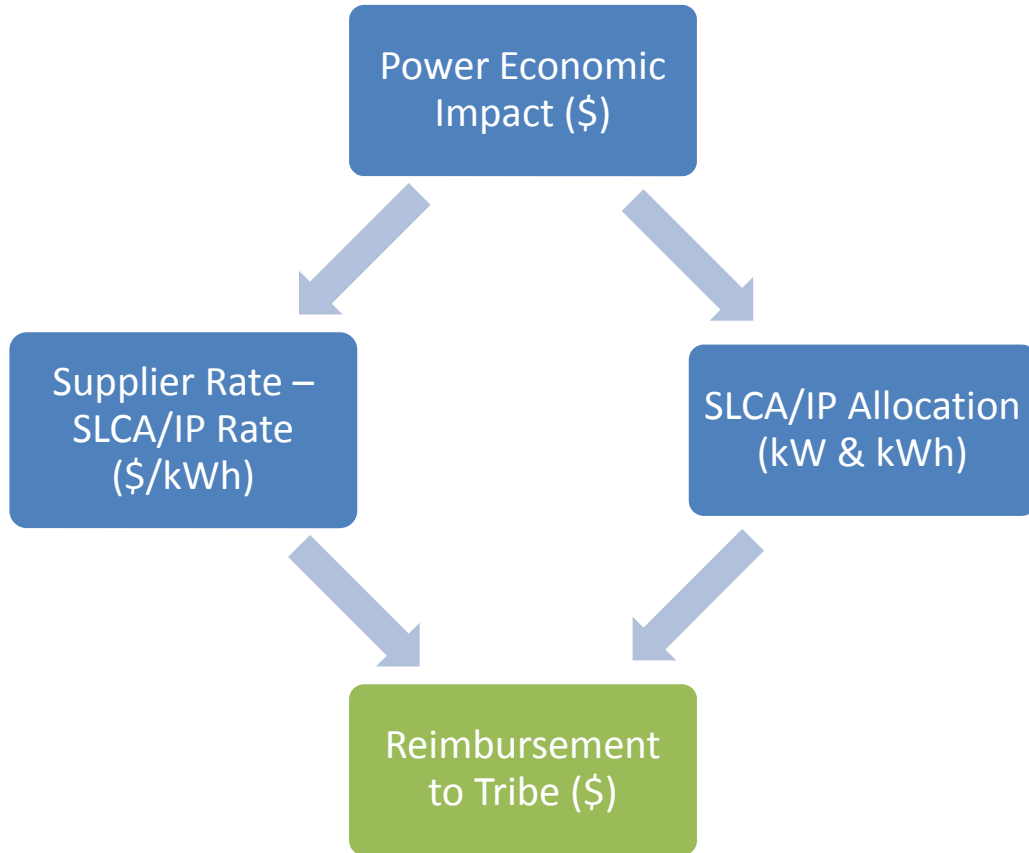

FIGURE K.4-1 Calculation of Change in Tribal Benefit Resulting from LTEMP DEIS Alternatives

Attachment K-11 includes the list of the Tribes receiving their SLCA/IP allocation from a supplier along with the name of the electrical supplier that serves the Tribal reservation or Tribal lands. Section K.3 includes the estimated retail rate change for SLCA/IP customers by alternative. The financial impacts on the Tribes based on changes in the SLCA/IP rate were calculated using the following equation:

$$\text{Financial Loss/Gain} = \text{Total Reservation Electricity Consumption}^{25} \times \text{Change in Retail Rate}^{26} \quad (\text{Eq. 2})$$

Attachment K-12 is a list of Tribes receiving SLCA/IP allocations and the estimated total electrical use by Tribe. These data were partly gathered and required by Western as part of the development of the post-2004 marketing plan. They are referred to as applicant profile data.

²⁵ This estimate is for the year 2015. It is therefore an annual amount of electrical energy used. The financial loss or gain should be interpreted as an annual financial impact.

²⁶ These estimated changes in retail rates by alternative are taken directly from Section K.3.

1 These applicant profile data are believed to be out of date because they are based on
2 electrical use by Tribes in 1998. However, more current data on Tribal electrical use were not
3 readily available or published. Therefore, the amounts of electrical energy shown in Attachment
4 K-12 were escalated by 2.5% per year to 2015.²⁷ The estimated Tribal electricity use calculated
5 with Equation 2 is therefore an escalated amount and represents an estimate of the current
6 electrical use by Tribes.

7
8 The estimated 2015 total electrical use by Tribal households and commercial
9 establishments on Tribal lands was multiplied by the change in the retail rate estimated for the
10 electrical service supplier—which is an SLCA/IP FES customer—as derived from the analysis
11 described in Section K.3. This results in an estimated increase (or decrease) in the retail electrical
12 utility costs paid by each Tribe annually under each alternative (via the Tribal members who live
13 on Tribal lands).

14 15 16 **K.4.5 Calculation of Tribal Impacts for Tribes That Are Direct SLCA/IP Recipients**

17
18 For the Tribes that operate electrical utilities and receive SLCA/IP power directly from
19 Western, the impacts of LTEMP alternatives were calculated. This calculation is the difference
20 in the SLCA/IP FES rate between each of the action alternatives and the No Action alternative
21 multiplied by the total escalated electrical use for each Tribe. Multiplying the change in
22 SLCA/IP rate (from Section K.2) by the escalated Tribal electrical use yields the estimated
23 financial impacts for each of the LTEMP DEIS alternatives on each of the nine Tribes that
24 receive SLCA/IP allocations directly from Western.

25
26 Table K.4-1 is the result of the retail-rate impact analysis for the average household on a
27 Tribal reservation or on Tribal lands. The estimates, by Tribe, presented in Table K.4-1 describe
28 how a residential household might be impacted by the LTEMP DEIS alternatives due to a
29 changed retail rate. The numbers in Table K.4-1 are taken from the retail rate impact analysis
30 described in Appendix K.3. That analysis computed the monthly change in an electric utility bill
31 for an average residence across the SLCA/IP market footprint. Table K.4-2 shows this change. It
32 is extracted from similar information in Section K.3. It assumes that residences on Tribal lands
33 incur the same change in residential monthly electrical utility bills as other residences in the
34 same electrical service area.

35
36 For example, the reservation of the Ute Tribe is electrically served by Moon Lake
37 Electric. According to the estimate in Section K.3, Moon Lake Electric residences will pay
38 slightly over a dollar a month more for electricity under Alternative F. It was assumed that the
39 residences of the Ute Tribe on the Ute reservation, served by Moon Lake Electric, will also pay
40 slightly over a dollar a month more for electricity under Alternative F. Remember that the
41 information in Table K.4-1 is one of two financial impacts on the Tribes caused by the
42 alternatives. The total financial impact on Tribes is presented in Table K.4-2.

²⁷ Based on data reported by the EIA, 2.5% is the approximate average annual increase in electrical energy use over the last decade in states where Tribal entities reside.

1 **TABLE K.4-1 Monthly Change in Residential Electric Utility Bill for Tribes by Alternative**

| Tribal Entity | Difference from Alternative A | | | | | |
|------------------------------------------------------------------|-------------------------------|---------------|---------------|---------------|---------------|---------------|
| | Alternative B | Alternative C | Alternative D | Alternative E | Alternative F | Alternative G |
| <i>Tribes that Operate Their Own Utility</i> | | | | | | |
| Navajo Tribal Utility Authority | -0.035 | 0.339 | 0.234 | 0.211 | 1.011 | 0.591 |
| Navajo Agricultural Products Industries | NA | NA | NA | NA | NA | NA |
| Ak-Chin Indian Community | -0.123 | 1.187 | 0.820 | 0.740 | 3.539 | 2.069 |
| Tohono O’odham Utility Authority | -0.013 | 0.122 | 0.084 | 0.076 | 0.362 | 0.212 |
| Fort Mojave Indian Tribe | -0.032 | 0.309 | 0.214 | 0.193 | 0.922 | 0.539 |
| Bureau of Indian Affairs Colorado River Agency | NA | NA | NA | NA | NA | NA |
| San Carlos Irrigation Project | NA | NA | NA | NA | NA | NA |
| Jicarilla Apache Tribe | NA | NA | NA | NA | NA | NA |
| Gila River Indian Community | NA | NA | NA | NA | NA | NA |
| <i>Tribes That Have a Benefit Contracting Arrangement</i> | | | | | | |
| Alamo Navajo Chapter | -0.012 | 0.115 | 0.080 | 0.072 | 0.344 | 0.201 |
| Canoncito Navajo Chapter | -0.014 | 0.134 | 0.092 | 0.083 | 0.399 | 0.233 |
| Cocopah Indian Tribe | 0.000 | 0.000 | 0.000 | 0.000 | 0.000 | 0.000 |
| Colorado River Indian Tribes | 0.000 | 0.000 | 0.000 | 0.000 | 0.000 | 0.000 |
| Confederated Tribes of the Goshute Reservation | -0.015 | 0.145 | 0.100 | 0.091 | 0.433 | 0.253 |
| Duckwater Shoshone Tribe | -0.015 | 0.145 | 0.100 | 0.091 | 0.433 | 0.253 |
| Ely Shoshone Tribe | -0.015 | 0.145 | 0.100 | 0.091 | 0.433 | 0.253 |
| Ft. McDowell Mojave-Apache Indian Community | -0.016 | 0.158 | 0.109 | 0.099 | 0.471 | 0.275 |
| Havasupai Tribe | -0.123 | 1.187 | 0.820 | 0.740 | 3.539 | 2.069 |
| Hopi Tribe | -0.007 | 0.065 | 0.045 | 0.041 | 0.195 | 0.114 |
| Hualapai Tribe | 0.000 | 0.000 | 0.000 | 0.000 | 0.000 | 0.000 |
| Las Vegas Paiute Tribe | 0.000 | 0.000 | 0.000 | 0.000 | 0.000 | 0.000 |
| Mescalero Apache Tribe | -0.021 | 0.206 | 0.142 | 0.128 | 0.614 | 0.359 |
| Nambe Pueblo | -0.026 | 0.246 | 0.170 | 0.153 | 0.733 | 0.429 |
| Paiute Indian Tribe of Utah | 0.000 | 0.000 | 0.000 | 0.000 | 0.000 | 0.000 |
| Pascua Yaqui Tribe | -0.123 | 1.187 | 0.820 | 0.740 | 3.539 | 2.069 |
| Picuris Pueblo | -0.018 | 0.170 | 0.118 | 0.106 | 0.508 | 0.297 |
| Pueblo De Cochiti | 0.000 | 0.000 | 0.000 | 0.000 | 0.000 | 0.000 |
| Pueblo of Acoma | -0.014 | 0.134 | 0.092 | 0.083 | 0.399 | 0.233 |
| Pueblo of Isleta | 0.000 | 0.000 | 0.000 | 0.000 | 0.000 | 0.000 |
| Pueblo of Jemez | -0.026 | 0.246 | 0.170 | 0.153 | 0.733 | 0.429 |
| Pueblo of Laguna | -0.014 | 0.134 | 0.092 | 0.083 | 0.399 | 0.233 |
| Pueblo of Pojoaque | -0.026 | 0.246 | 0.170 | 0.153 | 0.733 | 0.429 |
| Pueblo of San Felipe | 0.000 | 0.000 | 0.000 | 0.000 | 0.000 | 0.000 |
| Pueblo of San Ildefonso | -0.026 | 0.246 | 0.170 | 0.153 | 0.733 | 0.429 |
| Pueblo of San Juan | -0.026 | 0.246 | 0.170 | 0.153 | 0.733 | 0.429 |

2

TABLE K.4-1 (Cont.)

| Tribal Entity | Difference from Alternative A | | | | | |
|------------------------------------------------------------------|-------------------------------|---------------|---------------|---------------|---------------|---------------|
| | Alternative B | Alternative C | Alternative D | Alternative E | Alternative F | Alternative G |
| <i>Tribes That Have a Benefit Contracting Arrangement</i> | | | | | | |
| Pueblo of Sandia | 0.000 | 0.000 | 0.000 | 0.000 | 0.000 | 0.000 |
| Pueblo of Santa Clara | -0.026 | 0.246 | 0.170 | 0.153 | 0.733 | 0.429 |
| Pueblo of Santo Domingo | 0.000 | 0.000 | 0.000 | 0.000 | 0.000 | 0.000 |
| Pueblo of Taos | -0.018 | 0.170 | 0.118 | 0.106 | 0.508 | 0.297 |
| Pueblo of Tesuque | 0.000 | 0.000 | 0.000 | 0.000 | 0.000 | 0.000 |
| Pueblo of Zia | -0.026 | 0.246 | 0.170 | 0.153 | 0.733 | 0.429 |
| Pueblo of Zuni | -0.014 | 0.134 | 0.092 | 0.083 | 0.399 | 0.233 |
| Quechan Indian Tribe | 0.000 | 0.000 | 0.000 | 0.000 | 0.000 | 0.000 |
| Ramah Navajo Chapter | -0.014 | 0.134 | 0.092 | 0.083 | 0.399 | 0.233 |
| Salt River Pima-Maricopa Indian Community | -0.016 | 0.158 | 0.109 | 0.099 | 0.471 | 0.275 |
| San Carlos Apache Tribe | 0.000 | 0.000 | 0.000 | 0.000 | 0.000 | 0.000 |
| Santa Ana Pueblo | 0.000 | 0.000 | 0.000 | 0.000 | 0.000 | 0.000 |
| Skull Valley Band of Goshute Indians | 0.000 | 0.000 | 0.000 | 0.000 | 0.000 | 0.000 |
| Southern Ute Indian Tribe | -0.011 | 0.106 | 0.073 | 0.066 | 0.317 | 0.185 |
| Tonto Apache Tribe | 0.000 | 0.000 | 0.000 | 0.000 | 0.000 | 0.000 |
| Ute Indian Tribe | -0.009 | 0.086 | 0.059 | 0.054 | 0.256 | 0.150 |
| Ute Mountain Ute Tribe | -0.035 | 0.338 | 0.234 | 0.211 | 1.009 | 0.590 |
| White Mountain Apache Tribe | 0.000 | 0.000 | 0.000 | 0.000 | 0.000 | 0.000 |
| Wind River Reservation | -0.020 | 0.189 | 0.130 | 0.118 | 0.562 | 0.329 |
| Yavapai Apache Nation | 0.000 | 0.000 | 0.000 | 0.000 | 0.000 | 0.000 |
| Yavapai Prescott Indian Tribe | 0.000 | 0.000 | 0.000 | 0.000 | 0.000 | 0.000 |
| Yomba Shoshone Tribe | 0.000 | 0.000 | 0.000 | 0.000 | 0.000 | 0.000 |

1 **TABLE K.4-2 Total Dollar Annual Impact on Tribes under LTEMP Alternatives Relative to Alternative A**

| Tribal Entity | SLCA/IP Allocation (MWh) | Difference from Alternative A (\$) | | | | | |
|------------------------------------------------------------------|--------------------------|------------------------------------|---------------|---------------|---------------|---------------|---------------|
| | | Alternative B | Alternative C | Alternative D | Alternative E | Alternative F | Alternative G |
| <i>Tribes That Operate Their Own Utility</i> | | | | | | | |
| Navajo Tribal Utility Authority | 183,625 | 9,090 | 205,442 | 183,625 | 139,991 | 936,304 | 1,110,839 |
| Navajo Agricultural Products Industries | 49,046 | 2,452 | 55,422 | 49,536 | 37,765 | 252,587 | 299,671 |
| Ak-Chin Indian Community | 11,356 | 562 | 12,705 | 11,356 | 8,658 | 57,905 | 68,699 |
| Tohono O'Odham Utility Authority | 7,765 | 384 | 8,687 | 7,765 | 5,920 | 39,592 | 46,973 |
| Fort Mojave Indian Tribe | 1,036 | 51 | 1,159 | 1,036 | 790 | 5,282 | 6,266 |
| Bureau of Indian Affairs Colorado River Agency | 2,451 | 121 | 2,742 | 2,451 | 1,868 | 12,497 | 14,826 |
| San Carlos Irrigation Project | 5,919 | 293 | 6,622 | 5,919 | 4,512 | 30,179 | 35,805 |
| Gila River Indian Community | 148,828 | -13,860 | 206,171 | 148,828 | 128,785 | 705,437 | 564,644 |
| Jicarilla Apache Tribe | 2,464 | 122 | 2,757 | 2,464 | 1,879 | 12,566 | 14,909 |
| <i>Tribes That Have a Benefit Contracting Arrangement</i> | | | | | | | |
| Alamo Navajo Chapter | 1,222 | -50 | 1,575 | 1,222 | 1,012 | 5,954 | 5,640 |
| Canoncito Navajo Chapter | 900 | -37 | 1,159 | 900 | 745 | 4,382 | 4,151 |
| Cocopah Indian Tribe | 4,355 | 216 | 4,873 | 4,355 | 3,321 | 22,209 | 26,348 |
| Colorado River Indian Tribes | 18,072 | 895 | 20,219 | 18,072 | 13,778 | 92,150 | 109,327 |
| Confederated Tribes of the Goshute Reservation | 292 | -7 | 367 | 292 | 238 | 1,432 | 1,418 |
| Duckwater Shoshone Tribe | 389 | -10 | 490 | 389 | 318 | 1,912 | 1,892 |
| Ely Shoshone Tribe | 595 | -15 | 749 | 595 | 486 | 2,923 | 2,895 |
| Ft. McDowell Mojave-Apache Indian Community | 8,895 | 380 | 10,065 | 8,895 | 6,825 | 45,202 | 52,851 |
| Havasupai Tribe | 887 | 29 | 1,021 | 887 | 687 | 4,484 | 5,124 |
| Hopi Tribe | 22,836 | (1,580) | 30,613 | 22,836 | 19,366 | 109,616 | 95,282 |
| Hualapai Tribe | 2,304 | 114 | 2,578 | 2,304 | 1,757 | 11,748 | 13,938 |

K-194

1 **TABLE K.4-2 (Cont.)**

| Tribal Entity | SLCA/IP Allocation (MWh) | Difference from Alternative A (\$) | | | | | |
|-------------------------------------------|--------------------------|------------------------------------|---------------|---------------|---------------|---------------|---------------|
| | | Alternative B | Alternative C | Alternative D | Alternative E | Alternative F | Alternative G |
| Las Vegas Paiute Tribe | 2,310 | 114 | 2,585 | 2,310 | 1,761 | 11,780 | 13,976 |
| Mescalero Apache Tribe | 6,322 | -261 | 8,147 | 6,322 | 5,235 | 30,792 | 29,163 |
| Nambe Pueblo | 399 | -16 | 514 | 399 | 330 | 1,942 | 1,840 |
| Paiute Indian Tribe of Utah | 583 | 29 | 652 | 583 | 445 | 2,973 | 3,527 |
| Pascua Yaqui Tribe | 4,754 | 153 | 5,472 | 4,754 | 3,684 | 24,035 | 27,463 |
| Picuris Pueblo | 312 | -13 | 402 | 312 | 258 | 1,518 | 1,432 |
| Pueblo De Cochiti | 767 | 38 | 858 | 767 | 585 | 3,912 | 4,641 |
| Pueblo of Acoma | 2,669 | -110 | 3,439 | 2,669 | 2,210 | 12,999 | 12,310 |
| Pueblo of Isleta | 4,123 | 204 | 4,612 | 4,123 | 3,143 | 21,021 | 24,940 |
| Pueblo of Jemez | 1,542 | -63 | 1,986 | 1,542 | 1,276 | 7,510 | 7,117 |
| Pueblo of Laguna | 4,809 | -199 | 6,197 | 4,809 | 3,982 | 23,422 | 22,183 |
| Pueblo of Pojoaque | 1,544 | -63 | 1,989 | 1,544 | 1,278 | 7,523 | 7,130 |
| Pueblo of San Felipe | 1,406 | 70 | 1,573 | 1,406 | 1,072 | 7,168 | 8,504 |
| Pueblo of San Ildefonso | 409 | -17 | 527 | 409 | 338 | 1,990 | 1,885 |
| Pueblo of San Juan | 1,935 | -80 | 2,494 | 1,935 | 1,602 | 9,425 | 8,926 |
| Pueblo of Sandia | 3,278 | 162 | 3,668 | 3,278 | 2,499 | 16,717 | 19,833 |
| Pueblo of Santa Clara | 1,541 | -63 | 1,986 | 1,541 | 1,276 | 7,507 | 7,115 |
| Pueblo of Santo Domingo | 1,662 | 82 | 1,859 | 1,662 | 1,267 | 8,472 | 10,051 |
| Pueblo of Taos | 1,811 | -74 | 2,332 | 1,811 | 1,499 | 8,823 | 8,367 |
| Pueblo of Tesuque | 2,288 | 113 | 2,560 | 2,288 | 1,744 | 11,666 | 13,841 |
| Pueblo of Zia | 493 | -20 | 635 | 493 | 408 | 2,402 | 2,277 |
| Pueblo of Zuni | 7,101 | -293 | 9,148 | 7,101 | 5,879 | 34,587 | 32,771 |
| Quechan Indian Tribe | 2,319 | 115 | 2,595 | 2,319 | 1,768 | 11,825 | 14,029 |
| Ramah Navajo Chapter | 2,295 | -94 | 2,956 | 2,295 | 1,899 | 11,178 | 10,597 |
| Salt River Pima-Maricopa Indian Community | 56,758 | 2,423 | 64,225 | 56,758 | 43,551 | 288,436 | 337,237 |

K-195

1 **TABLE K.4-2 (Cont.)**

| Tribal Entity | SLCA/IP Allocation (MWh) | Difference from Alternative A (\$) | | | | | |
|------------------------------------------|--------------------------|------------------------------------|----------------|----------------|----------------|------------------|------------------|
| | | Alternative B | Alternative C | Alternative D | Alternative E | Alternative F | Alternative G |
| San Carlos Apache Tribe | 14,791 | 732 | 16,549 | 14,791 | 11,277 | 75,421 | 89,480 |
| Santa Ana Pueblo | 1,622 | 80 | 1,814 | 1,622 | 1,236 | 8,269 | 9,810 |
| Skull Valley Band of Goshute Indians | 56 | 3 | 63 | 56 | 43 | 286 | 339 |
| Southern Ute Indian Tribe | 7,391 | -305 | 9,523 | 7,391 | 6,119 | 35,996 | 34,095 |
| Tonto Apache Tribe | 1,364 | 68 | 1,527 | 1,364 | 1,040 | 6,957 | 8,254 |
| Ute Indian Tribe | 4,835 | (342) | 6,495 | 4,835 | 4,105 | 23,190 | 20,060 |
| Ute Mountain Ute Tribe | 3,169 | (131) | 4,083 | 3,169 | 2,623 | 15,432 | 14,618 |
| White Mountain Apache Tribe | 22,090 | 1,094 | 24,715 | 22,090 | 16,841 | 112,639 | 133,636 |
| Wind River Reservation | 7,284 | (823) | 10,361 | 7,284 | 6,408 | 34,163 | 25,349 |
| Yavapai Apache Nation | 6,246 | 309 | 6,988 | 6,246 | 4,762 | 31,848 | 37,784 |
| Yavapai Prescott Indian Tribe | 2,877 | 142 | 3,219 | 2,877 | 2,193 | 14,670 | 17,404 |
| Yomba Shoshone Tribe | 116 | 6 | 129 | 116 | 88 | 589 | 699 |
| Total | 658,509 | -336 | 738,872 | 609,463 | 486,660 | 3,030,857 | 3,204,513 |
| Total for Systems that Operate Utility | | 10,503 | 237,357 | 212,151 | 161,739 | 1,081,759 | 1,283,408 |
| Total for Systems with Benefit Contracts | | -10,839 | 501,515 | 397,312 | 324,921 | 1,949,098 | 1,921,105 |

K-196

1 **K.4.6 Total Impact of LTEMP DEIS Alternatives: Benefit Change and Rate Effect**
2

3 Table K.4-2 lists the estimated Tribal financial impact by alternative relative to the
4 impact under Alternative A. Table K.4-2 lists the total annual financial impact, which is (1) the
5 change in Tribal benefit plus (2) the increase in the electrical utility bill of Tribal households and
6 businesses due to a change in the SLCA/IP FES customers' retail rate.²⁸ Negative numbers
7 indicate a positive financial benefit (this only occurs under Alternative B). Note that:
8

- 9 • Tribes whose electrical service is provided by a non-SLCA/IP FES customer
10 have no retail rate change, but do experience a change in Tribal benefits;
11
- 12 • The Tribes that operate their own utility have no change in Tribal benefits, but
13 do experience a change in retail rates; and
14
- 15 • Tribes whose lands are served by SLCA/IP customers are impacted by both a
16 change in retail rate and a change in Tribal benefits.
17

18 Alternative impacts listed in Table K.4-2 include the sum of both types of financial
19 impacts.²⁹ Alternative impacts included in Table K.4-2 are good indications of the rank order of
20 the alternatives and the direction of impacts (positive or negative), and they describe an
21 estimated financial impact under current contractual obligations. These financial impacts would
22 continue beyond 2024 if contract commitments to all FES customers including Tribes and Tribal
23 entities do not change. They represent one possible outcome of the post-2024 marketing plan.
24 For the final EIS, assumptions concerning post-2024 commitment levels may be revised to
25 duplicate the range examined in the economic analysis described in Section K.1.
26

27
28 **K.4.7 Total Impact on Tribes and Tribal Members Versus Retail Rate Changes to**
29 **Households**
30

31 Figures K.4-2 through K.4-7 illustrate the difference between the total financial impact of
32 the alternatives on Tribes as compared to the financial impact on non-Tribal households and
33 businesses that receive retail service from utilities that are SLCA/IP customers.
34

²⁸ Table K.4-2 shows the total financial impact. The separate financial impacts from a change in Tribal benefits and from a change in the electrical utility payments made by Tribal households and businesses were calculated but not shown here because of space limitations.

²⁹ The Tribal benefit calculation is the difference the Supplier's average production cost and the SLCA/IP rate multiplied by the Tribe's SLCA/IP allocation. For simplicity, the authors assume that the supplier's average production cost does not change as a result of an LTEMP DEIS alternative. It is more likely that an increase in a SLCA/IP rate will result in a lesser increase in the average production cost of a SLCA/IP FES customer. Therefore, the calculations of Tribal benefit change are overestimates for those Tribes that are served by SLCA/IP FES customers.

1 The financial impacts on non-Tribal households and businesses are, for illustrative
2 purposes in this analysis, the percentage change in the electrical retail rate for the SLCA/IP FES
3 customer (or their utility system member that provides retail electrical service in a service area).
4 This information is a duplication of the analysis included in Appendix K.3, which is the retail rate
5 analysis of the alternatives. In Figures K.4-2 through K.4-7, the blue lines illustrate non-Tribal
6 SLCA/IP FES customers or member systems and are the same data that are included in
7 Section K.3.
8

9 An increase (decrease) in the retail rates of an SLCA/IP FES customer or member system
10 causes a financial effect (positive or negative) on households and businesses in the utilities'
11 service area by increasing (decreasing) the electrical utility cost paid. This change in the utility bill
12 and the resulting financial effect at the household/business level is approximately equivalent to the
13 financial impact on Tribes and Tribal members.
14

15 Figures K.4-2 through K.4-7 present the percentage difference (compared to Alternative A)
16 of financial impacts on Tribes and non-Tribes³⁰ for each alternative. Alternative B is the only
17 alternative that results in a reduction in impacts relative to Alternative A (Figure K.4-3). The
18 financial impacts of Alternatives C, D, and E are relatively similar (Figures K.4-3 through K.4-5),
19 but greater than under either Alternative A or Alternative B. The financial impacts of
20 Alternatives F and G are relatively similar to each other (Figure K.4-3), and higher than under any
21 of the other alternatives. Alternative F has the highest financial impacts of any alternative.
22
23

24 **K.4.8 Conclusions**

25
26 Several conclusions can be drawn from this analysis:
27

- 28 • LTEMP alternatives are estimated to have a financial effect on Tribes that
29 receive an SLCA/IP allocation. Compared to Alternative A, the impact is
30 negative for Alternatives C, D, E, F, and G. These impacts are larger for
31 Alternatives F and G. The financial impact on Tribes under Alternative B is
32 largely positive.
- 33 • The financial impacts on Tribes are from two sources:
 - 34 ○ A change in the Tribal benefits provided to the Tribes under benefit
35 crediting contracts; and
 - 36 ○ A change in the electrical utility bills paid by Tribal members and
37 businesses that receive retail service from a supplier that receives an
38 SLCA/IP allocation.
 - 39 ○
 - 40 ○
 - 41 ○

³⁰ The total percentage change is measured on the y-axis. For Tribal entities, this percentage change is the sum of the retail rate impact and the Tribal benefit impact. For non-Tribal SLCA/IP customers or members systems, it is the percentage change from the retail rate impact.

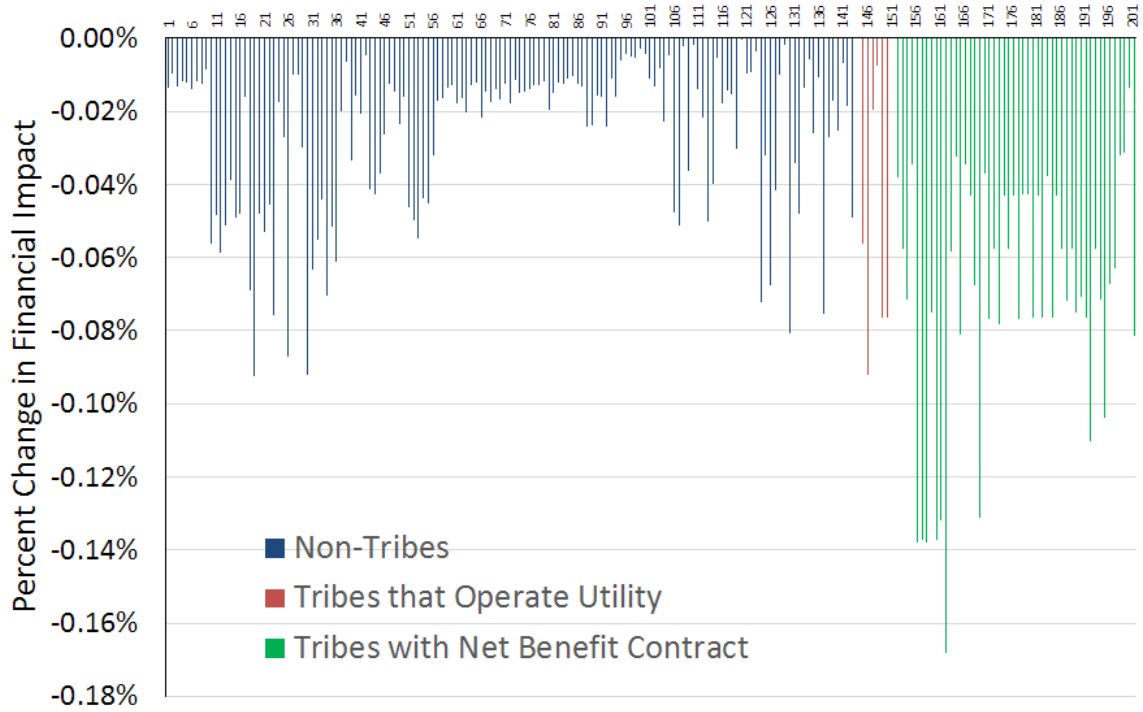

1

FIGURE K.4-2 Financial Impacts under Alternative B Relative to Alternative A for Tribal and Non-Tribal Entities

2
3
4

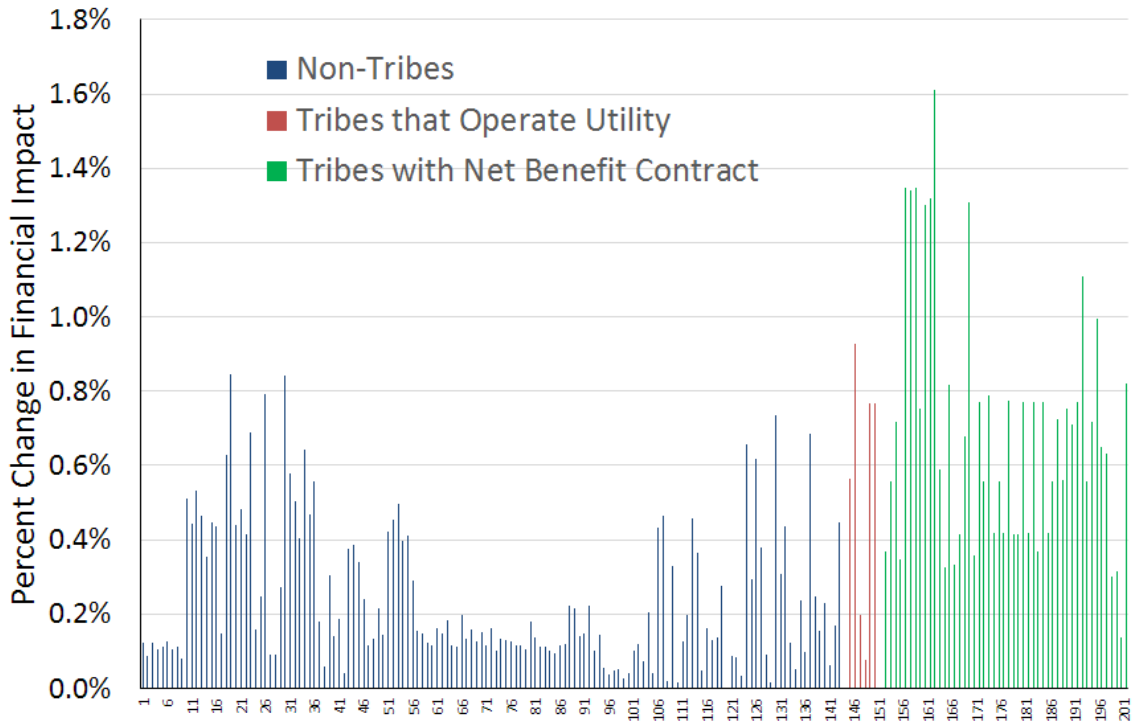

5

FIGURE K.4-3 Financial Impacts under Alternative C Relative to Alternative A for Tribal and Non-Tribal Entities

6
7

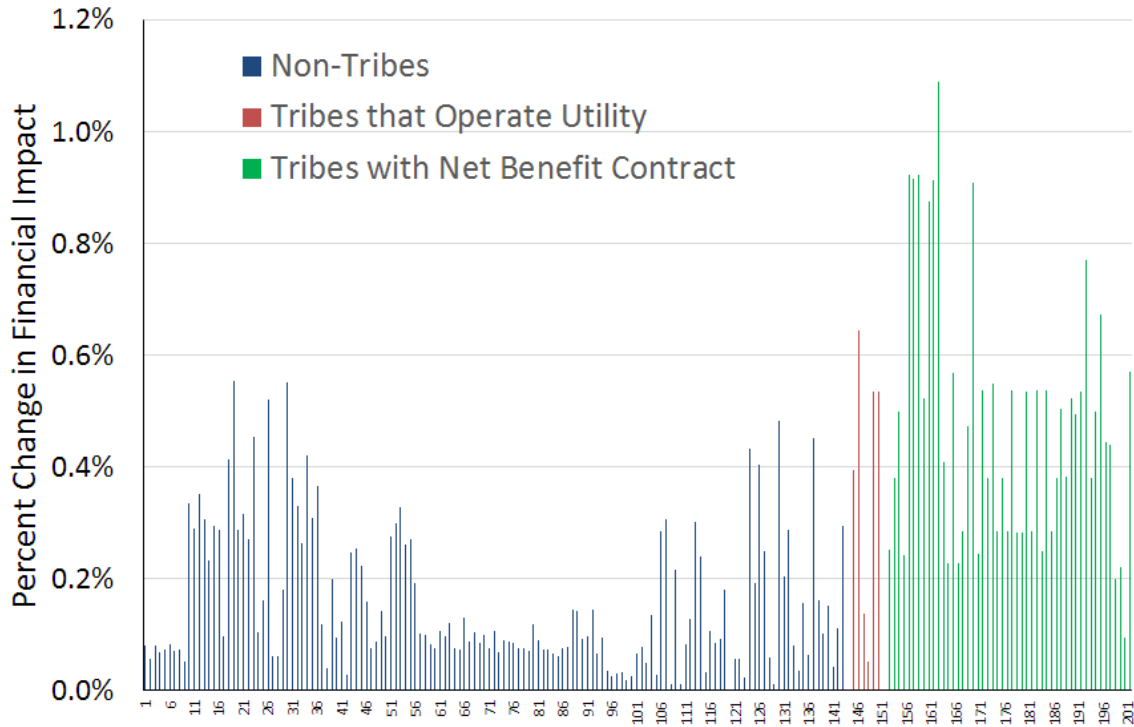

1
2
3
4

FIGURE K.4-4 Financial Impacts under Alternative D Relative to Alternative A for Tribal and Non-Tribal Entities

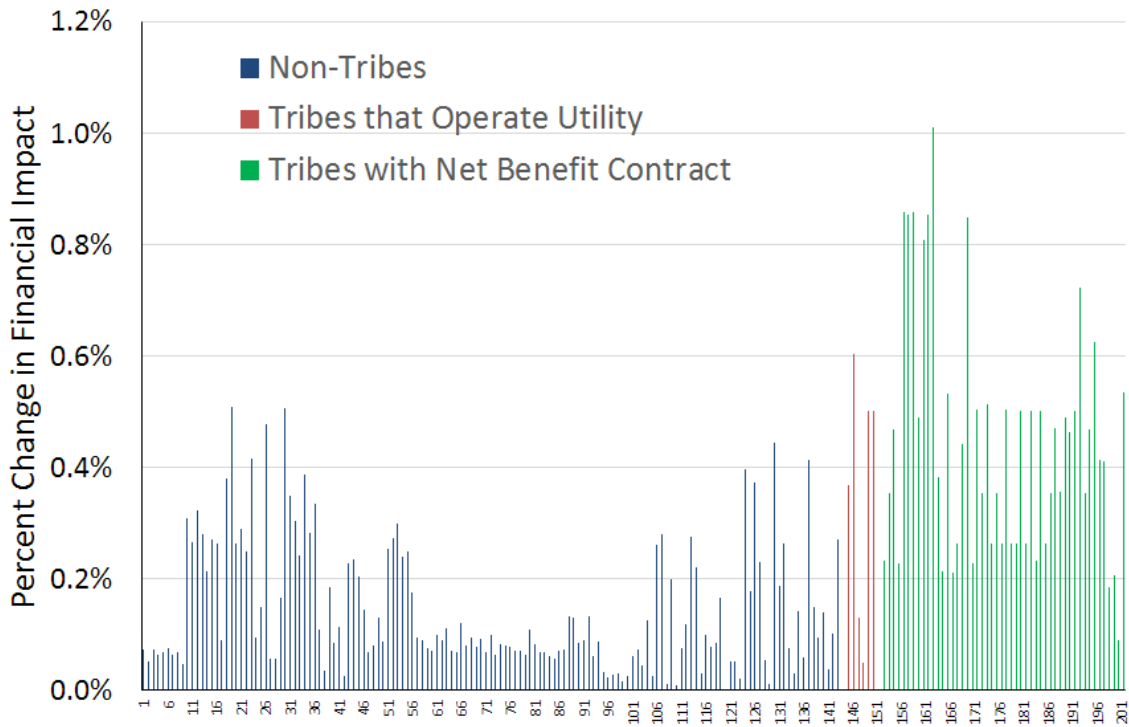

5
6
7

FIGURE K.4-5 Financial Impacts under Alternative E Relative to Alternative A for Tribal and Non-Tribal Entities

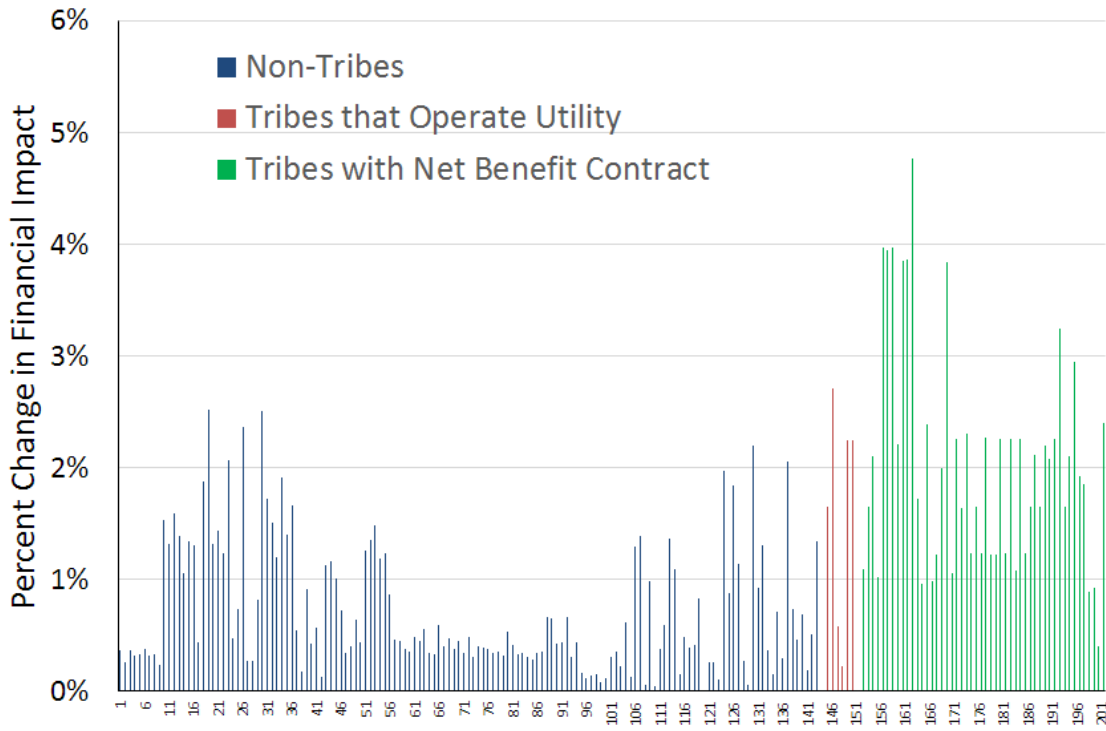

1
2
3
4

FIGURE K.4-6 Financial Impacts under Alternative F Relative to Alternative A for Tribal and Non-Tribal Entities

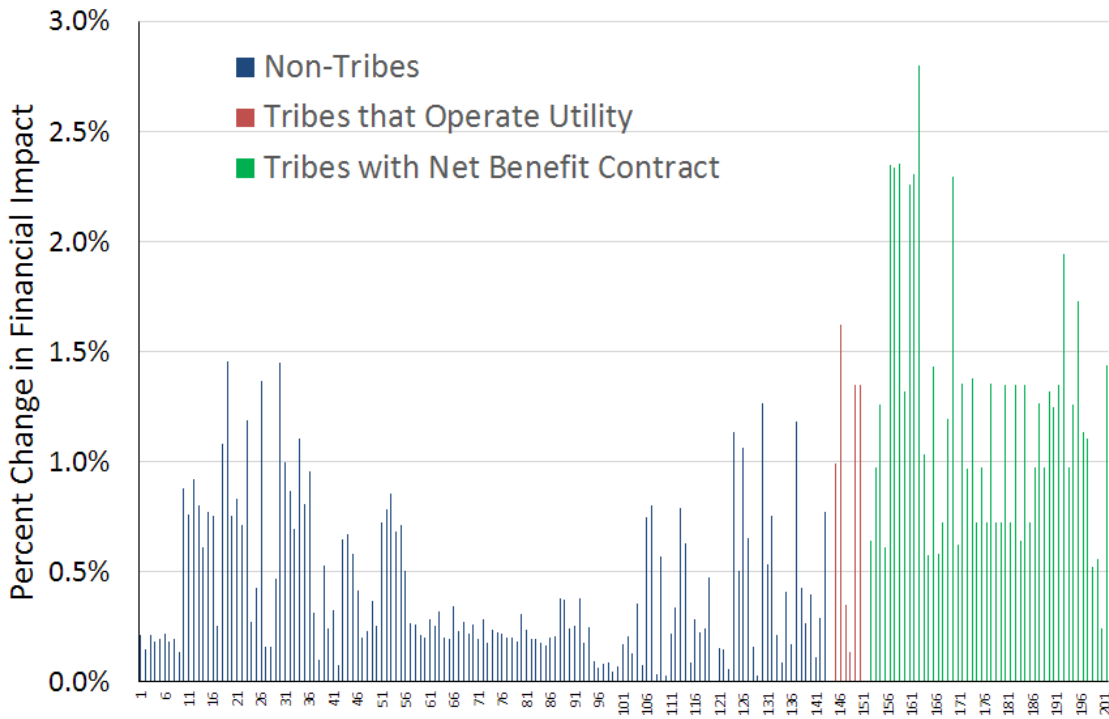

5
6
7

FIGURE K.4-7 Financial Impacts under Alternative G Relative to Alternative A for Tribal and Non-Tribal Entities

- These two sources of financial impact are additive for some Tribes—those who receive Tribal benefits and whose reservation or Tribal land is served by electrical utilities that are SLCA/IP FES customers.
- Tribal financial impacts for Alternatives C, D, E, F, and G, relative to Alternative A, are larger than the financial impacts on non-Tribes.

K.5 IMPACTS OF LTEMP ALTERNATIVES ON LAKE MEAD AND THE HOOVER DAM POWERPLANT

Water released from Lake Powell through the Glen Canyon Dam travels down the Colorado River through GCNP and then into the Lake Mead Reservoir. By the time the water travels the roughly 370 river miles from Lake Powell to Lake Mead, hourly water release fluctuations from the Glen Canyon Dam are almost completely attenuated. However, changes from Lake Powell current monthly water release volumes under LTEMP alternative operating criteria will impact pool elevations in Lake Mead. For example, under Alternative F Lake Powell monthly water releases from late winter through spring are higher than for Alternative A (Figure K.5-1), raising the pool elevation at Lake Mead above levels projected under Alternative A from April through November (Figure K.5-2). Because Glen Canyon Dam annual release volumes under all alternatives are nearly identical, the impacts of changed operations are within an annual time frame. Note that in Figure K.5-2 both alternatives have nearly the same average end-of-month (EOM) pool elevation in December.

Changes in Glen Canyon Dam monthly water release volumes have the greatest impact on Lake Mead, and therefore the Hoover Powerplant, when the pool elevation is low. Figure K.5-3 shows the Lake Mead Reservoir storage-elevation curve (primary y-axis) and the change in the Mead pool elevation as a function of change in the water storage volume (secondary y-axis). When the water storage (and therefore the pool elevation) is low, an additional million acre-feet (maf) of water increases the pool elevation substantially more than when the reservoir is nearly full. For example, when Lake Mead contains 4 maf (992.8 ft pool elevation) an additional 1 maf will increase the pool elevation by about 17.4 ft. At the other extreme, when Lake Mead contains 24 maf (1,205.6 ft pool elevation) an additional 1 maf of water increases the pool elevation by only 7.0 ft; that is, a rate of elevation change that is about 2.5 times less than at low pool.

A changed Lake Mead pool elevation in turn impacts Hoover Dam Powerplant firm capacity and energy generated by water releases through its turbines. When Lake Mead is full, the 17 France turbines and 2 Pelton Waterwheel station service units that are located in the Hoover Dam Powerhouse have a combined hydropower capacity of approximately 2,074 MW (<http://www.usbr.gov/lc/hooverdam/faqs/powerfaq.html> and <https://www.wapa.gov/About/Pages/power-projects.aspx>); that is significantly larger than the 1,356 MW nameplate capacity of the Glen Canyon Dam Powerplant. In addition, unlike operating criteria at Glen Canyon Dam, which does not typically permit powerplant schedulers and operators to realize its full output potential, the Hoover Powerplant is allowed to routinely generate up to its maximum output as dictated by the pool elevation of Lake Mead. Because the Parker Dam and the Davis Dam

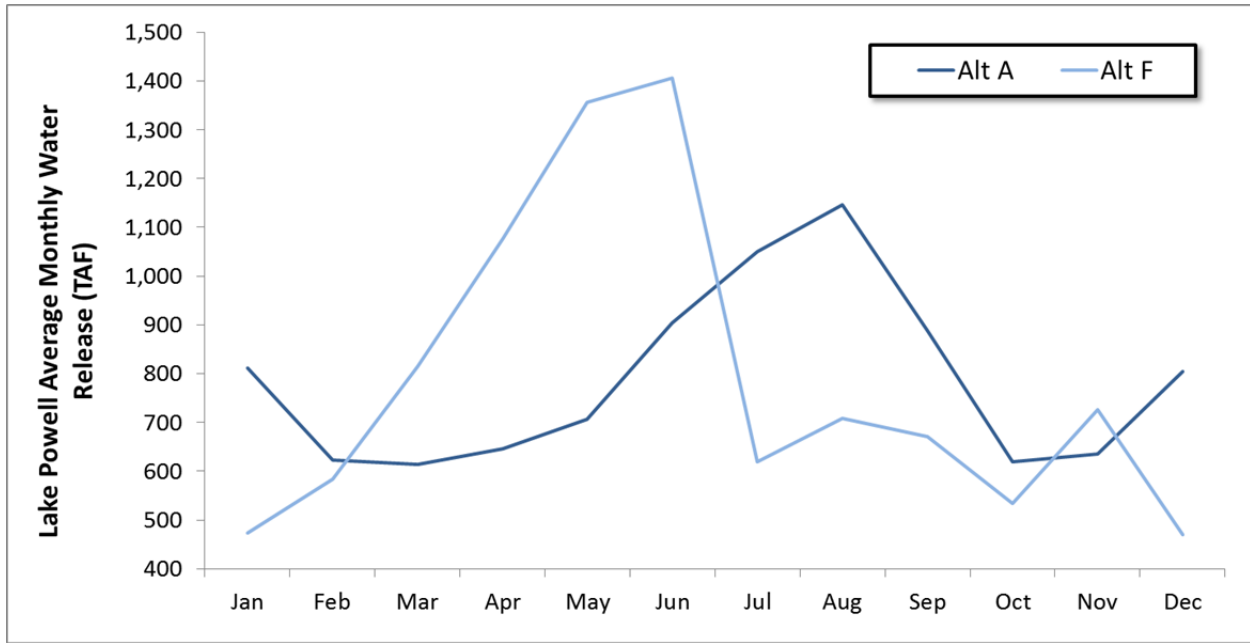

1
 2 **FIGURE K.5-1 Comparison of Alternative A and Alternative F Lake Powell Average Monthly**
 3 **Water Releases over the 20-Year Study Period and 21 Hydrology Traces**
 4
 5

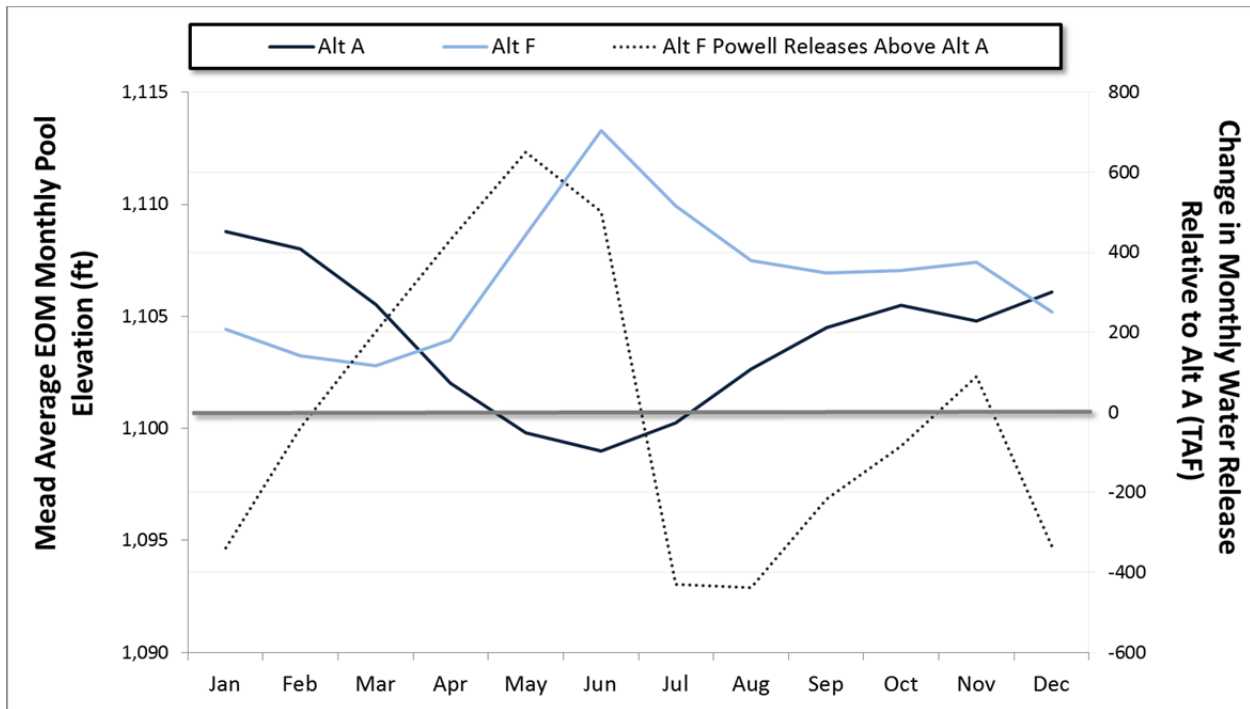

6
 7 **FIGURE K.5-2 Impact of Changed Lake Powell Month Water Release Volumes on Mead Average**
 8 **EOM Pool Elevations**
 9

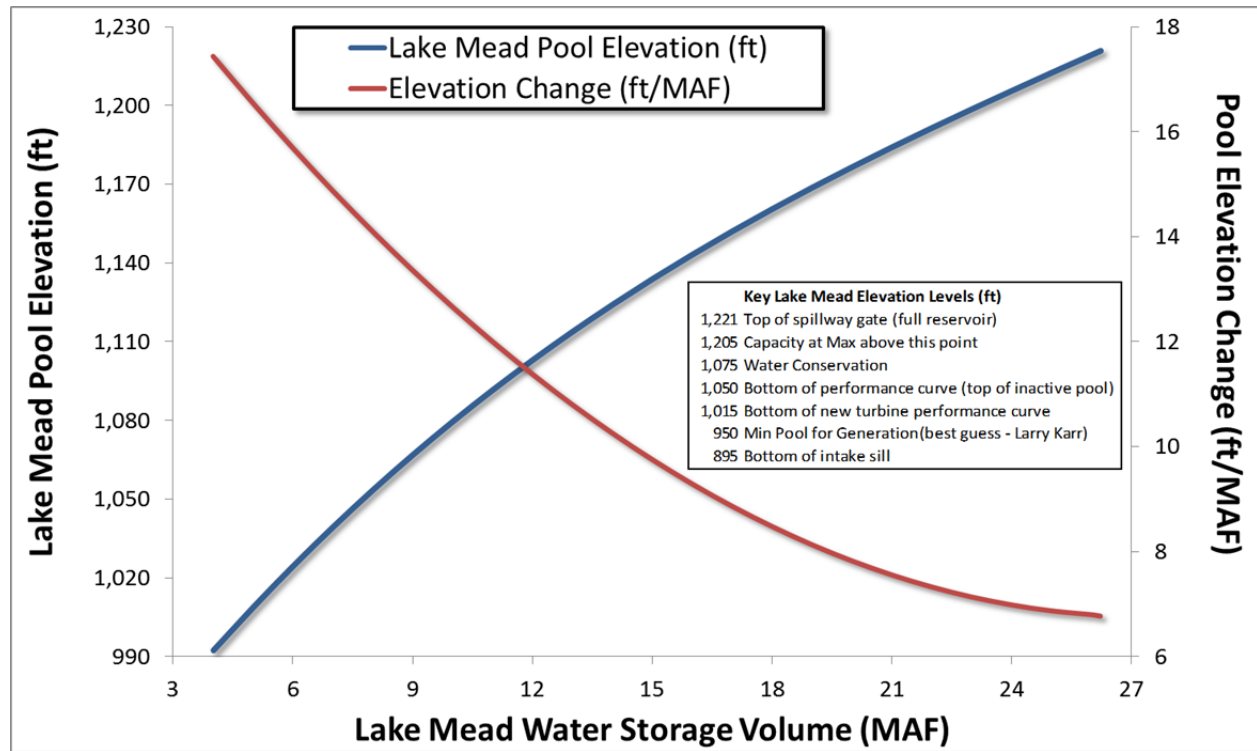

1
 2 **FIGURE K.5-3 Lake Mead Storage Elevation Curve and Change in Elevation as a Function of**
 3 **Lake Mead Water Storage**
 4
 5

6 Projects provide re-regulation of the Colorado River downstream from Hoover Dam, powerplant
 7 hourly operations are allowed to fluctuate nearly unfettered by environmental operating criteria.
 8 On the other hand, Lake Mead monthly release volumes are largely dictated by downstream
 9 water delivery obligations.

10
 11 Alternative Glen Canyon Dam operating criteria evaluated in the LTEMP DEIS will
 12 impact Hoover’s Powerplant operation and therefore its economic value. The monthly allocation
 13 of annual releases from Lake Powell, and hence inflows into Lake Mead, affect several aspects
 14 of the Hoover Powerplant. The most significant factors impacting the Hoover Powerplant
 15 include changes in (1) the routing of Lake Mead’s water releases³¹; (2) conversion of Lake Mead
 16 water releases into electricity (i.e., energy) production³²; (3) maximum operating output
 17 capability³³ and firm capacity³⁴; and (4) in some situations, but not all, monthly water release

31 For this analysis, a distinction is made between water that is routed through the powerplant turbines and water that bypasses the dam and powerplant.

32 Turbine water releases convert the kinetic energy of falling water into mechanical energy which is then converted to electricity by a generator. The volume of water needed to generate 1 MWh of electricity is a function of several factors.

33 For this analysis, we distinguish between the capacity of the powerplant and its output potential, which varies as a function of hydraulic head. It is assumed that the powerplant output potential decreases with lower Lake Mead pool elevations. The output potential or maximum output level is sometimes referred to as derated capacity.

1 volumes from Lake Mead. In terms of the economic impacts of alternatives on the Hoover
2 Powerplant, the first two tend to be much larger than the latter two. As discussed in more detail
3 below, Hoover Powerplant impacts are the greatest when Lake Mead has low water levels
4 because the powerplant's maximum physical power output is significantly more sensitive at low
5 pool as compared to high pool. This is exacerbated by the fact that when Lake Mead contains
6 relatively little water, the pool elevation is more sensitive to change in storage volume
7 (Figure K.5-3).

8
9 For the LTEMP DEIS, a model of Hoover Powerplant monthly operations was developed
10 to provide approximations of LTEMP impacts on Hoover Powerplant economics; that is, to
11 estimate the general magnitude and ranking of LTEMP alternative impacts on Hoover power.
12 Two Hoover economic metrics, both in terms of net present value (NPV), were computed for
13 each alternative; namely, firm capacity and energy. The following sections describe the methods,
14 model, and comparative impacts of LTEMP alternatives on Lake Mead, Hoover Powerplant
15 operations, and power system economics.

16 17 18 **K.5.1 Hoover Methods, Model, and Supporting Data**

19
20 The methods and the tool developed to estimate comparative impacts of LTEMP
21 alternatives on Hoover Powerplant operations and economics use many of the same underlying
22 assumptions and input data/information that were used for both the Glen Canyon Dam
23 Structured Decision Analysis (SDA) and the SLCA/IP power systems economic analysis.
24 However, this tool, referred to in this report as the "Hoover Powerplant Model," does not
25 produce as rigorous an analysis.

26
27 The Hoover Powerplant Model utilizes monthly Lake Mead water release volumes and
28 EOM reservoir pool elevations that are projected by the Sand Budget Model (SBM) for 21
29 hydrology traces over the 20-year LTEMP study period. The SBM relies on results from both the
30 CRSS model and the lite version of the Generation and Transmission Maximization (GTMax-
31 lite) model. For each alternative and hydrology trace, the SBM schedules HFEs at Glen Canyon
32 Dam. Because an experiment typically requires a large water release volume, the SBM
33 reallocates Glen Canyon Dam monthly water releases within a WY in order to provide the HFE
34 with a sufficient amount of water. Note that the SBM only reallocates water within the same
35 WY, not among WYs. The SBM does not alter Hoover Dam monthly water releases. It does,
36 however, change CRSS Lake Mead monthly inflows, water storage volumes, and reservoir
37 elevations in order to maintain a water mass balance in the Colorado River Basin.

38
39 The Hoover Powerplant Model uses monthly average market on-peak and off-peak prices
40 computed from hourly prices for the Palo Verde hub. These are the same hourly prices used in
41 the SDA and power systems economic analysis. In addition, as for the SDA approach, firm

³⁴ Firm capacity in this study is based on the Hoover Powerplant's output potential during the time of system peak load at a specified probability level. For this analysis, the powerplant firm capacity is set to the output potential that is equal to or higher than the firm capacity level 90% of the time during the month of August.

1 hydropower capacity is based on a 90th percentile exceedance level during the month of August.
2 Other factors such as unit random outage probabilities and unit maintenance schedules can also
3 factor into powerplant maximum (potential) output levels and firm capacity computations, but
4 were not included in this simpler model.
5

6 The economic value of Hoover firm capacity is based on the same replacement costs as
7 those used for the SDA and very similar to the average costs used in the power systems
8 economic analysis. It is based on the levelized cost of capital plus annual fixed O&M costs to
9 construct a new advanced combustion turbine (CT), which amounts to \$51,300/MW-yr.
10 However, as discussed later, these capacity replacement costs are irrelevant to the final economic
11 cost computation. The time series of Hoover economic costs are discounted at the same 3.375%
12 annual rate used in the SDA and power systems analysis.
13

14 **K.5.2 Hoover Monthly Energy Production and Water-to-Power Conversion**

15
16
17 The Hoover Powerplant Model estimated powerplant monthly energy production over
18 the 20-year LTEMP study period based on SBM monthly projections of Lake Mead EOM pool
19 elevation and Hoover Dam monthly water releases for each of the 21 hydrology traces. A model-
20 derived water-to-power conversion factor³⁵ was multiplied by the SBM monthly water release
21 volume to project monthly Hoover Powerplant energy production. The operating characteristics
22 of the Hoover Powerplant were based on and derived from information provided by
23 Reclamation.
24

25 The Hoover Powerplant Model estimated future water-to-power conversion factors using
26 an equation that relates both monthly EOM Lake Mead pool elevation and total Hoover plant-
27 level turbine water releases to energy production. Argonne derived the form of the water-to-
28 power conversion equation and its coefficients based on historical Mead and Hoover data, as
29 recorded in Form PO&M-59, which was supplied by Reclamation. The equation is composed of
30 two components. The first component is a linear relationship between the conversion factor and
31 the pool elevation. The second component relates the conversion factor to monthly water release
32 volumes in the form of a third-order polynomial function. To assess the accuracy of the derived
33 equation, a back-casting exercise was conducted. Results of this exercise are shown in
34 Figure K.5-4. Due to the implementation and application of new software at Hoover Dam that
35 optimizes the powerplant unit dispatch to increase plant-level power conversion efficiency,
36 equation coefficients in the period prior to March 2011 differ from the coefficients used after this
37 date.³⁶
38

35 The water-to-power conversion factor, expressed in terms of MWh/ac-ft equals the monthly turbine water release (ac-ft) divided by monthly generation. Note that this conversion factor only includes turbine releases; that is, bypass water is excluded.

36 McManes (2014) discusses the change in Hoover Powerplant efficiency (3.4% improvement) that results from using unit dispatch software to guide power operations.

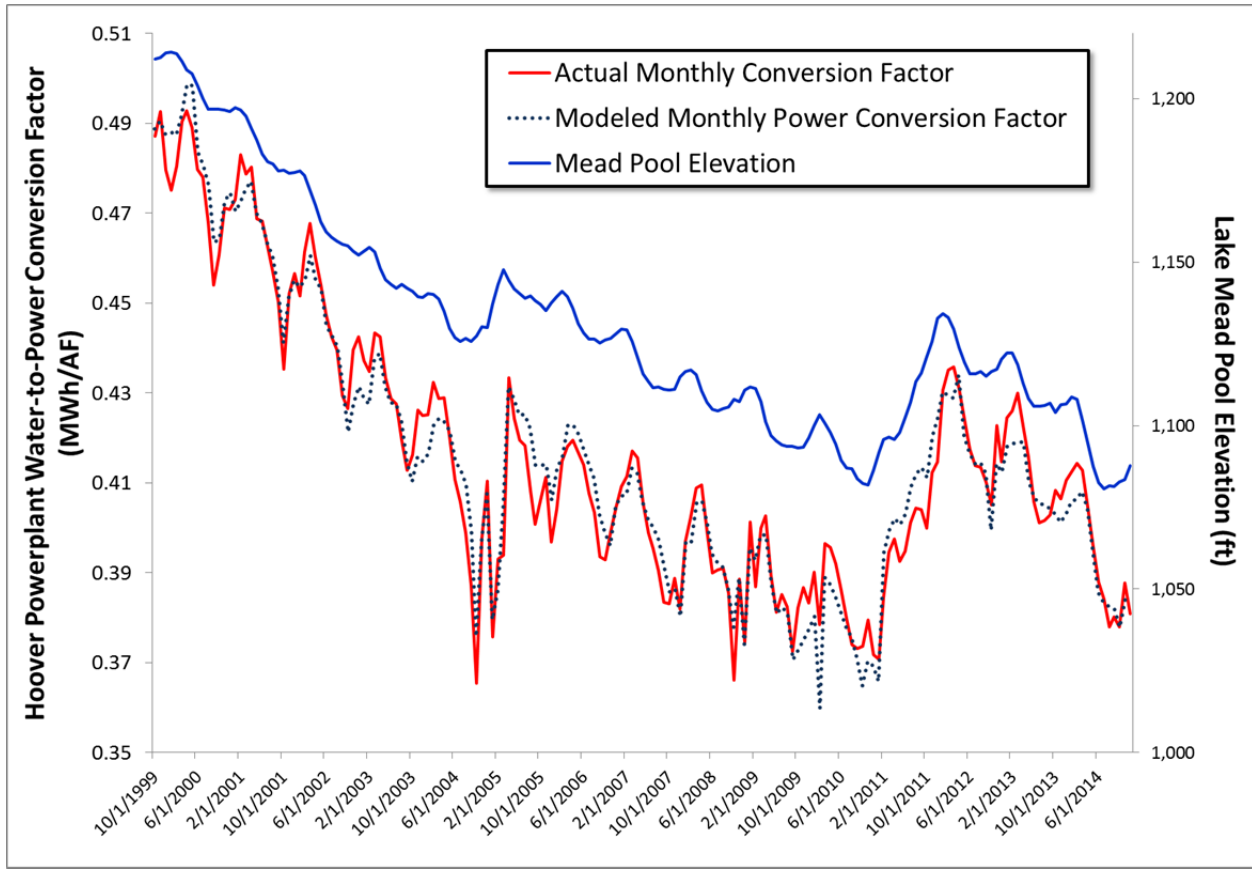

1

2 **FIGURE K.5-4 Results of Water-to-Power Conversion Factor Back-casting Exercise**

3

4

5

6

7

8

9

10

11

12

13

14

15

16

17

18

19

20

21

22

23

Figure K.5-4 shows that the Lake Mead pool elevation and water-to-power conversion factors have a similar pattern and can be used to explain most, but not all, of the changes in power conversion over time. Monthly turbine releases yield additional accuracy to the equations, but relatively small inaccuracies still exist. The average absolute error during both pre- and post-2011 periods is less than 0.005 ac-ft/MWh; that is, less than an average error of 1.2% of the average historical power conversion factor. The simple average of the errors equals zero. For comparative analyses such as this one, this level of accuracy was judged to be sufficient.

Projections of future monthly water-to-power conversion factors use equation coefficients derived for the post-2011 time period. In reality, conversion efficiencies (and therefore water-to-power conversion factors) will change in the future as equipment ages and changes are made to the powerplant. One such change that is partially implemented involves the replacement of old turbines with ones that can be operated over a wider range of hydraulic heads and have a narrower operating rough zone.

Based on information and guidance from Reclamation, this study conservatively assumes that the minimum pool elevation for energy production at the Hoover Powerplant is 1,050 ft above sea level. This elevation delineates the active and inactive pools. Hoover turbines may be mechanically and electronically operable below a pool elevation of 1,050 ft. This is in part

1 supported by turbine performance curves for new wide-head turbines that bottoms at
2 approximately 1,015 ft (Harpman 2014a,b). However, none of the Hoover turbines have actually
3 been operated at a pool elevation below 1,050 ft.
4

5 When the SBM projects that the Lake Mead elevation drops into the inactive pool, the
6 Hoover Powerplant Model releases the entire SBM projected monthly water volume through one
7 or more of the project's six outlets that are designed to bypass water around the Hoover Dam and
8 Powerplant (<http://www.usbr.gov/lc/hooverdam/faqs/tunlfaqs.html>). Therefore, both the monthly
9 maximum possible Hoover Powerplant output and generation are set equal to zero under this
10 condition. These non-power water releases are referred to in this report as "bypass" water.
11

12 Figure K.5-5 shows Hoover model results for Alternative A average monthly water-to-
13 power conversion factors (i.e., red line: plant-level generation/turbine water release) over the
14 20-year study period for all 21 SBM traces. Note that on average the power conversion factor
15 changes little among months of the year. The blue line in the figure shows the ratio of Hoover
16 Powerplant generation (in MWh) to total Lake Mead water releases that include both turbine and
17 bypass releases. The difference between the two lines in the graph is due to water bypasses that
18 occur when the pool elevation in Lake Mead is projected to be below 1,050 ft (i.e., the minimum
19 power pool elevation). Under these circumstances, any required releases must be made through
20 the outlet works rather than the turbines. Figure K.5-6 shows Hoover Powerplant average
21 monthly turbine and Lake Mead bypass water releases for the 21 hydrology traces over the
22 20-year LTEMP period under Alternative A.
23

24 Monthly average turbine water releases at Hoover Dam differ by alternative, as shown in
25 Figure K.5-7. The greatest difference among alternatives relative to Alternative A is about 81 kaf
26 (thousand acre-feet) (roughly 11.7% more) in June under Alternative F. In almost all cases, the
27 difference in turbine water release among alternatives is nearly counterbalanced by changes in
28 bypass water releases. In the example above, 69 kaf more water is bypassed under Alternative A
29 than under Alternative F. This is due to a higher occurrence of dead pool reservoir elevations
30 under Alternative A. There is also a greater average total water release (turbine and bypass),
31 about 12 kaf, in June under Alternative F. This is offset by lower water releases in the winter and
32 early spring. On an average annual basis, there is very little difference in total Lake Mead water
33 releases among alternatives.
34

35 The amount of water bypassed under each alternative is in part explained by the
36 probability that the pool water drops into to the inactive zone. Figure K.5-8 shows the fraction of
37 time the SBM projects that the pool elevation will be below 1,050 ft, thereby causing bypass
38 release events. Alternatives A and B have the largest probability of a bypass event. Alternative F
39 typically has the lowest, especially from late spring through the end of summer. This is primarily
40 the result of changes in the monthly distribution of water releases from the Glen Canyon Dam
41 relative to Alternative A. For example, as described previously, Alternative F has high Glen
42 Canyon Dam releases during the late winter and early spring. These relatively high releases
43 increase the pool level in Lake Mead, thereby reducing the probability that a low-pool bypass
44 water release will occur. As shown in Figure K.5-9, the monthly bypass release probability
45 pattern has a large impact on powerplant generation (in terms of megawatt-hours per ac-ft of
46

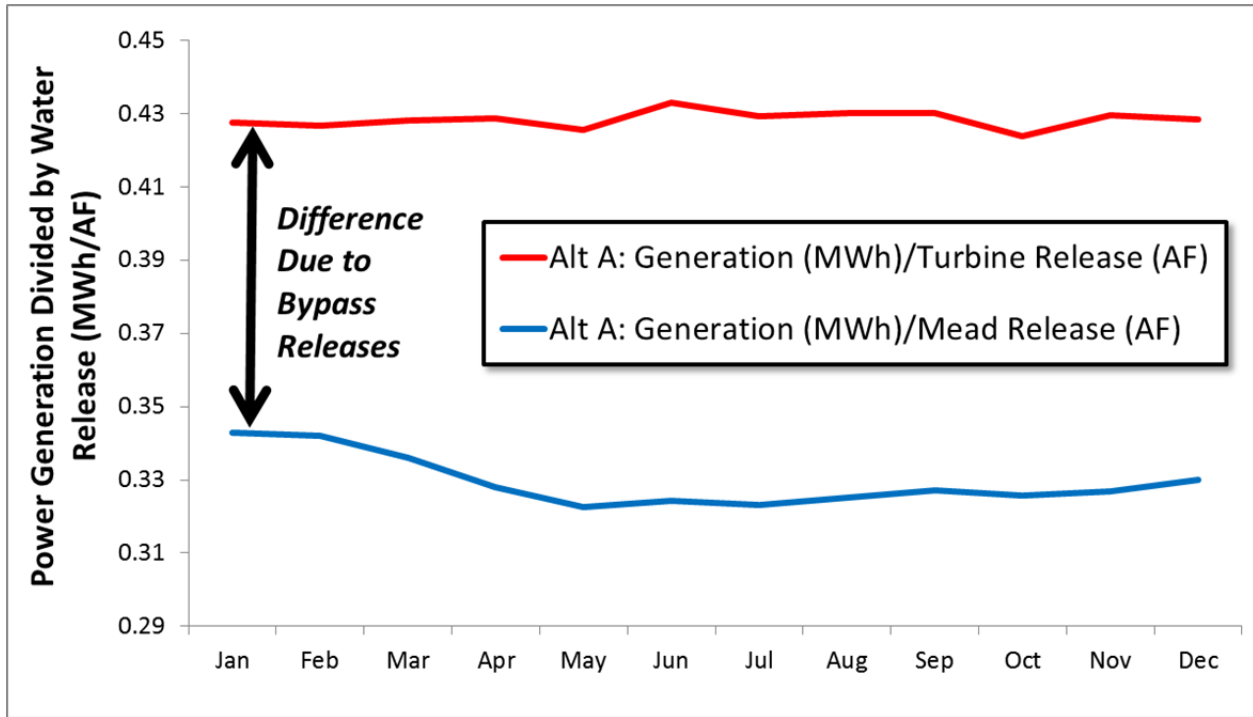

1

2 **FIGURE K.5-5 Average Monthly Water-to-Power Conversion Factor and Energy Production per**
 3 **ac-ft of Total Mead Reservoir Release**

4

5

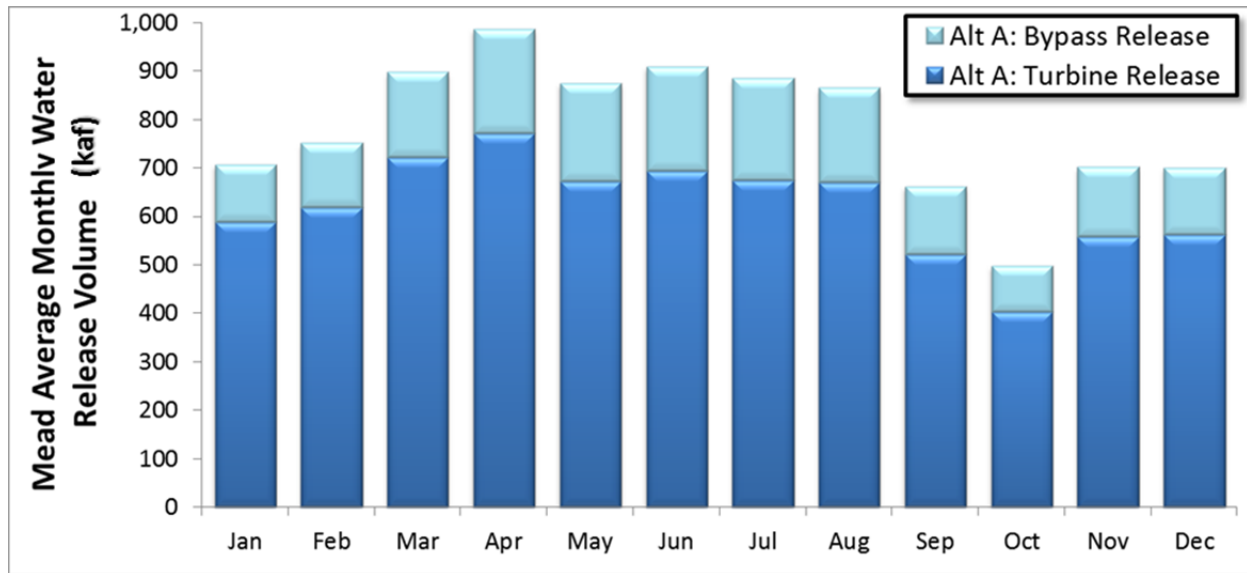

6

7 **FIGURE K.5-6 Average Monthly Turbine and Bypass Water Releases**

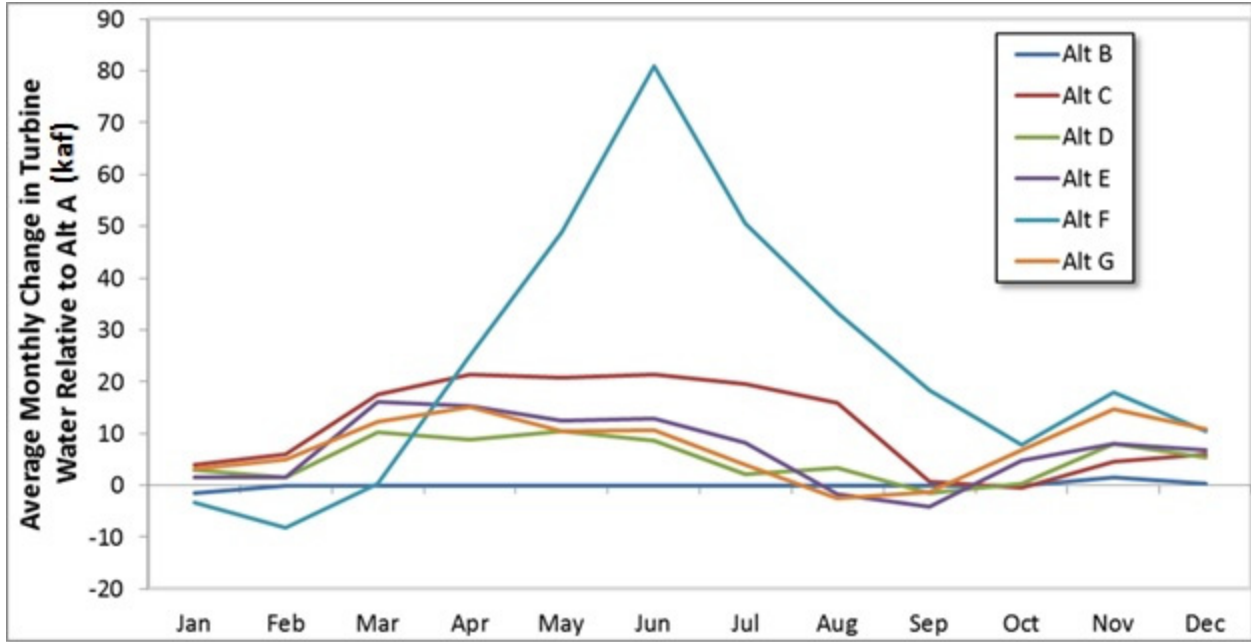

1

2 **FIGURE K.5-7 Average Monthly Change in Turbine Water Releases**

3

4

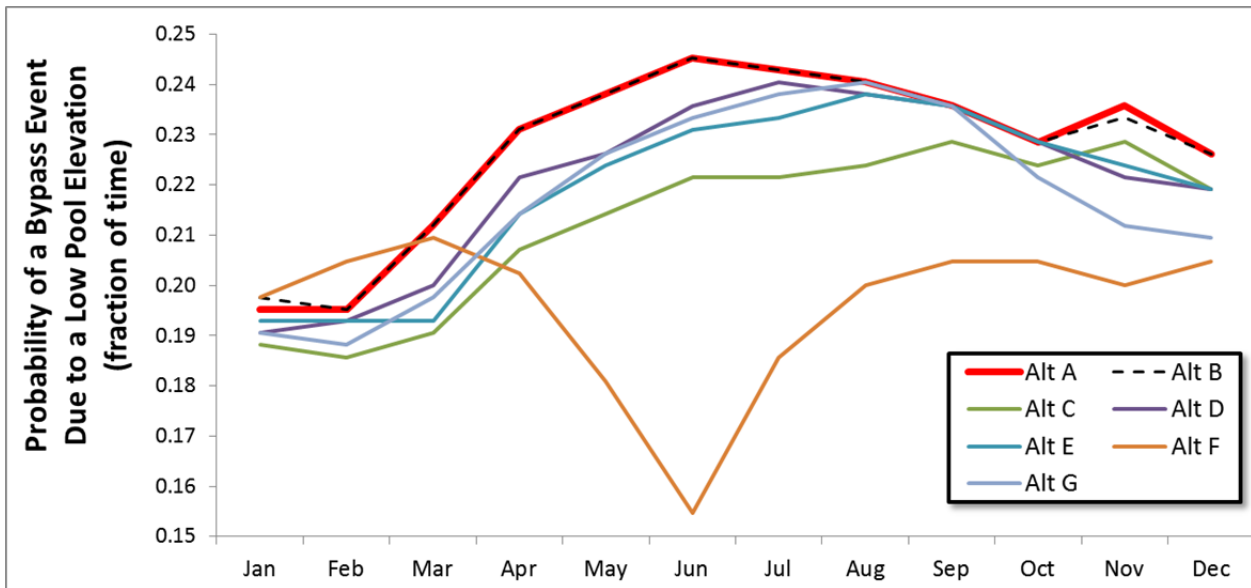

5

6 **FIGURE K.5-8 Monthly Probability of a Water Bypass Event Due to a Low Mead Pool Elevation**

7

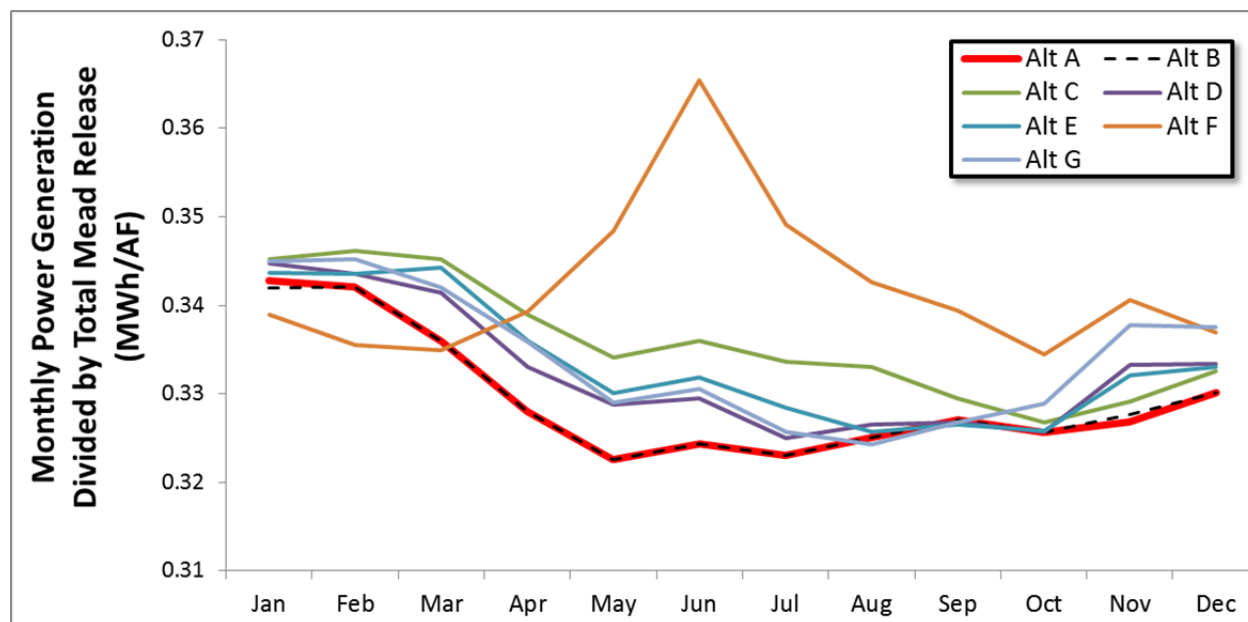

1

2 **FIGURE K.5-9 Average Monthly Generation per ac-ft of Total Mead Reservoir Release for All**
 3 **Power Systems Primary LTEMP DEIS Alternatives**

4
5

6 total Mead Reservoir release) during the summer months. Note that for each LTEMP alternative
 7 the pattern is the inverse of the one in Figure K.5-8.

8

9 As mentioned earlier, water releases that are made when Lake Mead is below 1,050 ft do
 10 not produce power. Therefore, for any alternative, Hoover Powerplant economics are not
 11 affected by water releases that are made from the dead pool, because all alternatives have zero
 12 power value at those elevations. It therefore follows that a change in water release from
 13 Alternative A also does not affect power economics at that point in time unless it raises the
 14 elevation above the power pool elevation. However, a changed monthly water release will
 15 indirectly affect the economics in other months of the year and Lake Mead’s pool elevation in
 16 the month(s) that follow.

17

18 Differences in monthly water releases from Lake Mead are primarily caused by operating
 19 criteria that were established under the *Interim Guidelines for Operation of Lake Powell and*
 20 *Lake Mead* Record of Decision (ROD) that was signed on December 13, 2007 (Reclamation
 21 2007b). The 2007 Interim Guidelines drive Hoover Dam releases, resulting in different Mead
 22 monthly total water releases among alternatives. Figure K.5-10 shows (1) Alternative F changes
 23 in Lake Mead monthly total water releases for hydrology trace 8 and (2) Lake Mead reservoir
 24 elevations under Alternatives A and F. Changes from Alternative A monthly water release are
 25 sometimes, but not always, triggered when elevations cross one of the shortage condition levels
 26 listed above (shown as dashed horizontal lines in Figure K.5-10). Because monthly water release
 27 decisions for the upcoming year are made at the beginning of the calendar year and forecasts of
 28 the future are uncertain, Hoover releases sometimes differ from the ones that would have
 29 occurred had the future been know with perfect foresight.

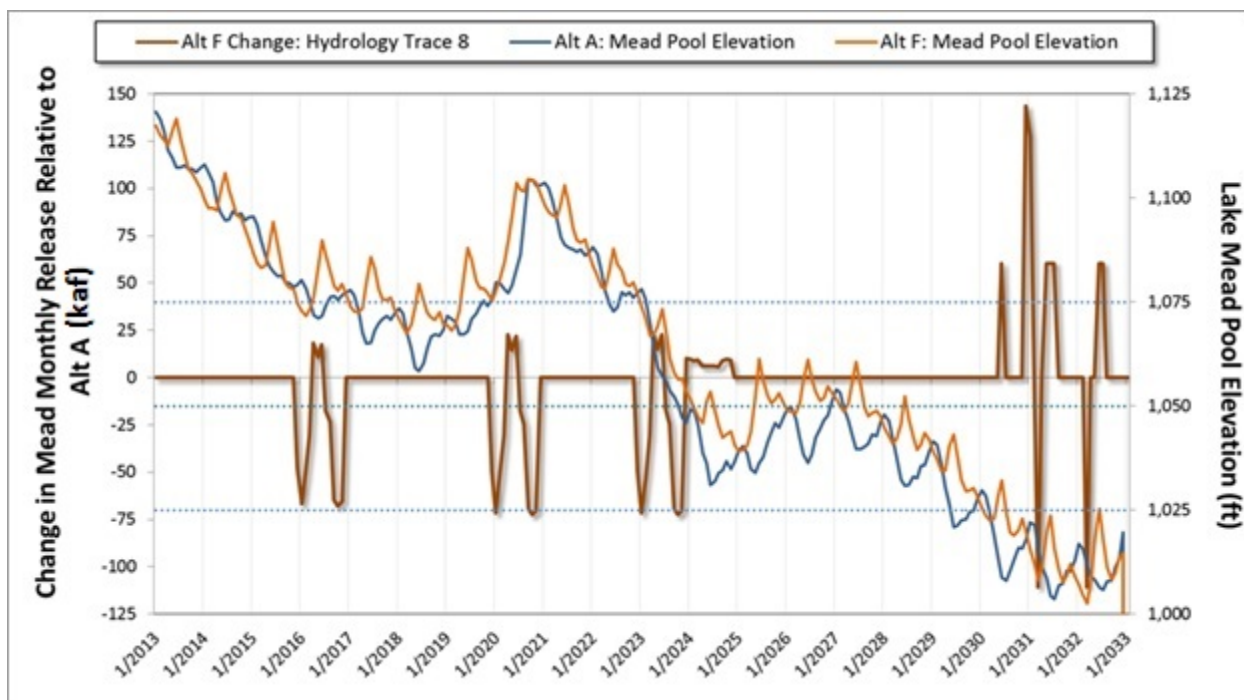

1

2 **FIGURE K.5-10 Alternative F Changes in Monthly Hoover Powerplant Turbine Water Releases**
 3 **under Hydrology Trace 8**

4

5

6

7

8

9

10

11

12

13

14

K.5.3 Hoover Maximum Physical Output and Firm Capacity

15

16

17

18

19

20

21

22

23

24

25

26

27

In addition to water-to-power conversion factors discussed in the preceding section, the maximum physical output of the Hoover Dam Powerplant is also affected by the pool elevation of Lake Mead. Figure K.5-12 shows the assumed relationship between pool elevation and maximum powerplant output. This curve is based on information provided by Reclamation. Note that below a pool elevation of 1,050 ft the maximum output is zero and above an elevation of 1,205 ft the maximum output remains constant at 2,075 MW (powerplant capacity).

The curve shown in Figure K.5-12 and SBM projections of Lake Mead pool elevations over the LTEMP study period were used to estimate monthly maximum physical output levels for the Hoover Powerplant for all 21 hydrological traces. Using the results for only August, the exceedance probability curve of the Hoover powerplant maximum output shown in Figure K.5-13 was constructed. To be consistent with other LTEMP power systems analyses,

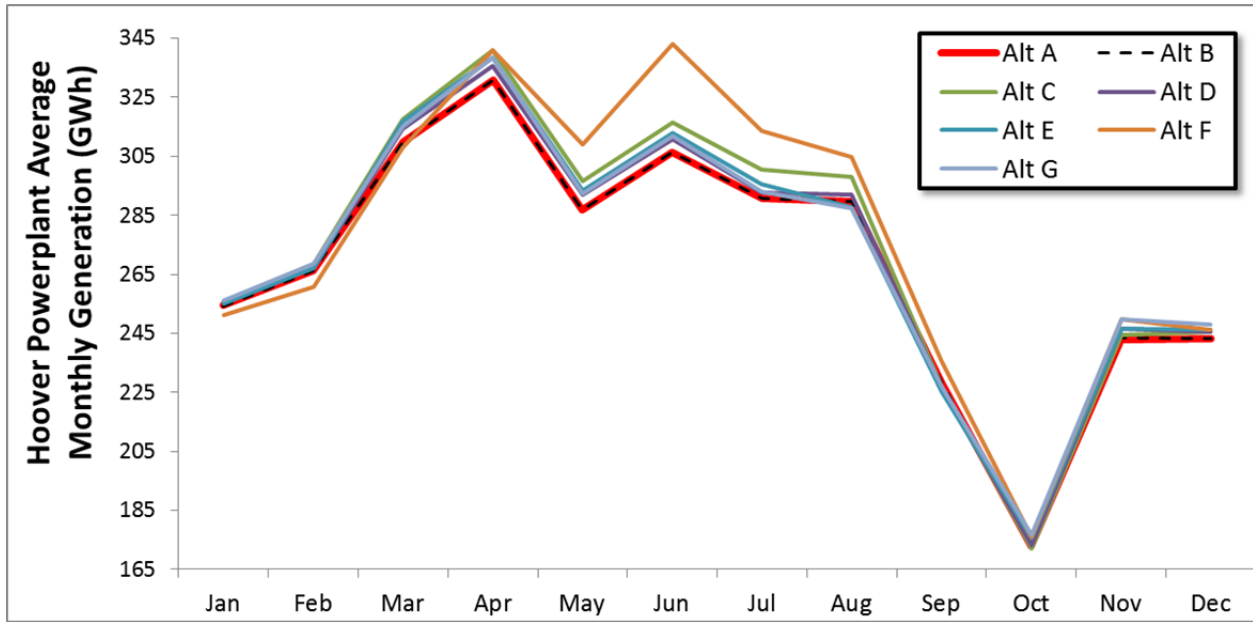

1
 2 **FIGURE K.5-11 Average Monthly Hoover Powerplant Generation for All Power Systems Primary**
 3 **LTEMP DEIS Alternatives**

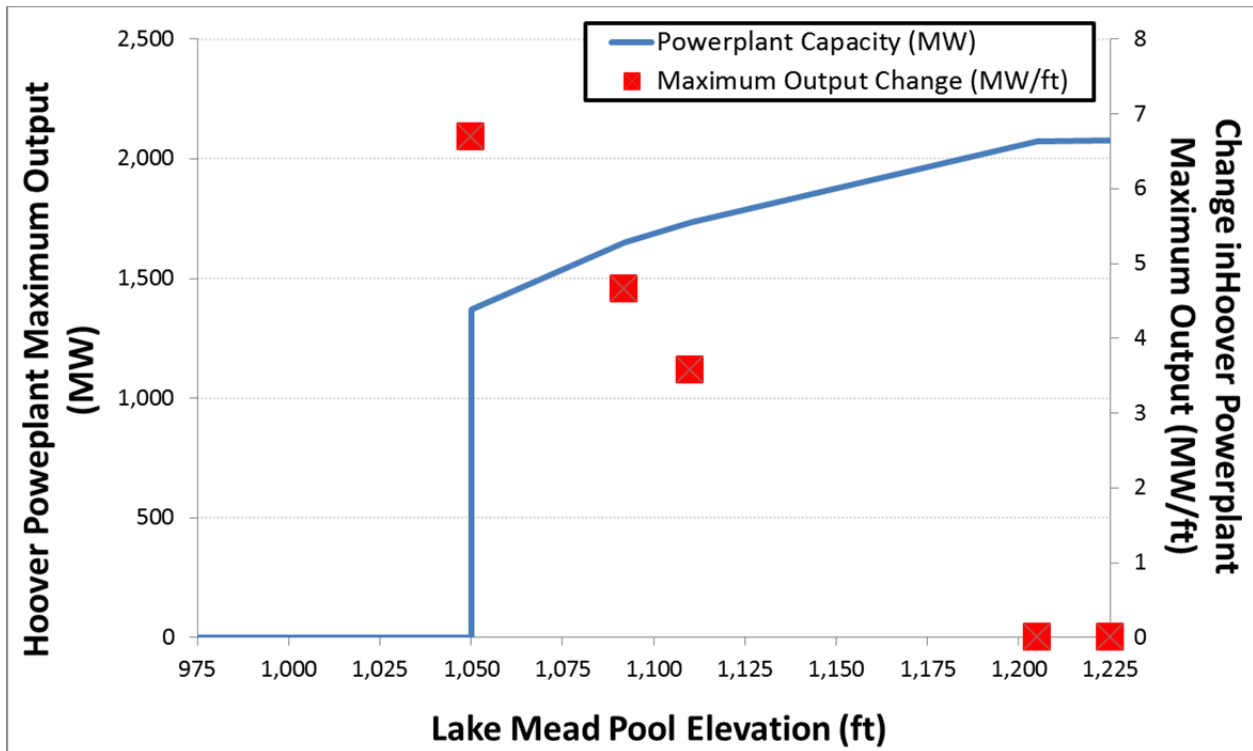

6
 7 **FIGURE K.5-12 Hoover Powerplant Maximum Physical Output as a Function of Lake Mead Pool**
 8 **Elevation**

9
 10

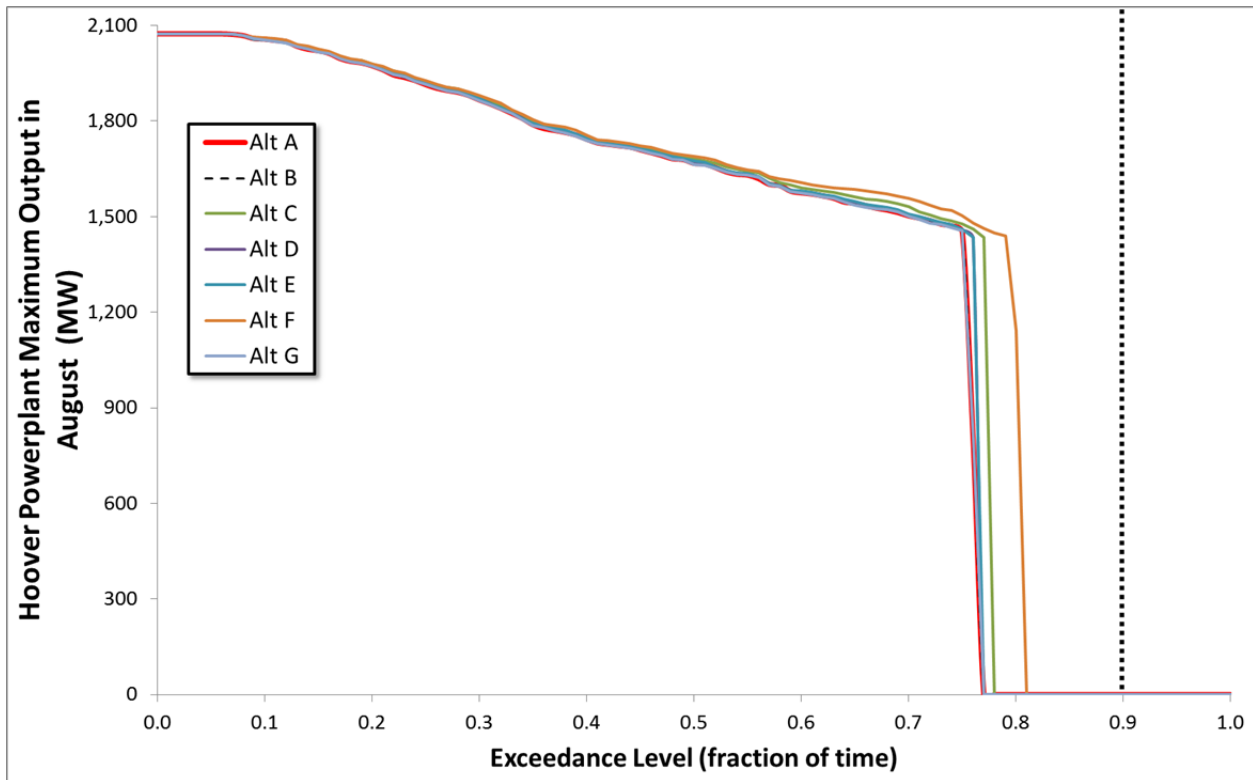

1

2 **FIGURE K.5-13 Hoover Powerplant Maximum Output Exceedance Curve for the Month of**
 3 **August**

4
 5

6 this analysis assumed that the firm hydropower capacity of Hoover is based on a 90th percentile
 7 exceedance. Based on the analysis shown in Figure K.5-13, under all alternatives, Lake Mead’s
 8 elevation in August would be below the active pool level (where no generation is possible) more
 9 than 10% of the time. Because the maximum output level is zero under all alternatives, the
 10 powerplant is credited with no firm capacity despite projections that indicate that the maximum
 11 output for the Hoover Powerplant is expected to be greater than zero most of the time. It
 12 therefore follows that LTEMP alternatives have no impact on Hoover Powerplant’s firm
 13 capacity and economic value.

14
 15

16 **K.5.4 Hoover Powerplant Economic Energy Value**

17
 18

19 The change in the economic value of Hoover Powerplant energy production under each
 20 alternative is computed by multiplying the change in monthly energy production by monthly
 21 market prices of energy as projected by the AURORA model. Estimates are made for each
 22 month of the 20-year LTEMP period for all 21 hydrology traces. For this analysis, it was
 assumed that the powerplant generates 95% of its total energy production during hours of the

1 week that have relatively high market prices (16 hours per day, 7 days a week).³⁷ The remaining
 2 5% is generated during times when prices are lower. Figure K.5-14 shows monthly average
 3 results of these calculations. Note that the values shown in the figure are average values over all
 4 21 hydrology traces during the 20-year time period and are not discounted.

5
 6 To compare the economic impact of alternatives on a consistent basis, the net present
 7 value (NPV) of Hoover Powerplant economic benefits were computed using a 3.375% annual
 8 discount rate, the same rate used for computing the NPV of SLCA/IP costs. The result of NPV
 9 calculations for the Hoover Powerplant is shown for each alternative in Figure K.5-15. The NPV
 10 benefit for Hoover ranges from nearly zero for Alternative B to about \$89 million for
 11 Alternative F.

12
 13 The economic benefits of alternatives at the Hoover Powerplant are lower than the
 14 economic costs of the alternatives in the SLCA/IP system that range from about -\$30 million (a
 15 benefit) for Alternative B to roughly \$420 million for Alternative F (see Table 4.14-1 for more
 16 details). Figure K.5-16 illustrates the difference between SLCA/IP costs and Hoover Powerplant
 17 benefits resulting from LTEMP alternatives. For example, Alternative F has a net cost that
 18 ranges from \$315 million (without excess capacity sales) to \$335 million (with excess capacity
 19 sales). Figure K.5-17 shows the net costs (SLCA/IP costs minus Hoover benefits) for all
 20 alternatives. When Hoover benefits are taken into account the net costs of LTEMP alternatives
 21 are less; however, the ranking among alternatives are identical to the case where Hoover benefits
 22 are not taken into account (green bars and dashes shown in Figure K.5-16).

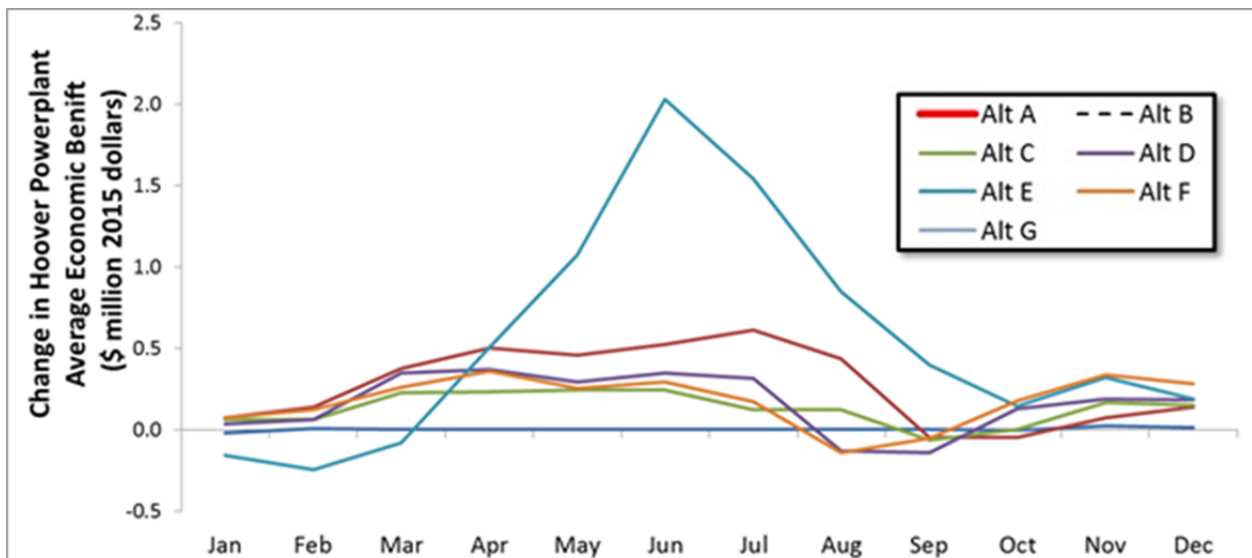

25
 26 **FIGURE K.5-14 Average Monthly Change in Hoover Powerplant Energy Economic Value**
 27 **(undiscounted) Relative to Alternative A for All Power Systems Primary LTEMP SEIS**
 28 **Alternatives**

³⁷ The 95% assumption is based on discussions with Reclamation staff.

1

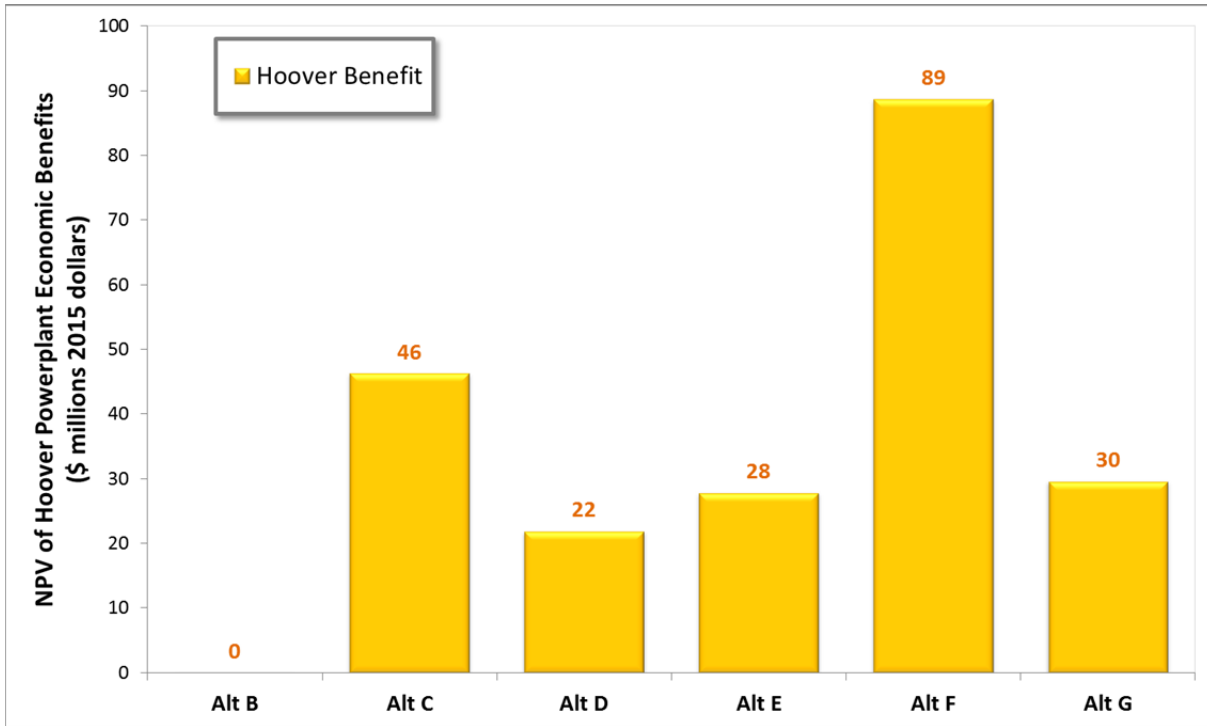

2

3

FIGURE K.5-15 NPV of Hoover Powerplant Benefits Relative to Alternative A Resulting from LTEMP Alternatives

4

5

6

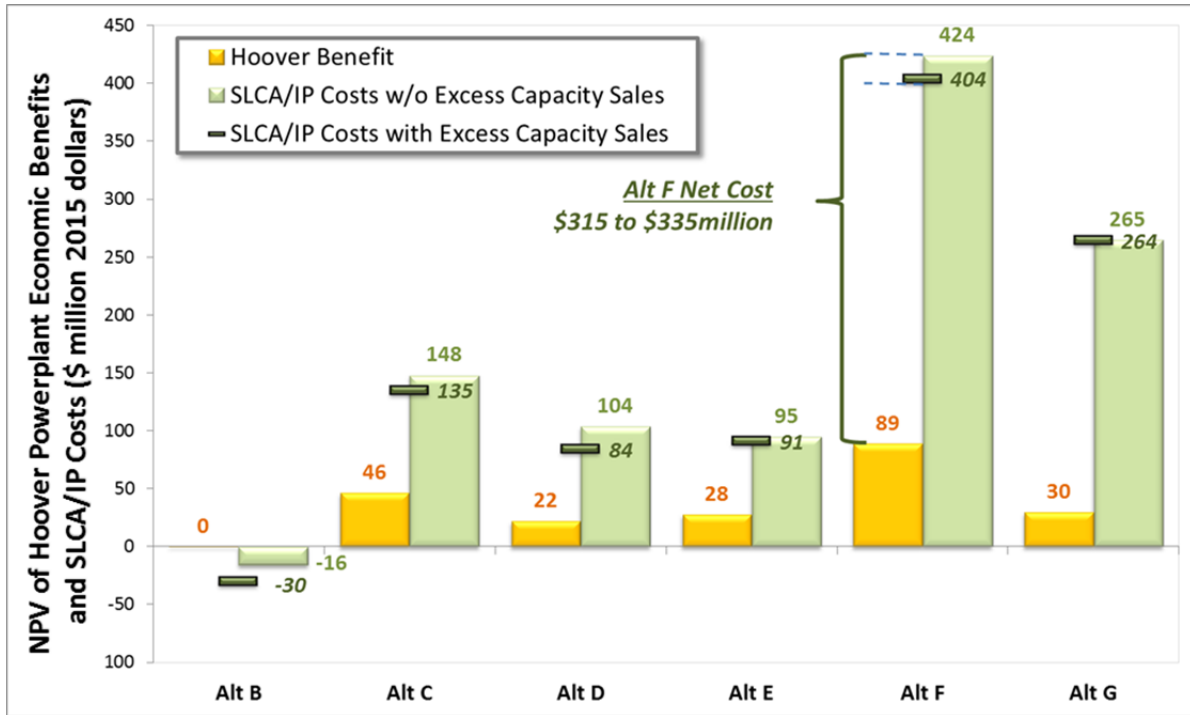

1

FIGURE K.5-16 NPV Comparison of SLCA/IP Costs and Hoover Powerplant Benefits Resulting from Changed Operating Criteria at Glen Canyon Dam

2
3
4
5

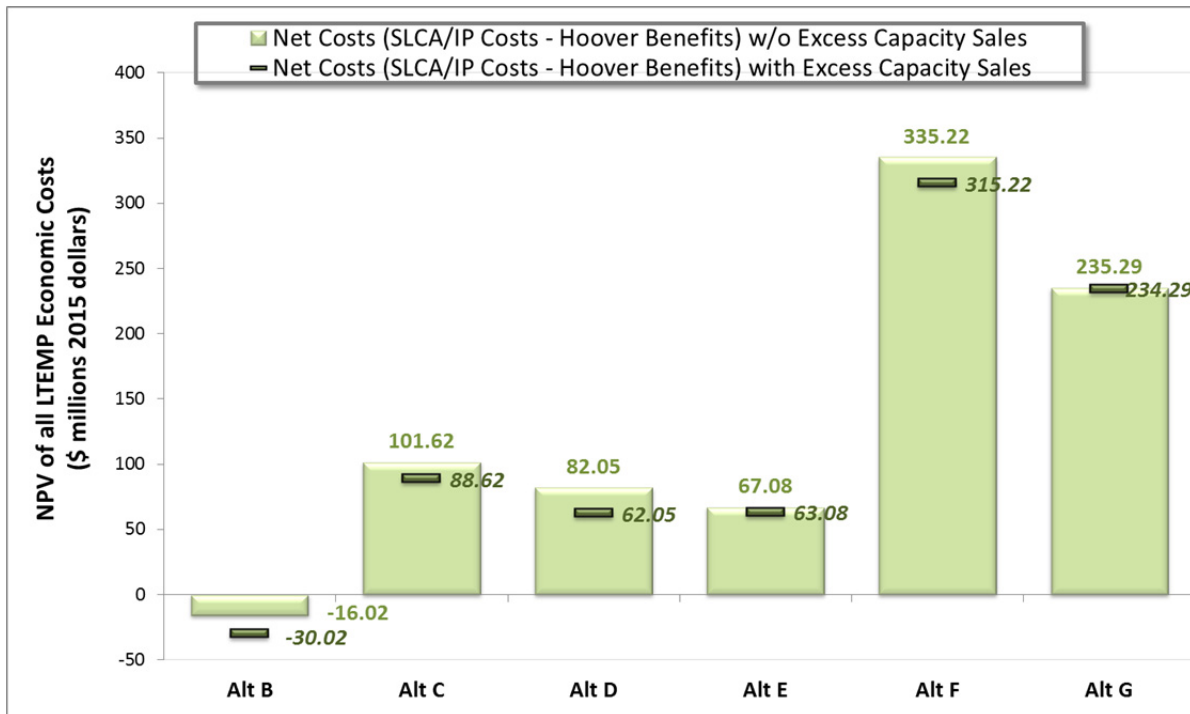

6

FIGURE K.5-17 NPV Comparison of SLCA/IP Costs and Hoover Powerplant Benefits Resulting from LTEMP Alternatives

7
8

1 **K.6 REFERENCES**

2
3 Anderson, K., 2014, personal communication from Anderson (Utah Associated Municipal Power
4 Systems), to L. Poch (Argonne National Laboratory), Feb. 24.

5
6 Bloomberg Business, undated, *Markets—United States Government Bonds*. Available at
7 <http://www.bloomberg.com/markets/rates-bonds/government-bonds/us>. Accessed Dec. 3, 2015.

8
9 BondsOnline, undated, *Income Investor Tools*. Available at
10 http://www.bondsonline.com/Todays_Market/Composite_Bond_Yields_table.php. Accessed
11 Dec. 3, 2015.

12
13 BLS (Bureau of Labor Statistics), undated, *Databases, Tables, & Calculators by Subject*, Series
14 ID code pcu22112-22112. Available at <http://data.bls.gov/cgi-bin/srgate>. Accessed Dec. 3, 2015.

15
16 Clayton, R., 2013, personal communication from Clayton (Bureau of Reclamation), to L. Poch
17 (Argonne National Laboratory), Mar. 8.

18
19 CRCN (Colorado River Commission of Nevada), 2015, *Colorado River Commission of*
20 *Nevada—Home*. Available at <http://crc.nv.gov/index.asp>. Accessed July 17, 2015.

21
22 CSU (Colorado Springs Utilities), 2012, *2012 Electric Integrated Resource Plan*, Aug. 6.

23
24 Deseret (Deseret Power Electric Cooperative), 2012, *Integrated Resource Plan Update*, Oct.

25
26 E3 (Energy and Environmental Economics, Inc.), 2014, *Capital Cost Review of Generation*
27 *Technologies: Recommendations for WECC's 10- and 20-Year Studies*, prepared for Western
28 Electric Coordinating Council, March.

29
30 EIA (U.S. Energy Information Administration), 2014, *Assumptions to the Annual Energy*
31 *Outlook 2014*, Washington D.C., June. Available at [http://www.eia.gov/forecasts/aeo/](http://www.eia.gov/forecasts/aeo/assumptions/pdf/0554(2014).pdf)
32 [assumptions/pdf/0554\(2014\).pdf](http://www.eia.gov/forecasts/aeo/assumptions/pdf/0554(2014).pdf). Accessed Mar. 2, 2015

33
34 EIA, 2015a, *Electric Power Sales, Revenue, and Energy Efficiency Form EIA-861 Detailed Data*
35 *Files*. Available at <http://www.eia.gov/electricity/data/eia861>. Accessed July 16, 2015.

36
37 EIA, 2015b, “Annual Energy Outlook 2015 Data Tables.” Available at
38 http://www.eia.gov/forecasts/aeo/supplement/sup_t2t3.xlsx. Accessed July 16.

39
40 EIA, 2015c, *Annual Energy Outlook 2015 with Projections to 2040*. Available at
41 <http://www.eia.gov/forecasts/aeo/pdf/0383%282015%29.pdf>. Accessed July 16, 2015.

42
43 EPRI (Electric Power Research Institute), 2013, *Program on Technology Innovation: Integrated*
44 *Generation Technology Options 2012 (Technical Update)*, Feb. Available at
45 <http://www.epri.com/abstracts/Pages/ProductAbstract.aspx?productId=00000000001026656>.
46 Accessed Feb. 25, 2015.

- 1 FWS (U.S. Fish and Wildlife Service), 1992, *Final Biological Opinion on the Operation of*
2 *Flaming Gorge Dam*, Mountain-Prairie Region, Denver, Col., Nov. 25.
3
- 4 Graziano, D.J., L.A. Poch, T.D. Veselka, C.S. Palmer, S. Loftin, and B. Osiek, 2015, *Financial*
5 *Analysis of Experimental Releases Conducted at Glen Canyon Dam during Water Year 2014*,
6 ANL-15/10, Technical Memorandum, Argonne National Laboratory, Sept.
7
- 8 Harpman, D., 2014a, personal communication from Harpman (U.S. Bureau of Reclamation) to
9 T. Veselka (Argonne National Laboratory), Aug. 26.
10
- 11 Harpman, D., 2014b, personal communication from Harpman (U.S. Bureau of Reclamation) to
12 T. Veselka (Argonne National Laboratory), Oct. 7.
13
- 14 Harpman, D.A., and A.S. Rosekrans, 1996, *Modeling Hourly Operations at Glen Canyon Dam,*
15 *Colorado River Storage Project, Arizona, GCPS09 version 1.0*, EC-96-12, U.S. Department of
16 the Interior, Bureau of Reclamation, Sept.
17
- 18 IAEA (International Atomic Energy Agency), 1980, *Wien Automatic Planning Package*
19 *(WASP): A Computer Code for Power Generating System Expansion Planning*, ver. 3, Vienna,
20 Austria, Nov.
21
- 22 McManes, C., 2014, “Modern Technology Helps American Icon Generate More Power,” *IEEE-*
23 *USA InSight*, July 1. Available at <http://insight.ieeeusa.org/insight/content/ieeeusa/68196>.
24 Accessed Dec. 3, 2015.
25
- 26 James, L., 2014, personal communication from James (Colorado River Energy Distributors
27 Association) to M. Runge (United States Geological Survey), K. LaGory (Argonne National
28 Laboratory), G. Knowles (Bureau of Reclamation), and R. Billerbeck (National Park Service),
29 Apr. 18.
30
- 31 Loftin, S.D., J. McCoy, R. E. Moulton, T. L. Myers, and B. Sands, 1998, Replacement Resource
32 Process, *Final Methods Report and Executive Summary*, prepared for Western Area Power
33 Administration, March.
34
- 35 NTUA (Navajo Tribal Utility Authority), 2012, *Integrated Resource Plan: Third Five-Year*
36 *Update*, Oct.
37
- 38 Osiek, B., 2014, “Salt Lake City Area Integrated Projects, Post-2004 Allocations - Effective
39 October 1, 2008 through September 30, 2024,” personal communication from Osiek (Western
40 Area Power Administration) to Les Poch (Argonne National Laboratory), May 23.
41
- 42 Platte River Power Authority, 2015, *Platte River Power Authority—Home*. Available at
43 <http://www.prpa.org>. Accessed July 17, 2015.
44
- 45 PRPA (Platte River Power Authority), undated, *2012 Integrated Resource Plan*.
46

- 1 Reclamation (Bureau of Reclamation), undated, *Bureau of Reclamation Construction Cost*
2 *Trends*, U.S. Department of the Interior. Available at
3 <http://www.usbr.gov/tsc/techreferences/mands/cct-pdfs/cct12-15.pdf>. Accessed May 28, 2015.
4
- 5 Reclamation, 2005, *Operation of Flaming Gorge Dam Final Environmental Impact Statement*,
6 U.S. Department of the Interior, Upper Colorado Region, Salt Lake City, Utah, Sep.
7
- 8 Reclamation, 2006, *Record of Decision: Operation of Flaming Gorge Dam Final Environmental*
9 *Impact Statement*, U.S. Department of the Interior, Feb. Available at
10 <http://www.usbr.gov/uc/envdocs/rod/fgFEIS/final-ROD-15feb06.pdf>. Accessed April 1, 2015.
11
- 12 Reclamation, 2007a, *Colorado River Interim Guidelines for Lower Basin Shortages and*
13 *Coordinated Operations for Lake Powell and Lake Mead*, U.S. Department of the Interior,
14 Boulder City, Nev., Oct. Available at <http://www.usbr.gov/lc/region/programs/strategies/FEIS>.
15 Accessed May 27, 2015.
16
- 17 Reclamation, 2007b, *Environmental Impact Statement—Colorado River Interim Guidelines for*
18 *Lower Basin Shortages and Coordinated Operations for Lake Powell and Lake Mead*, Bureau of
19 Reclamation, Upper and Lower Colorado Region, October. Available at [http://www.usbr.gov/lc/](http://www.usbr.gov/lc/region/programs/strategies.html)
20 [region/programs/strategies.html](http://www.usbr.gov/lc/region/programs/strategies.html). Accessed May 2013.
21
- 22 Reclamation, 2014a, “Change in Discount Rate for Water Resources Planning,” *Federal*
23 *Register* Vol. 79 No. 248, Dec. 29, p. 78108.
24
- 25 Reclamation, 2014b, “Subject: Interest Rates for Fiscal Year 2015,” Control No. 84-55000,
26 memorandum from R. Gonzales, Director of Policy and Administration, Nov. 25.
27
- 28 Scheid, N., 2015, personal communication from Scheid (Western Area Power Administration),
29 to T. Veselka (Argonne National Laboratory), Mar. 3.
30
- 31 SRP (Salt River Project), 2012, *Integrated Resource Plan FY 2013*, Town of Gilbert, Fort
32 McDowell Yavapai Nation, and Salt River Pima-Maricopa Indian Community, Dec. 19.
33
- 34 Tri-State (Tri-State Generation and Transmission Association, Inc.), 2010, *Integrated Resource*
35 *Plan/Electric Resource Plan*, Nov.
36
- 37 Tri-State, 2015, *Member Systems*. Available at [http://www.tristategt.org/OurMembers/members-](http://www.tristategt.org/OurMembers/members-directory.cfm)
38 [directory.cfm](http://www.tristategt.org/OurMembers/members-directory.cfm). Accessed July 17, 2015.
39
- 40 UAMPS (Utah Associated Municipal Power Systems), 2013, *2012 Integrated Resource Plan*.
41
- 42 UMPA (Utah Municipal Power Agency), 2013, *Integrated Resource Plan: Five-Year Plan*
43 *(FY2013 to FY2017)*, Apr. 24.
44
- 45 UMPA, 2015, *Utah Municipal Power Agency—Home*. Available at <http://www.umpa.cc>.
46 Accessed July 17, 2015.

- 1 Veselka, T.D., L.A. Poch, C.S. Palmer, S. Loftin, and B. Osiek, 2010, *Ex Post Power Economic*
2 *Analysis of Record of Decision Operational Restrictions at Glen Canyon Dam*, ANL/DIS-10-6,
3 Technical Memorandum, Argonne National Laboratory, July.
4
- 5 Veselka, T.D., L.A. Poch, C.S. Palmer, S. Loftin, and B. Osiek, 2011, *Revised Financial*
6 *Analysis of Experimental Releases Conducted at Glen Canyon Dam during Water Years 1997*
7 *through 2005*, Technical Memorandum ANL/DIS-11-1, Argonne National Laboratory, January.
8
- 9 Western (Western Area Power Administration), 2015, *Power Marketing—Power Allocations*.
10 Available at <https://www.wapa.gov/regions/CRSP/PowerMarketing/Pages/power->
11 [marketing.aspx](https://www.wapa.gov/regions/CRSP/PowerMarketing/Pages/power-marketing.aspx). Accessed Nov. 13, 2015.
12
- 13 Wicks, P., 2014, personal communication from Wicks (Western Area Power Administration), to
14 T. Veselka and L. Poch (Argonne National Laboratory), Oct. 1.
15
- 16 WM Financial Strategies, undated, *Rates over Time—Interest Rate Trends*. Available at
17 <http://www.munibondadvisor.com/market.htm>. Accessed Dec. 3, 2015.
18
- 19 WMPA (Wyoming Municipal Power Agency), 2015, *WMPA Membership*. Available at
20 <http://www.wmpa.org/members>. Accessed July 17, 2015.
21

ATTACHMENT K.1:

GEOGRAPHIC SCOPE OF THE ANALYSIS

The geographic scope of the economic effects of the operations of Glen Canyon Dam has long been a topic of discussion among staff at the Western Area Power Administration (Western), Bureau of Reclamation (Reclamation), National Park Service (NPS), Grand Canyon Monitoring and Research Center (GCMRC), and Argonne National Laboratory (Argonne). The method described herein assumes that the effect of changes to the operation of the Glen Canyon Dam is limited to the Salt Lake City Area Integrated Projects (SLCA/IP) system; that is, SLCA/IP federal hydropower resources and Western’s SLCA/IP long-term firm (LTF) customers. Figure 1 shows the extent of the study area considered in this analysis. This assumption became essential when the scope and timing of the Glen Canyon Dam Long-Term Experimental and Management Plan (LTEMP) power systems analysis were re-evaluated in June 2014 as a result of funding and schedule considerations. Several proposed options for proceeding were developed at that time to offer different levels of analytical detail, costs, and completion dates. The option selected (middle ground relative to detail, funding, and timing) defined the geographic scope as Western’s SLCA/IP marketing area with ties to the rest of the Western Interconnection (WI) for market transaction at the Palo Verde hub. This topology is the basis of analysis and results to be developed for the LTEMP Draft Environmental Impact Statement (DEIS). Initial assessments for the value of expanding the scope to all of the WI are discussed briefly in a section that follows, but those deliberations are no longer relevant to this initial stage of analysis. Budget and timing factors have determined the scope of this initial analysis.

This analysis assumes that there is little, if any, economic effect at electricity hubs outside the SLCA/IP system of hydropower plants and Western’s firm customers in terms of changes in locational marginal prices (LMPs) as a result of alternative operations at Glen Canyon Dam. Recently, Argonne undertook a study verifying this limited regional influence. This is known as the WECCi-leaks study. The topology of the region in the WECCi-leaks study is shown in Figure 2. It models the entire extent of the U.S. portion of the WI and is the same topology used in the 2010 WECC Power Supply Assessment. A report documenting this study will be written and peer reviewed. A final, peer-reviewed version of this report will be available in time for reference in the final LTEMP EIS. Therefore, when simulating the operation of Glen Canyon Dam the region of detailed modeling is restricted to the SLCA/IP system. Spot market transactions conducted at points between this system and the rest of the WI will be represented as a static set of market prices for the Palo Verde hub.

WI Energy Transactions

The SLCA/IP system is directly connected with other private or invest-owned electric utilities (IOUs) in the geographic area. Among these are Rocky Mountain Power, Excel Energy, and Public Service Company of New Mexico. An electrical market exists such that the SLCA/IP system can exchange with these utilities and others to which they are indirectly connected in order to lower operating costs. To approximate these economic energy exchanges, the AURORA

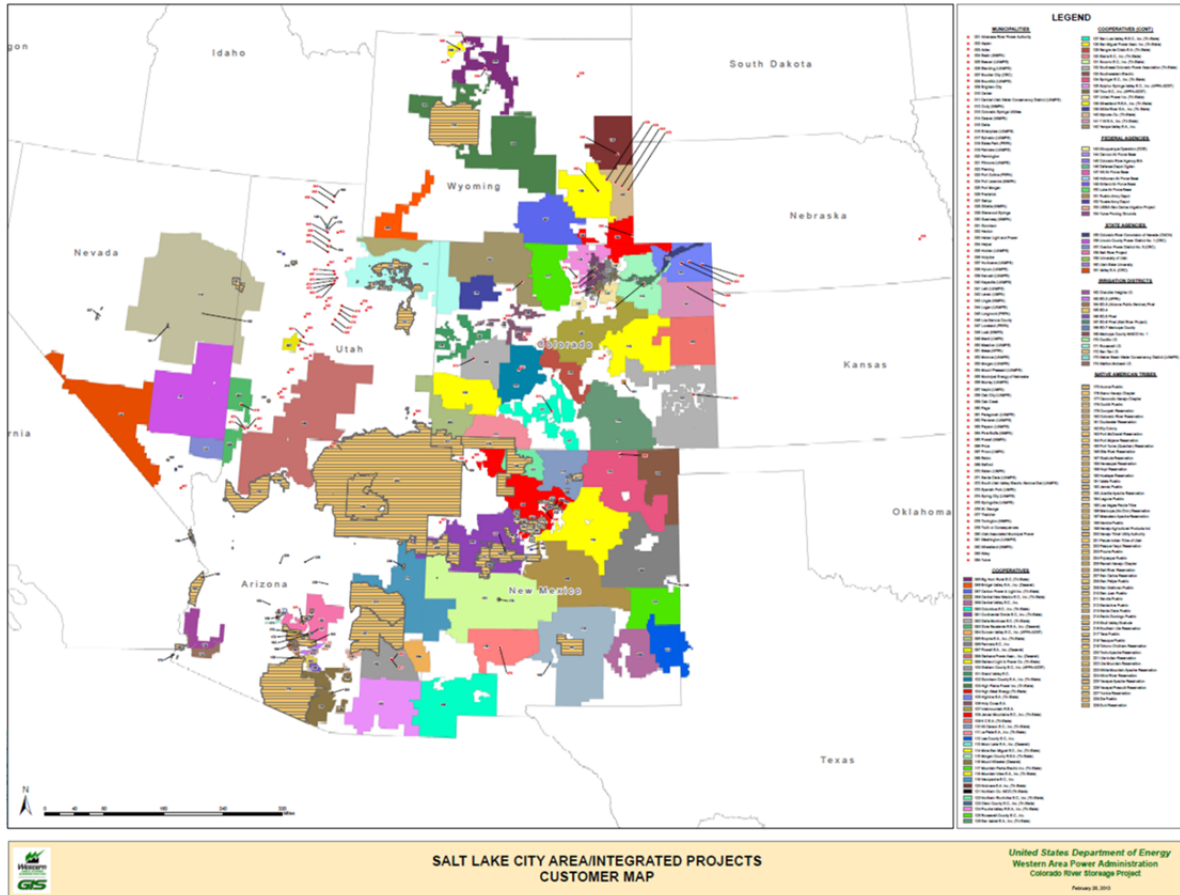

FIGURE 1 Study Area Considered in the LTEMP Power Systems Analysis

model was run to simulate the dispatch of the entire WI. Resulting prices from this run are then input into the more geographically limited, but more detailed, model of the SLCA/IP powerplants and its firm customers. It is assumed that these prices are static and do not change as a result of alternative operating criteria at Glen Canyon Dam. Glen Canyon Dam is a very small resource compared to the total WI generating capacity and is thought to have only a miniscule impact on WI market prices.

WI Capacity Transactions

For this analysis, we make the simplifying assumption that no capacity exchange or joint expansion planning occurs—economic impacts of changes in Glen Canyon Dam capacity are limited to Western’s eight large SLCA/IP LTF customers. Note that smaller customers do not have significant supply resources. It is therefore assumed that small customers will not build capacity in the future. All lost Glen Canyon Dam capacity as a result of operational changes at Glen Canyon Dam would be replaced by the eight larger utility systems, and any resulting

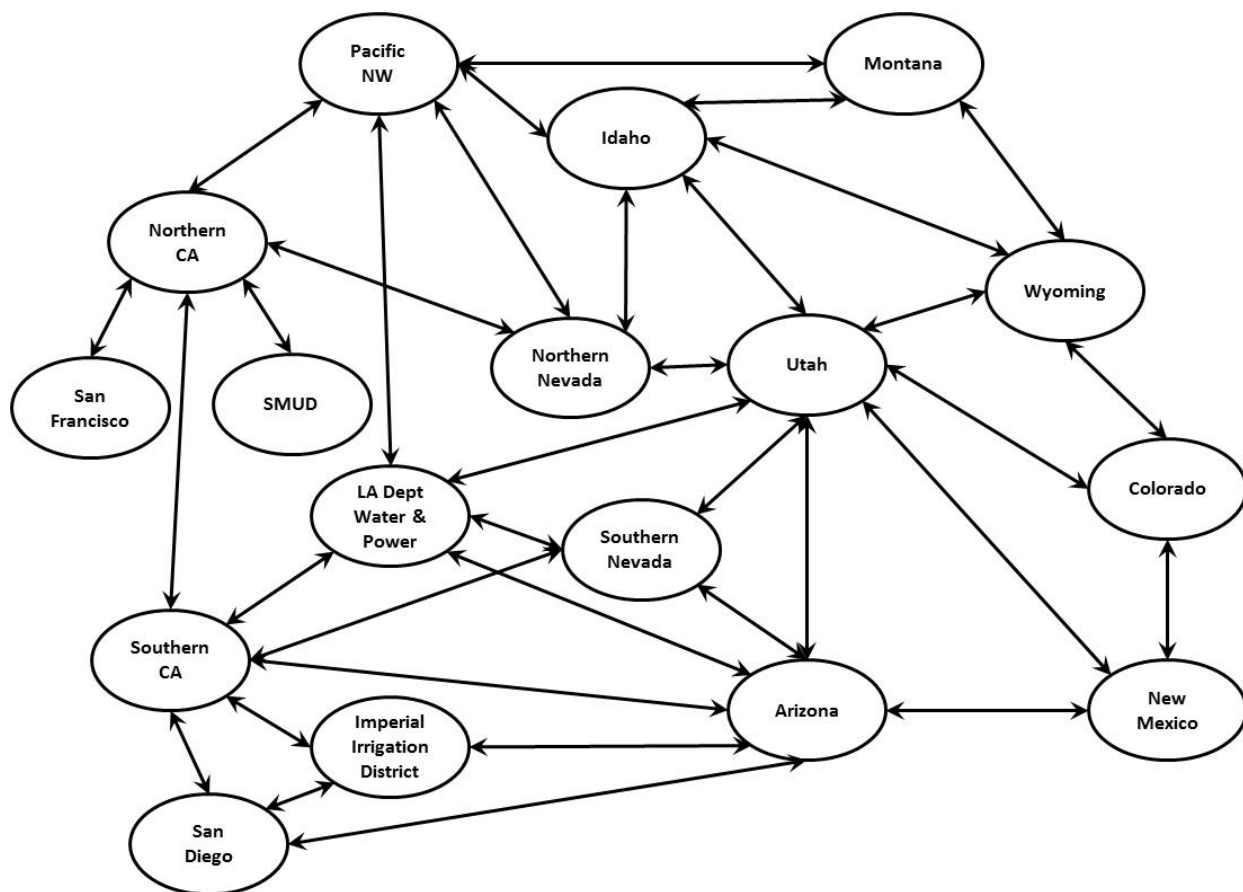

FIGURE 2 Topology Used in the WECCi-Leaks Study

capacity losses for the small customers would be replaced via LTF capacity agreements with the larger utilities.

This assumption that the SLCA/IP system will replace lost capacity through its own initiatives can be justified if there is no accessible excess capacity in the larger region. Therefore, a capacity loss at Glen Canyon Dam cannot be replaced via the purchase of excess capacity from a surrounding utility; for example, from IOUs with whom they are connected. If this assumption is true, the methodology described here will provide a very good approximation of the true economic impact, since the loss of Glen Canyon Dam capacity will require the construction of new capacity somewhere in the grid.

In order to properly assess the strength of this assumption, an examination of relevant regional data, such as integrated resource plans (IRPs) of Western’s large customers that own generating facilities and large IOUs in the geographic and “electrical” area was conducted. In general, all IRPs examined revealed that utilities are expanding capacity with both renewable and thermal technologies in the near future. In addition, some utilities are increasing Demand Side Management programs to reduce the need for expanding capacity. It was also discovered that the loss of capacity in one large IOU (namely, NVEnergy) from a mandated shutdown of

1 coal-fired powerplants will be replaced with natural gas-fired generation about a year after the
2 first group of coal-fired units are shut down (see Figure 7 in Attachment K-9). Summaries of key
3 IRPs are provided in Attachment K-9. The conclusion drawn from the review of the IRPs is that
4 there is very little, if any, excess capacity in the Balancing Authorities in which Western’s
5 customers are located and in the broader power pool areas that are defined in the AURORA
6 “out-of-the-box” model configuration. Therefore, loss in capacity at Glen Canyon Dam would
7 need to be replaced soon after the loss was incurred. This loss could be replaced by new capacity
8 that is either built by Western’s customers or alternatively by another utility and sold via LTF
9 capacity contracts. In this analysis, it is assumed that the replacement capacity would be directly
10 built by the customers. From a purely economic viewpoint, there is little difference if the pool of
11 eight large customers builds the capacity or if it is built by another utility.
12
13

14 **Analysis Fidelity**

15
16 Although in reality Western and its customers operate in the WI, the approach used by
17 Argonne power system analysts emphasizes performing high-fidelity analyses on a smaller
18 network topology as opposed to analyzing system response of the entire WI to changes in
19 operating criteria dictated by LTEMP DEIS alternatives. By accurately modeling a smaller
20 system, it is possible to track and explain with a relatively high level of confidence both system-
21 and component-level reactions to alternative operating criteria and to trout management flow
22 (TMF) and HFE operation schedules. SLCA/IP system interactions with the broader WI are also
23 represented, but in far less detail. As described in this attachment, power systems analysts were
24 able to fairly closely match historical 2013 generation levels for the eight large utility systems.
25

26 It should also be noted that unit commitments, system dispatch, and capacity expansion
27 decisions are not made by a single entity that makes decisions for the entire interconnect. Instead
28 autonomous decisions under uncertainty are made by many entries in the WI using market price
29 signals such as the ones reported by the Intercontinental Exchange (ICE) to take unit
30 commitment, dispatch, and energy market transaction decisions. Therefore, the AURORA model
31 of the WI tends to “over optimize” system operations. Low 2012 Palo Verde market prices
32 computed by AURORA may be in part due to the “single decision maker” approach that is
33 employed. Another difficulty in modeling WI operations is that hydropower operating
34 constraints for the multitude of hydropower plants within the interconnection are extremely
35 challenging. The approach used in this analysis represents a middle ground between simulating
36 each utility individually and optimizing WI operations. It also allows the modeler to represent
37 hydropower operations at a level of detail that cannot be simulated at an adequate level of
38 fidelity by AURORA.
39
40

ATTACHMENT K.2:

AURORA WI SPOT MARKET ENERGY PRICES ADJUSTMENTS

The power systems analysis uses a representation of the spot market at the Palo Verde hub where SLCA/IP market system participants buy and sell energy at a set of given hourly prices. The methodology applied in this study uses this price set to represent the economic value of energy; that is, the marginal cost to produce energy that serves the last megawatt of load. This includes both fuel costs and variable operation and maintenance (O&M) expenses. Historical economic values are extremely difficult to accurately estimate because the Western Interconnection is comprised of numerous independent entities that operate in a geographically large and very complex grid. Difficulties associated with modeling the Western Interconnection for long-term analyses consist of but certainly not limited to the following (<http://www.ipd.anl.gov/anlpubs/2012/04/73032.pdf>):

1. The interconnection includes multiple U.S. states and three countries;
2. Part of the system operates in an organized central market (i.e., CAISO) and other portions operate in a bilateral market;
3. A large fraction of Western Interconnection loads are supplied by hydropower plants, many of which are subject to complicated and difficult to model environmental operating criteria (even on a site-specific level);
4. A lack of unit-specific information on fuel prices and heat rate curves ;
5. Insufficient data on bus-level loads;
6. A large and complicated transmission system;
7. Lack of information on resource availability (e.g., unit outage and transmission line outages);
8. Forecast errors associated with loads, hydropower inflows, and variable resource (wind/solar) output; and
9. Complex interactions among entities that make decisions under uncertainty based on limited information about the interconnection.

All power systems models, including AURORA, must therefore make many simplifying assumptions about the grid and the mathematical representation of each grid component. These assumptions lead to an imperfect representation of reality.

In the study, spot market prices modeled for 2013 by the default WI AURORA model were significantly different from day-ahead market (DAM) prices published by the ICE and the

1 CAISO. The Palo Verde hub was chosen to represent prices for the spot market in the
 2 AURORA network topology for the LTEMP analysis because it is the hub closest to Glen
 3 Canyon Dam and is often used as the benchmark price for Western energy transactions.
 4

5 The ICE publishes day-ahead weighted average peak, off-peak, and Sunday off-peak
 6 electricity price for every day each year. Sunday off-peak hours are the 16 daytime hours that
 7 have the highest loads; they correspond to the 16 hours classified as peak in the other 6 days of
 8 the week. Hourly prices generated by the AURORA model were subdivided into 7 categories;
 9 namely, holiday, Sunday daytime, Sunday nighttime, Saturday peak, Saturday off-peak,
 10 weekday peak, and weekday off-peak. The monthly averages were computed for each category
 11 and compared against the monthly average of the ICE prices in these categories.
 12

13 In order to bring AURORA model hourly prices in line with these ICE prices, AURORA
 14 model results were scaled to match ICE averages. A scalar (ratio of the ICE to AURORA prices)
 15 was generated for each month and each category. In this preliminary investigation, it was
 16 discovered that prices generated by the AURORA model were generally lower than the ICE
 17 prices. Prices in off-peak hours were lower by about 5 to 15% and prices in peak hours were
 18 lower by as much as 20 to 50%. To adjust for this discrepancy in prices, future AURORA model
 19 runs for the LTEMP network topology, AURORA prices at the Palo Verde hub were multiplied
 20 by the aforementioned scalar. The scalars derived from ICE prices are shown in Table 1.
 21
 22

23 **TABLE 1 Scalars Used to Adjust Spot Market Prices in the AURORA Model**

| Month | Sunday | | | Saturday | | Weekday | |
|-----------|-----------------|---------|-----------|----------|----------|---------|----------|
| | Holiday | Daytime | Nighttime | Peak | Off Peak | Peak | Off Peak |
| January | 1.053 | 1.032 | 1.110 | 1.068 | 1.042 | 1.058 | 1.019 |
| February | NA ^a | 1.145 | 1.221 | 1.123 | 1.083 | 1.093 | 1.140 |
| March | NA ^a | 1.133 | 1.175 | 1.119 | 1.126 | 1.105 | 1.120 |
| April | NA ^a | 1.319 | 1.297 | 1.257 | 1.132 | 1.163 | 1.183 |
| May | 0.943 | 1.143 | 1.126 | 1.156 | 1.046 | 1.165 | 1.053 |
| June | NA ^a | 1.210 | 1.241 | 1.241 | 1.067 | 1.200 | 1.066 |
| July | 1.100 | 1.222 | 1.204 | 1.343 | 1.009 | 1.538 | 1.094 |
| August | NA ^a | 1.175 | 1.142 | 1.231 | 1.004 | 1.230 | 1.060 |
| September | 1.088 | 1.133 | 1.251 | 1.218 | 1.051 | 1.170 | 1.116 |
| October | NA ^a | 1.134 | 1.235 | 1.156 | 1.118 | 1.094 | 1.142 |
| November | 1.079 | 1.084 | 1.208 | 1.166 | 1.159 | 1.098 | 1.113 |
| December | 1.082 | 1.279 | 1.470 | 1.233 | 1.265 | 1.228 | 1.299 |

^a NA = Not applicable.

24
 25

1 The scaled AURORA prices were used as a surrogate for the economic value of energy
2 based on the premise that the ICE data adequately reflects actual market prices and those market
3 prices are a good measure of economic costs. In economic theory, a perfect market will produce
4 prices that reflect economic costs. However, no market is perfect, including those in the Western
5 Interconnect. Therefore, due to the complexities associated with modeling actual economic costs
6 at the margin, power system modeler used the aforementioned scaling methodology. This not
7 ideal, but it appears that market mechanisms in the Western Interconnection are working
8 reasonably well and market monitors (such as those in the CAISO) help to ensure that
9 participants do not unduly take advantage of market imperfections.

10

11

1 **TABLE 1 Powell Outflow Exceedance: Rankings of Traces by Least-Squares Differentials as a Measure for Matching the Distribution of**
 2 **Releases for All Traces^a**

| Rank | Alternative A (No Action Alternative) | | Long-Term Strategy B1 | | Long-Term Strategy C1 | | Long-Term Strategy E1 | | Alternative F | | Alternative G | |
|------|---------------------------------------|-----------------------|-----------------------|-----------|-----------------------|-----------|-----------------------|-----------|---------------|-----------|---------------|-----------|
| | Trace | Sq. Diff ^b | Trace | Sq. Diff. | Trace | Sq. Diff. | Trace | Sq. Diff. | Trace | Sq. Diff. | Trace | Sq. Diff. |
| 1 | Trace 14 | 710 | Trace 14 | 710 | Trace 13 | 636 | Trace 13 | 637 | Trace 14 | 533 | Trace 13 | 872 |
| 2 | Trace 19 | 836 | Trace 19 | 836 | Trace 19 | 906 | Trace 14 | 1,130 | Trace 13 | 832 | Trace 14 | 940 |
| 3 | Trace 13 | 1,024 | Trace 13 | 1,024 | Trace 14 | 1,055 | Trace 19 | 1,401 | Trace 19 | 930 | Trace 19 | 1,133 |
| 4 | Trace 12 | 1,208 | Trace 12 | 1,208 | Trace 12 | 1,241 | Trace 12 | 1,448 | Trace 12 | 1,257 | Trace 12 | 1,337 |
| 5 | Trace 15 | 2,353 | Trace 15 | 2,353 | Trace 15 | 2,548 | Trace 15 | 2,620 | Trace 15 | 2,639 | Trace 15 | 2,590 |
| 6 | Trace 3 | 2,594 | Trace 3 | 2,594 | Trace 3 | 3,811 | Trace 3 | 3,945 | Trace 3 | 3,003 | Trace 3 | 3,746 |
| 7 | Trace 18 | 3,509 | Trace 18 | 3,509 | Trace 18 | 4,249 | Trace 7 | 4,661 | Trace 7 | 4,150 | Trace 18 | 3,833 |
| 8 | Trace 7 | 3,962 | Trace 7 | 3,962 | Trace 7 | 4,641 | Trace 18 | 4,835 | Trace 18 | 4,394 | Trace 7 | 4,362 |
| 9 | Trace 4 | 4,096 | Trace 4 | 4,096 | Trace 4 | 5,110 | Trace 4 | 5,106 | Trace 4 | 4,642 | Trace 4 | 4,676 |
| 10 | Trace 17 | 4,541 | Trace 17 | 4,541 | Trace 2 | 5,406 | Trace 17 | 5,392 | Trace 17 | 5,129 | Trace 17 | 5,028 |
| 11 | Trace 16 | 5,245 | Trace 16 | 5,246 | Trace 17 | 5,420 | Trace 2 | 5,846 | Trace 2 | 5,440 | Trace 2 | 5,631 |
| 12 | Trace 2 | 5,325 | Trace 2 | 5,325 | Trace 6 | 7,051 | Trace 16 | 6,429 | Trace 6 | 6,467 | Trace 16 | 5,919 |
| 13 | Trace 6 | 5,648 | Trace 6 | 5,648 | Trace 20 | 7,258 | Trace 6 | 7,047 | Trace 16 | 6,669 | Trace 6 | 6,460 |
| 14 | Trace 20 | 7,399 | Trace 20 | 7,399 | Trace 16 | 7,572 | Trace 20 | 7,359 | Trace 20 | 7,511 | Trace 20 | 7,390 |
| 15 | Trace 8 | 9,687 | Trace 8 | 9,688 | Trace 0 | 10,979 | Trace 8 | 10,992 | Trace 0 | 10,858 | Trace 8 | 10,202 |
| 16 | Trace 10 | 10,446 | Trace 10 | 10,446 | Trace 1 | 11,068 | Trace 0 | 11,008 | Trace 10 | 11,016 | Trace 0 | 10,865 |
| 17 | Trace 0 | 10,868 | Trace 0 | 10,868 | Trace 8 | 11,350 | Trace 1 | 11,332 | Trace 8 | 11,255 | Trace 10 | 11,111 |
| 18 | Trace 1 | 11,249 | Trace 1 | 11,249 | Trace 10 | 11,557 | Trace 10 | 11,601 | Trace 1 | 11,491 | Trace 1 | 11,408 |
| 19 | Trace 5 | 11,262 | Trace 5 | 11,262 | Trace 5 | 12,662 | Trace 5 | 12,816 | Trace 5 | 12,712 | Trace 5 | 12,113 |
| 20 | Trace 9 | 13,003 | Trace 9 | 13,003 | Trace 9 | 14,797 | Trace 9 | 14,807 | Trace 9 | 13,982 | Trace 9 | 14,046 |
| 21 | Trace 11 | 14,321 | Trace 11 | 14,321 | Trace 11 | 16,284 | Trace 11 | 16,349 | Trace 11 | 15,433 | Trace 11 | 15,501 |

^a Trace 14, the selected representative trace, is highlighted in green.

^b Note: Sq. Diff. = least squares differential between the trace-specific exceedance curve and the all-traces exceedance curve.

1 exceedance curve and the all-traces exceedance curve. These differentials were calculated
2 separately for each of the six alternatives and long-term strategies.

3
4 Table 2 shows hydrology Trace 14 provides a distribution of annual water releases that
5 closely mimics the full set of releases for all traces. We also observed that differences in the
6 rankings when examining Powell outflows versus estimated power releases were minor and
7 relatively insignificant to the selection of a single representative trace. Thus, the illustrations
8 used in this summary focus primarily on Powell outflows.

9
10 Trace 13 also provides a good match with all-trace outflows, especially for Alternative G
11 and Long-Term Strategies C1 and E1, where the least-squares differences are less than those for
12 Trace 14. However, a large portion of the least-squares difference between Traces 13 and 14 is
13 accredited to the closer match to near-peak releases for some alternatives in Trace 13 versus
14 Trace 14, whereas Trace 14 exhibits a closer fit over other portions of the flow distributions
15 (illustrated in figures that follow). Additionally, alternative-to-alternative inconsistencies in end-
16 of-year Powell elevations and annual water releases were significantly greater for Trace 13 than
17 Trace 14.

18
19 Trace 19 represents another possible contender with a good match to the all-trace
20 variability. It is not considered further, though, because it includes numerous occurrences of
21 Powell elevations below the top of the penstock within the 20-year modeling period (4 months
22 for each alternative except Alternative F). The below-penstock occurrences across the 21 traces
23 and 20 years are listed below:

- 24
- 25 • Alternative A—trace 8: 3 in 2032; trace 19: 12 in 2016 to 3 in 2017 inclusive.
 - 26
 - 27 • Long-Term Strategy B1—trace 8: 3 in 2032; trace 19: 12 in 2016 to 3 in 2017
28 inclusive.
 - 29
 - 30 • Long-Term Strategy C1—trace 8: 3 in 2032; trace 19: 12 in 2016 to 3 in 2017
31 inclusive.
 - 32
 - 33 • Long-Term Strategy E1—trace 8: 3 and 4 in 2032; trace 9: 3 in 2027;
34 trace 19: 12 in 2016 to 3 in 2017 inclusive.
 - 35
 - 36 • Alternative F—none; all elevations above 3,490 ft.
 - 37
 - 38 • Alternative G—trace 8: 2 in 2032 to 4 in 2032 inclusive; trace 19: 12 in 2016
39 to 3 in 2017 inclusive.
 - 40

41 Figures 1 through 5 illustrate the close match between Trace 14 and all-traces exceedance
42 curves for annual Powell outflows. For comparison purposes, we also show: (1) Trace 14
43 exceedance curve for Long-Term Strategy C1, where Trace 14 ranked third instead of first in the
44 distribution match (this represents the worst-case match for Trace 14); and (2) the Trace 19, 13,
45 and 16 exceedance curves for the No Action Alternative (Alternative A) to illustrate the
46 difference in fit between the top and middle-ranked traces (rankings for Alternative A are:
47 Trace 19 = 2nd; Trace 13 = 3rd; and Trace 16 = 11th).

1
2

TABLE 2 Number of HFEs and Amount of Water Spilled during HFEs in Trace 14 and the All-Trace Average

| Alternative/ Long-Term Strategy | Characteristic | Trace 14 | 21 Traces Average |
|---------------------------------------|-------------------------------------------|----------|----------------------|
| A (No Action Alternative) | Number of HFEs | 4 | 4 |
| | Amount of water spilled during HFEs (kaf) | 262 | 346 |
| B1 | Number of HFEs | 6 | 7 |
| | Amount of water spilled during HFEs (kaf) | 472 | 553 |
| C1 | Number of HFEs | 17 | 19 |
| | Amount of water spilled during HFEs (kaf) | 1,329 | 1,522 |
| E1 | Number of HFEs | 15 | 16 |
| | Amount of water spilled during HFEs (kaf) | 1,236 | 1,211 |
| F | Number of HFEs | 18 | 19 |
| | Amount of water spilled during HFEs (kaf) | 1,734 | 1,853 |
| G | Number of HFEs | 22 | 22 |
| | Amount of water spilled during HFEs (kaf) | 3,188 | 2,591 |

3
4

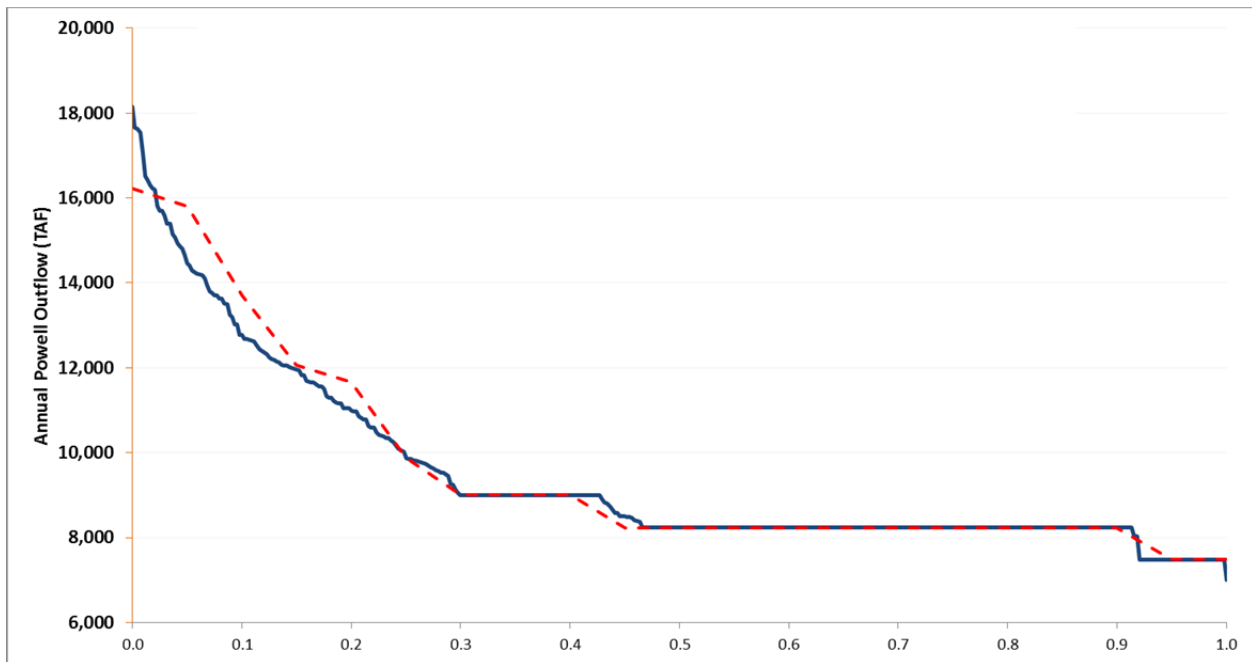

5

FIGURE 1 Exceedance Curve Comparing Outflows of Trace 14 (red dotted line) and the All-Trace Average (blue line) for the No Action Alternative

7

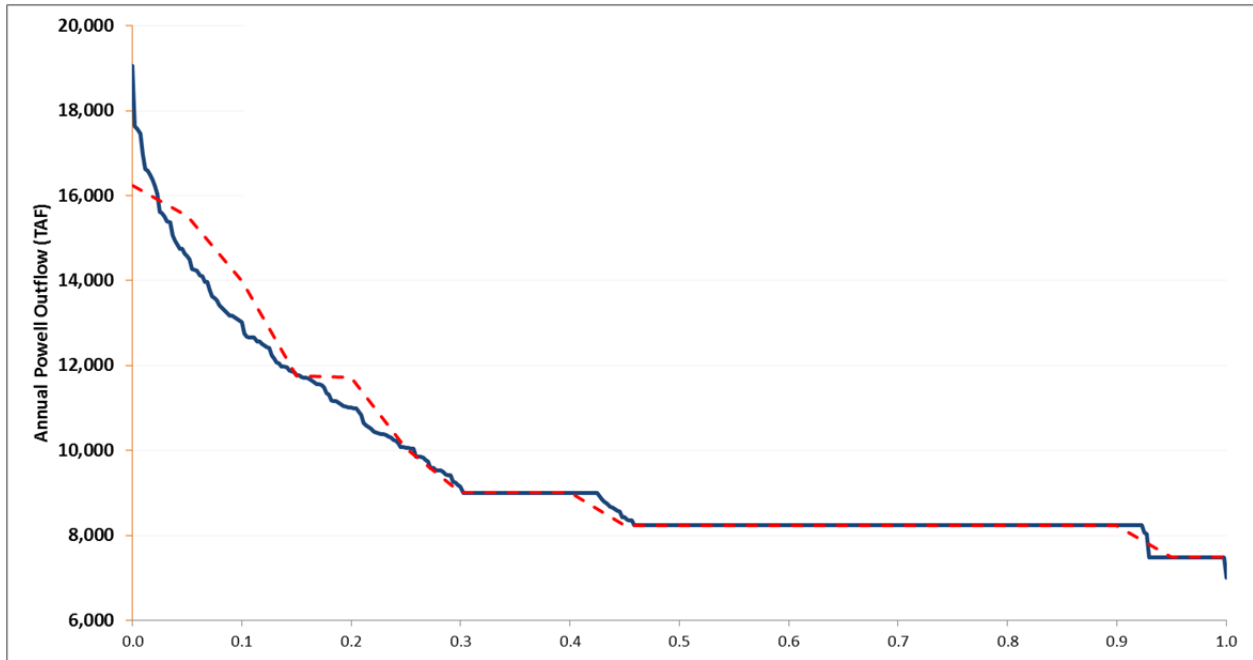

1

2 **FIGURE 2 Exceedance Curve Comparing Outflows of Trace 14 (red dotted line) and the All-**
3 **Traces Average (blue line) for Long-Term Strategy C1**

4

5

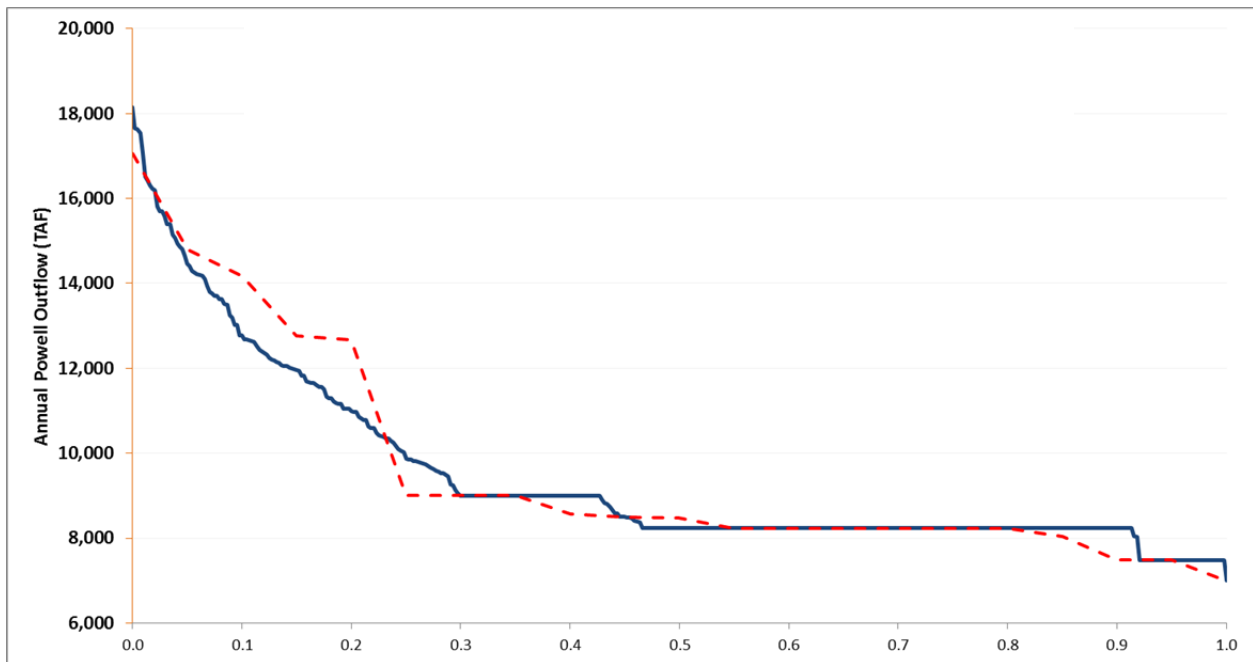

6

7 **FIGURE 3 Exceedance Curve Comparing Outflows of Trace 19 (red dotted line) and the All-**
8 **Traces Average (blue line) for the No Action Alternative**

9

10

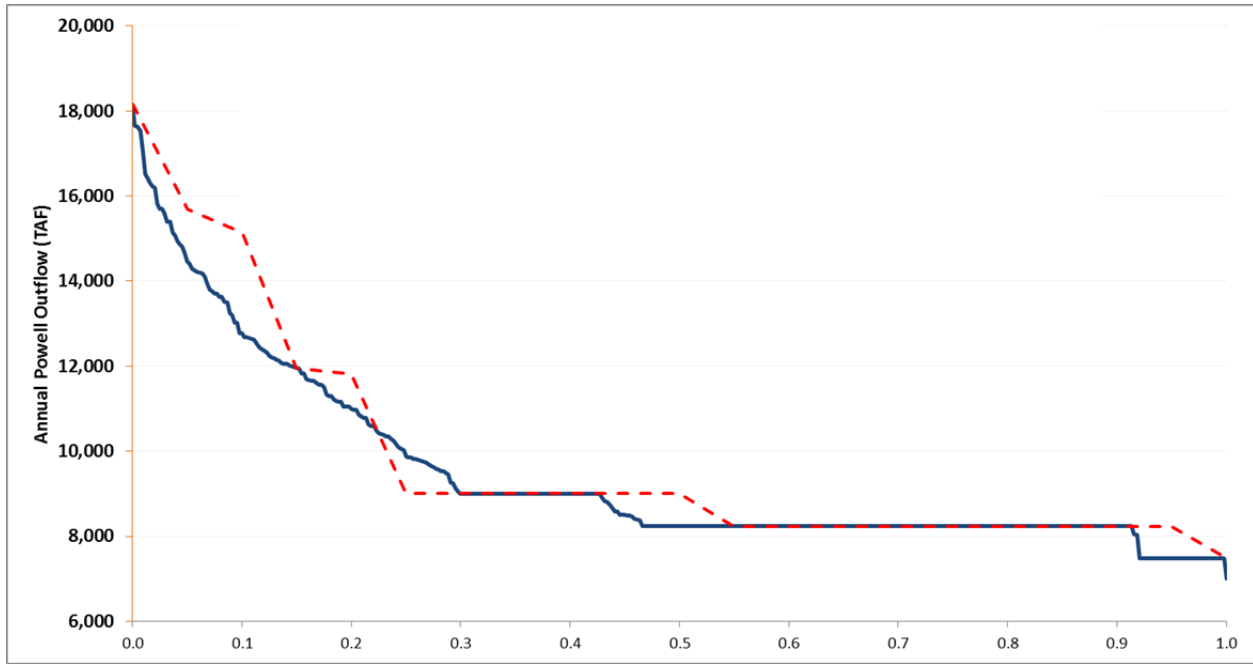

1
2 **FIGURE 4 Exceedance Curve Comparing Outflows of Trace 13 (red dotted line) and the All-**
3 **Traces Average (blue line) for the No Action Alternative**

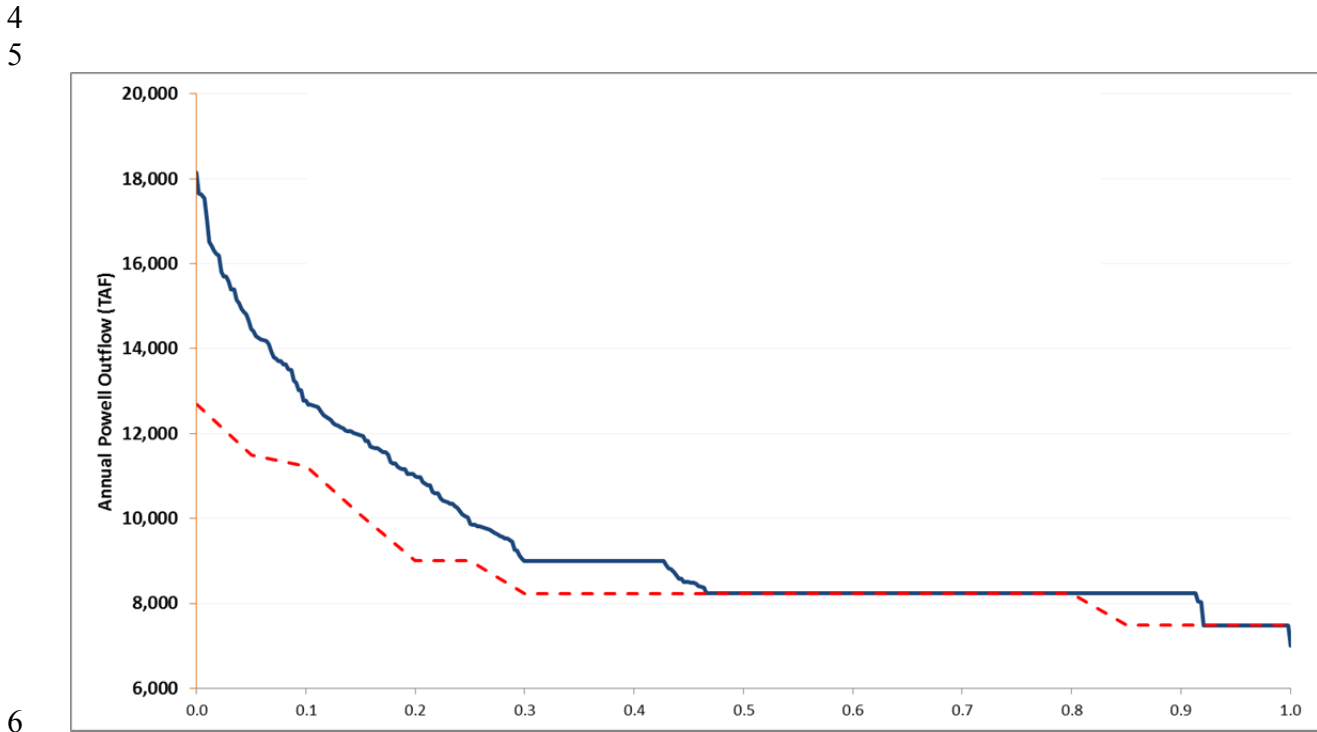

6
7 **FIGURE 5 Exceedance Curve Comparing Outflows of Trace 16 (red dotted line) and the All-**
8 **Traces Average (blue line) for the No Action Alternative**

9
10

Comparison of Monthly Water Releases and Powell Elevations to Averages

Complementing the probability distribution analysis, monthly Powell elevations and water releases for each trace were compared to the associated averages for each month in the 20-year study period for all traces. Again, these comparisons were made separately for each alternative and long-term strategy. The objective in these examinations is to provide “representative variability” over the 20-year spans relative to average outcomes (i.e., the goal is to include conditions that are sometimes “wet,” sometimes “dry,” and sometime “average,” rather than conditions that are uniformly “average” across the entire study period).

Results of monthly outflow and end-of-month elevations for Trace 14 and the all-trace averages are plotted in Figures 6 to 11. Table 3 shows the number of HFEs and the amount of water spilled during all HFEs for Trace 14 and the all-trace average. Trace 14 is characterized by lower-than-average water outflow through 2019, higher water outflow through 2026, followed by lower-than-average water outflow through 2033. As seen from these figures, the monthly Powell elevations and water releases averaged over the 21 traces are significantly less variable than observed for a single trace.

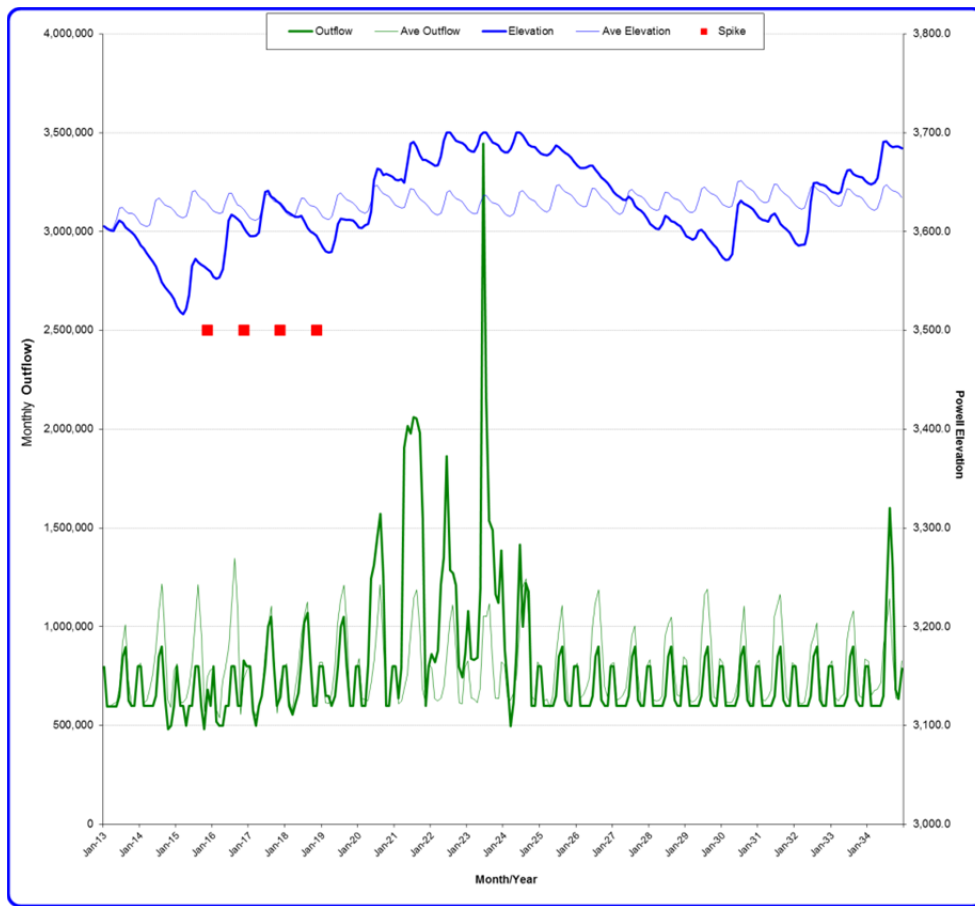
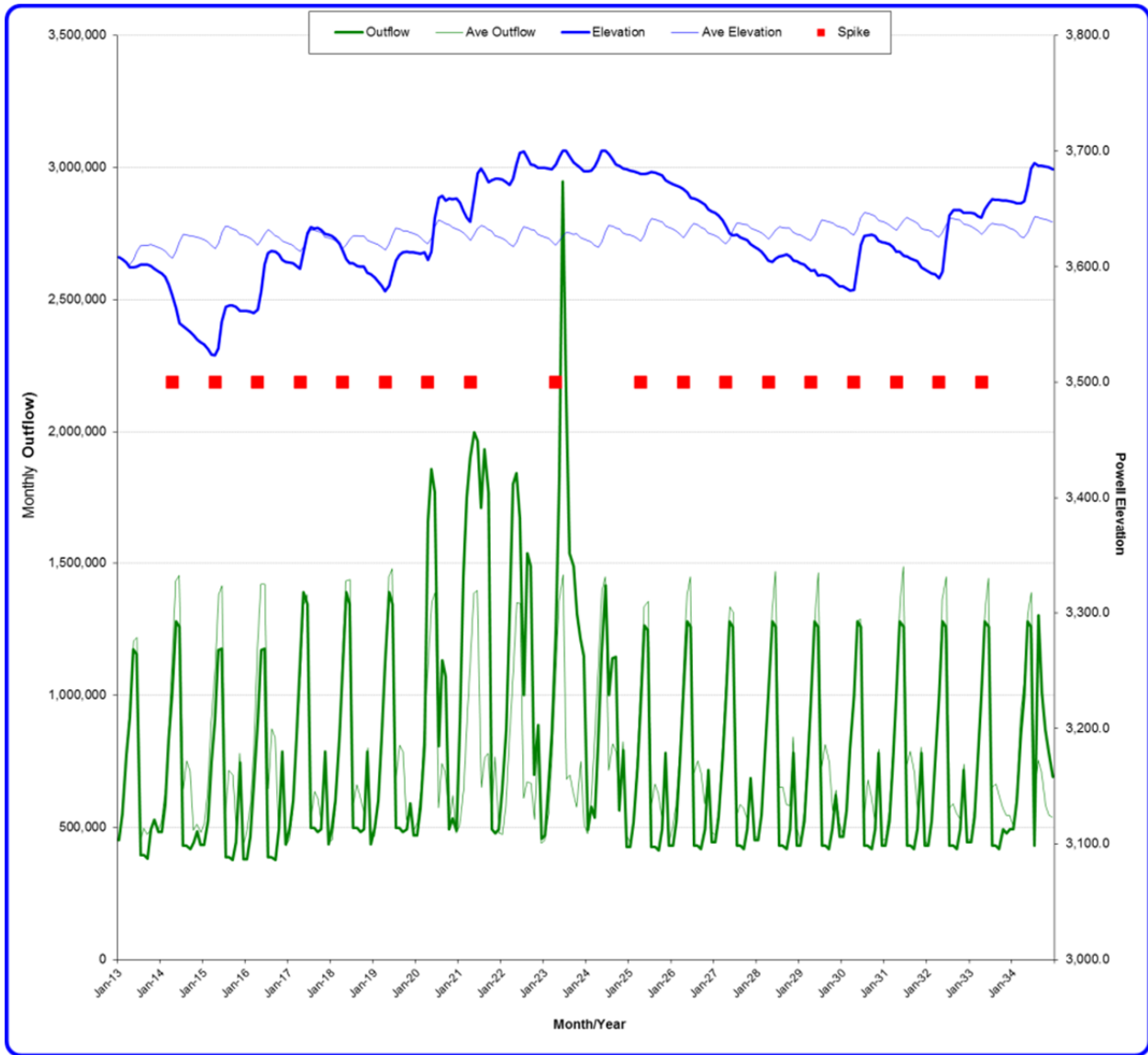
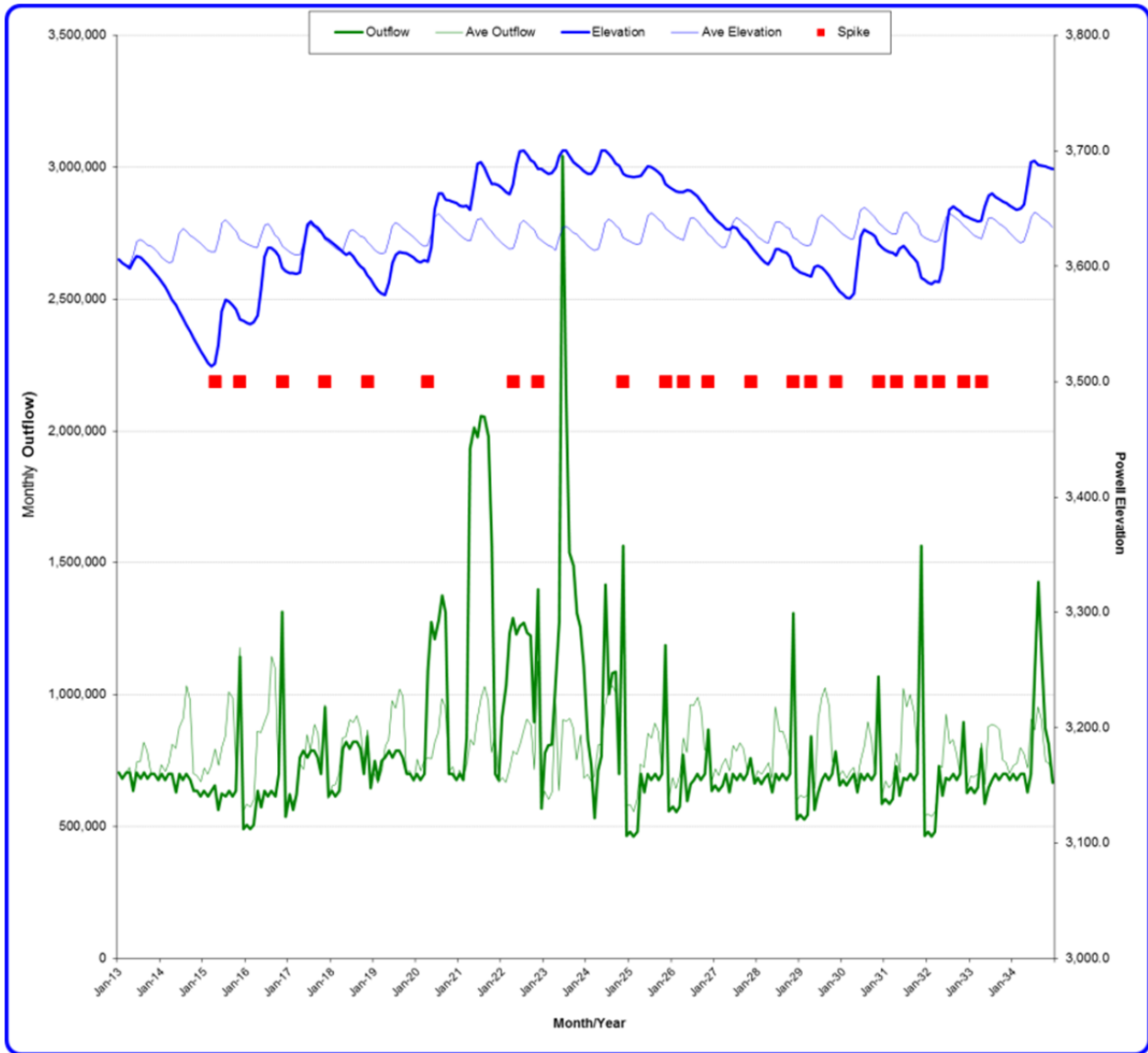

FIGURE 6 Comparison of Monthly Outflow and End-of-Month Elevation of Trace 14 and the All-Trace Average for the No Action Alternative



1
 2
 3
 4
 5

FIGURE 7 Comparison of Monthly Outflow and End-of-Month Elevation of Trace 14 and the All-Trace Average for Alternative F



1
 2
 3
 4
 5

FIGURE 8 Comparison of Monthly Outflow and End-of-Month Elevation of Trace 14 and the All-Trace Average for Alternative G

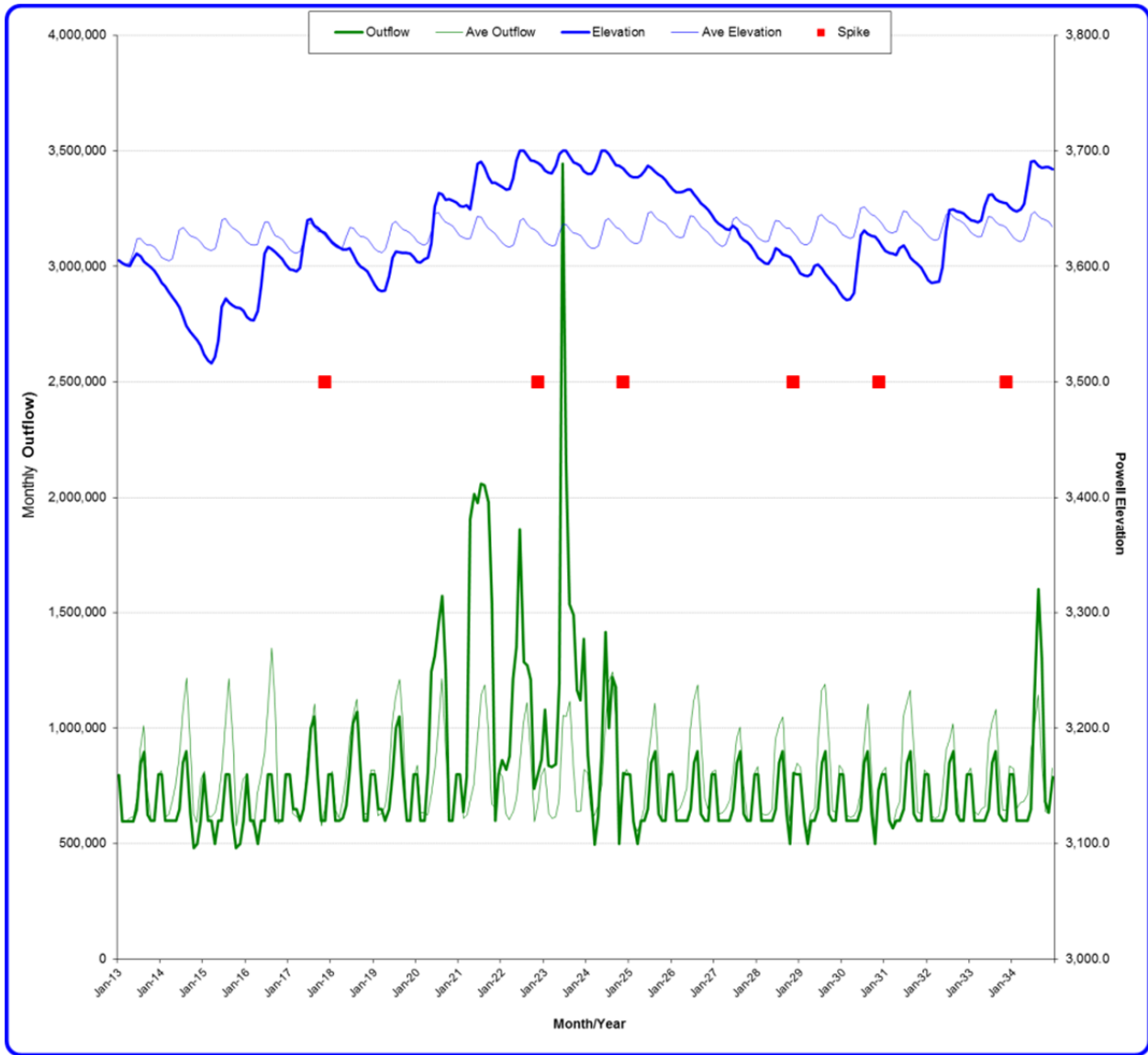

1
 2
 3
 4
 5

FIGURE 9 Comparison of Monthly Outflow and End-of-Month Elevation of Trace 14 and the All-Trace Average for Long-Term Strategy B1



1
2
3
4
5

FIGURE 10 Comparison of Monthly Outflow and End-of-Month Elevation of Trace 14 and the All-Trace Average for Long-Term Strategy C1

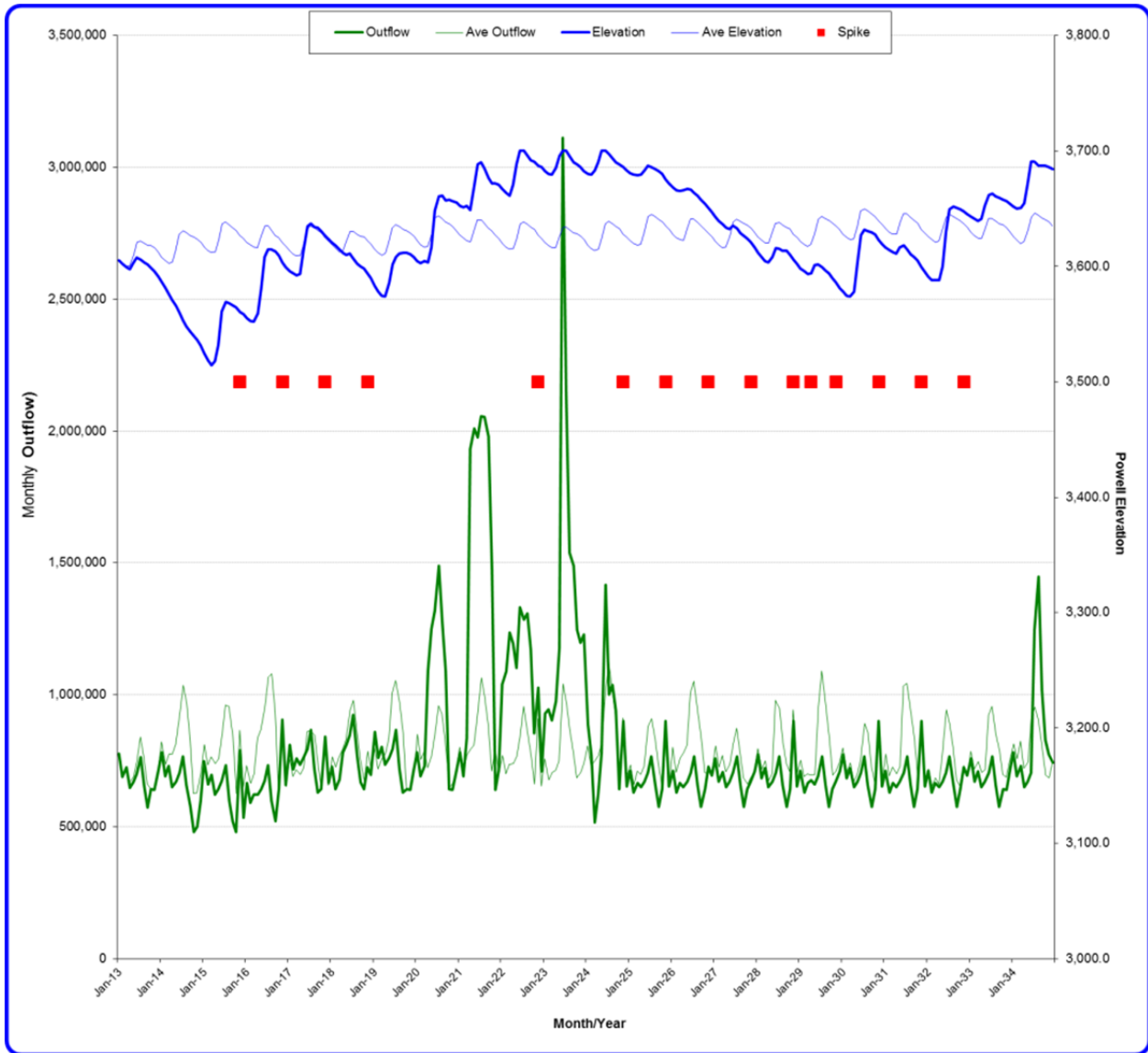

1
 2
 3
 4
 5
 6

FIGURE 11 Comparison of Monthly Outflow and End-of-Month Elevation of Trace 14 and the All-Trace Average for Long-Term Strategy E1

1
2
3

4
5
6
7
8
9
10
11
12
13
14
15
16
17
18
19
20
21
22
23
24
25
26
27
28
29
30
31
32
33
34
35

TABLE 3 Rankings of Hydrology Trace 14 in Matching Average Elevations and Outflows Compared to the 21-Trace Average

| Alternative/ Long-Term Strategy | Powell Elevation Trace 14 Rank | Powell Outflow Trace 14 Rank |
|---------------------------------------|-----------------------------------|---------------------------------|
| A (No Action Alternative) | 11 | 13 |
| B1 | 11 | 13 |
| C1 | 11 | 13 |
| E1 | 10 | 13 |
| F | 12 | 13 |
| G | 10 | 13 |

Because capturing variability is an important objective for this study, an exact match to the 21-trace averages is not desirable. Table 4 illustrates how Trace 14 ranks near the middle of variability for all of the 21 traces; it is neither too close to the average during all years, nor the most extreme divergence from the average over all years.

To assess the 21 traces on a common metric, rankings were calculated based on the least-squares differences by rank relative to the monthly average of all 21 traces: Rank = 1 is the closest match to the average (smallest least-squares difference); Rank = 21 represents the largest difference relative to the average. Table 4 demonstrates that Trace 14 is in the mid-range for both elevation and outflow. The point of this comparison is to illustrate that the selected trace contains neither excessive variability, nor insufficient variability relative to all of the traces under consideration.

Evaluation of Differentials in End-of-Year Powell Elevations and Annual Water Releases

For the representative hydrology trace selection, we also examined how closely each trace’s end-of-year Powell elevations and annual water releases match when compared across all six alternatives and long-term strategies. In theory, these values should match closely, but we found that this is not the case for a majority of the traces. To generate a common metric for trace-specific comparisons, we first calculated the differences in both end-of-year elevation and annual outflow between Alternatives A and F; A and G; A and Long-Term Strategy B1; A and Long-Term Strategy C1; and A and Long-Terms Strategy E1 for each of the 20 years and each hydrology trace (using Alternative A [no action alternative] as a reference point). Since these values should ideally all be zero, we calculated the least-squares differentials and ranked the traces according to the sum of the least-squares differences for the five comparisons listed above. Table 5 shows that for these criteria, Trace 14 ranks near the middle of all traces, indicating that it does not represent an extreme case for deviations in end-of-year elevations or annual water releases. In contrast, Trace 13 exhibits the worst match (21st) in annual outflows and ranks 18th in Powell end-of-year elevations.

1 **TABLE 4 Rankings of Hydrology Traces Compared to All-Trace Average for End-of-Year**
 2 **Elevations and Annual Water Releases**

| Rank (1 = least differential) | Powell Elevation | | Powell Outflow | |
|-------------------------------------|-----------------------|---------------------|-----------------------|---------------------|
| | Trace Number | Square Differential | Trace Number | Square Differential |
| 1 | Trace 4 | 6.51 | Trace 9 | 0.000 |
| 2 | Trace 9 | 20.05 | Trace 4 | 0.000 |
| 3 | Trace 11 | 26.91 | Trace 11 | 0.000 |
| 4 | Trace 6 | 32.63 | Trace 6 | 0.001 |
| 5 | Trace 0 | 43.05 | Trace 8 | 0.003 |
| 6 | Trace 20 | 47.32 | Trace 12 | 0.006 |
| 7 | Trace 3 | 47.95 | Trace 15 | 0.006 |
| 8 | Trace 1 | 54.64 | Trace 14 ^a | 0.007 |
| 9 | Trace 2 | 59.81 | Trace 0 | 0.008 |
| 10 | Trace 7 | 64.72 | Trace 20 | 0.010 |
| 11 | Trace 12 | 127.00 | Trace 2 | 0.015 |
| 12 | Trace 15 | 192.56 | Trace 1 | 0.015 |
| 13 | Trace 14 ^a | 235.30 | Trace 3 | 0.016 |
| 14 | Trace 17 | 326.53 | Trace 17 | 0.018 |
| 15 | Trace 19 | 354.81 | Trace 7 | 0.019 |
| 16 | Trace 16 | 458.47 | Trace 5 | 0.029 |
| 17 | Trace 8 | 583.18 | Trace 19 | 0.060 |
| 18 | Trace 13 ^a | 838.12 | Trace 10 | 0.071 |
| 19 | Trace 5 | 914.47 | Trace 18 | 0.086 |
| 20 | Trace 18 | 1085.39 | Trace 16 | 0.099 |
| 21 | Trace 10 | 2363.07 | Trace 13 ^a | 0.112 |

^a Traces 13 and 14 are highlighted to illustrate their relative rank with respect to end-of-year elevations and annual water releases.

3
 4
 5
 6
 7
 8
 9

Examining this same issue through graphical depictions, Figures 12 and 13 compare the differentials for Traces 14 and 13 side by side, in year-by-year plots of the pairwise end-of-year differentials. Trace 14 is preferred over Trace 13 because of the more consistent end-of-year Powell elevations and annual water releases across the six alternatives and long-term strategies.

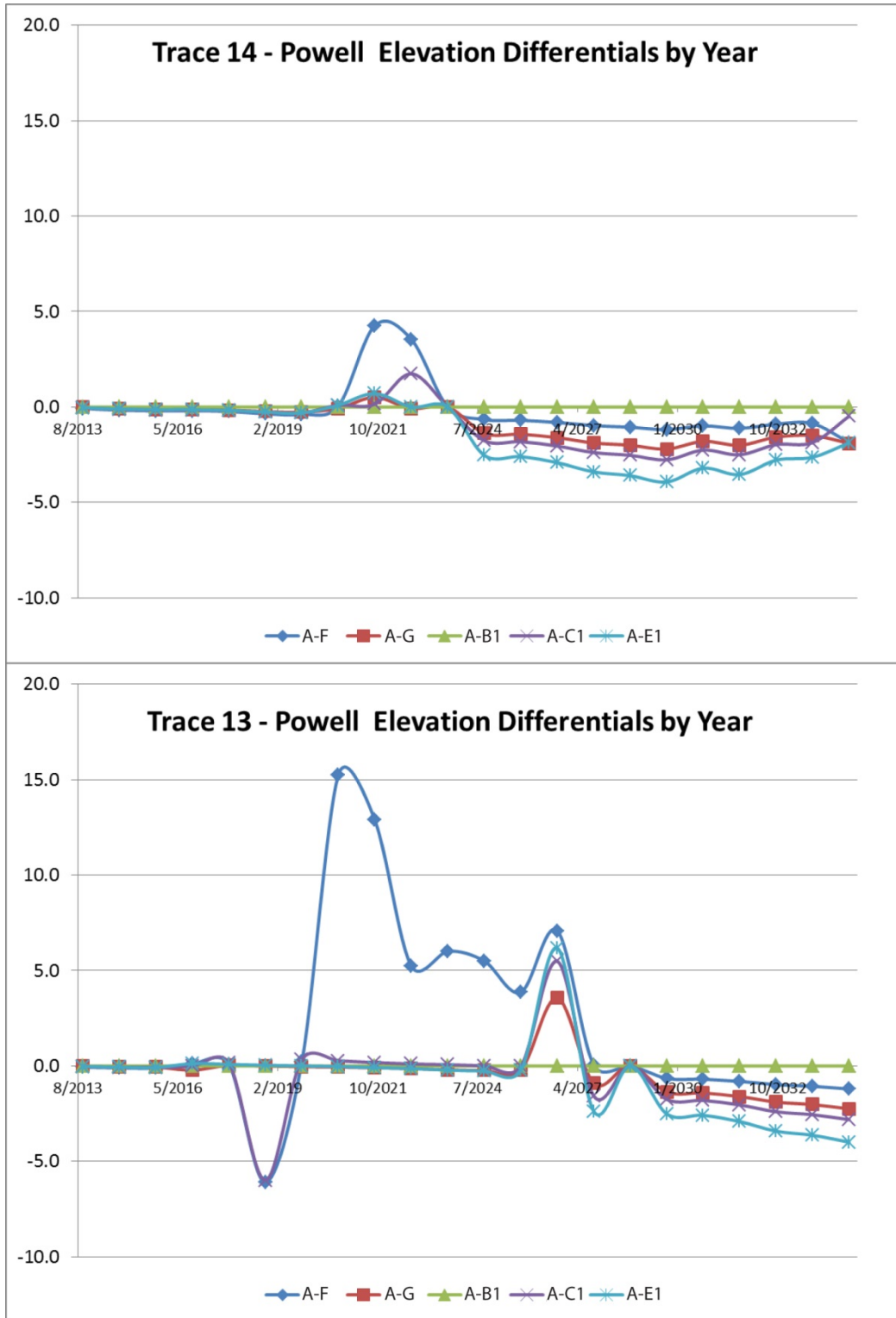

k1071513

1
2
3
4

FIGURE 12 Pairwise Annual Lake Powell Elevation Differentials for Traces 14 and 13 (Alternative A is the reference case)

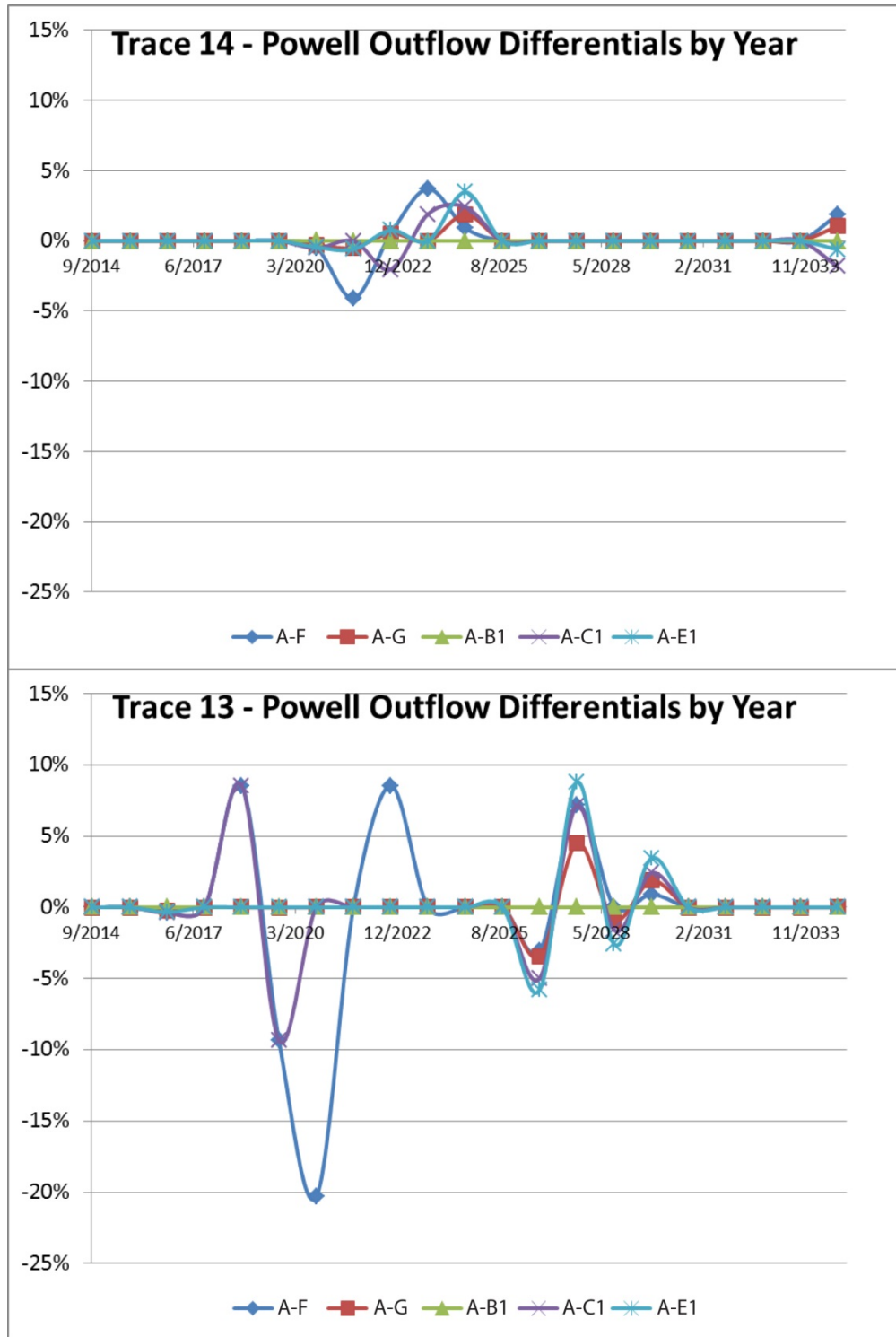

K1071514

1
2
3
4

FIGURE 13 Pairwise Annual Lake Powell Outflow Differentials for Traces 14 and 13 (Alternative A is the reference case)

Evaluation of HFE Spills

As a final comparison, Figure 14 shows quantities of water spilled during the HFEs for Trace 14 (highlighted as enlarged red diamond) compared to other traces for each of the six alternatives. These comparisons show that Trace 14 exhibits outcomes that span the range of possible rankings relative to other traces. That is, Trace 14 exhibits HFE spill volumes that are low, medium, and high, for various alternatives, in comparison with other traces. These observations make Trace 14 a favorable candidate for representative spill characteristics across all alternatives.

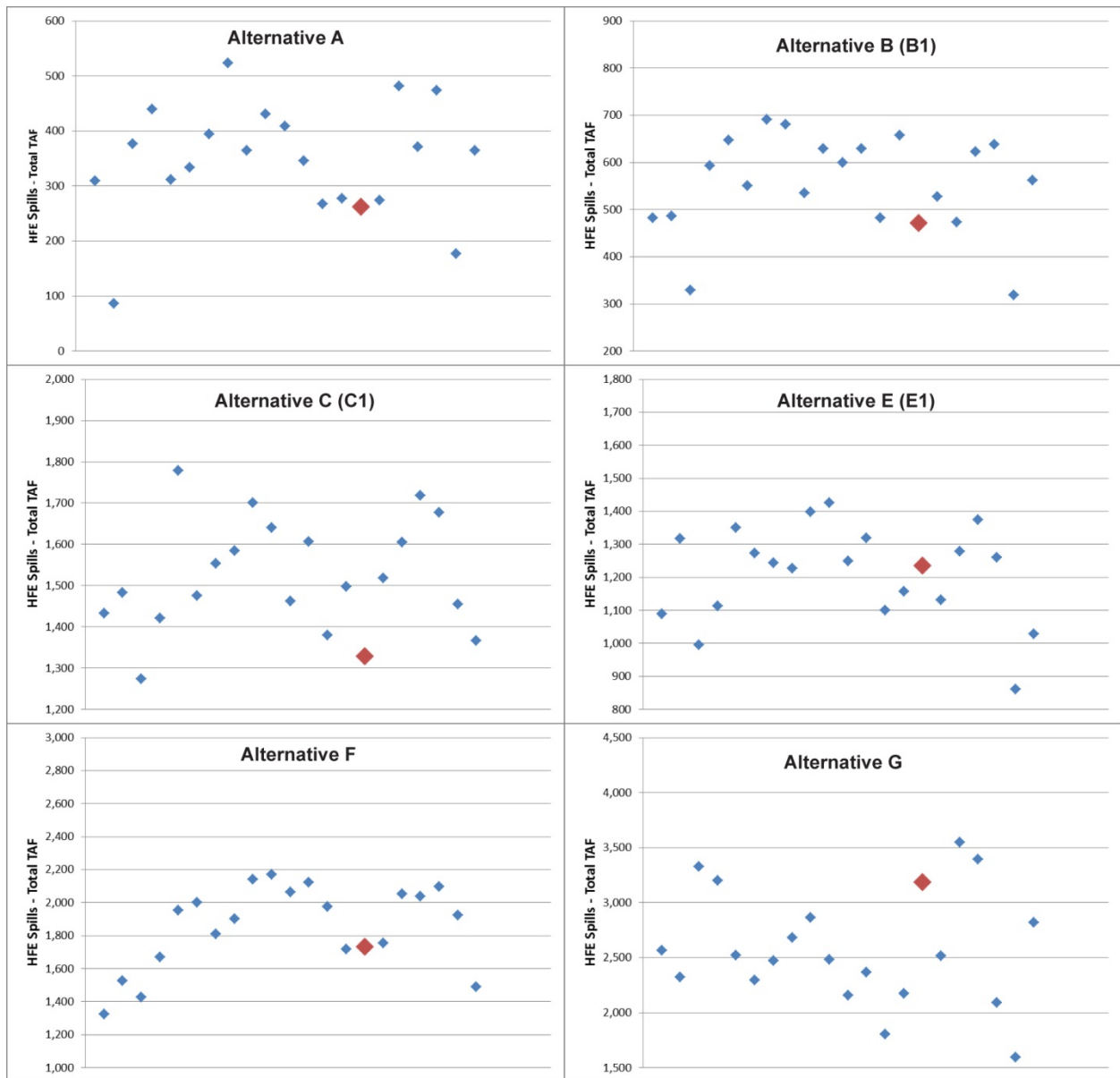

kl071515

FIGURE 14 Quantity of Water Spilled during HFEs across All Hydrology Traces and All Six Alternatives

1 **Summary**
2

3 The observations and comparisons described above were used to select hydrology Trace
4 14 as the representative trace. Characteristics such as annual water release distributions, monthly
5 water release variability, spill events, and end-of-year elevation/volume consistency were
6 considered and a majority of these factors favor Trace 14. While a few other traces show
7 comparable strengths in certain comparison categories, each of those candidate traces show less
8 favorable rankings in other categories.
9

10 The power systems analysis will focus on Trace 14 for all six LTEMP alternatives. At
11 some point in the study, sensitivity tests may be conducted to approximate the potential range of
12 variation that might be expected to occur if other traces were used in the capacity expansion and
13 unit dispatch simulations.
14

1 specific procedures. These ongoing efforts will lead to production of a consolidated document,
 2 the *Principles, Requirements and Guidelines* (PR&Gs). Finalization of this effort is slated for
 3 calendar year 2016.
 4

5 Two procedural points are relevant to this analysis. First, the forthcoming PR&Gs do not
 6 alter the statutory requirement of federal water resource agencies to employ the federal plan
 7 formulation and evaluation rate in their water resource analyses. Second, this environmental
 8 impact study was initiated well-prior to completion of these new guidelines, and the PR&Gs are
 9 not applicable to the analysis reported here.
 10

11 As prescribed by law and described in the P&Gs, federal water resource agencies must
 12 use an administratively determined discount rate for cost-benefit analysis. This rate is known as
 13 the federal discount rate for plan formulation and evaluation. The plan formulation and
 14 evaluation rate is calculated annually by the Secretary of the Treasury pursuant to 42 U.S.C.
 15 1962d-1 (see the *Code of Federal Regulations* [CFR] at 18 CFR Part 704 for a description of the
 16 methodology) and then is officially transmitted to the water resource agencies. The plan
 17 formulation and evaluation rate for fiscal year (FY) 2015 is 3.375% (Reclamation 2014a,b).
 18

19 TABLE 1 summarizes the inflation, escalation, and discounting procedures used in this
 20 analysis. As illustrated, the base year chosen for this economic analysis is 2015. The period of
 21 analysis is 21 calendar-years, spanning the period 2013 to 2033. All economic value estimates
 22 reported in this document are measured in 2015 dollars, unless otherwise stated.
 23

24 The prices and values employed as input data for the economic modeling were reported at
 25 various times. To create a common input baseline, these prices and values were inflated from the
 26 year in which they were reported to 2014 dollars, using the annual Western Regional Consumer
 27 Price Index (CPI) (Bureau of Labor Statistics 2015).
 28
 29
 30

TABLE 1 Discounting Procedures

| Parameter | Value |
|-------------------------------------------|----------|
| Base year for reported results | 2015 |
| Period of analysis 2013 through 2033 | 21 years |
| Price escalation rate (2014 through 2015) | 2.2126% |
| Price escalation rate (2015 through 2033) | 0.0% |
| Discount rate ^a | 3.375% |

^a Federal Water Resource plan formulation and evaluation rate for FY 2015.

31
 32
 33

1 Modeling output was inflated from 2014 to 2015 dollars for reporting purposes. The
2 equivalent annual CPI rate during the most recent 10-year (2004 to 2014) period was calculated
3 to be 2.2126 percent (rounded to 4 decimal places). Price inflation from 2014 to 2015 was
4 assumed to be the same as it was during this 10-year period. All 2014 values and prices were
5 escalated from 2014 to the base year of 2015 using an escalation rate of 2.2126 percent.
6

7 To summarize, consistent with applicable federal law, the procedures described in the
8 *Economic and Environmental Principles and Guidelines for Water and Related Land Resources*
9 *Implementation Studies* (U.S. Water Resources Council 1983), all costs and benefits that occur
10 after 2015 are reported in constant 2015 dollars (they are not escalated). Costs and benefits that
11 occur in 2015 are not discounted, given that 2015 is the base year for this analysis. All costs and
12 benefits that occur after 2015 are discounted back to the 2015 base year using the FY 2015
13 federal discount rate for plan formulation and evaluation (3.375%).
14

15 16 **References**

17
18 Bureau of Labor Statistics, 2015, “Consumer Price Index Overview Table—West.” Available at
19 http://www.bls.gov/xg_shells/ro9xg01.htm. Accessed Feb. 4, 2015.
20

21 Burgess, D., and R.O. Zerbe, Jr., 2011, “Appropriate Discounting for Benefit-Cost Analysis”
22 *Journal of Benefit-Cost Analysis* 2(2):1–20.
23

24 Council on Environmental Quality, 2014, *Principles, Requirements and Guidelines for Federal*
25 *Investments in Water and Land Related Resources Implementation Studies*, Executive Office of
26 the President, Washington, D.C., updated December 2014. Available at
27 <http://www.whitehouse.gov/administration/eop/ceq/initiatives/PandG>. Accessed Feb. 6, 2015.
28

29 EPA (Environmental Protection Agency), 2010, *Guidelines for Preparing Economic Analyses*,
30 EPA 240-R-10-001, Office of the Administrator, Washington, D.C., Dec.
31

32 Field, B.C., 2008, *Natural Resource Economics—An Introduction*, 2nd Edition, Waveland Press,
33 Inc., Long Grove, Ill.
34

35 Reclamation (Bureau of Reclamation), 2014a, “Change in Discount Rate for Water Resources
36 Planning,” *Federal Register* Vol. 79 No. 248, Dec. 29, p. 78108.
37

38 Reclamation, 2014b, “Subject: Interest Rates for Fiscal Year 2015,” Control No. 84-55000,
39 memorandum from R. Gonzales, Director of Policy and Administration, Nov. 25.
40

41 Tietenberg, T., and L. Lewis, 2009, *Environmental and Natural Resource Economics*, 8th
42 Edition, Pearson, Addison-Wesley Inc., Boston, Mass.
43

44 U.S. Water Resources Council, 1983, *Economic and Environmental Principles and Guidelines*
45 *for Water and Related Land Resources Implementation Studies*, U.S. Government Printing
46 Office, Washington, D.C.

ATTACHMENT K.5:

**FORCED OUTAGE SCENARIO GENERATION FOR HYDROELECTRIC
POWER FACILITIES**

The following is a description of the methodology used in creating a forced outage scenario for hydroelectric power facilities.

Requirement

1. Generate a reasonable forced outage scenario consistent with industry average for hydro units.
2. The forced outages should be multiple of 24 hours.
3. The forced outage always starts at the beginning of a day.

Inputs

1. Planned maintenance schedule for the hydroelectric power facility being modeled (from Reclamation)
2. Cause code statistics from the North American Electric Reliability Corporation (NERC)
3. Forced outage rate distribution from NERC

NERC publishes generating availability data system (GADS; <http://www.nerc.com/page.php?cid=4|43|47>). These reports contain aggregate statistics for various unit types. The cause code group statistics provides the number of forced outages and the number of hours under forced outage per unit per year. Tables 1 and 2 contain the relevant data extracted from GADS 2010.

Methodology

1. For each year and for each unit, randomly assign a forced outage rate (FOR) based on the distributions in Table 2.
2. Compute the forced outage hours based on the assigned FOR and service hours. Service hours are the number of hours the unit is not on planned maintenance schedule (i.e., available for generation).
3. Sum forced outage hours across all the units for a given year (TOTSYS)

1 **TABLE 1 Cause Code Statistics for Hydro Plants >30 MW 2006–2010**

| Unit Type | Index | Cause Code | Description | Avg. No. of Outages per Unit Year | Avg. Hours Out per Unit Year |
|-----------|-------|------------|---------------------------------|-----------------------------------|------------------------------|
| 9 | 1 | 3600-3689 | Electrical | 0.31 | 25.28 |
| 9 | 2 | 3810-3899 | AuxiliarySystems | 0.06 | 2.71 |
| 9 | 3 | 3950-3999 | Miscellaneous(BalanceOfPlant) | 0.04 | 0.39 |
| 9 | 4 | 4500-4590 | GENERATOR | 0.17 | 45.18 |
| 9 | 5 | 4600-4609 | Exciter | 0.16 | 10.75 |
| 9 | 6 | 4610-4650 | CoolingSystem | 0.04 | 3.03 |
| 9 | 7 | 4700-4750 | Controls | 0.19 | 4.28 |
| 9 | 8 | 4800-4899 | Miscellaneous(Generator) | 0.1 | 9.92 |
| 9 | 9 | 7000-7099 | Turbine | 0.36 | 42.05 |
| 9 | 10 | 7100-7199 | WaterSupplyDischarge | 0.29 | 25.83 |
| 9 | 11 | 7200-7299 | Miscellaneous(HydroTurbinePump) | 0.23 | 11.25 |
| 9 | 12 | 9000-9040 | Catastrophe | 0.06 | 1.57 |
| 9 | 13 | 9135-9160 | Economic | 0.01 | 9.24 |
| 9 | 14 | 9300-9320 | Miscellaneous(External) | 0.26 | 1.4 |
| 9 | 15 | 9504-9590 | Regulatory | 0.01 | 0.01 |
| 9 | 16 | 9676-9696 | OtherOperatingEnvironmentalLim | 0.01 | 0.15 |
| 9 | 17 | 9700-9720 | Safety | 0 | 0 |
| 9 | 18 | 9900-9920 | PERSONNELERRORS | 0.05 | 0.22 |
| 9 | 19 | 9999-9999 | PERFORMANCE | 0.01 | 0.27 |

2
3
4
5

TABLE 2 Equivalent Forced Outage Rate Distribution

| Unit Type | Index | FOR (Max) | Exceedance Curve |
|-----------|-------|-----------|------------------|
| 9 | 1 | 0 | 0.069 |
| 9 | 2 | 0.01 | 0.5727 |
| 9 | 3 | 0.02 | 0.7063 |
| 9 | 4 | 0.05 | 0.8238 |
| 9 | 5 | 0.1 | 0.8987 |
| 9 | 6 | 0.2 | 0.9383 |
| 9 | 7 | 0.3 | 0.9574 |
| 9 | 8 | 0.4 | 0.9721 |
| 9 | 9 | 0.5 | 0.9838 |
| 9 | 10 | 0.6 | 0.9883 |
| 9 | 11 | 0.7 | 0.9927 |
| 9 | 12 | 0.8 | 0.9956 |
| 9 | 13 | 0.9 | 0.9971 |
| 9 | 14 | 1 | 1 |

6

- 1 4. Using cause code statistics, calculate average outage length in hours for each
2 cause code (column 6 divide by column 5 in Table 1).
3
- 4 5. Compute the total forced outage hours for each cause code across all units
5 (column 6 * no. of units) and also the total forced outage hours across all units
6 and all cause codes (TOTFOH).
7
- 8 6. Total outage hours based on cause codes are typically much lower than the
9 hours out for units since cause codes outages are based on actual data and
10 reflect only those hours that the unit is in service or called into service.
11 Compute a "SCALE" as the ratio of TOTFH and TOTSYS.
12
- 13 7. Compute the total number of outages for each cause code across units using
14 the "SCALE", column 5 from Table 1 and the total number of units.
15
- 16 8. For each cause code, loop through the number of outages. Randomly select a
17 unit and a random start time that the unit is not on planned maintenance.
18 Assign the forced outage for the duration of average outage length for the
19 given cause code (from step 4 above).
20
- 21 9. Adjust the length of forced outage to be a multiple of 24 hours and move to
22 the beginning of the day, if necessary.
23
24

ATTACHMENT K.6:

**FORECAST OF MONTHLY PEAK LOADS AND ENERGY BY SLCA/IP
LONG-TERM FIRM CUSTOMER**

The development of hourly load projections over the study period is based on the 2006 representative nominal load profile and monthly projections of utility-level peak and total loads. Implementation of this method differs from utility to utility depending upon data availability. The primary source of forecast information was the utility's integrated resource plan (IRP). If these data are not available in the IRP, then generation and capacity projections from the Energy Information Administration's (EIA's) 2014 Annual Energy Outlook (EIA 2014) are used instead. The method for developing the hourly load forecast for each of the eight utilities plus Western's remaining small customers is described in more detail in Section K.1.6.3 of Appendix K.

Figures 1 and 2 show monthly peak loads and total monthly load projections, respectively, for each of the eight large customers and the two aggregate small customer groups. This data was used to generate the graphs shown in Figures K.1-15 and K.1-16 in Section K.1.6.3 of Appendix K.

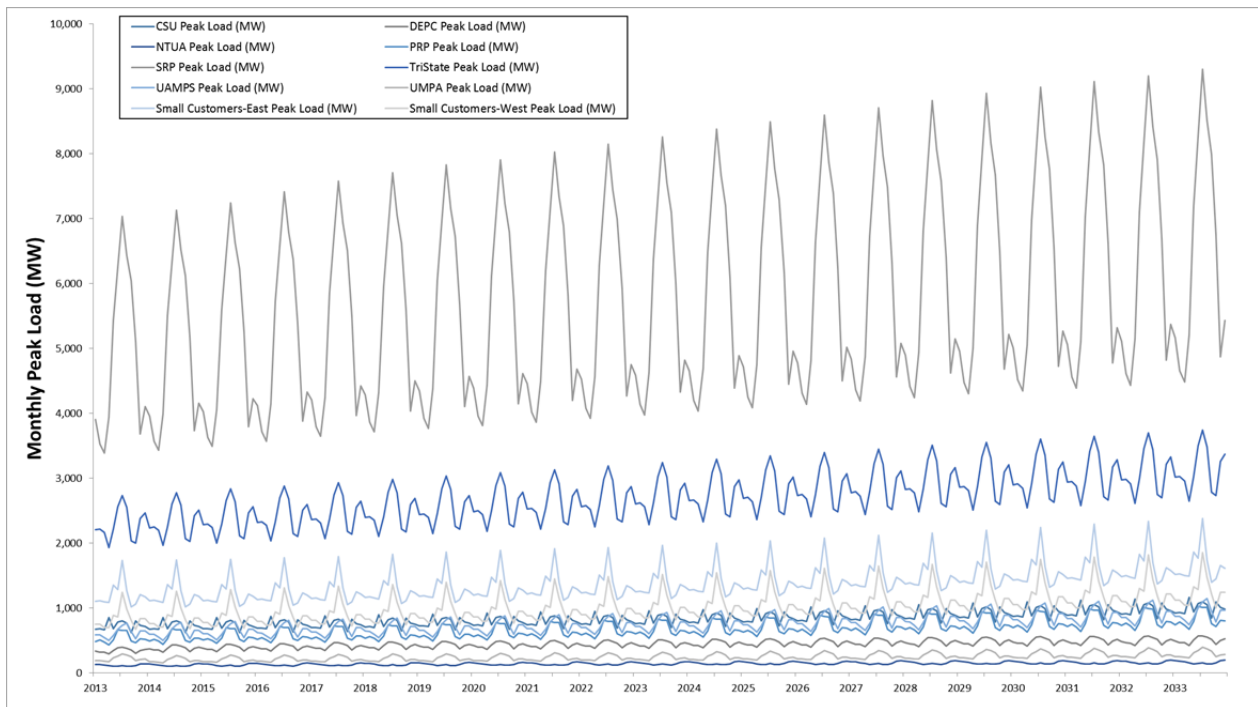
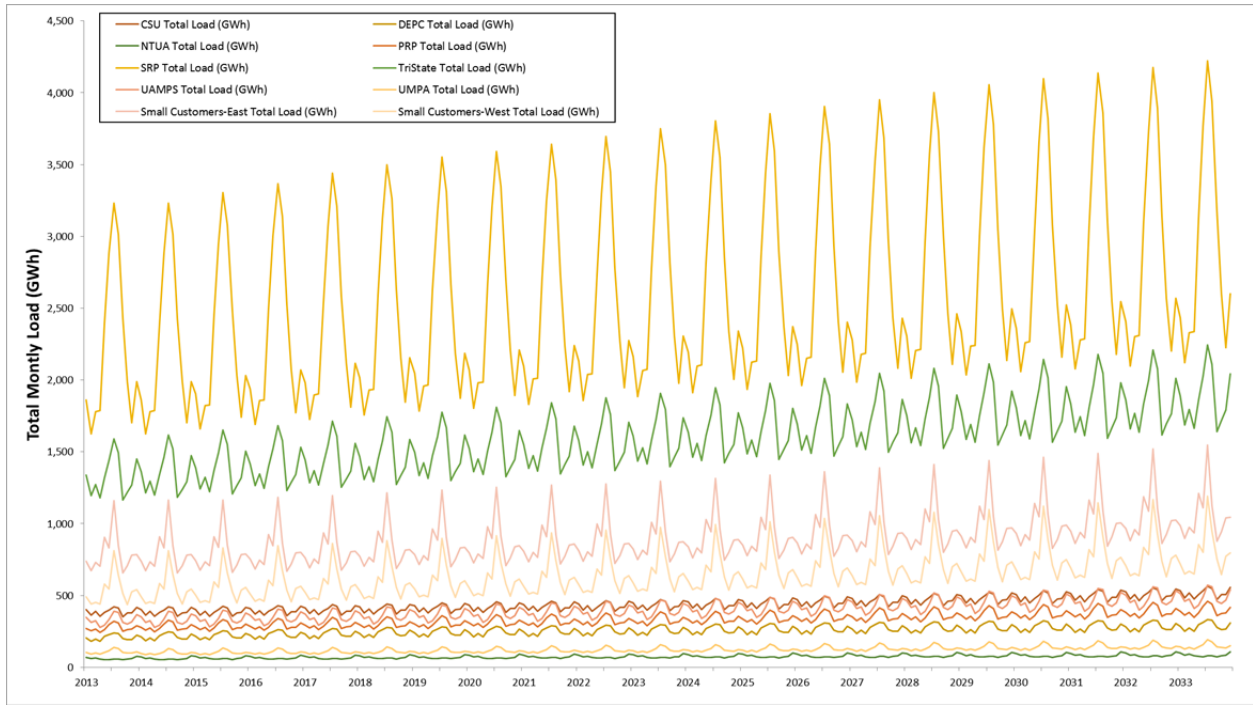

FIGURE 1 Projected Future Peak Loads by Each Large Customer and Small Customer Groups in the SLCA/IP Market System during the LTEMP Period



1
2 **FIGURE 2 Projected Future Monthly Loads by Each Large Customer and Small Customer**
3 **Groups in the SLCA/IP Market System during the LTEMP Period**
4
5

6 **Reference**

7
8 EIA (U.S. Energy Information Administration), 2014, *Assumptions to the Annual Energy*
9 *Outlook 2014*, Washington D.C., June. Available at [http://www.eia.gov/forecasts/aeo/](http://www.eia.gov/forecasts/aeo/assumptions/pdf/0554(2014).pdf)
10 [assumptions/pdf/0554\(2014\).pdf](http://www.eia.gov/forecasts/aeo/assumptions/pdf/0554(2014).pdf). Accessed March 2, 2015.
11

ATTACHMENT K.7:

ANALYSIS OF THE TIMING OF THE PEAK LOAD

In the recent past, Western’s coincidental peak load has occurred in the summer, but it does not consistently occur in a specific month. A study was performed to determine the month in which the peak occurred in recent history.

Hourly load data was obtained for 2006 to 2012 from Federal Energy Regulatory Commission (FERC) Form 714 for Western’s 8 largest customers; namely, SRP, Tri-State, CSU, Platte River, NTUA, UAMPS, UMPA, and Deseret. These customers account for 75% of Western’s energy and capacity, so the aggregate load of these customers would determine when Western’s peak occurs.

Table 1 shows the peak load in each month of the year from 2006 to 2012. Data was not available for NTUA and Deseret from 2010 to 2012, so those utilities were not included in those years. However, Figure 1 shows that NTUA and Deseret only account for 1% and 3% of the peak load from 2006 to 2009, respectively, so not having their data in the last 3 years of the study would not alter the occurrence of the coincidental peak.

The peak load occurs in July in 3 of the 7 years and in August in 4 of the 7 years (as indicated by the shaded areas in Table 1). Therefore, the peak occurs in either July or August with nearly equal frequency. For the LTEMP DEIS analysis, August was chosen as the peak month.

TABLE 1 Aggregate Monthly Peak Load of Western’s Eight Large Customers for 2006 to 2012^a

| Month | 2006 | 2007 | 2008 | 2009 | 2010 | 2011 | 2012 |
|-------|--------|--------|--------|--------|--------|--------|--------|
| 1 | 7,470 | 8,089 | 8,411 | 7,983 | 7,426 | 7,836 | 7,160 |
| 2 | 6,974 | 7,619 | 8,293 | 7,611 | 7,434 | 8,626 | 6,740 |
| 3 | 6,781 | 7,204 | 7,308 | 6,983 | 7,091 | 6,964 | 6,514 |
| 4 | 6,852 | 7,878 | 7,934 | 7,760 | 7,029 | 7,214 | 7,959 |
| 5 | 9,053 | 9,116 | 9,969 | 9,820 | 8,328 | 7,884 | 9,234 |
| 6 | 10,419 | 10,624 | 10,744 | 10,549 | 10,625 | 10,624 | 11,009 |
| 7 | 11,336 | 11,670 | 11,188 | 11,416 | 11,049 | 11,069 | 10,722 |
| 8 | 10,691 | 11,639 | 11,656 | 11,461 | 10,495 | 11,301 | 11,604 |
| 9 | 9,361 | 10,403 | 9,382 | 10,232 | 9,884 | 10,840 | 9,738 |
| 10 | 8,143 | 8,374 | 8,738 | 7,947 | 8,956 | 8,191 | 8,295 |
| 11 | 7,596 | 7,377 | 7,535 | 7,478 | 7,788 | 6,665 | 6,803 |
| 12 | 7,888 | 8,102 | 8,326 | 8,480 | 8,247 | 7,623 | 7,452 |
| Total | 11,336 | 11,670 | 11,656 | 11,461 | 11,049 | 11,301 | 11,604 |

^a Missing NTUA and Deseret. Maximum values are highlighted in yellow.

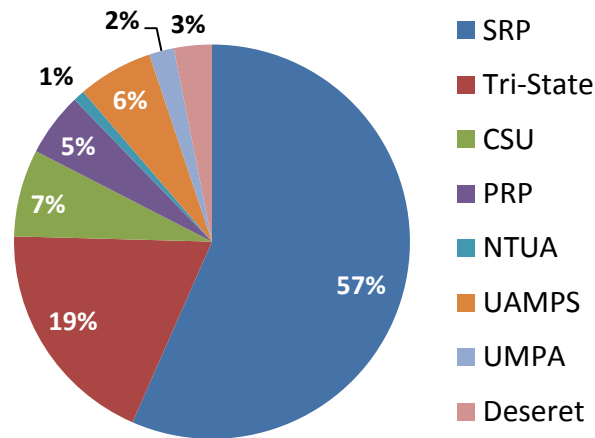

FIGURE 1 Breakdown of Non-coincident Peak by Customer

Figures 2 through 9 show monthly peak loads for the eight large SLCA/IP LTF power customers. All customers except the NTUA peak in the summer months of either July or August. However, in one year, CSU reported an abnormally high peak load in April.

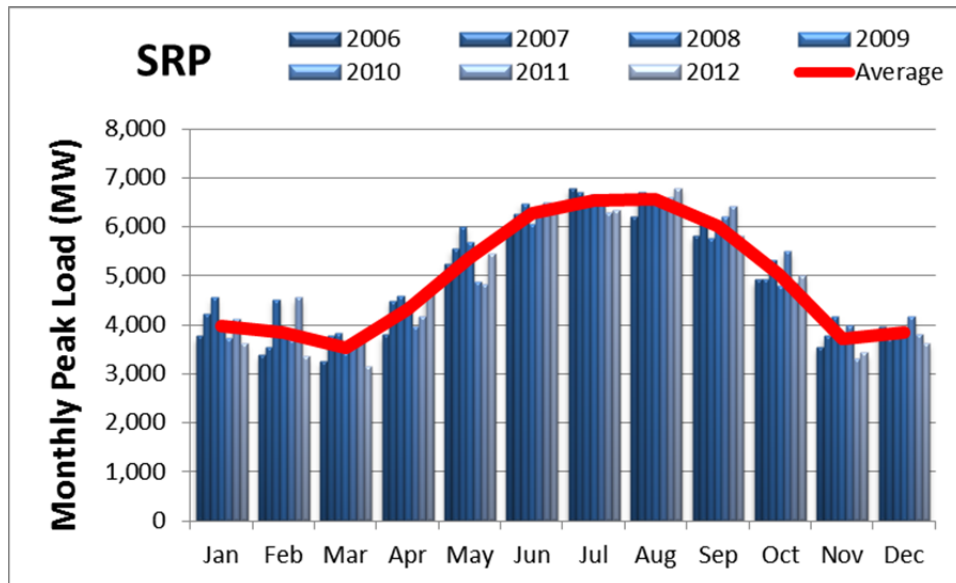
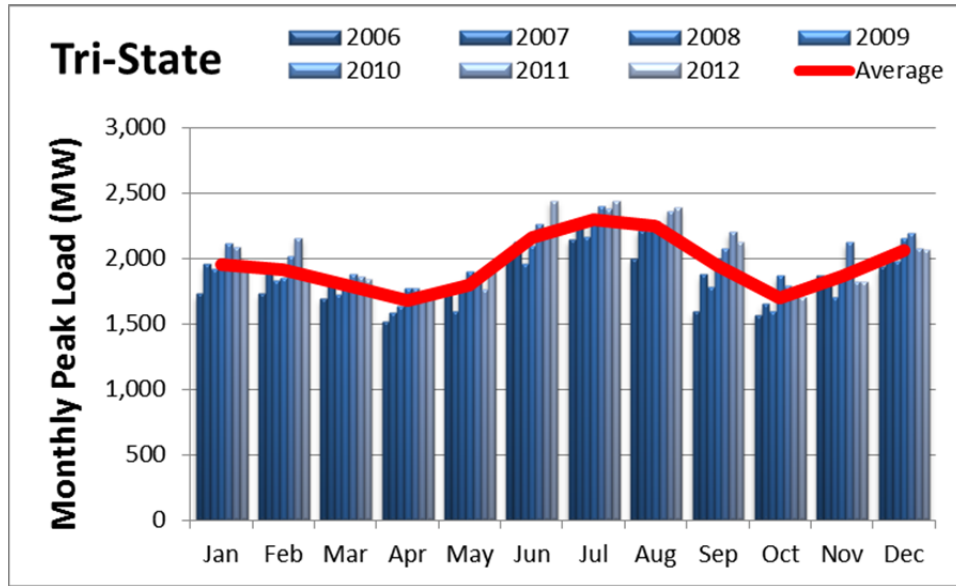

FIGURE 2 SRP Historical Monthly Peak Load



1

FIGURE 3 Tri-State Historical Monthly Peak Loads

2

3

4

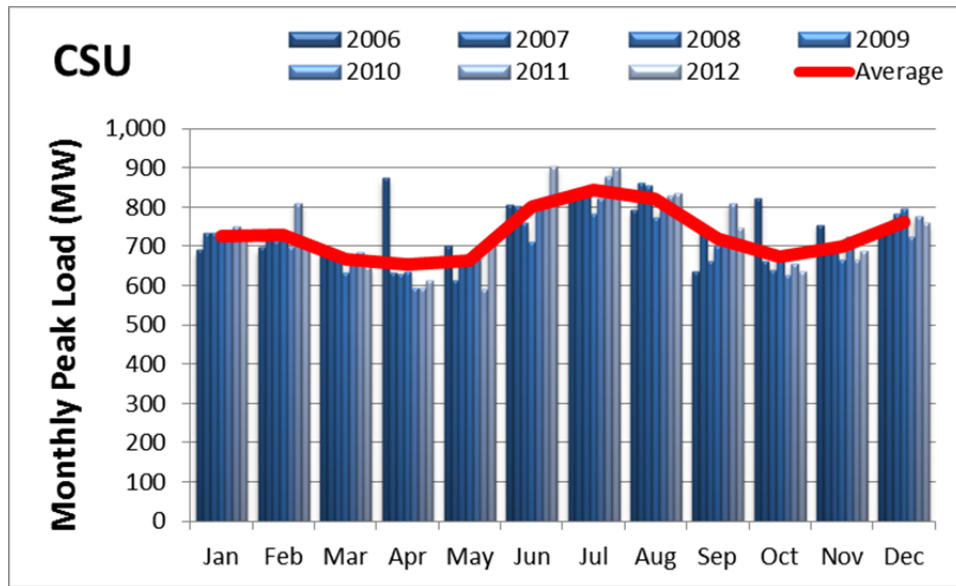

5

FIGURE 4 CSU Historical Monthly Peak Loads

6

7

8

9

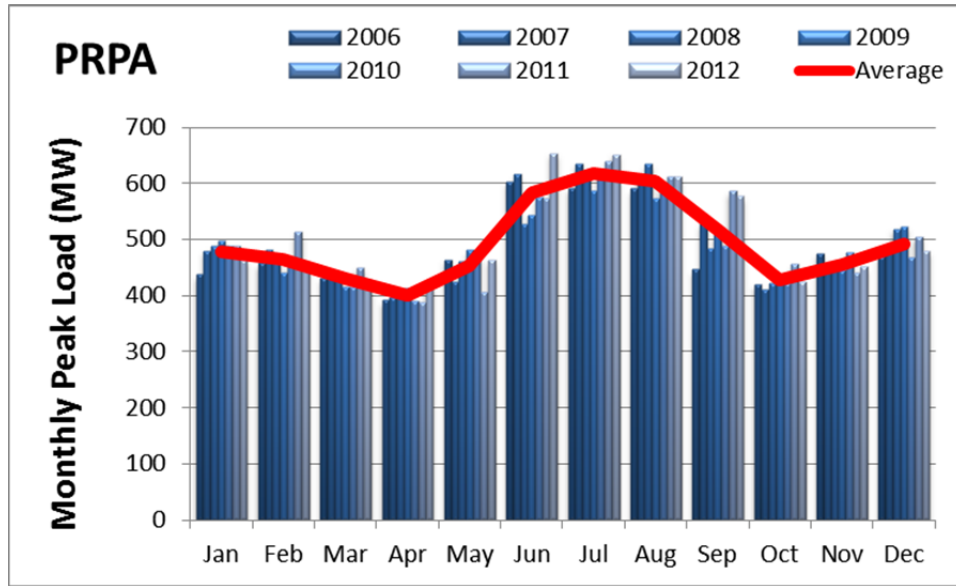

1

FIGURE 5 PRPA Historical Monthly Peak Loads

2

3

4

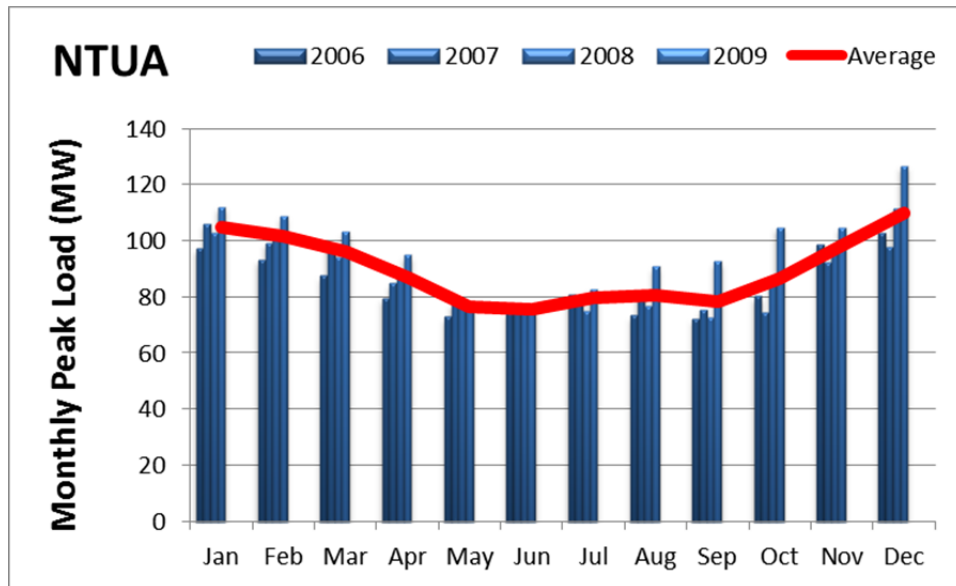

5

FIGURE 6 NTUA Historical Monthly Peak Loads

6

7

8

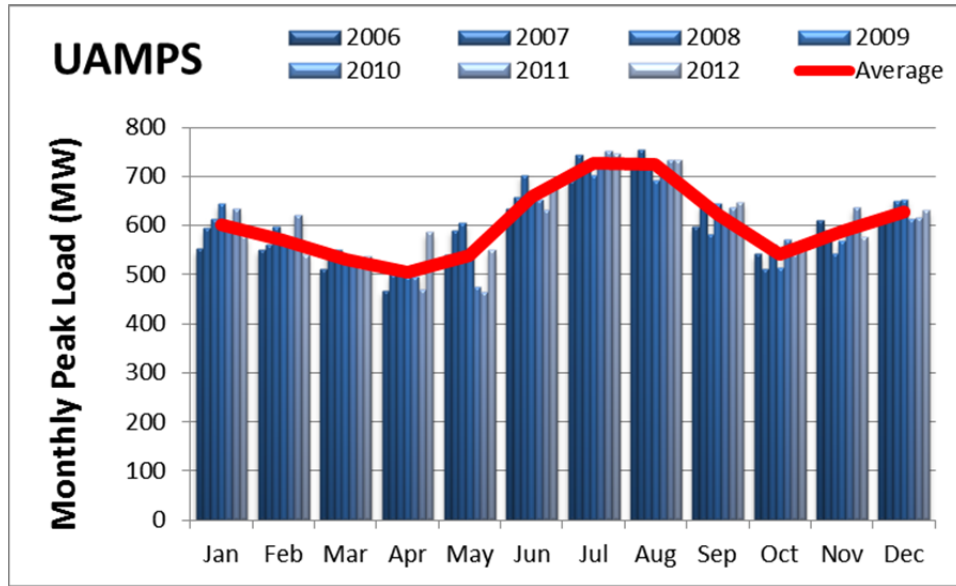

1
2
3
4

FIGURE 7 UAMPS Historical Monthly Peak Loads

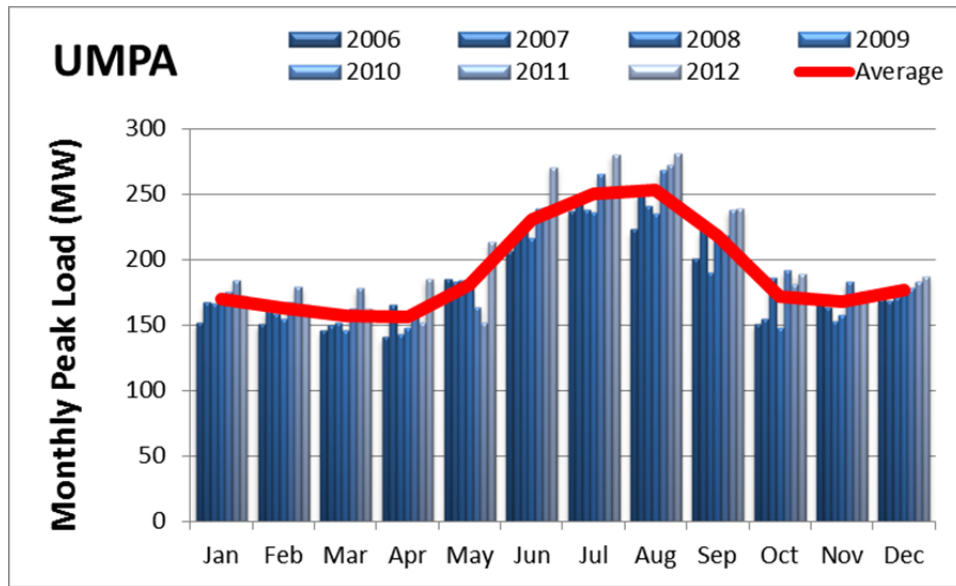

5
6
7
8

FIGURE 8 UMPA Historical Monthly Peak Loads

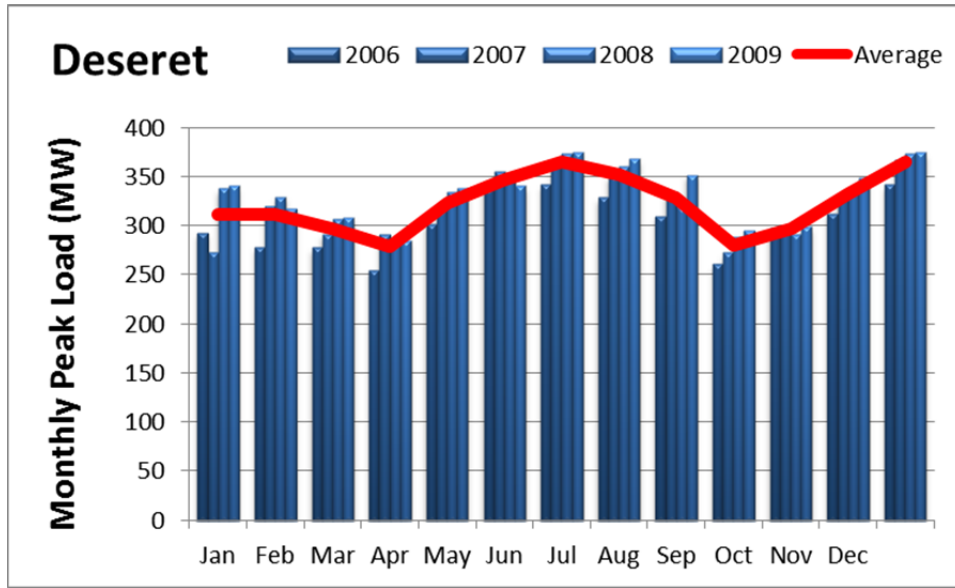

1

2

3

FIGURE 9 Deseret Historical Monthly Peak Loads

ATTACHMENT K.8:

**ANALYSIS OF CAPACITY DETERMINATIONS—
COMPARING RESULTS USING A RANGE OF EXCEEDENCE LEVELS
AND TWO SUMMER PEAK MONTHS**

Marketable capacity is very sensitive to the assumed exceedance level and the timing of the annual peak load. This attachment will describe that sensitivity. In the Western Interconnection (WI) annual peak loads almost always occur in either July or August; in fact, the study described in Attachment K-7 shows the peak occurs in either July or August with nearly equal frequency.

The graphs on the left side of Figure 1 show the marketable capacity for the six major alternatives and long-term strategies at exceedance levels from 10% to 99% for the three hydropower resource components combined. Marketable capacity was also shown for three different times when the peak load was assumed to occur, namely, July, August, and July/August combined. All alternatives have less marketable capacity at all exceedance levels than the no action alternative, except for Long-Term Strategy B1, which is expected because it has the least restrictive environmental constraints of any alternative.

The graphs on the right of Figure 1 show the difference in marketable capacity compared to Alternative A, which is the the no action alternative. The graphs show that the greatest difference in capacity occurs at the 50% exceedance level and the smallest at the 99% exceedance level.

There is also a noticeable difference in marketable capacity for some alternatives compared to the no action alternative depending upon the month chosen. Long-Term Strategies C1 and E1 have a much smaller difference in marketable capacity compared to Alternative A in July than in August at all exceedance levels.

The choice of the peak month and exceedence level used for Glen Canyon Dam capacity availability is a policy choice by Western and is related to the degree of risk Western chooses to take when marketing long-term capacity. There have been variations in level of risk chosen by Western when marketing long-term capacity from various projects. For the Long-Term Experimental and Management Plan (LTEMP) Draft Environmental Impact Statement (DEIS), an exceedance level of 90% and a peak month of August were selected. The exceedance level was chosen based on a retrospective study performed by Argonne on marketable capacity offered by the CRSP Management Center of Western. Over the last 10 years they marketed capacity at a 90% exceedance level. Results were presented in Section K.1.10.4 for exceedance levels of 50% and 99%; this range may bracket the risk preference level that the CRSP Management Center may choose to use when determining future LTF capacity commitment levels.

1
2
3
4
5
6
7
8

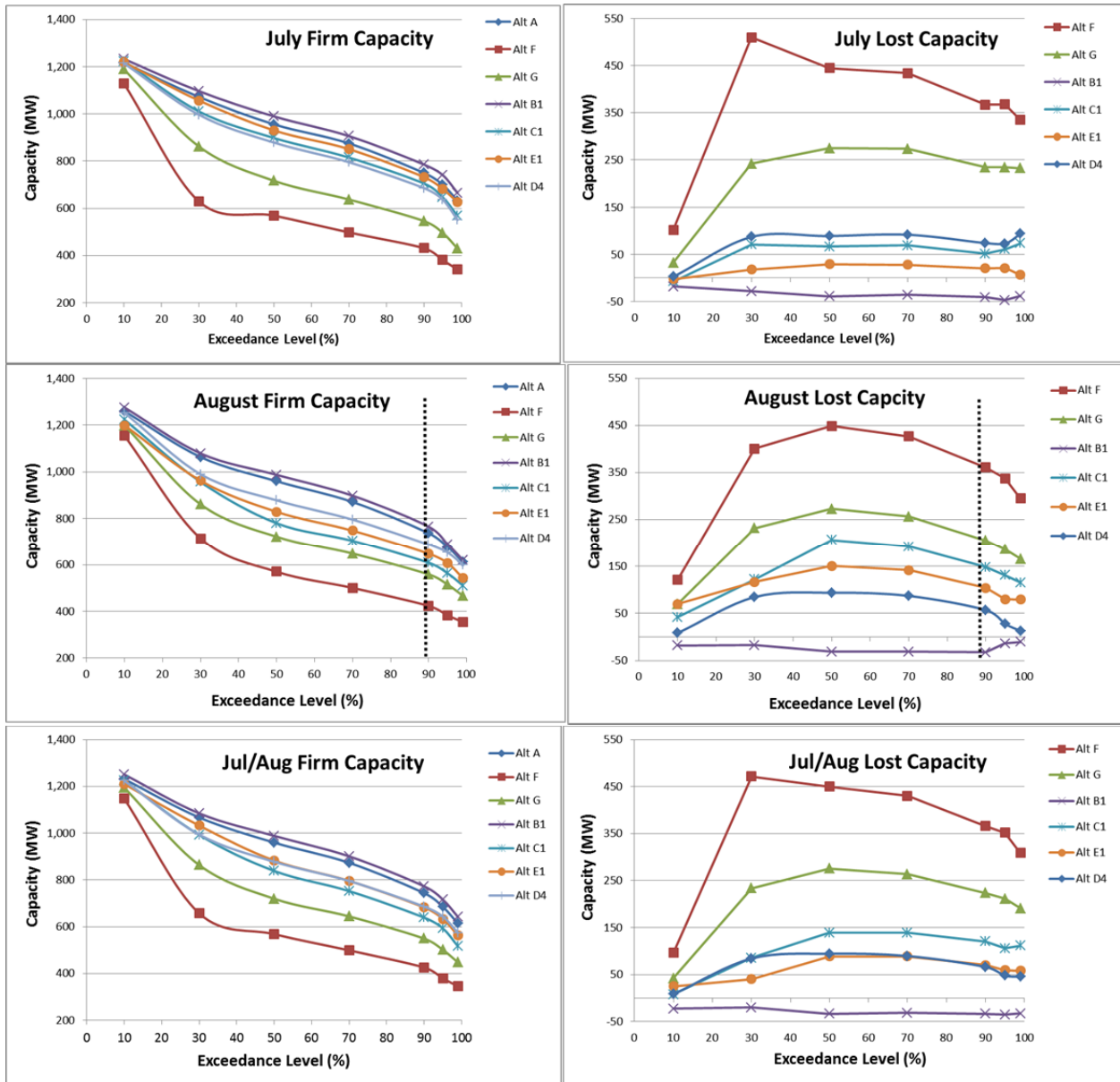

FIGURE 1 Comparison of SLCA/IP Federal Hydropower Firm and Lost Capacity Determinations across Alternatives, Exceedance Levels, and Summer Peak Months

ATTACHMENT K.9:

**RESULTS OF A SURVEY OF ELECTRIC UTILITY INTEGRATED
RESOURCE PLANS**

An integrated resource plan (IRP) is a comprehensive decision support tool and roadmap for meeting an electric utility’s objective of providing reliable and least-cost electric service to all of its customers. It is typically developed with considerable involvement from state agencies and regulators, customer and industry advocacy groups, project managers, and other stakeholders. Key elements of an IRP include determining the need for resources over a specific planning period, such as the next 10 to 20 years; the preferred portfolio of supply-side and demand-side resources to meet this need; and an action plan identifying the steps to implement the plan, such as the timing of bringing new resources online.

A survey of IRPs of Western’s large customers that own generating facilities and large investor-owned utilities (IOUs) in the geographic and “electrical” area was conducted to determine the timing and type of resources these utilities were planning to reliably meet future electric demand. The results of this IRP survey could be compared to the results of the AURORA expansion model to see how well the AURORA prediction matched against the utility’s best estimate. Western’s customers surveyed included Platte River Power Authority (PRP), Colorado Springs Utilities (CSU), Tri-State Generation and Transmission Association (Tri-State), and Salt River Project (SRP).

Large IOUs surveyed included Public Service of Colorado (PSCO; now part of Xcel Energy), Public Service Company of New Mexico (PNM), Rocky Mountain Power (RMP; the eastern business unit of PacifiCorp or PACE), Arizona Public Service Company (AZPS), Tucson Electric Power Company (TEPC), Nevada Power Company (NEVP; the southern subsidiary of NV Energy), and Sierra Pacific Power Company (SPPC; the northern subsidiary of NV Energy). All IRPs were obtained from company websites and were all published between 2011 and 2014. These IOUs were chosen because they have contracts to supply generation to some of Western’s customers and are also located in the same power pools in the AURORA model as Western’s customers. Figure 1 shows the approximate service territories of these IOUs in the WI.

If the timing and type of new generation predicted by our AURORA expansion model runs are similar to what is planned in the IRPs, then the limited scope in our model is a good surrogate for modeling the larger system.

Figure 2 shows the least-cost baseline expansion plan for PSCO in its most recent IRP, which was published in October 2011. The plan predicts that several combustion turbine will come online between 2018 and 2022 followed by a combined-cycle gas turbine in 2023. Expansion plans from the 2014 PNM IRP shown in Figure 3 forecasts a small 40-MW gas turbine in 2016 followed by a 177-MW gas turbine in 2018. Rocky Mountain Power’s expansion plans from its 2013 IRP are shown in Figure 4. A 645-MW combined-cycle unit was just brought online in 2014 as forecast by the IRP. RMP also plans to bring a combined-cycle combustion turbine and wind turbines online in 2024.

1
2 Figure 5 shows a future capacity addition plan from the APS IRP. The capacity it obtains
3 from long-term contracts is steadily decreasing from over 2,800 MW in 2014 to less than 350
4 MW by 2029. ASP plans to bring over 1,000 MW of natural gas-fired generation online in 2019
5 followed by 2,000 MW more in 2024 and 1,000 MW in 2029. ASP also plans to rely more
6 heavily on customer energy efficiency beginning in 2019. Additional generation from
7 renewables will begin in 2019.

8
9 Figure 6 shows a future capacity addition plan from the TEP IRP. New natural gas
10 generation of over 370 MW is planned for 2015 followed by another 640 MW in 2019. All short-
11 term market resources will be phased out by 2019.

12
13 Figure 7 shows capacity addition plans from the NEVP IRP for four scenarios. To
14 comply with a Nevada law phasing out certain coal-fired generation, a combination of new solar
15 photovoltaic and natural gas-fired generation will be brought online between 2016 and 2021. To
16 satisfy future demand, additional combined-cycle generation of 597 MW is planned to come
17 online as early as 2020 and another 273 MW of capacity in 2022.

18
19 Figure 8 shows capacity addition plans from the SPP IRP for four scenarios. Depending
20 upon the scenario, combustion turbines with a total capacity of from 273 MW to 536 MW are
21 planned as early as 2022 and 2023. By 2025, an addition of over 570 MW of combined-cycle
22 generation is planned followed by over 300 MW of combustion turbine capacity in 2029.

23
24 The IRPs of four of Western's large customers that own generation were also surveyed;
25 namely, PRP, CSU, Tri-State, and SRP. The PRP IRP states that new peaking capacity may be
26 needed as early as 2020 because that is when its reserve margin is forecast to drop below 15%.
27 The CSU IRP shows capacity expansion plans for a number of future scenarios. Depending on
28 the scenario, new renewables are expected to begin coming online beginning in 2017 to 2023.
29 New combustion turbines of approximately 40 MW will start coming online from 2029 to 2031.
30 The Tri-State IRP also examines numerous future scenarios. Depending on the scenario, new
31 combined-cycle powerplants with a capacity of 588 MW will start coming online as early as
32 2019 to 2022; new renewable generation in multiples of 50 MW blocks will come online steadily
33 from 2015 to 2029. Finally, SRP expects to bring new natural gas-fired peaking generation
34 online between 2020 and 2022.

35
36 In conclusion, the survey of new capacity additions shown in IRPs for both Western's
37 customers and large IOUs show that new capacity, both thermal and renewable generation, is
38 scheduled to be brought online as early as 2017 to 2018. This means that there is very little
39 excess capacity in the power pools in which Western's customers are located. Therefore, any
40 capacity lost at Glen Canyon due to changes in operations from the Long-Term Experimental
41 and Management Plan alternatives might cause new generation to be brought online earlier than
42 the current IRPs indicate.

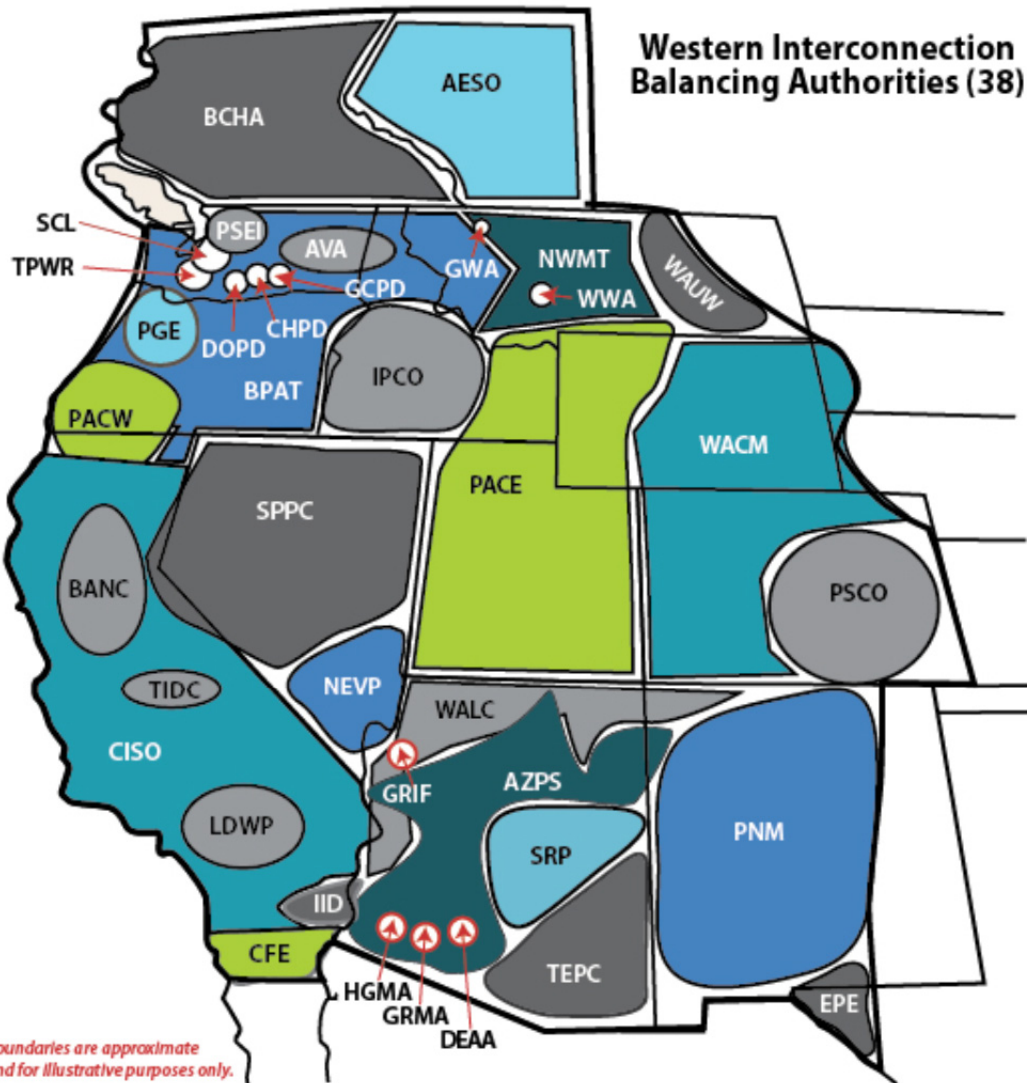

AESO - Alberta Electric System Operator
 AZPS - Arizona Public Service Company
 AVA - Avista Corporation
 BANC - Balancing Authority of Northern California
 BRAT - Bonneville Power Administration - Transmission
 BCHA - British Columbia Hydro Authority
 CISO - California Independent System Operator
 CFE - Comision Federal de Electricidad
 DEAA - Arlington Valley, LLC
 EPE - El Paso Electric Company
 GRMA - Gila River Power, LP
 GRIF - Griffith Energy, LLC
 IPCO - Idaho Power Company

IID - Imperial Irrigation District
 LDWP - Los Angeles Department of Water and Power
 GWA - NaturEner Power Watch, LLC
 NEVP - Nevada Power Company
 HGMA - New Harquahala Generating Company, LLC
 NWMT - NorthWestern Energy
 PACE - PacifiCorp East
 PACW - PacifiCorp West
 PGE - Portland General Electric Company
 PSCO - Public Service Company of Colorado
 PNM - Public Service Company of New Mexico
 CHPD - PUD No. 1 of Chelan County
 DOPD - PUD No. 1 of Douglas County

PSEI - Puget Sound Energy
 SRP - Salt River Project
 SCL - Seattle City Light
 SPPC - Sierra Pacific Power Company
 TPWR - City of Tacoma, Department of Public Utilities
 TEPC - Tucson Electric Power Company
 TIDC - Turlock Irrigation District
 WACM - Western Area Power Administration, Colorado-Missouri Region
 WALC - Western Area Power Administration, Lower Colorado Region
 WAUW - Western Area Power Administration, Upper Great Plains West
 WWA - NaturEner Wind Watch, LLC

11272012:hr

1
 2 **FIGURE 1 Balancing Authorities in the Western Interconnection (Source: WECC website:**
 3 **https://www.wecc.biz/Reliability/VGS_BalancingAuthorityCooperation**
 4 **Concepts_Intra-HourScheduling.pdf)**

| Year | Baseload ¹ | 2x1 ¹ Combined Cycle | 1x1 ¹ Combined Cycle | Combustion Turbine ¹ | Battery | Wind ² | Solar PV ² | Solar Thermal ² |
|------|-----------------------|---------------------------------------|---------------------------------------|------------------------------------|---------|-------------------|-----------------------|-------------------------------|
| 2011 | | | | | | | | |
| 2012 | | | | | | | | |
| 2013 | | | | | | | | |
| 2014 | | | | | | | | |
| 2015 | | | | | | | | |
| 2016 | | | | | | | | |
| 2017 | | | | | | | | |
| 2018 | | | | 346 MW | | | | |
| 2019 | | | | 173 MW | | | | |
| 2020 | | | | 173 MW | | | | |
| 2021 | | | | 173 MW | | | | |
| 2022 | | 643 MW | | 346 MW | | | | |
| 2023 | | | | | | | | |
| 2024 | | | | | | | | |
| 2025 | | | | | | | | |
| 2026 | | | | | | | | |
| 2027 | | 643 MW | | | | | | |
| 2028 | | | | | | | | |
| 2029 | | | | 173 MW | | | | |
| 2030 | | | | | | 200 MW | | |
| 2031 | | | | 173 MW | | | 100 MW | |
| 2032 | | 643 MW | | | | | | |
| 2033 | | | | | | | | |
| 2034 | | 643 MW | | | | | | |
| 2035 | | | | | | | | |
| 2036 | | 643 MW | | | | | | |
| 2037 | | | | | | | | |
| 2038 | | | | | | | | |
| 2039 | | | | | | | | |
| 2040 | | | | | | | | |
| 2041 | | | | | | | | |
| 2042 | 485 MW | 643 MW | | | | | | |
| 2043 | | | | | | 200 MW | 25 MW | |
| 2044 | | | | | | 200 MW | 25 MW | |
| 2045 | | | | | | 100 MW | | |
| 2046 | | | | | | 200 MW | 25 MW | |
| 2047 | | | | | | 100 MW | | |
| 2048 | | | | | | 100 MW | | |
| 2049 | | | | 346 MW | | | | |
| 2050 | | | | | | | | |

(1) Listed as summer accredited capacity rating
 (2) Listed as nameplate capacity

Source: <http://www.xcelenergy.com/staticfiles/xcel/Regulatory/Regulatory%20PDFs/PSCo-ERP-2011/Exhibit-No-KJH-1-Volume-2.pdf>

1

2 **FIGURE 2 Least-Cost Baseline Expansion Plan from PSCO’s Current IRP**

3

4

| Scenario Description | Revised SIP with PV3 78 MW Scenario | Revised SIP with PV3 132 MW Scenario |
|--------------------------------|----------------------------------------------------|---------------------------------------------------|
| Load Forecast | Current | Current |
| Gas Pricing | PACE Reference Case | PACE Reference Case |
| CO2 | PACE Reference Case (\$11 in 2020) | PACE Reference Case (\$11 in 2020) |
| San Juan Investment Recovery | \$16,401,523 | \$16,401,523 |
| SJ Retirements/Unit 4 Addition | Units 2 & 3 (Dec 2017) + 78 MW to SJ4 | Units 2 & 3 (Dec 2017) + 132 MW to SJ4 |
| 2014 | | |
| 2015 | Red Mesa (102 MW) 2015 Solar (23 MW) | Red Mesa (102 MW) 2015 Solar (23 MW) |
| 2016 | Aeroderivative (40 MW) Solar PV Tier 1 (40 MW) | Aeroderivative (40 MW) Solar PV Tier 1 (40 MW) |
| 2017 | San Juan BART | San Juan BART |
| 2018 | Large GT (177 MW) Palo Verde 3 (134 MW) | Large GT (177 MW) Palo Verde 3 (134 MW) |
| 2019 | Solar PV Tier 2 (60 MW) | |
| 2020 | Solar PV Tier 2 (20 MW) Solar PV Tier 3 (20 MW) | Solar PV Tier 2 (20 MW) |
| 2021 | Solar PV Tier 3 (60 MW) | Solar PV Tier 2 (60 MW) |
| 2022 | Solar PV Tier 3 (60 MW) | Solar PV Tier 3 (40 MW) |
| 2023 | Large GT (177 MW) | Solar PV Tier 3 (60 MW) |
| 2024 | | Wind (100 MW) Large GT (177 MW) |
| 2025 | | |
| 2026 | Large GT (177 MW) Wind (100 MW) | |
| 2027 | | 2nd Aeroderivative (40 MW) |
| 2028 | | Large GT (177 MW) |
| 2029 | | |
| 2030 | Reciprocating Engines (93 MW) | |
| 2031 | 2nd Aeroderivative (40 MW) | Aeroderivative (40 MW) Solar PV Tier 3 (40 MW) |
| 2032 | Aeroderivative (40 MW) | Reciprocating Engines (93 MW) |
| 2033 | Small GT (85 MW) | |

Source: <https://www.pnm.com/documents/396023/396193/PNM+2014+IRP/bdcccdd52-b0bc-480b-b1d6-cf76c408fdcf>

1
2
3
4

FIGURE 3 Expansion Plan for PNM in Current IRP

| Preferred Portfolio (EG-2 Case-07a) | | Capacity(MW) | | | | | | | | | | | | | |
|-----------------------------------------------|-----------------------------------------|--------------|------|-------|------|------|------|------|------|------|------|------|------|------|---|
| | | 2013 | 2014 | 2015 | 2016 | 2017 | 2018 | 2019 | 2020 | 2021 | 2022 | 2023 | 2024 | 2025 | |
| Existing Plant Retirements/Conversion: | Hayden1 | - | - | - | - | - | - | - | - | - | - | - | - | - | |
| | Hayden2 | - | - | - | - | - | - | - | - | - | - | - | - | - | |
| | Carbon1 (Early Retirement Conversion) | - | - | (67) | - | - | - | - | - | - | - | - | - | - | |
| | Carbon2 (Early Retirement Conversion) | - | - | (105) | - | - | - | - | - | - | - | - | - | - | |
| | Johnston1 | - | - | - | - | - | - | - | - | - | - | - | - | - | |
| | Johnston2 | - | - | - | - | - | - | - | - | - | - | - | - | - | |
| | Johnston3 | - | - | - | - | - | - | - | - | - | - | - | - | - | |
| | Johnston4 | - | - | - | - | - | - | - | - | - | - | - | - | - | |
| | Naughton1 | - | - | - | - | - | - | - | - | - | - | - | - | - | |
| | Naughton2 | - | - | - | - | - | - | - | - | - | - | - | - | - | |
| | Naughton3 (Early Retirement Conversion) | - | - | (330) | - | - | - | - | - | - | - | - | - | - | |
| | Coal Ret. WY - Gas RePower | - | - | 338 | - | - | - | - | - | - | - | - | - | - | |
| | Expansion Resources: | | | | | | | | | | | | | | |
| | | COCTFD 2d | - | - | - | - | - | - | - | - | - | - | - | - | - |
| | COCTJ 1d | - | - | - | - | - | - | - | - | - | - | - | 423 | - | |
| | Lake Side II | - | 645 | - | - | - | - | - | - | - | - | - | - | - | |
| | SOCTFrame C1 | - | - | - | - | - | - | - | - | - | - | - | - | - | |
| | SOCTFrame ID | - | - | - | - | - | - | - | - | - | - | - | - | - | |
| | Coal Plant Turbine Upgrades | 1.8 | - | - | - | - | - | - | - | - | - | - | - | - | |
| | Wind, Wyoming, 40 | - | - | - | - | - | - | - | - | - | - | - | 432 | 218 | |
| | Total Wind | - | - | - | - | - | - | - | - | - | - | - | 432 | 218 | |
| | CHP - Biomass | 0.2 | 0.2 | 0.2 | 0.2 | 0.2 | 0.2 | 0.2 | 0.2 | 0.2 | 0.2 | 0.2 | 0.2 | 0.2 | |
| | CHP - Other | 0.4 | 0.4 | 0.4 | 0.4 | 0.4 | 0.4 | 0.4 | 0.4 | 0.4 | 0.4 | 0.4 | 0.4 | 0.4 | |
| | DSM Class 1, ID-Curtail | - | - | - | - | - | - | - | - | - | - | - | - | - | |
| | DSM Class 1, ID-Irrigate | - | - | - | - | - | - | - | - | - | - | - | - | - | |
| | DSM Class 1, UT-Curtail | - | - | - | - | - | - | - | - | - | - | - | - | - | |
| | DSM Class 1, UT-Irrigate | - | - | - | - | - | - | - | - | - | - | - | - | - | |
| | DSM Class 1, WY-Curtail | - | - | - | - | - | - | - | - | - | - | - | - | - | |
| | DSM Class 1, WY-Irrigate | - | - | - | - | - | - | - | - | - | - | - | - | - | |
| | DSM Class 1 Total | - | - | - | - | - | - | - | - | - | - | - | - | - | |
| | DSM Class 2, ID | 3 | 3 | 3 | 3 | 3 | 3 | 4 | 3 | 4 | 4 | 3 | 3 | 3 | |
| | DSM Class 2, UT | 63 | 61 | 54 | 52 | 50 | 48 | 48 | 43 | 42 | 40 | 30 | 33 | 30 | |
| | DSM Class 2, WY | 4 | 4 | 5 | 5 | 6 | 6 | 6 | 6 | 7 | 7 | 6 | 7 | 7 | |
| | DSM Class 2 Total | 69 | 67 | 61 | 60 | 59 | 57 | 58 | 52 | 52 | 51 | 39 | 42 | 39 | |
| | Micro Solar - Pv | 7.11 | 11.0 | 14.2 | 16.4 | 17.0 | 13.1 | 13.1 | 13.1 | 13.1 | 13.1 | 13.1 | 13.1 | 13.1 | |
| | Micro Solar - Water Heating | - | - | - | - | 0.8 | 0.4 | 0.5 | 0.6 | 2.4 | 2.4 | 2.4 | 2.4 | 2.4 | |
| | FOT Mona Q8 | - | - | - | - | - | 37 | 151 | 248 | 19 | 161 | 255 | - | 132 | |

Source: http://www.pacificorp.com/content/dam/pacificorp/doc/Energy_Sources/Integrated_Resource_Plan/2013IRP/PacificCorp-2013IRP_Vol1-Main_4-30-13.pdf (see page 239)

- 1
- 2
- 3
- 4

FIGURE 4 Rocky Mountain Power Expansion Plan from 2013 IRP

| 2014 IRP (VALUES IN MW AT PEAK) | | | | |
|-----------------------------------------------------|--------------|--------------|---------------|---------------|
| | 2014 | 2019 | 2024 | 2029 |
| TOTAL PROJECTED LOAD REQUIREMENTS (NEEDS) | 8,124 | 9,543 | 11,276 | 12,982 |
| EXISTING RESOURCES AS OF DEC. 31, 2013 | | | | |
| APS-Owned Generation | 6,315 | 6,086 | 6,063 | 6,066 |
| Long-Term Contracts | 2,872 | 1,490 | 389 | 346 |
| Total Existing Resources as of Dec. 31, 2013 | 9,187 | 7,576 | 6,452 | 6,412 |
| FUTURE* PROJECTED CUSTOMER RESOURCES | | | | |
| Energy Efficiency | 109 | 877 | 1,230 | 1,447 |
| Distributed Energy | 45 | 109 | 203 | 261 |
| Demand Response | 0 | 0 | 150 | 275 |
| Total Future* Customer Resources | 153 | 986 | 1,584 | 1,983 |
| FUTURE* PROJECTED GENERATION RESOURCES | | | | |
| Natural Gas | 0 | 1,010 | 3,030 | 4,205 |
| Renewable Energy | 0 | 57 | 295 | 425 |
| Total Future* Projected Utility Resources | 0 | 1,067 | 3,325 | 4,630 |
| Total Future* Projected Resource Additions | 153 | 2,053 | 4,909 | 6,613 |
| Total Resources | 9,340 | 9,630 | 11,361 | 13,025 |

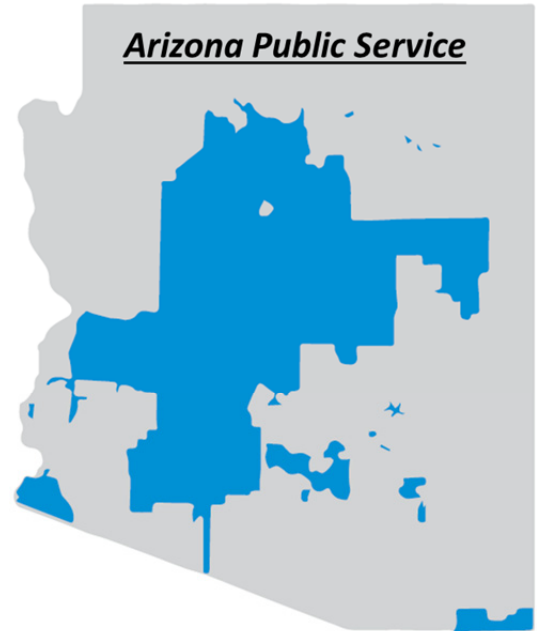

*Future resources added after December 31, 2013 Source: http://www.aps.com/library/resource%20alt/2014_IntegratedResourcePlan.pdf

1

2

FIGURE 5 Capacity Expansion Plan for Arizona Public Service Company from 2014 IRP

3

| Future Resources (Nameplate Capacity MW) | 2014 | 2015 | 2016 | 2017 | 2018 | 2019 | 2020 | 2021 | 2022 | 2023 | 2024 | 2025 | 2026 | 2027 | 2028 |
|---------------------------------------------|------------|--------------|--------------|--------------|--------------|--------------|--------------|--------------|--------------|--------------|--------------|--------------|--------------|--------------|--------------|
| Natural Gas Resources | - | 374 | 374 | 374 | 374 | 1,016 | 1,018 | 1,020 | 1,022 | 1,114 | 1,116 | 1,118 | 1,210 | 1,212 | 1,214 |
| Utility Scale Renewables | 208 | 258 | 258 | 258 | 258 | 258 | 258 | 258 | 326 | 326 | 475 | 529 | 529 | 529 | 529 |
| Distributed Generation (DG) | 71 | 78 | 94 | 110 | 125 | 141 | 157 | 173 | 190 | 210 | 229 | 250 | 254 | 259 | 265 |
| Energy Efficiency (EE) | 48 | 80 | 110 | 137 | 164 | 191 | 217 | 229 | 233 | 238 | 244 | 249 | 253 | 259 | 262 |
| Demand Response (DR) | 15 | 19 | 24 | 29 | 35 | 40 | 45 | 45 | 45 | 45 | 45 | 45 | 45 | 45 | 50 |
| Total Nameplate Capacity | 342 | 808 | 859 | 908 | 956 | 1,646 | 1,695 | 1,724 | 1,817 | 1,933 | 2,109 | 2,191 | 2,291 | 2,304 | 2,320 |
| Short-Term Market Resources | 400 | 250 | 200 | 200 | 570 | - | - | - | - | - | - | - | - | - | - |
| Total System Resources | 742 | 1,058 | 1,059 | 1,108 | 1,526 | 1,646 | 1,695 | 1,724 | 1,817 | 1,933 | 2,109 | 2,191 | 2,291 | 2,304 | 2,320 |

Source: <https://www.tep.com/doc/planning/2014-TEP-IRP.pdf>

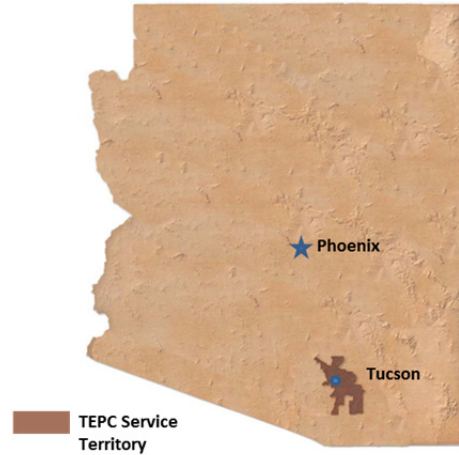

1
2
3
4

FIGURE 6 Capacity Expansion Plan for Tucson Electric Power Company from 2014 IRP

| Nevada Power Company Expansion Plans - Base Load | | | |
|------------------------------------------------------------------------------|-----------------------|-----------------------|-----------------------|
| Case A | Case B | Case C | Case D |
| To replace retired coal plants in accordance with Nevada Law (SB 123) | | | |
| 15 MW PV - 2016 | 15 MW PV - 2016 | 496 MW Merchant CC | 274 MW Merchant CC |
| 597 MW CC - 2018 | 568 MW CTs (8) - 2018 | 15 MW PV - 2016 | 15 MW PV - 2016 |
| 35 MW PV - 2021 | 35 MW PV - 2021 | 200 MW PV - 2016 | 200 MW PV - 2016 |
| | | 35 MW PV - 2021 | 500 MW PV - 2018 |
| Future conventional resource additions | | | |
| 597 MW CC - 2020 | 597 MW CC - 2020 | 597 MW CC - 2020 | 597 MW CC - 2020 |
| 273 MW CC - 2022 | 273 MW CC - 2022 | 273 MW CC - 2022 | 273 MW CC - 2022 |
| 213 MW CTs (3) - 2023 | 213 MW CTs (3) - 2023 | 213 MW CTs (3) - 2023 | 213 MW CTs (3) - 2023 |
| 597 MW CC - 2024 | 597 MW CC - 2024 | 597 MW CC - 2024 | 597 MW CC - 2024 |
| 234 MW CTs (3) - 2030 | 234 MW CTs (3) - 2030 | 213 MW CTs (3) - 2027 | 234 MW CTs (3) - 2030 |
| 234 MW CTs (3) - 2032 | 234 MW CTs (3) - 2032 | 234 MW CTs (3) - 2030 | 234 MW CTs (3) - 2032 |
| | | 234 MW CTs (3) - 2032 | |

Source: https://www.nvenergy.com/company/rates/filings/IRP/NPC_IRP/ERCRC_NPC/Vol4-Narratives.pdf

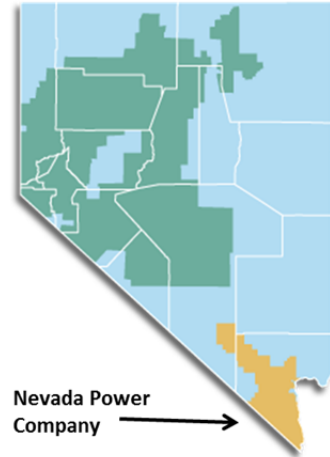

1
2
3
4

FIGURE 7 Capacity Expansion Plan for Nevada Power Company from 2014 IRP

| Sierra Pacific Power Expansion Plans - Base Load | | | |
|--------------------------------------------------|----------------------------|------------------------------------------|----------------------------------------|
| Case 1 <u>ALL Market</u> | Case 2 <u>Renewable</u> | Case 3 - Alternative Plan <u>CT's</u> | Case 4 - Preferred Plan <u>CC's</u> |
| | 402 MW CTs (6) - 2022 | 536 MW CTs (6) - 2022 | 273 MW CC - 2022 |
| 237 MW CTs (3) - 2023 | | | |
| 571 MW CC - 2025 | 571 MW CC - 2025 | 571 MW CC - 2025 | 571 MW CC - 2025 |
| 316 MW CTs (4) - 2029 | 316 MW CTs (4) - 2029 | 316 MW CTs (4) - 2029 | 316 MW CTs (4) - 2029 |

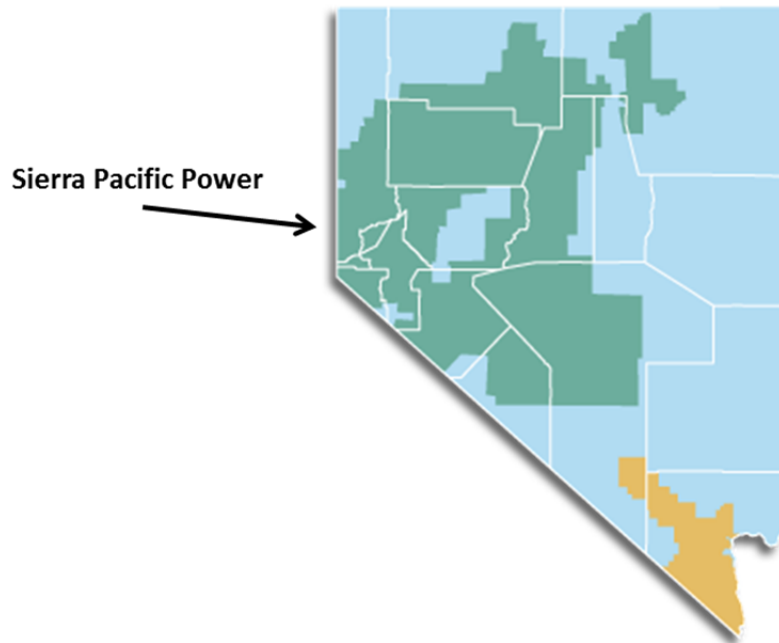

1
2
3
4
5
6

FIGURE 8 Capacity Expansion Plan for Sierra Pacific Power Company from 2014 IRP

ATTACHMENT K.10:

INDICES USED FOR CONVERTING DOLLARS FROM ONE YEAR TO ANOTHER

The Argonne National Laboratory Glen Canyon Dam Long-Term Experimental and Management Plan (LTEMP) Draft Environmental Impact Statement (DEIS) power systems team has data that are expressed in terms of various nominal dollars. However, it is important that model runs and analysis be performed on a consistent dollar year basis. The range of nominal dollars that was used ranges from 2010 dollars to 2013 dollars. In addition, the LTEMP DEIS co-lead team has also decided that results presented to the public should be expressed in terms of 2015 dollars. For all power systems analyses, the gross national product (GNP) implicit price deflator (IPD) was used for converting nominal dollars from one year to another. Argonne staff used the Federal Reserve Economic Data (FRED) for the IPD with the series ID of the Gross Domestic Product: Implicit Price Deflator (GDPDEF) found on the St. Louis Federal Reserve Bank (Fed) website (<http://research.stlouisfed.org/fred2/data/GDPDEF.txt>).

The IPD is a good measure of the rate of price change in the economy as a whole. However, the last data point available from the St. Louis Fed is for October 2014. Therefore, the index was projected through January 2015. Based on a simple trend analysis using a third-order polynomial to fix the GNP price deflator over the January to October 2014 time period, the projected IPD was approximately 107.7 in January 2015 (January 2010 index = 100); that is a decline of about 0.3% from the October 2014 level. Figure 1 and Table 1 below show results of the trend analysis.

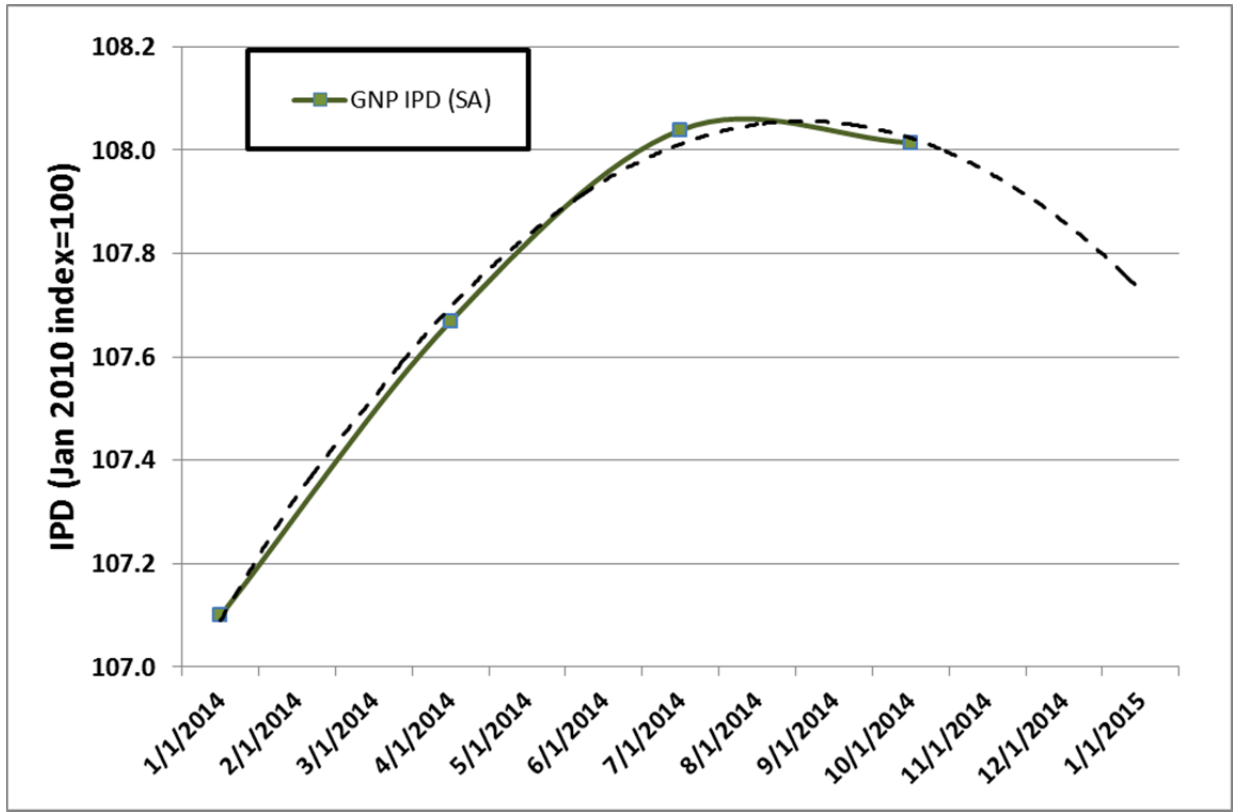

1
2 **FIGURE 1 Results of Trend Analysis to Project Implicit Price Deflator (IPD) to January 2015**
3 **(SA = seasonally adjusted)**
4
5

1 As shown in Figure 2, there is a similar, but
 2 somewhat more pronounced, decline when a trend
 3 analysis was conducted using monthly data for the
 4 seasonally adjusted (SA) consumer price index (CPI)
 5 for all U.S. cities/all items (series ID: CUSR0000SA0)
 6 (see [http://download.bls.gov/pub/time.series/cu/](http://download.bls.gov/pub/time.series/cu/cu.data.1.AllItems)
 7 [cu.data.1.AllItems](http://download.bls.gov/pub/time.series/cu/cu.data.1.AllItems)) and also for producer price index
 8 (PPI) data for total final demand (series ID: WPUFD4)
 9 from January 2014 through December 2015 (see
 10 <http://www.bls.gov/news.release/ppi.nr0.htm>). Both the
 11 CPI and PPI are about 1.0% lower in December 2014
 12 relative to September 2014.

**TABLE 1 Historical Quarterly
 Implicit Price Deflators and Projection
 for January 2015**

| Date | IPD |
|-----------|--------------------|
| 1/1/2010 | 100.0 |
| 4/1/2010 | 110.4 |
| 7/1/2010 | 100.9 |
| 10/1/2010 | 101.4 |
| 1/1/2011 | 101.9 |
| 4/1/2011 | 102.6 |
| 7/1/2011 | 103.2 |
| 10/1/2011 | 103.4 |
| 1/1/2012 | 103.9 |
| 4/1/2012 | 104.4 |
| 7/1/2012 | 104.9 |
| 10/1/2012 | 105.3 |
| 1/1/2013 | 105.7 |
| 4/1/2013 | 105.9 |
| 7/1/2013 | 106.4 |
| 10/1/2013 | 106.7 |
| 1/1/2014 | 107.1 |
| 4/1/2014 | 107.7 |
| 7/1/2014 | 108.0 |
| 10/1/2014 | 108.0 |
| 1/1/2015 | 107.7 ^a |

^a Projected.

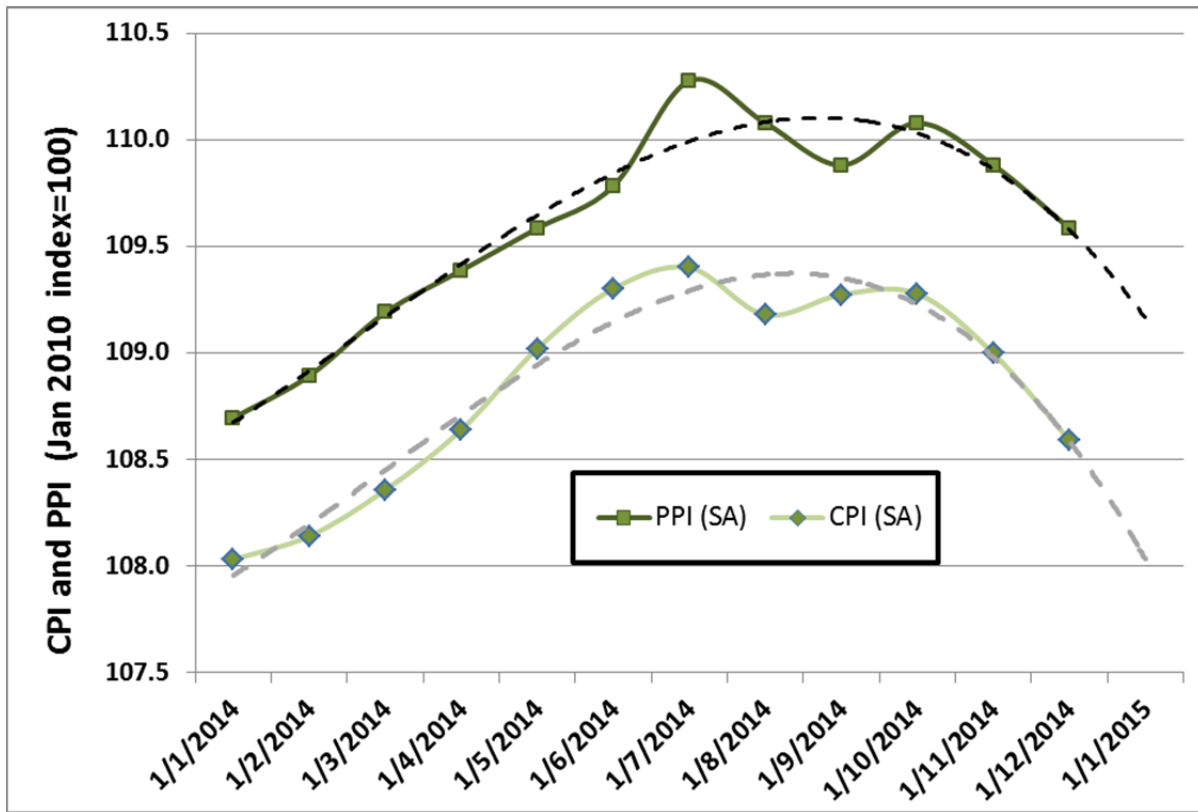

1

2

FIGURE 2 Comparison of Trend Analyses Projecting Produce Price Index (PPI) and Consumer Price Index (CPI) to January 2015 (SA = seasonally adjusted)

3

4

5

6

A downward trend in future producer prices through January 2015 is also in line with projections made by the Financial Forecast Center, which projects a 1% lower PPI for all commodities in January 2015 compared to December 2014 levels (see <http://www.forecasts.org/ppi.htm>).

7

8

9

10

11

The lower, but not as dramatic decrease in the IPD is further supported by Figure 3 below that shows both the CPI and PPI compared to the IPD. Both roughly follow the same trend in the January 2010 and October 2015 time period. However, the IPD tends to follow a smoother, less jagged track, implying that in general it may be somewhat less responsive to short-term economic drivers.

12

13

14

15

16

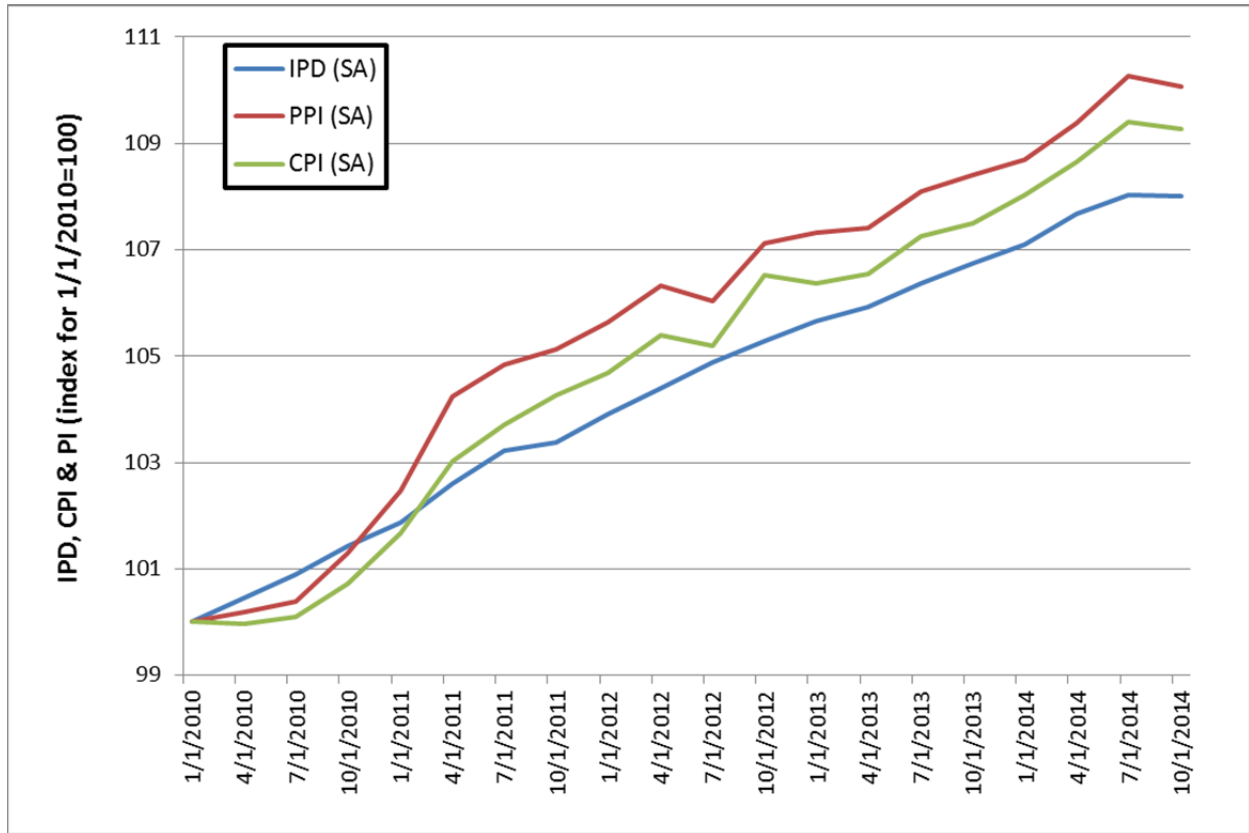

1
2
3
4
5

FIGURE 3 Comparison of Historical Trends for Implicit Price Deflator (IPD), Consumer Price Index (CPI), and Producer Price Index (PPI) from January 2010 to January 2014 (SA = seasonally adjusted)

1
2
3
4
5
6
7

ATTACHMENT K.11:
**ANNUAL SLCA/IP ALLOCATIONS TO
AMERICAN INDIAN TRIBES AND BENEFIT INFORMATION**

K-279

| Customer Name | Winter Season | | Summer Season | | Supplier Responsible for Benefit Crediting | Utility Serving Tribal Reservation |
|------------------------------------------------|---------------|--------------|---------------|--------------|--------------------------------------------|--------------------------------------------------------------------------------------------------------------------------------------------------------------|
| | Capacity (kW) | Energy (kWh) | Capacity (kW) | Energy (kWh) | | |
| Ak-Chin Indian Community | 1,920 | 3,520,881 | 4,244 | 7,722,879 | N/A | Operate own utility |
| Bureau of Indian Affairs Colorado River Agency | 881 | 1,593,277 | 442 | 883,290 | N/A | Bureau of Indian Affairs operated utility |
| San Carlos Irrigation Project | 1,840 | 3,373, 246 | 1,366 | 2,486,780 | N/A | Bureau of Indian Affairs operated utility contracted with Gila River Indian Community Utility Authority (GRICUA) |
| Alamo Navajo Chapter | 196 | 373,654 | 184 | 329,415 | Tri-State | Socorro Electric Cooperative—Member of Tri-State |
| Canoncito Navajo Chapter | 145 | 276,206 | 135 | 241,351 | Tri-State | Continental Divide Electric Cooperative—Member of Tri-State |
| Cocopah Indian Tribe | 1,058 | 2,022,535 | 1,281 | 2,289,809 | NTUA | Arizona Public Service Company |
| Colorado River Indian Tribes | 3,772 | 7,207,343 | 5,978 | 10,685,860 | Page Electric Utility | Arizona Public Service Company |
| Confederated Tribes of the Goshute Reservation | 62 | 118,806 | 39 | 69,992 | Deseret/Mt. Wheeler | Deseret/Mt. Wheeler |
| Duckwater Shoshone Tribe | 67 | 128,586 | 69 | 122,947 | Deseret/Mt. Wheeler | Deseret/Mt. Wheeler |
| Ely Shoshone Tribe | 129 | 246,599 | 78 | 138,741 | Deseret/Mt. Wheeler | Deseret/Mt. Wheeler |
| Fort Mojave Indian Tribe | 272 | 520,611 | 282 | 504,931 | N/A | Operate own utility |
| Ft. McDowell Mojave-Apache Indian Community | 2,270 | 4,336,951 | 2,346 | 4,192,957 | SRP | Salt River Project |
| Gila River Indian Community | 13,330 | 25,473,606 | 13,920 | 24,883,872 | N/A | Operate own utility |
| Havasupai Tribe | 237 | 452,237 | 199 | 356,282 | NTUA | Provided by BIA—Truxton Canon Agency, but power is from Mohave Electric, Member of AEPSCO, which has a SLCA/IP allocation—see APPA Contract No. 87-BCA-10001 |

K-280

| Customer Name | Winter Season | | Summer Season | | Supplier Responsible for Benefit Crediting | Utility Serving Tribal Reservation |
|-----------------------------------------|---------------|--------------|---------------|--------------|----------------------------------------------------|---------------------------------------------------------------------------------------------------------------|
| | Capacity (kW) | Energy (kWh) | Capacity (kW) | Energy (kWh) | | |
| Hopi Tribe | 2,810 | 5,369,665 | 2,716 | 4,854,810 | NTUA | NTUA and Arizona Public Service Company (depends where on reservation) |
| Hualapai Tribe | 609 | 1,163,130 | 625 | 1,118,127 | NTUA | Mojave Electric Cooperative |
| Jicarilla Apache Tribe | 735 | 1,403,805 | 580 | 1,036,264 | N/A | Operate own utility/buy wholesale from PNM for supplemental |
| Las Vegas Paiute Tribe | 523 | 999,427 | 721 | 1,288,008 | NTUA | NV Energy |
| Mescalero Apache Tribe | 990 | 1,890,996 | 976 | 1,743,837 | Tri-State | Otero County Electric Cooperative—Member of Tri-State |
| Nambe Pueblo | 65 | 124,829 | 59 | 104,627 | Tri-State | Jemez Mountains Electric Cooperative—Member of Tri-State |
| Navajo Agricultural Products Industries | 500 | 2,212,425 | 22,900 | 48,833,990 | N/A | All Requirements Met by WAPA |
| Navajo Tribal Utility Authority | 48,052 | 97,612,554 | 42,614 | 84,194,098 | N/A | Operate own utility. Tucson Electric Power provides other wholesale power resources |
| Paiute Indian Tribe of Utah | 154 | 294,452 | 158 | 282,873 | NTUA | PacifiCorp, City of St. George, and Flowell Electric (Tribe fragmented geographically) |
| Pascua Yaqui Tribe | 1,032 | 1,972,271 | 1,320 | 2,360,127 | NTUA | TriCo Electric Cooperative—Member of AEPCO, which has a SLCA/IP allocation—see APPA Contract No. 87-BCA-10001 |
| Picuris Pueblo | 22 | 42,183 | 76 | 135,363 | Tri-State | Kit Carson Electric Cooperative—Member of Tri-State |
| Pueblo De Cochiti | 224 | 428,910 | 185 | 330,732 | PNM-non-Western Area Power Administration customer | Public Service Company of New Mexico |

K-281

| Customer Name | Winter Season | | Summer Season | | Supplier Responsible for Benefit Crediting | Utility Serving Tribal Reservation |
|-------------------------|---------------|--------------|---------------|--------------|----------------------------------------------------|-------------------------------------------------------------|
| | Capacity (kW) | Energy (kWh) | Capacity (kW) | Energy (kWh) | | |
| Pueblo of Acoma | 410 | 783,229 | 420 | 750,759 | Tri-State | Continental Divide Electric Cooperative—Member of Tri-State |
| Pueblo of Isleta | 1,109 | 2,119,606 | 1,098 | 1,962,172 | NTUA | Public Service Company of New Mexico |
| Pueblo of Jemez | 265 | 505,513 | 214 | 382,418 | Tri-State | Jemez Mountains Electric Cooperative—Member of Tri-State |
| Pueblo of Laguna | 753 | 1,438,435 | 742 | 1,326,495 | Tri-State | Continental Divide Electric Cooperative—Member of Tri-State |
| Pueblo of Pojoaque | 271 | 517,903 | 208 | 371,891 | Tri-State | Jemez Mountains Electric Cooperative—Member of Tri-State |
| Pueblo of San Felipe | 422 | 805,473 | 328 | 586,285 | PNM-non-Western Area Power Administration customer | Public Service Company of New Mexico |
| Pueblo of San Ildefonso | 64 | 122,213 | 63 | 112,702 | Tri-State | Jemez Mountains Electric Cooperative—Member of Tri-State |
| Pueblo of San Juan | 303 | 579,114 | 298 | 533,433 | Tri-State | Jemez Mountains Electric Cooperative—Member of Tri-State |
| Pueblo of Sandia | 817 | 1,561,033 | 943 | 1,684,993 | PNM-non-Western Area Power Administration customer | Public Service Company of New Mexico |
| Pueblo of Santa Clara | 264 | 505,350 | 214 | 382,268 | Tri-State | Jemez Mountains Electric Cooperative—Member of Tri-State |

K-282

| Customer Name | Winter Season | | Summer Season | | Supplier Responsible for Benefit Crediting | Utility Serving Tribal Reservation |
|-------------------------------------------|---------------|--------------|---------------|--------------|----------------------------------------------------|-------------------------------------------------------------|
| | Capacity (kW) | Energy (kWh) | Capacity (kW) | Energy (kWh) | | |
| Pueblo of Santo Domingo | 438 | 837,643 | 452 | 807,426 | PNM-non-Western Area Power Administration customer | Public Service Company of New Mexico |
| Pueblo of Taos | 340 | 649,082 | 221 | 395,819 | Tri-State | Kit Carson Electric Cooperative—Member of Tri-State |
| Pueblo of Tesuque | 598 | 1,143,446 | 628 | 1,121,780 | PNM-non-Western Area Power Administration customer | Public Service Company of New Mexico |
| Pueblo of Zia | 85 | 161,712 | 68 | 122,326 | Tri-State | Jemez Mountains Electric Cooperative—Member of Tri-State |
| Pueblo of Zuni | 1,185 | 2,264,600 | 1,020 | 1,822,622 | Tri-State | Continental Divide Electric Cooperative—Member of Tri-State |
| Quechan Indian Tribe | 729 | 1,393,402 | 505 | 902,692 | N/A | Arizona Public Service Company |
| Ramah Navajo Chapter | 412 | 786,592 | 300 | 536,096 | Tri-State | Continental Divide Electric Cooperative—Member of Tri-State |
| Salt River Pima-Maricopa Indian Community | 13,380 | 25,569,197 | 16,144 | 28,858,050 | SRP | Salt River Project |
| San Carlos Apache Tribe | 3,780 | 7,222,993 | 4,152 | 7,421,915 | NTUA | Arizona Public Service Company |
| Santa Ana Pueblo | 410 | 783,525 | 460 | 822,045 | PNM-non-Western Area Power Administration customer | Public Service Company of New Mexico |
| Skull Valley Band of Goshute Indians | 15 | 28,290 | 15 | 27,269 | N/A | PacifiCorp |

| Customer Name | Winter Season | | Summer Season | | Supplier Responsible for Benefit Crediting | Utility Serving Tribal Reservation |
|----------------------------------|---------------|--------------|---------------|--------------|--------------------------------------------|---------------------------------------------------|
| | Capacity (kW) | Energy (kWh) | Capacity (kW) | Energy (kWh) | | |
| Southern Ute Indian Tribe | 1,174 | 2,243,756 | 1,122 | 2,006,482 | Tri-State | La Plata Electric Association—Member of Tri-State |
| Tohono O’Odham Utility Authority | 3,044 | 5,816,784 | 1,047 | 1,871,035 | N/A | Operate own utility |
| Tonto Apache Tribe | 349 | 667,470 | 382 | 683,459 | NTUA | Arizona Public Service Company |
| Ute Indian Tribe | 688 | 1,315,260 | 457 | 816,884 | Page Electric Utility | Deseret/Moon Lake Electric |
| Ute Mountain Ute Tribe | 508 | 970,293 | 477 | 852,108 | Tri-State | Empire Electric Association—Member of Tri-State |
| White Mountain Apache Tribe | 5,999 | 11,463,994 | 5,822 | 10,407,621 | Ak-Chin | Arizona Public Service Company |
| Wind River Reservation | 491 | 938,332 | 484 | 865,612 | Tri-State | High Plains Power—Member of Tri-State |
| Yavapai Apache Nation | 1,465 | 2,800,451 | 1,893 | 3,383,533 | NTUA | Arizona Public Service Company |
| Yavapai Prescott Indian Tribe | 805 | 1,538,623 | 733 | 1,309,825 | NTUA | Arizona Public Service Company |
| Yomba Shoshone Tribe | 30 | 58,232 | 31 | 56,131 | NTUA | NV Energy |

K-283

1
2
3
4
5

ATTACHMENT K.12:

**SLCA/IP AMERICAN INDIAN TRIBAL ALLOCATIONS
 ESTIMATED TOTAL ELECTRICAL USE BY TRIBE IN 1998**

| State | Benefit Credit Arrangement | Current Provider | Summer Estimated Load | Winter Estimated Load | Total Estimated Load |
|---------------------------------|----------------------------|---------------------|-----------------------|-----------------------|----------------------|
| Arizona | | | | | |
| Hopi Tribe | NTUA | APS | 10,681,912 | 11,388,535 | 22,070,447 |
| Navajo Tribal Utility Authority | NTUA | Currently Files IRP | 139,960,634 | 164,696,156 | 304,656,790 |
| White Mountain Apache Tribe | Ak-Chin | Navopache | 28,219,987 | 29,713,959 | 57,933,946 |
| New Mexico | | | | | |
| Acoma Pueblo | Tri-State | Tri-State | 3,724,900 | 3,583,590 | 7,308,490 |
| Alamo Navajo Chapter | Tri-State | Tri-State | 1,634,400 | 1,709,619 | 3,344,019 |
| Canoncito Navajo Chapter | Tri-State | Tri-State | 1,197,466 | 1,263,755 | 2,461,221 |
| Cochiti Pueblo | PNM | PNM | 727,700 | 909,677 | 1,637,377 |
| Isleta Pueblo | NTUA | PNM | 4,317,315 | 4,495,477 | 8,812,792 |
| Jemez Pueblo | Tri-State | Tri-State | 1,897,372 | 2,312,927 | 4,210,299 |
| Jicarilla Apache Tribe | Tri-State | Tri-State | 5,141,438 | 6,422,977 | 11,564,415 |
| Laguna Pueblo | Tri-State | Tri-State | 6,581,424 | 6,581,424 | 13,162,848 |
| Mescalero Apache Tribe | Tri-State | Tri-State | 8,652,073 | 8,652,073 | 17,304,146 |
| Nambe Pueblo | Tri-State | Tri-State | 519,108 | 571,141 | 1,090,249 |
| Picuris Pueblo | Tri-State | Tri-State | 671,608 | 193,005 | 864,613 |
| Pojaque Pueblo | Tri-State | Tri-State | 1,845,144 | 2,369,616 | 4,214,760 |
| Ramah Navajo Chapter | Tri-State | Tri-State | 2,659,850 | 3,598,976 | 6,258,826 |
| San Felipe Pueblo | PNM | PNM | 1,289,988 | 1,708,330 | 2,998,318 |
| San Ildefonso Pueblo | Tri-State | Tri-State | 559,175 | 559,175 | 1,118,350 |
| San Juan Pueblo | Tri-State | Tri-State | 2,646,684 | 2,649,680 | 5,296,364 |
| Sandia Pueblo | PNM | PNM | 3,707,446 | 3,310,798 | 7,018,244 |
| Santa Ana Pueblo | PNM | PNM | 1,808,724 | 1,661,781 | 3,470,505 |
| Santa Clara Pueblo | Tri-State | Tri-State | 1,896,628 | 2,312,183 | 4,208,811 |
| Santo Domingo Pueblo | PNM | PNM | 1,776,558 | 1,776,558 | 3,553,116 |
| Taos Pueblo | Tri-State | Tri-State | 1,963,860 | 2,969,811 | 4,933,671 |
| Tesuque Pueblo | PNM | PNM | 2,468,223 | 2,425,138 | 4,893,361 |
| Zia Pueblo | Tri-State | Tri-State | 606,921 | 739,899 | 1,346,820 |
| Zuni Pueblo | Tri-State | Tri-State | 9,042,967 | 10,361,462 | 19,404,429 |
| Nevada/Utah | | | | | |
| Confederated Tribes Goshute | Deseret G&T | Deseret G&T | 209,433 | 338,279 | 547,712 |
| Duckwater Shoshone Tribe | Deseret G&T | Deseret G&T | 367,885 | 366,124 | 734,009 |
| Ely Shoshone Tribe | Deseret G&T | Deseret G&T | 415,144 | 702,144 | 1,117,288 |

| State | Benefit Credit Arrangement | Current Provider | Summer Estimated Load | Winter Estimated Load | Total Estimated Load |
|---------------------------------------|----------------------------|------------------------------------------|-----------------------|-----------------------|----------------------|
| <i>Nevada/Utah (Cont.)</i> | | | | | |
| Las Vegas Paiute Tribe | NTUA | Nevada Power | 2,833,971 | 2,119,688 | 4,953,659 |
| Paiute Indian Tribe of Utah | NTUA | St. George/DG&T/Pac | 899,650 | 888,418 | 1,788,068 |
| Skull Valley Band of Goshute | NTUA | UP&L | 60,000 | 60,000 | 120,000 |
| Ute Indian Tribe | Deseret G&T | Deseret G&T | 4,052,985 | 6,017,847 | 10,070,832 |
| Yomba Shoshone Tribe | NTUA | Sierra Pacific | 123,504 | 123,504 | 247,008 |
| <i>Colorado/Wyoming</i> | | | | | |
| Southern Ute Indian Tribe | Tri-State | Tri-State | 9,955,191 | 10,266,092 | 20,221,283 |
| Ute Mountain Ute Tribe | Tri-State | Tri-State | 4,227,748 | 4,439,484 | 8,667,232 |
| Wind River Reservation | Tri-State | Tri-State | 11,884,905 | 23,766,810 | 35,651,715 |
| <i>Desert Southwest Region</i> | | | | | |
| Arizona | | | | | |
| Cocopah Indian Tribe | NTUA | APS | 5,038,208 | 4,289,600 | 9,327,808 |
| Colorado River Indian Tribes | Colorado River Agency | Currently files Integrated Resource Plan | 41,479,273 | 29,149,736 | 70,629,009 |
| Fort Mojave Indian Tribe | Aha Macav | Aha Macav | 12,348,324 | 8,991,679 | 21,340,003 |
| Ft. McDowell Mojave-Apache | SRP | SRP | 9,737,573 | 9,689,253 | 19,426,826 |
| Gila River Indian Community | SRP | SRP | 88,141,802 | 85,858,156 | 173,999,958 |
| Havasupai Tribe | NTUA | Mohave | 881,383 | 1,073,587 | 1,954,970 |
| Hualapai Tribe | NTUA | Mohave | 2,766,060 | 2,761,209 | 5,527,269 |
| Pascua Yaqui Tribe | NTUA | AEPCO | 5,838,562 | 4,682,066 | 10,520,628 |
| Quechan Indian Tribe | NTUA? | IID | 1,986,170 | 2,955,270 | 4,941,440 |
| Salt River Pima-Maricopa | SRP | SRP | 67,018,896 | 57,124,556 | 124,143,452 |
| San Carlos Apache Tribe | NTUA | APS/SCIP/AEP CO | 16,479,679 | 15,454,342 | 31,934,021 |
| Tohono O'odham Utility Authority | TOUA | TOUA | 22,127,390 | 20,566,786 | 42,694,176 |
| Tonto Apache Tribe | NTUA | APS | 1,503,798 | 38 | 2,919,436 |
| Yavapai Apache Nation | NTUA | APS | 7,444,699 | 5,939,483 | 13,384,182 |
| Yavapai Prescott Indian Tribe | NTUA | APS | 12,529,338 | 13,975,168 | 26,504,506 |
| Total | | | 576,551,076 | 591,952,641 | 1,168,503,717 |

1
2
3
4
5
6
7
8
9
10
11
12
13
14

This page intentionally left blank

1
2
3
4
5
6
7
8
9
10
11
12
13
14
15
16

**APPENDIX L:
SOCIOECONOMIC TECHNICAL INFORMATION AND ANALYSIS**

1
2
3
4
5
6
7
8
9
10
11
12
13
14
15

This page intentionally left blank

APPENDIX L:

SOCIOECONOMIC TECHNICAL INFORMATION AND ANALYSIS

The socioeconomic analysis of changes in Glen Canyon Dam operations included a number of parts:

- Analysis of changes in recreational activity in Lake Mead, Lake Powell, and the Colorado River in terms of recreation use values, non-use (passive use) values, and regional economic impacts; and
- Analysis of the regional economic impacts of changes in retail electricity prices resulting from changes in Western Area Power Administration (Western) wholesale electricity rates, and the analysis of the impacts of the construction and operation of additional Western customer utility generating capacity.

L.1 RECREATION ECONOMIC ANALYSES

L.1.1 Recreation Use Values

Estimation of use values associated with potential changes in recreational resources under each of the alternatives used benefits transfer methods; this involves applying existing use value data or estimates for a particular time period, site, level of resource quality, or combination thereof at an original or study site to a policy site for which data are not available. The benefits transfer method involves choosing study and policy sites with similar socioeconomic and environmental characteristics, similar recreational activities, and similar ranges of change in recreational quality.

Benefits transfer studies involve either the transfer of use values from a study site or the transfer of a statistical model used to estimate use values. The traditional benefits transfer approach to valuing recreation has been to employ existing use values from either travel cost or contingent valuation studies conducted at a study site, adjusting estimates to account for inflation by converting the original values to current dollars using the consumer price index (CPI) or some other price index, and applying them to analysis at the policy site. Given improvements in valuation techniques over time, however, the preferred approach is to employ statistical recreation models developed for a study site at a policy site. Proposed alternative-specific information about variables in the model can be gathered for the policy site. This information is used in conjunction with coefficients from the study site to estimate recreation visitation and/or value at the policy site, allowing the model transfer technique to improve the validity of the results compared to the use value transfer approach.

1 Benefits transfer methods present a reliable alternative to conducting original research
2 when the analysis is not expected to be controversial, when time and budget constraints prevent
3 the pursuit of original research, or when original research efforts have already been conducted at
4 most of the geographic areas of interest. Because statistical models have been developed for
5 estimating recreation value per trip for two of the three river reaches in the Glen Canyon Dam
6 Long-Term Experimental and Management Plan (LTEMP) study area—Glen Canyon and Upper
7 Grand Canyon—and models estimating recreation use have been developed for Lake Powell and
8 Lake Mead, while other studies have estimated values per trip for recreation use of Lake Powell
9 and Lake Mead, the benefits transfer methods provides a useful and reliable approach to
10 estimating river use values and lake visitation. More information on the background literature,
11 data, and assumptions in applying the benefits transfer method to the analysis undertaken for the
12 DEIS can be found in Reclamation (2014).

13
14 For the DEIS, the net economic value of recreation was estimated for Lake Powell, Lake
15 Mead, and three reaches of the Colorado River—Glen Canyon (from Glen Canyon Dam to Lees
16 Ferry), Upper Grand Canyon (from Lees Ferry to Diamond Creek), and Lower Grand
17 Canyon(from Diamond Creek to Lake Mead)—using two utility programs:

- 18
19 • The Lake_Full program was used to estimate recreation economic value for
20 Lake Powell and Lake Mead.
- 21
22 • The GCRec_Full utility program was used to estimate the economic value for
23 recreation on the Colorado River.

24 25 26 **L.1.1.1 Lake_Full Utility Model**

27
28 The Lake_Full utility model incorporates the recreation-use relationships for Lake Powell
29 and Lake Mead described in Neher et al. (2013). The model operates on a monthly time step and
30 was designed to use all years and all traces of monthly data supplied by the Colorado River
31 Storage Simulation (CRSS) model. The utility uses the end-of-month (EOM) reservoir contents
32 to predict recreation use at the specified reservoir. The user supplies a unit economic value per
33 trip and the utility employs the predicted recreation use in a given month and the unit economic
34 value to calculate the monthly economic value of recreation. This calculation is repeated for each
35 month in the period of analysis and for each hydrologic trace or sequence. The major analytical
36 modeling steps are shown in Figure L-1.

37
38 The user also supplies appropriate inflation, escalation, and discount rates for the
39 intended analysis. The Lake_Full utility program employs these economic inputs to compute the
40 present economic value of recreation for each hydrologic trace present in the dataset. The results
41 of these computations are reported for each reservoir as summary metrics computed from the
42 distribution of trace present economic values. Current versions of the utility model output the
43 5% exceedance, 10% exceedance, 25% exceedance, mean, median (50% exceedance), standard
44 deviation, 75% exceedance, 90% exceedance, and 95% exceedance.

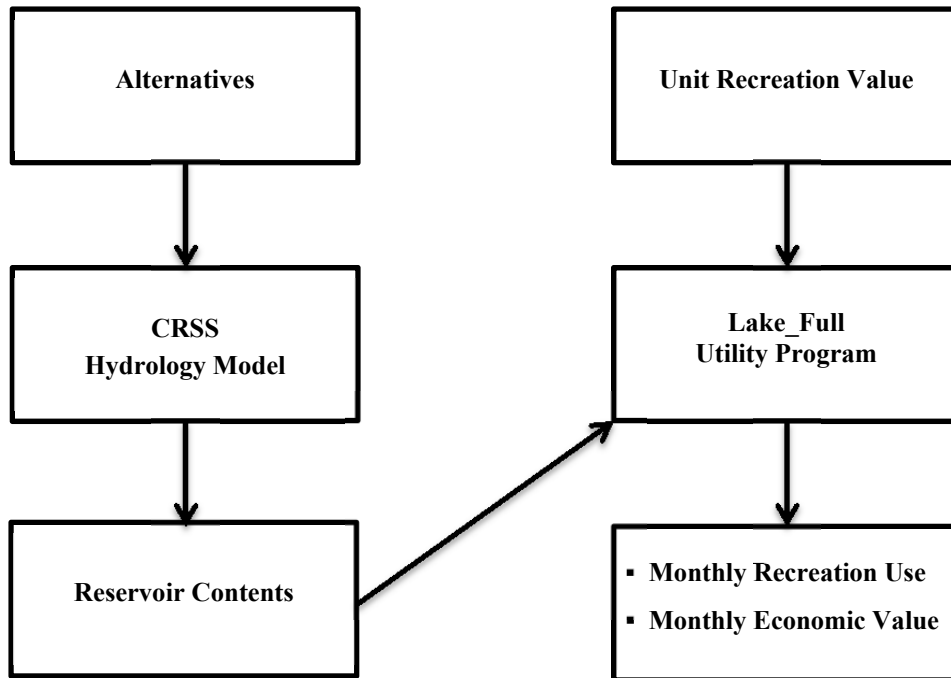

FIGURE L-1 Elements of the Lake_Full Utility Model

L.1.1.2 GCRec_Full Utility Model

The GCRec_Full utility model uses the recreation value relationships for Glen Canyon and Upper Grand Canyon estimated by Bishop et al. (1987). For purposes of this study, these relationships are extended to the Lower Grand Canyon. The model operates on a monthly time step and was designed to use all years and all traces of monthly data supplied by the CRSS model. The utility uses the mean monthly release from Glen Canyon Dam and the presence or absence of daily fluctuations exceeding 10,000 cfs per day during the month to predict the economic value of day-use rafting and angling in Glen Canyon and the economic value of commercial and private whitewater boating in the Upper Grand Canyon. The user also supplies the monthly recreation use, by activity. The utility employs the recreation use in a given month and the estimated economic value per trip to calculate the monthly net economic value of recreation for each activity. These calculations are repeated for each month in the period of analysis and for each hydrologic trace or sequence in the supplied dataset. The major analytical modeling steps are shown in Figure L-2.

The analyst also supplies appropriate inflation, escalation, and discount rates for the intended analysis. The GCRec_Full utility program employs these economic inputs for computing the present economic value of recreation for each hydrologic trace in the dataset. The results of these computations are aggregated and then reported as summary metrics computed from the distribution of trace present economic values. Current versions of the utility model output the 5% exceedance, 10% exceedance, 25% exceedance, mean, median (50% exceedance), standard deviation, 75% exceedance, 90% exceedance, and 95% exceedance levels.

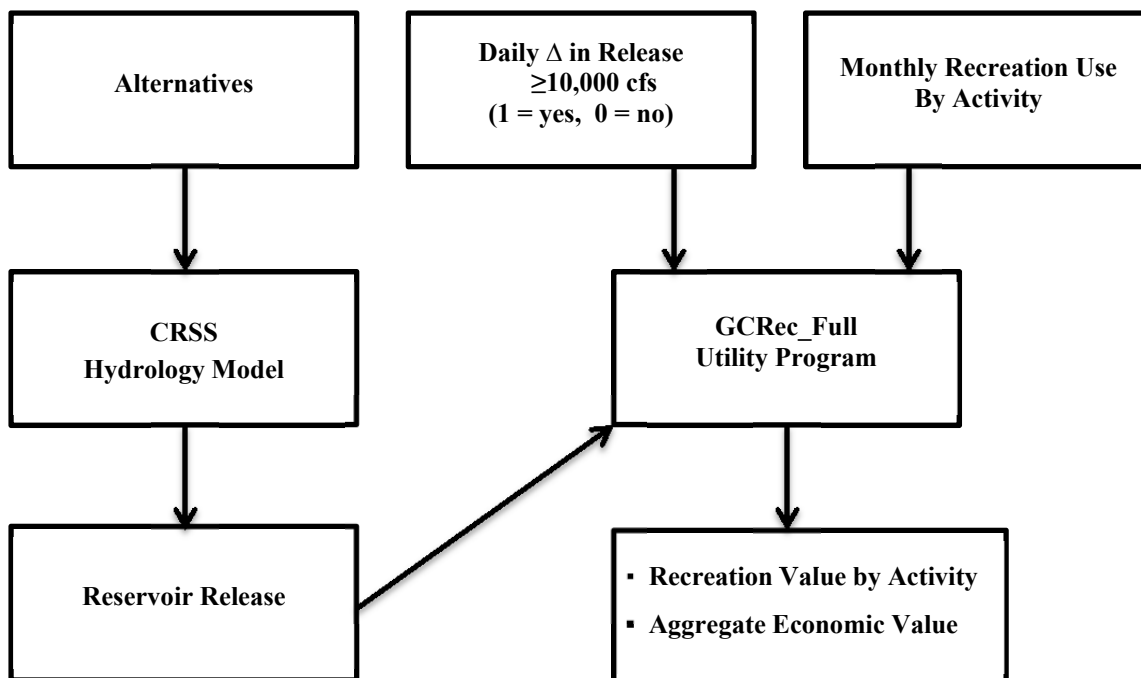

FIGURE L-2 Elements of the GCRec_Full Utility Model

More information on the background literature, data, assumptions, and output for these two models can be found in Reclamation (2014).

L.1.2 Recreation Non-Use Values

Non-use values are values that may be placed on the status of the natural or physical environment by non-users, or individuals who may never visit or otherwise use a natural resource that might still be affected by changes in its status or quality, and may assign a non-use or passive-use economic value to a resource. Although there are two approaches for measuring non-use values—revealed preference and stated preference methods—stated preference methods are typically used.

Stated preference valuation techniques include contingent valuation (CV), which is a means of eliciting the maximum dollar amount an individual would be willing to pay for a resource of a specified quantity and quality. CV methods use surveys to ascertain value by asking people about their willingness to pay (WTP) for a carefully specified change in environmental amenities. The dichotomous choice CV methodology is frequently employed in non-use valuation studies to estimate the net economic value for natural resource amenities. Respondents are presented with a hypothetical situation, including a price that they may be willing to pay for a change in an environmental condition, and they are then asked to respond to a dichotomous choice (yes or no) question. Using the data obtained from these surveys, the probability that an individual will respond “yes” is estimated using logistic regression analysis;

1 estimated regression coefficients are used to estimate the consumer surplus or net economic
2 value associated with a particular resource.

3
4 Stated preference methods also include conjoint analysis, where respondents are
5 presented with the characteristics or attributes of different hypothetical situations, and are then
6 asked to either rank them or choose between them. Using the resultant survey data, the
7 probability that an individual will rank or choose any particular scenario is then estimated, with
8 data used to estimate households' total value for outcome changes associated with each
9 alternative. There is a growing body of work that suggests that CV models and discrete choice
10 methods can yield valid measures of willingness to pay (see, for example, Vossler and Evans
11 [2009], and Vossler et al. [2012]).

12
13 Contingent valuation and conjoint methods have been applied widely in policy analysis,
14 in particular in studies relating to measuring non-use values associated with river and lake
15 resources associated with Grand Canyon National Park, Lake Mead National Recreation Area,
16 and Glen Canyon National Recreation Area. Government agencies have also begun to use
17 contingent valuation methods in benefit-cost analyses. The Bureau of Reclamation
18 (Reclamation), for example, used contingent valuation to place a value on the impact of
19 removing dams and restoring river habitat within the Klamath River Basin
20 (RTI International 2012). The non-use values were used in a subsequent benefit-cost analysis
21 (U.S. Department of the Interior 2012).

22
23 Contingent valuation surveys have been applied widely in the published economics
24 literature to estimate passive-use values associated with preserving river and lake resources.
25 Sanders et al. (1990), for example, estimated the total value of preserving 15 wild and scenic
26 rivers in Colorado. They reported that Colorado residents expressed a use value of \$19.15 and a
27 non-use value of \$81.96 per household per year. The total (use and non-use) value of protecting
28 15 Colorado rivers aggregated over these 12 million households was estimated at approximately
29 \$120 million annually, approximately four times the recreation use value. Welsh et al. (1995)
30 estimated the willingness to pay to improve native vegetation, native fishes, game fish, river
31 recreation, and cultural sites in Glen Canyon National Recreation Area and Grand Canyon
32 National Park. Value estimates varied between \$17.74 and \$26.91 for a U.S. sample, and
33 between \$29.05 and \$38.02 for a western U.S. sample.

34
35 Subsequent studies indicate that the range of values per household or respondent can be
36 large, producing larger ranges in aggregated values. For example, Duffield and Patterson (1991)
37 estimated a willingness to pay \$2.24 per licensed angler to maintain fisheries resources, based on
38 a one-time cash donation, while Hanemann et al. (1989) estimated \$181 per California household
39 per year. Large ranges in value have also been found in lake studies, with values ranging from
40 about \$45 per household annually for the preservation value of Flathead Lake in Montana
41 (Sutherland and Walsh 1985) to about \$60 per year for an increment of lake elevation at Mono
42 Lake, California (Loomis 1989). In a 2010 survey, the annual value (in 2011 dollars) of Klamath
43 River Basin restoration after the removal of dams, water sharing agreements, and improved fish
44 habitat was estimated at \$122 for households in a 12-county area, \$213 by households in the rest
45 of Oregon and California, and \$213 in the rest of the United States (RTI International 2012).

1 The National Research Council (2005) has concluded that the results of studies using
2 contingent valuation methods are of high quality; however, the results and findings of studies
3 relating to the Colorado River Corridor are considerably outdated. Others have emphasized the
4 need for additional or updated research on the sources and magnitudes of values associated with
5 operational goals (see National Research Council 1999). To address these concerns, the National
6 Park Service (NPS) has proposed to conduct a survey to determine non-use values associated
7 with river-based amenities located in Lake Powell, Lake Mead, and the Upper and Lower Grand
8 Canyon. The proposed survey, the results of which will not be available until after the Final EIS
9 is published, closely follows the methodology developed by Welsh et al. (1995) by using stated
10 preference methods to measure the changes in total value associated with the impacts on riparian
11 areas caused by changes in operations of Glen Canyon Dam. If approved by the Office of
12 Management and Budget, the survey will be conducted by the University of Montana, and will
13 be administered to households selected from two samples, a national sample including all U.S.
14 households, and a regional sample, consisting of all households receiving power from Western
15 Area Power Administration, and including all utilities receiving power from the Glen Canyon
16 Dam. The study will involve three phases.

17
18 The first phase will be a survey of a subsample ($n = 200$) of the total sample population.
19 These responses will be used to conduct preliminary analysis on the data to determine whether
20 the levels will be adjusted up or down to create greater differences between the LTEMP
21 alternatives. If more than 80% ($n = 160$) of individuals in the subsample select the No Action
22 Alternative, then the cost of the alternatives will be adjusted downward. The results from this
23 sample will inform the choice of attribute levels in the final conjoint version of the survey mailed
24 to the respondents in second phase of the study. Once the attributes have been evaluated and
25 adjusted, the final mail survey will be used to collect data. Two survey instruments, both of
26 which use identical sampling methods, will be used. All respondents will receive the same
27 instructions and answer a series of common introductory questions to determine general socio-
28 demographic background, visitation patterns, recreational preferences, values, and other
29 information. Then 75% ($n = 4,668$) of individuals in the sample will receive Survey A with a
30 section that will include conjoint questions. The remaining 25% ($n = 1,500$) will receive
31 Survey B, which will include contingent valuation questions.

32
33 The final phase will include a short non-response phone survey that will be used to help
34 test for any non-response bias. The results will be presented to the NPS in a report on the survey,
35 including data collection, response rates, analysis, and non-response corrections if needed.

36 37 38 **L.1.3 Regional Recreation Economic Impacts**

39
40 Economic impacts of changes in recreational activity are measured by changes in visitor
41 expenditures associated with various types of recreational activities, including angling, rafting,
42 and boating. Visitor expenditures in the river corridor may include spending on food and
43 beverages, fishing and boating equipment, gasoline for vehicles and boats, camping fees or motel
44 expenses, guide services, and fishing license fees. Economic impacts also include the secondary
45 effects of changes in expenditures that may occur on income, employment, and tax revenues.
46 The major analytical modeling steps are shown in Figure L-3.

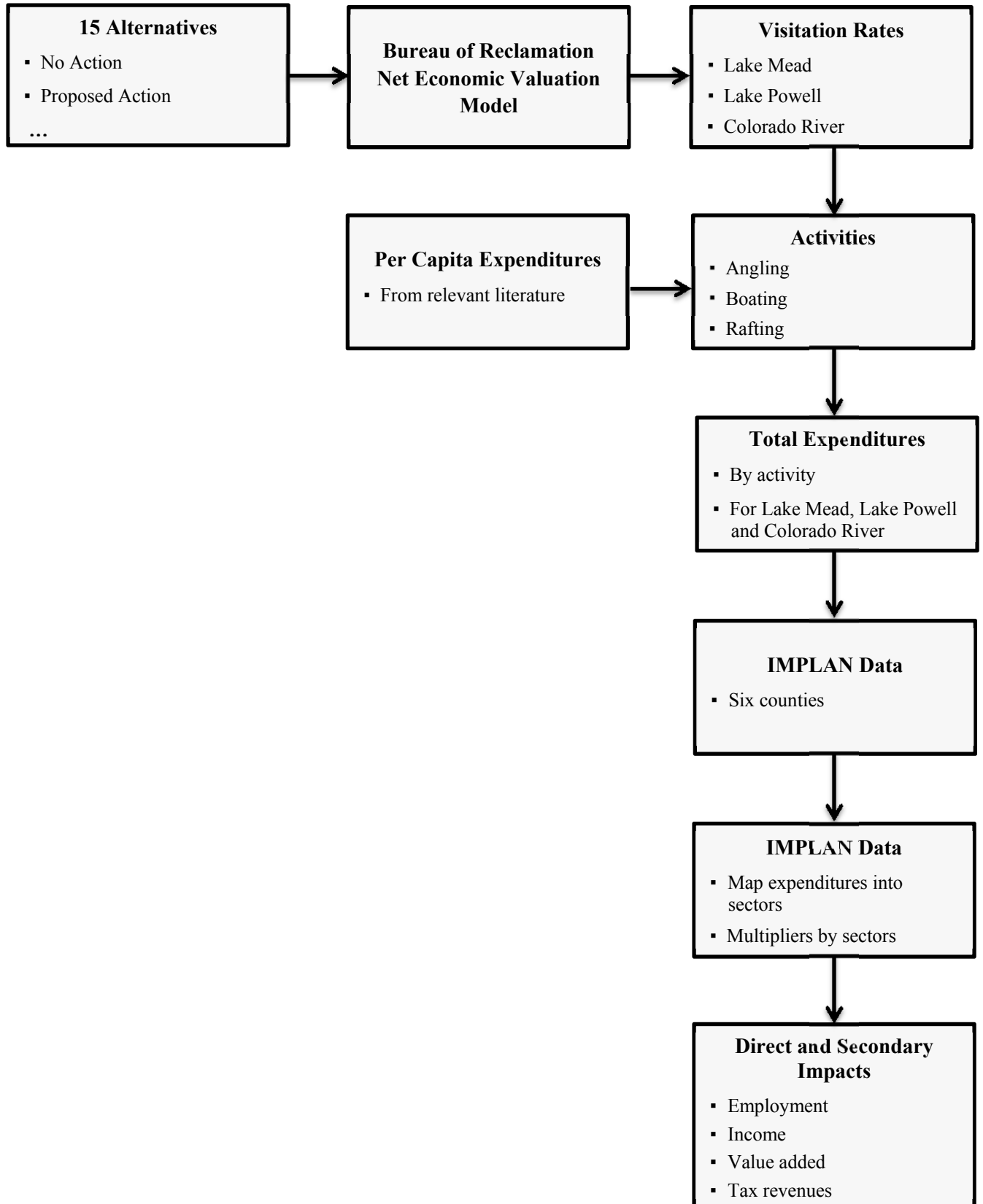

1

2 **FIGURE L-3 Elements of the Regional Recreation Impacts Analysis**

1 Analysis of these effects was undertaken in the six-county region in which the majority of
2 current Glen Canyon, Grand Canyon, and Colorado River recreational expenditures occur:

- 3
- 4 • Coconino County and Mohave County, Arizona; and
 - 5
 - 6 • Garfield County, Kane County, San Juan County, and Washington County,
7 Utah.
 - 8

9 The following data were used in the analysis:

- 10
- 11 • Changes in visitation rates, by alternative and river reach, from the analysis of
12 changes in activity resulting from changes in lake and river water levels for a
13 range of river and lake segments using the Net Economic Valuation (NEV)
14 model (see Section L.1), and
 - 15
 - 16 • Typical per-capita expenditure data by type of activity, based on studies of
17 typical visitor spending patterns reported in existing technical and academic
18 literature.
 - 19

20 Data from these sources are combined to produce changes in expenditure by activity type,
21 by year, and by alternative.

22

23 Two types of effects result from changes in recreational expenditures: (1) direct effects
24 are employment and income effects in sectors of the economy in which recreational expenditures
25 occur, while (2) indirect effects are employment and income effects in sectors providing
26 materials, equipment, and services to sectors in which recreational expenditures occur. Indirect
27 effects occur when suppliers to local businesses increase or decrease their purchases of
28 equipment, materials, and services from other businesses, and those businesses in turn change
29 their level of purchases. For food and beverages, for example, indirect effects occur when local
30 food manufacturers purchase additional produce from local farmers, and the farmers then
31 purchase additional supplies in order to grow products necessary to meet this demand.
32 Additional, induced effects result from wages paid to households by both directly and indirectly
33 affected businesses.

34

35 Input-output data and the associated multipliers can be readily used to determine the
36 impact of changes in recreational expenditures through the estimation of multipliers for each
37 sector in the multi-county region in which recreational expenditures occur. These multipliers
38 typically give the total (direct plus indirect plus induced) benefits to the region in terms of
39 employment, income, and taxes. Input-output data includes information for 440 separate North
40 American Industry Classification System (NAICS) industries used by the U.S. Department of
41 Commerce, Bureau of Economic Analysis. These accounts show the flow of commodities between
42 industries and institutional consumers. Industries represented are those in agriculture, mining,
43 construction, manufacturing, wholesale and retail trade, utilities, finance, insurance and real estate,
44 and consumer and business services. Each industry is described in terms of its purchases from, and
45 sales to, all other industries in the local economy.

46

1 Input-output accounts also provide information on value added by industry, and sales by
2 industry, to final demand. Value added includes employee compensation (wages and salary
3 payments, benefits, life insurance, retirement, etc.), proprietary income (payments received by
4 self-employed individuals as income), other property-type income (payments received from
5 royalties and dividends), and indirect business taxes (primarily excise and sales taxes paid by
6 individuals to businesses). Final demands include personal consumption expenditures (payments
7 by individuals/households to industries for goods and services used for personal consumption),
8 federal government (military and nonmilitary) purchases and sales, state and local government
9 (public education and non-education) purchases and sales, inventory purchases (unsold annual
10 output), sales (where inventory reduction exceeds additions from production), capital formation
11 (expenditures made to obtain capital equipment), and exports outside the region and nation.
12

13 Estimates of the regional economic impacts of changes in recreation expenditure came
14 from the IMPLAN model, an “off-the-shelf” model produced by IMPLAN Group, LLC, that
15 provides county-level and state-level input-output data. The model allows detailed analysis of the
16 impacts of changes in recreation expenditures by mapping changes in expenditures by item (gas,
17 food, lodging, etc.) into the appropriate sectors in the model, and then using IMPLAN multipliers
18 to provide estimates of indirect effects and total effects, by alternative, activity type, and year in
19 terms of employment (full-time equivalent staff, or ftes), income (\$m), and the various
20 components of value added (\$m), including employment compensation, proprietor income, and tax
21 revenues.
22
23

24 **L.1.4 Estimates of Recreational Economic Impacts**

25

26 Glen Canyon and Grand Canyon attract large numbers of visitors every year
27 (see Section 3.10), and expenditures on gas, food and drink, lodging, guide services, and outdoor
28 equipment are substantial. They produce direct income and employment both in sectors of the
29 economy in which expenditures occur, and in the remainder of the economy; wages and salaries,
30 and dollars spent on the purchases of goods and services, in these sectors circulate through the
31 regional economy, producing indirect effects (effects in other industries) and induced effects
32 (household effects). In 2011, spending by visitors to the Glen Canyon National Recreational
33 Area, Grand Canyon National Park, and Lake Mead National Recreational Area produced
34 10,301 direct, indirect, and induced jobs and \$373.7 million in total income (Table L-1).
35

36 As part of the overall impact of recreational visitation, various studies have attempted to
37 estimate the regional economic impacts of specific recreational activities. Douglas and Harpman
38 (1995) estimated that Glen Canyon and Grand Canyon recreational use in the region comprised
39 of Coconino and Mojave Counties supported approximately 585 jobs. More recently, Hjerpe and
40 Kim (2007) estimated that Grand Canyon boating recreation spending supported approximately
41 394 jobs in Coconino County, with commercial boating producing the majority (357) of the jobs
42 created; Douglas (2005) found that whitewater boating in Grand Canyon National Park
43 supported 438 jobs.
44

1
2

TABLE L-1 Total Regional Economic Impacts (Direct, Indirect, and Induced) of Non-Local Recreation Expenditures, 2013

| Parameter | Glen Canyon National Recreation Area | Grand Canyon National Park | Lake Mead National Recreation Area | Total |
|---------------------------|--------------------------------------|----------------------------|------------------------------------|--------|
| Employment | 1,435 | 6,238 | 2,628 | 10,301 |
| Income (\$m 2013 dollars) | 39.3 | 235.9 | 98.5 | 373.7 |

Source: Thomas et al. (2014).

3
4
5
6
7
8
9
10
11

In addition to the economic impacts of recreational visitation in Glen Canyon and Grand Canyon, recreation in the region also provides employment and income for Navajo tradespeople selling jewelry and souvenirs to the traveling public along various routes in the region; jewelry production and sales provides 400 to 700 jobs (Reclamation 2011). Jobs held by the Navajo people are especially important because wage earners usually support extended families.

12 **L.2 REGIONAL ELECTRICITY ANALYSES**

13
14

15 **L.2.1 Regional Electricity Price Impacts**

16
17
18
19
20
21

The analysis of increases in electricity rates considered (1) changes in customer utility electricity prices resulting from changes in Glen Canyon Dam operations; and (2) impacts of constructing and operating additional power plants with customer utility capacity expansion plans to replace energy and capacity previously provided by Western

22 Analyses were conducted in the seven-state region in which Western markets power: Arizona, Colorado, Nebraska, Nevada, New Mexico, Utah, and Wyoming. This includes the service territories of the eight major Western customer utilities:

23
24
25
26
27
28
29
30
31
32
33
34
35

- Colorado Springs Utilities,
- Deseret Generation and Transmission Cooperative,
- Navajo Tribal Utility Authority,
- Platte River Power Authority,
- Salt River Project,

- 1 • Tri-State Generation and Transmission,
- 2
- 3 • Utah Municipal Power Agency, and
- 4
- 5 • Utah Associated Municipal Power Systems.
- 6

7 Separate analyses considered the following:

- 8
- 9 • The effects changes in Glen Canyon operations and changes in power
- 10 marketing by the Colorado River Storage Project (CRSP) would have on
- 11 wholesale electricity rates charged to customer utilities, by state and customer
- 12 utility, from the GTMax/GTMax Lite models (see Appendix H); and
- 13
- 14 • The impacts changes in Glen Canyon and CRSP electricity rates would have
- 15 on commercial, industrial, and residential electricity rates charged by the eight
- 16 largest Western customer utilities, by state and customer utility, from the
- 17 ratepayer analysis (see Appendix K).
- 18

19 Data used to analyze the regional economic impact of increases in electricity prices
20 consisted of the following:

- 21
- 22 • Current and forecasted electricity prices, by state, from Energy Information
- 23 Administration (EIA) data and other sources; and
- 24
- 25 • Estimates of the response in customer demand to changes in electricity prices
- 26 (elasticities) for each customer class—commercial, industrial, and
- 27 residential—taken from the technical and academic literature.
- 28

29 IMPLAN input-output models (see Section L.1), were used to estimate the regional
30 economic impacts of changes in electricity prices, with a separate IMPLAN model representing
31 each of the seven states in the Western marketing area. The analysis involved a number of steps:

- 32
- 33 • Aggregation of sectors in each state input-output models into the three
- 34 customer classes: commercial, industrial, and residential;
- 35
- 36 • Calculation of electricity expenditure shares for each customer class; and
- 37
- 38 • Calculation of IMPLAN multipliers for each customer class.
- 39

40 These data, combined with changes in prices and price elasticities, give the total (direct
41 plus indirect plus induced) impact of changes in aggregate electricity prices on the economy of
42 each state, by alternative, state, and year, in terms of employment (fres), income (\$m), and the
43 various components of value added (\$m), including employment compensation, proprietor income,
44 and tax revenues. The major analytical modeling steps are shown in Figure L-4.

45

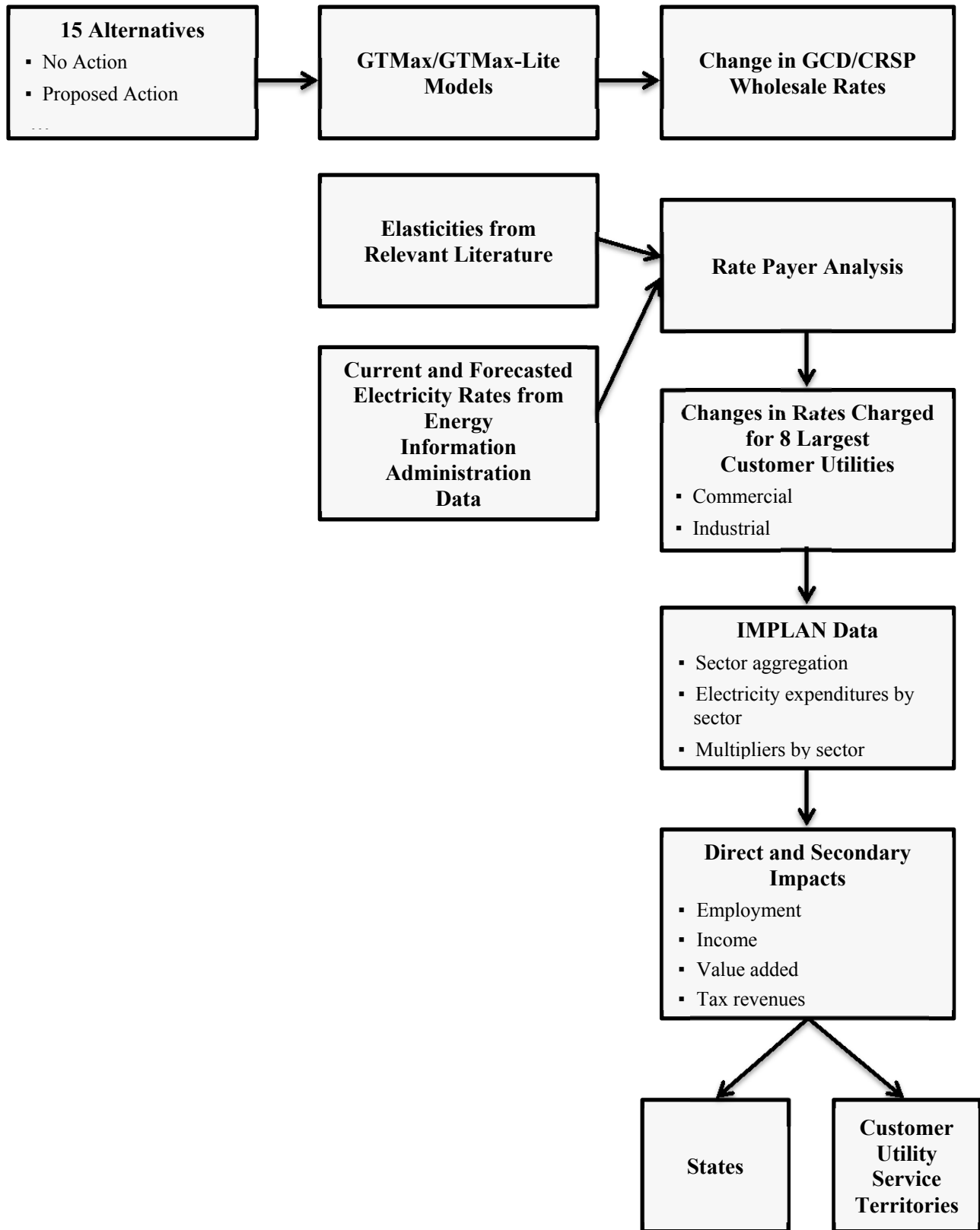

1
2
3

FIGURE L-4 Elements of the Regional Electricity Price Impacts Analysis

1 **L.2.2 Regional Electricity Generating Capacity Expansion Impacts**
2

3 Analysis of the effects changes in Glen Canyon operations would have on electricity rates
4 and capacity expansion required data on capital and operating expenditures, by alternative,
5 including the following:
6

- 7 • Capacity expansion requirements, by state and customer utility, from the
8 GTMax/GTMax Lite models (see Appendix K); and
9
- 10 • Expenditures on materials, equipment, services, direct and indirect labor, by
11 year, from appropriate projects (similar in terms of fuel type, technology, size,
12 and location), from the Jobs and Economic Development Impact (JEDI)
13 model (NREL 2015).
14

15 Capacity expansion capital and operating expenditures were mapped into the appropriate sectors
16 in an IMPLAN input-output model for each state, which were then used to estimate the
17 appropriate multipliers to provide estimates of indirect effects and total effects, by alternative and
18 year, in terms of employment (ftes), income (\$m), and the various components of value added
19 (\$m), including employment compensation, proprietor income, and tax revenues. The major
20 analytical modeling steps are shown in Figure L-5.
21
22

23 **L.3 ADDITIONAL SOCIOECONOMIC DATA**
24

25 Table L-2 contains data pertaining to population, median household income, and poverty
26 in each community in the six-county affected environment forming the basis of the regional
27 recreational economy.
28
29

30 **L.3.1 Urban Population in the Six-County Region**
31

32 Within the six counties in 2010, there were 86 places identified by the U.S. Census
33 Bureau in the region of influence (ROI), including incorporated cities and Census Designated
34 Places CDPs (unincorporated areas). The population of the ROI in 2010 was 83% urban; the
35 largest town, St. George, Utah, had a 2010 population of 72,897; other places in the ROI with
36 more than 10,000 inhabitants include Flagstaff (65,870), Lake Havasu City (52,527), Bullhead
37 City (39,540), Kingman (28,068), New Kingman-Butler (12,134), and Sedona (10,031), all of
38 which are in Arizona. There were 27 smaller towns in the ROI with 2010 populations of between
39 1,000 and 10,000, and an additional 50 places with populations of less than 1,000.
40

41 Urban population in the ROI grew at an average annual rate of 2.9% over the period from
42 2000 to 2010, although growth rates within the ROI varied considerably. Winslow West,
43 Arizona, grew at an average annual rate of 12.8%; Spanish Valley, Utah, at 10.5%; and Arizona
44 Village, Arizona, at 10.4% during this period, with higher than average growth also experienced
45 in Washington, Utah (8.6%); Mesquite Creek, Arizona (7.3%); Mojave Ranch Estates, Arizona
46 (6.4%); Golden Valley, Arizona (6.4%); Peach Springs, Arizona (6.2%); and Willow Valley,

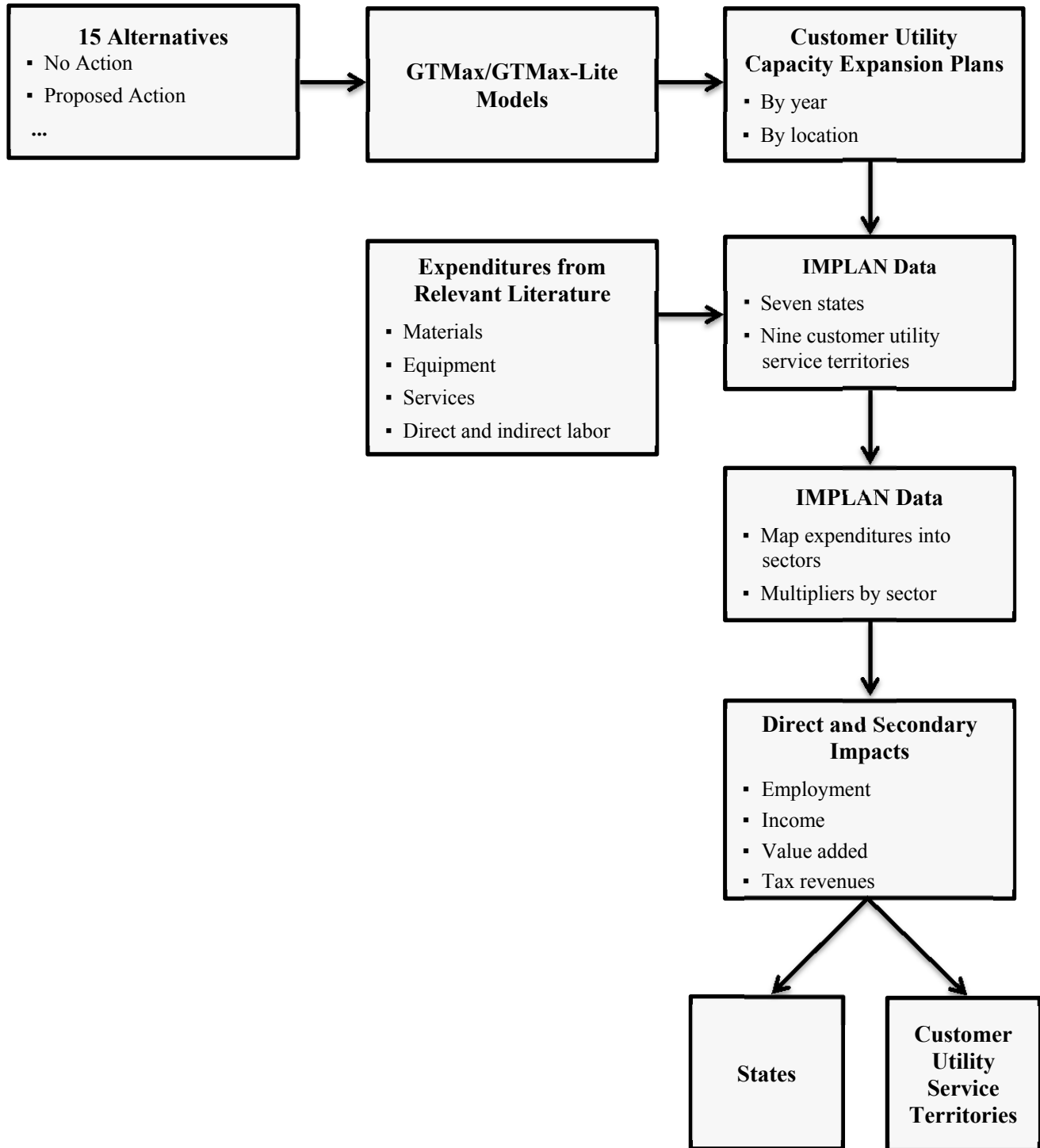

1

2 **FIGURE L-5 Elements of the Regional Electricity Generating Capacity Expansion Impacts**
 3 **Analysis**

4

1 **TABLE L-2 Urban Population, Income, and Poverty in the Six-County Region**

| City | Population | | | Median Household Income | | | Percent of Individuals Living in Poverty, 2010 |
|-----------------------------|------------|--------|-------------------------------------------------------|---------------------------|---------------------------|-------------------------------------------------------|------------------------------------------------------------|
| | 2000 | 2010 | Average Annual Growth Rate, 2000–2010 (%) | 2000 (2013 dollars) | 2010 (2013 dollars) | Average Annual Growth Rate, 2000–2010 (%) | |
| Alton | 134 | 119 | -1.2 | 41,712 | 51,414 | 2.1 | 31.4 |
| Aneth CDP | 598 | 501 | -1.8 | 23,393 | 22,435 | -0.4 | 54.2 |
| Antimony | 122 | 122 | 0.0 | 30,439 | 31,160 | 0.2 | 32.9 |
| Apple Valley | NA | 701 | NA ^a | NA | 67,365 | NA | 1.6 |
| Arizona Village | 351 | 946 | 10.4 | 35,723 | 44,549 | 2.2 | 25.6 |
| Big Water | 417 | 475 | 1.3 | 40,961 | 32,623 | -2.3 | 19.9 |
| Bitter Springs CDP | 547 | 452 | -1.9 | 33,666 | 44,350 | 2.8 | 33.5 |
| Blanding | 3,162 | 3,375 | 0.7 | 44,631 | 46,949 | 0.5 | 23.0 |
| Bluff CDP | 320 | 258 | -2.1 | 32,341 | 38,801 | 1.8 | 35.4 |
| Boulder | 180 | 226 | 2.3 | 40,585 | 46,618 | 1.4 | 0.0 |
| Bryce Canyon City | NA | 198 | NA | NA | 36,724 | NA | 0.0 |
| Bullhead City | 33,769 | 39,540 | 1.6 | 40,884 | 39,047 | -0.5 | 20.7 |
| Cameron CDP | 978 | 885 | -1.0 | 33,514 | 23,916 | -3.3 | 46.1 |
| Cannonville | 148 | 167 | 1.2 | 38,894 | 47,407 | 2.0 | 7.5 |
| Central | NA | 645 | NA | NA | 50,951 | NA | 6.0 |
| Colorado City | 3,334 | 4,821 | 3.8 | 44,408 | 43,115 | -0.3 | 35.3 |
| Dammeron Valley | NA | 803 | NA | NA | 66,400 | NA | 6.4 |
| Desert Hills | 2,183 | 2,245 | 0.3 | 36,091 | 40,971 | 1.3 | 20.8 |
| Dolan Springs | 1,867 | 2,033 | 0.9 | 23,411 | 33,736 | 3.7 | 8.2 |
| Doney Park CDP | NA | 5,395 | NA | NA | 79,457 | NA | 7.2 |
| Enterprise | 1,285 | 605 | -7.3 | | | | 0.0 |
| Escalante | 818 | 797 | -0.3 | 43,484 | 44,363 | 0.2 | 7.5 |
| Flagstaff | 52,894 | 65,870 | 2.2 | 50,252 | 52,852 | 0.5 | 19.4 |
| Fredonia | 1,036 | 1,314 | 2.4 | 40,974 | 45,168 | 1.0 | 7.0 |
| Glendale | 355 | 381 | 0.7 | 48,618 | 51,580 | 0.6 | 15.0 |
| Golden Valley | 4,515 | 8,370 | 6.4 | 37,686 | 36,477 | -0.3 | 15.7 |
| Grand Canyon Village CDP | 1,460 | 2,004 | 3.2 | 56,931 | 49,731 | -1.3 | 13.5 |
| Halchita CDP | 270 | 266 | -0.1 | 13,359 | 12,383 | -0.8 | 47.1 |
| Halls Crossing CDP | 89 | 6 | -23.6 | 36,033 | NA | NA | 0.0 |
| Hatch | 127 | 133 | 0.5 | 50,167 | 48,576 | -0.3 | 0.7 |
| Henrieville | 159 | 230 | 3.8 | 38,556 | 60,391 | 4.6 | 12.1 |
| Hildale | 1,895 | 2,726 | 3.7 | 44,209 | 32,623 | -3.0 | 50.3 |
| Hurricane | 8,250 | 13,748 | 5.2 | 44,461 | 54,311 | 2.0 | 7.9 |
| Ivins | 4,450 | 6,753 | 4.3 | 55,868 | 53,417 | -0.4 | 13.4 |
| Kachina Village CDP | 2,664 | 2,622 | -0.2 | 61,828 | 50,975 | -1.9 | 4.4 |
| Kaibab CDP | 275 | 124 | -7.7 | 29,029 | 32,451 | 1.1 | 24.8 |
| Kaibito CDP | 1,607 | 1,522 | -0.5 | 49,040 | 34,350 | -3.5 | 31.6 |
| Kanab | 3,564 | 4,312 | 1.9 | 47,518 | 45,176 | -0.5 | 6.5 |
| Kingman | 20,069 | 28,068 | 3.4 | 46,112 | 46,845 | 0.2 | 13.2 |
| La Sal CDP | 339 | 395 | 1.5 | 35,073 | 58,457 | 5.2 | 0.0 |

2

TABLE L-2 (Cont.)

| City | Population | | | Median Household Income | | | Percent of Individuals Living in Poverty, 2010 |
|-------------------------------|------------|--------|-------------------------------------------------------|---------------------------|---------------------------|-------------------------------------------------------|------------------------------------------------------------|
| | 2000 | 2010 | Average Annual Growth Rate, 2000–2010 (%) | 2000 (2013 dollars) | 2010 (2013 dollars) | Average Annual Growth Rate, 2000–2010 (%) | |
| La Verkin | 3,392 | 4,060 | 1.8 | 48,633 | 47,997 | -0.1 | 14.8 |
| Lake Havasu City | 41,938 | 52,527 | 2.3 | 49,377 | 46,630 | -0.6 | 11.6 |
| LeChee CDP | 1,606 | 1,443 | -1.1 | 65,443 | 59,912 | -0.9 | 20.7 |
| Leeds | 547 | 820 | 4.1 | 55,804 | 54,936 | -0.2 | 8.3 |
| Leupp CDP | 970 | 951 | -0.2 | 29,029 | 30,848 | 0.6 | 29.8 |
| Mesquite Creek | 205 | 416 | 7.3 | 44,812 | 46,206 | 0.3 | 23.7 |
| Mexican Hat CDP | 88 | 31 | -9.9 | 77,999 | NA | NA | 0.0 |
| Moenkopi CDP | 901 | 964 | 0.7 | 52,368 | 56,229 | 0.7 | 33.5 |
| Mohave Valley | 13,694 | 2,616 | -15.3 | 46,430 | 57,353 | 2.1 | 11.8 |
| Mohave Ranch Estates | 28 | 52 | 6.4 | NA | 43,179 | NA | 0.0 |
| Montezuma Creek CDP | 507 | 335 | -4.1 | 39,739 | 32,851 | -1.9 | 23.4 |
| Monticello | 1,958 | 1,972 | 0.1 | 48,606 | 42,026 | -1.4 | 8.8 |
| Mountaineer CDP | 1,014 | 1,119 | 1.0 | 55,804 | 67,333 | 1.9 | 3.5 |
| Munds Park CDP | 1,250 | 631 | -6.6 | 56,050 | 59,620 | 0.6 | 3.8 |
| Navajo Mountain CDP | 379 | 354 | -0.7 | 19,205 | 46,473 | 9.2 | 24.1 |
| New Harmony | 190 | 207 | 0.9 | 46,785 | 45,071 | -0.4 | 3.1 |
| New Kingman-Butler | 14,810 | 12,134 | -2.0 | 35,061 | 31,765 | -1.0 | 23.0 |
| Oljato-Monument Valley CDP | 864 | 674 | -2.5 | 43,545 | 47,742 | 0.9 | 40.6 |
| Orderville | 596 | 577 | -0.3 | 48,389 | 34,357 | -3.4 | 16.0 |
| Page | 6,809 | 7,247 | 0.6 | 63,495 | 53,787 | -1.6 | 17.2 |
| Panguitch | 1,623 | 1,520 | -0.7 | 45,320 | 43,910 | -0.3 | 14.0 |
| Parks CDP | 1,137 | 1,188 | 0.4 | 53,959 | 66,850 | 2.2 | 8.4 |
| Peach Springs | 600 | 1,090 | 6.2 | 24,613 | 45,636 | 6.4 | 40.0 |
| Pine Valley | NA | 186 | NA | NA | 81,015 | NA | 0.0 |
| Rockville | 247 | 245 | -0.1 | 51,295 | 44,069 | -1.5 | 6.5 |
| Santa Clara | 4,630 | 6,003 | 2.6 | 71,389 | 73,078 | 0.2 | 3.4 |
| Sedona | 10,192 | 10,031 | -0.2 | 59,581 | 53,149 | -1.1 | 10.8 |
| Spanish Valley CDP | 181 | 491 | 10.5 | 67,923 | 74,055 | 0.9 | 0.0 |
| Springdale | 457 | 529 | 1.5 | 56,287 | 38,727 | -3.7 | 2.6 |
| St. George | 49,663 | 72,897 | 3.9 | 49,385 | 51,815 | 0.5 | 11.1 |
| Supai CDP | 0 | 208 | NA | 0 | 40,063 | NA | 48.0 |
| Tonalea CDP | 562 | 549 | -0.2 | 43,370 | 15,357 | -9.9 | 46.5 |
| Toquerville | 910 | 1,370 | 4.2 | 46,048 | 48,648 | | 12.2 |
| Tropic | 508 | 530 | 0.4 | 57,495 | 64,354 | 1.1 | 7.6 |
| Tselakai Dezza CDP | 103 | 109 | 0.6 | 63,921 | 144,726 | 8.5 | 7.5 |
| Tuba City CDP | 8,225 | 8,611 | 0.5 | 52,160 | 49,509 | -0.5 | 24.5 |
| Tusayan CDP | 562 | 558 | -0.1 | 47,237 | 53,468 | 1.2 | 6.6 |
| Valle CDP | NA | 832 | NA | NA | 31,511 | NA | 36.4 |
| Veyo | NA | 483 | NA | NA | 31,511 | NA | 4.6 |
| Virgin | 394 | 596 | 4.2 | NA | 52,160 | NA | 4.5 |
| Washington | 8,196 | 18,761 | 8.6 | 47,810 | 55,407 | 1.5 | 11.7 |

TABLE L-2 (Cont.)

| City | Population | | Average Annual Growth Rate, 2000–2010 (%) | Median Household Income | | Average Annual Growth Rate, 2000–2010 (%) | Percent of Individuals Living in Poverty, 2010 |
|------------------|------------|-------|-------------------------------------------|-------------------------|---------------------|-------------------------------------------|------------------------------------------------|
| | 2000 | 2010 | | 2000 (2013 dollars) | 2010 (2013 dollars) | | |
| White Mesa CDP | 277 | 242 | -1.3 | 18,601 | 21,100 | 1.3 | 37.7 |
| Williams | 2,842 | 3,023 | 0.6 | 43,906 | 46,072 | 0.5 | 19.3 |
| Willow Valley | 585 | 1,062 | 6.1 | 53,099 | 37,577 | -3.4 | 23.5 |
| Winslow West CDP | 131 | 438 | 12.8 | 11,161 | 35,122 | 12.1 | 45.9 |

^a NA = data not available.

Source: U.S. Census Bureau (2013).

1
 2
 3 Arizona (6.1%). The remaining places experienced lower growth rates between 2000 and 2010,
 4 with 29 places experiencing negative growth rates during this period. Rural population in the
 5 ROI grew at an annual average rate of 7.5% between 2000 and 2010.

6
 7
 8 **L.3.2 Urban Income in the Six-County Region**

9
 10 Median household incomes in 2010 varied considerably across places in the ROI. Ten
 11 places in the Arizona portion of the ROI had median incomes that were higher than the average
 12 for the state (\$50,991); these included Doney Park (\$79,457), Mountaineer (\$67,333), Parks
 13 (\$66,850), LeChee (\$59,912), Munds Park (\$59,620), Mohave Valley (\$57,353), and Moenkopi
 14 (\$56,229). Twenty-eight places in the Arizona portion of the ROI had median incomes lower
 15 than the state average, and two places, Cameron (\$23,916) and Tonalea (\$15,357), had incomes
 16 that were less than half that of the state average. In 21 places, more than 20% of individuals were
 17 living in poverty, with poverty particularly marked in four communities, Supai (48.0% of
 18 individuals), Tonalea (46.5%), Cameron (46.1%), and Winslow West (45.9%).

19
 20 Nine places in in the Utah portion of the ROI had median incomes higher than the state
 21 average (\$59,014) in 2010; these included Tselakai Dezza (\$144,726), Enterprise (\$104,585),
 22 Pine Valley (\$81,015), Spanish Valley (\$74,055), and Santa Clara (\$73,078). Thirty-six places
 23 had median incomes lower than the state average, and three places, Aneth (\$22,435), White
 24 Mesa (\$21,100), and Halchita (\$12,383), had incomes that were less than half the state average.
 25 In 11 places, more than 20% of individuals were living in poverty, with higher poverty levels in
 26 four communities, Aneth (54.2% of individuals), Hildale (50.3%), Halchita (47.1%), and Oljato-
 27 Monument Valley (40.6%).

28
 29 Median income growth rates within the ROI varied considerably over the period from
 30 2000 to 2010. In the Arizona portion of the ROI, 39 places had annual average growth rates

1 higher than the state rate (−0.7%), with high growth rates in Winslow West (12.1%) and Peach
2 Springs (6.4%) during this period. The remaining places experienced lower growth rates between
3 2000 and 2010, with 15 places experiencing negative growth rates. In the Utah portion of the
4 ROI, 24 places had annual average growth rates higher than the state rate (−0.6%), including
5 Navajo Mountain (9.2%), Tselakai-Dezza (8.5%), and Enterprise (8.0%). The remaining places
6 experienced lower growth rates between 2000 and 2010, with 16 places experiencing negative
7 growth rates.
8
9

10 **L.4 REFERENCES**

11
12 Bishop, R., K. Boyle, M. Welsh, R. Baumgartner, and P. Rathbun, 1987, *Glen Canyon Dam*
13 *Releases and Downstream Recreation: An Analysis of User Preferences and Economic Values*,
14 Glen Canyon Environmental Studies Report No. 27/87, Bureau of Reclamation, Washington,
15 D.C.
16

17 Douglas, A., 2005, *Colorado River Environmental and Recreational Values below Glen Canyon*
18 *Dam: Fort Collins, Colo.*, U.S. Geological Survey.
19

20 Douglas, A., and D. Harpman, 1995, “Estimating Recreation Employment Effects with IMPLAN
21 for the Glen Canyon Dam Region,” *Journal of Environmental Management* 44:233–247.
22

23 Duffield, J., and D. Patterson, 1991, “Inference and Optimal Design for a Welfare Measure in
24 Logistic Contingent Valuation,” *Land Economics*, 67:225–239.
25

26 Hanemann, M., J. Loomis, and B. Kanninen, 1991, “Statistical Efficiency of Double-Bounded
27 Dichotomous Choice Contingent Valuation,” *American Journal of Agricultural Economics*
28 73:1255–1263.
29

30 Hjerpe, E., and Y.-S. Kim, 2007, “Regional Economic Impacts of Grand Canyon River
31 Runners,” *Journal of Environmental Management* 85:137–149.
32

33 Loomis, J.B., 1989, “Test-Retest Reliability of the Contingent Valuation Method: A Comparison
34 of General Population and Visitor Responses,” *American Journal of Agricultural Economics*
35 71:76–84.
36

37 National Research Council, 1999, *Downstream: Adaptive Management of Glen Canyon Dam*
38 *and the Colorado River Ecosystem*, National Academy Press, Washington, D.C.
39

40 National Research Council, 2005, *Valuing Ecosystem Services: Toward Better Environmental*
41 *Decision-making*, National Academy Press, Washington, D.C.
42

43 Neher, C., J. Duffield, and D. Patterson, 2013, “Modeling the Influence of Water Levels on
44 Recreational Use at Lakes Mead and Powell,” *Lake and Reservoir Management* 29(4):233–246.
45

- 1 NREL (National Renewable Energy Laboratory), 2015, *Jobs and Economic Development Impact*
2 *(JEDI) Model Homepage*. Available at <http://www.nrel.gov/analysis/jedi>.
3
- 4 Reclamation (Bureau of Reclamation), 2011, *Environmental Assessment: Non-Native Fish*
5 *Control Downstream from Glen Canyon*, Dec. Available at [http://www.usbr.gov/uc/envdocs/](http://www.usbr.gov/uc/envdocs/ea/gc/nafc/index.html)
6 [ea/gc/nafc/index.html](http://www.usbr.gov/uc/envdocs/ea/gc/nafc/index.html).
7
- 8 Reclamation, 2014, *Recreation Economic Analysis for the Long-Term Experimental and*
9 *Management Plan Environmental Impact Statement*, Draft Economics Technical Report
10 EC-2014-03, June 24.
11
- 12 RTI International, 2012, *Klamath River Basin Restoration Non Use Value Survey – Final Report*,
13 prepared for U.S. Bureau of Reclamation, Jan. Available at [http://klamathrestoration.gov/sites/](http://klamathrestoration.gov/sites/klamathrestoration.gov/files/DDDDD.Printable.Klamath%20Nonuse%20Survey%20Final%20Report%202012%5B1%5D.pdf)
14 [klamathrestoration.gov/files/DDDDD.Printable.Klamath%20Nonuse%20Survey%20Final%20R](http://klamathrestoration.gov/sites/klamathrestoration.gov/files/DDDDD.Printable.Klamath%20Nonuse%20Survey%20Final%20Report%202012%5B1%5D.pdf)
15 [eport%202012%5B1%5D.pdf](http://klamathrestoration.gov/sites/klamathrestoration.gov/files/DDDDD.Printable.Klamath%20Nonuse%20Survey%20Final%20Report%202012%5B1%5D.pdf).
16
- 17 Sanders, L., R. Walsh, and J. Loomis, 1990, “Toward Empirical Estimation of the Total Value of
18 Protecting Rivers,” *Water Resources Research*, 26(7):1345–1357.
19
- 20 Sutherland, R., and R. Walsh, 1985, “Effect of Distance on the Preservation Value of Water
21 Quality,” *Land Economics* 61:281–291.
22
- 23 Thomas, C., C. Huber, and L. Koontz, 2014, *2012 National Park Visitor Spending Effects:*
24 *Economic Contributions to Local Communities, States and the Nation*, Natural Resource Report
25 NPS/NRSS/EQD/NRR-2014/765, U.S. Department of the Interior, Feb. Available at
26 http://www.nature.nps.gov/socialscience/docs/NPSVSE2012_final_nrss.pdf.
27
- 28 U.S. Census Bureau, 2013, *American Fact Finder*. Available at [http://factfinder2.census.gov/](http://factfinder2.census.gov/faces/nav/jsf/pages/index.xhtml)
29 [faces/nav/jsf/pages/index.xhtml](http://factfinder2.census.gov/faces/nav/jsf/pages/index.xhtml).
30
- 31 U.S. Department of the Interior, 2012, *Economics and Tribal Summary Technical Report for the*
32 *Secretarial Determination on Whether to Remove Four Dams on the Klamath River in California*
33 *and Oregon*, Denver CO. Available at [http://klamathrestoration.gov/sites/klamathrestoration.gov/](http://klamathrestoration.gov/sites/klamathrestoration.gov/files/2013%20Updates/Econ%20Studies%20h.Economics_Tribal_FULL_7-24-2012(accessible).pdf)
34 [files/2013%20Updates/Econ%20Studies%20h.Economics_Tribal_FULL_7-24-](http://klamathrestoration.gov/sites/klamathrestoration.gov/files/2013%20Updates/Econ%20Studies%20h.Economics_Tribal_FULL_7-24-2012(accessible).pdf)
35 [2012\(accessible\).pdf](http://klamathrestoration.gov/sites/klamathrestoration.gov/files/2013%20Updates/Econ%20Studies%20h.Economics_Tribal_FULL_7-24-2012(accessible).pdf).
36
- 37 Vossler, C., and M. Evans, 2009, “Bridging the Gap between the Field and the Lab:
38 Environmental Goods, Policy Maker Input, and Consequentiality,” *Journal of Environmental*
39 *Economics and Management* 58:338–345.
40
- 41 Vossler C., M. Doyon, and D. Rondeau, 2012, “Truth in Consequentiality: Theory and Field
42 Evidence on Discrete Choice Experiments,” *American Economic Journal: Microeconomics*
43 4:145–171.
44
- 45 Welsh, M., R. Bishop, M. Phillips, and R. Baumgartner, 1995, *Glen Canyon Dam, Colorado*
46 *River Storage Project, Arizona—Nonuse Value Study Final Report*, Madison, Wisc.

1
2
3
4
5
6
7
8
9
10
11
12
13
14

This page intentionally left blank

1
2
3
4
5
6
7
8
9
10
11
12
13
14
15
16
17

APPENDIX M:
AIR QUALITY AND CLIMATE CHANGE
TECHNICAL INFORMATION AND ANALYSIS

1
2
3
4
5
6
7
8
9
10
11
12
13
14
15

This page intentionally left blank

APPENDIX M:

**AIR QUALITY AND CLIMATE CHANGE
TECHNICAL INFORMATION AND ANALYSIS**

This appendix provides a description of the analysis used to evaluate the impacts of the alternatives considered in the Glen Canyon Dam Long-Term Experimental and Management Plan (LTEMP) Draft Environmental Impact Statement (DEIS). Glen Canyon Dam hydropower generation does not generate air emissions. However, dam operations can affect air emissions and ambient air quality over the 11-state Western Interconnection, comprising Arizona, California, Colorado, Idaho, Montana, Nevada, New Mexico, Oregon, Utah, Washington, and Wyoming, because hydropower generation offsets generation from other non-hydropower generating facilities in the SLCA/IP and in the Western Interconnection via the spot market. Differences among alternatives in the amount of Glen Canyon Dam generation at peak demand hours could affect regional air emissions, through differences in the technology mix of compensating generating facilities within SLCA/IP and, if SLCA/IP generation is insufficient to meet Western's long-term firm contract obligations, through generation from combustion sources in the greater Western Interconnection accessed via the spot market..

Air quality issues within the study area include visibility degradation in Federal Class I areas. Coal, natural gas, and oil units emit SO₂ and NO_x, which are precursors to sulfate and nitrate aerosols, respectively. These aerosols play an important role in visibility degradation by contributing to haze. Among anthropogenic sources, sulfate is a primary contributor to regional haze in the Grand Canyon, and nitrate is a minor contributor. Effects on visibility are analyzed through a comparison of regional SO₂ and NO_x emissions under the various alternatives.

Differences among alternatives in the amount and timing of Glen Canyon Dam generation directly affect the generation needed from coal, natural gas, or oil units within the 11-state Western Interconnection region of which the SLCA/IP system is a part, from the wholesale power market. As described in Section M.2, changes in generation from facilities within this interconnected system under various LTEMP alternatives result in small changes in total emissions due to similarly small differences in emissions from the contributing facilities.

Effects on visibility were analyzed through a comparison of SO₂ and NO_x emissions under the various alternatives. SO₂ and NO_x are also criteria air pollutants with limits on ambient concentrations under the National Ambient Air Quality Standards (NAAQS). Alternatives were compared on the basis of total emissions of these two pollutants from the contributing generation facilities in the interconnected system.

Electricity generation of combustion facilities in the system produces CO₂ and other greenhouse gases (GHGs). LTEMP alternatives can affect GHG emissions through changes in Glen Canyon Dam operations and related changes in GHG emissions of interconnected combustion facilities, as for SO₂ and NO_x. For the purpose of this analysis, the principal GHG of concern is CO₂, which accounts for over 99% of GHG emissions related to power generation.

1 However, facility- or technology-specific GHG emission factors also consider other GHGs, such
2 as methane (CH₄) and nitrous oxide (N₂O), which may be emitted during facility operations.
3
4

5 **M.1 ANALYSIS METHODS**

6

7 To compute total air emissions under the LTEMP alternatives, emissions were summed
8 from all generating facilities in the SLCA/IP system. This analysis was tiered off the power
9 systems analysis (Section 4.13 of the DEIS and Appendix K), which estimated electrical power
10 generation for the same facilities under each of the alternatives, including base operations and
11 experimental flows such as high-flow experiments (HFEs), trout management flows, and low
12 summer flows. Emissions were estimated using emission factor and corresponding generation
13 level along with emission control efficiency for facilities equipped with a control system.
14 Emission factors (either lb/MWh for power output or lb/MMBtu for heat input) were taken from
15 standard references (EIA 2013; EPA 2014). Generation levels (either MWh/yr or MMBtu/yr)
16 were the estimated electricity generation of each facility and the electricity traded on the spot
17 market under each alternative by calendar year, which were obtained from the AURORA model
18 outputs described in Appendix K. Emissions were then estimated by multiplying emission
19 factors by electrical power generation. Emission controls were reflected in the emission factors
20 used. Table M-1 presents emission factors used for SO₂, NO_x, and GHGs by plant for individual
21 plants in the SLCA/IP system and the spot market. Table M-2 presents annual-average power
22 generation for the same plants and for the spot market.
23
24

25 **M.1.1 System Power Generation**

26

27 Table M-1 presents emission factors by power generation type for (1) specific existing
28 powerplants, (2) specific generating stations with multiple generating units under long-term
29 contract, (3) power generation under long-term contract where no generating units are specified,
30 and (4) future plants needed to provide additional capacity employing advanced gas
31 technologies. For specific powerplants in the SLCA/IP system, pollutant emission factors (in
32 lb/MWh) available in the *Emissions and Generation Resource Integrated Database* (eGRID)¹
33 with year 2010 data (EPA 2014) were used to estimate air emissions (Table M-1).
34

35 For advanced natural gas-fired simple cycle and combined cycle generating units to be
36 built in the future, emission factors for advanced combustion turbine (ACT) and advanced
37 generation natural gas combined cycle (AG-NGCC) in EIA (2013) were used with the following
38 values: 0.001 lb/MMBtu for SO₂ for both simple cycle (0.0098 lb/MWh) and combined cycle
39 (0.0064 lb/MWh); 0.03 lb/MMBtu (0.29 lb/MWh) for simple cycle and 0.0075 lb/MMBtu

¹ eGRID is a comprehensive inventory of environmental attributes of electric power systems. The preeminent source of air emissions data for the electric power sector, eGRID is based on available plant-specific data for all U.S. electricity generating plants that provide power to the electric grid and report data to the U.S. Government. eGRID plant-level emissions reflect monitored data, estimated data, or a combination of both.

1 (0.048 lb/MWh) for NO_x for combined cycle; and 117 lb/MMBtu for CO₂ for both simple cycle
2 (1,141 lb/MWh) and combined cycle (752 lb/MWh).
3

4 Since emission factors for future plants and plants under long-term contract (Coolidge
5 and Fort Lupton generating stations) are based on emissions per heat energy input (lb/MMBtu),
6 conversion to lb/MWh is needed to produce the values shown in Table M-1 for these entities.
7 Conversion factors were taken from the AURORA model outputs described in Appendix K and
8 had the following values (in units of MWh/MMBtu): 6.43 for advanced combined cycle; 9.75 for
9 advanced simple cycle; 9 for Coolidge; and 9.19 for Fort Lupton. For Brush 2 under long-term
10 contract, emission factors in the eGrid database were used.
11

12 The Coolidge Generating Station under long-term contract has 12 simple-cycle natural
13 gas-fired peaking units with a total capacity of 575 MW, which began service in 2011. For this
14 station, emission factors in lb/MMBtu for a conventional combustion turbine (CT) are assumed,
15 which are the same as those for ACT (EIA 2013). The Fort Lupton Cogeneration Powerplant is a
16 272-MW combined-cycle natural gas-fired station. For this station, emission factors in
17 lb/MMBtu for conventional natural gas combined cycle (NGCC) are assumed, which are the
18 same as those for AG-NGCC (EIA 2013).
19

20 For unspecified powerplants under long term-contract, composite emission factors were
21 employed that are representative of all types of powerplants (such as fossil fuel-fired,
22 hydroelectric, nuclear, and renewable resources) currently in operation over the 11-state Western
23 Interconnection region. Composite emission factors were estimated to be 0.74, 1.07, and
24 963 lb/MWh for SO₂, NO_x, and GHGs in units of CO₂ equivalents (CO₂e),² respectively. Note
25 that three plants (Kyrene, Rawhide, and Ray D. Nixon) have more than one generation type, but
26 only one plant-wide composite emission factor for each pollutant is given in the EPA's eGRID
27 database (EPA 2014). The available emission factors were applied to all generation at these three
28 plants.
29

30 31 **M.1.2 Spot Market** 32

33 For spot market purchases and sales, composite emission factors in Table M-1 were used
34 that are representative of power generation from gas powerplants currently in operation over the
35 Western Interconnection, based on the assumption that spot market generation is primarily to
36 serve peak loads. Composite emission factors were estimated to be 0.0083, 0.266, and
37 888 lb/MWh for SO₂, NO_x, and GHGs, respectively (EIA 2013).
38
39

² Emission factors for GHGs are expressed in CO₂ equivalent (CO₂e) for the long-term contract (unspecified generation type) and power stations available in the EPA's eGrid database. CO₂e is a measure used to compare the emissions from various GHGs on the basis of their global warming potential, defined as the ratio of heat trapped by one unit mass of the GHG to that of one unit mass of CO₂ over a specific time period (usually 100 years).

1 **M.1.3 Generation Type**
2

3 Tables M-1 and M-2 group plants and other generation entities according to the type of
4 generation technology used. Such grouping is for the purpose of understanding the differences in
5 emissions under various LTEMP alternatives due to differences in generation from contributing
6 generation technologies. Different operating regimes of Glen Canyon Dam under the various
7 LTEMP alternatives supply different proportions of baseload or peaking power. Peaking power
8 produced at the dam is assumed to displace power that would otherwise be produced by plants
9 using gas turbine technologies, while baseload power produced at the dam is assumed to displace
10 power produced by plants employing steam turbine technologies, most typically coal-fired
11 plants. Gas- and coal-fired technologies have distinctly different emission profiles and levels.
12 Gas plants emit far less SO₂ and NO_x than do coal-fired plants per unit of energy produced.
13 Different mixes of these two types of technologies under various alternatives is related to the
14 total levels of emissions. The technology groupings shown in Tables M-1 and M-2 are used
15 below in the reporting and interpretation of results.
16

17
18 **M.2 RESULTS**
19

20
21 **M.2.1 SO₂ and NO_x**
22

23 The potential effects on visibility from emissions of SO₂ and NO_x, which are precursors
24 of sulfate and nitrate aerosols, respectively, and which contribute to haze, are shown in
25 Table M-3 for LTEMP alternatives. The geographic area of potential visibility impacts
26 corresponds to the location of contributing powerplants in the SLCA/IP system and, to a small
27 degree, the 11-state Western Interconnection and includes Grand Canyon National Park. Because
28 the sources are geographically dispersed, effects would be similarly dispersed and low at any
29 particular location. Further, due to very small differences in SO₂ and NO_x precursor emissions,
30 negligible differences are expected among the alternatives with regard to visibility and haze in
31 the region.
32

33 Emissions of SO₂ and NO_x under various LTEMP alternatives are compared with respect
34 to air quality effects under NAAQS. Tables M-4 and M-5 show emissions of SO₂ and NO_x,
35 respectively, under each LTEMP alternative, from contributing plants (35 primary facilities) and
36 other contributing entities in the SLC/IP system, and presents subtotals of emissions by
37 generation technology type. These tables also show contributions from the spot market computed
38 according to the level of electrical power generated at each plant and entity, using the emission
39 factors in Table M-1.
40

41 Table M-6 presents a summary of total system emissions by generation technology type
42 drawn from Tables M-4 and M-5 for the generation facilities within the SCLA/IP system and
43 from contributions from the spot market. The 35 generating facilities within the SLCA/IP system
44 are categorized according to generation technology type, such as gas turbine or steam turbine
45 (usually coal-fired), so that contributing emissions can be summed by technology type across the
46 system to evaluate emissions from different technology mixes under alternatives. With respect to

1 the spot market entries in these tables, “sales” refers to sales of power by system utilities to non-
2 system utilities within the Western Interconnection. Sales result in a net credit to total Western
3 Interconnection emissions, because the sales result in a reduction in emissions from those non-
4 system utilities that are purchasing the power. “Purchases” refers to purchases by system utilities
5 from non-system utilities within the Western Interconnection. Emissions related to these
6 purchases are added to the total emissions in the Western Interconnection.
7

8 Total SO₂ and NO_x emissions in the system averaged over the 20-year LTEMP period
9 under Alternative A are estimated to be about 42,465 tons/yr and 78,496 tons/yr, respectively,
10 while emissions under other LTEMP alternatives are similar to those under Alternative A.
11 Differences in emissions of SO₂ and NO_x under LTEMP alternatives relative to those under
12 Alternative A are very small, at most -0.04% and correspond to average annual emission
13 differences that range from -18 to 5 tons/yr for SO₂ and -10 to 6 tons/yr for NO_x, compared to
14 those under Alternative A.
15

16 With respect to generation technology type, SO₂ and NO_x emissions within the SLCA/IP
17 system are dominated by steam turbine technologies, mainly coal-fired powerplants. Estimated
18 differences among alternatives reflect slight differences in the contributions from various
19 powerplant technologies; these are attributed to small differences in baseload and peaking energy
20 generated by Glen Canyon Dam. As noted above, gas turbine peaking plant technologies produce
21 lower SO₂ and lower NO_x emissions than baseload coal-fired plants. Thus, offsetting gas turbine
22 peaking power with hydropower from Glen Canyon Dam has a potentially lower effect on total
23 system emissions than does offsetting coal-fired baseload with baseload energy from Glen
24 Canyon Dam.
25

26 Table M-6 shows levels of electricity generation at Glen Canyon Dam in MWh/day that
27 would be produced under each LTEMP alternative. Differences in generation at the dam affect
28 the amount of power needed by other contributing generators in the system. Little difference
29 exists in generation at the dam among alternatives, which ranges from 11,438 MWh/day to
30 11,650 MWh/day. Alternative A produces the most energy, while Alternatives F and G produce
31 roughly 2% less hydropower energy than Alternative A (98.3% and 98.2%, respectively). This
32 reduction in generation is a consequence of the more frequent HFEs under these alternatives in
33 which a portion of flows bypass the powerplant turbines.
34

35 Despite the fact that the steady-flow Alternatives F and G generate less power at Glen
36 Canyon Dam than do the fluctuating-flow Alternatives A–E, and this lost generation must be
37 made up by additional generation at other facilities in the system, Alternatives F and G have the
38 lowest total emissions of all alternatives. This result may be explained by the operational regime
39 of the dam under these alternatives with respect to baseload or peaking power. Under steady-
40 flow Alternatives F and G, the dam produces baseload power which would displace baseload
41 power from other facilities in the system, mainly coal-fired (steam turbine) facilities with
42 relatively high emissions, while under fluctuating-flow Alternatives A–E, the dam produces a
43 portion of peaking power, which offsets gas-fired peaking plants in the system, with relatively
44 low emissions. See a more detailed discussion of this interpretation of results in Section 4.14.2 of
45 the DEIS.
46

1 **M.2.2 Greenhouse Gas Emissions**
2

3 Table M-7 presents emissions in CO₂e for contributing plants (approximately 35 primary
4 facilities) and other contributing entities in the SLC/IP system described above under each
5 LTEMP alternative and presents subtotals of emissions by generation technology type and for
6 contributions from the spot market. The spot market reflects the effects of Glen Canyon Dam
7 operations on the larger Western Interconnection region and represents an offset of about 1% of
8 system emissions. Emissions are computed from the level of electrical power generated at each
9 plant and entity under each alternative using the emission factors in Table M-1.
10

11 Table M-8 summarizes emissions in Table M-7 by technology type and presents total
12 emissions under the LTEMP alternatives. Total CO₂e emissions in the system averaged over the
13 20-year LTEMP period under Alternative A are estimated to be 55,177,668 MT/yr
14 (60,822,967 tons/yr), while emissions under other LTEMP alternatives are similar to those under
15 Alternative A. Differences in emissions of CO₂e from Alternative A are very small, and would
16 range from an increase of 0.011% (Alternative B) to 0.081% (Alternative F) and corresponds to
17 average emission increases that would range from 5,900 MT/yr (6,503 tons/yr) (Alternative B) to
18 44,522 MT/yr (49,077 tons/yr) (Alternative F), considering total emissions (system generation
19 plus spot market sales and purchases) compared to that under Alternative A. Alternatives C, D,
20 E, and G would have intermediate increases in CO₂e emissions of 18,161; 22,908; 16,503; and
21 40,960 MT/yr (0.033%, 0.042%, 0.030%, and 0.074%), respectively, compared to Alternative A.
22

23 With respect to generation technology type, CO₂e emissions are dominated (about 87%)
24 by steam turbine technologies within the system, mainly coal-fired powerplants, as is the case for
25 SO₂ and NO_x (about 98%). Estimated differences among alternatives reflect slight differences in
26 the contributions from various powerplant technologies providing baseload and peaking energy
27 in conjunction with Glen Canyon Dam, as discussed above for SO₂ and NO_x. Since gas turbine
28 peaking plant technologies produce about half the CO₂e emissions as baseload coal-fired plants
29 per unit of energy produced (Table M-1), offsetting gas turbine peaking power with hydropower
30 from Glen Canyon Dam has a potentially lower effect on total system emissions than does
31 offsetting coal-fired baseload with baseload energy from Glen Canyon Dam.
32

33 As shown in Table M-8, total CO₂e emissions are expected to be slightly higher for
34 steady-flow Alternatives F and G than for the fluctuating-flow alternatives A–E. These increases
35 in total emissions result mainly from relatively higher gas turbine emissions under Alternatives F
36 and G. Higher gas turbine emissions are, in turn, attributable to the lack of peaking power from
37 Glen Canyon Dam under the steady-flow alternatives, which require compensating peaking
38 power from gas turbine peaking plants within the system. As for SO₂ and NO_x, Alternatives F
39 and G have lower CO₂e emissions from steam turbine technologies than Alternative A and other
40 fluctuating-flow alternatives, reflecting relatively greater offsets of baseload coal-fired plants
41 from the steady-flow alternatives. However, total CO₂e emissions are greatest overall for
42 Alternatives F and G due to a more than compensating increase in the gas turbine contribution
43 under these alternatives. Alternatives F and G rank highest for CO₂e, but lowest for SO₂ and low
44 for NO_x. This reversal in rank is due to smaller differences in emission factors between gas
45 turbine and steam turbine technologies for CO₂e than for SO₂ and NO_x. CO₂e emission factors
46 are lower for gas turbine technologies by roughly a factor of 2, while SO₂ is lower by almost two

1 orders of magnitude, and NO_x is lower by roughly a factor of 5 for gas turbines than for (coal-
2 fired) steam turbines, as reflected in emission factors shown in Table M-1.

3
4 As shown in Table M-8, total system CO_{2e} emissions are a small fraction of total
5 United States GHG emissions, totaling about 0.81% for all LTEMP alternatives.

6
7
8 **M.3 REFERENCES**

9
10 EIA (U.S. Energy Information Administration), 2013, *Updated Capital Cost Estimates for Utility*
11 *Scale Electricity Generating Plants*, April. Available at [http://www.eia.gov/forecasts/](http://www.eia.gov/forecasts/capitalcost/pdf/updated_capcost.pdf)
12 [capitalcost/pdf/updated_capcost.pdf](http://www.eia.gov/forecasts/capitalcost/pdf/updated_capcost.pdf). Accessed Jan. 21, 2015.

13
14 EPA (U.S. Environmental Protection Agency), 2013, *Inventory of U.S. Greenhouse Gas*
15 *Emissions and Sinks: 1990–2011*, EPA 430-R-13-001, April 12. Available at
16 [http://www.epa.gov/climatechange/Downloads/ghgemissions/US-GHG-Inventory-2013-Main-](http://www.epa.gov/climatechange/Downloads/ghgemissions/US-GHG-Inventory-2013-Main-Text.pdf)
17 [Text.pdf](http://www.epa.gov/climatechange/Downloads/ghgemissions/US-GHG-Inventory-2013-Main-Text.pdf). Accessed Oct. 28, 2013.

18
19 EPA, 2014, “eGRID,” ninth edition with year 2010 data (Version 1.0). Available at
20 <http://www.epa.gov/cleanenergy/energy-resources/egrid>. Accessed May 23, 2014.

21

1 **TABLE M-1 Emission Factors by Plant for System Power Generation and Spot Market**

| Generation Type | Plant Name | EIA Plant No. | Emission Factor (lb/MWh) | | |
|--------------------------------|--------------------------------------------------|---------------------|--------------------------|-----------------|--------------------------------|
| | | | SO ₂ | NO _x | CO ₂ e ^a |
| System Power Generation | | | | | |
| Combined cycle | Advanced Combined Cycle Gas Turbine ^b | - ^c | 0.006 | 0.048 | 752 |
| | Desert Basin | 55,129 | 0.005 | 0.094 | 1,001 |
| | Front Range | 55,283 | 0.005 | 0.264 | 975 |
| | Kyrene #KY7 & #KY7Ae | 147 | 0.005 | 0.141 | 932 |
| | Long-Term Contract (Fort Lupton) ^b | - ^c | 0.009 | 0.069 | 1,075 |
| | Mesquite | 55,481 | 0.004 | 0.064 | 879 |
| | Nebo | 56,177 | 0.005 | 0.135 | 890 |
| | Rifle | 10,755 | 0.021 | 1.026 | 716 |
| | Santan | 8,068 | 0.004 | 0.112 | 843 |
| Composite | Long-Term Contract (Unspecified) ^d | - ^c | 0.744 | 1.068 | 963 |
| Gas turbine | Advanced Simple Cycle Gas Turbine ^b | - ^c | 0.010 | 0.293 | 1,141 |
| | Frank Knutson | 55,505 | 0.033 | 0.394 | 1,500 |
| | Kyrene KY4-KY6 ^e | 147 | 0.005 | 0.141 | 932 |
| | Limon | 55,504 | 0.111 | 0.794 | 1,714 |
| | Long-Term Contract (Brush 2) | 10,683 | 0.040 | 1.950 | 1,429 |
| | Long-Term Contract (Coolidge) ^b | - ^c | 0.009 | 0.270 | 1,053 |
| | Pyramid | 7,975 | 0.042 | 1.045 | 1,308 |
| | Rawhide #A-#F ^e | 6,761 | 0.775 | 1.616 | 2,049 |
| Internal combustion | Payson | 7,408 | 1.313 | 19.637 | 1,473 |
| | Provo | 3,686 | 0.257 | 17.719 | 1,493 |
| Steam turbine | Bonanza | 1 | 0.803 | 3.769 | 2,099 |
| | Coronado | 6,177 | 3.755 | 4.044 | 2,353 |
| | Craig | 6,021 | 0.694 | 3.035 | 2,216 |
| | Escalante | 87 | 1.449 | 3.721 | 2,449 |
| | Four Corners | 2,442 | 1.588 | 5.586 | 2,083 |
| | George Birdsall | 493 | 0.058 | 3.138 | 1,948 |
| | Hayden | 525 | 1.495 | 4.259 | 2,357 |
| | Hunter | 6,165 | 1.038 | 3.689 | 2,248 |
| | Intermountain | 6,481 | 0.765 | 3.999 | 2,011 |
| | Kyrene 1 & 2 ^c | 147 | 0.005 | 0.141 | 932 |
| | Laramie River 1 | 6,204.1 | 1.258 | 2.164 | 2,461 |
| | Laramie River 2 & 3 | 6,204.2 | 1.627 | 2.890 | 2,332 |
| | Martin Drake | 492 | 7.428 | 4.205 | 2,435 |
| | Navajo | 4,941 | 0.621 | 2.974 | 2,179 |
| | Nucla | 527 | 3.859 | 4.874 | 2,625 |
| | Rawhide #1 ^e | 6,761 | 0.775 | 1.616 | 2,049 |
| | Ray D Nixon 1 ^e | 8,219 | 4.878 | 2.391 | 2,282 |
| | San Juan | 2,451 | 0.847 | 3.113 | 2,330 |
| Springerville | 8,223 | 1.211 | 1.174 | 2,026 | |

TABLE M-1 (Cont.)

| Generation Type | Plant Name | EIA Plant No. | Emission Factor (lb/MWh) | | |
|--------------------|------------------------------------|---------------------|--------------------------|-----------------|--------------------------------|
| | | | SO ₂ | NO _x | CO ₂ e ^a |
| Spot Market | | | | | |
| | Sales and purchases ^{f,g} | - ^c | 0.0083 | 0.266 | 888 |

- ^a Greenhouse gas (GHG) emissions are expressed in carbon dioxide equivalent (CO₂e), except for advanced combined cycle, advanced simple cycle, and long-term contract emissions (Coolidge and Fort Lupton), which are expressed as CO₂ and shaded for clarity.
- ^b Emission factors were originally given in lb/MMBtu but were converted into lb/MWh using conversion factors (MMBtu/MWh) from the AURORA model outputs described in Appendix K: 6.43 for advanced combined cycle; 9.75 for advanced simple cycle; 9 for Coolidge; and 9.19 for Fort Lupton.
- ^c A hyphen denotes “not applicable.”
- ^d Generation type was not specified, so composite emission factors representative of all types of powerplants currently in operation over the 11 Western Interconnect states were used.
- ^e These plants have more than one generation type and only one plant-wide emission factor for each pollutant were given in the EPA’s 2010 eGrid database.
- ^f Composite emission factors representative of gas powerplants currently in operation over the 11 Western Interconnection states were used.
- ^g “Sales” refers to sales of power by system utilities to non-system utilities within the Western Interconnection. Sales result in a net credit to total Western Interconnection emissions, because the sales result in a reduction in emissions from those non-system utilities that are purchasing the power. “Purchases” refers to purchases by system utilities from non-system utilities within the Western Interconnection. Emissions related to these purchases are added to the total emissions in the Western Interconnection.

Source: EIA (2013); EPA (2014).

1 **TABLE M-2 Power Generation (in MWh per Year) Averaged over the 20-Year LTEMP Period by Alternative**

| Generation Type | Plant Name | EIA Plant No. | Alternative | | | | | | |
|--------------------------------|-----------------------------------------|----------------|---------------------------|-------------------|-------------------|---------------------------|-------------------|-------------------|-------------------|
| | | | A (No Action Alternative) | B | C | D (Preferred Alternative) | E | F | G |
| System Power Generation | | | | | | | | | |
| Combined cycle | Advanced combined cycle gas turbine | - ^a | 7,620,301 | 7,623,594 | 7,617,489 | 7,620,763 | 7,622,969 | 7,605,136 | 7,609,471 |
| | Desert Basin | 55,129 | 585,800 | 586,934 | 590,663 | 589,933 | 589,238 | 588,298 | 594,677 |
| | Front Range | 55,283 | 919,790 | 914,735 | 921,585 | 924,406 | 919,148 | 930,841 | 925,349 |
| | Kyrene #KY7 & #KY7A | 147 | 46,112 | 45,923 | 46,315 | 47,042 | 46,657 | 47,749 | 46,933 |
| | Long-term contract (Fort Lupton) | - ^a | 123,898 | 121,375 | 121,530 | 122,814 | 120,978 | 121,286 | 127,739 |
| | Mesquite | 55,481 | 4,637,436 | 4,639,304 | 4,637,048 | 4,637,704 | 4,637,659 | 4,639,378 | 4,636,160 |
| | Nebo | 56,177 | 205,798 | 204,042 | 206,783 | 206,287 | 206,392 | 210,230 | 209,969 |
| | Rifle | 10,755 | 145,808 | 145,812 | 145,755 | 145,838 | 145,754 | 146,621 | 146,144 |
| | Santan | 8,068 | 1,409,562 | 1,404,660 | 1,416,449 | 1,417,293 | 1,418,136 | 1,423,356 | 1,430,155 |
| Combined Cycle Subtotal | | | 15,694,506 | 15,686,380 | 15,703,618 | 15,712,080 | 15,706,930 | 15,712,895 | 15,726,598 |
| Composite | Long-term contract (unspecified) | - ^a | 1,628,526 | 1,629,588 | 1,628,457 | 1,630,110 | 1,629,858 | 1,632,176 | 1,627,328 |
| Gas turbine | Advanced simple cycle gas turbine | - ^a | 597,114 | 587,362 | 672,023 | 639,175 | 647,159 | 774,061 | 702,516 |
| | Frank Knutson | 55,505 | 62,101 | 60,909 | 62,752 | 63,133 | 62,638 | 70,930 | 67,843 |
| | Kyrene KY4-KY6 | 147 | 938 | 940 | 932 | 936 | 938 | 950 | 962 |
| | Limon | 55,504 | 37,077 | 36,889 | 36,664 | 36,912 | 36,575 | 41,589 | 38,986 |
| | Long-term contract (Brush 2) | 10,683 | 35,169 | 33,873 | 34,940 | 35,592 | 34,641 | 36,379 | 38,201 |
| | Long-term contract (Coolidge) | - ^a | 249,994 | 248,005 | 247,539 | 249,364 | 248,463 | 248,981 | 252,243 |
| | Pyramid | 7,975 | 162,140 | 156,957 | 163,256 | 164,392 | 162,204 | 172,688 | 178,097 |
| | Rawhide #A-#F | 6,761 | 4,280 | 4,267 | 4,306 | 4,354 | 4,278 | 4,796 | 4,548 |
| Gas Turbine Subtotal | | | 1,148,814 | 1,129,201 | 1,222,411 | 1,193,859 | 1,196,895 | 1,350,374 | 1,283,395 |
| Internal combustion | Payson | 7,408 | 1,717 | 1,713 | 1,678 | 1,691 | 1,679 | 1,670 | 1,714 |
| | Provo | 3,686 | 854 | 850 | 825 | 882 | 869 | 844 | 828 |
| | Internal Combustion Subtotal | | | 2,571 | 2,563 | 2,503 | 2,573 | 2,548 | 2,542 |

M-12

2
3

TABLE M-2 (Cont.)

| Generation Type | Plant Name | EIA Plant No. | Alternative | | | | | | |
|----------------------------------------|-------------------------------------------|-----------------|---------------------------|-------------------|-------------------|---------------------------|-------------------|-------------------|-------------------|
| | | | A (No Action Alternative) | B | C | D (Preferred Alternative) | E | F | G |
| System Power Generation (Cont.) | | | | | | | | | |
| Steam turbine | Bonanza | 7,790 | 3,589,525 | 3,589,527 | 3,589,525 | 3,589,524 | 3,589,525 | 3,589,364 | 3,589,525 |
| | Coronado | 6,177 | 5,764,907 | 5,767,009 | 5,764,236 | 5,764,829 | 5,764,453 | 5,762,531 | 5,761,006 |
| | Craig | 6,021 | 8,061,885 | 8,061,806 | 8,061,979 | 8,061,745 | 8,061,885 | 8,061,388 | 8,061,713 |
| | Escalante | 87 | 1,783,864 | 1,783,312 | 1,782,293 | 1,783,100 | 1,783,539 | 1,775,851 | 1,781,911 |
| | Four Corners | 2,442 | 1,145,170 | 1,145,639 | 1,145,109 | 1,145,343 | 1,145,548 | 1,143,803 | 1,144,356 |
| | George Birdsall | 493 | 116 | 115 | 116 | 116 | 114 | 141 | 121 |
| | Hayden | 525 | 989,044 | 989,196 | 989,115 | 989,115 | 989,327 | 989,267 | 989,196 |
| | Hunter | 6,165 | 1,514,296 | 1,514,296 | 1,514,296 | 1,514,296 | 1,514,296 | 1,514,296 | 1,514,296 |
| | Intermountain | 6,481 | 5,491,131 | 5,491,122 | 5,491,139 | 5,491,139 | 5,491,139 | 5,491,139 | 5,491,137 |
| | Kyrene 1 & 2 | 147 | 1,028 | 1,034 | 1,023 | 1,034 | 1,027 | 1,053 | 1,053 |
| | Laramie River 1 | 6,204.1 | 1,039,808 | 1,039,810 | 1,039,806 | 1,039,789 | 1,039,805 | 1,039,800 | 1,039,774 |
| | Laramie River 2 & 3 | 6,204.2 | 2,079,620 | 2,079,620 | 2,079,620 | 2,079,620 | 2,079,620 | 2,079,620 | 2,079,620 |
| | Martin Drake | 492 | 1,920,235 | 1,920,236 | 1,920,225 | 1,920,234 | 1,920,236 | 1,920,231 | 1,920,225 |
| | Navajo | 4,941 | 3,741,478 | 3,741,640 | 3,741,240 | 3,741,369 | 3,741,359 | 3,740,851 | 3,740,803 |
| | Nucla | 527 | 753,249 | 753,276 | 753,462 | 753,462 | 753,504 | 752,312 | 752,981 |
| | Rawhide #1 | 6,761 | 2,108,554 | 2,108,554 | 2,108,554 | 2,108,554 | 2,108,554 | 2,108,554 | 2,108,554 |
| | Ray D Nixon 1 | 8,219 | 1,663,200 | 1,663,200 | 1,663,200 | 1,663,200 | 1,663,200 | 1,663,200 | 1,663,200 |
| | San Juan | 2,451 | 571,214 | 571,347 | 571,264 | 571,231 | 571,344 | 570,592 | 570,934 |
| | Springerville | 8,223 | 6,131,532 | 6,133,174 | 6,130,698 | 6,130,759 | 6,131,637 | 6,121,038 | 6,126,970 |
| | Steam Turbine Subtotal | | 48,349,855 | 48,353,913 | 48,346,900 | 48,348,459 | 48,350,114 | 48,325,031 | 48,337,375 |
| | System Subtotal | | 66,824,271 | 66,801,645 | 66,903,888 | 66,887,081 | 66,886,345 | 67,022,991 | 66,977,238 |
| Spot Market | | | | | | | | | |
| | Sales (emissions subtracted) ^b | -. ^a | -3,753,513 | -3,707,051 | -3,830,282 | -3,784,783 | -3,812,913 | -3,915,541 | -3,872,321 |
| | Purchases (emissions added) ^b | -. ^a | 2,823,573 | 2,816,937 | 2,848,706 | 2,836,661 | 2,848,870 | 2,865,526 | 2,861,183 |
| | Spot Market Subtotal | | -929,940 | -890,114 | -981,576 | -948,122 | -964,043 | -1,050,015 | -1,011,139 |
| Total (System + Spot Market) | | | 65,894,331 | 65,911,531 | 65,922,312 | 65,938,959 | 65,922,302 | 65,972,976 | 65,966,099 |

Footnotes on next page.

TABLE M-2 (Cont.)

a A hyphen denotes “not applicable.”

b “Sales” refers to sales of power by system utilities to non-system utilities within the Western Interconnection. Sales result in a net credit to total Western Interconnection emissions, because the sales result in a reduction in emissions from those non-system utilities that are purchasing the power. “Purchases” refers to purchases by system utilities from non-system utilities within the Western Interconnection. Emissions related to these purchases are added to the total emissions in the Western Interconnection.

Data source: AURORA model outputs described in Appendix K.

1 **TABLE M-3 Summary of Potential Impacts of LTEMP Alternatives on Visibility and**
 2 **Regional Air Quality**

| Air Quality | Alternative | | | | | | |
|----------------------------------------------------------------------|----------------------------------------------------------------|---------------------------------------------------------------------------------------------------------------|--------------------------------------------------------------------------------------------------------------------------------------------|------------------------------------------------------------------------------------------------------------------------------------------------|---------------------------------------------------------------------------------------------------------------|---------------------------------------------------------------------------------------------------------------|---------------------------------------------------------------------------------------------------------------------------------------------------------|
| | A (No Action Alternative) | B | C | D (Preferred Alternative) | E | F | G |
| Overall summary of impacts | No change from current conditions | Negligible increase in SO ₂ and NO _x emissions compared to Alternative A | Negligible decrease in SO ₂ emissions and no change in NO _x emissions compared to Alternative A | No change in SO ₂ emissions and negligible increase in and NO _x emissions compared to Alternative A | Negligible increase in SO ₂ and NO _x emissions compared to Alternative A | Negligible decrease in SO ₂ and NO _x emissions compared to Alternative A | Negligible decrease in SO ₂ emissions and negligible increase in NO _x emissions compared to Alternative A |
| Visibility ^a | No change from current conditions | No change from Alternative A | No change from Alternative A | No change from Alternative A | No change from Alternative A | No change from Alternative A | No change from Alternative A |
| <i>Air Quality in 11-State Western Interconnection Region</i> | | | | | | | |
| SO ₂ emissions (tons/yr) | 42,465 ^b No change from current conditions | 42,471 ^b Negligible increase (0.01%) ^c | 42,463 ^b Negligible reduction (-0.01%) ^c | 42,465 ^b No change from current conditions | 42,466 ^b Negligible increase (<0.005%) ^c | 42,448 ^b Negligible reduction (-0.04%) ^c | 42,453 ^b Negligible reduction (-0.03%) ^c |
| NO _x emissions (tons/yr) | 78,496 ^b No change from current conditions | 78,501 ^b Negligible increase (0.01%) ^c | 78,496 ^b No change from current conditions | 78,503 ^b Negligible increase (0.01%) ^c | 78,500 ^b Negligible increase (<0.005%) ^c | 78,487 ^b Negligible reduction (-0.01%) ^c | 78,498 ^b Negligible increase (<0.005%) ^c |

^a Visibility effects are estimated from expected changes in the emissions of sulfate and nitrate precursors, SO₂ and NO_x.

^b Total air emissions from combustion-related powerplants in the Western Interconnection averaged over the 20-year LTEMP period.

^c Changes in air emissions compared to Alternative A.

Source: EPA (2014).

1 **TABLE M-4 Annual SO₂ Emissions (in tons per Year) Averaged over the 20-Year LTEMP Period by Alternative**

| Generation Type | Plant Name | EIA Plant No. | Alternative | | | | | | |
|--------------------------------|-----------------------------------------|-------------------------------------|---------------------------|------------|------------|---------------------------|------------|------------|------------|
| | | | A (No Action Alternative) | B | C | D (Preferred Alternative) | E | F | G |
| System Power Generation | | | | | | | | | |
| Combined cycle | Advanced combined cycle gas turbine | - ^a | 24 | 25 | 24 | 25 | 25 | 24 | 24 |
| | Desert Basin | 55,129 | 1 | 1 | 1 | 1 | 1 | 1 | 1 |
| | Front Range | 55,283 | 2 | 2 | 2 | 2 | 2 | 2 | 2 |
| | Kyrene #KY7 & #KY7A | 147 | 0 | 0 | 0 | 0 | 0 | 0 | 0 |
| | Long-term contract (Fort Lupton) | - ^a | 1 | 1 | 1 | 1 | 1 | 1 | 1 |
| | Mesquite | 55,481 | 10 | 10 | 10 | 10 | 10 | 10 | 10 |
| | Nebo | 56,177 | 0 | 0 | 0 | 0 | 0 | 0 | 0 |
| | Rifle | 10,755 | 2 | 2 | 2 | 2 | 2 | 2 | 2 |
| | Santan | 8,068 | 3 | 3 | 3 | 3 | 3 | 3 | 3 |
| | | Combined Cycle Subtotal | | 44 | 44 | 44 | 44 | 44 | 44 |
| Composite | Long-term contract (unspecified) | - ^a | 606 | 607 | 606 | 607 | 607 | 608 | 606 |
| Gas turbine | Advanced simple cycle gas turbine | - ^a | 3 | 3 | 3 | 3 | 3 | 4 | 3 |
| | Frank Knutson | 55,505 | 1 | 1 | 1 | 1 | 1 | 1 | 1 |
| | Kyrene KY4-KY6 | 147 | 0 | 0 | 0 | 0 | 0 | 0 | 0 |
| | Limon | 55,504 | 2 | 2 | 2 | 2 | 2 | 2 | 2 |
| | Long-term contract (Brush 2) | 10,683 | 1 | 1 | 1 | 1 | 1 | 1 | 1 |
| | Long-term contract (Coolidge) | - ^a | 1 | 1 | 1 | 1 | 1 | 1 | 1 |
| | Pyramid | 7,975 | 3 | 3 | 3 | 3 | 3 | 4 | 4 |
| | Rawhide #A-#F | 6,761 | 2 | 2 | 2 | 2 | 2 | 2 | 2 |
| | | Gas Turbine Subtotal | | 13 | 13 | 13 | 13 | 13 | 15 |
| Internal combustion | Payson | 7,408 | 1 | 1 | 1 | 1 | 1 | 1 | 1 |
| | Provo | 3,686 | 0 | 0 | 0 | 0 | 0 | 0 | 0 |
| | | Internal Combustion Subtotal | | 1 | 1 | 1 | 1 | 1 | 1 |

M-16

TABLE M-4 (Cont.)

| Generation Type | Plant Name | EIA Plant No. | Alternative | | | | | | |
|-----------------------------------------------|-------------------------------------------|----------------|---------------------------|---------------|---------------|---------------------------|---------------|---------------|---------------|
| | | | A (No Action Alternative) | B | C | D (Preferred Alternative) | E | F | G |
| <i>System Power Generation (Cont.)</i> | | | | | | | | | |
| Steam turbine | Bonanza | 7,790 | 1,441 | 1,441 | 1,441 | 1,441 | 1,441 | 1,441 | 1,441 |
| | Coronado | 6,177 | 10,822 | 10,826 | 10,821 | 10,822 | 10,821 | 10,818 | 10,815 |
| | Craig | 6,021 | 2,795 | 2,795 | 2,795 | 2,795 | 2,795 | 2,795 | 2,795 |
| | Escalante | 87 | 1,293 | 1,292 | 1,291 | 1,292 | 1,292 | 1,287 | 1,291 |
| | Four Corners | 2,442 | 909 | 910 | 909 | 910 | 910 | 908 | 909 |
| | George Birdsall | 493 | 0 | 0 | 0 | 0 | 0 | 0 | 0 |
| | Hayden | 525 | 739 | 739 | 739 | 739 | 740 | 739 | 739 |
| | Hunter | 6,165 | 786 | 786 | 786 | 786 | 786 | 786 | 786 |
| | Intermountain | 6,481 | 2,099 | 2,099 | 2,099 | 2,099 | 2,099 | 2,099 | 2,099 |
| | Kyrene 1 & 2 | 147 | 0 | 0 | 0 | 0 | 0 | 0 | 0 |
| | Laramie River 1 | 6,204 | 654 | 654 | 654 | 654 | 654 | 654 | 654 |
| | Laramie River 2 & 3 | 6,204 | 1,692 | 1,692 | 1,692 | 1,692 | 1,692 | 1,692 | 1,692 |
| | Martin Drake | 492 | 7,132 | 7,132 | 7,132 | 7,132 | 7,132 | 7,132 | 7,132 |
| | Navajo | 4,941 | 1,161 | 1,161 | 1,161 | 1,161 | 1,161 | 1,161 | 1,161 |
| | Nucla | 527 | 1,453 | 1,453 | 1,454 | 1,454 | 1,454 | 1,451 | 1,453 |
| | Rawhide #1 | 6,761 | 817 | 817 | 817 | 817 | 817 | 817 | 817 |
| | Ray D Nixon 1 | 8,219 | 4,056 | 4,056 | 4,056 | 4,056 | 4,056 | 4,056 | 4,056 |
| | San Juan | 2,451 | 242 | 242 | 242 | 242 | 242 | 242 | 242 |
| | Springerville | 8,223 | 3,712 | 3,713 | 3,712 | 3,712 | 3,712 | 3,706 | 3,710 |
| | Steam Turbine Subtotal | | 41,805 | 41,810 | 41,802 | 41,804 | 41,805 | 41,785 | 41,792 |
| | System Power Generation Total | | 42,469 | 42,474 | 42,467 | 42,469 | 42,470 | 42,452 | 42,457 |
| <i>Spot Market</i> | | | | | | | | | |
| | Sales (emissions subtracted) ^b | - ^a | -16 | -15 | -16 | -16 | -16 | -16 | -16 |
| | Purchases (emissions added) ^b | - ^a | 12 | 12 | 12 | 12 | 12 | 12 | 12 |
| | Spot Market Subtotal | | -4 | -4 | -4 | -4 | -4 | -4 | -4 |
| Total (System + Spot Market) | | | 42,465 | 42,471 | 42,463 | 42,465 | 42,466 | 42,448 | 42,453 |

Footnotes on next page.

M-17

TABLE M-4 (Cont.)

- a A hyphen denotes “not applicable.”
- b “Sales” refers to sales of power by system utilities to non-system utilities within the Western Interconnection. Sales result in a net credit to total Western Interconnection emissions, because the sales result in a reduction in emissions from those non-system utilities that are purchasing the power. “Purchases” refers to purchases by system utilities from non-system utilities within the Western Interconnection. Emissions related to these purchases are added to the total emissions in the Western Interconnection.

1
2

1 **TABLE M-5 Annual NO_x Emissions (in tons per Year) Averaged over the 20-Year LTEMP Period by Alternative**

| Generation Type | Plant Name | EIA Plant No. | Alternative | | | | | | |
|---------------------------------------|-----------------------------------------|-------------------------------------|---------------------------|------------|------------|---------------------------|------------|------------|------------|
| | | | A (No Action Alternative) | B | C | D (Preferred Alternative) | E | F | G |
| <i>System Power Generation</i> | | | | | | | | | |
| Combined cycle | Advanced combined cycle gas turbine | - ^a | 184 | 184 | 184 | 184 | 184 | 183 | 183 |
| | Desert Basin | 55,129 | 28 | 28 | 28 | 28 | 28 | 28 | 28 |
| | Front Range | 55,283 | 122 | 121 | 122 | 122 | 121 | 123 | 122 |
| | Kyrene #KY7 & #KY7A | 147 | 3 | 3 | 3 | 3 | 3 | 3 | 3 |
| | Long-term contract (Fort Lupton) | - ^a | 4 | 4 | 4 | 4 | 4 | 4 | 4 |
| | Mesquite | 55,481 | 147 | 147 | 147 | 147 | 147 | 147 | 147 |
| | Nebo | 56,177 | 14 | 14 | 14 | 14 | 14 | 14 | 14 |
| | Rifle | 10,755 | 75 | 75 | 75 | 75 | 75 | 75 | 75 |
| | Santan | 8,068 | 79 | 79 | 80 | 80 | 80 | 80 | 80 |
| | Combined Cycle Subtotal | | 655 | 654 | 656 | 657 | 656 | 658 | 658 |
| Composite | Long-term contract (unspecified) | - ^a | 869 | 870 | 869 | 870 | 870 | 871 | 869 |
| Gas turbine | Advanced simple cycle gas turbine | - ^a | 87 | 86 | 98 | 93 | 95 | 113 | 103 |
| | Frank Knutson | 55,505 | 12 | 12 | 12 | 12 | 12 | 14 | 13 |
| | Kyrene KY4-KY6 | 147 | 0 | 0 | 0 | 0 | 0 | 0 | 0 |
| | Limon | 55,504 | 15 | 15 | 15 | 15 | 15 | 17 | 15 |
| | Long-term contract (Brush 2) | 10,683 | 34 | 33 | 34 | 35 | 34 | 35 | 37 |
| | Long-term contract (Coolidge) | - ^a | 34 | 33 | 33 | 34 | 34 | 34 | 34 |
| | Pyramid | 7,975 | 85 | 82 | 85 | 86 | 85 | 90 | 93 |
| | Rawhide #A-#F | 6,761 | 3 | 3 | 3 | 4 | 3 | 4 | 4 |
| | | Gas Turbine Subtotal | | 271 | 265 | 282 | 278 | 277 | 307 |
| Internal combustion | Payson | 7,408 | 17 | 17 | 16 | 17 | 16 | 16 | 17 |
| | Provo | 3,686 | 8 | 8 | 7 | 8 | 8 | 7 | 7 |
| | | Internal Combustion Subtotal | | 24 | 24 | 24 | 24 | 24 | 24 |

M-19

TABLE M-5 (Cont.)

| Generation Type | Plant Name | EIA Plant No. | Alternative | | | | | | |
|----------------------------------------|-------------------------------------------|-----------------|---------------------------|---------------|---------------|---------------------------|---------------|---------------|---------------|
| | | | A (No Action Alternative) | B | C | D (Preferred Alternative) | E | F | G |
| System Power Generation (Cont.) | | | | | | | | | |
| Steam turbine | Bonanza | 7,790 | 6,764 | 6,764 | 6,764 | 6,764 | 6,764 | 6,764 | 6,764 |
| | Coronado | 6,177 | 11,656 | 11,661 | 11,655 | 11,656 | 11,655 | 11,652 | 11,648 |
| | Craig | 6,021 | 12,236 | 12,235 | 12,236 | 12,235 | 12,236 | 12,235 | 12,235 |
| | Escalante | 87 | 3,319 | 3,318 | 3,316 | 3,318 | 3,318 | 3,304 | 3,315 |
| | Four Corners | 2,442 | 3,199 | 3,200 | 3,198 | 3,199 | 3,200 | 3,195 | 3,196 |
| | George Birdsall | 493 | 0 | 0 | 0 | 0 | 0 | 0 | 0 |
| | Hayden | 525 | 2,106 | 2,107 | 2,106 | 2,106 | 2,107 | 2,107 | 2,107 |
| | Hunter | 6,165 | 2,793 | 2,793 | 2,793 | 2,793 | 2,793 | 2,793 | 2,793 |
| | Intermountain | 6,481 | 10,979 | 10,979 | 10,979 | 10,979 | 10,979 | 10,979 | 10,979 |
| | Kyrene 1 & 2 | 147 | 0 | 0 | 0 | 0 | 0 | 0 | 0 |
| | Laramie River 1 | 6,204.1 | 1,125 | 1,125 | 1,125 | 1,125 | 1,125 | 1,125 | 1,125 |
| | Laramie River 2 & 3 | 6,204.2 | 3,005 | 3,005 | 3,005 | 3,005 | 3,005 | 3,005 | 3,005 |
| | Martin Drake | 492 | 4,037 | 4,037 | 4,037 | 4,037 | 4,037 | 4,037 | 4,037 |
| | Navajo | 4,941 | 5,563 | 5,563 | 5,562 | 5,562 | 5,562 | 5,562 | 5,562 |
| | Nucla | 527 | 1,836 | 1,836 | 1,836 | 1,836 | 1,836 | 1,833 | 1,835 |
| | Rawhide #1 | 6,761 | 1,704 | 1,704 | 1,704 | 1,704 | 1,704 | 1,704 | 1,704 |
| | Ray D Nixon 1 | 8,219 | 1,989 | 1,989 | 1,989 | 1,989 | 1,989 | 1,989 | 1,989 |
| | San Juan | 2,451 | 889 | 889 | 889 | 889 | 889 | 888 | 889 |
| | Springerville | 8,223 | 3,600 | 3,601 | 3,600 | 3,600 | 3,600 | 3,594 | 3,598 |
| | Steam Turbine Subtotal | | 76,800 | 76,806 | 76,796 | 76,799 | 76,801 | 76,766 | 76,781 |
| | System Power Generation Total | | 78,620 | 78,620 | 78,626 | 78,629 | 78,628 | 78,626 | 78,632 |
| Spot Market | | | | | | | | | |
| | Sales (emissions subtracted) ^b | -. ^a | -499 | -492 | -509 | -503 | -506 | -520 | -514 |
| | Purchases (emissions added) ^b | -. ^a | 375 | 374 | 378 | 377 | 378 | 381 | 380 |
| | Spot Market Subtotal | | -124 | -118 | -130 | -126 | -128 | -139 | -134 |
| | Total (System + Spot Market) | | 78,496 | 78,501 | 78,496 | 78,503 | 78,500 | 78,487 | 78,498 |

Footnotes on next page.

M-20

TABLE M-5 (Cont.)

- a Ahyphen denotes “not applicable.”
- b “Sales” refers to sales of power by system utilities to non-system utilities within the Western Interconnection. Sales result in a net credit to total Western Interconnection emissions, because the sales result in a reduction in emissions from those non-system utilities that are purchasing the power. “Purchases” refers to purchases by system utilities from non-system utilities within the Western Interconnection. Emissions related to these purchases are added to the total emissions in the Western Interconnection.

1
2

TABLE M-6 Summary of Impacts of LTEMP Alternatives on SO₂ and NO_x Emissions

| Generation Type | Alternative | | | | | | |
|-------------------------------------------------------------------------------------------------|---------------------------------|-------------------|-------------------|---------------------------------|-------------------|-------------------|-------------------|
| | A (No Action Alternative) | B | C | D (Preferred Alternative) | E | F | G |
| Total Glen Canyon Dam power generation relative to Alternative A (MWh/day) (% of Alternative A) | 11,650 (100%) | 11,616 (99.7%) | 11,566 (99.3%) | 11,525 (98.9%) | 11,571 (99.3%) | 11,449 (98.3%) | 11,438 (98.2%) |
| SO ₂ Emissions (tons per year) | | | | | | | |
| System Power Generation | | | | | | | |
| Combined cycle | 44 | 44 | 44 | 44 | 44 | 44 | 44 |
| Composite ^a | 606 | 607 | 606 | 607 | 607 | 608 | 606 |
| Gas turbine | 13 | 13 | 13 | 13 | 13 | 15 | 14 |
| Internal combustion | 1 | 1 | 1 | 1 | 1 | 1 | 1 |
| Steam turbine | 41,805 | 41,810 | 41,802 | 41,804 | 41,805 | 41,785 | 41,792 |
| System Subtotal | 42,469 | 42,474 | 42,467 | 42,469 | 42,470 | 42,452 | 42,457 |
| Spot Market^b | | | | | | | |
| Sales (emissions subtracted) | -16 | -15 | -16 | -16 | -16 | -16 | -16 |
| Purchases (emissions added) | 12 | 12 | 12 | 12 | 12 | 12 | 12 |
| Spot Market Subtotal | -4 | -4 | -4 | -4 | -4 | -4 | -4 |
| Total (System + Spot Market) | 42,465 | 42,471 | 42,463 | 42,465 | 42,466 | 42,448 | 42,453 |
| NO _x Emissions (tons per year) | | | | | | | |
| System Power Generation | | | | | | | |
| Combined cycle | 655 | 654 | 656 | 657 | 656 | 658 | 658 |
| Composite ^a | 869 | 870 | 869 | 870 | 870 | 871 | 869 |
| Gas turbine | 271 | 265 | 282 | 278 | 277 | 307 | 300 |
| Internal combustion | 24 | 24 | 24 | 24 | 24 | 24 | 24 |
| Steam turbine | 76,800 | 76,806 | 76,796 | 76,799 | 76,801 | 76,766 | 76,781 |
| System Subtotal | 78,620 | 78,620 | 78,626 | 78,629 | 78,628 | 78,626 | 78,632 |
| Spot Market Sales^b | | | | | | | |
| Sales (emissions subtracted) | -499 | -492 | -509 | -503 | -506 | -520 | -514 |
| Purchases (emissions added) | 375 | 374 | 378 | 377 | 378 | 381 | 380 |
| Spot Market Subtotal | -124 | -118 | -130 | -126 | -128 | -139 | -134 |
| Total (System + Spot Market) | 78,496 | 78,501 | 78,496 | 78,503 | 78,500 | 78,487 | 78,498 |

^a Unspecified generation type.

^b “Sales” refers to sales of power by system utilities to non-system utilities within the Western Interconnection. Sales result in a net credit to total Western Interconnection emissions, because the sales result in a reduction in emissions from those non-system utilities that are purchasing the power. “Purchases” refers to purchases by system utilities from non-system utilities within the Western Interconnection. Emissions related to these purchases are added to the total emissions in the Western Interconnection.

1 **TABLE M-7 Annual Greenhouse Gas Emissions (in metric tons per year CO₂e)^a under LTEMP Alternatives**

| Generation Type | Plant Name | EIA Plant No. | Alternative | | | | | | |
|---------------------------------------|-----------------------------------------|----------------|---------------------------|------------------|------------------|---------------------------|------------------|------------------|------------------|
| | | | A (No Action Alternative) | B | C | D (Preferred Alternative) | E | F | G |
| <i>System Power Generation</i> | | | | | | | | | |
| Combined cycle | Advanced combined cycle gas turbine | - ^b | 2,600,367 | 2,601,491 | 2,599,408 | 2,600,525 | 2,601,278 | 2,595,192 | 2,596,672 |
| | Desert Basin | 55,129 | 265,937 | 266,452 | 268,144 | 267,813 | 267,498 | 267,071 | 269,967 |
| | Front Range | 55,283 | 406,591 | 404,356 | 407,384 | 408,631 | 406,307 | 411,476 | 409,048 |
| | Kyrene #KY7 & #KY7A | 147 | 19,494 | 19,414 | 19,580 | 19,887 | 19,724 | 20,186 | 19,841 |
| | Long-term contract (Fort Lupton) | - ^b | 60,427 | 59,216 | 59,291 | 59,907 | 59,026 | 59,174 | 62,270 |
| | Mesquite | 55,481 | 1,849,137 | 1,849,882 | 1,848,983 | 1,849,244 | 1,849,226 | 1,849,912 | 1,848,629 |
| | Nebo | 56,177 | 83,114 | 82,405 | 83,512 | 83,312 | 83,354 | 84,904 | 84,799 |
| | Rifle | 10,755 | 47,363 | 47,364 | 47,345 | 47,372 | 47,345 | 47,627 | 47,472 |
| | Santan | 8,068 | 539,188 | 537,313 | 541,823 | 542,146 | 542,468 | 544,465 | 547,066 |
| | Combined Cycle Subtotal | | | 5,871,619 | 5,867,894 | 5,875,470 | 5,878,837 | 5,876,226 | 5,880,006 |
| Composite | Long-term contract (unspecified) | - ^b | 711,604 | 712,068 | 711,574 | 712,296 | 712,186 | 713,199 | 711,081 |
| Gas turbine | Advanced simple cycle gas turbine | - ^b | 308,968 | 303,922 | 347,729 | 330,732 | 334,863 | 400,526 | 363,507 |
| | Frank Knutson | 55,505 | 42,240 | 41,430 | 42,683 | 42,942 | 42,605 | 48,246 | 46,146 |
| | Kyrene KY4-KY6 | 147 | 396 | 397 | 394 | 396 | 396 | 402 | 407 |
| | Limon | 55,504 | 28,833 | 28,686 | 28,511 | 28,704 | 28,442 | 32,341 | 30,317 |
| | Long-term contract (Brush 2) | 10,683 | 22,800 | 21,960 | 22,651 | 23,074 | 22,458 | 23,585 | 24,766 |
| | Long-term contract (Coolidge) | - ^b | 119,405 | 118,455 | 118,233 | 119,105 | 118,674 | 118,921 | 120,479 |
| | Pyramid | 7,975 | 96,184 | 93,109 | 96,845 | 97,520 | 96,222 | 102,441 | 105,650 |
| | Rawhide #A-#F | 6,761 | 3,979 | 3,966 | 4,003 | 4,047 | 3,977 | 4,458 | 4,227 |
| | Gas Turbine Subtotal | | | 622,805 | 611,925 | 661,049 | 646,520 | 647,637 | 730,920 |
| Internal combustion | Payson | 7,408 | 1,147 | 1,145 | 1,121 | 1,130 | 1,122 | 1,116 | 1,145 |
| | Provo | 3,686 | 579 | 576 | 559 | 597 | 588 | 572 | 561 |
| | Internal Combustion Subtotal | | | 1,726 | 1,721 | 1,680 | 1,728 | 1,711 | 1,688 |

M-23

TABLE M-7 (Cont.)

| Generation Type | Plant Name | EIA Plant No. | Alternative | | | | | | |
|----------------------------------------|-------------------------------------------|---------------|---------------------------|-------------------|-------------------|---------------------------|-------------------|-------------------|-------------------|
| | | | A (No Action Alternative) | B | C | D (Preferred Alternative) | E | F | G |
| System Power Generation (Cont.) | | | | | | | | | |
| Steam turbine | Bonanza | 7,790 | 3,418,218 | 3,418,220 | 3,418,218 | 3,418,217 | 3,418,218 | 3,418,064 | 3,418,218 |
| | Coronado | 6,177 | 6,153,123 | 6,155,366 | 6,152,407 | 6,153,039 | 6,152,639 | 6,150,587 | 6,148,959 |
| | Craig | 6,021 | 8,102,872 | 8,102,792 | 8,102,966 | 8,102,731 | 8,102,872 | 8,102,372 | 8,102,699 |
| | Escalante | 87 | 1,981,912 | 1,981,299 | 1,980,168 | 1,981,064 | 1,981,551 | 1,973,010 | 1,979,743 |
| | Four Corners | 2,442 | 1,081,762 | 1,082,205 | 1,081,704 | 1,081,925 | 1,082,120 | 1,080,471 | 1,080,993 |
| | George Birdsall | 493 | 103 | 101 | 103 | 103 | 101 | 124 | 107 |
| | Hayden | 525 | 1,057,553 | 1,057,715 | 1,057,628 | 1,057,628 | 1,057,855 | 1,057,791 | 1,057,715 |
| | Hunter | 6,165 | 1,544,335 | 1,544,336 | 1,544,335 | 1,544,335 | 1,544,336 | 1,544,335 | 1,544,335 |
| | Intermountain | 6,481 | 5,009,462 | 5,009,453 | 5,009,469 | 5,009,469 | 5,009,469 | 5,009,469 | 5,009,467 |
| | Kyrene 1 & 2 | 147 | 435 | 437 | 432 | 437 | 434 | 445 | 445 |
| | Laramie River 1 | 6,204.1 | 1,160,583 | 1,160,585 | 1,160,581 | 1,160,562 | 1,160,580 | 1,160,574 | 1,160,546 |
| | Laramie River 2 & 3 | 6,204.2 | 2,199,501 | 2,199,501 | 2,199,501 | 2,199,501 | 2,199,501 | 2,199,501 | 2,199,501 |
| | Martin Drake | 492 | 2,120,585 | 2,120,587 | 2,120,574 | 2,120,585 | 2,120,587 | 2,120,581 | 2,120,575 |
| | Navajo | 4,941 | 3,697,248 | 3,697,409 | 3,697,013 | 3,697,141 | 3,697,131 | 3,696,629 | 3,696,581 |
| | Nucla | 527 | 896,805 | 896,837 | 897,059 | 897,059 | 897,108 | 895,690 | 896,486 |
| | Rawhide #1 | 6,761 | 1,960,118 | 1,960,118 | 1,960,118 | 1,960,118 | 1,960,118 | 1,960,118 | 1,960,118 |
| | Ray D Nixon 1 | 8,219 | 1,721,687 | 1,721,687 | 1,721,687 | 1,721,687 | 1,721,687 | 1,721,687 | 1,721,687 |
| | San Juan | 2,451 | 603,661 | 603,801 | 603,714 | 603,679 | 603,799 | 603,004 | 603,365 |
| | Springerville | 8,223 | 5,634,678 | 5,636,188 | 5,633,913 | 5,633,969 | 5,634,776 | 5,625,035 | 5,630,487 |
| | Steam Turbine Subtotal | | 48,344,640 | 48,348,638 | 48,341,590 | 48,343,248 | 48,344,880 | 48,319,488 | 48,332,026 |
| | System Power Generation Total | | 55,552,395 | 55,542,246 | 55,591,363 | 55,582,629 | 55,582,640 | 55,645,301 | 55,626,074 |
| Spot Market | | | | | | | | | |
| | Sales (emissions subtracted) ^c | -.b | -1,512,509 | -1,493,787 | -1,543,444 | -1,525,109 | -1,536,444 | -1,577,799 | -1,560,383 |
| | Purchases (emissions added) ^c | -.b | 1,137,782 | 1,135,108 | 1,147,910 | 1,143,056 | 1,147,975 | 1,154,687 | 1,152,937 |
| | Spot Market Subtotal | | -374,727 | -358,679 | -395,534 | -382,053 | -388,469 | -423,112 | -407,447 |
| | Total (System + Spot Market) | | 55,177,668 | 55,183,567 | 55,195,829 | 55,200,576 | 55,194,171 | 55,222,189 | 55,218,627 |

Footnotes on next page.

M-24

TABLE M-7 (Cont.)

- a To convert from metric tons to tons, multiply by 1.023.
- b A hyphen denotes “not applicable.”
- c “Sales” refers to sales of power by system utilities to non-system utilities within the Western Interconnection. Sales result in a net credit to total Western Interconnection emissions, because the sales result in a reduction in emissions from those non-system utilities that are purchasing the power. “Purchases” refers to purchases by system utilities from non-system utilities within the Western Interconnection. Emissions related to these purchases are added to the total emissions in the Western Interconnection.

1
2

1 **TABLE M-8 Summary of Impacts of LTEMP Alternatives on CO₂e Emissions**

| CO ₂ e Emissions Source | CO ₂ e Emissions by Alternative (MT/yr) ^{a,b} | | | | | | |
|-----------------------------------------------------------------------------|-------------------------------------------------------------------|--------------------|--------------------|---------------------------------|--------------------|--------------------|--------------------|
| | A (No Action Alternative) | B | C | D (Preferred Alternative) | E | F | G |
| System Power Generation | | | | | | | |
| Combined cycle | 5,871,619 | 5,867,894 | 5,875,470 | 5,878,837 | 5,876,226 | 5,880,006 | 5,885,763 |
| Composite ^c | 711,604 | 712,068 | 711,574 | 712,296 | 712,186 | 713,199 | 711,081 |
| Gas turbine | 622,805 | 611,925 | 661,049 | 646,520 | 647,637 | 730,920 | 695,498 |
| Internal combustion | 1,726 | 1,721 | 1,680 | 1,728 | 1,711 | 1,688 | 1,706 |
| Steam turbine | 48,344,640 | 48,348,638 | 48,341,590 | 48,343,248 | 48,344,880 | 48,319,488 | 48,332,026 |
| System Subtotal | 55,552,395 | 55,542,246 | 55,591,363 | 55,582,629 | 55,582,640 | 55,645,301 | 55,626,074 |
| Spot Market^d | | | | | | | |
| Sales (emissions subtracted) | -1,512,509 | -1,493,787 | -1,543,444 | -1,525,109 | -1,536,444 | -1,577,799 | -1,560,383 |
| Purchases (emissions added) | 1,137,782 | 1,135,108 | 1,147,910 | 1,143,056 | 1,147,975 | 1,154,687 | 1,152,937 |
| Spot Market Subtotal | -374,727 | -358,679 | -395,534 | -382,053 | -388,469 | -423,112 | -407,447 |
| Total Emissions (System + Spot Market) | 55,177,668 | 55,183,567 | 55,195,829 | 55,200,576 | 55,194,171 | 55,222,189 | 55,218,627 |
| | No change from current conditions | 0.011% increase | 0.033% increase | 0.042% increase | 0.030% increase | 0.081% increase | 0.074% increase |
| Difference from Alternative A (MT/yr) | 0 | 5,900 | 18,161 | 22,908 | 16,503 | 44,522 | 40,960 |
| Total Emissions as % of Total U.S. GHG Emissions^e | No change from current conditions | 0.011% increase | 0.033% increase | 0.042% increase | 0.030% increase | 0.081% increase | 0.074% increase |

^a GHG emissions are expressed in carbon dioxide equivalent (CO₂e).

^b GHG emissions (metric tons) from combustion-related powerplants in the Western Interconnect averaged over the 20-year LTEMP period.

^c Unspecified generation type.

^d “Sales” refers to sales of power by system utilities to non-system utilities within the Western Interconnection. Sales result in a net credit to total Western Interconnection emissions, because the sales result in a reduction in emissions from those non-system utilities that are purchasing the power. “Purchases” refers to purchases by system utilities from non-system utilities within the Western Interconnection. Emissions related to these purchases are added to the total emissions in the Western Interconnection.

^e U.S. total GHG emissions at 6,810.3 million MT/yr CO₂e in 2010 (EPA 2013).

2