



U.S. DEPARTMENT OF
ENERGY

Nuclear Energy

**Office Of Nuclear Energy
Sensors and Instrumentation
Annual Review Meeting**

**Embedded I&C for Extreme Environments
Roger Kisner
Oak Ridge National Laboratory
NEET Program**

October 28-29, 2015



Project Overview

■ Goal, and Objectives

- Demonstrate performance gains possible using embedded I&C in extreme environments — high temperature, radiation, high pressure, high vibration, and high EMF conditions
- Demonstrate a magnetically suspended canned-rotor motor using functional embedding
- Affect nuclear power industry’s ability to make more reliable, efficient, & less costly components

■ Participants

- R. Kisner
- A. Melin
- A. Drira
- D. Fugate
- C. Johnson
- D. Holcomb

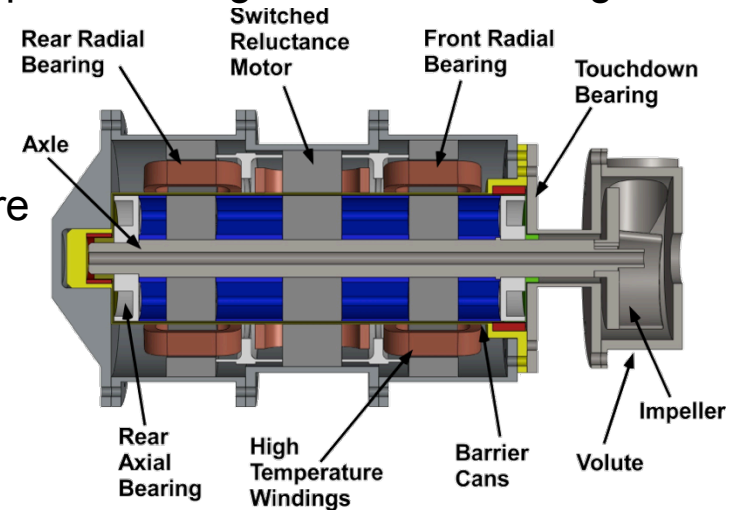

Key Milestones & Deliverables

FY 2015	<ul style="list-style-type: none"> •Bench-scale testbed designed and built •Stable feedback control of bench-scale active magnetic bearings achieved
FY 2016	<ul style="list-style-type: none"> •Loop-scale component design finalized •Loop-scale component manufactured & assembled
FY 2017	<ul style="list-style-type: none"> •Component with embedded I&C integrated into loop •Testing/evaluation of performance enhancements and fault tolerance complete



Accomplishments

■ Construction of electromechanical test bed for magnetic bearing demonstration

Results: Finished bench-scale testbed for magnetic bearings and motor drive. This design based on work performed in FY2012 and FY2014, which included conceptual design, failure-modes and effects analysis, modeling, and simulation.

Accomplishments: The bench-scale test bed gives a work platform for the remaining tasks for fabricating a working motor/pump. Sensors and control hardware and software are installed on the test bed. Real-time control system has been tested. Stable control has been achieved.

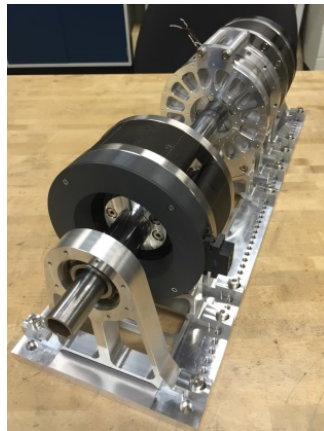

Test Bed



Suspension Bearing



Thrust Bearing



Accomplishments

- Mechanical, magnetic, and control design was accomplished using the modeling, simulation, and visualization capabilities of MATLAB and SOLIDWORKS

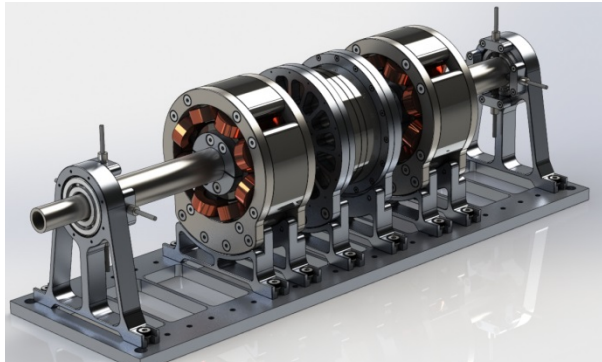

Test Stand Rendering

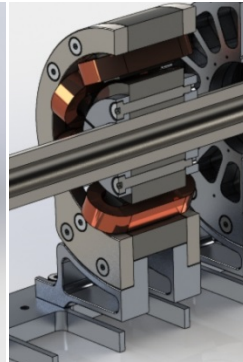

Bearing Cutaway

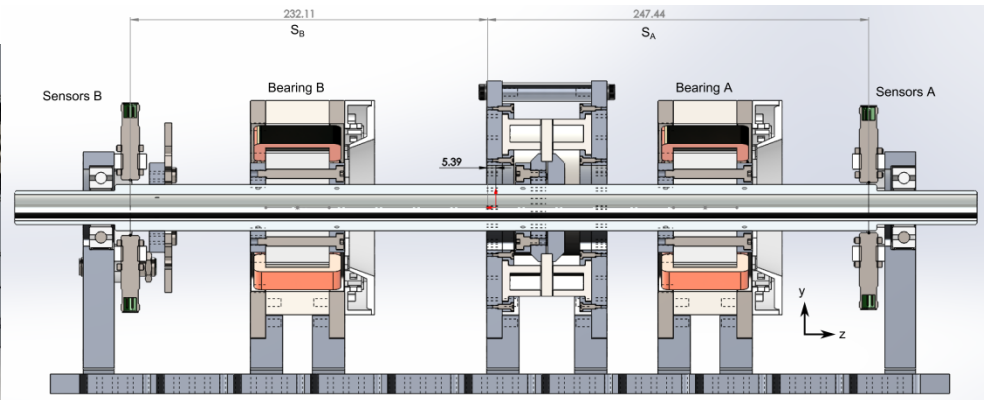

Side View Cutaway

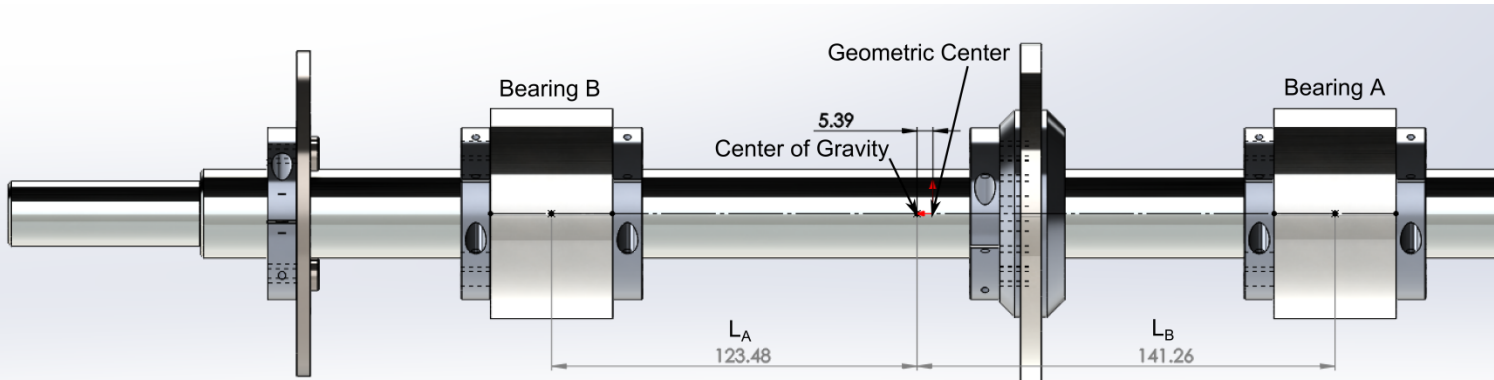

Shaft Side View

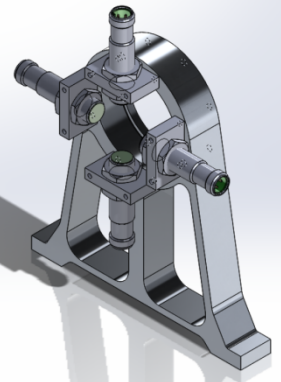

Position Sensing



Accomplishments

- The test bed has become a physical reality

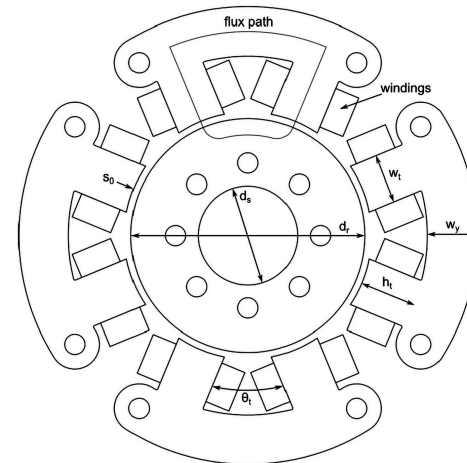
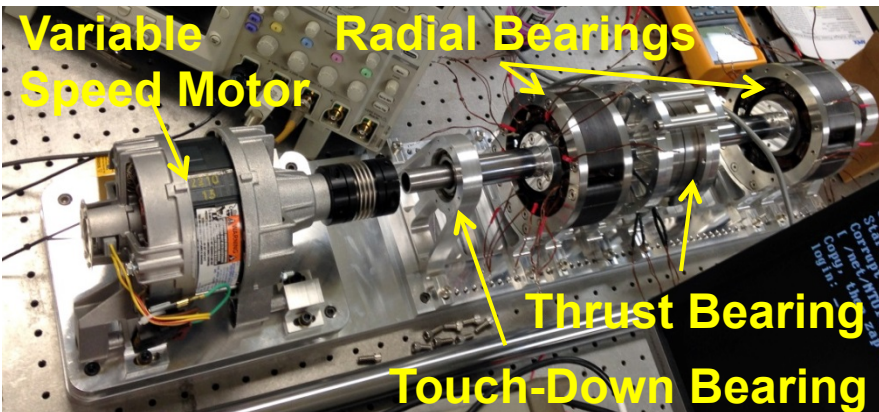
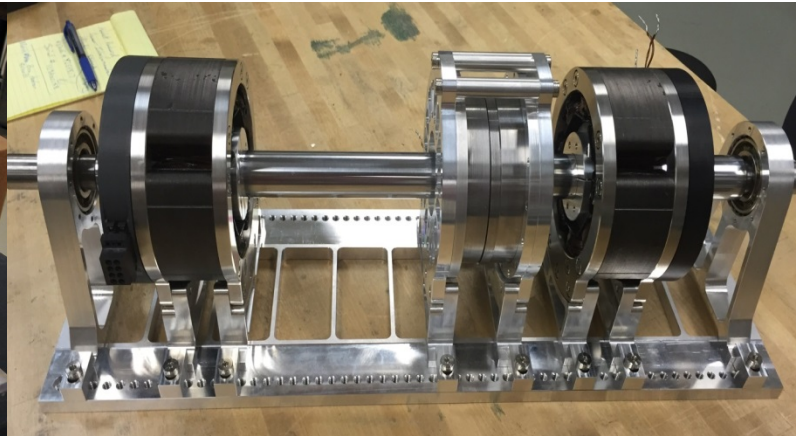
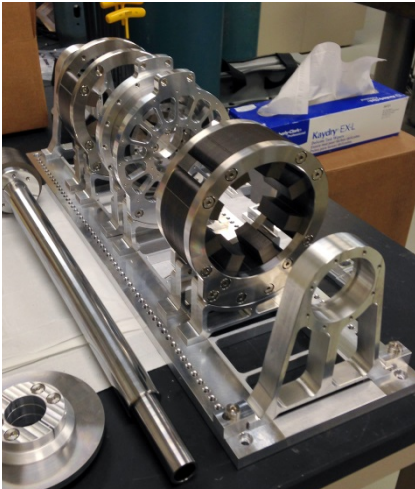



Accomplishments

- The team achieved stable suspension of axial rotor in active magnetic bearing stator housing



Speedgoat Real-Time Controller

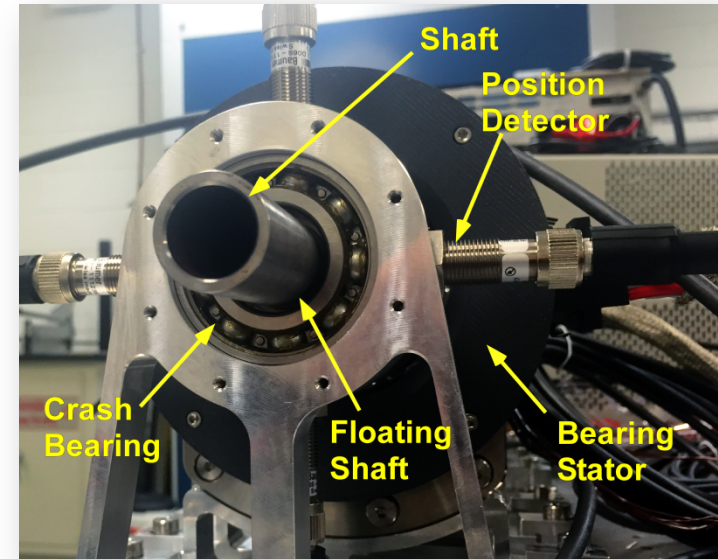
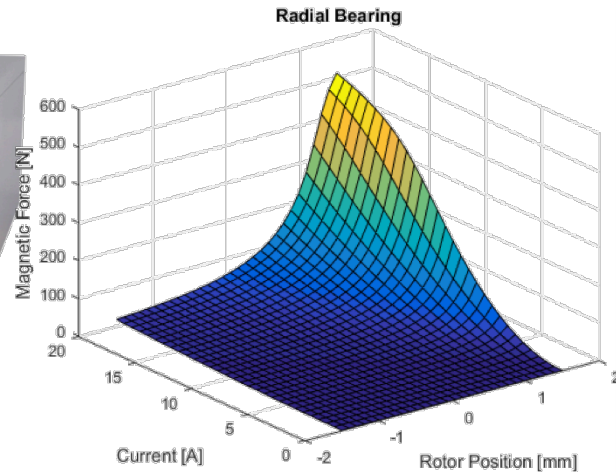

MOSFET H-Drive

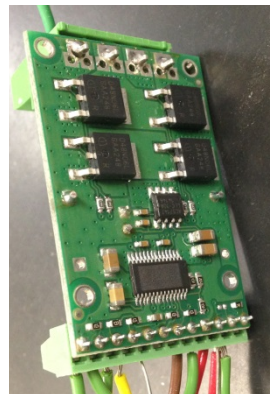
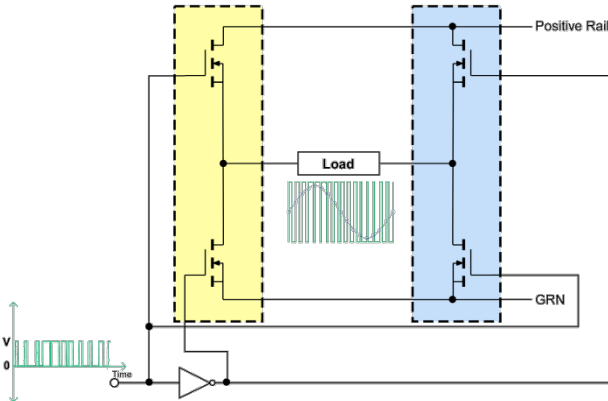

X, Y: 24VDC, 80A ea.
Z: 24VDC, 31A



Accomplishments

Report delivered

Embedded Sensors and Controls to Improve Component Performance and Reliability – Bench-scale Testbed Design Report, ORNL/TM-2015/584

ORNL/TM-2015/584

Embedded Sensors and Controls to Improve Component Performance and Reliability – Bench-scale Testbed Design Report



Alexander M. Melin
Roger Kisner
Anis Drita
F. Kyle Reed
David L. Fugate
September 2015

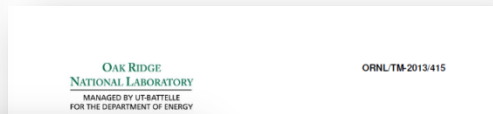
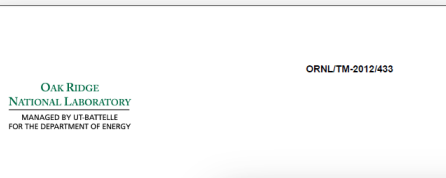

Embedded Sensors Improve Component Reliability Concepts

September 2012

Prepared by
R. Kisner
A. Melin
T. Burgess
D. Fugate
D. Holcomb,
J. Wilgen,
J. Miller,
D. Wilson,
P. Silva,
L. Whitlow, and
F. Peretz

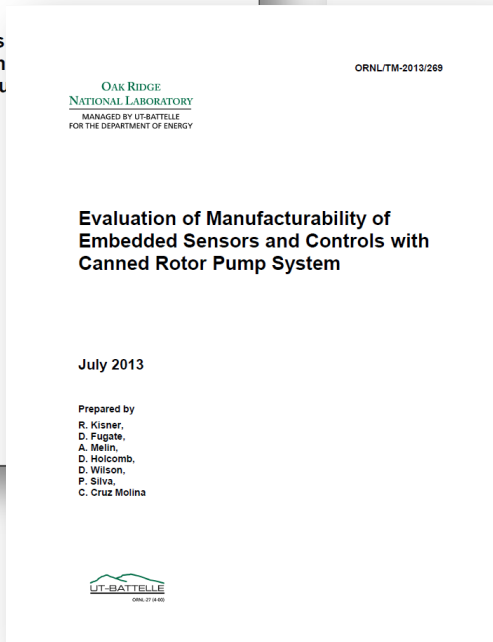

Evaluation of Manufacturability of Embedded Sensors and Controls with Canned Rotor Pump System

July 2013

Prepared by
R. Kisner,
D. Fugate,
A. Melin,
D. Holcomb,
D. Wilson,
P. Silva,
C. Cruz Molina



Sensors and Controls to Improve Component Performance and System Dynamics Modeling and System Design

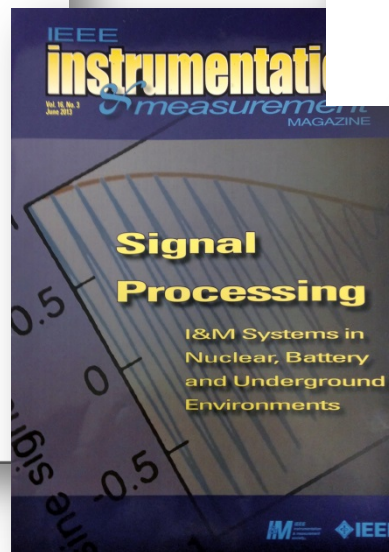

OAK RIDGE NATIONAL LABORATORY
MANAGED BY UT-BATTELLE FOR THE U.S. DEPARTMENT OF ENERGY

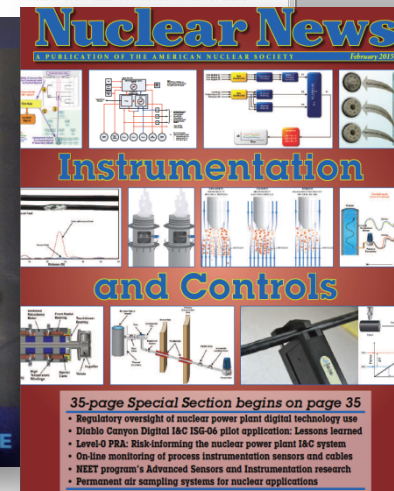

35-page Special Section begins on page 35

- Regulatory oversight of nuclear power plant digital technology use
- Diablo Canyon Digital I&C ISO-06 pilot application: Lessons learned
- Level-0 PRA: Risk-informing the nuclear power plant I&C system
- On-line monitoring of process instrumentation sensors and cables
- NEET program's Advanced Sensors and Instrumentation research
- Permanent air sampling systems for nuclear applications



Accomplishments

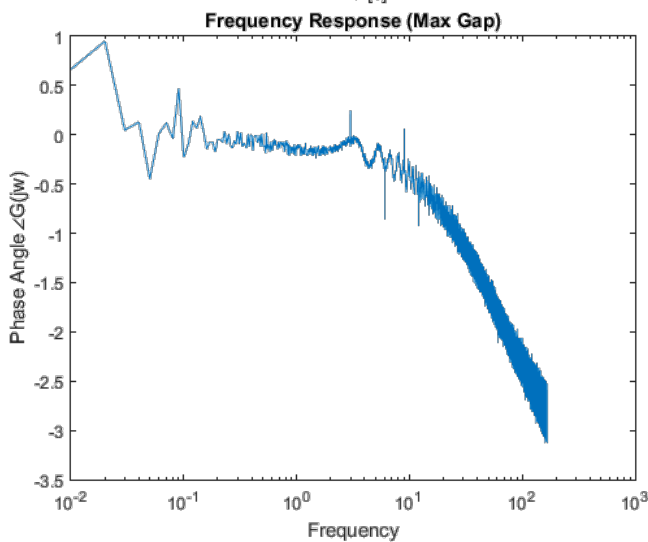
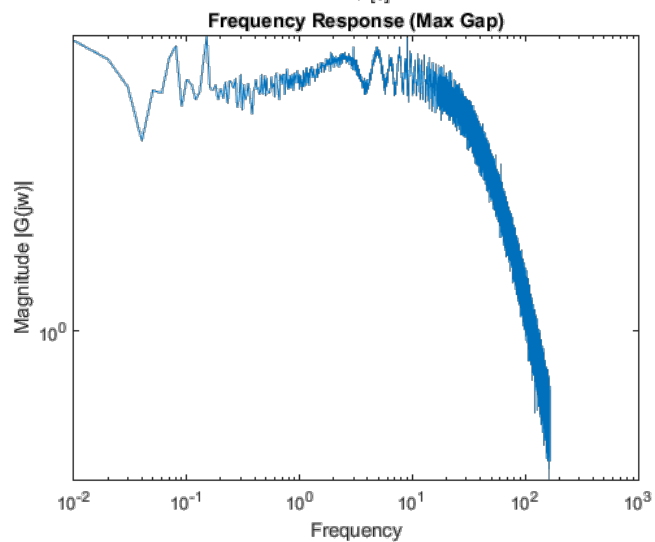
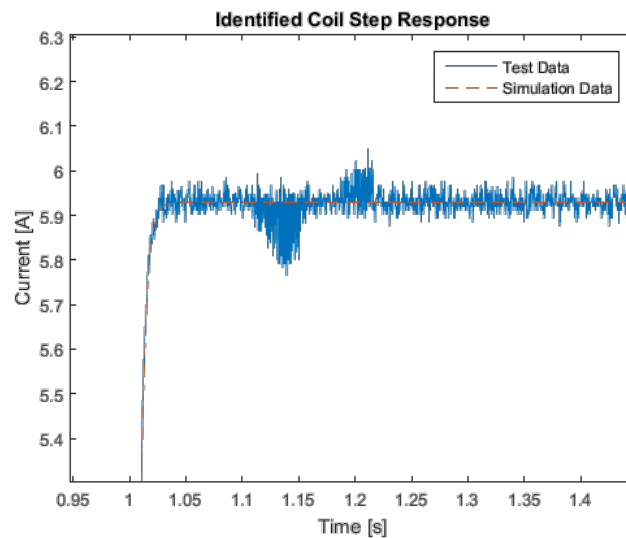
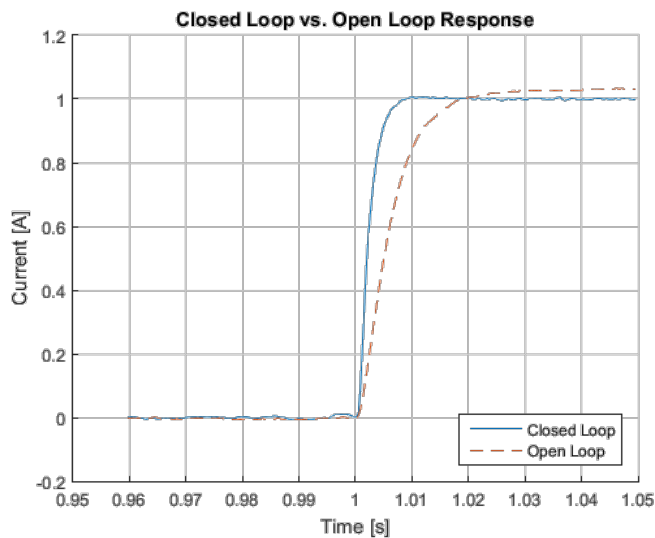

Next

- Next immediate steps are concentrate on the electronics
 - Enclose the system

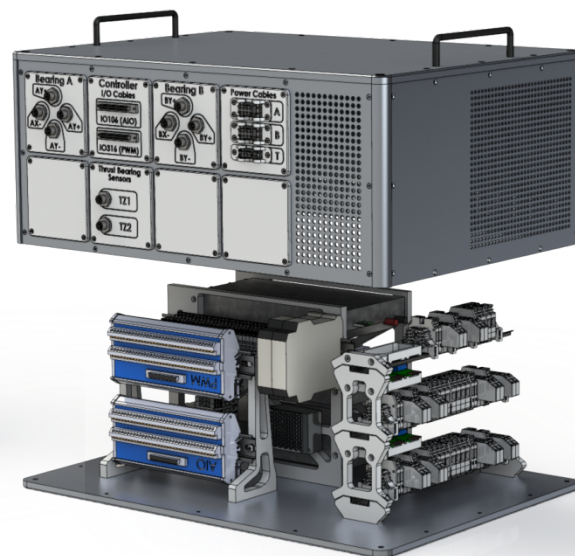

- System Identification
- Compare different control strategies (PID, LQG, Nonlinear,...)
- We want to explore position measurement without separate sensor



Technology Impact

- Sensors and controls have not typically been embedded in nuclear power reactor components (compared with other industries)
 - Aircraft
 - Industrial
 - *Transportation*
 - *Electric Power*
- Modern jet engines have experienced a 1000X reliability improvement with embedded I&C
- Existing nuclear system components have limitations for new reactor concepts related to size, mass, temperature ...
- This technology is crosscutting

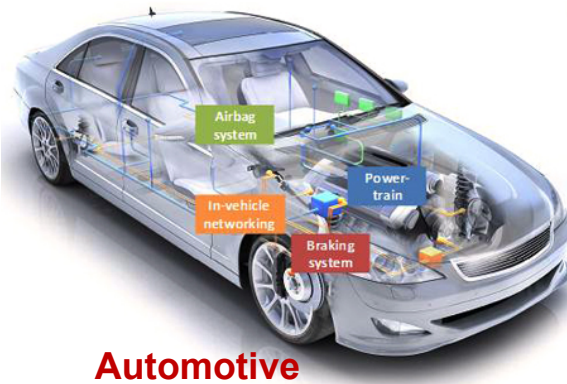

Technology Impact

- **Successful completion of this project will yield cross-cutting sensor and control technologies for nuclear power reactors**
- **The embedding of sensors and control always involves multi-disciplinary design integration techniques**
- **The loop-scale embedded I&C testbed and demonstration platform is an excellent resource for future research into embedded instrumentation and control technologies for extreme environments**
- **Performance testing at bench-scale and small loop-scale will yield quantifiable measures of the performance improvements due to embedded I&C**
- **Future projects can extend this work to high temperature demonstration systems and eventually to full-scale systems**

Conclusion

- **The project is demonstrating the performance, reliability, and cost benefits of embedded I&C on a relevant prototypic reactor component – a high-temperature coolant pump**
- **Technical benefits of embedded systems are improvements in reliability, potentially less challenges to safety, and operating life extension of crucial components**
- **Programmatic benefit of embedded systems is lower cost components**
- **A demonstration of embedding serves to draw attention to the need for the new technical approach**