



U.S. DEPARTMENT OF
ENERGY

Energy Efficiency &
Renewable Energy



2015 DOE Bioenergy Technologies Office (BETO) Project Peer Review

March 23-27, 2015

Thermochemical Conversion -
Feedstock Interface, Bio-oils

This presentation does not contain any proprietary, confidential, or otherwise restricted information

Tyler Westover, Idaho National
Laboratory (WBS 2.2.1.301)

Daniel Carpenter, National
Renewable Energy Laboratory

Daniel Howe, Pacific Northwest
National Laboratory

Goal Statement

GOAL: Enable the use of diverse “high-impact” resources in thermochemical conversion to achieve feedstock & conversion cost targets

- Pulpwood achieves conversion target (\$2.50/Gallon Gasoline Equivalent, GGE) but does not have sufficient volume at allowable cost (~\$80/dry ton)

Outcome: *Specifications (feedstocks & oils) combined with preprocessing and operating conditions to enable low-cost, high-volume resources to achieve conversion targets similar to pulpwood*

Relevance: Cost-competitive biofuel production at national scale will require high volumes of low-cost and diverse biomass types

- Cannot be based on pulpwood alone

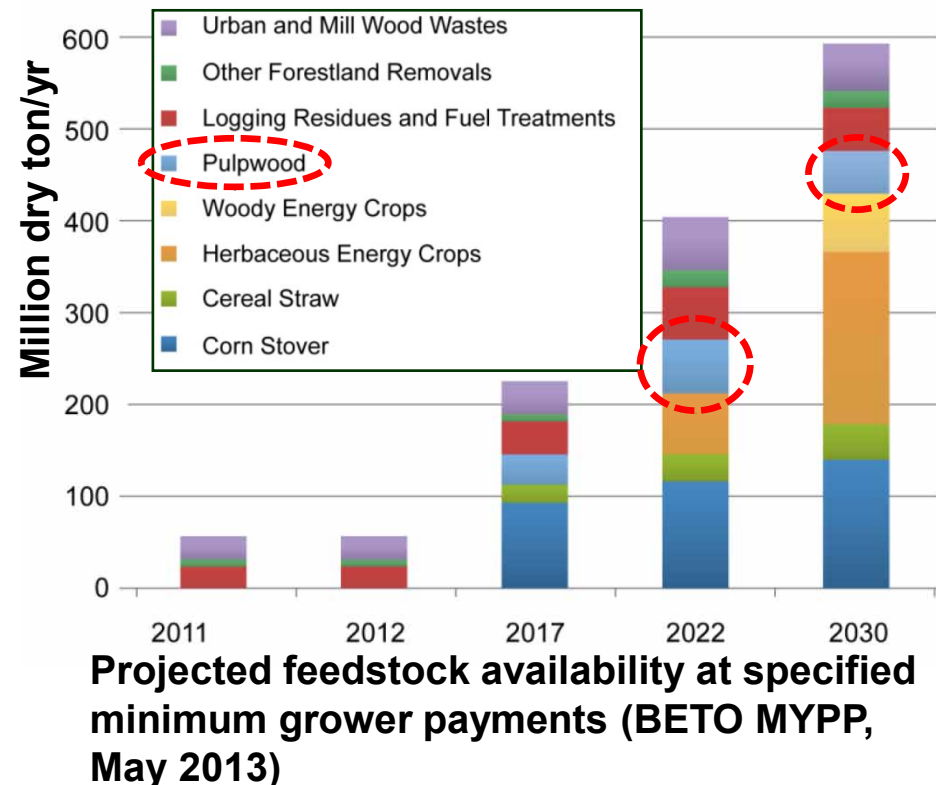

Project Quad Chart Overview

Timeline

- Start: October 2007
- End: September 2022
- 47% complete

Budget

Total project funding: \$9,739K

- DOE share: 100%

Funding in FYs 2012-2015 (\$1,000s)

WBS	2012	2013	2014	2015
2.2.1.301	0	0	755	1805
2.9.2.1	0	0	1,050	0
3.1.2.3	1950	2175	0	0

2.9.2.1 & 3.1.2.3 are related and their work is included in this presentation

Barriers

- Tt-K: Thermochemical Process Integration
- Ft-A: Resource Availability & Cost
- Ft-G: Feedstock Quality and Monitoring
- Ft-M: Overall Integration and Scale-Up
- Tt-C: Gasification of Biomass
- Tt-E: Pyrolysis of Biomass & Bio-Oil Stabilization

Partners & Roles

- INL – Feedstock handling and assembly
- NREL – Oil generation and analysis
- PNNL – Oil upgrading, and analysis
- NCSU/IBSS – TC conversion
- RTI – Fast pyrolysis & upgrading
- MTU – TC conversion rapid screening

1 - Project Overview

Background

- Feedstock $\approx \frac{1}{3}$ of total fuel cost
 - Large **risk factor** for biorefineries
- Resource **assessments** (e.g. Billion Ton Update) identify low-cost, high-impact feedstocks
- Techno-economic analyses (TEAs) identify areas for cost reduction
- This project determines process **sensitivities to blending** low-cost feedstocks into the supply chain.

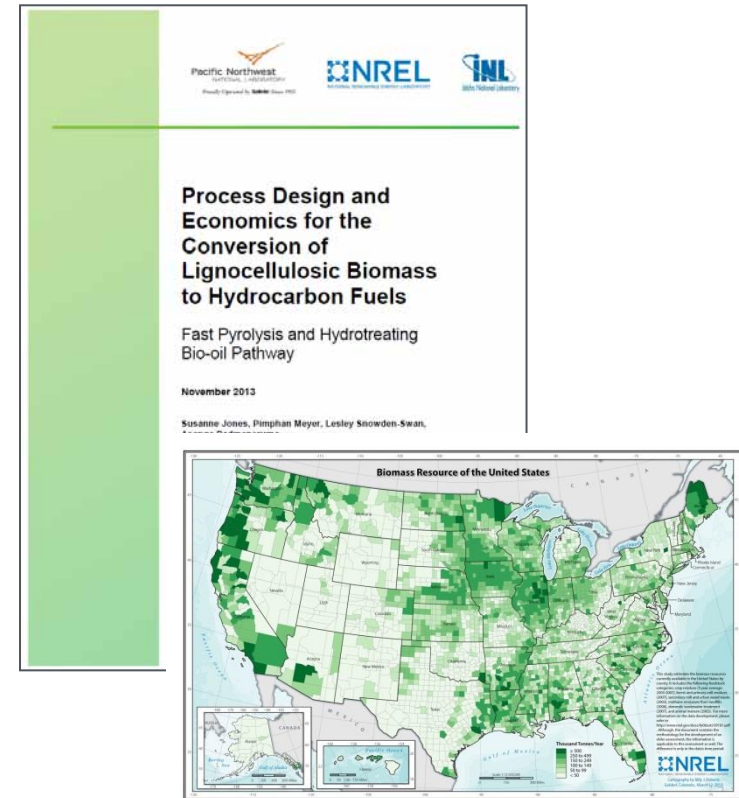

Overall Objective: Determine relationships between properties (of feedstocks or oils) and integrated processes
→ **Outcome: specifications to link technologies**

2 - Approach (Technical)

Overall Approach

1. Lab-scale process integration tests with NREL & PNNL ($\approx 10/\text{yr}$; $\sim 1\text{kg}$ scale)
 2. Rapid characterization tests to complement lab-scale tests
 - Evaluate numerous sample types & process conditions ($\sim 1\text{g}$; $> 100/\text{yr}$)
 3. Evaluations of specific preprocessing technologies (costs & benefits)
- * Interact with TEA at each step to update models & identify future research*

Critical Success Factors

1. Validation of yield & quality ***predictive models*** for key (pre)conversion technologies
2. Successful bio-oils validations in 2017 & 2022 based upon co-optimized biomass resources and conversion technologies (***demonstrate that conversion targets can be achieved with low-cost feedstocks***)

Top Potential Challenges

1. ***Broad scope***: Numerous combinations exist to convert and upgrade biofuels resources. The effects of many parameters are still unclear.
2. ***Highly non-equilibrium conditions*** in conversion technologies complicate development of predictive models.

2 – Approach (Diagram)

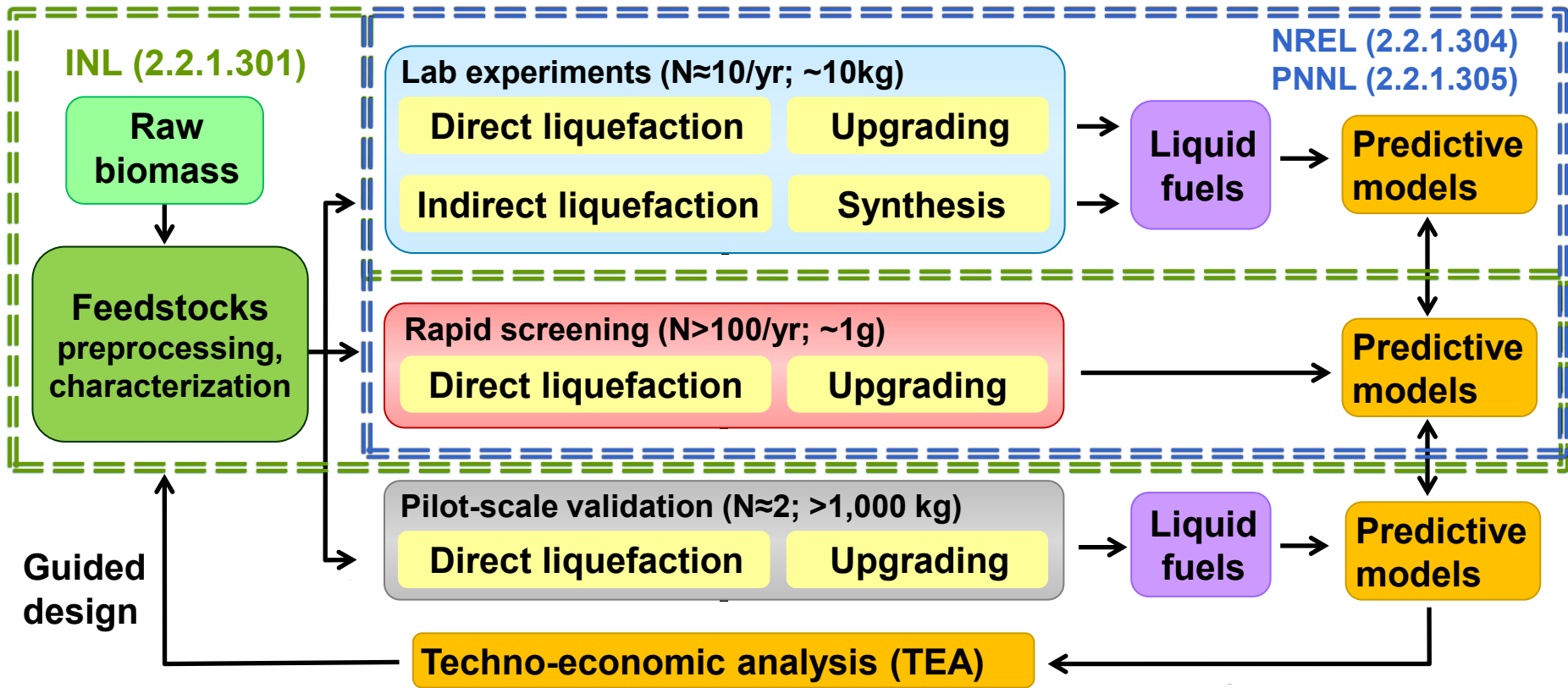

• **Integrated lab-scale tests are needed to establish baselines**

• **Rapid characterization & screening methods:**

- Optimize (1) feedstock preparation (separations, treatments & blending) and (2) conversion operating conditions (T, P, filtration, condensation)
- Provide rapid quality assurance at points of sale in biomass feedstock-to-fuel industry (facilitate transactions and decrease risk)

2 - Approach (Managerial)

Task Leadership: plan, prioritize, coordinate, review progress:

- Periodic inter-laboratory team meetings & visits
- Weekly progress and coordination meetings
- Quarterly BETO Review Meeting

Leverage related BETO sponsored work (feedstock, pyrolysis, gasification, test equipment):

- Share data with Feedstock Harvesting and Supply (data up to plant gate)
- Standardize test procedures, including tests at representative conversion conditions
- Data mining and assimilation of BETO program data into Biomass Resource Library

Create & follow approved project management plans

- Regular milestones (1/quarter) and deliverables (annual reports)

3 – Technical Progress

1. Lab-scale integration tests: Produce feedstocks (~1,000 kg) for multi-year conversion tests at NREL and PNNL. Feedstock selection is based upon
 - “High impact:” component of blend with ~50 million ton/yr availability at ~\$80/ton (pine, forest residues, C&D waste, switchgrass)
 - Extreme good/bad performance to build robust predictor models (e.g. tulip poplar, pinion/juniper, oak)
2. Rapid characterization tests of feedstocks/blends/processes → predictive models
 - Inorganic composition: LIBS; X-ray spectroscopy
 - Organic composition: NIR; FTIR; py-MBMS
 - Fast pyrolysis performance: microwave radiation, stirred mini-reactor, py-MBMS
3. Evaluation of preprocessing technologies
 - Mineral removal
 - Thermal treatment

3 - Technical Progress: Production & Characterization

03/31/15 Milestone: Prepare 8 feedstocks/blends from pine, poplar, switchgrass, pinion-juniper, and oriented-strand board (OSB), which is typical of C&D waste.

Feedstock selection criteria:

- “High impact” feedstocks
- Extreme performers (good & bad) for robust model
- Blends to test linearity
- Replicates for Q/A

New Equipment: Custom pilot-scale rotary divider fabricated to divide samples

- Interfaces directly with production equipment to divide samples into two 1/8 splits and two 3/8 splits.
- Accepts super sacks for subsequent sample dividing

#	FY2014	FY2015
1	Clean Pine (CP)	Clean Pine (repeat)
2	WP/TP/SG (34/33/33)	WP/TP/SG (repeat)
3	Whole Pine (WP)	Pinion-Juniper
4	Hybrid Poplar (HP)	OSB
5	Tulip Poplar (TP)	CP/OSB/SG (80/20/00)
6	Switchgrass (SG)	CP/OSB/SG (70/20/10)
7	Corn Stover (CS)	CP/OSB/SG (40/20/40)
8	WP/HP/CP (34/33/33)	SG for 450°C pyrolysis
9	-	Clean Pine (repeat)
10	-	Whole Pine (repeat)



3 - Technical Progress: Production & Characterization

INL: Ult./prox. & inorganic key values

Feedstock	C	HHV	Ash	K
	(%)	(BTU/lb)	(%)	(ppm)
TP	47.4	8202	0.5	822
HP	48.1	8250	0.9	1,956
CP	49.6	8428	0.7	758
WP	50.2	8883	0.7	756
WP/TP/SG	47.5	8179	1.7	2,505
WP/HP/CP	48.5	8551	0.6	1,137
SG	45.4	7768	4.3	6,097
CS	46.1	7567	4.2	9,338

NREL/PNNL: Pyrolysis & upgrading

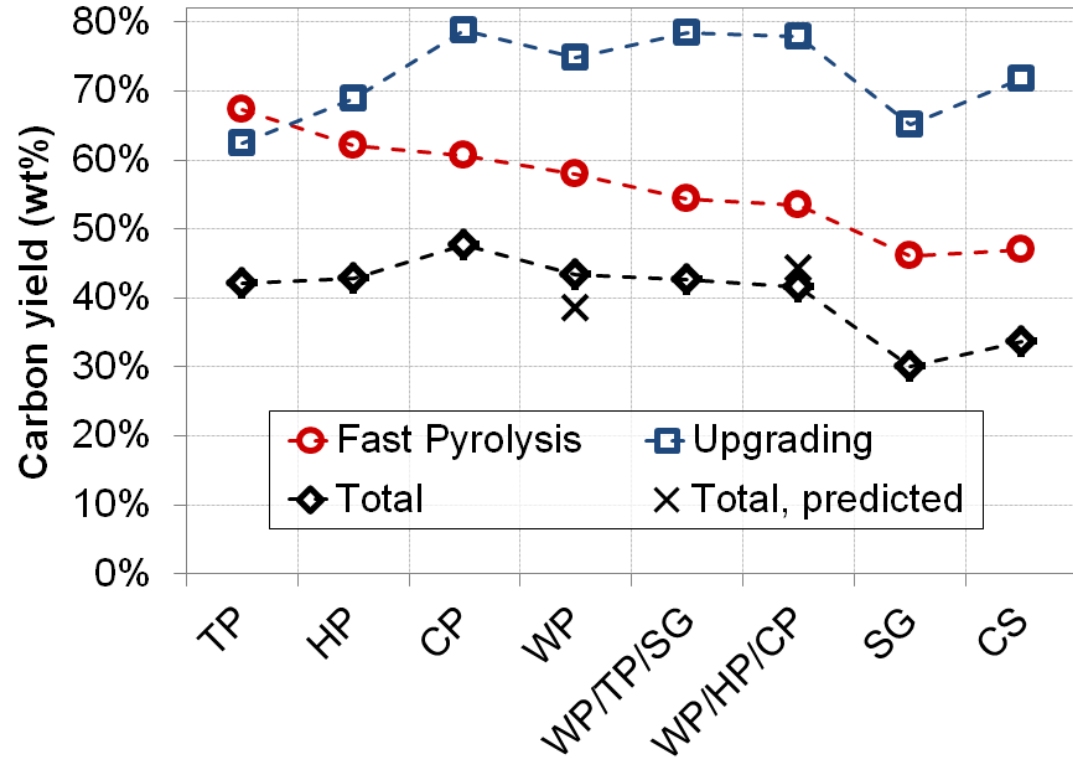

Performances of fast pyrolysis and upgrading are very different!

- CP & WP have similar properties but different conversion
- Blends have different properties but similar conversion
- “Field-to-Fuel” lab scale tests are valuable but slow & costly
- Tests need more replications
- Rapid screening methods with robust predictive models based are needed!

3 – Technical Progress

1. Lab-scale integration tests: Produce feedstocks (~1,000 kg) for multi-year conversion tests at NREL and PNNL. Feedstock selection is based upon
 - “High impact:” component of blend with ~50 million ton/yr availability at ~\$80/ton (pine, forest residues, C&D waste, switchgrass)
 - Extreme good/bad performance to build robust predictor models (e.g. tulip poplar, pinion/juniper, oak)

2. Rapid characterization tests of feedstocks/blends/processes→predictive models

- Inorganic composition: LIBS; X-ray spectroscopy
- Organic composition: NIR; FTIR; py-MBMS
- Fast pyrolysis performance: focused microwave beam, stirred mini-reactor, py-MBMS

Note: underlined terms are performed at INL (this project)

3. Evaluation of preprocessing technologies

- Mineral removal
- Thermal treatment

3 – Technical Progress: Characterization & Rapid Screening

06/30/14 Milestone: Analyze ultimate/proximate values as well as inorganic content of 30+ poplar and willow samples from Regional Feedstock Partnership (RFP).

Laser-induced breakdown spectroscopy (LIBS) chosen to analyze inorganics

- ***LIBS method developed for herbaceous feedstocks before 2013 Peer Review***

- **Advantages**

- Rapid analysis with little prep
- Configurable as field-portable system

- **Challenges**

- Material differences can require extensive calibrations
- Material heterogeneity

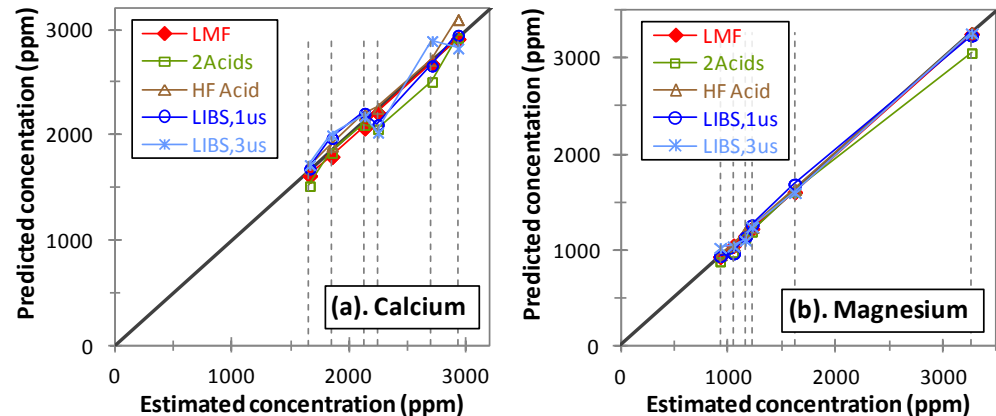
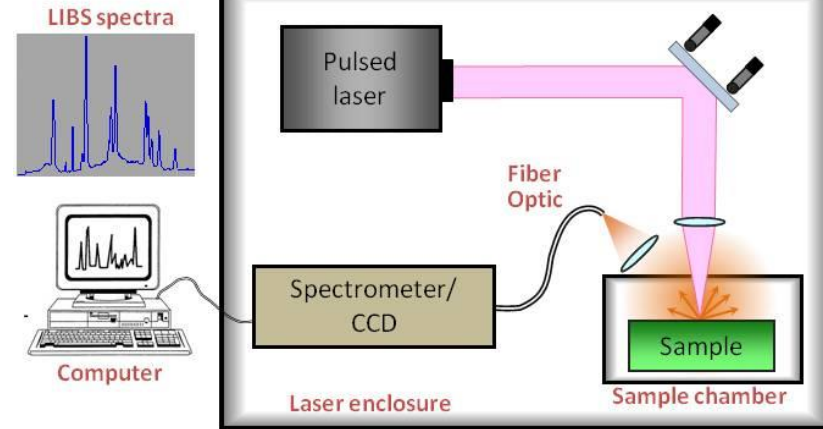

Comparison of calibration data with LIBS predictions for calcium and magnesium

3 – Technical Progress: Characterization & Rapid Screening

Two examples using LIBS for rapid characterization

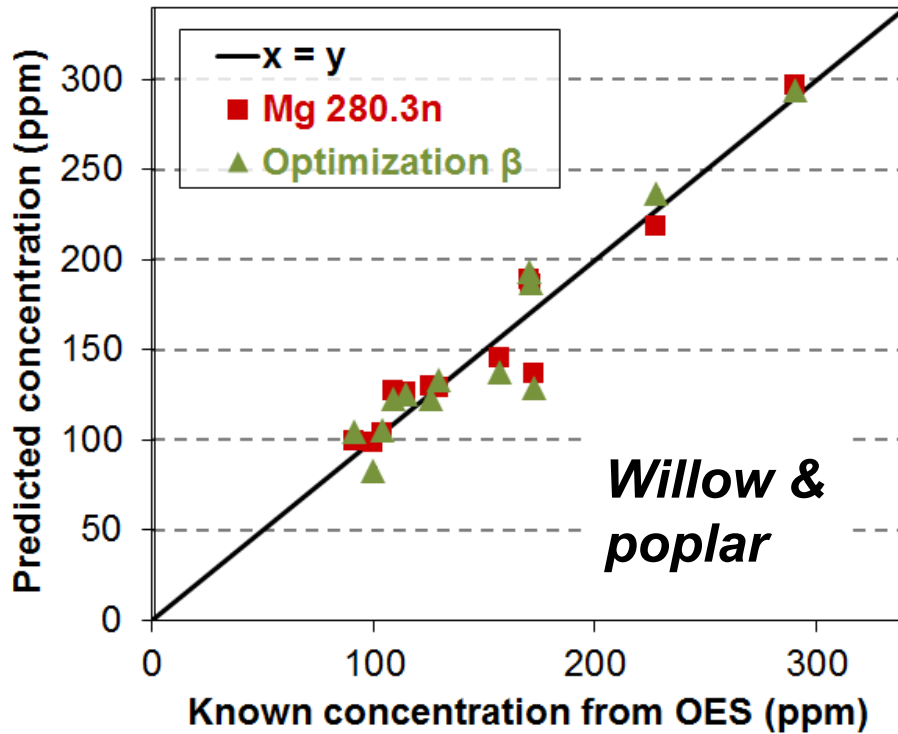

LIBS calibration for Mg (ppm) $U_{95\%} \approx 38$ ppm, based on 18 samples

- ≈ 50 samples analyzed to date
- ≈ 50 more samples in process
- Ultimate/proximate analysis also being compared to NIR

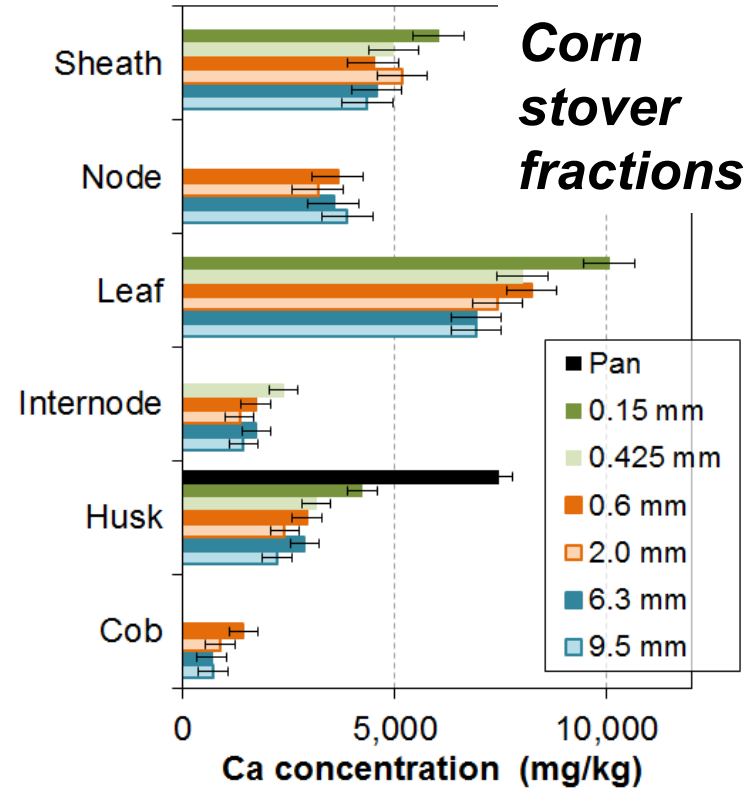

Ca concentration (ppm) in 70+ samples. $U_{95\%} = 300 - 600$ ppm, depending upon fraction.

Time for analysis ≈ 3 min/sample

3 – Technical Progress: Characterization & Rapid Screening

03/31/15 Milestone: Evaluate microwave-enhanced fast pyrolysis reactor for fast pyrolysis rapid screening. Metrics are correlations of oil yield and oil carbon content.

Features and Advantages

- Heating rate: Up to 150°C/sec
- Sample mass ≤ 2g
- Particle size ≤ 6 mm
- Samples doped with 2-10% activated carbon to enhance μ wave absorption

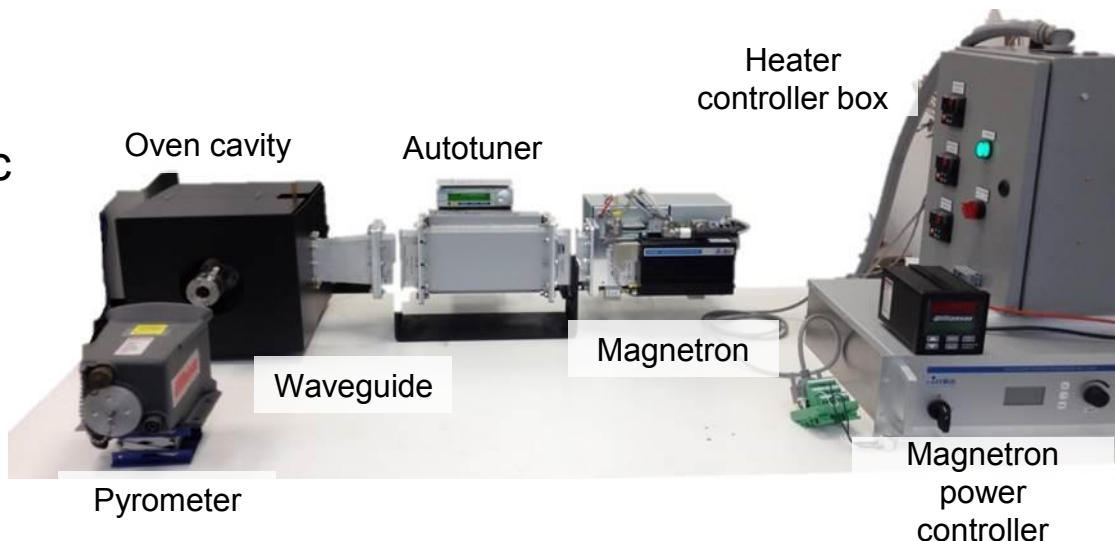

Doping	Heating Rate (°C/s)	250°C Oven			425°C Oven		
		%Oil	%Solid	%Gas**	%Oil	%Solid	%Gas**
0%	17	-	17	-	41	18	41
2%	72	-	14	-	48	16	36
5%	120	28	14	58	56	15	35
10%	119	21	30	49	25	29	46

Pellets (0.8 g pine) doped with activated carbon.

%Gas measured by difference

3 – Technical Progress: Characterization & Rapid Screening

Additional Features

- Solid, liquid, and gas yields are directly measured
- Total time (heating & cooling) < 5 sec. for complete reaction is possible
- Low gas flow & no sand
- Exhaust gases analyzed using GC-MS-FID and/or by IR gas analyzer.

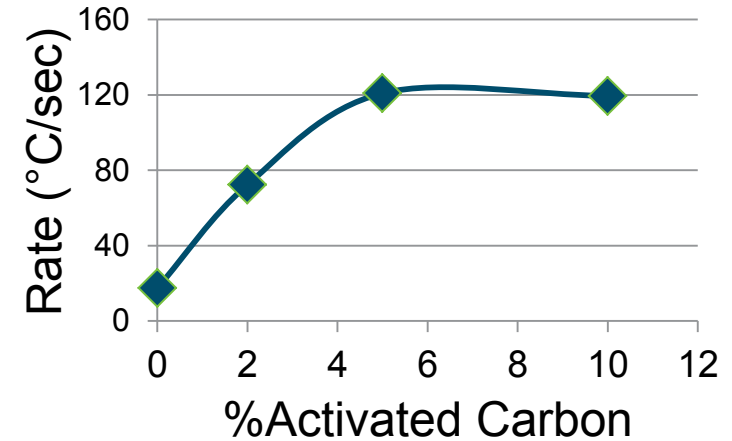
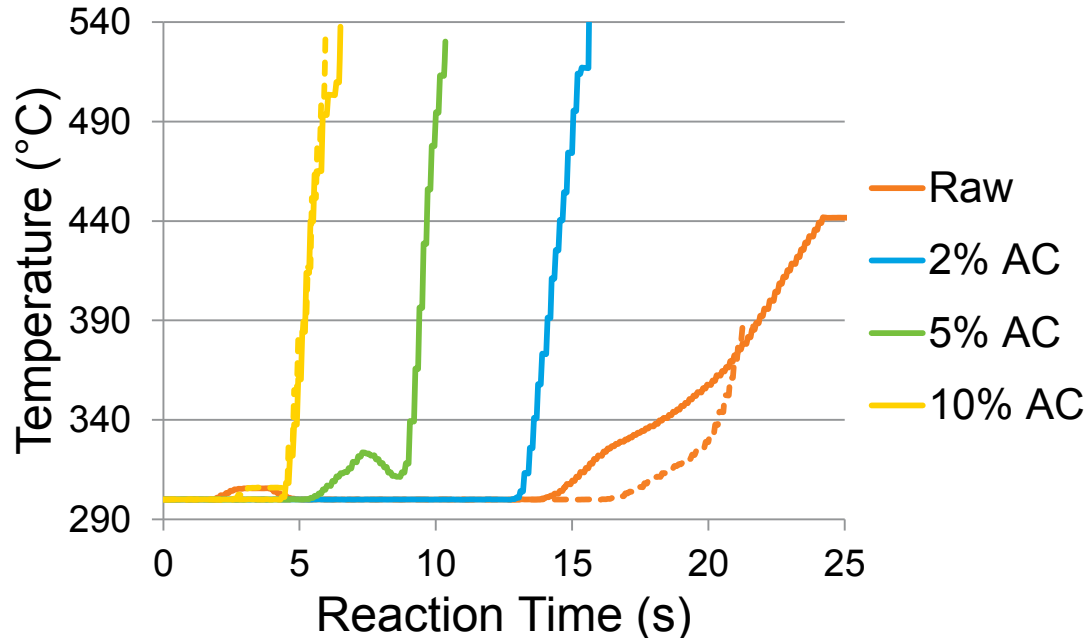

- Optimal doping $\approx 5\%$;
- Heating rates $> 100^\circ\text{C}/\text{sec}$.

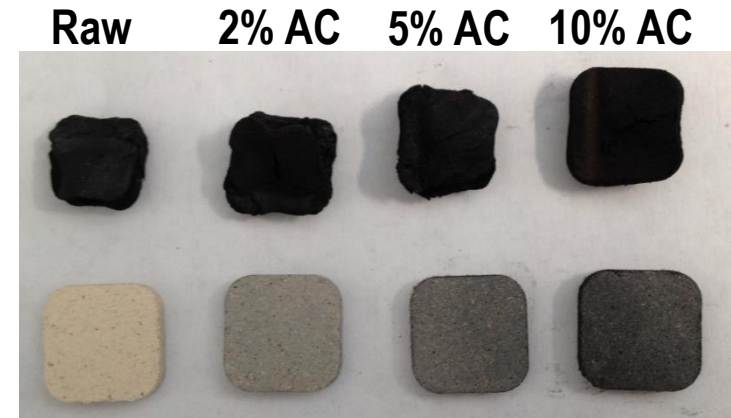

Photographs of pellets doped with different levels of activated carbon (AC).

3 – Technical Progress (Outline)

1. Lab-scale integration tests: Produce feedstocks (~1,000 kg) for multi-year conversion tests at NREL and PNNL. Feedstock selection is based upon
 - “High impact:” component of blend with ~50 million ton/yr availability at ~\$80/ton (pine, forest residues, C&D waste, switchgrass)
 - Extreme good/bad performance to build robust predictor models (e.g. tulip poplar, pinion/juniper, oak)
2. Rapid characterization tests of feedstocks/blends/processes → predictive models
 - Inorganic composition: LIBS; X-ray spectroscopy
 - Organic composition: NIR; FTIR; py-MBMS
 - Fast pyrolysis performance: microwave radiation, stirred mini-reactor, py-MBMS
3. Evaluation of preprocessing technologies
 - Mineral removal
 - Thermal treatment

3 – Technical Progress: Mineral Removal

12/31/14 milestone: Model the costs to remove different levels of inorganic species including Ca, K, Mg, Na, P, S, and Cl from forest thinnings and logging residues using a range of mechanical, aerodynamic and chemical leaching methods.

Motivation for mineral removal:

- Alkali metals and alkaline earth metals (AAEMs) catalyze thermal breakdown
- Studies show that bulk minerals reduce bio-oil yields

Approach

1. Test combinations of mechanical & aerodynamic material separations with chemical leaching to remove minerals
2. Develop mineral removal process model in Aspen® and estimate treatment costs.

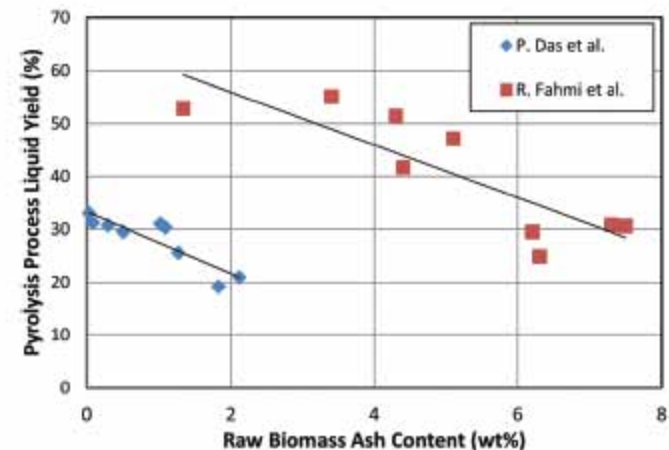

3 – Technical Progress: Mineral Removal

Air classification followed by chemical leaching of fractions with high mineral content. Results shown are for forest thinnings. Residues exhibited similar results.

Fan speed of 10 Hz (≈\$2/ton):

- Total ash of feed reduced from 1.09% to 0.63%
- Retention of 94% of organic material.

Fan speed of 12 Hz followed by leaching of air-separated fraction (≈\$5/ton):

- Total ash reduced from 1.09% to 0.84%
- K+Ca+Mg+Na+P → 0.34%;
- Retention of >99% of organic material.

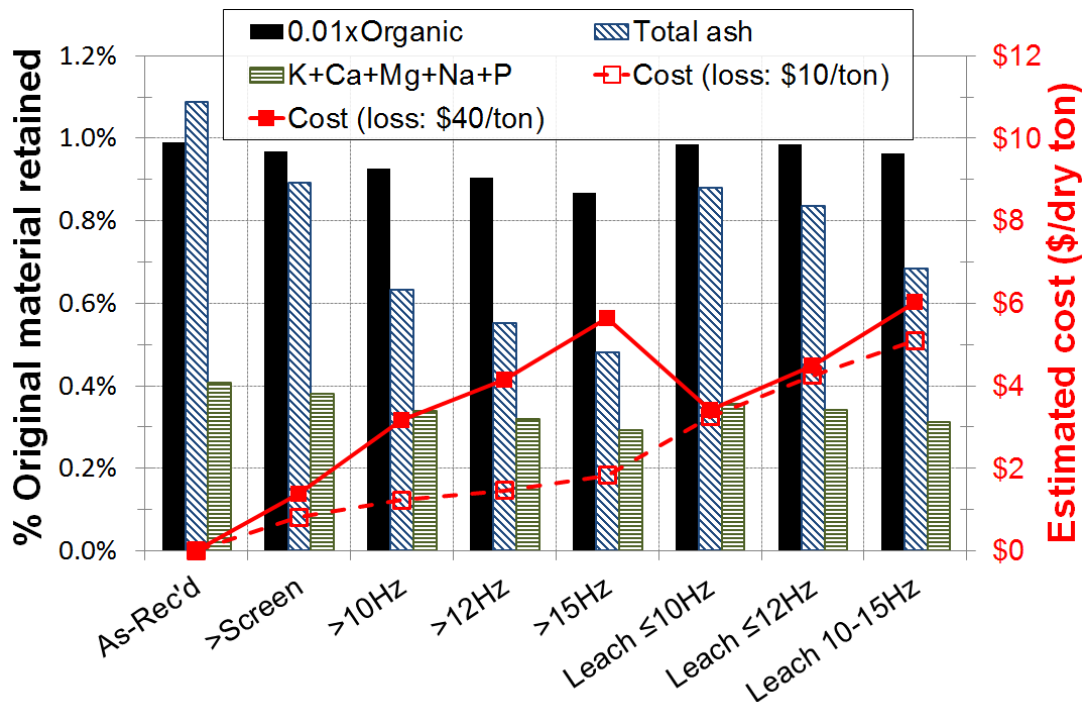

Effectiveness and estimated costs of 8 mineral removal scenarios.

Collaboration with WBS 1.2.1.2 (INL), which provided test data for maximum mineral removal for various conditions

3 – Technical Progress: Thermal Treatment

12/31/13 Milestone: Evaluate effectiveness and cost of a range of dry thermal pretreatments to enhance key feedstock supply chain and conversion properties and reduce their variability.

Motivation for thermal treatment:

- *Reduces grinding energy & increases grinding rate**
- *Decreases hygroscopicity, lengthens shelf-life**
- *Increases flowability**
- Increases carbon content
- Decreases oxygen content

* Quantified prior to 2013 Peer Review

Approach

1. Measured properties of 14 feedstocks dried at 105 °C and treated at 255 °C
2. Developed process model in Aspen® to estimate cost.

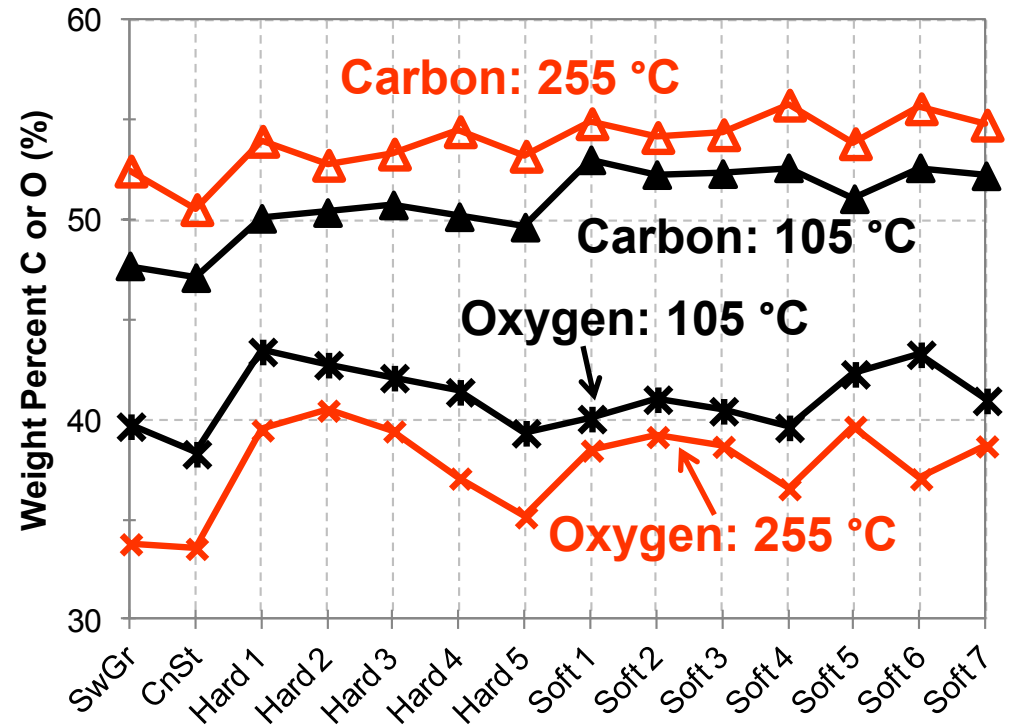

3 – Technical Progress: Thermal Treatment

- Cost for treatment at:**
- 220-250 °C w/o heat recovery: ≈ **\$29/ton**
 - 270 °C with heat recovery: ≈ **\$14/ton**

- Estimated cost benefits:**
- \$14/ton drying
 - \$3/ton grinding
 - \$2/ton handling?
 - \$5-8/ton treatment of exhaust gases from subsequent conversion?

- To be determined:**
- Conversion effects
 - Shipping

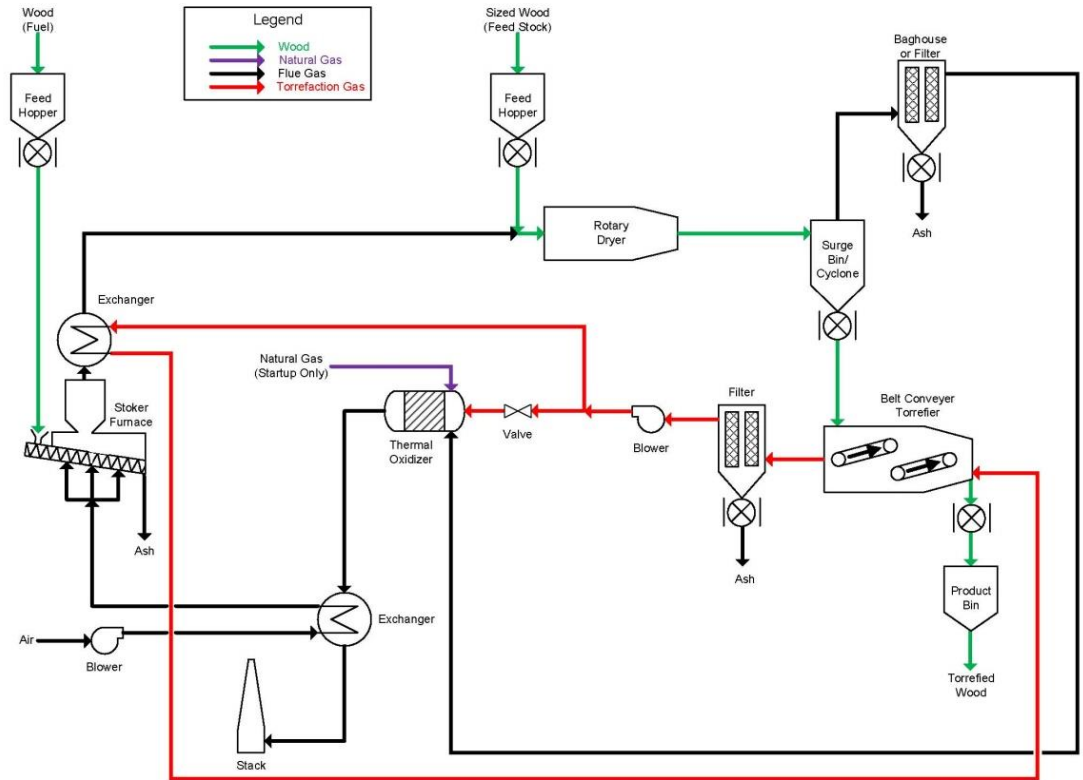

Basic depot thermal processing configuration.

Estimated cost to treat 20% of blend (SwGr component?): \$3-\$6/ton

4 – Relevance (INL, NREL, PNNL)

BETO FY17 Performance Goal:

“...deliver **feedstock**...at required conversion process in-feed **specifications** at or below \$80/dry ton...”

BETO 2022 Milestone:

“By 2022, validate the Office performance goal of \$3/GGE...using **on-specification blended, low-cost feedstock** via a thermochemical pathway that produces gasoline and diesel blendstock fuels.”

Barriers

- **Tt-C.** Relationship Between Feedstock Composition and Conversion Process
- **Ft-G.** Biomass Material Properties and Variability
- **Tt-E/F.** Deconstruction of Biomass Feedstocks to Form Gaseous/Bio-Oil Intermediates
- **Tt-I/J.** Catalytic Upgrading of Gaseous/Bio-Oil Intermediates to Fuels and Chemicals
- **St-C., At-C.** Analysis and Sustainability



*Process-relevant **data** – feeding & handling, product yield & composition vs feedstock – leading to in-feed **specifications** will help feedstock and biorefinery developers during commercialization.*

5 – Future Work

1. Rapid characterization & integrated lab-scale tests

- Isolate fractions of low quality feedstocks with high ash & acid contents
- Treat separated fractions to improve properties (see below)
- Apply rapid screening (fast pyrolysis & oil upgrading) to identify methods, including blending, that enable feedstocks to achieve conversion targets
- Perform 10+ integrated lab scale “field-to-fuel” tests each year to benchmark and validate rapid screening tools
- Characterize 50-100 “high impact” feedstocks each year to assess variability

2. Develop feedstocks & blends for hydrothermal liquefaction (HTL)

- Prepare slurries for HTL conversion at PNNL
- Measure viscosity and flow shear parameters for slurries of feedstocks and blends at reaction conditions (200-300 °C and 1,000-2,000 psi)

3. Evaluate multi-stage fast pyrolysis for low quality feedstocks

- 1st stage (mild) pyrolysis removes organic acids from hemicellulose with little impact on oil yield; also enables novel mineral removal strategies
- Will be important for low quality feedstocks (e.g. switchgrass) with high mineral and organic acid contents.

Summary

We are developing specifications for feedstock preparation and conversion operating conditions to enable low-cost, high-volume resources to achieve conversion targets, similar to pulpwood

- Feedstock properties affect yields and qualities of pyrolysis & oil upgrading
- Integrated lab-scale tests provide baseline performance values
- Rapid characterization methods optimize feedstock preparation & blending as well as conversion operating conditions

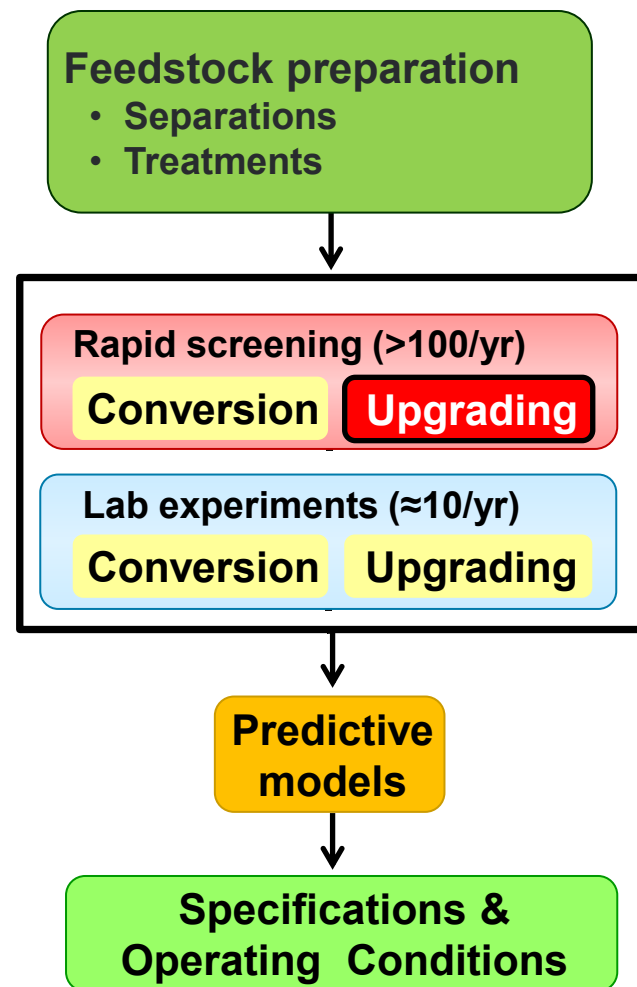
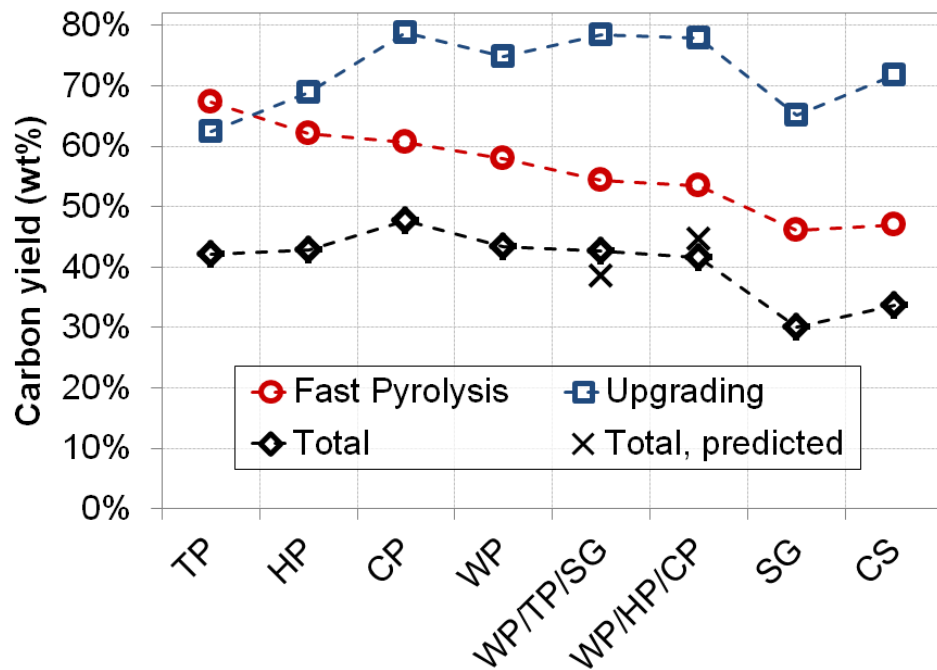

ACKNOWLEDGMENTS



Stuart Black

Daniel Carpenter*

Singfoong Cheah

Earl Christensen

Mark Davis

Steve Deutch

Robert Evans (MicroChem)

Rick French

Whitney Jablonski

Kellene McKinney

Anne Starace

Corinne Drennan

Dan Howe*

Susanne Jones

Igor Kutnyakov

Craig Lukins

Daniel Santosa

Alan Zacher

Rachel Emerson

Sergio Hernandez

Amber Hoover

Austin Matthews

J. Chad Ryan

Tyler Westover*

C. Luke Williams

*This work was supported by the **Bioenergy Technologies Office (BETO)** at the U.S. Department of Energy's Office of Energy Efficiency and Renewable Energy. **National Renewable Energy Laboratory** is operated by The Alliance for Sustainable Energy, LLC under Contract no. DE-AC36-08-GO28308. **Pacific Northwest National Laboratory** is operated by Battelle under contract DEAC05-76RL01830.*

***Project Leads at respective labs**



Manuscripts

1. Howe, D.; Westover, T.; Carpenter, D.; Santosa, Emerson, Deutch, Starace, Kutnyakov, Lukins, “*Field to Fleet Performance Testing of Lignocellulosic Feedstocks: An Integrated Study of the Fast Pyrolysis/Hydrotreating Pathway*”, Submitted to Energy and Fuels, February 2015
2. Carpenter, D.; Westover, T.; Jablonski, W.; Czernik, S. “*Biomass Feedstocks for Renewable Fuel Production: A review of the impacts of feedstock and pretreatment on the yield and product distribution of fast pyrolysis bio-oils and vapors.*” Green Chem., 2014, DOI: 10.1039/C3GC41631C, <http://xlink.rsc.org/?doi=C3GC41631C>).
3. Jeffrey A Lacey.; Rachel M Emerson; Tyler L Westover; David N Thompson, Ash reduction strategies in corn stover facilitated by anatomical and size fractionation. Submitted to Biomass and Bioenergy, January 2015
4. Jeffrey A. Lacey, Tyler L Westover, John E. Aston, Robert S. Cherry, David N. Thompson, Air classification as a method to isolate high- and low-mineral content fractions in loblolly pine forest residues, submitted to Fuels, March 2015
5. Manunya Phanphanich, Tyler L. Westover, Amber Hoover, and Daniel Stevens, Effect of thermal treatment on equilibrium moisture content of southern pine, Submitted to Biofuels.
6. Cheah, S.; Olstad, J.; Jablonski, W.; Barthelemy, K.; Carpenter, D.; Robichaud, D.; Westover, T. “*Effect of feedstock torrefaction and catalytic gasification on product gas composition.*” To be submitted.

Presentations/posters

1. Carpenter, D.; Westover, T.; Howe, D.; Evans, R.; French, R.; Kutnyakov, I.; Santosa, D. *“Field-to-fuel performance testing of various biomass feedstocks: production and catalytic upgrading of bio-oil to refinery blendstocks.”* Oral Presentation, TCS2014, September 2014, Denver, CO.
2. Cheah, S.; Jablonski, W.; Olstad, J.; Carpenter, D.; Robichaud, D.; Westover, T. *“Impact of feedstock torrefaction and catalytic gasification on product gas composition.”* Oral Presentation, TCS 2014, September 2014, Denver, CO.
3. Carpenter, D.; Westover, T.; Howe, D.; Jones, S.; Evans, R.; French, R.; Kutnyakov, I.; Santosa, D. *“Conversion of lignocellulosic biomass to hydrocarbon fuels via hydroprocessing: case study for eight high-volume U.S. feedstocks”*, Oral Presentation, 2nd International Symposium on Energy Challenges & Metrics, Aberdeen, Scotland, August 2014.
4. Ash composition analysis of anatomical and particle size fractions of corn stover using laser-induced breakdown spectroscopy (LIBS), Rachel Emerson, Tyler L. Westover, Jeffrey Lacey, SciX 2014 presented by FACCS, RENO NV, Sept. 28-Oct 3, 2014.
5. Thermal properties of biofuel feedstocks over a wide temperature range, Daniel Stevens, Rachel Emerson, Tyler L. Westover, International Biomass Conference, Orlando, FL, Mar. 24-26, 2014.
6. Ash Composition Analysis of Herbaceous and Woody Biomass Using Laser-Induced Breakdown Spectroscopy (LIBS). TC Biomass 2013, Chicago, IL. Sept. 3-6, 2013.

Additional Slides

4 – Relevance (cont.)

Cost sensitivities show potential impacts of feedstock on MFSP (ex-situ upgrading case).

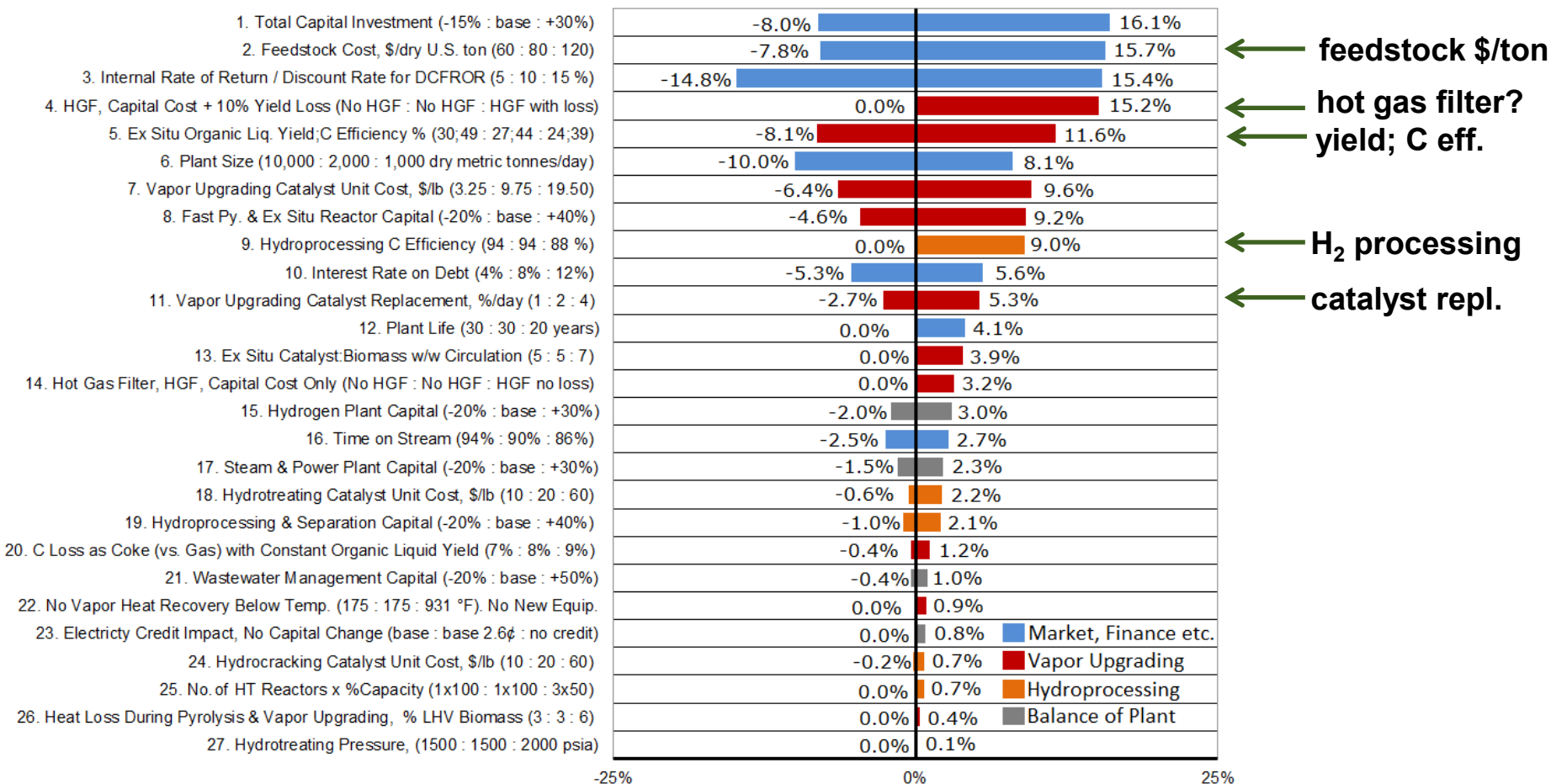

← feedstock \$/ton
 ← hot gas filter?
 ← yield; C eff.
 ← H₂ processing
 ← catalyst repl.

-25% 0% 25%

% Change to MFSP from the ex situ base case (\$3.31/GGE)



Energy Efficiency & Renewable Energy

Responses to 2013 Review Comments

Note: The three INL/NREL/PNNL interface projects were combined for the 2013 Peer Review

4). Critical Success Factors

Please evaluate the degree to which:

- The project performers have identified critical factors (including technical, market, and business) that will impact the potential technical and commercial success of the project.
- The project performers have presented adequate plans to recognize, address, and overcome the top two to three challenges (technical and non-technical) that need to be overcome for achieving successful project results.
- Successful completion of the project will advance the state of technology and impact the viability of commercial bioenergy applications.

Reviewer Comments

a). The CSF's are reasonable. There is a balance between a need for specificity (i.e., knowing precisely what the conversion process "customer" is doing) and generality (i.e., the conversion process in vogue today may be on tomorrow's trash heap, so measurements and processes must apply across a range of conversion technologies). This work could shift a bit toward generality, since the conversion work at the Labs is typically some years behind the state of the art. The real risk is in major changes in direction, like cellulosic ethanol waning while hydrothermal liquefaction waxes, gasification declining while pyrolysis work increases, etc. The balance of this project should be carefully assessed vs. the MYPP as it evolves over time.

b). Seem to understand critical factors

c). Good goal, but may be difficult to achieve. Tests that can be used in the field vs run at a national lab need to be developed. This can be a huge hurdle. Non-linearity of blends creates other hurdles. Lastly, ash composition vs feedstock and ash vs yields creates a possible way of valuing alternative biomass feedstocks.

d). Significant success has already been made. The investigators seem to understand the barriers to progress.

Presenter Response:

a). We agree that this task must evaluate a broad range of technologies and feedstocks, so generality is given greater weight than specificity. However, comparing different technologies and feedstocks require that specific examples be explored and the results generalized where possible. This project closely watches the MYPP to assist in guiding research efforts.

c). A principal focus of this project is to develop tools and test methods that can be applied in the field real time, such as LIBS and FTIR spectroscopies and possibly TGA/DSC. An important aspect of conducting the research is assuring that research performed in the laboratory used 'field-run' material that is truly representative of material that is harvested at full commercial scale.

5). Future work

Please evaluate the degree to which:

The project performers have outlined adequate plans for future work, including key milestones and go/no go decision points.

The project performers have addressed how they plan to deal with upcoming decision points and any remaining issues.

Reviewer Comments

a). The Future Plans are sound.

b). Still several methods to evaluate to be done
Go back and figure out what funds left to do needed tasks

c). May not have time and scope to achieve the goal, considering the complex scope of this task. A good plan though.

d). Future work is well defined and planned.

Presenter Response:

b). There are still many technologies and feedstocks (including blends) that need to be evaluated. This task cannot evaluate all possible methods, so it is essential that we prioritize what technologies and feedstocks are evaluated with the available funds. We look for and appreciate guidance from Industry regarding how the prioritization should be made.

c). See response to b).

6). Technology Transfer and Collaboration

Please comment on the degree to which the project coordinates with other institutions and projects to provide additional benefits to both BETO and the industry. Please provide suggestions on additional opportunities for encouraging further coordination.

Reviewer Comments

- a). The collaboration is almost 100% focused on the other Labs, which is understandable, but over time, there should be more emphasis on engaging industry partners, even if it is only informally via sample exchanges and periodic discussions / workshops. Tunnel vision based on what the other Labs are doing in the conversion arena is the biggest risk here.
- b). Articles and conference proceedings published.
- c).
- d). This is a well coordinated project and will be transferable to many other bio-oil projects.

Presenter Response:

a). Although industry partners are not explicitly listed as partners in the quad chart, this project does work indirectly with industrial partners through the Core Feedstock and Conversion Platforms. The process is like a pipeline or flow chart: Industry (feedstocks) → Feedstock Platform (DOE) → Interface Task (DOE) → Conversion Platform (DOE) → Industry (Conversion & Upgrading). If the Interface Tasks engages in substantial effort directly with industry, it runs the risk of cutting out the Feedstock and Conversion Platforms, which could cause confusion and duplicate effort.

4 – Critical Success Factors

- Rapid screening tools and interpretive performance models for rapid determination of least-cost pathways (real-time)
 - Integrated models for supply, preconversion, and conversion, including costs
- Reduce costs for feedstocks and delivered fuels by properly matching feedstocks and technologies
 - Optimized preconversion operations and feedstock formulations will allow access to all local low cost resources
- Challenges
 - Very wide scope (feedstocks & technologies) – Must assess not develop
 - Effects of feedstock parameters on (pre)conversion not understood
 - *Non-linear effects complicate predictive regression-type models*
 - *Many feedstocks must be tested for robust model construction & validation*
 - Rapid screening techniques tend to be expensive & complicated.
 - *Economic and field-portable technologies must be developed*
 - Results from lab-scale tests must be transferable to pilot-scale.
 - *Pilot scale tests are needed to confirm lab results*

3 – Technical Progress: Characterization & Rapid Screening

12/31/2013 Milestone: Screening methods for feedstock quality and micro/macro-scale variability using FT-IR microscopy.

Capability

- Capture FTIR spectra from 128x128 pixel detector (focal plane array) in seconds to build micron-scale hyperspectral ‘maps’
- Potentially track spatially resolved physiochemical changes at cell level in real time during thermochemical processes

Progress

- Developed methodologies to analyze biomass samples using reflectance, transmission, & total attenuated reflectance (ATR)
- Analyzed biomass qualitatively
- Models to predict proximate and ultimate properties of switchgrass
- Efforts in progress to build models for additional feedstocks and at the micron scale

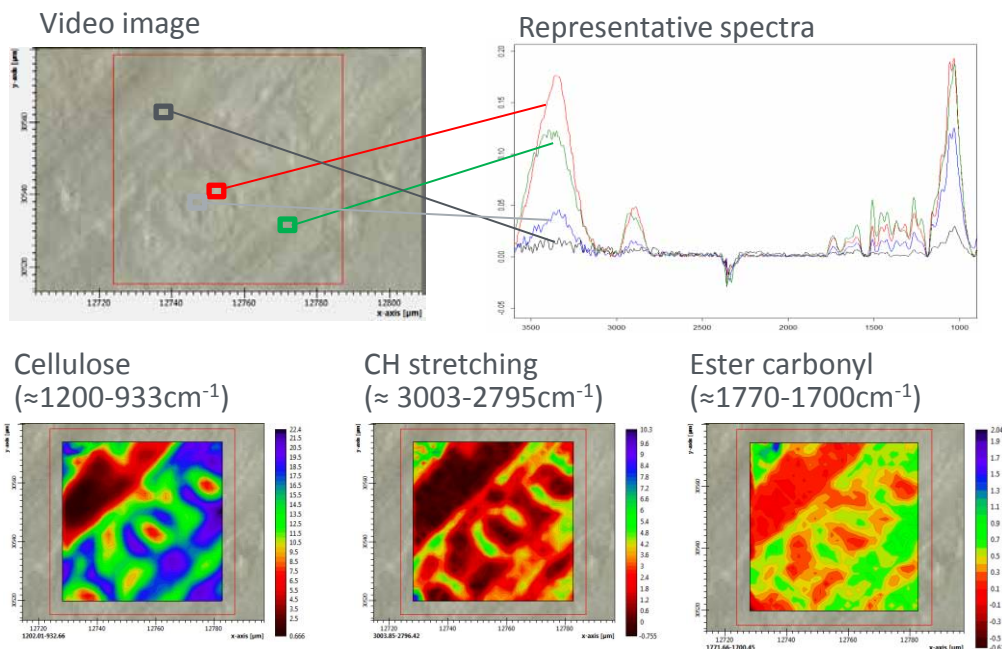

Images of a pine chip dried at 105°C.

Component	%Fixed Carbon		
	RMSEC	RMSECV	R ²
Model Merit	0.29	0.67	0.92

Benefits of thermal treatment

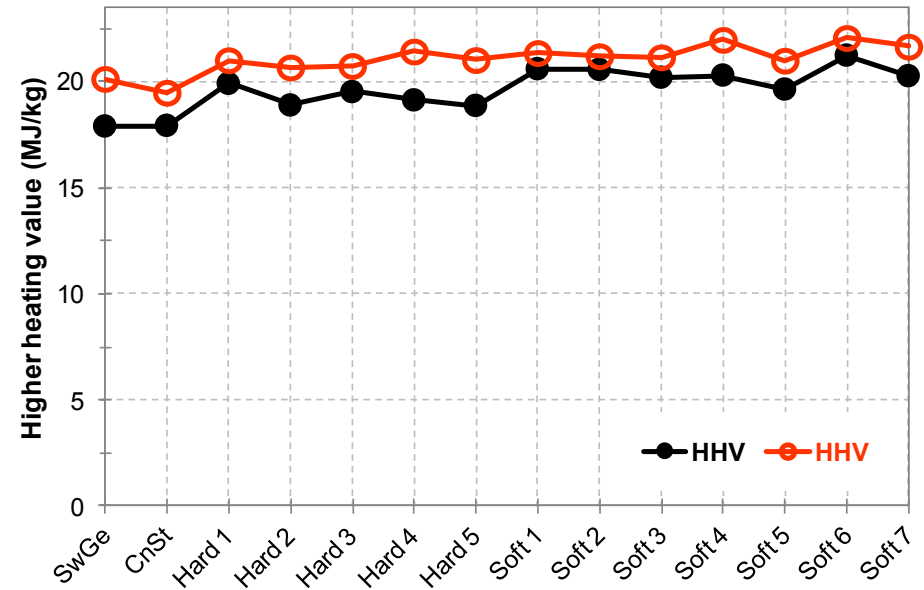
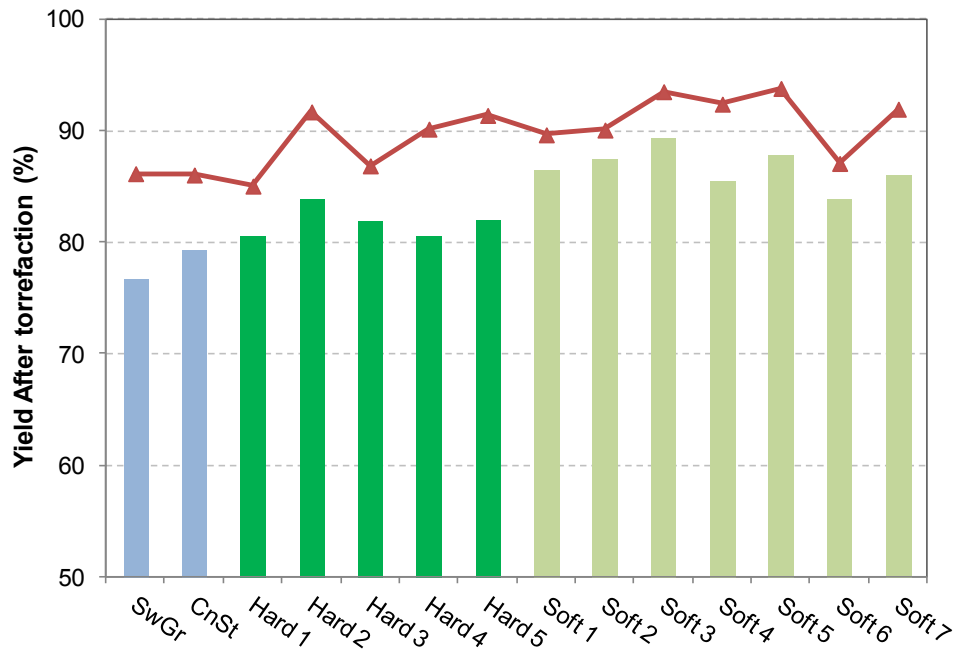

Percent solid yield (bar graphs) and percent energy yield (red line) of feedstock after thermal treatment at 255°C for 30 min.

Higher heating value (HHV) of feedstocks dried at 105°C (black) and torrefied at 250°C (orange).

Cost estimate of thermal treatment

Estimated Cost:

- \$14-29/ton

Estimated Savings:

- \$14/ton drying
- \$3/ton grinding
- \$2/ton handling
- \$5-8/ton exhaust gas treatment

Unaccounted for:

- Conversion effects
- Moisture
- Shipping

Chips at 30% MC		Treatment costs (\$ million/year)		
Cost components	Cost basis	180 °C	230 °C	270 °C
Wood chips (lower yield at higher temp.)	\$25/dry ton		0.25	1.4
Wood chips (as stoker furnace fuel)			0.3	
Natural gas			0.2	0.2
Electricity			1.8	1.8
Operating labor*			1.7	1.8
Maintenance labor and materials				-2.9
Steam sales			4.3	2
OPERATING EXPENSES			3	3
Capital recovery charge			7.4	5.3
TOTAL EXPENSES			\$29	\$14
<i>Thermal processing</i>			<i>\$49</i>	<i>\$34</i>
<i>w/ capital recovery</i>				

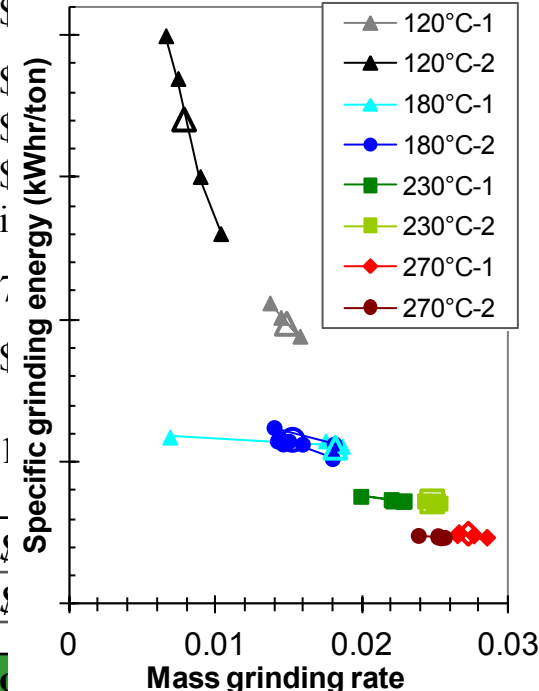

Process provider	Production (ton/hr)	Mass grinding rate (metric ton/hr)	Capital cost scaled to ton/hour (\$ million)
Agri-Tech Producers	5	5	11.5
HM3 Energy	11	20	28.6
This report, depot case at 230 °C	20	21.1	24.9

- **Technical Approach (6 specific tasks):**
 1. Produce, characterize, & share feedstocks & bio-oils (Areas 1: “Specs”)
 2. Assess preconversion processes for benefits & costs on feedstock supply & conversion (Areas 1 & 3: “Specs” & “Sub-project”)
 3. Assess impact of feedstock compositional characteristics on liquid, gas, and solid yield as well as oil quality (Areas1: “Specs”)
 4. Develop methods for vapor and oil characterization (Areas 1 & 2: “Specs” & “Screening”)
 5. Rapid analytical screening tools: ash composition, FT-IR microscopy (Area 2: “Screening”)
 6. Techno-economic analyses to optimize feed/conversion systems (Area1: “Specs”)
- **Success Metrics**
 - Predictive performance models for supply, preconversion, and conversion performance, including costs, for rapid determination of least-cost pathways
 - Reduced costs for feedstocks & delivered fuels
 - Accomplished by optimizing preconversion operations and feedstock formulations to access full local supply of all low cost resources

2 - Technical Progress

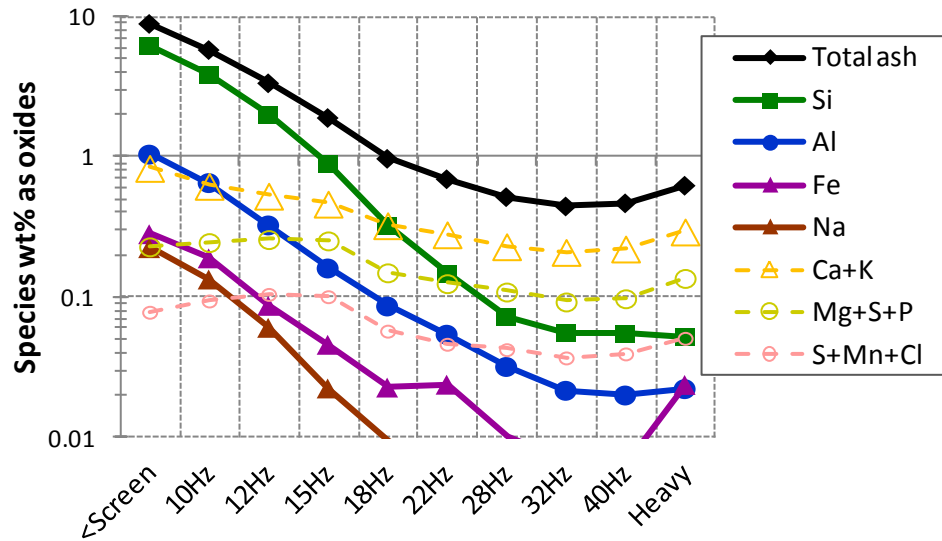

Inorganic species in air separated fractions of pine logging residues as % wt of total material.

Scenario Alias	Description
None	No ash removal
>Screen	Fraction collected below screen is removed from feed stream. ¹
>10Hz	Fraction with fan speed $\leq 10\text{Hz}$ is removed from feed stream. ¹
>12Hz	Fraction with fan speed $\leq 12\text{Hz}$ is removed from feed stream. ¹
>15Hz	Fraction with fan speed $\leq 15\text{Hz}$ is removed from feed stream. ¹
Leach $\leq 10\text{Hz}$	Fraction with fan speed $\leq 10\text{Hz}$ is separated and subjected to chemical leaching before being returned to feed stream. ¹
Leach $\leq 12\text{Hz}$	Fraction with fan speed $\leq 12\text{Hz}$ is separated and subjected to chemical leaching before being returned to feed stream. ¹
Leach $\leq 15\text{Hz}$	Fraction with fan speed $\leq 15\text{Hz}$ is separated and subjected to chemical leaching before being returned to feed stream. ¹

- Air separations causes minerals to be removed in two groups:
 - Group 1: Entrained soil (Si, Al, Fe, and Na).
 - Group 2: Bound minerals (Ca, K, Mg, S, P) – more difficult to remove
- 8 potential scenarios were investigated, combining air separation with chemical leaching to remove ash.

Thermal treatment systems

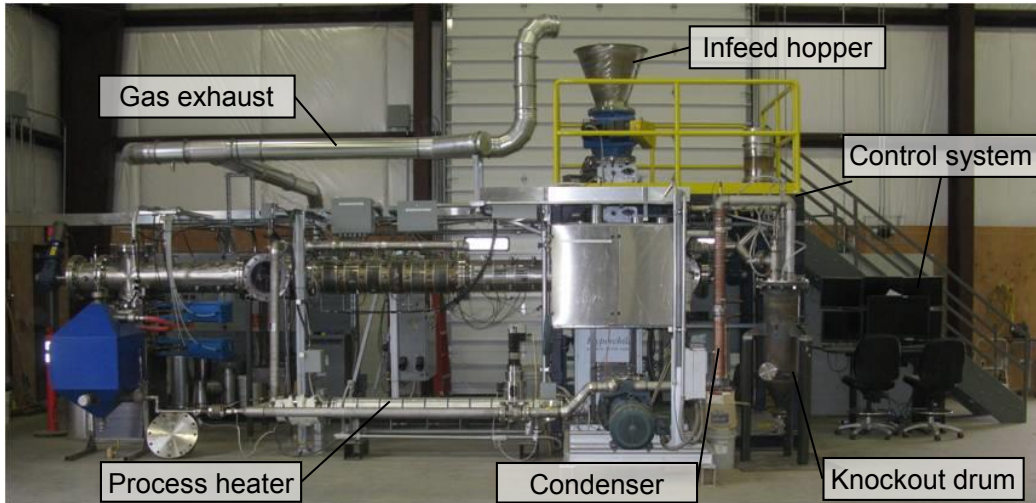

Continuous feed thermal treatment system (20 kg/hr)



Batch thermal treatment system (3 kg/batch)



- Pine chips thermally treated at 120, 180, 230, 270°C

Equipment is set up for thermal treatment of materials to achieve feeding and conversion specifications

2 – Technical Progress (INL)

“Flowability” via Schulze ring shear tester

- Tendency of bulk solid to flow increases as compressive stress increases relative to material’s shear strength (σ_1 / σ_c = flowability, ff_c)
- Cases in which $ff_c > 10$ are generally considered ‘free flowing,’ although flow problems can still occur.

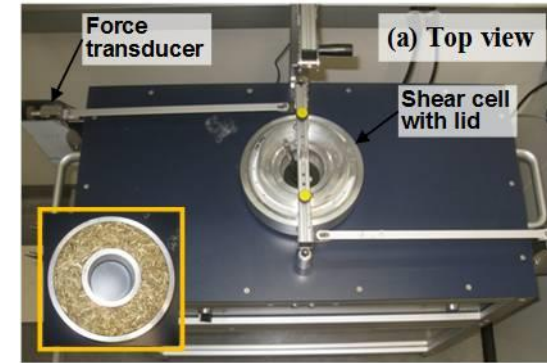

Schulze ring shear tester

- Additional hopper feeding tests indicate that flow behavior of thermally treated material is similar to cohesionless dry sand

- Thermal treatment greatly increases flowability
 - Treatment at $T > 180^\circ\text{C}$ greatly improves flow properties

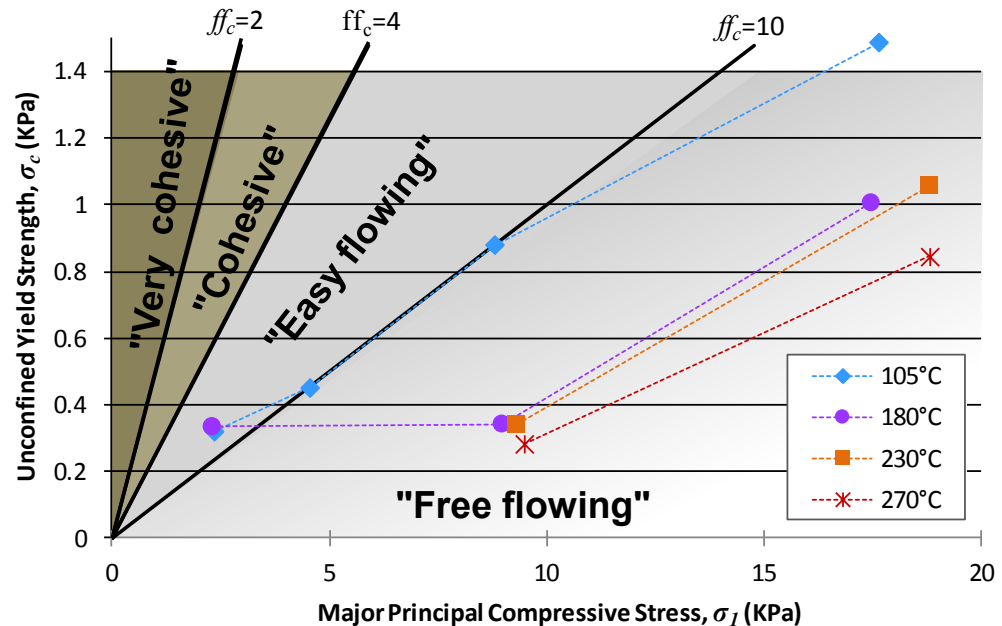

Measured unconfined yield (shear) strength, σ_c , as a function of major principal compressive stress, σ_1 , for pine chips thermally treated at 105, 180, 230, and 270C.

2 – Technical Progress (INL)

(a) Grinder power consumption

(b) Cumulative ground material mass for thermally treated pine chips as functions of time.

(c) Specific grinding energy in kWhr/metric ton as functions of the material grinding rate.

- Small solid symbols were calculated over short time periods of approximately 25 seconds over which the material grinding rate appeared constant.
- Large hollow symbols were calculated as the average over longer time intervals as marked in (a).
- Green circles and red diamonds represent the start and end, respectively, of the long time intervals used to calculate the large hollow symbols in (b).

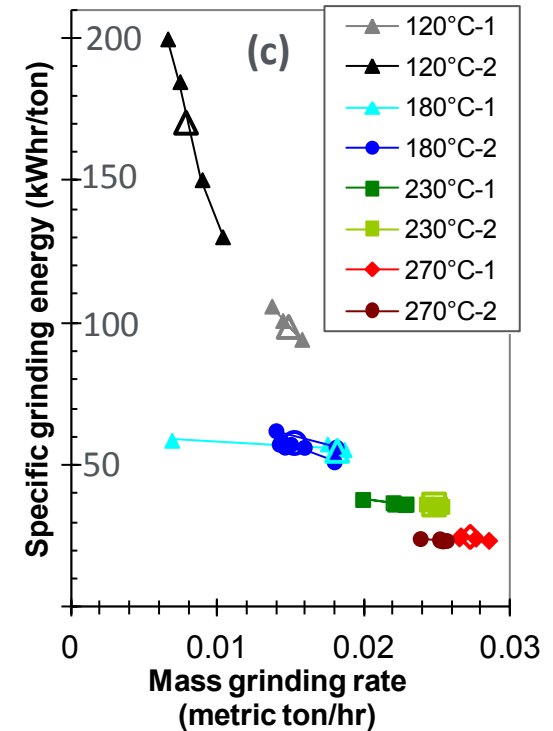
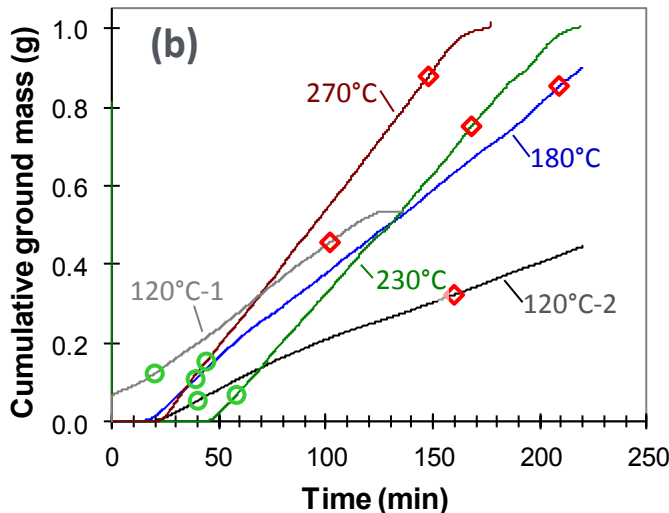
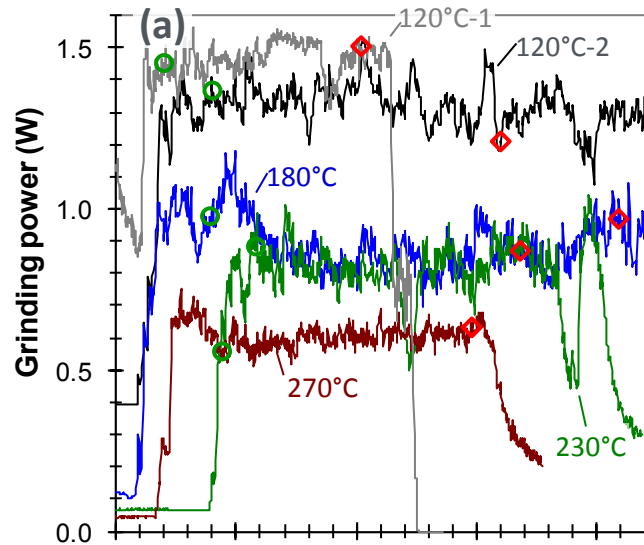

As temperature increases:

- Grinding rate increases
- Grinding energy decreases

Assess benefits of thermal treatment

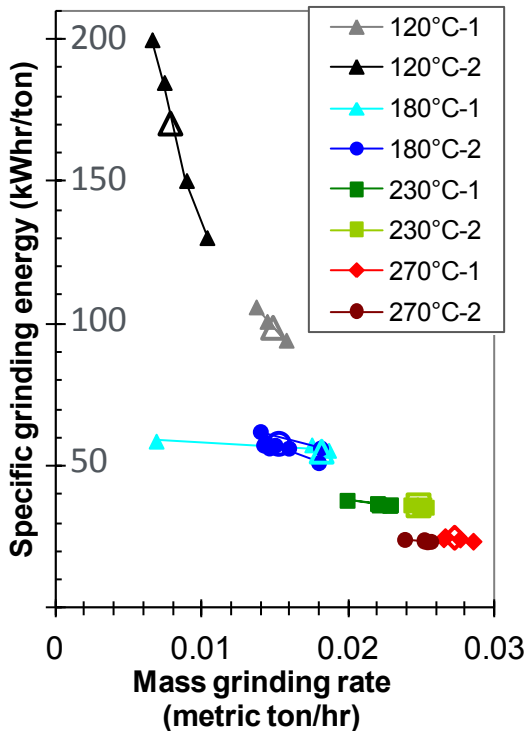

Specific grinding energy in kWhr/metric ton as functions of the material grinding rate.

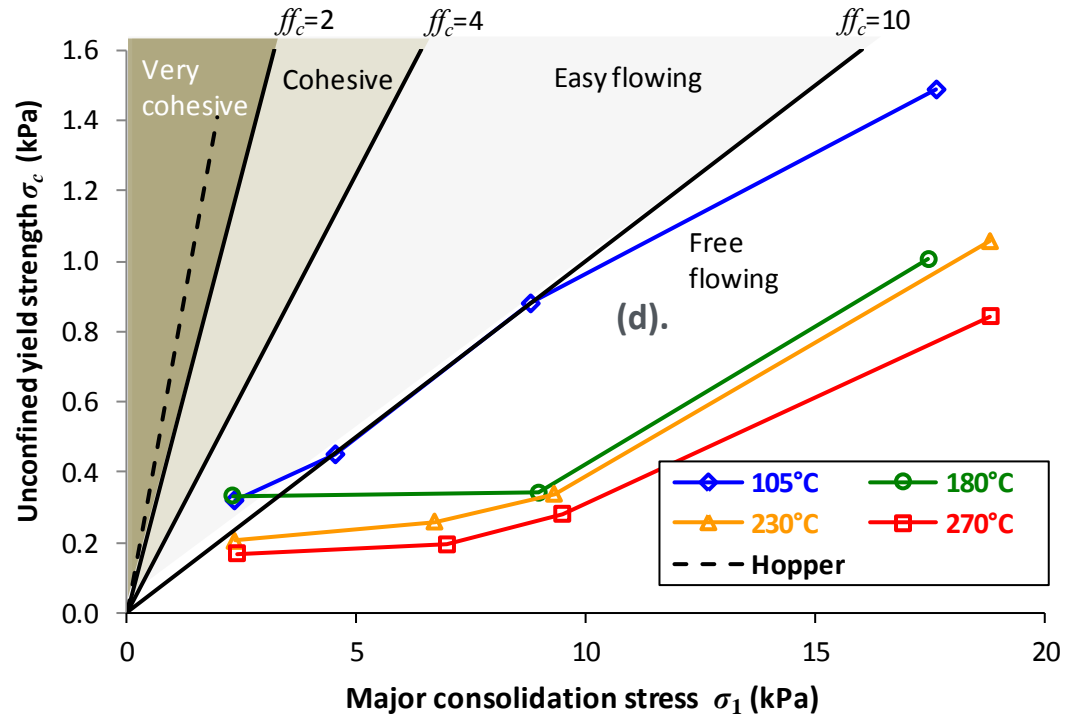

Measured unconfined yield (shear) strength as a function of major principal compressive stress for pine chips thermally treated at 105, 180, 230, and 270C.

- Reduces specific grinding energy
- Improves grinding rate
- Improves feeding performance

Depot Thermal Preprocessing Configuration

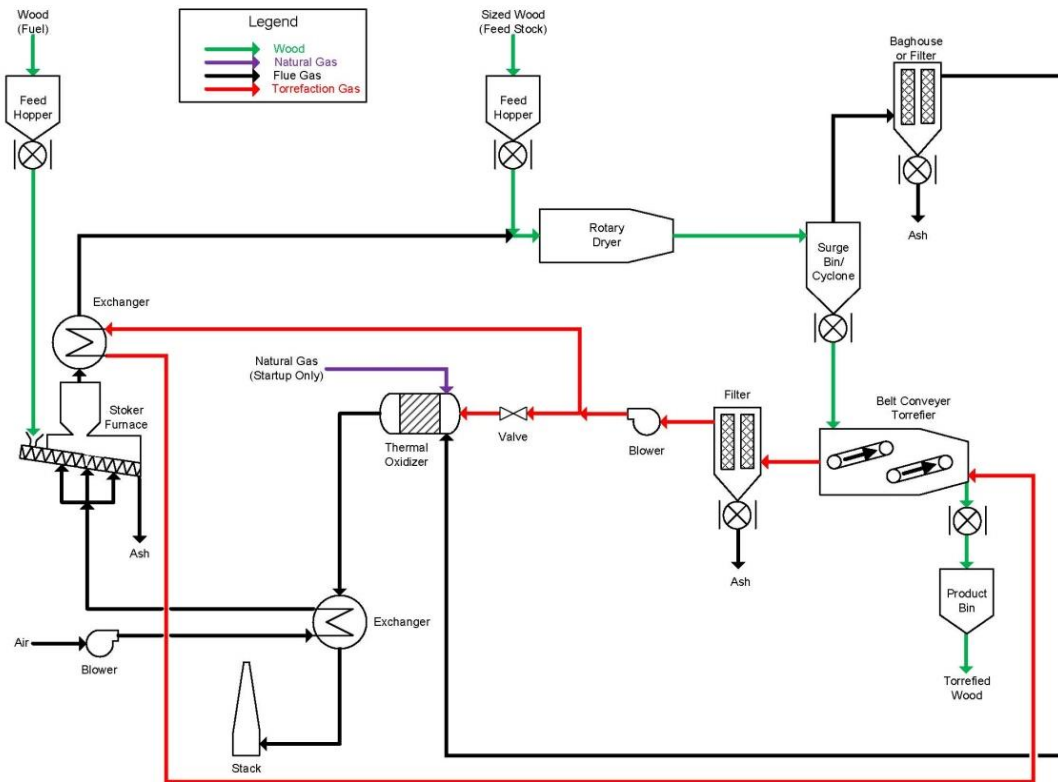

Basic depot thermal processing configuration

Topic Relevance to BETO Platforms

- Biomass contains both introduced soil ash and endogenous ash
- Endogenous ash is comprised of structural and non-structural physiological ash
- Ash is comprised of metals and heteroatoms that may be
 - Inert... e.g., SiO_2 in biochemical conversions
 - Destructive to conversion products... e.g., K, Na, Ca, Mg in pyrolysis
 - Fouling agents for conversion catalysts... e.g., N, S, P for several processes
 - Sources of pollutants... e.g., N, S in combustion and gasification
 - Damaging to equipment... e.g., SiO_2 , K, Na in combustion and gasification
- This increases processing costs and/or reduces product yields
- Knowing the chemical form, function and plant tissue location of specific ash components aids in identifying effective

Impact of Ash for the Bio-Oil and Biochemical Platforms

- Bio-oil Design Case... increasing ash content to 1.9% from 0.9% increased processing costs by nearly \$19/dry ton of feedstock
- In the Biochemical Design Case, biorefinery costs increase by ~\$2.25/dry ton feedstock per percentage point over 5% ash
- We are utilizing mechanical and chemical ash removal technologies in tandem to reduce the amount of non-spec feedstock blend components requiring further preprocessing to meet specifications
- A recent report estimated that the costs to sort MSW leads to an MSW cost of \$84.27/ton (\$70/ton after sale of recyclables)
 - With the MSW fraction at 5% or 10% in the 2017 design blends for the thermochemical and biochemical platforms, respectively, the contribution of MSW to the feedstock cost would range from \$3.50-\$4.21/ton of blend for thermochemical, and \$7.00-\$8.43/ton of blend

Where Do Ash Components Originate?

- Mineral nutrients – specific and essential functions in metabolism
 - Macronutrients – high growth requirement – Ca, K, S, Mg, N, P
 - Micronutrients – lower growth requirement – Zn, Fe, Mn, Cu, Cl
 - Beneficial elements – stimulate growth – Na, Si, Al
- Physiological functions (general)
 - K^+ , Na^+ ...most involved in vascular transport, typically free ions in solution
 - Ca^{2+} , Mg^{2+} ...complexed with organic acids/proteins or inside cells (soluble)
 - S...component of proteins (as S^{2-}) and sulfolipids in cell walls (as SO_4^{2-})
 - N,P...component of proteins/DNA; P also soluble in cytoplasm (as PO_4^{3-})
 - SiO_2 ...deposited in the epidermal cells and cell walls of xylem vessels
- Tissue locations

1 - Project Overview

Purpose: Collaborate with NREL and PNNL to determine effectiveness and costs of feedstocks and operations in “field-to-fuel” framework:

1. Produce & characterize feedstocks, bio-oils, & bio-products;
2. Evaluate solid, liquid, and gas yields, qualities and costs for preprocessing & conversion technologies;
3. Develop yield & quality predictive models based upon rapid screening.

