

DOE Bioenergy Technologies Office (BETO) 2015 Project Peer Review: NREL Thermochemical Platform Analysis

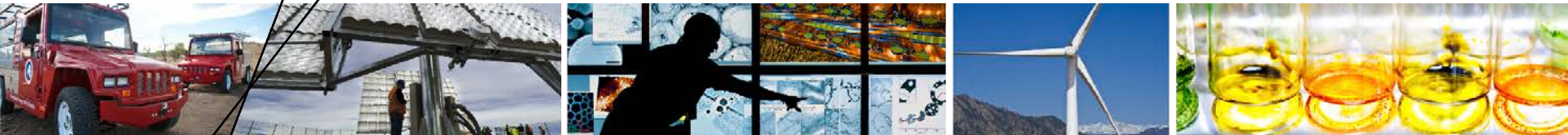

Presenter: Abhijit Dutta

on behalf of Mary Bidy, Jack Ferrell and Michael Talmadge (PI)

BETO 2015 Project Peer Review

Hilton Mark Center, Alexandria, VA

March 26, 2015

1. Goal and Supporting Objectives

Goal Statement: Develop **process** and **techno-economic models** for biomass-to-fuels research.

- **Develop design cases** / reports to identify barriers and **set technical and cost targets** for cost competitiveness by 2022
- Use research results to **track State of Technology** (SOT) & sustainability metrics
- Constant **feedback** between TEA and research efforts

Supporting Objectives:

- **Increase predictive capabilities** of process models using kinetic models and improved phase equilibrium predictions
- Support BETO on **quick-turnaround TEA** as needed / requested
- Develop **analyses** for pathways **outside of BETO core research**

1. Quad Chart Overview

Timeline for *Hydrocarbon Fuels*

Start Date	October 1, 2012
End Date	September 30, 2017
% Complete	40%

Budget (WBS 2.1.0.302)

	FY2010 – FY2012 Costs	FY2013 Costs	FY2014 Costs	Planned FY2015- End Date
DOE Funded	\$2,600k	\$1,000k	\$1,170k*	\$6,460** (Estimated)
Cost Share	No cost share (100% DOE-BETO funding)			

* FY2014 funding was \$1,350. Some funds were reserved to continue uninterrupted in early FY2015.

** Two (2) additional subtasks were incorporated into the TC Platform Analysis project in FY2015 (Syngas Conversion Modeling, Phase Equilibrium Predictions for Fast Pyrolysis Vapor Upgrading).

Barriers Addressed (from MYPP)

- Tt-F. Deconstruction to Bio-Oils
- Tt-H. Bio-Oil Stabilization and Vapor Cleanup
- Tt-J. Catalytic Upgrading of Bio-Oils
- Tt-I. Catalytic Upgrading of Syngas
- Tt-R. Process Integration

Partners

- NREL (experiments & research)
- Idaho National Lab (feedstock)
- PNNL (TEA / sustainability analysis)
- Harris Group Inc. (capital cost estimates)
- DWH Consulting (capital costs / engineering)
- NIST (phase equilibrium modeling)
- Colorado School of Mines (reactor modeling)
- Computational Pyrolysis Consortium (reactor modeling)
- Johnson Matthey (catalyst technologies)

1. Project Overview

Five (5) sub-tasks with focus on **techno-economic analysis (TEA)** and quantification of **sustainability** metrics for thermochemical conversion of biomass to cost-competitive liquid transportation fuels.

Pyrolysis Pathways with *In Situ* / *Ex Situ* Vapor Upgrading:

- Develop design reports and SOT cases, & more predictive reactor models (Sub-Task 1)
- Advance phase-equilibrium predictions for fast pyrolysis vapor upgraded products and integrate with process models to increase predictive capabilities (Sub-Task 5)

Gasification / Indirect Liquefaction (IDL) Pathways:

- Develop design reports and SOT cases for gasification pathways (Sub-Task 2)
- Create kinetic and hydrodynamic models for syngas conversion and integrate with process models to increase predictive capabilities (Sub-Task 4)

TEA Assessments of Pathways Outside of BETO Core Research:

- Assess SOT cost and sustainability metrics for other BETO-supported pathways (Sub-Task 3)

History:

- **FY07 to FY12:** Demonstrated **cost-competitive ethanol** pathway via gasification and mixed alcohol synthesis
- **FY13 to FY17:** Focused on **hydrocarbon fuels** via **bio-oil** and **syngas intermediates**

2. Management / Technical Approach

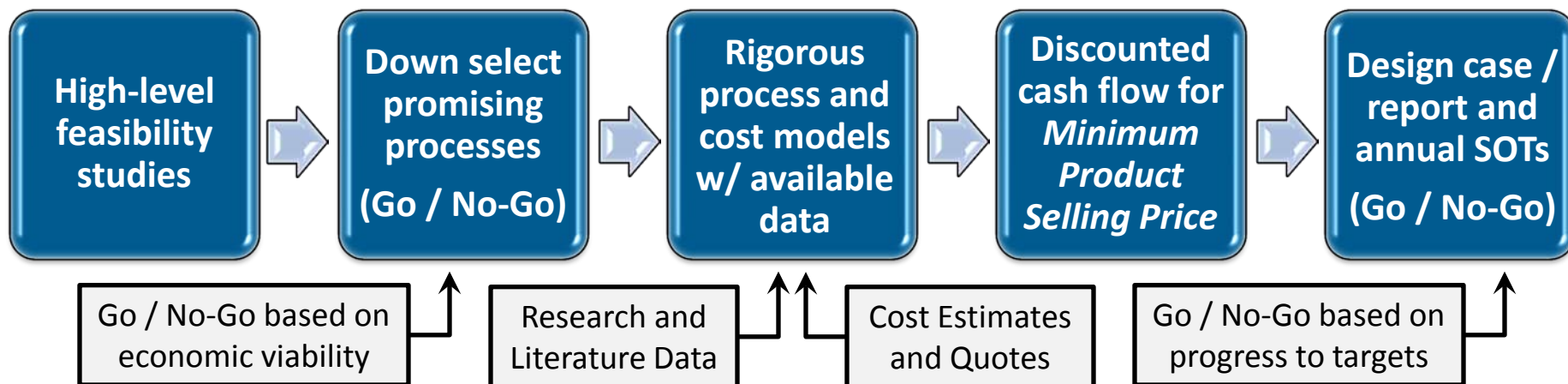

- **Milestones & schedule** in Annual Operating Plan (AOP) prior to fiscal
*Note: Work plans and detailed list of milestone and Go / No-Go points **included in back-up slides***
 - **Identify significant cost drivers** for targeted improvements
 - Apply **benchmark** model **to track the progress of research** towards targets for commercialization (State of Technology assessments)
 - Perform **sensitivity analysis to quantify impact of uncertainties**
 - Risk management of uncertainties in analysis conclusions
- **Go / No-Go decision point(s)**
 - Specific criteria and **metrics defined for each project**
 - Early termination if not progressing towards technical and / or cost goals

2. Management / Technical Approach

Critical Success Factors

- **Set & track technical and cost targets** for achieving BETO 2022 goals
- **Use critical feedback from stakeholders**
- Design effective conceptual processes for low costs & sustainability
- Constant **feedback** between TEA and research team(s)
 - **Consider research alternatives**
- Timely responses delivered to BETO for quick-turnaround requests
- Fulfil criteria for Go / No-Go decision points

Technical Challenges [Mitigation]

- Work with **limited data** during early stages [**sensitivity analysis**]
- Design process models with sufficient capabilities for **alternate research approaches** [**versatile models** with adaptability]
- Balance rigor with available time & budget [impact-specific efforts]
- Enhancement of **predictive modeling** [**strategic partnerships**]

2. Management / Technical Approach

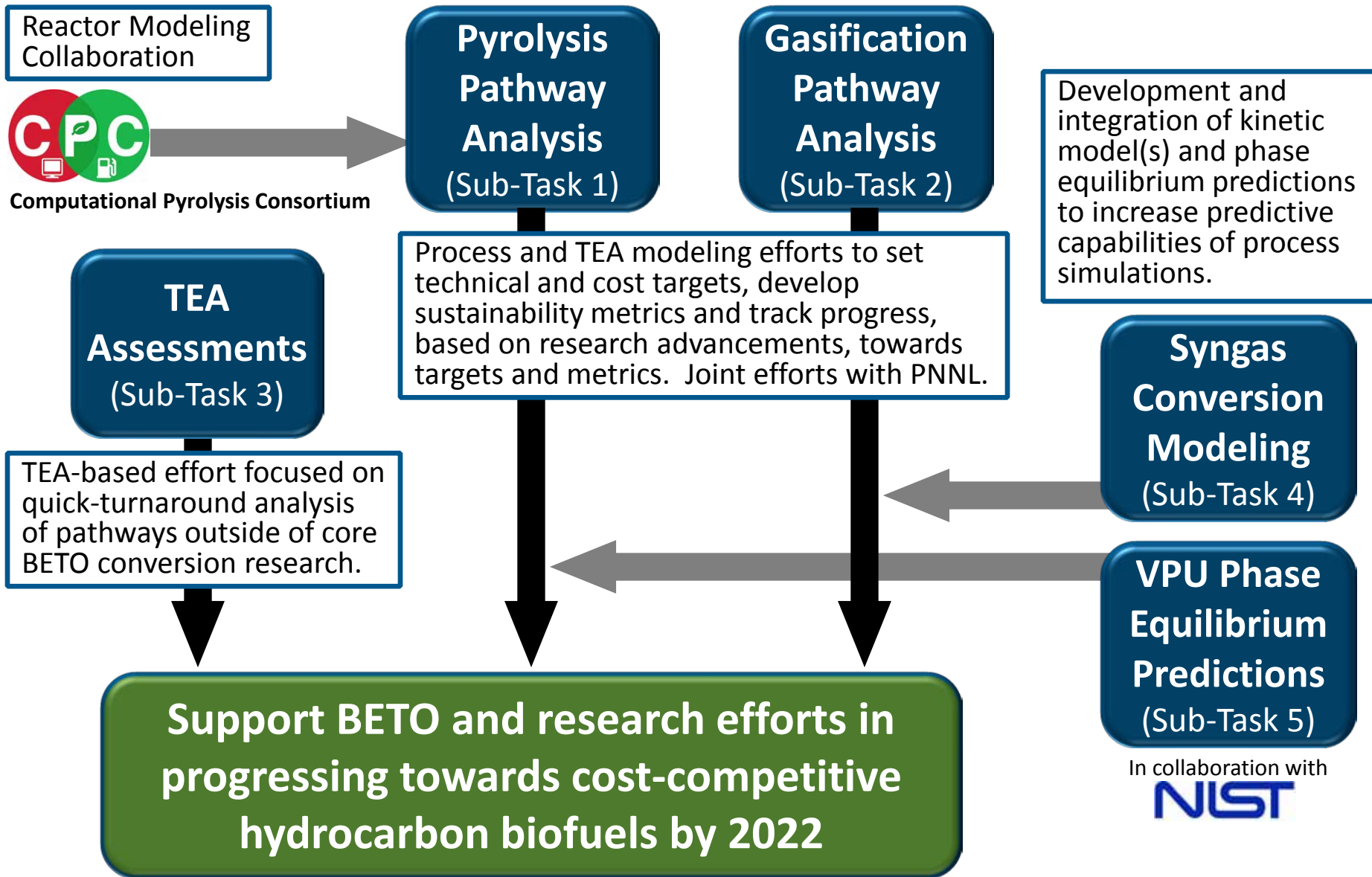

3. Technical Accomplishments

- All planned milestones met (details & dates included in back-up slides)
- Design Reports published jointly with PNNL following review by 10 – 15 industry experts (non-NREL/PNNL).
 - (1) Fast pyrolysis with *in situ* / *ex situ* vapor upgrading
NREL/TP-5100-62455, PNNL-23823, 2015.
 - (2) High-octane gasoline blendstock via gasification
NREL/TP-5100-62402, PNNL-23822, 2015.
- Publications/Presentations (in backup slides)
- 2014 State of Technology (SOT) assessments
- Technical, cost targets and sustainability metrics established for 2015 through 2022. Targets published in BETO MYPP.

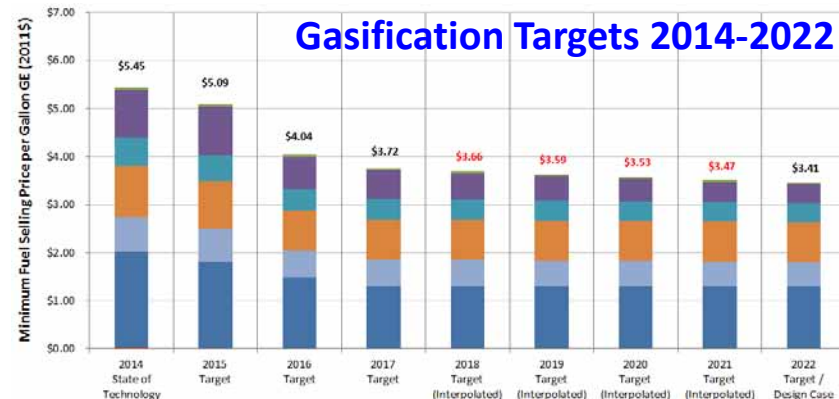
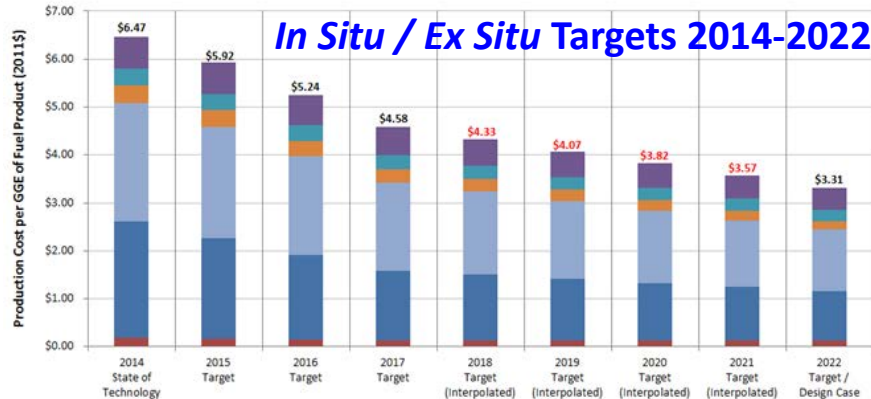
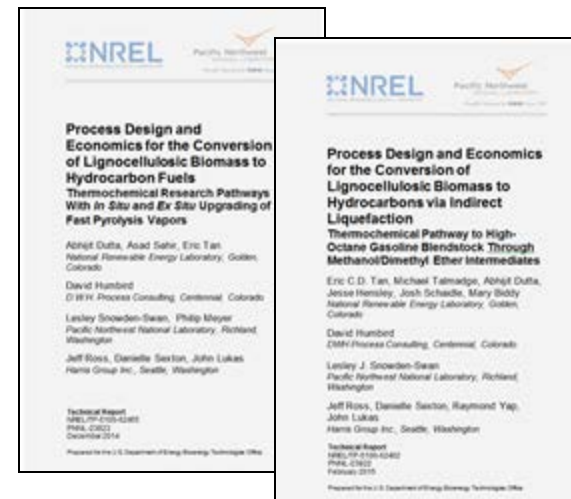

3. Technical Accomplishments

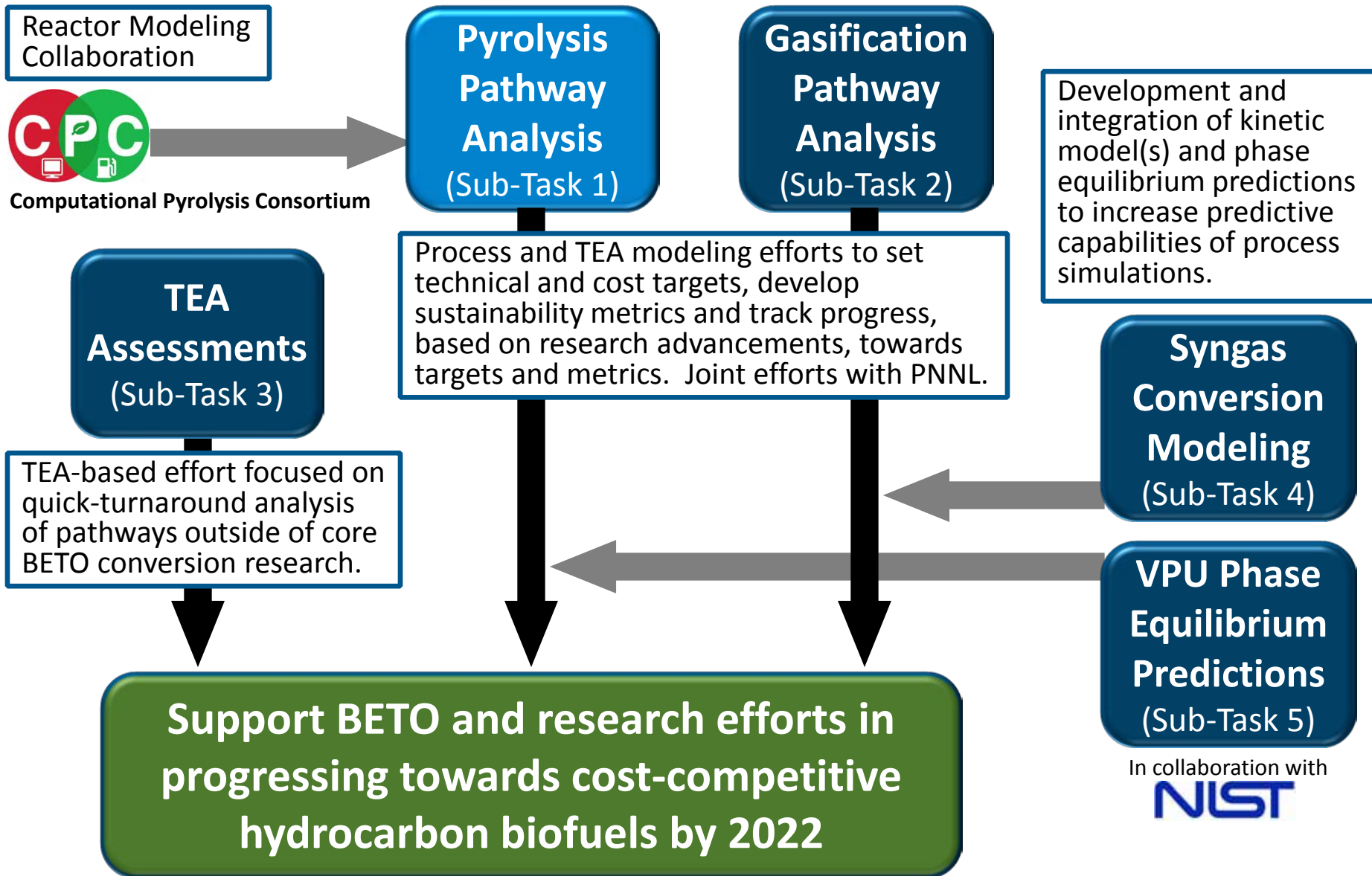

Pyrolysis Process Flow (*In Situ* / *Ex Situ*)

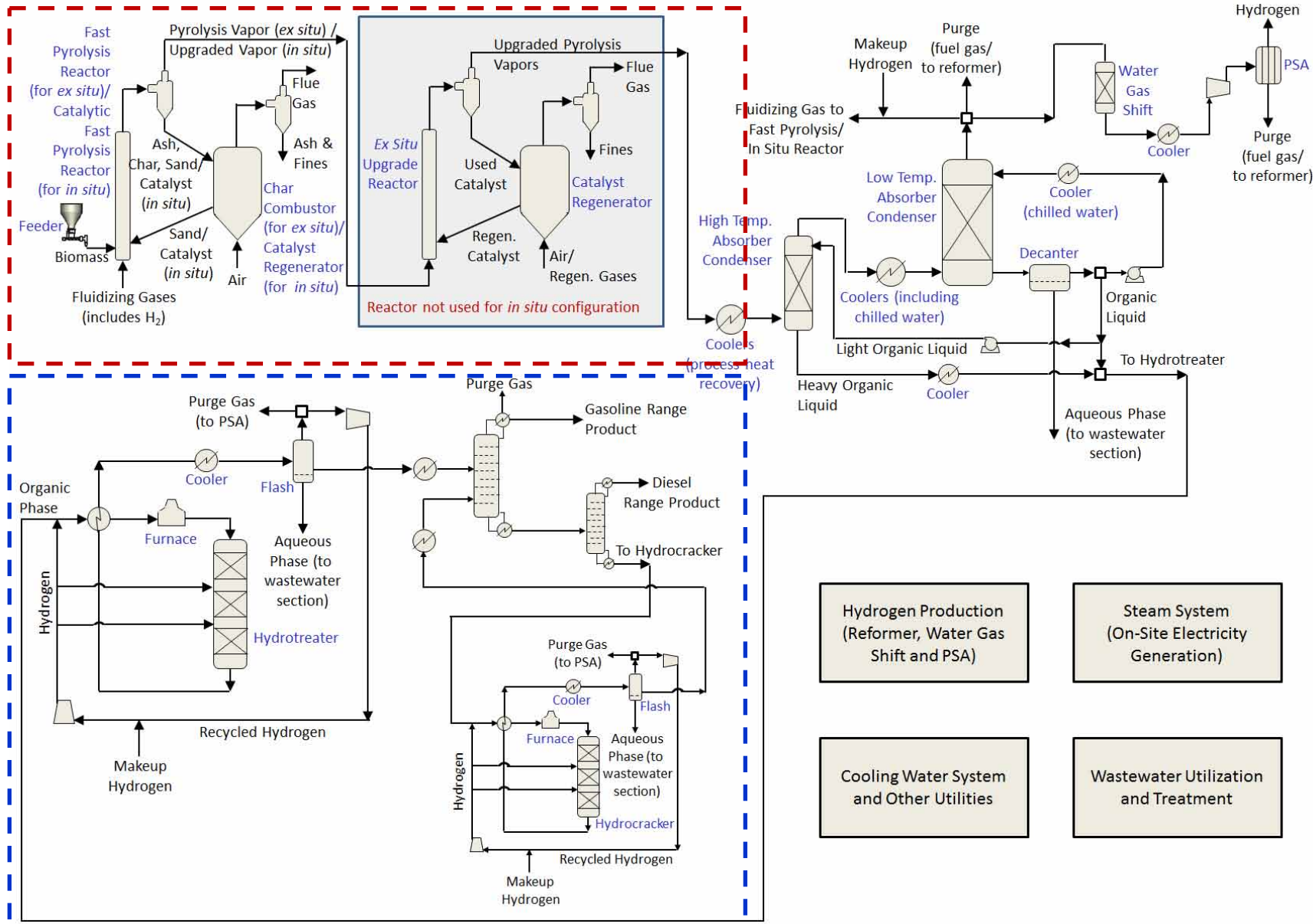

In Situ / Ex Situ Configurations & Yield

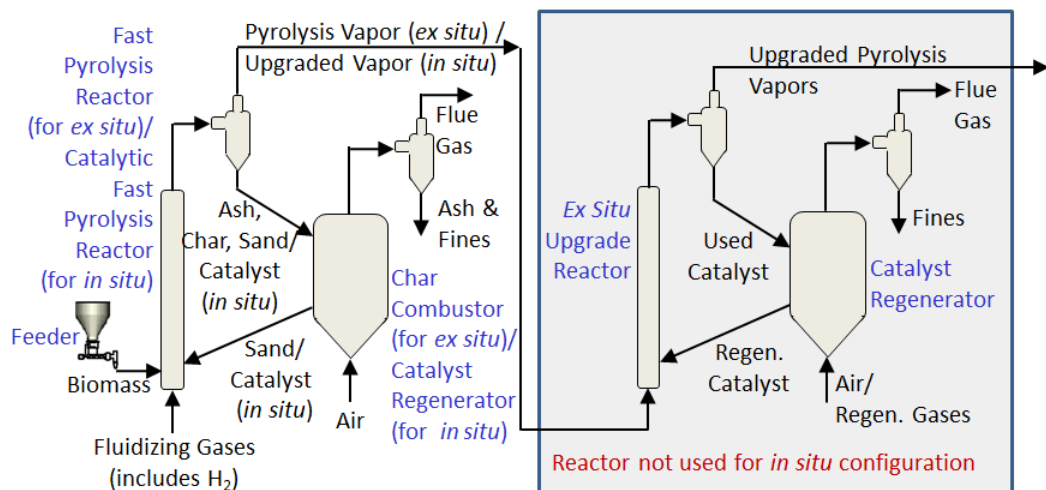

Yield bases for 2022

- Maximize organics
- Preserve carbon via HDO*
- Allow for coke & gas losses
- **Justifiable losses balanced for cost-competitiveness**
- Added **higher diesel-range products for *ex situ*** pathway

*HDO - Hydrodeoxygenation

• In Situ Configuration

- Reactor **similar to FCC**, circulating fluidized bed (CFB) reactor, e.g. Ensyn reactor

• Ex Situ Configuration

- Non-catalytic fast pyrolysis followed by **secondary** vapor phase **upgrading in CFB** reactor

In Situ vs. *Ex Situ* Vapor Upgrading

In Situ

- Fluidized bed only
- Catalyst mixes with biomass, char, ash
 - Difficult environment
- Less can be achieved during vapor upgrading
- Lower capital
 - Expected higher catalyst replacement
- Hot gas filter (HGF) not required
- Operating conditions tied to fast pyrolysis

Ex Situ

- Fluidized or fixed bed
- Biomass, char, ash reduced or removed
 - More benign for catalyst
- More diverse catalysts and chemistry possible
- Higher capital
 - Expected lower catalyst replacement
- HGF may be included, *necessary for fixed bed*
- Operating conditions can be different from fast pyrolysis

SOT and Target Cases (*Ex Situ* / *In Situ*)

Process Parameter	<i>Ex Situ</i>		<i>In Situ</i>	
	2014 SOT	2022 Target	2014 SOT	2022 Target
Vapor Products (wt.% dry biomass)				
Non-Condensable Gases	35	23	31	23
Aqueous Phase (% C Loss)	25 (2.9)	30 (1.3)	26 (3.2)	29 (2.1)
Solids (Char + Coke)	12 + 11	12 + 8.0	12 + 12	12 + 8.1
Organic Phase	17.5	27.2	19.5	28.3
H/C Molar Ratio	1.1	1.6	1.1	1.5
Carbon Efficiency (%)	27	44	29	44
Oxygen Content (% of organic)	15.0	6.4	15.6	10.5
Hydroprocessing C Eff.* (% of org.liq.)	88	94	88	91
Carbon Eff. to Fuel Blendstocks (%)	23.5	41.5	25.8	40.4
Energy Efficiency to Fuels (LHV basis)	30.4	56.6	33.2	54.3
Diesel-Range Product (% GGE basis)	15	55	17	27
Minimum Fuel Selling Price (\$ / GGE)	\$6.47	\$3.31	\$6.16	\$3.46

*Efficiency basis shown in additional slides

In Situ / Ex Situ Catalyst R&D to Achieve Targets

- Reduced coke and coke precursors
- Reduced non-condensable species
- Hydrogen utilization at low pressure (5-6 bars)
- Coupling: reduce gases, increase distillates
- Attrition resistance of fluidizable catalysts
- Catalyst maintenance & regeneration protocols
- Acceptable catalyst replacement/longevity

Base cases built on assumption of modified zeolites, in fluidized bed

- Research will also consider:
 - Fixed bed systems with preceding hot gas filter
 - Other catalysts, only suitable in fixed beds

SOT*/ Targets† for *Ex Situ* Pyrolysis Vapor Upgrading

*SOT = State of Technology, †Tabulated metrics and further details in backup slides

2014 SOT based on NREL Experiments

Improve Yields (Less Coke, Gas)

Some Hydrodeoxygenation

Mild Hydrogenation

Model Compound Coupling

More Yield Improvements

More Hydrodeoxygenation

More Hydrogenation

Actual Pyrolysis Vapor Coupling for Diesel

More Process Options, Including Fixed Bed

Optimize Hydroprocessing & Wastewater

Product Characterization/Quality Specs.

Similar Targets for *In Situ*

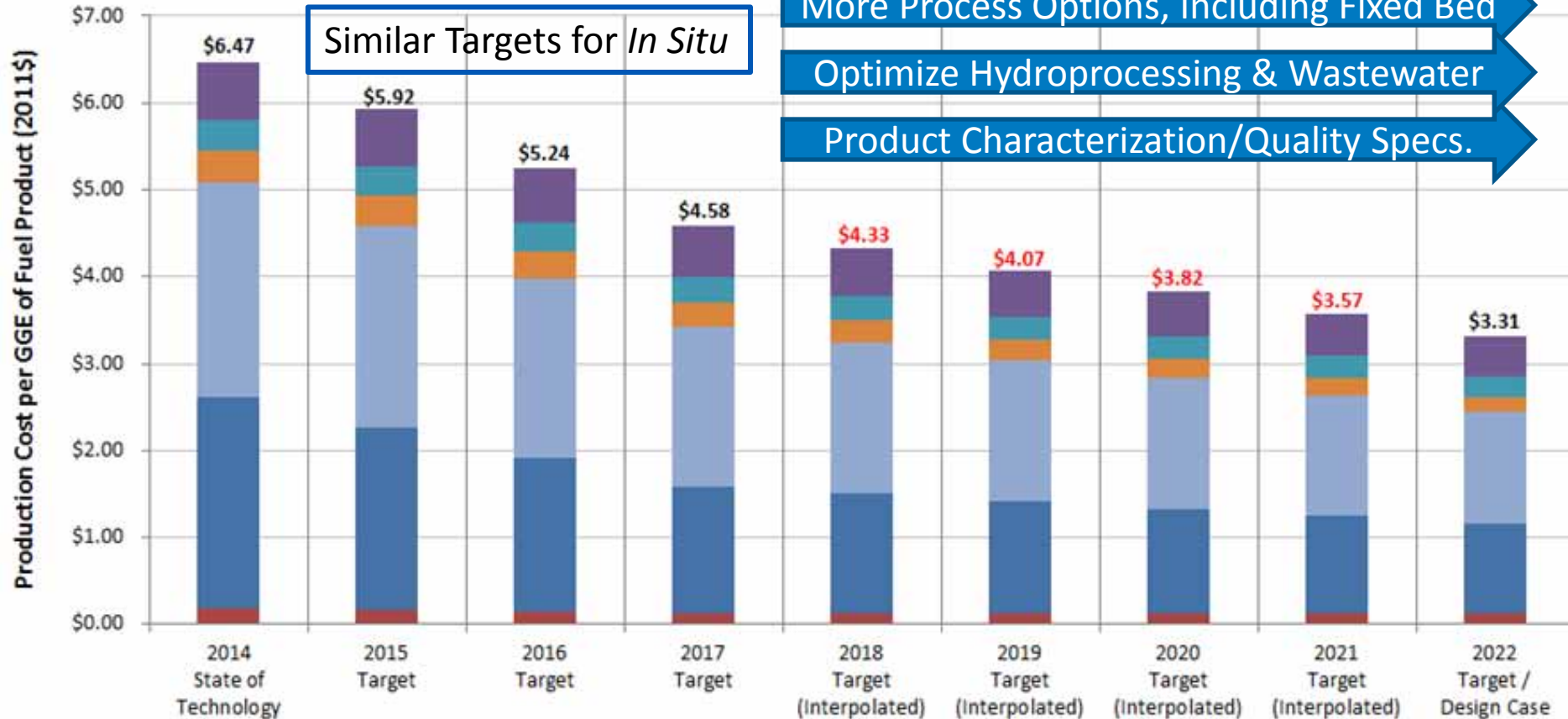

SOT / Projected Sustainability Metrics for *Ex Situ* Pathway

Sustainability Metrics*	SOT	Out-Year Projections							
	2014	2015	2016	2017	2018	2019	2020	2021	2022
Fossil GHG Emissions† (g CO ₂ -e / MJ Fuel)	-41.5	-36.5	-27.9	-19.3	-15.7	-12.0	-8.4	-4.8	-1.2
Fossil Energy Consumption† (MJ FE / MJ Fuel)	-0.47	-0.41	-0.31	-0.22	-0.17	-0.13	-0.09	-0.05	-0.01
Total Fuel Yield (GGE / Ton)	42	44	50	56	60	64	69	73	78
Carbon Efficiency to Fuel Blendstock (%C in Feedstock)	23.5	25.0	27.6	30.6	32.8	34.9	37.1	39.3	41.5
Water Consumption (Gal H ₂ O / GGE Fuel Blend)	1.4	1.3	1.2	1.1	1.0	0.9	0.8	0.8	0.7
Electricity Production (kWh/GGE)	21.0	19.2	16.0	13.1	11.7	10.3	8.9	7.6	6.2
Electricity Consumption (entire process, kWh/GGE)	12.7	12.0	10.4	9.1	8.4	7.8	7.1	6.4	5.7

* For conversion process only

† Includes electricity credit

Sustainability metrics for *In Situ* Pathway in back-up slides

Concluding Remarks (*In Situ* / *Ex Situ*)

- Developed **a trajectory for cost competitive hydrocarbon fuels** via *in situ* and *ex situ* pyrolysis vapor upgrading with corresponding technical targets
 - ***In Situ***: \$ 6.16/GGE (2014) to \$ 3.46/GGE (2022)
 - ***Ex Situ***: \$ 6.47/GGE (2014) to \$3.31/GGE (2022)
- **Outlined catalyst performance requirements** for improved vapor phase:
 - Reduce coke and non-condensable gases
 - Hydrodeoxygenation and hydrogenation in vapor phase
 - Enable molecular combination (coupling) for increased diesel-range product
 - Cost-justifiable catalyst materials and maintenance; compatible reactor systems
- **Near-term goals** (2017)
 - Yield improvements via hydrodeoxygenation
 - Initial development of hydrogenation activity
 - Coupling using model compounds
 - TEA assessments of alternate approaches (e.g. hot gas filter, fixed bed systems)
- **Long-term goals** (2022)
 - Significant hydrogenation for product quality improvements
 - Coupling reactions with pyrolysis vapors, process options include fixed bed systems
 - Product quality specifications & additional targets informed by experimental results
 - Optimize hydroprocessing and wastewater management

3. Technical Accomplishments

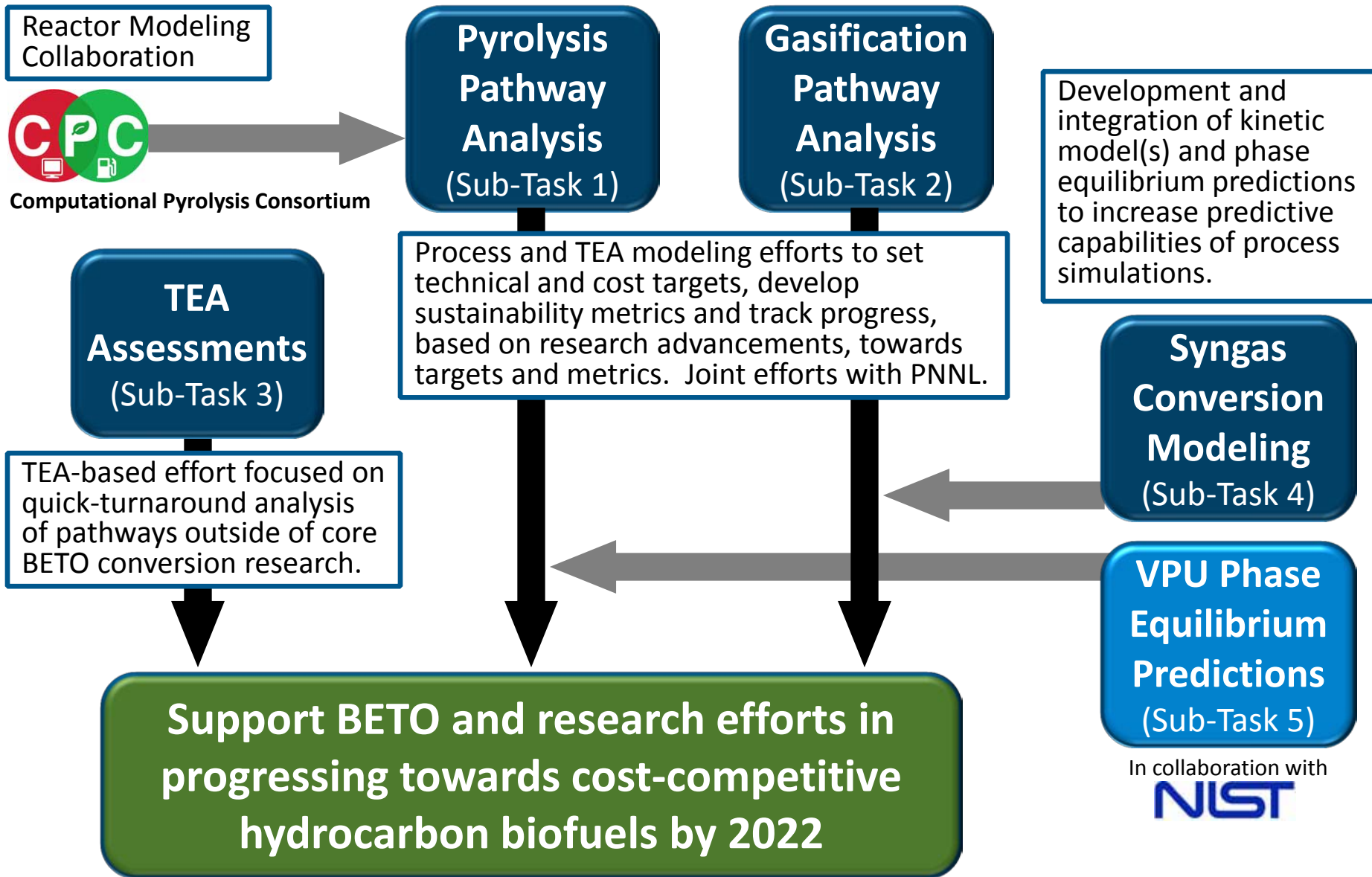

Phase Equilibrium for Pyrolysis Products

- **Started in FY15 to improve phase behavior predictions**
 - For products from fast pyrolysis vapor upgrading
 - Oxygenates-hydrocarbons-water
 - Compositions can vary significantly based on levels of upgrading
- **Impact on research and techno-economics**
 - Predictive capabilities will allow
 - Better product separation strategies for optimal processing to final products (via **Liquid-Liquid Equilibrium** or **LLE** methods for predictions)
 - Optimal wastewater handling based on better compositional estimates
- **Leverage NIST-TRC's Expertise:**
 - NIST-TRC thermodynamic database and consistency checks
 - Estimated 80% of all data for organic compounds available
 - Predictive property models, Liquid-Liquid
 - Modified UNIFAC-LLE, COSMO and others
 - Parameter development
- **Phase Equilibrium Experiments (third party):**
 - Fill key data gaps for relevant compounds classes
 - Experiments involve costs, and schedule limitations
 - Physical & chemical expt. challenges for many compounds
 - Results used to inform and validate the predictive models
- **Publish all relevant results for stakeholders**
- **Integrate with Aspen Plus models for fast pyrolysis**

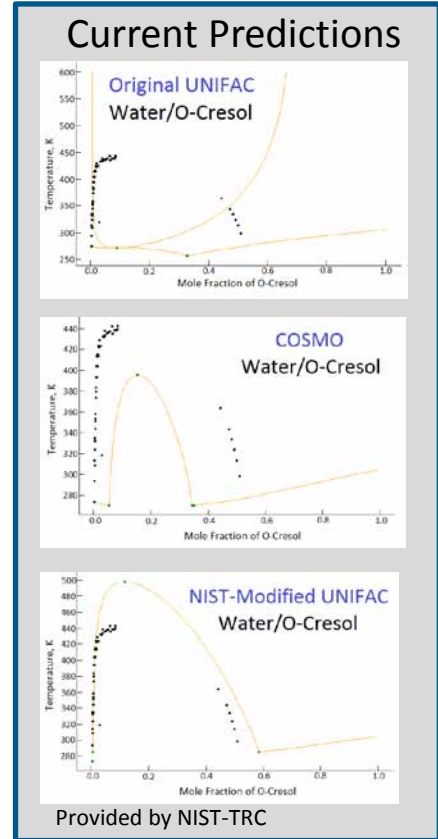

NIST-TRC already has ~250 aqueous LLE, ~450 mutual LLE pair systems data for NREL-identified compounds

3. Technical Accomplishments

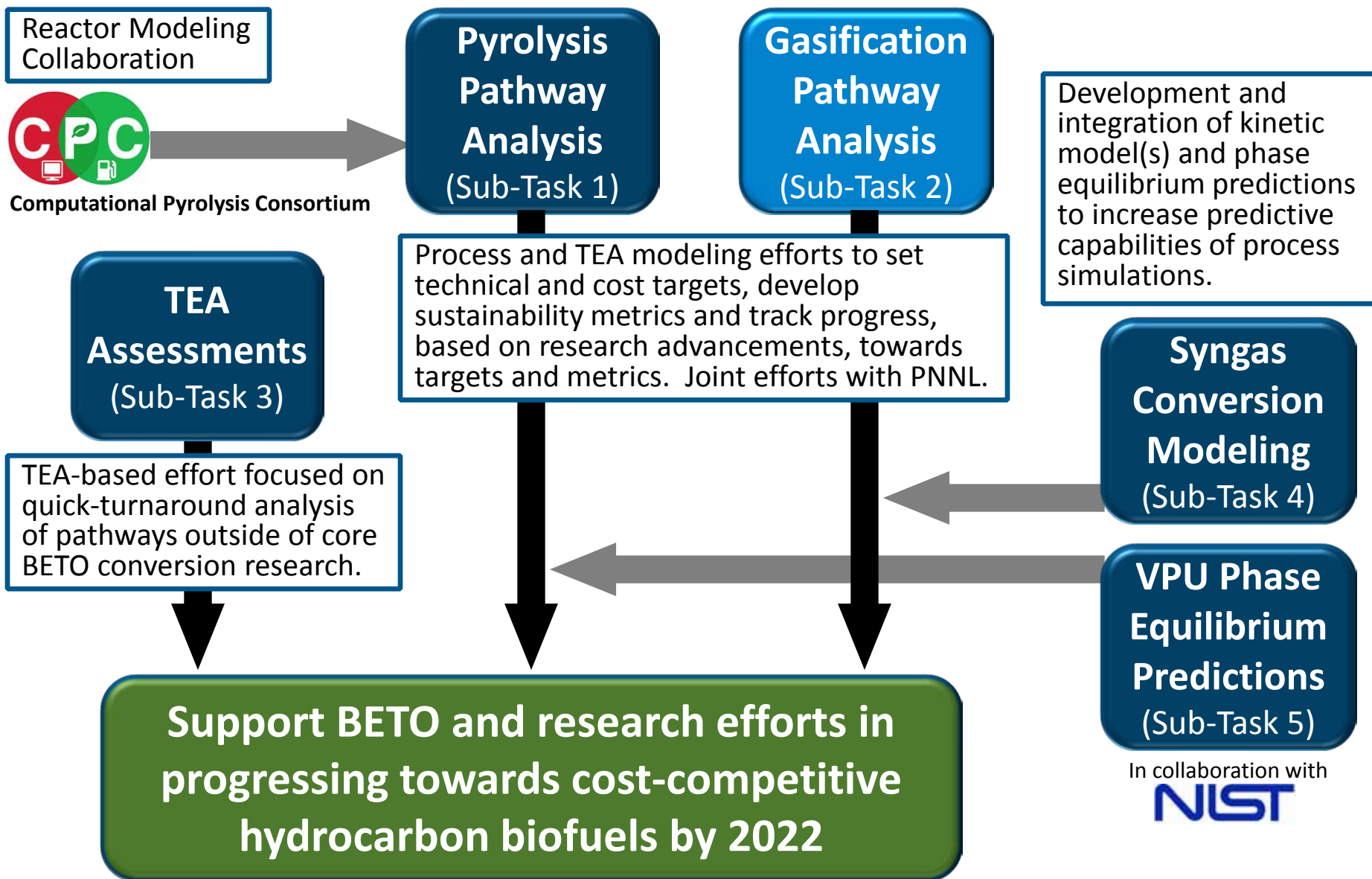



IDL Process Design Highlights

- Methanol intermediate converted to **high-octane, branched C₇-rich gasoline blendstock** via **beta-zeolite catalyst** in a fixed-bed.
 - **C₃- compounds** from the reactor products are utilized as **fuel gas**.
 - **C₄ compounds** are **recycled** to the reactor **to maximize gasoline yield**.
 - **C₅+ compounds** are recovered as **gasoline blendstock**.
- No fossil energy imports in base design case.
- Current operating and financing assumptions (2011\$, 90% reliability, etc).
- Competitive carbon efficiency and MFSP relative to mixed alcohols due to lower severity conditions (alcohol synthesis pressure).

Pathway Parameter	2014 SOT	2022 Target
Minimum Fuel Selling Price	\$5.45/GGE = \$5.42/Gal	\$3.41/GGE = \$3.25/Gal
C5+ Product Yield	39.7 Gallons / Ton	64.9 Gallons / Ton
Carbon Efficiency to C5+ Product	20.7 %	31.2 %

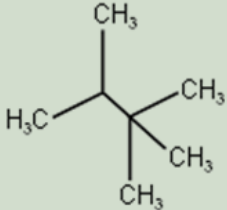
High-Octane Gasoline Pathway vs. MTG

Process Attribute	High-Octane Gasoline Pathway Target	Methanol to Gasoline (MTG) Pathway	Impact on Techno-Economic Analysis
Molecular structures favored in synthesis reactions	Branched paraffins 	Aromatics 	High octane product rich in branched paraffins, similar to a refinery alkylate. H-saturation decreases density, increasing product volume.
Example Compound Specific Gravity	Triptane 0.70	Toluene 0.87	
Hydrocarbon synthesis catalyst	Beta-Zeolite (12-membered rings)	ZSM-5 (10-membered rings)	Different pore sizes and structures result in different compound selectivities.
Octane number of gasoline-range product	RON: 95+ MON: 90+	RON: 92 MON: 83	Octane number increases value of product as a finished fuel blendstock.
Selectivity of C ₅ +product	C ₅ + product only (~65 Gal / Ton)	~ 85% C ₅ + (~55 Gal / Ton)	High selectivity to primary (premium quality) product maximizes overall product value.
Severity of synthesis operating conditions	350 – 450 Deg. F 130 PSIA	650 – 950 Deg. F 315 PSIA	The lower severity operating conditions result in lower capital and operating costs relative to MTG.
Coke formation	Coke formation is minimized by hydrogen addition and selectivity to branched paraffins rather than aromatics.	High propensity for coke formation due to aromatic coke pre-cursors.	Minimizing coke formation helps to maximize product yield / carbon efficiency and maximizes catalyst regeneration and replacement cycles.

Sources: (1) 2011 NREL MTG Design Report (Phillips et al), (2) Methanol to Gasoline (MTG) Production of Clean Gasoline from Coal (ExxonMobil Research and Engineering)

Major Technical Targets for High-Octane Gasoline Pathway

Process Parameter	2014 SOT	2015 Target	2016 Target	2017 Target	2022 Target / Design Case
Hydrocarbon Synthesis Catalyst	Commercially available beta-zeolite		Beta-zeolite modified with copper (Cu) and gallium (Ga) for performance improvement		
H ₂ Addition to HC Synthesis	No	Yes			
C ₄ Co-Product (Function of Recycle)	Yes (No Recycle of C ₄ s)		No (Recycle C ₄ s)		
Single-Pass DME conversion	15%	15%	20%	30%	40%
Productivity of Hydrocarbon Synthesis Catalyst (kg/kg-cat/h)	0.02	0.03	0.04	0.05	0.10
Carbon Selectivity to C ₅ + Product	46.2%	50.8%	86.1%	89.9%	93.1%
Carbon Selectivity to Aromatics (HMB represents coke / pre-cursors)	25% Aromatics (10% HMB)	15% Aromatics (7% HMB)	8% Aromatics (4% HMB)	4% Aromatics (2% HMB)	0.5% as HMB
Dimerization of C ₄ -C ₈ Olefins to Jet	No	Consider in SOT cases as sensitivity or modify target case			
C ₅ + Product Yield (Gallons / Ton)	39.7	40.4	61.8	64.2	64.9
Carbon Efficiency to C ₅ + Product	20.7%	21.1%	29.9%	31.0%	31.2%
C ₄ Product Yield (Gallons / Ton)	17.9	18.1	0.0	0.0	0.0
Carbon Efficiency to C ₄ Product	7.5%	7.6%	0.0%	0.0%	0.0%
Minimum Fuel Selling Price (\$ / GGE)	\$5.45	\$5.09	\$4.04	\$3.72	\$3.41

SOT* / Targets† for High-Octane Gasoline Pathway

†Tabulated metrics and further details in backup slides

2014 SOT*
Based on NREL Experiments

2015 – 2017

2017 – 2022

- Maximize yield of C₅+
- Recycle C₄ compounds
- Reduce aromatic content
- Add H₂ to HC synthesis

- **Dimerize naphtha-range olefins to high-quality jet / diesel-range compounds**
- Reduce aromatic content to near-zero
- Optimize to improve sustainability metrics
- Increase process scale and integrate with upstream operations (gasifier / gas cleanup)

*SOT = State of Technology

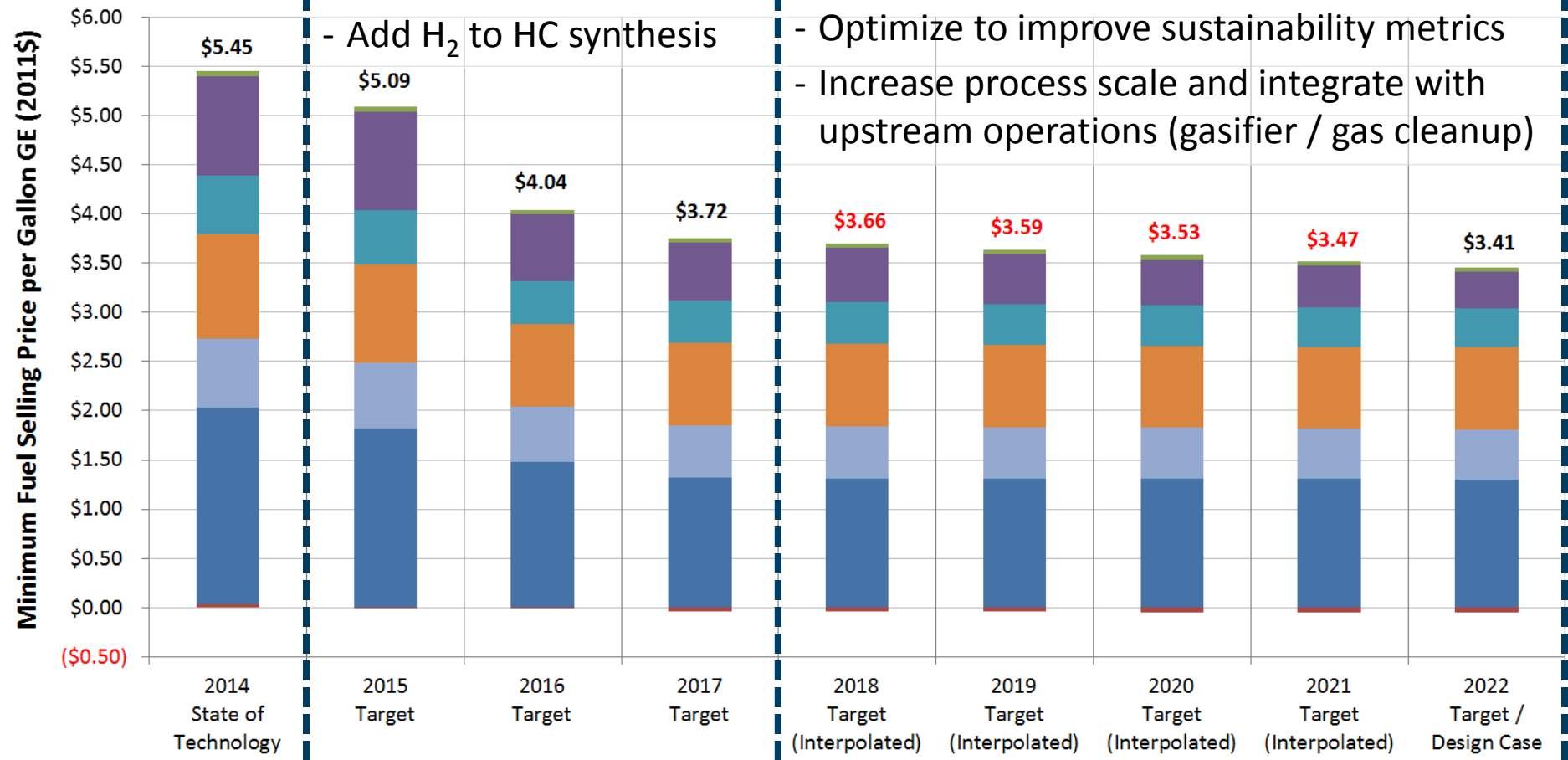

SOT / Projected Sustainability Metrics for High-Octane Gasoline

Sustainability Metrics*	SOT	Out-Year Projections							
	2014	2015	2016	2017	2018	2019	2020	2021	2022
Fossil GHG Emissions (g CO ₂ -e / MJ Fuel)	1.64	1.42	1.19	0.96	0.88	0.81	0.74	0.67	0.60
Fossil Energy Consumption (MJ FE / MJ Fuel)	0.023	0.019	0.011	0.013	0.011	0.010	0.009	0.007	0.006
Total Fuel Yield (Gallons / Ton)	57.5	58.5	61.8	64.2	64.4	64.5	64.6	64.8	64.9
Total Fuel Yield (GGE / Ton)	51.3	52.2	59.1	61.4	61.5	61.6	61.7	61.8	61.9
Carbon Efficiency to HCs (%C in Feedstock)	28.2	28.7	29.9	31.0	31.0	31.0	31.1	31.1	31.2
Water Consumption (gal H ₂ O / gal C ₅ + HCs)	12.4	9.3	5.8	5.2	4.5	3.8	3.1	2.4	1.7

* For conversion process only

Concluding Remarks (IDL)

- Developed **trajectory for cost competitiveness based on fuel yields and quality improvements** for the production of hydrocarbon blendstocks

2014 SOT

2022 Target

○ Minimum Fuel Selling Price	\$5.45/GGE = \$5.42/Gal	\$3.41/GGE = \$3.25/Gal
○ C5+ Product Yield	39.7 Gallons / Ton	64.9 Gallons / Ton
○ Carbon Efficiency to C5+ Product	20.7 %	31.2 %

- Pathway **leverages demonstrated technologies for upstream steps**
 - Gasification / syngas cleanup based on 2012 mixed alcohol demonstration (TRL 5-6)
 - Syngas to Methanol and Methanol to DME are commercial technology (TRL 8-9)
 - Potential to leverage BETO-funded research (HT TIGAS) to improve economics and simplify process
- Out-year focus** areas
 - Production of **high-quality jet** (low aromatics) or **diesel** (low sulfur, low aromatics)
 - Process intensification and optimization resulting in sustainability metric improvements
 - Process scale (2014 SOT TRL 3-4)

3. Technical Accomplishments

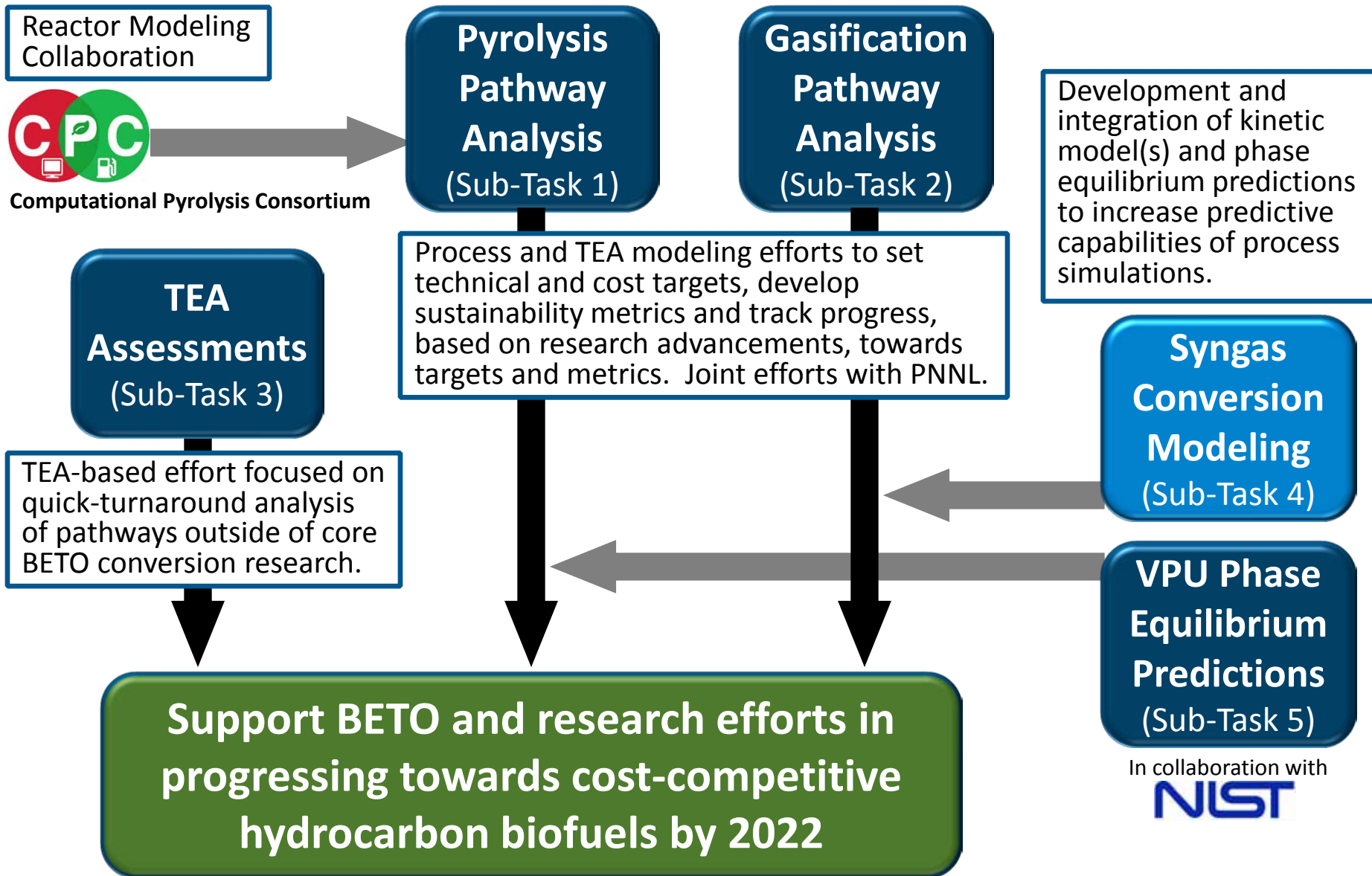

Process Modeling Tools for Syngas Conversion

- **Develop a new tool for process modeling:**
 - **Projections** for catalyst behavior **in scaled-up industrial reactors** will be modeled by coupling bench-scale kinetic models with mass and heat transfer effects, along with the impacts of various operating conditions (including **recycles**)
 - **Inform research about optimal operating conditions**
- **The conversion of syngas to mixed alcohols over a K-CoMoS_x catalyst will be used for initial evaluation and validation**
 - Significant quantities of **experimental data** are currently available
 - **Microkinetic models for other systems** being developed in **collaboration with computational group** for energetics of elementary steps
- **Finished reaction modeling tool applicable to multiple systems, both biological & thermochemical, with sufficient expt. data**
- **The reaction modeling tool will be compatible with Aspen Plus, which will:**
 - **Improve** quality of **techno-economic projections**, and allow for process optimization
 - Enhance confidence in model projections for new technologies upon potential scale-up and commercialization

Mixed Alcohol Synthesis Kinetic Model

GOAL: Develop a kinetic model for mixed alcohol synthesis on a $K\text{-CoMoS}_x$ catalyst using bench-scale data sets collected for the 2012 mixed alcohols demonstration for application in TEA of mixed alcohol synthesis.

Input: Experimental conditions (295)

- Composition ($x_{CO} = 0.2 - 0.7$, $x_{H_2} = 0.3 - 0.7$, $x_{CH_3OH} = 0 - 0.05$)
- Pressure (70 – 130 atm)
- Temperature (300 - 330°C)
- Space velocity (0.3 – 0.7 mol/h/kgcat)

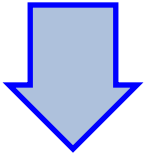

Kinetic Model

- Reaction rate expressions
 - CH_3OH , C_2H_5OH , C_3H_7OH , CH_4 , water-gas-shift
- Differential mole balances
 - System of ODEs
 - CH_3OH , C_2H_5OH , C_3H_7OH , CH_4 , CO_2 , H_2O , H_2 , CO

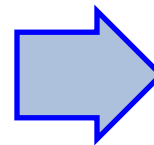

Output: Flowrates (mol/h)

CH_3OH , C_2H_5OH , C_3H_7OH ,
 CH_4 , CO_2 , H_2O , H_2 , CO

Mixed Alcohol Synthesis Kinetic Model

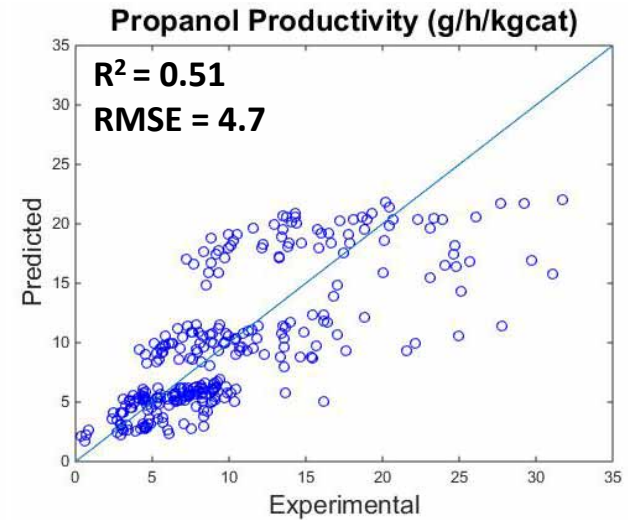
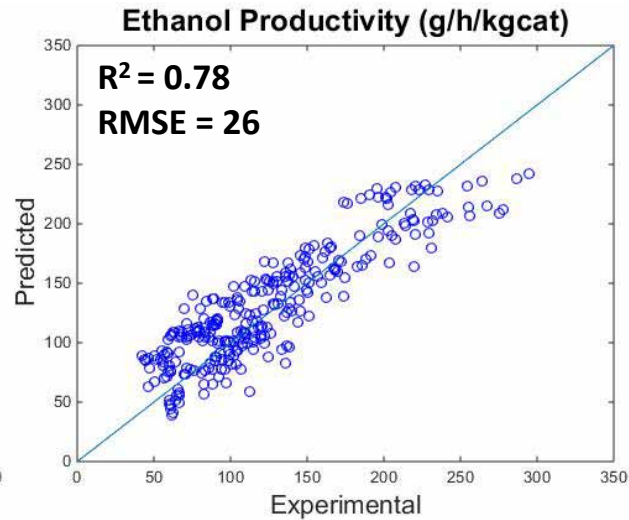
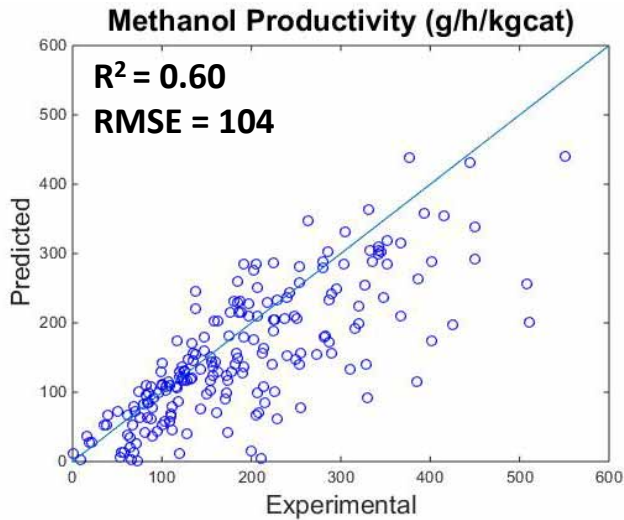

Accomplishment:

Kinetic model predicts experimentally observed productivities for all major reaction products.

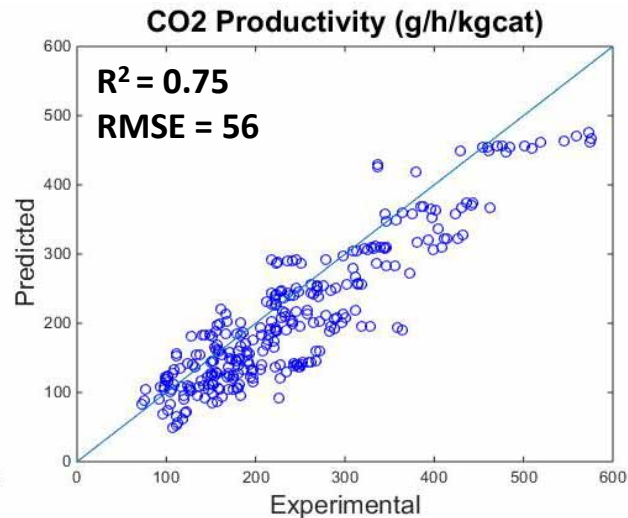
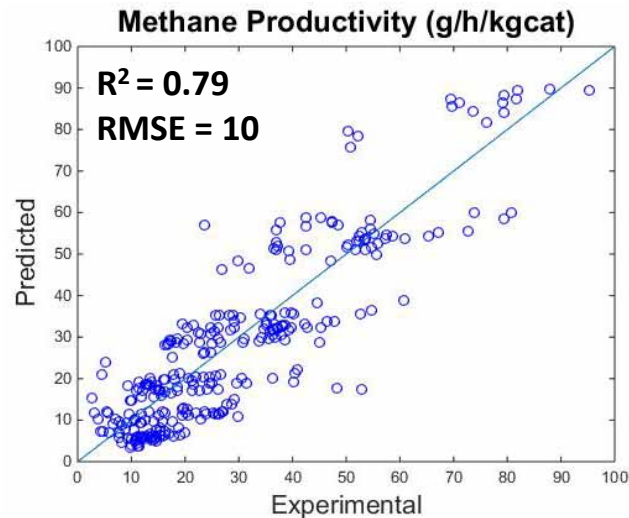

3. Technical Accomplishments

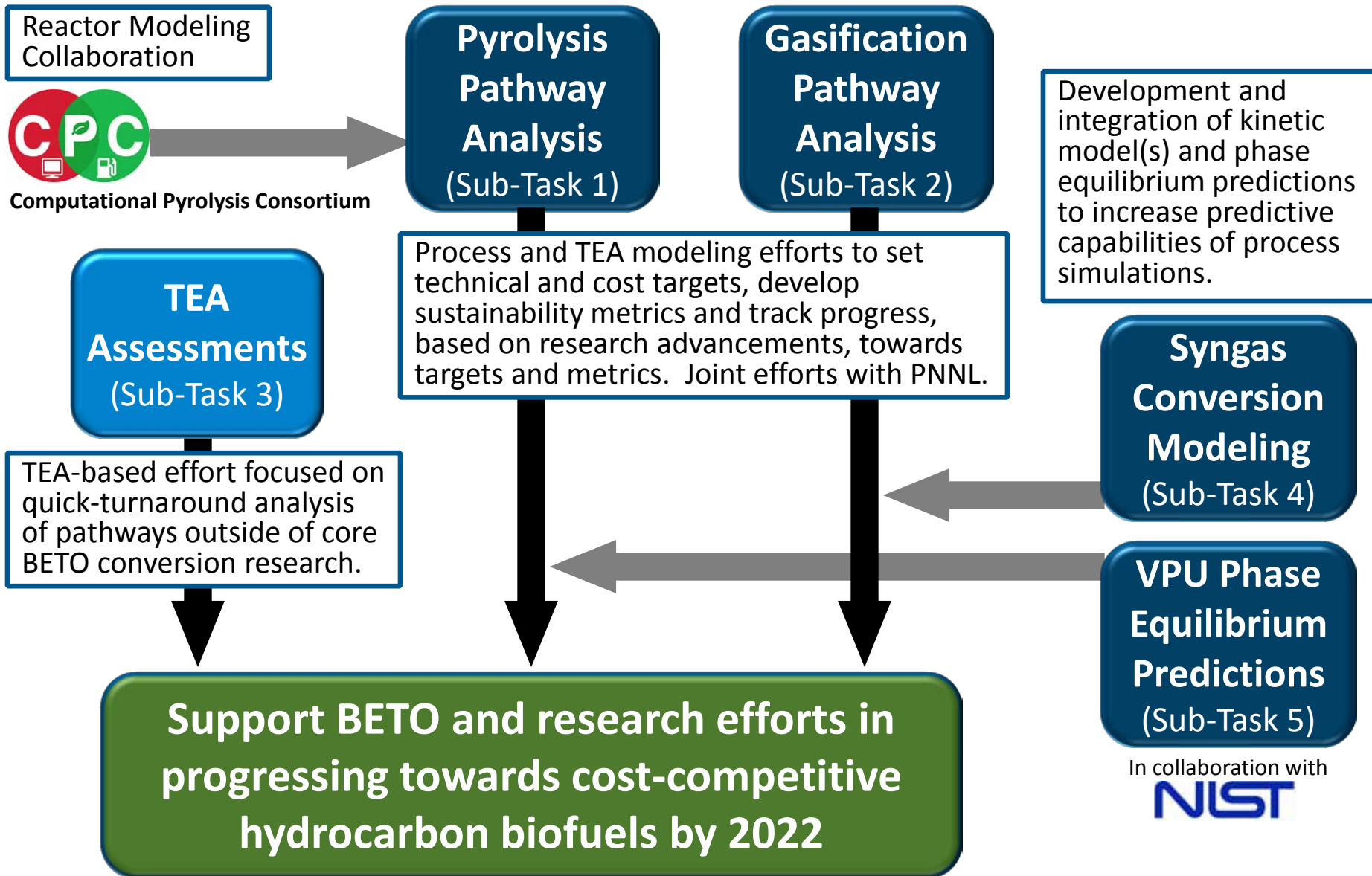

Thermochemical TEA Assessments

Purpose: Risk mitigation and increased probability of achieving BETO cost goals by examining pathways outside core lab research (at NREL and PNNL)

Catalytic Fast Pyrolysis (*In Situ*)

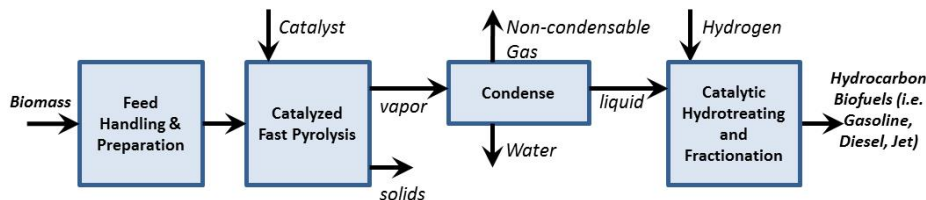

Hydropyrolysis

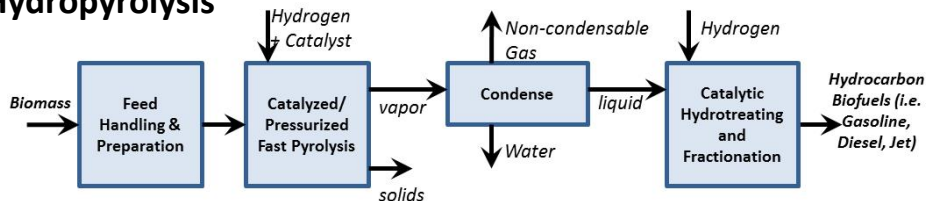

Hydrothermal Liquefaction

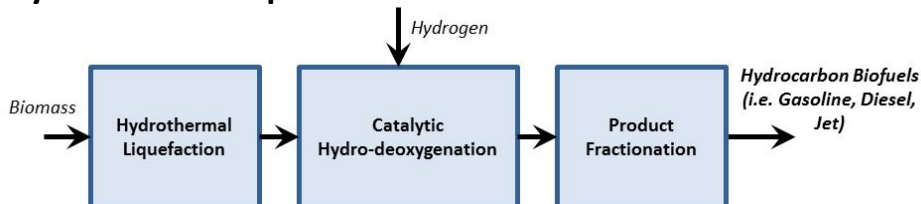

FY14: Developed summary report of 3 liquefaction processes

- Catalytic Fast Pyrolysis
- Hydropyrolysis
- Hydrothermal Liquefaction

Reviewed Current SOT

- Considered over a dozen studies
- Focused on BETO funded projects outside of core research efforts
- Developed high-level, quick-turnaround analysis
- Identify data gaps, R&D needs and direction towards out year cost goals

FY15: Develop TEA models for 2 pathways

4. Relevance

- **Pathway analyses** (pyrolysis and gasification) directly supports research progress **towards 2022 goal for cost-competitive hydrocarbon fuels** from biomass via thermochemical pathways
 - Design reports define **technical, cost targets and sustainability** metrics
 - State of Technology assessments **track progress towards targets**
 - Cost analyses for **alternate scenarios** based on available experimental data
 - Feedback to research plans when results deviate from expectations / targets
 - **Collaborations with industrial technology partners** (e.g. Johnson Matthey)
 - **Publish SOT and analysis results** for industry stakeholders via **MYPP***, design reports and journal **publications (listed in additional slides)**
- Pyrolysis Reactor, VPU Phase Equilibrium, and Syngas Conversion Modeling **increase predictive capabilities of process models**
- **TEA Assessments** provide **broader view** & increase probability of achieving cost goals by assessing SOT of pathways outside core research

*MYPP = BETO Multi-Year Program Plan

4. Relevance – Scenarios and Sensitivity

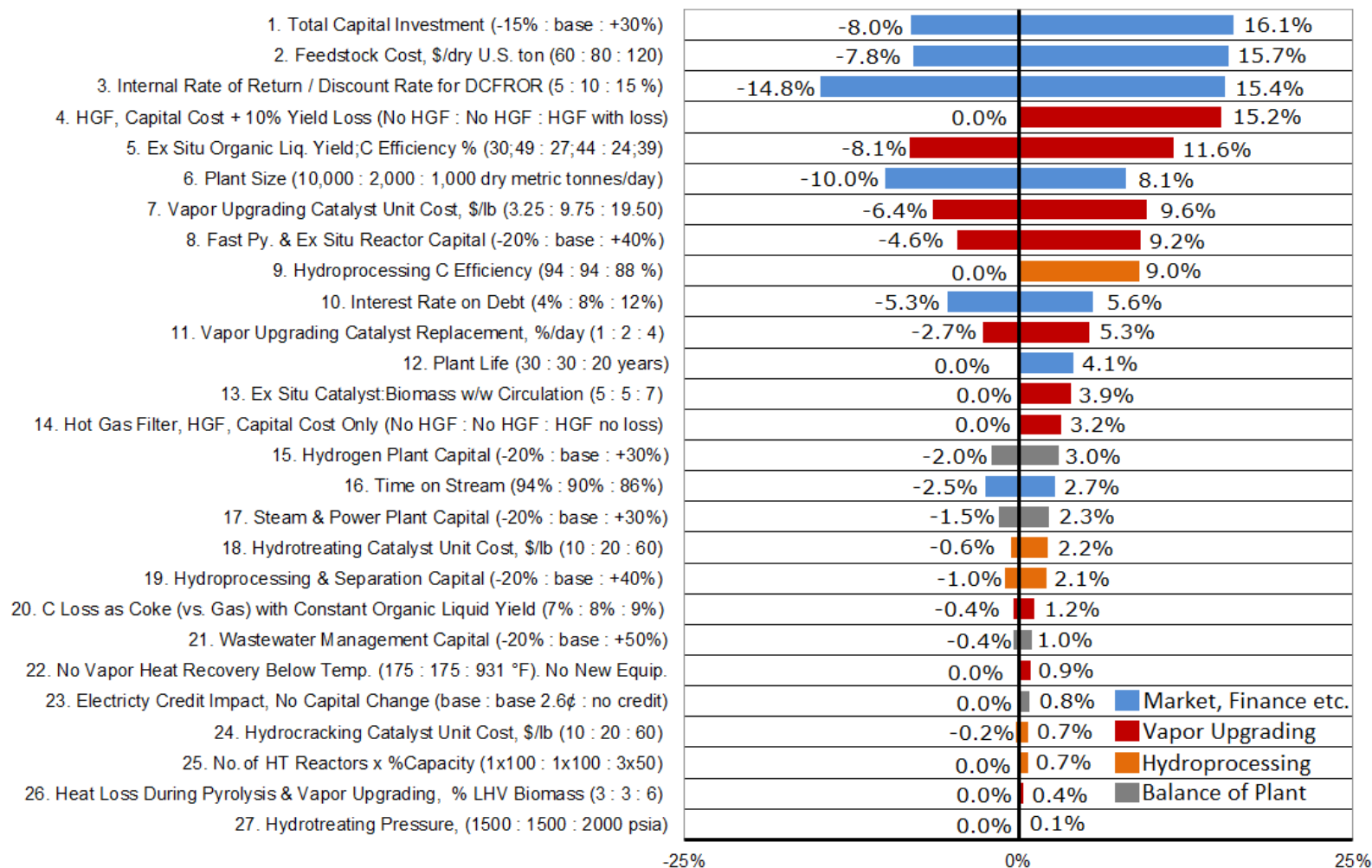

Example of sensitivity studies for *ex situ* case

% Change to MFSP from the ex situ base case (\$3.31/GGE)

Inform the research about the impacts of targets, their variances, and potential tradeoffs

5. Future Work

Milestones and schedules for FY2013 – FY2015 and FY2016 (proposed) provided in back-up slides.

- **Support the program**
 - State of Technology assessments for the pathways to **quantify progress towards 2022**
 - Model **alternate scenarios & research variances** for achievement of 2022 targets
 - **Contribute** and publish technical targets and SOTs in future **Multi-Year Program Plans**
 - Present data / results with measurable criteria for BETO Go / No-Go decision points
 - Deliver **timely responses** from high-quality analysis to **BETO's** quick-turnaround **requests**
- **Improve modeling** information and techniques
 - Integrate Syngas Conversion Modeling, Pyrolysis Reactor Modeling, and VPU Phase Equilibrium results to increase **predictive capabilities of models**
 - Interact with researchers to **capture key experimental information in simulations**, including compounds, property methods and reactions
- Continue to integrate **sustainability metrics** into analyses
- **Share** goals and **results publicly** through NREL / PNNL technical reports, BETO Multi-Year Program Plan (MYPP) and journal publications.
- Continue to develop and maintain **strong partnerships with industry**

Thank You

DOE BETO for funding and support

- Kevin Craig , Jay Fitzgerald, Nichole Fitzgerald, Prasad Gupte, Liz Moore (TC Conversion)
- Zia Haq, Kristen Johnson, Alicia Lindauer (Analysis & Sustainability)

NREL

- Mary Bidy
- Adam Bratis
- Daniel Carpenter
- Mark Davis
- Abhijit Dutta
- Carrie Farberow
- Jack Ferrell
- Tom Foust
- Jesse Hensley
- Kristina lisa
- Kim Magrini
- Mark Nimlos
- Asad Sahir
- Josh Schaidle
- Michael Talmadge
- Eric Tan
- Erick White

- TC research team

- Biorefinery analysis team
- Bob Evans (MicroChem)

PNNL

- Corinne Drennan
- Susanne B. Jones
- Aye Meyer
- Lesley Snowden-Swan

INL

- Kara Cafferty
- J. Richard Hess
- Jake Jacobson
- Erin M. Searcy
- Chris T. Wright

Harris Group Inc.

- John Lukas

- Jeff Ross

- Danielle Sexton
- Raymond Yap

DWH Process Consulting LLC

- David Humbird

NIST-TRC

- Robert Chirico
- Vladimir Diky
- Kenneth Kroenlein (PI)

Colorado School of Mines

- Anna Trendewicz
- Robert Braun

Johnson Matthey

Computational Pyrolysis Consortium

DOE Bioenergy Technologies Office (BETO) 2015 Project Peer Review: NREL Thermochemical Platform Analysis

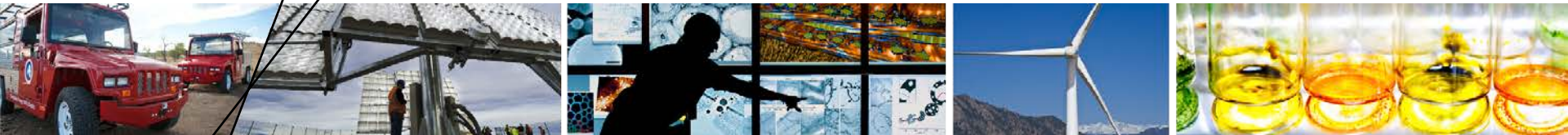

BACKUP SLIDES

Presenter: Abhijit Dutta

on behalf of Mary Bidy, Jack Ferrell and Michael Talmadge (PI)

BETO 2015 Project Peer Review

Hilton Mark Center, Alexandria, VA

March 26, 2015

Additional Content for Reviewers

- Completed and Future Project Milestones
- Responses to Comments from 2013 Review
- Publications and Presentations Since 2013 Peer Review
- Contacts for NREL TC Platform Analysis Projects
- Related Projects
- Industrial Partners and Commercialization
- Additional Slides on Sub-Tasks
 - Pyrolysis Pathway Analysis
 - Gasification / Indirect Liquefaction Pathway Analysis
 - Syngas Conversion Modeling

Completed Milestones (FY2013)

Milestone Type	Milestone Name and Description	Due Date and Status
E	Study of fluidized reactors for pyrolysis (e.g. fast pyrolysis, catalytic fast pyrolysis, vapor phase upgrading etc.) – design, bulk fluid flow, heat transfer and cost aspects.	12/31/12 Completed
E	Thermochemical mixed alcohols 2012 SOT sustainability metrics – Update and report on “sustainability metrics” work for thermochemical mixed alcohols production consistent with the Sept 2012 SOT case. Metrics include GHG, water, as well as other inputs and outputs associated with the biorefinery conversion process. (Joint milestone with Biochemical Platform Analysis)	12/31/12 Completed
E	Detailed analysis of fast pyrolysis with vapor phase upgrading (both integrated with and segregated from fast pyrolysis) to support experimental efforts. Model framework will be capable of capturing process and cost impacts of various experimental efforts such as catalyst development and testing, vapor and liquid phase filtration etc. While the base model will be delivered in Q2, model enhancements will continue to be made afterwards based on experimental feedback.	03/31/13 Completed
DL	Deliver draft fast pyrolysis & bio-oil upgrading design report for external review (joint work with PNNL)	06/30/13 Completed
DL	Finalize metrics from fast pyrolysis and bio-oil upgrading design report for submission to MYPP change control board (joint work with PNNL).	08/08/13 Completed
Joule	Deliver final fast pyrolysis & bio-oil upgrading updated design report (joint work with PNNL)	09/30/13 Completed

Completed Milestones (FY2014)

Milestone Type	Milestone Name and Description	Due Date and Status
Regular	Develop Aspen Plus model to support and help guide research efforts for at least one (1) of the configurations envisioned for NREL experimental efforts for pyrolysis vapor phase upgrading. If relevant experimental results are available for that configuration at the time of milestone delivery then report modeled process results for at least one (1) of the data sets, else report modeled results based on literature data.	12/31/2013 Completed
Regular	Report progress on four (4) aspects of the fluidized reactor model development for fast pyrolysis to be used for techno-economic analysis. The 4 aspects to be reported will include the treatment of the following in the model: reaction kinetics, bulk fluid flow, particle modeling, heat transfer. Results will show the modeled profiles for key process variables including temperature, pressure and velocity.	3/31/2014 Completed
Regular	Submit draft reports to BETO and external peer reviewers documenting two (2) biomass conversion pathways including fast pyrolysis with (a) in-situ and (b) ex-situ vapor upgrading. The reports will document in detail one (1) base target case for each configuration showing key process metrics that need to be met for those base case scenarios in order to enable the production of cost-competitive transportation fuels from biomass. (with PNNL)	6/30/2014 Completed
Regular	Submit draft reports to BETO and external peer reviewers documenting one (1) biomass conversion pathway via gasification of biomass and using the produced syngas for the production of hydrocarbons. The report will document in detail one (1) base target case showing key process metrics that need to be met for the base case scenario in order to enable the production of cost-competitive transportation fuels from biomass. (with PNNL)	6/30/2014 Completed
Regular	Submit to BETO for publication approval after addressing comments from external peer reviews reports documenting two (2) biomass conversion pathways including fast pyrolysis with (a) in-situ and (b) ex-situ vapor upgrading. The reports will document in detail one (1) base target case for each configuration showing key process metrics that need to be met for those base case scenarios in order to enable the production of cost-competitive transportation fuels from biomass. (with PNNL)	9/30/2014 Completed
Regular (with PNNL)	Submit to BETO for publication approval after addressing comments from external peer reviews a report documenting one (1) biomass conversion pathway via gasification of biomass and using the produced syngas for the production of hydrocarbons. The report will document in detail one (1) base target case showing key process metrics that need to be met for the base case scenario in order to enable the production of cost-competitive transportation fuels from biomass.	9/30/2014 Completed
Regular	Develop milestone report for submission to BETO on (a) current State of Technology basis, (b) target basis, (c) identified data gaps to be addressed, as well as comments on the path forward for at least three (3) thermochemical conversion pathways.	9/30/2014 Completed

Current (FY2015) Milestones

Milestone Type	Milestone Name and Description	Due Date and Status
Quarterly Progress Measure	(Task 1: Pyrolysis) Inclusion of the impact of alkali on the pyrolysis of cellulose into fast pyrolysis reactor model. This work will modify the currently implemented literature-based kinetic model to capture yield trends observed in experiments with potassium-impregnated cellulose.	12/31/2014 Completed
Quarterly Progress Measure	(Task 1: Pyrolysis) State of Technology (SOT) assessment based on the FY14 in situ/ex situ fast pyrolysis vapor upgrading design case. Include current research information into the process model and document scale-up assumptions for calculating current product cost for the process. The analysis team will provide preliminary SOT analysis results to BETO prior to the March 2015 peer review. The final milestone report will include sustainability metrics for the conversion process.	3/31/2015 In-Progress
Quarterly Progress Measure and Go / No-Go	(Task 2: Gasification) State of Technology (SOT) assessment based on the FY14 biomass to high-octane gasoline design report. Include current research information into the process model and document scale-up assumptions for calculating current product cost for the process. The analysis team will provide preliminary SOT analysis results to BETO prior to the March 2015 peer review. The final milestone report will include sustainability metrics for the conversion process.	3/31/2015 In-Progress
Quarterly Progress Measure	(Task 4: Syngas Modeling) Develop a kinetic model for mixed alcohol synthesis on a K-CoMoSx catalyst along with parameter estimation using bench-scale data sets collected for the 2012 mixed alcohols demonstration. At least two (2) data sets that were not run as replicates of any of the data sets used for parameter estimation will be used to compare model predictions with experimental results to show model effectiveness.	4/30/2015 In-Progress
Annual Milestone	(Task 1: Pyrolysis) Analysis of research scenarios for in situ/ex situ fast pyrolysis vapor upgrading. This study will include analysis to show the impacts of alternate process operations compared to the base case outlined in the FY14 design report; alternates will include the use of (1) hot gas filters, (2) fixed bed upgrading reactors in addition to other identified options based on research results. The purpose of this milestone is to provide analysis for research alternatives that were not captured in the FY14 design report base case. The results will be compared with the FY14 design report and FY14 State of Technology along with identification of research targets for cost-competitiveness with at least one of the alternate process configurations.	6/30/2015 In-Progress
Quarterly Progress Measure	(Task 2: Gasification) Prepare a draft report for peer reviews documenting one (1) biomass conversion pathway via gasification of biomass and using the produced syngas for the production of oxygenated intermediates with further conversion to hydrocarbons for use in liquid fuel blends. The report will document in detail one (1) base target case showing key process metrics that need to be met for the base case scenario in order to enable the production of cost-competitive transportation fuels from biomass. Joint milestone with PNNL.	7/15/2015 In-Progress

Current (FY2015) Milestones *(continued)*

Milestone Type	Milestone Name and Description	Due Date and Status
Quarterly Progress Measure	(Task 3: TEA Assessments) Develop milestone report, building on data mined in FY14. This milestone report will be focused on process models and economic analysis for current SOT basis, target basis, identified data gaps to address as well as provide recommendations for path forward for at least two (2) direct liquefaction pathways.	9/30/2015 In-Progress
Quarterly Progress Measure	(Task 5: Pyrolysis Upgrading Phase Equilibrium) Provide proof of concept of LLE predictions using data for a set of surrogate compounds with functional groups relevant to fast pyrolysis oils/upgraded oils, and at least one physical property method. The data used may be from existing literature sources, since experiments initiated in Q3 may not be completed by this time. Predictive capabilities will be tested by generating predictions for similar, but not identical compounds in the experimental data sets, and comparing with experimental data or relevant closest experimental data that is available.	9/30/2015 In-Progress
Annual Milestone	(Task 2: Gasification) Submit to BETO for publication approval after addressing comments from external peer reviews a report documenting one (1) biomass conversion pathway via gasification of biomass and using the produced syngas for the production of oxygenated intermediates with further conversion to hydrocarbons for use in liquid fuel blends. The report will document in detail one (1) base target case showing key process metrics that need to be met for the base case scenario in order to enable the production of cost-competitive transportation fuels from biomass. Joint milestone with PNNL.	9/30/2015 In-Progress
Quarterly Progress Measure	(Task 2: Gasification) State of Technology assessment for the biomass to high-octane gasoline pathway based on FY15 experimental results. Include current research information into the process model and document scale-up assumptions for calculating current product cost for the process. Sustainability metrics for the conversion process will be included.	10/26/2015 In-Progress
Quarterly Progress Measure	(Task 1: Pyrolysis) State of Technology assessment for the in situ/ex situ fast pyrolysis vapor upgrading pathways based on FY15 experimental results. Include current research information into the process model and document scale-up assumptions for calculating current product cost for the process. Sustainability metrics for the conversion process will be included.	11/13/2015 In-Progress

Future Milestones (Proposed FY2016)

Milestone Type	Milestone Name and Description	Due Date
Quarterly Progress Measure	(Task 2: Gasification) State of Technology assessment for the biomass to high-octane gasoline pathway based on FY15 experimental results. Include current research information into the process model and document scale-up assumptions for calculating current product cost for the process. Include sustainability metrics for the conversion process as well.	10/26/2015
Quarterly Progress Measure	(Task 1: Pyrolysis) State of Technology assessment for the in situ/ex situ fast pyrolysis vapor upgrading pathways based on FY15 experimental results. Include current research information into the process model and document scale-up assumptions for calculating current product cost for the process. Include sustainability metrics for the conversion process as well.	11/13/2015
Go/No-Go	(Task 1: Pyrolysis) Set initial research goals through detailed process analysis and publication of detailed design report with conceptual processes towards potential commercialization implementation pathways for <i>in situ</i> and <i>ex situ</i> upgrading of fast pyrolysis vapors as outlined in FY14 AOP, (b) follow experimental research progress through State of Technology assessments as outlined in the FY14 and FY15 AOPs, and (c) provide future research performance recommendations with specific targets based on the analysis of experimental results in the context of conceptual commercial processes.	3/31/2016
Go/No-Go	(Task 3: TEA Assessments) Provide process-model based analysis for at least 2 liquefaction pathways using process information collected in FY14 and FY15, as outlined in FY15 Q4 progress measure.	3/31/2016
Go/No-Go	(Task 4: Syngas Conversion Modeling) Provide detailed kinetic models, at least one of which should be fully integrated into a plant simulation TEA model.	3/31/2016
Go/No-Go	(Task 5: Pyrolysis Upgrading Phase Equilibrium) Provide proof of concept of liquid-liquid equilibrium predictions for surrogate compounds in water-oxygenates-hydrocarbon systems, as outlined in FY15 Q4 progress measure.	3/31/2016
Annual Milestone	(Task 1: Pyrolysis) Provide techno-economic analysis for at least two (2) research approaches, significantly outside the scope of research pathways outlined in the FY15 design report (NREL/TP-5100-62455), requiring modifications to major process equipment, heat balance and cost reduction strategies. Demonstrate how required modifications to the design in NREL/TP-5100-62455 will impact the process and conversion costs.	6/30/2016
Go/No-Go	(Task 2: Gasification) Set initial research goals through detailed process analysis and publication of design report with conceptual process(es) towards potential commercialization implementation pathways for syngas conversion pathways as outlined in the FY15 AOP, (b) follow experimental research progress through State of Technology for the process(es), and (c) provide future research performance recommendations with specific targets based on the analysis of experimental results in the context of conceptual commercial processes.	9/30/2016

Responses to Comments from 2013 Peer Review

Syngas Mixed Alcohol Cost Validation

Overall Impressions

- Continue support of this function within BETO because of its critical need to inform decision makers regarding BETO's direction. Continue to encourage interaction with industry to obtain accurate and current technical and economic data that feed into these types of analysis.
- Running the process simulations and economic analysis in conjunction with the R&D testing is critical. DOE should continue to fund this type of work. See notes above about concerns for modeling hydrocarbon pathways.
- This project served as a focal point for all of the activities in the portfolio, identifying performance targets for technological improvements, and using the resulting experimental data to validate the model's cost predictions. Continuous interaction with researchers and industry was used to great effect to help meet the modeled cost target of \$2.05/gallon of gasoline equivalent for this Technology Area, the capstone accomplishment for many years of development. The significant differences between the NREL pilot plant and the modeled benchmark plant are somewhat concerning, but can be clarified in a recommended revision to the updated design report. It is hoped that the models developed here for mixed-alcohol synthesis will continue to be supported by NREL as long as industry shows interest in them.

- This was a well-executed project with strong input from Dow. This is an excellent example of good collaboration between the private sector and a national laboratory.
- With the recognition of importance of addressing sustainability issues/criteria, it is essential to build upon the existing TEA database to evaluate long-term viability and environmental compliance of research innovations and pathways. DOE may find it beneficial to explore supporting the setup of a similar database for TEA, LCA, and sustainable development by at least one other organization that would be complementary to NREL's efforts. DOE should consider organizing an outreach introduction to the principles of TEA, LCA, and sustainable development to interested members of BETO's "extended family" at a convenient time and location.

PI Response to Reviewer Comments

- We will leverage current work and methodologies for the future hydrocarbon pathways analysis. Regarding your concern about the consistent handling of uncertainties among the various pathways, we will follow protocols established under BETO's Analysis and Sustainability Technology Area.
- We submitted a journal article for peer review on June 30, 2013, detailing the demonstration efforts. It includes significant information and direct comparison of experimental data with the 2011 design report, with explanations for variances. It gives a detailed cost breakdown for a lower pressure case with experimental basis, which also shows we met the cost target. A poster was displayed at TC Biomass 2013.
- We share the hope that the significant progress in mixed-alcohol synthesis from biomass-derived syngas will be leveraged by interested industrial partners; we will be willing and happy to help and participate in the further advancement of this technology.

- TEA for future hydrocarbon pathways will be conducted jointly by NREL and PNNL, similar to your suggestion that "at least one other organization" be involved in the efforts. Various aspects of LCA are already being addressed by multiple national laboratories, including ANL, NREL, PNNL, INL, and others. While the 2011 design report Aspen Plus model was not made publicly available because of proprietary content from the Dow Chemical Company provided under a CRADA, previous versions of this and other TEA models are made publicly

available by NREL online. The models and methods have been leveraged in the past by multiple entities including industry, national laboratories, and universities. Modeling information is shared with all interested parties, and reasonable efforts are made to reply to queries on a regular basis. In addition, a collaboration between NREL, Iowa State University, and ConocoPhillips resulted in joint model development and multiple publications using the TEA methodologies developed at NREL.

Additional details are included in the write-up for this project, located on pages 561 – 563 of the 2013 Peer Review Report →

http://www.energy.gov/sites/prod/files/2014/03/f14/2013_peer_review.pdf

Publications and Presentations since 2013 Peer Review

Design Reports:

- Dutta, A.; Sahir, A.; Tan, E.; Humbird, D.; Snowden-Swan, L.; Meyer, P.; Ross, J.; Sexton, D.; Yap, R.; Lukas, J. Process Design and Economics for the Conversion of Lignocellulosic Biomass to Hydrocarbon Fuels - Thermochemical Research Pathways With In Situ and Ex Situ Upgrading of Fast Pyrolysis Vapors. NREL/TP-5100-62455, PNNL-23823, 2015. *(led by NREL)*
- Tan, E.; Talmadge, M.; Dutta, A.; Hensley, J.; Schaidle, J.; Bidy, M.; Humbird, D.; Snowden-Swan, L.; Ross, J.; Sexton, D.; Lukas, J. Process Design for the Conversion of Lignocellulosic Biomass to High Octane Gasoline - Thermochemical Research Pathway With Indirect Gasification and Methanol Intermediate. NREL/TP-5100-62402, PNNL-23822, 2015. *(led by NREL)*
- Jones, S.; Meyer, P.; Snowden-Swan, L.; Padmaperuma, A.; Tan, E.; Dutta, A.; Jacobson, J.; Cafferty, K. (2013). Process Design and Economics for the Conversion of Lignocellulosic Biomass to Hydrocarbon Fuels: Fast Pyrolysis and Hydrotreating Bio-oil Pathway. 97 pp.; PNNL-23053; NREL Report No. TP-5100-61178. *(led by PNNL)*

Journal Articles:

- Trendewicz, A.; Evans, R.; Dutta, A.; Sykes, R.; Carpenter, D.; Braun, R. (2015). Evaluating the effect of potassium on cellulose pyrolysis reaction kinetics. *Biomass and Bioenergy*, 2015, 74, pp. 15-25.
- Trendewicz, A.; Braun, R.; Dutta, A.; Ziegler, J. (2014). One Dimensional Steady-State Circulating Fluidized-Bed Reactor Model for Biomass Fast Pyrolysis. *Fuel*. Vol. 133, 1 October 2014; pp. 253-262. (Corrigendum at: *Fuel*. Vol. 144, 15 March 2015; pp. 439-440.)

Publications and Presentations since 2013 Peer Review

Journal Articles (continued):

- Dutta, A.; Hensley, J.; Bain, R.; Magrini, K.; Tan, E. C. D.; Apanel, G.; Barton, D.; Groenendijk, P.; Ferrari, D.; Jablonski, W.; Carpenter, D. (2014). Technoeconomic Analysis for the Production of Mixed Alcohols via Indirect Gasification of Biomass Based on Demonstration Experiments. *Industrial and Engineering Chemistry Research*. Vol. 53(30), 30 July 2014; pp. 12149-12159.
- Muth, D. J.; Langholtz, M. H.; Tan, E. C. D.; Jacobson, J. J.; Schwab, A.; Wu, M. M.; Argo, A.; Brandt, C. C.; Cafferty, K. G.; Chiu, Y. W.; Dutta, A.; Eaton, L. M.; Searcy, E. M. (2014). Investigation of Thermochemical Biorefinery Sizing and Environmental Sustainability Impacts for Conventional Supply System and Distributed Pre-Processing Supply System Designs. *Biofuels, Bioproducts and Biorefining*. Vol. 8(4), July/August 2014; pp. 545-567.

Presentations:

- Talmadge, Michael; Dutta, Abhijit; Bain, Richard. “Techno-economic and Market Analysis of Pathways from Syngas to Fuels and Chemicals.” Presented at IEA Bioenergy, Task 33 / IEA IETS Workshop on System and Integration of Biomass-based Gasification, Gothenburg, Sweden. November 20, 2013.
- Talmadge, M.; Dutta, A.; Bain, R. Techno-economic and market analysis of pathways from syngas to fuels and chemicals. September 4, 2013.
- Eric Tan presented “Sustainability Metrics and Life Cycle Assessment for Thermochemical Conversion of Woody Biomass to Mixed Alcohols” at the 2013 2nd International Conference on Environment, Energy and Biotechnology in Singapore. The paper was judged as one of the best papers at the conference. Conference paper available at: <http://www.ipcbee.com/vol51/014-ICEEB2013-A10014.pdf>

Publications and Presentations since 2013 Peer Review

Posters:

- Dutta, A.; Humbird, D.; Sahir, A. Material and energy balance implications of the efficiency of catalytic upgrading of biomass fast pyrolysis vapors on conceptual biorefinery processes. TCS2014, Denver, Colorado, 2-4 September, 2014, NREL/PO-5100-62714.
- Trendewicz, A.; Evans, R.; Dutta, A.; Sykes, R.; Carpenter, D.; Braun, R. Describing the Effect of Potassium on Cellulose Pyrolysis Process Based on a Statistical Analysis of MBMS data. TCS2014, Denver, Colorado, 2-4 September, 2014.
- Sahir, A.; Dutta, A. Relevance of petroleum refinery fluid catalytic cracking to biomass catalytic fast pyrolysis. TCS2014, Denver, Colorado, 2-4 September, 2014, NREL/PO-5100-62684.
- Dutta, A.; Hensley, J.; Bain, R.; Magrini, K.; Tan E.; Apanel, G.; Barton, D.; Groenendijk, P.; Ferrari, D.; Jablonski, W.; Carpenter, D. Demonstration of the production of mixed alcohols via indirect gasification of biomass: Techno-economics and life-cycle analysis. September 4-5, 2013.
- Dutta, A.; Czernik, S. Process considerations for the feasibility of upgrading vapors from the fast pyrolysis of biomass to benefit downstream products. September 4-5, 2013.
- Talmadge, M.; Dutta, A. Techno-economic analysis of biomass-derived synthesis gas to ethanol via biological conversion and subsequent alcohol conversion to naphtha-range hydrocarbons. September 4-5, 2013.
- Trendewicz, A.A.; Braun, R.J.; Dutta, A.; Czernik, S.; Pepiot, P. Modeling Circulating Fluidized Bed Reactors For Biomass Fast Pyrolysis. September 4-5, 2013.

Contacts for NREL TC Platform Analysis Projects

Pyrolysis and Gasification Pathway Analysis

- Abhijit Dutta Abhijit.Dutta@nrel.gov
- Mike Talmadge Michael.Talmadge@nrel.gov
- Eric Tan Eric.Tan@nrel.gov

Thermochemical TEA Assessments

- Mary Bidy Mary.Bidy@nrel.gov

Syngas Conversion Modeling

- Jack Ferrell Jack.Ferrell@nrel.gov
- Carrie Farberow Carrie.Farberow@nrel.gov

Phase Equilibrium Predictions for FP Upgrading

- Abhijit Dutta Abhijit.Dutta@nrel.gov

Thermochemical Platform Leadership

- Mark Davis Mark.Davis@nrel.gov
- Adam Bratis Adam.Bratiss@nrel.gov

Related Projects

The related NREL tasks and associated WBS numbers are as follows:

- Thermochemical Feedstock Interface (WBS: 2.2.1.304)
- Computational Pyrolysis Consortium (WBS: 2.5.1.302)
- Development and Standardization of Techniques for Bio-oil Characterization (WBS:2.5.2.301)
- Integration and Scale Up (WBS: 2.4.1.301)
- Thermochemical Capital Equipment (WBS: 2.4.1.302)
- Liquid Fuels via Upgrading of Syngas Intermediates (WBS: 2.3.1.305)
- Reforming Pyrolysis Aqueous Waste Streams to Process Hydrogen and Hydrocarbons (WBS: 2.3.1.311)
- Catalytic Pyrolysis Science (WBS: 2.3.1.313)
- Catalytic Upgrading of Pyrolysis Products (WBS: 2.3.1.314)
- Catalyst Development and Testing (WBS: 2.3.1.315)
- Sustainability Analysis (WBS: 4.2.1.30)

Additional related tasks at other national laboratories and associated WBS numbers are as follows:

- Analysis and Sustainability Interface – PNNL (WBS: 2.1.0.301)
- Life-Cycle and Sustainability Analysis – ANL (WBS: 4.1.1.10)

Industrial Partners and Commercialization

Close collaboration with industrial partners and expected continued efforts by partners towards future commercialization:

- **Johnson Matthey:** NREL pilot runs showed their fixed-bed catalyst can meet technical targets for reforming biomass-syngas (catalyst & cost analysis not allowed per agreement)
- **National Institute of Standards and Testing (NIST):**
Collaboration to advance phase-equilibrium predictions for fast pyrolysis vapor upgrading and integrate with process models to increase predictive capabilities
- **Rentech:** Successful pilot-scale tests using NREL fluidizable catalyst in reforming-regenerating dual bed system (2012 mixed alcohols demonstration)
- **Dow Chemical:** Alcohol synthesis catalyst improvements (2012 mixed alcohols demonstration)