

DOE Bioenergy Technologies Office (BETO) 2015 Project Peer Review

Testing, Evaluation, and Qualification of Bio-Oil for Heating

March 26, 2015

Dr. Thomas A. Butcher
Brookhaven National Laboratory



BROOKHAVEN
NATIONAL LABORATORY

Goal Statement

- The goal of this project is to enable the replacement of 20% of the petroleum-derived heating oil in the Northeast with infrastructure compatible bio-oil by 2020 thereby stabilizing the supply and cost peaks for heating oil.
- Heating oil and diesel transportation both use the same fuel – renewable fuel use in both areas has a similar national impact;
- Heating applications are technically simpler, providing a logical entry point for biofuels, enabling more rapid growth in fuel use and scale-up;
- Experience with end use equipment, supply and distribution, manufacturer and code acceptance in the heating oil market will facilitate the acceptance process in the transportation market.

Quad Chart Overview

Timeline

- Project start date – Nov. 2012
- Project end date - Sept. 2015
- Percent complete – 85%

Budget (\$,000)

	Total Costs FY 10 – FY 12	FY 13 Costs	FY 14 Costs	Total Planned Funding (FY 15- Project End Date)
DOE Funded	\$0	\$65	\$200	\$85
Project Cost Share (Comp.)*	\$0	\$0	\$0	\$0

*If there are multiple cost-share partners, separate rows should be used.

- Barriers addressed
 - Dm-A, Distribution Infrastructure
 - Mm-A, Industry and Consumer Acceptance
 - Dt-B Codes, Standards and Approval for Use
 - Tt-E, Pyrolysis of Biomass and Stabilization
 - Im-D, Lack of Industry Standards
- Partners
 - The National Oilheat Research Alliance (NORA) is a subcontractor to BNL. NORA's role is to provide outreach to industry to ensure that industry concerns and constraints are addressed. \$50K, 14% of the total project budget.
 - BNL's work is part of a larger initiative involving PNNL, ORNL, and INL (funded separately). There is considerable coordination among the labs.

Project Overview

- Foundation based on Technical Information Exchange on Pyrolysis Oil: Potential for Renewable Heating Oil Substitution Fuel in New England, May 9-10, 2012.
- Focus on fungible fuel which could be blended at 20% level
- Need to understand cost and performance tradeoffs for deploying a less-than-perfectly conditioned pyrolysis oil.
- Need to understand technical barriers to be overcome across the supply, distribution, end use chain.
- Target is 7.2 billion gallons of No. 2 oil used annually in this market.

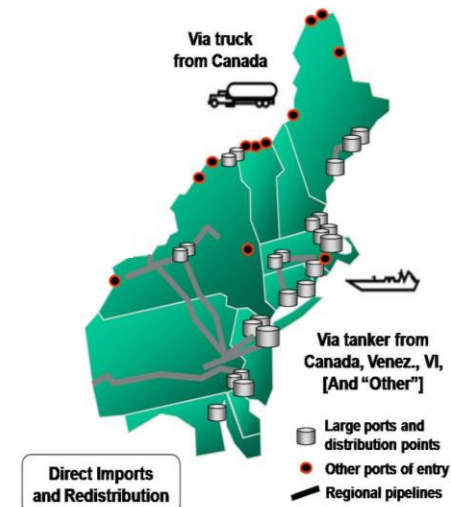
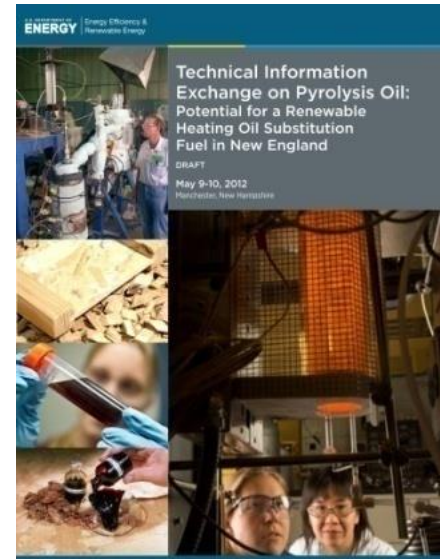

Project Overview - collaborations

- PNNL – FP, Upgrading, TEA/LCA
- INL – Feedstock supply and logistics
- ORNL – Corrosion studies
- BNL – End use/ testing with fuels from PNNL
- National Oilheat Research Alliance (NORA) – engage industry

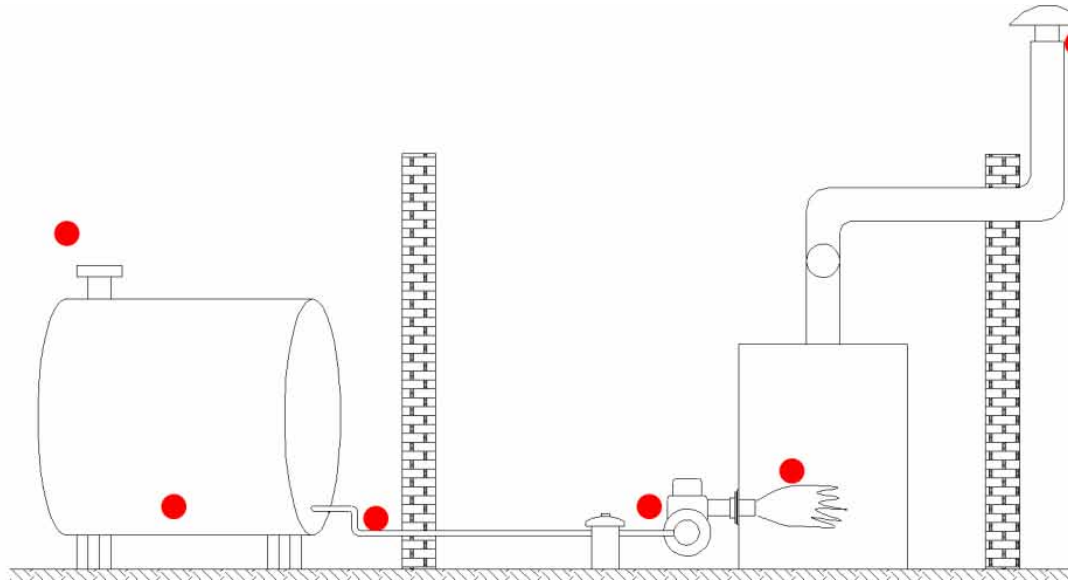

Approach (Technical)

- *BNL Work focused on technical evaluation of end use acceptance of 20% blends of upgraded fuels produced by PNNL. Tasks:*
 - *Fuel Properties – in addition to available data from PNNL*
 - *Storage Stability Measurements*
 - *Compatibility with legacy system elastomers*
 - *Combustion and emissions*
 - *Technical documentation to support standards process*
 - *Engage industry, through NORA, to ensure their concerns and interests are reflected. This includes shippers, major terminal operators, wholesale distributors, retail marketers, service organizations, and manufacturers (burners, pumps, storage tanks, valves, rebuilders, other components)*
- *Critical Success Factors*
 - *Cost*
 - *No increased service requirements*
 - *Standards acceptance*

Approach (Technical – top potential challenges)

- *Storage stability*
 - *This market sector requires 1 year storage minimum*
 - *Degradation of No. 2 oil is currently the most significant service issue*
- *Elastomer compatibility*
 - *Currently different types of nitrile commonly used*
 - *Elastomer material change would require pump replacement*
 - *Retailers deliver to 3,000 to 12,000 customers. The logistics of delivering separate fuels to different parts of the customer base would be a significant acceptance barrier*

Approach (Management)

- *Critical success factors*
 - *Supply and end use chain must be convinced that all technical issues have been addressed;*
 - *If a new fuel standard must be defined under ASTM D-396, manufacturers will need to begin producing products listed for use with this new fuel.*
- *Top potential challenges*
 - *This fuel is not yet defined*
 - *Significant volumes are not yet available*
- *This project has been structured to address the basic technical feasibility of the use of this fuel in this market sector and the engage industry to pre-stage market acceptance.*

Technical Accomplishments/ Progress/Results

- *FY 14 Milestones Completed*
 - *Received Fuel Samples from PNNL*
 - *Characterization of Bio-Oil Samples*
 - *Storage Stability Evaluation*
 - *Combustion Testing Completed*
- *FY 15 Milestones*
 - *Report on Combustion Studies, 11/30/14 – Done*
 - *Completion of Seal Elastomer Studies, 11/30/14 – Done*
 - *NORA Feedback Report on Industry Interactions – Delayed to allow for presentation during spring industry conference season*
 - *Project Final Report – planned for 3/31/15. Delayed pending NORA feedback*

Note on milestone schedule – during FY 14 work was delayed pending completion of fuel samples. These were received in FY 14 and progress on planned tasks were rapidly completed.

A report on all experimental work with the test fuels has been completed and sent to PNNL for integration. A multi-lab publication on this work is now in preparation.

Technical Accomplishments/ Progress/Results (Cont)

Three fuel samples were received from PNNL

- *No. 2 fuel oil (HHO)*
- *20% Blend of a nominally low oxygen bio-oil in No. 2 fuel oil (R-HHO-MOX)*
- *20% Blend of a somewhat higher oxygen bio-oil with No. 2 fuel oil (R-HHO-HOX)*

Physicochemical properties of fuel samples

Property	Method	Fuel Samples		
		HHO	R-HHO-MOX	R-HHO-HOX
<i>Elemental Composition</i>				
C		85.86	85.14	85.17
H		12.82	12.68	12.36
O	ASTM D5373 mod	1.32	2.15	2.29
N			<0.05	<0.05
S	ASTM D4239		<0.1	<0.1
<i>Physical Properties</i>				
Water, wt.%	ASTM D6869	<0.03	0.03	0.08
Acid Number, mg KOH/g	ASTM D3339	<0.01	8.31	8.55
Kinematic Viscosity, cSt		2.88	2.68	3.21
Density, g/mL		0.828	0.838	0.849

Technical Accomplishments/ Progress/Results (Cont)

- *Basic observations about the fuels – HOX and MOX blends were stored at 5 C. After 2 months sediments in the bottom of the HOX and MOX fuel blends were noted.*

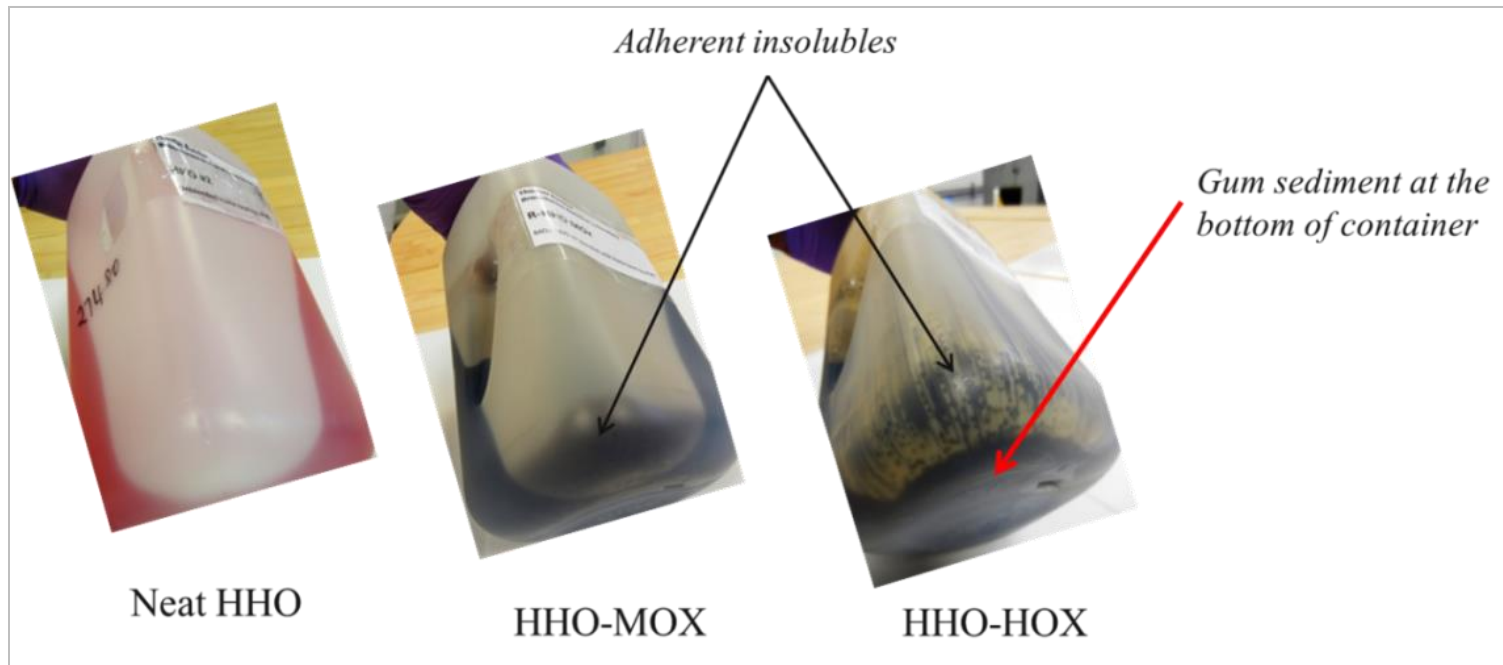

- *GC/MS analysis of the bottom sediments in the HOX fuel indicated oxygenate compounds - phenols, carboxylic acids, ketones. Acid number of the gum found to be 35.4. Clearly indicating bio-oil in origin and suggesting further processing needed.*

Technical Accomplishments/ Progress/Results (Cont)

Thermal Stability Test

ASTM D6468 – 150 C / 180 minutes

Fuel Stability Parameter	Test Fuel Samples		
	HHO	R-HHO-MOX	R-HHO-HOX
Filter pad rating before test, % Reflectance	95.1	76.1	68.97
Filter pad rating after D6468 test, % Reflectance	93.85	13.5	-
*Initial Total Insolubles, mg/100 mL	1.13	6.80	11.07
D6468 Total Insolubles, mg/100 mL	2.47	19.0	493.3

*Filterable insolubles obtained in the pre-filtration of the fuels before testing.

Both MOX and HOX blends considered unacceptable

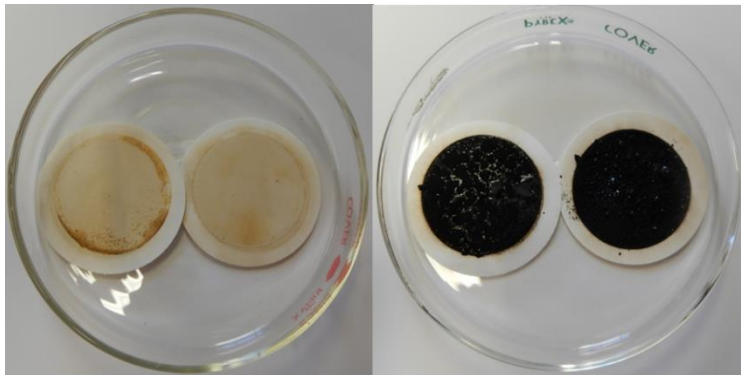

Before Stability test ASTM D6468:
Filter paper- after filtering HHO-HOX

After stability test ASTM D6468:
Filter paper- after filtering aged HHO-HOX

GC/MS analysis indicates oxygenated species such as cyclopentanone, alkylated phenols, and levoglucosan participate in formation of insolubles.

Technical Accomplishments/ Progress/Results (Cont)

- *Long Term Storage Stability*
 - ASTM D4625 – 43 C 12 weeks

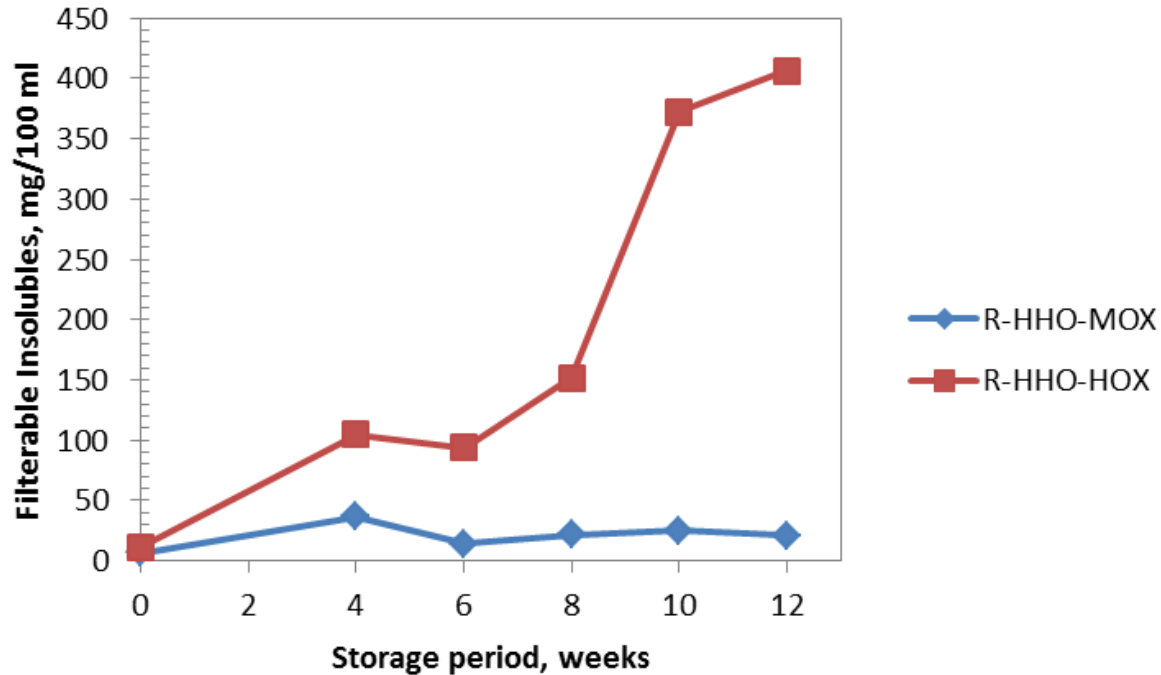

FTIR analysis suggests aliphatic hydrocarbons participate in insolubles formation process. Also clear participation of phenolics, aromatics, and carbonyl compounds.

Technical Accomplishments/ Progress/Results (Cont)

- *Impact of “yellow metals” on stability – an area of concern in the industry. Brass burner nozzles and piping are commonly used. Temperatures in the 80 C range are common following burner shutdown.*

80 C, 1 week

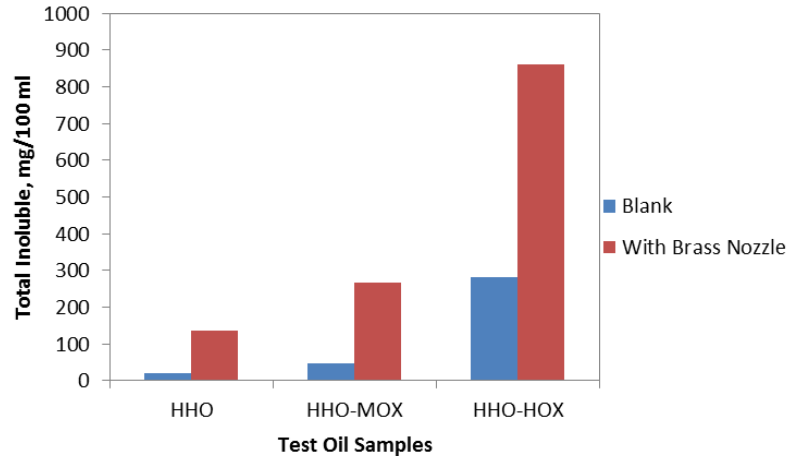

Neat HHO



R-HHO-MOX



R-HHO-HOX

Technical Accomplishments/ Progress/Results (Cont)

- *Elastomer swell*

Swell Test Results – Physical Size Change Method (Volume Percent Swell)				
Days Exposure	Generic Nitrile		Pump Seal Nitrile Material	
	R-HHO-HOX	R-HHO-MOX	R-HHO-HOX	R-HHO-MOX
0	0	0	0	0
10	70.4	34.8	27.6	22.6
30	96.6	47.9	40.0	31.6

Elastomers included both a generic nitrile and slabs of nitrile used in most common pump seal material. Limit of 25% volume swell after 72 hours but observed swell typically under 5%. Overall these results indicate unacceptable or, at best, marginal behavior.

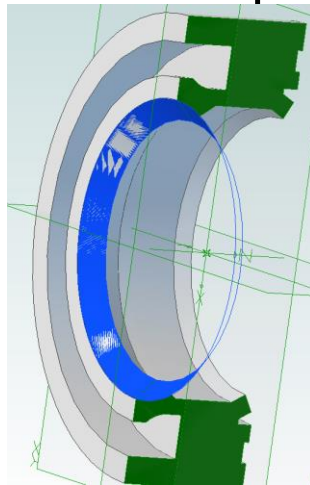

Technical Accomplishments/ Progress/Results (Cont)

- *Combustion Testing – Quartz Combustion Chamber – full size residential burner. Allows flame visualization.*

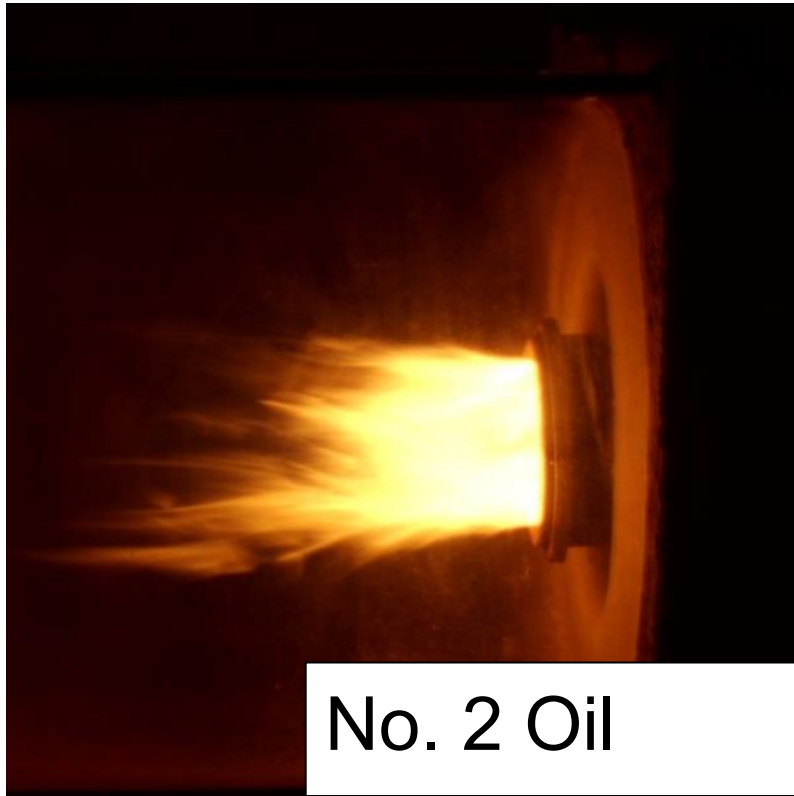
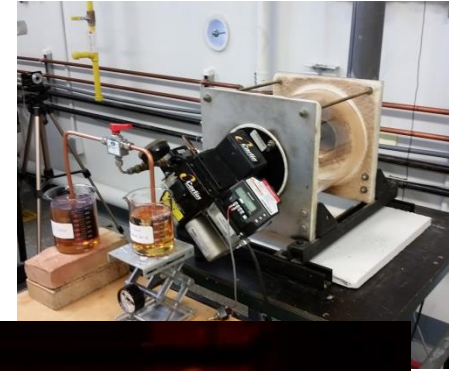

No. 2 Oil



HOX Blend

Overall – excellent flame stability, changes in flame shape/length minor

Technical Accomplishments/ Progress/Results (Cont)

- *Typical residential boiler / burner combination*

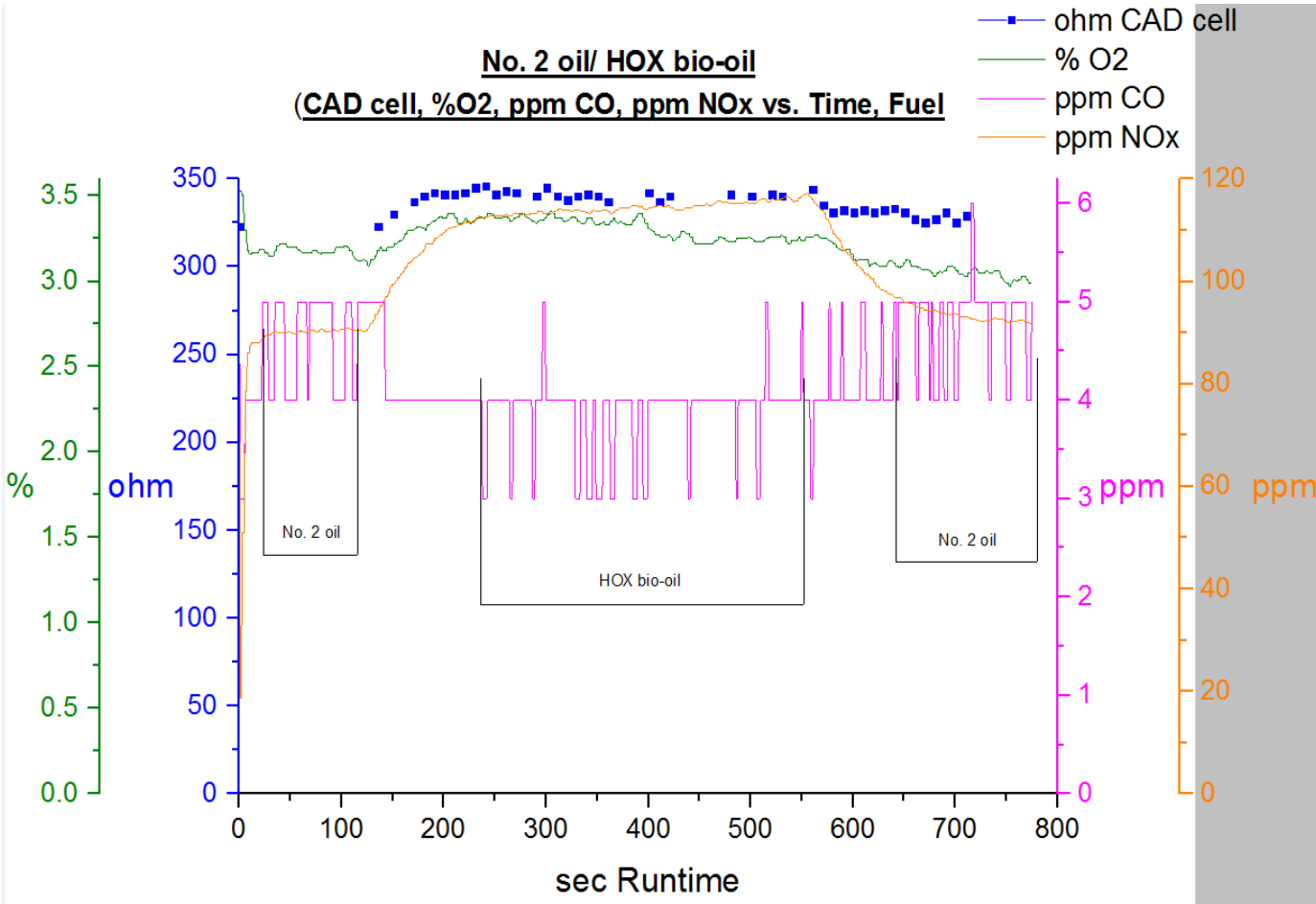

With limited fuel available, tests were done switching from No. 2 oil

Technical Accomplishments/ Progress/Results (Cont)

- *Summary of Combustion Test Results*

Summary of Emissions Data

Parameter	Units	No. 2 Oil	R-HHO-HOX Blend	R-HHO-MOX Blend
Oxygen	%	3.19	3.31	3.21
NOx	ppm	90.1	114.7	104.5
CO	ppm	neg. ¹	neg. ¹	neg. ¹
Smoke Number	-	0	0	0
Cad Cell Resistance	ohms	324	340	339

1. CO is at levels considered negligible for all tests.

NOx emissions are clearly higher with the bio-oil blends. While undesirable, in this market NOx is not regulated. Based on the tests done, combustion performance is not considered an important barrier to market acceptance of this fuel.

Technical Accomplishments/ Progress/Results (Cont)

- *Market Outreach*
 - *Led by NORA, the major industry association*
 - *Small group outreach to relevant industry groups*
 - *presentations planned for conferences in Spring 2015*
 - *Survey of manufacturers in progress*
- *Results to Date*
 - *Wholesale and retail fuel marketers interested and very willing to integrate with the market if: cost is lower and there are no technical concerns. Renewable fuel attribute useful in marketing but not a primary driver.*
 - *Reliable, regional fuel supplier critical to acceptance by terminal operators.*
 - *Fuel quality management program would help raise confidence.*
 - *Detailed specifications needed to ensure a quality product is marketed and acceptance by code and tax officials.*

Technical Accomplishments/ Progress/Results (Cont)

- *Standards and Approvals*
 - *Burners and other fuel handling components in this market sector are approved for use against UL standards*
 - *“Listing” defines the fuels for which components are approved*
 - *Heating fuels are defined in ASTM D396.*
 - *ASTM D7544 – Standard for Pyrolysis Liquid Biofuel not applicable*
 - *Two options:*
 - *Define a new bio-oil specification (inside or outside of D396)*
 - *Fuel product is so low in oxygen content it is considered a hydrocarbon and so is equivalent to No. 2 oil*
 - *If a new fuel is defined, component manufacturers will develop and list new products*
 - *Manufacturers reluctant to approve existing products for a new fuel – they assume risk and listing costs without the benefit of new product sales.*

Technical Accomplishments/ Progress/Results (Cont)

- *Hydrocarbon (from D975)*
 - *“Hydrocarbon oil – homogeneous mixture or solution with elementary composition primarily of carbon and hydrogen and also containing sulfur, oxygen or nitrogen from residual impurities and contaminants and excluding oxygenated materials. “*
 - *Fuel as tested is not a hydrocarbon oil.*

Relevance

- *Heating oil as a target market is specifically discussed in the BETO Multi-Year Program Plan.*
- *Relative to transportation, the heating oil market is technically simpler, yet contains many of the same barriers. It provides an important entry point for biofuels.*
- *Penetration into the heating oil market will increase the near-term market size for emerging bio-oil producers, yield considerable experience in the supply and distribution areas that are relevant to transportation, and create a pathway for fuel specification and acceptance.*
- *Through NORA, there is a direct market engagement mechanism for all parts of the heating oil industry.*

Future Work

- *NORA will communicate the results of this initiative and the opportunity emerging to key industry stakeholders through briefing packages, conference presentations, surveys, and workshops. A workshop with a live firing demonstration is being planned for industry.*
- *New fuel system components are being introduced now to the market which are biofuel compatible, targeting biodiesel. Materials compatibility and pump run tests are underway (HOX fuel).*
- *Project final report*
- *The fuel as tested does not meet the target compatibility requirements. Future activities which push the cost/quality ratio toward lower oxygen content will be required.*

Summary

1. Overview

1. Heating oil market presents an important opportunity for bio-oil deployment
2. This multilab effort is focused on lower cost, partially upgraded fuel

2. Approach

1. BNL is evaluating all aspects of distribution and end use for 20% blends
2. NORA is providing industry outreach

3. Technical Accomplishments/Progress/Results

1. Stability in storage and elastomer compatibility are seen as key barriers
2. Combustion behavior is very good although NO_x is higher.

4. Relevance

1. Heating oil is an attractive entry pathway for bio-oil
2. Many of the supply and end use issues addressed in this market sector will be relevant for acceptance in the transportation market

5. Future work.

1. Additional upgrading is required to provide a fully compatible fuel
2. It is likely that a new fuel specification and standard will be required

Additional Slides

Publications, Patents, Presentations, Awards, and Commercialization

- A journal paper is currently being prepared jointly by the National Labs involved.
- A presentation on this work will be made at the NYS Biotechnology Symposium, May 2015
- A presentation on this work will be made at the Pyrolysis Oil Utilization Workshop, planned for March 30 and 31, N. Conway, New Hampshire.
- Renewable Home Heating Oil in the Northeastern U.S., T. Butcher, and E. Levine, U.S. DOE. Advanced Energy Conference, New York City, May 1, 2013.
- Renewable Home Heating Oils (HHO): Pyrolysis and Upgrading of Bio-Oils Derived from U.S. Northeast Hardwoods, poster presentation, Third International Conference on Thermochemical Conversion of Biomass, Chicago, Sept. 2013.
- Qualification of Alternative Fuels, T. Butcher, J. Huber, DOE Technical Information Exchange on Pyrolysis Oil Workshop, New Hampshire, May 8, 2012.
- Integrated System Sensitivities and Perspective - A qualitative discussion on conversion, stabilization, and upgrading versus infrastructure compatibility and retrofit requirements J. L. Male, DOE Technical Information Exchange on Pyrolysis Oil Workshop, New Hampshire, May 8, 2012.

Additional information on upgraded fuels, data provided by PNNL



	Water by Karl Fischer	Acid Number	Carbon	Hydrogen	Nitrogen	Oxygen	Sulfur	Viscosity	Density
ASTM	D6869	D3339	D5373 / D5291			D5373mod	D4239/D1552		
	wt%	mg-KOH/g	wt%	wt%	wt%	wt%	wt%	cSt	g/mL
HHO #2	<0.03	<0.01	85.86	12.82		1.32		2.88	0.828
HT209 Feed	22.18	142.85	47.75	7.49	0.08	44.68	<0.1	104.95	1.238
HT209 - MOx	1.05	46.82	79.04	11.32	0.08	9.47	<0.1	3.07	0.892
HT209 - HOx	1.23	49.54	78.75	9.68	0.13	11.33	<0.1	17.74	0.962
R-HHO - MOx	0.03	8.31	85.14	12.68	<0.05	2.15	<0.1	2.68	0.838
R-HHO - HOx	0.08	8.55	85.17	12.36	<0.05	2.29	<0.1	3.21	0.849

Note: The elemental analyses for the oil samples were normalized to 100%.

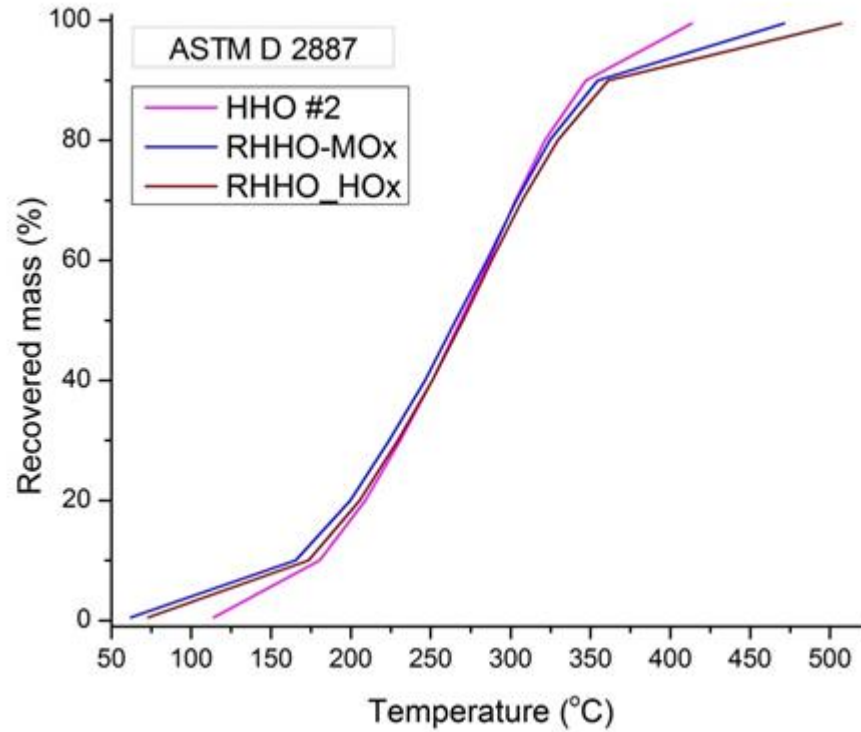
Additional information on upgraded fuels, data provided by PNNL

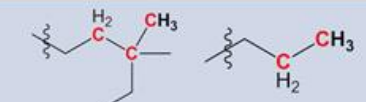
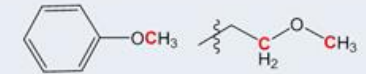
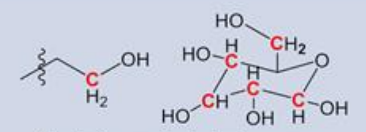
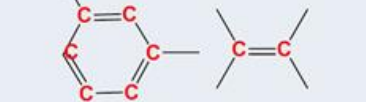
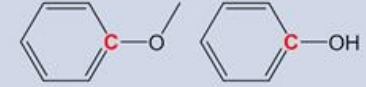
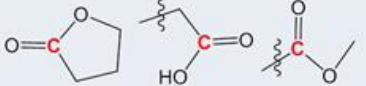

Additional information on upgraded fuels, NMR data provided by PNNL

Chemical Shift range (ppm)	Carbon assignment	Feed	MOx	HOx	HHO #2
0 – 53	 <p>Short, long, and branched aliphatics</p>	14.22	72.16	66.19	88.48
53 – 62	 <p>Ethers, methoxy groups</p>	3.25		1.01	
62 – 95	 <p>Alcohols, carbohydrate sugars</p>	27.46	0.33	3.31	
95 – 142	 <p>Aromatic, olefins</p>	22.54	18.17	19.04	11.01
142 - 170	 <p>phenolic</p>	15.3	3.43	4.04	0.51
170 – 190	 <p>Carboxylics, ethers, lactones</p>	8.56	1.96	2.98	
190 – 220	 <p>Ketones, aldehydes</p>	8.68	3.95	3.42	