



# **Eighteen-Month Final Evaluation of UPS Second Generation Diesel Hybrid-Electric Delivery Vans**

M. Lammert and K. Walkowicz  
*National Renewable Energy Laboratory*

**NREL is a national laboratory of the U.S. Department of Energy, Office of Energy Efficiency & Renewable Energy, operated by the Alliance for Sustainable Energy, LLC.**

**Technical Report**  
NREL/TP-5400-55658  
September 2012

Contract No. DE-AC36-08GO28308

# **Eighteen-Month Final Evaluation of UPS Second Generation Diesel Hybrid-Electric Delivery Vans**

M. Lammert and K. Walkowicz  
*National Renewable Energy Laboratory*

Prepared under Task No. FC08.3000

**NREL is a national laboratory of the U.S. Department of Energy, Office of Energy  
Efficiency & Renewable Energy, operated by the Alliance for Sustainable Energy, LLC.**

## NOTICE

This report was prepared as an account of work sponsored by an agency of the United States government. Neither the United States government nor any agency thereof, nor any of their employees, makes any warranty, express or implied, or assumes any legal liability or responsibility for the accuracy, completeness, or usefulness of any information, apparatus, product, or process disclosed, or represents that its use would not infringe privately owned rights. Reference herein to any specific commercial product, process, or service by trade name, trademark, manufacturer, or otherwise does not necessarily constitute or imply its endorsement, recommendation, or favoring by the United States government or any agency thereof. The views and opinions of authors expressed herein do not necessarily state or reflect those of the United States government or any agency thereof.

Available electronically at <http://www.osti.gov/bridge>

Available for a processing fee to U.S. Department of Energy and its contractors, in paper, from:

U.S. Department of Energy  
Office of Scientific and Technical Information  
P.O. Box 62  
Oak Ridge, TN 37831-0062  
phone: 865.576.8401  
fax: 865.576.5728  
email: <mailto:reports@adonis.osti.gov>

Available for sale to the public, in paper, from:

U.S. Department of Commerce  
National Technical Information Service  
5285 Port Royal Road  
Springfield, VA 22161  
phone: 800.553.6847  
fax: 703.605.6900  
email: [orders@ntis.fedworld.gov](mailto:orders@ntis.fedworld.gov)  
online ordering: <http://www.ntis.gov/help/ordermethods.aspx>

Cover Photos: (left to right) PIX 16416, PIX 17423, PIX 16560, PIX 17613, PIX 17436, PIX 17721



Printed on paper containing at least 50% wastepaper, including 10% post consumer waste.

## **Acknowledgments**

This evaluation is funded through the Advanced Vehicle Testing Activity, which is managed by Lee Slezak within the U.S. Department of Energy (DOE) Office of Energy Efficiency and Renewable Energy. All publications regarding the United Parcel Service (UPS) hybrid delivery van evaluation will be posted on DOE's Energy Efficiency and Renewable Energy Web site. See the Medium- and Heavy-Duty Vehicles section at the following link:  
<http://www1.eere.energy.gov/vehiclesandfuels/avta/index.html>.

This evaluation, conducted at UPS, would not have been possible without the support and cooperation of many people. The authors wish to thank each of the following:

### **U.S. Department of Energy**

Lee Slezak

### **UPS**

Mike Britt  
James C. Francis  
Andy Grzelak  
Robert K. Hall  
Bill Brentar

### **Eaton Corporation**

Alex Stucky

## List of Acronyms and Abbreviations

AVTA	Advanced Vehicle Testing Activity
CANBUS	controller area network bus
CARB	California Air Resources Board
cfm	cubic feet per minute
CFR	Code of Federal Regulations
CO	carbon monoxide
CO <sub>2</sub>	carbon dioxide
CR	Conventional Route
DOE	U.S. Department of Energy
DPF	diesel particulate filter
FT&E	Fleet Test and Evaluation (NREL team)
GPS	global positioning system
HC	hydrocarbon
HHDDT	Heavy Heavy-Duty Diesel Truck (duty cycle)
hp	horsepower
HTUF4	Hybrid Truck Utility Forum Class 4 (duty cycle)
KI	kinetic intensity
kW	kilowatt
mpg	miles per gallon
mph	miles per hour
MY	model year
NO <sub>x</sub>	oxides of nitrogen
NREL	National Renewable Energy Laboratory
NYC Comp	New York City Composite (duty cycle)
PM	particulate matter
ReFUEL	Renewable Fuels and Lubricants (Laboratory)
THC	total hydrocarbons
UPS	United Parcel Service
VDC	voltage direct current

## **Executive Summary**

This 18-month final evaluation is part of a series of evaluations by the U.S. Department of Energy (DOE). Using an established and documented evaluation protocol, DOE—through the National Renewable Energy Laboratory (NREL)—has been tracking and evaluating new propulsion systems in transit buses and trucks for more than 10 years. The DOE/NREL vehicle evaluations are a part of the Advanced Vehicle Testing Activity (AVTA), which supports DOE’s Vehicle Technologies Program.

The role of AVTA is to bridge the gap between research and development and the commercial availability of advanced vehicle technologies that reduce petroleum use in the United States and improve air quality. The main objective of AVTA projects is to provide comprehensive, unbiased evaluations of advanced vehicle technologies in commercial use. Data are collected and analyzed for operation, maintenance, performance, costs, and emissions characteristics of both advanced-technology fleets and comparable conventional-technology fleets that are operating at the same site. AVTA evaluations enable fleet owners and operators to make informed vehicle-purchasing decisions.

This report focuses on a parallel hybrid-electric diesel delivery van propulsion system currently being operated by United Parcel Service (UPS). The propulsion system is an alternative to the standard diesel system and could enable reductions in emissions as well as reductions in petroleum use.

### **Evaluation Design**

This 18-month evaluation used eleven P100H hybrid vans and eleven P100D conventional vans that are located at a UPS facility in the Minneapolis, Minnesota, area. On-vehicle data logging, fueling, and maintenance records are used to evaluate the performance of these hybrid step delivery vans in-use. The two study groups switched route assignments during the study to provide a more balanced review of the vehicles on the same routes.

In addition, a P100H hybrid and a P100D conventional were tested at NREL’s Renewable Fuels and Lubricants (ReFUEL) research laboratory. Testing was performed over three standard drive cycles to evaluate the fuel economy and emissions benefits gained through hybridization.

### **Evaluation Results**

The results and related discussions included here focus only on the selected facilities, the two P100 study groups, and the two P100 vehicles tested at the ReFUEL laboratory.

### **Van Use and Duty Cycle**

Route and drive cycle analysis showed that the study groups were on different duty cycles and would require a route switch between the study groups to provide a valid comparison, which UPS accommodated. The hybrid group accumulated 33% fewer miles than the conventional group during the complete 18-month study. The hybrid group accumulated miles at a slower rate than the conventional group during the 13 months of

the original route assignments, indicating more “urban” route assignments with a short highway leg to the delivery area, but then accumulated miles at a faster rate than the conventional group for the 5 months after the route switch when they were assigned the original conventional routes.

### **In-Use Fuel Economy**

Fuel economy was evaluated during equal 5-month periods from different years. During the second period, the route assignments originally assigned to the conventional and hybrid van groups were swapped so that the conventional vehicles were assigned to the original hybrid van routes and vice versa.

- Analysis of initial conventional route assignments (lower kinetic intensity): Fuel economy of the hybrid group on the original conventional route assignments over 5 months was 10.4 mpg, 13% greater than the 9.2 mpg of the conventional group on those routes a year earlier.
- Analysis of initial hybrid route assignments (higher kinetic intensity): Fuel economy of the hybrid group on the original hybrid route assignments over 5 months was 9.4 mpg, 20% greater than the 7.9 mpg of the conventional group on those routes a year later.

The difference in hybrid advantage in fuel economy is as expected. The hybrids demonstrated a greater advantage on the initial hybrid route assignments, which were more “urban” (low speed, high stops-per-mile routes) and lower advantage on initial conventional route assignments with a longer highway leg and less dense delivery zones.

### **Maintenance Costs**

There was no statistically significant difference in total maintenance cost per mile (P value = 0.1128).

Propulsion-related maintenance cost per mile was 77% higher for the hybrids (P value = 0.0278). However, this was only 52% more when considered on a cost per delivery day basis.

### **Fuel Costs**

Hybrid fuel costs per mile were 11% less than for the conventional vans when a fuel price of \$3.58/gallon (the average cost of diesel during the study) is used.

### **Operating Costs**

Hybrid vehicle total cost of operation per mile (assuming \$3.58/gal) was 3% more than the cost of operation for the diesel group (\$0.59 vs. \$0.57 per mile), but not found to be statistically significant (P value = 0.9677).

### **Reliability**

The hybrid group had a cumulative uptime of 92.5% compared to the conventional group uptime of 99.7%.

## **Laboratory Testing**

Laboratory dynamometer testing demonstrated 13%–36% hybrid fuel economy improvement, depending on duty cycle, and up to a 45% improvement in ton-mi/gal.

Laboratory testing demonstrated an increase in emissions of oxides of nitrogen of 21% to 49% for the hybrid.



# Table of Contents

<b>Executive Summary</b> .....	<b>v</b>
Evaluation Design .....	v
Evaluation Results .....	v
<b>Overview</b> .....	<b>1</b>
Advanced Vehicle Testing Activity .....	1
Project Design and Data Collection .....	2
Host Site Profile—UPS, Minneapolis, Minnesota .....	6
<b>Evaluation Results</b> .....	<b>6</b>
Van Use .....	6
Van Duty Cycle .....	8
Fuel Economy .....	12
Similar Route Fuel Economy Analysis .....	13
18-Month Fuel Economy .....	14
Maintenance Cost Analysis .....	15
Maintenance Costs .....	16
Total Cost per Mile .....	21
Reliability .....	21
Batteries .....	22
<b>Laboratory Fuel Economy and Emissions Testing</b> .....	<b>22</b>
Test Cycle Selection .....	22
Test Plan .....	26
Vehicle Specifications .....	26
Laboratory Test Results .....	27
Comparison of Laboratory Results to In-Use Results .....	29
Status of UPS Hybrid Fleet .....	30
<b>Conclusions</b> .....	<b>31</b>
<b>Contacts</b> .....	<b>32</b>
<b>Appendix: Laboratory Description and Test Methods</b> .....	<b>33</b>
General Lab Description .....	33
Chassis Dynamometer .....	33
Fuel Storage and Blending .....	34
Fuel Metering and Conditioning .....	35
Air Handling and Conditioning .....	35
Emissions Measurement .....	35

## List of Figures

Figure 1. UPS hybrid van .....	2
Figure 2. Eaton hybrid system schematic .....	3
Figure 3. Eaton hybrid system components.....	4
Figure 4. Eaton hybrid system components on UPS undercarriage.....	5
Figure 5. Hybrid and conventional monthly mileage per van .....	7
Figure 6. Hybrid and conventional cumulative mileage per group .....	7
Figure 7. Hybrid and conventional route visualization.....	9
Figure 8. Hybrid and conventional duty cycle breakdown by miles %.....	10
Figure 9. Hybrid and conventional duty cycle breakdown by miles traveled .....	11
Figure 10. Route switch fuel economy analysis time periods .....	13
Figure 11. Total maintenance cost per mile.....	18
Figure 12. Propulsion maintenance cost per mile.....	19
Figure 13. Propulsion maintenance cost per mile (conventional vans) .....	20
Figure 14. Propulsion maintenance cost per mile (hybrids) .....	20
Figure 15. Cumulative uptime .....	22
Figure 16. Average driving speed and KI comparison .....	23
Figure 17. Stops per mile and KI comparison .....	24
Figure 18. NYC Comp trace .....	24
Figure 19. HTUF Class 4 trace .....	25
Figure 20. CARB HHDDT trace .....	25
Figure 21. Laboratory fuel economy .....	27
Figure 22. Laboratory ton-mi./gallon fuel economy.....	28
Figure 23. Laboratory NO <sub>x</sub> emissions .....	29
Figure 24. Laboratory and in-use fuel economy results .....	30

## List of Tables

Table 1. FT&E Heavy-Duty Vehicle Evaluations .....	1
Table 2. Hybrid Propulsion-Related Systems.....	3
Table 3. Vehicle System Descriptions.....	5
Table 4. Drive Cycle Statistics from Vans with GPS Loggers from Each Study Group (before any routing changes) .....	12
Table 5. Route Switch Fuel Economy (in-use records) of Hybrid and Conventional Vans on Two Route Sets.....	14
Table 6. Hybrid and Conventional Van Fuel Use and Economy.....	14
Table 7. Hybrid and Conventional Group Total and Propulsion Maintenance Costs .....	16
Table 8. Hybrid and Conventional Van Total Cost per Mile.....	17
Table 9. Hybrid and Conventional Van Propulsion Cost per Mile.....	17
Table 10. Hybrid and Conventional Van Total Cost per Mile.....	21
Table 11. Test Cycle Statistics and In-Field Average Comparison .....	26
Table 12. Test Vehicle Information .....	26
Table 13. Fuel Economy of Hybrid and Conventional Van on Various Cycles on Chassis Dynamometer.....	27

Table 14. Ton Fuel Economy of Hybrid and Conventional Van on Various Cycles on Chassis Dynamometer .....	28
Table 15. Average NO <sub>x</sub> Emission Results of Hybrid and Conventional Vans on Specified Cycles.....	28
Table 16. Average Values for Emission Results of Hybrid and Conventional Vans on Specified Cycles.....	29

## Overview

### Advanced Vehicle Testing Activity

The role of the U.S. Department of Energy's (DOE's) Advanced Vehicle Testing Activity (AVTA) is to help bridge the gap between research and development and commercial availability for advanced vehicle technologies that reduce petroleum use and meet air-quality standards. AVTA supports the DOE's Vehicle Technologies Program by examining market factors and customer requirements and evaluating the performance and durability of alternative-fuel and advanced-technology vehicles in fleet applications. The National Renewable Energy Laboratory's (NREL's) Fleet Test and Evaluation (FT&E) team conducts evaluations with support from AVTA.

The main objective of FT&E projects is to conduct comprehensive, unbiased evaluations of advanced-technology vehicles. Data collected and analyzed include the operations, maintenance, performance, cost, and emissions characteristics of advanced-technology vehicles and comparable conventional technology in fleets operating at the same site. The FT&E evaluations help fleet owners and operators make informed vehicle-purchasing decisions. The evaluations also provide valuable data to DOE about the maturity of the technology being assessed.

The FT&E team has been conducting several evaluations of advanced-propulsion heavy-duty vehicles (see Table 1). Information on these and other evaluations involving advanced technologies or alternative fuels, such as biodiesel and Fischer-Tropsch diesel, is available at [www.nrel.gov/vehiclesandfuels/fleetttest](http://www.nrel.gov/vehiclesandfuels/fleetttest).

**Table 1. FT&E Heavy-Duty Vehicle Evaluations**

Fleet	Location	Vehicle	Technology	Evaluation Status
Coca Cola Refreshments	Miami, FL	2010 Kenworth T-370 Tractors	Eaton Hybrid Electric Propulsion	Completed in August 2012
UPS	Phoenix, AZ	2007 Freightliner P70	Eaton Hybrid Electric Propulsion	Completed in March 2012
FedEx	Los Angeles, CA	Ford E-450 strip chassis	Gasoline hybrid electric parcel delivery trucks, Azure Dynamics	Completed in January 2011
UPS	Phoenix, AZ	P70 Delivery Van	Parallel hybrid, Eaton system	Completed in December 2009
Long Beach Transit	Long Beach, CA	New Flyer 40-ft low floor transit bus	Gasoline-electric series hybrid	Completed in June 2008
Metro	St. Louis, MO	Gillig 40-ft transit bus	Biodiesel blend (B20)	Completed in July 2008
New York City Transit	Manhattan, NY; Bronx, NY	Orion VII 40-ft transit bus	Series hybrid, BAE Systems HybriDrive propulsion system (diesel), order of 200 (Gen II); order of 125 (Gen I)	Completed in January 2008
New York City Transit	Manhattan, NY; Bronx, NY	Orion VII 40-ft transit bus	Series hybrid, BAE Systems HybriDrive propulsion system (diesel), order of 125; DDC S50G compressed natural gas engines	Completed in November 2006
Denver RTD	Boulder, CO	Gillig 40-ft transit bus	Biodiesel blend (B20)	Completed in October 2006
King County Metro	Seattle, WA	New Flyer 60-ft articulated transit bus	Parallel hybrid, GM–Allison EP 50 System (diesel)	Completed in December 2006
IndyGo	Indianapolis, IN	Ebus 22-ft bus	Series hybrid, Capstone MicroTurbine (diesel)	Completed in 2005
Knoxville Area Transit	Knoxville, TN	Ebus 22-ft bus	Series hybrid, Capstone MicroTurbine (propane)	Completed in 2005

## Project Design and Data Collection

This report discusses an 18-month in-use evaluation of 11 model year (MY) 2010 Freightliner P100H hybrid step delivery vans (Figure 1) that were placed in service at United Parcel Service's (UPS's) facility in Minneapolis, Minnesota, during the first half of 2010. These new hybrids are an evolution from UPS's original 50 Eaton hybrids that NREL documented in 12-month and 36-month studies.<sup>1</sup> The new hybrids have more advanced control algorithms and an integrated "engine off at idle" feature that automatically stops and restarts the engine at stoplights and other short stops when certain conditions are met. These hybrid vehicles are evaluated against 11 MY 2010 Freightliner P100D conventional step delivery vans that were placed in service at the same facility a couple months after the hybrids. The conventional vans were chosen using UPS's database and comparing the average miles per day of the 11 hybrids to that of conventional vans that had the same size and cargo capability. Even so, the route profiles are very different, requiring a route assignment switch between the groups to be evaluated in this report. All fueling and maintenance data were collected by UPS from its databases and were shared with NREL for this evaluation.



Figure 1. UPS hybrid van.<sup>2</sup>

<sup>1</sup> See [http://www.nrel.gov/vehiclesandfuels/fleetttest/research\\_hybrid\\_ups.html](http://www.nrel.gov/vehiclesandfuels/fleetttest/research_hybrid_ups.html).

<sup>2</sup> This image is reproduced with permission of United Parcel Service of America, Inc. © 2011 United Parcel Service of America, Inc. All rights reserved. Photo from UPS, NREL/PIX 19821.

Table 2 presents additional details on Eaton Corporation’s parallel hybrid system, and Figure 2 provides a schematic of the system.

**Table 2. Hybrid Propulsion-Related Systems**

Category	Hybrid Van Description
Manufacturer/integrator	Eaton Corporation
Transmission	Fuller medium-duty automated manual 6-speed Prototype
Motor	Synchronous brushless, permanent magnet Continuous power, 26 kW Peak power, 44 kW
Energy storage	Lithium ion batteries 340 VDC 1.8 kWh total storage

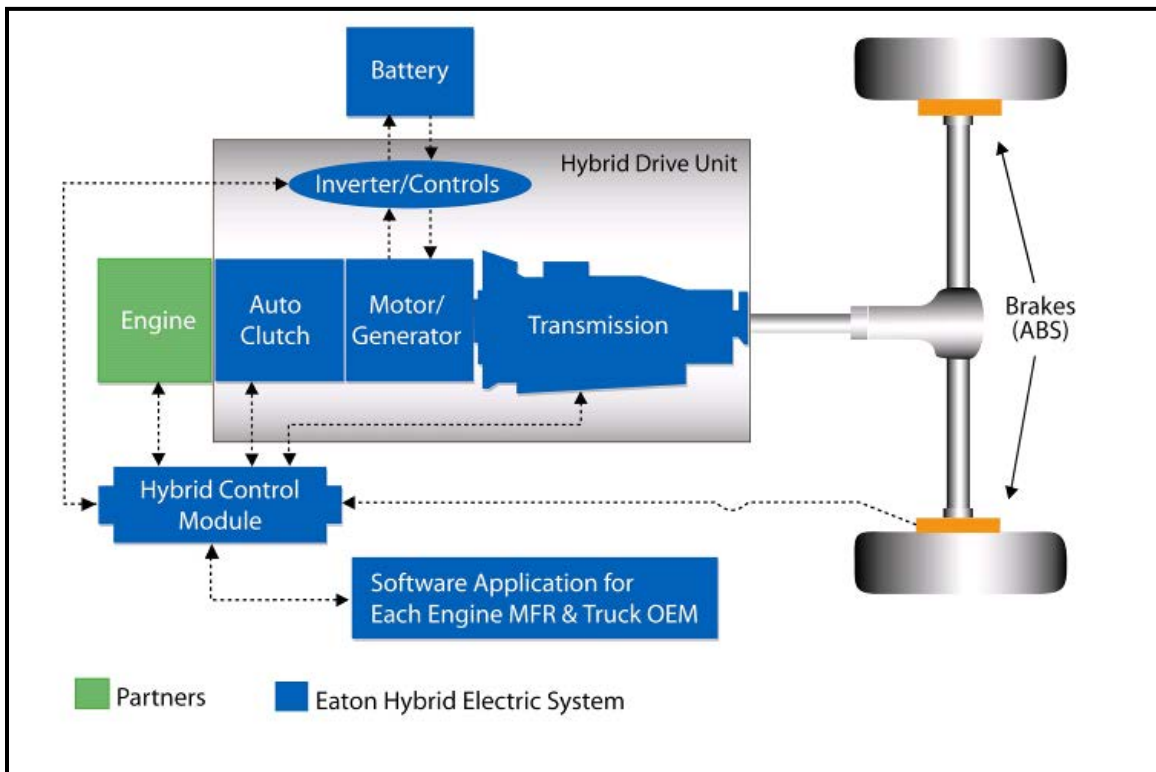

**Figure 2. Eaton hybrid system schematic**

Figure 3 shows the primary hybrid components in the Eaton system.

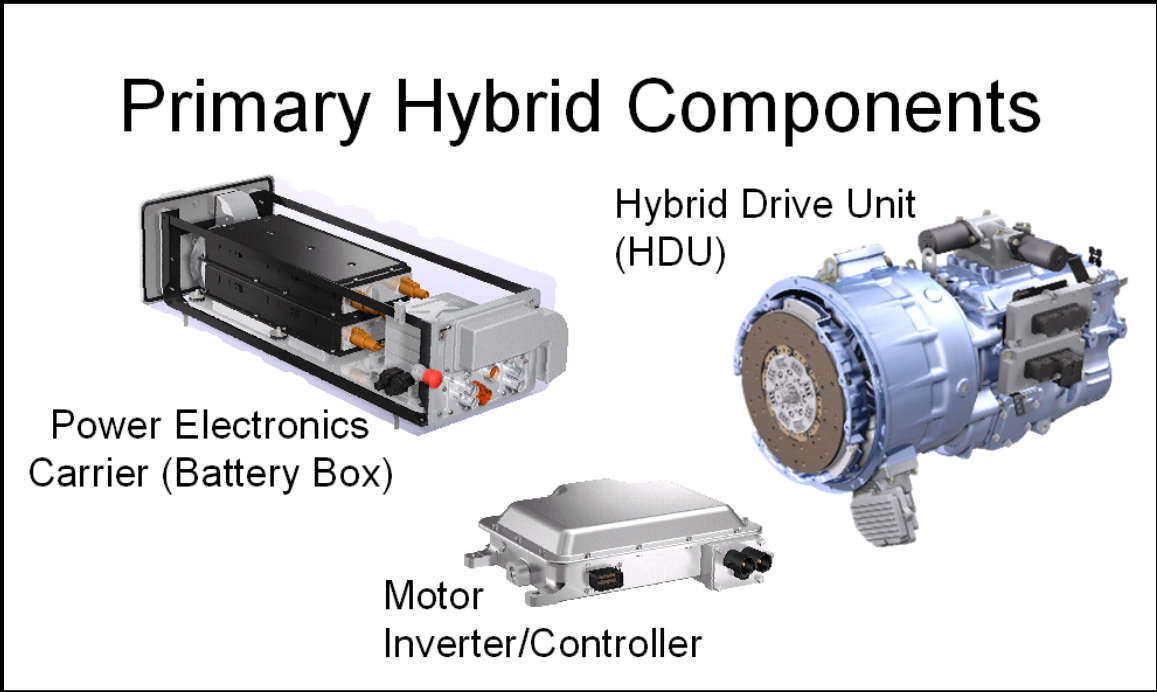
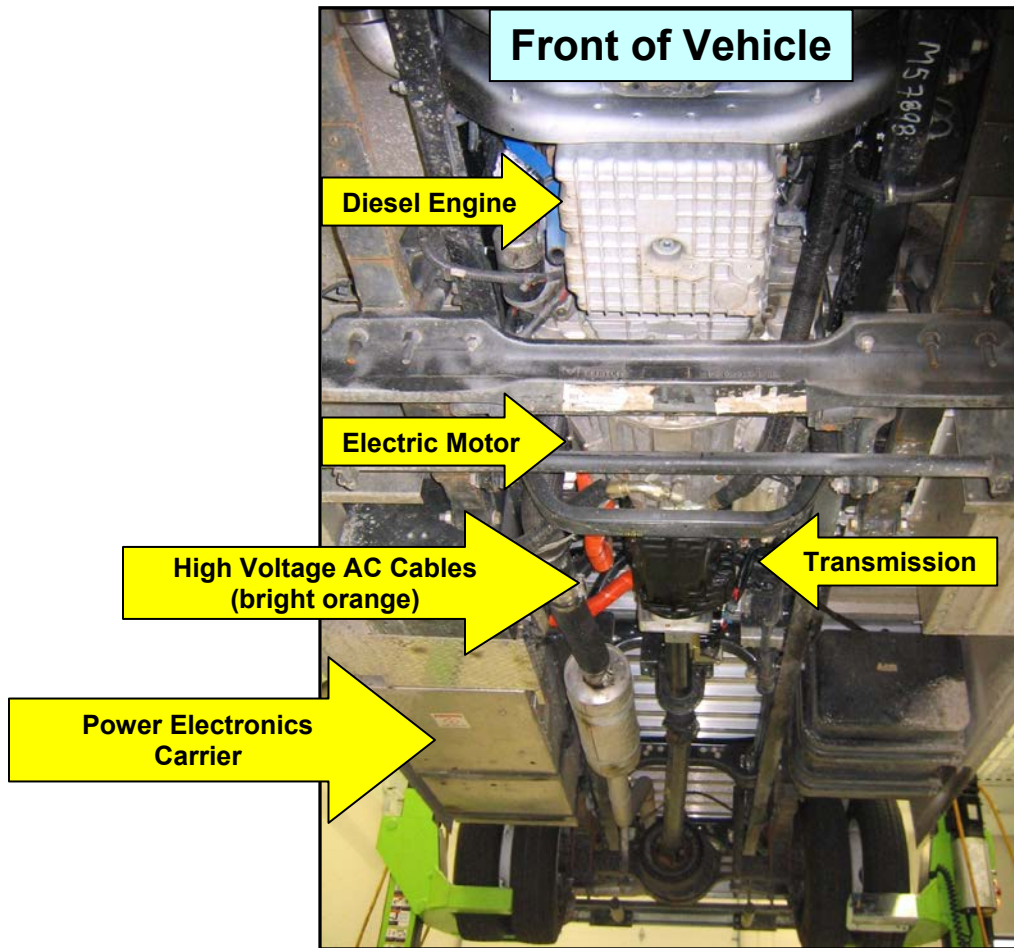

Figure 3. Eaton hybrid system components

Figure 4 shows the primary hybrid components arranged in the undercarriage of a UPS delivery van.



**Figure 4. Eaton hybrid system components on UPS undercarriage**

UPS has custom delivery vans built to the company’s specifications. The P100 vehicles in this study are manufactured by Freightliner for UPS. Table 3 provides brief descriptions of the vehicle systems.

**Table 3. Vehicle System Descriptions**

Van Specification	Hybrid Electric Vans	Conventional Vans
Van manufacturer	Freightliner Corp.	Freightliner Corp.
Van model	P100H step van	P100D step van
Van model year	2010	2010
Engine manufacturer and model	Cummins ISB 200 HP MY 2009	Cummins ISB 200 HP MY 2009
Emissions equipment	DPF	DPF
Retarder/regenerative braking	Regenerative braking	None
Air conditioning type	None	None
Gross vehicle weight rating	23,000 lbs	23,000 lbs

DPF = diesel particle filter



## **Host Site Profile—UPS, Minneapolis, Minnesota**

The host site consists of one large distribution facility in Minneapolis. Eleven hybrid vans and 11 conventional vans were used for this evaluation. It was not necessary to modify the Minneapolis facility in any way to implement the hybrid vehicles into the fleet. Drivers were given training on the operation of the hybrids, but no restrictions or special accommodations were made for their use; however, UPS did assign the hybrid vans to urban routes rather than rural routes to make the best use of the hybrid drive train. Dispatch and maintenance practices are the same for both vehicle study groups. The Minneapolis facility has on-site fueling, and the vehicles are fueled by drivers as needed, using an internal fuel card system. The drivers then log their fueling events on their electronic tablets, and the records are uploaded to a central database. Failure on the part of the driver to log fueling events led to some months from each study group being left out of fuel economy calculations due to inaccurate fueling data.

## **Evaluation Results**

### **Van Use**

Figure 5 shows the average monthly miles driven per van for each van group with  $\pm 95\%$  confidence interval lines. The width of the 95% confidence interval gives some idea about how uncertain we are about the average based on the variation observed in the data. Hybrid vans were placed in service at the end of March 2010. Conventional vans were placed in service from March through June 2010. As such, July 2010 is the “clean point” in the data when all study vehicles are assumed to be operating in a normal fashion. Monthly usage did not change significantly after the clean point until June 2011; the hybrids consistently were driven roughly half as many miles throughout this period because of the shorter, denser urban routes they were purposely assigned to. In June 2011, a route switch was initiated to balance the evaluation and provide data for both vehicle groups on both route types. Vehicles from each group were assigned routes previously assigned to the other group; the drivers kept their original route assignments but with a new vehicle. The area in orange denotes when the route switch took place between the groups, causing the mileage change from June into August 2011. Note that not only did the average miles per van swap, but also the width of the 95% confidence interval lines swapped as well. The original diesel group routes had a wide range of daily miles driven while the hybrids were on routes with more tightly grouped daily miles.

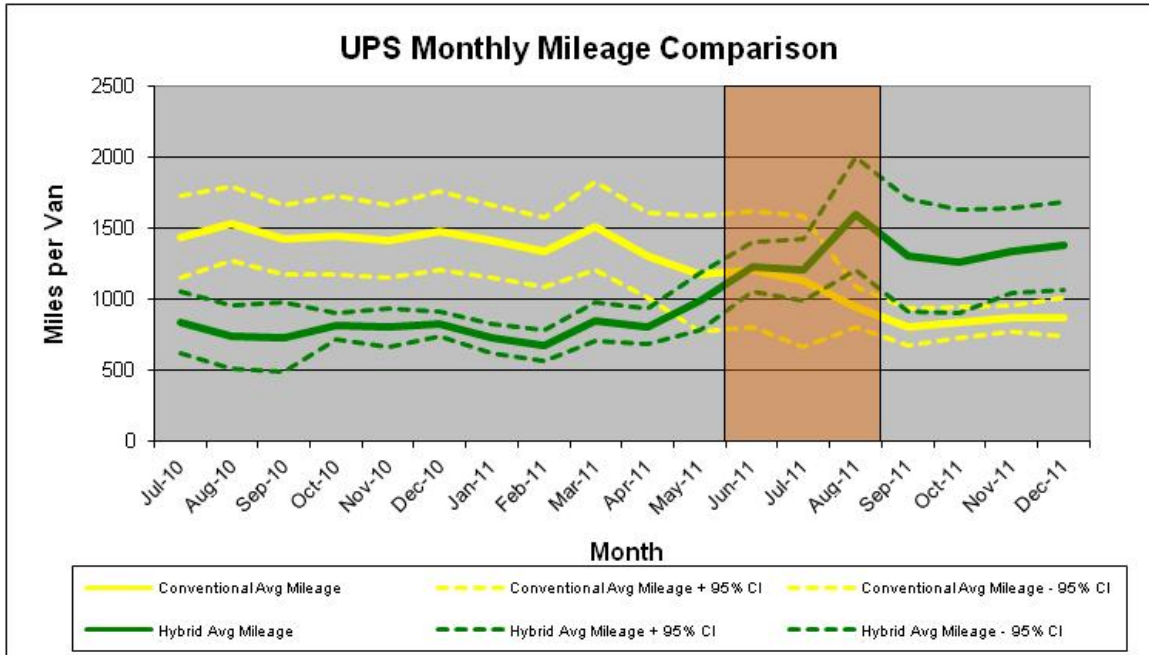

**Figure 5. Hybrid and conventional monthly mileage per van**

Figure 6 shows the cumulative monthly miles driven by each van study group. The area in orange denotes when the route switch took place between the groups. Evidenced here again is the much slower mileage accumulation of the hybrids until the route switch time frame. At that point, the hybrid group began accruing miles faster than the conventional van group.

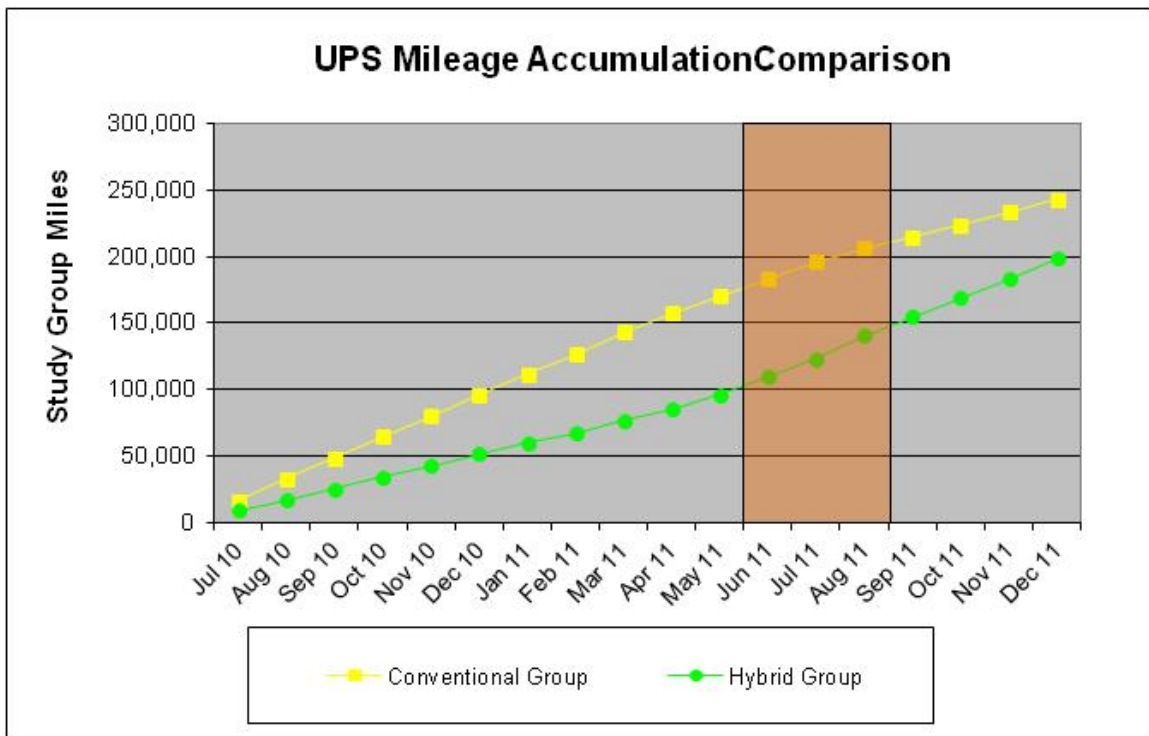

**Figure 6. Hybrid and conventional cumulative mileage per group**

## Van Duty Cycle

Isaac Instruments DRU900/908 data logging devices (Isaacs) with global positioning system (GPS) antennas and J1939 controller area network bus (CANBUS) connections were deployed to the UPS fleet on two occasions. The first period covered was from July 14, 2010, to July 29, 2010, and the second was from April 12, 2011, to June 21, 2011. During the first period, only three Isaacs were available, and on the second occasion seven vans from each group were instrumented with the devices for most of the duration (including one that had been instrumented during the previous period). In total, 338 days of hybrid operation and 252 days of conventional operation on eight vans from each group were documented. The GPS and J1939 channels were recording at a 5-Hz rate. Twenty-three J1939 CANBUS channels were recorded, including wheel-based vehicle speed, engine speed, and engine fuel rate. The data presented here are not representative of the entire UPS fleet or even of the entire depot, but only of the P100 study vehicles. Figure 7 shows a GPS visualization of some typical routes of thirteen logged vans. The exact routes vary daily, but the depictions shown are typical of a day of operation for that van as captured by the GPS loggers and show the operation of the hybrids being near the depot with less “stem” time while the conventional vehicles include more “stem” time prior to arriving at the delivery area.

Comparing the routes driven by the two groups is difficult because of the disparity in the average daily miles driven. Initially, the conventional vans averaged 64 miles a day while the hybrids averaged only 43 miles a day. Figure 8 shows the average distance (as a percentage) that vans with GPS loggers drove at different vehicle speeds. The hybrids drove a greater percentage of their distance at slower speeds than the conventional vans did, and the conventional vans drove more of their miles operating at higher speeds.

- The hybrid vans drove 44% of their miles below 20 mph, while the conventional vans drove only 30.5% of their miles at those slow speeds.
- The van groups drove a similar percentage of their miles at the intermediate speeds of 20–50 mph: 47% for conventional and 43% for hybrids.
- The hybrid vans drove only 13% of their miles above 50 mph, while the conventional vans drove 22% of their miles at those highway speeds.

The greater percent of miles driven by the hybrids at slower speeds is an indication of a more urban duty cycle. The lower percentage of miles driven at highway speeds is an indication of routes closer to the depot.

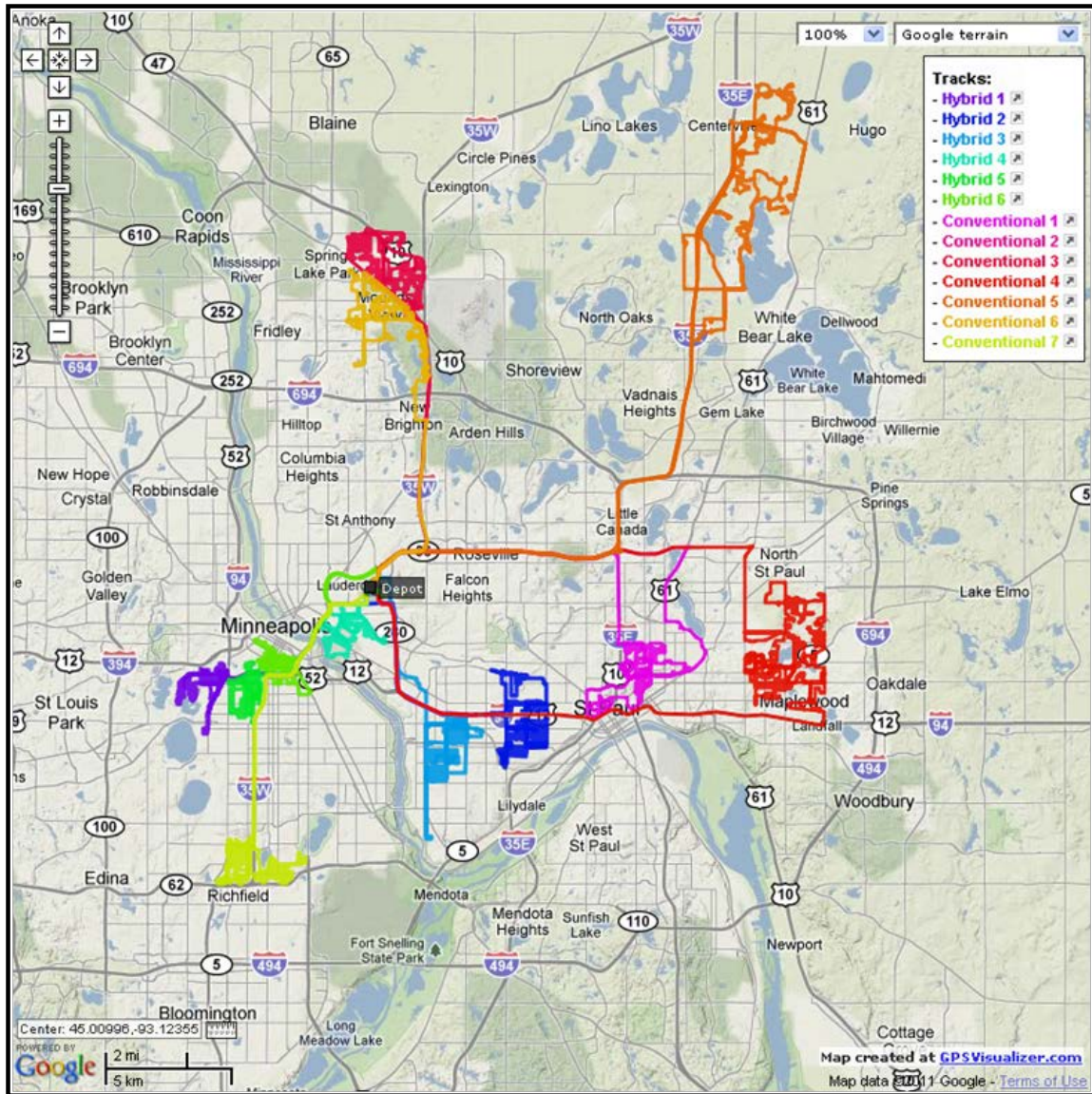
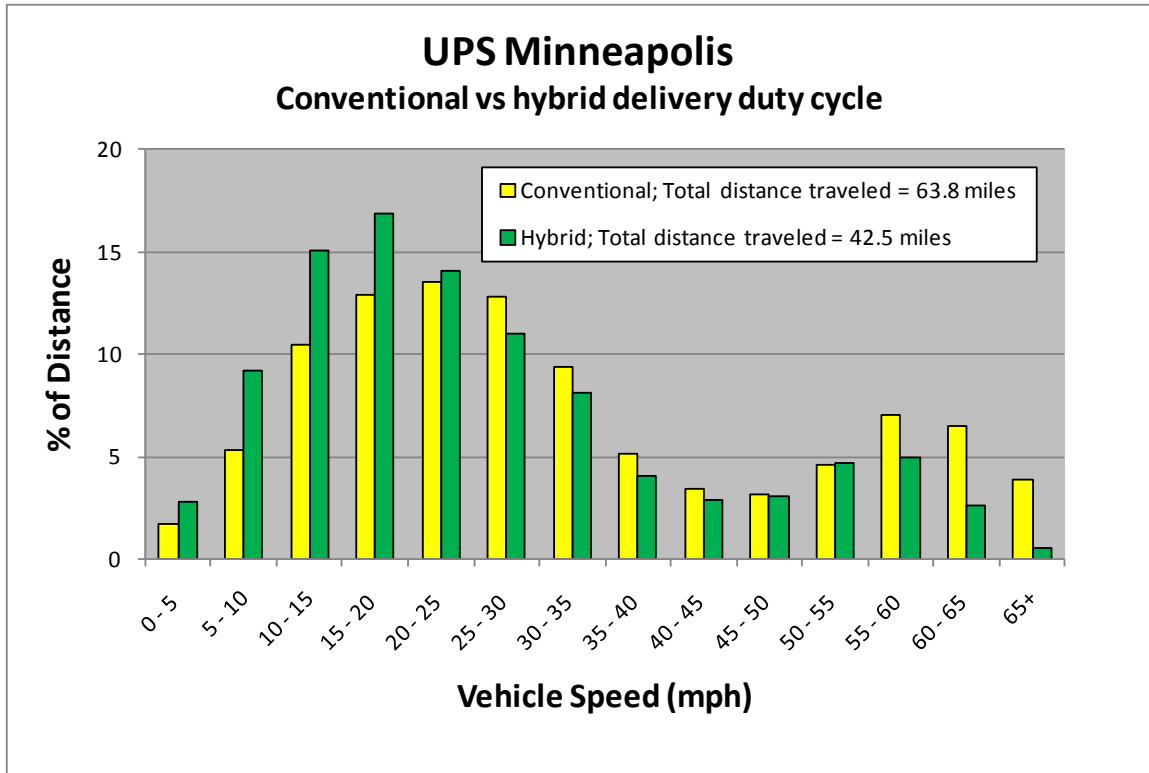

Figure 7. Hybrid and conventional route visualization



**Figure 8. Hybrid and conventional duty cycle breakdown by miles %**

Figure 9 shows the average distance (in miles) that vans with GPS loggers drove at different vehicle speeds. This distance based chart highlights a different breakdown of the routes.

- The conventional vans drove more miles at all speeds above 10 mph.
- The hybrid and conventional vans both drove 17 miles in the 0–20 mph range.
- The hybrid vans drove 37% fewer miles in the 20–50 mph range: 19 vs. 30. This indicates the conventional vans had longer surface street drives between delivery stops.
- The hybrid vans drove 62% fewer miles in the 50+ mph highway range: 6 vs. 15. This indicates the conventional vans had longer highway legs to get to their assigned delivery areas.

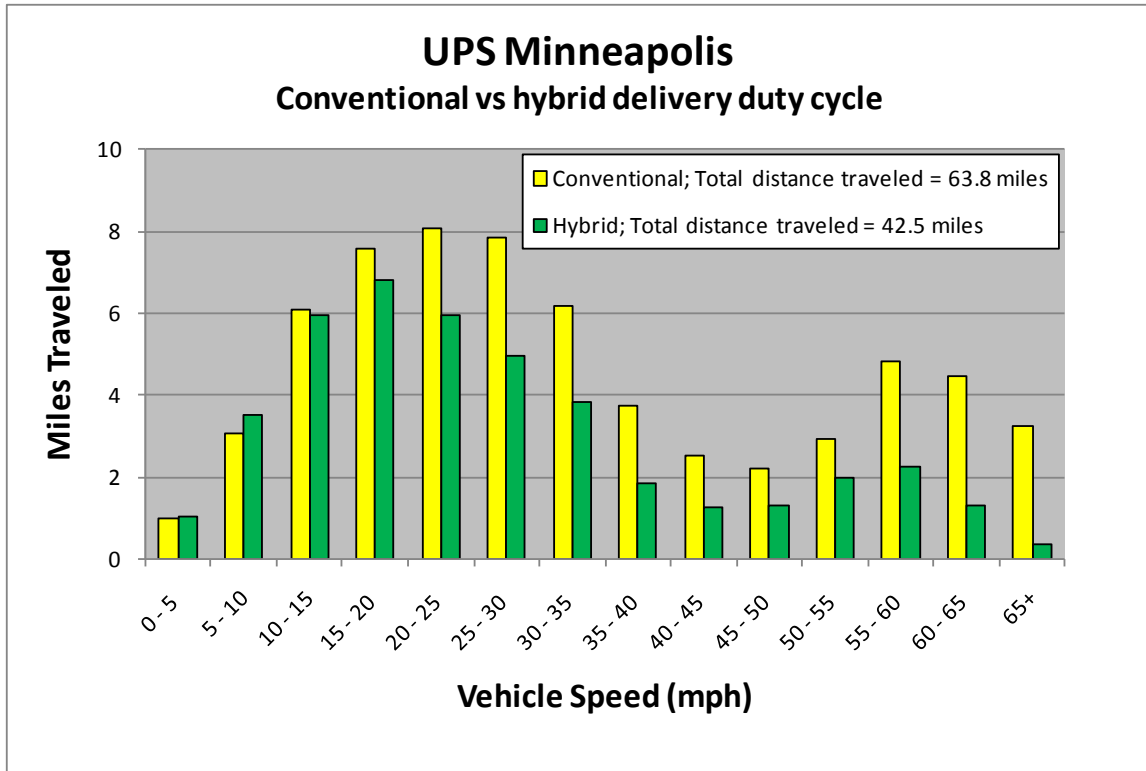

**Figure 9. Hybrid and conventional duty cycle breakdown by miles traveled**

Table 4 presents other duty-cycle statistics gathered from the GPS data logging.

- The hybrid vans’ average driving speed of 16.5 mph was 21% lower than the conventional vans’ 20.7 mph.
- The hybrid vans averaged roughly the same number of stops per day as the conventional vans’ (205 for the hybrid vans vs. 220 for the conventional vans).
- The hybrid vans had 5.3 stops per mile, 37% more than the conventional vans’ 3.9.
- The hybrid vans had 25.7 acceleration events per mile, 34% more than the conventional vans’ 19.2.

These statistics indicate that the hybrid vans were initially operating on very different route types (urban vs. rural) than the conventional vans. Because of these major differences, the study groups switched route assignments in June/July 2011. As of August 2011 the hybrid vans had assumed the drive characteristics of the conventional group and the conventional vans had assumed the drive characteristics of the hybrid group. The hybrid fuel economy advantage discussed below will be compared while the groups were on the same routes rather than during the same time periods. Thus, we will gain an understanding of hybrid advantage on two very different route sets, one more densely urban and one with more of a highway leg and extended surface street driving between stops.

**Table 4. Drive Cycle Statistics from Vans with GPS Loggers from Each Study Group (before any routing changes)**

<b>Cycle Statistics</b>	<b>Conventional Average</b>	<b>Hybrid Average</b>	<b>Difference (Conventional - Hybrid)</b>	<b>% Difference</b>
Distance traveled (miles)	63.8	42.5	21.3	-33%
Average speed over cycle (mph)	11.8	8.3	3.5	-30%
Average driving speed (mph)	20.7	16.5	4.3	-21%
Maximum speed (mph)	66.2	60.5	5.7	-9%
Time at zero speed (s)	8,670.0	9,059.6	---	---
Acceleration (% of total cycle)	29.5	26.6	2.9	-10%
Deceleration (% of total cycle)	27.6	23.9	3.7	-13%
Average acceleration (ft/s <sup>2</sup> )	2.2	1.9	0.3	-14%
Average deceleration (ft/s <sup>2</sup> )	-2.3	-2.1	-0.2	-8%
Number of acceleration events	1,157.5	1,015.9	141.7	-12%
Number of acceleration events per mile	19.2	25.7	-6.5	34%
Number of deceleration events	1,157.5	1,015.9	141.7	-12%
Number of deceleration events per mile	19.2	25.7	-6.5	34%
Number of stops	219.9	205.1	14.8	-7%
Number of stops per mile	3.9	5.3	-1.4	37%

## **Fuel Economy**

UPS fuels its hybrid and conventional vans with standard ultra-low-sulfur diesel. Because of the very different route assignments for the hybrid and conventional van groups, a route switch was necessary to evaluate the in-use performance fairly. As such fuel economy is considered for the entire 18-month study period as well as comparing both groups on the same routes during different time periods. One hybrid van clearly was missing many fueling events, including 5 months with no fueling events recorded, while still reporting normal mileage accumulation. After the route switch, a conventional van now assigned to that route showed the same behavior. Most fuel economy months from that route were removed from this report, but the affected vans are still fully considered in the maintenance analysis and reliability sections. Chauvenet's Criterion was used to identify van monthly MPG results that were statistical outliers. This method removed 22 vehicle-months from the conventional van group and 48 vehicle-months from the hybrid van group that were statistically not possible to occur for that particular vehicle based on that vehicle's performance during each of the two route assignment periods. A 95% confidence interval outlier analysis removed an additional 4 vehicle-months from the conventional group that had a very low likelihood of occurring. Most of the removed data points were obviously impossible for the vehicles to attain, but by using a consistent statistical approach the grey areas for each vehicle were treated in the same manner. In total, 74 vehicle-months were removed from the original data set of 396 vehicle-months.

## Similar Route Fuel Economy Analysis

UPS implemented a complete route switch of each of the 11 study vans in both groups from June 2011 through early August 2011. Fuel economy was analyzed for each route over similar calendar year time periods (August 1 through December 31 of both 2011 and 2012). Limiting the comparison to these months reduces the affect of seasonal variations both in weather and load. This five-month snapshot compares the conventional vans on their original route assignments [Conventional Route (CR) 1 period] to the hybrid vans on those routes a year later and the hybrid vans on their original route assignments to the conventional vans on those routes a year later (Conventional Route 2 period). Drivers stayed with their known routes and were assigned a new vehicle. Drivers receiving the hybrids had to receive training on their operation before the switches could be implemented. Figure 10 illustrated the route assignment time periods being compared.

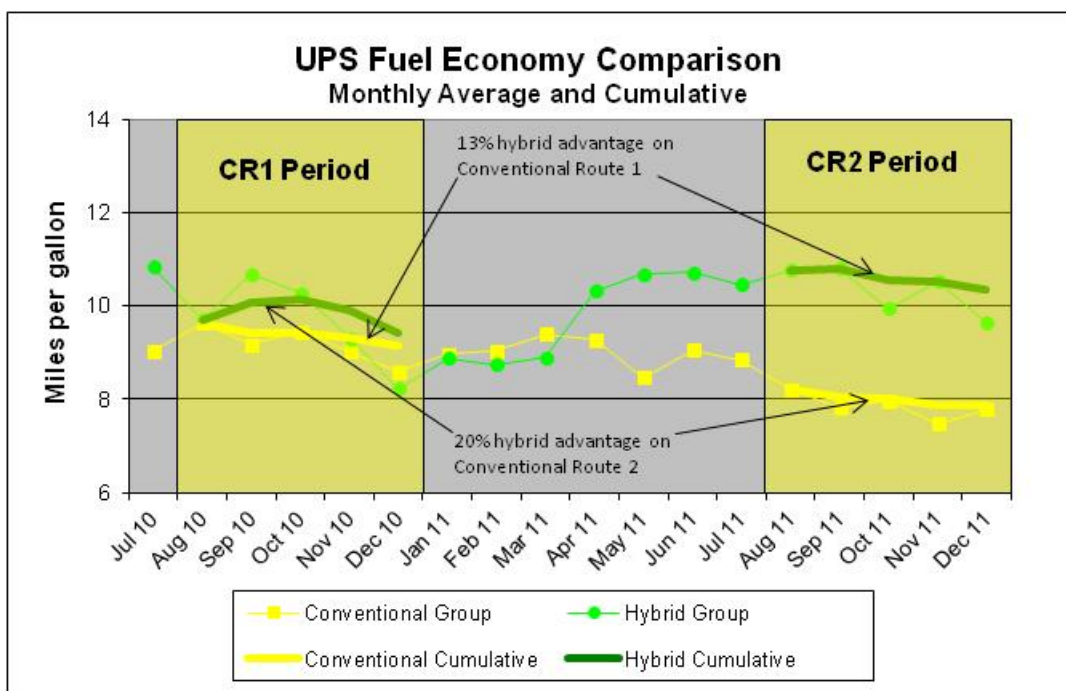

Figure 10. Route switch fuel economy analysis time periods

## Route Effect on Fuel Economy

Both study groups had lower mpg on Conventional Route 2 than on Conventional Route 1: 14% lower for the conventional vans and 9% lower for the hybrid vans, which validates the statistical duty cycle analysis indicating that the conventional group was on a less demanding duty cycle while the hybrids were on a more demanding one. Both groups accumulated about half as many miles on Conventional Route 2 as on Conventional Route 1, showing that the route switch was implemented effectively and the groups assumed each other's drive characteristics after the swap. Table 5 shows the group fuel economy comparison for the route switch. Also of note is that the hybrid advantage was 13% on the less kinetically intense, more highway-biased route assignments (Conventional Route 1), matching well with the laboratory results on the Heavy Heavy-Duty Diesel Truck (HHDDT) cycle presented later in this report, while they achieved a 20% hybrid advantage on the more kinetically intense Conventional Route 2 assignments



(although the second route comparison was not quite statistically significant because removing fueling months eliminated some vans, which reduced the sample set).

**Table 5. Route Switch Fuel Economy (in-use records) of Hybrid and Conventional Vans on Two Route Sets**

	<b>Conventional Route 1</b>	<b>Conventional Route 2</b>	<b>Effect of Higher KI Route Assignment</b>
<b>Conventional</b>	Aug thru Dec 2010	Aug thru Dec 2011	
Mileage	75,404	37,901	-50%
Fuel	8,233	4,822	-41%
Group MPG	<b>9.2</b>	<b>7.9</b>	<b>-14%</b>
MPG Vehicle Months	51	44	
<b>Hybrid Group</b>	Aug thru Dec 2011	Aug thru Dec 2010	
Mileage	62,991	32,149	-49%
Fuel	6,086	3,417	-44%
Group MPG	<b>10.4</b>	<b>9.4</b>	<b>-9%</b>
MPG Vehicle Months	46	39	
<b>Hybrid Advantage</b>	<b>13%</b>	<b>20%</b>	
<i>t</i> -test P value (cumulative mpg of individual vans in the group)	0.0015	0.1468	

KI = kinetic intensity

### 18-Month Fuel Economy

Because the original route assignments were so different as to necessitate a route switch to fairly compare the fuel economy performance of the groups, the overall average fuel economy of the groups over the total 18 months is of little analytical value. However, those statistics are included here for completeness even though no conclusions of relative performance can be drawn. Table 6 shows the fuel consumption and economy data for each van in each study group. The hybrid vans consumed 14,615 gallons of fuel over 145,568 miles for the 18-month period, resulting in an average fuel economy for the hybrid vans of 10.0 mpg. The conventional van group consumed 24,673 gallons of fuel over 218,225 miles for an average of 8.8 mpg.

**Table 6. Hybrid and Conventional Van Fuel Use and Economy**

Van	Hybrid Vehicles		Miles per Gallon
	Fuel Economy Miles	Fuel Economy Gallons	
144561	14,119	1,557	9.1
144564	17,067	1,570	10.9
144590	21,816	1,996	10.9
144594	5524	547	10.1
144595	11,986	1,166	10.3
144596	13,028	1,367	9.5
144597	11,193	1,292	8.7
144598	12,383	1,271	9.7
144712	14,843	1,547	9.6
144719	18,313	1,923	9.5

<b>Hybrid Vehicles</b>			
<b>Van</b>	<b>Fuel Economy Miles</b>	<b>Fuel Economy Gallons</b>	<b>Miles per Gallon</b>
144736	10,820	926	11.7
<b>Hybrid Total</b>	<b>145,568</b>	<b>14,615</b>	<b>10.0</b>
<b>Conventional Vehicles</b>			
<b>Van</b>	<b>Fuel Economy Miles</b>	<b>Fuel Economy Gallons</b>	<b>Miles per Gallon</b>
149765	19,684	2,235	8.8
149772	16,685	1,983	8.4
149777	16,994	2,167	7.8
149779	20,154	2,180	9.2
149780	17,159	1,843	9.3
149783	13,025	1,511	8.6
149784	12,580	1,461	8.6
149831	21,452	2,514	8.5
149832	22,811	2,536	9.0
149833	36,216	3,855	9.4
149871	21,465	2,388	9.0
<b>Conventional Total</b>	<b>218,225</b>	<b>24,673</b>	<b>8.8</b>

### **Maintenance Cost Analysis**

This evaluation focuses on van operations spanning 18 of the first 21 months of operation for the hybrid and conventional vans. This snapshot does not yield enough operating cost data to provide a complete understanding of the full life-cycle cost of the hybrid vans. Understanding costs requires an examination of the purchase cost of the vans plus warranty and operation costs as well as longer-term maintenance activities, such as engine rebuilds or replacements and battery replacements, which also must be considered. Finally, it is critical that areas in which cost savings can be achieved (e.g., in brake repair) be examined. The intent of this evaluation, however, is to capture accurate, known operations costs associated with the hybrid and conventional vehicles for the selected period. This analysis is not predictive of maintenance costs assumed by UPS beyond the warranty period. The exact components and warranty periods—as negotiated by UPS, Eaton, and Freightliner—are contractual and confidential.

The hybrid and conventional vans all are still new enough that much of the maintenance is completed under warranty. All maintenance for the Eaton hybrid drive was done by Eaton mechanics. These maintenance costs are not included in the maintenance-cost analysis in this section. Not accounting for warranty repairs in the evaluation of total maintenance cost does offer an incomplete picture of total maintenance cost. Even without warranty costs, however, this analysis reflects the actual cost to UPS during the period selected.

Maintenance costs were collected in the same manner for each study group. All work orders and parts information available were collected for the study vans. Maintenance practices are the same for both the conventional and hybrid study groups. The maintenance analysis discussions include only the maintenance data that were gathered during the evaluation period on the study group vans.

## Maintenance Costs

This cost category includes the costs for parts and for labor at \$50 per hour; it does not include warranty costs. All costs related to an accident on a hybrid vehicle have been removed from this section as they do not represent the vehicle and powertrain comparison of interest. Cost per mile is calculated as follows:

$$\text{Cost per mile} = ((\text{labor hours} * 50) + \text{parts cost})/\text{mileage}.$$

The labor rate has been set artificially at a constant rate of \$50 per hour; however, other analysts can change this rate to one more similar to their own situation. This rate does not directly reflect UPS's current hourly mechanic rate.

Table 7 shows total and propulsion-related maintenance costs for the two study groups. The propulsion-related vehicle systems include the engine; transmission; electric propulsion; exhaust; fuel; and nonlighting electrical, which includes general electrical, charging, cranking, and ignition. The total maintenance cost per mile of \$0.219 for the hybrid vans was 30% more than the \$0.168 for the conventional vans but was not statistically significant (P value = 0.1128); total maintenance costs directly were only 6% greater. The propulsion-related maintenance cost per mile of \$0.074 for the hybrid vans was 77% more than the \$0.042 for the conventional vans (P value = 0.0278); propulsion-related costs directly were only 45% greater. However, because the groups were running very different routes for most of the study with the hybrids accumulating far fewer miles per day, maintenance costs are also considered on a cost-per-delivery-day basis. The total maintenance cost per day of \$10.90 for the hybrid vans was 11% more than the \$9.80 for the conventional vans. The propulsion-related maintenance cost per day of \$3.68 for the hybrid vans was 52% more than the \$2.43 for the conventional vans. The higher hybrid maintenance costs are driven by more labor hours in most categories with transmission-related hours being seven times higher than on the diesel vans. The significantly fewer miles driven by the hybrids increases the cost per mile metric dramatically. There was no statistically significant difference in group total maintenance costs per month considered directly (P value = 0.7334).

**Table 7. Hybrid and Conventional Group Total and Propulsion Maintenance Costs**

Study Group	Miles	Parts Cost	Labor Hours	Maintenance Cost	Cost per Mile (\$/mile)	Cost per Day (\$/day)
Hybrid total	198,220	\$12,703	613	\$43,367	\$0.219	\$10.90
Hybrid propulsion-related	198,220	\$2,779	237	\$14,651	\$0.074	\$3.68
Conventional total	242,957	\$17,934	458	\$40,835	\$0.168	\$9.80
Conventional propulsion-related	242,957	\$2,336	156	\$10,124	\$0.042	\$2.43

Included in the propulsion-related maintenance cost data are exhaust diesel particulate filter (DPF) manual regenerations, which are a large part of the propulsion maintenance costs for each group. In previous studies, exhaust system-related costs were negligible, but with these 2007-certified engines the exhaust maintenance is a significant cost driven primarily by the new DPF units and the need to manually regenerate them.

Table 8 shows a breakdown by individual van of the total maintenance cost per mile.

**Table 8. Hybrid and Conventional Van Total Cost per Mile**

<b>Total Maintenance Cost Comparison</b>					
<b>Car</b>	<b>Powertrain</b>	<b>Mileage Total</b>	<b>Labor Hours</b>	<b>Parts Cost</b>	<b>Cost (\$/mile)</b>
149765	Conventional	20,448	29	\$878	\$0.115
149772	Conventional	18,648	66	\$1,426	\$0.255
149777	Conventional	17,566	53	\$1,097	\$0.213
149779	Conventional	21,370	24	\$2,363	\$0.167
149780	Conventional	17,159	56	\$1,954	\$0.277
149783	Conventional	18,814	31	\$363	\$0.103
149784	Conventional	17,811	38	\$1,590	\$0.195
149831	Conventional	22,922	25	\$1,552	\$0.123
149832	Conventional	29,805	52	\$2,813	\$0.182
149833	Conventional	36,216	41	\$2,628	\$0.129
149871	Conventional	22,198	42	\$1,270	\$0.152
<b>Total</b>	<b>Conventional</b>	<b>242,957</b>	<b>458</b>	<b>\$17,934</b>	<b>\$0.168</b>
144561	Hybrid	14,940	51	\$373	\$0.197
144564	Hybrid	17,067	42	\$759	\$0.169
144590	Hybrid	23,988	61	\$1,843	\$0.204
144594	Hybrid	17,663	35	\$145	\$0.106
144595	Hybrid	18,554	100	\$1,419	\$0.346
144596	Hybrid	14,757	41	\$475	\$0.170
144597	Hybrid	14,704	56	\$1,425	\$0.286
144598	Hybrid	16,024	62	\$1,793	\$0.305
144712	Hybrid	20,247	27	\$1,128	\$0.123
144719	Hybrid	19,456	80	\$1,302	\$0.274
144736	Hybrid	20,820	58	\$2,041	\$0.237
<b>Total</b>	<b>Hybrid</b>	<b>198,220</b>	<b>613</b>	<b>\$12,703</b>	<b>\$0.219</b>

Table 9 shows a breakdown by individual van of the propulsion-related maintenance cost per mile.

**Table 9. Hybrid and Conventional Van Propulsion Cost per Mile**

<b>Propulsion Maintenance Cost Comparison</b>					
<b>Car</b>	<b>Powertrain</b>	<b>Mileage Total</b>	<b>Labor Hours</b>	<b>Parts Cost</b>	<b>Cost (\$/mile)</b>
149765	Conventional	20,448	11	\$307	\$0.042
149772	Conventional	18,648	25	\$212	\$0.078
149777	Conventional	17,566	22	\$61	\$0.066
149779	Conventional	21,370	7	\$61	\$0.018
149780	Conventional	17,159	29	\$243	\$0.098
149783	Conventional	18,814	6	\$209	\$0.027
149784	Conventional	17,811	12	\$243	\$0.048
149831	Conventional	22,922	8	\$236	\$0.027
149832	Conventional	29,805	12	\$371	\$0.032
149833	Conventional	36,216	8	\$197	\$0.017
149871	Conventional	22,198	17	\$194	\$0.047
<b>Total</b>	<b>Conventional</b>	<b>242,957</b>	<b>156</b>	<b>\$2,336</b>	<b>\$0.042</b>
144561	Hybrid	14,940	21	\$154	\$0.082
144564	Hybrid	17,067	20	\$253	\$0.074
144590	Hybrid	23,988	36	\$447	\$0.094
144594	Hybrid	17,663	10	\$124	\$0.034

Propulsion Maintenance Cost Comparison					
Car	Powertrain	Mileage Total	Labor Hours	Parts Cost	Cost (\$/mile)
144595	Hybrid	18,554	19	\$339	\$0.070
144596	Hybrid	14,757	8	\$136	\$0.036
144597	Hybrid	14,704	23	\$55	\$0.083
144598	Hybrid	16,024	23	\$187	\$0.084
144712	Hybrid	20,247	8	\$157	\$0.027
144719	Hybrid	19,456	40	\$234	\$0.116
144736	Hybrid	20,820	29	\$694	\$0.103
<b>Total</b>	<b>Hybrid</b>	<b>198,220</b>	<b>237</b>	<b>\$2,779</b>	<b>\$0.074</b>

Figure 11 shows monthly and cumulative total maintenance costs for the two study groups. The hybrid group started off costing more than the conventional group, but stayed level while the conventional group's cost started lower and began to rise after 8 months of study.

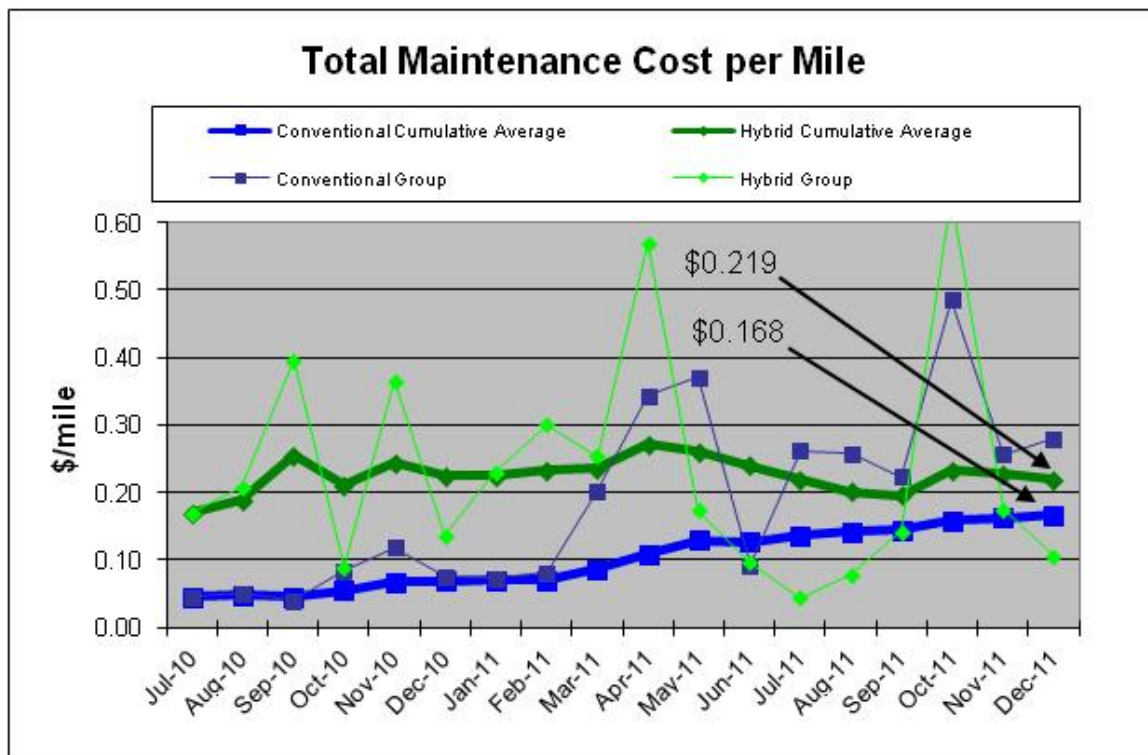

Figure 11. Total maintenance cost per mile

Figure 12 shows monthly and cumulative propulsion-related maintenance costs for the two study groups.

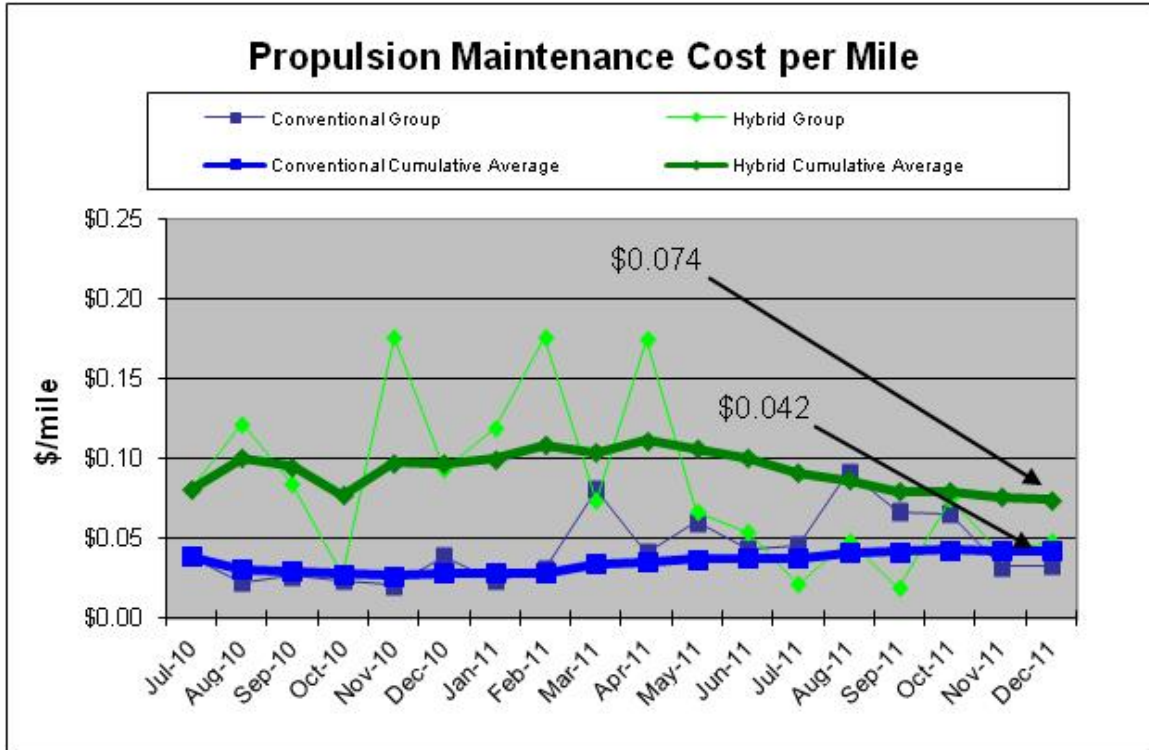
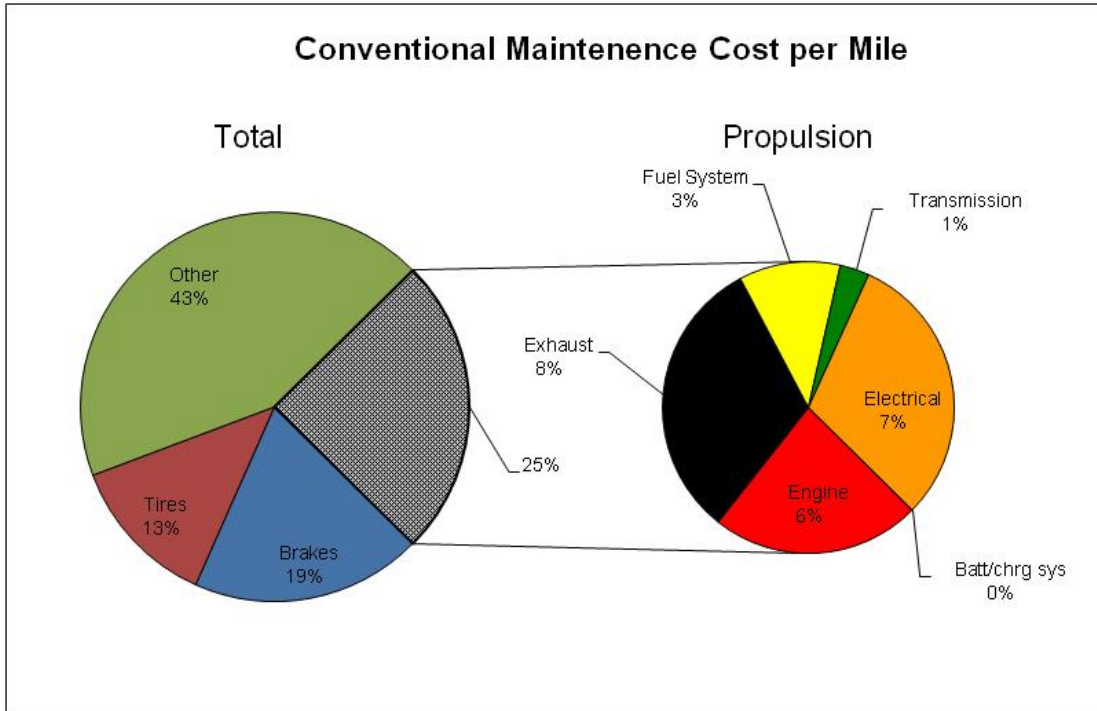
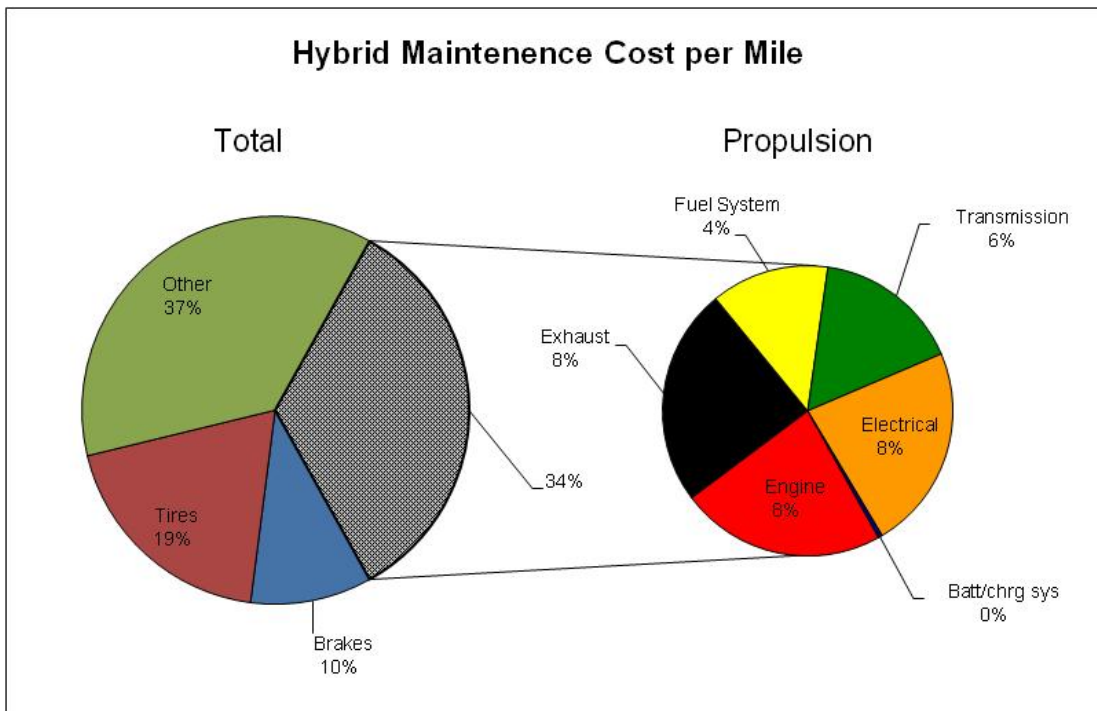

Figure 12. Propulsion maintenance cost per mile

Figures 13 and 14 show a breakdown of total and propulsion-related maintenance costs per mile for the conventional and hybrid study groups, respectively. For both groups note the high percentage of costs related to the exhaust system, which is primarily related to manual regeneration of the DPF.



**Figure 13. Propulsion maintenance cost per mile (conventional vans)**



**Figure 14. Propulsion maintenance cost per mile (hybrids)**

## Total Cost per Mile

Table 10 shows a breakdown by individual van of the total cost per mile of operation. Fuel cost per mile dominated the total cost per mile for both groups, and the fuel cost per mile was a statistically significant 11% less for the hybrid group (P value = 0.0034). However, the greater hybrid maintenance costs balanced out the fuel cost savings. As such, total cost per mile was found not to be statistically significant (P value = 0.9677). The average price for diesel was \$3.58/gallon during this study period, and this figure was used to calculate fuel cost per mile.

**Table 10. Hybrid and Conventional Van Total Cost per Mile**

Total Operating Cost Comparison						
Car	Powertrain	Mileage Total	Non-Prop Maint (\$/mile)	Prop Maint (\$/mile)	Fuel Cost (\$/mile)	Total Cost (\$/mile)
149765	Conventional	20,448	\$0.073	\$0.042	\$0.406	\$0.521
149772	Conventional	18,648	\$0.177	\$0.078	\$0.425	\$0.680
149777	Conventional	17,566	\$0.147	\$0.066	\$0.457	\$0.670
149779	Conventional	21,370	\$0.148	\$0.018	\$0.387	\$0.554
149780	Conventional	17,159	\$0.178	\$0.098	\$0.385	\$0.661
149783	Conventional	18,814	\$0.076	\$0.027	\$0.415	\$0.518
149784	Conventional	17,811	\$0.147	\$0.048	\$0.416	\$0.611
149831	Conventional	22,922	\$0.096	\$0.027	\$0.420	\$0.542
149832	Conventional	29,805	\$0.149	\$0.032	\$0.398	\$0.580
149833	Conventional	36,216	\$0.112	\$0.017	\$0.381	\$0.510
149871	Conventional	22,198	\$0.105	\$0.047	\$0.398	\$0.550
<b>Total</b>	<b>Conventional</b>	<b>242,957</b>	<b>\$0.126</b>	<b>\$0.042</b>	<b>\$0.405</b>	<b>\$0.573*</b>
144561	Hybrid	14,940	\$0.115	\$0.082	\$0.395	\$0.592
144564	Hybrid	17,067	\$0.095	\$0.074	\$0.329	\$0.498
144590	Hybrid	23,988	\$0.110	\$0.094	\$0.328	\$0.532
144594	Hybrid	17,663	\$0.072	\$0.034	\$0.355	\$0.461
144595	Hybrid	18,554	\$0.277	\$0.070	\$0.348	\$0.694
144596	Hybrid	14,757	\$0.134	\$0.036	\$0.376	\$0.545
144597	Hybrid	14,704	\$0.203	\$0.083	\$0.413	\$0.699
144598	Hybrid	16,024	\$0.221	\$0.084	\$0.367	\$0.672
144712	Hybrid	20,247	\$0.096	\$0.027	\$0.373	\$0.497
144719	Hybrid	19,456	\$0.158	\$0.116	\$0.376	\$0.649
144736	Hybrid	20,820	\$0.134	\$0.103	\$0.306	\$0.543
<b>Total</b>	<b>Hybrid</b>	<b>198,220</b>	<b>\$0.152</b>	<b>\$0.078</b>	<b>\$0.359</b>	<b>\$0.589*</b>

\*not a statistically significant comparison at the 95% confidence level

## Reliability

As previously stated, some of the costs incurred by the vehicles were covered by in-warranty repairs and possibly were not reported as part of this report. Another measure of system reliability is the up-time or availability of the vehicles. UPS records instances in which a vehicle is not available to load in the morning as scheduled. Scheduled maintenance events of any kind do not get recorded in this way, so only unscheduled maintenance is included. During this 18-month evaluation, there were 380 operational days available for deliveries for a total of 4,180 days for each study group of eleven vans. The hybrid group missed substantially more days of operation than the conventional group (200 days vs. 13 days), especially during the first 3 months of the study. Figure 15 shows the monthly and cumulative uptime for each group as a percentage of the total available delivery days.



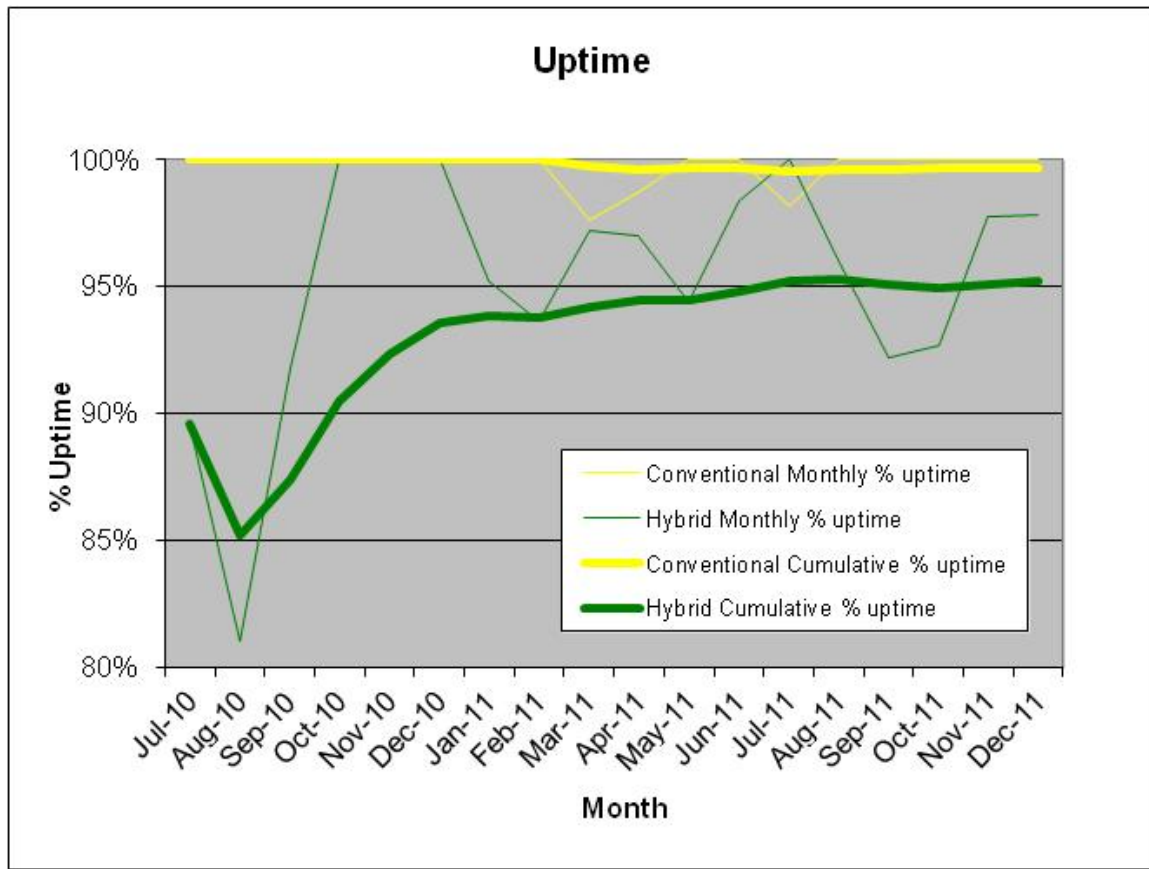

Figure 15. Cumulative uptime

### Batteries

The Eaton system uses lithium ion batteries supplied by Hitachi for energy storage. The batteries have a capacity of 1.8 kWh and operate at a nominal voltage of 340 VDC. These batteries and associated reliability data were not available to NREL during the evaluation period for detailed evaluation. The batteries are included in the power electronics carrier shown in Figures 3 and 4. The service life of the battery is estimated by Eaton at more than 7 years.

### Laboratory Fuel Economy and Emissions Testing

Two UPS delivery vehicles were tested on the chassis dynamometer at NREL's Renewable Fuels and Lubricants (ReFUEL) Research Laboratory. The remainder of this document includes the test plan and results from the vehicle testing performed. The ReFUEL laboratory description, experimental setup, and test procedures are given in the appendix.

### Test Cycle Selection

Figures 16 and 17 illustrate how the HHDDT, Hybrid Truck Utility Forum Class 4 (HTUF4) and New York City Composite (NYC Comp) cycles compare to the observed daily in-use fleet data. The selected cycles bracket the range of observed field data well on these and other metrics and bracket the in-field data on both the X and Y axes. Although the curves created by these three cycles do not perfectly match the field data, they are the best fit available using standard duty cycles and considering all of the prioritized metrics, only some of which are shown here. The NYC Comp cycle is a bit more aggressive than most of the observed field data points from Minneapolis in regard to low average speed, high stops per mile, and high kinetic intensity (KI),

but this cycle represents a better hybrid scenario that may be available in other UPS fleet locations. Most of the observed field data points fall around the HTUF4 cycle or between it and the NYC Comp cycle. The HHDDT cycle brackets the observed data on the more “highway speed”-dominant end of the UPS in-use data.

Also, it is important to note the spread of hybrid and conventional vehicle data in the cloud of observed field data. Half of the conventional vehicle data is clearly more highway oriented and less intense than the hybrid data. The remainder of the conventional data is included with the hybrid data, again reinforcing the need for the route switch in the field analysis.

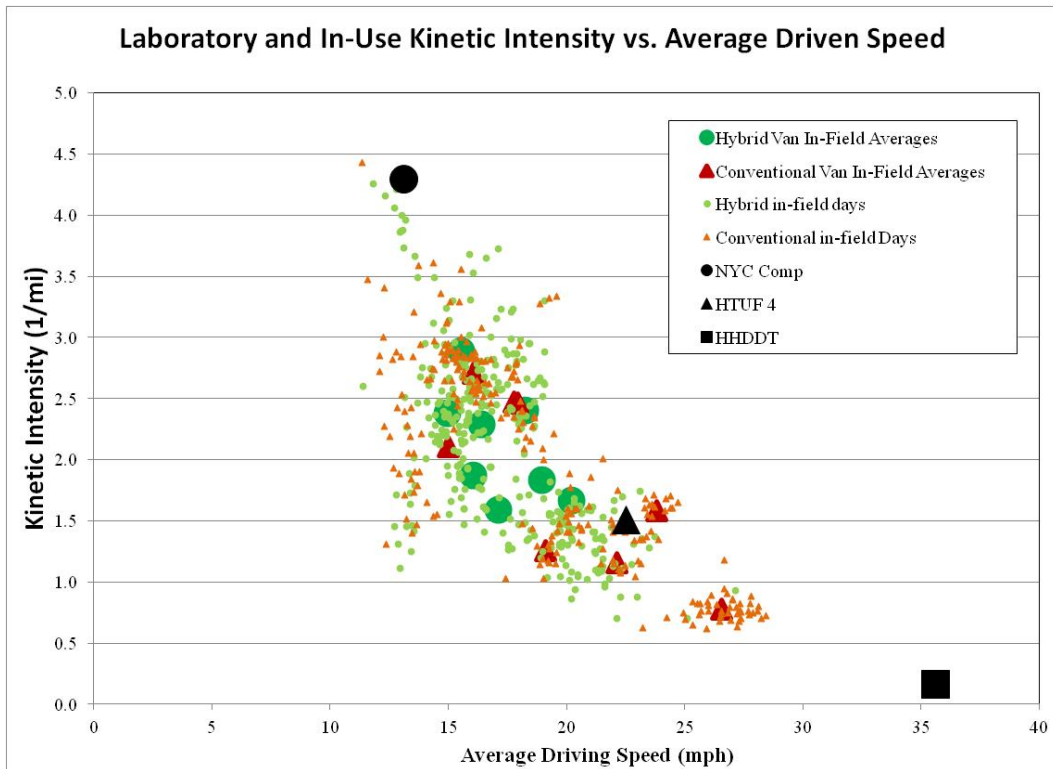

**Figure 16. Average driving speed and KI comparison**

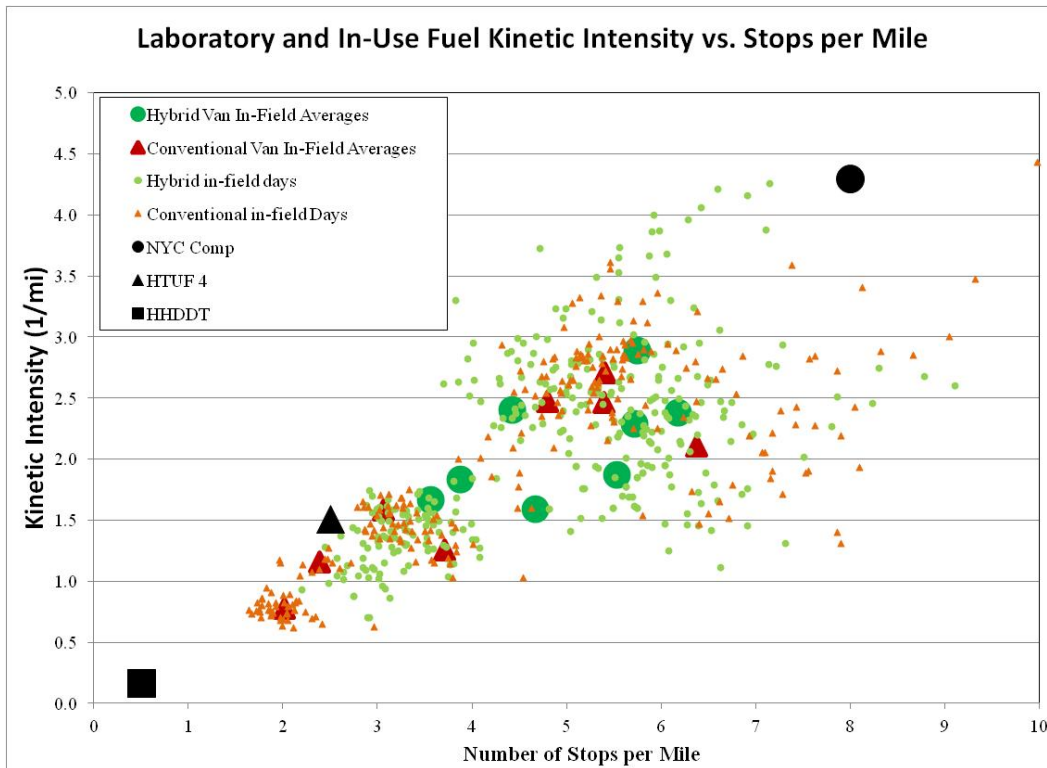

Figure 17. Stops per mile and KI comparison

### Selected Duty Cycle Description

The NYC Comp duty cycle (Figure 18) represents “city” or urban driving commonly performed by medium- and heavy-duty commercial vehicles. The NYC Comp cycle is 1,030 seconds with an average driving speed of approximately 13.1 mph and travels a distance of 2.5 miles with a KI of 4.3. This cycle was determined to represent the most “urban” route observed during the drive cycle assessment of the UPS fleet and may be representative of typical routes in other cities. The most “urban” driving of the field data collected shows most of the data below a KI of 3 and above 15 mph average speed, so this cycle brackets the urban end of the spectrum.

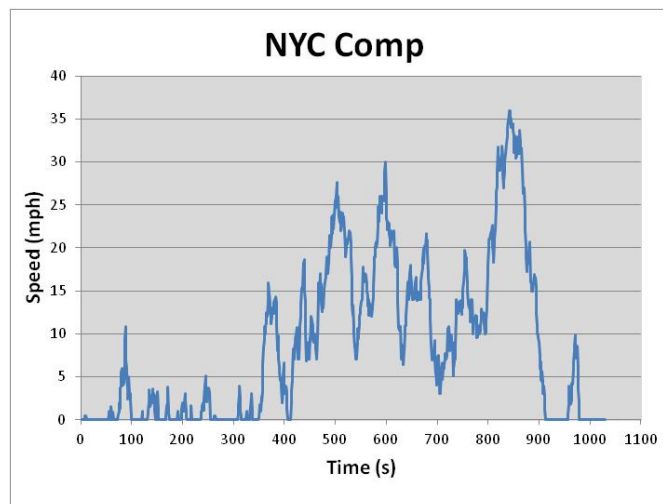

Figure 18. NYC Comp trace

The HTUF4 duty cycle (Figure 19) is a duty cycle lasting approximately 3,336 seconds with an average driving speed of approximately 22.5 mph and travels a distance of 11.2 miles with a KI of 1.51. This cycle was selected to represent the middle range of observed UPS operation in Minneapolis; much of the field data collected is between 15 and 25 mph average speed with a KI of 1 to 3.

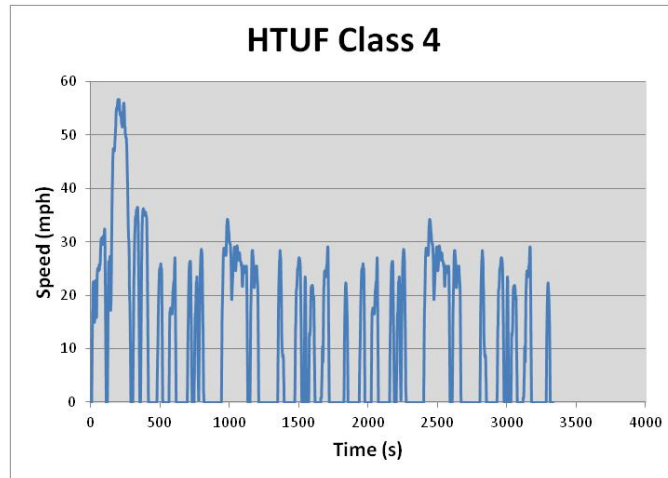

Figure 19. HTUF Class 4 trace

The California Air Resources Board (CARB) HHDDT duty cycle (Figure 20) is a composite duty cycle developed to represent medium- and heavy-duty commercial vehicles. It consists of four segments: an initial idle segment (600 sec, average driving speed 0 mph), a creep segment (250 sec, average driving speed approximately 3 mph), a transient segment (650 sec, average driving speed approximately 18 mph), and finally, a highway segment (2,100 sec, average driving speed approximately 43 mph). The total cycle, which lasts 3,600 seconds, reaches a top speed of 59.3 mph and travels a distance of 26 miles with an average speed of 35.6 mph and a KI of 0.17. This cycle was selected to bracket the most “rural” or “highway” type operation observed in the UPS Minneapolis fleet. The most rural type of driving of the field data collected shows most of the data are above a KI of 0.7 and below 27 mph average speed.

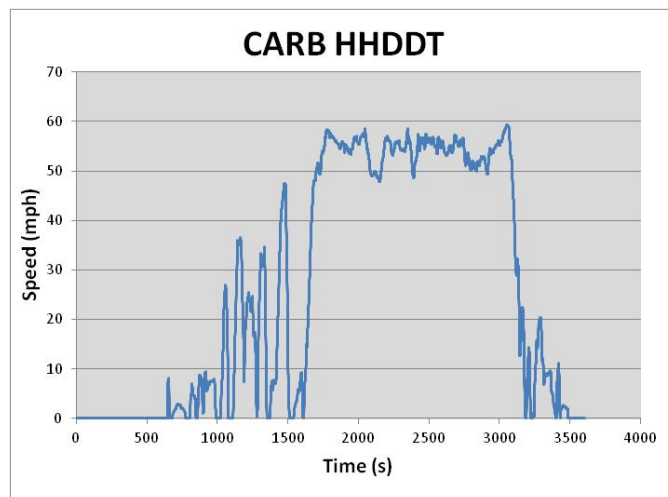

Figure 20. CARB HHDDT trace

The test cycle statistics are shown in Table 11. These test cycles bracket the in-use GPS data discussed earlier with the NYC Comp cycle having slower speeds, more stops per mile, and highest KI while the HHDDT cycle is more highway oriented with higher speeds and low stops per mile and KI. HTUF 4 more closely matches the midrange of the GPS data.

**Table 11. Test Cycle Statistics and In-Field Average Comparison**

Cycle Statistics	Distance Traveled (miles)	Average Speed over Cycle (mph)	Average Driving Speed (mph)	Maximum Speed (mph)	Number of Stops per Mile	Kinetic Intensity (1/mi)
NYC Comp	2.5	8.8	13.1	36	8.0	4.30
HTUF4	11.2	12.1	22.5	56.5	2.5	1.51
CARB HHDDT	26.0	26.0	35.6	59.3	0.5	0.17
Hybrid Van in-field Data Range	16 – 86	3.3 – 13.2	11.4 – 27.1	38 – 79	2.2 – 9.1	0.7 – 4.3
Conventional Van in-field Data Range	22 – 133	3.3 – 19.3	11.3 – 28.4	53 – 74	1.6 – 10	0.6 – 4.4

### Test Plan

Tests were performed on one 2010 hybrid electric Workhorse P100H delivery van and one conventional 2009 Workhorse P100D delivery van during May and June 2011 to determine emissions and fuel economy benefits of the hybrid electric powertrain being evaluated at UPS. The 2009 conventional van is identical in specification to the 2010 conventional vans studied in Minneapolis, but was available closer to the laboratory test location. The hybrid test vehicle was transported from the study group in Minneapolis for the laboratory testing. The tests were conducted over the NYC Comp cycle, the HTUF Class 4 cycle, and the CARB HHDDT cycle. Vehicle exhaust emissions and fuel consumption were measured for repeated test conditions. All dynamometer sensors and instruments were monitored and recorded continuously by the ReFUEL data acquisition system throughout each test cycle run, unless otherwise noted.

### Vehicle Specifications

Table 12 shows the test vehicle information. Vehicle test weights are different because the hybrid system adds to the curb weight. Each vehicle was loaded with the same amount of cargo weight (4,000 lbs).

**Table 12. Test Vehicle Information**

	Conventional P100D	Hybrid P100H
<b>Engine</b>	Cummins ISB 07 (CM2150)	Cummins ISB 07 (CM2150)
<b>Transmission</b>	Allison Auto HS 2200 Series	Eaton Automated Manual
<b>Gross Vehicle Weight Rating</b>	23,000 lbs	23,000 lbs
<b>Curb Weight</b>	11,020 lbs	12,260 lbs
<b>Test Weight</b>	15,020 lbs	16,260 lbs

	Conventional P100D	Hybrid P100H
<b>After Treatment</b>	DPF	DPF
<b>Fuel</b>	Diesel	Diesel
<b>Chassis</b>	Morgan Olson/Freightliner P100D	Utilimaster P100H

### Laboratory Test Results

All fuel economy and emissions results are averaged over four test runs of each cycle. Fuel economy results for the vans are shown in Table 13 and in Figure 21 with  $\pm 95\%$  confidence interval error bars. The hybrid vans showed a 13%–36% improvement in fuel economy over the conventional vans on the tested duty cycles.

**Table 13. Fuel Economy of Hybrid and Conventional Van on Various Cycles on Chassis Dynamometer**

Fuel Economy	NYC Comp	HTUF4	HHDDT
Conventional P100D (mpg)	6.8	7.5	9.6
Hybrid P100H (mpg)	8.8	10.1	10.8
<b>Hybrid Advantage (%)</b>	<b>29%</b>	<b>36%</b>	<b>13%</b>
<i>t</i> -test P Value	0.0001	0.0000	0.0002

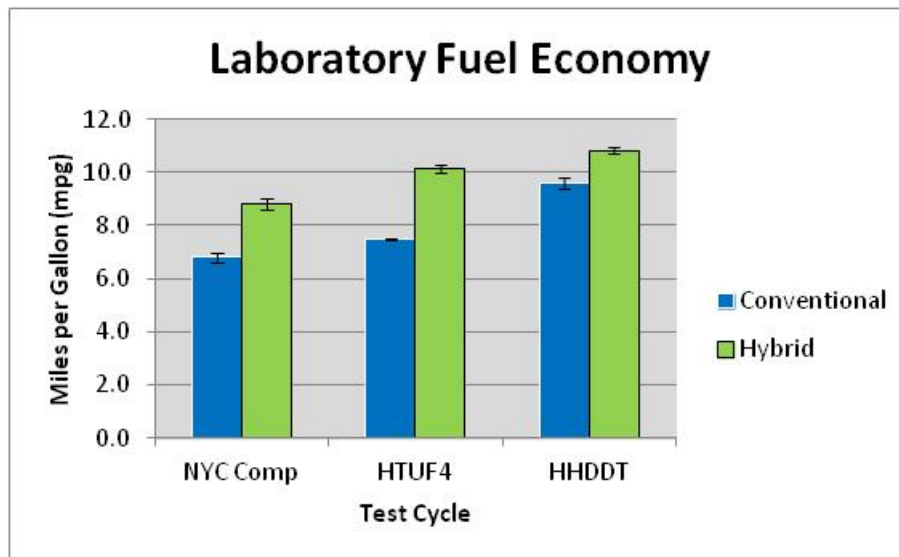
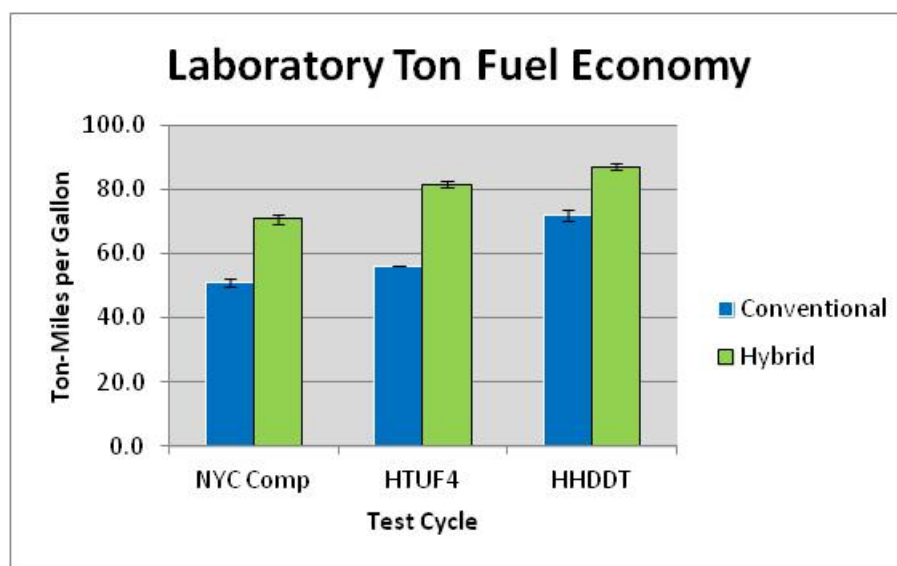

**Figure 21. Laboratory fuel economy**

Ton-mi./gal fuel economy results for the vans are shown in Table 14 and in Figure 22 with  $\pm 95\%$  confidence interval error bars. The hybrid vans showed a 21%–45% improvement in fuel economy over the conventional vans on the tested duty cycles.

**Table 14. Ton Fuel Economy of Hybrid and Conventional Van on Various Cycles on Chassis Dynamometer**

Ton Fuel Economy	NYC Comp	HTUF4	HHDDT
Conventional P100D (ton-mi./gal)	51.1	56.2	72.0
Hybrid P100H (ton-mi./gal)	70.9	81.6	87.2
<b>Hybrid Advantage (%)</b>	<b>39%</b>	<b>45%</b>	<b>21%</b>
<i>t</i> -test P Value	0.0000	0.0000	0.0001

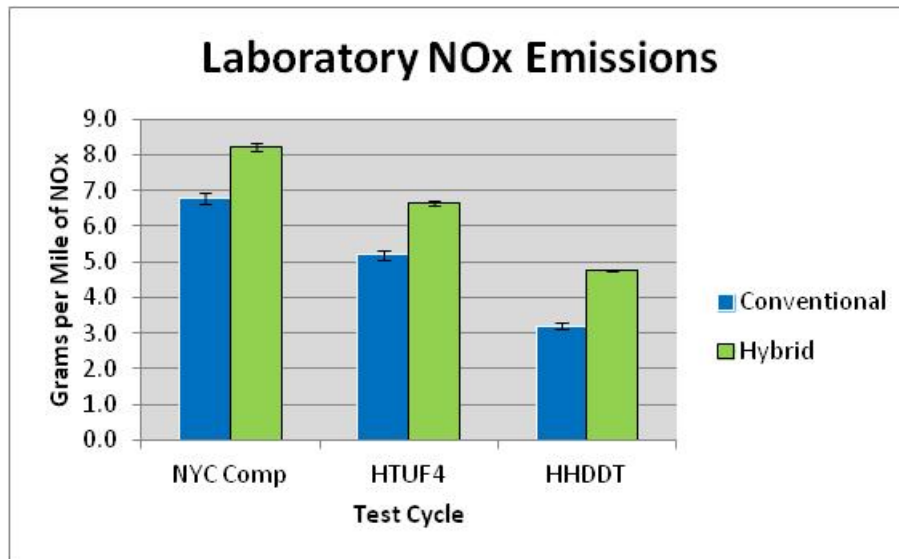

**Figure 22. Laboratory ton-mi./gallon fuel economy**

Emissions results for oxides of nitrogen ( $\text{NO}_x$ ) are shown in Table 15 and in Figure 23 with  $\pm 95\%$  confidence interval error bars.  $\text{NO}_x$  emissions increased on the hybrid on all cycles, and the results were statistically significant. The engines from both the hybrid and conventional vehicles were of the same engine family, model, model year, U.S. Environmental Protection Agency (EPA)  $\text{NO}_x$  certification level, and horsepower rating. Heavy-duty engines are certified with the EPA engine certification test, but are not certified with the completed hybrid configuration. Engine operation during a chassis dynamometer test is different than during the EPA engine certification test.

**Table 15. Average  $\text{NO}_x$  Emission Results of Hybrid and Conventional Vans on Specified Cycles**

$\text{NO}_x$ Emissions	NYC Comp	HTUF4	HHDDT
Conventional P100D (g/mile)	6.8	5.2	3.2
Hybrid P100H (g/mile)	8.2	6.6	4.8
<b>Hybrid Increase (%)</b>	<b>21%</b>	<b>28%</b>	<b>49%</b>
<i>t</i> -test P Value	0.0001	0.0001	0.0000



**Figure 23. Laboratory NO<sub>x</sub> emissions**

Emissions results for carbon dioxide (CO<sub>2</sub>), total hydrocarbons (THC), carbon monoxide (CO), and particulate matter (PM) are shown in Table 16 and in Figures 24–27 with ±95% confidence interval error bars. Results that are not statistically significant at the 95% confidence level are in the gray areas. CO<sub>2</sub> emissions were consistently reduced on the hybrid as this is a measure of fuel consumption. Emissions of THC, CO, and PM were all extremely low for both vehicles on all cycles, and most differences were not statistically significant.

**Table 16. Average Values for Emission Results of Hybrid and Conventional Vans on Specified Cycles**

	NYC Comp				HTUF 4				HHDDT			
	Diesel	Hybrid	Hybrid % diff	P Value	Diesel	Hybrid	Hybrid % diff	P Value	Diesel	Hybrid	Hybrid % diff	P Value
CO <sub>2</sub> (g/mile)	1466	1143	-22%	0.000	1357	1008	-26%	0.000	1049	965	-8%	0.006
THC (g/mile)	0.06	0.10	73%	0.027	0.00	-0.01	<del>259%</del>	<b>0.58</b>	0.00	0.02	<del>942%</del>	<b>0.21</b>
CO (g/mile)	1.58	1.05	<del>33%</del>	<b>0.09</b>	0.17	0.90	423%	0.000	0.20	0.14	<del>32%</del>	<b>0.38</b>
PM (g/mile)	0.0011	0.0009	<del>15%</del>	<b>0.82</b>	0.0001	0.0003	<del>272%</del>	<b>0.14</b>	0.0003	0.0011	<del>325%</del>	<b>0.26</b>

### Comparison of Laboratory Results to In-Use Results

The J1939 data logging devices used during the duty cycle study were also used during the dynamometer testing to assess the accuracy of their fuel economy measurement when used in the field. Data logger-derived fuel economy was consistently 6% higher on the conventional van and 11% higher on the hybrid van as compared to the in-laboratory gravimetric measurements (as described in the appendix) of those test runs; therefore, these offsets were used to correct the field data in the analysis below. Also, zero-speed fuel usage has been removed to eliminate the effect of high idle times observed in the field (30-55% of the time for the conventional and



hybrid vans) as compared to the relatively low idle times that are part of the three standard industry test cycles.

Figure 24 shows a comparison of laboratory results to the corrected in-use vehicle days and vehicle averages. The vehicle days show the wide daily variation in fuel economy while the vehicle averages generally fall in line with the laboratory testing results—higher-KI drive cycles result in lower fuel economy. It is also clear that the hybrid group averages are more kinetically intense while half of the conventional group has lower KI averages than all the hybrids. Conventional van averages ranged from 4.9 to 9.1 mpg, while hybrid van averages ranged from 8.2 to 10.4 mpg. In total, 338 days of hybrid van operation and 252 days of conventional van operation on eight vans from each group were documented and are displayed in this figure.

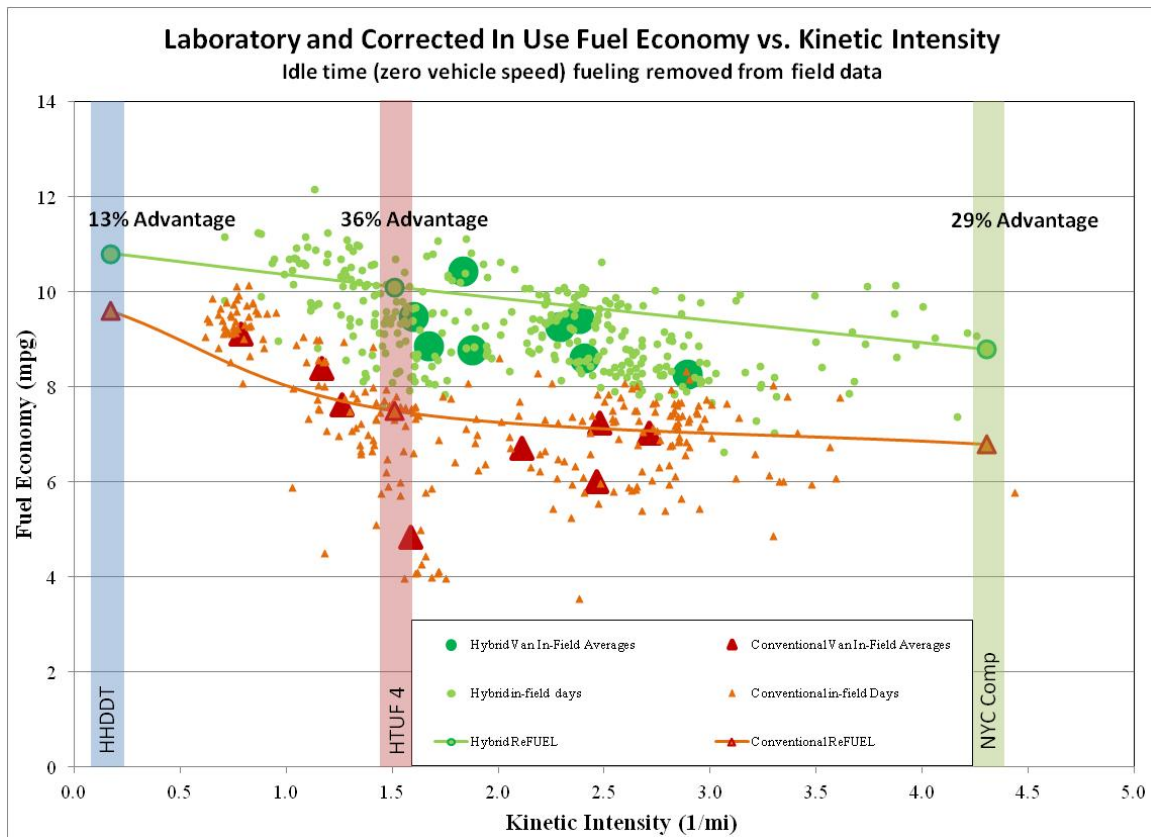

Figure 24. Laboratory and in-use fuel economy results

### Status of UPS Hybrid Fleet

UPS was satisfied with the performance of the original 50 (prototype) hybrid electric vans over the first year of service, which is documented in 12- and 36-month NREL technical reports.<sup>3</sup> UPS ordered and has taken delivery of an additional 200 second-generation hybrids with additional features, including “engine off at idle”; this report documents those updates.

<sup>3</sup> [http://www.nrel.gov/vehiclesandfuels/fleettest/research\\_hybrid\\_ups.html](http://www.nrel.gov/vehiclesandfuels/fleettest/research_hybrid_ups.html)

## Conclusions

- Cumulative miles per van for the hybrids were 33% less than the conventional group during the complete 18-month study. The hybrid group accumulated miles at a slower rate than the conventional group during the 13 months of the original route assignments, but at a faster rate than the conventional group for the 5 months after the route switch.
- The study groups were on significantly different duty cycles, necessitating a route switch between the groups to more accurately compare fuel economy and maintenance costs.
- Fuel economy before and after the route switch during equal 5-month periods from different years on a route assignment was considered.
  - “Conventional,” lower-KI route analysis: Fuel economy of the hybrid group on the original conventional route assignments over 5 months was 10.4 mpg, or 13% greater than the 9.2 mpg of the conventional group on those routes a year earlier.
  - “Hybrid,” higher-KI route analysis: Fuel economy of the hybrid group on the original hybrid route assignments over 5 months was 9.4 mpg, or 20% greater than the 7.9 mpg of the conventional group on those routes a year later.
  - The difference in hybrid advantage in fuel economy is as expected. The hybrids demonstrated a greater advantage on more urban, low speed, high stops-per-mile route assignments and lower advantage on route assignments with a longer highway leg and less dense delivery zones.
- Total maintenance cost per mile was 30% higher for the hybrids, but was not statistically significant (P value = 0.1128). However, this was only 11% more when considered on a cost-per-delivery-day basis.
- Propulsion-related maintenance cost per mile was 77% higher for the hybrids (P value = 0.0278). However, this was only 52% more when considered on a cost-per-delivery-day basis.
- Fuel costs per mile (assuming \$3.58/gal) for the hybrids were 11% less than those for the conventional vans (P value = 0.0034).
- Total operating costs per mile (assuming \$3.58/gal) for the hybrids were not found to be statistically significant (P value = 0.9677).
- The hybrid group had a cumulative uptime of 92.5% compared to the conventional group uptime of 99.7%.
- Laboratory testing demonstrated 13% to 36% increase in fuel economy for the hybrid.
- Laboratory testing demonstrated 21% to 45% increase in ton-mi/gal for the hybrid.
- Laboratory testing demonstrated an increase in NO<sub>x</sub> emissions of 21% to 49% for the hybrid.

## **Contacts**

### **U.S. Department of Energy**

Energy Efficiency and Renewable Energy

Vehicle Technologies Program

Lee Slezak

Manager, Advanced Vehicle Testing Activity

Phone: 202-586-2335

E-mail: [lee.slezak@ee.doe.gov](mailto:lee.slezak@ee.doe.gov)

### **National Renewable Energy Laboratory**

Mike Lammert

Project Engineer

Phone: 303-275-4067

E-mail: [michael.lammert@nrel.gov](mailto:michael.lammert@nrel.gov)

Kevin Walkowicz

Advanced Vehicle Testing Activity Lead

Phone: 303-275-4492

E-mail: [kevin.walkowicz@nrel.gov](mailto:kevin.walkowicz@nrel.gov)

### **United Parcel Service**

Mike Britt

Director of Maintenance & Engineering, Ground Fleet

Phone: 404-828-4661

E-mail: [mbritt@ups.com](mailto:mbritt@ups.com)

James C. Francis

UPS Engineering - Area Automotive Manager, Northern Plains District

Phone: 612-379-6610

E-mail: [jcfrancis@ups.com](mailto:jcfrancis@ups.com)

### **Eaton Corporation**

Alex Stuckey

Special Projects Engineering

Phone: 269-342-3105

E-mail: [AlexBStucky@Eaton.com](mailto:AlexBStucky@Eaton.com)

## **Appendix: Laboratory Description and Test Methods**

### **General Lab Description**

The vehicles were tested at the Renewable Fuels and Lubricants (ReFUEL) Laboratory, which is operated by the National Renewable Energy Laboratory (NREL) and located in Denver, Colorado. The lab includes a heavy-duty vehicle (chassis) test cell and an engine dynamometer test cell with emissions measurement capability. Regulated emissions measurements are performed using procedures consistent with SAE J2711. Instrumentation and sensors at the laboratory are maintained with National Institute of Standards and Technology (NIST)-traceable calibration. Test procedures, calibrations, and measurement accuracies are maintained to meet the requirements outlined in the current Code of Federal Regulations (CFR) Title 40, Section 86, Subpart N. Data acquisition and combustion analysis equipment are used to measure vehicle performance and emissions. Other capabilities of the laboratory include systems for sampling and analyzing unregulated emissions, on-site fuel storage and fuel blending equipment, high-speed data acquisition hardware and software to support in-cylinder measurements, and fuel ignition quality testing. Instrumentation and sensors at the laboratory are maintained with NIST-traceable calibration.

### **Chassis Dynamometer**

The ReFUEL laboratory's chassis dynamometer is installed in the main high-bay area of the laboratory. The roll-up door to the high bay is 14 ft x 14 ft, high enough to accept all highway-ready vehicles without modification. The dynamometer is installed in a pit below the ground level, such that the only exposed part of the dynamometer is the top of the 40-in.-diameter rolls. Two sets of rolls are installed, so that twin-axle tractors can be tested. The distance between the rolls can be varied between 42 in. and 56 in. The dynamometer will accommodate vehicles with a wheelbase between 89 in. and 293 in. The dynamometer can simulate up to 80,000-lb vehicles at speeds up to 60 mph.

The chassis dynamometer, illustrated in Figure A-1 is composed of three major components: the rolls, which are in direct contact with the vehicle tires during testing; the direct current electric motor (380 hp absorbing/360 hp motoring) dynamometer; and the flywheels.

The rolls are the means by which power is absorbed from the vehicle. The rolls are attached to gearboxes that increase the speed of the central shaft by a factor of 5. The flywheels, mounted on the back of the dynamometer, provide a mechanical simulation of the vehicle inertia.

The electric motor is mounted on trunnion bearings and is used to measure the shaft torque from the rolls. The energy absorption capability of the dynamometer is used to apply the "road load," which is a summation of the aerodynamic drag and friction losses that the vehicle experiences in use, as a function of speed. The road load may be determined experimentally if data are available or estimated from standard equations. The electric dynamometer is also used to adjust the simulated inertia, either higher or lower than the 31,000-lb base dynamometer inertia, as the test plan requires. The inertia simulation range of the chassis dynamometer is 8,000–80,000 lb. The electric motor may also be used to simulate grades and provide braking assist during decelerations.

The test vehicle is secured with the drive axles over the rolls. A driver's aid monitor in the cab is used to guide the vehicle operator in driving the test trace. A large fan may be used to cool the

vehicle radiator during testing. The chassis dynamometer is supported by 72 channels of data acquisition in addition to the emissions measurement, fuel metering, and combustion analysis subsystems.

The dynamometer is capable of simulating vehicle inertia and road load during drive cycle testing. When the vehicle is jacked up off the rolls, an automated dynamometer warm-up procedure is performed daily, prior to testing, to ensure that parasitic losses in the dynamometer and gearboxes have stabilized at the appropriate level to provide repeatable loading. An unloaded coast-down procedure is also conducted to confirm that inertia and road load are being simulated by the dynamometer control system accurately. Between test runs, a loaded coast-down procedure is performed to further ensure the stability of vehicle and dynamometer parasitic losses and accurate road load simulation during testing.

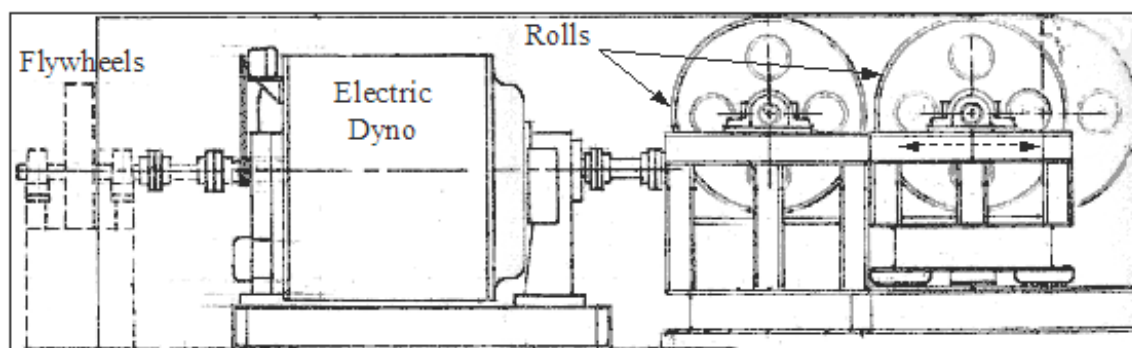

**Figure A-1. Chassis dynamometer schematic**

### **Fuel Storage and Blending**

There are buildings designed specifically for safely storing and handling fuels at the ReFUEL facility. The fuel storage shed is 8 ft x 26 ft and holds up to 48 drums (55 gal. each). Features include heating/cooling, secondary containment to 25% of capacity, continuous ventilation, explosion-proof wiring/lighting, and a dry chemical fire suppression system.

The fuel blending shed is 8 ft x 14 ft and has a nominal storage capacity of 24 drums. It has all of the features of the storage shed plus explosion-proof electrical outlets for powering accessories. The fuel blending can be performed on a gravimetric or volumetric basis, with capability for both large- (L/kg) and small-scale (cc/g) measurements.

A fuel line inside a sealed conduit delivers the fuel from the supply drum to the fuel metering/conditioning system inside the ReFUEL laboratory, eliminating the need for bulk fuel storage inside the laboratory. Another fuel line in the same conduit delivers waste fuel back to the fuel blending shed for storage (waste fuel is generated only when a fuel changeover requires a flush of the system).

## Fuel Metering and Conditioning

The fuel metering and conditioning system (Figure A-2) supports test work for both the engine and the chassis dynamometers. The meter measures volumetric flow to an accuracy of  $\pm 0.5\%$  of the reading, with a manufacturer's stated reproducibility of 0.2%. An in-line sensor measures the density with an accuracy of  $\pm 0.001$  g/cc, allowing an accurate mass measurement over the test cycle even if the density of the fuel blend is not known prior to testing.

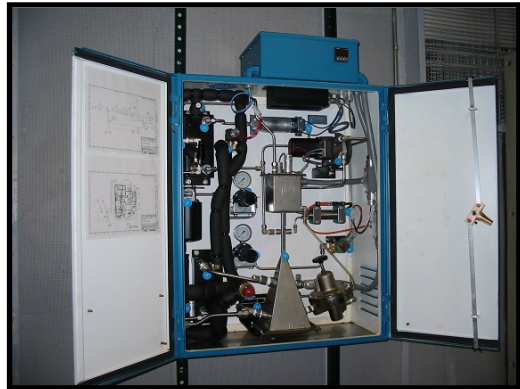

Figure A-2. Pierburg fuel metering system

## Air Handling and Conditioning

Dilution air and the air supplied to the test engine or vehicle for combustion are derived from a common source, a roof-mounted system that conditions the temperature of the air and humidifies as needed to meet desired specifications. The system can also pressurize the incoming air to simulate sea level combustion. This gives the lab the ability to simulate any altitude between sea level and 5,280 feet. This air is passed through a HEPA filter, in accordance with 2007 CFR specifications, to eliminate background particulate matter as a source of uncertainty in particulate measurements. The average inlet air temperature to the vehicle is maintained within a window of  $75^{\circ}\text{F} \pm 4^{\circ}\text{F}$  for all test runs, and average humidity is controlled to 75 grains/lb (absolute)  $\pm 4$  grains/lb.

## Emissions Measurement

The ReFUEL Laboratory's emissions measurement system supports both the engine and chassis dynamometers. It is based on the full-scale exhaust dilution tunnel method with a constant volume sampling system for mass flow measurement. The system is designed to comply with the requirements of the 2007 version of 40 CFR 86 Subpart N. Exhaust from the engine or vehicle flows through insulated piping to the full-scale 18-in. diameter stainless steel dilution tunnel. A static mixer ensures thorough mixing of exhaust with conditioned, filtered, dilution air prior to sampling of the dilute exhaust stream to measure gaseous and particulate emissions.

A system with three venturi nozzles (Figure A-3) is employed to maximize the flexibility of the emissions measurement system. Featuring 500-cubic foot per minute (cfm), 1,000-cfm, and 1,500-cfm venturi nozzles and gas-tight valves, the system flow can be varied from 500 cfm to 3,000 cfm flow rates in 500-cfm increments.

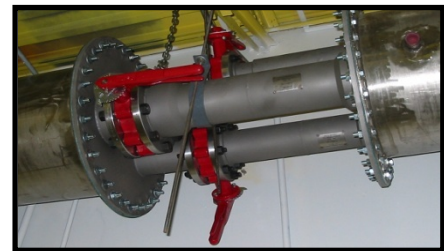

Figure A-3. Venturi nozzles

This allows the dilution level to be tailored to the engine size being tested (whether on the engine stand or in a vehicle), maximizing the accuracy of the emissions measurement equipment.

The gaseous emissions bench is a Pierburg model AMA-2000 (Figure A-4, center). It features continuous analyzers for THC,  $\text{NO}_x$ , CO,  $\text{CO}_2$ , and oxygen. The system also features auto-ranging, automated calibration, zero check, and span check features as well as integrating functions for calculating cycle emissions. It communicates with the ReFUEL data acquisition systems through a serial interface.

There are two heated sample trains for gaseous emissions measurement: one for HC and another for the other gaseous emissions. NO<sub>x</sub> and HC measurements are performed on a wet basis, while CO, CO<sub>2</sub> and oxygen are measured on a dry basis. Sample probes are located in the same plane in the dilution tunnel.

The particulate matter sample control bench, shown in Figure A-4, is managed by the ReFUEL data acquisition system through a serial connection. It maintains a desired sample flow rate through the particulate matter (PM) filters in proportion to the overall constant volume sampling flow, in accordance with the CFR. Stainless steel filter holders, designed to the 2007 CFR requirements (Figure A-5, center), house 47-mm-diameter Teflon membrane filters through which the dilute exhaust sample flows. The PM sampling system is capable of drawing a sample directly from the large full-scale dilution tunnel or utilizing secondary dilution to achieve the desired temperature, flow, and concentration characteristics. A cyclone separator, as described in the CFR requirements, is employed to mitigate tunnel PM artifacts.



**Figure A-4. Emissions bench**

A dedicated clean room/environmental chamber (Figure A-5, left) is inside the ReFUEL facility. It is a Class 1000 clean room with precise control over the temperature and humidity ( $\pm 1^\circ\text{C}$  for temperature and dew point). This room is used for all filter handling, conditioning, and weighing.



**Figure A-5. Class 1000 clean room, filter housing, and microbalance**

The microbalance (Figure A-5, right) for weighing PM filters has a readability of 0.1  $\mu\text{g}$  (a CFR requirement) and features a barcode reader for filter identification and tracking and a computer interface for data acquisition. The microbalance is installed on a specially designed table to eliminate variation in the measurement due to vibration. The microbalance manufacturer (Sartorius) was consulted on the design of the clean room, to ensure that the room air flow would be compatible with the microbalance.