

# DOE OCCUPATIONAL RADIATION EXPOSURE

Report  
1995



# Foreword

The goal of the U.S. Department of Energy (DOE) is to conduct its radiological operations to ensure the health and safety of all DOE employees including contractors and subcontractors, and the general public. The DOE strives to maintain radiation exposures to its workers and the public and releases of radioactivity to the environment below administrative control levels and DOE limits and to further reduce these exposures and releases to levels that are As Low As Reasonably Achievable (ALARA).

The DOE Occupational Radiation Exposure Report, 1995 provides summary and analysis of the occupational radiation exposure received by individuals associated with DOE activities. The DOE mission includes stewardship of the nuclear weapons stockpile and the associated facilities, environmental restoration of DOE and precursor agency sites, and energy research.

Collective exposure at DOE has declined by 78% over the past decade due to a cessation in opportunities for exposure during the transition in DOE mission from weapons production to cleanup, deactivation, and decommissioning, and changes in reporting requirements and dose calculation methodology. In 1995, the collective dose increased by 12% from the 1994 value due to increased activities involving radioactive materials at five of the six highest-dose DOE sites. These activities range from increased operations to materials stabilization and cleanup activities.

This is the second report published after a significant effort in cooperation with the field to re-engineer the DOE Occupational Radiation Exposure Report. The intent is to make this report a valuable tool for managers in their management of radiological safety programs and commitment of resources. The process of data collection, analysis, and report generation is being streamlined to give managers a current assessment of the performance of the Department with respect to radiological operations. The cooperation of the sites in promptly and correctly reporting field radiation exposure information is key to the timeliness of this report.

Your feedback and comments are important to us to make this report meet your needs. A user survey form is included in Appendix F to collect your suggestions to improve this report.

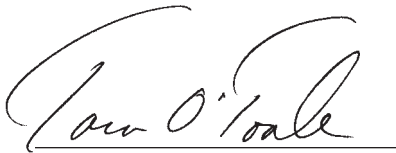

*Tara O'Toole, MD., M.P.H.  
Assistant Secretary  
Environment, Safety and Health*

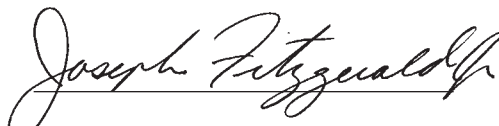

*Joseph Fitzgerald, Jr.  
Deputy Assistant Secretary  
Office of Worker Health and Safety*



# Contents

## Table of Contents

<b>FOREWORD</b> .....	iii
<b>ACKNOWLEDGMENTS</b> .....	ix
<b>EXECUTIVE SUMMARY</b> .....	xi
<b>SECTION 1 — INTRODUCTION</b>	
1.1 Report Organization .....	1-1
1.2 Annual Report Improvement Process .....	1-2
1.3 Report Availability .....	1-2
<b>SECTION 2 — STANDARDS AND REQUIREMENTS</b>	
2.1 Radiation Protection Requirements .....	2-1
2.1.1 Monitoring Requirements .....	2-2
2.1.1.1 External Monitoring .....	2-2
2.1.1.2 Internal Monitoring .....	2-2
2.2 Radiation Dose Limits .....	2-3
2.2.1 Administrative Control Levels .....	2-4
2.2.2 ALARA Principle .....	2-4
2.3 Reporting Requirements .....	2-5
2.4 Change in Internal Dose Methodology .....	2-5
2.4.1 Annual Effective Dose Equivalent .....	2-5
2.4.2 Committed Effective Dose Equivalent .....	2-6
2.4.3 Impact on the Dose Data .....	2-6
2.4.4 External Dose .....	2-7
<b>SECTION 3 — OCCUPATIONAL RADIATION DOSE AT DOE</b>	
3.1 Analysis of the Data .....	3-1
3.2 Analysis of Collective Data .....	3-1
3.2.1 Number of Monitored Individuals .....	3-1
3.2.2 Number of Individuals with Measurable Dose .....	3-1
3.2.3 Collective Dose .....	3-2
3.2.4 Average Measurable Dose .....	3-5
3.2.5 Dose Distribution .....	3-5
3.3 Dose to Individuals .....	3-8
3.3.1 Doses in Excess of DOE Limits .....	3-8
3.3.2 Doses in Excess of Administrative Control Level .....	3-10
3.3.3 Internal Depositions of Radioactive Material .....	3-11
3.4 Site Analysis .....	3-14
3.4.1 Collective TEDE by Operations/Field Offices .....	3-14
3.4.2 Dose by Labor Category .....	3-16
3.4.3 Dose by Facility Type .....	3-17
3.4.4 Radiation Protection Occurrence Reports .....	3-18
3.5 Activities Contributing to Collective Dose in 1995 .....	3-21
3.6 Operational Status of Certain DOE Facilities .....	3-23

## SECTION 4 — ALARA ACTIVITIES AT DOE

4.1 LANL Electro-Septum Magnet Redesign .....	4-1
4.2 Submitting ALARA Success Stories for Future Annual Reports .....	4-3
4.3 Lessons Learned Process Improvement Team.....	4-3

## SECTION 5 — CONCLUSIONS AND RECOMMENDATIONS

5.1 Conclusions .....	5-1
5.2 Recommendations.....	5-2

<b>REFERENCES</b> .....	R-1
-------------------------	-----

<b>GLOSSARY</b> .....	G-1
-----------------------	-----

## APPENDICES

A DOE Reporting Sites and Reporting Codes .....	A-1
B Additional Data .....	B-1
C Facility Type Code Descriptions .....	C-1
D Limitations of Data .....	D-1
E Access to Radiation Exposure Information .....	E-1
F User Survey .....	F-1

## LIST OF EXHIBITS

Exhibit 1-1: Report Re-engineering Process .....	1-2
Exhibit 2-1: DOE Dose Limits from 10 CFR 835 .....	2-3
Exhibit 3-1: Monitoring of the DOE Workforce .....	3-2
Exhibit 3-2: Components of TEDE, 1991-1995 .....	3-3
Exhibit 3-3: Average Measurable DDE Dose and Average Measurable TEDE .....	3-5
Exhibit 3-4: Dose Distributions, 1991-1995 .....	3-6
Exhibit 3-5: Distribution of Collective Dose vs Dose Values .....	3-7
Exhibit 3-6: Number of Individuals Exceeding 5 rem (TEDE), 1991-1995 .....	3-8
Exhibit 3-7: Doses in Excess of DOE Limits, 1991-1995 .....	3-9
Exhibit 3-8: Number of Doses in Excess of the DOE 2 rem Administrative Control Level, 1991-1995 .....	3-10
Exhibit 3-9: Number of Intakes, Collective Internal Dose, and Average Dose by Nuclides, 1993-1995 .....	3-11
Exhibit 3-10: Internal Dose Distribution from Intakes, 1991-1995 .....	3-12
Exhibit 3-11: Collective TEDE by Site/Facility .....	3-14
Exhibit 3-12: Collective TEDE and Number of Individuals with Measurable TEDE by Site/Facility, 1993-1995 .....	3-15
Exhibit 3-13: Doses by Labor Category, 1993-1995 .....	3-16
Exhibit 3-14: Graph of Doses by Labor Category, 1993-1995 .....	3-16
Exhibit 3-15: Graph of Dose by Facility Type, 1993-1995 .....	3-17
Exhibit 3-16: Doses by Facility Type, 1993-1995 .....	3-17
Exhibit 3-17: Criteria for Radiation Exposure and Personnel Contamination Occurrence Reporting .....	3-18
Exhibit 3-18: Radiation Exposure Occurrence Reports, 1993-1995 .....	3-19
Exhibit 3-19: Personnel Contamination Occurrence Reports, 1993-1995 .....	3-19
Exhibit 3-20: Personnel Contamination by Affected Area, 1994-1995 .....	3-20
Exhibit 3-21: Radiation Exposure Occurrence Reports by Site, 1993-1995 .....	3-21
Exhibit 3-22: Personnel Contamination Occurrence Reports by Site, 1993-1995 .....	3-21
Exhibit 3-23: Activities Contributing to Collective TEDE in 1995 for Six Sites .....	3-22
Exhibit 3-24: Percentage of Collective TEDE by Operational Phase at Six DOE Sites for 1995 (Graph) .....	3-23
Exhibit 3-25: Percentage of Collective TEDE by Operational Phase at Six DOE Sites for 1995 .....	3-24
Exhibit 4-1: Electro-Septum Magnet Diagram .....	4-1
Exhibit 4-2: Electro-Septum Magnet Photo .....	4-2



# Acknowledgments

---

The Office of Worker Health and Safety wishes to gratefully acknowledge the assistance of several organizations that contributed to the revision of this report.

- ❖ The participants of the Annual Report Workshop conducted at DOE Headquarters in October 1995 that resulted in the core set of recommendations for this report.
- ❖ The U.S. DOE Office of Operating Experience Analysis and Feedback for their support in providing occurrence report information.
- ❖ The U.S. Nuclear Regulatory Commission for project and computer systems support.
- ❖ Support for the development and preparation of this report was provided by Science Applications International Corporation.





# Executive Summary

This is the second report published as the result of a re-engineering process initiated by the U.S. Department of Energy (DOE) Office of Environment, Safety and Health (EH) to improve the DOE Occupational Radiation Exposure Report and associated database. The intent is to make this report a valuable tool for DOE/DOE contractor managers in their management of radiological safety programs and to assist them in the prioritization of resources. We appreciate the efforts and contributions from the various stakeholders within and outside the DOE and hope we have succeeded in making the report more useful.

The DOE Occupational Radiation Exposure Report, 1995 presents an overview of the radiation exposure received by DOE employees, contractors, subcontractors, and the general public. The exposure information is analyzed in terms of collective data, dose to individuals, and dose by site. For the purposes of examining trends, data for the past 5 years are included in the analysis.

As shown in the figure below, between 1994 and 1995, the DOE collective total effective dose equivalent (TEDE) increased by 12% due to an increase in activities at 5 of the 6 highest dose sites. In addition, the average dose to workers with measurable dose increased by 20%, the number of individuals receiving measurable dose dropped by 7%, and there were no exposures over the Department's 5 rem TEDE limit.

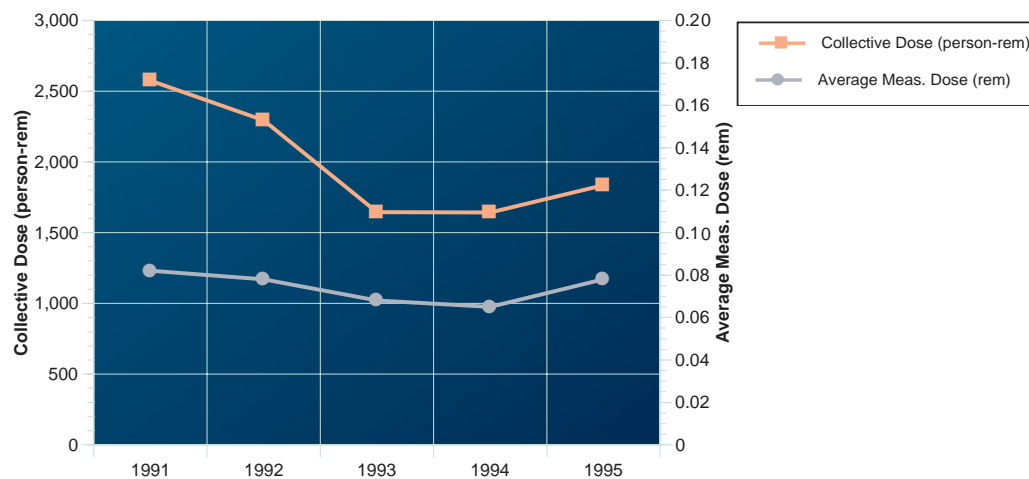

Nearly 80% of the collective TEDE for the DOE complex was accrued at just six DOE sites in 1995. These six sites are Savannah River, Rocky Flats, Hanford, Los Alamos, Idaho, and Brookhaven. Weapons fabrication and testing facilities account for the highest collective dose. For the past 3 years, technicians received the highest collective dose of any specified labor category.

Occupational radiation exposure at DOE has been impacted over the past 5 years by changes in:

- ♦ reporting requirements, and
- ♦ operational status of DOE facilities, and
- ♦ radiation protection standards and practices

Changes in the reporting requirements have had a significant impact on the collective dose at DOE. The change in internal dose methodology from annual effective dose equivalent

(AEDE) to committed effective dose equivalent (CEDE) between 1992 and 1993 resulted in an apparent reduction of the collective TEDE by up to 28% because the dose from intakes from previous years is no longer reported in the current year.

Changes in operational status of facilities was the predominant driver behind changes in the collective dose between 1985 and 1992. As facilities shut down and underwent transition from operation to stabilization or decommissioning and decontamination, there were significant reductions in the opportunities for individuals to be exposed. Changes in operational status resulted in a large reduction in dose in the late 1980s as many facilities were shut down. The activities contributing to the collective dose and operational status of certain DOE sites in 1995 is discussed in Sections 3.5 and 3.6.

Radiation protection practices have changed during the past 5 years because of the implementation of the DOE Radiological Control (RadCon) Manual. The RadCon Manual changed the methods of determining internal dose, established Administrative Control Levels (ACLs), standardized radiation protection programs, and formalized “As Low As Reasonably Achievable” (ALARA) practices. Occupational doses at DOE facilities in excess of 2 rem ACL and 5 rem TEDE limit have decreased over the past 5 years, as shown in the figures below. For the second year in a row, there were no individuals with doses in excess of the DOE 5 rem TEDE limit.

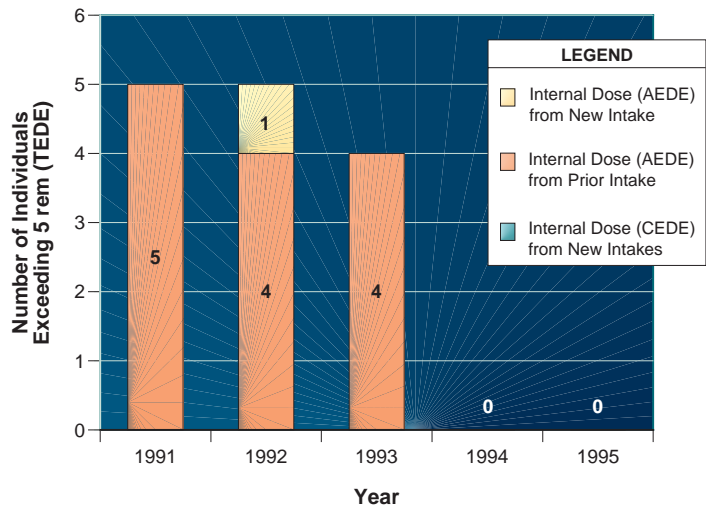
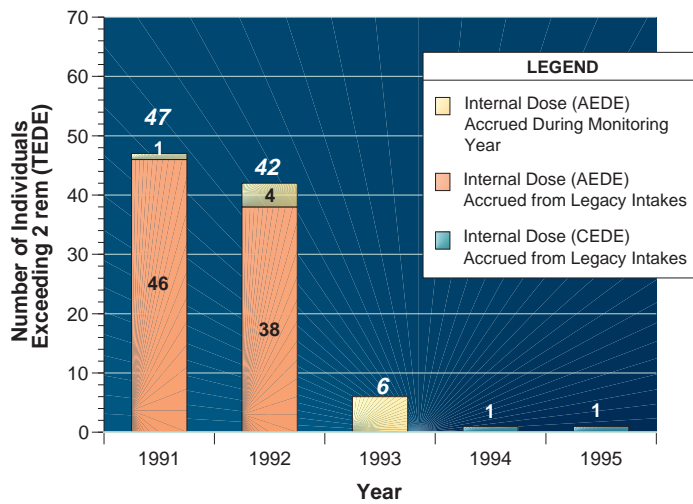

As a result of the analysis presented in this report, several recommendations are made.

- ◆ The changing mission of the DOE has resulted in a shift in the phase of operation for most of the weapons production facilities at the DOE resulting in the need to track and analyze this information in relation to the radiation exposure at these facilities.
- ◆ It is recommended that, in coordination with CAIRS, ORPS, Epidemiological Surveillance, and other EH database systems, facility type codes should be standardized.
- ◆ The sites need to improve the procedures for recording and reporting the occupation codes of the monitored individuals in accordance with the reporting requirements.
- ◆ DOE should establish a historical repository of intake information in order to track and assess radiation dose from intakes from prior years, since internal dose from prior intakes is no longer reported by the sites.



# Section One

## Introduction

1

Introduction

The *DOE Occupational Radiation Exposure Report, 1995* reports occupational radiation exposures incurred by individuals at U.S. Department of Energy (DOE) facilities during the calendar year 1995. This report includes occupational radiation exposure information for all DOE employees, contractors, subcontractors, and visitors. This information is analyzed and trended over time to provide a measure of the DOE's performance in protecting its workers from radiation.

Occupational radiation exposure at DOE has been decreasing in recent years, but experienced an increase in 1995. The increase in collective dose was attributed to increased activities at five of the six largest DOE sites. There were no doses in excess of the 5 rem TEDE limit.

The analysis of trends is complicated by recent changes in internal dose reporting methodology and the shifting of the DOE mission from weapons production to stabilization and cleanup activities across the DOE complex. The change in internal dose reporting and its impact on the occupational exposure data are examined in Sections 2 and 3. An analysis of the

change in mission and operational status of certain DOE facilities in relation to radiation exposure is included in Section 3.6.

In general, the occupational radiation exposure received by DOE workers is low compared to DOE exposures in prior years, particularly during the Cold War era, and in comparison with occupational exposure received in the commercial nuclear industry.

### 1.1 Report Organization

This report is organized into the five sections listed below.

Supporting technical information, tables of data, and additional items that were identified by users as useful are provided in the appendices.

<b>Section One</b>	Provides the introduction of re-engineering efforts and organization of the report.
<b>Section Two</b>	Provides a discussion of the radiation protection and dose reporting requirements and their impacts on data interpretation. Additional information on dose calculation methodologies, personnel monitoring methods and reporting thresholds, regulatory dose limits, and ALARA are included.
<b>Section Three</b>	Presents the occupational radiation dose data from monitored individuals at DOE facilities for 1995. The data are analyzed to show trends over the past 5 years.
<b>Section Four</b>	Includes examples of successful ALARA projects within the DOE complex.
<b>Section Five</b>	Conclusions are presented based on the analysis contained in this report. Where applicable, recommendations are included to address issues that require attention.

## 1.2 Annual Report Improvement Process

The organization of this report, as well as many other changes from previous reports, is the result of recommendations from a working group tasked with improving the usefulness of DOE occupational radiation exposure data. Additional input was obtained from a survey of report users and external stakeholders. Similar reports published by other agencies were reviewed to identify data treatment techniques that would better serve the report users. The report re-engineering process, as shown in Exhibit 1-1, identified several analyses that may be useful to users but were not previously included in DOE exposure reports. Analyses that have been added to the 1995 report include; a summary of radiation exposure occurrence reports, information on the status of operations at certain DOE facilities, a description of activities contributing to dose, and additional data tables containing information on internal and neutron dose. This report is made possible by the valuable contributions and efforts of stakeholders.

DOE also instituted a process of continuous improvement to ensure the report continues

to evolve in meeting user and stakeholder needs. As a part of this process, a questionnaire is included in this report (Appendix E) to collect suggestions for improving the report. The report provides DOE occupational radiation dose status and analysis of the dose data. The report is intended to be a valuable tool for DOE/DOE contractor managers to improve the radiation protection programs and ALARA programs, and to assist them in prioritizing allocation of resources. The report also is useful in demonstrating DOE radiation safety performance to external stakeholders.

## 1.3 Report Availability

Requests for additional copies of this report or access to the data files used to compile this report should be directed to Ms. Nirmala Rao, REMS Project Manager, U.S. Department of Energy, Office of Worker Protection Programs and Hazards Management (EH-52), Germantown, MD 20874 or by calling the ES&H InfoCenter at 1-800-473-4375. A discussion of the various methods of accessing the DOE occupational radiation exposure information is presented in Appendix F

Exhibit 1-1:  
Report Re-engineering  
Process

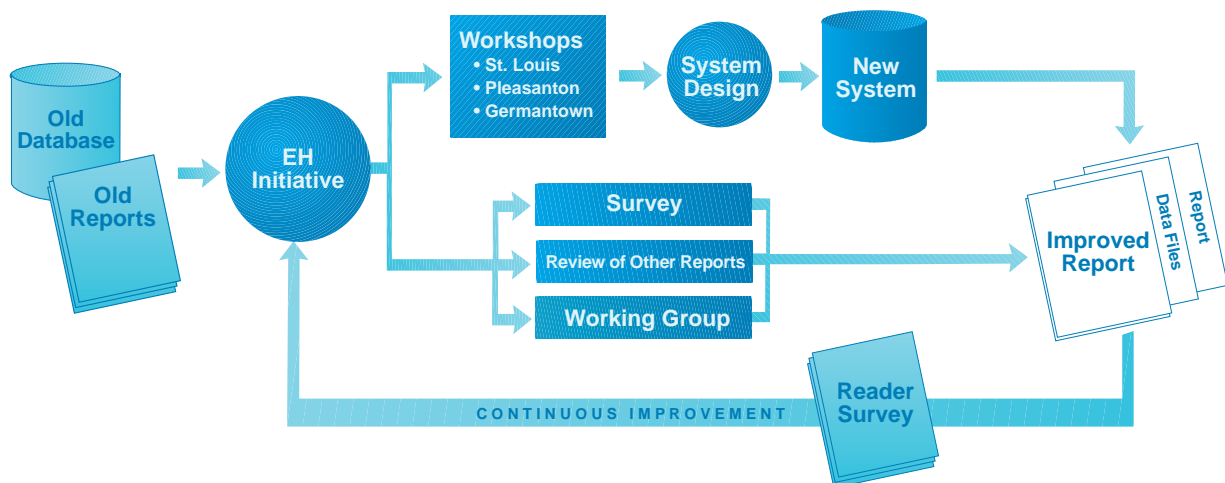

# Section Two

## Standards and Requirements

# 2

One of DOE's primary objectives is to ensure that all of its operations and those of its contractors are conducted safely. To help achieve this objective, DOE has established radiation protection standards and program requirements to protect workers and the public from ionizing radiation. The basic DOE standards are radiation dose limits, which establish maximum permissible doses to workers and visitors. In addition to the requirement that radiation doses not exceed the limits, it is DOE's policy that doses also be maintained ALARA.

This section discusses the radiation protection standards and requirements that were in effect for the year 1995. The requirements leading up to this time period are also included to facilitate a better understanding of changes that have occurred in the recording and reporting of occupational dose.

### 2.1 Radiation Protection Requirements

DOE radiation protection standards are based on federal guidance for protection against occupational radiation exposure promulgated by the U.S. Environmental Protection Agency (EPA) in 1987 [1]. These standards are provided to ensure that workers at DOE are adequately protected from exposure to ionizing radiation. This guidance, initially implemented in 1989, is based on the 1976 recommendations of the International Commission on Radiological Protection [2] and the National Council on Radiation Protection and Measurements [3]. The new guidance required that internal organ dose (resulting from the intake of radionuclides) be added to the external whole-body dose to determine the Total Effective Dose Equivalent (TEDE). Prior to this, the whole-body dose and internal organ dose were each limited separately. The new DOE dose limits based on the TEDE were established from this guidance.

DOE became the first federal agency to implement the revised guidance when it promulgated DOE Order 5480.11, "Radiation Protection for Occupational Workers," in December 1988 [4]. DOE Order 5480.11 was effective from 1989 through 1995.

In June 1992, the DOE Radiological Control (RadCon) Manual [5] was issued and became effective in 1993. The RadCon Manual was the result of a Secretarial initiative to improve and standardize radiological protection practices throughout DOE and to achieve the goal of making DOE the pacesetter for radiological health and safety. The RadCon Manual is a comprehensive guidance document written for line managers and senior management. The RadCon Manual states DOE's views on the best practices currently available in the area of radiological control. The RadCon Manual was revised in 1994 in response to comments from the field and to enhance consistency with the requirements in 10 CFR 835 [6].

10 CFR 835 became effective on January 13, 1994, and required full compliance by January 1, 1996. In general, 10 CFR 835 codifies existing radiation protection requirements in DOE Order 5480.11. With the promulgation of 10 CFR 835, DOE Order 5480.11 was canceled and the RadCon Manual was made non-mandatory guidance. The rule provides nuclear safety requirements that, if violated, will provide a basis for the assessment of civil and criminal penalties under the Price-Anderson Amendments Act of 1988, Public Law 100-408, August 20, 1988 [7].

DOE Notice 441.1, "Radiological Protection for DOE Activities," [8] (applicable to defense nuclear facilities) was issued to establish radiological protection program requirements that, combined with 10 CFR 835 and its associated non-mandatory implementation guidance, form the basis for a comprehensive radiological protection program.



During 1994 and 1995, DOE undertook an initiative to reduce the burden of unnecessary, repetitive, or conflicting requirements on DOE contractors. As a result, DOE Order 5484.1 [9] requirements for reporting radiation dose records are now located in the associated manual, DOE M 231.1-1, "Environment, Safety and Health Reporting" [10], which became effective September 30, 1995.

The requirements of DOE M 231.1-1 are basically the same as Order 5484.1, however, the dose terminology was revised to reflect the changes made in radiation protection standards and requirements. For 1995, DOE Order 5484.1 remained in effect. However, a few sites began reporting under the new DOE M 231.1-1 for 1995. Because each site implements the new requirements as operating contracts are issued or renegotiated, complete implementation will take several years.

### **2.1.1 Monitoring Requirements**

10 CFR §835.402 requires that, for external monitoring, personnel dosimetry be provided to personnel expected to receive an effective dose equivalent to the whole-body greater than 0.1 rem or an effective dose equivalent to the skin or extremities, lens of the eye, or any organ or tissue greater than 10% of the corresponding annual limits. Monitoring for internal radiation exposure is required when the individual is likely to receive 0.1 rem or more Committed Effective Dose Equivalent (CEDE), and/or 5 rems or more Committed Dose Equivalent (CDE) to any organ or tissue. Monitoring for minors and members of the public is required if the dose (internal or external) is likely to exceed 50% of the annual limits. Monitoring of declared pregnant females is required if the dose (internal or external) to the embryo/fetus is likely to exceed 10% of the limit.

Monitoring for external exposures is required for any individuals entering a high or very high radiation area.

#### **2.1.1.1 External Monitoring**

External dosimeters are used to measure ionizing radiation from sources external to the individual. The choice of dosimeter is based on the type and energy of radiation that the individual is likely to encounter in the workplace. An algorithm is then used to convert the exposure readings into dose. External monitoring devices include photographic film (film badges), thermoluminescent dosimeters, pocket ionization chambers, electronic dosimeters, personnel nuclear accident dosimeters, bubble dosimeters, plastic dosimeters, and combinations of the above.

Beginning in 1990, the Department of Energy Laboratory Accreditation Program (DOELAP) formalized accuracy and precision performance standards for external dosimeters and quality assurance/quality control requirements on the overall external dosimetry programs for facilities within the DOE complex. All DOE facilities were DOELAP-accredited by the fall of 1995.

External dosimeters have a limit of detection of approximately 0.010 - 0.030 rem per monitoring period. The differences are attributable to the particular type of dosimeter used and the types of radiation monitored. Monitoring periods are usually quarterly for individuals receiving less than 0.300 rem/year and monthly for individuals who routinely receive higher doses or who enter higher radiation areas.

#### **2.1.1.2 Internal Monitoring**

Personnel internal radiation monitoring programs include work area monitoring and bioassay monitoring. Work area monitoring includes both air sampling and surface contamination monitoring. The purpose of work area monitoring is to identify sources of removable radioactive material. Bioassay monitoring includes in-vitro (outside the body) and in-vivo (inside the body) sampling. In-vitro assays include urine and fecal samples, nose

swipes, saliva samples, and hair samples. In-vivo assays include whole-body counting, thyroid counting, lung counting, and wound counting.

Monitoring intervals for internal dosimetry are dependent on the radionuclides being monitored and their concentrations in the work environment. Routine monitoring intervals may be monthly, quarterly, or annually, whereas special monitoring intervals following an incident may be daily or weekly. Reporting thresholds for internal dosimetry are highly dependent on the monitoring methods, the radionuclides in question, and their chemical form. Follow-up measurements and analysis may take many months to confirm preliminary findings. With the advent of the publication of ANSI N13.30-1996, "Performance Criteria for Radiobioassay", DOE is developing a Radiobioassay Accreditation Program with scheduled implementation in 1998.

## 2.2 Radiation Dose Limits

Radiation dose limits are now codified in 10 CFR §835.201-209 and are summarized in *Exhibit 2-1*.

Under § 835.204, Planned Special Exposures (PSEs) may be authorized in certain conditions allowing an individual to receive exposures in excess of the dose limits shown in *Exhibit 2-1*. With the appropriate prior authorization, the dose limit for an individual may be increased to an additional 5 rems TEDE above the routine exposure limit as long as the individual does not exceed a cumulative lifetime TEDE of 25 rems. PSE doses are required to be recorded separately and are only intended to be used in exceptional situations where dose reduction alternatives are unavailable or impractical. Restrictions on the use of PSEs are extensive, and for this reason, they are expected to be rarely used at DOE.

**Exhibit 2-1:**  
**DOE Dose Limits from 10 CFR 835**

Personnel Category	Section of 10 CFR 835	Type of Exposure	Acronym	Annual Limit
General Employees	§835.202	Total Effective Dose Equivalent	TEDE	5 rems
		Deep Dose Equivalent + Committed Dose Equivalent to any organ or tissue (except lens of the eye). This is often referred to as the Total Organ Dose Equivalent	DDE+CDE (TODE)	50 rems
		Lens of the Eye Dose Equivalent	LDE	15 rems
		Shallow Dose Equivalent to the skin of the Whole-body or to any Extremity	SDE-WB and SDE-ME	50 rems
Declared Pregnant Worker	§835.206	Total Effective Dose Equivalent	TEDE	0.5 rem per gestation period
Minors	§835.207	Total Effective Dose Equivalent	TEDE	0.1 rem
Members of the Public	§835.208	Total Effective Dose Equivalent	TEDE	0.1 rem

### 2.2.1 Administrative Control Levels

ACLs were included in the RadCon Manual. ACLs are established below the regulatory dose limits to administratively control and help reduce individual and collective radiation dose. ACLs are multi-tiered, with increasing levels of authority required to approve a higher level of exposure.

The RadCon Manual established a DOE ACL of 2 rem per year per person for all DOE activities. Prior to allowing an individual to exceed this level, approval from the appropriate Secretarial Officer or designee must be received. In addition, contractors were required to establish an annual facility ACL. This control level is established by the contractor senior site executive and is based upon an evaluation of historical and projected radiation exposures, workload, and mission. The RadCon Manual suggests an annual facility ACL of 0.5 rem or less; however, the Manual also states that a control level greater than 1.5 rem is, in most cases, not sufficiently challenging. Approval by the contractor senior site executive must be received prior to an individual exceeding the facility ACL.

ACLs are not specified in 10 CFR 835. However, they are specified under DOE Notice 441.1. Administrative controls are required to be implemented to keep doses below the dose limits and to keep doses ALARA. DOE N 441.1 establishes the following administrative control limits: a 2 rem annual TEDE, a 1 rem cumulative TEDE per year of age, and requires that a facility-specific ACL be established for each site.

### 2.2.2 ALARA Principle

Up until the 1970s, the fundamental radiation protection principle was to limit occupational radiation dose to quantities less than the regulatory limits and to be

concerned mainly with high dose and high dose rate exposures. During the 1970s, there was a fundamental shift within the radiation protection community to be concerned with low dose and low dose rate exposures because it can be inferred from the linear no-threshold dose response hypothesis that there is an increase level of risk associated with any radiation exposure. The ALAP (As Low As Practicable) concept was initiated and became part of numerous guidance documents and radiation protection good practices. ALAP was eventually replaced by ALARA. DOE Order 5480.11, the RadCon Manual, and 10 CFR 835 formalized the guidance and required that each DOE facility have an ALARA Program as part of its overall Radiation Protection Program.

The ALARA methodology considers both individual and group doses and generally involves a cost/benefit analysis. The analysis considers social, technical, economic, practical, and public policy aspects to the overall goal of dose reduction. Because it is not feasible to reduce all doses at DOE facilities to zero, ALARA cost/benefit analysis must be used to optimize levels of radiation dose reduction. According to the ALARA principle, resources spent to reduce dose needs to be balanced against the risks avoided. Reducing doses below this point results in a misallocation of resources; the resources could be spent elsewhere and have a greater impact on health and safety.

To ensure that doses are maintained ALARA at DOE facilities, the DOE mandated in DOE Order 5480.11 and subsequently in the RadCon Manual that ALARA plans and procedures be implemented and documented. To help facilities meet this requirement, the DOE developed a manual of good practices for

reducing exposures to ALARA levels [11]. This document includes guidelines for administration of ALARA programs, techniques for performing ALARA calculations based on cost/benefit principles, guidelines for setting and evaluating ALARA goals, and methods for incorporating ALARA criteria into both radiological design and operations. The establishment of ALARA as a required practice at DOE facilities demonstrates DOE's commitment to ensure minimum risk to workers from the operation of its facilities.

## 2.3 Reporting Requirements

In 1987, the DOE promulgated revised reporting requirements in DOE Order 5484.1, "Environmental Protection, Safety, and Health Protection Information Reporting Requirements." Previously, contractors were required to report only the number of individuals who received an occupational whole-body exposure in one of 16 dose equivalent ranges. The revised Order requires the reporting of exposure records for each employee and visitor. Required dose data reporting includes the TEDE, internal dose equivalent, shallow dose equivalent to the skin and extremities, and Deep Dose Equivalent (DDE). Other reported data included the individual's age, sex, employment status, and occupation, as well as the relevant organization and facility type.

Occupational radiation exposure reporting requirements are now included in DOE M 231.1-1, which became effective September 30, 1995. The reporting requirements under DOE M 231.1-1 are very similar to the requirements under Order 5484.1.

## 2.4 Change in Internal Dose Methodology

Prior to 1989, intakes of radionuclides into the body were not reported as dose, but as body burden in units of activity ( $\mu\text{Ci}$ ) of intake. The implementation of DOE Order 5480.11 in 1989 specified that the intakes of radionuclides be converted to internal dose and reported using the annual effective dose equivalent (AEDE) methodology.

With the implementation of the RadCon Manual in 1993, the methodology used to calculate and report internal dose was changed from the AEDE to the 50-year CEDE. The change was made to conform with the consensus of the radiation protection community and the revised 10 CFR 20 [12], which was implemented in 1994 regulating commercial nuclear power plants and other commercial uses of radiation and radioactive materials. The CEDE methodology is now codified in 10 CFR 835.

The following is a description of these methodologies and a discussion of how this change has impacted the DOE dose data.

### 2.4.1 Annual Effective Dose Equivalent

The AEDE method of determining internal dose involves calculating the annual dose to the worker for each year since the original intake event. Because many of the radionuclides used at DOE are long-lived, workers can receive an annual dose from past intakes for many years, even a lifetime. DOE used the AEDE method for calculating internal dose equivalent because the annual dose resulting from an intake was more representative of the actual dose received by the worker during each calendar year.

**Readers should note that the method of calculating internal dose changed from AEDE to CEDE between 1992 and 1993.**

The AEDE method is problematic from a radiological control viewpoint. It does not account for the dose that would be received by an individual during his lifetime. Facilities must keep track of prior intakes to determine the dose for the current year. The AEDE method does not consider the future dose to the worker resulting from a current year intake. The AEDE method may also impact the individual's future job potential. The accumulation of prior year AEDE doses (legacy doses) may result in a current year dose in excess of the facility's ACL and restrict the individual's current year radiation work opportunities.

The AEDE method spreads the accounting of an intake across many future years. This decreases the likelihood that the annual reported dose will exceed a regulatory limit or ACL and therefore reduces the likelihood of regulatory enforcement and/or corrective actions related to intakes of radioactive material.

#### **2.4.2 Committed Effective Dose Equivalent**

The CEDE method assigns all of the dose the individual will receive from an intake for the next 50 years to the year the intake occurred. The sum of all AEDE doses over 50 years from a given intake of radionuclides is equal to the CEDE from the same intake. By assigning all of the future dose to the year of intake, even small intakes of long-lived radioactive material can result in a relatively large dose being assigned to a single year in the year of intake. The CEDE increases the pressure on facilities to limit such exposures and allows DOE to limit internal dose during the year of occurrence while not unduly impacting the worker's future employability.

#### **2.4.3 Impact on the Dose Data**

This change in internal dose accounting and reporting has two main impacts on the DOE dose data. First and foremost is that "legacy doses" (internal AEDE dose resulting from intakes in years prior to the dose report year) are included in the collective TEDE shown in this report for 1991 and 1992. Legacy doses represent a significant amount of dose to the DOE worker population during these years.

In 1992, nearly 5,500 individuals were receiving 65% of their annual dose from intakes that occurred in prior years, many having occurred 20 to 30 years before. In the analysis of exposures in excess of the DOE limits and the 2 rem ACL presented in Sections 3.3.1 and 3.3.2, readers should note that most of the exposures for 1991 and 1992 were because of the inclusion of the AEDE from prior year intakes.

Beginning in 1993, internal dose was reported using the CEDE methodology. Legacy doses were no longer included or reported because the CEDE is calculated only from new intakes occurring during the year of the report. The new reporting requirements did not require the reporting of internal dose resulting from intakes during prior monitoring years.

Because these legacy doses are no longer reported, there is an apparent large drop from 1992 to 1993 in the total collective dose for all workers, and in the number of workers who received high doses. Where applicable, the contribution from legacy dose has been highlighted. Readers should be alerted to the significance of this change in order to correctly interpret the data.

The second major impact of the change from AEDE to CEDE is in the internal dose for 1993 through 1995. As noted previously, the CEDE includes the dose to the individual for the next 50 years. This greatly magnifies the dose from small intakes of long-lived radionuclides. Intakes that would have resulted in an AEDE below ACLs prior to 1993 now may result in a CEDE above the regulatory limits. For long-lived radionuclides, the difference in values between AEDE and CEDE may be up to 50 times.

It is important to note that the change from AEDE to CEDE impacted the calculation of dose from only long-lived isotopes, such as uranium and plutonium. Internal dose from the intake of isotopes with retention periods of less than a year, such as tritium, were not impacted. For short-lived isotopes or isotopes with short retention periods, AEDE is equal to the CEDE because the entire dose is accrued during the year of intake.

#### **2.4.4 External Dose**

The change from the AEDE to CEDE for internal dose does not affect the reporting of external dose. The only changes in the DDE data from 1987 through 1995 have been the continuing improvements in dosimeter detection levels and standardization through accreditation by DOELAP. Interpreting the trends of DDE during this period is, therefore, consistent.



# Section Three

## Occupational Radiation Dose at DOE

# 3

### 3.1 Analysis of the Data

The purpose of analyzing occupational radiation dose data is to reveal opportunities to improve safety and to demonstrate performance. This is accomplished through analysis and explanation of observed trends. Several indicators were identified from the data submitted to the central data repository that can be used to evaluate the occupational radiation exposures received at DOE facilities. Analysis of these indicators falls into three categories: collective, individual, and site. In addition, the key indicators are analyzed to identify and correlate parameters having an impact on radiation dose at DOE.

The key indicators for the analysis of collective data are: collective dose, number of monitored individuals and individuals with measurable dose, average measurable dose, and the distribution of dose. Analysis of individual dose data includes an examination of doses exceeding DOE limits, and doses exceeding the 2 rem DOE ACL. Analysis of site data includes comparisons by site, labor category, and facility type. Additional information is provided concerning activities at sites contributing to the collective dose.

### 3.2 Analysis of Collective Data

#### 3.2.1 Number of Monitored Individuals

The number of monitored individuals represents the size of the worker population at DOE provided with dosimetry. This number represents the sum of all monitored individuals, including all DOE employees, contractors, and visitors. The number of monitored individuals is an indication of the size of a dosimetry program, but it is not necessarily an indicator of the size of the

exposed workforce. This is because of the conservative practice at some DOE facilities of providing dosimetry to individuals for reasons other than the potential for exposure to radiation and/or radioactive materials exceeding the monitoring thresholds. Many individuals are monitored for reasons such as security, administrative convenience, and legal liability. Some sites offer monitoring for any individual who requests monitoring, independent of the potential for exposure. For this reason, workers receiving measurable dose better represent the exposed workforce.

#### 3.2.2 Number of Individuals with Measurable Dose

The DOE uses the number of individuals receiving measurable dose to represent the exposed workforce size. The number of individuals with measurable dose includes any individuals with reported TEDE greater than zero.

*Exhibit 3-1* shows the total number of workers at DOE, the total number monitored, and the number with measurable dose for the past 5 years. From 1991 to 1995, 66% of DOE employees and contractors were monitored for radiation exposure. However, most of these individuals did not receive any measurable radiation dose. Only 22% of monitored workers (12% of the DOE workforce) received a measurable dose during this 5-year time period. The number of workers with measurable dose has decreased by 25% over the past 5 years.

Half (14) of the 28 sites experienced decreases in the number of workers with measurable dose from 1994 to 1995, with the largest decreases occurring at the Hanford and Savannah River sites. Portsmouth Gaseous Diffusion Plant experienced a large increase in the number



**Exhibit 3-1:**  
**Monitoring of the DOE Workforce**

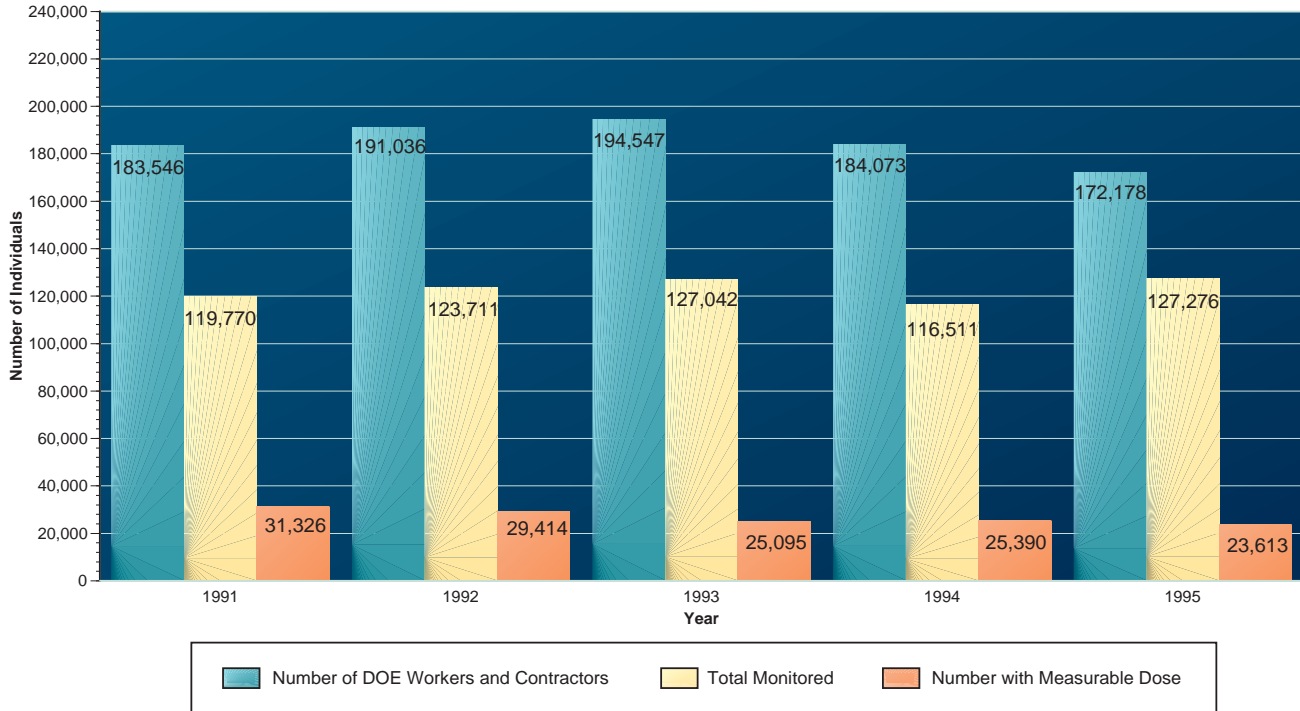

**About 22% of monitored workers received a measurable dose over the past 5 years.**

**The number of workers with measurable dose has decreased by 25% over the past 5 years.**

**Overall, the number of individuals with a measurable dose decreased by 7% between 1994 and 1995.**

of individuals with measurable dose due to a change in dosimetry. While the increased sensitivity of the new dosimeters resulted in more individuals reporting a measurable dose, the collective dose at Portsmouth decreased in 1995. Overall, the number of individuals with a measurable dose decreased by 7% between 1994 and 1995. A discussion of activities at various facilities is included in Section 3.5.

### 3.2.3 Collective Dose

The collective dose is the sum of the dose received by all individuals with measurable dose (*Exhibit 3-1*) and is measured in units of person-rem. The collective dose is an indicator of the overall radiation exposure at DOE facilities and includes the dose to all DOE employees, contractors, and visitors. DOE's objective is to keep individual

exposures and collective exposure ALARA. The collective dose is also used in analysis of the statistical risk of radiation injury to workers in an exposed population. For these reasons, DOE monitors the collective dose as a measure of success of the overall performance of radiation protection programs to keep individual exposures and collective exposures ALARA.

As shown in *Exhibit 3-2*, the collective TEDE increased at DOE by 12% from 1994 to 1995. Half of the DOE sites reported increases in the collective TEDE from the 1994 values. Five out of six of the highest dose sites reported increases in the collective TEDE. A discussion of the activities leading to this increase is included in Section 3.5.

**Exhibit 3-2:  
Components of TEDE, 1991-1995**

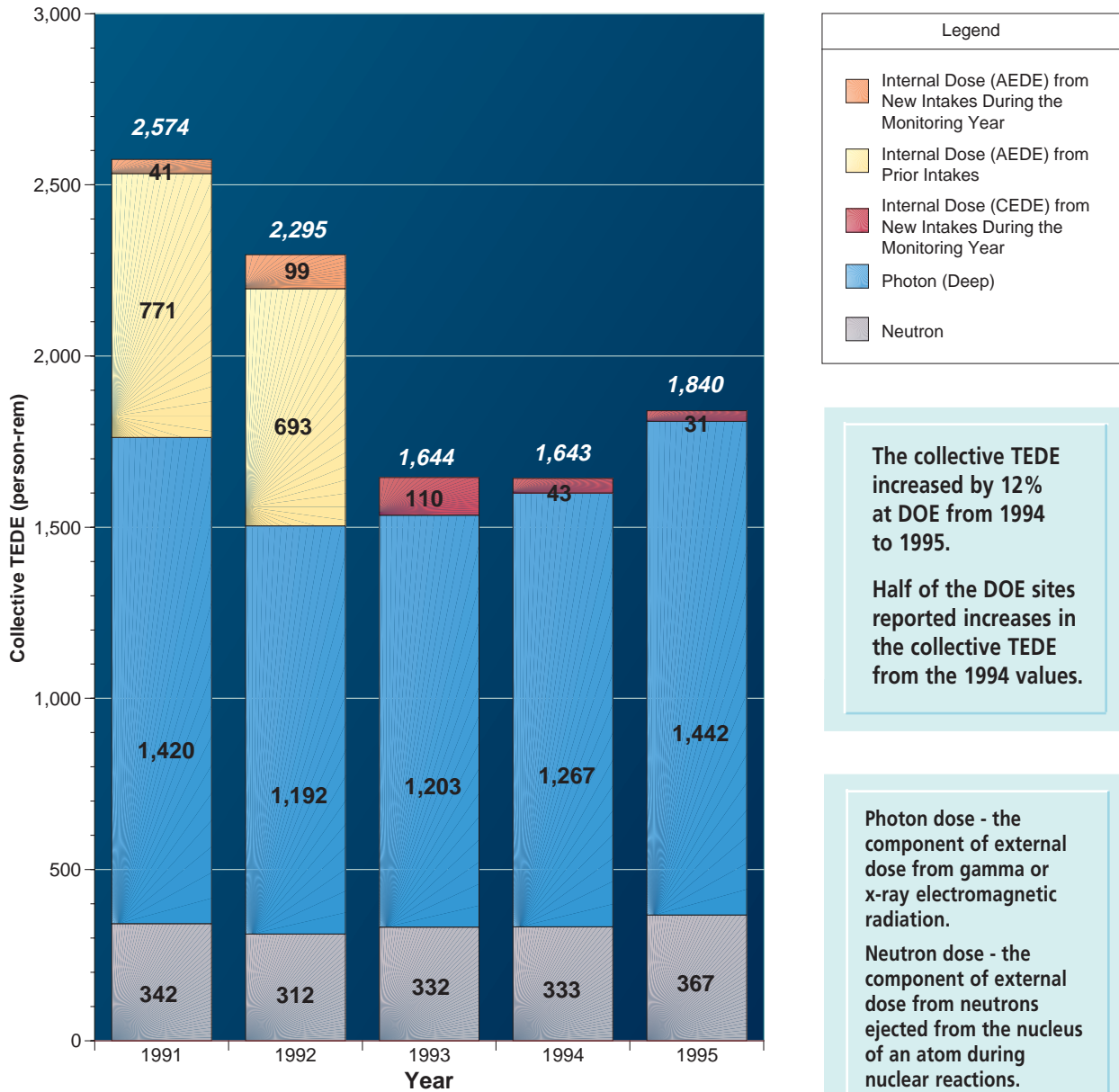

The collective TEDE increased by 12% at DOE from 1994 to 1995.

Half of the DOE sites reported increases in the collective TEDE from the 1994 values.

Photon dose - the component of external dose from gamma or x-ray electromagnetic radiation.

Neutron dose - the component of external dose from neutrons ejected from the nucleus of an atom during nuclear reactions.

Internal Dose - radiation dose resulting from radioactive material taken into the body.

It is important to note that the collective TEDE includes the components of external dose and internal dose. *Exhibit 3-2* shows the types of radiation and their contribution to the collective TEDE. The photon, neutron, and internal dose components are shown.

The large decrease in the internal dose from 1992 to 1993 was due to the change in calculating and reporting of the internal dose from AEDE to CEDE. It must be noted that the internal dose shown in *Exhibit 3-2* for 1993 through 1995 is based on the CEDE and therefore

should not be compared with the AEDE internal dose from 1991 and 1992. The internal dose component decreased by 40% from 1994 to 1995, primarily due to decreases in internal dose at Los Alamos National Laboratory (LANL) and Rocky Flats.

Because the reporting of internal dose changed in 1993 (see Section 2.4), it is necessary to analyze the collective external dose during this time period in order to examine the collective dose trend across the past 5 years. External dose is comprised of radiation dose from photons (gamma or x-ray) and neutrons.

The photon dose decreased by 16% from 1991 to 1992 primarily because of decreases at Savannah River, Idaho, and LANL resulting from decreased activities at these facilities. The photon dose remained fairly stable at about 1,200 person-rem during the years 1992-1994, but increased by 14% to 1,442 person-rem in 1995 due to increased activities at 5 of the 6 highest dose sites. Activities responsible for increased dose at these sites included work on power sources for NASA, increased research at an accelerator facility, nuclear materials stabilization activities, and decontamination and decommissioning work. A discussion of the activities leading to this increase is included in Section 3.5.

The neutron component of the TEDE has increased by 8% from 1994 to 1995. This is primarily due to an increase in the neutron dose at LANL. LANL contributes 48% of the neutron dose at the DOE. This is because LANL is one of the few remaining sites to actively handle plutonium. Working with plutonium in gloveboxes results in neutron dose from the alpha,n reaction and from spontaneous fission of the plutonium. Activities involving plutonium at LANL increased in 1995 due to the production of heat sources for the National Aeronautics and Space Administration (NASA), which resulted in an increased neutron dose from 132.5 person-rem in 1994 to 174.1 person-rem in 1995.

The neutron dose at Brookhaven National Laboratory (BNL) also increased from 1994 to 1995. This increase was due to an 82% increase in the number of days of operation of their accelerator facility. The collective neutron dose by site is shown in Appendix B, Exhibit B-3.

Collective dose information for prior years can be found in Appendix B, Exhibit B-4.

**Exhibit 3-3:**  
Average Measurable DDE Dose and Average Measurable TEDE

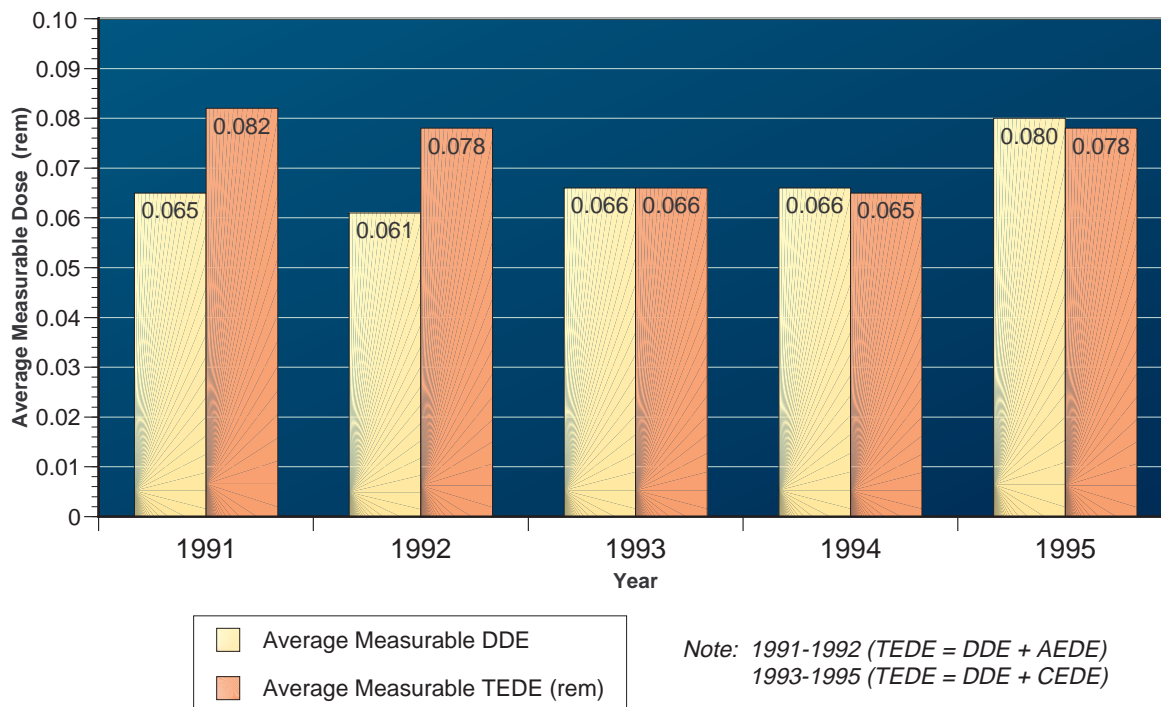

### 3.2.4 Average Measurable Dose

The average measurable dose to DOE workers is determined by dividing the collective dose by the number of individuals with measurable dose. This is considered a key indicator of the overall level of radiation dose received by DOE workers.

The average measurable TEDE is shown in *Exhibit 3-3*. The average measurable TEDE decreased by 21% from 1991 to 1994, but increased by 20% from 1994 to 1995. The average measurable DDE increased by 21% from 1994 to 1995. The increase in average measurable dose for 1995 is due to the 12% increase in the collective TEDE, as well as a 7% decrease in the number of individuals with measurable TEDE. The combined factors of fewer individuals receiving more dose resulted in the increase in average measurable dose.

While the collective dose and average measurable dose serve as measures of the magnitude of the dose accrued by workers at DOE, they do not provide any indication of how each dose was distributed across the worker population. An effective measure of ALARA is the reduction in dose to individuals, as well as to the overall workforce.

The average measurable TEDE increased by 20% from 1994 to 1995.

### 3.2.5 Dose Distribution

Exposure data are commonly analyzed in terms of dose intervals to depict the manner in which the dose is distributed among the worker population. *Exhibit 3-4* shows the number of individuals in each of 18 different dose ranges. The dose ranges are presented for the TEDE and DDE to allow analysis of the dose independent of the change in internal

**Exhibit 3-4:**  
Dose Distributions, 1991-1995

Dose Ranges (rem)		1991		1992		1993		1994		1995	
		TEDE	DDE	TEDE	DDE	TEDE	DDE	TEDE	DDE	TEDE	DDE
Number of Individuals in Each Dose Range*	Less than Measurable	88,444	92,526	94,297	98,900	101,947	103,905	91,121	92,245	103,663	104,793
	Measurable < 0.1	25,319	23,031	23,896	21,019	21,210	19,356	21,511	20,469	19,273	18,191
	0.10 - 0.25	3,752	2,753	3,581	2,585	2,487	2,437	2,437	2,389	2,543	2,513
	0.25 - 0.5	1,447	988	1,252	852	1,017	985	934	920	1,134	1,124
	0.5 - 0.75	381	266	346	235	195	183	329	317	374	371
	0.75 - 1.0	187	111	165	78	93	89	99	94	131	131
	1 - 2	193	95	132	42	87	86	79	77	157	153
	2 - 3	25		22							
	3 - 4	9		9				1		1	
	4 - 5	8		6		2	1				
	5 - 6										
	6 - 7	2		2							
	7 - 8			1							
	8 - 9	1				1					
9 - 10			1		1						
10 - 11											
11 - 12											
> 12	2		1		2						
Total Monitored		119,770	119,770	123,711	123,711	127,042	127,042	116,511	116,511	127,276	127,276
Number with Meas. Dose		31,326	27,244	29,414	24,811	25,095	23,137	25,390	24,266	23,613	22,483
Number with Dose >0.1 rem		6,007	4,213	5,518	3,792	3,885	3,781	3,879	3,797	4,340	4,292
% of Individuals with Meas. Dose		26%	23%	24%	20%	20%	18%	22%	21%	19%	18%
Collective Dose (person-rem)		2,574	1,762	2,295	1,504	1,644	1,534	1,643	1,600	1,840	1,809
Average Measurable Dose (rem)		0.082	0.065	0.078	0.061	0.066	0.066	0.065	0.066	0.078	0.080

\* Individuals with doses equal to the dose value separating the dose ranges are included in the next higher dose range.

dose reporting from 1992 to 1993 (see Section 2.3). The number of individuals receiving doses above 0.1 rem is also included to show the number of individuals with doses above the monitoring threshold specified in 10 CFR 835.402(a) and (c).

A reduction in the number of individuals in the higher dose ranges as seen in *Exhibit 3-4* is one indication that ALARA principles are being effectively applied to reduce dose to individual workers in the DOE workplace. A few examples of successful ALARA practices are included in Section 4. However, an analysis of the number of individuals in each dose range is limited, because the relative magnitude of the collective dose received by these individuals is not taken into

consideration. Another way to examine the dose distribution is to analyze the percentage of the dose received above a certain dose value compared to the total collective dose.

In 1982, the United Nations Scientific Committee on the Effects of Atomic Radiation (UNSCEAR) [13] defined CR as the fraction of the collective dose delivered above 1.5 rem. UNSCEAR identified this parameter as an indicator of the efforts to reduce high doses. The DOE has adapted this approach to allow a quantification and analysis of the dose distribution at DOE.

Ideally, only a small percentage of the collective dose is delivered to individuals in the higher dose ranges. In addition, a

**Exhibit 3-5:**  
**Distribution of Collective Dose vs Dose Values**

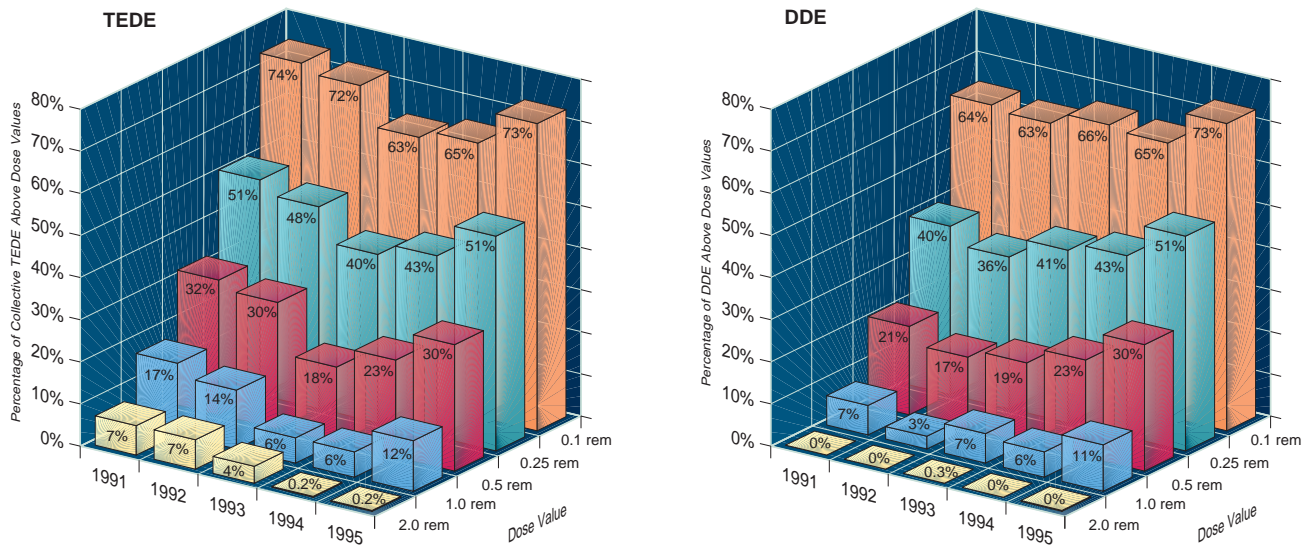

trend in the percentage above a certain dose range decreasing over time indicates the effectiveness of ALARA programs to reduce doses to individuals in the higher dose ranges.

Exhibit 3-5 shows the distribution ratio given by percentage of collective TEDE and DDE above each of five dose values, from 0.1 rem to 2 rem. This graph shows the two properties described above as the goal of effective ALARA programs at DOE: (1) a relatively small percentage of the collective dose accrued in the high dose ranges, and (2) a decreasing trend over time of the percentage of the collective dose accrued in the higher dose ranges. Much of the observed trend that occurred from 1992 to 1993 coincides with the change from AEDE to CEDE.

The data for 1995 reveal that a greater percentage of the collective TEDE was accrued between 0.1 rem and 2.0 rem

than in the previous 2 years. The percentages of the collective TEDE above 0.1 rem, 0.25 rem, and 0.5 rem were up nearly 10% for each dose value. This indicates an increase in the collective TEDE accrued by individuals in these dose ranges. Seventy percent of the workers in these dose ranges are in the labor categories of Operators, Scientists, and Technicians. This coincides with the information gathered from the sites that operational and research activities increased during 1995, which would tend to increase dose to workers in these labor categories.

The distribution of the collective TEDE shown in Exhibit 3-5 for 1995 is similar to the distribution in 1992. It should be noted that greater than 25% of all of the collective TEDE from 1991-1995 was delivered at doses less than the monitoring threshold of 0.1 rem specified in 10 CFR 835.402 (a) and (c).

### 3.3 Dose to Individuals

The above analyses are all based on collective dose data for DOE. From an individual worker perspective as well as a regulatory perspective, it is important to more closely examine the doses received by individuals in the high dose ranges in order to more thoroughly understand the circumstances leading to high doses in the workplace and how these doses may be mitigated in the future. The following analysis focuses on doses received by individuals that were in excess of the DOE limit (5 rem TEDE) and the DOE ACL (2 rem TEDE).

doses, radionuclides involved, and site where the doses occurred is shown in *Exhibit 3-7*. Most of the doses in excess of the limit shown for 1991 and 1992 were from legacy intakes as noted in the exhibit.

For the second year in a row, there were no doses above the 5 rem TEDE limit. There were no reported doses in excess of the DOE limits (see *Exhibit 2-1*) to the eyes, skin, or extremities for 1995. However, there were two events involving the intake of radioactive material that resulted in committed dose equivalents (CDE) to the maximally exposed organ or tissue in excess of the 50 rem limit specified in 10 CFR 835.202. The two events are summarized below.

There were no individuals with a dose in excess of the 5 rem TEDE limit in 1994 or 1995.

All of the events resulting in doses in excess of DOE limits from 1991 to 1993 were from internal dose.

#### 3.3.1 Doses in Excess of DOE Limits

*Exhibit 3-6* shows the number of doses in excess of the regulatory limit (5 rem TEDE) from 1991 through 1995. Further information concerning the individual

**Exhibit 3-6:**  
Number of Individuals Exceeding 5 rem (TEDE), 1991-1995

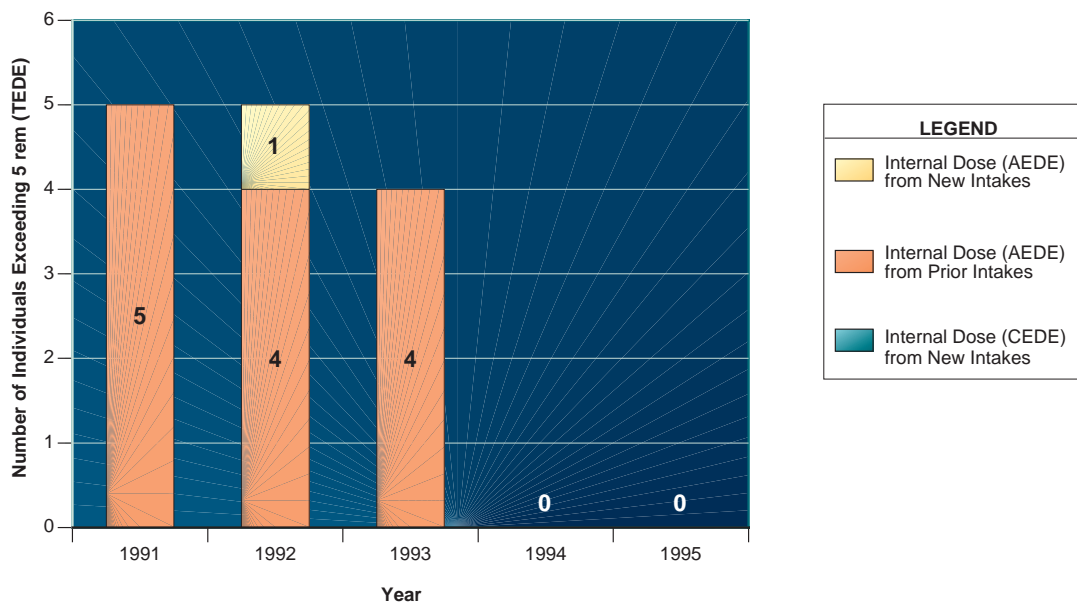

**Exhibit 3-7:  
Doses in Excess of DOE Limits, 1991-1995**

Year	Year Uptake	Person	TEDE* (rem)	DDE (rem)	Internal Dose**	Intake Nuclides	Facility Types	Site
1991	1952	A	6.339	0	6.339	Pu238	Research, General	Los Alamos Nat'l. Lab.
1991	1967		17.471	0	17.471	Pu238	Maint. & Support	Los Alamos Nat'l. Lab.
1991	<1991	B	15.000	0.050	14.950	Pu239, Pu240, Am-241	Weapons Fabrication	Rocky Flats
1991	<1991	C	6.500	0.034	6.466	Pu239, Pu240, Am-241	Weapons Fabrication	Rocky Flats
1991	<1991	D	8.000	0.057	7.943	Pu239, Pu240, Am-241	Weapons Fabrication	Rocky Flats
1992	1952	A	6.400	0	6.400	Pu238	Research, General	Los Alamos Nat'l. Lab.
1992	<1992	B	14.490	0.013	14.477	Pu239, Pu240, Am-241	Weapons Fabrication	Rocky Flats
1992	<1992	C	6.526	0.019	6.507	Pu239, Pu240, Am-241	Weapons Fabrication	Rocky Flats
1992	<1992	D	7.789	0.019	7.770	Pu239, Pu240, Am-241	Weapons Fabrication	Rocky Flats
1992	1992		9.855	0	9.855	Pu239, Pu240, Am-241	Weapons Fabrication	Rocky Flats
1993	1993		17.220	0	17.220	Pu239, Pu240	Maint. & Support	Los Alamos Nat'l. Lab.
1993	1993		22.068	0.189	21.879	Pu239, Pu240	Research, General	Los Alamos Nat'l. Lab.
1993	1993		8.709	0.209	8.500	Pu239, Pu240	Research, General	Los Alamos Nat'l. Lab.
1993	1993		9.218	0.058	9.160	Pu239, Pu240, Am-241	Weapons Fabrication	Rocky Flats
1994						None Reported		
1995						None Reported		

\* TEDE is provided for 1991-1992 for comparison purposes only.

\*\* AEDE for 1991-1992, CEDE for 1993-1995.

< Year of uptake is unknown, but is known to be prior to the year indicated.

The first incident occurred at the Oak Ridge National Laboratory (ORNL) and was due to an intake of Plutonium-238 and Americium-241. The individual received an intake from a wound to the hand during cutting operations on a low level waste line located inside a high contamination area. The intake resulted in a CDE to the bone surfaces of 53.9 rem. This individual also received an external deep dose (DDE) of 0.089 rem resulting in a TODE (DDE+CDE) to the bone surfaces of 53.989 rem. The CEDE for this individual was determined to be 2.99 rem.

The second event occurred at Lawrence Livermore National Laboratory (LLNL) and is still in the process of being assessed. The final calculated dose may or may not exceed the limit. The intake involved a long-lived nuclide (neptunium) that resulted in a dose to the bone surface that is near the DOE organ

dose limit of 50 rem. A postdoctoral student was working with a mixture of natural uranium, Np-237 and Th-232 when the centrifuge failed, resulting in cuts to the individual's hand, chest, and chin as well as personnel contamination.

Long-term follow-up bioassay and dose assessment for this incident is continuing, but is complicated by the fact that a chelated intake of Np-237 is involved, for which there is little or no human experience. The best estimate to date is that the 50-year CEDE will be in the range of from 1 to 3 rem. The ranges of corresponding committed organ doses are as follows:

Organ	Estimated CDE (rem)
Bone Surfaces	20 to 70 rem
Red Bone Marrow	2 to 6 rem
Liver	1 to 2 rem
Ovaries	0.2 to 0.6 rem



This range of values is based on bioassay results received through 9 months post-incident. These estimates indicate that the 50 rem CDE limit to the bone surfaces may be exceeded. As planned, additional longer-term bioassay samples are being collected or are in analysis, and analysis of the available results is ongoing.

Further information may be obtained from the Occurrence Report SAN—LLNL-LLNL-1995-0032.

### 3.3.2 Doses in Excess of Administrative Control Level

The RadCon Manual sets a 2 rem ACL for TEDE, which cannot be exceeded without prior DOE approval. Each DOE site is required to establish its own, more restrictive ACLs that require contractor management approval to be exceeded. The number of individuals receiving doses in excess of the 2 rem ACL is a measure of the effectiveness of DOE's radiation protection program.

The number of individuals with exposures above 2 rem has dropped considerably during 1991-1995, as shown in *Exhibit 3-8*. However, nearly all of this decrease occurred between 1992 and 1993 because of the change in internal dose reporting. Legacy internal doses contributed to the vast majority of the individuals above 2 rem for 1991 and 1992.

If one excludes the legacy doses from prior years, it should be noted that the number of doses in excess of 2 rem in 1994 and 1995 is equivalent to the number in 1991. In 1993 the number increased to 6. This was also the first year of reporting the 50-year committed effective dose equivalent (CEDE) which results in the calculation of higher internal doses from long-lived nuclides. Four of these 6 doses also exceeded the 5 rem TEDE limit as described in *Section 3.3.1*.

**Exhibit 3-8:**  
Number of Doses in Excess of the DOE 2 rem ACL, 1991-1995

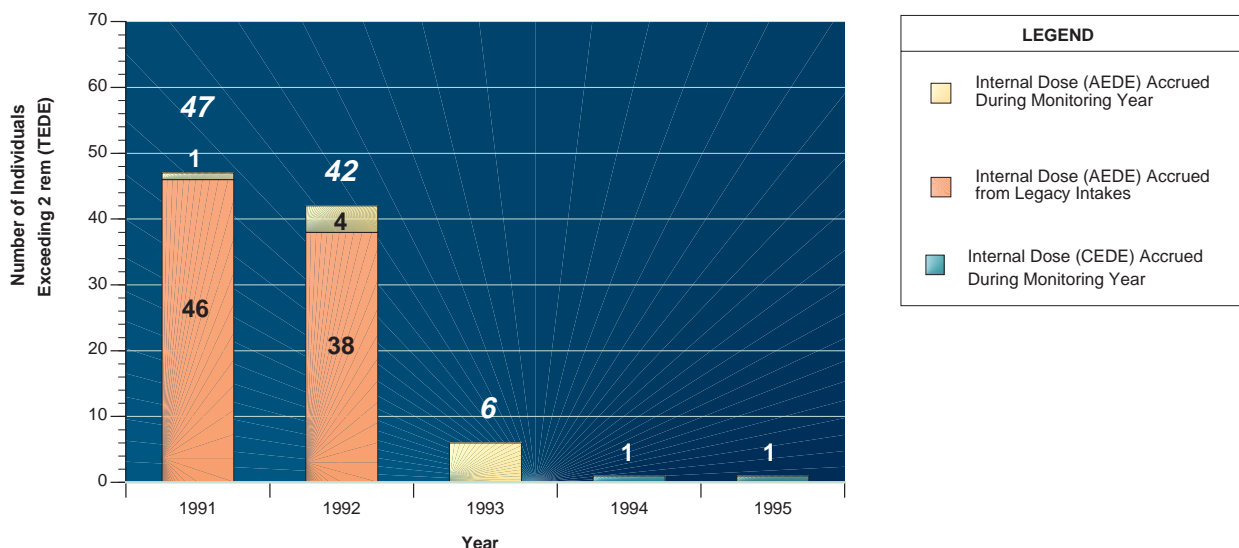

There was only one TEDE dose in excess of 2 rem in 1995. The dose was due to an intake of Plutonium-238 and Americium-241 that occurred at the ORNL. The individual received an intake from a wound received during cutting operations on a low level waste line located inside a high contamination area. The resultant CEDE for the individual was calculated to be 2.99 rem. This individual also received an external dose of 0.089 rem resulting in a TEDE of 3.079 for 1995. Two other individuals also received internal dose from skin contamination during this incident resulting in doses below the 2 rem ACL.

The final dose assessment for this event was not reported until 5/2/97 and therefore the dose in excess of the ACL was not included in earlier reports of occupational exposure for 1995. For more information concerning this event, see the Occurrence Reports ORO-LMES-X10CM-1996-004 and ORO-MKFO-X10CONSTRM-1995-0010.

### 3.3.3 Internal Depositions of Radioactive Material

As discussed in Section 3.3.1, in the past, some of the most significant doses to individuals have been the result of intakes of radioactive material. For this reason, DOE emphasizes the need to avoid intakes and tracks the number of intakes as a performance measure.

The number of internal depositions of radioactive material (otherwise known as worker intakes) for 1993-1995 is shown in *Exhibit 3-9*. The internal depositions were categorized into one of eight radionuclide groups. Intakes involving multiple nuclides are listed as “mixed” nuclides. Nuclides where fewer than ten individuals had intakes over the 3-year period were grouped together as “other” nuclides.

*Exhibit 3-9* only shows the intakes that occurred during the past 3 years that were reported using the CEDE internal dose calculation methodology. For an analysis of legacy doses from prior years, see the annual report for the period 1992 - 1994.

**Exhibit 3-9:**  
**Number of Intakes, Collective Internal Dose, and Average Dose by Nuclides, 1993-1995**

Nuclide	Number of Workers with New Intakes*			Collective CEDE (person-rem)			Average CEDE (rem)		
	1993	1994	1995	1993	1994	1995	1993	1994	1995
Hydrogen-3 (Tritium)	1,455 ◀	908	810	10.695	10.680	6.995	0.007	0.012	0.009
Technetium	19	27		0.218	0.281		0.011	0.010	
Thorium	268	280	31	3.387	2.918	1.192	0.013	0.010	0.038
Uranium	1,365	914 ◀	880 ◀	16.146	10.660	11.354 ◀	0.012	0.012	0.013
Plutonium	116	66	72	78.257 ◀	18.290 ◀	9.682	0.675 ◀	0.277	0.134 ◀
Americium-241	13	3	20	0.642	1.560	0.457	0.049	0.520 ◀	0.023
Other	29	14	34	0.542	0.072	0.918	0.019	0.005	0.027
Mixed	2	16	4	0.026	1.139	0.166	0.013	0.071	0.042
<b>Totals</b>	<b>3,267</b>	<b>2,228</b>	<b>1,851</b>	<b>109.913</b>	<b>45.600</b>	<b>30.764</b>	<b>0.034</b>	<b>0.020</b>	<b>0.017</b>

Note: Arrowed values indicate the greatest value in each column.

\*Individuals may have received intakes of more than one nuclide and therefore may be counted more than once.

Most intakes of radioactive material during the 3-year period were the result of exposure to tritium or uranium. The highest collective CEDE dose was from plutonium. The average CEDE doses from these intakes are quite low because of the radiological and biological characteristics of these radionuclides and the large number of monitored individuals with low CEDE dose from these radionuclides.

The highest average CEDE dose was from plutonium. Plutonium yields particularly high values for CEDE because of the long radiological half-life and the long-term deposition of the material in the bone. Americium intakes have a high average CEDE for similar reasons, but the number of intakes and collective dose are much smaller than for plutonium. Both the collective and average doses for plutonium and americium were down significantly for 1995, primarily due to a significant drop in intakes reported at LANL. LANL experienced a drop in collective CEDE from 15 person-rem to 1

person-rem despite an overall increase in activities involving plutonium in 1995. Rocky Flats also experienced a significant decrease in the number of intakes and internal dose.

The internal dose records indicate that the majority of the intakes reported are at very low doses. In 1995, 85% of the internal doses are below 0.020 rem representing only 25% of the collective internal dose. The 15% of the internal doses above 0.020 rem accounts for 75% of the collective internal dose. Over the 5-year period, internal doses from new intakes accounted for only 3% of the collective TEDE and only 12% of the individuals received internal dose above the monitoring threshold specified in 10 CFR 835.402 (c).

**The internal dose records indicate that the majority of the intakes reported are at very low doses.**

**Exhibit 3-10:**  
**Internal Dose Distribution from Intakes, 1991-1995**

Number of Individuals\* with internal dose in each dose range (rem).

Year	<0.020	0.020-0.100	0.100-0.250	0.250-0.500	0.500-0.750	0.750-1.000	1.0-2.0	2.0-3.0	3.0-4.0	4.0-5.0	>5.0	Total No. of Individ. *	Total Collective Internal Dose ** (person-rem)
1991	2,913	420	36	12	1		1					3,383	41.101
1992	2,970	537	70	12	13	8	4	1	2		1	3,618	99.386
1993	2,533	354	56	22	6	2	1			1	4	2,979	109.913
1994	1,712	224	29	18	7	2	2		1			1,995	45.600
1995	1,564	245	33	4	1		3	1				1,851	30.764

Note: Individuals with doses equal to the dose value separating the dose ranges are included in the next higher dose range.

\* Individuals may have multiple intakes in a year and, therefore, may be counted more than once.

\*\* Collective internal dose = AEDE for 1991-1992, CEDE for 1993-1995.

*Exhibit 3-10* shows the distribution of the internal dose from 1991 to 1995. The total number of individuals with doses in each dose range is for each record of intake. The internal dose does not include doses from prior intakes (legacy AEDE dose). Individuals with multiple intakes during the year are counted more than once in *Exhibit 3-9* and, for this reason, the totals in *Exhibit 3-10* do not correspond to those in *Exhibit 3-9*. Doses below 0.020 rem are shown as a separate dose range to show the large number of doses in this low-dose range. Even with the change in methodology from AEDE to CEDE in 1993, all but six of the doses are below the 2 rem ACL and all but four are below the 5 rem DOE dose limit for the years 1993-1994. All but one of the internal doses were below 2 rem in 1995. The distribution of internal dose by site and nuclide for 1995 is presented in Appendix B-21.

When examining trends involving internal dose, several factors should be considered. Some of the largest changes in the number of reported intakes over the years were the result of changes in internal dosimetry practices. Periodically, sites will change monitoring practices or procedures, which may involve increasing the sensitivity of the detection equipment, thereby increasing the number of individuals with measurable internal doses. Conversely, sites may determine that internal monitoring is no longer required due to historically low levels of internal dose or a decreased potential for intake. There are relatively few intakes each year, and the CEDE method of calculating internal dose can result in large internal doses from the intake of long-lived nuclides. This can result in significant statistical variability of the internal dose data from year to year.

## 3.4 Site Analysis

### 3.4.1 Collective TEDE by Operations/Field Offices

The collective TEDE for 1993-1995 for the major DOE sites and Operations/Field Offices is shown in *Exhibit 3-11*. A list of the collective TEDE and number of individuals with measurable TEDE for the DOE Operations/Field Offices and sites is shown in *Exhibit 3-12*. The collective TEDE increased by 12% between 1994 and 1995 with six of the highest dose sites (LANL, BNL, Idaho, Rocky Flats, Hanford, and Savannah River) contributing 80% of the total DOE collective TEDE.

**Exhibit 3-11:**  
Collective TEDE by Site/Facility

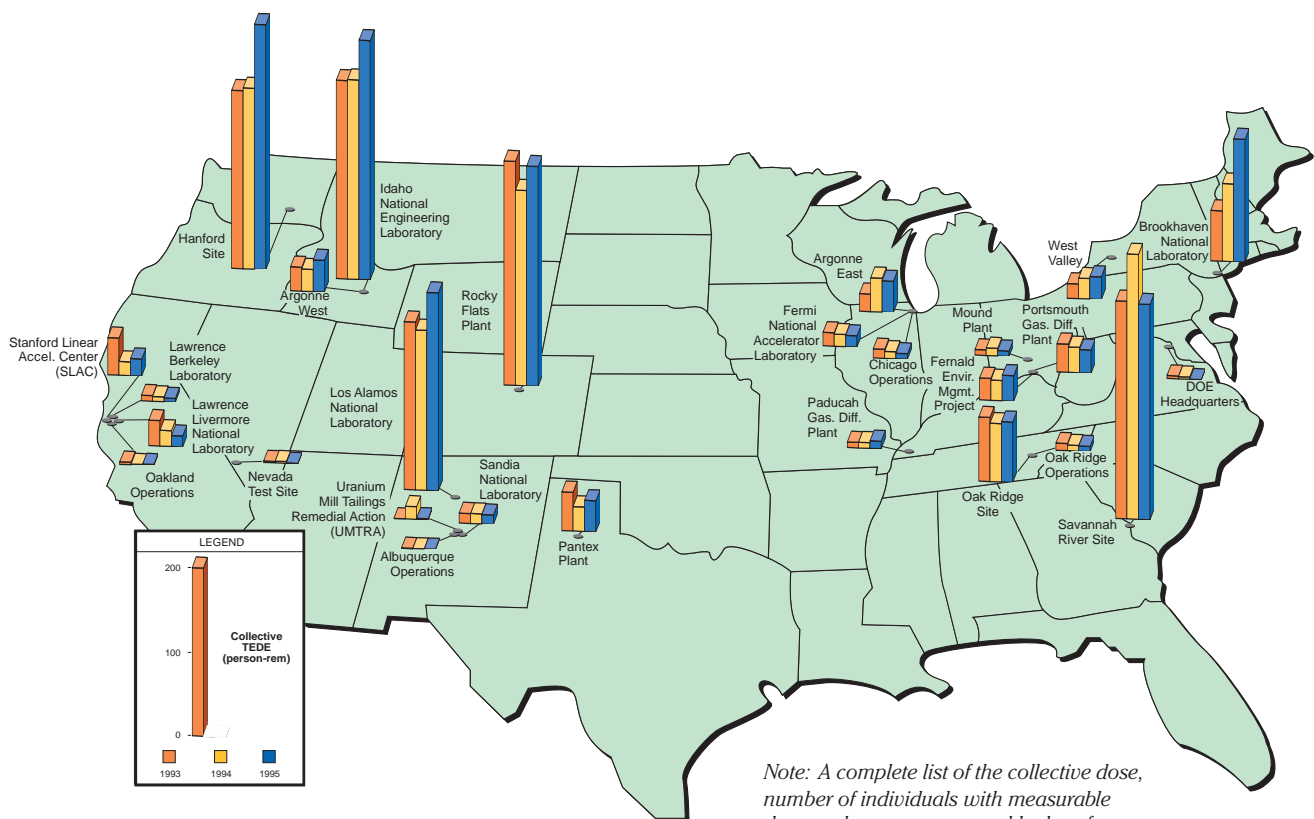

**Exhibit 3-12:**  
**Collective TEDE and Number of Individuals with Measurable TEDE by Site/Facility, 1993-1995**

Operations/ Field Office	Site/Facility	1993		1994		1995	
		Collective TEDE (person-rem)	Number with Meas. TEDE	Collective TEDE (person-rem)	Number with Meas. TEDE	Collective TEDE (person-rem)	Number with Meas. TEDE
Albuquerque	Ops. and Other Facilities	0.5	28	0.4	26	1.6	40
	Los Alamos National Lab. (LANL)	199.2	1,391	190.0	2,448	234.9	2,583
	Pantex Plant (PP)	46.0	445	29.1	347	36.9	329
	Sandia National Lab. (SNL)	11.9	314	12.0	250	11.1	343
	Uranium Mill Tailings Remedial Action (UMTRA) Project	9.2	369	15.0	390	1.3	58
Chicago	Ops. and Other Facilities	10.8	321	8.3	233	6.5	135
	Argonne Nat'l. Lab. - East (ANL-E)	20.9	185	40.3	280	37.2	297
	Argonne Nat'l. Lab. - West (ANL-W)	28.4	263	26.3	343	37.6	335
	Brookhaven Nat'l. Lab. (BNL)	59.9	713	92.3	865	145.8	973
	Fermi Nat'l. Accelerator Lab. (FERMI)	16.0	238	14.3	526	13.4	473
DOE HQ	DOE Headquarters	3.4	61	2.7	43	0.1	8
Idaho	Idaho Site	235.5	1,175	236.8	1,659	284.0	1,501
Nevada	Nevada Test Site (NTS)	1.7	20	2.0	20	0.5	9
Oakland	Ops. and Other Facilities	3.0	32	0.8	20	1.3	20
	Lawrence Berkeley Lab. (LBL)	6.8	137	5.7	92	4.5	76
	Lawrence Livermore Nat'l. Lab. (LLNL)	30.2	194	18.8	146	13.0	159
	Stanford Linear Accelerator Center (SLAC)	44.0	615	16.3	219	20.2	236
Oak Ridge	Ops. and Other Facilities	8.6	171	6.8	255	6.2	167
	Oak Ridge Site	76.1	1,939	69.2	1,613	76.9	1,804
	Paducah Gaseous Diff. Plant (PGDP)	6.5	171	6.8	151	9.0	225
	Portsmouth Gaseous Diff. Plant (PORTS)	33.6	832	30.3	836	27.5	1,623
Ohio	Ops. and Other Facilities	-	-	0.0	2	0.0	5
	Fernald Environmental Management Project*	26.1	1,020	24.2	925	30.4	955
	Mound Plant**	6.6	258	9.1	299	6.4	175
	West Valley***	17.5	249	24.3	292	26.9	311
Rocky Flats	Rocky Flats Eng. Tech. Site (RFETS)	<b>265.9</b> ◀	<b>5,605</b> ◀	231.9	3,660	260.8	3,427
Richland	Hanford Site	211.5	3,147	214.8	3,166	<b>290.7</b> ◀	2,500
Savannah River	Savannah River Site (SRS)	264.4	5,202	<b>314.5</b> ◀	<b>6,284</b> ◀	255.5	<b>4,846</b> ◀
<b>Totals</b>		<b>1,644.2</b>	<b>25,095</b>	<b>1,643.1</b>	<b>25,390</b>	<b>1,840.2</b>	<b>23,613</b>

\* Fernald Site reported under the Fernald Field Office in 1993 and the Ohio Field Office in 1994.

\*\* Mound Site reported under Albuquerque Ops. Office in 1993 and now reports under the Ohio Field Office.

\*\*\* West Valley Site reported under Idaho Ops. Office in 1993 and now reports under the Ohio Field Office.

Note: Arrowed values indicate the greatest value in each column.

**Exhibit 3-13:**  
Doses by Labor Category, 1993-1995

Labor Category	Number with Meas. Dose			Collective TEDE* (person-rem)			Average Meas. TEDE (rem)		
	1993	1994	1995	1993	1994	1995	1993	1994	1995
Agriculture	6	7	9	0.8	0.7	0.5	<b>0.130</b> ◀	<b>0.100</b> ◀	0.058
Construction	2,533	2,335	2,300	137.9	149.0	164.2	0.054	0.064	0.071
Laborers	849	807	729	59.7	55.2	76.3	0.070	0.068	0.105
Management	2,171	2,003	1,629	77.2	80.6	74.4	0.036	0.040	0.046
Misc.	2,735	1,655	3,496	111.6	77.5	169.4	0.041	0.047	0.048
Production	3,319	3,090	2,779	268.2	284.5	282.0	0.081	0.092	0.101
Scientists	<b>4,402</b> ◀	<b>5,201</b> ◀	3,513	171.5	197.7	153.7	0.039	0.038	0.044
Service	1,279	1,201	962	44.8	51.8	37.0	0.035	0.043	0.038
Technicians	4,111	4,238	3,929	<b>382.4</b> ◀	<b>393.8</b> ◀	429.1	0.093	0.093	0.109
Transport	423	478	313	14.9	21.1	18.0	0.035	0.044	0.057
Unknown	3,267	4,375	<b>3,954</b> ◀	375.2	331.2	<b>435.4</b> ◀	0.115	0.076	<b>0.110</b> ◀
<b>Totals</b>	<b>25,095</b>	<b>25,390</b>	<b>23,613</b>	<b>1,644.2</b>	<b>1,643.1</b>	<b>1,840.2</b>	<b>0.066</b>	<b>0.065</b>	<b>0.078</b>

Note: Arrowed values indicate the greatest value in each column.

\* 1993-1995 TEDE = CEDE + DDE

### 3.4.2 Dose by Labor Category

DOE occupational exposures are tracked by labor category at each site to facilitate identification of exposure trends, which assist management in prioritizing ALARA activities. Worker occupation codes are reported in accordance with DOE Order 5484.1 (or the new DOE M 231.1-1) and are grouped into major labor categories in this report. The collective TEDE to each

labor category for 1993-1995 are shown in Exhibits 3-13 and 3-14. Apart from the “unknown” category, Technicians and Production staff have the highest collective TEDE for 1995 because they generally handle more radioactive sources than individuals in the other labor categories. Thirty-six percent of the technician dose is attributed to radiation monitoring technicians.

**Exhibit 3-14:**  
Graph of Doses by Labor Category, 1993-1995

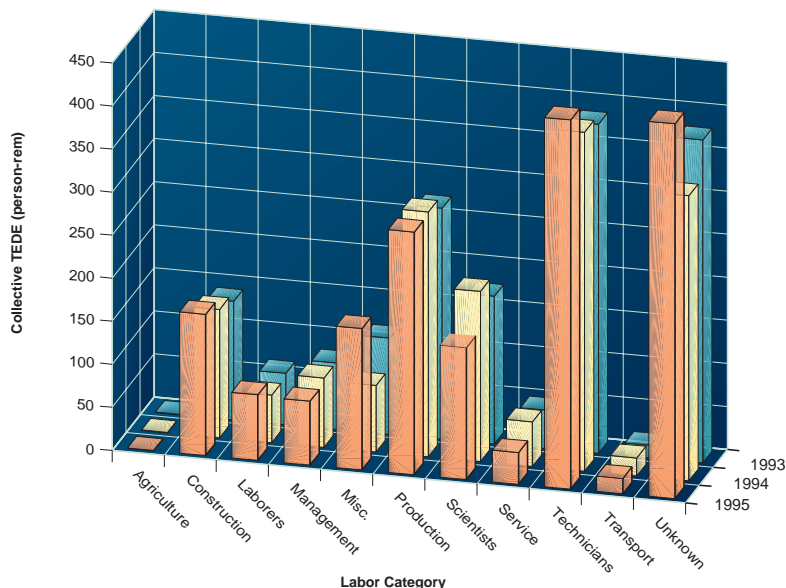

The collective TEDE is also high for the “unknown” category. One of the reasons this occupation category contains a large number of individuals is because LANL reports all of their workers in this category. Fifty-four percent of the dose in this category is attributed to LANL. The LANL computer system does not currently maintain the data necessary to report occupation codes in accordance with DOE M 231.1-1. LANL is addressing this issue. Other sites also report large numbers of individuals with an occupation code of “unknown”. Typically these workers are subcontractors or temporary workers. Information concerning these workers tends to be limited.

To examine internal dose by labor category, the dose from intake is presented in Appendix B, Exhibit B-19.

**Exhibit 3-15:**  
**Graph of Dose by Facility Type, 1993-1995**

### 3.4.3 Dose by Facility Type

DOE occupational exposures are tracked by facility type at each site to better understand the nature of exposure trends and assist management in prioritizing ALARA activities. Contribution of certain facility types to the DOE collective TEDE is shown in Exhibits 3-15 and 3-16. The collective dose for each facility type at each Operations/Field Office is shown in Appendix B, Exhibit B-7.

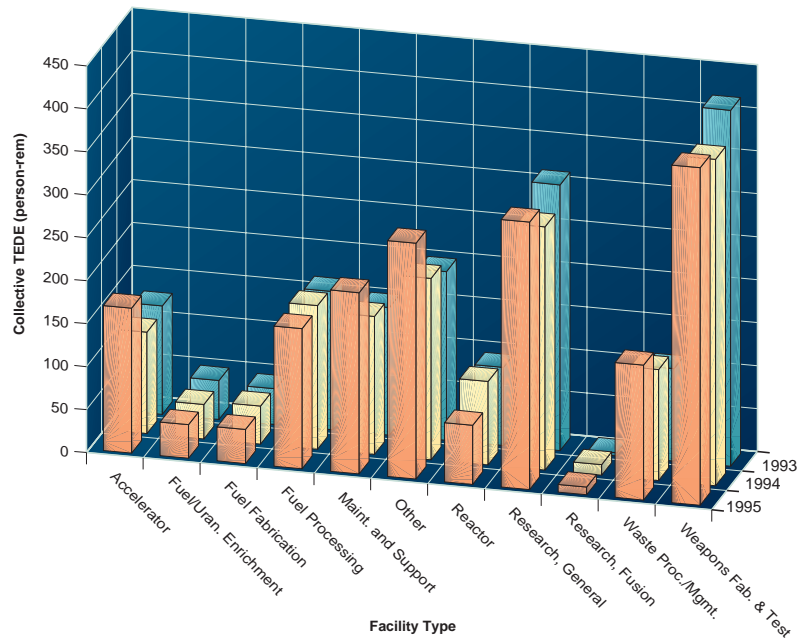

The highest collective TEDE for 1993-1995 were those at weapons fabrication and testing facilities. Sixty-six percent of this dose was accrued at Rocky Flats, with 20% and 9% from Pantex and Savannah River, respectively.

To examine internal dose by facility type, the internal dose from intake is presented in Appendix B, Exhibit B-17.

**Exhibit 3-16:**  
**Doses by Facility Type, 1993-1995**

Facility Type	Number with Meas. Dose			Collective TEDE* (person-rem)			Average Meas. TEDE (rem)		
	1993	1994	1995	1993	1994	1995	1993	1994	1995
Accelerator	1,650	1,750	1,718	125.8	118.1	168.5	0.076	0.068	0.098
Fuel/Uranium Enrichment	1,150	1,121	1,915	45.3	40.1	39.2	0.039	0.036	0.020
Fuel Fabrication	1,234	1,140	1,055	41.7	44.3	39.5	0.034	0.039	0.037
Fuel Processing	1,921	2,049	1,505	160.9	167.0	163.0	0.084	<b>0.082</b> ◀	0.108
Maintenance and Support	2,804	3,189	2,820	148.5	160.8	210.9	0.053	0.050	0.075
Other	2,150	2,889	2,510	196.3	211.1	280.9	0.091	0.073	<b>0.110</b> ◀
Reactor	1,322	1,280	896	90.8	97.0	68.7	0.069	0.076	0.077
Research, General	2,922	3,435	3,269	309.3	283.0	311.1	<b>0.106</b> ◀	<b>0.082</b> ◀	0.095
Research, Fusion	120	160	134	3.6	12.6	9.0	0.030	0.079	0.067
Waste Processing/Mgmt.	1,940	2,923	2,458	107.6	129.2	156.9	0.055	0.044	0.064
Weapons Fab. and Testing	<b>7,892</b> ◀	<b>5,454</b> ◀	<b>5,333</b> ◀	<b>414.2</b> ◀	<b>379.8</b> ◀	<b>392.5</b> ◀	0.053	0.070	0.074
<b>Totals</b>	<b>25,095</b>	<b>25,390</b>	<b>23,613</b>	<b>1,644.2</b>	<b>1,643.1</b>	<b>1,840.2</b>	<b>0.066</b>	<b>0.065</b>	<b>0.078</b>

Note: Arrowed values indicate the greatest value in each column.

\* 1993-1995 TEDE = CEDE + DDE



**Exhibit 3-17:**  
**Criteria for Radiation Exposure and Personnel Contamination Occurrence Reporting**

Occurrence	Category	DOE M 232.1-1 Criteria
Radiation Exposure	Unusual	Individuals receiving a dose in excess of the occupational exposure limits (See Exhibit 2-1) for on-site exposure or exceeding the limits in DOE 5400.5 for offsite exposures to a member of the public.
	Off-Normal	<ul style="list-style-type: none"> <li>◆ Any single occupational exposure that exceeds an expected exposure by 100 mrem.</li> <li>◆ Any single unplanned exposure onsite to a minor, student, or member of the public that exceeds 50 mrem.</li> <li>◆ Any dose that exceeds the limits specified in DOE 5400.5 for offsite exposures to a member of the public.</li> </ul>
Personnel Contamination	Unusual	<ul style="list-style-type: none"> <li>◆ Any single occurrence resulting in the contamination of five or more personnel or clothing at a level exceeding the RCM values for total contamination limits.</li> <li>◆ Any occurrence requiring off-site medical assistance for contaminated personnel.</li> <li>◆ Any measurement of personnel or clothing contamination offsite at a level exceeding the RCM limits for removable contamination.</li> </ul>
	Off-Normal	Any measurement of personnel or clothing contamination at a level exceeding the RCM total contamination limits.

### 3.4.4 Radiation Protection Occurrence Reports

In addition to the records of individual radiation exposure monitoring required by DOE M 231.1-1 (previously DOE Order 5484.1), sites are required to report certain unusual or off-normal occurrences involving radiation under DOE M 232.1-1 (previously DOE Order 5000.3B). These reports are submitted to the Occurrence Reporting and Processing System (ORPS). Two of the categories of occurrences are directly related to occupational exposure and are required to be reported under Section 8.3 as “Group 4” occurrences. Group 4A reports are *Radiation Exposure* occurrences, and Group 4B are *Personnel Contamination* occurrence reports. The occurrence reporting requirements for DOE M 232.1-1 are summarized in *Exhibit 3-17*.

In summary, *Radiation Exposure* occurrences are reported in instances where individuals were exposed to radiation above anticipated levels. *Personnel Contamination* occurrences are

reported when personnel or clothing are contaminated above certain thresholds. The number of reports submitted to ORPS is indicative of breaches or lapses in radiation protection practices resulting in unanticipated radiation exposure or contamination of personnel or clothing. Increases or decreases in the number of these occurrences may reflect trends in activities which result in radiation exposures and the effectiveness of radiation protection programs at DOE.

It is important to note that reports are submitted to ORPS for an occurrence or event. In some cases, one event could result in the contamination or exposure of multiple individuals. In ORPS, this is counted as one occurrence, even though multiple individuals were exposed. In addition, one occurrence report may involve multiple similar occurrences. For this reason, the number of occurrences and the number of occurrence reports are considered here.

**Exhibit 3-18:**  
**Radiation Exposure Occurrence Reports, 1993-1995**

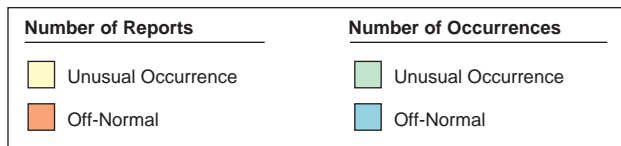
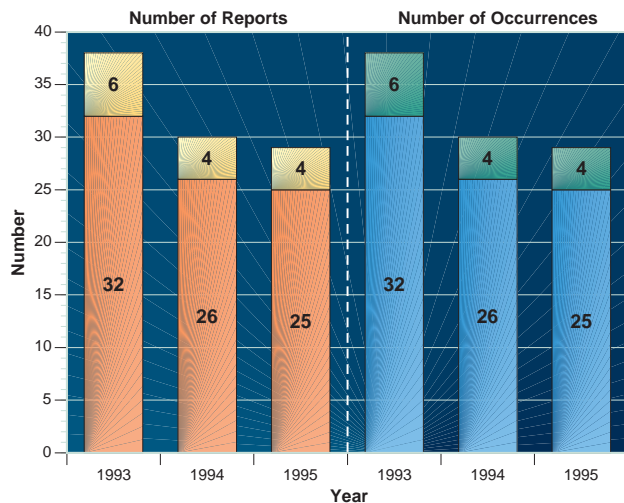

**Exhibit 3-19:**  
**Personnel Contamination Occurrence Reports, 1993-1995**

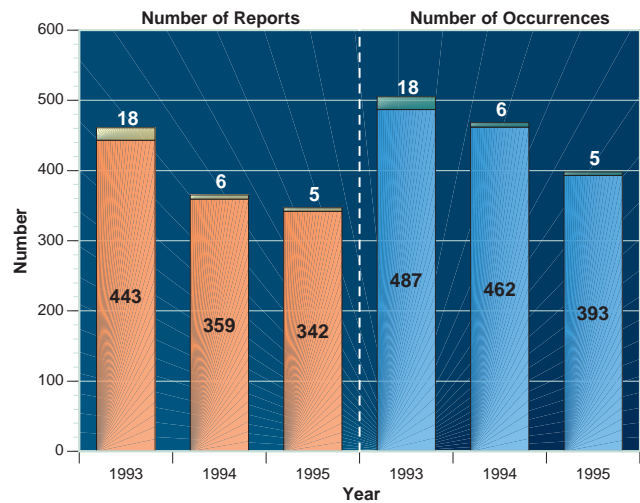

The number of occurrences and occurrence reports for *radiation exposures* and *personnel contaminations* is presented in Exhibits 3-18 and 3-19. The number of occurrence reports for both types of events has decreased over the past 3 years. The number of *Radiation Exposure* occurrence reports has decreased by 22% over the past 3 years, while the number of *Personnel Contamination* reports has decreased by 25%.

For *radiation exposure* occurrences, there is no difference in the number of reports and the number of occurrences, indicating that no reports were submitted that included multiple occurrences. Therefore the number of occurrences and occurrence reports decreased by 22%. For *personnel contamination* occurrences, there have been several reports that contain multiple occurrences that have been submitted over the past 3 years, but only for "off-normal" occurrences. All of the occurrence reports that were

categorized as "unusual" dealt with a single occurrence. The number of *personnel contamination* occurrences has decreased by 19% from 1993 to 1995.

The decrease in the number of *radiation exposure* occurrences is primarily due to a decrease in the number of occurrences at the Hanford site between 1993 and 1994 due to decreased activities that had the potential to result in exposures requiring occurrence reports. In addition, several of the 1993 occurrence reports concerned events that occurred in 1991 and were discovered and reported during 1993.

The decrease in the number of *personnel contamination* reports is primarily due to decreases for the Oak Ridge site (mainly the Y-12 Plant) and Argonne National Lab., West (ANL-W). Three factors contributed to the decrease at the Oak Ridge site. In 1994, Y-12 began combining multiple occurrences into one report, called "roll-

**The number of *Radiation Exposure* occurrences has decreased by 22% from 1993 to 1995.**

**The number of *Personnel Contamination* occurrences has decreased by 19%.**

up” reports. The Y-12 Plant also underwent an operational stand-down during 1994 that reduced the opportunities for these types of occurrences. In addition, the reporting requirements in effect for Oak Ridge changed from DOE Order 5000.3A to Order 5000.3B during 1993. The reporting threshold for *personnel contamination* occurrences under 5000.3A were much lower than 5000.3B, and therefore, more occurrences were reportable.

At ANL-W, the decrease in *personnel contamination* reports is due to the completion of decontamination activities at two 30-year old facilities; the Fuel Cycle Facility, completed in 1993, and the Analytical Laboratory, completed during 1995.

For 1995, 25 of the 29 occurrence reports (86%) shown in *Exhibit 3-18* involve “off-normal” occurrences. Nineteen of the 29 reports (66%) for 1995 involved

occurrences with the potential for internal dose from contamination and inhalation. Seven of the 19 reports involved the potential for internal dose, but did not result in doses received by workers. Four of the 19 reports involved possible intakes where bioassay monitoring is ongoing. The remaining seven reports involve intakes resulting in internal dose in excess of anticipated doses and one report involved beryllium and did not result in any radiation exposure.

Three of the four “unusual” events involved internal dose. One report involved CEDE doses to two individuals of 1.195 and 1.335 rem. Another report involved an intake of neptunium as described in Section 3.3.1. The third report does not involve dose received by any individuals, but involved a contamination event that resulted in the potential for intake. The fourth report involved a high reading on an individuals’ dosimeter.

No *Radiation Exposure* occurrence reports submitted to ORPS from 1993 to 1995 have involved exposures to minors or members of the public.

For the years 1994 and 1995, 371 of the *Personnel Contamination* occurrences involved contamination of the skin of the worker, 333 involved contamination of the clothing, and 270 involved contamination of the shoes worn by the worker, as shown in *Exhibit 3-20*. The breakdown of reports by affected area for 1993 is not available.

**Exhibit 3-20:**  
**Personnel Contamination Occurrences by Affected Area, 1994-1995**

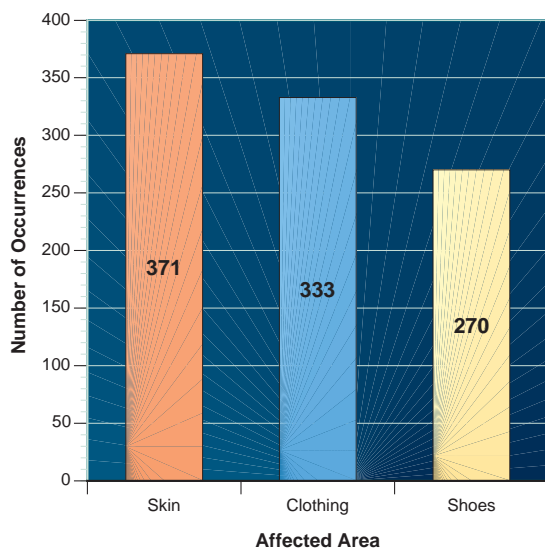

Exhibits 3-21 and 3-22 show the breakdown of occurrence reports for *Radiation Exposure* and *Personnel Contamination* by site for the 3-year period 1993 to 1995. Fifty-five percent of the *Radiation Exposure* occurrences were reported by two sites, Rocky Flats and Hanford. *Personnel Contamination* occurrence reports are more evenly distributed among the sites, with Hanford and the Oak Ridge sites submitting nearly 40% of the reports. Almost all of the sites submitted fewer reports for both types of exposure occurrence for 1995 with the exception of Savannah River, which submitted more of both types of reports in 1995.

Further information concerning ORPS information can be obtained by contacting Eugenia Boyle, of EH-33, or the ORPS web page at:

```
http://tis.eh.doe.gov/systems/orps.html
```

### 3.5 Activities Contributing to Collective Dose in 1995

In an effort to identify the reasons for changes in the collective dose at DOE, several of the larger sites were contacted to provide information on activities that contributed to the collective dose for 1995. The sites were: LANL, BNL, Idaho, Rocky Flats, Hanford, and Savannah River. These sites were the top six sites in their contribution to the collective TEDE for 1995 and comprise 80% of the total DOE dose. Five of the six sites reported increases in the collective TEDE, which resulted in a 12% increase in the DOE collective dose in 1995. The six sites are shown in *Exhibit 3-23* including a description of activities at the site that contributed to the collective TEDE for 1995.

**Exhibit 3-21:**  
**Radiation Exposure Occurrence Reports by Site, 1993-1995**

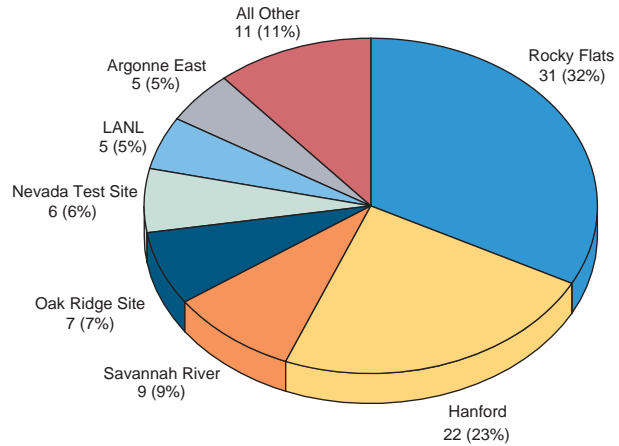

**Exhibit 3-22:**  
**Personnel Contamination Occurrence Reports by Site, 1993-1995**

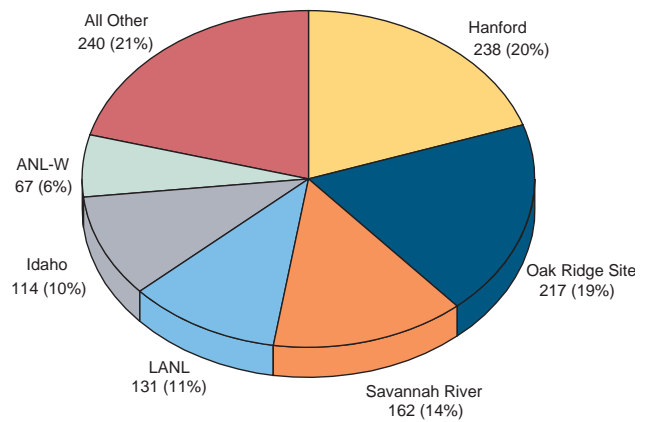

**Exhibit 3-23:**  
**Activities Contributing to Collective TEDE in 1995 for Six Sites**

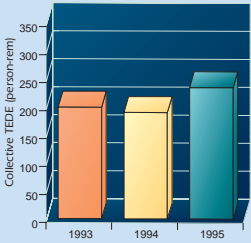
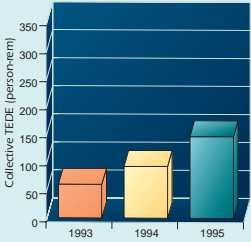
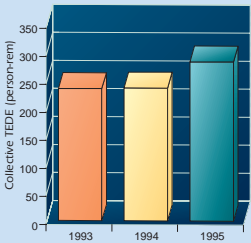
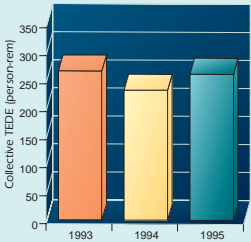
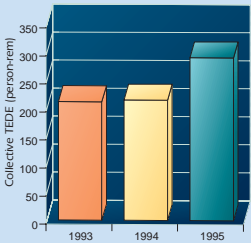
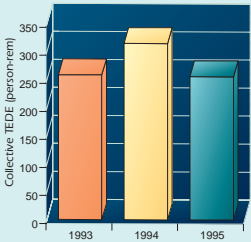
Site	Collective TEDE (person-rem)	% Change from 1994 to 1995	Description of Activities at the Site
<b>Los Alamos National Lab.</b>		24% ▲	The site collective TEDE was up by 24% for 1995. Most of this increase was attributed to increased work in the production of power sources for NASA. The power sources are for NASA's Cassini-Huygens mission to Saturn scheduled for October 1997. A Radioisotope Thermoelectric Generator (RTG) will be used to power the spacecraft. An RTG converts heat from the natural decay of plutonium dioxide directly into electrical energy. Neutron dose was also up at LANL due to the increase in work with plutonium for the RTG.
<b>Brookhaven National Lab.</b>		58% ▲	The site collective TEDE increased by 58% from 1994 to 1995. This follows a 54% increase from 1993 to 1994. BNL attributes most of this increase to the 82% increase in the days of operation and intensity of the Alternating Gradient Synchrotron (AGS) accelerator. Approximately 80% of the site dose is attributed to the AGS. The increased intensity of the AGS also contributed to an increase in neutron dose for 1995. Increased frequency of maintenance surveys conducted on aging equipment also contributed to the increased dose at BNL.
<b>Idaho</b>		7% ▲	The site collective TEDE increased by 7% from 1994 to 1995. At the Idaho site, the Idaho Chemical Processing Plant (ICPP) contributes about 80% of the site dose. Operations at the ICPP increased during 1995, resulting in an increase in the site collective dose by 7%. Two key ICPP facilities were deactivated in 1995, preparation for which, involved extensive work activities.
<b>Rocky Flats</b>		12% ▲	At Rocky Flats, the collective TEDE increased by 12% in 1995. The increased dose was attributed to increased activities involved in decontamination and decommissioning and material stabilization work. Consolidation of special nuclear material into Building 371 and the processing of potentially unstable residues for safe storage began in 1995.
<b>Hanford</b>		35% ▲	The site collective TEDE increased by 35% from 1994 to 1995. The Plutonium Finishing Plant and Building 324 each accounts for approximately 30% of the total collective TEDE for the site. The tank farm and the K Basins account for approximately 14% and 11%, respectively. Each of these facilities had increased use during 1995 associated with nuclear material and facility stabilization. The elimination of spent nuclear fuel storage at the K Basins and operation of the mixed low-level waste evaporator associated with the tank farms accounted for most of the increase.
<b>Savannah River</b>		-19% ▼	Savannah River experienced a 19% decrease in collective TEDE for 1995. The largest contributors to the collective TEDE are the FB Line (nearly 40%), the HB Line and the H Area Tank Farm (approximately 15% each), and the Defense Waste Processing Facility (DWPF) and the Savannah River Technical Center (approximately 5% each). The DWPF was restarted near the end of 1995. With the exception of the DWPF, operations in the facilities were about the same as 1994.

A historical analysis of events and trends over the past 10 years is included in Appendix B, Exhibit B-21.

### 3.6 Operational Status of Certain DOE Facilities

One of the most significant factors impacting the occupational dose at DOE is the operational status of DOE facilities. The shutdown of a facility that processes radioactive materials may limit the potential for radiation exposure of a large number of workers. Conversely, the resumption or acceleration of activities at a facility or the commencement of environmental restoration activities can increase exposures. This section examines the phase of operation of certain DOE facilities and the relationship to the

collective dose. The term “facility” is used here to denote a building or functional group of buildings within a DOE site. This should not be confused with the “facility type” discussed in Section 3.4.3.

For purposes of this analysis, the phases of operation were broken down into the following four categories:

**Facility or Laboratory Operation** - This phase of operation includes new facilities that are brought on line to replace or augment existing facilities and the maintenance and operation of facilities. This phase of operation includes laboratories that are dedicated to a specific function (i.e., sampling laboratories that are included in operations), and research laboratories.

**Exhibit 3-24:**  
Percentage of Collective TEDE by Operational Phase at Six DOE Sites for 1995

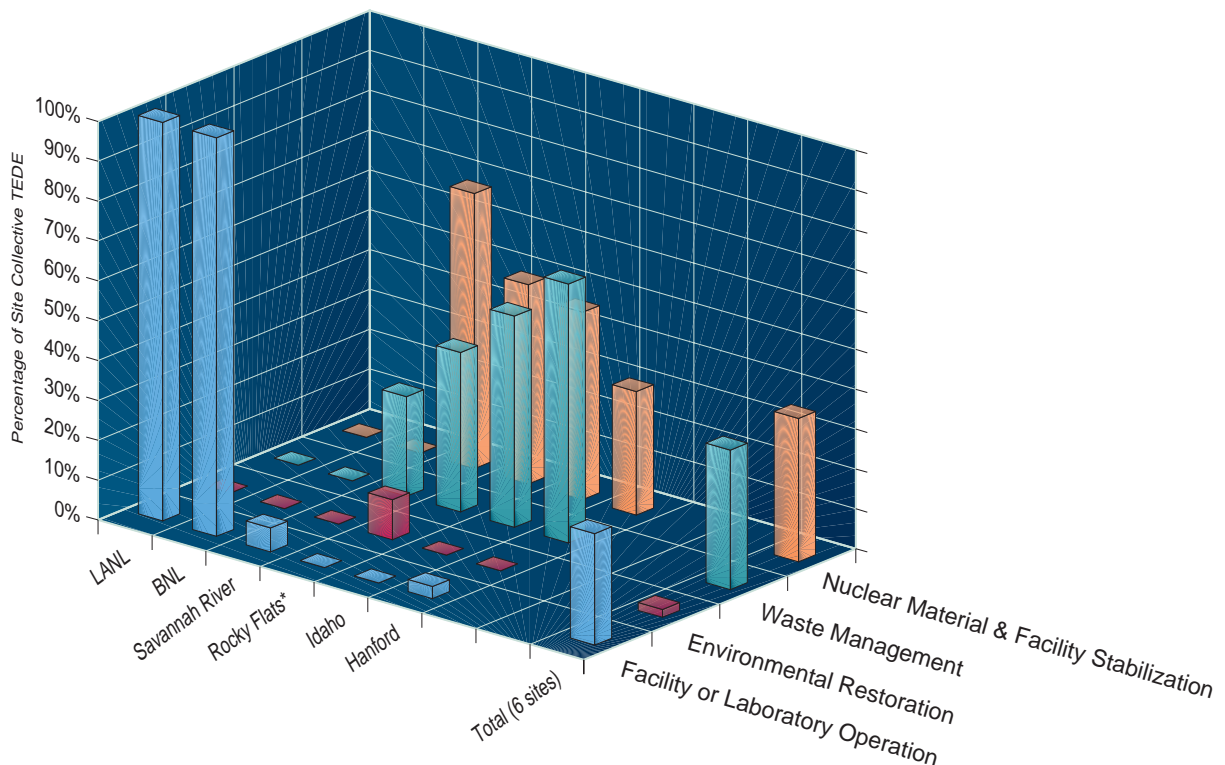

\*Exposure breakdown by phase of operation for Rocky Flats was estimated.

**Exhibit 3-25:**  
**Percentage of Collective TEDE by Operational Phase at Six DOE Sites for 1995**

<b>Plant</b>	<b>Nuclear Material and Facility Stabilization</b>	<b>Waste Management</b>	<b>Environmental Restoration</b>	<b>Facility or Laboratory Operation</b>
LANL	0%	0%	0%	100%
BNL	0%	0%	0%	100%
Savannah River	69%	25%	0%	6%
Rocky Flats*	50%	40%	10%	0%
Idaho	47%	53%	0%	0%
Hanford	31%	65%	0%	4%
<b>Total</b>	<b>36%</b>	<b>35%</b>	<b>2%</b>	<b>27%</b>

\*Exposure breakdown by phase of operation for Rocky Flats was estimated.

**Nuclear Material and Facility Stabilization** - This phase of operation includes the protection of workers and the environment from exposure and contamination, stabilization of hazardous nuclear and chemical materials, deactivation of facilities to attain the lowest surveillance and maintenance costs, and disposition of facilities to the Environmental Restoration phase of operation.

**Waste Management** - This phase of operation includes managing the treatment, storage, and disposal of wastes, and working to minimize the generation of new waste. Waste management includes high-level radioactive waste, transuranic waste, low-level radioactive waste, hazardous waste, mixed waste (radioactive and hazardous) and spent nuclear fuel. The remediation of treatment and disposal facilities and corrective activities that are conducted to bring these facilities into compliance with applicable local, state, and federal regulations are also part of the waste management phase.

**Environmental Restoration** - This phase of operation includes the assessment and remediation of facilities and land no longer used for nuclear weapons production, as well as other inactive sites. These sites range from contaminated buildings to abandoned or inactive waste disposal sites. This phase of operation is often described as the “cleanup” portion of environmental management.

These phases of operation are recorded in the 1996 Baseline Environmental Management Report (BEMR) [14] for each facility, or group of facilities, at each DOE site. These phases correspond with phases B through F in Exhibit A-2. Phases D and E have been combined into Environmental Restoration.

Six sites are included in this analysis. These six sites were the top six contributors to the DOE collective dose and accounted for 80% of the DOE collective dose in 1995. These six sites provided a breakdown of the site collective dose per facility. These two sources of information were combined to

provide a representation (*Exhibits 3-24 and 3-25*) of percentage of the collective dose attributed to each phase of operation at these sites.

*Exhibit 3-24* shows the changing nature of the DOE mission. Two of the six sites are laboratories that are continuing their mission of support for energy research (at BNL) and defense programs (at LANL). The other four sites have all been turned over to the environmental management program and their operational activities have almost completely shut down. These sites are heavily involved in the Nuclear Material and Facility Stabilization phase with Waste Management accounting for a large percentage of the collective dose. Three of the sites have been in the environmental management program for several years; Hanford since 1989, Rocky Flats and Idaho since 1994. The Savannah River site was turned over to environmental management in 1995 and therefore shows the largest percentage of collective dose in the Nuclear Materials and Facility Stabilization phase. The four weapons facilities (Savannah River, Rocky Flats, Idaho, and Hanford) are shown from left to right in the relative chronological order of their transition from stabilization to cleanup. As the collective dose from stabilization activities decreases, the dose from waste management activities increases. The total percentage of the collective dose for all six sites broken down by phase of

operation is also shown in *Exhibits 3-24 and 3-25*. The dose contribution from the Facility or Laboratory Operations is nearly the same relative magnitude as Nuclear Material and Facility Stabilization and Waste Management in 1995. To date, environmental restoration activities do not yet contribute significantly to the DOE collective dose.

In future years, it is anticipated that there will be a continued decrease in Facility or Laboratory Operations, Nuclear Material and Facility Stabilization, and Waste Management activities with an increase in Environmental Restoration activities. Because contaminated facilities continue to be added to the environmental management program, any decrease in the collective TEDE for Nuclear Material and Facility Stabilization in the near future could be offset by new facilities being incorporated into the environmental management program.

DOE Headquarters will continue to monitor the transition of the phase of operation of these facilities in future years in relation to the collective dose. The transition in phase of operation can take several years; therefore, many years of data must be collected to provide further analysis.





This section recognizes highly successful ALARA projects and encourages the use of similar innovative ideas at other locations in the DOE complex. In future years, ALARA success stories, such as those described below, will be included in the *DOE Occupational Radiation Exposure Report*.

The following is a description of a successful ALARA project submitted by the Los Alamos National Laboratory (LANL) concerning a project which reduced radiation exposure during accelerator magnet replacement activities.

### 4.1 LANL Electro-Septum Magnet Redesign

During 1995 a project was undertaken to redesign an electro-septum magnet used in the Proton Storage Ring (PSR) at LANL. The previous magnet was difficult to maintain, repair, and replace. Dose levels routinely exceeded 15 rem/hr. Typical magnet maintenance activities resulted in 1500-2000 person-millirem of exposure and resulted in up to 72 hours of downtime for the accelerator.

A LANL design team was formed with members from the Accelerator Physics and Engineering group and the Accelerator Maintenance and Development group. The Accelerator Operations and Technology Division supports design and operations for the Los Alamos Neutron Science Center (LANSCE) beam delivery complex, maintains the equipment associated with the complex, and develops new accelerator/beam delivery capabilities. The group is responsible for: ion sources and injectors, the radio-frequency and mechanical systems in the accelerator, all of the systems for the PSR and its associated transfer lines, and beam diagnostics in the accelerator and transfer lines. The team was charged with developing a magnet, magnet support, and radiation shield which would minimize exposure to maintenance personnel during repair or replacement activities.

The final design, as shown in *Exhibits 4-1* and *4-2*, incorporates a self-aligning aluminum support structure, single bolt chain clamped metal sealed Helicoflex™ flanges with bellows, easily accessible electrical and water connections, and a heavy steel shield for installation during maintenance periods. Self-alignment

**Exhibit 4-1:**  
**Electro-Septum Magnet Diagram**

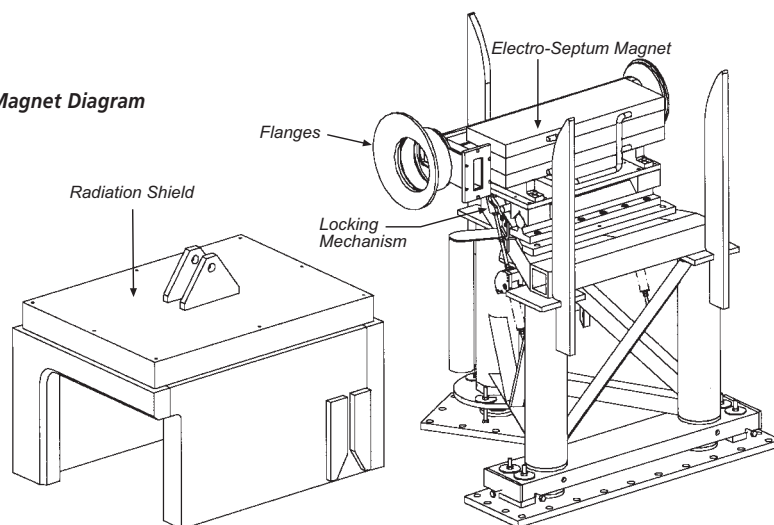

Diagram Courtesy of LANL

Exhibit 4-2:  
Electro-Septum Magnet Photo

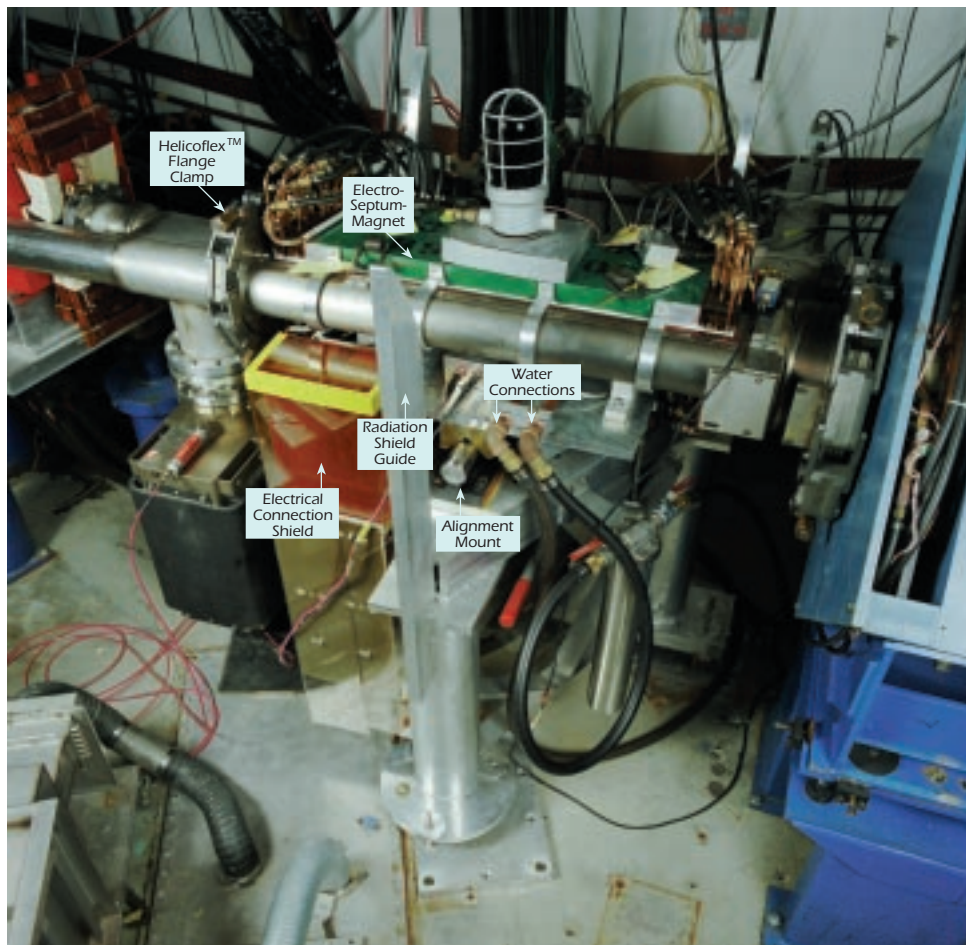

Photo Courtesy of LANL

eliminates the exposure previously incurred when two alignment technicians were needed to position the magnet. Aluminum was used to take advantage of shorter half-lives of isotopes produced through spallation reactions. Single bolt flanges with bellows allow relatively quick vacuum joints to be assembled and a radiation shield protects workers maintaining or repairing utilities on the magnet or working in the immediate vicinity.

Initial trial runs and final installation have indicated that the magnet may be replaced and full beam production returned within 16 hours. The alignment of a new magnet repeats within four thousands of an inch. General background radiation levels with the

shield installed are reduced by approximately 50%. The total person-rem of exposure needed to remove an old magnet and install a new magnet is estimated to have been reduced by 50% because of the time saved. This resulted in an estimated dose savings of 750-1000 person-millirem. In addition to dose reduction, downtime costs were also dramatically reduced. Downtime during beam production periods at the LANSCE is estimated at \$10,000 per hour. The 56-hour reduction in downtime translates into a cost savings of \$560,000 per magnet replacement.

For further information concerning this project, contact Michael Borden at LANL, MS H838, Los Alamos, NM, 87545 or via e-mail at [borden@lanl.gov](mailto:borden@lanl.gov).

**The redesign effort resulted in an estimated dose reduction of 50%.**

## 4.2 Submitting ALARA Success Stories for Future Annual Reports

Individual success stories should be submitted in writing to the DOE Office of Worker Protection Programs and Hazards Management. The submittal should describe the process in sufficient detail to provide a basic understanding of the project, the radiological concerns, and the activities initiated to reduce dose.

### The submittal should address the following:

- ◆ mission statement,
- ◆ project description,
- ◆ radiological concerns,
- ◆ information on how the process implemented ALARA techniques in an innovative or unique manner,
- ◆ estimated dose avoided,
- ◆ project staff involved,
- ◆ approximate cost of the ALARA effort,
- ◆ impact on work processes, in person-hours if possible (may be negative or positive), and
- ◆ point-of-contact for follow-up by interested professionals.

---

## 4.3 Lessons Learned Process Improvement Team

In March 1994, the Deputy Associate Secretary for Field Management established a DOE Lessons Learned Process Improvement Team (LLPIT). The purpose of the LLPIT is to develop a complex-wide program to standardize and facilitate identification, documentation, sharing, and use of

lessons learned from actual operating experiences throughout the DOE complex. This information sharing and utilization is commonly termed "Lessons Learned" within the DOE community.

The collected information is currently located on an Internet World Wide Web (Web) site as part of the Environmental Safety & Health (ES&H) Technical Information System (TIS). This system allows for shared access to lessons learned across the DOE complex. The information available on the system complements existing reporting systems presently used within DOE. DOE is taking this approach to enhance those existing systems by providing a method to quickly share information among the field elements. Also, this approach goes beyond the typical occurrence reporting to identify good lessons learned. DOE uses the Web site to openly disseminate such information so that not only DOE but other entities will have a source of information to improve the health and safety aspects of operations at and within their facilities. Additional benefits include enhancing the work place environment and reducing the number of accidents and injuries.

The Web site contains several items that are related to health physics. Items range from off-normal occurrences to procedural and training issues. Documentation of occurrences includes the description of events, root-cause analysis, and corrective measures. Several of the larger sites have systems that are connected through this system. DOE organizations are encouraged to participate in this valuable effort.

The Web site address for DOE Lessons Learned is:

<http://www.tis.eh.doe.gov:80/others/11/11.html>

The specific Web site address may be subject to change. This Web site can always be accessed through the main ES&H TIS Web site at:

<http://www.tis.eh.doe.gov>

# Section Five

## Conclusions and Recommendations

# 5

### 5.1 Conclusions

The current philosophy of radiation protection is based on the assumption that any radiation dose, no matter how small, may result in human health effects. Radiogenic health events have been observed in humans at doses in excess of 10 rem delivered at high dose rates. In the past, DOE workers were at risk for high occupational exposure to radiation. As the data clearly indicate, most exposures in recent years are less than 1 rem per year. It is important to monitor the DOE workforce, however, because there is less certainty about the effects of low doses delivered at low dose-rates over long time periods.

The detailed nature of the data available has made it possible to investigate distribution and trends in data and to identify and correlate parameters having an effect on occupational radiation exposure at DOE sites. This also revealed the limitations of available data, and identified additional data needed to correlate more definitively trends in occupational exposure to past and present activities at DOE sites.

During the past 5 years, the occupational radiation dose at DOE has been impacted by three factors: changes in reporting requirements, changes in operational status, and changes in radiation protection standards and practices. These factors and their impact are discussed below in order of their significance.

1. The change in methods to determine internal dose from AEDE to CEDE between 1992 and 1993 resulted in an overall reduction of the annual collective TEDE of approximately 700 person-rem (about 30%) because of the exclusion of the legacy internal dose. This represents a significant dose that is no longer accounted for in the collective dose reported to DOE Headquarters. This change in methodology resulted in the largest impact on collective TEDE in the past 5 years.
2. In 1995, the collective TEDE increased by 12% due to increased activities at 5 of the 6 highest dose sites. Most of these activities involved nuclear material and facility stabilization. Two of these sites were laboratories (LANL and BNL) that also experienced an increase in collective TEDE due to increases in operational activities (see Section 3.5).
3. The collective dose at DOE facilities experienced a dramatic (78%) decrease over the past decade (see Appendix B-4 and B-21). The main reasons for this large decrease were the shutdown of facilities because of safety problems within the weapons complex and the end of the Cold War era, which shifted the DOE mission from weapons production to shutdown, stabilization, and decommissioning and decontamination activities. The DOE weapons production sites have contributed the majority of the collective dose over these years. As facilities are shut down and undergo transition from operation to stabilization or decommissioning and decontamination, there are significant changes in the opportunities for individuals to be exposed. More modest reductions in collective dose have occurred during the past 5 years at some facilities that have continued to transition to shutdown and stabilization.
4. The implementation of the RadCon Manual and 10 CFR 835 has resulted in changes in radiation protection practices. As described previously, the RadCon Manual changed the methodology concerning internal dose. While it is not possible to quantify the impact of the RadCon Manual on the collective dose, it did establish ACLs, standardized radiation protection programs, engineering controls, and formalized ALARA practices.

## 5.2 Recommendations

1. Because the change in operational status has been shown to be a significant factor impacting the occupational dose, this information should be collected from DOE facilities. A "phase of operation" status code should be added to the occupational radiation reporting requirements for individual dose records (see Appendix A.4). In combination with the facility type codes already reported, this will provide an indication of the operational mode and type of activities being conducted at a given facility. This will become increasingly important as more facilities transition from stabilization activities into decommissioning and decontamination. The phase of operation of the six highest-dose sites in 1995 is presented in Section 3.6. The Office of Worker Protection Programs and Hazards Management (EH-52) plans to implement this recommendation in the next revision of the reporting requirements of DOE Manual 231.1-1.
2. Analysis revealed that the sites are inconsistent in the assignment of the facility type codes and have difficulty correlating the dose from specific facilities at the site with the facility type codes. A standardized approach to facility categorization should be established, in coordination with CAIRS, ORPS, Epidemiological Surveillance, and other EH database systems, to augment the facility type information with the phase of operation information (see Appendix A.3). Standardization will allow further analysis of how changes in operational status impact the occupational dose. This issue has been submitted to the Office of Information Management (OIM) for consideration.
3. In addition to the standardization of facility type codes, many sites do not report the occupation codes for monitored individuals or report them as "miscellaneous" or "unknown". This results in a large number of individuals grouped into the "unknown" labor category. Sites have indicated that it is often difficult to obtain the occupation code for subcontract workers. The sites need to improve their radiation exposure recordkeeping processes and procedures in order to obtain and report this information to the REMS system as specified in DOE Manual 231.1-1 in order to improve the analysis of radiation exposure by occupation.
4. As stated previously, the internal dose from prior intakes (legacy dose) is a significant contributor of dose to the individual worker. It is recommended that DOE establish a repository of intake information to allow analysis of the lifetime dose from prior (legacy) intakes. This information will allow analysis of the dose accrued each year for worker health and epidemiologic research in addition to the current requirements of monitoring and reporting the committed dose for regulatory enforcement purposes.

# References

1. EPA (U.S. Environmental Protection Agency), 1987. "Radiation Protection Guidance to Federal Agencies for Occupational Exposure," *Federal Register* 52, No. 17, 2822; with corrections published in the *Federal Registers* of Friday, January 30, and Wednesday, February 4, 1987.
2. ICRP (International Commission on Radiological Protection), 1977. "Recommendations of the International Commission on Radiological Protection," ICRP Publication 26, *Annals of the ICRP*, Vol. 1, No. 3 (Pergamon Press, New York).
3. NCRP (National Council on Radiation Protection and Measurements), 1987. "Recommendations on Limits for Exposure to Ionizing Radiation," NCRP 91; superseded by NCRP Report No. 116.
4. DOE (U.S. Department of Energy), Order 5480.11, Radiation Protection for Occupational Workers, December 21, 1988, Change 3, June 17, 1992.
5. DOE 1994. *Radiological Control Manual*. Revision 1, DOE/EH-0256T, Assistant Secretary for Environment, Safety and Health, April.
6. 10CFR Part 835. "Occupational Radiation Protection." Final Rule; DOE *Federal Register*, December 14, 1993.
7. The Price-Anderson Amendments Act of 1988, Public Law 100-408, August 20, 1988.
8. DOE Notice 441.1, "Radiological Protection for DOE Activities," September 29, 1995.
9. DOE Order 5484.1, "Environmental Protection, Safety, and Health Protection Information Reporting Requirements," February 24, 1981, Change 7, October 17, 1990.
10. DOE M231.1-1, "Environment, Safety and Health Reporting," September 10, 1995.
11. Munson, L.H. et al., 1988. *Health Physics Manual of Good Practices for Reducing Radiation Exposures to Levels that are As Low As Reasonably Achievable (ALARA)*, PNL-6577, Pacific Northwest Lab.
12. 10CFR Part 20. "Standards for Protection Against Radiation," Final Rule, *Federal Register*, May 21, 1991.
13. UNSCEAR (United Nations Scientific Committee on the Effects of Atomic Radiation), 1982. "Ionizing Radiation Sources and Biological Effects," report to the General Assembly.
14. DOE (U.S. Department of Energy), 1996. *1996 Baseline Environmental Management Report*, DOE/EM-0290, Office of Environmental Management, June.
15. Rich, B.L. et al., 1988. *Health Physics Manual of Good Practices for Uranium Facilities*, EGG-2530, Idaho National Engineering Lab.
16. Faust, L.G. et al., 1988. *Health Physics Manual of Good Practices for Plutonium Facilities*, EGG-6534, Pacific Northwest Lab, 1988.





## **ALARA**

Acronym for “As Low As Reasonably Achievable,” which is the approach to radiation protection to manage and control exposures (both individual and collective) to the work force and the general public to as low as is reasonable, taking into account social, technical, economic, practical, and public policy considerations. ALARA is not a dose limit but a process with the objective of attaining doses as far below the applicable limits as is reasonably achievable.

## **Annual Effective Dose Equivalent (AEDE)**

The summation for all tissues and organs of the products of the dose equivalent calculated to be received by each tissue or organ during the specified year from all internal depositions multiplied by the appropriate weighting factor. Annual effective dose equivalent is expressed in units of rem.

## **Average Measurable Dose**

Dose obtained by dividing the collective dose by the number of individuals who received a measurable dose. This is the average most commonly used in this and other reports when examining trends and comparing doses received by workers because it reflects the exclusion of those individuals receiving a less than measurable dose.

## **Collective Dose**

The sum of the total annual effective dose equivalent or total effective dose equivalent values for all individuals in a specified population. Collective dose is expressed in units of person-rem.

## **Committed Dose Equivalent (CDE) ( $H_T,50$ )**

The dose equivalent calculated to be received by a tissue or organ over a 50-year period after the intake of a radionuclide into the body. It does not include contributions from radiation sources external to the body. Committed dose equivalent is expressed in units of rem.

## **Committed Effective Dose Equivalent (CEDE) ( $H_E,50$ )**

The sum of the committed dose equivalents to various tissues in the body ( $H_T,50$ ), each multiplied by the appropriate weighting factor ( $w_T$ )—i.e.,  $H_E,50 = \sum w_T H_T,50$ . Committed effective dose equivalent is expressed in units of rem.

## **CR**

CR is defined by the United Nations Scientific Committee on the Effects of Atomic Radiation as the ratio of the annual collective dose delivered at individual doses exceeding 1.5 rem to the collective dose.

## **Deep Dose Equivalent (DDE)**

The dose equivalent derived from external radiation at a depth of 1 cm in tissue.

### **Effective Dose Equivalent ( $H_E$ )**

The summation of the products of the dose equivalent received by specified tissues of the body ( $H_T$ ) and the appropriate weighting factor ( $w_T$ )—i.e.,  $H_E = \sum w_T H_T$ . It includes the dose from radiation sources internal and/or external to the body. The effective dose equivalent is expressed in units of rem.

### **External Dose**

Radiation dose resulting from the exposure to sources of radiation that are external to the body. As used in this report, external dose is Deep Dose Equivalent (DDE) comprised of penetrating dose from photon and neutron radiation.

### **Internal Dose**

Radiation dose resulting from radioactive material taken into the body through various modes of intake, such as inhalation, ingestion, or absorption through the skin. As used in this report, internal dose is calculated using the Annual Effective Dose (AEDE) or the Committed Effective Dose Equivalent (CEDE) methodology as noted. See Section 2.4.

### **Lens of the Eye Dose Equivalent (LDE)**

The dose exposure for the lens of the eye is taken as the external equivalent at a tissue depth of 0.3 cm.

### **Lower Limit of Detection (LLD)**

The smallest quantity of radioactive material or level of radiation that can be distinguished from background with a specified degree of confidence. Often used synonymously with minimum detection level (MDL) or minimum detectable activity (MDA).

### **Neutron Dose**

The component of the Deep Dose Equivalent (DDE) resulting from exposure to neutron radiation, which is comprised of the neutral charged particles ejected from the nucleus of an atom during nuclear reactions.

### **Number of individuals with measurable exposure**

The subset of all monitored individuals who receive a measurable exposure (greater than limit of detection for the monitoring system). Many personnel are monitored as a matter of prudence and may not receive a measurable exposure. For this reason, the number of individuals with measurable exposure is presented in this report as a more accurate indicator of the exposed workforce.

### **Occupational exposure**

An individual's exposure to ionizing radiation (external and internal) as a result of that individual's work assignment. Occupational exposure does not include planned special exposures, exposure received as a medical patient, background radiation, or voluntary participation in medical research programs.

**Photon Dose**

The component of the Deep Dose Equivalent (DDE) from sources of gamma or x-ray radiation that are external to the body.

**Shallow Dose Equivalent (SDE)**

The dose equivalent deriving from external radiation at a depth of 0.007 cm in tissue.

**Total Effective Dose Equivalent (TEDE)**

The sum of the effective dose equivalent for external exposures and the effective dose equivalent for internal exposures. Deep dose equivalent to the whole body is typically used as effective dose equivalent for external exposures. The internal dose component of TEDE changed from the Annual Effective Dose Equivalent (AEDE) to the Committed Effective Dose Equivalent (CEDE) in 1993.

**Total monitored individuals**

All individuals who are monitored and reported to the DOE Headquarters database system. This includes DOE employees, contractors, and visitors.



# Appendix A DOE Reporting Sites and Reporting Codes

---

A

A.1	Labor Categories and Occupaton Codes .....	A-2
A.2	Organizations Reporting to DOE REMS, 1991-1995 .....	A-3
A.3	Facility Type Codes .....	A-6
A.4	Phase of Operation - Lifecycle for a DOE Facility .....	A-7

DOE Reporting Sites and Reporting Codes

## A.1 Labor Categories and Occupation Codes

The following is a list of the Occupation Codes that are reported with each individual's dose record to the DOE Radiation Exposure Monitoring System (REMS) system in accordance with DOE Order 5484.1 [8]. Occupation Codes are grouped into Labor Categories for the purposes of analysis and summary in this report.

Labor Category	Occupation Code (5484.1)	Occupation Name
Agriculture	0562	Groundskeepers
	0570	Forest Workers
	0580	Misc. Agriculture
Construction	0610	Mechanics/Repairers
	0641	Masons
	0642	Carpenters
	0643	Electricians
	0644	Painters
	0645	Pipe Fitter
	0650	Miners/Drillers
	0660	Misc. Repair/Construction
Laborers	0850	Handlers/Laborers/Helpers
Management	0110	Manager - Administrator
	0400	Sales
	0450	Admin. Support and Clerical
Misc.	0910	Military
	0990	Miscellaneous
Production	0681	Machinists
	0682	Sheet Metal Workers
	0690	Operators, Plant/ System/Utility
	0710	Machine Setup/Operators
	0771	Welders and Solderers
	0780	Misc. Precision/Production
Scientists	0160	Engineer
	0170	Scientist
	0184	Health Physicist
	0200	Misc. Professional
	0260	Doctors and Nurses
Service	0512	Firefighters
	0513	Security Guards
	0521	Food Service Employees
	0524	Janitors
	0525	Misc. Service
Technicians	0350	Technicians
	0360	Health Technicians
	0370	Engineering Technicians
	0380	Science Technicians
	0383	Radiation Monitors/Techs.
	0390	Misc. Technicians
Transport	0820	Truck Drivers
	0821	Bus Drivers
	0825	Pilots
	0830	Equipment Operators
	0840	Misc. Transport
Unknown	0001	Unknown

## A.2 Organizations Reporting to DOE REMS, 1991-1995

The following is a listing of all organizations reporting to the DOE REMS from 1991 to 1995. The Operations Office and Site groupings used in this report are shown in addition to the organization reporting code and name.

Operations/ Field Office	Site	Organization Code	Organization Name
<b>Albuquerque</b>	Ops. and Other Facilities	0501001	Albuquerque Field Office
		0501006	Albuquerque Office Subs.
		0502009	Albuquerque Transportation Division
		0530001	Kansas City Area Office
		0531002	Allied-Signal, Inc.
		0550001	Pinellas Area Office
		0553002	Martin Marietta Specialty Components
		0590001	WIPP Project Integration Office
		0593004	Carlsbad Area Miscellaneous Contractors
		2806003	National Renewable Energy Lab (NREL)
	Los Alamos National Lab. (LANL)	0540001	Los Alamos Area Office
		0544003	Los Alamos National Laboratory
		0544809	Protection Technologies Los Alamos
		0544904	Johnson Controls, Inc.
	Pantex Plant (PP)	0510001	Amarillo Area Office
		0514004	Battelle - Pantex
		0515002	Mason & Hanger - Amarillo
		0515006	M&H - Amarillo - Subcontractors
		0515009	M&H - Amarillo - Security Forces
	Sandia National Lab. (SNL)	0570001	Kirtland Area Office
0575003		Inhalation Toxicology Research	
0577004		Ross Aviation, Inc.	
0578003		Sandia National Laboratory	
Uranium Mill Tailings Remedial Action (UMTRA) Project	0580001	UMTRA Project Office	
	0582004	MK-Ferguson Subs - UMTRA	
	0582005	MK-Ferguson Co. - UMTRA	
	0583004	Jacobs-Weston Team	
<b>Chicago</b>	Ops. and Other Facilities	1000503	Ames Laboratory (Iowa State)
		1000903	Battelle Memorial Institute - Columbus
		1001501	Chicago Field Office
		1001606	Chicago Office Subs
		1002001	Environmental Meas. Lab.
		1004031	New Brunswick Laboratory
		1004503	Mass. Inst. of Tech.
		1005003	Princeton Plasma Physics Laboratory
		1006003	National Renewable Energy Lab (NREL)
		1000703	Argonne National Laboratory - East
	1000713	Argonne National Laboratory - West	
1001003	Brookhaven National Laboratory		
1002503	Fermi Lab.		
<b>DOE HQ</b>	DOE Headquarters	1504001	DOE Headquarters
		1504506	DOE Office Subs
<b>Idaho</b>	Idaho Site	3000209	Protection Technology - INEL
		3000504	Chem-Nuclear Geotech
		3003003	EG&G Idaho, Inc.
		3003402	Babcock & Wilcox Idaho, Inc.
		3003502	Westinghouse Idaho Nuclear Co.
		3004001	Idaho Field Office
		3004004	Idaho Office Subs
		3005004	Lockheed Idaho Tech. Co. - Services
		3005505	MK-Ferguson Company - ID
		3005506	MK-Ferguson Subcontractors - ID



## A.2 Organizations Reporting to DOE REMS, 1991-1995 (continued)

Operations/ Field Office	Site	Organization Code	Organization Name	
<b>Nevada</b>	Nevada Test Site (NTS)	3502504	EG&G Kirtland	
		3502804	EG&G Special Technologies Laboratory	
		3502904	EG&G Washington D.C.	
		3503004	EG&G Las Vegas	
		3503504	EG&G Los Alamos	
		3504004	EG&G Amador Valley Operations	
		3504504	EG&G Santa Barbara	
		3505004	Fenix & Scisson, Inc. (old org. code)	
		3505007	Fenix & Scisson, Inc.	
		3506004	Raytheon Services - Nevada	
		3506007	Holmes & Narver, Inc., ESD	
		3506024	Raytheon Services Subcontractors	
		3507501	Nevada Field Office	
		3507514	Nevada Miscellaneous Contractors	
		3507531	Defense Nuclear Agency - Kirtland	
		3507551	Environmental Protection Agency (EPA)	
		3508504	Reynolds Elec. & Engr. Co. Services	
3508505	Reynolds Elec. & Engr. Co. - NTS			
3508703	Science Applications Intern'l Corp.			
3509009	Wackenhut Services, Inc. - NV			
3509504	Westinghouse Electric Corp. - NV			
<b>Oakland</b>	Ops. and Other Facilities	8001003	Rockwell International, Rocketdyne	
		8006103	U. of Cal./Davis, Radiobiology Lab.	
		8006303	U. of Cal./SF - Lab of Radiobiology	
		8007001	Oakland Field Office	
		8003003	Lawrence Berkeley Laboratory	
	Lawrence Berkeley Lab. (LBL) Lawrence Livermore Nat'l. Lab. (LLNL)	8004003	Lawrence Livermore National Laboratory	
		8004004	LLNL Subcontractors	
		8004009	LLNL Security	
		8004024	LLNL Plant Services	
		8005003	Lawrence Livermore Nat'l Lab.	
Stanford Linear Acc. Center (SLAC)	8008003	Stanford Linear Accelerator Center		
<b>Ohio</b>	Ops. and Other Facilities	4500001	Ohio Field Office	
		4510001	Miamisburg Area Office	
	Fernald Field, 1993 Oak Ridge, 1992	Fernald Environmental*	4521001	Fernald Area Office
			4521004	Fernald Office Service Subcontractors
			4523702	Fernald Envir. Rest. Mgmt. Corp (FERMCO)
			4523706	FERMCO Subcontractors
			2503702	Fernald Envir. Rest. Mgmt. Corp (FERMCO)
	Albuquerque, 1992 Albuquerque, 1993	Mound Plant**	4003702	Westinghouse Envir Mgmt. Co. of Ohio
			4516002	EG&G Mound Applied Technologies
			4516004	EG&G Mound Subcontractors
			4516009	EG&G Mound Security Forces
			0520001	Dayton Area Office
	Idaho, 1992-1993	West Valley Project***	0526002	EG&G Mound Applied Technologies
			4539004	West Valley Nuclear Services, Inc
			3009004	West Valley Nuclear Services, Inc
<b>Oak Ridge</b>	Ops. and Other Facilities	4001117	Jacobs Environmental Restoration Team	
		4004203	Oak Ridge Inst. for Sci. & Educ.	
		4004501	Oak Ridge Field Office	
		4004704	Bechtel National, Inc. - (FUSRAP)	
		4005002	RMI Company	
		4009006	Morrison-Knudsen (WSSRAP)	
		4009503	Southeastern Univ. Research Assoc.	

\* Fernald site reported under the Oak Ridge Ops. Office in 1992, the Fernald Field Office in 1993, and the Ohio Field Office in 1994.

\*\* Mound Site reported under Albuquerque Ops. Office in 1992 and 1993 and now reports under the Ohio Field Office.

\*\*\* West Valley Site reported under Idaho Ops. Office in 1992 and 1993 and now reports under the Ohio Field Office.

## A.2 Organizations Reporting to DOE REMS, 1991-1995 (continued)

Operations/ Field Office	Site	Organization Code	Organization Name
<b>Oak Ridge</b>	Oak Ridge Site	4005105	Lockheed Martin/MK-Ferguson Co.
		4006002	Lockheed Martin Energy Systems (K-25)
		4006503	Lockheed Martin Energy Systems (ORNL)
		4008002	Lockheed Martin Energy Systems (Y-12)
	Paducah Gas. Diff. Plant (PGDP) Portsmouth Gaseous Diff. Plant (PORTS)	4007002	Martin Marietta (Paducah)
		4002502	Martin Marietta (Portsmouth)
		4002504	M.M. Portsmouth Subcontractors
	4002506	M.M. Portsmouth Subcontractors	
<b>Rocky Flats</b>	Rocky Flats Eng. Tech. Site (RFETS)	7700001	Rocky Flats Office
		7700006	Rocky Flats Office Subs
		7700007	Rocky Flats Office Subs
		7707002	EG&G Rocky Flats
		7707004	Rocky Mountain Management Group
		7707005	J. A. Jones - Rocky Flats
		7707006	EG&G Rocky Flats Subcontractors
		7707009	EG&G Rocky Flats Security Forces
		7709009	Wackenhut Services - Rocky Flats
		7711004	Kaiser-Hill RFETS
<b>Richland</b>	Hanford Site	7500503	Battelle Memorial Institute (PNL)
		7500705	Bechtel Power Co.
		7502504	Hanford Environmental Health Foundation
		7503005	Kaiser Engineers Hanford
		7506001	Richland Field Office
		7508805	US Corps of Engineers - RL
		7509004	Westinghouse Hanford Services
7509104	Westinghouse Hanford Service Subs		
<b>Savannah River</b>	Savannah River Site (SRS)	8500204	American Telephone & Telegraph
		8500505	Bechtel Construction - SR
		8501002	Westinghouse Savannah River Co.
		8501004	Service America
		8501014	Westinghouse S.R. Subcontractors
		8501024	Diversco
		8501034	Industrial Phases - SR
		8503001	S.R. Army Corps of Engineers
		8505001	S.R. Forest Station
		8505501	Savannah River Field Office
		8507004	Miscellaneous DOE Contractors
		8507504	Southern Bell Tel. & Tel.
		8509003	Univ. of Georgia Ecology Laboratories
8509509	Wackenhut Services, Inc. - SR		

### Not included in this report

<b>Pittsburgh Naval Reactor Office</b>	Pittsburgh Naval Reactor Office	6007001	Pittsburgh N.R. Office
		6007504	Westinghouse Plant Apparatus Division
		6008003	Westinghouse Electric (BAPL)
		6009003	Westinghouse Electric (NRF)
		6009014	Newport News Reactor Services
<b>Schenectady Naval Reactor Office</b>	Schenectady Naval Reactor Office	9004003	LM-KAPL - Kesselring
		9004005	Gen. Dynam. - Kesselring - Electric Boat
		9005003	LM-KAPL - Knolls
		9005004	LM-KAPL - Knolls Subs
		9007003	LM-KAPL - Windsor
		9007005	LM-KAPL - Windsor - Electric Boat
9009001	Schenectady N.R. Office		

### A.3 Facility Type Codes

The following is the list of facility type codes reported to REMS in accordance with DOE Order 5484.1 [8]. A facility type code is reported with each individual's dose record indicating the facility type where the majority of the individual's dose was accrued during the monitoring year.

Exhibit A-1.  
Facility Type Codes.

Facility Type Code	Description
10	Accelerator
21	Fuel/Uranium Enrichment
22	Fuel Fabrication
23	Fuel Processing
40	Maintenance and Support (Site Wide)
50	Reactor
61	Research, General
62	Research, Fusion
70	Waste Processing/Mgmt.
80	Weapons Fab. and Testing
99	Other

See complete Facility Type descriptions shown in Appendix C.

## A.4 Phase of Operation

In addition to the Facility Type listing that has been reported in the past, the DOE Office of Environment Safety and Health is interested in obtaining information on the operational status of these facilities. This information will be codified in terms of a Phase of Operation to describe the operating status of a facility. The listing that follows covers each of the phases of operation from construction to the final stage of surveillance and maintenance once a site has undergone environmental restoration.

The phase of operation will be recorded for the calendar year for which the phase of operation is most appropriate. For facilities that transition between phases during a year, the phase that is appropriate for the majority of the calendar year should be recorded. The Phase of Operation will be recorded and submitted

along with the Facility Type as part of the monitored individual's dose record. Reporting format and specifications will be included in subsequent revisions to DOE M231.1-1 [11].

Each DOE facility falls into one of the Phase of Operations shown in *Exhibit A-2*. In general, each phase follows in sequential order, although a facility may forgo one or more phases or may not follow the order listed here.

This is the proposed table for the phases of operation of DOE facilities. Please submit comments, additions, or revisions to this table, to EH-52 (see Appendix E for address).

**Exhibit A-2.**  
**Phase of Operation - Lifecycle for a DOE Facility.**

Code	Phase of Operation	Definition
<b>A</b>	Construction (includes Major Renovation)	New facilities that are brought on line to replace or augment existing facilities. This phase includes major renovations for existing facilities but does not include environmental restoration construction.
<b>B</b>	Operation/ Maintenance	Includes the operations and maintenance of the reported Facility Type.
<b>C</b>	Stabilization	Facilities that have been declared to be surplus (assigned to the environment restoration program). This includes facilities where all operations have been suspended but environmental restoration activities have not begun. This may include periods of surveillance and maintenance prior to environmental restoration activities.
<b>D</b>	Remediation	Period during which corrective actions that are necessary to bring the facility into regulatory compliance are being performed.
	Decontamination and Decommissioning	Decontamination is the act of removing a chemical, biological, or radiologic contaminant from, or neutralizing its potential effect on, a person, object or environment by washing, chemical action, mechanical cleaning, or other techniques. Decommissioning is the process of closing and securing a facility.
<b>F</b>	Waste Management	This phase includes the management of wastes generated during the environment restoration process. (D,E)
<b>G</b>	Surveillance and Maintenance	This phase includes those activities that provide for the safety and protection of a facility after the environmental restoration phase.
<b>Z</b>	Other	All DOE facilities should fit into one of the above categories. "Other" should be used only in highly unusual circumstance.

These phases comprise Environmental Restoration

# Additional Data

# B

B-1a	Operations Office/Site Dose Data (1993)	B-2
B-1b	Operations Office/Site Dose Data (1994)	B-3
B-1c	Operations Office/Site Dose Data (1995)	B-4
B-2	Internal Dose by Operations/Site, 1993 - 1995	B-5
B-3	Neutron Dose by Site, 1993-1995	B-6
B-4	Distribution of Deep Dose Equivalent (DDE) and Total Effective Dose Equivalent (TEDE), 1974-1994	B-7
B-5	Collective TEDE and Number with Measurable Dose 1974-1994	B-8
B-6	Number with Measurable Dose and Average Measurable Dose 1974-1994	B-9
B-7a	Distribution of TEDE by Facility Type - 1993	B-10
B-7b	Distribution of TEDE by Facility Type - 1994	B-11
B-7c	Distribution of TEDE by Facility Type - 1995	B-12
B-8a	Collective TEDE by Facility Type, 1993	B-13
B-8b	Collective TEDE by Facility Type, 1994	B-14
B-8c	Collective TEDE by Facility Type, 1995	B-15
B-9	Distribution of TEDE by Facility Type Listed in Descending Order of Average Measurable TEDE for Accelerator Facilities, 1995	B-16
B-10	Distribution of TEDE by Facility Type Listed in Descending Order of Average Measurable TEDE for Fuel Facilities, 1995	B-17
B-11	Distribution of TEDE by Facility Type Listed in Descending Order of Average Measurable TEDE for Maintenance and Support, 1995	B-19
B-12	Distribution of TEDE by Facility Type Listed in Descending Order of Average Measurable TEDE for Other, 1995	B-21
B-13	Distribution of TEDE by Facility Type Listed in Descending Order of Average Measurable TEDE for Reactor Facilities, 1995	B-24
B-14	Distribution of TEDE by Facility Type Listed in Descending Order of Average Measurable TEDE for Research-General, 1995	B-25
B-15	Distribution of TEDE by Facility Type Listed in Descending Order of Average Measurable TEDE for Research-Fusion, 1995	B-27
B-16	Distribution of TEDE by Facility Type Listed in Descending Order of Average Measurable TEDE for Waste Processing/Management, 1995	B-28
B-17	Distribution of TEDE by Facility Type Listed in Descending Order of Average Measurable TEDE for Weapons Fabrication and Testing, 1995	B-30
B-18	Internal Dose by Facility Type and Nuclide, 1993-1995	B-32
B-19a	Distribution of TEDE by Labor Category, 1993	B-33
B-19b	Distribution of TEDE by Labor Category, 1994	B-34
B-19c	Distribution of TEDE by Labor Category, 1995	B-35
B-20	Internal Dose by Labor Category, 1993-1995	B-36
B-21	Internal Dose Distribution by Site and Nuclide, 1995	B-37
B-22	Correlation of Occupational Radiation Exposure with Nuclear Weapons Production	B-38

## B-1a: Operations Office/Site Dose Data (1993)

		1993									
Operations/ Field Office	Site	Collective TEDE (person-rem)		Number with Meas. Dose		Avg. Meas. TEDE (rem)		Percentage of Coll. TEDE above 0.500 rem		Percent Change from 1992	
		Percent Change from 1992	Percent Change from 1992	Percent Change from 1992	Percent Change from 1992	Percent Change from 1992	Percent Change from 1992	Percent Change from 1992	Percent Change from 1992	Percent Change from 1992	Percent Change from 1992
Albuquerque	Ops. and Other Facilities Los Alamos Nat'l. Lab. (LANL) Panex Plant (PP) Sandia Nat'l. Lab. (SNL) Uranium Mill Tailings Remedial Action (UMTRA) Project****	0.5	-83%	28	-74%	0.017	-35%	0%	-		
		199.2	-14%	1,391	-19%	0.143	7%	50%	27%		
		46.0	-11%	445	16%	0.103	-23%	32%	-18%		
		11.9	-34%	314	-39%	0.038	8%	9%	-41%		
Chicago	Ops. and Other Facilities Argonne Nat'l. Lab. - East (ANL-E) Argonne Nat'l. Lab. - West (ANL-W) Brookhaven Nat'l. Lab. (BNL) Fermi Nat'l. Accelerator Lab. (FERMI)	10.8	17%	321	-10%	0.034	30%	0%	-		
		20.9	24%	185	24%	0.113	0%	31%	2%		
		28.4	50%	263	6%	0.108	41%	14%	46%		
		59.9	2%	713	-27%	0.084	39%	21%	73%		
		16.0	-29%	238	-50%	0.067	43%	22%	127%		
DOE HQ	DOE Headquarters (Includes DNFSB)	3.4	<b>497%</b>	61	-12%	0.056	<b>575%</b>	17%	100%		
Idaho	Idaho Site	235.5	169%	1,175	17%	<b>0.200</b>	130%	46%	<b>410%</b>		
Nevada	Nevada Test Site (NTS)	1.7	-20%	20	-46%	0.083	47%	0%	-		
Oakland	Ops. and Other Facilities Lawrence Berkeley Lab. (LBL) Lawrence Livermore Nat'l. Lab. (LLNL) Stanford Linear Accelerator Center (SLAC)	3.0	-68%	32	0%	0.095	-68%	41%	-35%		
		6.8	6%	137	41%	0.049	80%	10%	100%		
		30.2	-38%	194	-20%	0.156	-22%	<b>58%</b>	-13%		
		44.0	165%	615	<b>219%</b>	0.072	-17%	14%	26%		
Oak Ridge	Ops. and Other Facilities Oak Ridge Site Paducah Gaseous Diff. Plant(PGD) Portsmouth Gaseous Diff. Plant (PORTS)	8.6	-7%	171	-11%	0.050	5%	0%	-100%		
		76.1	-21%	1,939	-31%	0.039	14%	10%	-52%		
		6.5	-9%	171	10%	0.038	-17%	0%	-		
		33.6	50%	832	9%	0.040	38%	6%	100%		
Ohio (Fernald) (Abuquerque) (Idaho)	Ops. and Other Facilities Fernald Environmental Mgmt. Project* Mound Plant** West Valley Project***	-	-	-	-	-	-	0%	-		
		26.1	-26%	1,020	45%	0.026	-49%	0%	-100%		
		6.6	-8%	258	18%	0.026	-22%	0%	-100%		
		17.5	2%	249	15%	0.070	-11%	16%	28%		
Rocky Flats	Rocky Flats Eng. Tech. Site (REETS)	<b>265.9</b>	-70%	<b>5,605</b>	-28%	0.047	-58%	10%	-76%		
Richland	Hanford Site	211.5	-19%	3,147	4%	0.067	-22%	17%	-43%		
Savannah River	Savannah River Site (SRS)	264.4	-25%	5,202	-20%	0.051	-6%	6%	-55%		
<b>Totals</b>		<b>1,644.2</b>	<b>-28%</b>	<b>25,095</b>	<b>-15%</b>	<b>0.066</b>	<b>-15%</b>	<b>22%</b>	<b>-24%</b>		

\* Fernald site reported under the Oak Ridge Ops. Office in 1992, the Fernald Field Office in 1993, and the Ohio Field Office in 1994.

\*\* Mound Site reported under Albuquerque Ops. Office in 1992 and 1993 and now reports under the Ohio Field Office.

\*\*\* West Valley Site reported under Idaho Ops. Office in 1992 and 1993 and now reports under the Ohio Field Office.

Note: Boxed values indicate the greatest value in each column.

B.2

DOE Occupational Radiation Exposure

## B-1b: Operations Office/Site Dose Data (1994)

		1994							
Operations/ Field Office	Site	Collective TEDE (person-rem)	Percent Change From 1993	Number with Meas. Dose	Percent Change From 1993	Avg. Meas. TEDE (rem)	Percent Change From 1993	Percentage of Coll. TEDE above 0.500 rem	Percent Change From 1993
Albuquerque	Ops. and Other Facilities Los Alamos Nat'l. Lab. (LANL) Pantex Plant (PP) Sandia Nat'l. Lab. (SNL) Uranium Mill Tailings Remedial Action (UMTRA) Project	0.4	-10% ▼	26	-7% ▼	0.016	-3% ▼	0%	-
		190.0	-5% ▼	2,448	76% ▲	0.078	46% ▼	44%	-12% ▼
		29.1	-37% ▼	347	-22% ▼	0.084	-19% ▼	15%	-54% ▼
		12.0	1% ▼	250	-20% ▼	0.048	26% ▼	24%	182% ▼
		15.0	63% ▼	390	6% ▼	0.039	56% ▼	0%	-
Chicago	Ops. and Other Facilities Argonne Nat'l. Lab. - East (ANL-E) Argonne Nat'l. Lab. - West (ANL-W) Brookhaven Nat'l. Lab. (BNL) Fermi Nat'l. Accelerator Lab. (FERMI)	8.3	-23% ▼	233	-27% ▼	0.036	6% ▼	6%	100% ▼
		40.3	<b>93%</b> ▲	280	51% ▲	<b>0.144</b>	27% ▼	<b>48%</b>	57% ▼
		26.3	-7% ▼	343	30% ▼	0.077	-29% ▼	11%	-24% ▼
		92.3	54% ▼	865	21% ▼	0.107	27% ▼	29%	41% ▼
		14.3	-11% ▼	526	<b>121%</b> ▲	0.027	<b>-60%</b> ▼	0%	-100% ▼
DOE HQ	DOE Headquarters (includes DNFSB)	2.7	-20% ▼	43	-30% ▼	0.064	14% ▼	0%	-100% ▼
Idaho	Idaho Site	236.8	1% ▼	1,659	41% ▼	0.143	-29% ▼	42%	-8% ▼
Nevada	Nevada Test Site (NTS)	2.0	20% ▼	20	0% ▼	0.099	20% ▼	0%	-
Oakland	Ops. and Other Facilities Lawrence Berkeley Lab. (LBL) Lawrence Livermore Nat'l. Lab. (LLNL) Stanford Linear Accelerator Center (SLAC)	0.8	-72% ▼	20	-38% ▼	0.042	-56% ▼	0%	-100% ▼
		5.7	-17% ▼	92	-33% ▼	0.062	24% ▼	9%	-10% ▼
		18.8	-38% ▼	146	-25% ▼	0.129	-17% ▼	47%	-19% ▼
		16.3	-63% ▼	219	-64% ▼	0.074	4% ▼	10%	-28% ▼
Oak Ridge	Ops. and Other Facilities Oak Ridge Site Paducah Gaseous Diff. Plant(PGDP) Portsmouth Gaseous Diff. Plant (PORTS)	6.8	-20% ▼	255	49% ▼	0.027	47% ▼	0%	-
		69.2	-9% ▼	1,613	-17% ▼	0.043	9% ▼	7%	-28% ▼
		6.8	5% ▼	151	-12% ▼	0.045	19% ▼	0%	-
		30.3	-10% ▼	836	0% ▼	0.036	-10% ▼	4%	-31% ▼
Ohio	Ops. and Other Facilities Fernald Environmental Mgmt. Project Mound Plant West Valley Project	0.0	-7% ▼	2	-9% ▼	0.023	2% ▼	0%	-
		24.2	37% ▼	925	16% ▼	0.030	18% ▼	6%	100% ▼
		9.1	39% ▼	292	17% ▼	0.083	19% ▼	20%	28% ▼
Rocky Flats	Rocky Flats Eng. Tech. Site (RFETS)	231.9	-13% ▼	3,660	-35% ▼	0.063	34% ▼	3%	-73% ▼
Richland	Hanford Site	214.8	2% ▼	3,166	1% ▼	0.068	1% ▼	21%	20% ▼
Savannah River	Savannah River Site (SRS)	<b>314.5</b>	22% ▼	<b>6,284</b>	39% ▼	0.050	-12% ▼	22%	<b>245%</b> ▼
<b>Totals</b>		<b>1,643.1</b>	<b>1%</b> ▼	<b>25,390</b>	<b>6%</b> ▼	<b>0.065</b>	<b>-4%</b> ▼	<b>23%</b>	<b>4%</b> ▼

Note: Boxed values indicate the greatest value in each column.



## B-1c: Operations Office/Site Dose Data (1995)

		1995							
Operations/ Field Office	Site	Collective TEDE (person-rem)	Percent Change from 1994	Number with Meas. Dose	Percent Change from 1994	Avg. Meas. TEDE (rem)	Percent Change from 1994	Percentage of Coll. TEDE above 0.500 rem	Percent Change from 1994
Albuquerque	Ops. and Other Facilities Los Alamos Nat'l. Lab. (LANL) Pantex Plant (PP) Sandia Nat'l. Lab. (SNL) Uranium Mill Tailings Remedial Action (UMTRA) Project	1.6	300%	40	54%	0.040	150%	0%	-
		234.9	24%	2,583	6%	0.091	17%	49%	10%
		36.9	27%	329	-5%	0.112	33%	24%	62%
		11.1	-8%	343	37%	0.032	-33%	0%	-100%
Chicago	Ops. and Other Facilities Argonne Nat'l. Lab. - East (ANL-E) Argonne Nat'l. Lab. - West (ANL-W) Brookhaven Nat'l. Lab. (BNL) Fermi Nat'l. Accelerator Lab. (FERMI)	1.3	-91%	58	-85%	0.022	-43%	0%	-
		6.5	-21%	135	-42%	0.048	35%	0%	-100%
		37.2	-8%	297	6%	0.125	-13%	36%	-24%
		37.6	43%	335	-2%	0.112	46%	10%	-5%
DOE HQ	DOE Headquarters (includes DNFSB)	145.8	58%	973	12%	0.150	40%	33%	15%
		13.4	-6%	473	-10%	0.028	5%	0%	-
		0.1	-96%	8	-81%	0.012	-81%	0%	-
		284.0	20%	1,501	-10%	0.189	32%	62%	49%
Nevada	Nevada Test Site (NTS)	0.5	-77%	9	-55%	0.051	-48%	0%	-
		1.3	60%	20	0%	0.064	53%	0%	-
Oakland	Ops. and Other Facilities Lawrence Berkeley Lab. (LBL) Lawrence Livermore Nat'l. Lab. (LLNL) Stanford Linear Accelerator Center (SLAC)	4.5	-21%	76	-17%	0.059	-5%	17%	89%
		13.0	-31%	159	9%	0.082	-37%	14%	-71%
		20.2	24%	236	8%	0.086	16%	10%	-2%
		6.2	-9%	167	-35%	0.037	37%	0%	-
Oak Ridge	Ops. and Other Facilities Oak Ridge Site Paducah Gaseous Diff. Plant (PGDP) Portsmouth Gaseous Diff. Plant (PORTS)	76.9	11%	1,804	12%	0.043	0%	16%	135%
		9.0	33%	225	49%	0.040	-11%	0%	-
		27.5	-9%	1,623	94%	0.017	-53%	4%	4%
		0.0	0%	5	150%	0.007	-70%	0%	-
Ohio	Ops. and Other Facilities Fernald Environmental Mgmt. Project Mound Plant West Valley Project	30.4	26%	955	3%	0.032	23%	0%	-
		6.4	-30%	175	-41%	0.036	21%	9%	45%
		26.9	11%	311	7%	0.087	4%	14%	-28%
		260.8	12%	3,427	-6%	0.076	21%	11%	252%
Richland	Hanford Site	290.7	35%	2,500	-21%	0.116	71%	34%	62%
		255.5	-19%	4,846	-23%	0.053	5%	13%	-40%
Savannah River	Savannah River Site (SRS)	1,840.2	12%	23,613	-7%	0.078	20%	30%	30%
<b>Totals</b>									

Note: Boxed values indicate the greatest value in each column.

## B-2: Internal Dose by Operations/Site, 1993 - 1995

Operations/ Field Office	Site	No. of Individuals with New Intakes*			Collective CEDE Dose from Uptake (person-rem)			Average CEDE (rem)		
		1993	1994	1995	1993	1994	1995	1993	1994	1995
Albuquerque	Ops. and Facilities	10	6	17	0.097	0.015	0.214	0.010	0.003	0.013
	LANL	159	112	134	<b>57.039</b> ◀	<b>15.810</b> ◀	1.264	0.359	<b>0.141</b> ◀	0.009
	Pantex	69	50	48	0.259	0.115	0.101	0.004	0.002	0.002
	Sandia	15	12	-	0.265	0.192	-	0.018	0.016	-
Chicago	Ops. and Other Facilities	36	52	50	0.367	0.477	0.478	0.010	0.009	0.010
	ANL-E	20	61	28	0.547	1.708	0.391	0.027	0.028	0.014
	ANL-W	1	-	-	0.106	-	-	0.106	-	-
	BNL	51	50	61	3.050	5.090	3.157	0.060	0.102	0.052
Idaho	Idaho Site	7	8	16	0.237	0.133	0.398	0.034	0.017	0.025
Oakland	LBL	4	4	5	0.190	0.327	0.237	0.048	0.082	0.047
	LLNL	1	4	3	0.024	0.004	0.006	0.024	0.001	0.002
Oak Ridge	Ops. and Other Facilities	61	21	45	6.238	1.741	3.227	0.102	0.083	<b>0.072</b> ◀
	Oak Ridge Site	942	511	<b>673</b> ◀	6.881	4.327	<b>12.904</b> ◀	0.007	0.008	0.019
	Paducah	47	27	17	0.169	0.086	0.048	0.004	0.003	0.003
	Portsmouth	270	280	6	6.578	5.817	0.049	0.024	0.021	0.008
Ohio	Fernald	-	32	108	-	0.261	0.684	-	0.008	0.006
	Mound Plant	94	70	78	0.285	0.254	1.141	0.003	0.004	0.015
Rocky Flats	Rocky Flats	23	24	16	16.004	2.916	0.367	<b>0.696</b> ◀	0.122	0.023
Richland	Hanford Site	12	12	13	4.825	1.553	0.709	0.402	0.129	0.055
Savannah River	Savannah River Site	<b>1,157</b> ◀	<b>613</b> ◀	533	6.752	4.726	5.389	0.006	0.008	0.010
<b>Totals</b>		<b>2,979</b>	<b>1,949</b>	<b>1,851</b>	<b>109.913</b>	<b>45.552</b>	<b>30.764</b>	<b>0.037</b>	<b>0.023</b>	<b>0.017</b>

Facilities with no new intakes: UMTRA, Chicago Ops. ANL-W, Fermi Lab, DOE-HQ, NTS, Oakland Ops., SLAC, Ohio Ops., West Valley Project.

\* Only includes intakes that occurred during the monitoring year. Individuals may be counted more than once.

Note: Arrowed values indicate the greatest value in each column.

**B-3: Neutron Dose by Site, 1993-1995**

		1993	1994	1995		
Operations/ Field Office	Site/Facility	Collective DDE Neutron Dose (person-rem)	Collective DDE Neutron Dose (person-rem)	Collective DDE Neutron Dose (person-rem)	Percent of Total DOE Neutron Dose	
Albuquerque	Ops. and Other Facilities Los Alamos National Lab. (LANL) Pantex Plant (PP) Sandia National Lab. (SNL) Uranium Mill Tailings Remedial Action (UMTRA) Project	0.2	0.1	0.9		0%
		<b>99.8</b> ▼	<b>132.5</b> ▼	<b>174.1</b> ▼		<b>47%</b> ▼
		13.0	6.6	10.2		3%
		0.5	0.4	0.4		0%
		-	-	-		0%
Chicago	Ops. and Other Facilities Argonne Nat'l. Lab. - East (ANL-E) Argonne Nat'l. Lab. - West (ANL-W) Brookhaven Nat'l. Lab. (BNL) Fermi Nat'l. Accelerator Lab. (FERMII)	0.0	-	-		0%
		4.0	2.0	4.6		1%
		0.7	0.3	0.3		0%
		3.9	11.4	42.1		11%
		8.3	-	-		0%
DOE HQ	DOE Headquarters	2.4	1.9	0.1		0%
Idaho	Idaho Site	0.9	2.0	1.3		0%
Nevada	Nevada Test Site (NTS)	0.1	0.5	0.2		0%
Oakland	Ops. and Other Facilities Lawrence Berkeley Lab. (LBL) Lawrence Livermore Nat'l. Lab. (LLNL) Stanford Linear Accelerator Center (SLAC)	-	-	-		0%
		1.0	0.3	0.1		0%
		5.9	3.5	5.2		1%
		7.4	2.7	4.7		1%
Oak Ridge	Ops. and Other Facilities Oak Ridge Site Paducah Gaseous Diff. Plant (PGDP) Portsmouth Gaseous Diff. Plant (PORTS)	-	0.7	-		0%
		9.9	11.7	10.5		3%
		-	0.0	-		0%
		-	-	-		0%
Ohio	Ops. and Other Facilities Fernald Environmental Management Project* Mound Plant** West Valley***	-	0.0	-		0%
		-	-	-		0%
		3.2	5.4	3.1		1%
		-	-	0.0		0%
Richland	Hanford Site	51.9	49.8	26.5		7%
Rocky Flats	Rocky Flats Eng. Tech. Site (RFETS)	42.0	26.4	38.9		11%
Savannah River	Savannah River Site (SRS)	76.6	74.7	43.9		12%
	<b>Totals</b>	<b>331.6</b>	<b>332.9</b>	<b>367.4</b>		<b>100%</b>

\* Fernald Site reported under the Fernald Field Office in 1993, and the Ohio Field Office in 1994.

\*\* Mound Site reported under Albuquerque Ops. Office in 1993 and now reports under the Ohio Field Office.

\*\*\* West Valley Site reported under Idaho Ops. Office in 1993 and now reports under the Ohio Field Office.

Note: Boxed values indicate the greatest value in each column.

**B-4: Distribution of Deep Dose Equivalent (DDE) and Total Effective Dose Equivalent (TEDE), 1974-1995**

<b>Deep Dose Equivalent (DDE)</b>																		
Number of Individuals Receiving Radiation Doses in Each Dose Range (rem)																		
Year	Less than Meas.	Meas.-1	1-2	2-3	3-4	4-5	5-6	6-7	7-8	8-9	9-10	10-11	11-12	>12	Total Monitored	No. with Meas. DDE	Coll. DDE (person-rem)	Avg. Meas. DDE
1974	37,060	29,735	1,531	652	149	40	4								69,171	32,111	<b>10,202</b> ◀	<b>0.318</b> ◀
1975	41,390	36,795	1,437	541	122	28				1					80,314	38,924	9,202	0.236
1976	38,408	41,321	1,296	387	70	6	1								81,489	43,081	8,938	0.207
1977	41,572	44,730	1,499	540	103	23			1	2				2	88,472	46,900	10,199	0.217
1978	43,317	51,444	1,311	439	53	11									96,575	<b>53,258</b> ◀	9,390	0.176
1979	48,529	48,553	1,281	416	33	10	1							2	98,825	50,296	8,691	0.173
1980	43,663	35,385	1,113	387	16										80,564	36,901	7,760	0.210
1981	43,775	33,251	967	263	29	5									78,290	34,515	7,223	0.209
1982	47,420	30,988	990	313	56	28									79,795	32,375	7,538	0.233
1983	48,340	32,842	1,225	294	49	31									82,781	34,441	7,720	0.224
1984	46,056	38,821	1,223	312	31	11									86,454	40,398	8,113	0.201
1985	54,582	34,317	1,362	356	51	8				1					90,677	36,095	8,340	0.231
1986	53,586	33,671	1,279	349	35	1		1					1		88,923	35,337	8,095	0.229
1987	45,241	28,995	1,210	283	36										75,765	30,524	6,056	0.198
1988	48,704	27,492	502	34											76,732	28,028	3,735	0.133
1989	56,363	28,925	428	21											85,737	29,374	3,151	0.107
1990	76,798	31,110	140	17											108,065	31,267	2,230	0.071
1991	92,526	27,149	95												119,770	27,244	1,762	0.065
1992	98,900	24,769	42												123,711	24,811	1,504	0.061
1993	103,905	23,050	86			1									127,042	23,137	1,534	0.066
1994	92,245	24,189	77												116,511	24,266	1,600	0.066
1995	104,793	22,330	153												<b>127,276</b> ◀	22,483	1,809	0.080

<b>Total Effective Dose Equivalent (TEDE)*</b>																		
Year	Less than Meas.	Meas.-1	1-2	2-3	3-4	4-5	5-6	6-7	7-8	8-9	9-10	10-11	11-12	>12	Total Monitored	No. with Meas. TEDE	Coll. TEDE (person-rem)	Avg. Meas. TEDE
1990	71,991	35,780	226	47	8	8	1	2		1				1	108,065	<b>36,074</b> ◀	<b>3,052</b> ◀	<b>0.085</b> ◀
1991	88,444	31,086	193	25	9	8		2		1				2	119,770	31,326	2,574	0.082
1992	94,297	29,240	132	22	9	6		2	1		1			1	123,711	29,414	2,295	0.078
1993	101,947	25,002	87			2				1	1			2	127,042	25,095	1,644	0.066
1994	91,121	25,310	79		1										116,511	25,390	1,643	0.065
1995	103,663	23,455	157		1										<b>127,276</b> ◀	23,613	1,840	0.078

\* 1990-1992 TEDE=DDE+AEDE

1993-1994 TEDE=DDE+CEDE

Note: Arrowed values indicate the greatest value in each column.

**B-5: Collective TEDE and Average Measurable Dose 1974-1995**

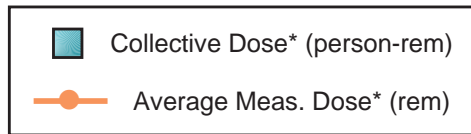
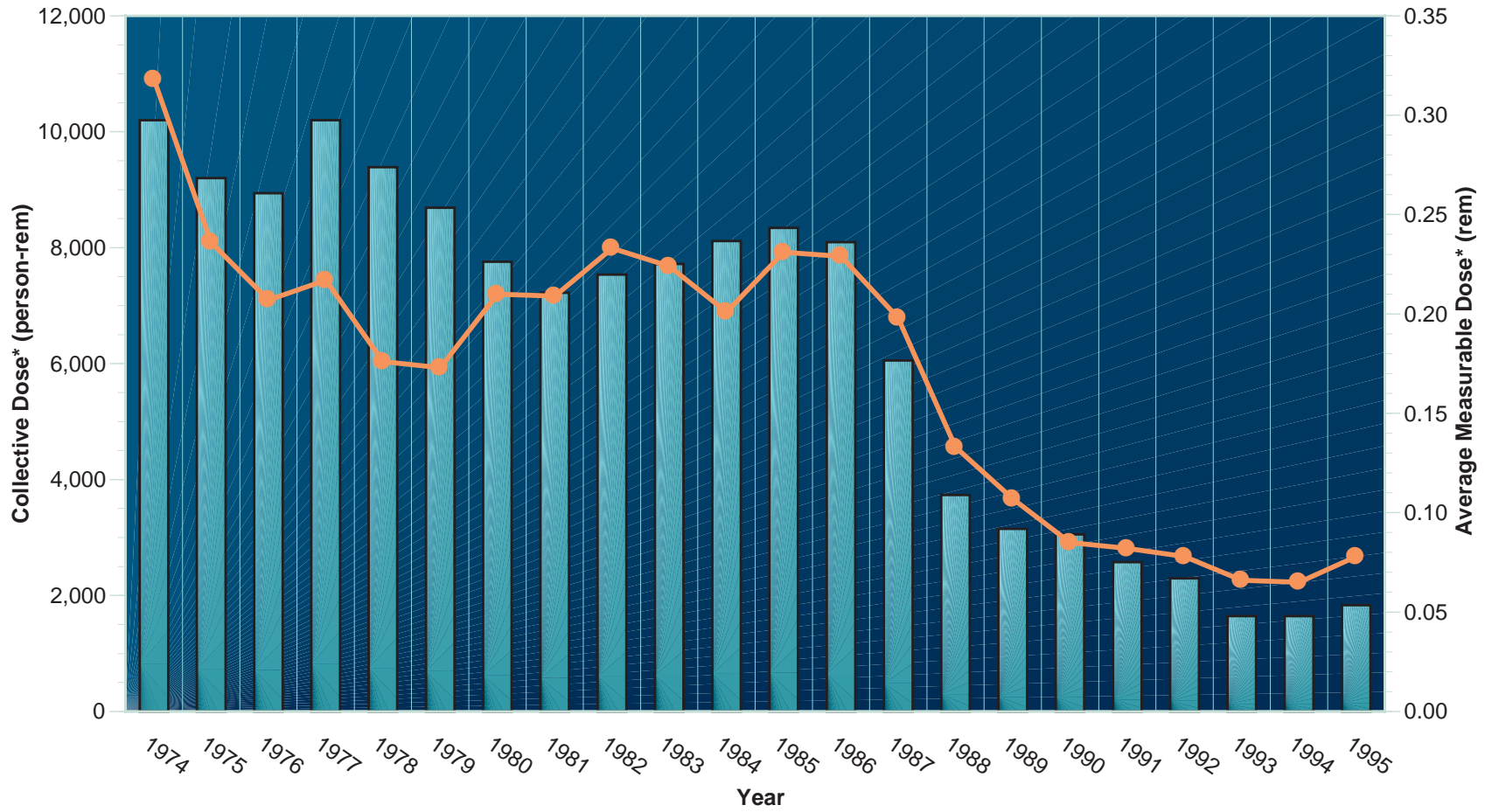

\* 1974-1990 Collective Dose=DDE  
 1990-1992 Collective Dose=DDE+AEDE  
 1993-1995 Collective Dose=DDE+CEDE

**B-6: Number with Measurable Dose and Average Measurable Dose 1974-1995**

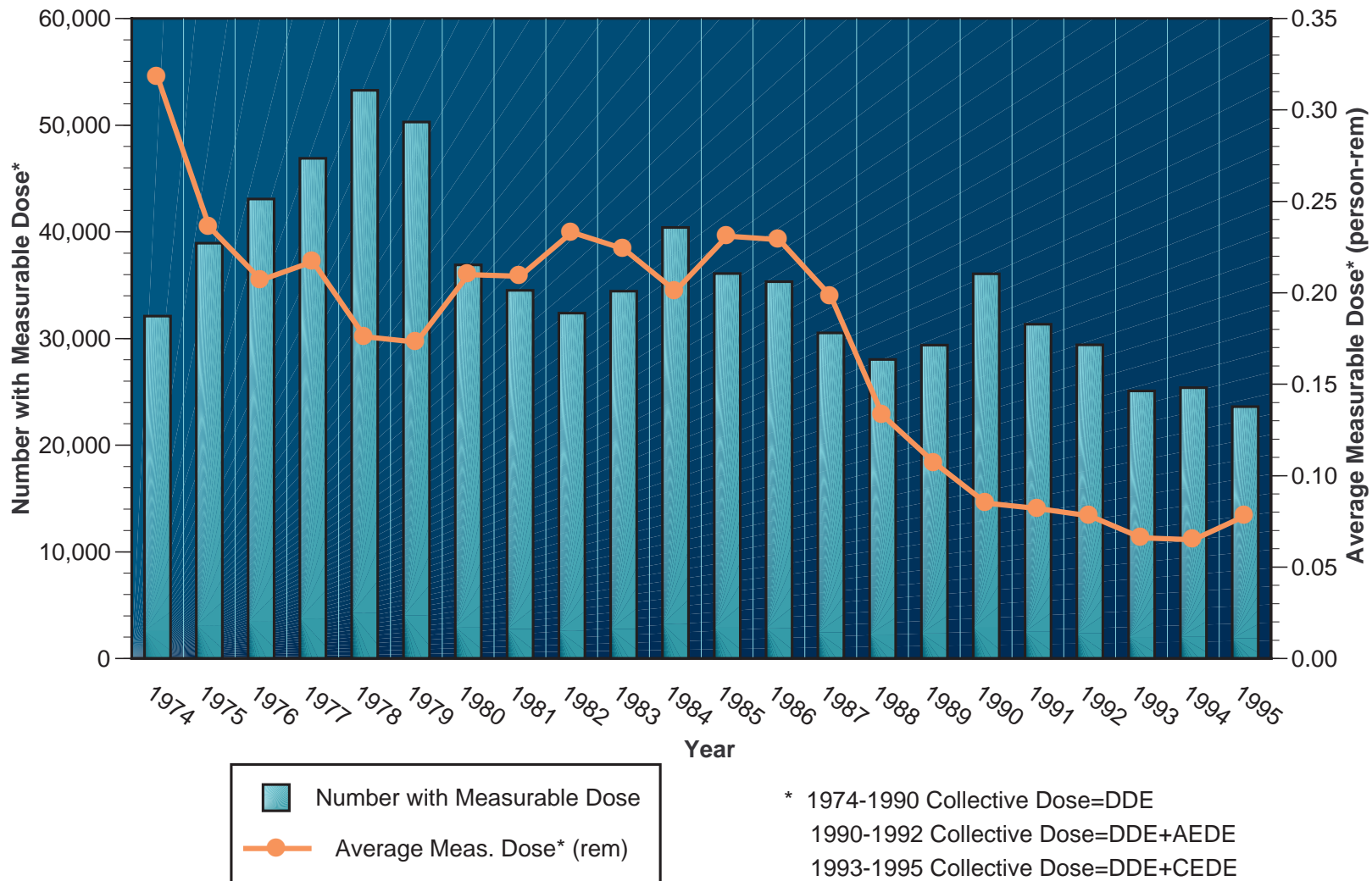

**B-7a: Distribution of TEDE by Facility Type - 1993**

Total Effective Dose Equivalent (TEDE)																							
Number of Individuals Receiving Radiation Doses in Each Dose Range (rem)																							
Facility Type	Less than Meas.	Meas.-0.10	0.10-0.25	0.25-0.50	0.50-0.75	0.75-1.00	1-2	2-3	3-4	4-5	5-6	6-7	7-8	8-9	9-10	10-11	11-12	>12	Total Monitored	Percent of Monitored with Meas. TEDE	No. with Meas. TEDE	Collective TEDE (person-rem)	Average Meas. TEDE (rem)
Accelerator	7,248	1,316	231	78	14	7	4												8,898	19%	1,650	125.837	0.076
Fuel/Uran. Enrich.	12,441	1,066	55	23	3	3													13,591	8%	1,150	45.347	0.039
Fuel Fabrication	3,077	1,147	66	16	5														4,311	29%	1,234	41.757	0.034
Fuel Processing	3,960	1,484	261	141	23	5	7												5,881	31%	1,921	160.933	0.084
Maint. and Support	16,946	2,444	252	90	12	5												1	19,750	13%	2,804	148.524	0.053
Other	13,325	1,805	160	76	31	28	50												15,475	14%	2,150	196.344	0.091
Reactor	2,629	1,058	166	93	2	1	1			1									3,951	27%	1,322	90.827	0.069
Research, General	19,265	2,236	371	195	63	31	24							1				1	22,187	13%	2,922	309.250	<b>0.106</b> ◀
Research, Fusion	1,269	112	7	1															1,389	9%	120	3.584	0.030
Waste Proc./Mgmt.	7,163	1,605	253	78	2	2													9,103	21%	1,940	107.597	0.055
Weapons Fab. & Test.	14,624	6,937	665	226	40	11	1			1					1				<b>22,506</b> ◀	<b>35%</b> ◀	<b>7,882</b> ◀	<b>414.199</b> ◀	0.053
<b>Totals</b>	<b>101,947</b>	<b>21,210</b>	<b>2,487</b>	<b>1,017</b>	<b>195</b>	<b>93</b>	<b>87</b>	<b>0</b>	<b>0</b>	<b>2</b>	<b>0</b>	<b>0</b>	<b>0</b>	<b>1</b>	<b>1</b>	<b>0</b>	<b>0</b>	<b>2</b>	<b>127,042</b>	<b>20%</b>	<b>25,095</b>	<b>1,644.199</b>	<b>0.066</b>

Note: Arrowed values indicate the greatest value in each column.

This table displays the distribution of TEDE for the monitored DOE employees and contractors by facility type, including the total number of monitored individuals, the number of individuals with measurable TEDE, the collective TEDE, and the average TEDE.

**B-7b: Distribution of TEDE by Facility Type - 1994**

<b>Total Effective Dose Equivalent (TEDE)</b>																							
Number of Individuals Receiving Radiation Doses in Each Dose Range (rem)																							
Facility Type	Less than Meas.	Meas.-0.10	0.10-0.25	0.25-0.50	0.50-0.75	0.75-1.00	1-2	2-3	3-4	4-5	5-6	6-7	7-8	8-9	9-10	10-11	11-12	>12	Total Monitored	Percent of Monitored with Meas. TEDE	No. with Meas. TEDE	Collective TEDE (person-rem)	Average Meas. TEDE (rem)
Accelerator	6,458	1,463	171	83	20	8	5												8,208	21%	1,750	118.135	0.068
Fuel/Uran. Enrich.	10,072	1,037	62	20	1	1													11,193	10%	1,121	40.055	0.036
Fuel Fabrication	2,793	1,074	41	9	8	8													3,933	29%	1,140	44.315	0.039
Fuel Processing	3,441	1,641	204	123	69	11	1												5,490	37%	2,049	167.049	<b>0.082</b> ◀
Maint. and Support	16,734	2,796	242	115	25	9	2												19,923	16%	3,189	160.756	0.050
Other	11,956	2,462	244	82	45	16	40												14,845	19%	2,889	211.054	0.073
Reactor	1,911	1,019	140	94	25	1	1												3,191	<b>40%</b> ◀	1,280	97.025	0.076
Research, General	16,776	2,776	373	157	65	37	26		1										<b>20,211</b> ◀	17%	3,435	283.028	<b>0.082</b> ◀
Research, Fusion	983	133	12	8	3	2	2												1,143	14%	160	12.602	0.079
Waste Proc./Mgmt.	5,974	2,582	257	71	11	1	1												8,897	33%	2,923	129.249	0.044
Weapons Fab. & Test.	14,023	4,528	691	172	57	5	1												19,477	28%	<b>5,454</b> ◀	<b>379.796</b> ◀	0.070
<b>Totals</b>	<b>91,121</b>	<b>21,511</b>	<b>2,437</b>	<b>934</b>	<b>329</b>	<b>99</b>	<b>79</b>	<b>0</b>	<b>1</b>	<b>0</b>	<b>0</b>	<b>0</b>	<b>0</b>	<b>0</b>	<b>0</b>	<b>0</b>	<b>0</b>	<b>0</b>	<b>116,511</b>	<b>22%</b>	<b>25,390</b>	<b>1,643.064</b>	<b>0.065</b>

Note: Arrowed values indicate the greatest value in each column.

This table displays the distribution of TEDE for the monitored DOE employees and contractors by facility type, including the total number of monitored individuals, the number of individuals with measurable TEDE, the collective TEDE, and the average TEDE.



### B-7c: Distribution of TEDE by Facility Type - 1995

#### Total Effective Dose Equivalent (TEDE)

Number of Individuals Receiving Radiation Doses in Each Dose Range (rem)

Facility Type	Less than Meas.	Meas.- 0.10	0.10- 0.25	0.25- 0.50	0.50 0.75	0.75- 1.00	1-2	2-3	3-4	4-5	>5	Total Monitored	Percent of Monitored with Meas. TEDE	No. with Meas. TEDE	Collective TEDE (person-rem)	Average Meas. TEDE (rem)
Accelerator	6,921	1,277	238	136	38	20	9					8,639	20%	1,718	168.527	0.098
Fuel/Uran. Enrich.	11,669	1,825	72	16	2							13,584	14%	1,915	39.230	0.020
Fuel Fabrication	2,673	986	46	19	4							3,728	28%	1,055	39.545	0.037
Fuel Processing	3,257	1,123	173	119	61	17	12					4,762	32%	1,505	162.958	0.108
Maint. and Support	16,576	2,324	285	135	42	18	16					19,396	15%	2,820	210.894	0.075
Other	17,464	2,035	203	120	51	30	70	1				19,974	13%	2,510	280.871	<b>0.112</b> ◀
Reactor	1,724	705	115	59	15	2						2,620	<b>34%</b> ◀	896	68.710	0.077
Research, General	18,280	2,579	366	193	54	29	48					21,549	15%	3,269	311.100	0.095
Research, Fusion	909	111	10	10	3							1,043	13%	134	8.953	0.067
Waste Proc./Mgmt.	6,580	2,019	311	98	25	3	2					9,038	27%	2,458	156.936	0.064
Weapons Fab. & Test.	17,610	4,289	724	229	79	12						<b>22,943</b> ◀	23%	<b>5,333</b> ◀	<b>392.522</b> ◀	0.074
<b>Totals</b>	<b>103,663</b>	<b>19,273</b>	<b>2,543</b>	<b>1,134</b>	<b>374</b>	<b>131</b>	<b>157</b>	<b>1</b>				<b>127,276</b>	<b>19%</b>	<b>23,613</b>	<b>1,840.246</b>	<b>0.078</b>

Note: Arrowed values indicate the greatest value in each column.

November 26, 1996, 8:30 a.m.

This table displays the distribution of TEDE for the monitored DOE employees and contractors by facility type, including the total number of monitored individuals, the number of individuals with measurable TEDE, the collective TEDE, and the average TEDE.

**B-8a: Collective TEDE by Facility Type, 1993**

DOE Operations/Site		Accelerator	Fuel/Uranium Enrichment	Fuel Fabrication	Fuel Processing	Maintenance and Support	Reactor	Research, General	Research, Fusion	Waste Processing/Management	Weapons Fab. and Testing	Other	Totals
DOE Operations	Site												
Albuquerque	Ops. and Other Facilities										0.5	0.0	<b>0.5</b>
	Los Alamos National Lab. (LANL)	21.3				44.1	0.2	<b>129.3</b> ◀	0.6	1.8	0.0	1.8	<b>199.2</b>
	Pantex Plant (PP)										46.0		<b>46.0</b>
	Sandia National Lab. (SNL) Uranium Mill Tailings Remedial Action (UMTRA) Project	0.5				0.7	4.8	4.0	0.0	0.4	0.8	0.7	<b>11.9</b>
											9.2		<b>9.2</b>
Chicago	Ops. and Other Facilities					6.0		1.9	<b>3.0</b> ◀			0.0	<b>10.8</b>
	Argonne Nat'l. Lab. - East (ANL-E)	8.6				0.8		10.4		1.1			<b>20.9</b>
	Argonne Nat'l. Lab. - West (ANL-W)			0.3		1.4	1.7	23.5				1.4	<b>28.4</b>
	Brookhaven Nat'l. Lab.(BNL) Fermi Nat'l. Accelerator Lab.(FERMI)	31.2 16.0				2.5	12.1	10.1		0.9		3.1	<b>59.9</b> <b>16.0</b>
DOE HQ	DOE Headquarters										3.4	<b>3.4</b>	
Idaho	Idaho Site				64.9	2.3	<b>42.7</b> ◀	7.6		1.9		<b>116.2</b> ◀	<b>235.5</b>
Nevada	Nevada Test Site (NTS)	0.0								0.0	1.6	0.1	<b>1.7</b>
Oakland	Ops. and Other Facilities							3.0					<b>3.0</b>
	Lawrence Berkeley Lab.(LBL)	4.1						2.7					<b>6.8</b>
	Lawrence Livermore Nat'l. Lab. (LLNL) Stanford Linear Accelerator Center (SLAC)	0.1 <b>44.0</b> ◀	3.4			2.1		12.5	0.0	0.0	6.0	6.0	<b>30.2</b> <b>44.0</b>
Oak Ridge	Ops. and Other Facilities							1.6		1.1		5.9	<b>8.6</b>
	Oak Ridge Site			1.8				43.7			20.5	10.1	<b>76.1</b>
	Paducah Gaseous Diff. Plant (PGDP) Portsmouth Gaseous Diff. Plant (PORTS)			6.5 <b>33.6</b> ◀									<b>6.5</b> <b>33.6</b>
Ohio (Fernald Field Off.) (Albuquerque) (Idaho)	Ops. and Other Facilities												
	Fernald Environmental Mgmt. Project*				<b>26.1</b> ◀								<b>26.1</b>
	Mound Plant** West Valley***					2.5				0.0	4.0	0.1 17.5	<b>6.6</b> <b>17.5</b>
Rocky Flats	Rocky Flats Eng. Tech. Site (RFETS)										<b>265.9</b> ◀	<b>265.9</b> ◀	
Richland	Hanford Site	0.0		0.2	4.6	<b>73.3</b> ◀	14.2	47.0		<b>54.3</b> ◀		18.0	<b>211.5</b>
Savannah River	Savannah River Site (SRS)			15.1	<b>91.5</b> ◀	12.6	15.2	12.0		46.1	69.1	2.8	<b>258.4</b>
	<b>Totals</b>	<b>125.8</b>	<b>45.3</b>	<b>41.7</b>	<b>160.9</b>	<b>148.5</b>	<b>90.8</b>	<b>309.2</b>	<b>3.6</b>	<b>107.6</b>	<b>414.2</b>	<b>196.3</b>	<b>1,644.2</b>

\* Fernald site reported under the Oak Ridge Ops. Office in 1992, the Fernald Field Office in 1993, and the Ohio Field Office in 1994.  
 \*\* Mound Site reported under Albuquerque Ops. Office in 1992 and 1993 and now reports under the Ohio Field Office.  
 \*\*\* West Valley Site reported under Idaho Ops. Office in 1992 and 1993 and now reports under the Ohio Field Office.  
 Note: Arrowed values indicate the greatest value in each column.

**B-8b: Collective TEDE by Facility Type, 1994**

DOE Operations/Site		Accelerator	Fuel/Uranium Enrichment	Fuel Fabrication	Fuel Processing	Maintenance and Support	Research, General	Research, Fusion	Waste Processing/Management	Weapons Fab. and Testing	Other	Totals	
DOE Operations	Site												
Albuquerque	Ops. and Other Facilities							0.1			0.2	0.1	<b>0.4</b>
	Los Alamos National Lab. (LANL)	23.7				44.0	0.2	<b>114.3</b> ◀	0.7	1.6	0.0	5.5	<b>190.0</b>
	Pantex Plant (PP)										29.1		<b>29.1</b>
	Sandia National Lab. (SNL)	0.4				0.8	5.4	2.8	0.0	0.2	0.4	2.0	<b>12.0</b>
	Uranium Mill Tailings Remedial Action (UMTRA) Project											15.0	<b>15.0</b>
Chicago	Ops. and Other Facilities					1.8		3.3	3.2			0.0	<b>8.3</b>
	Argonne Nat'l. Lab. - East (ANL-E)	5.7				1.0		9.5		2.2		21.9	<b>40.3</b>
	Argonne Nat'l. Lab. - West (ANL-W)			0.2		0.8	2.6	22.5				0.1	<b>26.3</b>
	Brookhaven Nat'l. Lab. (BNL)	<b>53.7</b> ◀				2.7	7.5	13.3		1.5		13.7	<b>92.3</b>
	Fermi Nat'l. Accelerator Lab. (FERMI)	14.3											<b>14.3</b>
DOE HQ	DOE Headquarters										2.7	<b>2.7</b>	
Idaho	Idaho Site				73.4	8.0	<b>51.2</b> ◀	8.1		5.5		<b>90.6</b> ◀	<b>236.8</b>
Nevada	Nevada Test Site (NTS)	0.1									1.9		<b>2.0</b>
Oakland	Ops. and Other Facilities							0.8					<b>0.8</b>
	Lawrence Berkeley Lab. (LBL)	1.9						3.8					<b>5.7</b>
	Lawrence Livermore Nat'l. Lab. (LLNL)	0.3	1.2			1.0		1.7			2.2	3.6	<b>10.0</b>
	Stanford Linear Accelerator Center (SLAC)	16.3							<b>8.8</b> ◀				<b>25.1</b>
Oak Ridge	Ops. and Other Facilities	1.9			0.5			0.7		1.7		2.0	<b>6.8</b>
	Oak Ridge Site		1.8					44.9			14.7	7.9	<b>69.2</b>
	Paducah Gaseous Diff. Plant (PGDP)		6.8										<b>6.8</b>
	Portsmouth Gaseous Diff. Plant (PORTS)	<b>30.3</b> ◀											<b>30.3</b>
Ohio	Ops. and Other Facilities					0.0							<b>0.0</b>
	Fernald Environmental Mgmt. Project			<b>24.2</b> ◀									<b>24.2</b>
	Mound Plant					6.4					2.4	0.2	<b>9.1</b>
	West Valley											24.3	<b>24.3</b>
Rocky Flats	Rocky Flats Eng. Tech. Site (RFETS)										<b>231.9</b> ◀	<b>231.9</b>	
Richland	Hanford Site			0.4	4.9	<b>77.7</b> ◀	13.4	43.8		56.0	18.7	<b>214.8</b>	
Savannah River	Savannah River Site (SRS)			19.5	<b>88.3</b> ◀	16.4	16.8	13.3		<b>60.7</b> ◀	96.9	2.6	<b>314.5</b> ◀
	<b>Totals</b>	<b>118.1</b>	<b>40.1</b>	<b>44.3</b>	<b>167.1</b>	<b>160.8</b>	<b>97.0</b>	<b>283.0</b>	<b>12.6</b>	<b>129.2</b>	<b>379.8</b>	<b>211.1</b>	<b>1,643.1</b>

Note: Arrowed values indicate the greatest value in each column.

B-8c: Collective TEDE by Facility Type, 1995

DOE Operations/Site		Accelerator	Fuel/Uranium Enrichment	Fuel Fabrication	Fuel Processing	Maintenance and Support	Reactor	Research - General	Research - Fusion	Waste Processing/Management	Weapons Fab. and Testing	Other	Totals		
DOE Operations	Site														
Albuquerque	Ops. and Other Facilities											0.3	1.3	<b>1.6</b>	
	Los Alamos National Lab. (LANL)	23.6					68.7	0.1	<b>130.0</b> ◀	1.0	2.6	0.1	8.9	<b>234.9</b>	
	Pantex Plant (PP)											36.9		<b>36.9</b>	
	Sandia National Lab. (SNL) UMTRA	0.3					1.5	3.3	4.0		0.4	0.3	1.2	<b>11.1</b>	
Chicago	Ops. and Other Facilities						2.8		0.4	3.3			0.1	<b>6.5</b>	
	Argonne Nat'l. Lab. - East (ANL-E)	6.7					2.6		11.9		4.1		12.0	<b>37.2</b>	
	Argonne Nat'l. Lab. - West (ANL-W)			0.3			0.8	5.5	31.0					<b>37.6</b>	
	Brookhaven Nat'l. Lab. (BNL)	<b>102.1</b> ◀					6.0	9.9	8.9		1.3		17.6	<b>145.8</b>	
	Fermi Nat'l. Accelerator Lab. (FERMI)	13.4												<b>13.4</b>	
DOE HQ	DOE Headquarters											0.1	<b>0.1</b>		
Idaho	Idaho Site					<b>94.2</b> ◀	9.0	<b>19.2</b> ◀	6.7		6.6		<b>148.3</b> ◀	<b>284.0</b>	
Nevada	Nevada Test Site (NTS)											0.5		<b>0.5</b>	
Oakland	Ops. and Other Facilities								1.2				0.1	<b>1.3</b>	
	Lawrence Berkeley Lab. (LBL)	1.2							3.3					<b>4.5</b>	
	Lawrence Livermore Nat'l. Lab. (LLNL)	0.4	1.9		1.1				1.2	<b>4.7</b> ◀		2.0	1.7	<b>13.0</b>	
	Stanford Linear Accelerator Center (SLAC)	20.2												<b>20.2</b>	
Oak Ridge	Ops. and Other Facilities	0.8							0.5		1.8		3.1	<b>6.2</b>	
	Oak Ridge Site			0.9					42.1			12.6	21.4	<b>76.9</b>	
	Paducah Gaseous Diff. Plant (PGDP)			9.0										<b>9.0</b>	
	Portsmouth Gaseous Diff. Plant (PORTS)			<b>27.5</b> ◀										<b>27.5</b>	
Ohio	Ops. and Other Facilities													<b>0.0</b>	
	Fernald Environmental Mgmt. Project				<b>30.4</b> ◀									<b>30.4</b>	
	Mound Plant West Valley						4.1					1.9	0.3	<b>6.4</b>	
												26.9	<b>26.9</b>		
Rocky Flats	Rocky Flats Eng. Tech. Site (RFETS)												<b>260.6</b> ◀	0.2	<b>260.8</b>
Richland	Hanford Site					7.0	<b>97.5</b> ◀	17.4	54.9		<b>81.5</b> ◀		32.4	<b>290.7</b> ◀	
Savannah River	Savannah River Site (SRS)			8.8	61.8	16.7	13.4	14.9		58.7	77.4	3.9		<b>255.5</b>	
	<b>Totals</b>	<b>168.5</b>	<b>39.2</b>	<b>39.5</b>	<b>163.0</b>	<b>210.9</b>	<b>68.7</b>	<b>311.1</b>	<b>9.0</b>	<b>156.9</b>	<b>392.5</b>	<b>280.9</b>		<b>1,840.2</b>	

Note: Arrowed values indicate the greatest value in each column.

**B-9: Distribution of TEDE by Facility Type Listed in Descending Order of Average Measurable TEDE for Accelerator Facilities, 1995**

<b>ACCELERATOR FACILITIES</b>															
Number of Individuals Receiving Radiation Doses in Each Dose Range (rem)															
Ops. Office	Site/Contractor	Less than Meas.	Meas.- 0.10	0.10- 0.25	0.25- 0.50	0.50- 0.75	0.75- 1.00	1.00- 2.00	>2	Total Monitored	% of Monitored with Meas. TEDE	No. with Meas. TEDE	Collective TEDE (person-rem)	Avg. Meas. TEDE (rem)	% of TEDE above 0.5 rem
CH	Brookhaven Nat. Lab.	680	200	108	103	30	17	8		1,146	41%	466	<b>102.109</b> ◀	<b>0.219</b> ◀	<b>41%</b> ◀
OAK	Stanford Linear Acc.	1,955	176	43	14	2	1			2,191	11%	236	20.196	0.086	10%
OAK	Lawrence Livermore	300	4	0	1					305	2%	5	0.389	0.078	-
AL	Los Alamos	300	250	47	11	6	2	1		617	51%	317	23.566	0.074	29%
CH	Argonne - East	731	115	13	6					865	15%	134	6.670	0.050	-
OAK	Lawrence Berkeley	7	27	2						36	<b>81%</b> ◀	29	1.168	0.040	-
CH	Fermilab	1,815	447	25	1					<b>2,288</b> ◀	21%	<b>473</b> ◀	13.400	0.028	-
OR	Oak Ridge Field Office	4	1							5	20%	1	0.020	0.020	-
OR	CEBAF	883	41							924	4%	41	0.750	0.018	-
AL	Sandia Nat. Lab.	216	16							232	7%	16	0.259	0.016	-
RL	Battelle Mem. Inst. (PNL)	16								16	0%	-	-	-	-
NV	EG&G Santa Barbara	6								6	0%	-	-	-	-
NV	EG&G Spec. Tec. Lab.	4								4	0%	-	-	-	-
AL	Johnson Controls, Inc.	2								2	0%	-	-	-	-
CH	Argonne - West	1								1	0%	-	-	-	-
RL	Westinghouse Hanford	1								1	0%	-	-	-	-
	<b>Totals</b>	<b>6,921</b>	<b>1,277</b>	<b>238</b>	<b>136</b>	<b>38</b>	<b>20</b>	<b>9</b>		<b>8,639</b>	<b>20%</b>	<b>1,718</b>	<b>168.527</b>	<b>0.098</b>	<b>30%</b>

Note: Arrowed values indicate the greatest value in each column.

This table displays the distribution of TEDE for Accelerator facilities in order of decreasing average measurable TEDE, including the total number of monitored individuals, the number of individuals with measurable TEDE, the collective TEDE, and the percentage of TEDE accrued above 0.5 rem.

**B-10: Distribution of TEDE by Facility Type Listed in Descending Order of Average Measurable TEDE for Fuel Facilities, 1995**

<b>FUEL FACILITIES</b>															
Number of Individuals Receiving Radiation Doses in Each Dose Range (rem)															
Ops. Office	Site/Contractor	Less than Meas.	Meas.- 0.10	0.10- 0.25	0.25- 0.50	0.50- 0.75	0.75- 1.00	1.0- 2.0	>2	Total Monitored	% of Monitored with Meas. TEDE	No. with Meas. TEDE	Collective TEDE (person-rem)	Avg. Meas. TEDE (rem)	% of TEDE above 0.5 rem
<b>ENRICHMENT</b>															
OAK	Lawrence Livermore Nat. Lab.	604	12	2	3					621	3%	17	1.866	<b>0.110</b> ◀	-
OR	Paducah	3,833	201	21	3					4,058	6%	225	9.020	0.040	-
OR	M.M. Portsmouth GDP	1,569	1,332	45	10	2				2,958	<b>47%</b> ◀	<b>1,389</b> ◀	<b>25.052</b> ◀	0.018	<b>5%</b> ◀
OR	Oak Ridge K-25	4,370	48	2						<b>4,420</b> ◀	1%	50	0.871	0.017	-
OR	M.M. Portsmouth Contractors	1,293	232	2						1,527	15%	234	2.421	0.010	-
	<b>Total</b>	<b>11,669</b>	<b>1,825</b>	<b>72</b>	<b>16</b>	<b>2</b>				<b>13,584</b>	<b>14%</b>	<b>1,915</b>	<b>39.230</b>	<b>0.020</b>	<b>3%</b>
<b>FABRICATION</b>															
SR	WSRC	148	54	4	13	4				223	34%	75	8.476	<b>0.113</b> ◀	<b>25%</b> ◀
CH	Argonne - West	28	5	1						34	18%	6	0.293	0.049	-
OH	FERMCO Subcontractors	779	300	20	5					1,104	29%	325	10.636	0.033	-
OH	FERMCO	1,606	602	20	1					<b>2,229</b> ◀	28%	<b>623</b> ◀	<b>19.725</b> ◀	0.032	-
SR	Westinghouse S.R. Sub.	19	4	1						24	21%	5	0.140	0.028	-
SR	Wackenhut Services, Inc. - SR	5	8							13	<b>62%</b> ◀	8	0.121	0.015	-
RL	Westinghouse Hanford	8	3							11	27%	3	0.041	0.014	-
OH	Fernald	66	7							73	10%	7	0.084	0.012	-
SR	Savannah River	3	2							5	40%	2	0.023	0.012	-
SR	Bechtel Construction - SR	3	1							4	25%	1	0.006	0.006	-
OH	Fernald Office Serv. Sub.	6								6	0%	-	-	-	-
RL	Kaiser Engineers, Hanford	1								1	0%	-	-	-	-
SR	Misc. DOE Contractors - SR	1								1	0%	-	-	-	-
	<b>Total</b>	<b>2,673</b>	<b>986</b>	<b>46</b>	<b>19</b>	<b>4</b>				<b>3,728</b>	<b>28%</b>	<b>1,055</b>	<b>39.545</b>	<b>0.037</b>	<b>5%</b>

Note: Arrowed values indicate the greatest value in each column.

**B-10: Distribution of TEDE by Facility Type Listed in Descending Order of Average Measurable TEDE for Fuel Facilities, 1995 (Continued)**

<b>FUEL FACILITIES</b>															
Number of Individuals Receiving Radiation Doses in Each Dose Range (rem)															
Ops. Office	Site/Contractor	Less than Meas.	Meas.-0.10	0.10-0.25	0.25-0.50	0.50-0.75	0.75-1.00	1.0-2.0	>2	Total Monitored	% of Monitored with Meas. TEDE	No. with Meas. TEDE	Collective TEDE (person-rem)	Avg. Meas. TEDE (rem)	% of TEDE above 0.5 rem
<b>PROCESSING</b>															
RL	Westinghouse Hanford	11	9	2	0	9	1			32	66%	21	6.999	<b>0.333</b> ◀	<b>92%</b> ◀
ID	Lockheed ID Tech. Co. -Serv.	1,769	229	65	69	40	16	11		<b>2,199</b> ◀	20%	430	<b>94.138</b> ◀	0.219	55%
SR	Service America	3	5	4	3					15	<b>80%</b> ◀	12	1.913	0.159	-
SR	WSRC	1,028	713	96	47	12	0	1		1,897	46%	<b>869</b> ◀	56.307	0.065	14%
SR	Bechtel Construction - SR	115	115	6						236	51%	121	3.019	0.025	-
ID	Idaho	50	4							54	7%	4	0.054	0.014	-
SR	Wackenhut Serv. Inc. - SR	119	20							139	14%	20	0.269	0.013	-
SR	Westinghouse SR Sub.	109	18							127	14%	18	0.181	0.010	-
SR	Savannah River	48	10							58	17%	10	0.078	0.008	-
SR	Misc. DOE Contractors - SR	4								4	0%	-	-	-	-
RL	Bechtel Power Co.	1								1	0%	-	-	-	-
	<b>Total</b>	<b>3,257</b>	<b>1,123</b>	<b>173</b>	<b>119</b>	<b>61</b>	<b>17</b>	<b>12</b>		<b>4,762</b>	<b>32%</b>	<b>1,505</b>	<b>162.958</b>	<b>0.108</b>	<b>40%</b>

Note: Arrowed values indicate the greatest value in each column.

This table displays the distribution of TEDE for Fuel facilities in descending order of average measurable TEDE for Enrichment, Fabrication, and Processing facilities. Also included are the total number of monitored individuals, the number of individuals with measurable TEDE, the Collective TEDE, and the percentage of TEDE accrued above 0.5 rem.

**B-11: Distribution of TEDE by Facility Type Listed in Descending Order of Average Measurable TEDE for Maintenance and Support, 1995**

<b>MAINTENANCE AND SUPPORT</b>															
Number of Individuals Receiving Radiation Doses in Each Dose Range (rem)															
Ops. Office	Site/Contractor	Less than Meas.	Meas.-0.10	0.10-0.25	0.25-0.50	0.50-0.75	0.75-1.00	1.00-2.00	>2	Total Monitored	% of Monitored with Meas. TEDE	No. with Meas. TEDE	Collective TEDE (person-rem)	Avg. Meas. TEDE (rem)	% of TEDE above 0.5 rem
RL	Battelle Mem. Inst. (PNL)	26	1	0	1	0	0	1		29	10%	3	1.496	<b>0.499</b> ◀	<b>76%</b> ◀
CH	Argonne - East	764	11	4	2	1				782	2%	18	2.565	0.143	26%
RL	Kaiser Engineers, Hanford	1,298	208	57	43	14	6			1,626	20%	328	44.769	0.136	30%
AL	Los Alamos Nat. Lab.	1,435	316	29	23	11	8	12		1,834	22%	399	49.350	0.124	61%
RL	Westinghouse Hanford	2,368	417	89	39	11	2			<b>2,926</b> ◀	19%	<b>558</b> ◀	<b>50.368</b> ◀	0.090	16%
CH	Brookhaven Nat. Lab.	654	49	10	8	1				722	9%	68	6.018	0.089	9%
CH	Battelle Mem. Inst. - Columbus	331	32	10	1					374	11%	43	2.794	0.065	-
AL	Johnson Controls, Inc.	1,016	263	28	15	3	2			1,327	23%	311	18.295	0.059	18%
CH	Argonne - West	36	11	2						49	27%	13	0.760	0.058	-
ID	Lockheed Idaho Tech. Co. - Serv.	646	159	13	0	0	0	2		820	21%	174	8.917	0.051	29%
SR	Service America	24	5	2						31	23%	7	0.357	0.051	-
OAK	LLNL Subcontractors	2,509	21	1						2,531	1%	22	0.982	0.045	-
OH	EG&G Mound App. Tech.	726	78	9	1	1				815	11%	89	3.498	0.039	16%
RL	Bechtel Power Co.	229	15	2						246	7%	17	0.601	0.035	-
RL	Westinghouse Hanford Serv. Sub.	287	10							297	3%	10	0.302	0.030	-
SR	Bechtel Construction - SR	310	118	6	1					435	29%	125	3.692	0.030	-
SR	WSRC	894	389	19	1	0	0	1		1,304	31%	410	11.890	0.029	10%
OH	EG&G Mound Subcontractors	933	22	1						956	2%	23	0.639	0.028	-
SR	Wackenhut Services, Inc. - SR	80	8							88	9%	8	0.209	0.026	-
AL	Sandia Nat. Lab.	558	58	2						618	10%	60	1.535	0.026	-
OAK	LLNL Plant Services	312	6							318	2%	6	0.149	0.025	-
AL	Protection Tech. Los Alamos	319	65							384	17%	65	1.044	0.016	-
ID	Idaho Field Office	97	4							101	4%	4	0.052	0.013	-



**B-11: Distribution of TEDE by Facility Type Listed in Descending Order of Average Measurable TEDE for Maintenance and Support, 1995 (Continued)**

<b>MAINTENANCE AND SUPPORT</b>															
Number of Individuals Receiving Radiation Doses in Each Dose Range (rem)															
Ops. Office	Site/Contractor	Less than Meas.	Meas.-0.10	0.10-0.25	0.25-0.50	0.50-0.75	0.75-1.00	1.00-2.00	>2	Total Monitored	% of Monitored with Meas. TEDE	No. with Meas. TEDE	Collective TEDE (person-rem)	Avg. Meas. TEDE (rem)	% of TEDE above 0.5 rem
SR	Westinghouse SR Subcontractors	186	36	1						223	17%	37	0.440	0.012	-
OH	EG&G Mound Security Forces	89	1							90	1%	1	0.011	0.011	-
SR	Savannah River Field Office	41	8							49	16%	8	0.068	0.009	-
AL	Los Alamos Area Office	35	6							41	15%	6	0.045	0.008	-
SR	Diversco	1	1							2	50%	1	0.007	0.007	-
SR	Misc. DOE Contractors - SR	12	6							18	33%	6	0.041	0.007	-
OAK	LLNL Security	296								296	0%	-	-	-	-
OH	Miamisburg Area Office	24								24	0%	-	-	-	-
OH	Ohio Field Office	16								16	0%	-	-	-	-
ID	Idaho Office Subs	6								6	0%	-	-	-	-
NV	Wackenhut Services, Inc. - NV	6								6	0%	-	-	-	-
SR	Southern Bell Tel. & Tel.	4								4	0%	-	-	-	-
OAK	Lawrence Livermore Nat. Lab-NV	2								2	0%	-	-	-	-
RL	Richland Field Office	2								2	0%	-	-	-	-
SR	Univ. of GA Ecology Lab.	2								2	0%	-	-	-	-
HQ	DOE Headquarters	1								1	0%	-	-	-	-
NV	Nevada Misc. Contractors	1								1	0%	-	-	-	-
	<b>Totals</b>	<b>16,576</b>	<b>2,324</b>	<b>285</b>	<b>135</b>	<b>42</b>	<b>18</b>	<b>16</b>		<b>19,396</b>	<b>15%</b>	<b>2,820</b>	<b>210.894</b>	<b>0.075</b>	<b>29%</b>

Note: Arrowed values indicate the greatest value in each column.

This table displays the distribution of TEDE for Maintenance and Support facilities, listed in descending order of average measurable TEDE, and including the total number of monitored individuals, the number of individuals with measurable TEDE, the collective TEDE, and the percentage of TEDE accrued above 0.5 rem. Note that only 15% of individuals monitored received any measurable TEDE.

**B-12: Distribution of TEDE by Facility Type Listed in Descending Order of Average Measurable TEDE for Other, 1995**

<b>OTHER</b>															
Number of Individuals Receiving Radiation Doses in Each Dose Range (rem)															
Ops. Office	Site/Contractor	Less than Meas.	Meas.- 0.10	0.10- 0.25	0.25- 0.50	0.50- 0.75	0.75- 1.00	1.00- 2.00	>2	Total Monitored	% of Monitored with Meas. TEDE	No. with Meas. TEDE	Collective TEDE (person-rem)	Avg. Meas. TEDE (rem)	% of TEDE above 0.5 rem
ID	Lockheed ID Tech. Co. - Serv.	493	342	36	33	33	26	58		1,021	52%	<b>528</b> ◀	<b>148.184</b> ◀	<b>0.281</b> ◀	<b>82%</b> ◀
CH	Argonne - East	0	37	5	10	3	1	2		58	<b>100%</b> ◀	58	12.044	0.208	52%
AL	Albuquerque Office Subs.	0	1	4	1					6	<b>100%</b> ◀	6	1.089	0.181	-
RL	Battelle Mem. Inst. (PNL)	2,038	110	12	13	2	2	5		2,182	7%	144	18.726	0.130	49%
RL	Bechtel Power Co.	519	54	11	11	2				597	13%	78	8.690	0.111	15%
OH	West Valley Nuclear Serv., Inc.	1,207	234	54	19	1	1	2		1,518	20%	311	26.923	0.087	14%
OR	RMI Company	59	28	8	2					97	39%	38	3.068	0.081	-
CH	Brookhaven Nat. Lab.	20	202	31	10	6				269	93%	249	17.638	0.071	19%
RL	Westinghouse Hanford	1,331	37	2	3					1,373	3%	42	2.832	0.067	-
RL	Kaiser Engineers, Hanford	315	14	0	2					331	5%	16	0.970	0.061	-
AL	Johnson Controls, Inc.	106	23	1	2					132	20%	26	1.506	0.058	-
OR	Lockheed Martin/MK-Ferguson	3,017	372	28	7	3		1	1	<b>3,429</b> ◀	12%	412	21.351	0.052	33%
OAK	LLNL Subcontractors	2,635	28	3	1					2,667	1%	32	1.531	0.048	-
AL	Los Alamos National Lab.	866	169	6	2	1	0	2		1,046	17%	180	7.058	0.039	47%
AL	Protection Tech. Los Alamos	48	8							56	14%	8	0.302	0.038	-
SR	Misc. DOE Contractors - SR	19	2							21	10%	2	0.072	0.036	-
OH	EG&G Mound Applied Tech.	43	10							53	19%	10	0.308	0.031	-
SR	WSRC	416	99	2	4					521	20%	105	3.013	0.029	-
SR	Bechtel Construction - SR	16	10							26	38%	10	0.286	0.029	-
RL	Hanford Environ. Health Foun.	83	1							84	1%	1	0.028	0.028	-
AL	Ross Aviation, Inc.	40	16							56	29%	16	0.445	0.028	-
AL	Sandia National Laboratory	390	28							418	7%	28	0.768	0.027	-
RL	Richland Field Office	1,248	40							1,288	3%	40	1.070	0.027	-
RL	US Corps of Engineers - RL	45	4							49	8%	4	0.099	0.025	-
OAK	Lawrence Livermore Nat. Lab.	5	6							11	55%	6	0.141	0.024	-
AL	MK-Ferguson Subs - UMTRA	762	56							818	7%	56	1.274	0.023	-
ID	Chem-Nuclear Geotech	145	2							147	1%	2	0.045	0.023	-
SR	Wackenhut Services, Inc. - SR	20	4							24	17%	4	0.086	0.022	-

B-12: Distribution of TEDE by Facility Type Listed in Descending Order of Average Measurable TEDE for Other, 1995 (Continued)

OTHER															
Number of Individuals Receiving Radiation Doses in Each Dose Range (rem)															
Ops. Office	Site/Contractor	Less than Meas.	Meas.- 0.10	0.10- 0.25	0.25- 0.50	0.50- 0.75	0.75- 1.00	1.00- 2.00	>2	Total Monitored	% of Monitored with Meas. TEDE	No. with Meas. TEDE	Collective TEDE (person-rem)	Avg. Meas. TEDE (rem)	% of TEDE above 0.5 rem
AL	Allied-Signal, Inc.	82	8							90	9%	8	0.170	0.021	-
CH	Chicago Field Office	120	3							123	2%	3	0.060	0.020	-
ID	Idaho Field Office	22	6							28	21%	6	0.119	0.020	-
SR	Westinghouse SR Subs	51	15							66	23%	15	0.269	0.018	-
RFO	Kaiser-Hill RFETS	15	6							21	29%	6	0.103	0.017	-
CH	Argonne - West	0	2							2	100%	2	0.032	0.016	-
RFO	EG&G Rocky Flats	128	5							133	4%	5	0.076	0.015	-
HQ	DOE Headquarters	9	8							17	47%	8	0.095	0.012	-
OAK	U of CA/Davis, Radiobiology Lab	77	6							83	7%	6	0.070	0.012	-
AL	MK-Ferguson Co. - UMTRA	102	2							104	2%	2	0.022	0.011	-
OH	EG&G Mound Subcontractors	73	2							75	3%	2	0.020	0.010	-
SR	Savannah River Field Office	124	19							143	13%	19	0.185	0.010	-
SR	Service America	4	3							7	43%	3	0.023	0.008	-
OH	Ohio Field Office	41	5							46	11%	5	0.035	0.007	-
AL	Los Alamos Area Office	36	5							41	12%	5	0.031	0.006	-
SR	Univ. of GA Ecology Lab.	14	1							15	7%	1	0.006	0.006	-
OR	LMES (Y-12)	210	2							212	1%	2	0.008	0.004	-
AL	Mason & Hanger - Amarillo	143								143	0%	-	-	-	-
NV	Reynolds Elec. & Engr. Co. - NTS	87								87	0%	-	-	-	-
NV	Nevada Field Office	79								79	0%	-	-	-	-
OR	Jacobs Environ. Restoration	58								58	0%	-	-	-	-
RL	Westinghouse Hanford Subs	46								46	0%	-	-	-	-
NV	Nevada Misc. Contractors	16								16	0%	-	-	-	-
OR	Southeastern Univ. Res. Assoc	8								8	0%	-	-	-	-
OR	Oak Ridge Field Office	7								7	0%	-	-	-	-
AL	Kansas City Area Office	6								6	0%	-	-	-	-
NV	EG&G Santa Barbara	4								4	0%	-	-	-	-

**B-12: Distribution of TEDE by Facility Type Listed in Descending Order of Average Measurable TEDE for Other, 1995 (Continued)**

<b>OTHER</b>															
Number of Individuals Receiving Radiation Doses in Each Dose Range (rem)															
Ops. Office	Site/Contractor	Less than Meas.	Meas.-0.10	0.10-0.25	0.25-0.50	0.50-0.75	0.75-1.00	1.00-2.00	>2	Total Monitored	% of Monitored with Meas. TEDE	No. with Meas. TEDE	Collective TEDE (person-rem)	Avg. Meas. TEDE (rem)	% of TEDE above 0.5 rem
NV	EG&G Washington, D.C.	4								4	0%	-	-	-	-
NV	DNA - Kirtland AFB	3								3	0%	-	-	-	-
NV	EG&G Las Vegas	3								3	0%	-	-	-	-
SR	Southern Bell Tel. & Telegraph	3								3	0%	-	-	-	-
SR	SR Army Corps of Engineers	2								2	0%	-	-	-	-
NV	EG&G Los Alamos	1								1	0%	-	-	-	-
	<b>Totals</b>	<b>17,464</b>	<b>2,035</b>	<b>203</b>	<b>120</b>	<b>51</b>	<b>30</b>	<b>70</b>	<b>1</b>	<b>19,974</b>	<b>13%</b>	<b>2,510</b>	<b>280.871</b>	<b>0.112</b>	<b>56%</b>

Note: Arrowed values indicate the greatest value in each column.

This table displays the distribution of TEDE for all Other facility types, listed in descending order of average measurable TEDE. This includes individuals that did not match one of the ten types listed, those who did not work for any appreciable times at any specific facility (e.g., transient workers), or those for whom the facility type was not indicated when reported. Also included are the number of individuals with measurable TEDE, the collective TEDE, and the percentage of TEDE accrued above 0.5 rem. The Other category accounts for 13% of the DOE collective dose, 13% of the total number of monitored individuals, and has one of the largest distribution percentages of all the facility types.

**B-13: Distribution of TEDE by Facility Type Listed in Descending Order of Average Measurable TEDE for Reactor Facilities, 1995**

<b>REACTOR FACILITIES</b>															
Number of Individuals Receiving Radiation Doses in Each Dose Range (rem)															
Ops. Office	Site/Contractor	Less than Meas.	Meas.- 0.10	0.10- 0.25	0.25- 0.50	0.50- 0.75	0.75- 1.00	1.00- 2.00	>2	Total Monitored	% of Monitored with Meas. TEDE	No. with Meas. TEDE	Collective TEDE (person-rem)	Avg. Meas. TEDE (rem)	% of TEDE above 0.5 rem
RL	Kaiser Engineers, Hanford	54	5	3	2					64	16%	10	1.498	<b>0.150</b> ◀	-
RL	Westinghouse Hanford	389	73	12	10	10	2			496	22%	107	15.684	0.147	<b>52%</b> ◀
CH	Argonne - West	116	26	3	10	1				156	26%	40	5.472	0.137	10%
CH	Brookhaven Nat. Lab.	106	47	17	12	3				185	43%	79	9.920	0.126	20%
AL	Sandia National Laboratory	63	16	5	5					89	29%	26	3.253	0.125	-
ID	Lockheed ID Tech. Co. - Serv.	381	121	53	16	1				572	33%	191	<b>19.167</b> ◀	0.100	3%
SR	Bechtel Construction - SR	44	76	9	2					131	66%	87	4.047	0.047	-
RL	Bechtel Power Co.	29	4	1						34	15%	5	0.185	0.037	-
SR	WSRC	411	285	12	2					<b>710</b> ◀	42%	<b>299</b> ◀	8.507	0.028	-
AL	Los Alamos Nat. Lab.	7	4							11	36%	4	0.100	0.025	-
SR	Wackenhut Services, Inc. - SR	17	37							54	<b>69%</b> ◀	37	0.771	0.021	-
ID	Idaho Field Office	13	3							16	19%	3	0.041	0.014	-
SR	Savannah River Field Office	9	3							12	25%	3	0.026	0.009	-
SR	Service America	4	2							6	33%	2	0.017	0.009	-
SR	Westinghouse SR Subs	71	3							74	4%	3	0.022	0.007	-
SR	Misc. DOE Contractors - SR	7								7	0%	-	-	-	-
AL	Johnson Controls, Inc.	1								1	0%	-	-	-	-
RL	Battelle Mem. Inst. (PNL)	1								1	0%	-	-	-	-
RL	Richland Field Office	1								1	0%	-	-	-	-
	<b>Totals</b>	<b>1,724</b>	<b>705</b>	<b>115</b>	<b>59</b>	<b>15</b>	<b>2</b>			<b>2,620</b>	<b>34%</b>	<b>896</b>	<b>68.710</b>	<b>0.077</b>	<b>16%</b>

Note: Arrowed values indicate the greatest value in each column.

This table displays the distribution of TEDE for Reactor facilities, listed in descending order of average measurable TEDE, and including the total number of monitored individuals, the number of individuals with measurable TEDE, the collective TEDE, and the percentage of TEDE accrued above 0.5 rem.

**B-14: Distribution of TEDE by Facility Type Listed in Descending Order of Average Measurable TEDE for Research-General, 1995**

<b>RESEARCH, GENERAL</b>															
Number of Individuals Receiving Radiation Doses in Each Dose Range (rem)															
Ops. Office	Site/Contractor	Less than Meas.	Meas.-0.10	0.10-0.25	0.25-0.50	0.50-0.75	0.75-1.00	1.00-2.00	>2	Total Monitored	% of Monitored with Meas. TEDE	No. with Meas. TEDE	Collective TEDE (person-rem)	Avg. Meas. TEDE(rem)	% of TEDE above 0.5 rem
CH	Argonne - East	1,322	30	11	7	2	0	4		1,376	4%	54	11.868	0.220	56%
RL	Battelle Mem. Inst. (PNL)	1,514	222	43	23	14	8	13		1,837	18%	323	54.051	0.167	60%
AL	Los Alamos Nat. Lab.	2,463	877	107	72	23	16	31		3,589	31%	1,126	129.972	0.115	54%
CH	Argonne - West	461	184	50	35	3	2			735	37%	274	31.048	0.113	11%
CH	Brookhaven Nat. Lab.	416	62	19	9	2				508	18%	92	8.865	0.096	12%
OAK	Rockwell Int., Rocketdyne - ETEC	19	10	3	1					33	42%	14	1.213	0.087	-
OR	LMES (ORNL)	7,213	397	80	31	7	2			7,730	7%	517	42.057	0.081	14%
ID	Lockheed ID Tech. Co. - Serv.	548	70	13	4	2				637	14%	89	6.739	0.076	16%
RL	Westinghouse Hanford	156	9	2	1					168	7%	12	0.862	0.072	-
OAK	Lawrence Berkeley Lab.	15	40	4	2	0	1			62	76%	47	3.321	0.071	23%
OAK	LLNL Subcontractors	977	18	2	1					998	2%	21	1.200	0.057	-
SR	WSRC	764	339	22	5	1				1,131	32%	367	12.191	0.033	-
CH	New Brunswick Laboratory	45	5							50	10%	5	0.150	0.030	-
SR	Westinghouse SR Subcontractors	23	14	0	1					38	39%	15	0.443	0.030	-
SR	Bechtel Construction - SR	53	40	3						96	45%	43	1.244	0.029	-
AL	Sandia National Laboratory	1,618	133	5	1					1,757	8%	139	3.586	0.026	-
AL	Inhalation Tox. Research Inst.	139	20	1						160	13%	21	0.460	0.022	-
OR	Oak Ridge Inst. for Sci. & Educ.	84	24							108	22%	24	0.490	0.020	-
SR	Wackenhut Services, Inc. - SR	17	18							35	51%	18	0.366	0.020	-
CH	Ames Laboratory (Iowa State)	103	14							117	12%	14	0.280	0.020	-
SR	Misc. DOE Contractors - SR	31	20	1						52	40%	21	0.387	0.018	-

**B-14: Distribution of TEDE by Facility Type Listed in Descending Order of Average Measurable TEDE for Research-General, 1995 (Continued)**

<b>RESEARCH, GENERAL</b>															
Number of Individuals Receiving Radiation Doses in Each Dose Range (rem)															
Ops. Office	Site/Contractor	Less than Meas.	Meas.- 0.10	0.10- 0.25	0.25- 0.50	0.50- 0.75	0.75- 1.00	1.00- 2.00	>2	Total Monitored	% of Monitored with Meas. TEDE	No. with Meas. TEDE	Collective TEDE (person-rem)	Avg. Meas. TEDE(rem)	% of TEDE above 0.5 rem
AL	Johnson Controls, Inc.	9	1							10	10%	1	0.017	0.017	-
RL	Kaiser Engineers, Hanford	1	1							2	50%	1	0.011	0.011	-
AL	National Renewable Energy Lab	25	1							26	4%	1	0.010	0.010	-
SR	Savannah River Field Office	55	27							82	33%	27	0.249	0.009	-
SR	Univ. of GA Ecology Lab.	30	2							32	6%	2	0.015	0.008	-
SR	Service America	9	1							10	10%	1	0.005	0.005	-
OAK	U of CA/SF - Lab of Radiobiology	41								41	0%	-	-	-	-
CH	Chicago Office Subs	37								37	0%	-	-	-	-
ID	Idaho Field Office	30								30	0%	-	-	-	-
NV	Nevada Misc. Contractors	20								20	0%	-	-	-	-
CH	Environmental Meas. Lab.	13								13	0%	-	-	-	-
AL	Protection Tech. Los Alamos	10								10	0%	-	-	-	-
OAK	LLNL - Nevada	9								9	0%	-	-	-	-
AL	Los Alamos Area Office	5								5	0%	-	-	-	-
RL	Bechtel Power Co.	2								2	0%	-	-	-	-
DOEH	DOE Headquarters	1								1	0%	-	-	-	-
SR	SR Army Corps of Engineers	1								1	0%	-	-	-	-
SR	Southern Bell Tel. & Tel.	1								1	0%	-	-	-	-
	<b>Totals</b>	<b>18,280</b>	<b>2,579</b>	<b>366</b>	<b>193</b>	<b>54</b>	<b>29</b>	<b>48</b>		<b>21,549</b>	<b>15%</b>	<b>3,269</b>	<b>311.100</b>	<b>0.095</b>	<b>39%</b>

Note: Arrowed values indicate the greatest value in each column.

This table displays the distribution of TEDE for General Research facilities, listed in descending order of average measurable TEDE, and including the total number of monitored individuals, the number of individuals with measurable TEDE, the collective TEDE, and the percentage of TEDE accrued above 0.5 rem.

**B-15: Distribution of TEDE by Facility Type Listed in Descending Order of Average Measurable TEDE for Research-Fusion, 1995**

<b>RESEARCH, FUSION</b>															
Number of Individuals Receiving Radiation Doses in Each Dose Range (rem)															
Ops. Office	Site/Contractor	Less than Meas.	Meas.-0.10	0.10-0.25	0.25-0.50	0.50-0.75	0.75-1.00	1.00-2.00	>2	Total Monitored	% of Monitored with Meas. TEDE	No. with Meas. TEDE	Collective TEDE (person-rem)	Avg. Meas. TEDE (rem)	% of TEDE above 0.5 rem
OAK	LLNL Subcontractors	315	14	7	4	3				343	8%	28	<b>4.698</b> ◀	<b>0.168</b> ◀	<b>38%</b> ◀
CH	Princeton Plas. Phys. Lab.	474	63	2	5					<b>544</b> ◀	13%	<b>70</b> ◀	3.254	0.046	-
AL	Los Alamos Nat. Lab.	46	31	1	1					79	<b>42%</b> ◀	33	0.959	0.029	-
AL	Sandia National Lab.	57	3							60	5%	3	0.042	0.014	-
OAK	LLNL - Nevada	17								17	0%	-	-	-	-
	<b>Totals</b>	<b>909</b>	<b>111</b>	<b>10</b>	<b>10</b>	<b>3</b>				<b>1,043</b>	<b>13%</b>	<b>134</b>	<b>8.953</b>	<b>0.067</b>	<b>20%</b>

Note: Arrowed values indicate the greatest value in each column.

This table displays the distribution of TEDE for Research Fusion facilities, listed in descending order of average measurable TEDE, and including the total number of monitored individuals, the number of individuals with measurable TEDE, the collective TEDE, and the percentage of TEDE accrued above 0.5 rem.  
 EDIT \*\*\*\*\*



**B-16: Distribution of TEDE by Facility Type Listed in Descending Order of Average Measurable TEDE for Waste Processing/Management, 1995**

<b>WASTE PROCESSING, MANAGEMENT</b>															
Number of Individuals Receiving Radiation Doses in Each Dose Range (rem)															
Ops. Office	Site/Contractor	Less than Meas.	Meas.-0.10	0.10-0.25	0.25-0.50	0.50-0.75	0.75-1.00	1.00-2.00	>2	Total Monitored	% of Monitored with Meas. TEDE	No. with Meas. TEDE	Collective TEDE (person-rem)	Avg. Meas. TEDE(rem)	% of TEDE above 0.5 rem
RL	Bechtel Power Co.	143	63	19	16	4	2			247	42%	104	15.204	<b>0.146</b> ◀	<b>29%</b> ◀
CH	Argonne - East	48	12	20	1					81	41%	33	4.056	0.123	-
RL	Westinghouse Hanford	1,796	441	122	36	19	1	2		2,417	26%	621	<b>61.212</b> ◀	0.099	24%
RL	Kaiser Engineers, Hanford	273	36	11	5					325	16%	52	5.037	0.097	-
ID	Lockheed ID Tech. Co. - Services	266	44	21	5					336	21%	70	6.590	0.094	-
SR	Service America	14	9	2	2					27	48%	13	1.091	0.084	-
CH	Brookhaven Nat. Lab.	2	13	6						21	90%	19	1.290	0.068	-
SR	Bechtel Construction - SR	371	363	32	9	1				776	52%	405	18.890	0.047	3%
SR	WSRC	1,761	779	71	22	1				<b>2,634</b> ◀	33%	<b>873</b> ◀	37.129	0.043	2%
OR	Bechtel National, Inc. - (FUSRAP)	358	57	1						416	14%	58	1.786	0.031	-
AL	Sandia National Laboratory	100	15							115	13%	15	0.440	0.029	-
AL	Los Alamos National Laboratory	284	91	5	1					381	25%	97	2.512	0.026	-
SR	Westinghouse SR Subcontractors	142	48	1	1					192	26%	50	1.206	0.024	-
AL	Johnson Controls, Inc.	1	2							3	67%	2	0.041	0.021	-
SR	SR Army Corps of Engineers	2	2							4	50%	2	0.029	0.015	-
OR	Morrison-Knudsen (WSSRAP)	606	5							611	1%	5	0.050	0.010	-
SR	Savannah River Field Office	74	33							107	31%	33	0.330	0.010	-
SR	Misc. DOE Contractors - SR	15	4							19	21%	4	0.032	0.008	-
AL	Los Alamos Area Office	0	1							1	<b>100%</b> ◀	1	0.006	0.006	-
SR	Univ. of GA Ecology Lab.	0	1							1	<b>100%</b> ◀	1	0.005	0.005	-

**B-16: Distribution of TEDE by Facility Type Listed in Descending Order of Average Measurable TEDE for Waste Processing-Management, 1995 (Continued)**

<b>WASTE PROCESSING, MANAGEMENT</b>															
Number of Individuals Receiving Radiation Doses in Each Dose Range (rem)															
Ops. Office	Site/Contractor	Less than Meas.	Meas.- 0.10	0.10- 0.25	0.25- 0.50	0.50- 0.75	0.75- 1.00	1.00- 2.00	>2	Total Monitored	% of Monitored with Meas. TEDE	No. with Meas. TEDE	Collective TEDE (person-rem)	Avg. Meas. TEDE (rem)	% of TEDE above 0.5 rem
AL	Carlsbad Area Misc. Contractors	89								89	0%	-	-	-	-
OAK	LLNL Subcontractors	79								79	0%	-	-	-	-
NV	Nevada Misc. Contractors	62								62	0%	-	-	-	-
NV	Science Appl. Int'l. Corp. - NV	43								43	0%	-	-	-	-
ID	Idaho Field Office	17								17	0%	-	-	-	-
NV	Nevada Field Office	9								9	0%	-	-	-	-
NV	Reynolds Elec. & Engr. Co. - NTS	6								6	0%	-	-	-	-
RL	Battelle Mem. Inst. (PNL)	3								3	0%	-	-	-	-
SR	Southern Bell Tel. & Tel.	3								3	0%	-	-	-	-
AL	WIPP Project Integration Office	2								2	0%	-	-	-	-
CH	Argonne - West	2								2	0%	-	-	-	-
RL	Richland Field Office	2								2	0%	-	-	-	-
RL	Westinghouse Hanford Serv. Subs	2								2	0%	-	-	-	-
SR	SR Forest Station	2								2	0%	-	-	-	-
SR	Wackenhut Services, Inc. - SR	2								2	0%	-	-	-	-
NV	Raytheon Services - Nevada	1								1	0%	-	-	-	-
	<b>Totals</b>	<b>6,580</b>	<b>2,019</b>	<b>311</b>	<b>98</b>	<b>25</b>	<b>3</b>	<b>2</b>		<b>9,038</b>	<b>27%</b>	<b>2,458</b>	<b>156.936</b>	<b>0.064</b>	<b>13%</b>

Note: Arrowed values indicate the greatest value in each column.

This table displays the distribution of TEDE for Waste Processing and Waste Management facilities, listed in descending order of average measurable TEDE, and including the total number of monitored individuals, the number of individuals with measurable TEDE, the collective TEDE, and the percentage of TEDE accrued above 0.5 rem.  
 EDIT\*\*\*\*\*

**B-17: Distribution of TEDE by Facility Type Listed in Descending Order of Average Measurable TEDE  
for Weapons Fabrication and Testing, 1995**

<b>WEAPONS FABRICATION AND TESTING</b>															
Number of Individuals Receiving Radiation Doses in Each Dose Range (rem)															
Ops. Office	Site/Contractor	Less than Meas.	Meas.- 0.10	0.10- 0.25	0.25- 0.50	0.50- 0.75	0.75- 1.00	1.00- 2.00	>2	Total Monitored	% of Monitored with Meas. TEDE	No. with Meas. TEDE	Collective TEDE (person-rem)	Avg. Meas. TEDE(rem)	% of TEDE above 0.5 rem
SR	Service America	5	4	1	4					14	64%	9	1.681	<b>0.187</b> ◀	-
SR	WSRC	575	245	70	80	28	5			1,003	43%	428	67.769	0.158	<b>30%</b> ◀
AL	M&H - Amarillo - Sec. Forces	517	3	1	1					522	1%	5	0.609	0.122	-
AL	Mason & Hanger - Amarillo	1,875	198	60	29	14	1			2,177	14%	302	35.039	0.116	26%
OAK	LLNL Subcontractors	711	17	2	3					733	3%	22	2.009	0.091	-
RFO	EG&G Rocky Flats	994	2,296	505	96	36	6			3,933	<b>75%</b> ◀	<b>2,939</b> ◀	<b>236.152</b> ◀	0.080	11%
AL	Battelle - Pantex	310	17	4						331	6%	21	1.220	0.058	-
RFO	Rocky Mt. Management Group	1,125	317	39	16	1				1,498	25%	373	21.155	0.057	3%
SR	Bechtel Construction - SR	67	57	12						136	51%	69	3.888	0.056	-
AL	Los Alamos National Lab.	36	1	1						38	5%	2	0.110	0.055	-
NV	Reynolds Elec. & Engr. Co. - NTS	847	8	1						856	1%	9	0.463	0.051	-
OH	EG&G Mound Applied Tech.	131	37	6						174	25%	43	1.745	0.041	-
RFO	Rocky Flats Office	333	80	8						421	21%	88	2.947	0.033	-
SR	Westinghouse SR Subcontractors	22	9	1						32	31%	10	0.313	0.031	-
SR	Wackenhut Services, Inc. - SR	89	116	1						206	57%	117	3.561	0.030	-
SR	Savannah River Field Office	19	5							24	21%	5	0.140	0.028	-
RFO	Rocky Flats Office Subs	50	16							66	24%	16	0.347	0.022	-
OH	EG&G Mound Subcontractors	166	7							173	4%	7	0.144	0.021	-
OR	LMES (Y-12)	8,778	811	12						<b>9,601</b> ◀	9%	823	12.614	0.015	-
AL	Albuquerque Field Office	176	7							183	4%	7	0.103	0.015	-

**B-17: Distribution of TEDE by Facility Type Listed in Descending Order of Average Measurable TEDE for Weapons Fabrication and Testing, 1995 (Continued)**

<b>WEAPONS FABRICATION AND TESTING</b>															
Number of Individuals Receiving Radiation Doses in Each Dose Range (rem)															
Ops. Office	Site/Contractor	Less than Meas.	Meas.- 0.10	0.10- 0.25	0.25- 0.50	0.50- 0.75	0.75- 1.00	1.00- 2.00	>2	Total Monitored	% of Monitored with Meas. TEDE	No. with Meas. TEDE	Collective TEDE (person-rem)	Avg. Meas. TEDE(rem)	% of TEDE above 0.5 rem
AL	Sandia National Laboratory	191	18							209	9%	18	0.254	0.014	-
AL	M.M. Specialty Comp. Inc.	223	18							241	7%	18	0.234	0.013	-
AL	Amarillo Area Office	126	1							127	1%	1	0.013	0.013	-
AL	Kirtland Area Office	36	1							37	3%	1	0.012	0.012	-
NV	Reynolds Elec. & Engr. Co. Serv.	54								54	0%	-	-	-	-
NV	EG&G Las Vegas	37								37	0%	-	-	-	-
NV	Environ. Prot. Agency (NERC)	29								29	0%	-	-	-	-
NV	Nevada Misc. Contractors	28								28	0%	-	-	-	-
NV	Raytheon Services - Nevada	28								28	0%	-	-	-	-
NV	Def. Nuc. Agency - Kirtland AFB	14								14	0%	-	-	-	-
OH	Miamisburg Area Office	5								5	0%	-	-	-	-
OH	Ohio Field Office	5								5	0%	-	-	-	-
AL	Albuquerque Transp. Division	4								4	0%	-	-	-	-
NV	Raytheon Services Subcontractors	2								2	0%	-	-	-	-
SR	Misc. DOE Contractors - SR	1								1	0%	-	-	-	-
SR	Southern Bell Tel. & Tel.	1								1	0%	-	-	-	-
	<b>Totals</b>	<b>17,610</b>	<b>4,289</b>	<b>724</b>	<b>229</b>	<b>79</b>	<b>12</b>			<b>22,943</b>	<b>23%</b>	<b>5,333</b>	<b>392.522</b>	<b>0.074</b>	<b>15%</b>

Note: Arrowed values indicate the greatest value in each column.

This table displays the distribution of TEDE for Weapons Fabrication and Testing facilities, listed in descending order of average measurable TEDE, and including the total number of monitored individuals, the number of individuals with measurable TEDE, the collective TEDE, and the percentage of TEDE accrued above 0.5 rem.

B-18: Internal Dose by Facility Type and Nuclide, 1993-1995

Facility Type	Nuclide*	No. of Individuals with New Intakes**			Collective CEDE (person-rem)			Average CEDE (rem)		
		1993	1994	1995	1993	1994	1995	1993	1994	1995
Accelerator	Hydrogen-3			15			0.272			0.018
	Other			6			0.008			0.001
	Uranium			1			0.014			0.014
	<b>Total</b>	<b>11</b>	<b>11</b>	<b>22</b>	<b>0.267</b>	<b>1.843</b>	<b>0.294</b>	<b>0.024</b>	<b>0.168</b>	<b>0.013</b>
Fuel Fabrication	Hydrogen-3			2			0.008			0.004
	Thorium			25			0.180			0.007
	Uranium			83			0.504			0.006
	<b>Total</b>	<b>7</b>	<b>34</b>	<b>110</b>	<b>0.021</b>	<b>0.579</b>	<b>0.692</b>	<b>0.003</b>	<b>0.017</b>	<b>0.006</b>
Fuel Processing	Americium			1			0.059			0.059
	Hydrogen-3			83			0.261			0.003
	Mixed			1			0.042			0.042
	Plutonium			8			1.478			0.185
	<b>Total</b>	<b>197</b>	<b>157</b>	<b>93</b>	<b>1.549</b>	<b>1.527</b>	<b>1.840</b>	<b>0.008</b>	<b>0.010</b>	<b>0.020</b>
Fuel/Uranium Enrichment	Thorium			3			0.027			0.009
	Uranium			43			0.231			0.005
	<b>Total</b>	<b>376</b>	<b>390</b>	<b>46</b>	<b>7.004</b>	<b>6.239</b>	<b>0.258</b>	<b>0.019</b>	<b>0.016</b>	<b>0.006</b>
Maintenance and Support	Americium			19			0.398			0.021
	Hydrogen-3			104			0.357			0.003
	Mixed			2			0.122			0.061
	Plutonium			12			1.664			0.139
	Thorium			2			0.645			<b>0.323</b> ◀
	Uranium			48			0.372			0.008
	<b>Total</b>	<b>312</b>	<b>167</b>	<b>187</b>	<b>22.128</b>	<b>4.680</b>	<b>3.558</b>	<b>0.071</b>	<b>0.028</b>	<b>0.019</b>
Other	Hydrogen-3			9			0.022			0.002
	Other			9			0.382			0.042
	Plutonium			17			5.133			0.302
	Uranium			40			3.124			0.078
	<b>Total</b>	<b>204</b>	<b>139</b>	<b>75</b>	<b>8.591</b>	<b>4.018</b>	<b>8.661</b>	<b>0.042</b>	<b>0.029</b>	<b>0.115</b>
Reactor	Hydrogen-3			338			4.787			0.014
	<b>Total</b>	<b>539</b>	<b>384</b>	<b>338</b>	<b>6.472</b>	<b>7.828</b>	<b>4.787</b>	<b>0.012</b>	<b>0.020</b>	<b>0.014</b>
Research, Fusion	Hydrogen-3			48			0.251			0.005
Research, General	Hydrogen-3			52			0.286			0.006
	Mixed			1			0.002			0.002
	Other			20			0.868			0.043
	Plutonium			8			0.577			0.072
	Uranium			41			0.345			0.008
	<b>Total</b>	<b>176</b>	<b>96</b>	<b>122</b>	<b>36.975</b>	<b>11.208</b>	<b>2.078</b>	<b>0.210</b>	<b>0.117</b>	<b>0.017</b>
Waste Processing	Hydrogen-3			38			0.133			0.004
	Plutonium			10			0.468			0.047
	Uranium			17			0.585			0.034
	<b>Total</b>	<b>135</b>	<b>24</b>	<b>65</b>	<b>4.442</b>	<b>0.765</b>	<b>1.186</b>	<b>0.033</b>	<b>0.032</b>	<b>0.018</b>
Weapons Fab. and Testing	Hydrogen-3			121			0.618			0.005
	Plutonium			17			0.362			0.021
	Uranium			<b>607</b> ◀			<b>6.179</b> ◀			0.010
	<b>Total</b>	<b>981</b>	<b>485</b>	<b>745</b>	<b>22.018</b>	<b>6.359</b>	<b>7.159</b>	<b>0.022</b>	<b>0.013</b>	<b>0.010</b>
<b>Totals</b>	<b>2,979</b>	<b>1,950</b>	<b>1,851</b>	<b>109.913</b>	<b>45.552</b>	<b>30.764</b>	<b>0.037</b>	<b>0.023</b>	<b>0.017</b>	

\* Intakes grouped by nuclide. Intakes involving multiple nuclides were grouped into "mixed".

◀ Nuclides where fewer than 10 individuals had intakes were grouped as "other".

\*\*Individuals may be counted more than once.

Note: Arrowed values indicate the greatest value in each column.

**B-19a: Distribution of TEDE by Labor Category, 1993**

<b>Total Effective Dose Equivalent (TEDE)</b>																							
Number of Individuals Receiving Radiation Doses in Each Dose Range (rem)																							
Labor Category	Less than Meas.	Meas.- 0.10	0.10- 0.25	0.25- 0.50	0.50 0.75	0.75- 1.00	1-2	2-3	3-4	4-5	5-6	6-7	7-8	8-9	9- 10	10- 11	11- 12	>12	Total Monitored	Percent of Monitored with Meas. TEDE	No. with Meas. TEDE	Collective TEDE (person-rem)	Average Meas. TEDE (rem)
Agriculture	123	3	2	1															129	5%	6	0.780	<b>0.130</b> ◀
Construction	7,243	2,168	256	84	15	7	3												9,776	26%	2,533	137.880	0.054
Laborers	1,690	685	106	48	3	2	5												2,539	33%	849	59.708	0.070
Management	15,745	2,047	85	30	6	2	1												17,916	12%	2,171	77.185	0.036
Misc.	6,260	2,520	155	51	6	1	1								1				8,995	30%	2,735	111.568	0.041
Production	4,383	2,537	499	238	32	12	1												7,702	<b>43%</b> ◀	3,319	268.150	0.081
Scientists	29,905	4,037	269	75	11	5	5												<b>34,307</b> ◀	13%	<b>4,402</b> ◀	171.524	0.039
Service	4,959	1,190	80	8	1														6,238	21%	1,279	44.846	0.035
Technicians	9,597	3,020	713	287	55	25	9			2									13,708	30%	4,111	<b>382.444</b> ◀	0.093
Transport	1,426	398	20	5															1,849	23%	423	14.943	0.035
Unknown	20,616	2,605	302	190	66	39	62							1				2	23,883	14%	3,267	375.171	0.115
<b>Totals</b>	<b>101,947</b>	<b>21,210</b>	<b>2,487</b>	<b>1,017</b>	<b>195</b>	<b>93</b>	<b>87</b>	<b>0</b>	<b>0</b>	<b>2</b>	<b>0</b>	<b>0</b>	<b>0</b>	<b>1</b>	<b>1</b>	<b>0</b>	<b>0</b>	<b>2</b>	<b>127,042</b>	<b>20%</b>	<b>25,095</b>	<b>1,644.199</b>	<b>0.066</b>

Note: Arrowed values indicate the greatest value in each column.

This table displays the distribution of TEDE for the monitored DOE employees and contractors by labor category, including the total number of monitored individuals, the number of individuals with measurable TEDE, the collective TEDE, and the average TEDE.

**B-19b: Distribution of TEDE by Labor Category, 1994**

B-34

**Total Effective Dose Equivalent (TEDE)**

Number of Individuals Receiving Radiation Doses in Each Dose Range (rem)

Laobr Category	Less than Meas.	Meas.- 0.10	0.10- 0.25	0.25- 0.50	0.50 0.75	0.75- 1.00	1-2	2-3	3-4	4-5	>5	Total Monitored	Percent of Monitored with Meas. TEDE	No. with Meas. TEDE	Collective TEDE (person-rem)	Average Meas. TEDE (rem)
Agriculture	63	4	2	1								70	10%	7	0.688	<b>0.098</b> ◀
Construction	6,218	1,964	232	97	34	4	4					8,553	27%	2,335	148.978	0.064
Laborers	1,141	660	101	36	7	2	1					1,948	41%	807	55.208	0.068
Management	16,143	1,855	113	28	7							18,146	11%	2,003	80.552	0.040
Misc.	7,703	1,488	107	35	16	7	2					9,358	18%	1,655	77.546	0.047
Production	3,524	2,343	426	203	96	21	1					6,614	<b>47%</b> ◀	3,090	284.523	0.092
Scientists	28,106	4,848	256	69	15	8	5					<b>33,307</b> ◀	16%	<b>5,201</b> ◀	197.716	0.038
Service	4,279	1,099	86	10	5	1						5,480	22%	1,201	51.849	0.04
Technicians	8,691	3,118	739	281	62	21	17					12,929	33%	4,238	<b>393.785</b> ◀	0.093
Transport	1,176	426	44	7	1							1,654	29%	478	21.055	0.044
Unknown	14,077	3,706	331	167	86	35	49		1			18,45	24%	4,375	331.164	0.076
<b>Totals</b>	<b>91,121</b>	<b>21,511</b>	<b>2,437</b>	<b>934</b>	<b>329</b>	<b>99</b>	<b>79</b>	<b>0</b>	<b>1</b>	<b>0</b>	<b>0</b>	<b>116,511</b>	<b>22%</b>	<b>25,390</b>	<b>1,643.064</b>	<b>0.065</b>

Note: Arrowed values indicate the greatest value in each column.

This table displays the distribution of TEDE for the monitored DOE employees and contractors by labor category, including the total number of monitored individuals, the number of individuals with measurable TEDE, the collective TEDE, and the average TEDE.

DOE Occupational Radiation Exposure

### B-19c: Distribution of TEDE by Labor Category, 1995

Total Effective Dose Equivalent (TEDE)													
Number of Individuals Receiving Radiation Doses in Each Dose Range (rem)													
Labor Category	Less than	Meas.- 0.10	0.10- 0.25	0.25- 0.50	0.50- 0.75	0.75- 1.00	1-2	>2	Total Monitored	Percent of Monitored with Meas. TEDE	No. with Measurable TEDE	Collective TEDE (person-rem)	Average Measurable TEDE (rem)
Agriculture	51	7	1	1					60	15%	9	0.521	0.058
Construction	5,935	1,887	263	110	20	8	12		8,235	28%	2,300	164.232	0.071
Laborers	1,113	516	125	59	17	10	2		1,842	40%	729	76.317	0.105
Management	15,762	1,493	88	31	12	3	2		17,391	9%	1,629	74.446	0.046
Misc.	22,173	3,141	259	69	19	4	3	1	25,669	14%	3,496	169.447	0.048
Production	3,388	2,061	358	226	113	18	3		6,167	45% ◀	2,779	282.010	0.101
Scientists	27,343	3,173	231	81	15	3	10		30,856 ◀	11%	3,513	153.724	0.044
Service	4,236	880	63	15	3	0	1		5,198	19%	962	37.031	0.038
Technicians	8,219	2,705	780	304	83	31	26		12,148	32%	3,929	429.095	0.109
Transport	1,172	279	18	10	6				1,485	21%	313	17.979	0.057
Unknown	14,271	3,131	357	228	86	54	98		18,225	22%	3,954 ◀	435.444 ◀	0.110 ◀
<b>Totals</b>	<b>103,663</b>	<b>19,273</b>	<b>2,543</b>	<b>1,134</b>	<b>374</b>	<b>131</b>	<b>157</b>	<b>1</b>	<b>127,276</b>	<b>19%</b>	<b>23,613</b>	<b>1,840.246</b>	<b>0.078</b>

Note: Arrowed values indicate the greatest value in each column.

This table displays the distribution of TEDE for the monitored DOE employees and contractors by labor category, including the total number of monitored individuals, the number of individuals with measurable TEDE, the collective TEDE, and the average TEDE.



**B-20: Internal Dose by Labor Category, 1993 - 1995**

Labor Category	Number of Individuals with New Intakes*			Collective CEDE (person-rem)			Average CEDE (rem)		
	1993	1994	1995	1993	1994	1995	1993	1994	1995
Construction	377	211	206	5.029	2.521	1.739	0.013	0.012	0.008
Laborers	103	67	73	1.501	1.334	0.517	0.015	0.020	0.007
Management	189	110	120	4.165	2.455	2.389	0.022	0.022	0.020
Misc.	265	184	217	11.837	2.527	<b>7.297</b> ◀	0.045	0.014	<b>0.034</b> ◀
Production	<b>805</b> ◀	<b>571</b> ◀	<b>549</b> ◀	9.901	6.454	5.881	0.012	0.011	0.011
Scientist	309	159	157	5.592	4.862	4.879	0.018	0.031	0.031
Service	126	109	50	1.740	2.186	0.329	0.014	0.020	0.007
Technicians	354	241	245	11.039	6.182	4.946	0.031	0.026	0.020
Transport	6	8	5	0.010	0.047	0.040	0.002	0.006	0.008
Unknown	447	289	229	<b>59.163</b> ◀	<b>16.984</b> ◀	2.747	<b>0.132</b> ◀	<b>0.059</b> ◀	0.012
<b>Totals</b>	<b>2,981</b>	<b>1,949</b>	<b>1,851</b>	<b>109.977</b>	<b>45.552</b>	<b>30.764</b>	<b>0.037</b>	<b>0.023</b>	<b>0.017</b>

\* Only included intakes that occurred during the monitoring year. Individuals may be counted more than once.

Note: Arrowed values indicate the greatest value in each column.

**B-21: Internal Dose Distribution by Site and Nuclide, 1995**

Operations/ Field Office	Site	Nuclide	Number of Individuals Receiving Doses in Each Dose Range							Total Individuals with Meas. CEDE	Collective CEDE (person-rem)	Average CEDE (rem)			
			<0.020	0.020-0.100		0.100-0.250		0.250-0.500					1.0-2.0	2.0-3.0	>3.0
				0.020-0.100	0.100-0.250	0.250-0.500	0.500-1.000	1.0-2.0	2.0-3.0						
Albuquerque	Ops. and Other Facilities	Hydrogen-3	16	1							17	0.214	0.013		
	Los Alamos Nat'l. Lab (LANL)	Hydrogen-3	71	5							76	0.394	0.005		
		Uranium	49	4	1						54	0.466	0.009		
		Plutonium				1					1	0.400	0.400		
Chicago	Pantex Plant (PP)	Other	3								3	0.004	0.001		
		Hydrogen-3	48								48	0.101	0.002		
	Ops. and Other Facilities	Hydrogen-3	30	2							32	0.134	0.004		
		Americium	12	6							18	0.344	0.019		
	Argonne Nat'l. Lab - East (ANL-E)	Hydrogen-3	3								3	0.005	0.002		
		Plutonium	13	10							23	0.383	0.017		
		Other	1								1	0.001	0.001		
		Mixed	1								1	0.002	0.002		
	Brookhaven Nat'l. Lab (BNL)	Hydrogen-3	11	28	11	1					51	3.120	0.061		
		Other	10								10	0.037	0.004		
Idaho	Idaho Site	Uranium	5	1							6	0.095	0.016		
		Plutonium	3	6							9	0.261	0.029		
	Mixed	1								1	0.042	0.042			
	Hydrogen-3	3	1	1						5	0.237	0.047			
Oakland	Lawrence Berkeley Lab. (LBL)	Hydrogen-3	3							3	0.006	0.002			
	Lawrence Livermore Nat'l. Lab. (LLNL)	Hydrogen-3	3							3	0.006	0.002			
Oak Ridge	Ops. and Other Facilities	Uranium	15	20	9	1				45	3.227	0.072			
	Oak Ridge Site	Hydrogen-3	2							2	0.002	0.001			
Ohio	Fernald Environmental Mgmt. Project*	Thorium									1	0.340	0.340		
		Uranium	534	112	2	1					648	6.796	0.010		
	Plutonium				1	1				2	4.890	2.445			
	Other	11	3	6						20	0.876	0.044			
	Uranium	17								17	0.048	0.003			
	Thorium	3								3	0.027	0.009			
	Uranium	3								3	0.022	0.007			
	Thorium	23	2							25	0.180	0.007			
	Uranium	79	4							83	0.504	0.006			
	Mound Plant**	Hydrogen-3	51							51	0.133	0.003			
Rocky Flats	Rocky Flats Eng. Tech. Site (RFETS)	Thorium						1			2	0.645	0.323		
		Uranium	23								23	0.101	0.004		
	Plutonium				1	1				2	0.262	0.131			
	Uranium	9	6							15	0.095	0.006			
	Plutonium				1					1	0.272	0.272			
	Mixed	6	3	2						11	0.587	0.053			
	Other	2								2	0.122	0.061			
	Hydrogen-3	502	20							522	2.649	0.005			
	Plutonium	4	3					2		9	2.627	0.292			
	Americium	2								2	0.113	0.057			
<b>Totals</b>			<b>1,564</b>	<b>245</b>	<b>33</b>	<b>4</b>	<b>1</b>	<b>3</b>	<b>1</b>	<b>1,851</b>	<b>30.764</b>	<b>0.017</b>			

**B-22: Correlation of Occupational Radiation Exposure with Nuclear Weapons Production**

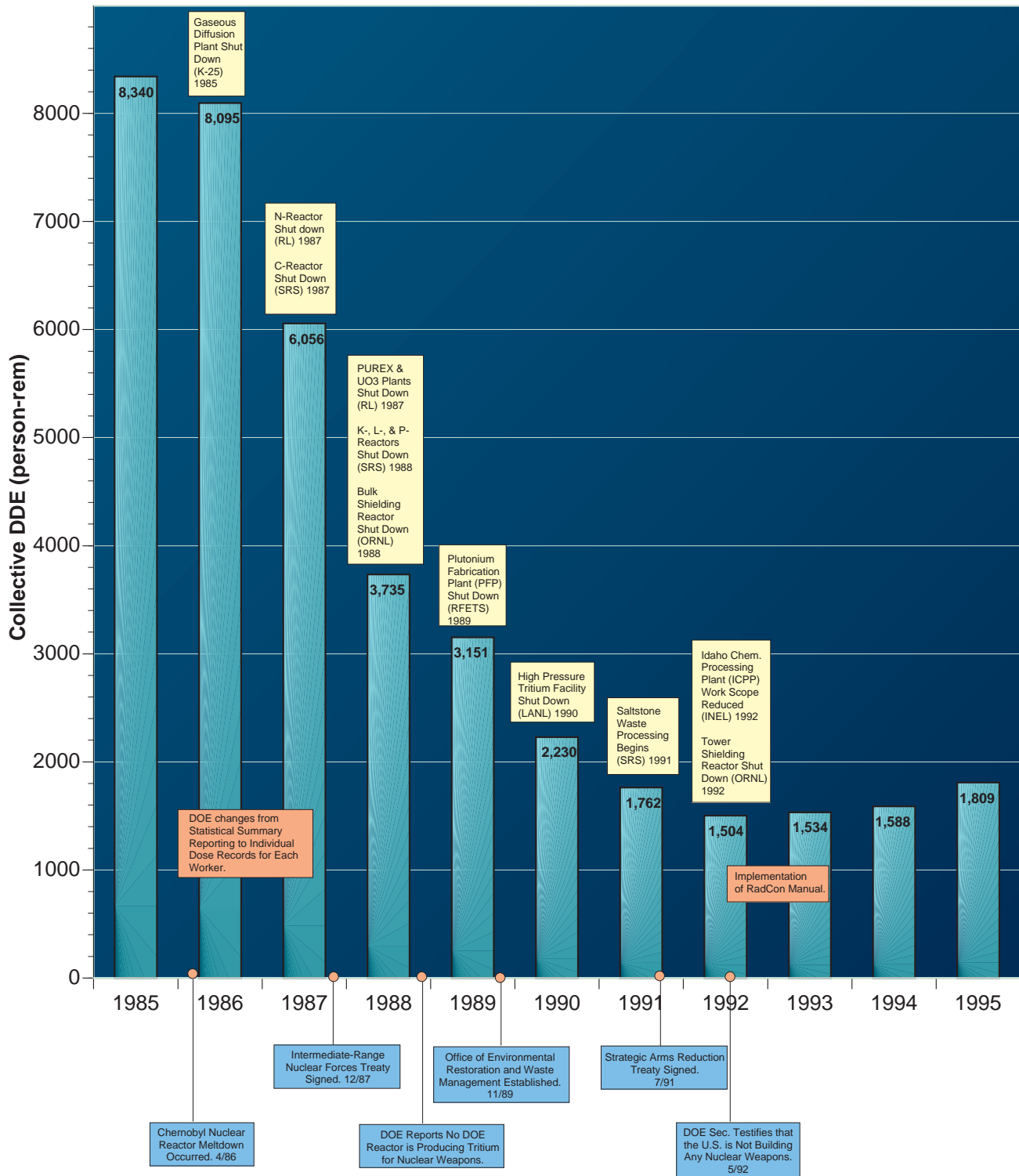

**B-22: Correlation of Occupational Radiation Exposure with Nuclear Weapons Production (Continued)**

Site	Facility	Total Collective DDE (person-rem)										
		1985	1986	1987	1988	1989	1990	1991	1992	1993	1994	1995
Idaho Nat'l. Engineering Lab.	Fuel Processing	169	156	141	145	218	146	61	38	65	73	94
	Maintenance & Support	0	16	10	8	6	5	2	2	2	8	9
	Other	12	214	11	9	28	150	61	14	117	91	148
	Reactor	166	144	79	44	40	31	33	28	43	51	19
	Research, General	0	4	2	27	19	12	4	4	8	8	7
	Waste Processing/Mgmt.	0	4	5	4	5	3	1	1	2	5	7
	<b>INEL TOTAL</b>	<b>347</b>	<b>537</b>	<b>248</b>	<b>238</b>	<b>315</b>	<b>347</b>	<b>162</b>	<b>87</b>	<b>236</b>	<b>237</b>	<b>284</b>
Los Alamos National Lab.	Accelerator	0	0	0	48	72	45	23	18	21	22	24
	Maintenance & Support	0	0	2	92	32	16	15	22	24	40	68
	Other	31	22	1	46	19	12	9	2	2	5	9
	Reactor	0	0	0	2	1	0	0	0	0	0	0
	Research, Fusion	0	0	0	1	0	0	0	1	0	0	1
	Research, General	745	548	376	199	201	146	113	89	93	108	129
	Waste Processing/Mgmt.	0	0	0	0	0	5	1	0	1	1	3
	Weapons Fab. & Testing	0	0	0	3	0	0	0	0	0	0	0
<b>LANL TOTAL</b>	<b>776</b>	<b>570</b>	<b>379</b>	<b>391</b>	<b>325</b>	<b>224</b>	<b>162</b>	<b>132</b>	<b>142</b>	<b>176</b>	<b>234</b>	
Oak Ridge Site	Fuel Processing	0	0	9	3	3	0	1	0	0	0	0
	Fuel/Uranium Enrichment	3	2	5	5	1	1	0	1	2	1	1
	Other	2	0	0	1	0	0	0	0	9	8	16
	Research, General	116	137	149	77	43	30	42	42	45	45	41
	Weapons Fab. & Testing	50	181	103	75	71	31	17	29	15	12	7
	<b>Oak Ridge Site TOTAL</b>	<b>171</b>	<b>320</b>	<b>265</b>	<b>162</b>	<b>118</b>	<b>62</b>	<b>59</b>	<b>71</b>	<b>71</b>	<b>66</b>	<b>64</b>
Rocky Flats	Weapons Fab. & Testing	1,370	1,245	880	654	412	145	313	297	250	229	260
<b>Rocky Flats TOTAL</b>	<b>1,370</b>	<b>1,245</b>	<b>880</b>	<b>654</b>	<b>412</b>	<b>145</b>	<b>313</b>	<b>297</b>	<b>250</b>	<b>229</b>	<b>260</b>	
Hanford Site	Fuel Fabrication	62	94	14	3	10	1	1	1	0	0	0
	Fuel Processing	0	0	14	22	62	11	8	10	5	5	7
	Maintenance & Support	0	0	1,098	172	152	118	103	86	72	77	97
	Other	1,105	887	29	7	16	9	10	13	17	19	32
	Reactor	1,183	964	776	152	163	51	19	20	14	13	17
	Research, General	183	307	103	56	85	55	42	46	47	44	55
	Waste Processing/Mgmt.	0	0	367	239	131	86	69	64	52	56	81
<b>Hanford Site TOTAL</b>	<b>2,533</b>	<b>2,251</b>	<b>2,402</b>	<b>652</b>	<b>619</b>	<b>330</b>	<b>252</b>	<b>239</b>	<b>207</b>	<b>213</b>	<b>290</b>	
Savannah River Site	Fuel Fabrication	70	89	57	49	31	33	0	0	15	19	9
	Fuel Processing	405	423	267	215	209	126	117	1	90	87	60
	Maintenance & Support	0	0	368	376	379	372	159	265	12	16	15
	Other	716	787	50	52	45	48	73	27	3	3	4
	Reactor	144	129	50	55	37	29	17	15	12	14	12
	Research, General	41	57	30	25	24	17	8	9	12	13	15
	Waste Processing/Mgmt.	0	0	112	105	76	51	35	0	46	61	59
	Weapons Fab & Testing	18	13	11	10	3	6	3	0	69	97	77
	<b>SRS TOTAL</b>	<b>1,394</b>	<b>1,498</b>	<b>945</b>	<b>887</b>	<b>804</b>	<b>683</b>	<b>412</b>	<b>317</b>	<b>258</b>	<b>310</b>	<b>250</b>
Totals	<b>TOTAL FOR SIX SITES</b>	<b>6,592</b>	<b>6,422</b>	<b>5,119</b>	<b>2,983</b>	<b>2,593</b>	<b>1,791</b>	<b>1,360</b>	<b>1,144</b>	<b>1,163</b>	<b>1,231</b>	<b>1,382</b>
	<b>DOE OVERALL TOTAL*</b>	<b>8,340</b>	<b>8,095</b>	<b>6,056</b>	<b>3,735</b>	<b>3,151</b>	<b>2,230</b>	<b>1,762</b>	<b>1,504</b>	<b>1,534</b>	<b>1,600</b>	<b>1,809</b>
	Percentages of Sites to DOE Overall	79%	79%	85%	80%	82%	80%	77%	76%	76%	77%	76%

\* Does not include Schenectady Naval Reactor Office or Pittsburgh Naval Reactor Office.

**B-22: Correlation of Occupational Radiation Exposure with Nuclear Weapons Production  
(Continued)**

Events	Impacts
<p>The N-Reactor closed at the Hanford Site in January 1987, followed by the shutdown of both the PUREX and UO3 plants in 1988, and the shutdown of the PFP in 1989.</p>	<p>A large decrease in the collective dose at the Hanford Site for the “Reactor” ① and “Other” ② facility types occurs between 1987 and 1988. The overall decrease in collective dose at the Hanford Site from 1987 to 1988 is dramatic ③.</p>
<p>DOE reported in mid-1988 that no DOE reactor was producing tritium for nuclear weapons. The C-Reactor at the SRS was shut down in 1987. The L-Reactor at SRS was restarted in 1985 and shutdown again in 1988. The P-Reactor and the K-Reactor at SRS were shut down in 1988 and never restarted except for a brief K-Reactor test run in 1992. The production of nuclear weapons materials at SRS ended in 1992.</p>	<p>Collective dose for the “Reactor” ④ and “Other” ⑤ facility types at the SRS decreased between 1986 and 1987. The overall decrease for the SRS indicates that there is a slowdown in activity at the SRS ⑥.</p>
<p>Rocky Flats PFP operations were curtailed in 1989 and many other functions suspended in the subsequent years with a total halt in plutonium operations in 1991. The plant began preparations to resume activities in 1991, but a change in mission to shut down, decontaminate, and decommission occurred in 1993.</p>	<p>The collective dose at the Rocky Flats Site decreased by 88% from 1986 to 1990 ⑦. It increased in 1991 ⑧ as a result of the aborted resumption effort, and has slowly decreased between 1991 and 1994.</p>
<p>The Office of Environmental Restoration and Waste Management (EM) was established in November 1989. The K-25 Plant at Oak Ridge was shut down in 1985 and became an EM site in 1992. The bulk shielding and tower shielding reactors at ORNL were shut down in 1988 and 1992, respectively. The mission of the Y-12 Plant has been changed to the disassembly of nuclear weapons.</p>	<p>The collective dose at the Oak Ridge Site decreased from 1986 to 1991 ⑨ and increased slightly in 1992 ⑩. In general, the K-25 Plant is reported as a “Fuel/Uranium Enrichment” facility type, ORNL is reported as a “Research, General” facility type, and the Y-12 Plant is reported as a “Weapons, Fab &amp; Testing” facility type. The shutdown of the K-25 Plant occurred before 1985. The shutdown of the experimental reactors at ORNL correlates with a collective dose decrease in the “Research, General” facility type from 1987 to 1990 ⑪. The Y-12 Plant, “Weapon, Fab &amp; Testing” facility type collective dose decreased between 1986 and 1991 ⑫. This correlates with the end of weapons assembly.</p>
<p>The Secretary of Energy testified before Congress in May 1992 that the United States was not building any nuclear weapons for the first time since 1945. The high pressure tritium facility at LANL was shut down in 1990 and the work scope at the Idaho Chemical Processing Plant (ICPP) (INEL) was reduced in 1992.</p>	<p>The basic mission at the LANL has not changed and INEL has many missions with the US Navy. The collective dose shown for these sites shows gradual decrease. LANL collective dose decreases 82% from 1985 to 1992 ⑬. INEL shows a decrease of more than 79% during this period but this decrease is not consistent from year to year ⑭.</p>
<p>During the reporting period 1992-1994, the DOE overall collective DDE increased by 5% ⑮. The collective DDE at the Hanford, Rocky Flats, and Oak Ridge Sites decreased ⑯ and the collective DDE at the SRS has remained about constant ⑰. The collective dose increased at INEL and LANL ⑱ as a result of increased activities at the ICPP, and increased throughput for satellite heat sources at the LANL plutonium facilities.</p>	
<p>As can be seen from this analysis, changes in mission and operational status can have a large impact on the occupational dose at DOE.</p>	

# Appendix C

## Facility Type Code Descriptions

C

DOE Order 5484.1 [9] requires contractors to indicate for each reported individual the facility contributing the predominant portion of that individual's effective dose equivalent. In cases when this cannot be distinguished, the facility type indicated should represent the facility type wherein the greatest portion of work service was performed.

The facility type indicated must be one of 11 general facility categories shown in *Exhibit C-1*. Because it is not always a straightforward procedure to determine the appropriate facility type for each individual, the assignment of an individual to a particular facility type is a policy decision of each contractor.

The facility descriptions that follow indicate the types of facilities included in each category. Also included are the types of work performed at the facilities and the sources of the majority of the radiation exposures.

### Accelerator

The DOE administers approximately a dozen laboratories that perform significant accelerator-based research. The accelerators range in size from small single-room electrostatic devices to a 4-mile circumference synchrotron, and their energies range from keV to TeV.

The differences in accelerator types, sizes, and energies result in differences in the radiation types and dose rates associated with the accelerator facilities. In general, radiation doses to employees at the facilities are attributable to neutrons and X-rays, as well as muons at some larger facilities. Dose rates inside the primary shielding can range up to 0.2 rem/h as a result of X-ray production near some machine components. Outside the shielding, however, X-ray exposure rates are

very low, and neutron dose rates are generally less than 0.005 rem/h. Average annual doses at these facilities are slightly higher than the overall average for DOE; however, the collective dose is lower than the collective dose for most other DOE facility categories because of the relatively small number of employees at accelerator facilities. Regarding internal exposures, tritium and short-lived airborne activation products exist at some accelerator facilities, although annual internal doses are generally quite low.

### Fuel/Uranium Enrichment

The DOE involvement in the nuclear fuel cycle generally begins with uranium enrichment operations and facilities [15]. The current method of enrichment is isotopic separation using the gaseous diffusion process, which involves diffusing uranium through a porous membrane and using the different molecular weights of the uranium isotopes to achieve separation.

**Exhibit C-1:**  
**Facility Type Codes**

Facility Type Code	Description
10	Accelerator
21	Fuel/Uranium Enrichment
22	Fuel Fabrication
23	Fuel Processing
40	Maintenance and Support (Site Wide)
50	Reactor
61	Research, General
62	Research, Fusion
70	Waste Processing/Mgmt.
80	Weapons Fab. and Testing
99	Other

Although current facility designs and physical controls result in low doses from internally deposited uranium, the primary radiological hazard is the potential for inhalation of airborne uranium [15]. Because of the low specific activity of uranium, external dose rates are usually a few millirem per hour or less. Most of the external doses that are received are attributable to gamma exposures, although neutron exposures can occur, especially when work is performed near highly enriched uranium. Both the average and collective external doses at these facilities are among the lowest of any DOE facility category.

---

## Fuel Fabrication

Activities at fuel fabrication facilities involve the physical conversion of uranium compounds to usable forms, usually rod-shaped metal. Radiation exposures to personnel at these facilities are attributable almost entirely to gamma and beta radiation. However, beta radiation is considered the primary external radiation hazard because of high beta dose rates (up to several hundred mrad per hour) at the surface of uranium rods [15]. For example, physical modification of uranium metal by various metalworking operations, such as machining and lathing operations, requires protection against beta radiation exposures to the skin, eyes, and extremities. Average external doses at fuel fabrication facilities are generally higher than at other types of DOE facilities; however, collective doses are relatively low because the number of employees is low. Internal doses from inhalation of uranium are kept very low.

## Fuel Processing

The DOE administers several facilities that reprocess spent reactor fuel. These facilities separate the plutonium produced in reactors for use in defense programs. They also separate the fission products and uranium; the fission products are normally designated as radioactive waste products, while the uranium can be refabricated for further use as fuel.

The very high radioactivity of fission products in spent nuclear fuel results in employees at fuel processing facilities consistently having among the highest average doses of any DOE facility type. However, the collective dose at these facilities is less significant because of the small total number of employees. Penetrating doses are attributable primarily to gamma photons, although some neutron exposures do occur. Skin and extremity doses from handling samples are also significant, although only a few employees typically receive skin doses greater than 5 rem/year. Strict controls are in place at fuel reprocessing facilities to prevent internal depositions; however, several measurable intakes typically occur per year. Plutonium isotopes represent the majority of the internal depositions, and annual effective dose equivalents from the depositions are typically less than 0.5 rem.

---

## Maintenance and Support

Most DOE sites have facilities dedicated to maintaining and supporting the site. In addition, some employees may be classified under this facility type if their main function is to provide site maintenance and support, even though they may not be located at a single facility dedicated to that purpose.

Because many maintenance and support activities at DOE sites do not involve work near sources of ionizing radiation, the average dose equivalent per monitored employee is typically among the lowest of any facility type. However, those employees who do perform work near radiation sources receive relatively high average annual doses, as is indicated by the relatively high average annual dose per employee who receives a measurable exposure. Also, collective doses are relatively high because there is a large number of these employees relative to the number classified under other facility types. The sources of ionizing radiation exposure are primarily gamma photons. However, variations in the types of work performed and work locations result in exposures of all types, including exposures to beta particles, x-rays, neutrons, and airborne radioactivity.

equipment and plant areas, spent reactor fuel, activated reactor components, and other areas containing fission or activation products encountered during plant maintenance and decommissioning operations. Neutron exposures do occur at operating reactors, although the resulting doses are a very small fraction of the collective penetrating doses. Gamma dose rates in some plant areas can be very high (up to several rems per hour), requiring extensive protective measures. The average and collective external doses relative to other facility types are highly dependent on the status of reactor operations. Inhalation of airborne radioactive material is a concern in some plant areas. However, protective measures, such as area ventilation or use of respiratory-protection equipment, result in low internal doses.

---

## Reactor

The DOE and its predecessors have built and operated dozens of nuclear reactors since the mid-1940s. These facilities have included plutonium and tritium production reactors, prototype reactors for energy production, research reactors, reactors designed for special purposes such as production of medical radioisotopes, and reactors designed for the propulsion of naval vessels.

In 1992, many of the DOE reactors were not operating. As a result, personnel exposures at DOE reactor facilities were attributable primarily to gamma photons and beta particles from contaminated

---

## Research, General

The DOE contractors perform research at many DOE facilities, including all of the national laboratories. Research is performed in general areas including biology, biochemistry, health physics, materials science, environmental science, epidemiology, and many others. Research is also performed in more specific areas such as global warming, hazardous waste disposal, energy conservation, and energy production.

The spectrum of research involving ionizing radiation or radioactive materials being performed at DOE facilities results in a wide variety of radiological conditions. Depending on the research performed, personnel may be exposed to virtually any type of external radiation, including beta particles, gamma photons,



x-rays, and neutrons. In addition, there is the potential for inhalation of radioactive material. Area dose rates and individual annual doses are highly variable. Relative to other facility types, average annual individual doses are slightly above average at general research facilities. The collective dose equivalent is higher than at most other facility types because of the many individuals employed at general research facilities.

---

## Research, Fusion

DOE currently operates both major and small facilities that participate in research on fusion energy. In general, both penetrating and shallow radiation doses are minimal at these facilities because the dose rates near the equipment are both low and intermittent. The external doses that do occur are attributable primarily to x-rays from energized equipment. Relative to other DOE facility types, average individual doses and collective doses are typically the lowest at fusion research facilities. Regarding internal exposures, airborne tritium is a concern at some fusion research facilities, although the current level of operation results in minimal doses.

---

## Waste Processing/ Management

Most DOE sites have facilities dedicated to the processing and disposal of radioactive waste. In general, the dose rates to employees when handling waste are very low because of the low specific activities or the effectiveness of shielding materials. As a result, very few employees at these

facilities receive annual doses greater than 0.1 rem. At two DOE sites, however, large-scale waste processing facilities exist to properly dispose of radioactive waste products generated during the nuclear fuel cycle. At these facilities, radiation doses to some employees can be relatively high, sometimes exceeding 1 rem/ year. Penetrating doses at waste processing facilities are attributable primarily to gamma photons; however, neutron exposures are significant at the large-scale facilities. Skin doses are generally not a significant problem. Overall, average annual doses at waste processing/management facilities are among the highest of any DOE facility type, which is attributable primarily to the two large-scale facilities and the shift in DOE mission from national defense production to waste management and environmental restoration. The annual collective doses are closer to the average of all facility types, however, because of the relatively small number of employees at this type of facility.

---

## Weapons Fabrication and Testing

The primary function of a facility in this category is to fabricate weapons-grade material for the production or testing of nuclear weapons. At the testing facilities, radiation doses received by personnel are generally minimal because of the strict controls over personnel access to testing areas, although extremity doses can be relatively high from handling neutron-

activated materials. Radiation doses are a greater concern at facilities where weapons and weapons-grade nuclear material are handled. At these facilities, neutron radiation dose rates can be significant when processing relatively small quantities of  $^{238}\text{Pu}$  or larger quantities of mixed plutonium isotopes [16]. Penetrating doses from gamma photons and plutonium x-rays can also be significant in some situations, as can skin and extremity doses from plutonium x-rays. Overall, average individual annual doses at these facilities are slightly higher than the DOE average. The collective doses received by employees at these facilities are generally higher than the collective doses at other facility types because of the large number of individuals employed.

Also of significant concern at these facilities is inhalation of plutonium, where inhalation of very small amounts can result in doses exceeding limits. To prevent plutonium intakes, strict controls are in place including process containment, contamination control procedures, and air monitoring and bioassay programs [16]. As a result, significant internal exposures are very rare at these facilities.

## Other

Individuals included in this facility type can be generally classified under three categories: (1) those who worked in a facility that did not match one of the ten facility types described above; (2) those who did not work for any appreciable time at any specific facility, such as transient workers; or (3) those for whom facility type was not indicated on the report forms. Examples of a facility type not included in the ten described above include construction and irradiation facilities. In general, employees classified under this facility type receive annual doses significantly less than the annual doses averaged over all DOE facilities. However, the wide variation in the type of work performed by these individuals results in a wide variation in the types and levels of exposures. Although exposures to gamma photons are predominant, some individuals may be exposed to beta particles, x-rays, neutrons, or airborne radioactive material.



# Appendix D

## Limitations of Data

# D

The following is a description of the limitations of the data currently available in the DOE Radiation Exposure Monitoring System (REMS). While these limitations have been taken into consideration in the analysis presented in this report, readers should be alert to these limitations and consider their implications when drawing conclusions from these data.

### Individual Dose Records vs Dose Distribution

Prior to 1987, exposure data were reported from each facility in terms of a statistical dose distribution wherein the number of individuals receiving a dose within specific dose ranges was reported. The collective dose was then calculated from the distribution by multiplying the number of individuals in each dose range by the midpoint value of the dose range. Starting in 1987, reports of individual exposures were collected that recorded the specific dose for each monitored individual. The collective dose can be accurately determined by summing the total dose for each individual. The dose distribution reporting method prior to 1987 resulted in up to a 20% overestimation of collective dose. The reason is that the distribution of doses within a range is usually skewed toward the lower end of the range. If the midpoint of the range is multiplied by the number of people in the range, the product overestimates the collective dose.

### Monitoring Practices

Radiation monitoring practices differ widely from site to site and are based on the radiation hazards and work practices at each site. Sites use different dosimeters and have different policies on which workers to monitor. While all sites have achieved

compliance with the DOE Laboratory Accreditation Program (DOELAP), which standardizes the quality of dosimetry measurements, there are still differences in the dosimeters used that can contribute to differences in the collective dose from site to site. The number of monitored individuals can significantly impact the site's collective dose. Some sites supply dosimeters to virtually all workers. While this tends to inflate the number of monitored workers with no dose, it also can add a large number of very low dose workers to the total number of workers with measurable dose, thereby lowering the site's average measurable dose. Even at low doses, these workers add significantly to the site collective dose. In contrast, other sites only monitor workers who exceed the monitoring requirement threshold (10% of the dose limit). This tends to reduce the number of monitored workers and reports only those workers receiving doses in the higher dose ranges. This can decrease the site's collective dose while increasing the average measurable dose.

### AEDE vs CEDE

Prior to 1990, the dose resulting from penetrating ionizing radiation (external dose) and the dose resulting from the intake of radionuclides (internal dose), was reported separately. In 1993, the DOE changed the internal dose calculation methodology from annual effective dose equivalent (AEDE) to the 50-year committed effective dose equivalent (CEDE). The total effective dose equivalent (TEDE) then became the sum of the CEDE and the deep dose equivalent (DDE). This report presents TEDE data from 1991 through 1995. Internal AEDE data are reported from 1991 through 1995 and internal CEDE data are reported for 1993, 1994, and 1995. Where possible, the legacy

component of the AEDE data is highlighted when presenting TEDE data that are trended from 1990 through 1994. See Section 2.4 for a discussion of this change in requirements.

---

## Occupation Codes

Each individual's dose record includes the occupation code for the individual while he or she worked at the DOE site during the monitoring year. Any change in occupation during the monitoring year is not reflected in the current database. The occupation codes are very broad categorizations and are grouped into nine general categories. Each year a large percentage (up to 20%) of the occupations are listed as unknown, or as miscellaneous. The definitions of each of the labor categories are subject to interpretation by the reporting organization and/or the individual's employer.

---

## Facility Type

The facility type is also recorded with each dose record for the monitoring year. It is intended to reflect the type of facility where the individual received most of their occupational radiation exposure during the monitoring year. While the facility types are clearly defined (see Appendices A and C), the reporting organizations often have difficulty tracking which facility type contributed to the majority of the individual's exposure. Certain individuals tend to work in the proximity of several different facility types throughout the monitoring year and are often included in the "Maintenance and Support (Site-wide)" facility type. The facility type for temporary contract workers and visitors is often not reported and is defaulted to "unknown."

In addition to these uncertainties, the phase of operation of the facility types is not

currently reported. A facility type of "accelerator" may be reported when in fact, the accelerator has not been in operation for a considerable time and may be in the process of stabilization, decommissioning, or decontamination. In addition, several sites have commented that they have difficulty assigning the facility type, because many of the facilities are no longer operational. For example, some sites commented that a reactor that is being decommissioned is no longer considered a "reactor" facility type. Other sites continue to categorize a facility based on the original intent or design of the facility, regardless of its current status.

DOE Headquarters will be reviewing the Facility Type codification scheme and modifying the reporting requirements to standardize the use of facility type classifications and improve the quality of the data and the data analysis.

---

## Organization Code

Facilities report data to the central repository based on an "organization code". This code identifies the Operations or Field Office, the reporting facility, and the contractor or subcontractor that is reporting the exposure information. The organization code changes over time as DOE Offices are reorganized. In some cases, new Operations or Field Offices are created, in other cases a Field Office may change organizations and begin reporting with another Field Office. Two such changes are noteworthy within the past several years. The Fernald Field Office began reporting independently in 1993. Prior to 1993 it reported under the Oak Ridge Field Office. In 1994, Fernald was incorporated into the newly created Ohio Field Office. The Ohio Field Office began reporting in 1994. For this reason, the Fernald data are shown under the Ohio Field Office. The Mound Plant and West

Valley Project also changed Operations Office during the past 3 years and are now shown under the Ohio Field Office. Footnotes indicate the change in Operations Offices.

---

## Naval Reactor Facilities

The exposure information for the Schenectady and Pittsburgh Naval Reactor facilities is not included in this report because of limited information concerning these exposures. Readers should note that the dose information for the overall DOE complex presented in this report may differ from other reports or sources of information because of the exclusion of these data.

Exposure information for Naval Reactor programs can be found in the following reports:

- ◆ NT-93-2, February 1993 — “Occupational Radiation Exposure from U.S. Naval Nuclear Plants and Their Support Facilities”,
- ◆ NT-93-3, March 1993 — “Occupational Radiation Exposure from U.S. Naval Reactors’ Department of Energy Facilities”,
- ◆ NT-94-2, March 1994 — “Occupational Radiation Exposure from U.S. Naval Nuclear Plants and Their Support Facilities, and
- ◆ NT-94-3, March 1994 — “Occupational Radiation Exposure from U.S. Naval Reactors’ Department of Energy Facilities”.

## Updates to the Data

The data in the REMS database are subject to correction and update on a continuous basis. Data for prior years are subject to correction as well as the data for the most recent year included in this report. Corrections will be reflected in subsequent annual reports. For the most up-to-date status of radiation exposure information, contact:

Ms. Nirmala Rao  
REMS Project Manager  
U.S. Department of Energy  
Office of Worker Protection Programs and  
Hazards Management (EH-52)  
Germantown, MD 20874



# Appendix E

## Access to Radiation Exposure Information

# E

### Radiation Exposure Monitoring System

The data used to compile this report were obtained from the DOE Radiation Exposure Monitoring System (REMS), which serves as the central repository of radiation exposure information for DOE Headquarters.

Recently the REMS has undergone an extensive redesign effort in combination with the efforts involved in revising the annual report. One of the main goals of the redesign effort is to allow researchers better access to the REMS data. However, there is considerable diversity in the goals and needs of these researchers. For this reason, a multi-tiered approach has been developed to allow researchers flexibility in accessing the REMS data.

*Exhibit E-1* lists the various ways of accessing the DOE radiation exposure information contained in REMS. A description is given for each access method as well as requirements for access and skill sets needed for each method. Descriptions of the intended research audience and experience level (for computer systems) are also provided. To obtain further information, a contact name and phone number is provided.

A brief summary of the multi-tier access to the REMS information is shown in *Exhibit E-1*.

The data contained in the REMS system is subject to periodic update. Data for the current or previous years may be updated as corrections or additions are submitted by the sites. For this reason, the data presented in published reports may not agree with the current data in the REMS database. These updates typically have a relatively small impact on the data and should not affect the general conclusions and analysis of the data presented in this report.

### Comprehensive Epidemiologic Data Resource

Of interest to researchers in radiation exposure is the health risk associated with the exposure. While the health risk from occupational exposure is not treated in this report, it has been extensively researched by DOE. The Comprehensive Epidemiologic Data Resource (CEDR) serves as a central resource for radiation health risk studies at the DOE.

Epidemiologic studies on health effects of radiation exposures have been supported by the DOE for more than 30 years. The results of these studies, which initially focused on the evaluation of mortality among workers employed in the nuclear weapons complex, have been published in scientific literature. However, the data collected during the conduct of the studies were not widely shared. CEDR has now been established as a public-use database to broaden independent access and use of these data. At its introduction in 1993, CEDR included primarily occupational studies of the DOE workforce, including demographic, employment, exposure, and mortality follow-up information on more than 420,000 workers. In the past 2 years, the program's holdings have been expanded to include data from both occupational and community health studies, such as those examining the impact of fallout from nuclear weapons testing, community dose reconstructions, data from the decades of follow-up on atomic bomb survivors, and health surveillance reports on current DOE workers.

CEDR accomplishes this by a hierarchical structure that accommodates analysis and working files generated during a study, as well as files of documentation that are critical for understanding the data. CEDR provides easy access to its holdings through the Internet or dial-up connections, phone and mail interchanges, and provides an



extensive catalog of its holdings. CEDR has become a unique resource comprising the majority of data that exist on the risks of radiation exposure.

For further information concerning the CEDR system, contact

Ms. Barbara G. Brooks  
Program Manager  
Office of Epidemiologic Studies, EH-62  
U.S. Department of Energy  
19901 Germantown Road  
Germantown, MD 20874-1290

E-mail: [barbara.brooks@hq.doe.gov](mailto:barbara.brooks@hq.doe.gov)  
Or access the CEDR internet web page at  
<http://cedr.lbl.gov>

## E-1: Methods of Accessing REMS Information

REMS Information Access Method	Experience Requirements			Software Requirements <sup>3</sup>	Eligibility Requirements	To Get Access
	Knowledge of REMS Data	Computer Expertise				
		User	System Administrator-Setup			
Hardcopy Annual Report	<b>None.</b> Data explained in report.	<b>N/A</b>	<b>N/A</b>	<b>None.</b>	<b>None.</b>	Contact EH-52 <sup>1</sup> to request that you be added to Annual Report mailing list.
Web Page	<b>Low.</b> General knowledge/interest in radiation data.	<b>Minimal</b> computer skills. Only a knowledge of how to use the Web browser, and an Internet connection.	<b>Medium.</b> Supply LAN connection to Provider. Support Web browser.	Internet access. Web browser client software.	<b>None.</b>	Connect to <a href="http://rems.eh.doe.gov/">http://rems.eh.doe.gov/</a>
InfoMaker - Pre-defined reports	<b>Medium.</b> Need to know the data limitations of the data in REMS, and what the exposure data represent.	<b>Minimal.</b> Familiarity with Windows applications. Need to understand difference between Query and Reports.	<b>Medium.</b> Client-server computer configuration can be complex, but this is a one-time effort. InfoMaker support provided by DOE HQ.	Internet access (TCP/IP). Oracle SQLNet. PowerSoft InfoMaker. Oracle SNS software if Category 1 user]	No requirements for Category 2 users <sup>4</sup> . Category 1 users must get "need to know" Privacy Act authorization from EH-52 <sup>1</sup> .	Contact OIM <sup>2</sup> to request access. EH-52 authorization required for Category 1 users.
InfoMaker - Ad Hoc Queries	<b>High.</b> Need to thoroughly understand the data dictionary, relationships and structure of the database. Limitations of the data.	<b>Medium</b> (to High). Some knowledge of SQL highly recommended. Should be familiar with "Report generation"-type software.	<b>Medium.</b> Client-server computer configuration can be complex, but this is a one-time effort. InfoMaker support provided by DOE HQ.	Internet access (TCP/IP). Oracle SQLNet. PowerSoft InfoMaker. Oracle SNS software if Category 1 user]	No requirements for Category 2 users <sup>4</sup> . Category 1 users must get "need to know" Privacy Act authorization from EH-52 <sup>1</sup> .	Contact OIM <sup>2</sup> to request access. EH-52 authorization required for Category 1 users.
Client query tool other than InfoMaker	<b>High.</b> Need to thoroughly understand the data dictionary, relationships and structure of the database. Limitations of the data.	<b>High.</b> Need to be skilled in SQL and connecting to the system. Need to be skilled in the use of whatever query tool is used.	<b>Medium.</b> Support for LAN connection to Internet or Internet Provider. Support user query software.	Internet access (TCP/IP). Oracle SQLNet. ODBC Drivers. Query Tool client. Oracle SNS software if Category 1 user]	No requirements for Category 2 users <sup>4</sup> . Category 1 users must get "need to know" Privacy Act authorization from EH-52 <sup>1</sup> .	Contact OIM <sup>2</sup> to request access. EH-52 authorization required for Category 1 users.
Running SQL on the REMS Server	<b>High.</b> Need to thoroughly understand the data dictionary, relationships and structure of the database. Limitations of the data.	<b>High.</b> Need to be skilled in SQL and connecting to the system.	<b>Medium.</b> Support for LAN connection to Internet or Internet Provider. Support TELNET software.	Internet access (TCP/IP). TelNet software.	Category 2 use only. TelNet authorization required for firewall.	Contact OIM <sup>2</sup> to request access.

① EH-52 contact Ms. Nirmala Rao at — Phone: (301) 903-2297, Fax: (301) 903-7773; E-mail: Nimi.Rao@hq.doe.gov

② OIM contact Mr. Pat Heinig at — Phone: (301) 903-9850, Fax: (301) 903-0118

③ See REMS User Manual for detailed software requirements.

④ Category 1 - All data in the REMS system, including Privacy Act data such as name and social security number of the monitored individual. Category 2 - Access to non-sensitive radiation monitoring information per monitored individual. See REMS Reference Manual for details.



# User Survey



## DOE and DOE Contractor Employees Annual Radiation Exposure Report

### User Survey

DOE, striving to meet the needs of its stakeholders, is looking for suggestions on ways to improve the DOE and DOE Contractor Employees Annual Radiation Exposure Report. **Your feedback is important.** Constructive feedback will ensure the report can continue to meet user needs. Please fill out the attached survey form and return it to:

Ms. Nirmala Rao  
DOE EH-52 270/cc  
19901 Germantown Road  
Germantown, MD 20874

Questions concerning the survey  
should be directed to Ms. Rao at (301) 903-2297

-----

### 1. Identification:

Name: .....  
Title: .....  
Mailing Address: .....  
.....  
.....  
.....

### 2. Distribution:

- 2.1 Do you wish to remain on distribution for the report? \_\_\_ yes \_\_\_ no
- 2.2 Do you wish to be added to the distribution? \_\_\_ yes \_\_\_ no

### 3. Was the presentation/discussion of dose distribution data for:

DOE-wide ..... adequate \_\_\_ inadequate \_\_\_  
Sites ..... adequate \_\_\_ inadequate \_\_\_  
Facilities ..... adequate \_\_\_ inadequate \_\_\_  
Occupation/Labor ..... adequate \_\_\_ inadequate \_\_\_

Comments/areas for improvement:

.....  
.....  
.....  
.....  
.....  
.....  
.....

**4. Was the presentation/discussion of dose trends for:**

- DOE-wide ..... adequate \_\_\_ inadequate \_\_\_
- Sites..... adequate \_\_\_ inadequate \_\_\_
- Facilities ..... adequate \_\_\_ inadequate \_\_\_
- Occupation/Labor ..... adequate \_\_\_ inadequate \_\_\_

Comments/areas for improvement:

.....  
.....  
.....  
.....  
.....  
.....  
.....

**5. Was the discussion of ALARA Projects at specific sites:**

- Useful \_\_\_ Keep in future reports \_\_\_
- Not useful \_\_\_ Delete from future reports \_\_\_

**6. Was the discussion of AEDE vs CEDE helpful?**

- Useful \_\_\_ Keep in future reports \_\_\_
- Not useful \_\_\_ Delete from future reports \_\_\_

**7. Would additional/different breakouts of the data be helpful?**

- Yes \_\_\_ No \_\_\_

Comments/areas for improvement:

.....  
.....  
.....  
.....  
.....  
.....

**8. Suggestions for new facility type, occupation, and/or labor codes.**

.....  
.....  
.....  
.....  
.....

9. If/when the data become available, would person/rem-hour or person-rem/RWP be useful in this report?

Yes \_\_\_ No \_\_\_

Comments/areas for improvement:

.....  
.....  
.....  
.....  
.....  
.....  
.....

10. To publish this report in the second quarter and to be able to use it as a management tool, we need the data *as soon as possible* after you have processed it. Please indicate when you can provide the data.

Quarterly \_\_\_  
Semi-Annually \_\_\_ \*By end of January, February, March  
Yearly\* \_\_\_ (please circle one)

11. DOE is considering the addition of a code for indicating the Phase of Operation of the facility type that is currently reported with each dose record (see A-4). The Phase of Operation will allow for expanded analysis of the dose information by considering the operational phase of the facility. Please indicate whether this information is available at your site, and the years the information would cover.

Available \_\_\_ Years: \_\_\_\_\_ to \_\_\_\_\_  
Not available \_\_\_

