

**Evaluation of Options for
Permanent Geologic Disposal
of Spent Nuclear Fuel and High-
Level Radioactive Waste**
in Support of a Comprehensive National
Nuclear Fuel Cycle Strategy

**Volume II:
Appendices**

Fuel Cycle Research & Development

*Prepared for
U.S. Department of Energy
Used Fuel Disposition Campaign
by Sandia National Laboratories
April 15, 2014*

FCRD-UFD-2013-000371, Revision 1
SAND2014-0187P (Vol. I); SAND2014-0189P (Vol. II)



**Coordinated/Integrated by Sandia National Laboratories
representing a multidisciplinary team, as follows:**

Sandia National Laboratories, Coordinating/Integrating Org.

**E. Bonano, F. Durán , C. Jaeger, T. Lewis, P. McConnell, M. Pendleton, L. Price,
S. Saltzstein, D. Sassani, P. Swift, J. Tillman**

Argonne National Laboratory

J. Cunnane, W. Ebert, J. Jerden, W.M. Nutt

Complex Systems Group

T. Cotton

Idaho National Laboratory

S. Birk, B. Carlsen, W. Hintze, L. Pincock, R. Wigeland

Lawrence Livermore National Laboratory

W. Halsey

Los Alamos National Laboratory

F. Badwan, S. DeMuth, M. Miller, B. Robinson

Massachusetts Institute of Technology

M. Driscoll, C. Forsberg, M. Kazimi

Naval Nuclear Propulsion Program

A. Denko

Oak Ridge National Laboratory

R. Howard, J. Peterson, J. Wagner

Pacific Northwest National Laboratory

D. Kim, J. Vienna, J. Westsik

Savannah River National Laboratory

J. Marra

South Dakota School of Mines and Technology

R. White

The Catholic University of America

W. Kot, I. Pegg

Special Review and Oversight

DOE NE: W. Boyle, T. Gunter

DOE EM: N. Buschman, S. Gomberg

DISCLAIMER

This information was prepared as an account of work sponsored by an agency of the U.S. Government. Neither the U.S. Government nor any agency thereof, nor any of their employees, makes any warranty, expressed or implied, or assumes any legal liability or responsibility for the accuracy, completeness, or usefulness, of any information, apparatus, product, or process disclosed, or represents that its use would not infringe privately owned rights. Reference herein to any specific commercial product, process, or service by trade name, trade mark, manufacturer, or otherwise, does not necessarily constitute or imply its endorsement, recommendation, or favoring by the U.S. Government or any agency thereof. The views and opinions of authors expressed herein do not necessarily state or reflect those of the U.S. Government or any agency thereof.

Revision History

Version	Description
FCRD-UFD-2013—000371	Initial Release (Volume I: SAND2014-0187P and Volume II: SAND2014-0189P).
Revision 1	Revised for minor corrections. Changes to correct cesium/strontium capsule radioactivity description as fraction of Hanford wastes. Additional changes to incorporate System Plan 18 information for Savannah River Site.

(Approved for UNCLASSIFIED UNLIMITED RELEASE)



Sandia National Laboratories is a multi-program laboratory managed and operated by Sandia Corporation, a wholly owned subsidiary of Lockheed Martin Corporation, for the U.S. Department of Energy National Nuclear Security Administration under contract DE-AC04-94AL85000. Volume I: SAND2014-0187P and Volume II: SAND2014-0189P.

CONTENTS

Appendix A Waste Types and Waste Forms	A-1
A-1. Spent Nuclear Fuel	A-3
A-1.1 Commercial Spent Nuclear Fuel	A-3
A-1.1.1 Physical Form	A-6
A-1.1.2 Radionuclide Inventory	A-11
A-1.1.3 Thermal Output	A-14
A-1.1.4 Chemical Composition	A-16
A-1.1.5 Storage Configuration	A-16
A-1.1.6 Safeguards and Security Classification	A-18
A-1.2 DOE Managed Spent Nuclear Fuel	A-19
A-1.2.1 DOE SNF General Description	A-19
A-1.2.2 Plans for Packaging and Disposal of DOE SNF	A-34
A-1.3 Naval Spent Fuel	A-38
A-1.3.1 Chemical Reactivity	A-38
A-1.3.2 Waste Form and Packaging	A-38
A-1.4 Small Modular Reactor Fuels	A-41
A-2. High Level Wastes	A-41
A-2.1 Existing Vitrified HLW	A-41
A-2.1.1 West Valley High-Level Radioactive Waste Glass	A-42
A-2.1.2 Savannah River Site High-Level Radioactive Waste Glass	A-48
A-2.1.3 Radioactive Waste Glass at Hanford for Federal Republic of Germany	A-53
A-2.2 Projected Vitrified HLW	A-56
A-2.2.1 Hanford High Level Radioactive Waste Glass	A-56
A-2.2.2 Savannah River Site Tank Waste	A-66
A-2.2.3 Common Characteristics of Vitrified HLW Types	A-68
A-2.3 Existing Wastes Other Than Glass	A-69
A-2.3.1 Calcine Waste at Idaho National Laboratory	A-69
A-2.3.2 Sodium-Bearing Waste at INL	A-75
A-2.3.3 Cesium and Strontium Capsules at Hanford	A-82
A-2.4 Sodium-Bonded Spent Nuclear Fuels and Associated Waste Forms	A-87
A-2.4.1 The Ceramic Waste Form for EMT Salt Waste	A-88
A-2.4.2 Metallic Waste Form for EMT Metallic Waste	A-90
A-2.4.3 Direct Disposal of EMT Salt Waste	A-97
A-3. Waste Categorization by Risk	A-99
A-4. Orphan Wastes	A-101
A-5. References	A-101

Appendix B TRU Waste and WIPP Disposal	B-1
B-1. TRU Waste and WIPP Disposal.....	B-2
B-2. References	B-12
Appendix C Input Tabulations	C-1
C-1. Wastes and Waste Groups Tables	C-2
Appendix D Safeguards and Security	D-1
D-1. Introduction to Safeguards and Security	D-2
D-1.1 Safeguards and Security Requirements.....	D-2
D-1.2 Safeguards and Security Metrics.....	D-5
D-2. References	D-13
Appendix E Output Tabulations	E-1
Appendix F Additional Insights	F-1
F-1. Criteria and Metrics.....	F-2
F-1.1 Disposal Option Performance	F-3
F-1.1.1 Likely to Meet Expected Health and Safety Standards.....	F-3
F-1.1.2 Identification of Key Attributes of Disposal Option.....	F-3
F-1.2 Confidence in Expected Performance Bases.....	F-4
F-1.2.1 Additional Engineered Barrier System Considerations (Compared to Disposal of Commercial SNF and HLW glass).....	F-4
F-1.2.2 Robustness/Confidence in Information bases.....	F-4
F-1.3 Operational Feasibility	F-4
F-1.3.1 Ease in Ensuring Worker Health and Safety.....	F-4
F-1.3.2 Special Physical Considerations	F-4
F-1.4 Secondary Waste Production	F-5
F-1.4.1 Low-Level Waste (A, B, C, or GTCC) Generated	F-5
F-1.4.2 Mixed Waste Generated.....	F-5
F-1.5 Technical Readiness (e.g., TRL).....	F-5
F-1.5.1 Status of Needed Waste Form Generation.....	F-5
F-1.5.2 Status of Needed Transportation and Waste Handling Systems	F-5
F-1.5.3 Status of Needed Disposal Technologies.....	F-6
F-1.6 Safeguards and Security	F-6
F-1.6.1 National Security Implementation Difficulty (Fissile Material Content)	F-6
F-1.6.2 Radiological Dispersion Device (and Sabotage) Prevention Implementation Difficulty	F-6
F-1.7 Discussion of Differential to System-Level Cost.....	F-6
F-1.8 Discussion of Institutional Considerations.....	F-6
F-2. Additional Cross-Cutting Characteristics Considerations for Evaluated Waste Groups.....	F-7

F-2.1	Small Waste Forms	F-7
F-2.2	Non-Naval HEU Waste Forms.....	F-8
F-2.3	Waste Forms with Mixed Waste Characteristics	F-9
F-3.	Comparison of Amounts of Waste Forms	F-9

FIGURES

Figure A-1.	Location and quantity of discharged commercial SNF in the U.S. as of 2011	A-4
Figure A-2.	Distribution of current (2011) commercial SNF inventory in wet and dry storage	A-5
Figure A-3.	Typical PWR fuel assembly.....	A-7
Figure A-4.	BWR fuel assembly composition.....	A-8
Figure A-5.	General DPC configuration of the sleeve and space plate type	A-10
Figure A-6.	Discharge burnup as a function of initial enrichment and discharge date	A-11
Figure A-7.	Mass of selected isotopes (actinides) in commercial SNF (2048) for fuel discharged through 2002.....	A-12
Figure A-8.	Mass of selected isotopes (fission products) in commercial SNF (2048) as a function of burnup for fuel discharged through 2002.....	A-12
Figure A-9.	Activity of selected isotopes (actinides) in commercial SNF (2048) as a function of burnup for fuel discharged through 2002	A-13
Figure A-10.	Activity of selected isotopes (fission products) in commercial SNF (2048) as a function of burnup for fuel discharged through 2002.....	A-14
Figure A-11.	Decay heat per canister type for BWR SNF as a function of time after discharge	A-15
Figure A-12.	Decay heat per canister type for PWR SNF as a function of time after discharge	A-15
Figure A-13.	A typical dry cask storage cask for commercial SNF.....	A-18
Figure A-14.	Decay heat estimates per canister for 2030.....	A-20
Figure A-15.	Multicanister overpack	A-35
Figure A-16.	Standardized DOE SNF canister.....	A-36
Figure A-17.	Photograph of HLW glass canisters stored in the chemical process cell of WVDP main process building.....	A-48
Figure A-18.	Range of projected Hanford HLW glass component concentrations in wt % of reference oxides	A-63
Figure A-19.	Projected decay heat per Hanford HLW canister.....	A-65
Figure A-20.	Schematic of cesium chloride capsule	A-83
Figure B-1.	Map of TRU waste sites.....	B-2
Figure B-2.	TRU waste volumes, broken out by site—CH waste (top) and RH waste (bottom).....	B-3
Figure B-3.	Activities for TRU waste, broken out by site—top: CH waste, bottom: RH waste.....	B-4
Figure B-4.	TRUPACT II waste transport system	B-5
Figure B-5.	HalfPACT waste transport system.....	B-5
Figure B-6.	TRUPACT-II transportation system arriving at the WIPP repository.....	B-6
Figure B-7.	Schematic of RH-72B waste transport system.....	B-6

Figure B-8.	Photograph of RH-72B waste transport system.....	B-7
Figure B-9.	CH waste being disposed in a disposal room at WIPP	B-7
Figure B-10.	RH waste disposal equipment used for disposal at WIPP	B-8
Figure B-11.	Radionuclide activities by species for Hanford TRU waste—top plot: CH TRU waste; bottom plot: RH TRU waste.....	B-9
Figure B-12.	Mass of nonradiological components in TRU waste.....	B-10
Figure B-13.	Mass of complexing agents in TRU waste	B-11
Figure B-14.	Mass of anions in TRU waste	B-11
Figure D-1.	Domestic and international responsibilities for regulating safeguards and security (example requirements)	D-3
Figure F-1.	Volumes of U.S. SNF and HLW in 2048	F-10
Figure F-2.	Masses of commercial and DOE-managed SNF, existing and projected in 2048, assuming constant rate of nuclear power generation in commercial reactors.....	F-11
Figure F-3.	Volumes of DOE-managed SNF for disposal.....	F-12
Figure F-4.	Volumes of HLW projected to exist in 2048, based on the assumptions that calcine is HIP processed with additives, SBW is treated by fluidized bed steam reforming, and all waste forms other than sodium-bonded fuels at the INL are vitrified.....	F-13
Figure F-5.	Relative activity of HLW projected in 2048.....	F-14

TABLES

Table A-1.	Potential purpose-built canister capacity for generic media	A-6
Table A-2.	Summary of physical attributes for BWR and PWR assemblies	A-9
Table A-3.	Physical characteristics of both PBCs and DPCs.....	A-10
Table A-4.	A summary of the isotopes in commercial SNF (through 2002) per assembly decayed to 2048	A-17
Table A-5.	Ranges of nominal properties for DOE-managed spent nuclear fuel	A-27
Table A-6.	Mass and canister count estimates by fuel group for DOE-managed SNF	A-32
Table A-7.	Radionuclide inventory for a representative naval SNF canister at 5 years after reactor shutdown.....	A-39
Table A-8.	WVDP HLW canister data summary.....	A-43
Table A-9.	Target composition of WVDP glass and measured ranges for production glasses.....	A-45
Table A-10.	Normalized Product Consistency Test data for WVDP HLW glass.....	A-46
Table A-11.	TCLP test results of WVDP HLW glass.....	A-46
Table A-12.	Total and maximum (per canister) radionuclide content of West Valley HLW glass indexed to 2015 and 3115	A-47
Table A-13.	Properties of HLW borosilicate glass	A-49
Table A-14.	Canisters produced, glass mass and canister heat content (at the time of production) in macrobatches 1-8	A-50
Table A-15.	Reportable radionuclide data for macrobatches 1-8	A-51
Table A-16.	Typical composition for HLW borosilicate glasses.....	A-52
Table A-17.	Glass compositions for DWPF macrobatches 1-8	A-53
Table A-18.	Average heat and dose characteristics for FRG glass canisters	A-54
Table A-19.	Nominal glass compositions for the 30 FRG heat and radiation source canisters	A-55
Table A-20.	FRG canister weight data summary.....	A-55
Table A-21.	Dimensions of casks used to store FRG isotopic heat and radiation sources	A-56
Table A-22.	Chemical inventory in Hanford HLW storage tanks	A-58
Table A-23.	Radionuclide inventory in Hanford HLW tanks as of January 1, 2008.....	A-59
Table A-24.	Hanford HLW canister data summary	A-61
Table A-25.	Design codes and standards for the Hanford HLW canisters	A-61
Table A-26.	Summary of system plan Hanford HLW glass composition region	A-62
Table A-27.	Range of projected radionuclide content of Hanford HLW glasses in Ci/canister	A-64
Table A-28.	Summary of Hanford HLW glass fissile composition.....	A-65
Table A-29.	Curie inventory in tanks at SRS as of January 2013.....	A-67

Table A-30.	Number of canisters in wattage ranges for projected DWPF canisters.....	A-68
Table A-31.	Typical chemical composition of four types of calcine	A-70
Table A-32.	Chemical inventory in each of the six CSSFs.....	A-71
Table A-33.	Calcine radioactivity in each of the six CSSFs decayed to January 1, 2016	A-72
Table A-34.	RCRA metal content of INL calcines	A-73
Table A-35.	Chemical composition of sodium-bearing waste	A-76
Table A-36.	Concentrations of RCRA metals and underlying hazardous constituents in SBW.....	A-77
Table A-37.	Radionuclide inventory of INTEC sodium-bearing waste decayed to January 2003	A-78
Table A-38.	Chemical composition of sodium-bearing waste	A-79
Table A-39.	Concentrations of RCRA metals and underlying hazardous constituents in SBW.....	A-80
Table A-40.	Radionuclide inventory of INTEC sodium-bearing waste decayed to January 2012	A-81
Table A-41.	Characteristics of cesium and strontium capsules.....	A-84
Table A-42.	Type W cesium capsules and contents.....	A-84
Table A-43.	Radioactivity and heat generation characteristics for cesium capsules	A-85
Table A-44.	Radioactivity and heat generation characteristics for strontium capsules	A-86
Table A-45.	EBR-II and FFTF ceramic waste radionuclide composition	A-89
Table A-46.	EBR-II and FFTF metal waste radionuclide composition	A-92
Table A-47.	Average radionuclide inventory (Ci) per canister used in calculations for TSPA for the Yucca Mountain license application	A-94
Table A-48.	Current estimated electrorefiner salt composition (mass fractions, from Lee et al. 2013).....	A-97
Table A-49.	Isotopic inventory for EMT salt waste used in Lee et al. (2013).....	A-98
Table C-1.	Nuclear wastes included in the evaluation.....	C-3
Table C-2.	Waste form groups used in the evaluation.....	C-9
Table D-1.	NRC Appendix M to Part 110—Categorization of Nuclear Material.....	D-7
Table D-2.	DOE Order 474.2, Graded Safeguards table.....	D-8
Table D-3.	IAEA categories for radioactive sources	D-9
Table D-4.	IAEA Security Level A: recommended objectives and measures	D-10
Table E-1.	Evaluation results for WG1	E-2
Table E-2.	Evaluation results for WG2	E-3
Table E-3.	Evaluation results for WG3	E-4
Table E-4.	Evaluation results for WG4	E-5
Table E-5.	Evaluation results for WG5	E-6

**Evaluation of Options for Permanent Geologic Disposal of Spent Nuclear Fuel
and High-Level Radioactive Waste, Volume II**

April 15, 2014

xi

Table E-6.	Evaluation results for WG6	E-7
Table E-7.	Evaluation results for WG7	E-8
Table E-8.	Evaluation results for WG8	E-9
Table E-9.	Evaluation results for WG9	E-11
Table E-10.	Evaluation results for WG10	E-12
Table E-11.	Evaluation results for salt disposal concept	E-13
Table E-12.	Evaluation results for the crystalline disposal concept	E-16
Table E-13.	Evaluation results for the clay/shale disposal concept	E-19
Table E-14.	Evaluation results for deep borehole disposal concept	E-22
Table F-1.	Volumes of small waste forms suitable for deep borehole disposal	F-7
Table F-2.	Activity of HLW Projected in 2048	F-14

ACRONYMS and ABBREVIATIONS

BISO	buffered isotropic
BWR	boiling water reactor
CH	contact-handled
CSSF	Calcine Solids Storage Facility
CBF	ceramic waste form
DMR	denitration and mineralization reformer
DOE	U.S. Department of Energy
DOE-NE	Department of Energy Office of Nuclear Energy
DPC	dual-purpose canister
DWPF	Defense Waste Processing Facility
EBR-II	Experimental Breeder Reactor II
EMT	electrometallurgical treatment
EOL	end-of-life
FFTF	Fast Flux Test Facility
FRG	Federal Republic of Germany
GTCC	Greater Than Class C
HEU	highly enriched uranium
HIP	hot isostatic pressing
HLW	high-level radioactive waste
IAEA	International Atomic Energy Agency
ILW	intermediate-level waste
INL	Idaho National Laboratory
INTEC	Idaho Nuclear Technology and Engineering Center
LEU	low-enriched uranium
LLW	low-level waste
LWR	light water reactor
MC&A	material control and accounting
MCO	multicanister overpack
MEU	medium-enriched uranium
MOX	mixed oxide
MWF	metallic waste form
NRC	U.S. Nuclear Regulatory Commission
PBC	purpose-built canister
PWR	pressurized water reactor
PUREX	plutonium uranium extraction
RCRA	Resource Conservation and Recovery Act
RH	remote-handled
SBW	sodium-bearing waste
SMR	small modular reactor
SNF	spent nuclear fuel
SNM	special nuclear material
SRS	Savannah River Site
TCLP	Toxicity Characteristic Leaching Procedure
THOREX	thorium extraction
TRISO	tristructural isotropic
TRU	transuranic
U.S.	United States
WAPS	Waste Acceptance Product Specifications

WESF	Waste Encapsulation and Storage Facility
WIPP	Waste Isolation Pilot Plant
WIR	waste incidental to reprocessing
WVDP	West Valley Demonstration Project
WTP	Waste Treatment and Immobilization Plant

Units

ft	foot
GWd	gigawatt-days
in.	inch
lb	pound
MT	metric ton
MTHM	metric ton of heavy metal
MTU	metric ton of uranium
MWd	megawatt-days
wt %	weight percent
W	watt

Appendix A

Waste Types and Waste Forms

This study is chartered to evaluate existing and “reasonably foreseeable” spent nuclear fuel (SNF) and high-level radioactive waste (HLW) inventories. The existing wastes are those that can be inventoried, and those scheduled to be generated by currently operating reactors (or reactors under construction) and high-level waste generating activities. The boundary of “reasonably foreseeable” is selected to include wastes that can be forecast from current actions by industry or government, but is not intended to include potential waste streams from advanced fuel cycle technologies that may be—or may not be—deployed in the future. This enables the physical and radiological characteristics of both existing and reasonably foreseeable wastes to be sufficiently well defined for evaluation in disposal options. Future wastes are typically not so well defined. Potential future wastes are considered elsewhere in a more general sense within advanced fuel cycle evaluation and system analysis studies (e.g., Wigeland et al. 2010; DOE 2011b).

Several examples help describe the boundary of “reasonably foreseeable” wastes.

- Several prototype high-temperature gas-cooled reactors have been built and operated in the past in the U.S., and spent fuel from these reactors exists in current inventories. These fuels are clearly included in the scope of this study. The quantity and characteristics of these fuels are well known and included in the Section 2.1.2 inventories. In contrast, the U.S. Department of Energy, Office of Nuclear Energy (DOE-NE) program to develop and deploy a ‘Next-Generation Nuclear Plant’ seeks to build new high-temperature gas-cooled reactors in the future. Several types of fuel have been proposed for this reactor, and the final characteristics of discharged fuel are not well established. Furthermore, at this time there is not a construction commitment for this reactor, and there is no firm schedule for deployment. Spent fuel from these potential reactors is considered beyond the ‘reasonably foreseeable’ boundary, and thus is not considered in the scope for this study.
- Several prototype sodium-cooled fast-spectrum reactors have been built and operated in the past in the U.S., and spent fuel from these reactors exists in current inventories, are well characterized and included in Section 2.1.2 inventories—and are thus included within the scope of this study. Driver and blanket fuels from Experimental Breeder Reactor II (EBR-II) are currently being processed at DOE-NE facilities at the Idaho National Laboratory (INL), so the HLW generated from this processing is included in the scope of this study as both existing and reasonably foreseeable. The recent U.S. DOE-NE program to develop a fast-spectrum burner reactor proposed building new fast spectrum reactors in the future. However, this program is not currently being actively pursued, so spent fuel from these potential reactors is considered beyond the scope for this study.
- Evolutionary improvements in LWR fuel cladding are an ongoing industrial activity, and some new cladding or slight fuel variant may be currently being tested and their irradiated characteristics can be predicted (are well understood). These fuels would be considered reasonably foreseeable, and thus within the scope for this study. For example, fuel for small modular reactors (SMRs) is not identical to commercial spent nuclear fuel (e.g., about half the length) but is similar enough that it is assumed to be part of the same waste group considered for disposal below. Research on advanced ‘accident tolerant’ fuels is being conducted by DOE-NE. However, there are a variety of other design concepts being considered within the fuel cycle—so specific characteristics are uncertain. In addition, there is no schedule for deployment of these fuels. Therefore, they are considered outside the ‘reasonably foreseeable’ boundary of wastes considered for this study.
- Although prototype HLW glass with higher radionuclide loading is being studied currently, such potential glass waste forms are considered beyond the scope of this study. Currently existing

glass waste forms and glass waste forms that are planned to be generated, such as at the vitrification facility at Hanford, are included within the scope of this evaluation.

Those spent fuel and high-level wastes that ‘exist,’ or are scheduled to exist by current activities, and those that fall within the ‘reasonably foreseeable’ boundary are described below. It should be noted here that given the wide range of waste types and forms considered in this appendix, there is no standard set of units (i.e., English versus metric) adopted within this discussion. Rather the units used within the large range of literature referenced herein and used throughout this appendix. Although it is recognized that some portion of the excess plutonium inventory (e.g., material not suitable for mixed oxide (MOX) fuel) will need to be dispositioned, that material is not included in this report due to the uncertainty in the amount/type of that inventory and the uncertainty in its disposal method and form.

Waste Categorization (versus Classification) Approach—Existing radioactive waste in the U.S. is classified under multiple laws and regulations into categories that include spent nuclear fuel, high-level radioactive waste, transuranic (TRU) waste, and low-level waste (LLW). Where relevant, these classifications are noted in discussions in this report. These classifications are based, in many cases, on the origin of the radioactive material or on the processes by which it was generated, rather than on inherent risks the waste poses to humans and the environment. For the purposes of this study, it is more useful to focus on disposal pathways for waste based on the risk posed by the waste; as such, this study focuses on disposal of high-level waste and intermediate-level waste as defined by the International Atomic Energy Agency (IAEA). This is discussed further in Section A-3, below.

A-1. Spent Nuclear Fuel

Spent nuclear fuel is generally categorized as either commercial or DOE-managed. Commercial spent nuclear fuel, in its many forms, is discussed in Section A-1.1. DOE-managed spent nuclear fuel exists in a variety of forms (Section A-1.2), including naval fuels (Section A-1.3), and a small amount (currently) of spent fuel to be generated in SMRs (Section A-1.4).

A-1.1 Commercial Spent Nuclear Fuel

The current inventory of domestic SNF is massive, diverse, dispersed, and increasing (e.g., Wagner et al. 2012). As of 2012, approximately 69,500 metric tons of heavy metal (MTHM) of commercial SNF (NEI 2013), representing a total of ~23 billion curies of long-lived radioactivity (Carter et al. 2012), are currently stored at 75 sites in 33 states (Figure A-1) (GAO 2012). The commercial SNF inventory is increasing annually by ~2,000 MTHM (GAO 2011) and will increase at a greater rate in the future if the number of operating nuclear reactors increases. Assuming that 2,000 MTHM of SNF is created each year from 2012 through 2048, the commercial SNF inventory in 2048 is estimated to be 142,000 MTHM. Commercial SNF discharge data, on an assembly basis, were collected and published (EIA 2004) by the Energy Information Administration for the Office of Civilian Radioactive Waste Management through 2002. Although limited to discharges through 2002, these data represent the most detailed available information on the commercially discharged SNF inventory. Recently, data have been assembled from a variety of sources by the DOE-NE Used Fuel Disposition Campaign to develop an inventory estimate through 2011 (Carter et al. 2012).

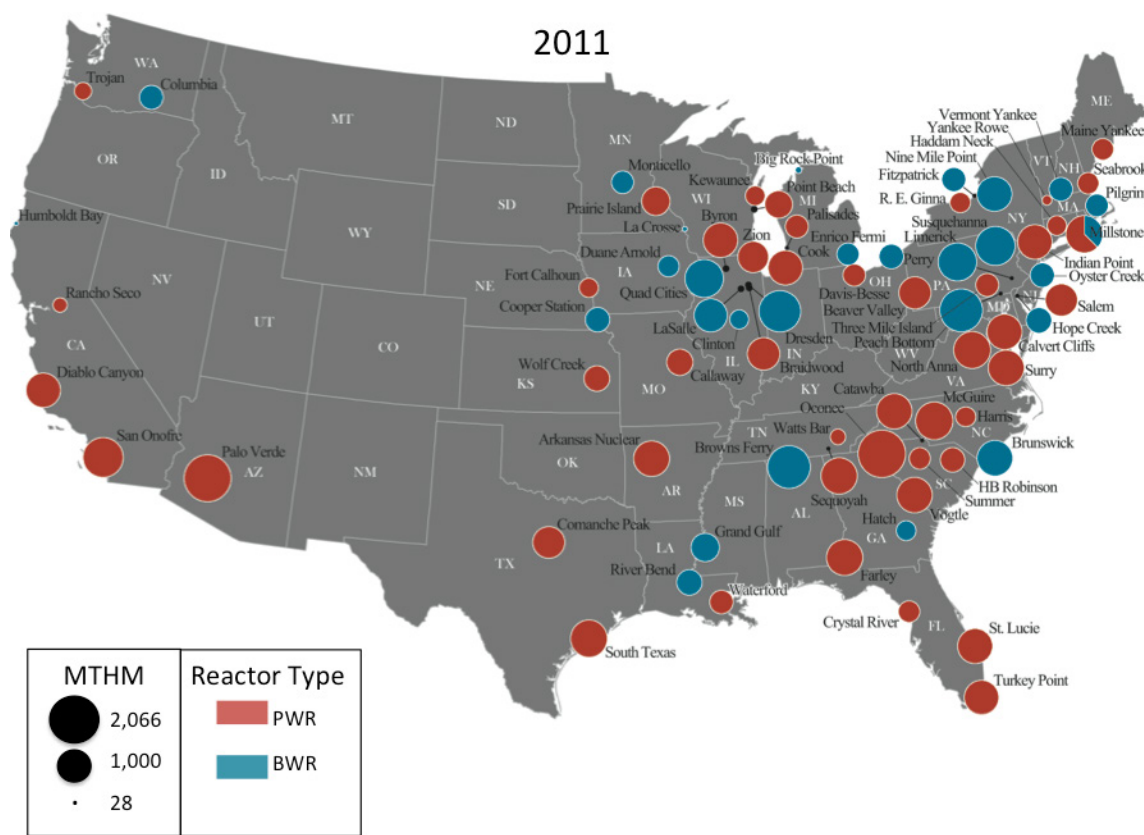

Note: Dot sizes are relatively proportional to metric tons of heavy metal (MTHM), as indicated in the legend. Data from GAO 2012.

Figure A-1. Location and quantity of discharged commercial SNF in the U.S. as of 2011

Commercial nuclear power plants have been operating in the U.S. since 1957,¹ and there are currently 100 operating nuclear power plants. Spent nuclear fuel from these plants is stored on-site in spent fuel pools and in dry storage casks. Dry storage facilities, referred to as independent spent fuel storage installations, are in operation at the majority of reactor sites, including 13 sites in 11 states that no longer have operating reactors. Commercial SNF includes irradiated fuel discharged from pressurized water reactors (PWRs) and boiling water reactors (BWRs). In 2011, ~74% of the total mass of commercial SNF was stored in spent fuel pools, and the remaining 26% was in dry cask storage (GAO 2011). However, these proportions will slowly change (GAO 2011; EIA 2004) as most spent fuel pools are at or near their capacity. The distribution of the 2011 SNF inventory from PWRs and BWRs in wet (pool) and dry storage is shown in Figure A-2.

¹ Note that the SNF from the first commercial nuclear power plant, the Shippingport Atomic Power Station, is now classified as DOE-owned fuel.

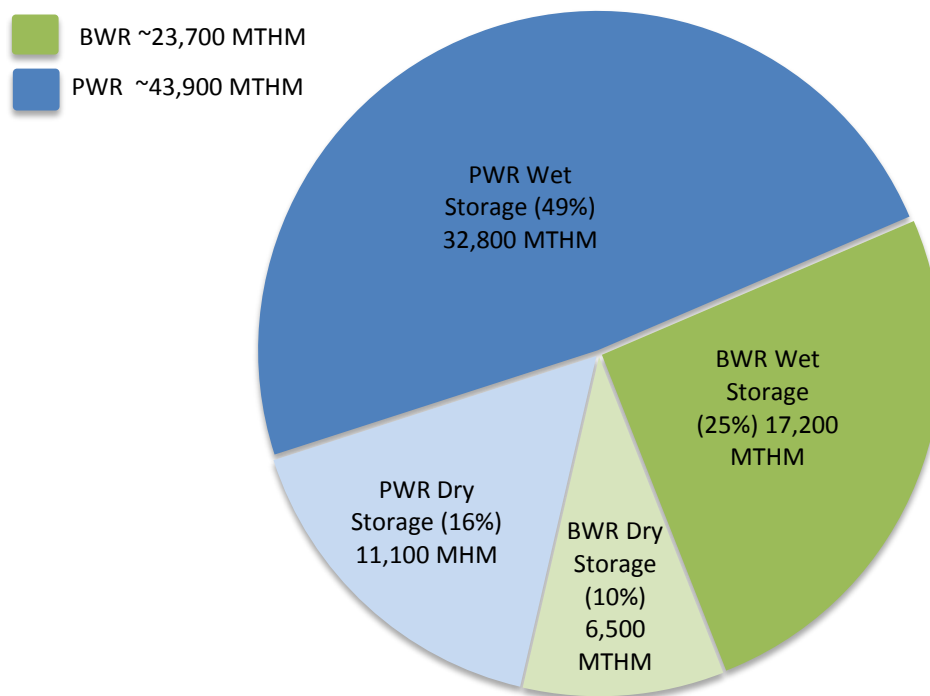

Source: Wagner et al. 2012, Figure 3.

Figure A-2. Distribution of current (2011) commercial SNF inventory in wet and dry storage

Based on the characteristics described below, PWR and BWR assemblies are not sufficiently different to warrant classifying them as different waste types. Although specific exceptions could be identified in the future, there is currently no known compelling reason to process the bulk of commercial SNF before disposal (Wagner et al. 2012). Although burnup is variable (see below), it has not been used here to make distinctions among commercial SNF types for purposes of this study. Therefore, commercial SNF represents one waste type with two waste forms: purpose-built canisters (PBCs) and dual-purpose canisters (DPCs).² Each of these waste forms are alternative pathways as neither has been finalized, but these represent two end-member pathways to evaluate the technical range of possibilities.

For the purposes of the Disposal Option Evaluation, PBCs are canisters that would be specifically designed (size, materials of fabrication, fabrication processes, etc.) and loaded for a repository concept taking into account the specific geologic setting and how engineered and natural barriers are expected to evolve over time. PBCs could contain both commercial SNF and non-fuel assembly hardware or, in the case of borehole disposal concepts, commercial SNF separated from assembly hardware (rod consolidation). DPCs are canisters that are designed and loaded to meet the current operational requirements of commercial nuclear power production facilities and the transportation and storage requirements of 10 CFR Part 71 and 10 CFR Part 72, respectively. The majority of SNF in existing dry storage is in DPCs and nearly all new dry storage transfers are in DPCs. These canisters typically hold as many as 32 PWRs assemblies (or 68 BWR assemblies) and recent designs hold even more. DPCs are not

² Note that under the Standard Contract the DOE is only obligated to accept bare fuel for disposal and that contract holders who have packaged their spent nuclear fuel into DPC will have to sign a contract amendment with the DOE to have their DPC accepted by the DOE.

designed for a specific disposal concept and therefore the repository would need to account for and accommodate the existing DPCs sizes, materials of fabrication, fabrication processes and as loaded and as received content and condition. DPCs contain commercial spent nuclear fuel and non-fuel assembly hardware.

Specially designed overpacks could be used to make a complete waste package as part of the repository concept engineered barrier system for either PBCs or DPCs. The common materials considered for waste package materials in reducing environments are carbon steel, stainless steel, copper, and titanium. Corrosion performance of waste package materials is a function of temperature, ionic strength, pH, and concentrations of halide ions. Steel has a number of attributes that might make it a suitable candidate as a canister for SNF disposal. It is widely available at relatively low cost, and is relatively easy to weld. Carbon steel and low-alloy steels have been extensively tested in ground water environments for several decades. As alternatives to active (corrosion allowance) canister materials such as copper and carbon steel, passive alloys of nickel and titanium, and stainless steel, have been considered as waste package materials in both oxidizing and reducing environments. These materials form a passive, stable oxide film on the surface in most chemical environments, and the physical properties and chemical inertness of this film limit the general corrosion rate. Passive materials may undergo localized corrosion (e.g., pitting or crevice corrosion) if the oxide film breaks down locally (Hardin et al. 2012).

The important characteristics of commercial SNF (with nonfuel assembly hardware) within PBCs and DPCs relevant to permanent disposal can be divided into the following categories discussed below: physical form; radionuclide inventory; thermal output; chemical composition; storage configuration; and safeguards and security classification.

The PBC design will depend significantly on the host geologic media and repository concept; therefore for this analysis there are four different representative sizes of PBCs that were analyzed and one representative size for DPCs. The different sizes can be seen in the Table A-1.

Table A-1. Potential purpose-built canister capacity for generic media

Canister type	Media/Design Concept	Representative Canister Capacity
PBC-Borehole	Deep Borehole	349 PWR fuel rods(consolidated) or 1 BWR Assembly ^a
PBC-Small	Clay/Shale or Crystalline: Enclosed	4 PWR or 9 BWR
PBC-Medium	Salt: Enclosed	12 PWR or 24 BWR
PBC-Large	Clay/Shale: Open	21 PWR or 44 BWR
DPC	N/A	32 PWR or 68 BWR

Notes: ^a. Minimum values based on the smaller inner diameter (8.05 in. or 20.4 cm; Arnold et al. 2011) deep borehole PBC. Additional capacity for BWR fuel rods can be achieved with rod consolidation. Sources: for deep borehole, Brady et al. 2009 and Arnold et al. 2011; remainder, Hardin et al. 2012.

A-1.1.1 Physical Form

Nearly all PWR SNF is composed of uranium dioxide (UO₂) ceramic pellets inserted into Zircaloy cladding tubes that are bound together by a grid assembly (Figure A-3). Although new cladding materials are being developed and a small fraction of the older SNF assemblies used stainless steel 304H, the predominant cladding materials are Zircaloy-4 and ZIRLO (a proprietary Zircaloy alloy developed by Westinghouse). PWRs typically have fuel assemblies arranged in 14×14, 15×15, 16×16, and 17×17 arrays of fuel pins, as well as some asymmetric configurations. The different reactor types and evolution in fuel assembly designs and reactor operating conditions have resulted in considerable variation in the

characteristics (e.g., assembly and cladding materials, initial enrichment, discharge burnup, burnable poison types, and irradiation exposure conditions) of the current SNF inventory. Additional components of a PWR fuel assembly include a top nozzle, control rod guide thimble tubes, and a bottom nozzle.

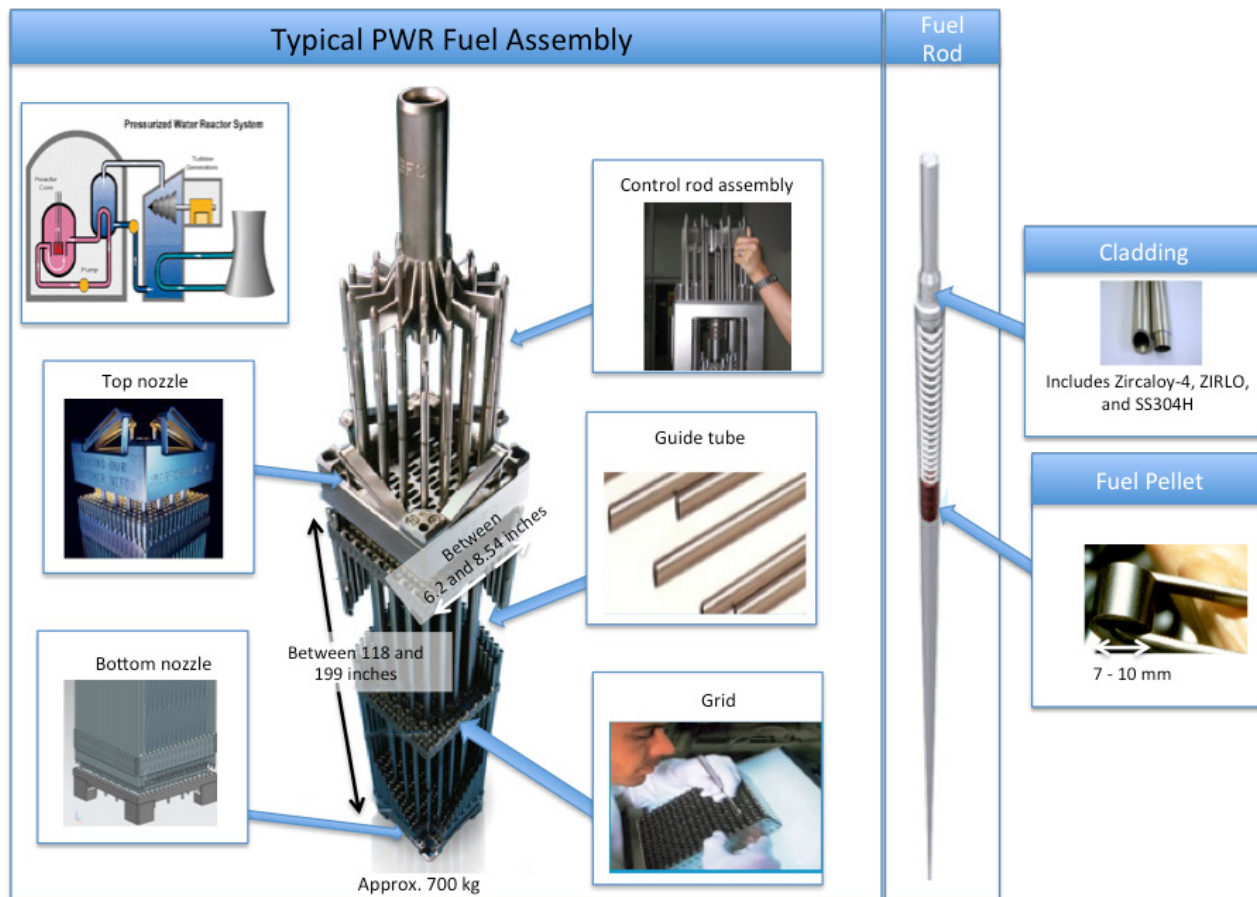

Source: Wagner et al. 2012, Figure A-1.

Figure A-3. Typical PWR fuel assembly

The BWR fuel assemblies are also composed of UO_2 fuel pellets surrounded by Zircaloy cladding (Figure A-4). The cladding material for BWR fuel is typically Zircaloy-2; stainless steel 348H was used in older assembly designs. Unlike the PWR, the BWR fuel has an outer sheath, referred to as the fuel channel, which is used to control the flow of water through the assembly. BWRs have fuel assemblies arranged in 6×6 , 7×7 , 8×8 , 9×9 , 10×10 , and 11×11 arrays of fuel pins and a range of lattice variations, such as water holes and part-length rods. Additional components of the BWR fuel assembly include plenum springs, expansion springs, water rods, upper and lower tie plates, a nose piece, and the bar handle.

A small number of MOX fuel assemblies were used in commercial nuclear power plants in the 1960s and 1980s (San Onofre and R.E. Ginna for PWRs and Dresden, Quad Cities, and Big Rock Point for BWRs) and in 2005 (Catawaba power station [PWR]) (WNA 2013). The mechanical design of MOX fuel is very similar to typical UO_2 fuel, but MOX SNF, like high burnup UO_2 SNF, has higher decay heat and specific activity than typical UO_2 SNF (IAEA 2011). However, the issues associated with higher decay heat and specific activity can be mitigated if necessary by requiring longer decay times before MOX SNF is loaded into canisters, blending MOX and UO_2 SNF assemblies in canisters for thermal management, or other appropriate measures.

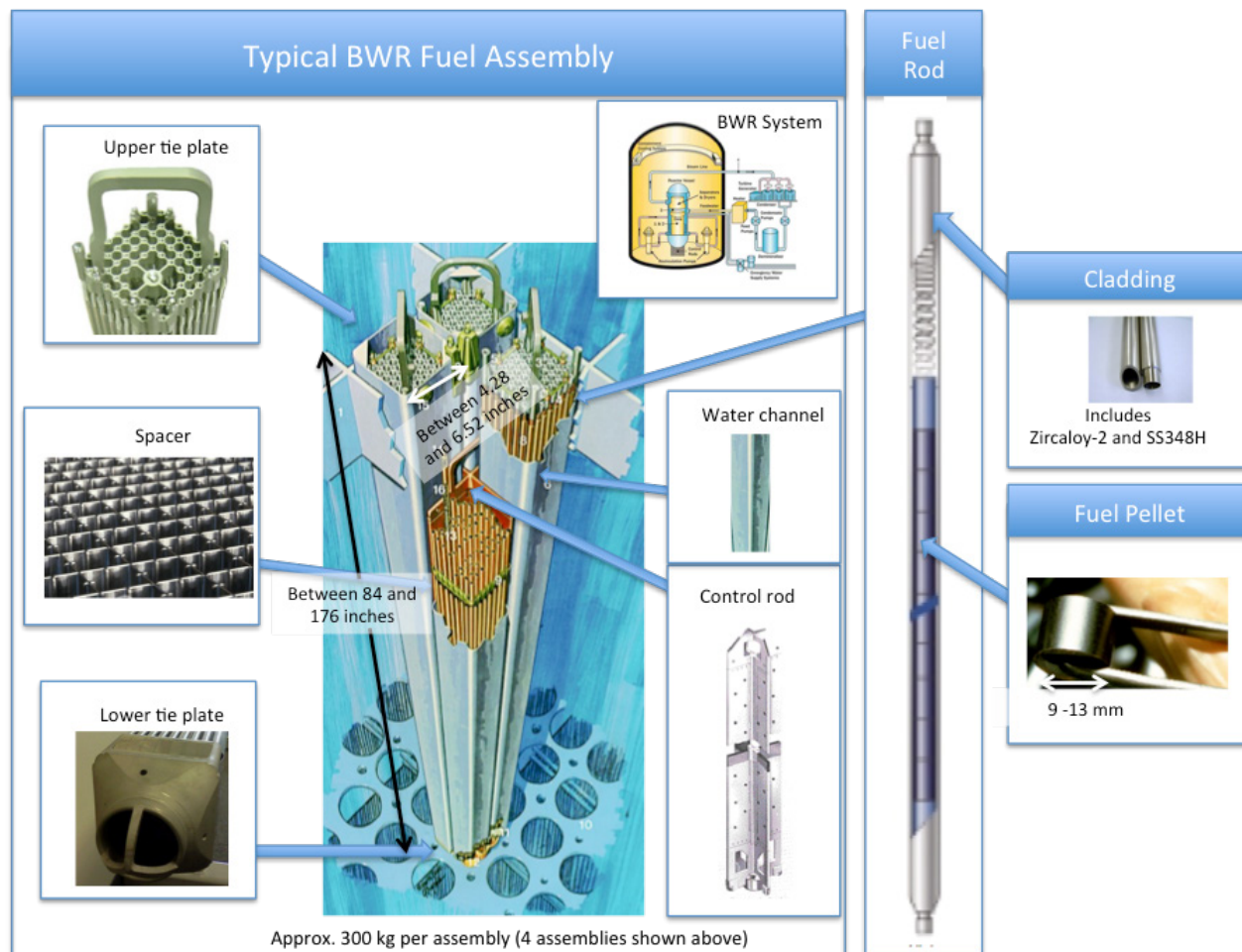

Source: Wagner et al. 2012, Figure A-2.

Figure A-4. BWR fuel assembly composition

There is also a small fraction (by mass) of the commercial SNF that is no longer in its as-built assembly form and has been placed in individual cans, referred to as “damaged” or “failed-fuel” cans. The cans may contain intact SNF assemblies, consolidated SNF rods, and/or pieces of SNF rods. DPCs are designed to accept failed-fuel cans, and PBCs can be designed to accept failed-fuel cans.

A summary of additional physical parameters for BWR and PWR assemblies is presented in Table A-2. A more detailed description of the physical parameters of BWR and PWR assemblies can be found in Appendices A-1 and A-2 of Wagner et al. (2012) and in Chapter 2 and Appendix 2 of *Characteristics of Spent Fuel, High-Level Waste, and Other Radioactive Wastes Which May Require Long-Term Isolation* (DOE 1987).

Table A-2. Summary of physical attributes for BWR and PWR assemblies

Physical Attribute	BWR				PWR			
	Avg.	Std.	Min.	Max.	Avg.	Std.	Min.	Max.
Length (in.)	173.3	10.5	84.0	176.2	161.2	9.8	111.8	199.0
Width (in.)	5.4	0.1	4.3	6.5	8.3	0.3	6.3	8.5
Mass (kg)	179.0	13.4	0.0	197.6	431.0	42.0	0.0	546.6
Rod array size			6×6	11×11			14×14	17×17

NOTE: The mass of the PWR assembly on average is 2.4 times larger than the mass of a BWR assembly. This difference can be seen in additional tables and charts because the results are presented sometime on an assembly basis. However, this difference was not judged to be significant enough to warrant dividing commercial SNF into two separate waste types.

The main contributors to nonfuel assembly hardware are BWR fuel channels, BWR control blades, PWR rod-cluster control assemblies, and PWR burnable poison rod assemblies. Other contributors include neutron sources, in-core instrumentation, and guide-tube thimbles or orifice rods (DOE 1987, Section 2.8 and Appendix 2E). Nonfuel assembly hardware is expected to be disposed with the fuel assemblies (e.g., burnable poison rods are being inserted into the assemblies in dry storage casks (Transnuclear 2004)) in most disposal concepts. Borehole disposal concepts may preclude the disposal of complete fuel assemblies due to size limitations.

In addition to commercial SNF (with nonfuel assembly hardware), DPCs and PBCs will have features such as baskets for fuel support, thermal shunts, neutron absorbers, flux traps, and inserts, spacers, or fillers (Hardin et al. 2012). The basket is an essential component to PBCs and DPCs and provides the primary heat transfer path for fuel assemblies, structural support, and criticality control. Either the basket is designed with gridded longitudinal plates or an array of square tubes—both of these features will have spacer plates (e.g., see Figure A-5). The lid assembly consists of a primary lid or shield plug and one or two top covers that are welded (Hardin et al. 2013). A summary of some of the physical characteristics of both PBCs and DPCs can be seen in Table A-3. As expected, the number of disposal canisters needed varies inversely with the canister size, and the range covers from about 11,400 DPCs to about 470,000 PBCs for disposal in boreholes of all commercial SNF estimated to be generated through the year 2048.

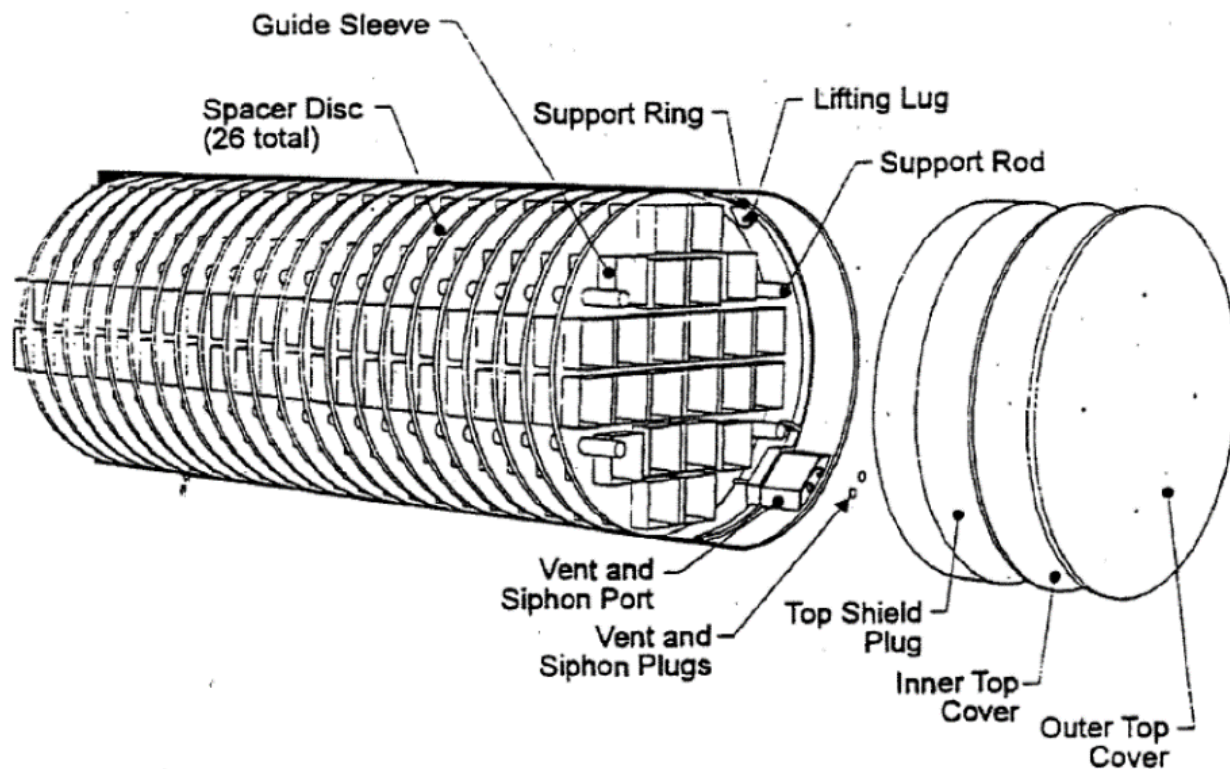

Source: Hardin et al. 2013, Figure 3-1.

Figure A-5. General DPC configuration of the sleeve and space plate type

Table A-3. Physical characteristics of both PBCs and DPCs

Canister type	Number of PWR canisters needed*	Number of BWR canisters needed*	Total number of canisters needed	Outer Diameter (m)**	Length (m)**
PBC-Borehole	173,163	296,900	470,063	0.27	4.6
PBC-Small	56,375	32,989	89,364	0.82	5
PBC-Medium	18,792	12,371	31,163	1.29	5.13
PBC-Large	10,738	6,185	16,924	1.6	5.13
DPC	7,047	4,366	11,413	2	5.13

* Data came from interpolating Scenario 2 of Carter et al. (2012) to the year 2048. Note that this data represents the number of canisters needed to disposal all of the commercial SNF generated up to the year 2048.

** Dimensional data from Arnold et al. (2011) for deep borehole canisters and from Hardin et al. (2012) for the remaining canister types.

A-1.1.2 Radionuclide Inventory

Assembly-average enrichments have increased across the U.S. commercial reactor fleet and are approaching the current limit of 5 wt % ^{235}U .³ Consequently, burnup values have also been increasing. Figure A-6 shows the discharged SNF inventory through 2002 as a function of burnup, enrichment, and discharge date.

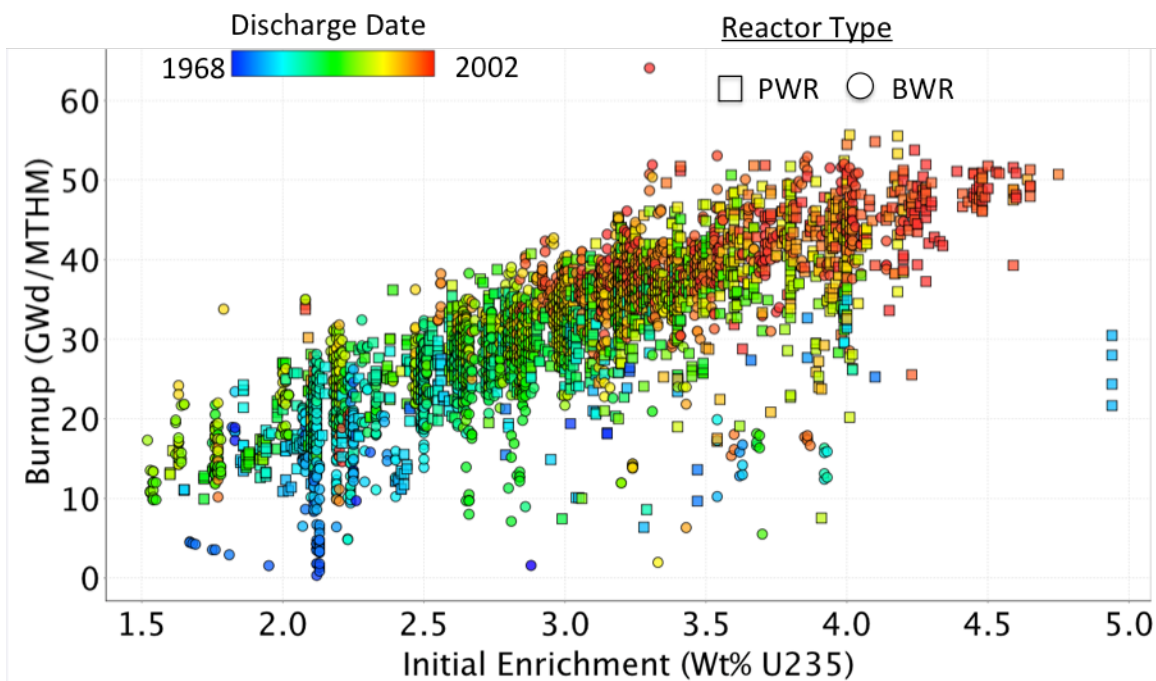

Source: Wagner et al. 2012.

Figure A-6. Discharge burnup as a function of initial enrichment and discharge date

Some important radionuclide inventories in commercial SNF corresponding to the year 2048, the strategic target date to open a geologic repository, are shown by mass in Figure A-7 and Figure A-8. The main drivers behind the variations in the isotopic compositions are the burnup, elapsed time since discharged from the reactor, and initial uranium loading. Other parameters that have a smaller effect on the isotopic variations include assembly design, reactor operation, and initial enrichment. A description of the types of discharged SNF assemblies in the U.S. can be found in Wagner et al. (2012), Appendix A. For the actinides shown in Figure A-7, the top five most abundant isotopes in SNF are ^{235}U , ^{236}U , ^{238}U , ^{239}Pu and ^{240}Pu . For the fission products shown in Figure A-8, ^{99}Tc , ^{93}Zr , and ^{135}Cs followed by ^{137}Cs , ^{107}Pd , ^{129}I , and ^{90}Sr are the most abundant of the plotted isotopes.

³ Note that if the current commercial reactor-licensing limit of 5.0 wt % ^{235}U on fuel enrichment was increased in the future, fuel design variations would be implemented to utilize higher enrichments and discharge burnup values would increase.

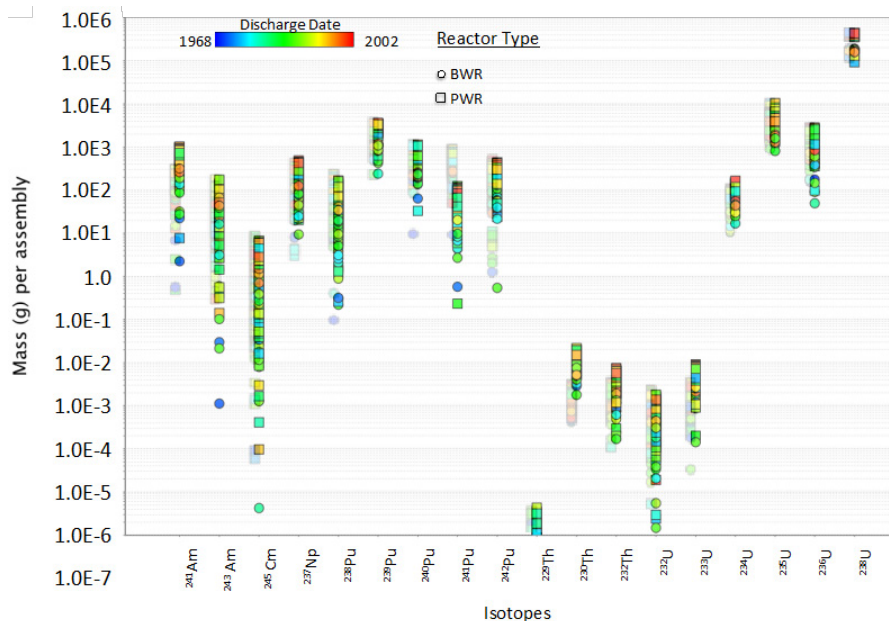

NOTE: The lighter data point corresponds to the mass of the isotopes when the fuel was discharged.

Figure A-7. Mass of selected isotopes (actinides) in commercial SNF (2048) for fuel discharged through 2002

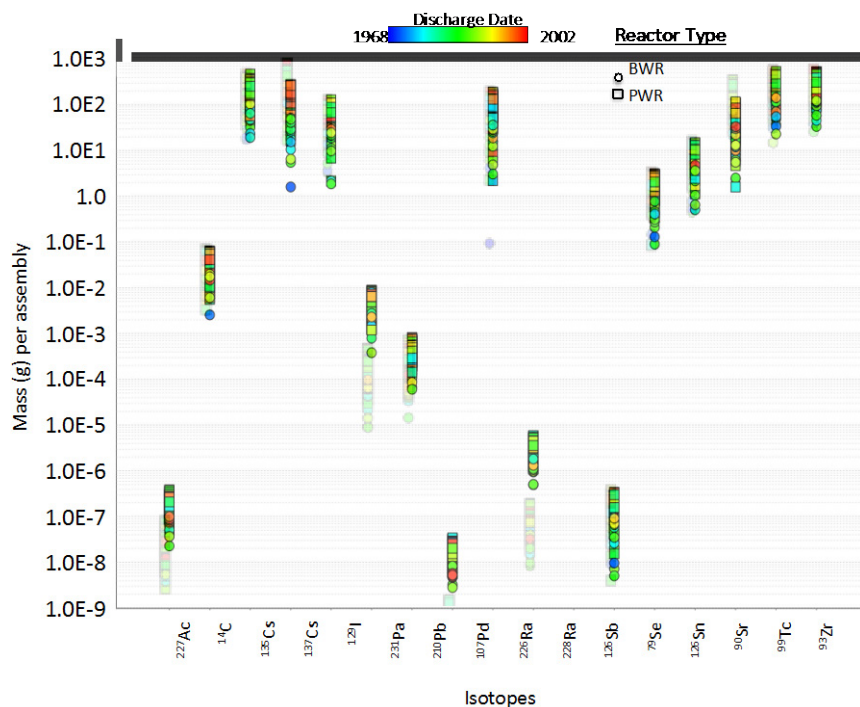

NOTE: The lighter data point corresponds to the mass of the isotopes when the fuel was discharged.

Figure A-8. Mass of selected isotopes (fission products) in commercial SNF (2048) as a function of burnup for fuel discharged through 2002

The ranges of activity for selected isotopes in commercial SNF corresponding to 2048 are shown in Figure A-9 and Figure A-10. The primary contributors to activity at the year 2048 for the fission products are ^{137}Cs (30 year half-life) and ^{90}Sr (28.8 year half-life). These isotopes will play a significant part in the radioactivity of the SNF at the beginning of the repository development. It should be noted that the radionuclide inventories shown above do not include fuel discharged after 2002. However, the lighter data points correspond to the mass of the isotopes when the fuel was discharged (representing newly discharged fuel).

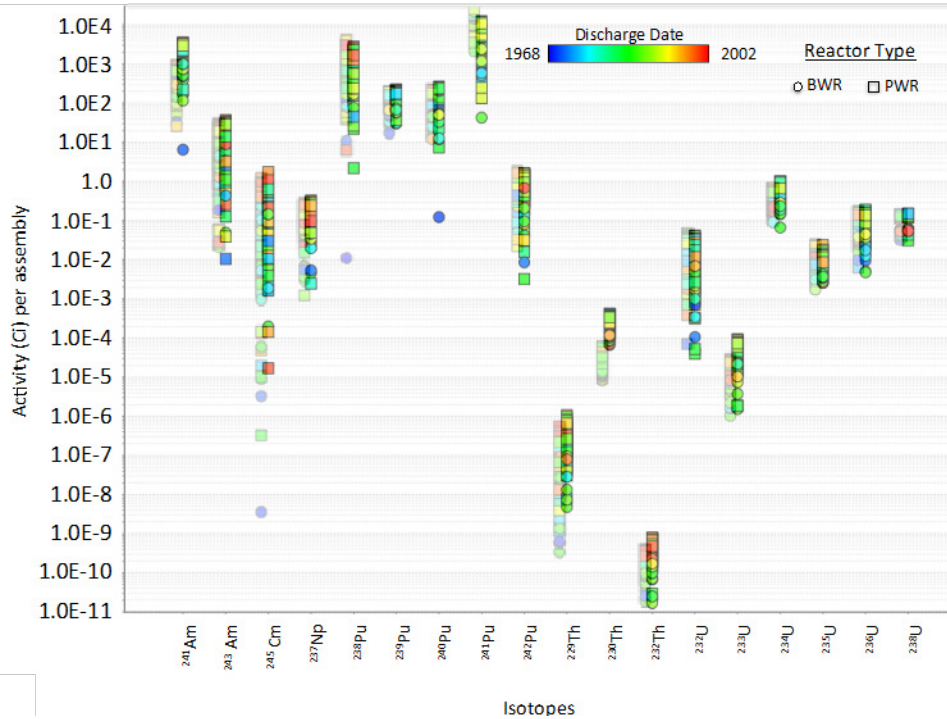

NOTE: The lighter data point corresponds to the activity of the isotopes when the fuel was discharged.

Figure A-9. Activity of selected isotopes (actinides) in commercial SNF (2048) as a function of burnup for fuel discharged through 2002

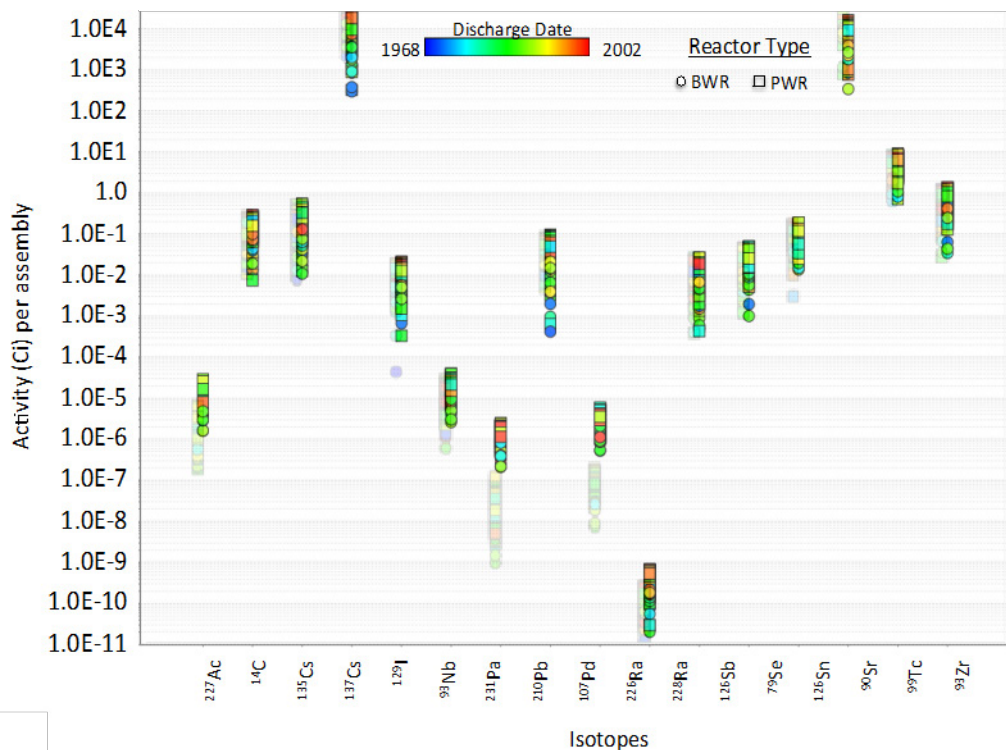

NOTE: The lighter data point corresponds to the mass of the isotopes when the fuel was discharged.

Figure A-10. Activity of selected isotopes (fission products) in commercial SNF (2048) as a function of burnup for fuel discharged through 2002

A-1.1.3 Thermal Output

Plots representing the possible range of decay heat (kW per canister) for BWR and PWR SNF canisters as a function of time after discharge are provided in Figure A-11 and Figure A-12. These results were generated by calculating the decay heat of every SNF assembly discharged through the year 2002 at multiple times after discharge and then scaling those results by the number of assemblies in each canister type (see Table A-1 for canister capacities). Because the results correspond to canisters fully loaded with identical assemblies, the range of values (both high and low) corresponding to each canister type is larger than what would be expected in reality, where SNF assemblies with varying decay heat are loaded together to achieve thermal management objectives. As seen in Figure A-11 and Figure A-12, there is a large difference between decay heat per canister for the four different PBCs and the DPC. However, there does not appear to be a large difference in heat between canisters of the same type loaded with either PWR or BWR SNF.

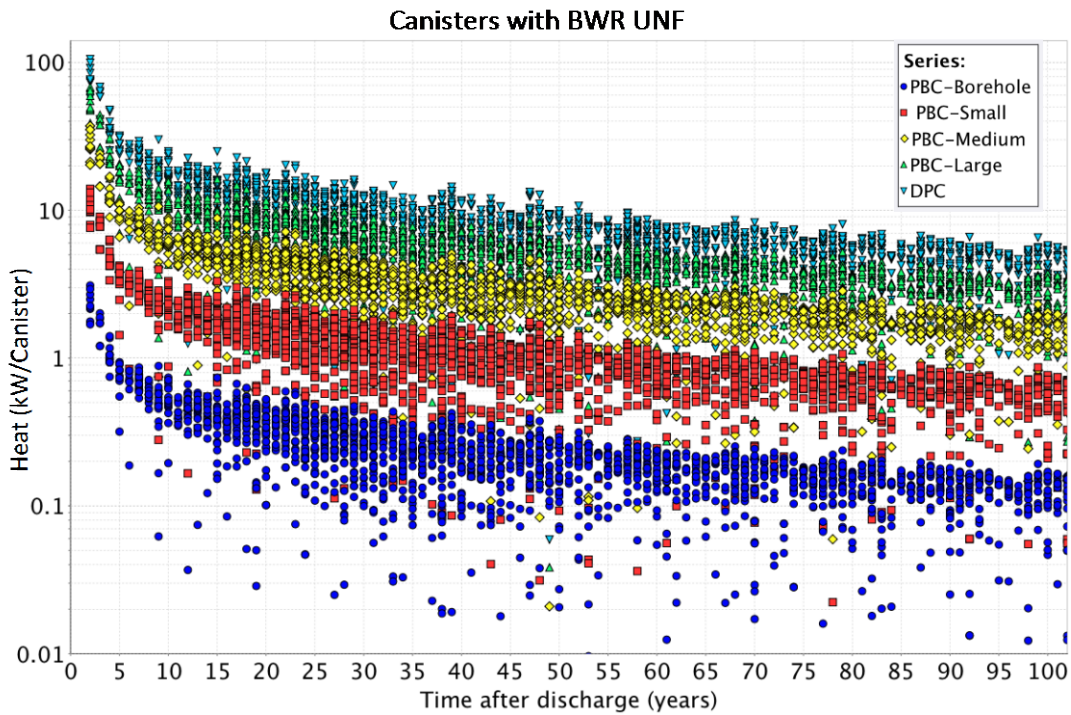

Figure A-11. Decay heat per canister type for BWR SNF as a function of time after discharge

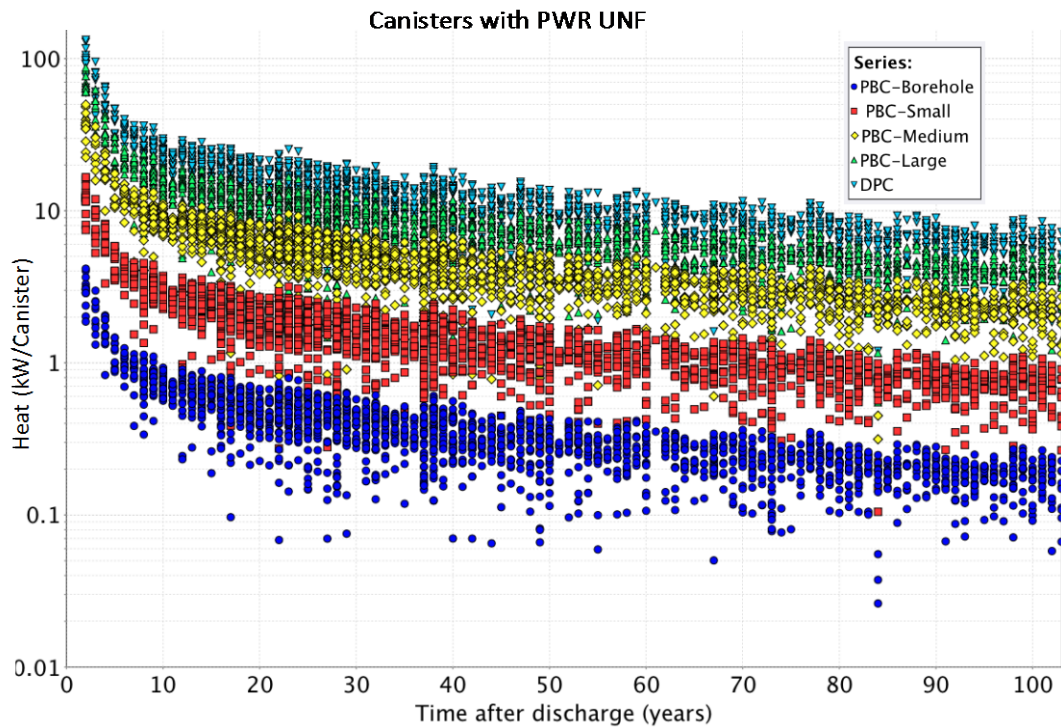

Figure A-12. Decay heat per canister type for PWR SNF as a function of time after discharge

A-1.1.4 Chemical Composition

The chemical composition of commercial SNF (Table A-4) includes uranium oxide, transuranics, fission products, cladding, and additional components, as discussed in Section A-1.1.1. The structural oxide U(IV)O₂, which adopts the face-centered cubic fluorite structure, is extremely insoluble under the reducing conditions found in some of the environments proposed for deep geologic repositories; however, the U(VI) is several orders of magnitude more soluble.

During irradiation, the steep thermal gradient in the fuel and low strength of UO₂ result in cracking of the fuel pellet, which leads to an increase in the surface area of the fuel. The in-core irradiation affects physical properties such as grain structure, grain size, and porosity. In addition, at high fuel burnup (i.e., >45 GWd/MTHM) a porous outer ring is formed on the surface of the fuel, typically referred to as the *rim effect*. These changes in particle size and surface area during irradiation of the BWR and PWR SNF increase the chemical reactivity and dissolution rate of UO₂ (Roth 2005).

A-1.1.5 Storage Configuration

Commercial SNF is currently stored in spent fuel pools at reactors and dry storage canisters and casks at independent spent fuel storage installations. A variety of dry storage systems have been designed, licensed, and used, but the majority of SNF assemblies in dry storage are in welded-metal DPCs within horizontal or vertical concrete storage casks. The main difference between the DPCs for PWR and BWR fuel assemblies is the quantity of fuel assemblies that are stored within each canister. PWR DPCs can typically contain 24 to 37 assemblies, whereas BWR DPCs can typically hold from 56 to 89 assemblies. (The transportation, aging, and disposal (“TAD”) canisters planned for use in a volcanic tuff repository held 21 PWR assemblies or 44 BWR assemblies.) A common DPC is shown in Figure A-13.

Table A-4. A summary of the isotopes in commercial SNF (through 2002) per assembly decayed to 2048

Isotope	Average Mass (g)*	Standard Deviation (g)*	Maximum Mass (g)*	Minimum Mass (g)*
²³⁸ U	2.46E+05 (2.46E+05)	1.15E+05 (1.15E+05)	4.51E+05 (4.51E+05)	5.57E+04 (5.57E+04)
²³⁵ U	2.65E+03 (2.65E+03)	1.48E+03 (1.48E+03)	1.50E+04 (1.50E+04)	4.91E+02 (4.89E+02)
²³⁹ Pu	1.64E+03 (1.64E+03)	8.96E+02 (8.97E+02)	3.69E+03 (3.69E+03)	5.91E+01 (5.92E+01)
²³⁶ U	1.00E+03 (1.00E+03)	6.92E+02 (6.90E+02)	3.03E+03 (3.02E+03)	3.07E+01 (3.07E+01)
²⁴⁰ Pu	4.41E+02 (4.29E+02)	3.43E+02 (3.37E+02)	1.37E+03 (1.25E+03)	3.98E-01 (4.01E-01)
²⁴¹ Am	4.08E+02 (1.23E+02)	2.46E+02 (7.15E+01)	1.08E+03 (3.32E+02)	1.13E-02 (3.97E-03)
⁹⁹ Tc	2.00E+02 (2.00E+02)	1.32E+02 (1.32E+02)	5.74E+02 (5.74E+02)	1.51E+00 (1.51E+00)
²⁴² Pu	1.63E+02 (1.63E+02)	1.00E+02 (1.00E+02)	6.22E+02 (6.22E+02)	4.38E-05 (4.38E-05)
²³⁷ Np	1.62E+02 (1.36E+02)	1.06E+02 (9.30E+01)	5.05E+02 (4.41E+02)	4.23E-01 (4.22E-01)
¹³⁵ Cs	1.38E+02 (1.38E+02)	8.97E+01 (8.97E+01)	4.90E+02 (4.90E+02)	5.47E-01 (5.47E-01)
¹³⁷ Cs	9.08E+01 (2.76E+02)	6.72E+01 (1.86E+02)	3.21E+02 (8.51E+02)	3.53E-01 (1.76E+00)
¹⁰⁷ Pd	6.46E+01 (6.46E+01)	4.17E+01 (4.17E+01)	2.44E+02 (2.44E+02)	8.70E-02 (8.70E-02)
²³⁴ U	6.32E+01 (4.42E+01)	3.80E+01 (2.59E+01)	1.72E+02 (1.48E+02)	1.01E+01 (9.68E+00)
²⁴³ Am	4.64E+01 (4.66E+01)	3.27E+01 (3.28E+01)	2.60E+02 (2.61E+02)	1.31E-07 (1.32E-07)
¹²⁹ I	4.24E+01 (4.24E+01)	2.79E+01 (2.79E+01)	1.36E+02 (1.36E+02)	2.15E-01 (2.15E-01)
²³⁸ Pu	4.22E+01 (6.15E+01)	3.39E+01 (4.79E+01)	2.02E+02 (2.81E+02)	3.13E-04 (5.43E-04)
⁹⁰ Sr	3.55E+01 (1.13E+02)	2.69E+01 (7.81E+01)	1.22E+02 (3.31E+02)	1.89E-01 (1.02E+00)
²⁴¹ Pu	3.34E+01 (3.44E+02)	2.59E+01 (2.13E+02)	1.25E+02 (9.39E+02)	2.96E-04 (8.74E-03)
¹²⁶ Sn	5.65E+00 (5.65E+00)	3.73E+00 (3.73E+00)	1.91E+01 (1.91E+01)	2.27E-02 (2.27E-02)
²⁴⁵ Cm	1.46E+00 (1.47E+00)	1.37E+00 (1.38E+00)	1.77E+01 (1.78E+01)	4.37E-13 (4.39E-13)
⁷⁹ Se	1.19E+00 (1.19E+00)	7.95E-01 (7.95E-01)	3.48E+00 (3.48E+00)	8.88E-03 (8.88E-03)
¹⁴ C	2.46E-02 (2.47E-02)	1.42E-02 (1.43E-02)	7.91E-02 (7.97E-02)	2.19E-04 (2.21E-04)
²³⁰ Th	8.55E-03 (1.11E-03)	4.84E-03 (6.42E-04)	2.33E-02 (3.62E-03)	1.64E-03 (1.99E-04)
²³³ U	3.36E-03 (1.09E-03)	2.16E-03 (7.50E-04)	1.06E-02 (3.50E-03)	2.29E-05 (1.35E-05)
⁹³ Nb	3.32E-03 (1.32E-04)	2.03E-03 (8.59E-05)	1.09E-02 (6.81E-04)	4.29E-05 (1.03E-06)
²³² Th	2.71E-03 (1.28E-03)	1.75E-03 (8.35E-04)	7.46E-03 (3.70E-03)	8.26E-05 (2.02E-05)
²³² U	4.27E-04 (5.46E-04)	3.81E-04 (4.63E-04)	2.22E-03 (2.62E-03)	5.07E-09 (9.20E-09)
²³¹ Pa	2.85E-04 (1.57E-04)	1.67E-04 (1.15E-04)	9.93E-04 (7.08E-04)	4.31E-05 (8.40E-06)
²²⁶ Ra	2.13E-06 (4.97E-08)	1.21E-06 (3.12E-08)	7.37E-06 (2.46E-07)	4.26E-07 (6.48E-09)
²²⁹ Th	9.11E-07 (4.54E-07)	7.04E-07 (4.72E-07)	5.22E-06 (4.19E-06)	5.85E-09 (4.33E-10)
²²⁷ Ac	1.26E-07 (1.81E-08)	7.55E-08 (1.33E-08)	4.54E-07 (9.14E-08)	1.82E-08 (6.94E-10)
¹²⁶ Sb	1.16E-07 (1.16E-07)	7.67E-08 (7.67E-08)	3.94E-07 (3.94E-07)	4.67E-10 (4.67E-10)
²¹⁰ Pb	1.11E-08 (2.64E-10)	6.59E-09 (2.43E-10)	4.51E-08 (1.66E-09)	2.23E-09 (6.75E-12)
²²⁸ Ra	9.90E-13 (3.16E-13)	6.37E-13 (2.07E-13)	2.72E-12 (9.66E-13)	3.02E-14 (4.21E-15)

* The number in the parentheses is the average mass at the time of discharge.

Dual Purpose Storage Cask*

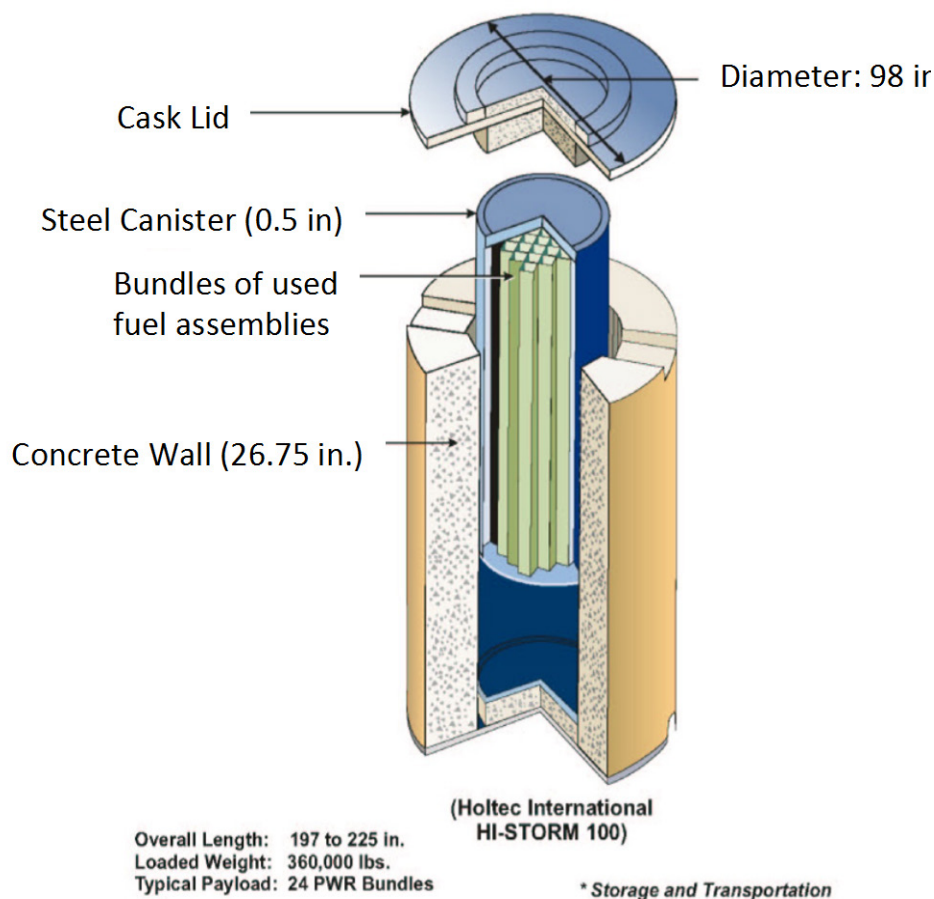

Source: modified from Easton 2011.

Figure A-13. A typical dry cask storage cask for commercial SNF

A-1.1.6 Safeguards and Security Classification

An important concept in the safeguarding of commercial SNF is self-protection. Within the U.S. Nuclear Regulatory Commission (NRC) regulations in 10 CFR Part 73, self-protection is attributed to SNF “which is not readily separable from other radioactive material and which has a total external radiation dose rate in excess of 100 rem per hour at a distance of 3 ft from any accessible surface without intervening shielding.” This self-protection limit has also been used by the IAEA for determining if the plutonium in the SNF should be classified as Category I (2 kg or more), Category II (2 kg but less than 500 g), or Category III (500 g or less but more than 15 g) (IAEA 1999).

Previous studies have shown that the dose rate for typical discharged commercial SNF will fall below the current self-protection limit (100 rem/h at 3 ft) between 70 and 120 years after discharge (Durán 2011). The BWR assembly will be closer to the 70-year time period, while the PWR assemblies will be closer to the 120-year time period. For the 2048 repository start-up target, many BWR fuel assemblies and some PWR assemblies discharged before 1978 (70 years old at 2048) may no longer be self-protecting.

Once the commercial SNF is no longer self-protecting, additional safeguard and security measures may be needed for storage and transportation purposes. This will be especially true with SNF assemblies that

contain more than 2 kg of plutonium (classified as safeguards and security Category I—see Appendix D, Table D-1) and require the additional security and national safeguards (for commercial SNF see Table A-4).

A-1.2 DOE Managed Spent Nuclear Fuel

SNF under the purview of the DOE includes a broad range of fuels resulting from decades of nuclear research, development and testing, defense power, electric power production, experimental power production, and production of weapons and research materials. In addition to fuels from reactors operated by the DOE and U.S. Department of Defense, DOE fuels also include a number of university research reactors as well as foreign research reactor fuel returned to the U.S. as part of the Foreign Research Reactor Spent Nuclear Fuel Acceptance Program. DOE SNF also includes some commercial SNF not in the possession of NRC-licensed commercial utilities (Carter et al. 2012). DOE SNF has been regulated by agencies such as the Department of Defense, DOE, foreign research reactor entities, and the NRC. Some of the DOE fuels are packaged into multicannister overpacks (MCOs), however, other fuels remain in storage and will require packaging prior to movement to a repository.

DOE SNF is further described below followed by a description of 34 categories, or fuel groupings, that have proven convenient conducting safety analyses.

A-1.2.1 DOE SNF General Description

DOE SNF includes a variety of geometries, fuel matrices, cladding types, fissile materials, enrichments and burnups. Both domestic and foreign suppliers supported the development of experimental fuels now managed by DOE (DOE 2007, Section 3.2). Some of these suppliers are no longer producing reactor fuels or have gone out of business.

DOE SNF and the associated reactors have used a variety of moderators such as beryllium, graphite, heavy water, light water, metal hydride, and organics. Additionally, DOE SNF has been used in many different reactors which used a variety of coolants such as air, helium, heavy water, light water, sodium-potassium alloy, nitrogen, organic, sodium, and even no coolant (DOE 2007, Section 3.1).

Fissile materials in DOE SNF include ^{233}U , ^{235}U , the various isotopes of plutonium, and other transuranics. The ^{235}U enrichment ranges from depleted uranium to over 93%. The effective end-of-life (EOL) enrichment values pertaining to DOE SNF are adjusted to account for the ingrowth of ^{233}U , plutonium, and other fissile radionuclides. DOE fuels can be grouped according to effective EOL enrichment as follows: “High”—those with enrichments greater than 20%; “Medium”—those greater than 5% but less than 20%; and “Low”—those with less than 5% (DOE 2007, Section 3.2).

The DOE SNF fuel compounds include: U Metal, U-Zr, U-Metal 2% Zr, U-Mo, UO_2 , $\text{UO}_2\text{-BeO}_2$, U_3O_8 , U-AL_x , U_3Si_2 , $\text{ThC}_2\text{-UC}_2$, ThC-UC , ThCO-UCO , Pu/U Carbide, $\text{PuO}_2\text{-UO}_2$, PuO_2 , $\text{ThO}_2\text{-UO}_2$ U-ZrH_x-Er, U-ZrH_x, U-10Zr, U-Pu-Zr, Pu/U Alloy, U-Th Metal, U Carbide, Pu/U Nitride, and Am Oxide. These can be grouped into compound classes, such as: Am oxide, Pu oxide, Pu/U alloy, Pu/U carbide, Pu/U nitride, Pu/U oxide, Th/U carbide, Th/U metal, Th/U oxide, U alloy, U carbide, U metal, U oxide, U silicide, and U-Zr hydride. These compounds may be embedded in matrices of various materials, such as: Aluminum, Alum (1100), B_4C , BEO, Gd_2O_3 , graphite, Nichrome, stainless steel stainless steel (i.e., 316L, stainless steel 302B, stainless steel 304, stainless steel 304B, stainless steel 347 powder, ZrO_2 , and $\text{ZrO}_2\text{-CaO}$ (DOE 2007, Section 3.2).

The size of DOE SNF is highly variable with minimum fuel unit at 0.15 in. x 0.06 in. x 0.29 ft (i.e., width x height x length) to a maximum fuel unit of 22.27 in. x 22.27 in. x 14.68 ft. The cross sections include geometries such as annular, circular, cylindrical, hexagonal, rectangular, rhombus, spherical, trapezoidal, and triangular (DOE 2007, Section 3.2).

Individual fuel handling units of DOE SNF may consist of: assembly, element, plate, scrap in canister, rods, basket, bundle, canister of rods, cask, experimental capsule, or canister (DOE 2007, Section 3.2). Canisters may contain scrap fuel materials resulting from testing and/or destructive examinations.

The cladding materials used for DOE SNF include zirconium, aluminum, unknown, stainless steel, none, Nichrome, Incoloy, Hastelloy, monopyrolytic carbon in graphite, tristructural isotropic (TRISO)-coated in graphite, and buffered isotropic (BISO)-coated in graphite. Cladding integrity varies from intact to significantly degraded. DOE classified the cladding conditions as “Good,” meaning no known or suspected through-cladding defects; “Fair,” meaning known or suspected defects are limited to pinhole leaks or hairline cracks; “Poor,” meaning known or suspected defects are greater than pinhole leaks or hairline cracks; and “None,” meaning declad or unclad SNF (DOE 2007, Section 3.2).

The burnup of DOE SNF ranges from very slightly irradiated to over 500 GWd per metric ton of uranium (MTU). For some DOE SNF, burnup is categorized in terms of ^{235}U burnup percentage and heavy metal burnup percent consumed rather than GWd/MTU. The burnup for these fuels range from very slightly irradiated to over 80% of the initial ^{235}U to over 70% of the initial heavy metal.

Thermal power for DOE fuel was estimated for 2010 and 2030. Figure A-14 shows a summary of the estimated decay heat for DOE SNF per transportation, aging, and disposal (“TAD”) canister for 2030. Most (~98%) of the DOE SNF falls below an estimated 500 W per canister; significantly less than the anticipated 25-kW limits for commercial fuels packaged in transportation, aging, and disposal canisters (BSC 2007). There are a few fuels that are above 500 W per canister. However, the source term for these fuels was calculated based on very conservative assumptions because very little was known about these fuels. When these fuels are actually packaged, it is likely that the actual measured decay heat will be much less than these conservative estimates (DOE 2007, Section 3.2).

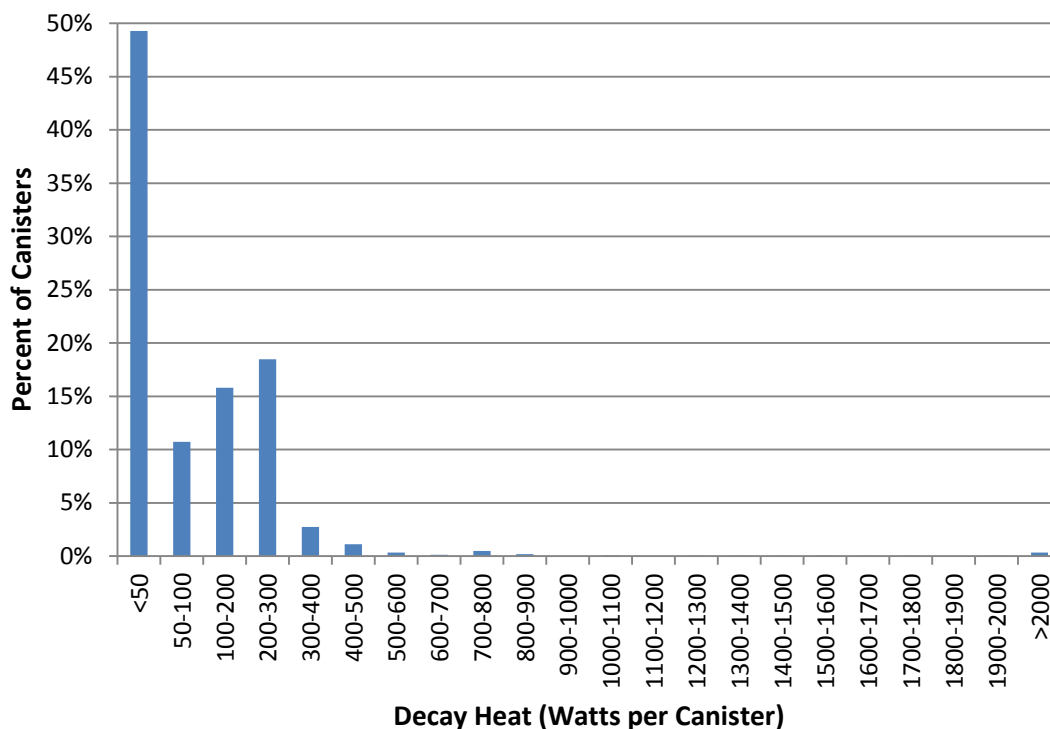

Figure A-14. Decay heat estimates per canister for 2030

DOE SNF Groups—Given the diversity of DOE SNF, fuels were grouped to support repository evaluations in previous work. The 34 DOE group descriptions below are not intended to address each fuel in the DOE group but rather to describe the key parameters representing the fuels in the DOE group and to specify a representative fuel:

- **DOE Group 01: U Metal, Zirc Clad, Low-Enriched Uranium**—This group contains a low-enriched uranium (LEU)-metal compound SNF with zirconium cladding (accounting for approximately 83% of the DOE SNF inventory by mass). Greater than 99% of the MTHM of SNF in this group is N Reactor SNF. The N Reactor was used for both material and power production. N Reactor fuel consists of two concentric tubes about 2.4 in. in diameter and about 2 ft long. N Reactor SNF has a nominal enrichment of about 1% and an average burnup of about 2.4 GWd/MTU. The cladding condition of the N Reactor SNF is fair to poor.
- **DOE Group 02: U Metal, Nonzirc Clad, Low-Enriched Uranium**—This group contains a LEU-metal compound SNF with nonzirc cladding. The largest single source of SNF in this group (approximately 37% of the MTHM) is from the Single-Pass Reactor, which was used for material production. The Single-Pass Reactor SNF consists of circular tubes roughly 1.5 in. in diameter and 0.75 ft long. The Single-Pass Reactor SNF has an EOL effective enrichment of about 0.4% and an average burnup of about 1 GWd/MTU. The cladding condition of the Single-Pass Reactor SNF is generally poor.
- **DOE Group 03: U-Zirc**—This group contains uranium-zirc compound SNF. Approximately 90% of the MTHM of fuel in this group is from the Experimental Boiling Water Reactor. The Experimental Boiling Water Reactor was a DOE light-water-cooled and moderated experimental power reactor. Experimental Boiling Water Reactor SNF consists of plate-type assemblies, roughly 3.75 in. square and 4.8 ft long. Experimental Boiling Water Reactor SNF has an EOL effective enrichment ranging from 0.7% to 1.3% and an average burnup ranging from 0.1 to 3.2 GWd/MTU. The cladding condition of the Experimental Boiling Water Reactor SNF is fair.
- **DOE Group 04: U-Mo**—This group contains a uranium-molybdenum alloy compound SNF. More than 99% of the MTHM of the SNF in this group is from the Enrico Fermi Atomic Power Plant, and the majority (over 90% of the MTHM) of the SNF in this group consists of Fermi standard fuel subassemblies. Fermi was a sodium-cooled fast neutron spectrum power reactor. Fermi driver fuel consists of rods roughly 0.16 in. in diameter and 2.7 ft long. The Fermi standard fuel subassembly SNF has an enrichment of about 26% and a maximum burnup of about 1.6 GWd/MTU. The condition of the cladding for the SNF in this group ranges from good to none.
- **DOE Group 05: U Oxide, Zirc Clad, Intact, High-Enriched Uranium**—This group contains a highly enriched uranium (HEU) oxide SNF with intact zirc cladding. About 90% of the MTHM of the SNF in this group consists of Shippingport PWR Core 2 blanket SNF, which is a uranium oxide compound dispersed in a zirconium-oxide (Seed 1) or zirconium-oxide calcium-oxide (Seed 2) matrix. Shippingport PWR was a light-water-moderated and cooled power reactor. Shippingport PWR fuel assemblies consist of 19 flat plates; the assemblies are 7.4 in. square and about 8.7 ft long. The Shippingport PWR Core 2 SNF has an EOL effective enrichment of about 69% to 81% and a depletion of roughly 38% to 53% of the initial fissile mass (^{235}U). The condition of the Shippingport PWR Core 2 blanket fuel cladding is good.
- **DOE Group 06: U Oxide, Zirc Clad, Intact, Medium-Enriched Uranium**—This group contains medium-enriched uranium (MEU) oxide SNF with intact zirc cladding. About 83% of the MTHM in this group consists of Experimental Boiling Water Reactor SNF. The Experimental Boiling Water Reactor was a DOE light-water-cooled and moderated experimental power reactor. Experimental Boiling Water Reactor SNF consists of plate-type assemblies,

roughly 3.75 in. square and 5.2 ft long. Experimental Boiling Water Reactor SNF has an enrichment of 6% and a maximum burnup of 3.0 GWd/MTU. The cladding condition of the Experimental Boiling Water Reactor SNF is fair.

- **DOE Group 07: U Oxide, Zirc Clad, Intact, Low-Enriched Uranium**—This group contains LEU oxide with intact zirc cladding. The majority (about 65% of the MTHM) of the SNF in this group was generated by typical commercial power reactors, such as the Calvert Cliffs, Surry, and Turkey Point reactors. The commercial power reactor SNF configuration includes intact rod arrays. The commercial power reactor SNF in this group has EOL effective enrichments ranging from 0.8% to 1.6%. The average burnup of the commercial power reactor SNF in this group ranges from about 10 GWd/MTU for some Peach Bottom SNF to about 38 GWd/MTU for the Calvert Cliffs SNF. The cladding condition of the commercial power reactor SNF in this group is good.
- **DOE Group 08: U Oxide, Stainless Steel/Hastelloy Clad, Intact, High-Enriched Uranium**—This group contains HEU oxide with intact stainless steel or Hastelloy cladding. About 40% of the MTHM of the SNF in this group was generated by superheaters for the Pathfinder Atomic Power Plant (a power reactor) and the Boiling Reactor Experiment V (a test, research, and education reactor). The Pathfinder SNF consists of rods 0.9 in. in diameter and 6.5 ft long. The Boiling Reactor Experiment V SNF consists of flat plate assemblies 3.7 in. wide and 2.1 ft long. The SNF in this group has an enrichment of roughly 93%. The Pathfinder and Boiling Reactor Experiment V SNF in this group have a depletion of less than 6% of the initial fissile mass (^{235}U), and the cladding condition is good to fair.
- **DOE Group 09: U Oxide, Stainless Steel Clad, Intact, Medium-Enriched Uranium**—This group contains MEU oxide SNF with intact stainless steel cladding. About 80% of the MTHM of the SNF in this group was driver fuel for the Power Burst Facility, which was a test reactor designed to investigate fuel performance during accident conditions. Power Burst Facility SNF consists of rods measuring 0.75 in. in diameter and 4 ft long. Power Burst Facility SNF has an enrichment of about 18% and an average burnup of about 1.8 GWd/MTU. The Power Burst Facility cladding condition is good.
- **DOE Group 10: U Oxide, Stainless Steel Clad, Intact, Low-Enriched Uranium**—This group contains LEU oxide SNF with intact stainless steel cladding. This group contains a small amount of material, approximately 43% of which by MTHM was generated by Connecticut Yankee reactors. The Connecticut Yankee SNF is typical commercial power reactor SNF, except that it has stainless steel cladding. The Connecticut Yankee SNF has an EOL effective enrichment of 2.1%. The Connecticut Yankee SNF has a burnup of about 32 GWd/MTU. The cladding condition of the Connecticut Yankee SNF is good.
- **DOE Group 11: U Oxide, Nonalum Clad, Nonintact or Declad, High-Enriched Uranium**—This group contains HEU oxide SNF with nonaluminum cladding that is not intact or that has been removed. About 60% of the MTHM of the SNF in this group is generated from medical isotope production targets from foreign research reactors in Canada. The Canadian foreign research reactor targets have an enrichment of about 50%. As there is no cladding on the Canadian foreign research reactor targets, the fuel cladding is categorized as none.
- **DOE Group 12: U Oxide, Nonalum Clad, Nonintact or Declad, Medium-Enriched Uranium**—This group contains MEU oxide SNF with failed nonaluminum cladding or no cladding. Virtually all of this SNF was generated as a result of severe-condition fuel experiments. These experiments generally involved segments of previously irradiated fuel rods that were sectioned and placed into experiment capsules for further irradiation under extremely high temperatures. The SNF in this group has EOL effective enrichments ranging from about 5%

to nearly 20%. The cladding condition of the SNF in this group is either poor or none (the cladding has been removed).

- **DOE Group 13: U Oxide, Nonalum Clad, Nonintact or Declad, Low-Enriched Uranium**—This group contains LEU oxide SNF with failed nonaluminum cladding or no cladding. About 75% of the MTHM of the SNF in this group is core debris from the Three Mile Island Unit 2 reactor accident. The Three Mile Island Unit 2 fuel has an enrichment of about 2.5% and an average burnup of about 3.2 GWd/MTU. The cladding condition of the Three Mile Island Unit 2 SNF is poor.
- **DOE Group 14: U Oxide, Alum Clad, High-Enriched Uranium**—This group contains HEU oxide SNF with aluminum cladding. About 85% of the MTHM of the SNF in this group is High-Flux Isotope Reactor SNF. The High-Flux Isotope Reactor is a DOE test reactor. High-Flux Isotope Reactor SNF consists of two concentric assemblies consisting of curved involute plates that are separated for disposal. The outer assemblies are about 17 in. in diameter and 2.6 ft long, and the inner assemblies are about 12 in. in diameter and 2.5 ft long. High-Flux Isotope Reactor SNF has an EOL effective enrichment of ranging from about 85% to 87%. High-Flux Isotope Reactor SNF has an average burnup ranging from about 200 to 250 GWd/MTU. The cladding condition of High-Flux Isotope Reactor SNF is good.
- **DOE Group 15: U Oxide, Alum Clad, Medium-Enriched Uranium, Low-Enriched Uranium**—This group contains MEU oxide SNF with aluminum cladding. Nearly all of the SNF in this group was generated from a number of foreign research reactors. The largest single source (about 65% of the MTHM) is the G.A. Siwabessy RSG-GAS-30 reactor in Indonesia. This Indonesian foreign research reactor SNF consists of square assembly plate-type fuel with a typical width of about 3 in. and a length of about 3.0 ft. This Indonesian research reactor SNF has an EOL effective enrichment of about 11% and a depletion of about 50% of the initial fissile mass (^{235}U). The cladding condition of most of the Indonesian research reactor SNF in this group is good.
- **DOE Group 16: U-Alx, Al-Clad High-Enriched Uranium**—This group contains HEU aluminide SNF. The SNF in this group is generated from domestic and foreign test, research, and education reactors. The Advanced Test Reactor is the largest single source of SNF in this group, accounting for about 65% of the MTHM. The Advanced Test Reactor SNF consists of curved plate assemblies about 4.2 in. wide, 2.7 in. high, and 5.5 ft long, before being cropped to about 4 ft for storage. The Advanced Test Reactor SNF has a typical EOL effective enrichment of about 85% with an average burnup of about 210 GWd/MTU. The cladding condition of Advanced Test Reactor SNF is good.
- **DOE Group 17: U-Alx, Al-Clad Medium-Enriched Uranium**—This group contains MEU aluminide SNF. The SNF in this group is generated from numerous domestic and foreign test, research, and education reactors. The largest single source of SNF in this group (about 35% of the MTHM) is the R-2 reactor in Sweden. The R-2 SNF is a square assembly of plate-type fuel about 3 in. wide and about 2.9 ft long. The R-2 SNF has an EOL effective enrichment of about 9% and a depletion of about 60% of the initial fissile mass (^{235}U). The cladding condition of the SNF in this group is generally good.
- **DOE Group 18: U_3Si_2** —This group contains uranium-silicide SNF. The SNF in this group is generated from numerous domestic and foreign test, research, and education reactors. About 45% of the MTHM in this group consists of foreign research reactor multi-pin clusters generated by the National Research Universal reactor in Canada. The National Research Universal reactor is heavy water moderated and cooled. National Research Universal SNF has a typical EOL

effective enrichment of about 6% and a depletion of about 76% of the initial fissile mass (^{235}U). The cladding condition of National Research Universal SNF is good.

- **DOE Group 19: Th/U Carbide, TRISO- or BISO-Coated Particles in Graphite**—This group contains thorium-carbide and uranium-carbide SNF with TRISO- or BISO-coated particles embedded in a graphite matrix. About 95% of the MTHM of the SNF in this group was generated from the Fort St. Vrain reactor. The Fort St. Vrain SNF consists of hexagonal graphite blocks about 14 in. wide by 2.6 ft long, containing TRISO-coated (i.e., inner pyrocarbon, silicon carbide, and outer pyrocarbon coatings) particles. The Fort St. Vrain SNF has an EOL effective enrichment of about 80% and a depletion of about 50% of the initial fissile mass (^{235}U). The particle coating condition of the Fort St. Vrain SNF is good.
- **DOE Group 20: Th/U Carbide, Monopyrolytic Carbon-Coated Particles in Graphite**—This group contains thorium-carbide and uranium-carbide SNF with monopyrolytic carbon-coated particles in a graphite matrix. The coated particles are embedded in a graphite matrix. All of the SNF in this group is Peach Bottom Unit 1 reactor core 1 fuel. The Peach Bottom Unit 1 reactor was a helium-cooled, graphite-moderated, electric power reactor. The Peach Bottom Unit 1 SNF is about 3.5 in. wide and 12 ft long. The Peach Bottom Unit 1 core 1 SNF has a typical EOL effective enrichment of about 86% and a depletion of about 30% of the initial fissile mass (^{235}U). The particle coating condition of the Peach Bottom Unit 1 core 1 SNF is poor.
- **DOE Group 21: Pu/U Carbide, Nongraphite Clad, Not Sodium Bonded**—This group contains a small quantity of plutonium/uranium-carbide SNF with nongraphite cladding and no sodium bonding. This SNF was generated primarily by the Fast Flux Test Facility (FFTF) and has stainless steel cladding. The FFTF reactor was a sodium-cooled DOE test and research reactor. About 56% of the MTHM in this group is the FFTF test fuel assembly TFA-FC-1. The FFTF TFA-FC-1 assembly cross section is a hexagon about 4.6 in. across the flats, 5.2 in. across the points, and the SNF is 12 ft long. The FFTF TFA-FC-1 SNF is about 21% EOL effective enriched and has an average burnup of about 60 GWd/MTU. The FFTF TFA-FC-1 cladding condition is good.
- **DOE Group 22: Mixed Oxide, Zirc Clad**—This group contains a small quantity of mixed oxide, uranium-oxide, and plutonium-oxide SNF with zirconium cladding. About 44% of the MTHM in this group is Experimental Boiling Water Reactor SNF, which experimented with the recycling of plutonium. The Experimental Boiling Water Reactor SNF has an EOL effective enrichment of 1.6% and an average burnup of about 2.6 GWd/MTU. The Experimental Boiling Water Reactor SNF cladding condition is fair.
- **DOE Group 23: Mixed Oxide, Stainless Steel Clad**—This group contains mixed oxide, uranium-oxide, and plutonium-oxide SNF with stainless steel cladding. About 80% of the MTHM of this group is FFTF reactor driver fuel assemblies and test driver fuel assemblies. The FFTF driver and test driver fuel assembly cross section is a hexagon about 4.6 in. across the flats and 5.2 in. across the points, and the SNF is 12 ft long. The FFTF driver fuel assembly and test driver fuel assembly SNF have EOL effective enrichments of about 24% and an average burnup of about 70 GWd/MTU. The cladding condition of the SNF in this group is poor to good.
- **DOE Group 24: Mixed Oxide, Non-Stainless Steel/Nonzirc Clad**—This group contains a small quantity of mixed oxide (uranium-oxide and plutonium-oxide, mixed oxide) SNF that does not have stainless steel or zirconium cladding. The SNF in this group is mostly the residue from hot cells and small experiments and does not have intact cladding. The majority of the SNF in this group (97% of the MTHM) is mixed-oxide scrap with an EOL effective enrichment of about 15%. The cladding condition of the SNF in this group is either poor or none.

- **DOE Group 25: Th/U Oxide, Zirc Clad**—This group contains thorium-oxide and uranium-oxide SNF with zirconium cladding. The SNF in this group was generated by the Shippingport Atomic Power Station with the Light Water Breeder Reactor core. The Shippingport Light Water Breeder Reactor was a power reactor that converted fertile ^{232}Th to fissile ^{233}U . About 27% of the MTHM in this group is Shippingport Light Water Breeder Reactor reflector IV SNF. Shippingport Light Water Breeder Reactor reflector IV assemblies are rods in a rectangular array about 17.1 in. by 13.8 in. and 11.8 ft long. The Shippingport Light Water Breeder Reactor reflector IV SNF has an EOL effective enrichment of about 98% and an average burnup of about 2 GWd/MTU. The cladding condition of the Shippingport Light Water Breeder Reactor reflector IV SNF is generally good.
- **DOE Group 26: Th/U Oxide, Stainless Steel Clad**—This group contains thorium-oxide and uranium-oxide SNF with stainless steel cladding. About 66% of the MTHM of the SNF in this group was generated from the Elk River Reactor, a light water power reactor. Elk River Reactor assemblies are rods in square arrays that are about 0.45 in. wide and high and 5.3 ft long. Elk River Reactor SNF has an EOL effective enrichment of 96%. Elk River Reactor SNF has an average burnup of about 6.0 GWd/MTU. The cladding condition of the Elk River Reactor SNF is generally fair.
- **DOE Group 27: U-Zirc Hydride, Stainless Steel/Incoloy Clad, High-Enriched Uranium**—This group contains high-enriched, uranium-zirc hydride SNF with stainless steel or Incoloy cladding. Most of the SNF in this group was generated from numerous domestic and foreign training, research, and isotope reactors built by General Atomics (TRIGA), with no dominant single generator. The TRIGA SNF in this group is generally of the fuel life improvement program design. TRIGA fuel life improvement program rods are typically 1.5 in. in diameter and 2.4 ft long. The EOL effective enrichment of the TRIGA fuel life improvement program SNF in this group has a range from about 40% to 70%, and the burnup ranges from about 9.4 GWd/MTU to 260 GWd/MTU. The cladding condition of the TRIGA fuel life improvement program SNF is generally good.
- **DOE Group 28: U-Zirc Hydride, Stainless Steel/Incoloy Clad, Medium-Enriched Uranium**—This group contains MEU-zirconium hydride SNF with stainless steel or Incoloy cladding. The SNF in this group was generated from numerous domestic and foreign TRIGA research reactors, with no dominant single generator. TRIGA rods in this group are typically 1.5 in. in diameter and 2.4 to 3.8 ft long. The TRIGA SNF in this group has EOL effective enrichments ranging from about 12% to 20% with average burnups ranging from slight irradiation to about 66 GWd/MTU. The cladding condition of the SNF in this group is generally good.
- **DOE Group 29: U-Zirc Hydride, Alum Clad, Medium-Enriched Uranium**—This group contains MEU-zirconium hydride SNF with aluminum cladding. The SNF in this group was generated from numerous domestic and foreign TRIGA research reactors, with no dominant single generator. The TRIGA rods in this group are typically 1.5 in. in diameter and 2.4 ft long. The TRIGA SNF in this group has EOL effective enrichments ranging from about 17% to 20%. The SNF in this group has average burnups ranging from slightly irradiated to about 37 GWd/MTU. The cladding condition of the SNF in this group is generally good.
- **DOE Group 30: U-Zirc Hydride, Declad**—This group contains uranium-zirconium hydride SNF that has been declad. The SNF in this group was generated from the System for Nuclear Auxiliary Power program, which was an experimental power program that involved five different reactors. The System for Nuclear Auxiliary Power rods are about 1.2 in. in diameter and 1.2 ft

long. The System for Nuclear Auxiliary Power SNF has an EOL effective enrichment of about 90%. The cladding has been removed, so the cladding condition is none.

- **DOE Group 31: Metallic Sodium Bonded**—This group contains a wide variety of SNF that has the common attribute of containing metallic, sodium bonding between the fuel matrix and the cladding.
- **DOE Group 32: Naval Fuel**—See Section A-1.3 below. Naval nuclear fuel is highly enriched (approximately 93 wt % to 97 wt %) in ^{235}U . Naval fuel consists of solid metal and metallic components that are nonflammable, highly corrosion-resistant, and neither pyrophoric, explosive, combustible, chemically reactive, nor subject to gas generation by chemical reaction or off-gassing. Naval SNF is from PWRs, with the exception of one design operated in sodium-cooled reactors. A small amount of the naval SNF from the sodium-cooled reactors remains (approximately 0.0023 MTHM SNF). Residual sodium has been cleaned from this naval SNF.
- **DOE Group 33: Canyon Stabilization**—This SNF is being treated in the Savannah River Site (SRS) canyons and will be disposed of as HLW.
- **DOE Group 34: Miscellaneous**—This group contains SNF that does not fit into other groups. The SNF in this group was generated from numerous reactors of different types. The dominant source is the Keuring van Electrotechnische Materialen SNF from the Aqueous Homogeneous Suspension Reactor, an experimental power reactor. Keuring van Electrotechnische Materialen SNF consists of canisters of thorium-oxide and uranium-oxide scrap. Keuring van Electrotechnische Materialen SNF has an enrichment of about 90%. Keuring van Electrotechnische Materialen SNF does not have cladding, so the condition is none.

These 34 DOE groups described above were further categorized to support analyses such as preclosure safety, criticality, and total system performance assessment for the Yucca Mountain license application. For preclosure safety, two parameters (fuel matrix and fuel condition) were determined to be significant. Fuel matrices were further collapsed into three groups and cladding condition was collapsed into two groups—resulting in six groups (3x2) for preclosure safety analysis. Ultimately, these analyses did not become part of the Yucca Mountain licensing basis because event sequences resulting in breach of a DOE standardized canister was a beyond Category 2 event sequence (i.e., not credible), so consequence analyses were not required (DOE 2008, Section 1.5.1.3.1.1.2).

Compared to commercial SNF, DOE SNF is much more heterogeneous. The spent fuels exist in a variety of compounds, sizes, and configurations (e.g., rod, canister of scrap, plates), with various cladding materials, cladding conditions, and fuel matrices. Tables A-5 and A-6 provide summaries of useful information about the 34 DOE groups (DOE 2007).

Table A-5. Ranges of nominal properties for DOE-managed spent nuclear fuel

DOE Spent Fuel Group	MTHM ^a	EOL Effective Enrichment (%)	Cladding Composition	Cladding Condition	Fuel Compound Names	Fuel Matrix	Configuration	Length (ft)	Width/ Height/ Diameter (in.)
01. U metal, zirc clad, LEU	2,096	1.6–0.5	Zirconium	Fair Poor	U metal	None	Tubes	2.2–9.9	1.1–2.5
02. U metal, nonzirc clad, LEU	10	3.3–0.2	Stainless steel Aluminum Unknown	Poor Good Fair N/A	U metal	None Unknown	Canister of scrap Tube Unknown	0.8–13.9	1.5–25.6
03. U-zirc	7	92.9–0.5	Zirconium	Fair Good N/A	U metal 2% Zr U-Zr	None	Tube Cylinders Plates Assembly	2.0–12.5	2.1–7.4
04. U-Mo	4	25.7–2.5	Zirconium Aluminum None	Good Poor Fair N/A	U-Mo	None	Rod Tube Plates in can	1.1–3.8	0.2–3.0
05. U oxide, zirc clad, intact, HEU	<1	92.2–23.2	Zirconium	Fair Good	UO ₂	ZrO ₂ -CaO Graphite ZrO ₂ None	Rod Rod array Assembly Plates	3.2–9.0	0.4–7.4
06. U oxide, zirc clad, intact, MEU	2	6.9–5.1	Zirconium	Fair Good	UO ₂	None	Rod Element Rod array	2.1–5.2	0.4–3.8
07. U oxide, zirc clad, intact, LEU	64	4.9–0.6	Zirconium	Good Fair	UO ₂	None	Tube Rod Rod array Plates Assembly Unknown	0.9–14.7	0.5–8.6
08. U oxide, stainless steel/hastelloy clad, intact, HEU	<1	93.2–91.1	Stainless steel Hastelloy	Good Fair	UO ₂ - BeO ₂ UO ₂	Stainless steel Stainless steel 316L Stainless steel 304B Stainless steel 304 None	Tubes Canister of scrap Rod Plates Assembly	2.1–6.6	1.0–3.7
09. U oxide, stainless steel clad, intact, MEU	<1	19.9–5.5	Stainless steel	Good Fair	UO ₂ -BeO ₂ UO ₂	ZrO ₂ -CaO None	Rod Element	2.5–4.0	0.4–1.5

Table A-5. Ranges of nominal properties for DOE-managed spent nuclear fuel (cont.)

DOE Spent Fuel Group	MTHM ^a	EOL Effective Enrichment (%)	Cladding Composition	Cladding Condition	Fuel Compound Names	Fuel Matrix	Configuration	Length (ft)	Width/ Height/ Diameter (in.)
10. U oxide, stainless steel clad, intact, LEU	<1	2.1–0.2	Stainless steel	Good Fair	UO ₂	None	Tube Rod Rod array Rod hex array	1.6–12.0	0.5–8.5
11. U oxide, non-alum clad, non-intact or declad, HEU	<1	93.3–21.1	Nichrome Hastelloy Stainless steel None	Poor N/A	UO ₂ UO ₂ -BeO ₂ U ₃ O ₈	BEO Stainless steel Nichrome Stainless steel 302B Stainless steel 347 Powder None	Canister of scrap Assembly Tubes Filters Particulate Plate	0.3–3.1	0.3–5.6
12. U oxide, non-alum clad, non-intact or declad, MEU	<1	18.9–5.2	None Zirconium Unknown	Poor N/A	UO ₂	Gd ₂ O ₃ None Stainless steel	Experiment capsule Canister of scrap Melted fuel	1.2–9.9	5.6–10.6
13. U oxide, non-alum clad, non-intact or declad, LEU	108	4.1–1.1	Zirconium Stainless steel	Poor N/A	UO ₂	None	Canister of scrap Scrap Rod Rod array Debris	2.6–13.6	0.5–14.0
14. U oxide, alum clad, HEU	4	89.9–58.2	Aluminum	Good Fair	U ₃ O ₈	Alum	Plates Assembly	1.2–3.6	2.9–17.2
15. U oxide, alum clad, MEU and LEU	<1	19.3–9.0	Aluminum	Good Fair Poor	U ₃ O ₈	Alum	Plates Assembly Tubes	2.1–3.3	0.1–4.8
16. U-AL _x , HEU	8	93.2–22.0	Aluminum	Good Fair Poor <blank>	U-AL _x	Alum	Rods array Tubes Plates Pin cluster Assembly Element Canister of scrap Cylindrical sections Stacked disks Multi-pin cluster	0.8–10.1	0.1–16.3

Table A-5. Ranges of nominal properties for DOE-managed spent nuclear fuel (cont.)

DOE Spent Fuel Group	MTHM ^a	EOL Effective Enrichment (%)	Cladding Composition	Cladding Condition	Fuel Compound Names	Fuel Matrix	Configuration	Length (ft)	Width/Height/Diameter (in.)
17. U-AL _x , MEU	3	20.0–9.1	Aluminum	Good Fair <blank>	U-AL _x	Alum	Assembly Element Plates	2.1–3.5	1.8–4.1
18. U ₃ Si ₂	7	22.0–5.6	Aluminum	Good Fair Poor <blank>	U ₃ Si ₂	Alum	Tubes Multi-pin cluster Assembly Canister of scrap Plates	2.1–3.4	0.1–3.7
19. Th/U carbide, TRISO- or BISO-coated particles in graphite ^b	25	84.4–71.5	BISO TRISO	Good Poor	ThC ₂ -UC ₂ ThC-UC	Graphite	Tubes Canister of scrap Carbon coated part	2.6–10.5	3.5–16.4
20. Th/U carbide, monopyrolytic carbon coated particles in graphite ^b	2	93.1–85.7	Monopyrolytic carbon	Poor	ThC ₂ -UC ₂	Graphite	Element	~12.0	~3.6
21. Pu/U carbide, non-graphite clad, not sodium bonded	<1	67.3–1.0	Stainless steel	Good Fair Poor	Pu/U carbide	None	Canister of scrap Rod Rod hex array	7.8–12.0	0.3–5.2
22. MOX, zirc clad	3	21.0–1.6	Zirconium	Poor Fair	PuO ₂ -UO ₂	None	Rod Canister of scrap Rod array Element	3.4–9.5	0.4–6.6
23. MOX, stainless steel clad	11	87.3 ^c –2.1	Stainless steel	Poor Good Fair	PuO ₂ -UO ₂ PuO ₂	None	Rod Plates Element Canister of scrap Scrap Rod hex array Melted fuel	1.2–12.0	0.3–9.1
24. MOX, non-stainless steel/nonzirc clad	<1	54.3–5.0	Unknown	N/A Poor	PuO ₂ -UO ₂	None Unknown	Scrap Canister of scrap Unknown	Unknown	Unknown
25. Th/U oxide, zirc clad	43	98.4–10.2 ^d	Zirconium	Good Poor N/A	ThO ₂ -UO ₂ ceramic ThO ₂ -UO ₂	None	Rod array Rod hex array Canister of scrap	~11.9	9.1–22.3
26. Th/U oxide, stainless steel clad	8	95.8–7.9	Stainless steel	Fair Poor	ThO ₂ -UO ₂	None	Canister of scrap Rod	5.3–9.9	~0.5

Table A-5. Ranges of nominal properties for DOE-managed spent nuclear fuel (cont.)

DOE Spent Fuel Group	MTHM ^a	EOL Effective Enrichment (%)	Cladding Composition	Cladding Condition	Fuel Compound Names	Fuel Matrix	Configuration	Length (ft)	Width/Height/Diameter (in.)
27. U-zirc hydride, stainless steel/incoloy clad, HEU	<1	93.2–20.0	Stainless steel Incoloy	Good Poor	U-ZrH _x U-ZrH _x -Er	None	Rod Element Rod array	2.2–4.0	0.6–3.2
28. U-zirc hydride, stainless steel/incoloy clad, MEU	2	20.0–11.9	Stainless steel Incoloy	Good Poor Fair <blank>	U-ZrH _x U-ZrH _x -Er	None B ₄ C	Element Canister of scrap Rod	2.4–4.0	0.6–1.9
29. U-zirc hydride, alum clad, MEU	<1	19.9–16.8	Aluminum	Good Fair Poor	U-ZrH _x	None	Element Rod	~2.4	~1.5
30. U-zirc hydride, declad	<1	~89.7	None	N/A	U-ZrH _x	None	Declad rod	~1.2	~1.3
31. Metallic sodium bonded	60	93.1–<0.1	Stainless steel None Unknown	Poor Good N/A Fair	U-10Zr U-Mo U metal U-Pu-Zr UO ₂ Pu/U alloy U-5 fissionium Pu/U carbide	None	Fuel in sodium Rod Assembly Canister of scrap Scrap Rod array Rod hex array Can	1.8–7.9	0.3–9.1
32. Naval	65 ^f	—	—	—	—	—	—	—	—
33. Canyon stabilization	N/A	—	—	—	—	—	—	—	—
34. Misc (not previously listed)	<1	89.9–1.6 ^e	None Zirconium Unknown Aluminum Stainless steel	Fair Poor N/A Good <blank>	ThO ₂ -UO ₂ U-Th metal U metal UO ₂ Pu/U nitride Pu/U alloy U-Al _x U-ZrH _x Unknown	None Alum Unknown	Canister of scrap Tube Rod Unknown Plates	0.6–9.9	0.6–5.6

^a MTHM are rounded to next higher whole number or reported as <1 MTHM, as applicable.

^b For fuel groups 19 and 20, cladding composition and cladding condition are reporting particle coating composition and condition.

^c Excludes record EPRI [67] at 100% enrichment to provide a more realistic value.

^d Excludes record SHIPPINGPORT (MET MOUNTS) [1087] at 0% enrichment to provide a more realistic value.

^e Excludes record BER-II [HMI] (END BOXES) (GERMANY) [892] at 0% enrichment to provide a more realistic value.

^f This is the expected generation of naval spent fuel mass through the year 2035 that was estimated for delivery to the Yucca Mountain site in its anticipated 25 years of operation (2010 through 2035).

Group 31 is sodium-bonded fuel. Some of this material has been or will be treated into HLW.

Group 33 will be processed into HLW.

Source: from DOE 2007, after Wagner et al. 2012, Table B-1; updated per query of DOE 2011a.

Table A-6. Mass and canister count estimates by fuel group for DOE-managed SNF

Fuel Group	MTHM ^a	MT ^a	Estimated Number of Canisters by Type ^b					Bare Fuel ^c	
			18x10	18x15	24x10	24x15	MCO ^d	PWR	BWR
01. U metal, zirc clad, LEU	2,096	3,130	-	2	-	-	388	-	-
02. U metal, non-zirc clad, LEU ^e	10	10	6	-	-	-	7	-	-
03. U-zirc	7	14	12	8	-	-	-	-	-
04. U-Mo	4	6	10	-	-	-	-	-	-
05. U oxide, zirc clad, intact, HEU	<1	23	3	55	-	-	-	-	-
06. U oxide, zirc clad, intact, MEU	2	4	8	-	-	-	-	-	-
07. U oxide, zirc clad, intact, LEU ^e	64	140	32	83	-	-	18	39	2
08. U oxide, stainless steel/hastelloy clad, intact, HEU	<1	2	13	-	-	-	-	-	-
09. U oxide, stainless steel clad, intact, MEU	<1	6	3	9	-	-	-	-	-
10. U oxide, stainless steel clad, intact, LEU	<1	3	1	3	-	-	-	1	-
11. U oxide, non-alum clad, non-intact or declad, HEU	<1	8	196	6	-	-	-	-	-
12. U oxide, non-alum clad, non-intact or declad, MEU	<1	4	112	1	-	-	-	-	-
13. U oxide, non-alum clad, non-intact or declad, LEU ^e	108	370	10	357	-	-	-	40	76
14. U oxide, alum clad, HEU	4	68	209	-	133	-	-	-	-
15. U oxide, alum clad, MEU and LEU	<1	2	9	-	-	-	-	-	-
16. U-ALx, HEU ^e	8	93	548	92	-	-	-	-	-
17. U-ALx, MEU	3	12	74	-	-	-	-	-	-
18. U ₃ Si ₂ ^e	7	27	93	145	-	-	-	-	-
19. Th/U carbide, TRISO- or BISO-coated particles in graphite ^e	25	316	1	505	-	-	-	-	-
20. Th/U carbide, monopyrolytic carbon coated particles in graphite	2	33	-	63	-	-	-	-	-
21. Pu/U carbide, non-graphite clad, not sodium bonded	<1	<1	3	3	-	-	-	-	-
22. MOX, Zirc clad	3	4	6	-	-	-	-	-	5
23. MOX, stainless steel clad	11	53	13	127	-	-	-	-	-
24. MOX, non-stainless steel/non-zirc clad	<1	<1	2	1	-	-	-	-	-
25. Th/U oxide, zirc clad	43	85	9	12	-	27	-	-	-
26. Th/U Oxide, stainless steel clad ^e	8	12	11	1	-	-	-	-	-
27. U-zirc hydride, sst/incoloy clad, HEU	<1	4	18	-	-	-	-	-	-
28. U-zirc hydride, sst/incoloy clad, MEU	2	18	70	-	-	-	-	-	-
29. U-zirc hydride, alum clad, MEU	<1	6	18	-	-	-	-	-	-
30. U-zirc hydride, declad	<1	<1	7	-	-	-	-	-	-

Table A-6. Mass and canister count estimates by fuel group for DOE-managed SNF (cont.)

Fuel Group	MTHM ^a	MT ^a	Estimated Number of Canisters by Type ^b					Bare Fuel ^c	
			18x10	18x15	24x10	24x15	MCO ^d	PWR	BWR
31. Metallic sodium bonded	60	-	-	-	-	-	-	-	-
32. Naval	65	-	-	-	-	-	-	-	-
33. Canyon stabilization	N/A	-	-	-	-	-	-	-	-
34. Misc (not previously listed) ^e	<1	<1	9	1	-	-	-	-	-
Totals	2,532	4,453	1,506	1,474	133	27	413	80	83

^a MTHM and MT are rounded to next higher whole number or reported as <1, as applicable.

^b Representation for standardized canister dimensions are "diameter in inches" x "length in feet," thus, 18x10 represents an 18 in. diameter by 10 ft long canister.

^c Intact PWR and BWR in groups 7, 10, and 22 will be shipped as bare fuel in a transport cask; it is assumed they will not need to be placed in a standardized canister. The non-intact fuel in group 13 will be placed in a standardized canister (DOE 2008).

^d MCOs are 24 in. in diameter and 166 in. long

^e Fuel group contains records with missing or incomplete MTHM and/or MT data.

Source: Query of Spent Fuel Database, Version 6.2.3 (DOE 2011a).

A-1.2.2 Plans for Packaging and Disposal of DOE SNF

DOE plans to package most of its SNF (about 98% of the metric tons of heavy metal) into MCOs and standardized canisters suitable for storage, transport, and disposal without the need to be re-opened (DOE 2007, Section 3.2). DOE SNF of commercial origin having handling features interchangeable with either BWR or PWR fuel assemblies and known to have no defects may be handled in the same manner as commercial SNF as specified in 10 CFR Part 961 (DOE 2008, Section 1.5.1.3), and thus will not be placed in standardized canisters

The canister count estimates in Table A-6 are estimates based on fuel dimensions and canister sizes. The actual canister count will change based on a variety of factors such as: fuel mixing, basket design and use, shield plug use, criticality considerations, and location of fuel and packaging facilities.

Management of criticality will be a major consideration for canister internals when disposing of SNF that used enriched uranium compounds (20% to 97% ^{235}U). Criticality management represents the only major postclosure design considerations for the canister package system. Development of appropriate neutron absorbing materials for these packages still needs to be completed. Neutron absorber requirements would be specified in the packaging standards. It is important to note, however, that neutron absorber systems are not independent of other canister internals design issues and must be designed into the overall packaging system.

The MCO is currently in use storing N Reactor fuel. Preliminary design work for the standardized canister has been completed. Materials testing and drop tests have been performed to demonstrate it will meet performance requirements during storage, transportation, and repository preclosure operations. Although no standardized canisters have yet been built and loaded, they are currently the planning basis for future storage (when needed for packaging upgrades, transport, or consolidation of storage facilities) for each of the DOE SNF storage sites.

Remaining work includes development of the remote closure process that will eliminate the need for a shield plug and thus enable more effective use of the available volume for spent fuels (i.e., substantially reduce the canister count) and to finalize the basket/poison materials and configurations to finalize loading configurations. These two activities will enable final configuration of canister internals and fuel loadings.

Multicanister Overpack—N Reactor (group 1) and some other fuels have been packaged into MCOs and are currently being stored at the Hanford site. Each MCO is a stainless steel canister having a shell diameter of approximately 24 in. and a closure diameter at the widest point of 25.51 in. and approximately 166 in. long. The MCO shell is a cylindrical vessel fabricated from 0.5 in. stainless steel welded to a 2 in. bottom plate assembly (see Figure A-15) (DOE 2008, Section 1.5.1.3.1.2.1.3).

Materials are specified as American Society of Mechanical Engineers (SA-182) or American Society for Testing and Materials (A) materials. The locking ring is made from Stainless Steel Type 304H or 304N. The MCO shell, collar, bottom, and shield plug are Stainless Steel Type 304/304L dual-certified material. This low-carbon austenitic alloy was chosen for its corrosion resistance, American Society of Mechanical Engineers code-approved mechanical properties, and excellent ductility over a wide range of temperatures. No ferritic materials are used in the design (DOE 2008, Section 1.5.1.3.1.2.1.3).

The maximum dry weight of an N Reactor MCO, including the heaviest fuel arrangement, is 20,220 lb. The weight for an MCO containing Shippingport Core 2 blanket SNF is about 9,525 lb (DOE 2008, Section 1.5.1.3.1.2.1.3).

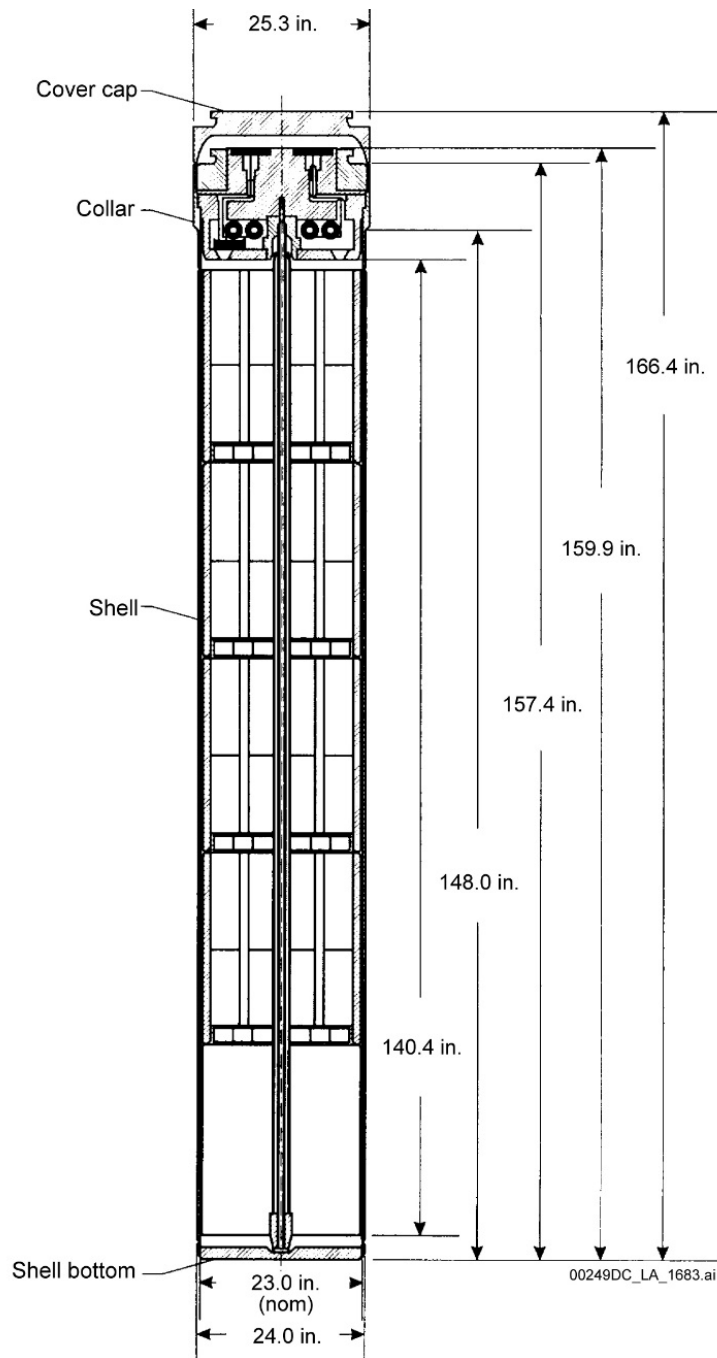

Source: DOE 2008, Figure 1.5.1-18.

Figure A-15. Multicanister overpack

Standardized Canister—DOE Fuel (other than intact commercial PWR and BWR fuels, fuels packaged in MCOs, and naval fuel) is planned to be placed into standardized canisters prior to transport and disposal. Standardized canisters have been designed and tested to provide a leak-tight boundary that can be credited to contain radiological material and to prevent moderator intrusion during handling and transportation (DOE 2008, Section 1.5.1.3.1.2.2.1).

The large-diameter standardized canister has a nominal outer diameter of 24 in. and a nominal wall thickness of 0.5 in. The small diameter standardized canister has a nominal outer diameter of 18 in. and a nominal wall thickness of 0.375 in. Both the large- and small-diameter standardized canisters are designed for two nominal overall lengths of approximately 10 and 15 ft (see Figure A-16) (DOE 2008, Section 1.5.1.3.1.2.1.1).

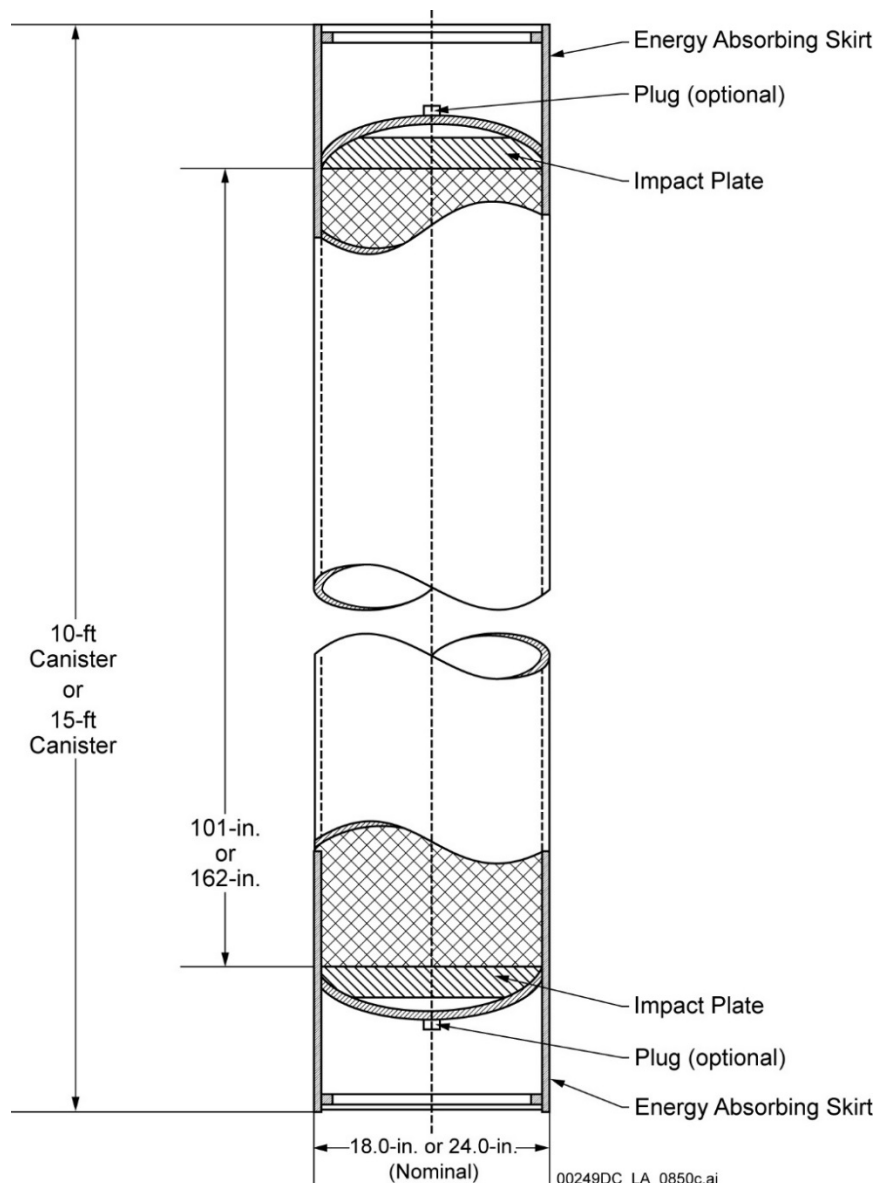

Source: DOE 2008, Figure 1.5.1-9.

Figure A-16. Standardized DOE SNF canister

The standardized canisters will be fabricated from SA-312 (welded or seamless pipe) Stainless Steel Type 316L (UNS S31603) for the shell. SA-240 (plate) Stainless Steel Type 316L is used for the heads and lifting rings. The optional plugs are SA-479 (bar) Stainless Steel Type 316L. The stainless steel materials will be annealed and pickled. This low-carbon austenitic alloy is chosen for its corrosion resistance, American Society of Mechanical Engineers code-approved mechanical properties, and ductility over a wide range of temperatures (DOE 2008, Section 1.5.1.3.1.2.1.1).

The maximum total allowable weight of each standardized canister plus its contents is approximately (DOE 2008, Section 1.5.1.3.1.2.1.1):

- 10,000 lb for the 24 in. diameter 15 ft standardized canister
- 9,000 lb for the 24 in. diameter 10 ft standardized canister
- 6,000 lb for the 18 in. diameter 15 ft standardized canister
- 5,000 lb for the 18 in. diameter 10 ft standardized canister.

Because the canister has been demonstrated to maintain its integrity (i.e., no breach), the radiological confinement and the subcriticality safety functions prior to emplacement are performed by the canister thus precluding the need to base preclosure safety arguments on maintaining the form or condition of the fuel itself (DOE 2008, Section 1.5.1.3.1.2.2.1). Mechanical and structural properties of DOE SNF to support such analyses would not be available without costly fuel characterization and, even if characterized, there would be high uncertainties due to operational and storage histories for many DOE SNFs and low pay-off due to the limited quantity of many fuel types.

The standardized canister was however not credited for performing safety functions in the postclosure repository environment (DOE 2008, Section 1.5.1.3.1.2.5.1). DOE SNFs, due to their relatively low quantity and typically low burnup, posed a relatively insignificant fraction of the repository source term. Subcriticality for the repository postclosure degraded analyses was based largely on neutron poisons (in the baskets and, for a very few highly reactive fuels, the addition of neutron-poison beads).

Supplemental neutron absorber materials may be included as part of the design of the internal components of the DOE SNF canister if analyses of the specific waste loading requires it. These materials are intended to prevent in-package criticality in the unlikely event that a breached waste package becomes flooded at some time after closure (DOE 2008, Section 1.5.1.3.1.2.7).

Standardized Canister Internals—The internal basket assemblies within standardized canisters have several functions. One function is to facilitate loading of DOE SNF. Some baskets will be preinstalled in the standardized canister prior to loading and final closure. Other baskets will be preloaded with fuels, and the loaded basket placed into the standardized canisters. Another function is to provide structural support of the DOE SNF during operations. The fuel basket is designed to remain intact and to provide relative geometry control of the fuel debris that might be formed from a drop event or other handling operations (DOE 2008, Section 1.5.1.3.1.2.1.2).

The DOE fuel assemblies to be loaded into a canister set the pattern for the arrangement of the basket configurations within the standardized canister. The basket for each configuration is customized to meet physical dimensions, type, and number of fuel assemblies to be packaged in a standardized canister. Each DOE SNF type has been assigned to one of the nine criticality analysis groups (eight for standardized canisters and one for MCOs). Each criticality analysis group has a corresponding basket design that was used for the representative DOE SNF type from that group (DOE 2008, Section 1.5.1.3.1.2.1.2).

The standardized canister internals also may serve a criticality control function in the preclosure and postclosure time periods. The canister internal fuel basket sets the number of assemblies that can be loaded, which controls the amount of fissile materials in a canister. As required to provide criticality control, supplemental neutron absorber materials will be added to the internal basket design. Basket materials may include either stainless steel baskets with or without supplemental neutron-absorbing materials and Ni/Gd alloy material with or without supplemental neutron-absorbing materials (DOE 2008, Section 1.5.1.3.1.2.1.2).

A-1.3 Naval Spent Fuel

Naval fuel consists of HEU, which is defined as uranium that has been enriched to 20% or greater in the ^{235}U isotope and is considered to be weapons usable. Naval SNF comes in different forms, including metals, oxides, solutions, reactor fuel, and irradiated spent nuclear fuel (see also Section A-1.2). In Wagner et al. (2012), HEU SNF (including naval fuel) was evaluated, and it was recommended that “a study be conducted to evaluate the benefits and issues associated with recovering this material.” As part of this disposal options study, the considerations associated with direct disposal of naval SNF are assessed to delineate its potential disposal options in case it is decided that recovery of the material is not preferred.

A-1.3.1 Chemical Reactivity

Naval spent fuel consists of solid metal and metallic components that are nonflammable and highly corrosion resistant, and neither pyrophoric, explosive, combustible, chemically reactive, nor subject to gas generation by chemical reaction or off-gassing. Naval SNF is from PWRs, with the exception of one design operated in a sodium cooled reactor. A small amount of the naval SNF from the sodium-cooled reactor remains (approximately 0.00234 MTHM). Residual sodium has been cleaned from this naval SNF (DOE 2008).

A-1.3.2 Waste Form and Packaging

Naval fuel is enriched (approximately 93 wt % to 97 wt %) in the isotope ^{235}U at the beginning of life. As a result of high uranium enrichment, very small amounts of transuranic isotopes are present in the naval SNF, as compared to commercial SNF. The zircaloy cladding of the naval SNF provides the primary containment for radioactive fission products. Structural components, made of Alloy 600 (UNS N06600), Alloy 625 (UNS N06625), Alloy X-750 (UNS N07750), or Stainless Steel Type 304 (UNS S30400), are attached to the fuel assemblies to provide support to the fuel assemblies in the reactor. In some cases a specific amount of this structural material is removed to make packing more efficient (DOE 2008).

There has been a long standing program of examination of irradiated tests specimens of naval SNF. A small percentage of naval SNF was disassembled for examination. In most cases, the disassembled assemblies have intact cladding and no exposed actinides or fission products. Intact cladding is undamaged or may have hairline cracks or pinholes leaks in a very few cases (DOE 2008).

In a few cases, destructive evaluation of disassembled components results in nonintact cladding and exposed actinides and fission products. Some test specimens have nonintact cladding because they were tested until the cladding failed. Less than 2% of the approximately 400 to-be-loaded HEU SNF canisters will contain nonintact naval SNF (DOE 2008).

The actual radionuclide inventory of naval SNF varies depending on factors such as canister size, basket design, and packaging method. In addition, there are variations related to operational history and time after shutdown. As a result, a radionuclide inventory for a representative naval SNF canister was developed based on detailed core depletion calculations. The inventory accounts for fission products, actinides, zircaloy cladding, hafnium control rods, activated structural components, and crud. Table A-7 provides the radionuclide inventory of a representative naval SNF canister five years after reactor shutdown.

Table A-7. Radionuclide inventory for a representative naval SNF canister at 5 years after reactor shutdown

Isotope	Activity (curies)	Isotope	Activity (curies)	Isotope	Activity (curies)
²²⁷ Ac	2.12 × 10 ⁻⁴	⁵⁵ Fe	1.68 × 10 ³	¹⁰² Rh	1.12 × 10 ⁻²
²⁴¹ Am	3.56 × 10 ¹	³ H	1.15 × 10 ³	¹⁰⁶ Rh	3.20 × 10 ³
²⁴² Am	3.84 × 10 ⁻¹	¹²⁹ I	8.03 × 10 ⁻²	¹²⁵ Sb	4.13 × 10 ³
^{242m} Am	3.86 × 10 ⁻¹	⁸⁵ Kr	2.41 × 10 ⁴	¹²⁶ Sb	1.34 × 10 ⁻¹
²⁴³ Am	4.66 × 10 ⁻¹	^{93m} Nb	2.27 × 10 ³	^{126m} Sb	9.55 × 10 ⁻¹
^{137m} Ba	2.93 × 10 ⁵	⁹⁴ Nb	2.06 × 10 ²	⁷⁹ Se	2.67 × 10 ⁻¹
¹⁴ C	6.40 × 10 ⁰	⁵⁹ Ni	1.34 × 10 ¹	¹⁴⁷ Sm	2.48 × 10 ⁻⁵
^{113m} Cd	2.33 × 10 ¹	⁶³ Ni	1.63 × 10 ³	¹⁵¹ Sm	9.78 × 10 ²
¹⁴⁴ Ce	1.47 × 10 ⁴	²³⁶ Np	4.92 × 10 ⁻⁵	^{121m} Sn	2.58 × 10 ¹
²⁴⁹ Cf	1.04 × 10 ⁻⁶	²³⁷ Np	1.17 × 10 ⁰	¹²⁶ Sn	9.55 × 10 ⁻¹
²⁵¹ Cf	7.15 × 10 ⁻⁸	²³⁸ Np	1.74 × 10 ⁻³	⁹⁰ Sr	3.05 × 10 ⁵
²⁵² Cf	8.08 × 10 ⁻⁶	²³⁹ Np	4.66 × 10 ⁻¹	⁹⁹ Tc	5.11 × 10 ¹
³⁶ Cl	1.36 × 10 ⁻¹	²³¹ Pa	7.77 × 10 ⁻⁴	^{125m} Te	1.01 × 10 ³
²⁴² Cm	9.70 × 10 ⁻¹	²¹⁰ Pb	2.97 × 10 ⁻⁶	²²⁹ Th	2.14 × 10 ⁻⁵
²⁴³ Cm	4.68 × 10 ⁻¹	¹⁰⁷ Pd	4.42 × 10 ⁻²	²³⁰ Th	3.22 × 10 ⁻³
²⁴⁴ Cm	4.40 × 10 ¹	¹⁴⁷ Pm	9.20 × 10 ⁴	²³² Th	1.19 × 10 ⁻⁵
²⁴⁵ Cm	3.85 × 10 ⁻³	¹⁴⁴ Pr	1.47 × 10 ⁴	²⁰⁸ Tl	8.76 × 10 ⁻²
²⁴⁶ Cm	1.20 × 10 ⁻³	²³⁶ Pu	6.33 × 10 ⁻¹	²³² U	5.29 × 10 ⁻¹
²⁴⁷ Cm	1.54 × 10 ⁻⁸	²³⁷ Pu	1.84 × 10 ⁻⁷	²³³ U	6.52 × 10 ⁻²
²⁴⁸ Cm	6.50 × 10 ⁻⁸	²³⁸ Pu	7.80 × 10 ³	²³⁴ U	1.86 × 10 ¹
⁶⁰ Co	1.18 × 10 ³	²³⁹ Pu	9.87 × 10 ⁰	²³⁵ U	2.65 × 10 ⁻¹
¹³⁴ Cs	4.95 × 10 ⁴	²⁴⁰ Pu	1.04 × 10 ¹	²³⁶ U	1.84 × 10 ⁰
¹³⁵ Cs	3.68 × 10 ⁰	²⁴¹ Pu	2.56 × 10 ³	²³⁷ U	6.13 × 10 ⁻²
¹³⁷ Cs	3.11 × 10 ⁵	²⁴² Pu	5.65 × 10 ⁻²	²³⁸ U	9.20 × 10 ⁻⁴
¹⁵² Eu	3.71 × 10 ¹	²⁴⁴ Pu	6.72 × 10 ⁻⁹	⁹⁰ Y	3.05 × 10 ⁵
¹⁵⁴ Eu	7.17 × 10 ³	²²⁶ Ra	1.50 × 10 ⁻⁵	⁹³ Zr	8.69 × 10 ⁰
¹⁵⁵ Eu	2.12 × 10 ³	²²⁸ Ra	9.03 × 10 ⁻¹⁰		

Source: DOE 2008, Table 1.5.1-32.

Naval SNF assemblies are composed of materials that keep temperatures low enough to maintain the integrity of the cladding. The decay heat in naval SNF originates from fission products and actinide decay and decreases exponentially over time based on the effective decay constant for the particular radionuclides. A decay heat limit of 11.8 kW was established for naval SNF canisters so that no canisters are shipped until the decay heat at the time of acceptance at the repository is less than or equal to 11.8 kW. This decay heat limit is sufficiently low that no aging is required prior to emplacement (DOE 2008). The average thermal load is 4,250 W per canister. Using projected thermal output in 2025, the naval SNF canisters are estimated to be distributed as: 13 canisters in 500 to 1,000 W range; 36 canisters in the 1,000 to 2,500 W range; 94 canisters in 2,500 to 5,000 W range; and 257 canisters above 5,000 W, but within the decay heat limit given above. (Note that the evaluations performed in this study are based on the average thermal load of a naval SNF canister.) As of March 2014, 93 naval SNF canisters have been loaded and are being temporarily stored at INL.

Naval SNF is to be packaged in canisters pending shipment to a repository. Two canisters, one short and one long, were designed to accommodate different naval fuel assembly designs. Both canisters were sized to fit within the proposed design for the Yucca Mountain repository waste package. The outer diameter of the canister is 66 in. nominal (66.5 in. maximum). The maximum external dimensions ensure naval SNF canisters fit into the waste packages. The short canister is 185.5 in. (nominal) in length (187 in. maximum), and the long canister is 210.5 in. (nominal) in length (212 in. maximum). With the exception of length, the other characteristics of the naval SNF canisters are identical. Approximately 400 canisters (310 long and 90 short) are planned to be packaged and temporarily stored pending shipment to a repository for disposal (DOE 2008).

To accommodate different fuel assembly designs, there are three different methods (A, B, and C) for packaging naval SNF into canisters. These packaging methods are based on the type of assemblies and whether the cladding is intact or nonintact. The designs for Packaging Method A are either completed or in development; designs for Packaging Methods B and C are still conceptual in nature. Each naval SNF canister would be loaded such that thermal, shielding, criticality, and other characteristics of the received waste would be within the proposed repository waste acceptance requirement limits (DOE 2008).

Packaging Method A uses baskets designed for specific naval SNF assemblies from the most common reactor designs. The baskets are made from corrosion-resistant materials (e.g., Alloy 22 (UNS N06022) and Stainless Steel Type 316/316L). The naval SNF assemblies packaged using Packaging Method A have intact cladding. Hafnium control rods or installed neutron-poison assemblies are used to reduce the reactivity of naval SNF assemblies under moderated conditions (DOE 2008).

Packaging Method B uses baskets made from corrosion-resistant material such as Stainless Steel Type 316/316L and Alloy 22. Packaging Method B baskets contain partial naval SNF assemblies that result from post-operational examinations, or naval SNF assemblies from less common core designs. Naval SNF assemblies packaged using Packaging Method B have intact cladding. Many of these assemblies do not contain control rods. Neutron poison assemblies will be inserted into the sleeves when necessary to reduce the reactivity of the naval SNF (DOE 2008).

Packaging Method C uses corrosion-resistant cans to package pieces, parts, and fines. The pieces, parts, and fines may have intact or nonintact cladding. The corrosion-resistant cans are designed to be loaded into a Packaging Method B basket. When necessary to reduce the reactivity of the naval SNF, neutron-poison assemblies will be inserted into the corrosion-resistant cans (DOE 2008).

Naval SNF is considered to be weapons-usable and is treated as a special nuclear material. Physical systems are required to provide physical protection against acts of radiological sabotage and to prevent the theft or diversion of naval SNF. Personnel security programs and material control and accountability systems are implemented to protect and track these materials. Administrative controls are also required to

ensure that these systems are properly implemented. Naval SNF will require storage until disposal. No other processing constraints were identified.

A-1.4 Small Modular Reactor Fuels

For most comparisons, an SMR fuel assembly (based on a light water reactor technology) can be generalized as an assembly from a large PWR with the only major difference being that the SMR's assembly will be approximately half the height of large PWRs. The SMR vendors have all stated that their assemblies will have enrichments below 5% and make use of burnable poisons/enrichment variations to control excess reactivity and power peaking in the core (NEI 2012). The expected waste stream from these assemblies, when measured using a metric that includes burnup, will roughly be the same as the full height assemblies. This conclusion is based on minimal differences between an SMR's and large PWR's neutron spectrum, fuel burnup, and fresh fuel enrichment. With that said, the ratio of assembly support structure (end fittings) to active fuel will be higher for SMRs compared to that of the large PWR.

After cooling, the gamma emission from spent fuel material and the assembly support structure is approximately 1,000 times higher for than for the initial fuel. Assuming no major reduction to these steel structures, the ratio will shrink to ~500, an insignificant reduction in terms of shielding for storage or reprocessing, as the major dose contributor will continue to be from the fuel. One SMR vendor (B&W mPower) has designed their system so that it does not use borated coolant. Generally PWRs use boron in the coolant as a "shim" to control excess reactivity. This boron additive is responsible for approximately 90% of the tritium production by the plant. By removing this source of tritium, B&W has effectively reduced the tritium by a factor of 10, putting this SMR system's tritium production on par with that produced from BWRs.

These SMR spent fuels will be similar enough to commercial spent nuclear fuel (though smaller in dimension and having more support structure per fuel mass) that they can be considered as a disposed waste form included in those considerations for commercial SNF described in detail in Section A-1.1 above. The absolute amount of these types of spent fuels will be small in comparison well into the foreseeable future of the fuel cycles.

A-2. High Level Wastes

HLW exists in several forms, each of which is discussed below. Tank waste from fuel reprocessing that has already been immobilized in borosilicate glasses is discussed in Section A-2.1, while Section A-2.2 presents the tank wastes from fuel reprocessing that is projected to be immobilized in borosilicate glass in the future. Calcine HLW at the Idaho site, for which several alternative treatment processes have been considered; sodium-bearing tank waste (SBW) at the Idaho site; and cesium/strontium capsules stored at the Hanford site are examined in Section A-2.3. Finally, HLW types that are being generated at the INL from the electrochemical treatment of sodium-bonded fuels, including salt waste and metallic waste, are discussed in Section A-2.4.

A-2.1 Existing Vitrified HLW

HLW tank waste from fuel reprocessing has been vitrified at the West Valley Demonstration Project (WVDP) in New York and SRS in South Carolina. The tank waste at WVDP is the result of commercial fuel reprocessing conducted in the between 1966 and 1972. The tank waste at SRS is the result of reprocessing fuels for nuclear weapons production and for recovery of special radioisotopes; fuel processing efforts at SRS began in the 1950s and continue today at H Canyon. In addition, the Hanford site produced some vitrified glass for the Federal Republic of Germany (FRG); this glass is currently stored at Hanford. These existing wastes are discussed below.

This section includes descriptions of the glass produced at WVDP, SRS, and the FRG HLW glass produced and currently stored at Hanford.

A-2.1.1 West Valley High-Level Radioactive Waste Glass

Commercial spent nuclear fuel was reprocessed at West Valley, New York, between 1966 and 1972. The plutonium uranium extraction (PUREX) process was used to recover plutonium and uranium from the spent fuel. The thorium extraction (THOREX) process was also used to process a batch of mixed uranium-thorium fuel. HLW from reprocessing, which was stored in tanks onsite, consisted of about two million liters of neutralized PUREX waste and about 55,000 liters of acidic THOREX waste (Cadoff 1996).

The West Valley Demonstration Project Act, which was signed into law in 1980, requires the solidification of West Valley HLW and development of containers for transport and permanent disposal in a geologic repository. Borosilicate glass was selected as the waste form in 1983.

To prepare the HLW for vitrification and to minimize the final volume of glass, chemical pretreatment at West Valley included treating the PUREX supernatant with 2,500 ft³ of IE-96 zeolite to remove radioactive cesium (and strontium/plutonium using TIE-96). The PUREX sludge was washed to remove soluble sulfates and interstitial supernatant. Subsequently, the THOREX waste was neutralized and mixed with the PUREX sludge before the spent zeolite was added. The estimated oxide composition of the final mixture provided the basis for the HLW glass composition. The decontaminated PUREX supernatant and the sludge wash solution were processed and solidified as cement, followed by disposal as waste incidental to reprocessing (WIR).

After mixing, the pretreated HLW was transferred to the concentrator feed make-up tank, where the slurry was concentrated by evaporation and samples taken for analysis. The chemical analytical results determined the amount and the mix of glass forming chemicals to be added. Sucrose was used to control glass redox and to prevent foaming reactions. Another chemical analysis was performed after addition of glass formers to verify the composition was correct before the slurry was transferred to the melter feed hold tank, from which the slurry feed was continually metered to the melter. During melter operation, molten glass was periodically discharged by airlifting into a canister held in position under the melter with a turntable.

The WVDP is required to demonstrate compliance with the Waste Acceptance Product Specifications (WAPS) (DOE 1996). The primary strategies to ensure that the HLW glass would meet the WAPS criteria were to (1) allow only acceptable feed materials to be delivered to the melter, (2) control the process temperature and redox state of the glass, and (3) predict and determine the composition of the glass product (Palmer and Misercola 2003).

Waste Form Canister—The West Valley canisters were fabricated from austenitic stainless steel Type 304L. They are comprised of four major components: canister shell, bottom head, top head and neck flange. The weld filler metal ASME SFA5.9 ER308L was used to assemble the canister. The 308L alloy was also used for the weld-beaded canister identification labels (Palmer and Barnes 2002).

The physical characteristics of the HLW canisters are summarized in Table A-8 (DOE 2008).

Table A-8. WVDP HLW canister data summary

Canister Length, cm	300
Nominal Outer Diameter, cm	61
Thickness, cm	0.34
Empty Canister Weight, kg	181.4
Available Volume, m ³	0.83
Material	Stainless Steel 304L
Nominal Fill Height, %	91
Nominal Glass Volume, m ³	0.76
Maximum Allowable Glass Weight, kg	2,500

Specifications of the components and fabrication method, supplemented by a rigorous program of inspection and verification, ensured the canister integrity. Upon receipt, every canister was visually and liquid penetrant inspected. Every acceptable canister was temporarily sealed and helium leak tested (per ASME Section V, Article 10). In order to pass the leak test, WVDP specified that the leak rate must be less than 1×10^{-7} atm-cc/sec helium (WVDP 1996).

Canister Production—The WVDP melter was a slurry-fed ceramic melter, first put into service in October 1995. Radioactive waste was first added in June 1996 and vitrification of HLW continued until August 2002 when the glass was poured to fill the final canister. A total of 68 batches of HLW were processed and blended with glass forming chemicals before melting in the WVDP melter at 1,150°C to produce 275 canisters of glass. The total amount of HLW glass produced was 573,802 kg (Palmer et al. 2004). In September 2002, the melter was emptied using an evacuated canister method before it was shut down.

The WAPS requires that the HLW canisters be at least 80% full. At WVDP, the fill height was measured by using a device that physically probed the height of glass in several places after the canister had cooled and been removed from the loading turntable. The actual average production value was 90.50% full (Palmer et al. 2004).

Canistered Waste Form—After filling with glass at the WVDP vitrification facility, the canister was allowed to cool and then a lid was welded onto the canister using a pulsed gas tungsten arc welding process and preprogrammed target weld parameters. The external surface of the welded canister was inspected visually and no glass was ever detected. To meet the WAPS requirement, the sealed canister must be leak-tight to 1×10^{-4} atm-cc/sec helium. Over the entire campaign that produced 275 canisters, fewer than 10 were determined to require a second welding (Palmer and Misercola 2003).

The canistered waste form was decontaminated by immersion in a solution of nitric acid ($\approx 1M$) and Ce^{4+} at 65°C before being transferred to the interim storage facility. The decontamination process employed the highly oxidizing Ce^{4+} to chemically mill a thin metal layer from the canister surface. The thickness of the stainless steel removed was estimated to be between ten and fifteen micrometers (Palmer and Barnes 2002). The decontaminated canister was then washed, first with dilute nitric acid and then with water, air dried and finally smear surveyed. The removable contamination from the surface of the canistered waste

form is limited by the WAPS to 2,000 dpm/100 cm² for alpha emitters and 22,000 dpm/100 cm² for beta and gamma emitters. A second decontamination process is planned before the canisters are packaged for final shipment.

Glass Composition—The WVDP melter processed and vitrified a relatively homogeneous HLW that resulted from combining and mixing of PUREX and THOREX wastes, producing HLW glass with one target composition. A projection was made of the expected process range for the reportable oxides (oxides with concentrations > 0.5 wt %) (WVDP 1996). The projection formed the basis for HLW glass composition development. Table A-9 lists the target glass composition, which is located at the center of the expected process region. Approximately 10% of the canisters of glass produced were sampled and analyzed for the reportable oxides; the ranges of analytical results from samples taken from 27 canisters over the course of the vitrification campaign are also listed in Table A-9.

Glass Properties—The waste form specifications in the WAPS define the requirements of the HLW glass properties, including phase stability and product consistency. In order to characterize the glass properties required for reporting, the WVDP prepared the target glass and several other glasses in the same compositional region. The glass transition temperature (T_g) measured for these glasses are in the range of 450°C to 465°C. The effect of redox and thermal history of the glass on T_g was insignificant. Crystallization behavior was reported in the Waste Form Qualification Report (WVDP 1996). Typical crystalline phases identified included spinels, hematite, and lithium phosphate. The amount of crystallization was about 2 vol % under normal cooling conditions and did not exceed 9 vol % under extreme conditions (96 hours at 700°C).

The capability of the WVDP HLW glass to satisfy the product consistency requirement in WAPS was demonstrated with production glass samples. The chemical composition of the glass samples was characterized and used in the prediction of the Product Consistency Test responses. The prediction was made using a regression model that relates Product Consistency Test response to glass composition. The average predicted Product Consistency Test releases of boron, lithium and sodium, after normalizing for the respective element concentrations in glass, are given in Table A-10 and compared to those of the reference standard glass waste glass identified in the Defense Waste Processing Facility (DWPF) Environmental Assessment.

The WVDP HLW glass is not classified as a listed hazardous waste. To determine whether the glass is a characteristic hazardous waste, WVDP prepared glasses with prototypical composition for evaluation by the Toxicity Characteristic Leaching Procedure (TCLP). The composition was selected for its high predicted Product Consistency Test releases. Glasses spiked with three times the expected amounts of the hazardous metals were also prepared and tested. Table A-11 summarizes the TCLP test results, which demonstrate that the WVDP glass is not a hazardous waste.

Table A-9. Target composition of WVDP glass and measured ranges for production glasses

Oxide	Target (wt %)	Measured Minimum (wt %)	Measured Maximum (wt %)
Al ₂ O ₃	6.00	5.6	7.1
B ₂ O ₃	12.89	11.2	14.8
BaO	0.16	NR	NR
CaO	0.48	0.21	0.6
Ce ₂ O ₃	0.31	NR	NR
CoO	0.02	NR	NR
Cr ₂ O ₃	0.14	NR	NR
Cs ₂ O	0.08	NR	NR
CuO	0.03	NR	NR
Fe ₂ O ₃	12.02	10.7	13.5
K ₂ O	5.00	4.1	5.3
La ₂ O ₃	0.04	NR	NR
Li ₂ O	3.71	3.3	4.2
MgO	0.89	0.7	1.3
MnO	0.82	0.7	0.9
MoO ₃	0.04	NR	NR
Na ₂ O	8.00	7.1	8.6
Nd ₂ O ₃	0.14	NR	NR
NiO	0.25	NR	NR
P ₂ O ₅	1.20	1.0	1.4
PdO	0.03	NR	NR
Pr ₆ O ₁₁	0.04	NR	NR
Rh ₂ O ₃	0.02	NR	NR
RuO ₂	0.08	NR	NR
SO ₃	0.23	NR	NR
SiO ₂	40.98	39.5	48.4
Sm ₂ O ₃	0.03	NR	NR
SrO	0.02	NR	NR
ThO ₂	3.56	0.1	3.6
TiO ₂	0.80	0.7	0.9
UO ₃	0.63	0.1	0.8
Y ₂ O ₃	0.02	NR	NR
ZnO	0.02	NR	NR
ZrO ₂	1.32	1.2	1.4

NR = not reportable.

Source: WVDP 1996; Palmer et al. 2004.

Table A-10. Normalized Product Consistency Test data for WVDP HLW glass

Glass	Product Consistency Test Release (mg/L)		
	Boron	Sodium	Lithium
Standard Glass	16,780	13,274	9,306
WVDP Glass Average	769	648	785

Source: Palmer et al. 2004.

Table A-11. TCLP test results of WVDP HLW glass

Metal	Environmental Protection Agency Limit (ppm)	Product Consistency Test Release (ppm)	
		Target Glass	Spiked Glass
Ag	5.0	<0.030	<0.030
As	5.0	<0.30	<0.30
Ba	100	0.39	0.36
Cd	1.0	<0.015	<0.015
Cr	5.0	0.038	0.03
Pb	5.0	<0.15	<0.15
Se	1.0	<0.30	<0.30

Source: WVDP 1996.

Radionuclide Concentrations—The total radionuclide inventory at WVDP was estimated using ORIGEN2, a computer code for use in simulating nuclear fuel reactions and calculating the resulting radionuclide concentrations. The estimates were supported with radiochemical analysis of waste samples removed from storage tanks. It was estimated that the total inventory in 1996 was 24 million curies. The radionuclide concentrations in the HLW glass per canister were also calculated. The maximum activity per canister was based on 100% filling and upper limits of error derived from analysis of HLW production data and actual sample analysis. Table A-12 tabulates the total and per-canister radioactivity data for the years 2015 and 3115. During the vitrification campaign, the poured glass was periodically sampled and analyzed for ^{137}Cs and ^{90}Sr to meet the WAPS requirement. Other radionuclides not measured were calculated based on the known concentration ratios to these two nuclides (Palmer et al. 2004).

Canister Heat Production—The heat generation rate for the HLW canister was calculated using the Standard Computer Analyses for Licensing Evaluation (SCALE) computer codes. The radionuclide concentrations provided the input for the SCALE computation. The maximum amount of heat generated, as determined for radioactive decay in 1996, was 362 W. The corresponding values predicted for 2015 and 3115 were 238 W and 3.5 W, respectively (Palmer and Barnes 2002). All predicted values are lower than the WAPS limit of 1,500 W per canister. The total thermal output for West Valley HLW canisters in 2017 is 44,200 W (DOE 2008).

Table A-12. Total and maximum (per canister) radionuclide content of West Valley HLW glass indexed to 2015 and 3115

Nuclide	2015		3115	
	Total Activity (Ci)	Maximum Activity (Ci/Canister)	Total Activity (Ci)	Maximum Activity (Ci/Canister)
¹⁴ C	1.37E+02	1.29E+00	1.20E+02	1.13E+00
⁵⁹ Ni	1.06E+02	1.00E+00	1.05E+02	9.94E-01
⁶³ Ni	7.08E+03	6.71E+01	1.78E+00	1.69E-02
⁷⁹ Se	6.02E+01	5.70E-01	5.95E+01	5.63E-01
⁹⁰ Sr	3.70E+06	1.78E+04	1.54E-05	7.45E-08
⁹³ Zr	2.72E+02	2.58E+00	2.72E+02	2.58E+00
^{93m} Nb	2.47E+02	2.34E+00	2.72E+02	2.58E+00
⁹⁹ Tc	1.70E+03	8.72E+00	1.69E+03	8.69E+00
¹⁰⁷ Pd	1.10E+01	1.04E-01	1.10E+01	1.04E-01
¹²⁶ Sn	1.04E+02	9.85E-01	1.03E+02	9.78E-01
¹³⁵ Cs	1.61E+02	1.09E+00	1.61E+02	1.09E+00
¹³⁷ Cs	4.05E+06	2.04E+04	3.72E-05	1.87E-07
¹⁵¹ Sm	6.96E+04	6.59E+02	1.46E+01	1.38E-01
²²⁷ Ac	1.20E+01	1.14E-01	1.49E+01	1.41E-01
²³² Th	1.64E+00	1.55E-02	1.64E+00	1.55E-02
²³¹ Pa	1.52E+01	1.44E-01	1.48E+01	1.41E-01
²³³ U	9.53E+00	9.03E-02	9.60E+00	9.09E-02
²³⁴ U	5.01E+00	2.61E-02	7.61E+00	3.96E-02
²³⁶ Np	9.47E+00	8.97E-02	9.41E+00	8.91E-02
²³⁷ Np	2.38E+01	1.52E-01	3.28E+01	2.10E-01
²³⁸ Pu	6.95E+03	3.39E+01	4.52E+00	2.21E-02
²³⁹ Pu	1.65E+03	8.75E+00	1.61E+03	8.53E+00
²⁴⁰ Pu	1.22E+03	6.31E+00	1.09E+03	5.66E+00
²⁴¹ Pu	2.46E+04	1.24E+02	8.06E-01	4.08E-03
²⁴² Pu	1.65E+00	8.16E-03	1.67E+00	8.23E-03
²⁴¹ Am	5.31E+04	5.03E+02	9.24E+03	8.76E+01
^{242m} Am	2.65E+02	2.51E+00	1.76E+00	1.66E-02
²⁴³ Am	3.46E+02	3.28E+00	3.12E+02	2.96E+00
²⁴⁴ Cm	2.93E+03	2.78E+01	1.49E-15	1.41E-17

Source: WVDP 1996.

Surface Dose Rates—The radionuclide concentrations and SCALE computer code were also used to calculate the surface dose rates (Palmer and Barnes 2002). The radionuclides ¹³⁷Cs and ⁹⁰Sr have the largest effect on gamma dose rates while the (α, n) reactions and spontaneous fissions were the two neutron sources included. The calculated results show maximum values of 6,400 rem/h for gamma and 0.088 rem/h for neutron. When indexed to the year 2015, the maximum surface dose rates are 3,500 rem/h for gamma and 0.005 rem/h for neutron (WVDP 1996). The WAPS limits are 10⁵ rem/h for gamma and 10 rem/h for neutron.

Waste Packaging—The WVDP HLW glass is currently stored as individual canisters in the chemical process cell of the main process plant building (see Figure A-17) that must be decontaminated and decommissioned to evacuate the source area of the North Plateau plume. In 2012 DOE contracted to

conduct the HLW Canister Relocation and Storage Project. Under this contract 275 HLW glass canisters, two evacuated HLW canisters, one nonroutine HLW canister (WV-413), and two SNF debris drums will be loaded into NAC International vertical storage DPCs for interim onsite storage (awaiting removal from the West Valley site). The general concept followed will be to use a modified independent spent fuel storage installation dry cask storage system design currently in use at commercial nuclear power facilities in the U.S. The 275 glass canisters will be loaded into 55 commercially available DPCs with five canisters per cask. A separate cask will be used for the two evacuated canisters and the non-routine HLW canister. The SNF debris will also be loaded into a separate cask for a total of 57 casks.



Source: Zadins 2011.

Figure A-17. Photograph of HLW glass canisters stored in the chemical process cell of WVDP main process building

A-2.1.2 Savannah River Site High-Level Radioactive Waste Glass

The SRS has been reprocessing spent fuel since 1954 and is currently vitrifying the waste that resulted from that reprocessing. There are two main types of wastes at SRS: plutonium-uranium extraction (PUREX) process and the H-modified PUREX process wastes. The PUREX process wastes tend to have higher iron contents while the H-modified wastes typically have higher aluminum concentrations. The waste tanks at SRS are made of mild steel (i.e., carbon steel) and cannot contain acid, which will corrode the tanks. Therefore, the wastes were neutralized with caustic to produce an alkaline waste that can be safely stored in these tanks. When the residual waste from plutonium separations is neutralized, it forms a solid layer known as sludge. The remaining liquid is called supernate. The supernate was evaporated to reduce the volume and, upon cooling, formed a solid salt known as salt cake. Therefore, the waste in the tanks consists of sludge, supernate, and salt cake fractions.

The tank waste is highly radioactive due to fission products from the irradiation of the uranium and other fissile materials to manufacture plutonium and other radioisotopes. Waste pretreatment processes are used to separate the waste into low and high activity streams before solidification. At SRS, the separated high activity waste fraction is vitrified in the DWPF. In the DWPF, the waste is chemically adjusted, mixed with glass frit and vitrified in a ceramic-lined Joule heated melter. The molten glass is poured into stainless steel canisters. The low activity waste fraction is stabilized in a cementitious waste form known as Saltstone for on-site disposal at SRS as WIR.

Savannah River Glass Waste Form Description—Although high level waste glass compositions can contain in excess of 30 components, the borosilicate glasses are primarily comprised of a few key constituents including: silica (SiO_2), boria (B_2O_3), soda (Na_2O) and alumina (Al_2O_3) (DOE 1996). Structurally, the glass is amorphous and made up of $(\text{SiO}_4)^{4-}$, $(\text{AlO}_4)^{4-}$ and $(\text{BO}_4)^{5-}$ tetrahedral and $(\text{BO}_3)^{3-}$ trigonal structural units that share corner oxygen atoms (i.e., bridging oxygen atoms). Any unshared oxygen atoms (i.e., non-bridging oxygen atoms) bond to other species such as alkali ions, alkaline-earth ions, etc. General properties for HLW borosilicate glasses are summarized in Table A-13.

Table A-13. Properties of HLW borosilicate glass

Property	Value
Density	2.75 g/cm ³
Tensile strength	57 MPa
Compressive strength	550 MPa
Thermal conductivity	0.95 W/m-K (at 100°C)
Heat capacity	0.83 J/g-K (at 25°C)
Softening point	500°C (nominal)
Annealing range	450°C to 500°C

Source: DOE 1996.

Waste Form Canisters—The canisters containing the solidified glass are constructed of 304L stainless steel (Cannell et al. 1998). The canister body is rolled and welded from stainless steel plate to form the cylinder. The cylinder is welded to top and bottom heads that are hot-formed from plates. The nozzle is machined from forge stock and is welded to the top head. After filling with glass, a plug is resistance upset welded in the nozzle to seal the canister.

For DWPF, the length of the unfilled canister, after accounting for the closure method, must be 3.000 m (+0.005 m, -0.020 m), including the neck and lifting flange (DOE 1996). The outer diameter of the unfilled DWPF canisters shall be 61.0 cm (+1.5 cm, -1.0 cm). The canister cylinder is nominally 0.95 cm thick. The top head and bottom head are nominally 1.59 cm thick and 1.27 cm thick, respectively.

After filling with glass, the canisters must satisfy two dimensional specifications. The dimensions of the canistered waste form shall be such that the canistered waste form will stand upright without support on a flat horizontal surface and fit completely without forcing when lowered vertically into a right-circular, cylindrical cavity, 64.0 cm in diameter and 3.01 m in length (DOE 1996). The weight of a filled and sealed DWPF waste form canister shall not exceed 2,500 kg (DOE 1996).

Canister Production—In the eight macrobatches that were processed from 1996 through early 2012 at SRS, over 15 million liters (~4 million gallons) of waste has been treated resulting in over 6.4 million kilograms of borosilicate glass contained in 3,339 canisters (each canister contains approximately 1,800 kg of glass), as shown in Table A-14. Note: Section A-2.2.2 provides projections for the remainder of the vitrified HLW that is to be produced at DWPF. To facilitate operations, DWPF uses a macrobatch strategy where a large volume of sludge (approximately 2 million liters) is prepared and staged for transfer to DWPF for processing. In this manner, a macrobatch represents a consistent waste chemistry

feed for glass production. The DWPF recently completed processing macrobatch 9. Data is available for glass produced through macrobatch 8 (early 2012) and will be presented in this appendix. Data reflecting processing of macrobatch 9 is included in the Section A-2.2.2. Table A-14 provides data on the number of canisters and amount of glass produced in the first 8 macrobatches at DWPF, representing operations from 1996 through early 2012.

Table A-14. Canisters produced, glass mass and canister heat content (at the time of production) in macrobatches 1-8

	Macrobatches							
	1	2	3	4	5	6	7	8
Number of canisters	495	726	363	727	314	323	194	197
Glass (kg x1000)	890	1260	650	1,300	560	590	310	350
Heat content (W/canister)	4.0	4.0	19.0	25.1	32.1	45.1	120.7	115.4

Radionuclide Content—During production of HLW glass, the DWPF must demonstrate compliance with the WAPS. Production records for each DWPF canistered waste form are used to document compliance with the WAPS. The data in the production records can be summarized at the macrobatch level since the macrobatch represents a sustained period of constant feed to DWPF. WAPS 1.2.2 requires that the DWPF report the inventory for radionuclides that have half-lives greater than 10 years and are present in the glass at greater than 0.05% of the total radionuclide inventory at any point up to 1,100 years after production (DOE 1996; WSRC 2001). To ensure that all radionuclides are correctly reported, the DWPF has extended this specification to all isotopes exceeding 0.01% under those conditions and has reflected this in the Waste Form Compliance Plan for DWPF operations (WSRC 1999).

Table A-15 provides the reportable radionuclide data for glass produced in the DWPF for macrobatches 1 through 8 (WSRC 2002; WSRC 2004; WSRC 2006; WSRC 2009; SRR 2011a, SRR 2011b, Johnson 2011, Johnson 2012). The radionuclides reported for macrobatches 7 and 8 are based on glass pour stream samples because the Production Records for these macrobatches are still in preparation. Concentrations of other minor radionuclides are available based on macrobatch waste samples characterized in advance of macrobatch processing (Hyder 1995; Fellingner et al. 2004; Bibler et al. 2002; Bannochie and Bibler 2005a; Bannochie et al. 2008; Bannochie et al. 2010; Bannochie and DiPrete 2011; Reboul et al. 2011). The concentration in glass can be calculated from these waste analyses using the determined sludge dilution factor and then extrapolated to a curie per canister value using a nominal mass of glass per canister value.

Table A-15. Reportable radionuclide data for macrobatches 1-8

Radionuclide	Macrobatches (Radioactivity in Ci/canister)							
	1	2	3	4	5	6	7	8
Am-241	3.90E+00	4.50E+00	2.30E+01	1.60E+01	1.37E+01	2.33E+01	2.5E+01	2.7E+01
Am-242m	NR	NR	NR	7.50E-02	5.45E-02	3.25E-01	NM	NM
Am-243	2.40E-02	3.90E-02	3.80E-01	1.30E+00	1.28E+00	6.94E-01	NM	NM
Bk-247	NR	NR	NR	NR	1.06E-02	NR	NM	NM
Cf-249	NR	NR	NR	2.40E-02	NR	NR	NM	NM
Cf-251	NR	NR	8.40E-03	1.90E-02	1.46E-02	1.82E-02	NM	NM
Cl-36	NR	NR	NR	NR	NR	7.00E-01	NM	NM
Cm-244	7.50E+00	3.00E+00	3.10E+01	5.90E+01	7.06E+01	3.31E+01	NM	NM
Cm-245	3.50E-04	NR	2.70E-03	9.20E-03	2.72E-02	3.21E-02	NM	NM
Cm-246	3.40E-03	2.80E-02	1.70E-02	1.40E-02	1.48E-02	9.26E-03	NM	NM
Cm-247	NR	NR	NR	2.20E-02	4.40E-03	NR	NM	NM
Cm-248	NR	NR	NR	2.30E-02	4.60E-03	NR	NM	NM
Co-60	NR	NR	NR	NR	NR	1.76E+00	NM	NM
Cs-137	4.10E+01	1.00E+02	1.90E+02	2.60E+02	2.75E+02	7.24E+02	2.4E+03	7.8E+02
Nb-93m	2.60E-02	4.40E-02	Note 1	Note 1	1.63E-01	2.82E-01	NM	NM
Ni-59	1.20E-02	3.30E-02	2.20E-01	5.60E-01	4.42E-01	9.32E-01	NM	NM
Ni-63	2.30E+00	5.70E+00	1.40E+01	4.60E+01	5.12E+01	7.96E+01	NM	NM
Np-237	8.70E-03	8.80E-03	9.30E-03	2.80E-02	2.02E-02	4.98E-02	3.1E-02	<3.4E-02
Pu-238	3.60E+01	4.40E+01	2.70E+01	2.20E+01	9.50E+01	1.98E+02	2.5E+02	1.4E+02
Pu-239	4.20E+00	3.30E+00	5.40E+00	1.20E+01	8.02E+00	1.46E+01	1.4E+01	1.1E+01
Pu-240	1.10E+00	1.20E+00	1.70E+00	4.00E+00	3.51E+00	4.74E+00	5.3E+00	<8.2E+00
Pu-241	2.00E+01	1.90E+01	2.00E+01	4.60E+01	8.41E+01	9.26E+01	6.70E+01	4.4E+01
Pu-242	9.90E-04	2.50E-03	3.20E-03	4.60E-03	4.54E-03	4.91E-03	<2.5E-02	<1.0E-01
Se-79	6.80E-03	2.80E-02	4.40E-02	1.70E-02	1.25E-02	NR	NM	NM
Sm-151	7.50E+00	4.30E+01	1.20E+02	1.60E+02	8.80E+01	1.31E+02	NM	NM
Sn-121m	NR	8.70E-01	2.60E+00	2.00E+00	NR	NR	NM	NM
Sn-126	4.00E-03	9.70E-03	3.20E-02	1.20E-02	2.52E-01	2.60E-01	NM	NM
Sr-90	3.30E+02	2.50E+03	3.20E+03	4.10E+03	5.63E+03	1.62E+04	1.1E+04	7.1E+04
Tc-99	1.40E-01	1.30E-01	8.90E-02	1.60E-01	1.10E-01	1.31E-01	<2.4E-01	3.3E-02
Th-229	8.10E-05	4.50E-05	NR	NR	NR	NR	1.7E-03	1.2E-03
U-233	1.60E-02	3.00E-02	7.50E-03	1.30E-02	1.49E-02	1.74E-02	1.3E-01	<4.4E-01
U-234	1.60E-02	2.00E-02	2.50E-02	2.50E-02	2.65E-02	4.54E-02	7.6E-02	<2.5E-01
U-235	NR	NR	4.60E-04	6.10E-04	4.99E-04	5.03E-04	4.2E-04	5.3E-04
U-236	5.20E-04	NR	6.60E-04	7.10E-04	6.32E-04	9.75E-04	1.1E-03	<1.4E-03
U-238	6.50E-03	6.50E-03	1.80E-02	1.90E-02	1.38E-02	1.20E-02	9.3E-03	1.3E-02
Zr-93	3.30E-02	5.60E-02	9.60E-02	3.70E-02	2.06E-01	3.75E-01	9.6E-01	9.8E-01

NR = not reportable; NM = not measured

Note 1: Nb-93m reaches secular equilibrium with Zr-93 over 1,100 years and becomes a reportable radionuclide.

Canister Heat Content—Based on the radionuclide concentrations and glass mass, the decay heat can be calculated on a per canister basis. These data are summarized for each macrobatch in Table A-14. It should be noted that the heat content in canisters has increased significantly in the later sludge batches.

This coincided with the inclusion of radionuclides in the glass removed from the supernate fraction of the wastes through waste treatment operations introduced at SRS (namely the Modular Caustic Side Solvent Extraction Unit to remove cesium from the waste and the Actinide Removal Process to remove strontium and transuranics from the waste). Prior to implementation of these processes, only the sludge fraction of the waste was being vitrified, resulting in glass with relatively low heat content.

Glass Composition—As discussed above, borosilicate glass compositions used for HLW immobilization are comprised of a few key oxides. The chemical composition of typical HLW borosilicate glasses is summarized in Table A-16.

Table A-16. Typical composition for HLW borosilicate glasses

Oxide	Weight Percent
Silica (SiO ₂)	33-65
Boria (B ₂ O ₃)	3-20
Soda (Na ₂ O)	4-22
Alumina (Al ₂ O ₃)	3-20
Metal Oxides (Fe ₂ O ₃ , MnO, NiO, MgO, CaO, Li ₂ O, etc.)	0-50

In DWPF, the specific glass compositions vary from macrobatch to macrobatch due to variations in the composition of the waste. Glass optimization efforts result in compositions that maximize waste loading while maintaining product quality and glass properties important to processing. Table A-17 summarizes the compositions produced to date in DWPF in macrobatches 1-8. The compositions were determined from pour stream samples taken during production campaigns for each macrobatch (Fellinger and Bibler 1999; Fellinger and Bibler 2000; Cozzi and Bibler 2004; Bannochie and Bibler 2005b; Reigel and Bibler 2010).

Table A-17. Glass compositions for DWPF macrobatches 1-8

Oxide	Macrobatch Glass Composition (Concentration in wt %)							
	1	2	3	4	5	6	7	8
Al ₂ O ₃	4.3	5.37	4.34	4.79	7.78	6.71	9.83	8.59
B ₂ O ₃	8.2	8.18	4.44	4.44	8.29	5.58	4.91	4.27
BaO	NR	NR	0.05	0.05	0.06	0.04	0.04	0.05
CaO	1.3	1.39	1.31	1.03	0.72	0.70	0.55	0.46
CdO	NR	NR	0.05	0.14	0.06	0.03	0.01	0.02
CeO ₂	NR	NR	0.06	0.02	BD	0.06	0.05	BD
Cr ₂ O ₃	NR	NR	0.08	0.06	0.06	0.05	0.09	0.07
CuO	NR	NR	0.03	0.01	0.04	0.02	0.03	0.4
Fe ₂ O ₃	12.6	10.5	12.2	10.80	8.21	8.53	9.21	8.37
Gd ₂ O ₃	NR	NR	0.03	0.01	0.01	0.03	0.03	0.05
K ₂ O	NR	NR	NR	NR	0.08	0.04	0.05	BD
La ₂ O ₃	NR	NR	0.01	0.01	0.01	0.02	0.03	0.04
Li ₂ O	3.6	3.53	5.27	4.96	5.25	5.55	5.04	4.56
MgO	2.1	2.16	1.16	1.16	0.78	0.51	0.35	0.27
MnO	1.1	1.76	1.47	2.09	1.62	1.73	2.44	2.01
MoO ₃	NR	NR	0.03	BD	BD	0.01	NR	BD
Na ₂ O	12.1	11.5	11.3	11.90	11.50	13.40	13.59	12.45
NiO	0.21	NR	0.55	0.55	0.48	0.96	1.11	1.22
P ₂ O ₅	0.39	0.63	0.48	0.29	0.25	0.21	0.20	BD
PbO	NR	NR	0.02	BD	0.01	0.01	0.01	BD
SO ₄	NR	NR	0.25	0.39	0.36	BD	0.24	BD
Sb ₂ O ₅	NR	NR	0.07	0.14	BD	BD	0.02	BD
SiO ₂	48.1	52.4	49.3	51.00	50.70	54.60	44.77	47.07
SnO ₂	NR	NR	0.08	0.14	BD	BD	NR	BD
SrO	NR	NR	0.32	0.28	0.01	0.02	0.02	0.03
ThO ₂	NR	NR	NR	NR	NR	NR	0.68	0.69
TiO ₂	NR	NR	0.06	0.06	0.07	0.20	0.04	0.66
U ₃ O ₈	1.0	1.1	3.36	3.51	2.23	2.22	2.03	2.43
ZnO	NR	NR	0.05	0.01	0.03	0.02	0.03	0.09
ZrO ₂	0.13	0.19	0.08	0.05	0.17	0.11	0.16	0.15

NR = not reported; BD = below detection

A-2.1.3 Radioactive Waste Glass at Hanford for Federal Republic of Germany

In 1986 and 1987, the Pacific Northwest Laboratory prepared isotopic heat and radiation sources to be used as part of the repository testing program by the FRG in the Asse Salt Mine (Kuhn and Rothfuchs 1989). Using the radioactive liquid-fed ceramic melter in the 324 Building, thirty stainless steel canisters were filled with borosilicate glass spiked with ¹³⁷Cs and ⁹⁰Sr to achieve the desired heat and dose targets. The ¹³⁷Cs was obtained from cesium capsules (see Section A-2.3.3) from the Hanford site and the ⁹⁰Sr was obtained from strontium nitrate in B-Plant. In addition to the 30 sources, two production demonstration canisters and two instrumented canisters for heat transfer studies were also produced. The FRG testing program was stopped before the canisters could be shipped and they have remained at the Hanford site. They are currently stored at the Central Waste Complex at the 200-West area on the central plateau of the Hanford site.

The 34 canisters were fabricated in Germany from stainless steel. They are 1.2 m long by 0.3 m in diameter. As part of the testing, the filled canisters passed through a 306 mm inside diameter tube to check their ovality.

The 30 isotopic source canisters were filled in three separate processing campaigns (RLFCM-7, RLFCM-8, and RLFCM-9) with different source objectives for each set of 10 canisters (Brouns and Powell 1988). Table A-18 summarizes the heat and dose characteristics of the 34 FRG glass canisters.

Table A-18. Average heat and dose characteristics for FRG glass canisters

Number of Canisters	¹³⁷ Cs Content (kCi)			⁹⁰ Sr Content (kCi)			Decay Heat (W/canister)	Surface Dose (R/hr)
	Average	Min	Max	Average	Min	Max	Average	Average
10	192	175	237	85	67	110	1490	272,000
10	78	17	187	143	90	159	1330	112,000
10	207	182	233	130	103	148	1860	310,000
2 ^a	Unknown	-	-	Unknown	-	-	1020	190,000
2 ^b	Unknown	-	-	Unknown	-	-	Unknown	Unknown

^aInstrumented canisters for heat transfer studies

^bProduction demonstration canisters

Source: Brouns and Powell 1988; Holton et al. 1989.

Table A-19 summarizes the glass compositions for the three campaigns. After filling, a controlled leak helium capsule was placed in each canister and a lid was welded on. The welds were confirmed by checking for helium outside the canisters. Each canister was then decontaminated by electropolishing. They were stored in A-Cell of 324 Building until being moved to the Central Waste Complex.

Table A-20 summarizes the weights of the canister components and the glass contained inside. Holton et al. (1989) provides appendices with data on the individual isotopic heat and radiation source canisters.

The canisters are currently stored in casks supplied by the FRG. There are two GNS casks and six CASTOR casks. Dimensions of the casks are shown in Table A-21 along with number of canisters in each cask.

An environmental assessment was prepared prior to shipping the canisters to the Central Waste Complex (DOE 1997). That environmental assessment states that the 34 canisters are classified as remote-handled (RH) transuranic waste. It is believed that some trace quantities of TRU were included in the FRG glass canisters as a result of residual TRU in the tanks in B-Plant through which the strontium nitrate was processed.

A final configuration for disposal of the FRG glass canisters has not been selected. Possible options include (1) stacking the canisters into stainless steel disposal containers (two per 3-m container or three per 4.57-m container) or (2) they would be individually disposed of in the repository.

Table A-19. Nominal glass compositions for the 30 FRG heat and radiation source canisters

Oxide Compound	Average Glass Composition, wt. %		
	RLFCM-7	RLFCM-8	RLFCM-9
Al ₂ O ₃	2.88	2.58	2.17
B ₂ O ₃	13.68	14.65	14.84
BaO	1.05	1.13	1.02
CaO	1.52	1.25	0.79
CeO ₂	0.06	0.05	0.07
Cr ₂ O ₃	0.58	0.38	0.45
Cs ₂ O	5.02	2.08	5.74
Fe ₂ O ₃	11.18	10.10	9.93
La ₂ O ₃	1.04	1.07	1.53
Li ₂ O	0.31	0.00	0.00
MgO	0.78	0.54	0.44
MnO ₂	0.80	1.20	1.11
MoO ₃	0.05	0.00	0.00
Na ₂ O	16.5	13.22	11.58
Nd ₂ O ₃	0.65	0.71	0.89
NiO	0.39	0.25	0.44
PbO	0.16	0.00	0.00
RuO ₂	0.02	0.00	0.00
SiO ₂	41.25	48.02	46.59
SrO	1.65	2.67	2.34
TiO ₂	0.19	0.07	0.03
ZnO	0.08	0.01	0.00
ZrO ₂	0.15	0.04	0.05
Total	100.00	100.00	100.00

Source: Holton et al. 1989.

Table A-20. FRG canister weight data summary

	Average	Standard Deviation	Minimum	Maximum
Canister Weight, kg	73.4	1.1	71.4	76.4
Lid Weight, kg	5.2	0.00	5.1	5.2
Fiberfrax Insulation Weight, kg	0.5	0.0	0.5	0.5
Helium Capsule Weight, kg	0.7	0.0	0.7	0.7
Total Empty Canister Weight, kg	79.8	1.1	77.8	82.8
Weight Removed in Electropolishing, kg	1.1	0.0	1.1	1.1
Full Canister Weight, kg	237	6.0	222	249
Glass Weight, kg	158.3	5.9	143.6	171.4
Glass Volume, liters	60.6	1.6	58.6	64.2
Glass Specific Gravity	2.61	0.10	2.32	2.81

Source: Holton et al. 1989.

Table A-21. Dimensions of casks used to store FRG isotopic heat and radiation sources

	GNS Cask Dimensions	CASTOR Cask Dimensions
Overall height (without impact limiters)	1,636 mm (64.4 in.)	1,795 mm (70.6 in.)
Overall diameter (without impact limiters)	1,050 mm (41.3 in.)	1,675 mm (65.9 in.)
Cavity diameter	723 mm (28.5 in.)	895 mm (35.2 in.)
Cavity height	1,220 mm (48.0 in.)	1,250 mm (49.2 in.)

Source: DOE 1997.

A-2.2 Projected Vitrified HLW

Although progress has been made at the SRS to vitrify HLW tank waste at SRS (see Section A-2.1.2), the bulk of the waste including most of the salt fraction remains to be vitrified. Additionally, all tank waste at Hanford remains to be vitrified. This section includes descriptions of the forecasted waste treatment and glass products at Hanford and SRS.

A-2.2.1 Hanford High Level Radioactive Waste Glass

A-2.2.1.1 Hanford Tank Waste

The Hanford Site, located in southeastern Washington State, has approximately 54.6 million gallons (~207 million liters) of radioactive and listed hazardous wastes stored in 177 underground tanks on Hanford's Central Plateau (Certa et al. 2011). The wastes were generated from plutonium production as part of the U.S. defense programs during World War II and the Cold War. Fuel from production reactors along the Columbia River (and some from other reactors) was reprocessed to extract plutonium and later uranium for recycling. Wastes from those reprocessing operations are stored in the underground tanks and in cesium and strontium capsules (see Section A-2.3.3). The Tank Waste Treatment and Immobilization Plant (WTP) is being constructed on the Hanford Site to treat the tank wastes and convert them to glass waste forms for disposal.

Nuclear fuel consisting of uranium metal in aluminum or zirconium cladding was irradiated in one of nine reactors on the Hanford Site, and most was subsequently reprocessed in one of five chemical plants on site (Gephart and Lundgren 1998). Initially, the bismuth phosphate process was used to precipitate plutonium from the dissolved fuel in B Plant (through 1952) and T Plant (through 1956). The wastes including uranium were sent to single shell tanks for storage. Later, the wastes were retrieved from the single-shell tanks and were processed through U Plant to recover uranium from the wastes. Solvent extraction processes using tributyl phosphate in the Reduction-Oxidation (REDOX) Plant (1952 through 1967) and in PUREX Plant (1956 through 1972) were used to separate both plutonium and uranium from the dissolved fuel. By 1972, essentially all of the aluminum clad fuel had been reprocessed. The PUREX plant operated from 1983 to 1988 to process most of the zirconium clad fuel from N Reactor.

High-level wastes from the separation processes were adjusted to a pH between 12 and 14 to prevent corrosion of the carbon steel tanks using sodium hydroxide addition before adding to the tanks. The wastes were also processed through evaporators to remove water and reduce the volume of wastes to be stored in the tanks. Initially, the wastes were stored in single-shell tanks, and ultimately 149 of the single-shell tanks were used. Beginning in 1971, the wastes were stored in double-shell tanks, and ultimately 28 double-shell tanks were used.

In addition to the HLW from the fuel reprocessing plants, the tanks also contain wastes from various chemical additions, waste transfers and evaporation processes and from other sources on the Hanford site including N Reactor operation, Plutonium Finishing Plant metal production and scrap recovery operations, and fuel fabrication and research and development activities in the 300 and 400 areas.

The end result is a mix of supernatant and interstitial liquids, water soluble saltcake solids, and water-insoluble sludge solids. The total radioactivity is estimated to be about 128 MCi in the solids and 70 MCi in the liquids. The major sources of radioactivity are ^{137}Cs , which is soluble in the supernatant, and ^{90}Sr , which is found mostly in the sludge. The saltcake will be dissolved for processing. Because at least 67 of the single-shell tanks are known or suspected to have leaked wastes to the soil, the supernatant and interstitial liquids have been removed from the single-shell tanks to the extent possible and are stored in the double-shell tanks. Recently, several single-shell tanks and one double-shell tank have been identified as leaking, heightening the urgency to manage Hanford's tank wastes.

Retrieval operations are continuing to empty the single-shell tanks of all wastes in preparation for eventual closure. The bulk of the waste has been removed from eight tanks to date (C-103, C-104, C-106, C-201, C-202, C-203, C-204, S-112) with retrieval to the limits of modified sluicing complete on four tanks (C-108, C-109, C-110, and C-112) (Rodgers 2013).

Although all of the Hanford tank waste has been managed as if it were HLW, 20 of the underground storage tanks at Hanford contain waste that might be considered to be TRU wastes because the waste may not meet the legal definition of HLW. Of the 20 potential TRU tanks, 11 (B-201, B-202, B-203, B-204, T-201, T-202, T-203, T-204, T-104, T-110, and T-111) contain contact-handled (CH) TRU (CH-TRU) and nine (T-105, T-107, T-112, B-107, B-110, B-111, SY-102, AW-103, and AW-105) contain RH TRU tank wastes.

In the current baseline (Certa et al. 2011), the CH-TRU was assumed be treated in a supplemental transuranic treatment facility, would be temporarily stored on-site, and could be disposed as TRU wastes at the Waste Isolation Pilot Plant (WIPP) near Carlsbad, New Mexico. The potential RH-TRU tank wastes are currently assumed to be converted to a glass waste form along with other HLW in the WTP HLW vitrification facility for storage and disposal at a federal repository.

The composition of the wastes in each tank is maintained in a database known as the Best Basis Inventory. The Best Basis Inventory is updated at least quarterly to reflect ongoing operations in the tank farms. Table A-22 lists the chemical inventory in the Hanford HLW, CH-TRU, and RH-TRU tanks. Table A-23 lists the radionuclide inventory in the tanks decayed to January 1, 2008.

Table A-22. Chemical inventory in Hanford HLW storage tanks

	CH-TRU Tanks (kg)	RH-TRU Tanks (kg)	HLW Tanks (kg)	Total Inventory (kg)
Al	2.88E+04	1.84E+05	8.46E+06	8.67E+06
Bi	1.77E+05	9.08E+04	2.88E+05	5.57E+05
Ca	9.45E+03	8.84E+03	2.50E+05	2.68E+05
Cl	4.93E+03	1.87E+04	8.03E+05	8.26E+05
TIC as CO ₃	3.66E+04	2.19E+05	9.83E+06	1.01E+07
Cr	1.13E+04	3.15E+04	5.49E+05	5.92E+05
F	3.30E+04	2.30E+05	1.02E+06	1.29E+06
Fe	7.60E+04	1.23E+05	1.06E+06	1.26E+06
Hg	8.22E+00	2.84E+01	1.95E+03	1.98E+03
K	1.04E+04	5.79E+04	8.85E+05	9.53E+05
La	2.34E+04	2.50E+03	6.15E+03	3.21E+04
Mn	3.62E+04	9.76E+03	1.17E+05	1.63E+05
Na	3.01E+05	1.44E+06	4.72E+07	4.89E+07
Ni	6.19E+02	9.61E+02	9.56E+04	9.71E+04
NO ₂	3.50E+04	3.15E+05	1.14E+07	1.18E+07
NO ₃	3.88E+05	1.17E+06	5.44E+07	5.60E+07
Pb	2.35E+03	5.17E+03	7.35E+04	8.10E+04
Oxalate	1.51E+04	8.23E+04	1.45E+06	1.55E+06
PO ₄	2.32E+05	2.87E+05	4.64E+06	5.16E+06
Si	3.49E+04	5.45E+04	7.43E+05	8.32E+05
SO ₄	2.46E+04	1.47E+05	3.64E+06	3.81E+06
Sr	1.84E+03	1.90E+03	3.85E+04	4.22E+04
TOC	1.05E+04	4.43E+04	1.27E+06	1.32E+06
UTOTAL	8.90E+03	4.94E+04	5.82E+05	6.40E+05
Zr	1.20E+02	2.72E+05	1.31E+05	4.03E+05

Table A-23. Radionuclide inventory in Hanford HLW tanks as of January 1, 2008

	CH-TRU Tanks (Ci)	RH-TRU Tanks (Ci)	HLW Tanks (Ci)	Total Inventory (Ci)
³ H	1.98E+00	1.93E+02	2.61E+03	2.80E+03
¹⁴ C	7.30E-02	1.15E+01	5.40E+02	5.52E+02
⁵⁹ Ni	1.22E-01	7.54E+00	1.61E+03	1.62E+03
⁶⁰ Co	8.94E-02	5.20E+01	4.03E+03	4.08E+03
⁶³ Ni	1.28E+01	5.21E+02	1.44E+05	1.45E+05
⁷⁹ Se	3.26E-03	5.69E+00	1.38E+02	1.44E+02
⁹⁰ Sr	1.13E+04	6.63E+05	4.65E+07	4.72E+07
⁹⁰ Y	1.13E+04	6.63E+05	4.65E+07	4.72E+07
⁹³ Zr	1.73E+00	4.82E+01	3.69E+03	3.74E+03
^{93m} Nb	1.59E+00	4.05E+01	3.13E+03	3.17E+03
⁹⁹ Tc	1.83E+01	9.04E+02	2.55E+04	2.65E+04
¹⁰⁶ Ru	4.13E-12	3.88E-02	1.20E+01	1.21E+01
^{113m} Cd	5.12E-02	6.74E+01	3.82E+03	3.89E+03
¹²⁵ Sb	3.08E-04	1.19E+02	4.00E+03	4.12E+03
¹²⁶ Sn	5.96E-03	6.37E+00	3.86E+02	3.92E+02
¹²⁹ I	5.10E-04	4.97E-01	2.90E+01	2.95E+01
¹³⁴ Cs	1.46E-03	9.19E+00	7.08E+02	7.17E+02
¹³⁷ Cs	4.76E+02	7.11E+05	3.81E+07	3.88E+07
^{137m} Ba	4.50E+02	6.71E+05	3.60E+07	3.67E+07
¹⁵¹ Sm	1.43E+02	1.42E+05	3.41E+06	3.55E+06
¹⁵² Eu	3.80E-03	8.45E+01	8.25E+02	9.10E+02
¹⁵⁴ Eu	1.74E+00	5.18E+02	5.22E+04	5.27E+04
¹⁵⁵ Eu	7.01E-01	2.65E+02	2.52E+04	2.54E+04
²²⁶ Ra	7.26E-06	2.17E-04	9.66E-03	9.89E-03
²²⁷ Ac	1.52E-04	1.64E-02	4.13E+00	4.15E+00
²²⁸ Ra	2.68E-10	1.05E-01	6.71E+00	6.81E+00
²²⁹ Th	3.18E-08	1.68E-02	1.46E+00	1.48E+00
²³¹ Pa	6.44E-04	5.34E-02	5.12E+00	5.18E+00
²³² Th	2.68E-10	1.05E-01	6.71E+00	6.81E+00
²³² U	3.63E-05	2.27E-01	8.61E+00	8.84E+00
²³³ U	3.12E-06	6.35E+00	6.74E+02	6.81E+02
²³⁴ U	3.09E+00	2.14E+01	2.11E+02	2.35E+02
²³⁵ U	1.30E-01	8.49E-01	8.66E+00	9.64E+00
²³⁶ U	3.60E-02	1.60E+00	4.84E+00	6.47E+00
²³⁷ Np	5.79E-02	4.03E+00	1.12E+02	1.16E+02
²³⁸ Pu	7.22E+00	3.43E+02	2.28E+03	2.63E+03
²³⁸ U	2.97E+00	1.64E+01	1.94E+02	2.14E+02
²³⁹ Pu	9.46E+02	6.80E+03	4.15E+04	4.92E+04
²⁴⁰ Pu	1.02E+02	1.52E+03	9.15E+03	1.08E+04
²⁴¹ Am	1.82E+02	2.18E+04	1.34E+05	1.56E+05
²⁴¹ Pu	1.73E+02	1.63E+04	6.70E+04	8.35E+04
²⁴² Cm	3.96E-02	1.11E+00	1.20E+02	1.21E+02
²⁴² Pu	3.04E-03	1.33E-01	6.61E-01	7.97E-01
²⁴³ Am	2.40E-02	6.51E+00	6.55E+01	7.20E+01
²⁴³ Cm	3.96E-04	5.11E-01	1.25E+01	1.30E+01
²⁴⁴ Cm	8.18E-03	1.10E+01	2.76E+02	2.87E+02

A-2.2.1.2 Hanford HLW Vitrification

The DOE's Office of River Protection manages the River Protection Project, the mission of which is to retrieve and treat the Hanford tank waste and close the tank farms to protect the Columbia River. The primary Office of River Protection strategy to accomplish the River Protection Project mission involves the construction and operation of the WTP, which will treat and vitrify the HLW fraction found in the Hanford tank farms. The HLW glass produced is designed for shipment to a geologic repository for disposal. A portion of the low-activity waste separated from the HLW will also be immobilized in the WTP low-activity waste vitrification facility; other facilities ("supplemental" low-activity waste treatment) are expected to be needed to meet the capacity required to treat the balance of the low-activity waste. The low-activity waste glass will be disposed of onsite at the Integrated Disposal Facility.

The construction of the WTP HLW vitrification facility was scheduled to be completed by 2016 and waste treatment is projected to be concluded in 2043, with the production of between 9,000 and 15,000 (GAO 2009) canisters of HLW glass with a current nominal value of 10,586 canisters (Certa et al. 2011); however, at present, a later date for the completion of construction appears likely.

The WTP complex under construction consists of four major facilities: pretreatment, HLW vitrification, low-activity waste vitrification, and an analytical laboratory. Pretreatment of Hanford tank waste includes concentrating the waste by removing excess water, ultra-filtration to separate solid and liquid fractions, washing and leaching of the solid fractions to remove soluble salts; aluminum; and chromium, and ion exchange of the liquid fractions and wash solutions to remove ¹³⁷Cs. Additional pretreatment may be performed on selected tank wastes to remove strontium and transuranic nuclides by precipitation. The treated liquid fraction (after cesium and potentially strontium and transuranic removal) constitutes the low-activity waste stream, which is transferred to the low-activity waste vitrification facility or a supplemental low-activity waste treatment facility. The HLW fraction comprises the separated solids, cesium concentrate, and strontium/transuranic precipitate. The HLW stream will contain over 95% of the radioactivity but less than 10% of the volume to be treated.

The WTP HLW vitrification facility consists of two joule-heated ceramic melters. The HLW feed will be mixed with a combination of glass-forming chemicals in one of two melter-feed preparation vessels to produce a melter feed. Glass-forming chemicals include aluminum silicate (kyanite), borax, boric acid, calcium silicate, ferric oxide, lithium carbonate, silica, sodium carbonate, titanium oxide, zinc oxide, and zirconium silicate. Other additives may also be required for process control (e.g., sucrose for redox control). Sampling and analysis of the melter feed will provide compositional data to support model calculations to confirm that the feed will produce a glass that meets all processing and regulatory requirements.

The melter feed slurry is fed to the melter by two air displacement slurry pumps through two feed nozzles in the melter lid. The feed slurry falls onto the molten glass surface and spreads out into a layer called the cold cap. As the feed material in the cold cap is heated to the glass pool temperature of 1,150°C, water evaporates and salts decompose, and the non-volatile materials react and fuse to form molten borosilicate glass. The gaseous reaction products are removed through the off-gas treatment system. The melter contains about 11 metric tons (MT) of glass. The nominal glass production rate is 3 MT per day per melter and the average residence time in the melter is about 4 days.

In addition to the melt chamber, each HLW melter has two discharge chambers that direct the molten glass to pour spouts. Glass will be periodically poured into cylindrical stainless steel HLW canisters by means of an airlift system. Canistered waste form specifications require that a height equivalent to at least 80% of the empty canister volume be filled. The filling process will be monitored with an infrared camera system to meet this requirement and prevent over filling. Glass pouring will be suspended when the 95% fill level is reached. The resolution of the camera system is adequate to document that the average canister fill level is greater than 95% and no canister is less than 87% full.

After the glass is cooled, a mechanical glass level detector or the indexed glass shard sampling wand will be used to determine the fill height in the canister. Filling of an HLW canister will take about one day. After filling, the canister will remain in place for initial cooling and off-gassing before removal from the melter pour spout. When the glass is sufficiently cool, each canister is inspected, the glass is sampled as necessary and the canister is sealed by welding. The HLW canisters are decontaminated by a nitric acid/cerium chemical milling process that removes a thin layer of the outer surface. Waste effluents from decontamination are recycled to the WTP pretreatment facility. If the decontamination is within specification limits, the HLW canister will be transferred to the Canister Storage Building on the Hanford site for interim storage. No overpacking of the canisters is planned for canister storage operations. Previous plans included the package of waste glass canisters and DOE fuel in codisposal packages for disposal in the federal geologic repository.

Table A-24 summarizes the physical and other characteristics of the Hanford HLW glass canisters, while Table A-25 lists the canister design codes and standards. As specified in the WAPS, the canistered waste form will have a concentric neck and lifting flange (DOE 2012a).

Table A-24. Hanford HLW canister data summary

Canister Length, cm	450
Nominal Outer Diameter, cm	61
Thickness, cm	0.95
Empty Canister Weight, kg	715
Available Volume, liter	1190
Material	Stainless Steel 304 L
Nominal Fill Height, % ^(a)	95
Nominal Glass Volume, liter	1135
Filled Canister Weight, kg	3735
Glass Weight, kg	3020
Glass Density, g/cm ³	2.66

Source: DOE 2008; Certa et al. 2011.

Table A-25. Design codes and standards for the Hanford HLW canisters

Material of Construction	Austenitic stainless steel per nationally recognized code
Canister Welding	2001 ASME Boiler and Pressure Vessel Code, Section IX (ASME 2001) (or equal)
Canister Weld Nondestructive Examination	Radiographic examination of all full penetration butt welds per 2001 ASME Boiler and Pressure Vessel Code, Section V (ASME 2001) (or equal)
Final Testing Prior to HLW Producer Acceptance	Pass both vendor pressure and helium leak tests

Source: DOE 2008.

The HLW glass must meet a variety of processing, performance, and WTP contract requirements; examples include melt viscosity, product consistency test responses, and minimum waste loading. Computer models are used in the River Protection Project to plan and evaluate operating scenarios, including optimization of HLW glass formulations to minimize the waste form volume. Models that

relate glass properties to composition have been and are being developed using data on glass compositions and properties including density, melt viscosity, electrical conductivity, Product Consistency Test response, TCLP response, and one-percent crystal temperature ($T_{1\%}$ —i.e., the equilibrium melt-glass temperature with 1 volume% crystals). Formulations of glasses for the various HLW types at Hanford are expected to be constrained primarily by the following glass components or properties: Bi_2O_3 , P_2O_5 , SO_3 , ZrO_2 , spinel- $T_{1\%}$, and nepheline (sodium aluminum silicate) formation. These constraints together determine about 98% of the HLW glass mass (Certa et al. 2011). Table A-26 and Figure A-18 present the System Plan HLW glass composition region as determined from a combined composition of the Hanford tank wastes derived from material balance estimates (Certa et al. 2011). The weighted average waste loading for the System Plan Reference Case HLW glass is 36.9 wt %.

Table A-26. Summary of system plan Hanford HLW glass composition region

Comp	Min	Median	Max
Al_2O_3	2.02	13.27	18.89
B_2O_3	4.00	10.41	20.00
BaO	0.00	0.02	0.20
Bi_2O_3	0.01	0.92	3.20
CaO	0.10	0.77	3.07
CdO	0.00	0.01	1.13
Cr_2O_3	0.05	0.48	1.04
F^-	0.00	0.20	0.62
Fe_2O_3	4.00	4.34	17.40
K_2O	0.02	0.16	2.55
La_2O_3	0.01	0.05	0.69
Li_2O	0.93	6.00	6.00
MgO	0.01	0.09	0.56
MnO	0.11	1.15	5.73
MoO_3	0.00	0.01	0.05
Na_2O	4.18	8.90	21.40
Nd_2O_3	0.00	0.02	0.27
NiO	0.04	0.36	1.75
P_2O_5	0.20	1.26	2.50
SiO_2	31.51	42.24	53.00
SO_3	0.05	0.23	0.50
SrO	0.01	0.12	3.68
ThO_2	0.00	0.07	2.84
TiO_2	0.00	0.01	0.03
UO_3	0.14	2.03	6.30
ZnO	0.00	0.02	0.06
ZrO_2	0.01	0.13	13.50
Minors	0.05	0.35	1.57

Source: Certa et al. 2011.

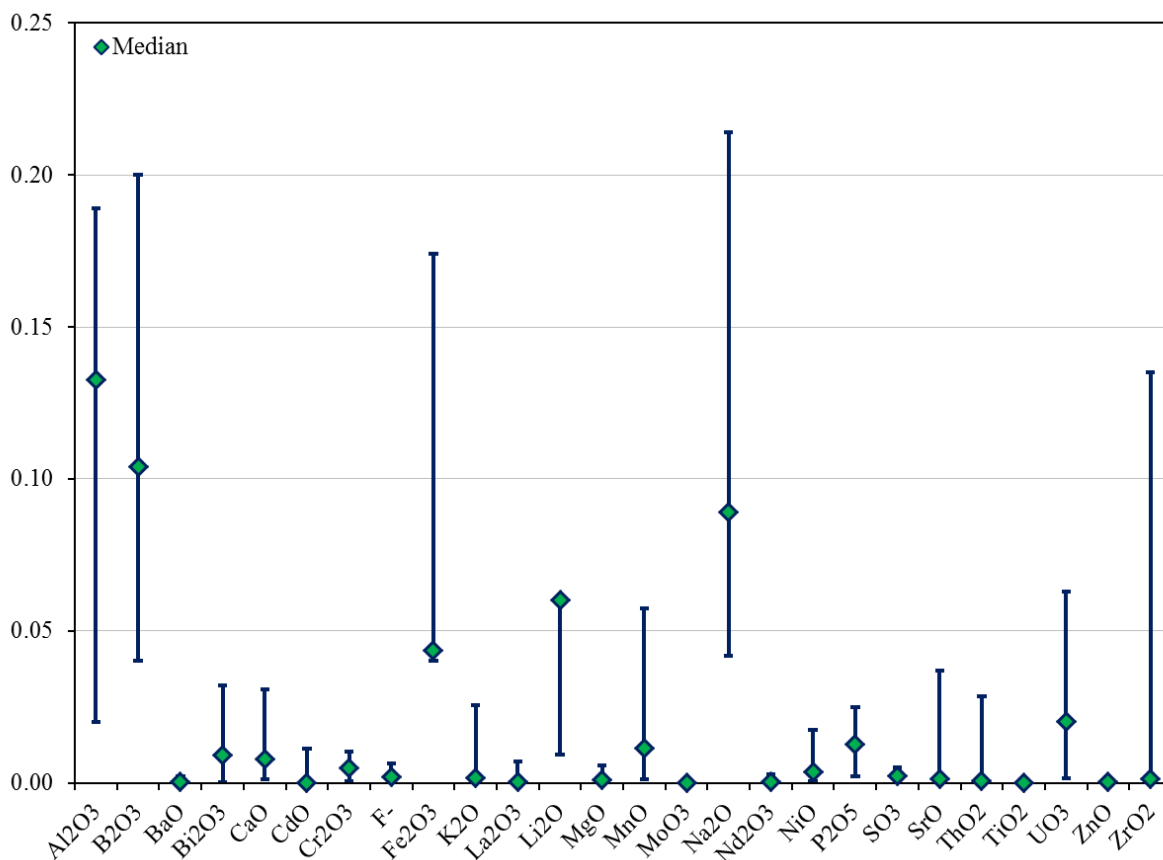

Figure A-18. Range of projected Hanford HLW glass component concentrations in wt % of reference oxides

Table A-27 summarizes the inventory of radionuclides that will be vitrified into HLW glass, as estimated from the System Plan. The total estimated thermal output from radionuclide decay of Hanford HLW tank waste is 306 kW. This yields an average of roughly 29 W/canister. Figure A-19 shows the projected heat per canister as a function of production time. The fissile content of Hanford HLW glass is summarized in Table A-28.

Work is ongoing to expand the glass database and models to significantly improve the waste loadings and waste processing rate of the WTP HLW glass over this baseline case in view of the substantial potential cost and schedule benefits (Matlack et al. 2007, 2012). The results of these activities are anticipated to increase the loading of Hanford HLW in glass to a weighted average in the range of 52 to 54 wt % and result in slightly less than 8,000 canisters (Vienna et al. 2013). The radionuclide concentrations and decay heat from such advanced glass formulations will necessarily increase.

Table A-27. Range of projected radionuclide content of Hanford HLW glasses in Ci/canister

Radionuclide	Min	Median	Max
⁵⁹ Ni	2.727E-03	9.894E-02	1.573E+00
⁶⁰ Co	4.291E-04	6.300E-03	1.699E+00
⁶³ Ni	2.051E-01	7.804E+00	1.177E+02
⁷⁹ Se	1.741E-04	1.398E-03	1.310E-02
⁹⁰ Sr	5.690E+01	1.396E+03	2.487E+04
⁹⁰ Y	1.982E+01	1.371E+03	3.236E+05
⁹³ Zr	2.918E-05	1.144E-01	3.330E+00
^{93m} Nb	1.396E-02	1.546E-01	5.203E-01
⁹⁹ Tc	7.707E-02	3.026E-01	2.014E+00
¹⁰⁶ Ru	0.000E+00	0.000E+00	2.641E-05
^{113m} Cd	3.108E-03	3.868E-02	3.202E+00
¹²⁵ Sb	2.084E-06	6.332E-05	7.313E-01
¹²⁶ Sn	3.565E-03	3.038E-02	1.321E-01
¹²⁹ I	NA	NA	NA
¹³⁴ Cs	0.000E+00	4.788E-07	1.011E-02
¹³⁷ Cs	1.212E+02	1.121E+03	1.424E+04
^{137m} Ba	3.852E+01	1.127E+03	1.587E+05
¹⁵¹ Sm	3.521E+01	1.602E+02	1.822E+03
¹⁵² Eu	1.297E-03	9.368E-03	1.123E+00
¹⁵⁴ Eu	1.748E-02	2.424E-01	1.657E+01
¹⁵⁵ Eu	6.187E-04	1.342E-02	4.014E+00
²²⁶ Ra	NA	NA	NA
²²⁷ Ac	1.532E-06	2.397E-04	2.648E-03
²²⁸ Ra	NA	NA	NA
²²⁹ Th	5.635E-09	3.644E-05	1.288E-03
²³¹ Pa	NA	NA	NA
²³² Th	1.329E-05	1.903E-04	8.274E-03
²³² U	3.461E-06	3.435E-04	5.496E-03
²³³ U	2.453E-04	2.957E-02	4.830E-01
²³⁴ U	1.289E-03	1.807E-02	7.042E-02
²³⁵ U	5.401E-05	7.514E-04	2.540E-03
²³⁶ U	3.925E-05	3.709E-04	3.656E-03
²³⁷ Np	7.903E-04	6.629E-03	1.216E-01
²³⁸ Pu	1.707E-02	9.147E-02	1.012E+00
²³⁸ U	1.192E-03	1.700E-02	5.282E-02
²³⁹ Pu	3.907E-01	3.414E+00	1.881E+01
²⁴⁰ Pu	5.526E-02	6.512E-01	4.308E+00
²⁴¹ Am	6.528E-01	5.177E+00	1.789E+02
²⁴¹ Pu	9.586E-02	9.693E-01	1.939E+01
²⁴² Cm	2.699E-04	2.898E-03	1.720E-01
²⁴² Pu	4.463E-06	4.018E-05	3.412E-04
²⁴³ Am	2.987E-04	3.026E-03	5.398E-02
²⁴³ Cm	9.090E-06	1.701E-04	1.120E-02
²⁴⁴ Cm	1.258E-04	2.781E-03	2.116E-01

NA: not available

Source: based on Certa et al. 2011

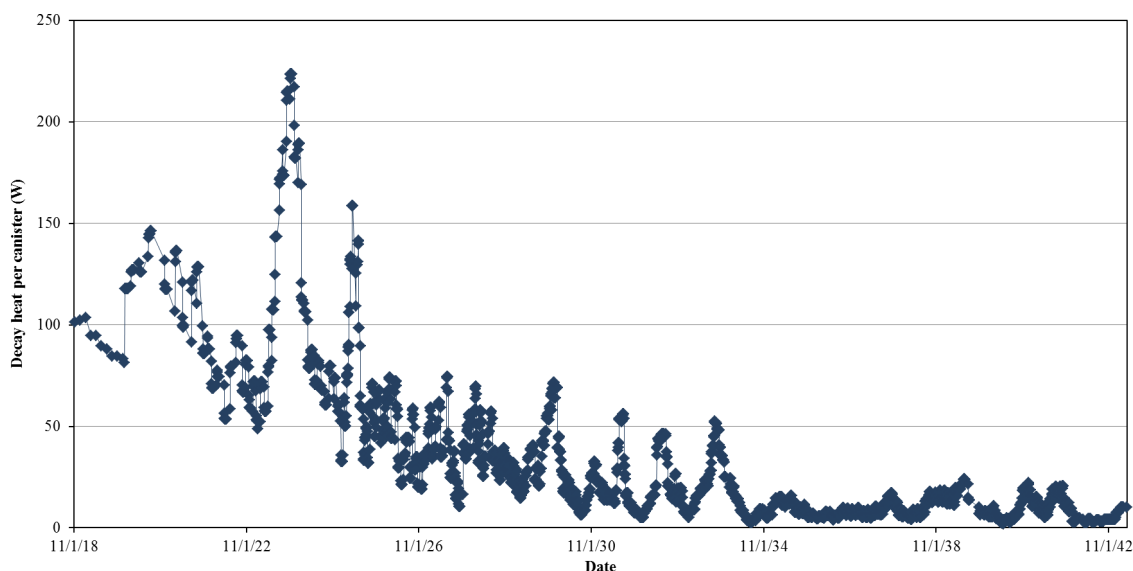

Source: Data from Certa et al. 2011.

Figure A-19. Projected decay heat per Hanford HLW canister

Table A-28. Summary of Hanford HLW glass fissile composition

²³³ U Mass	0.217 g
²³⁵ U Mass	257 g
²³⁹ Pu Mass	343 g
²⁴¹ Pu Mass	1.18 g
Total Fissile Isotope Mass	601 g
Nominal Glass Volume	1080 L
Fissile Isotope Concentration	0.557 g/L

Source: DOE 2008

To comply with the hazardous waste specification listed in the WAPS, the presence or absence of any hazardous waste listed in 40 CFR 261.31 through 261.33 in the HLW glass will need to be determined and reported. Hanford tank waste is a listed hazardous waste with Resource Conservation and Recovery Act (RCRA) hazardous metals (e.g., cadmium and lead). The WTP has prepared a petition to delist the Hanford HLW glass, in accordance with the U.S. Environmental Protection Agency guidance (Blumenkranz 2006). The delisting petition specifies that the TCLP response of glasses will be below a certain limit, and controlled through the use of a glass composition-TCLP model. The petition was submitted to Environmental Protection Agency and the Washington State Department of Ecology in 2006 by the DOE Office of River Protection. If granted, the petition will remove the Hanford HLW glass from Hazardous Waste Management Act/RCRA regulation through the delisting process.

The WAPS for HLW glass require that the canistered waste form shall not exceed a maximum surface gamma dose rate of 10^5 rem/hr and a neutron dose rate of 10 rem/hr at the time of shipment (DOE 2012a). The dose rates and range of variation will be calculated for the HLW glass per canister using projections

(upper limits) of radionuclide concentrations. The WTP employs commercial software packages, MicroShield and Monte Carlo N-Particle (MCNP), to calculate the dose rates (Kim 2010).

A-2.2.1.3 TRU Tank Waste Treatment

As described in Section 2.2.1.1, the waste in 11 Hanford tanks is potentially to be managed as CH-TRU. The potential CH-TRU would be treated in a modular facility that would be first located at the B Tank Farm and then at the T Tank Farm. The modular approach would keep the TRU wastes segregated from the other wastes by not commingling TRU wastes with HLW wastes in other single-shell tanks, double-shell tanks, Waste Retrieval Facilities, and transfer piping. The CH-TRU retrieved from the tanks would be treated in a high-vacuum, low-temperature, rotary dryer to remove water from the sludge (Certa et al. 2011). The dried, granular product, consisting of 80 wt % waste, 10 wt % water and 10 wt % sand would be packaged in 55-gallon drums for storage and disposal. Approximately 7,500 55-gallon drums of CH-TRU wastes would be produced (Certa et al. 2011).

If, instead of treating and disposing the CH-TRU as TRU wastes, the wastes were determined to be HLW and converted to a glass waste form in the WTP HLW vitrification facility, approximately 966 additional HLW glass canisters containing 2,916 MT of glass would be produced (Certa et al. 2011).

The current reference process for potential RH-TRU tank waste is comingling with HLW tank waste and vitrification in the WTP HLW vitrification facility. This waste is accounted for in the total HLW glass projections. There is a potential for the RH-TRU tank wastes to be treated and disposed of separately. Additionally, for the purposes of this study, if the waste classification were assumed to be based on hazard rather than based on the source-based definition of HLW, a large fraction of the Hanford tank waste would fall in the same general hazard class as RH-TRU.

A-2.2.2 Savannah River Site Tank Waste

As discussed in Section A-2.1.2, about 4 million gallons of liquid waste at SRS has already been incorporated into borosilicate glass, leaving about 33 million gallons still to be treated. The tank waste inventory at SRS was described in Section A-2.1.1. While early vitrification efforts focused primarily on only the sludge fraction of the waste, future efforts will ramp up treatment of the salt fraction in addition to the remaining sludge waste. The Salt Waste Processing Facility is under construction with a start-up date projected in approximately 2017. This facility will treat the salt fraction of the waste to remove the high activity constituents (namely cesium, strontium, and TRU). The stripped cesium, strontium, and TRU will be combined with the high activity waste sludge for incorporation into borosilicate glass in DWPF.

A system plan is used to forecast future liquid waste treatment at SRS. The objective of the plan is to integrate and document the actions necessary to receive, store, treat and dispose of the tank wastes to mission completion. The plan is routinely revised to account for changes in funding, operational schedules and other events that may impact future waste treatment schedules. *Liquid Waste System Plan Revision 18* (referred to below as System Plan Revision 18) is the most current version of the plan (Chew and Hamm 2013). The plan includes analysis of several operational scenarios and projects DWPF canister production schedules based on the scenarios. However, the nominal number of HLW canisters produced over the life of the mission does not vary significantly under the various scenarios. Therefore, the nominal case in System Plan Revision 18 will be used to project future glass production for this report.

Waste Form Description—The waste form associated with future DWPF operations will be consistent with the glass produced to date and described in Section A-2.1.2.

Waste Form Canisters—The canisters to be produced will be consistent with the canisters produced by DWPF to date. These were described in Section A-2.1.2.

Canister Production—System Plan Revision 18 (Chew and Hamm 2013) projects that 7,824 canisters will be produced at the completion of the SRS HLW mission. As reported in Section A-2.1.2, 3,339 canisters were produced during macrobatch 1-8 campaigns. Therefore, it is projected that 4,485 additional canisters will be produced post macrobatch 8. System Plan Revision 18 projects that twelve additional macrobatches will be processed in DWPF post macrobatch 8.

Radionuclide Content—Radionuclide values for DWPF macrobatches 1-8 are shown in Table A-15 above. The concentration of most radionuclides in glass produced in the future will be consistent with the concentrations in glass produced during macrobatches 1-8. The exception may be in the concentrations of cesium, strontium, and some actinides that are expected to increase when the full complement of salt waste treatment operations become available. Table A-29 gives the inventory of radionuclides in the SRS tanks as of January 2013.

Table A-29. Curie inventory in tanks at SRS as of January 2013

Radionuclide	Total Supernate (Ci)	Sludge (Ci)	Insoluble (Ci)
Am-241	7.60E+01	7.60E+04	
Am-242m	1.69E-01	1.69E+02	
Am-243	7.47E-02	7.46E+01	
Cm-244	1.84E+02	1.84E+05	
Cm-245	1.31E-01	1.31E+02	
Cm-246	1.28E-05	1.28E-02	
Co-60	8.50E+01	1.23E+05	
Cs-137	7.36E+07	4.82E+06	2.51E+05
Ni-59	2.45E+00	2.30E+03	
Ni-63	2.08E+02	1.95E+05	
Np-237	2.34E+01	3.90E+02	
Pu-238	8.89E+04	1.74E+06	7.17E+04
Pu-239	6.82E+03	3.95E+04	2.39E+03
Pu-240	1.77E+03	1.75E+04	
Pu-241	4.17E+04	8.14E+05	
Pu-242	5.55E+00	3.30E+01	
Se-79	8.90E+01	1.32E+03	
Sm-151	4.30E+03	4.30E+06	
Sn-126	4.27E+02	1.71E+03	
Sr-90	1.99E+04	5.97E+07	5.62E+06
Tc-99	2.87E+04	1.97E+04	
Th-229	1.58E+01	1.61E+02	
U-233	1.50E+01	1.53E+02	
U-234	8.77E+00	8.56E+01	
U-235	1.43E-01	1.47E+00	2.21E-01
U-236	4.63E-01	7.44E+00	
U-238	1.08E+01	5.69E+01	4.96E+00
Y-90	1.99E+04	5.97E+07	5.62E+06
Ru-106	7.64E+01	2.29E+02	
Rh-106	7.10E+01	2.13E+02	
Sb-125	1.49E+03	2.84E+04	
Te-125m	3.64E+02	6.92E+03	
Cs-134	3.23E+04	2.11E+03	
Ba-137m	6.96E+07	4.56E+06	2.37E+05
Pm-147	6.89E+02	6.89E+05	
Eu-154	4.36E+02	4.35E+05	
Eu-155	2.43E+02	2.42E+05	

Note: Data taken from Le, 2013, Table A1.

Canister Heat Content—Savannah River Remediation LLC has developed a series of Excel workbooks to project the compositions of future macrobatches and glasses to be produced in the DWPF (McIlmoyle and Hamm 2011) that can also be used to determine the wattage of future waste canisters. The canister wattage data was provided by McIlmoyle and Hamm (2011) in tabular form on a monthly production level. McIlmoyle and Hamm (2011) also provided canister wattage data for various scenarios regarding salt waste treatment and DWPF production. One case was a nominal case involving planned Salt Waste Processing Facility operations, while another case assumed some “sprint” processing in Salt Waste Processing Facility up to the plant’s full processing capacity to accommodate schedule delays or other operational issues. These cases provided the highest canister wattage values and were deemed the most applicable to the current study. The data from McIlmoyle and Hamm (2011) are summarized in this report by providing the number of canisters that fit within various wattage ranges. Table A-30 provides the projected canister wattage data for these scenarios. The total thermal output for all DWPF canisters produced over the DWPF mission is approximately 800,000 W.

Table A-30. Number of canisters in wattage ranges for projected DWPF canisters

Scenario	Number of DWPF Canisters in Wattage Range					
	<100 W	100–149 W	150–199 W	200–249 W	250–299 W	450–499 W
Nominal SWPF operations	459	897	1598	924	363	--
“Sprint” SWPF operations	459	1491	1565	462	--	264

Notes: Total decay heat for all 7,580 canisters during the DWPF mission is approximately 800,000 W. SWPF = Salt Waste Processing Facility. Numbers align with the number of canisters projected by System Plan Revision 17 (Chew and Hamm, 2012).

Glass Composition—The nominal glass composition and compositions for macrobatches 1-8 were discussed in Section A-2.1.2. The composition for glass projected to be produced in DWPF through the end of the vitrification mission is not expected to deviate significantly from what was reported in Section A-2.1.2.

A-2.2.3 Common Characteristics of Vitrified HLW Types

There are several characteristics of vitrified HLW as related to repository disposal that are common for waste regardless of where the vitrified HLW was generated. These common characteristics are described in this section.

Subcriticality—Criticality analyses of vitrified HLW forms have been performed to demonstrate compliance with the WAPS specification on subcriticality, which requires demonstration that criticality is precluded based on calculations of the effective neutron multiplication factor (K_{eff}) of the canistered waste form. These analyses indicated that the canistered waste forms will remain subcritical under all anticipated transportation and storage conditions.

Packaging and Transportation—Casks have not been selected or licensed for transportation of the vitrified defense HLW. There are no unique characteristics of vitrified HLW that are expected to hinder designing and licensing a suitable shipping cask. One potential option for waste packaging was described in Section A-2.1.1 for WVDP vitrified HLW.

Safeguards and Security—For canisters produced to date, no special safeguards and security measures are required to be implemented. Therefore, no special safeguards and security measures are envisioned for future canisters.

Secondary Wastes—Most secondary wastes that are generated or will be generated during HLW vitrification are planned and managed under the current programs. Secondary waste are typically handled via recycling or disposed of using existing waste disposal paths.

Currently, there is no specific plan for disposition of the used melters. To date, the DWPF has used two melters to vitrify HLW. The first melter operated for approximately eight years including almost 2 years at temperature processing simulated waste glass and the second melter is still in operation after approximately 10 years of service. The first melter was removed from the facility and is currently being stored in an on-site vault. Based on operational history to date, up to 5 used melters may need to be dispositioned at completion of the SRS vitrification mission. There is one HLW melter that was used at WVDP that will require dispositioning. Based on proposed operations for the WTP at the Hanford site, up to 12 HLW melters may need to be dispositioned.

Additional secondary wastes that have no specific defined disposition path will be handled in the future.

A-2.3 Existing Wastes Other Than Glass

Although, the high level radioactive tank waste at SRS and Hanford represent the most voluminous fractions of DOE HLW, there are other wastes that are classified as HLW or may be disposed of in a HLW repository.

A-2.3.1 Calcine Waste at Idaho National Laboratory

At the Idaho Nuclear Technology and Engineering Center (INTEC), previously known as the Idaho Chemical Processing Plant, spent nuclear fuel was reprocessed to recover enriched uranium and other nuclear-related products. The first-cycle raffinate from the uranium extraction was temporarily stored in underground tanks before being converted to a solid granular material called calcine. Fuel reprocessing began in 1953 and concluded in 1994, and the calcination operations ran from December 1963 to May 2000. Approximately 4,400 m³ of calcine is currently stored in six Calcine Solids Storage Facility (CSSF) bin sets (Staiger and Swenson 2011).

In the calcination process, the aqueous wastes are sprayed into a bed of air-fluidized solids at 400°C to 600°C. Water is evaporated and the solids dissolved in the waste form metal oxides and fluorides and smaller quantities of chlorides, phosphates, and sulfate. The granular product includes particles 0.3 to 1.0 mm in diameter removed from the fluidized bed and finer particulates removed through the off-gas treatment system.

Table A-31 shows the chemical composition of the four main types of calcine. The chemical composition of the calcine was dictated by the type of cladding on the spent fuel reprocessed and the flowsheet used for reprocessing the fuel. Most of the cladding was either aluminum or zirconium based, but also included stainless steel and a graphite matrix. The Fluorinel calcine is similar to the zirconium calcine but includes cadmium and sulfate from cadmium nitrate and sulfate added as a neutron poison in the dissolution process. The stainless steel and graphite cladding wastes were not processed alone but were calcine processed with the aluminum and zirconium wastes. SBW (see Section A-2.3.2) was also calcine processed with the zirconium and aluminum clad wastes, as well as nonradioactive aluminum nitrate.

Table A-31. Typical chemical composition of four types of calcine

Chemical Species	Units	Type of Calcine			
		Aluminum ^a	Zirconium ^a	Fluorinel / SBW Blend ^a	Aluminum Nitrate / SBW Blend ^a
Aluminum	wt %	47	8.1	7.5	38
Boron	wt %	0.1	1.0	1.0	0.1
Cadmium	wt %	— ^b	—	5.0	0.2
Calcium	wt %	—	28	27	3.2
Chloride	wt %	—	--	0.1	0.4
Chromium	wt %	0.1	0.3	0.1	0.1
Fluoride	wt %	--	25	17	1.7
Iron	wt %	0.8	0.1	0.3	0.6
Mercury	wt %	1.9	—	—	—
Nitrate	wt %	2.5	0.8	6.0	5.9 ^c
Oxygen	wt %	42	16	17	38
Potassium	wt %	0.2	0.1	0.7	1.8 ^c
Sodium	wt %	1.3	0.4	2.9	8.4 ^c
Sulfate	wt %	1.8	2.0	3.5	0.3
Tin	wt %	—	0.3	0.2	—
Zirconium	wt %	0.1	17	11	1.3

^a. Column totals are not 100% because of rounding values and the exclusion of trace components.

^b. A dash within a cell indicates an insignificant quantity.

^c. The aluminum nitrate/SBW blend nitrate value is a high-temperature (600°C) calcination value. Nitrate values were higher and alkali (sodium and potassium) values were lower when SBW was calcined at 500°C.

Source: Staiger and Swenson 2011.

The calcine is stored in the CSSFs. Within each CSSF are three to twelve stainless steel bins for containing the calcine. Because of the sequence in which the fuel was reprocessed and the subsequent wastes were calcined, there is significant variability in the composition of the calcine among the CSSFs, among the bins within a CSSF, and within an individual bin. In addition to the calcine, the bins include dolomite ($\text{CaMg}(\text{CO}_3)_2$) and fluorapatite ($\text{Ca}_{10}(\text{PO}_4)_6\text{F}_2$), which were used as startup beds for the calciners). Table A-32 summarizes the chemical composition within each CSSF. Staiger and Swenson (2011) provide additional detail down to segments within a bin. Table A-33 summarizes the radionuclide inventory in the individual CSSFs.

Table A-32. Chemical inventory in each of the six CSSFs

1/1/2016	CSSF I	CSSF II	CSSF III	CSSF IV	CSSF V	CSSF VI	Total
Element	kg	kg	kg	kg	kg	kg	kg
Al	8.68E+04	2.28E+05	1.54E+05	6.29E+04	1.52E+05	2.77E+05	9.60E+05
B	2.29E+02	5.62E+03	1.09E+04	5.57E+03	1.17E+04	4.10E+03	3.82E+04
Ca		1.84E+05	3.81E+05	1.88E+05	3.46E+05	6.79E+04	1.17E+06
Cd	4.91E-01	9.33E-01	9.81E-01	5.72E-01	4.06E+04	5.60E+03	4.62E+04
Cr	1.14E+02	2.00E+03	3.71E+03	1.90E+03	1.94E+03	1.12E+03	1.08E+04
Cs	5.61E+01	1.09E+02	1.15E+02	6.74E+01	1.44E+02	3.79E+01	5.30E+02
Fe	1.54E+03	2.59E+03	3.79E+03	3.00E+03	5.90E+03	5.46E+03	2.23E+04
Hg	3.43E+03	7.19E+03	1.74E+01	1.15E+01	2.78E+01	2.77E+01	1.07E+04
K	4.00E+02	1.46E+03	3.27E+03	2.50E+03	8.57E+03	1.26E+04	2.88E+04
Mg	6.02E+02	5.94E+03	1.25E+04	3.00E+03	9.84E+03	6.80E+03	3.86E+04
Mn	5.07E+01	6.27E+02	1.51E+03	6.37E+02	1.78E+03	1.58E+03	6.19E+03
Mo	1.01E+02	1.96E+02	2.11E+02	1.24E+02	2.61E+02	6.83E+01	9.61E+02
Na	2.41E+03	9.24E+03	1.41E+04	1.02E+04	3.63E+04	4.71E+04	1.19E+05
Nb	6.71E-04	7.57E+00	1.97E+01	1.23E+01	2.86E+03	6.06E+00	2.90E+03
Nd	1.26E+02	2.33E+02	2.33E+02	1.35E+02	2.92E+02	7.76E+01	1.10E+03
Ni		2.16E+02	6.14E+02	4.80E+02	7.81E+02	4.98E+02	2.59E+03
Sn	1.02E+00	1.75E+03	3.13E+03	1.38E+03	2.27E+03	2.55E+02	8.79E+03
Sr	1.84E+01	1.95E+03	3.90E+03	1.93E+03	3.60E+03	2.32E+02	1.16E+04
Zr	1.38E+02	1.11E+05	1.98E+05	8.73E+04	1.43E+05	1.60E+04	5.55E+05
Cl	6.88E+01	3.86E+02	9.24E+02	7.36E+02	1.95E+03	1.73E+03	5.80E+03
F		1.62E+05	2.77E+05	1.27E+05	2.17E+05	2.75E+04	8.11E+05
CO ₃		1.08E+04	2.53E+04	4.56E+03	1.85E+04	1.64E+04	7.56E+04
NO ₃	4.70E+03	1.80E+04	2.86E+04	2.07E+04	7.35E+04	8.43E+04	2.30E+05
PO ₄	2.81E+03	9.97E+03	2.39E+04	5.07E+03	1.23E+04	2.39E+03	5.65E+04
SO ₄	3.42E+03	2.10E+04	3.12E+04	1.39E+04	3.94E+04	9.01E+03	1.18E+05
Trace FP	6.15E+02	1.08E+03	1.04E+03	5.69E+02	1.37E+03	5.34E+02	5.21E+03
U	1.42E+01	2.79E+01	1.69E+01	3.42E+01	1.84E+02	2.14E+02	4.91E+02
O	7.82E+04	2.59E+05	2.63E+05	1.22E+05	2.67E+05	2.86E+05	1.28E+06
Total	1.86E+05	1.04E+06	1.44E+06	6.63E+05	1.40E+06	8.75E+05	5.61E+06

Source: Staiger and Swenson 2011.

Table A-33. Calcine radioactivity in each of the six CSSFs decayed to January 1, 2016

1/1/2016	CSSF I	CSSF II	CSSF III	CSSF IV	CSSF V	CSSF VI	Total
Radionuclide	Curies	Curies	Curies	Curies	Curies	Curies	Curies
⁶⁰ Co	3.82E-01	2.24E+01	4.05E+01	3.48E+01	7.10E+02	1.09E+02	9.18E+02
⁶³ Ni	0.00E+00	1.09E+03	2.79E+03	1.83E+03	3.19E+03	5.52E+02	9.45E+03
⁷⁹ Se	2.72E+00	5.02E+00	5.00E+00	2.91E+00	6.27E+00	1.67E+00	2.36E+01
⁹⁰ Sr	6.72E+05	1.49E+06	1.58E+06	9.94E+05	2.13E+06	5.35E+05	7.40E+06
⁹⁰ Y	6.72E+05	1.49E+06	1.58E+06	9.94E+05	2.13E+06	5.35E+05	7.40E+06
⁹⁹ Tc	4.25E+02	7.68E+02	7.41E+02	4.28E+02	9.33E+02	2.49E+02	3.54E+03
¹⁰⁶ Ru	1.48E-10	9.20E-09	5.50E-07	5.16E-06	3.61E-04	1.84E-04	5.51E-04
¹²⁵ Sb	1.11E-01	7.23E+00	3.39E+00	6.05E+00	3.48E+01	1.22E+01	6.38E+01
¹²⁶ Sn	1.10E+01	2.02E+01	2.02E+01	1.17E+01	2.53E+01	6.76E+00	9.51E+01
¹²⁹ I	6.88E-03	1.25E-02	1.22E-02	7.08E-03	1.54E-02	4.11E-03	5.82E-02
¹³⁴ Cs	5.04E-03	3.73E-01	8.35E-01	2.52E+00	3.68E+01	9.10E+00	4.96E+01
¹³⁵ Cs	1.07E+01	2.61E+01	3.51E+01	2.12E+01	4.26E+01	1.07E+01	1.46E+02
^{137m} Ba	7.66E+05	1.59E+06	1.74E+06	1.01E+06	2.18E+06	5.86E+05	7.88E+06
¹³⁷ Cs	8.09E+05	1.68E+06	1.84E+06	1.07E+06	2.30E+06	6.19E+05	8.33E+06
¹⁴⁴ Ce	4.13E-14	8.14E-12	1.53E-09	2.49E-08	9.59E-06	4.31E-06	1.39E-05
¹⁴⁴ Pr	4.13E-14	8.14E-12	1.53E-09	2.49E-08	9.59E-06	4.31E-06	1.39E-05
¹⁴⁷ Pm	2.96E+00	5.16E+01	7.26E+01	3.85E+01	9.59E+01	3.64E+01	2.98E+02
¹⁵¹ Sm	1.64E+04	2.43E+04	1.35E+04	6.85E+03	1.90E+04	5.94E+03	8.60E+04
¹⁵² Eu	6.92E+00	3.95E+01	6.62E+01	3.97E+01	8.06E+01	2.14E+01	2.54E+02
¹⁵⁴ Eu	4.31E+02	2.39E+03	2.14E+03	1.99E+03	6.62E+03	1.42E+03	1.50E+04
¹⁵⁵ Eu	2.13E+01	1.14E+02	1.26E+02	1.31E+02	5.41E+02	1.53E+02	1.09E+03
²³⁰ Th	1.01E-01	1.22E-01	6.15E-03	1.17E-03	7.24E-02	2.90E-02	3.31E-01
²³¹ Th	2.06E-02	3.97E-02	1.95E-02	1.61E-02	8.72E-02	7.31E-02	2.56E-01
²³³ Pa	1.09E+00	1.76E+00	7.83E+00	1.95E+01	3.70E+01	5.43E+00	7.26E+01
²³² U	8.02E-05	8.82E-03	9.80E-02	6.93E-02	9.68E-02	1.35E-02	2.86E-01
²³³ U	1.57E-04	2.37E-04	1.27E-03	3.12E-03	5.35E-03	7.29E-04	1.09E-02
²³⁴ U	2.96E+00	6.67E+00	2.00E+00	1.81E+00	7.10E+00	3.00E+00	2.35E+01
²³⁵ U	2.06E-02	3.97E-02	1.95E-02	1.61E-02	8.72E-02	7.31E-02	2.56E-01
²³⁶ U	4.78E-02	1.01E-01	5.02E-02	4.38E-02	2.70E-01	1.63E-01	6.76E-01
²³⁷ U	3.79E-03	1.19E-01	2.47E-01	1.50E-01	2.95E-01	7.83E-02	8.93E-01
²³⁸ U	1.17E-03	2.26E-03	2.37E-03	8.68E-03	4.72E-02	5.74E-02	1.19E-01
²³⁷ Np	1.09E+00	1.76E+00	7.83E+00	1.95E+01	3.70E+01	5.43E+00	7.26E+01
²³⁸ Pu	3.16E+02	8.10E+03	1.66E+04	1.65E+04	3.23E+04	4.99E+03	7.88E+04
²³⁹ Pu	4.27E+01	1.82E+02	4.41E+02	5.09E+02	8.87E+02	3.34E+02	2.40E+03
²⁴⁰ Pu	1.71E+01	1.44E+02	3.21E+02	3.30E+02	6.24E+02	1.80E+02	1.62E+03
²⁴¹ Pu	1.19E+02	4.05E+03	8.57E+03	6.01E+03	1.71E+04	4.90E+03	4.07E+04
²⁴² Pu	9.86E-03	3.35E-01	8.18E-01	8.69E-01	1.48E+00	3.76E-01	3.89E+00
²⁴¹ Am	1.22E+02	1.13E+03	2.48E+03	1.54E+03	2.87E+03	4.01E+02	8.55E+03
²⁴³ Am	8.65E-03	8.38E-02	3.12E-01	1.96E-01	3.43E-01	1.12E-01	1.06E+00
²⁴² Cm	7.22E-03	2.37E-01	5.09E-01	3.07E-01	6.06E-01	1.74E-01	1.84E+00
²⁴⁴ Cm	1.28E-02	8.87E-01	2.43E+00	1.49E+00	2.79E+00	8.44E-01	8.45E+00

Source: .Staiger and Swenson 2011.

Table A-34 summarizes the hazardous waste content of the calcine. Cadmium, chromium, and mercury were process additives for the different flowsheets used during the fuel reprocessing mission. Nickel and chromium were components of some of the alloys used as fuel cladding. Lead is present from dissolved shielding. Other hazardous waste species (silver, arsenic, barium, and selenium) are present in trace amounts, primarily as fission products from the reprocessed fuel.

The thermal output of the calcine varies with the type of calcine. The hottest calcine will have a heat generation rate of about 40 W/m³, and the coldest calcine will have a heat generation rate of about 3 W/m³ (in 2016). Over 99% of the radioactivity in calcine is due to ¹³⁷Cs/^{137m}Ba and ⁹⁰Sr/⁹⁰Y.

Table A-34. RCRA metal content of INL calcines

Metal	CSSF I (kg)	CSSF II (kg)	CSSF III (kg)	CSSF IV (kg)	CSSF V (kg)	CSSF VI (kg)	Total
Ag	3	14	16	7	19	12	71
As	3	12	13	6	13	4	49
Ba	67	154	186	103	215	50	775
Cd	0.5	1	1	1	40,609	5,605	46,217
Cr	114	2,004	3,707	1,900	1,940	1,122	10,788
Hg	3,425	7,185	17	11	28	28	10,695
Ni ^a	0	216	614	480	781	498	2,588
Pb	12	23	78	79	270	571	1,033
Se	2	3	3	2	4	1	16
Metal	CSSF I (ppm)	CSSF II (ppm)	CSSF III (ppm)	CSSF IV (ppm)	CSSF V (ppm)	CSSF VI (ppm)	Average (ppm) ^b
Ag	17	14	11	11	13	17	13
As	16	11	9	9	9	4	9
Ba	360	148	130	156	154	57	138
Cd	3	1	1	1	29,117	6,412	8,250
Cr	614	1,924	2,577	2,873	1,391	1,284	1,926
Hg	18,444	6,896	12	17	20	32	1,909
Ni	0	207	427	725	560	570	462
Pb	63	22	54	119	194	653	184
Se	10	3	2	3	3	1	3

^a Nickel is an underlying hazardous constituent in 40 CFR Part 268

^b Average values are weighted average of all CSSFs.

Source: Staiger and Swenson 2011.

A-2.3.1.1 Calcine Treatment

In 2010, DOE issued a Record of Decision (75 FR 137) documenting the selection of hot isostatic pressing (HIP) technology to treat the calcine and provide various possible waste forms suitable for disposal at a facility outside the State of Idaho. In the HIP process (CDP 2012; Russell and Taylor 1998), calcine retrieved from the CSSF is heat-treated (in a fluidized bed) at temperatures up to 600°C to remove moisture and NO_x. After heating, the calcine is mixed with amorphous silica, titanium (metal and oxides), and calcium sulfate or elemental sulfur, and the mixture is placed in a stainless steel can which is then sealed with a lid with a vent tube. The can is evacuated, the vent is sealed, and the can is placed in the HIP process vessel. The vessel is pressurized with argon gas to 7,000 to 15,000 psi and is heated to 1,150°C. At these processing conditions, the calcine is converted to a glass ceramic.

The can itself shrinks around the glass ceramic as the interstitial voids in the calcine mix collapse. A volume reduction of approximately 30% is expected. The currently planned size of the HIP waste form can (before treatment) is 60-in. diameter by 30-in. tall with a volume of approximately 1.36 m³. With a volume reduction of 30%, the 4,400 m³ of calcine would be reduced to approximately 3,080 m³ and the pressed can would have a volume of approximately 0.95 m³, yielding approximately 3,200 HIP processed cans at 100% fill. Heat load would be in the range of 4 to 54 W/can. The filled can would weigh approximately 4,500 pounds.

After the HIP process, the compressed cans will be placed in canisters 5.5-ft diameter by 17-ft tall, presently certified for SNF (CDP 2012). With the volume of each HIP can being reduced approximately 30%, each canister could hold 10 HIP-processed cans. Voids in the canister will be filled with sand, steel shot, or glass shot before being sealed.

Processing the calcine with the silica and titanium additives is needed to provide a glass ceramic waste form (CWF) that eliminates the RCRA hazardous waste characteristics (75 FR 137). The glass ceramic would have properties consistent with HLW borosilicate glass. The main minerals in the glass-ceramic are titanates, sulfides, glass/quartz, and nepheline (CDP 2012).

The 2010 Record of Decision (75 FR 137) retains an option to HIP the calcine *without* the addition of the silica, titanium and calcium sulfate. It is expected that this would provide *additional* volume reduction of up to approximately 50% (Hagers 2007). This alternate calcine waste form would include RCRA waste constituents and would be acceptable for disposal at a facility that accepts RCRA wastes.

Vitrification was considered as an option for treatment of the calcine for disposal (DOE 2002). The calcine would be mixed with a glass frit and would be converted to a calcine glass waste form in a Joule-heated melter. For 5,435 m³ of calcine (assumes remaining SBW is calcine—i.e., includes waste materials covered in A-2.3.2 as direct-disposed), approximately 14,115 10-ft long by 2-ft diameter canisters of vitrified calcine would be produced (Lopez and Kimmitt 1998). This would correspond to 11,400 canisters for 4,400 m³ of existing calcine. Heat load would be in the range of 1.2 to 15.4 W/canister. More recent work has considered the use of a cold-crucible induction melter to produce a glass or a glass ceramic at perhaps higher waste loading and fewer canisters for disposal (Maio 2011; King and Maio 2011). The specific volume reduction that could be achieved is not immediately available.

The last calcine waste form alternative would be to directly dispose of the calcine. A specific example of this option was evaluated. In this option, the calcine could be placed in a RH-72B canister. The RH-72B canister is 121 in. long and 26 in. diameter with a 0.25 in. diameter steel wall (Forrester et al. 2002). Internal volume is 0.9 m³. Thus, the 4,400 m³ of calcine would yield approximately 4,900 canisters at 100% fill or 5,400 canisters at 90% fill. Heat load would be in the range of 36 W/canister (high heat calcine and 100% fill) to 2.4 W/canister (low heat calcine and 90% fill). Another design alternative discussed in Carter et al. (2012) would produce 4,391 canisters of calcine waste. These canisters would

be 2 ft in diameter and 10 ft tall. Additionally, direct disposal of calcine waste could utilize other packaging configurations, such as small diameter packages for deep borehole disposal.

A-2.3.2 Sodium-Bearing Waste at INL

SBW is defined as mixed hazardous, radioactive waste generated as a by-product of spent nuclear fuel reprocessing at INTEC (Barnes et al. 2004). Approximately 850,000 gallons of SBW are stored in three underground tanks at INTEC. The aqueous wastes are composed primarily of decontamination solutions used over the years in support of operations, but include small fractions of first (1%), second (2%) and third (4%) cycle extraction wastes from the fuel reprocessing (70 FR 44598). The acidic wastes are relatively high in sodium and potassium from the decontamination solutions, thus the name “sodium-bearing waste.” SBW is high in transuranics, but has significantly less fission product activity than calcine derived from first-cycle raffinate. The SBW programmatic baseline assumes that SBW is TRU waste. However a determination in accordance with DOE O 435.1 will be made to finalize the disposition path for SBW (70 FR 75165).

By the end of 2004, the SBW including liquids and residual tank heels had been consolidated into three tanks (WM-187, WM-188, and WM-189) at INTEC. Newly generated liquid wastes from other facility operations not part of the spent fuel reprocessing were included with the SBW until 2005. Beginning in 2005, the newly generated liquid wastes has been segregated in separate tanks from the SBW. The newly generated liquid wastes will be treated by the same processes as the SBW but will follow a different disposal path.

Table A-35 lists the chemical compositions of the SBW in WM-187, WM-188, and WM-189 (Barnes et al. 2004). The compositions include both the liquid and solid fractions in the tanks. It is expected that the solids will be retrieved with the liquids and will be treated together in the SBW treatment process. Most of the solids are in tank WM-187. There are some operating scenarios in which there will be some blending of wastes among the three tanks to provide a more uniform waste stream to the SBW treatment facility. Table A-36 provides the concentration of the RCRA metals and underlying hazardous constituents in the SBW in the three storage tanks.

Table A-37 provides the inventory of selected radionuclides in terms of the concentrations in the individual SBW tanks and the total inventory in the SBW (Barnes et al. 2004). The values are decayed to January 2003. The radionuclide inventory is based in part on radiochemical analyses and in part on estimates based on the assumption that the radionuclide concentrations are proportional to all the nuclear fuel processed at the Idaho Chemical Processing Plant over the lifetime of the plant (Barnes et al. 2004).

Once the SBW was consolidated in WM-187, WM-188, and WM-189, the wastes were sampled and analyzed. The results are documented in an Engineering Design File (ICP 2008) that is controlled unclassified information and is not approved for public release. For the purposes of this disposal options study, the pertinent chemical and radiochemical composition tables were cleared for public release. Table A-38, Table A-39, and Table A-40 list the most current estimates. The silica, phosphorus, and zirconium numbers for the solids appear low relative to previous analyses and are suspect. To calculate the total inventories, the volumes of the liquids and the mass of the solids were taken from estimates in Barnes et al. (2004). The reported solids compositions for WM-187 were used for tanks WM-188 and WM-189. The radionuclide inventory is decayed to January 2012.

Table A-35. Chemical composition of sodium-bearing waste

	WM-187	WM-188	WM-189
Volume, Gallons	284,920 ^a	281,670	279,800
Volume, Liters	1.08E06	1.07E06	1.06E06
Species	Mole/Liter	Mole/Liter	Mole/Liter
H ⁺	1.04E+00	2.68E+00	2.86E+00
Al ⁺³	7.08E-01	6.77E-01	7.24E-01
B ⁺³	1.35E-02	2.19E-02	2.16E-02
Ca ⁺²	4.95E-02	6.55E-02	7.36E-02
Cl ⁻	3.99E-02	3.06E-02	2.22E-02
F ⁻	7.40E-02	3.53E-02	1.37E-02
Fe ⁺³	3.57E-02	2.56E-02	2.81E-02
Mg ⁺²	1.41E-02	2.58E-02	2.23E-02
Mn ⁺⁴	1.59E-02	1.66E-02	1.95E-02
NO ₃ ⁻	5.44E+00	6.71E+00	7.53E+00
PO ₄ ⁻³	3.22E-01	1.38E-02	2.65E-02
K ⁺	2.24E-01	1.77E-01	2.29E-01
Si ⁺⁴	5.93E-01	1.45E-02	2.80E-02
Na ⁺	2.13E+00	1.52E+00	2.07E+00
SO ₄ ⁻²	7.32E-02	3.76E-02	1.08E-01
Zr ⁺⁴	5.41E-02	5.93E-03	5.57E-03
	Grams/liter	Grams/liter	Grams/liter
Total Organic Carbon	0.50	0.40	0.58
Undissolved Solids	93	4.69	9.4

^a Volume includes liquids and solids
Source: Barnes et al. 2004.

Table A-36. Concentrations of RCRA metals and underlying hazardous constituents in SBW

		WM-187	WM-188	WM-189
Volume, Gallons		284,920 ^a	281,670	279,800
Volume, Liters		1.08E06	1.07E06	1.06E06
RCRA Metals (Mole/liter)	As ⁺⁵	5.53E-04	1.04E-05	1.06E-05
	Ba ⁺²	1.20E-04	7.92E-05	5.91E-05
	Cd ⁺²	8.62E-04	3.32E-03	3.92E-03
	Cr ⁺³	4.34E-03	5.42E-03	5.84E-03
	Pb ⁺²	1.35E-03	1.03E-03	1.17E-03
	Hg ⁺²	2.23E-03	7.10E-03	6.45E-03
	Se ⁺⁴	1.24E-04	6.92E-06	9.76E-06
	Ag ⁺	9.11E-04	1.87E-05	2.80E-05
Underlying Hazardous Constituents (Mole/liter)	Sb ⁺⁵	3.24E-05	5.82E-06	9.81E-06
	Be ⁺²	1.79E-05	1.88E-05	2.22E-05
	Ni ⁺²	1.80E-03	2.59E-03	2.41E-03
	Tl ⁺³	4.25E-05	3.07E-06	4.34E-06

^a Volume includes liquids and solids
Source: Barnes et al. 2004.

Table A-37. Radionuclide inventory of INTEC sodium-bearing waste decayed to January 2003

	WM-187	WM-188	WM-189	Total
Volume, Gallons	284,920 ^a	281,670	279,800	846,390
Volume, Liters	1.08E06	1.07E06	1.06E06	3.20E+06
Species	Curies/Liter	Curies/Liter	Curies/Liter	Curies
C-14	2.21E-10	1.69E-10	1.26E-10	5.65E-04
Se-79	8.77E-07	7.09E-07	6.49E-07	2.45E+00
Sr-90	2.53E-02	5.25E-02	3.91E-02	1.28E+05
Zr-93	1.33E-06	3.05E-06	2.19E-06	7.17E+00
Tc-99	6.43E-05	2.49E-05	1.20E-05	1.11E+02
Pd-107	9.95E-09	2.27E-08	1.63E-08	5.34E-02
Sn-126	7.54E-07	5.77E-07	4.29E-07	1.93E+00
Sb-126	3.46E-08	7.91E-08	5.69E-08	1.86E-01
I-129	9.39E-08	7.49E-08	5.58E-08	2.46E-01
Cs-135	1.46E-06	1.20E-06	8.93E-07	3.89E+00
Cs-137	8.25E-02	7.06E-02	5.23E-02	2.25E+05
Ra-226	4.93E-12	1.15E-11	8.10E-12	2.68E-05
Ac-227	2.32E-11	5.42E-11	3.81E-11	1.26E-04
Th-230	1.88E-09	1.18E-09	8.39E-10	4.27E-03
Th-232	4.26E-16	9.75E-16	7.00E-16	2.29E-09
Pa-231	5.38E-11	1.23E-10	8.83E-11	2.89E-04
U-232	4.03E-09	2.95E-09	2.03E-09	9.87E-03
U-233	9.70E-11	1.18E-10	8.02E-11	3.23E-04
U-234	1.51E-06	1.29E-06	1.75E-06	4.97E+00
U-235	7.49E-08	1.08E-07	6.07E-08	2.66E-01
U-236	1.17E-07	5.01E-08	7.90E-08	2.70E-01
U-238	3.36E-08	1.53E-08	4.35E-08	1.01E-01
Np-237	4.07E-16	4.03E-06	2.90E-06	7.54E+00
Pu-238	2.15E-03	6.43E-04	4.08E-04	3.52E+03
Pu-239	3.26E-04	7.31E-05	4.65E-05	4.90E+02
Pu-240	2.24E-05	1.47E-05	1.03E-05	5.19E+01
Pu-241	1.56E-03	4.08E-04	4.14E-04	2.62E+03
Pu-242	1.72E-08	1.18E-08	8.04E-09	4.06E-02
Am-241	1.07E-04	6.82E-05	7.36E-05	2.72E+02
Am-243	2.37E-08	3.36E-08	2.14E-08	8.61E-02
Cm-245	8.60E-10	4.12E-10	2.98E-10	1.72E-03

^a Volume includes liquids and solids

Source: Barnes et al. 2004.

Table A-38. Chemical composition of sodium-bearing waste

	WM-187 Liquid	WM-188 Liquid	WM-189 Liquid	WM-187 Solids	Total
Volume, Gallons	284,920	281,670	279,800		846,390
Volume, Liters	1.08E+06	1.07E+06	1.06E+06		3.20E+06
Solids, Kg	1.05E+05	5.00E+03	1.00E+04		1.20E+05
Species	mg/L	mg/L	mg/L	mg/Kg	Kg
Al	1.55E+04	2.09E+04	1.94E+04	2.63E+04	6.39E+04
B	1.05E+02	2.36E+02	2.18E+02	1.99E+02	6.32E+02
Ca	1.79E+03	3.04E+03	2.98E+03	3.07E+03	8.87E+03
Cl	7.51E+02	6.01E+02	9.75E+02	0.00E+00	2.53E+03
F	7.40E+01	1.45E+02	1.56E+02	0.00E+00	4.08E+02
Fe	1.12E+03	1.57E+03	1.56E+03	3.67E+03	5.07E+03
Mn	7.79E+02	9.49E+02	1.10E+03	1.39E+03	3.25E+03
NO ₃ as N	5.82E+04	8.30E+04	8.87E+04	0.00E+00	2.50E+05
P	2.50E+02	2.21E+01	6.82E+01	1.05E+03	4.99E+02
K	6.58E+03	8.41E+03	9.67E+03	1.20E+04	2.83E+04
Si	9.66E+00	5.77E+00	1.15E+01	3.30E+02	6.89E+01
Na	3.93E+04	4.14E+04	4.62E+04	6.95E+04	1.47E+05
S	2.08E+03	2.40E+03	2.66E+03	4.13E+03	8.27E+03
V	7.87E-01	1.46E+00	1.34E+00	2.05E+00	4.15E+00
Zn	6.56E+01	7.32E+01	7.92E+01	1.42E+02	2.55E+02
Zr	2.44E+00	2.36E+02	2.44E+01	1.84E+03	5.07E+02

Source: ICP 2008; Barnes et al. 2004

Table A-39. Concentrations of RCRA metals and underlying hazardous constituents in SBW

		WM-187 Liquid	WM-188 Liquid	WM-189 Liquid	WM-187 Solids	Total
Volume, gallons		284,920	281,670	279,800		846,390
Volume, liters		1.08E+06	1.07E+06	1.06E+06		3.20E+06
Solids, kg		1.05E+05	5.00E+03	1.00E+04		1.20E+05
Species		mg/L	mg/L	mg/L	mg/kg	kg
RCRA Metals	As	2.84E-01	2.94E-01	2.84E-01	5.90E+00	1.65E+00
	Ba	8.98E+00	1.51E+01	8.38E+00	1.78E+01	3.75E+01
	Cd	8.82E+01	3.64E+02	4.16E+02	1.66E+02	9.63E+02
	Cr	1.75E+02	3.29E+02	3.05E+02	4.04E+02	9.29E+02
	Pb	2.30E+02	2.42E+02	2.49E+02	4.77E+02	8.43E+02
	Hg	3.49E+02	1.28E+03	1.34E+03	2.11E+02	3.25E+03
	Se	-	-	-	-	-
Ag	1.91E-01	4.88E-01	2.62E-01	8.29E+02	1.01E+02	
Underlying Hazardous Constituents	Sb	6.50E-01	1.33E+00	2.42E-01	1.25E+01	3.93E+00
	Be	7.74E-02	1.63E-01	1.58E-01	1.20E-01	4.48E-01
	Ni	1.26E+02	1.75E+02	1.44E+02	2.55E+02	5.15E+02
	Tl	0.00E+00	4.62E-01	0.00E+00	0.00E+00	5.04E-01

Source: ICP 2008; Barnes et al. 2004.

Table A-40. Radionuclide inventory of INTEC sodium-bearing waste decayed to January 2012

	WM-187 Liquid	WM-188 Liquid	WM-189 Liquid	WM-187 Solids	Total
Volume, gallons	284,920	281,670	279,800		846,390
Volume, liters	1.08E+06	1.07E+06	1.06E+06		3.20E+06
Solids, kg	1.05E+05	5.00E+03	1.00E+04		1.20E+05
Species	Ci/L	Ci/L	Ci/L	Ci/Kg	Ci
Co-60	1.77E-06	1.67E-05	0.00E+00	1.22E-05	2.16E+01
Sr-90	1.60E-02	5.02E-02	3.00E-02	3.87E-02	1.09E+05
Nb-94	0.00E+00	0.00E+00	0.00E+00	1.42E-04	1.70E+01
Sb-125	0.00E+00	0.00E+00	0.00E+00	1.01E-04	1.21E+01
Cs-134	5.34E-07	2.72E-06	0.00E+00	6.38E-06	4.32E+00
Cs-137	2.42E-02	7.45E-02	4.56E-02	7.51E-02	1.66E+05
Eu-154	2.39E-05	1.30E-04	0.00E+00	7.98E-05	1.78E+02
U-233	0.00E+00	0.00E+00	0.00E+00	3.00E-07	3.60E-02
U-234	1.11E-06	1.56E-06	1.87E-06	3.27E-06	5.33E+00
U-235	2.34E-08	3.87E-08	4.59E-08	8.23E-08	1.27E-01
U-236	4.09E-12	4.40E-12	3.23E-12	7.89E-11	2.23E-05
U-238	2.40E-08	4.03E-08	4.29E-08	6.78E-08	1.25E-01
Np-237	6.74E-07	6.14E-07	0.00E+00	2.76E-06	1.74E+00
Pu-238	3.75E-04	6.77E-04	6.70E-04	1.69E-02	3.90E+03
Pu-239	4.75E-05	7.69E-05	6.59E-05	1.69E-03	4.10E+02
Pu-240	2.87E-05	2.63E-05	2.42E-05	5.56E-04	1.53E+02
Am-241	7.93E-05	7.00E-05	8.28E-05	5.29E-04	3.16E+02

Source: ICP 2008; Barnes et al. 2004.

Sodium Bearing Waste Treatment—Fluidized-bed steam reforming has been selected as the treatment method for the SBW. The Integrated Waste Treatment Unit has been constructed east of the INTEC and will begin treating the SBW in 2014 and is planned to be completed by the end of 2014. In the fluidized bed steam reforming process, nitric acid, nitrates, and nitrites are converted to nitrogen gas, organic materials are converted to carbon dioxide and water and the remaining inorganic species including the radionuclides are converted to a dry, granular/powder carbonate mineral product (ID-DEQ 2013).

The primary process vessel is the denitration and mineralization reformer (DMR) (ID-DEQ 2013). There, the wastes are atomized into the particle bed operating at between 580°C and 680°C. Heat is provided by superheated steam and coal that reacts with the steam to provide chemical reactants that convert the nitrogen oxides to nitrogen gas. Inorganic chemicals in the wastes dry onto the bed particles. Organics are volatilized, pyrolyzed, and steam reformed in the fluidized bed. As the bed particles increase in size, they are drawn from the bottom of the DMR and are transferred pneumatically to the product receiver/coolers. Particle size is up to 3/8 in. (0.95 cm).

Process gases from the DMR pass through a process gas filter to the carbon reduction reformer (CRR) (ID-DEQ 2013). The process gas filter removes particulates greater than 2 microns in size from the process gas. The particulates are transferred pneumatically to the product receiver/coolers. The CRR is another fluidized bed composed of granular alumina operating between 850°C and 1,100°C. The process gases from the DMR provide the fluidizing gases and carbon is added to the bed for heat generation and to provide chemical reactants. Oxygen is added to the CRR at different levels such that there are distinct reducing and oxidizing zones. Residual nitrates from the DMR are converted to nitrogen gas in the reducing zone and organics, hydrogen, and carbon monoxide are oxidized and steam reformed in the oxidizing zone to form carbon dioxide and water. Gases from the CRR pass through an off-gas cooler and off-gas filters (5 micron) and then further off-gas treatment. The off-gas filter removes residual carbon from the CRR. The fines captured on the filter are transferred pneumatically to the product receiver/coolers.

The solids contained in the product receiver/coolers are ultimately placed in canisters for storage, shipment to and disposal at the ultimate disposal facility. The canisters are approximately 26 in. (0.66 m) in diameter by 10 ft (3 m) high. They have a capacity of approximately 34 ft³ (0.96 m³). The current estimate is that there will be 688 waste canisters from the steam reforming of the SBW. This includes the tank heels that will be flushed from the tanks and treated after the bulk of the solution is treated. The estimate varies depending on the assumptions made for bulk density, canister fill level, and carbon concentration. In addition there are a couple of smaller tanks containing wastes that will be treated after the SBW. Between 8 and 40 additional canisters will be produced from these wastes. Total heat load in the SBW based on the radionuclide inventory in Table A-40 is 1,690 W for an average of 2.5 W/canister.

The final product from the SBW fluidized bed treatment will be a combination of the granular solids from the DMR plus the fine powders captured on the process gas filter after the DMR and the off-gas filter after the CRR. Chemically the material will be sodium carbonate plus sulfates, phosphates, halides, and oxides of aluminum, potassium, silicon, calcium, iron and the minor components and radionuclides in the wastes (Olson 2006). Also included will be residuals from additives to the process including alumina used as a startup bed for the DMR and as a semi-permanent bed for the CRR plus coal and carbon used in the DMR and CRR.

The fluidized-bed steam reforming process is expected to destroy hazardous organic constituents in the SBW. Though testing with simulants spiked with chromium, lead, and mercury (Crawford and Jantzen 2007) has shown that the fluidized-bed steam reforming product meets TCLP Universal Treatment Standards in 40 CFR Part 268 for Land Disposal Restrictions, the fluidized-bed steam reforming product is not expected to meet the Land Disposal Restrictions because some of the RCRA metals are not immobilized in the carbonate-based solid matrix (Olson 2006).

A-2.3.3 Cesium and Strontium Capsules at Hanford

There are 1,936 capsules stored on the Hanford Site (1,335 cesium capsules and 601 strontium capsules). The capsules on the Hanford Site contain strontium and cesium extracted from wastes generated from the chemical processing of defense fuel, a fraction of those elements in the form of the isotopes ⁹⁰Sr, ¹³⁷Cs, and ¹³⁵Cs (other radioisotopes having decayed away). The cesium and strontium were separated from the wastes in B-Plant to reduce the heat load of the wastes stored in the underground tanks on the Hanford Site. The cesium and strontium capsules were fabricated at the Waste Encapsulation and Storage Facility (WESF) in the 200 East Area beginning in 1974, with the final strontium capsule prepared in 1985. The cesium and strontium are stored underwater in double-walled capsules at the WESF. The capsules contain approximately a third of the total radioactivity on the Hanford Site.

Cesium Capsules—There are 1,335 cesium capsules including 1,312 in the standard capsules and 23 in Type W overpacks (Fluor Hanford 2000). Figure A-20 shows a schematic of a standard cesium capsule (Plys and Miller 2003). Both the inner capsule and the outer capsule were fabricated of 316L stainless

steel. Table A-41 shows the dimensions of the standard cesium capsule as well as the Type W overpack (Plys and Miller 2003). Cesium carbonate from B-Plant was converted to cesium chloride (CsCl) in WESF. The capsules were filled by pouring molten CsCl salt into the inner capsule. The inner capsule was capped, welded closed, leak tested and decontaminated. The inner capsule was then placed in the outer capsule, which was then capped and welded closed.

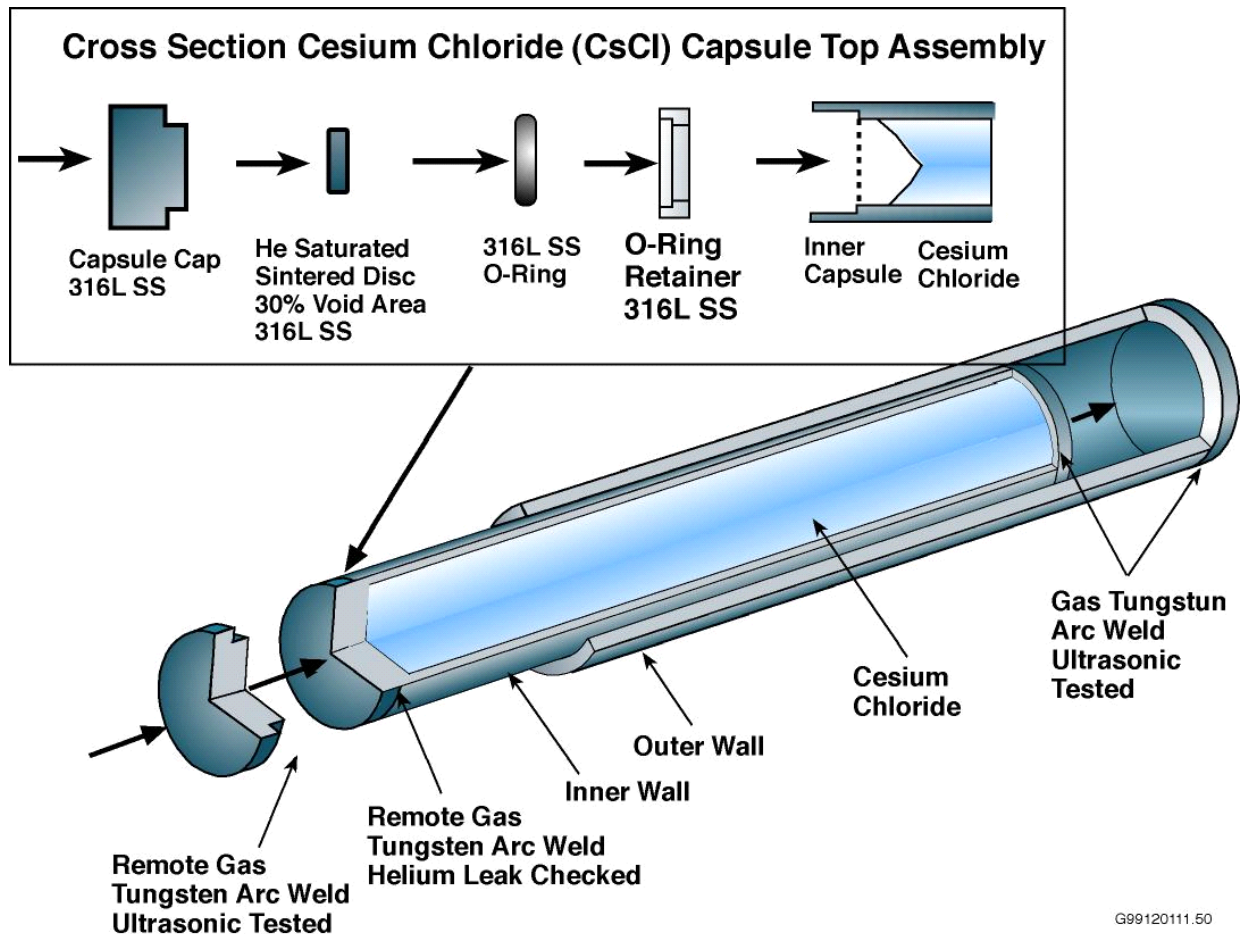

Source: Plys and Miller 2003, Figure 1.1.

Figure A-20. Schematic of cesium chloride capsule

Table A-41. Characteristics of cesium and strontium capsules

Item	Containment Boundary	Material	Wall Thickness ¹ (in.)	Outside Diameter (in.)	Total Length (in.)	Cap Thickness (in.)
CsCl Capsule	Inner	316L Stainless Steel	0.095 0.103 0.136	2.25	19.75	0.4
	Outer	316L Stainless Steel	0.109 0.119 0.136	2.625	20.775	0.4
CsCl Type W Overpack	Single	316L Stainless Steel	0.125	3.25	21.825	0.4
SrF ₂ Capsule	Inner	Hastelloy C-276	0.12	2.25	19.75	0.4
	Outer	316L Stainless Steel or Hastelloy C-276	0.12	2.625	20.1	0.4

¹The specified wall thickness of the CsCl capsules was increased twice during production. The capsules are referred to Type 1, Type 2, and Type 3, with Type 3 being the most numerous (Heard et al. 2003). Source: Plys and Miller 2003.

The Type W overpacks are used to encapsulate cesium capsules and materials derived from the cesium capsules that do not meet acceptance criteria for the WESF storage basins (Simmons 1998). Table A-42 shows the contents of the 23 Type W overpacks (Fluor Hanford 2000). In the 1980s, a large number of cesium capsules were leased to domestic and international irradiators or were used for other government programs. In 1988, cesium was detected in the storage basin of one of the commercial irradiators. As a result, the capsules were recalled to the Hanford Site. Of the 1,312 standard cesium capsules currently stored in WESF, 753 (~57%) were leased and subsequently returned (Bath et al. 2003). The 23 Type W overpack capsules contain returned capsules that did not meet WESF acceptance criteria and other residual materials containing CsCl. For most of the capsules in the overpacks, the capsules had swollen and deformed as a result of thermal cycling causing phase transitions in the CsCl salt (Tingey et al. 2003).

Table A-42. Type W cesium capsules and contents

Capsule Contents	Inner Capsule	Outer Capsule	Number of Type W
10 Nordian™ pencils from Oak Ridge, each containing CsCl originating from WESF	Yes	Yes	1
Cesium chloride powder and/or pellets from Oak Ridge	Yes	Yes	2
304L stainless steel type 4 containers from Oak Ridge containing CsCl originating from WESF	No	No	1
Remnants from destructive testing of WESF capsules	No	Yes	3
Swollen WESF capsules returned from commercial irradiators	Yes	Yes	16
Total			23

Source: Fluor Hanford 2000.

The cesium capsules contain ^{137}Cs , ^{135}Cs , and barium from the decay of the various cesium isotopes. Contaminants include sodium, potassium, magnesium, and the Dangerous Waste (per Washington State Regulations WAC 173-303) components chromium, lead, cadmium, and silver (Fluor Hanford 2000). Table A-43 shows summary information on the activity and heat generation for the cesium capsules.

Table A-43. Radioactivity and heat generation characteristics for cesium capsules

Capsules	Number		Wattage ^a	Activity (kCi) ^a	Original Activity (kCi)
All	1,335	Average	143.61	30.43	56.50
		Std Dev	14.10	2.99	6.89
		Maximum	195.37	41.39	75.85
		Minimum	16.29	3.45	4.24
Standard	1,312	Average	144.01	30.51	56.72
		Std Dev	12.86	2.72	6.29
		Maximum	195.37	41.39	75.85
		Minimum	93.86	19.89	36.86
Type W	23	Average	118.46	25.10	42.82
		Std Dev	38.87	8.24	17.88
		Maximum	158.64	33.61	62.50
		Minimum	16.29	3.45	4.24

^a As of August 29, 2007.

Strontium Capsules—There are 601 strontium capsules stored underwater at WESF. The construction is similar to the cesium capsule shown in Figure A-20. In the case of the strontium capsules, the inner capsule is fabricated of Hastelloy C-276 and the outer capsule is fabricated of 316L stainless steel, although there is some indication that some of the outer capsules may be fabricated of Hastelloy (Bath et al. 2003). Table A-41 shows the dimensions of the strontium capsule components. Strontium nitrate from B-Plant was converted to strontium fluoride (SrF_2) in WESF. After drying at 950°C to 800°C , the SrF_2 was chiseled from the drying pan and the resulting pieces were compacted into the Hastelloy inner capsule to within 1 in. of the top of the capsule. The inner capsule was capped, welded closed, leak tested and decontaminated. The inner capsule was then placed in the outer capsule, which was then capped and welded closed.

Of the 601 strontium capsules stored in WESF, 411 were filled as described in the previous paragraph. An additional 189 were filled with SrF_2 recovered from the work tables and cell floor where the SrF_2 was chiseled from the drying pan. These are referred to as strontium waste capsules and include other materials such as carbonaceous materials, metals, ceramics and other inorganic materials recovered with the SrF_2 (Bath et al. 2003). Typically, the strontium waste capsules have less heat generation than the standard production capsules. One capsule, called the tracer capsule, is filled with natural strontium and has no heat generation (Heard et al. 2003). Table A-44 summarizes the radioactivity and heat generation characteristics of the strontium capsules. In 1983, four strontium capsules were sent to the Nevada Test Site where they were placed in a steel container for permanent disposal in a greater confinement disposal borehole (Simmons 1998; Cochran et al. 2001).

Table A-44. Radioactivity and heat generation characteristics for strontium capsules

Capsules	Number		Wattage ^a	Activity (kCi) ^a	Original Activity (kCi)
All	600 ^b	Average	193.26	28.89	369.75
		Std Dev	101.00	15.10	211.47
		Max	504.63	75.43	1045.00
		Min	22.12	3.31	38.00
Standard	411	Average	235.97	35.27	454.23
		Std Dev	86.42	12.92	189.20
		Max	504.63	75.43	1045.00
		Min	22.12	3.31	38.00
Waste	189	Average	100.38	15.00	186.04
		Std Dev	59.57	8.90	121.89
		Max	384.75	57.51	797.00
		Min	27.24	4.07	50.00
Tracer	1		0	0	0

^a As of August 29, 2007

^b Does not include Tracer Capsule

The strontium capsules contain ⁹⁰Sr and zirconium from the decay of the ⁹⁰Sr. Dangerous Waste chemical impurities include barium, lead, cadmium, chromium, and silver (Fluor Hanford 2000). The strontium waste capsules could also include carbon from the carbonaceous materials; steel nuts, bolts, manipulator fingers, Hastelloy and Inconel chips, tungsten, and titanium; concrete, glass, and asbestos; and chemicals such as tri-sodium phosphate (Bath et al. 2003). Based on calorimetric measurements, some of the strontium waste capsules may be as much as 50% foreign materials.

Cesium and Strontium Capsules Treatment Options—Several studies have identified and evaluated options for the treatment and disposal of the cesium and strontium capsules (Claghorn 1996; DOE 1996; DOE 2012b). Common to the studies are two options for dispositioning the capsules. In one option, the capsules are left intact and are disposed in some sort of overpack or canister (direct disposal waste form). In the other option, the cesium and strontium are extracted from the capsules and is vitrified into a glass waste form at the Hanford WTP (cesium/strontium capsule glass waste form).

For the direct disposal option, the cesium and strontium capsules would be placed in stainless steel canisters matching the dimensions of the HLW glass canisters acceptable for disposal at the federal repository. Based on physical dimensions, a typical 10-ft (3-m) or 15-ft (4.42-m) canister could hold many capsules. However, the heat generation from the radioactive decay limits the number of capsules within a canister. Nankani (1994) calculated that a 10-ft canister could hold six cesium or six strontium capsules per canister and meet geologic repository heat load limits (0.8 kW per cesium canister, 1.17 kW per strontium canister) (2010 disposal year). This would yield 223 cesium capsule canisters and 101 strontium capsule canisters. Claghorn (1996) presents a concept in which the capsules are stacked end-to-end in a finned holder down the centerline of the canister. In this configuration, a 10-ft canister would hold five capsules and a 15-ft canister would hold 8 canisters. This would yield 267 or 167 cesium canisters and 121 or 76 strontium canisters, depending on the canister height.

It should be noted that other packaging options could be considered if it were advantageous for disposal; for example, smaller packages for deep borehole disposal. This would allow all of the cesium and strontium capsules to be disposed of within a single borehole.

In the vitrification option, the cesium and strontium would be extracted from the capsules and the resulting slurry would be converted to a glass waste form in the HLW melters of the WTP. In the

recently issued Tank Closure and Waste Management Environmental Impact Statement (DOE 2012b), all scenarios but the no-action scenario include vitrification of the capsule contents as a separate 1-year campaign after vitrification of the tank waste. The capsules would be cut open and the CsCl and SrF₂ would be removed. Cesium chloride is soluble in water and the resulting solution would be run through an ion exchange column to remove the chloride. Strontium fluoride is not soluble and would need to be pulverized to form a material suitable for slurry transport. The cesium and strontium would be stored in a dedicated vessel until the vitrification campaign. The Tank Closure and Waste Management Environmental Impact Statement (DOE 2012b) estimates that an additional 340 glass canisters would be produced solely from the inventory of cesium and strontium capsules. With a total heat content of 308 kW in the capsules, there would be an average of ~905 W per glass canister. Other possible operating scenarios include adding the cesium and strontium materials (with or without chloride removal) over the course of vitrifying the tank wastes. This may or may not reduce the number of additional glass canisters produced (Claghorn 1996).

A new Cesium and Strontium Capsule Processing Facility would be constructed to remove the cesium and strontium from the capsules and prepare the wastes for tank storage until vitrification. Secondary wastes from the cesium and strontium processing would include the inner and outer capsule metal lining. It is estimated that 8,500 kilograms (18,700 lbs.) of shredded metal would result in 100 drums of RH solid mixed LLW for disposal (DOE 2012b). Removal of chloride from the cesium would create an additional 115 drums of chloride-loaded ion-exchange resin that would require disposal as mixed waste (Claghorn 1996).

A-2.4 Sodium-Bonded Spent Nuclear Fuels and Associated Waste Forms

The DOE inventory of sodium-bonded spent nuclear fuel includes about 3.4 MTHM driver fuel and 57 MTHM blanket fuel. These fuels, which were generated during the operation of experimental fast-neutron breeder reactors, consist of HEU or depleted uranium alloy fuel surrounded by a layer of sodium metal (for heat transfer) within an alloy cladding. The driver fuel consists of HEU metal (approximately 65% ²³⁵U upon discharge) alloyed with 10 wt. % zirconium. The fuel is completely surrounded by a layer of metallic sodium which is contained within steel cladding. The blanket fuel (i.e., the fertile rod assemblies that surround the fissile core for the purposes of breeding) consists of depleted uranium in steel cladding. About 3.1 MTHM driver fuel and 22.4 MTHM blanket fuel are at the EBR-II facility in Idaho, ~0.3 MTHM driver fuel is from the Hanford FFTF, and about 34 MTHM blanket fuel is from the Detroit Edison Fermi Nuclear Power Plant facility.

These types of fuels represent a significant technical challenge for direct disposal due to the potentially energetic reaction of sodium metal with water to produce hydrogen gas and sodium hydroxide. Distillation of sodium from driver fuel is not effective because sodium becomes incorporated within the pore structure of the fuel. In addition, the fuel interacts with the cladding such that mechanical stripping is not effective. Several options for treating the fuel were considered, including: (1) electrometallurgical treatment (EMT); (2) melt and dilute; (3) distillation of blanket fuel (i.e., melt, drain, evaporate, carbonate—"MEDEC" process); (4) aqueous processing; and (5) the use of high integrity cans. The "MEDEC" process would produce a metallic spent fuel waste that could be considered for disposal without further treatment.

After development and demonstration of the EMT procedure (Benedict et al. 1999; which treats both the fuel and cladding), DOE made the decision to treat all sodium-bonded fuel except Fermi-1 blanket fuel using this process (65 FR 56565). The waste forms developed to dispose EMT wastes are to be qualified for disposal as HLW rather than as spent fuel (65 FR 56565; note that to this point only about ~0.8 MTHM of EBR-II driver fuel and ~3.2 MTHM of EBR-II blanket fuel have been processed with EMT).

Because of its different physical characteristics, DOE decided to store the Fermi-1 fuel while alternatives are evaluated, although EMT remains an option for this waste.

The separation and refining of uranium using the EMT process will generate about 9,900 and 22,450 kg of LEU from treatment of driver and blanket spent fuels, respectively plus two separate waste streams—high-level radioactive salt waste and metallic waste—that would be immobilized into waste forms for disposal. The recovered LEU will be stored until DOE decides on its future use, and the two waste types will be immobilized in suitable waste forms and disposed in the high-level radioactive waste repository.

The EMT process uses a molten salt electrolyte to separate uranium from the rest of the fuel by dissolution and electrotransport. Details of the electrorefiner design and operation are given by Goff et al. (1996). The EBR-II driver, INTEC driver, and FFTF fuels will be combined and treated in the Mk-IV electrorefiner. For the purposes of this study, it was assumed that the EBR-II blanket fuel will be treated in the Mark-V electrorefiner. Chopped fuel rods are placed in metal baskets and immersed in a molten LiCl-KCl eutectic salt that is spiked with 2 mole % actinide chlorides to initiate the refining process. The fuel is electrorefined using a steel mandrel as the cathode and the baskets as anodes. The electrorefiner is operated at about 500°C.

By careful control of the current and voltage, reactive components of the fuel are oxidized and dissolved into the salt, while uranium is reduced to the metal and accumulates on the steel mandrel. Oxidized fission products and actinides accumulate in the eutectic salt as chloride salts dissolve. The electrorefiner is run until a limiting amount of either sodium or plutonium accumulates in the salt. Sodium raises the liquidus temperature of the salt and is limited to about 6 mass % to ensure safe operation of the electrorefiner, whereas the accumulation of plutonium is limited by criticality considerations.

When either the sodium or plutonium limit is reached, salt is removed from the electrorefiner for disposal. This is referred to as the “throwaway option” for the salt and is the current baseline plan. Potential recycling options for the eutectic salt are being studied and could be implemented in the future. The uranium is recovered, diluted to low enrichment by adding depleted uranium, and then cast into ingots in a cathode processor. The cladding hulls and metallic fuel wastes are recovered from the anode baskets for disposal. Small amounts of salt that are entrained with the uranium and metal waste streams are volatilized and recovered, and then added back to the salt waste. The salt and metal wastes are being transferred from the electrorefiner to the Hot Fuel Examination Facility where they are being incorporated into waste forms for disposal. The waste forms will be stored at the Radioactive Scrap and Waste Facility at INL site until shipment to a federal repository.

A-2.4.1 The Ceramic Waste Form for EMT Salt Waste

Salt wastes from EMT of sodium-bonded fuels are composed of the LiCl-KCl salt electrolyte used in the electrorefiner plus radionuclides that were oxidized to form chloride salts. The EMT salt waste will contain about 8 mass % total actinides (with maximum amounts of about 5 mass % plutonium or 7 mass % uranium), with enrichments up to about 64% for driver fuel. The average radionuclide inventory for the CWF projected to the year 2040 is given in Table A-45 (Ebert 2005).

Table A-45. EBR-II and FFTF ceramic waste radionuclide composition

Isotope	Total mass (g)	Isotope	Total mass (g)	Isotope	Total mass (g)	Isotope	Total mass (g)
Li-6	3.79E-01	Ba-136	4.43E+01	Tb-159	1.00E+01	Pu-241	8.20E+01
Li-7	6.11E+00	Ba-137	2.91E+03	Tb-160	9.27E-11	Pu-242	1.76E+01
Be-9	7.50E-03	Ba-137	1.11E-03	Dy-160	2.99E-01	Pu-243	7.06E-20
Be-10	8.69E-04	Ba-138	1.04E+04	Dy-161	1.63E+00	Pu-244	2.36E-06
F-19	7.98E-06	La-138	2.06E-02	Dy-162	9.40E-01	Am-241	1.25E+02
Na-22	4.57E-05	La-139	1.03E+04	Dy-163	4.35E-01	Am-242	4.77E-06
Na-23	2.66E+05	Hf-140	1.03E+04	Dy-164	2.72E-01	Am-242	3.96E-01
Na-24	1.88E+01	Hf-141	1.58E-16	Ho-165	1.21E-01	Am-243	2.87E-01
Na-25	1.31E-01	Hf-142	9.22E+03	Ho-166	3.65E-04	Am-244	1.83E-21
Na-26	2.91E-01	Hf-144	4.68E+00	Er-166	2.75E-02	Cm-242	9.98E-04
Cl-35	1.72E-07	Pr-141	9.71E+03	Er-167	2.30E-04	Cm-243	1.10E-03
Cl-36	1.39E-12	Pr-142	1.92E-10	Fr-221	6.27E-14	Cm-244	5.74E-03
Cl-37	4.48E-06	Pr-144	1.98E-04	Fr-223	1.27E-13	Cm-245	1.28E-04
K-39	3.94E-10	Pr-144	9.89E-07	Ra-223	6.76E-09	Cm-246	6.66E-07
K-40	3.48E-05	Nd-142	1.72E+01	Ra-224	6.30E-07	Cm-247	2.07E-09
K-41	2.44E-09	Nd-143	9.29E+03	Ra-225	2.83E-10	Cm-248	8.24E-12
Ca-40	1.00E-01	Nd-144	8.68E+03	Ra-226	1.06E-05	Cm-250	6.22E-20
Ca-41	1.23E-05	Nd-145	6.27E+03	Ra-228	4.93E-12	Bk-249	2.81E-17
Ca-42	7.01E-04	Nd-146	5.01E+03	Th-227	1.08E-08	Cf-249	2.06E-14
Ca-43	5.87E-04	Nd-148	2.92E+03	Th-228	1.23E-04	Cf-250	1.56E-16
Ca-44	5.77E-03	Nd-150	1.28E+03	Th-229	5.19E-05	Cf-251	1.94E-18
Ca-45	7.25E-09	Pm-147	1.93E+02	Th-230	2.40E-01	Cf-252	1.22E-21
Ca-46	3.91E-04	Pm-148	3.01E-17	Th-231	8.57E-06		
Ca-48	2.32E-04	Pm-148	3.36E-15	Th-232	2.10E-02		
Br-79	1.40E-02	Sm-147	3.39E+03	Th-234	3.33E-04		
Br-81	2.28E+02	Sm-148	7.15E+01	Pa-231	3.05E-02		
Rb-85	1.18E+03	Sm-149	1.79E+03	Pa-233	4.31E-05		
Rb-87	2.30E+03	Sm-150	9.15E+01	Pa-234	3.89E-09		
Sr-86	4.35E+00	Sm-151	6.75E+02	Pa-234	1.12E-08		
Sr-87	5.38E-03	Sm-152	5.81E+02	U-232	1.21E-04		
Sr-88	3.30E+03	Sm-154	1.67E+02	U-233	2.11E-02		
Sr-89	2.09E-10	Eu-151	8.92E+01	U-234	1.97E+02		
Sr-90	4.01E+03	Eu-152	3.63E-01	U-235	5.34E+04		
Y-89	4.56E+03	Eu-153	3.52E+02	U-236	1.32E+03		
Y-90	1.01E+00	Eu-154	5.40E+00	U-237	3.52E-08		
Y-91	1.08E-08	Eu-155	1.93E+01	U-238	1.52E+05		
I-127	4.22E+02	Gd-152	6.74E-01	U-240	1.02E-18		
I-129	1.39E+03	Gd-153	1.92E-06	Np-237	1.23E+03		
Cs-133	1.04E+04	Gd-154	1.03E+01	Np-239	2.37E-07		
Cs-134	3.00E+00	Gd-155	1.02E+02	Np-240	3.90E-19		
Cs-135	1.05E+04	Gd-156	5.85E+01	Pu-236	4.57E-04		
Cs-137	7.29E+03	Gd-157	3.09E+01	Pu-238	3.38E+01		
Ba-134	8.50E+01	Gd-158	2.36E+01	Pu-239	2.61E+05		
Ba-135	9.61E-02	Gd-160	4.97E+00	Pu-240	5.71E+03		

The EM waste salts are not amenable to direct vitrification in borosilicate waste forms because borosilicate glasses have a low capacity for chlorine. Typically, only about 1% chlorine can be dissolved into a borosilicate glass. To overcome this limitation, a two-step process has been developed in which the EMT waste salt is first occluded within a zeolite matrix and then the zeolite is microencapsulated in a borosilicate glass (Goff et al. 1996). To start, the salt recovered from the electrorefiner is size-reduced to facilitate occlusion in zeolite by crushing and grinding under an argon atmosphere. The crushed salt is mechanically mixed with dried zeolite 5A in a V-mixer at a salt loading of about 10 mass % and then heated to about 500°C for 16 hours to occlude salt within the zeolite cages. The zeolite is dried to a water content of <1 mass % before being mixed with the salt to facilitate salt loading. The salt-loaded zeolite is then mixed with a borosilicate binder glass in a V-mixer (without heating) at a 3:1 mass ratio. That mixture is loaded into fill cans that are processed at about 915°C for about 72 hours. The glass becomes sufficiently fluid at this temperature to infiltrate and microencapsulate the granules of salt-loaded zeolite. As the mixture is heated above about 850°C during the encapsulating step, the salt-loaded zeolite converts to the mineral sodalite, $\text{Na}_8(\text{AlSiO}_4)_6\text{Cl}_2$, which incorporates NaCl and NaI from the occluded salt into its structure. Other elements are mostly excluded from the sodalite and enter the glass. The resulting waste form is a glass-bonded sodalite material referred to as the CWF. Note that direct disposal of the salt waste itself as a waste form has also been evaluated and is discussed below in Section A-2.4.3.

The relative amounts of salt, zeolite, and binder glass are controlled to produce an optimal waste form. Too much salt results in the formation of excessive halite inclusions and too little results in the formation of excessive nepheline (Ebert et al. 2005). The nominal amount of salt is slightly less than stoichiometric for the formation of sodalite. Based on the amount of salt loaded into the zeolite and the relative amounts of zeolite and glass, the CWF will contain about 8% by mass EMT waste salt.

Depending on the number of driver and blanket fuel rods processed in each batch, CWF products may contain 0.2 to 0.6 mass % LEU and up to about 0.5 mass % plutonium. The CWF will not contain RCRA-regulated constituents. An estimated 50,950 kg CWF will be produced from the combined EBR-II, and Hanford FFTF fuels. Each 1-m CWF cylinder will weigh about 400 kg (~128 cylinders total) and occupy a volume of about 0.2 m³. The CWF product dimensions provides the option of packaging two CWF products in a canister that is 3-m-long, with a 61-cm outer diameter (the internal length and volume of this canister are about 2.5 m and 0.67 m³, respectively). The approximately 128 CWF cylinders to be produced will require 64 HLW canisters containing the two waste forms.

Yoo et al. (2009) calculated the maximum waste loading for CWF products that would meet a thermal load limit of 3.82 kW/m³ estimated based on DOE waste acceptance criteria for the proposed Yucca Mountain disposal facility. They determined the total contributions of major heat-contribution isotopes in the salt waste stream (^{137m}Ba, ⁹⁰Y, ¹³⁴Cs, ¹⁵⁴Eu, ¹⁵⁵Eu, ¹⁴⁷Pm, ¹⁵¹Sm, ⁹⁰Sr, and ¹³⁷Cs) after decay times of 6, 10, and 20 years. Based on the amounts of those isotopes in the CWF compositions given in Table A-45, the thermal outputs of a canister with two CWF products are calculated to be 2.24, 1.73, and 1.25 kW/canister for 6-, 10-, and 20-year-old fuel wastes.

A-2.4.2 Metallic Waste Form for EMT Metallic Waste

The EMT metallic waste stream will be immobilized by melting it in an induction furnace at about 1,600°C with added zirconium and depleted uranium to produce an alloyed metallic waste form (MWF). Any EMT salt carried over with the cladding hulls will be volatilized and recovered from the furnace before the metal is melted, and that recovered salt will be added to the salt waste stream. The metallic waste stream is composed primarily of irradiated stainless steel and Zircaloy cladding hulls, plus residual zirconium from driver fuel rods. These hull materials are inert to electrochemical treatment (i.e., they do not oxidize and do not dissolve into the salt under the operating conditions used) and would be directed to the MWF. That is, they are not oxidized and do not dissolve into the salt under the operating conditions that are used. Stainless steel cladding will account for more than 90% of the metal waste stream that will

be generated from the EBR-II inventory. The average radionuclide inventory for the MWF projected to the year 2040 is given in Table A-46 (Ebert 2005).

The MWF will be composed of nearly equal amounts of two predominant phases interspersed on a microscopic scale: an Fe-Cr-Ni-Zr mixture (which is referred to as the intermetallic phase and is similar to the Laves $Zr(Fe,Cr,Ni)_{2+x}$ phase) and an iron solid solution phase. The iron solid solution may contain ferrite or a mixture of ferrite and austenite phases, depending on whether Type 304 or Type 316 stainless steel cladding is being immobilized. Zirconium may be added to the metallic waste stream as a trim metal to produce waste form ingots with consistent compositions, phase assemblages, and microstructures. Depleted uranium will also be added to the metallic waste stream during melting to reduce the enrichment to less than 20 mass % ^{235}U .

The amounts of zirconium and uranium to be added will be determined based on knowledge of the metal waste stream composition and controlled to produce waste forms having consistent compositions, phase assemblages, and microstructures. The acceptable range for zirconium content is 5 to 20 mass % with a target of 15 mass %. The lower limit of this range provides enough of the intermetallic phase to ensure all of the radionuclides in the metallic waste stream are alloyed and the upper limit ensures that the MWF has high physical integrity. The maximum uranium content is 11 mass % based on criticality limits, and the target uranium content is 10 mass %. The approach for product consistency is described by Keiser et al. (2002). Although the MWF products are likely to contain small amounts of cadmium and chromium, TCLP results for representative MWF materials were far below regulatory limits for characteristic-hazardous waste (Ebert 2005).

The MWF products are being cast as ingots sized to fit in the 3 m long HLW canisters that are also to be used to store/dispose the CWF products. The disk-shaped ingots will be about 14 to 16 in. in diameter and up to 5 in. thick, and will weigh about 12 kg. The first MWF waste ingot was produced in 2012 (Westphal et al. 2013). It is currently estimated that 5,850 kg of MWF will result from EMT treatment of sodium-bonded spent fuel. If it is assumed that each ingot produced will weigh 12 kg (this has yet to be finalized), the total number of MWF disks will be approximately 488. The total number of canisters containing MWF will depend on the mass limits per canister that may be imposed by handling operations. Given the 64 canisters needed for disposal of the CWF above, this would translate into 7 to 8 MWF disks per canister, which is about 84 to 96 kg of MWF per canister. The thermal output of the MWF is negligible due to the very small amount of heat-generating radionuclides.

Table A-46. EBR-II and FFTF metal waste radionuclide composition

Isotope	Total mass (g)	Isotope	Total mass (g)	Isotope	Total mass (g)	Isotope	Total mass (g)
H-1	8.84E+00	Mn-55	5.67E+04	Nb-93	9.57E-02	In-115	4.27E+01
H-2	6.99E-05	Fe-54	1.63E+05	Nb-94	1.44E+01	Sn-112	4.45E-04
H-3	3.32E-01	Fe-55	4.87E+00	Nb-95	1.22E-07	Sn-114	4.95E-03
He-3	1.18E-01	Fe-56	2.63E+06	Nb-95	1.21E-10	Sn-115	1.43E+00
He-4	8.43E+00	Fe-57	6.22E+04	Mo-92	1.66E+04	Sn-116	4.54E-01
B-10	2.06E+00	Fe-58	8.69E+03	Mo-93	3.62E+01	Sn-117	4.99E+01
B-11	1.07E+01	Fe-59	5.80E-15	Mo-94	1.05E+04	Sn-118	4.85E+01
C-12	3.84E+03	Co-58	3.67E-08	Mo-95	2.51E+04	Sn-119	4.98E+01
C-13	4.66E+01	Co-59	6.47E+03	Mo-96	1.95E+04	Sn-119	6.00E-04
C-14	5.82E-01	Co-60	3.56E+00	Mo-97	1.79E+04	Sn-120	5.05E+01
N-14	1.18E+03	Ni-58	4.60E+05	Mo-98	3.53E+04	Sn-121	1.65E-02
N-15	4.70E+00	Ni-59	1.40E+02	Mo-100	1.91E+04	Sn-122	6.01E+01
O-16	7.45E+01	Ni-60	1.82E+05	Tc-99	6.72E+03	Sn-123	3.32E-05
O-17	3.19E-02	Ni-61	8.05E+03	Ru-99	5.55E+03	Sn-124	9.93E+01
O-18	1.68E-01	Ni-62	2.59E+04	Ru-100	5.78E+03	Sn-126	2.11E+02
F-20	7.42E-01	Ni-63	5.91E+00	Ru-101	1.40E+04	Sb-121	5.25E+01
F-21	9.30E-05	Ni-64	6.78E+03	Ru-102	2.03E+04	Sb-123	6.77E+01
F-22	8.38E-04	Cu-63	2.43E+03	Ru-103	1.28E-13	Sb-124	1.63E-12
Al-27	2.40E+03	Cu-65	1.12E+03	Ru-104	1.19E+04	Sb-125	6.38E+00
Si-28	2.86E+04	Zn-64	7.22E-01	Ru-106	2.33E+00	Sb-126	1.00E-05
Si-29	1.50E+03	Zn-66	7.14E-01	Rh-103	1.08E+04	Sb-126	7.61E-08
Si-30	1.03E+03	Ga-69	4.57E-01	Rh-103	1.25E-16	Te-122	4.83E-01
P-31	1.18E+03	Ga-71	3.12E-01	Rh-106	2.18E-06	Te-123	2.75E-03
S-32	7.91E+02	Ge-72	1.77E-01	Pd-104	1.33E+03	Te-123	6.18E-10
S-33	6.44E+00	Ge-73	4.94E-01	Pd-105	2.93E+03	Te-124	2.97E-01
S-34	3.72E+01	Ge-74	1.21E+00	Pd-106	2.33E+03	Te-125	1.02E+02
S-35	6.55E-16	Ge-76	1.31E+01	Pd-107	6.70E+02	Te-125	1.52E-01
S-36	1.87E-01	As-75	5.34E+01	Pd-108	1.55E+03	Te-126	1.75E+00
Ar-36	1.74E-17	Se-76	4.70E-02	Pd-110	6.86E+02	Te-127	3.04E-08
Ar-37	1.77E-23	Se-77	2.91E+01	Ag-107	1.72E-03	Te-127	8.69E-06
Ar-38	5.17E-10	Se-78	5.51E+01	Ag-108	5.39E-15	Te-128	1.03E+03
Ar-39	1.06E-08	Se-79	8.70E+01	Ag-108	1.98E-06	Te-129	2.11E-20
Ar-40	1.69E-08	Se-80	1.56E+02	Ag-109	2.94E+02	Te-129	2.28E-17
Sc-45	9.80E-04	Se-82	3.50E+02	Ag-109	5.06E-16	Te-130	2.99E+03
Sc-46	1.40E-11	Br-80	2.35E-04	Ag-110	8.73E-13	Xe-128	3.96E+00
Ti-46	7.02E+02	Br-81	2.80E-06	Ag-110	5.51E-05	Xe-129	1.79E-02
Ti-47	6.56E+02	Br-82	1.87E+00	Cd-108	1.78E-05	Xe-130	8.68E+00
Ti-48	6.75E+03	Br-83	5.26E+02	Cd-109	5.01E-10	Xe-131	4.92E+03
Ti-49	5.15E+02	Br-84	9.15E+02	Cd-110	4.45E+00	Xe-132	7.23E+03
Ti-50	5.17E+02	Br-85	1.20E+02	Cd-111	8.40E+01	Xe-134	1.18E+04
V-49	2.07E-08	Br-86	1.79E+03	Cd-112	6.35E+01	Xe-136	9.54E+03
V-50	5.00E+00	Zr-90	8.15E+04	Cd-113	5.07E+01	Ta-180	6.67E-02
V-51	6.57E+02	Zr-91	2.34E+04	Cd-113	5.86E-01	Ta-181	5.38E+02
Cr-50	3.30E+04	Zr-92	3.32E+04	Cd-114	4.96E+01	Ta-182	1.10E-06
Cr-51	2.85E-22	Zr-93	6.31E+03	Cd-115	8.63E-15	W-180	1.22E+00
Cr-52	6.63E+05	Zr-94	3.50E+04	Cd-116	4.93E+01	W-181	3.36E-08
Cr-53	7.61E+04	Zr-95	1.01E-07	In-113	6.23E-01	W-182	2.71E+02
Cr-54	2.01E+04	Zr-96	1.14E+04	In-114	2.48E-21	W-183	1.48E+02
Mn-54	7.22E-02	Nb-93	3.92E+03	In-114	1.54E-16	W-184	3.20E+02

Table A-46. EBR-II and FFTF metal waste radionuclide composition (cont.)

Isotope	Total mass (g)	Isotope	Total mass (g)	Isotope	Total mass (g)	Isotope	Total mass (g)
W-185	1.67E-09	Bi-214	2.34E-13	U-235	3.19E+04	Am-243	4.36E-03
W-186	2.99E+02	Po-210	2.26E-10	U-236	8.02E+02	Am-244	2.80E-23
Tl-207	1.82E-12	Po-211	1.01E-17	U-237	3.73E-08	Cm-242	1.52E-05
Tl-208	1.25E-10	Po-212	3.64E-19	U-238	3.47E+05	Cm-243	1.67E-05
Tl-209	5.97E-16	Po-213	8.26E-22	U-240	6.88E-19	Cm-244	8.72E-05
Pb-204	1.61E-03	Po-214	3.96E-20	Np-237	1.87E+01	Cm-245	1.94E-06
Pb-206	2.80E-02	Po-215	1.19E-17	Np-239	3.61E-09	Cm-246	1.01E-08
Pb-207	2.57E-02	Po-216	2.90E-13	Np-240	5.94E-21	Cm-247	3.15E-11
Pb-208	6.17E-02	Po-218	3.69E-14	Pu-236	6.95E-06	Cm-248	1.26E-13
Pb-209	2.45E-12	At-217	6.83E-18	Pu-238	5.14E-01	Cm-250	9.46E-22
Pb-210	1.45E-08	Rn-219	2.70E-14	Pu-239	3.98E+03	Bk-249	4.29E-19
Pb-211	1.41E-11	Rn-220	1.10E-10	Pu-240	8.69E+01	Cf-249	3.12E-16
Pb-212	7.24E-08	Rn-222	6.78E-11	Pu-241	1.25E+00	Cf-250	2.38E-18
Pb-214	3.18E-13	Rn-225	1.87E-10	Pu-242	2.68E-01	Cf-251	2.95E-20
Bi-209	9.73E-03	Rn-227	4.75E-06	Pu-243	1.08E-21	Cf-252	1.86E-23
Bi-210	9.46E-12	Rn-228	5.14E-16	Pu-244	3.60E-08		
Bi-211	8.37E-13	U-232	7.82E-05	Am-241	1.90E+00		
Bi-212	6.89E-09	U-233	1.29E-02	Am-242	7.26E-08		
Bi-213	5.91E-13	U-234	1.34E+02	Am-242	6.03E-03		

A-2.4.2.1 CWF and MWF Compositions, Inventories, and Source Documents

The radionuclide inventories to be immobilized in the CWF and MWF products for EMT EBR-II and Hanford FFTF fuels are listed in Table A-45 and Table A-46, respectively (Ebert 2005). The CWF and MWF inventories that were used to calculate an average inventory for DHLW canisters for use in the Yucca Mountain TSPA calculations are listed in Table A-47 (Ebert 2005) with that average DHLW inventory; the DHLW inventory includes contributions from Hanford, SRS, WVDP, INL INTEC, CWF, and MWF waste forms (CRWMS M&O 2000a). This identifies those radionuclides for which CWF and MWF waste forms are the dominant source.

Table A-47. Average radionuclide inventory (Ci) per canister used in calculations for TSPA for the Yucca Mountain license application

Nuclide	EBR-II & FFTF CWF	EBR-II & FFTF MWF	HLW ^a	Nuclide	EBR-II & FFTF CWF	EBR-II & FFTF MWF	HLW ^a
Ac-225	1.15E-08	3.41E-08	3.34E-05	Po-212	1.21E-05	8.94E-06	5.53E-04
Ac-227	3.37E-07	1.55E-06	1.83E-03	Po-213	1.13E-08	3.34E-08	3.26E-05
Ac-228	2.50E-11	4.75E-12	2.18E-04	Po-214	1.23E-06	4.05E-07	1.67E-06
Am-241	1.89E+01	5.64E-03	4.96E+01	Po-215	3.37E-07	1.55E-06	1.83E-03
Am-242	0	0	3.07E-02	Po-216	1.89E-05	1.40E-05	8.64E-04
Am-242m	0	0	3.09E-02	Po-218	1.23E-06	4.06E-07	1.67E-06
Am-243	2.88E-03	7.95E-07	5.02E-02	Pr-144	1.89E-13	0	2.07E-08
At-217	1.15E-08	3.41E-08	3.34E-05	Pr-144m	2.65E-15	0	2.90E-10
Ba-137m	3.31E+03	0	1.72E+04	Pu-236	0	0	1.12E-04
Bi-210	6.04E-07	1.27E-07	2.92E-07	Pu-238	2.72E+00	8.09E-04	9.41E+02
Bi-211	3.37E-07	1.55E-06	1.83E-03	Pu-239	1.75E+02	5.52E-02	1.29E+01
Bi-212	1.89E-05	1.40E-05	8.64E-04	Pu-240	1.55E+01	4.85E-03	7.59E+00
Bi-213	1.15E-08	3.41E-08	3.33E-05	Pu-241	1.64E+01	4.66E-03	3.13E+02
Bi-214	1.23E-06	4.05E-07	1.67E-06	Pu-242	1.28E-03	3.37E-07	1.04E-02
C-14	0	7.12E-01	1.87E-02	Ra-223	3.37E-07	1.55E-06	1.83E-03
Cd-113m	0	0	2.44E-02	Ra-224	1.89E-05	1.40E-05	8.64E-04
Ce-142	2.35E-06	0	5.24E-07	Ra-225	1.15E-08	3.41E-08	3.34E-05
Ce-144	1.89E-13	0	2.07E-08	Ra-226	1.23E-06	4.06E-07	1.67E-06
Cm-242	0	0	2.54E-02	Ra-228	2.50E-11	4.75E-12	2.18E-04
Cm-243	6.31E-04	1.92E-07	5.29E-03	Rb-87	3.85E-06	0	4.91E-08
Cm-244	4.28E-03	1.13E-06	2.71E+01	Rh-102	0	0	7.98E-10
Cm-245	0	0	1.17E-04	Rh-106	0	5.19E-09	2.37E-06
Cm-246	0	0	1.33E-05	Rn-219	3.37E-07	1.55E-06	1.83E-03
Co-60	0	2.73E+00	2.62E+00	Rn-220	1.89E-05	1.40E-05	8.64E-04
Cs-134	1.19E-04	0	1.11E-02	Rn-222	1.23E-06	4.06E-07	1.67E-06
Cs-135	1.66E-01	0	1.24E-01	Ru-106	0	5.19E-09	2.37E-06
Cs-137	3.51E+03	0	1.82E+04	Sb-125	0	8.92E-02	3.36E-01
Eu-152	0	0	3.59E-03	Sb-126	0	6.55E-02	5.23E-02
Eu-154	8.56E-01	0	4.45E+01	Sb-126m	0	4.68E-01	3.74E-01
Eu-155	5.37E-01	0	4.59E+00	Se-79	0	0	1.43E-01
Fe-55	0	0	2.65E-07	Sm-146	0	0	1.23E-11
Fr-221	1.15E-08	3.41E-08	3.34E-05	Sm-147	9.34E-07	0	4.85E-07
Fr-223	4.65E-09	2.14E-08	2.52E-05	Sm-148	8.19E-12	0	1.04E-13
Gd-152	0	0	1.10E-15	Sm-149	7.99E-12	0	1.02E-13
H-3	0	0	3.58E-01	Sm-151	0	0	1.58E+02
I-129	3.52E-03	0	8.22E-04	Sn-121	0	0	9.53E-04
K-40	4.26E-05	0	4.70E-05	Sn-121m	0	0	1.23E-03
La-138	1.02E-08	0	1.30E-10	Sn-126	0	4.68E-01	3.74E-01
Nb-93m	0	8.75E-01	7.30E-01	Sr-90	2.77E+03	0	1.94E+04
Nb-94	0	4.54E-01	3.62E-04	Tc-99	0	2.12E+01	3.13E+00
Nd-144	4.16E-10	0	3.17E-11	Te-125m	0	2.18E-02	8.18E-02
Ni-59	0	1.78E+00	3.45E-02	Th-227	3.32E-07	1.53E-06	1.81E-03
Ni-63	0	5.21E+01	2.76E+00	Th-228	1.89E-05	1.40E-05	8.64E-04
Np-236	0	0	1.26E-03	Th-229	1.15E-08	3.41E-08	3.34E-05
Np-237	1.41E-02	4.07E-06	1.15E-02	Th-230	5.90E-05	4.71E-05	8.21E-05
Np-238	0	0	1.39E-04	Th-231	9.21E-04	4.22E-03	1.07E-04
Np-239	2.88E-03	7.95E-07	5.02E-02	Th-232	2.54E-11	5.98E-12	2.18E-04

Table A-47. Average radionuclide inventory (Ci) per canister used in calculations for TSPA for the Yucca Mountain license application (cont.)

Nuclide	EBR-II & FFTF CWF	EBR-II & FFTF MWF	HLW ^a	Nuclide	EBR-II & FFTF CWF	EBR-II & FFTF MWF	HLW ^a
Pa-231	7.76E-07	3.57E-06	2.02E-03	Th-234	2.88E-03	1.62E-02	8.50E-03
Pa-233	1.41E-02	4.07E-06	1.15E-02	Tl-206	7.97E-13	1.67E-13	3.85E-13
Pa-234	3.74E-06	2.11E-05	1.11E-05	Tl-207	3.36E-07	1.55E-06	1.83E-03
Pa-234m	2.88E-03	1.62E-02	8.50E-03	Tl-208	6.81E-06	5.02E-06	3.10E-04
Pb-209	1.15E-08	3.41E-08	3.33E-05	Tl-209	2.41E-10	7.17E-10	7.01E-07
Pb-210	6.04E-07	1.27E-07	2.92E-07	U-232	1.84E-05	1.36E-05	6.29E-04
Pb-211	3.37E-07	1.55E-06	1.83E-03	U-233	4.49E-06	9.72E-06	1.27E-03
Pb-212	1.89E-05	1.40E-05	8.64E-04	U-234	2.92E-02	1.28E-01	1.30E-01
Pb-214	1.23E-06	4.05E-07	1.67E-06	U-235	9.21E-04	4.22E-03	1.07E-04
Pd-107	0	0	1.31E-02	U-236	6.78E-04	3.03E-03	2.61E-04
Pm-146	0	0	2.73E-06	U-237	3.92E-04	1.12E-07	7.48E-03
Pm-147	1.20E-01	0	6.91E+00	U-238	2.88E-03	1.62E-02	8.50E-03
Po-210	6.04E-07	1.27E-07	2.92E-07	Y-90	2.78E+03	0	1.94E+04
Po-211	9.27E-10	4.27E-09	5.04E-06	Zr-93	0	0	9.25E-01

^a Values for CWF and MWF shown in bold exceed the HLW average.

The following source documents trace how the radionuclide inventories in the INL ceramic and metallic waste forms were included in the HLW inventory used in the Yucca Mountain TSPA for license application. Note that the CWF and MWF are described in most reports as part of the inventory from INL rather than as a separate inventory at ANL-W.

Initial Radionuclide Inventory (BSC 2002)—This report states (on page 32 of 48):

“DHLW glass comes from four sites and will be delivered to the repository in either short or long pour-canisters. The Hanford site will produce long canisters. Idaho National Engineering and Environmental Laboratory (INEEL) Site [now INL] will produce short canisters. The Savannah River Site (SRS) produces short canisters. The West Valley Demonstration Project produced short canisters.”

It also states on page 39 of 48 that “The inventory abstraction for the SR [Site Recommendation] (BSC 2001a) used information for glass from four sites: (1) Hanford, (2) INEEL, (3) SRS, and (4) the West Valley Demonstration Project.”

The reference “BSC 2001a” is *Inventory Abstraction* (BSC 2001a).

The inventories for Hanford and SRS used in *Initial Radionuclide Inventory* (BSC 2002) are updated from those provided in *Inventory Abstraction* (BSC 2001a), whereas the same INL and WVDP inventories in *Inventory Abstraction* (BSC 2001a) are used. Table 21 in *Initial Radionuclide Inventory* (BSC 2002) provides the average inventories for 32 radionuclides in commercial SNF, DOE-managed SNF, and defense HLW glass. The inventory in defense HLW glass includes the inventories in the CWF and MWF.

Inventory Abstraction (BSC 2001a)—Attachment I, “Calculation of Radionuclide Inventory in Grams per Waste Package for TSPA-SR,” cites *Waste Package Radionuclide Inventory Approximations for TSPA-SR* (BSC 2001b, Section 6) as providing “average radionuclide activities for each of the thirteen waste package configurations listed (Table I-1).” Only Configuration 6 contains short HLW canisters, and it is assumed that 1,100 waste packages will have Configuration 6.

Waste Package Radionuclide Inventory Approximations for TSPA-SR (BSC 2001b)—This document provides the calculation of the average radionuclide inventories projected at 2040 for each waste package configuration proposed for site recommendation. The report states on page 6 of 19 in Section 5.4:

“DEFENSE HIGH-LEVEL WASTE Savannah River Site (SRS), the West Valley Demonstration Project (WVDP), the Idaho National Engineering and Environmental Laboratory (INEEL) [now INL], and the Hanford Reservation (HR) will be producing DHLW glass packaged in canisters for disposal. SRS, WVDP, and INEEL will be placing their DHLW glass in short standardized canisters. The HR will be placing DHLW glass in long standardized canisters. In addition, INEEL will be packaging DHLW metal and DHLW ceramic (INEEL is the only site that will have non-glass DHLW) in short canisters.”

“In *Inventory Abstraction Data Input* (CRWMS M&O 2000[b]), the average inventories for individual radionuclides in the two DHLW canister types, short standardized canisters and long standardized canisters, were determined. The average curie value for an individual radionuclide in short standardized canisters was calculated by summing the SRS, WVDP, and INEEL site-wide curie values for that radionuclide in DHLW and dividing the sum by the total number of short DHLW canisters that will be produced. The average curie value for an individual radionuclide in long standardized canisters was calculated as the HR site-wide curie value for that radionuclide in DHLW divided by the number of long DHLW canisters that will be produced (since HR is the only site using the long canisters). The input values [from] *Inventory Abstraction Data Input* (CRWMS M&O 2000[b]) for DHLW short and long canisters are shown in Tables 4 and 5, respectively.”

Inventory Abstraction Data Input (CRWMS M&O 2000b)—Pages 3 of 6, 4 of 6, 5 of 6, and 6 of 6 of the table “Average Radionuclide Inventory (Ci) per Short Canister by Site at 2040” list the inventories for three INEEL waste forms: INTEC, Ceramic, and Metal. Cites *Source Terms for HLW Glass Canisters* (CRWMS M&O 2000a). Table 5-9 gives radionuclide inventory of ANL-W HLW Ceramic Matrix. Table 5-10 gives radionuclide inventory of ANL-W HLW Metal Matrix. Table 6-1 gives radionuclide inventories of SRS glass, WVDP glass, INTEC, CWF, and MWF, plus weighted average curie content per canister. Cites Goff (1998) letter, “Revision to Original INEEL Response to Yucca Mountain Site Characterization Office Data Call for High-Level Waste (Ref. Palmer and Benedict to Wichmann, July 2, 1997),” with attachment, “Modifications to Yucca Mountain Data Call.”

A-2.4.3 Direct Disposal of EMT Salt Waste

A preliminary performance assessment analysis has evaluated direct disposal of the salt waste from EMT of the EBR-II driver and blanket fuels in a salt repository concept (Lee et al. 2013). In that analysis, it is estimated that the mass of Mark-IV (treating the driver fuel) salt waste will be 1,017 kg, and the mass of Mark-V (treating the blanket fuel) salt waste will be 699 kg. The estimated salt compositions representing the waste from the driver fuel and the blanket fuel are shown in Table A-48 and Table A-49 lists the isotopic inventory for the radionuclides of the driver and blanket EMT salt wastes that were evaluated in Lee et al. (2013).

Table A-48. Current estimated electrorefiner salt composition (mass fractions, from Lee et al. 2013)

Salt Compound	Driver Fuel Salt Waste	Blanket Fuel Salt Waste
LiCl	3.181E-01	3.877E-01
KCl	3.881E-01	4.609E-01
NaCl	9.818E-02	5.787E-02
RbCl	1.666E-03	5.898E-05
SrCl ₂	4.983E-03	1.952E-04
YCl ₃	3.505E-03	1.621E-04
CsCl	1.235E-02	6.908E-04
BaCl ₂	7.199E-03	5.254E-04
LaCl ₃	8.517E-03	3.574E-04
CeCl ₃	1.622E-02	6.468E-04
PrCl ₃	8.015E-03	2.936E-04
NdCl ₃	2.730E-02	1.071E-03
PmCl ₃	5.723E-04	2.194E-05
SmCl ₃	5.196E-03	2.865E-04
EuCl ₃	2.418E-04	1.488E-05
GdCl ₃	1.620E-04	1.660E-05
NpCl ₃	1.414E-03	7.278E-05
UCl ₃	6.849E-02	3.163E-02
PuCl ₃	2.982E-02	5.750E-02
AmCl ₃	1.035E-05	1.299E-05

Table A-49. Isotopic inventory for EMT salt waste used in Lee et al. (2013)

Isotope	Half Life (yr)	Driver Fuel Salt Waste		Blanket Fuel Salt Waste	
		Fractional Mass	Isotope mass per WP (g/WP)	Fractional Mass	Isotope mass per WP (g/WP)
²²⁷ Ac	2.18E+01	9.452E-13	1.1342E-07	1.534E-10	1.8410E-05
²⁴¹ Am	4.32E+02	7.138E-06	8.5652E-01	8.983E-06	1.0780E+00
²⁴³ Am	7.37E+03	3.956E-09	4.7477E-04	4.000E-09	4.7999E-04
¹⁴ C	5.71E+03	0.000E+00	0.0000E+00	0.000E+00	0.0000E+00
³⁶ Cl	3.01E+05	8.486E-09	1.0183E-03	1.560E-14	1.8720E-09
²⁴⁵ Cm	8.50E+03	2.331E-12	2.7971E-07	3.107E-10	3.7290E-05
¹³⁵ Cs	2.30E+06	3.448E-03	4.1372E+02	2.055E-04	2.4658E+01
¹³⁷ Cs	3.01E+01	2.847E-03	3.4159E+02	1.478E-04	1.7731E+01
¹²⁹ I	1.70E+07	6.968E-04	8.3621E+01	3.023E-05	3.6275E+00
⁷ Li	N/A	5.187E-02	6.2239E+03	6.349E-02	7.6183E+03
⁹³ Nb	1.36E+01	0.000E+00	0.0000E+00	0.000E+00	0.0000E+00
²³⁷ Np	2.14E+06	9.717E-04	1.1661E+02	5.021E-05	6.0248E+00
²³¹ Pa	3.25E+04	7.259E-09	8.7112E-04	3.306E-10	3.9668E-05
²¹⁰ Pb	2.26E+01	0.000E+00	0.0000E+00	0.000E+00	0.0000E+00
¹⁰⁷ Pd	6.50E+06	0.000E+00	0.0000E+00	0.000E+00	0.0000E+00
²³⁸ Pu	8.77E+01	5.739E-05	6.8872E+00	1.116E-05	1.3389E+00
²³⁹ Pu	2.41E+04	1.993E-02	2.3915E+03	3.900E-02	4.6803E+03
²⁴⁰ Pu	6.54E+03	5.490E-04	6.5876E+01	7.508E-04	9.0096E+01
²⁴¹ Pu	1.44E+01	5.506E-06	6.6073E-01	9.372E-06	1.1246E+00
²⁴² Pu	3.76E+05	2.390E-07	2.8681E-02	1.093E-07	1.3118E-02
²²⁶ Ra	1.60E+03	3.967E-12	4.7609E-07	2.695E-10	3.2335E-05
²²⁸ Ra	6.70E+00	1.907E-18	2.2886E-13	1.821E-10	2.1853E-05
¹²⁶ Sb	3.61E-05	0.000E+00	0.0000E+00	0.000E+00	0.0000E+00
⁷⁹ Se	6.50E+04	0.000E+00	0.0000E+00	0.000E+00	0.0000E+00
¹²⁶ Sn	1.00E+05	0.000E+00	0.0000E+00	0.000E+00	0.0000E+00
⁹⁰ Sr	2.91E+01	1.613E-03	1.9354E+02	6.373E-05	7.6478E+00
⁹⁹ Tc	2.13E+05	0.000E+00	0.0000E+00	0.000E+00	0.0000E+00
²²⁹ Th	7.90E+03	1.965E-11	2.3583E-06	2.370E-10	2.8438E-05
²³⁰ Th	7.54E+03	1.380E-07	1.6560E-02	1.012E-09	1.2143E-04
²³² Th	1.41E+10	8.727E-09	1.0472E-03	3.431E-10	4.1173E-05
²³² U	6.89E+01	6.324E-10	7.5882E-05	1.591E-12	1.9093E-07
²³³ U	1.59E+05	6.550E-09	7.8598E-04	1.358E-10	1.6294E-05
²³⁴ U	2.45E+05	5.601E-06	6.7216E-01	1.133E-07	1.3602E-02
²³⁵ U	7.04E+08	9.262E-03	1.1114E+03	5.343E-05	6.4117E+00
²³⁶ U	2.34E+07	9.491E-04	1.1389E+02	1.704E-06	2.0444E-01
²³⁸ U	4.46E+09	3.686E-02	4.4229E+03	2.179E-02	2.6151E+03
⁹³ Zr	1.53E+06	0.000E+00	0.0000E+00	0.000E+00	0.0000E+00

Note the fractional mass of the isotopes listed in the column does not add up to one because it lists only those included in the source-term model.

The bulk of the salt waste is comprised of a LiCl-KCl mix (~70% for the salt waste form from the driver fuel and ~85% of the salt waste form from the blanket fuel). The next most abundant component of the salt waste form is NaCl, comprising ~10% of the driver fuel salt waste form and ~6% of the blanket salt waste form. The PuCl₃ content in these salt waste forms can be relatively high (~3% and ~6% is salt waste forms from the driver and blanket, respectively) and may present challenges for criticality considerations.

The isotopes listed in Table A-49 are only those evaluated for the source-term in the model of repository performance of Lee et al. (2013). Excluded from this list are the salt waste forms two most abundant isotopes ³⁵Cl and ³⁹K (roughly 60% and 20%, respectively). The dominant plutonium isotope is ²³⁹Pu and this may require further considerations in the storage, transportation and disposal packaging to mitigate potential nuclear criticality issues.

For the analysis of performance in a salt repository, idealized waste containers and waste canisters were described by Lee et al. (2013). A thin-walled stainless steel container with diameter of 25 cm and length of 50.5 cm was used to hold 40 kg of the EMT salt waste form. A larger stainless steel canister was listed as holding three of these canisters (120 kg EMT salt waste form; 27 cm outer diameter; 155 cm length) and is to be inserted into a cylindrical thicker-walled overpack (with welded lid) to complete the waste package. Lee et al. (2013) estimated EMT salt waste totals of 1,017 kg for the 3.1 MTHM of EBR-II driver fuel, and 699 kg for the 22.4 MTHM of EBR-II blanket fuel, with a total of 15 waste packages to be disposed. Assuming that treatment of the ~0.3 MTHM of FFTF driver fuel and the 34 MTHM of Fermi blanket fuel yields about 100 kg and 1,050 kg of salt, respectively, an additional 10 waste packages would be needed to dispose of the full treated sodium-bonded inventory discussed above in Section A-2.4, for a total of about 25 waste packages for direct disposal of all the EMT salt waste form.

A-3. Waste Categorization by Risk

Existing radioactive waste in the U.S. is classified under multiple laws and regulations into categories that include spent nuclear fuel, high-level radioactive waste, transuranic waste, and low-level waste. Where relevant, these classifications are noted in discussions in this report. These classifications are based, in many cases, on the origin of the radioactive material or on the processes by which it was generated, rather than on inherent risks the waste poses to humans and the environment. For the purposes of this study, it is more useful to focus on disposal pathways for waste based on risk; as such, this study focuses on disposal of high-level waste and intermediate-level waste as defined by the IAEA. Definitions provided by the IAEA are reproduced here (IAEA 2009, Section 2.2):

High-level waste (HLW): Waste with levels of activity concentration high enough to generate significant quantities of heat by the radioactive decay process or waste with large amounts of long lived radionuclides that need to be considered in the design of a disposal facility for such waste. Disposal in deep, stable geological formations usually several hundred meters or more below the surface is the generally recognized option for disposal of HLW.

Intermediate level waste (ILW): Waste that, because of its content, particularly of long lived radionuclides, requires a greater degree of containment and isolation than that provided by near surface disposal. However, ILW needs no provision, or only limited provision, for heat dissipation during its storage and disposal. ILW may contain long lived radionuclides, in particular, alpha emitting radionuclides that will not decay to a level of activity concentration acceptable for near surface disposal during the time for which institutional controls can be relied upon. Therefore, waste in this class requires disposal at greater depths, of the order of tens of meters to a few hundred meters.

Low level waste (LLW): Waste that is above clearance levels, but with limited amounts of long lived radionuclides. Such waste requires robust isolation and containment for periods of up to a few hundred years and is suitable for disposal in engineered near surface facilities. This class covers a very broad range of waste. LLW may include short lived radionuclides at higher levels of activity concentration, and also long lived radionuclides, but only at relatively low levels of activity concentration.

In the U.S., radioactive waste definitions embodied in legislative actions generally categorize wastes based on activity concentration, with the notable exception of HLW, the definition of which is primarily based on the processes that led to the creation of the wastes. The statutory definition of HLW contains activity-based criteria but those criteria have never been explicitly defined. While there is a significant correlation between these U.S. waste categories and risk, reliance on the origin-based definition of HLW has led to potential inefficiencies. For example, under current law, the origin-based definition of HLW mandates a specific disposition requirement, whereas a purely hazard-based approach that considers the actual characteristics of the waste might suggest that a lower level of isolation would be sufficient to protect human health and the environment. In contrast, the IAEA has worked to provide consensus on waste classification definitions that correlate to the hazard potential of the waste, so that policies defining the degree of isolation required for a given waste can be based on the inherent risk of the materials. This work acknowledges that the ongoing activities of the DOE are to dispose of radioactive wastes in compliance with current laws and regulations. The intent is to provide guidance for consistent and accurate future considerations of revisions to such statutes in cases where it may be useful. The next few paragraphs discuss those waste types that have the potential to fall within the IAEA definition of ILW.

Potential U.S. Intermediate Level Wastes—The principal wastes falling into this category in the U.S. inventory are transuranic (TRU) wastes, material contaminated with elements having atomic numbers greater than uranium (92 protons) in concentrations greater than 100 nanocuries/gram. Transuranic waste contains more than 100 nanocuries of alpha-emitting isotopes with half-lives greater than 20 years per gram of waste that cannot be classified as HLW. In the U.S., transuranic waste requires deep geologic disposal. Heat loads of the wastes are low, due to the particular radioactive constituents in the waste, and the dispersed nature of the radioactivity in the waste (e.g., contaminated worker clothing, equipment, etc.). Thus, TRU waste fits the IAEA definition of ILW given above. Disposal of TRU waste in the U.S. is covered in detail in Appendix B.

Other categories of waste that potentially fit the IAEA ILW definition include tank wastes that meet the definition of TRU waste, and perhaps other tank wastes or vitrified waste that in a hazard-based waste management schema (similar to that of the IAEA) might fall in the IAEA category of ILW rather than HLW. For example, the DOE has announced its preferred alternative to reclassify as mixed TRU waste 3.1 million gallons in 20 tanks at the Hanford site. More generally, the range of activities across the Hanford tank farms is very broad, suggesting that an IAEA-style waste definition based on hazard might identify additional tanks as ILW, even though the origin-based definition for these tanks is HLW. In addition, if different waste processing options beyond the current baseline are eventually developed and deployed, the inventory of waste forms that fit the ILW definition could grow substantially. Details of the characteristics of the tank wastes are described in Section A-2 above; they are mentioned here to point out that some portion of the wastes currently defined as HLW might eventually fit an IAEA ILW definition, and thus could be candidates for similar disposal options as the other ILW listed here.

Other wastes that could fall into the IAEA ILW category, at least from the standpoint of requiring isolation greater than can be provided by near-surface disposal, may include Greater Than Class C (GTCC) LLW and waste associated with the processing of surplus weapons-usable plutonium. Disposition pathways of these wastes are currently the subject of ongoing public processes by the DOE,

and are beyond the scope of the present study. Although it is expected that GTCC will be handled per the terms of the Standard Contract, for the purposes of this report it is not included in the HLW inventory.

A-4. Orphan Wastes

Over the last two decades, the DOE's Office of Environmental Management has actively decommissioned and cleaned up facilities at former nuclear weapons sites and managed the disposal of significant quantities of low level and transuranic wastes. Disposition paths have been identified for major classes of waste materials. Low level waste is being placed in near surface disposal facilities; waste designated as high level waste and spent nuclear fuel is being stored prior to disposal in a deep geologic repository; and defense transuranic waste is being placed in a deep geologic repository. There are some wastes generated by defense operations, cleanup activities, and other nuclear research activities that currently have no clear disposition path. These radioactive materials are evaluated in accordance with DOE Order 435.1, Radioactive Waste Management, to determine if the material should be managed as HLW, TRU waste, LLW, or mixed low level waste. Until these evaluations are completed, identification of additional waste streams requiring disposal in a deep geologic repository cannot be made.

A-5. References

- 10 CFR Part 71. Energy: Packaging and Transportation of Radioactive Material.
- 10 CFR Part 72. Energy: Licensing Requirements for the Independent Storage of Spent Nuclear Fuel, High-Level Radioactive Waste, and Reactor-Related Greater Than Class C Waste.
- 10 CFR Part 73. Energy: Physical Protection of Plants and Materials.
- 10 CFR Part 961. Energy: Standard Contract for Disposal of Spent Nuclear Fuel and/or High-Level Radioactive Waste.
- 40 CFR Part 261. Protection of Environment: Identification and Listing of Hazardous Waste.
- 40 CFR Part 268. Protection of Environment: Land Disposal Restrictions.
- 65 FR 56565. Department of Energy; Record of Decision for the Treatment and Management of Sodium-Bonded Spent Nuclear Fuel.
- 70 FR 44598. Notice of Preferred Sodium Bearing Waste Treatment Technology.
- 70 FR 75165. Office of Environmental Management; Record of Decision for the Idaho High-Level Waste and Facilities Disposition Final Environmental Impact Statement.
- 75 FR 137. Department of Energy; Amended Record of Decision: Idaho High-Level Waste and Facilities Disposition Final Environmental Impact Statement Revised by State 12/21/09.
- ASME (American Society of Mechanical Engineers) 2001. *2001 ASME Boiler and Pressure Vessel Code*. New York, New York: American Society of Mechanical Engineers.
- Arnold, B.W.; P.V. Brady; S.J. Bauer; C. Herrick; S. Pye; and J. Finger 2011. *Reference Design and Operations for Deep Borehole Disposal of High-Level Radioactive Waste*. SAND2011-6749. Albuquerque, New Mexico: Sandia National Laboratories.
- Bannochie, C.J. and N.E. Bibler 2005a. *Determination of Reportable Radionuclides for DWPF Sludge Batch 3 (Macrobatches 4)*. WSRC-TR-2005-00157 Aiken, South Carolina: Savannah River National Laboratory.
- Bannochie, C.J. and N.E. Bibler 2005b. *Analysis of Sludge Batch 3 (Macrobatches 4) DWPF Pour Stream Glass Sample for Canister S02312*. WSRC-TR-2005-00354 Aiken, South Carolina: Savannah River National Laboratory.

Bannochie, C.J.; N.E. Bibler; and D.P. DiPrete 2008. *Determination of Reportable Radionuclides for DWPF Sludge Batch 4 (Macrobatch 5)*. WSRC-STI-2008-00142. Aiken, South Carolina: Savannah River National Laboratory.

Bannochie, C.J.; N.E. Bibler; and D.P. DiPrete 2010. *Determination of Reportable Radionuclides for DWPF Sludge Batch 5 (Macrobatch 6)*. SRNL-STI-2009-00821. Aiken, South Carolina: Savannah River National Laboratory.

Bannochie, C.J. and D.P. DiPrete 2011. *Determination of Reportable Radionuclides for DWPF Sludge Batch 6 (Macrobatch 7)* WSRC-STI-2011-00189. Aiken, South Carolina: Savannah River National Laboratory.

Barnes, C.M.; S.K. Janikowski; and C.B. Millet 2004. *Feed Composition for the Sodium-Bearing Waste Treatment Process*. INEEL/EXT-2000-01378, Revision 4. Idaho Falls, Idaho: Idaho National Engineering and Environmental Laboratory.

Bath, S.S.; G. Cannell; and D. Robbins 2003. *Capsule Characterization Report for Capsule Dry Storage Project*. WMP-16938. Richland, Washington: Fluor Hanford.

Benedict, R.W.; McFarlane, H.F.; Henslee, S.P.; Lineberry, M.J.; Abraham, D.P.; Ackerman, J.P.; Ahluwalia, R.K.; Garcia, H.E.; Gay, E.C.; Goff, K.M.; Johnson, S.G.; Mariani, R.D.; McDeavitt, S.; Pereira, C.; Roach, P.D.; Sherman, S.R.; Westphal, B.R. Wigeland, R.A.; and Willit, J.L. 1999. *Spent Fuel Treatment Demonstration Final Report*. ANL-NT-106. Argonne, Illinois: Argonne National Laboratory.

Bibler, N.E.; D.P. DiPrete; and J.R. Harbour 2002. *Determination of Reportable Radionuclides for DWPF Sludge Batch 2 (Macro Batch 3)*. WSRC-TR-2002-00255. Aiken, South Carolina: Westinghouse Savannah River Company.

Blumenkranz, D. 2006. *Petition to Delist Immobilized High-Level Waste Generated at the Hanford Tank Waste Treatment and Immobilization Plant*. 24590-WTP-RPT-ENV-06-001, Rev. 0. Richland, Washington: River Protection Project, Waste Treatment Plant.

Brady, P.V.; B.W. Arnold; G.A. Freeze; P.N. Swift; S.J. Bauer; J.L. Kanney; R.P. Rechard; and J.S. Stein 2009. *Deep Borehole Disposal of High-Level Radioactive Waste*. SAND2009-4401. Albuquerque, NM: Sandia National Laboratories.

Brouns, R.A. and J.A. Powell 1988. *Nuclear Waste Treatment Program Annual Report for FY 1987*, PNL-6686. Richland, Washington: Pacific Northwest Laboratory.

BSC (Bechtel SAIC Company) 2001a. *Inventory Abstraction*. ANL-WIS-MD-000006 REV 00 ICN 03. Las Vegas, Nevada: Bechtel SAIC Company.

BSC 2001b. *Waste Package Radionuclide Inventory Approximations for TSPA-SR*. CAL-WIS-MD-000004 REV 00 ICN 01. Las Vegas, Nevada: Bechtel SAIC Company.

BSC 2002. *Initial Radionuclide Inventory*. ANL-WIS-MD-000020 Rev. 00. Las Vegas, Nevada: Bechtel SAIC Company.

BSC 2007. *Total System Model Scoping Analysis of Aging for a 25KW TAD Waste Stream*. 000-00R-G000-00700-000-000. Las Vegas, NV: Bechtel SAIC Company.

Cadoff, L.H. 1996. *Waste Form Compliance Plan for the West Valley Demonstration Project High-Level Waste Form*. WVDP-185. West Valley, New York: West Valley Nuclear Services Company.

Cannell, G.R.; J.T. Gee; and R.B. Heise 1998. *Sealing of Canistered High-Level Waste at SRS*. WSRC-MS-98-00626. Aiken, South Carolina: Westinghouse Savannah River Company.

Carter, J.T.; A.J. Luptak; J. Gastelum; C. Stockman; and A. Miller 2012. *Fuel Cycle Potential Waste Inventory for Disposition*. FCR&D-USED-2010-000031, Rev. 5. Washington, DC: U.S. Department of Energy.

CDP (Calcine Disposition Project) 2012. *Calcine Disposition Project Technology Maturation Plan*. PLN-1482. Idaho Falls, Idaho: Idaho Cleanup Project.

Certa P.J.; P.A. Empey; and M.N. Wells 2011. *River Protection Project System Plan*. ORP-11242, Revision 6. Richland, Washington: U.S. Department of Energy, Office of River Protection.

Chew, D.P. and B.A. Hamm 2012. *Liquid Waste System Plan Revision 17*. SRR-LWP-2009-00001, Rev. 17. Aiken, South Carolina: Savannah River Remediation LLC.

Chew, D.P. and B.A. Hamm 2013. *Liquid Waste System Plan Revision 18*. SRR-LWP-2009-00001, Rev. 18. Aiken, South Carolina: Savannah River Remediation LLC.

Claghorn, R.D. 1996. *Trade Study for the Disposition of Cesium and Strontium Capsules*. WHC-SD-WM-ES-382. Richland, Washington: Westinghouse Hanford Company.

Cochran, J.R.; W.E. Beyeler; D.A. Brosseau; L.H. Brush; T.J. Brown; B. Crowe; S.H. Conrad; P.A. Davis; T. Ehrhorn; T. Feeny; B. Fogleman; D.P. Gallegos; R. Haaker; E. Kalinina; L.L. Price; D.P. Thomas; and S. Wirth 2001. *Compliance Assessment Document for the Transuranic Wastes in the Greater Confinement Disposal Boreholes at the Nevada Test Site*. SAND2011-2977. Albuquerque, New Mexico: Sandia National Laboratories.

Cozzi, A.D. and N.E. Bibler 2004. *Analytical Results of DWPF Glass Sample Taken During Pouring of Canister S01913*. WSRC-TR-2004-00316. Aiken, South Carolina: Savannah River National Laboratory.

Crawford, C.L. and C.M. Jantzen 2007. *Durability Testing of Fluidized Bed Steam Reformer (FBSR) Waste Forms for Sodium Bearing Waste (SBW) at Idaho National Laboratory (INL)*. WSRC-STI-2007-00319. Aiken, South Carolina: Savannah River National Laboratory.

CRWMS M&O (Civilian Radioactive Waste Management System Management and Operating Contractor) 2000a. *Source Terms for HLW Glass Canisters*. CAL-MGR-NU-000002 REV 01. Las Vegas, Nevada: Civilian Radioactive Waste Management System Management and Operating Contractor.

CRWMS M&O 2000b. *Inventory Abstraction Data Input*. PA-WIS-MD-000006 REV 00. Las Vegas, Nevada: Civilian Radioactive Waste Management System Management and Operating Contractor.

DOE (U.S. Department of Energy) 1987. *Characteristics of Spent Fuel, High-Level Waste, and Other Radioactive Wastes Which May Require Long-Term Isolation*. DOE/RW-0184 Volume 1. Washington, DC: U.S. Department of Energy Office of Civilian Radioactive Waste Management.

DOE 1996. *Waste Acceptance Product Specifications for Vitrified High-Level Waste Forms*. DOE/EM-0093, Rev. 2. Washington, DC: U.S. Department of Energy Office of Environmental Management.

DOE 1997. *Environmental Assessment for the Relocation and Storage of Isotopic Heat Sources, Hanford Site, Richland, Washington*. DOE/EA-1211. Richland, Washington: U.S. Department of Energy.

DOE 2002. *Idaho High-Level Waste and Facilities Disposition Final Environmental Impact Statement*, DOE/EIS-0287. Idaho Falls, Idaho: U.S. Department of Energy Idaho Operations Office.

DOE 2007. *General Description of Database Information Version 5.0.1*. DOE/SNF/REP-094, Rev. 1. Idaho Falls, Idaho: U.S. Department of Energy, National Spent Nuclear Fuel Program.

DOE 2008. *Yucca Mountain Repository License Application*. DOE/RW-0573, Update No. 1. Washington, DC: U.S. Department of Energy, Office of Civilian Radioactive Waste Management.

DOE 2011a. *Spent Fuel Database Version 6.2.3*. DOE, National Spent Nuclear Fuel Program,

DOE 2011b. *A Screening Method for Guiding R&D Decisions: Pilot Application to Nuclear Fuel Cycle Options*. Washington, DC: U.S. Department of Energy, Office of Nuclear Energy. http://energy.gov/sites/prod/files/4.3_DOE_NE_Screening%20Brochure_web.pdf

DOE 2012a. *Waste Acceptance Product Specifications for Vitrified High-Level Waste Forms*. DOE/EM-0093, Rev. 3. Washington, DC: U.S. Department of Energy, Office of Environmental Management.

DOE 2012b. *Final Tank Closure and Waste Management Environmental Impact Statement for the Hanford Site, Richland, Washington*. DOE/EIS-0391. Richland, Washington: U.S. Department of Energy.

Durán, F.A.; G.D. Wyss; and C. D. Jaeger, “Security Issues for Long-Term Storage of Used Fuel,” Proceedings of the ASME 2011 14th International Conference on Environmental Remediation and Radioactive Waste Management, ICEM2011, September 25–29, 2011, Reims, France. [SAND2011-4907C]

Easton, E. 2011. *Developing a Regulatory Framework for Extended Storage and Transportation*. Presentation for the National Transportation Stakeholder Forum, Denver, Colorado: May 10–12, 2011. energy.gov/sites/prod/files/em/Easton_NTSF_2011.pdf

Ebert, W.L. 2005. *Testing to Evaluate the Suitability of Waste Forms Developed for Electrometallurgically Treated Spent Sodium-Bonded Nuclear Fuel for Disposal in the Yucca Mountain Repository*. ANL-05/43. Argonne, Illinois: Argonne National Laboratory.

Ebert, W.L.; N.L. Dietz; and D.E. Janney 2005. *Effects of Heat-Treatment and Formulation on the Phase Composition and Chemical Durability of the EBR II Ceramic Waste Form*. ANL-05/32. Argonne, Illinois: Argonne National Laboratory.

EIA (Energy Information Administration) 2004. *RW-859 Nuclear Fuel Data*. Washington, D.C.: Energy Information Administration.

Fellinger, T.L. and N.E. Bibler 1999. *DWPF Glass Results for the Analysis of a Pour Stream Sample Taken During Pouring of the 409th Canister (Canister S00834) in Macrobatches 1*. WSRC-RP-98-01400. Aiken, South Carolina: Westinghouse Savannah River Company.

Fellinger, T.L. and N.E. Bibler 2000. *Results of the Chemical Composition and Product Consistency Test for the DWPF Macro Batch 2 Glass Pour Stream Sample Taken During the Pouring of Canister S01142*. WSRC-RP-2000-00281 Aiken, South Carolina: Westinghouse Savannah River Company.

Fellinger, T.L.; N.E. Bibler; and J.R. Harbour 2004. *Characterization of and Waste Acceptance Radionuclides to be Reported for DWPF Macro Batch 2 (ESP 215-ESP 221)*. WSRC-RP-99-00436, Rev. 1. Aiken, South Carolina: Westinghouse Savannah River Company.

Fluor Hanford 2000. *Waste Encapsulation and Storage Facility Waste Analysis Plan*. HNF-7342. Richland, Washington: Fluor Hanford.

Forrester, T.W.; R.A. Hunt; and R.L. Riner 2002. “Interim Storage of RH-TRU 72B Canisters at the DOE Oak Ridge Reservation.” In *WM’02 Conference*, Tucson, Arizona.

GAO (U.S. Government Accountability Office) 2009. *Nuclear Waste: Uncertainties and Questions About Costs and Risks Persist with DOE’s Tank Waste Cleanup Strategy at Hanford*. GAO-09-913. Washington, DC: U.S. Government Accountability Office.

GAO 2011. *Commercial Nuclear Waste: Effects of a Termination of the Yucca Mountain Repository Program and Lessons Learned*. GAO-11-229. Washington, DC: U.S. Government Accountability Office.

GAO 2012. *Spent Nuclear Fuel: Accumulating Quantities at Commercial Reactors Present Storage and Other Challenges*. GAO-12-797. Washington, DC: U.S. Government Accountability Office.

Gephart, R.E. and R.E. Lundgren 1998. *Hanford Tank Cleanup: A Guide to Understanding the Technical Issues*. Volume 4. Columbus, Ohio: Battelle Press.

Goff, K.M. 1998. "Revision to Original INEEL Response to Yucca Mountain Site Characterization Office Data Call for High-Level Waste (Ref. Palmer and Benedict to Wichmann, July 2, 1997)." Letter from K.M. Goff (ANL-West) to M.B. Heiser (Lockheed), April 15, 1998, with attachment, "Modifications to Yucca Mountain Data Call."

Goff, K.M.; R.W. Benedict; K. Bateman; M.A. Lewis; C. Pereira; and C.A. Musick 1996. "Spent Fuel Treatment and Mineral Waste Form Development at Argonne National Laboratory-West." *Proceedings of the Spectrum '96 Meeting, Nuclear and Hazardous Waste Management International Topical Meeting held August 18–23, 1996, Seattle, Washington*, pp. 2436–2443. La Grange Park, Illinois: American Nuclear Society.

Hagers, J. 2007. *Hot Isostatic Pressing Technology*. Presentation slides.

<http://nnsfp.inel.gov/program/strategymtg/2007-aug/Hagers%20Background%20hot%20isostatic%20pressing%20without%20backup.pdf>

Hardin E.; T. Hadgu; D. Clayton; R. Howard; H. Greenberg; J. Blink; and P. Rodwell 2012. *Disposal Concepts/Thermal Load Management (FY11/12 Summary Report)*. FCRD-USED-2012-000219 Rev. 1. Washington, DC: U.S. Department of Energy, Office of Used Fuel Disposition

Hardin, E.; J. Scaglione; R. Howard; E. Pierce; D. Clayton; T. Severynse; J. Carter; and J. Blink 2013. *Preliminary Report on Dual-Purpose Canister Disposal Alternatives*. FCRD-USED-2013-000171 Rev. 0. Washington, DC: U.S. Department of Energy, Office of Used Fuel Disposition.

Heard, F.J.; K.R. Robertson; J.E. Scott; M.G. Plys; S.J. Lee; and B. Malinovic 2003. *Thermal Analysis of a Dry Storage Concept for Capsule Dry Storage Project*. WMP-16940. Richland, Washington: Fluor Hanford.

Holton, L.K., Jr.; M.L. Elliott; J.E. Surma; R.W. Goles; R.P. Allen; F.E. Haun; R.A. Brouns; R.F. Klein; G.H. Bryan; and R.D. Peters 1989. *Processing Summary Report: Fabrication of Cesium and Strontium Heat and Radiation Sources*. PNL-6790. Richland, Washington: Pacific Northwest Laboratory.

Hyder, M.L. 1995. *Waste Acceptance Radionuclides to be Reported in Tank 51 Sludge Only Glass*. WSRC-TR-95-0485. Aiken, South Carolina: Westinghouse Savannah River Company.

IAEA (International Atomic Energy Agency) 1999. *The Physical Protection of Nuclear Material and Nuclear Facilities*. INFCIRC/225/Rev. 4. Vienna, Austria: International Atomic Energy Agency.

IAEA 2009. *Classification of Radioactive Waste*. General Safety Guide No. GSG-1. Vienna, Austria: International Atomic Energy Agency.

IAEA 2011. *The Impact of High Burnup Uranium Oxide and Mixed Uranium-Plutonium Oxide Water Reactor Fuel on Spent Fuel Management*. IAEA Nuclear Energy Series No. NF-T-3.8. Vienna, Austria: International Atomic Energy Agency.

ICP (Idaho Cleanup Project) 2008. *VES-WM-187, VES-WM-188, and VES-WM-189 Tank Characterization*. EDF-8471 2008. Idaho Falls, Idaho: Idaho Cleanup Project.

ID-DEQ (State of Idaho Department of Environmental Quality) 2013. Hazardous Waste Storage and Treatment Facility Partial Permit for Idaho Nuclear Technology and Engineering Center Liquid Waste Management System (ILWMS), Draft Class 3 Permit Modification, June 28, 2013. Boise, Idaho: State of Idaho, Department of Environmental Quality. Available at www.deq.idaho.gov/news-archives/2013/june/waste-usdoe-inl-intec-hazardous-waste-permit-modification-to-comment-062813.aspx.

- Johnson, F.C. 2011. *Analysis of DWPF Sludge Batch 6 (Macrobatches 7) Pour Stream Glass Samples*. SRNL-STI-2011-00555. Aiken, South Carolina: Savannah River National Laboratory.
- Johnson, F.C. 2012. *Analysis of DWPF Sludge Batch 7a (Macrobatches 8) Pour Stream Glass Samples*. SRNL-STI-2012-00017. Aiken, South Carolina: Savannah River National Laboratory.
- Keiser, D.D., Jr.; S.G. Johnson; and W.L. Ebert 2002. *Monitoring the Consistency of the Metal Waste Form*. ANL-NT-196. Argonne, Illinois: Argonne National Laboratory.
- Kim, D. 2010. *Chemical and Radionuclide Composition Projections for Immobilized High Level Waste Product Qualification*. 24590-HLW-RPT-RT-08-001-01, Rev. 1. Richland, Washington: River Protection Project, Waste Treatment Plant.
- King, J.A. and V.C. Maio 2011. *Extended Development Work to Validate a HLW Calcine Waste Form via INL's Cold Crucible Induction Melter*. INL/EXT-11-23388. Idaho Falls, Idaho: Idaho National Engineering and Environmental Laboratory.
- Kuhn, K. and R. Rothfuchs 1989. "In Situ Experiments on the Disposal of High Level Radioactive Wastes (HAW) at the Asse Salt Mine Federal Republic of Germany." *Waste Management '89: Waste Processing, Transportation, Storage and Disposal, Technical Programs and Public Education Proceedings of the Symposium on Waste Management at Tucson, Arizona, February 26–March 2, 1989*. Post, R.G., ed., pp. 567–573. Tucson, Arizona: University of Arizona.
<http://www.wmsym.org/archives/1989/V1/93.pdf>
- Le, T.A. 2013. *1/2/13—January 2013 WCS Curie and Volume Inventory Report*. SRR-LWP-2013-00006, Revision 1. Aiken, South Carolina: Savannah River Remediation LLC.
- Lee, J.H.; M. Simpson; and Y. Wang 2013. *Initial Performance Assessment to Evaluate Technical Feasibility of Direct Disposal of Electrefiner Salt Waste in Salt Repository*. SAND2013-7304P; FCRD-UFD-2013-000275. Albuquerque, New Mexico: Sandia National Laboratories.
- Lopez, D.A. and R.R. Kimmitt 1998. *Vitrified Waste Option Study Report*. INEEL/EXT-97-01389. Idaho Falls, Idaho: Idaho National Engineering and Environmental Laboratory.
- Maio, V. 2011. *Generalized Test Plan for the Vitrification of Simulated High-Level-Waste in the Idaho National Laboratory's Bench-Scale Cold Crucible Induction Melter*. INL/EXT-23231. Idaho Falls, Idaho: Idaho National Engineering and Environmental Laboratory.
- Matlack, K.S.; H. Gan; W. Gong; I.L. Pegg; C.C. Chapman; and I. Joseph 2007. *High Level Waste Vitrification System Improvements*. VSL-07R1010-1, Rev. 0 Washington, DC: The Catholic University of America.
- Matlack, K.S.; H. Gan; M. Chaudhuri; W. Kot; I.L. Pegg; and I. Joseph 2012. *Melter Throughput Enhancements for High-Iron HLW*. VSL-12R2490-1, Rev. 0. Washington, DC: The Catholic University of America.
- McIlmoyle, D.W. and B.A. Hamm 2011. *Canister Wattage Projections for Future Sludge and Salt Processing at DWPF Using Liquid Waste System Plan Rev. 16*. SRR-TR-2011-00232. Aiken, South Carolina: Savannah River Remediation LLC.
- Nankani, F.D. 1994. *Preliminary Tank Waste Remediation System Environmental Impact Statement Engineering Data Package for Disposition of Cesium and Strontium Capsules*. WHC-SD-WM-DP-087. Richland, Washington: Westinghouse Hanford Company.
- NEI (Nuclear Energy Institute) 2012. *Small Modular Reactor Source Terms*. NEI Position Paper. Washington, DC: Nuclear Energy Institute.

NEI 2013. *Used Nuclear Fuel in Storage (Metric Tons, End of 2012)*, Washington, DC: Nuclear Energy Institute. <http://www.nei.org/getmedia/0e936169-02de-492f-a600-42f89d95a86a/Used-Fuel-Map-2012?width=1100&height=850&ext=.png> (accessed October 4, 2013).

Olson, A. 2006. *Pilot Plant Report for Treating Sodium-Bearing Waste Surrogates Carbonate Flowsheet*. RT-ESTD-PMR-001. Denver, Colorado: THOR Treatment Technologies, LLC and Washington Group International.

Palmer, R.A. and S.M. Barnes 2002. "West Valley Demonstration Project: Vitrification Campaign Summary" In *Environmental Issues and Waste Management Technologies in Ceramic and Nuclear Industries VII*, G.L. Smith, S.K. Sundaram and D.R. Spearing (eds.), pp. 87–96, Westerville, Ohio: The American Ceramic Society.

Palmer, R.A. and A.J. Misercola 2003. "Waste Form Qualification Experience at the West Valley Demonstration Project." In *Waste Management '03 Conference, February 23-27, 2002, Tucson AZ*. Tucson, Arizona: WM Symposia.

Palmer, R.A.; H.M. Houston; and A.J. Misercola 2004. "Completion of the Vitrification Campaign at the West Valley Demonstration Project," In *Environmental Issues and Waste Management Technologies in the Ceramic and Nuclear Industries IX*, J.D. Vienna and D.R. Spearing (eds.), 179–196. Hoboken, New Jersey: John Wiley & Sons.

Plys, M.G. and W.C. Miller 2003. *Summary Report for Capsule Dry Storage Project*. WMP-17265. Richland, Washington: Fluor Hanford.

Reboul, S.H.; D.P. DiPrete; D.R. Click; and C.J. Bannochie 2011. *Reportable Radionuclides for DWPF Sludge Batch 7a (Macrobatch 8)*. SRNL-STI-2011-00720. Aiken, South Carolina: Savannah River National Laboratory.

Reigel, M.M. and N.E. Bibler 2010. *Analysis of Sludge Batch 4 (Macrobatch 5) for Canister S02902 and Sludge Batch 5 (Macrobatch 6) for Canister S03317 DWPF Pour Stream Glass Samples*. SRNL-STI-2010-00435. Aiken, South Carolina: Savannah River National Laboratory.

Rodgers, M.J. 2013. *Waste Tank Summary Report for Month Ending January 31, 2013*. HNF-EP-0182, Rev. 298. Richland, Washington: Washington River Protection Solutions.

Roth, O. 2005. *Physical and Chemical Aspects of Radiation Induced Oxidation Dissolution of UO₂*. Stockholm, Sweden: Royal Institute of Technology.

Russell, N.E. and D.D. Taylor 1998. *Hot Isostatic Press Waste Option Study Report*. INEEL/EXT-97-01392. Idaho Falls, Idaho: Idaho National Engineering and Environmental Laboratory.

Simmons, F.M. 1998. *Capsule Integrity Program Plan for WESF Cesium and Strontium Capsule Storage*. HNF-2822. Richland, Washington: Babcock & Wilcox Hanford Company.

SRR (Savannah River Remediation LLC) 2011a. Calculation No. X-CLC-S-00180, Rev. 0. Aiken, South Carolina: Savannah River Remediation LLC.

SRR 2011b. Calculation No. X-CLC-S-00183, Rev. 0. Aiken, South Carolina: Savannah River Remediation LLC.

SRR 2012. *DWPF Curie Balance for Salt Disposition Integration (SDI)*. N-CLC-S-00115, Rev. 3. Aiken, South Carolina: Savannah River Remediation LLC.

Staiger, M.D. and M.C. Swenson 2011. *Calcined Waste Storage at the Idaho Nuclear Technology and Engineering Center*. INEEL/EXT-98-00445, Revision 4. Idaho Falls, Idaho: Idaho Cleanup Project.

- Tingey, J.M.; M.G. Plys; and G.L. Tingey 2003. *Capsule Integrity Report for Capsule Dry Storage Project*. WMP-16939. Richland, Washington: Fluor Hanford.
- Transnuclear 2004. *NUHOMS HD Horizontal Modular Storage System for Irradiated Nuclear Fuel Safety Analysis Report*. Hawthorne, NY: Transnuclear.
- Vienna, J.D.; D.S. Kim; D.C. Skorski; and J. Matyas 2013. *Glass Property Models and Constraints for Estimating the Glass to Be Produced at Hanford by Implementing Current Advanced Glass Formulation Efforts*. PNNL-22631. Richland, Washington: Pacific Northwest National Laboratory.
- Wagner, J.C.; J.L. Peterson; D.E. Mueller; J.C. Gehin; A. Worrall; T. Taiwo; M. Nutt; M.A. Williamson; M. Todosow; R. Wigeland; W.G. Halsey; R.P. Omberg; P.N. Swift; and J.T. Carter 2012. *Categorization of Used Nuclear Fuel Inventory in Support of a Comprehensive National Nuclear Fuel Cycle Strategy*. ORNL/TM-2012/308. FCRD-FCT-2012-000232. Oak Ridge, Tennessee; Oak Ridge National Laboratory.
- Westphal, B.R.; S.M. Frank; W.M. McCartin; D.G. Cummings; J.J. Giglio; T.P. O'Holleran; P.A. Hahn; T.S. Yoo; K.C. Marsden; K.J. Bateman; and M.N. Patterson 2013. "Characterization of Irradiated Metal Waste from the Pyrometallurgical Treatment of Used EBR-II Fuel." *Metallurgical and Materials Transactions A*. Published online November 18, 2013. New York, New York: Springer.
- WNA (World Nuclear Association) 2013. "MOX, Mixed Oxide Fuel." <http://www.world-nuclear.org/info/Nuclear-Fuel-Cycle/Fuel-Recycling/Mixed-Oxide-Fuel-MOX/>
- WSRC (Westinghouse Savannah River Company) 1999. *DWPF Waste Form Compliance Plan*. WSRC-IM-91-116-0, Rev. 6. Aiken, South Carolina: Westinghouse Savannah River Company.
- WSRC 2001. *Reporting the Radionuclide Inventory of the DWPF Product*. WSRC-IM-91-116-4, Rev. 1. Aiken, South Carolina: Westinghouse Savannah River Company.
- WSRC 2002. Calculation No. X-CLC-S-00107, Rev. 1, Aiken, South Carolina: Westinghouse Savannah River Company.
- WSRC 2004. Calculation No. X-CLC-S-00135, Rev. 0, Aiken, South Carolina: Westinghouse Savannah River Company.
- WSRC 2006. Calculation No. X-CLC-S-00143, Rev. 0, Aiken, South Carolina: Westinghouse Savannah River Company.
- WSRC 2009. Calculation No. X-CLC-S-00172, Rev. 0, Aiken, South Carolina: Westinghouse Savannah River Company.
- WVDP (West Valley Demonstration Project) 1996. *Waste Form Qualification Report (WQR)*. WVDP-186. West Valley, New York: West Valley Nuclear Services Company.
- Yoo, T.; K. Bateman, K., Teske, G., and Simpson, M. 2009. *Fission Salt Loading Effect on Furnace Operation and Permanent Disposal*. AFCI-TIO-PMO-QA-FM-2009-00052. Idaho Falls, Idaho: Idaho National Laboratory.
- Zadins, Z. 2011. "High-Level Waste Canister Relocation Project." Presentation to Nuclear Waste Technical Review Board, April 27, 2011. <http://www.nwtrb.gov/meetings/2011/april/zadins.pdf>

Appendix B

TRU Waste and WIPP Disposal

B-1. TRU Waste and WIPP Disposal

As discussed in Appendix A (Section A-3), TRU waste fits the IAEA definition of ILW. The U.S. has established the WIPP, near Carlsbad, New Mexico, as the nation's repository for disposal of TRU waste of defense origin. Within this broad category, wastes are partitioned into CH waste, with a surface dose of no greater than 200 millirem per hour, and RH waste, with a surface dose greater than 200 millirem per hour. The National TRU Waste Program maintains a detailed inventory of these wastes (DOE 2012) residing at sites across the DOE complex (Hanford, INL, Los Alamos National Laboratory, Oak Ridge National Laboratory, SRS, and various "small sites"). This appendix summarizes the published inventory information for the purposes of reviewing the current status of disposal of these wastes, which have a clear disposition pathway according to current law and DOE waste management baselines.

The current inventory of TRU waste that has not yet been disposed at the WIPP repository resides at a number of sites across the DOE complex (Figure B-1). Since the opening of the WIPP site to CH waste in 1999 and RH waste in 2007, much work has gone into the de-inventorying of waste from large sites such as Rocky Flats, INL, and Los Alamos National Laboratory, or the consolidation of waste from small sites and management at a smaller number of facilities. To date (July 2013), roughly 87,000 m³ of CH waste and 340 m³ of RH waste have been disposed in over 11,000 shipments. The volume capacity of WIPP is 175,570 m³. Sites that have shipped the largest quantities are the Rocky Flats Environmental Technology Site, INL, SRS, and the Hanford Site, and Los Alamos National Laboratory. In the description that follows, the focus will be on the active TRU waste site inventory, represented in yellow in the map. Of these, the sites with the largest inventories are the Hanford Site, Richland Operations Office (RL); INL (denoted as IN on the map); Los Alamos National Laboratory (denoted as LA); Oak Ridge National Laboratory (denoted as OR), and SRS (denoted as SR).

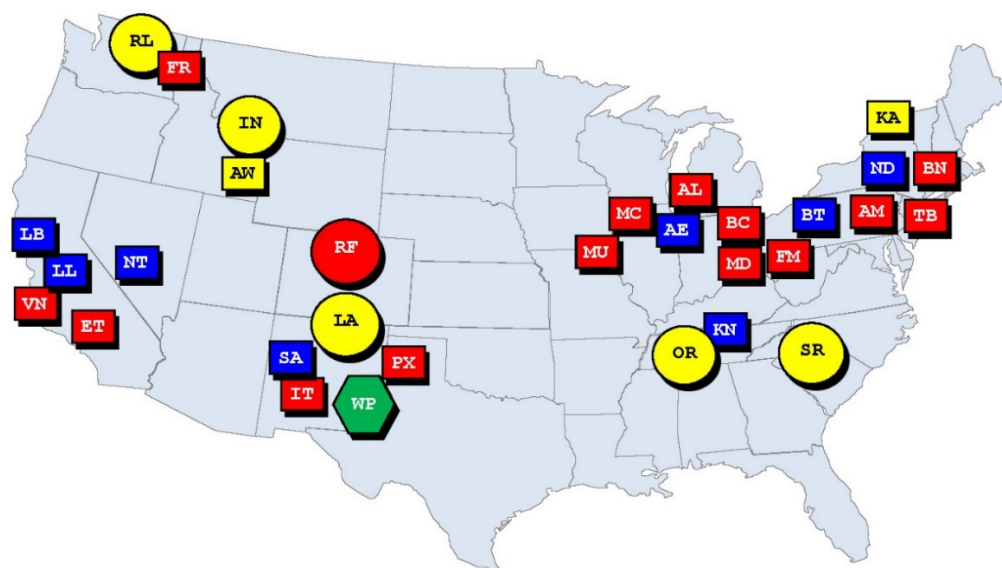

Yellow – Active TRU Waste Sites Red – De-inventoried of all TRU Waste Blue – De-inventoried of Legacy TRU waste

Source: reproduced from DOE 2012.

Figure B-1. Map of TRU waste sites

Figure B-2 depicts the total quantity (volume) of waste by site, in the forms of CH waste (top pie chart) and RH waste (bottom pie chart); CH waste is 95% of the inventory by volume. This CH waste resides predominantly at INL, Hanford, Los Alamos National Laboratory, and SRS. The largest quantities by volume of RH waste reside at Hanford, Oak Ridge National Laboratory, and INL. In terms of

radioactivity, the relative proportion of activity associated with the two waste streams is more equal as shown in Figure B-3 that depicts the activity by site for CH (top) and RH (bottom) wastes. The relative sizes of the two pie charts are approximately proportional to their total activity.

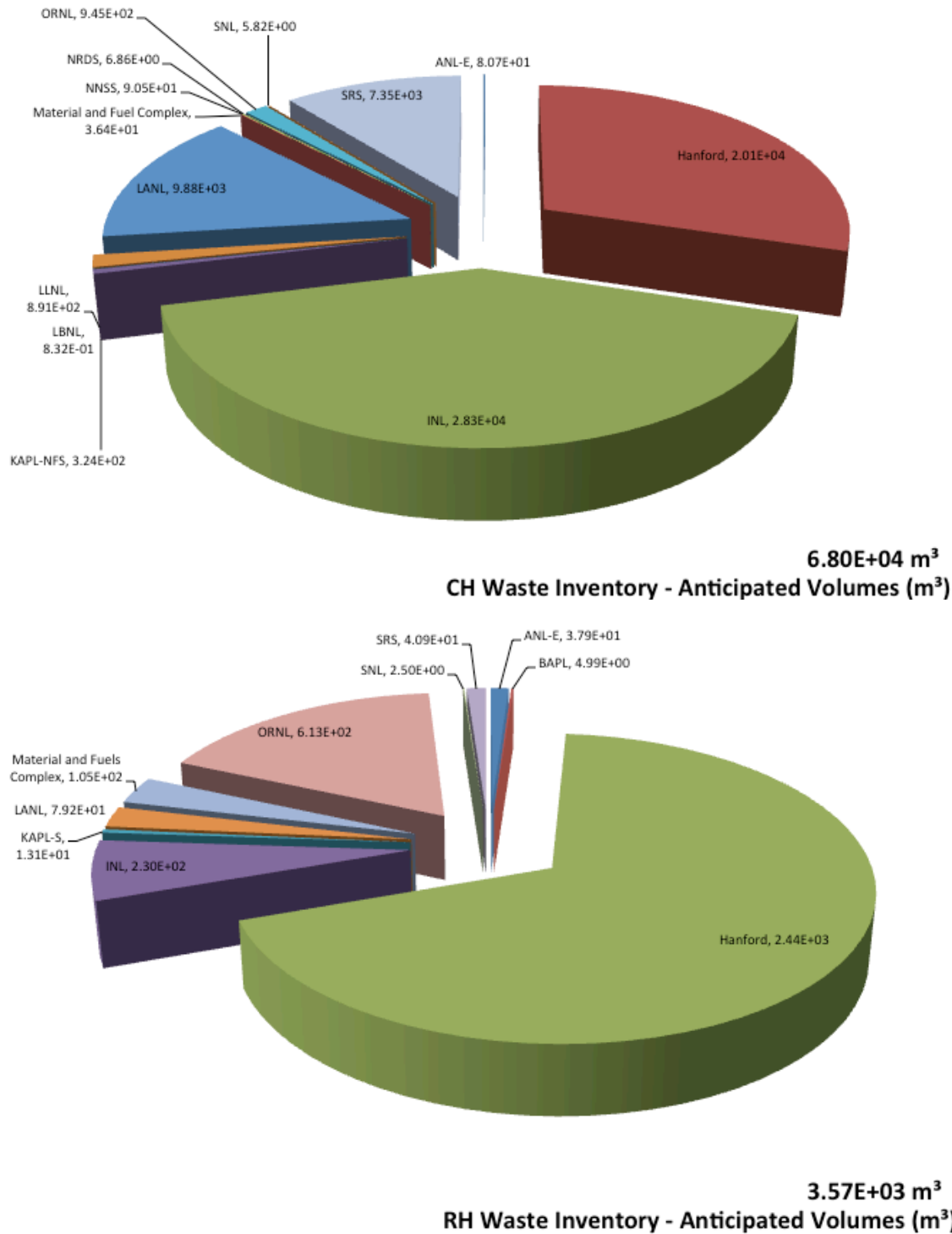

Source: data from Tables 3-1 and 3-2 of DOE 2012.

Figure B-2. TRU waste volumes, broken out by site—CH waste (top) and RH waste (bottom)

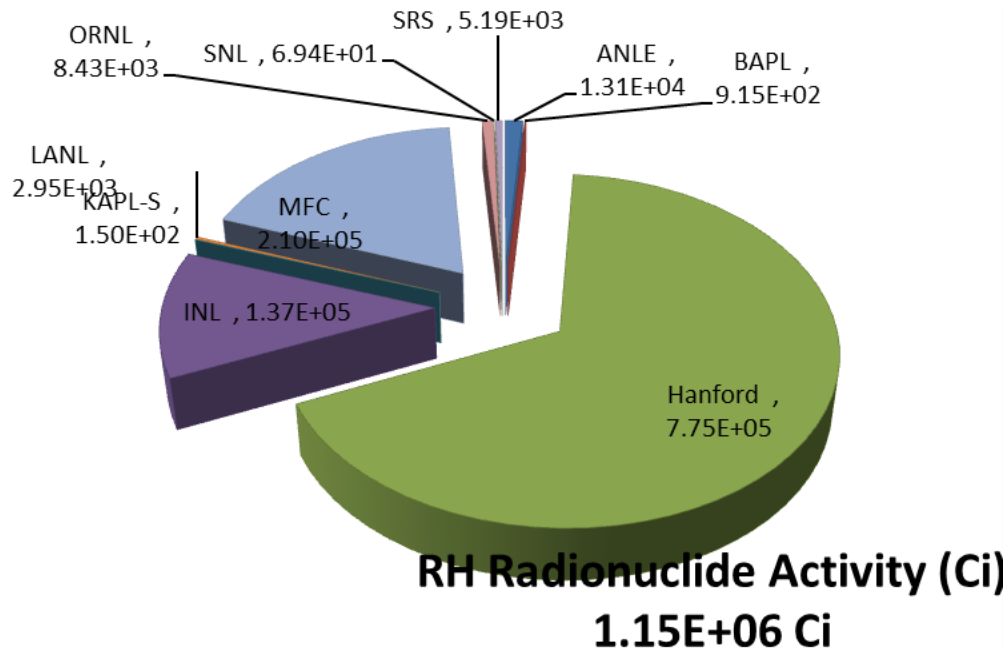
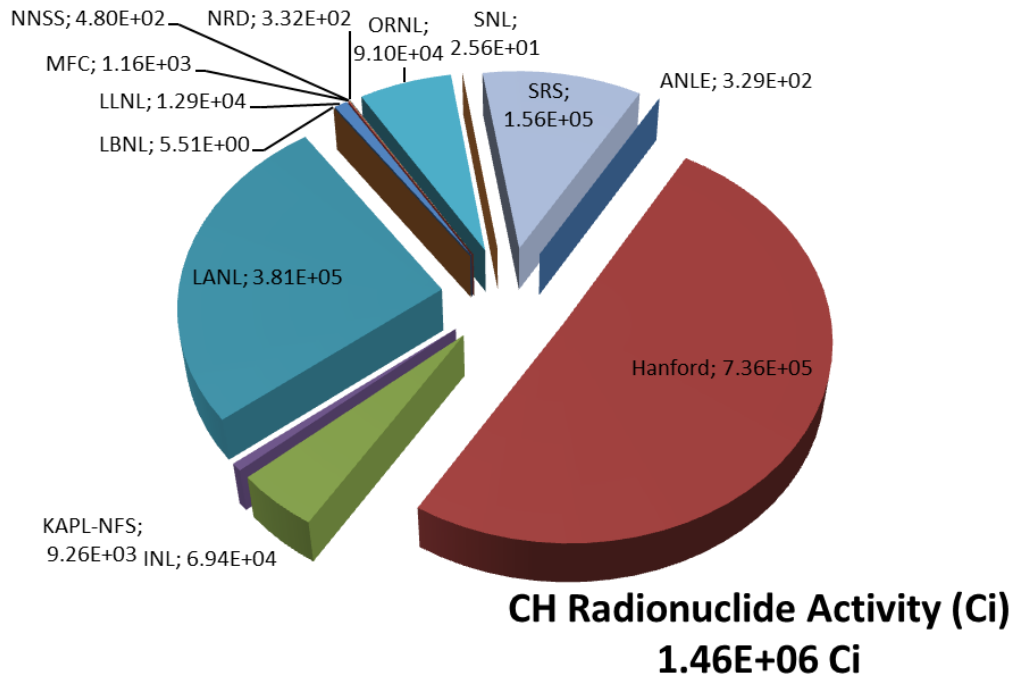

Source: data from Table 3-12 of DOE 2012.

Figure B-3. Activities for TRU waste, broken out by site—top: CH waste, bottom: RH waste

Physical Form—Due to the nature of TRU waste, the physical form is extremely varied. The WIPP transportation system is designed to accommodate this variability through the use of a variety of waste packaging and transportation options for CH and RH TRU waste. CH waste is packaged into 55-gallon drums that are transported in either TRUPACT-II or HalfPACT systems (Figures B-4 and B-5, respectively). The TRUPACT-II system is designed to carry either 14 55-gallon drums, 14 standard pipe overpacks, 14 S100 pipe overpacks, 14 S200 pipe overpacks, 14 S300 pipe overpacks, eight 85-gallon

drums, six 100-gallon drums, two standard waste boxes, or one TDOP. The HalfPACT design is optimized to transport up to seven 55-gallon drums, seven standard pipe overpacks, seven S100 pipe overpacks, seven S200 pipe overpacks, seven S300 pipe overpacks, four 85-gallon drums, three 100-gallon drums, one standard waste box, three shielded containers, or seven CCOs of waste. Figure B-6 is a photo of the TRUPACT-II system being transported to the WIPP repository.

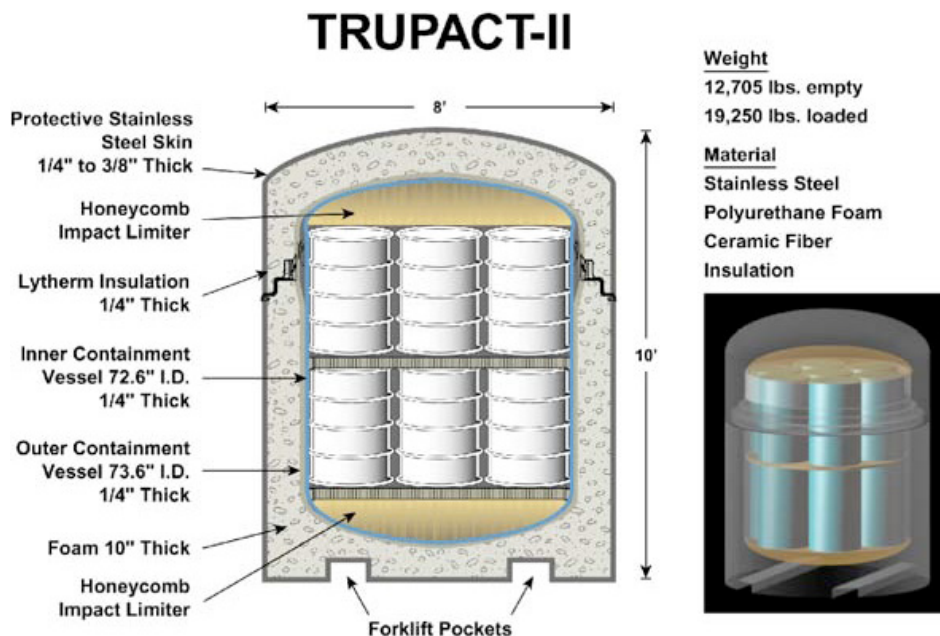

Figure B-4. TRUPACT II waste transport system

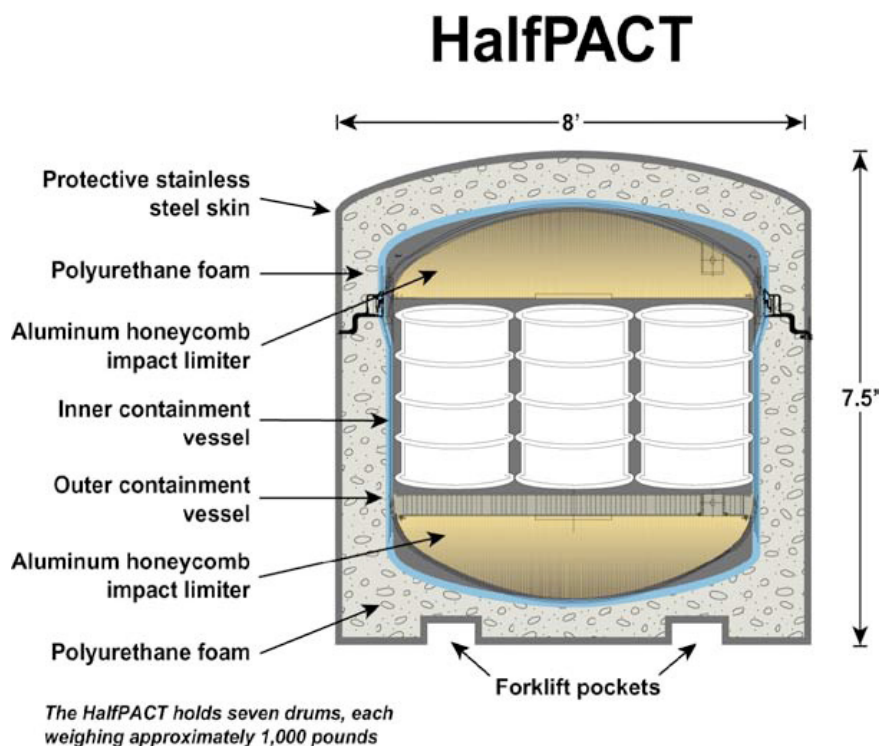

Figure B-5. HalfPACT waste transport system



Figure B-6. TRUPACT-II transportation system arriving at the WIPP repository

For RH TRU waste, the RH-72B package is employed (schematic shown in Figure B-7) to provide additional shielding for RH waste so the RH and CH TRU waste have the same dose rate limit on the outside of the shipping casks during transport. A photo of the RH-72B system used for transportation to the WIPP repository is shown in Figure B-8. Once at WIPP, CH waste is disposed within the disposal rooms (Figure B-9). RH waste is emplaced horizontal holes in the wall of the disposal room. Figure B-10 shows the emplacement equipment used to emplace the RH waste package. After inserting the RH waste package, a cement plug is installed for radiation shielding.

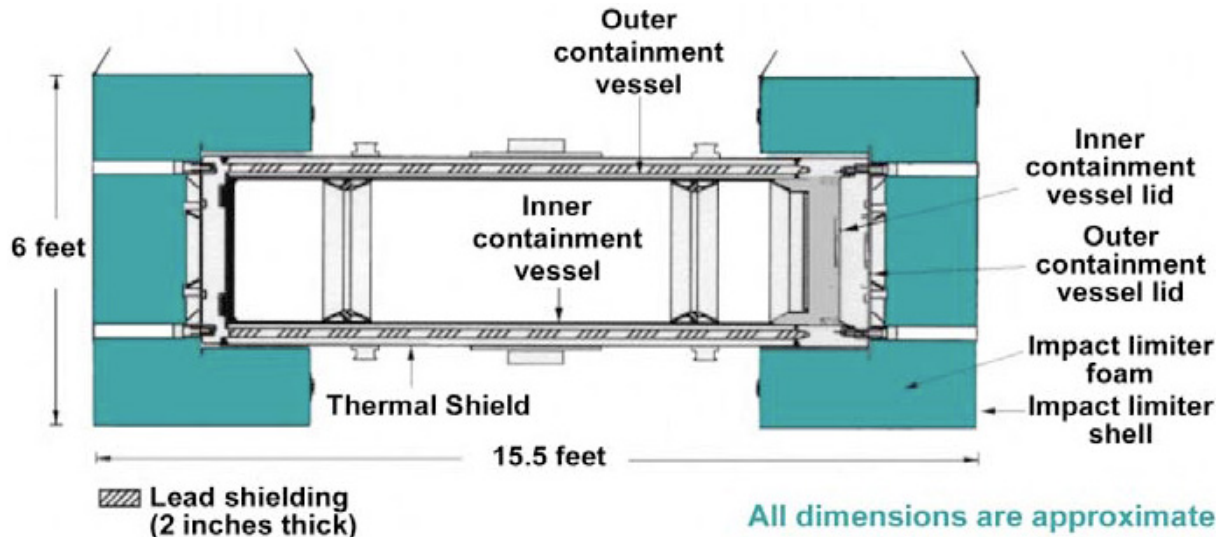

Figure B-7. Schematic of RH-72B waste transport system



Figure B-8. Photograph of RH-72B waste transport system



Figure B-9. CH waste being disposed in a disposal room at WIPP



Figure B-10. RH waste disposal equipment used for disposal at WIPP

Radionuclide Inventory—The characteristic nuclides that fit the definition of TRU waste are the transuranics, including the isotopes of plutonium (^{238}Pu , ^{239}Pu , ^{240}Pu , ^{242}Pu , ^{244}Pu), americium (^{241}Am and ^{243}Am), and curium (^{243}Cm , ^{245}Cm , ^{246}Cm , ^{247}Cm , ^{248}Cm , ^{250}Cm). Figure B-11 is a set representative plots, using Hanford data, of the activities of key radionuclides of CH waste (top plot) and RH waste (bottom plot), showing the transuranics, uranium, and other key fission products that contribute significantly to the total activity. For Hanford TRU waste, the presence of larger quantities of ^{137}Cs and ^{60}Co gives the RH waste its characteristic higher surface dose. Despite the fact that this summary focuses on the highest activity species, there may be value in examining other radionuclides that might be in smaller quantities but could still be impactful in a repository calculation. For a comprehensive listing of radionuclide activities for TRU, the reader should consult the source reference for this summary (DOE 2012).

Thermal—TRU waste is generally considered to be low-heat-generating— a characteristic that is central to placing it within an IAEA ILW definition. However, radioactive decay in the waste does result in some heat generation, making this parameter an important consideration in characterizing the waste. The WIPP waste acceptance criteria (DOE 2013) specifies the characteristics of waste that must be met in order to make transportation and disposal at WIPP permissible. In the case of decay heat, the limits are set in the technical requirements governing the transportation packages themselves, leading to the following limits (PECOS Management Services 2010):

- <40 W/container for TRUPACT-II
- <30 W/container for HalfPACT
- <50 W/container for RH-TRAMPAC (RH-TRU 72-B).

For comparison, the HLW heat load inventory based on current waste disposition assumptions places the percentage of canisters with heat load <50 W/container at about 72% (Carter et al. 2012, Table 3-3). This implies that despite the current origin-based definitions for waste categorization, the WIPP waste acceptance criteria sets limits for decay heat that would encompass a significant fraction of the HLW inventory.

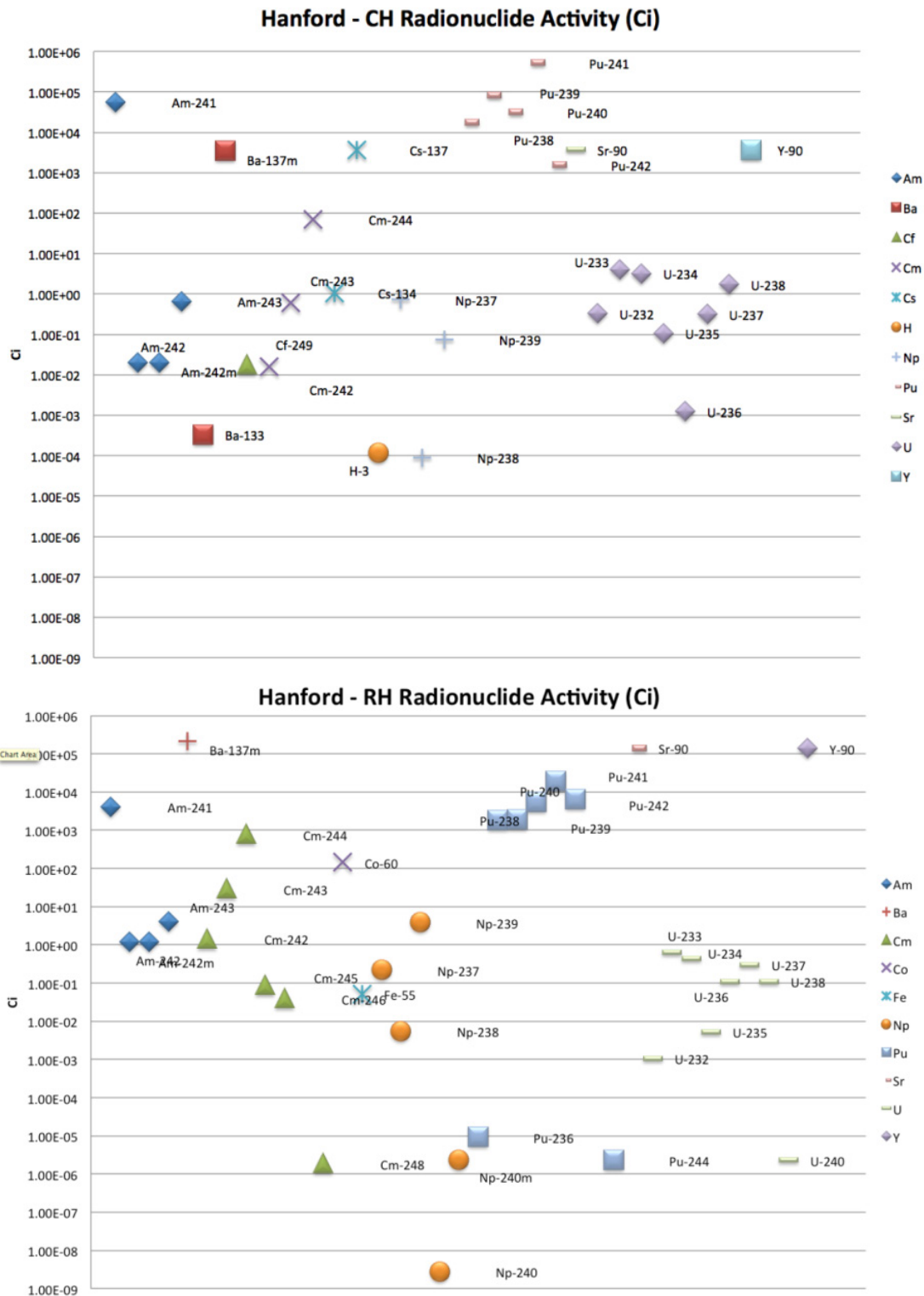

Source: data presented from DOE 2012.

Figure B-11. Radionuclide activities by species for Hanford TRU waste—top plot: CH TRU waste; bottom plot: RH TRU waste

Chemical composition—Because of the nature of waste designated as TRU waste, there is a large amount of non-radiological material commingled with the radioisotopes listed above. These materials are important to consider in the context of disposal in the WIPP repository, and may affect processes such as gas generation and radionuclide complexation in solution. For this reason, the inventory maintained by DOE-EM keeps track of these constituents. The data compiled in *Annual Transuranic Waste Inventory Report—2012* (DOE 2012) is a bottoms-up inventory, based on data calls made to each site, tracking materials such as metals (both within the waste itself and the packages containing the waste), other inorganic materials, cellulose, rubber, plastic, cement, and soils. Additionally, complexing agents are separately tracked because of their potential for affecting the solubility and mobility of transuranics and other radionuclides.

Figure B-12 shows the mass of different non-radiological components for CH and RH TRU waste in the inventory. The mass associated with the packaging is broken out from the mass of the waste itself, and illustrates the predominance of the metal mass associated with the packages. The plot also illustrates the total quantities of organics destined for the WIPP repository (from which assessments of potential gas buildup can be made). Figure B-13 is a similar plot specifically showing inventories of aqueous complexing agents. Figure B-14 is a scatter plot indicating the quantities of the nitrate, phosphate, and sulfate anions. The breakdown by site of the complexing agents is an indication of different processing activities at the sites, leading to variability in the specific chemical constituents in the waste being shipped. The anion plot (Figure B-14) is indicative of the predominance in the inventory of waste at the Hanford, INL, and Los Alamos National Laboratory sites.

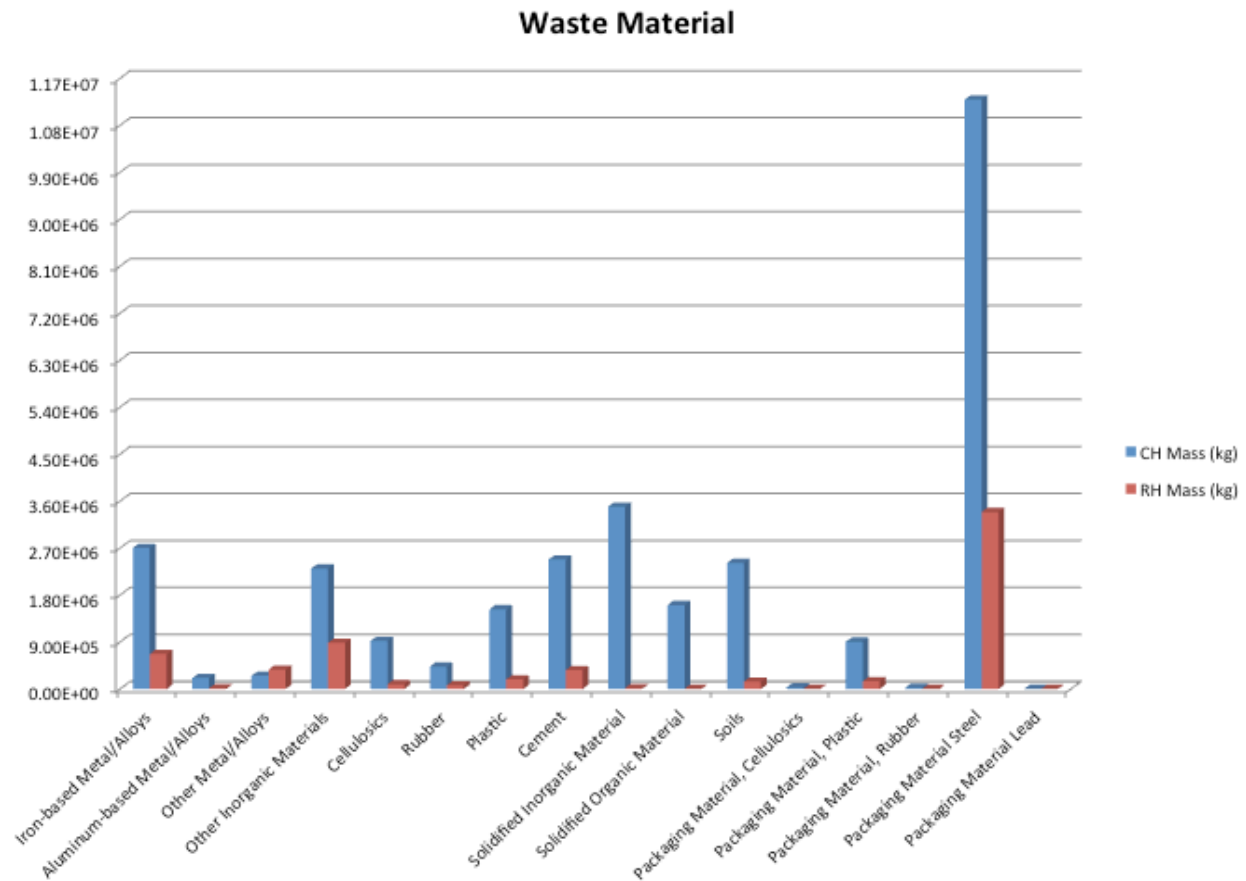

Source: data from Table 3-4 of DOE 2012.

Figure B-12. Mass of nonradiological components in TRU waste

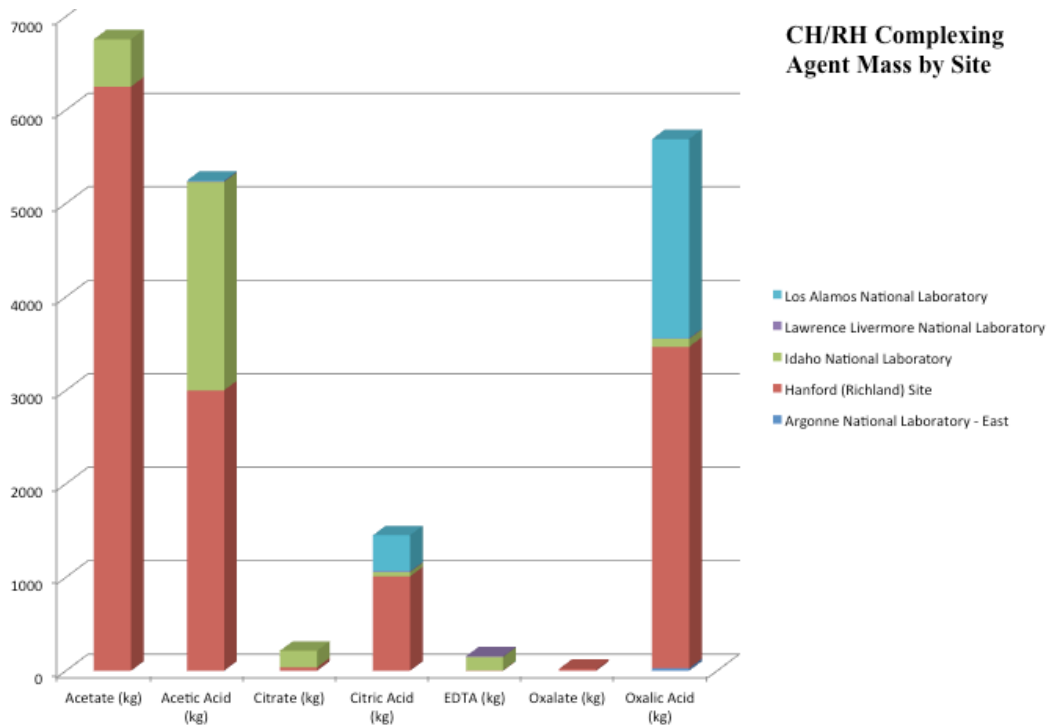

Source: data from Table 3-6 of DOE 2012.

Figure B-13. Mass of complexing agents in TRU waste

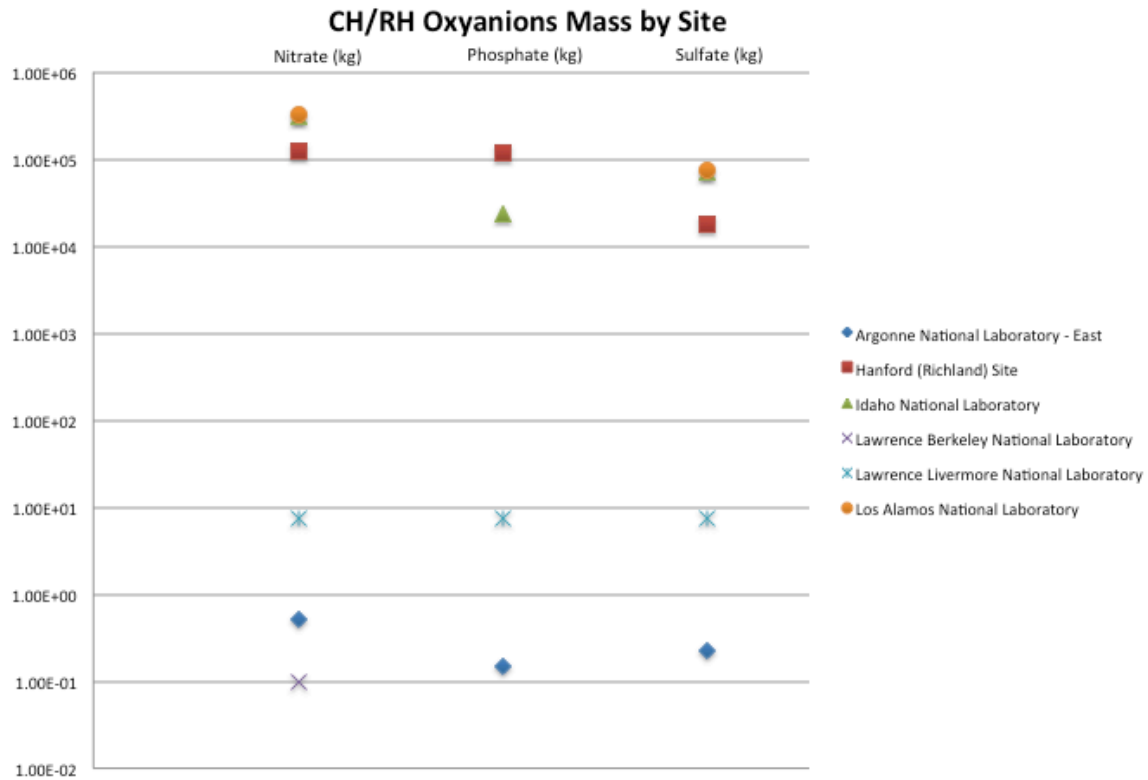

Source: data from Table 3-8 of DOE 2012.

Figure B-14. Mass of anions in TRU waste

Storage Configuration—TRU waste is stored at the individual DOE sites in accordance with applicable procedures for storage of this type of waste and the specifics of the processing steps that created the waste. The waste is stored in a manner in which it is easily retrievable, enabling compliant packaging and shipment to WIPP.

Safeguards and Security—Because of the transuranic content of TRU waste (including fissionable materials) material attractiveness and criticality issues must be taken into consideration. Since the opening of the repository, stored legacy TRU waste has been packaged and shipped to WIPP in a manner in which the safeguards and security requirements have been minimized. By design, the WIPP facility has been operated without the need for additional safeguarding against theft or diversion of special nuclear material (SNM) and the SNM accounting procedures that accompany those safeguards; therefore, safeguards must be terminated on the material prior to sending it to WIPP. For waste materials of very low attractiveness levels (to someone interested in stealing nuclear material), like much of the legacy TRU waste inventory, the process amounts to a routine determination of low attractiveness. However, in the future, as the DOE considers whether to dispose of higher grade SNM in its inventory, such as oxides or metals, issues of material attractiveness regarding theft or diversion will become more important. In the past, this issue has been addressed by reducing the attractiveness level through blending with chemical compounds that render it much more difficult to subsequently use. This method was used at Rocky Flats to complete its cleanup mission, and it is anticipated that similar approaches can be used on future TRU waste streams (Hayes and Nelson 2012). Criticality issues are addressed through the setting of ^{239}Pu fissile gram equivalent limits for packaged materials for the transportation containers and the disposal configuration at WIPP. Note that regardless of the methods employed to deal with material attractiveness and criticality issues, all other criteria specified in the WIPP waste acceptance criteria relating to radiological, physical, and chemical properties of the containers and waste must also be met.

B-2. References

Carter, J.T.; A.J. Luptak; J. Gastelum; C. Stockman; and A. Miller 2012. *Fuel Cycle Potential Waste Inventory for Disposition*. FCR&D-USED-2010-000031, Rev. 5. Washington, DC: U.S. Department of Energy.

DOE 2012. *Annual Transuranic Waste Inventory Report—2012*. DOE/TRU-12-3425, Revision 0. Carlsbad, New Mexico: U.S. Department of Energy, Carlsbad Field Office.

DOE 2013. *Transuranic Waste Acceptance Criteria for the Waste Isolation Pilot Plant*. DOE/WIPP-02-3122, Revision 7.4. Carlsbad, New Mexico: U.S. Department of Energy, Carlsbad Field Office.

Hayes, T. and R. Nelson 2012. “Terminating Safeguards on Excess Special Nuclear Material: Defense TRU Waste Clean-up and Nonproliferation.” Paper 12426, *Annual Waste Management Symposium 2012 (WM2012): Improving the Future in Waste Management, Phoenix, Arizona, USA, February 26–March 1, 2012*. Red Hook, New York: Curran Associates.

PECOS Management Services 2010. *A Study of WIPP Radiological Transuranic Waste Characterization Requirements and Activities*. PECOS Document 10-001. Carlsbad, New Mexico: PECOS Management Services.

Appendix C

Input Tabulations

C-1. Wastes and Waste Groups Tables

The tables in this appendix organize the detailed information (e.g., quantity, size, wattage, physical characteristics, and enrichment) for each waste form presented in Appendix A. Table C-1 describes the wastes included in the evaluation. Table C-2 presents the same wastes and information as in Table C-1, but organized by the waste groups that were formed during the evaluation.

Table C-1. Nuclear wastes included in the evaluation

Waste Identifier	Waste Group	Waste Type ^a	Quantity of Waste Type ^b	Waste Form	Quantity of Packages, Canisters, etc. ^b	Physical Description of Waste Type and Waste Form	BOL Enrichment	EOL Enrichment (%)	Final Average Assay Burnup (MWd/MTU)	Cladding Composition	Cladding Condition ^c	Fuel Compound Names	Fuel Matrix	Dimensions (in.)	Unit Volume (ft ³)	Total Volume (ft ³)	Unit Loaded mass (lbs.)	Non-radioactive constituents of interest	Thermal output in 2048
1A	1	Commercial SNF, currently existing and projected through 2048	142,000 MTHM	Purpose-built disposal canister (PBC) ^d	Borehole: 373,950 Small: 89,364 Medium: 31,163 Large: 16,924	Fuel rod assemblies in transportation, aging, and disposal canisters (assemblies are 6x6, 7x7, 8x8, 9x9, 10x10, 11x11, 14x14, 15x15, 16x16, 17x17, 13x14, 15x16, 17x18)	0.27 to 4.95	N/A	177 to 69,452	Zircaloy-2, Stainless steel	good, poor	UOX, MOX	UO ₂	Borehole: 13.4d, 197h Small: 32.3d, 197h Medium: 50.8d, 202h Large: 63d, 202h	Borehole: 16 Small: 93 Medium: 237 Large: 364	Varied	Varied	None	See Figures A-11 and A-12.
1B	2	Commercial SNF, currently existing and projected through 2048	142,000 MTHM	Dual purpose canisters (DPCs) ^d	11,413	Fuel rod assemblies in DPCs (assemblies are 6x6, 7x7, 8x8, 9x9, 10x10, 11x11, 14x14, 15x15, 16x16, 17x17, 13x14, 15x16, 17x18)	0.27 to 4.95	N/A	177 to 69,452	Zircaloy-2, Stainless steel	good, poor	UOX, MOX	UO ₂	79d, 202h	573	6,493,997	360,000	None	See Figures A-11 and A-12.
2	5	U metal, zirc clad, LEU (DOE group 1, mostly N Reactor)	2,096 MTHM	Multicanister overpack (MCO) 18x15 canister	MCO: 388 18x15: 2	Tubes	N/A	0.5 to 16	N/A	Zirconium	Fair Poor	U metal	None	MCO: 24d, 166.4h 18x15: 18d, 180h	MCO: 43.6 18x15: 26.5	16,971			
3	5	U metal, nonzirc clad, LEU (DOE group 2)	10 MTHM	MCO 18x10 canister	MCO: 7 18x10: 6	Canister of scrap Tube Unknown	N/A	0.2 to 3.3	N/A	Stainless steel Aluminum Unknown	Poor Good Fair N/A	U metal	None Unknown	MCO: 24d, 166.4h 18x10: 18d, 120h	MCO: 43.6 18x10: 18	413			
4	5	U-zirc (DOE group 3)	7 MTHM	18x10 canister 18x15 canister	18x10: 12 18x15: 8	Tube Cylinders Plates Assembly	N/A	0.5 to 92.9	N/A	Zirconium	Fair Good N/A	U metal 2% Zr U-Zr	None	18x10: 18d, 120h 18x15: 18d, 180h	18x10: 18 18x15: 27	432			
5	5	U-Mo (DOE group 4)	4 MTHM	18x10 canister	18x10: 10	Rod Tube Plates in can	N/A	2.5 to 25.7	N/A	Zirconium Aluminum None	Good Poor Fair N/A	U-Mo	None	18x10: 18d, 120h	18x10: 18	180			
6	7	U oxide, zirc clad, intact, HEU (DOE group 5)	<1 MTHM	18x10 canister 18x15 canister	18x10: 3 18x15: 55	Rod Rod array Assembly Plates	N/A	23.2 to 92.2	N/A	Zirconium	Fair Good	UO ₂	ZrO ₂ -CaO Graphite ZrO ₂ None	18x10: 18d, 120h 18x15: 18d, 180h	18x10: 18 18x15: 27	1,539			
7	7	U oxide, zirc clad, intact, MEU (DOE group 6)	2 MTHM	18x10 canister	18x10: 8	Rod Element Rod array	N/A	5.1 to 6.9	N/A	Zirconium	Fair Good	UO ₂	None	18x10: 18d, 120h	18x10: 18	144			
8	7	U oxide, zirc clad, intact, LEU (DOE group 7)	64 MTHM	18x10 canister 18x15 canister MCO	18x10 : 32 18x15: 83 MCO: 18	Tube Rod Rod array Plates Assembly Unknown	N/A	0.6 to 4.9	N/A	Zirconium	Good Fair	UO ₂	None	18x10: 18d, 120h 18x15: 18d, 180h MC: 24d, 166.4h	18x10: 18 18x15: 27 MCO: 43.6	3,602			
9	7	U oxide, stainless steel/hastelloy clad, intact, HEU (DOE group 8)	<1 MTHM	18x10 canister	18x10: 13	Tubes Canister of scrap Rod Plates Assembly	N/A	91.1 to 93.2	N/A	Stainless steel Hastelloy	Good Fair	UO ₂ - BeO ₂ UO ₂	Stainless steel Stainless steel 316L Stainless steel 304B Stainless steel 304 None	18x10: 18d, 120h	18x10: 18	234			

Table C-1. Nuclear wastes included in the evaluation (cont.)

Waste Identifier	Waste Group	Waste Type ^a	Quantity of Waste Type ^b	Waste Form	Quantity of Packages, Canisters, etc. ^b	Physical Description of Waste Type and Waste Form	BOL Enrichment	EOL Enrichment (%)	Final Average Assay Burnup (MWd/MTU)	Cladding Composition	Cladding Condition ^c	Fuel Compound Names	Fuel Matrix	Dimensions (in.)	Unit Volume (ft ³)	Total Volume (ft ³)	Unit Loaded mass (lbs.)	Non-radioactive constituents of interest	Thermal output in 2048
10	7	U oxide, stainless steel clad, intact, MEU (DOE group 9)	<1 MTHM	18x10 canister 18x15 canister	18x10: 3 18x15: 9	Rod Element	N/A	5.5 to 19.9	N/A	Stainless steel	Good Fair	UO ₂ -BeO ₂ UO ₂	ZrO ₂ -CaO None	18x10: 18d, 120h18x15: 18d, 180h	18x10: 1818x15: 27	297			
11	7	U oxide, stainless steel clad, intact, LEU (DOE group 10)	<1 MTHM	18x10 canister 18x15 canister	18x10: 1 18x15: 3	Tube Rod Rod array Rod hex array	N/A	0.2 to 2.1	N/A	Stainless steel	Good Fair	UO ₂	None	18x10: 18d, 120h 18x15: 18d, 180h	18x10: 18 18x15: 27	99			
12	7	U oxide, nonalum clad, nonintact or declad, HEU (DOE group 11)	<1 MTHM	18x10 canister 18x15 canister	18x10: 196 18x15: 6	Canister of scrap Assembly Tubes Filters Particulate Plate	N/A	21.1 to 93.3	N/A	Nichrome Hastelloy Stainless steel None	Poor N/A	UO ₂ UO ₂ -BeO ₂ U ₃ O ₈	BEO Stainless steel Nichrome Stainless steel 302B Stainless steel 347 Powder None	18x10: 18d, 120h 18x15: 18d, 180h	18x10: 18 18x15: 27	3,690			
13	7	U oxide, nonalum clad, nonintact or declad, MEU (DOE group 12)	<1 MTHM	18x10 canister 18x15 canister	18x10: 112 18x15: 1	Experiment capsule Canister of scrap Melted fuel	N/A	5.2 to 18.9	N/A	None Zirconium Unknown	Poor N/A	UO ₂	Gd ₂ O ₃ None Stainless steel	18x10: 18d, 120h 18x15: 18d, 180h	18x10: 18 18x15: 27	2,043			
14	7	U oxide, nonalum clad, nonintact or declad, LEU (DOE group 13)	108 MTHM	18x10 canister 18x15 canister	18x10: 10 18x15: 357	Canister of scrap Scrap Rod Rod array Debris	N/A	1.1 to 4.2	N/A	Zirconium Stainless steel	Poor N/A	UO ₂	None	18x10: 18d, 120h 18x15: 18d, 180h	18x10: 18 18x15: 27	9,819			
15	7	U oxide, alum clad, HEU (DOE group 14)	4 MTHM	18x10 canister 24x10 canister	18x10: 209 24x10: 133	Plates Assembly	N/A	58.2 to 89.9	N/A	Aluminum	Good Fair	U ₃ O ₈	Alum	18x10: 18d, 120h 24x10: 24d, 120h	18x10: 18 24x10: 31	7,885			
16	7	U oxide, alum clad, MEU and LEU (DOE group 15)	<1 MTHM	18x10 canister	18 x 10: 9	Plates Assembly Tubes	N/A	9.0 to 19.3	N/A	Aluminum	Good Fair Poor	U ₃ O ₈	Alum	18x10: 18d, 120h	18x10: 18	162			
17	5	U-Alx, HEU (DOE group 16)	8 MTHM	18x10 canister 18x15 canister	18x10: 548 18x15: 92	Rods array Tubes Plates Pin cluster Assembly Element Canister of scrap Cylindrical sections Stacked disks Multi-pin cluster	N/A	22.0 to 93.2	N/A	Aluminum	Good Fair Poor <blank>	U-Alx	Alum	18x10: 18d, 120h 18x15: 18d, 180h	18x10: 18 18x15: 27	12,348			
18	5	U-Alx, MEU (DOE group 17)	3 MTHM	18x10 canister	18x10: 74	Assembly Element Plates	N/A	9.1 to 20.0	N/A	Aluminum	Good Fair <blank>	U-Alx	Alum	18x10: 18d, 120h	18x10: 18	1,332			
19	5	U ₃ Si ₂ (DOE group 18)	7 MTHM	18x10 canister 18x15 canister	18x10: 93 18x15: 145	Tubes Multi-pin cluster Assembly Canister of scrap Plates	N/A	5.6 to 22	N/A	Aluminum	Good Fair Poor <blank>	U ₃ Si ₂	Alum	18x10: 18d, 120h 18x15: 18d, 180h	18x10: 18 18x15: 27	5,589			
20	9	Th/U carbide, TRISO- or BISO-coated particles in graphite (DOE group 19)	25 MTHM	18x10 canister 18x15 canister	18x10: 1 18x15: 505	Tubes Canister of scrap Carbon coated part	N/A	71.5 to 84.4	N/A	BISO TRISO	Good Poor	ThC ₂ -UC ₂ ThC-UC	Graphite	18x10: 18d, 120h 18x15: 18d, 180h	18x10: 18 18x15: 27	13,653			

Table C-1. Nuclear wastes included in the evaluation (cont.)

Waste Identifier	Waste Group	Waste Type ^a	Quantity of Waste Type ^b	Waste Form	Quantity of Packages, Canisters, etc. ^b	Physical Description of Waste Type and Waste Form	BOL Enrichment	EOL Enrichment (%)	Final Average Assay Burnup (MWd/MTU)	Cladding Composition	Cladding Condition ^c	Fuel Compound Names	Fuel Matrix	Dimensions (in.)	Unit Volume (ft ³)	Total Volume (ft ³)	Unit Loaded mass (lbs.)	Non-radioactive constituents of interest	Thermal output in 2048
21	9	Th/U carbide, monopyrolytic carbon coated particles in graphite (DOE group 20)	2 MTHM	18x15 canister	18x15: 63	Element	N/A	85.7 to 93.1	N/A	Mono-pyrolytic carbon	Poor	ThC ₂ -UC ₂	Graphite	18x15: 18d, 180h	18x15: 27	1,701			
22	5	Pu/U carbide, non-graphite clad, not sodium bonded (DOE group 21)	<1 MTHM	18x10 canister 18x15 canister	18x10: 3 18x15: 3	Canister of scrap Rod Rod hex array	N/A	1.0 to 67.3	N/A	Stainless steel	Good Fair Poor	Pu/U carbide	None	18x10: 18d, 120h 18x15: 18d, 180h	18x10: 18 18x15: 27	135			
23	7	MOX, zirc clad (DOE Group 22)	3 MTHM	18x10 canister	18x10: 6	Rod Canister of scrap Rod array Element	N/A	1.6 to 21.0	N/A	Zirconium	Poor Fair	PuO ₂ -UO ₂	None	18x10: 18d, 120h	39.6 to 85.2	511			
24	7	MOX, stainless steel clad (DOE group 23)	11 MTHM	18x10 canister 18x15 canister	18x10: 13 18x15: 127	Rod Plates Element Canister of scrap Scrap Rod hex array Melted fuel	N/A	2.1 to 87.3	N/A	Stainless steel	Poor Good Fair	PuO ₂ -UO ₂ PuO ₂	None	18x10: 18d, 120h 18x15: 18d, 180h	18x10: 18 18x15: 27	3,663			
25	7	MOX, non-stainless steel/nonzirc clad (DOE group 24)	<1 MTHM	18x10 canister 18x15 canister	18x10: 21 8x15: 1	Scrap Canister of scrap Unknown	N/A	5.0 to 54.3	N/A	Unknown	N/A Poor	PuO ₂ -UO ₂	None Unknown	18x10: 18d, 120h 18x15: 18d, 180h	18x10: 18 18x15: 27	63			
26	7	Th/U oxide, zirc clad (DOE group 25)	43 MTHM	18x10 canister 18x15 canister 24x15 canister	18x10: 9 18x15: 12 24x15: 27	Rod array Rod hex array Canister of scrap	N/A	10.2 to 98.4	N/A	Zirconium	Good Fair Poor	ThO ₂ -UO ₂ ceramic ThO ₂ -UO ₂	None	18x10: 18d, 120h 18x15: 18d, 180h 24x15: 24d, 180h	18x10: 18 18x15: 27 24x15: 47	1,755			
27	7	Th/U oxide, stainless steel clad (DOE group 26)	8 MTHM	18x10 canister 18x15 canister	18x10: 11 18x15: 1	Canister of scrap Rod	N/A	7.9 to 95.8	N/A	Stainless steel	Fair Poor	ThO ₂ -UO ₂	None	18x10: 18d, 120h 18x15: 18d, 180h	18x10: 18 18x15: 27	225			
28	5	U-zirc hydride, stainless steel/incoloy clad, HEU (DOE group 27)	<1 MTHM	18x10 canister	18x10: 18	Rod Element Rod array	N/A	20.0 to 93.2	N/A	Stainless steel Incoloy	Good Poor	U-ZrH _x U-ZrH _x -Er	None	18x10: 18d, 120h	18x10: 18	324			
29	5	U-zirc hydride, stainless steel/incoloy clad, MEU (DOE group 28)	2 MTHM	18x10 canister	18x10: 70	Element Canister of scrap Rod	N/A	11.9 to 20.0	N/A	Stainless steel Incoloy	Good Poor Fair <blank>	U-ZrH _x U-ZrH _x -Er	None B ₄ C	18x10: 18d, 120h	18x10: 18	1,260			
30	5	U-zirc hydride, alum clad, MEU (DOE group 29)	<1 MTHM	18x10 canister	18x10: 18	Element Rod	N/A	16.8 to 19.9	N/A	Aluminum	Good Fair Poor	U-ZrH _x	None	18x10: 18d, 120h	18x10: 18	324			
31	5	U-zirc hydride, declad (DOE group 30)	<1 MTHM	18x10 canister	18x10: 7	Declad rod	N/A	89.7	N/A	None	N/A	U-ZrH _x	None	18x10: 18d, 120h	18x10: 18	126			
32A	6	Metallic sodium bonded (EBR-II, INTEC, and FFTF) (DOE group 31)	22 MTHM ^g	Untreated metallic sodium bonded (EBR-II, INTEC, and FFTF) ^f	22 MTHM	Fuel in sodium Rod Assembly Canister of scrap Scrap Rod array Rod hex array Can	N/A	0.1 to 93.1	N/A	Stainless steel None Unknown	poor, good, N/A, fair	U-10Zr U-Mo U metal U-Pu-Zr UO ₂ Pu/U alloy U-5 fissionium Pu/U carbide	None	22 – 95h, 0.3 – 9.1d				Sodium Possible RCRA waste	

Table C-1. Nuclear wastes included in the evaluation (cont.)

Waste Identifier	Waste Group	Waste Type ^a	Quantity of Waste Type ^b	Waste Form	Quantity of Packages, Canisters, etc. ^b	Physical Description of Waste Type and Waste Form	BOL Enrichment	EOL Enrichment (%)	Final Average Assay Burnup (MWd/MTU)	Cladding Composition	Cladding Condition ^c	Fuel Compound Names	Fuel Matrix	Dimensions (in.)	Unit Volume (ft ³)	Total Volume (ft ³)	Unit Loaded mass (lbs.)	Non-radioactive constituents of interest	Thermal output in 2048
32B	4	Metallic sodium bonded (EBR-II, INTEC, and FFTF) (DOE group 31)	26 MTHM	Glass-bonded sodalite waste form from EMT	50,950 kg, 128 CWF canisters; 64 HLW canisters	Glass-bonded sodalite in canisters	N/A	N/A	N/A	N/A	N/A	N/A	N/A	20d, 39h (CWF cylinder) 24d, 120h (HLW canister)	7 (CWF cylinder) 31.4 (HLW canister)	896 (CWF cylinders) 2,009 (HLW canisters)	880		
	4			INL metal waste form resulting from EMT	5,850 kg, 488 ingots	Metal waste cast into ingots in canisters	N/A	N/A	N/A	N/A	N/A	N/A	N/A	N/A	16d, 5h	0.58	(disposed of with sodalite waste form in HLW canisters)	26.4	
32C	8	Metallic sodium bonded (EBR-II, INTEC, and FFTF) (DOE group 31)	26 MTHM	Salt waste from EMT ^f	15 canisters	Salt in canisters	N/A	N/A	N/A	N/A	N/A	N/A	N/A	10.5d, 60h	3	45	264		
	4			INL metal waste form resulting from EMT	5,850 kg, 488 ingots	Metal waste cast into ingots in canisters	N/A	N/A	N/A	N/A	N/A	N/A	N/A	N/A	16d, 5h	0.58	283	26.4	
33A	6	Metallic sodium bonded (Fermi-1) (DOE group 31)	34 MTHM	Untreated metallic sodium bonded (Fermi-1) ^f	34 MTHM	Fuel in sodium Rod Assembly Canister of scrap Scrap Rod array Rod hex array Can	N/A	0.1 to 93.1	N/A	Stainless steel None Unknown	poor, good, N/A, fair	U-10Zr U-Mo U metal U-Pu-Zr UO ₂ Pu/U alloy U-5 fissionium Pu/U carbide	None	0.3 to 9.1d, 22 to 95h				Sodium Possible RCRA waste	
33B	4	Metallic sodium bonded (Fermi-1) (DOE group 31)	34 MTHM	Glass-bonded sodalite waste form from EMT	66,630 kg 167 CWF canisters 84 HLW canisters	Glass in canisters	N/A	N/A	N/A	N/A	N/A	N/A	N/A	20d, 39h (CWF cylinder) 24d, 120h (HLW canister)	7 (CWF cylinder) 31.4 (HLW canister)	1,169 (CWF cylinders) 2,637 (HLW canisters)			
	4			INL metal waste form resulting from EMT	7,650 kg, 638 ingots	Metal waste cast into ingots in canisters	N/A	N/A	N/A	N/A	N/A	N/A	N/A	N/A	16d, 5h	0.58	(disposed of with sodalite waste form in HLW canisters)	26.4	
33C	8	Metallic sodium bonded (Fermi-1) (DOE group 31)	34 MTHM	Salt waste from EMT ^f	10 canisters	Salt in canisters	N/A	N/A	N/A	N/A	N/A	N/A	N/A	10.5d, 60h	3	30	264		
	4			INL metal waste form resulting from EMT	7,650 kg, 638 ingots	Metal waste cast into ingots in canisters	N/A	N/A	N/A	N/A	N/A	N/A	N/A	N/A	16d, 5h	0.58	370	26.4	
34	10	Naval (DOE group 32)	65 MTHM ^h	Naval fuel in naval canister	310 long canisters, 90 short canisters	Classified	93 to 97	N/A	N/A	Zircaloy, other (?)	intact (>98%), nonintact (<2%)	N/A	N/A	Short: 66d, 185.5h Long: 66d, 210.5h	Short: 367 Long: 417	162,300	Short: 157,000 Long: 162,000		< 11,800 W/canister < 32 W/ft ³ (short) < 28 W/ft ³ (long)
35	5	Misc DOE used nuclear fuel (not previously listed) (DOE group 34)	<1 MTHM	18x10 canister 18x15 canister	18x10: 9 18x15: 1	Canister of scrap Tube Rod Unknown Plates	N/A	1.6 to 89.9	N/A	None Zirconium Unknown Aluminum Stainless steel	fair, poor, N/A, good	ThO ₂ -UO ₂ , U-Th metal, U metal, Am oxide, Pu/U nitride	None, alum (1100), unknown	18x10: 18d, 120h 18x15: 18d, 180h	18x10: 18 18x15: 27	189			

Table C-1. Nuclear wastes included in the evaluation (cont.)

Waste Identifier	Waste Group	Waste Type ^a	Quantity of Waste Type ^b	Waste Form	Quantity of Packages, Canisters, etc. ^b	Physical Description of Waste Type and Waste Form	BOL Enrichment	EOL Enrichment (%)	Final Average Assay Burnup (MWd/MTU)	Cladding Composition	Cladding Condition ^c	Fuel Compound Names	Fuel Matrix	Dimensions (in.)	Unit Volume (ft ³)	Total Volume (ft ³)	Unit Loaded mass (lbs.)	Non-radioactive constituents of interest	Thermal output in 2048
36	3	Savannah River HLW tank waste	4 million gallons of reprocessing waste in tanks	Existing Savannah River HLW glass, through macrobatch 8	3,339 canisters	glass logs in canisters	N/A	N/A	N/A	N/A	N/A	N/A	N/A	24d, 120h	31.4	104,845	5,500 (max.)		4 to 120 W/canister (at time of production) 0.13 to 3.8 W/ft ³ (at time of production)
37	3	West Valley HLW tank waste	600,000 gallons of reprocessing waste in tanks	Existing West Valley HLW glass	275 canisters	glass logs in canisters	N/A	N/A	N/A	N/A	N/A	N/A	N/A	24d, 120h	31.4	8,635	5,900 (max.)		161 W/canister (average in 2017) 5.13 W/ft ³ (average in 2017)
38	3	FRG glass at Hanford	34 canisters	Glass logs containing strontium and cesium ^e	34 canisters	glass logs in canisters	N/A	N/A	N/A	N/A	N/A	N/A	N/A	12d, 48h	3.14	107	521		375 W/canister 119 W/ft ³
39	3	Hanford tank waste	~54.6 million gallons of reprocessing waste in tanks	Projected glass waste from Hanford	10,586 canisters of glass, 3,735 kg per canister (filled)	glass logs in canisters	N/A	N/A	N/A	N/A	N/A	N/A	N/A	24d, 180h	47	497,542	8,217	Possible RCRA waste.	360 W/canister 7.7 W/ft ³
40	3	Savannah River tank waste	28 million gallons of reprocessing HLW in tanks	Projected glass waste from Savannah River, from macrobatch 9 and up	4,485 canisters	glass logs in canisters	N/A	N/A	N/A	N/A	N/A	N/A	N/A	24d, 120h	31.4	140,829	5,500 (max.)		<500 W/canister (at time of production) <16 W/ft ³ (at time of production)
41A	4	Calcine waste	4,400 m ³	Calcine waste treated by hot isostatic pressing, including silica, titanium, and calcium sulfate	3,200 HIP cans (approximate) 320 disposal canisters (approximate)	glass ceramic in canisters	N/A	N/A	N/A	N/A	N/A	N/A	N/A	60d, 30h (HIP can) 66d, 204h (disposal canister)	49 (HIP can before treatment) 404 (disposal canister)	129,280 (assumes 320 disposal canisters)	4,500 (HIP can)	Possible RCRA waste	4 to 54 W/can (unknown time)
41B	4	Calcine waste	4,400 m ³	Calcine waste treated by hot isostatic pressing without silica, titanium, and calcium sulfate ^f	3,200 HIP cans (approximate) 270 disposal canisters (approximate)	glass ceramic in canisters	N/A	N/A	N/A	N/A	N/A	N/A	N/A	60d, 30h (HIP can) 66d, 204h (disposal canister)	49 (HIP can before treatment) 404 (disposal canister)	109,000 (assumes 270 disposal canisters)	4,500 (HIP can)	Possible RCRA waste	6 to 77 W/can (unknown time)
41C	3	Calcine waste	4,400 m ³	Calcine waste that has been vitrified ^f	11,400 canisters (estimated)	glass in canisters	N/A	N/A	N/A	N/A	N/A	N/A	N/A	24d, 120h	31.4	357,960		Possible RCRA waste	1.2 to 15.4 W/canister (unknown time)
41D	8	Calcine waste	4,400 m ³	Calcine waste that is disposed of without further treatment ^f	4,900 (100% fill) or 5,400 (90% fill)	solid granular material in canisters	N/A	N/A	N/A	N/A	N/A	N/A	N/A	26d, 121h	37.2	182,280		Possible RCRA waste	24 to 36 W/canister (unknown time)
42	8	Sodium-bearing waste at INL	850,000 gallons	Sodium-bearing waste treated by fluidized bed steam reforming	688 canisters	Solids and powders in canisters	N/A	N/A	N/A	N/A	N/A	N/A	N/A	26d, 120h	37	25,456		Possible RCRA waste	2.5 W/canister

Table C-1. Nuclear wastes included in the evaluation (cont.)

Waste Identifier	Waste Group	Waste Type ^a	Quantity of Waste Type ^b	Waste Form	Quantity of Packages, Canisters, etc. ^b	Physical Description of Waste Type and Waste Form	BOL Enrichment	EOL Enrichment (%)	Final Average Assay Burnup (MWd/MTU)	Cladding Composition	Cladding Condition ^c	Fuel Compound Names	Fuel Matrix	Dimensions (in.)	Unit Volume (ft ³)	Total Volume (ft ³)	Unit Loaded mass (lbs.)	Non-radioactive constituents of interest	Thermal output in 2048
43A	8	Cs/Sr capsules at Hanford	1,335 Cs capsules, 601 Sr capsules	Untreated overpacked Cs-Sr capsules from Hanford ⁱ	1,335 Cs capsules (leaking CsCl capsules in 23 Type W overpacks) 601 Sr capsules	CsCl salt and SrF ₂ crystalline solid in capsules. Some CsCl powder and some pellets in Type W overpacks.	N/A	N/A	N/A	N/A	N/A	N/A	N/A	CsCl capsules: 2.625d, 20.775h Type W overpack: 3.25d, 21.825h SrF ₂ : 2.625d, 20.1h	CsCl capsules: 0.065 Type W overpack: 0.105 SrF ₂ : 0.063	126		Possible RCRA waste	CsCl: 56 W/canister; 862 W/ft ³ ; 533 W/ft ³ for Type W overpack SrF ₂ : 73 W/canister 1,160 W/ft ³
43B	3	Cs/Sr capsules at Hanford	1,335 Cs capsules, 601 Sr capsules	Vitrified Cs and Sr from capsules ⁱ	340 canisters	glass logs in canisters	N/A	N/A	N/A	N/A	N/A	N/A	N/A	24d, 180h	47	15,980	8,217	Possible RCRA waste	Capsules: 349 W/canister; 7.4 W/ft ³

BOL = beginning of life

^a Projected as of 2048.

^b Existing or projected.

^c Cladding condition: good or fair is considered intact; poor or none is considered non-intact

^d For commercial SNF, both of these waste form disposal pathways are alternative pathways as neither has been finalized, but these represent two endmember pathways to evaluate the technical range of possibilities. Note that under the Standard Contract the DOE is only obligated to accept bare fuel for disposal and that contract holders who have packaged their spent nuclear fuel into DPC will have to sign a contract amendment with the DOE to have their DPC accepted by the DOE.

^e Contains known amounts of ¹³⁷Cs and ⁹⁰Sr; contains an unknown amount of ¹³⁵Cs.

^f This waste form disposal pathway is an alternative to the planned disposal pathway for this waste type shown in the table.

^g For this alternative waste form disposal pathway, there is only about 22 MTHM of untreated waste left as about 4 MTHM have already been processed via electrometallurgical treatment.

^h This waste mass represents the expected generation rate that would have been deliverable to Yucca Mountain in its projected 25 years of operation through 2035.

ⁱ For Cs/Sr capsules, both of these waste form disposal pathways are alternative pathways, as neither has been finalized.

Table C-2. Waste form groups used in the evaluation

Waste Group	Waste Identifier	Overlaps with	Waste Type ^a	Quantity of Waste Type ^b	Waste Form	Quantity of Packages, Canisters, etc. ^b	Physical Description of Waste Type and Waste Form	BOL Enrichment	EOL enrichment, %	Final Average Assay Burnup (MWd/MTU)	Cladding Composition	Cladding Condition ^c	Fuel Compound Names	Fuel Matrix	Dimensions (in.)	Unit Volume (ft ³)	Total Volume (ft ³)	Unit Loaded mass (lbs.)	Non-radioactive constituents of interest	Thermal output in 2048
WG1—Commercial SNF purpose-built containers																				
1	1A	1B	Commercial SNF, currently existing and projected through 2048	142,000 MTHM	Purpose-built disposal canister ^d	Borehole: 373,950 Small: 89,364 Medium: 31,163 Large: 16,924	Fuel rod assemblies in transportation, aging, and disposal canisters (assemblies are 6x6, 7x7, 8x8, 9x9, 10x10, 11x11, 14x14, 15x15, 16x16, 17x17, 13x14, 15x16, 17x18)	0.27 to 4.95	N/A	177 to 69452	Zircaloy-2, Stainless steel	good, poor	UOX, MOX	UO ₂	Borehole: 13.4d, 197h Small: 32.3d, 197h Medium: 50.8d, 202h Large: 63d, 202h	Borehole: 16 Small: 93 Medium: 237 Large: 364	Varied	Varied	None	Varies See Figures A-11 and A-12
WG2—Commercial SNF in DPCs																				
2	1B	1A	Commercial SNF, currently existing and projected through 2048	142,000 MTHM	Dual-purpose canisters (DPCs) ^d	11,413	Fuel rod assemblies in DPCs (assemblies are 6x6, 7x7, 8x8, 9x9, 10x10, 11x11, 14x14, 15x15, 16x16, 17x17, 13x14, 15x16, 17x18)	0.27 to 4.95	N/A	177 to 69452	Zircaloy-2, Stainless steel	good, poor	UOX, MOX	UO ₂	79d, 202h	569	6,493,997	360,000	None	See Figures A-11 and A-12
WG3—HLW glass																				
3	36		Savannah River HLW tank waste	4 million gallons of reprocessing waste in tanks	Existing Savannah River HLW Glass through macrobatch 8	3,339 canisters	glass logs in canisters	N/A	N/A	N/A	N/A	N/A	N/A	N/A	24d, 120h	31.4		5,500 (max.)		4 to 120 W/canister (at time of production) 0.13 to 3.8 W/ft ³ (at time of production)
3	37		West Valley HLW tank waste	600,000 gallons of reprocessing waste in tanks	Existing West Valley HLW Glass	275 canisters	glass logs in canisters	N/A	N/A	N/A	N/A	N/A	N/A	N/A	24d, 120h	31.4	8,635	5,900 (max.)		161 W/canister (average in 2017) 5.13 W/ft ³ (average in 2017)
3	38		FRG glass at Hanford	34 canisters	Glass logs containing Sr and Cs ^e	34 canisters	glass logs in canisters	N/A	N/A	N/A	N/A	N/A	N/A	N/A	12d, 48h	3.14	107	521		375 W/canister 119 W/ft ³
3	39		Hanford tank waste	~54.6 million gallons of reprocessing waste in tanks	Projected glass waste from Hanford	10,586 canisters of glass, 3,735 kg per canister (filled)	glass logs in canisters	N/A	N/A	N/A	N/A	N/A	N/A	N/A	24d, 180h	47	104,845	8,217	Possible RCRA waste.	360 W/canister 7.7 W/ft ³
3	40		Savannah River tank waste	28 million gallons of reprocessing HLW in tanks	Projected glass waste from Savannah River, macrobatch 9 and up	4,485 canisters	glass logs in canisters	N/A	N/A	N/A	N/A	N/A	N/A	N/A	24d, 120h	31.4	140,829	5,500 (max.)		<500 W/canister (at time of production) <16 W/ft ³ (at time of production)
3	41C	41A, 41B, 41D	Calcine waste	4,400 m ³	Calcine waste that has been vitrified ^f	11,400 canisters (estimated)	glass in canisters	N/A	N/A	N/A	N/A	N/A	N/A	N/A	24d, 120h	31.4	357,960		Possible RCRA waste	1.2 to 15.4 W/canister (unknown time)
3	43B	43A	Cs/Sr capsules at Hanford	1,335 Cs capsules, 601 Sr capsules	Vitrified Cs and Sr from capsules ^h	340 canisters	glass logs in canisters	N/A	N/A	N/A	N/A	N/A	N/A	N/A	24d, 180h	47	15,980	8,217	Possible RCRA waste	Capsules: 349 W/canister; 7.4 W/ft ³

Table C-2. Waste form groups used in the evaluation (cont.)

Waste Group	Waste Identifier	Overlaps with	Waste Type ^a	Quantity of Waste Type ^b	Waste Form	Quantity of Packages, Canisters, etc. ^b	Physical Description of Waste Type and Waste Form	BOL Enrichment	EOL enrichment, %	Final Average Assay Burnup (MWd/MTU)	Cladding Composition	Cladding Condition ^c	Fuel Compound Names	Fuel Matrix	Dimensions (in.)	Unit Volume (ft ³)	Total Volume (ft ³)	Unit Loaded mass (lbs.)	Non-radioactive constituents of interest	Thermal output in 2048
WG4—Other engineered waste forms																				
4	32B	32A, 32C	Metallic sodium bonded (EBR-II, INTEC, and FFTF) (group 31)	26 MTHM	Glass-bonded sodalite waste form from EMT	50,950 kg, 128 canisters 64 HLW canisters	Glass-bonded sodalite in canisters	N/A	N/A	N/A	N/A	N/A	N/A	N/A	20d, 39h (CWF cylinder) 24d, 120h (HLW canister)	7 (CWF cylinder) 31.4 (HLW canister)	896 (CWF cylinders) 2,009 (HLW canisters)	880		
4					INL metal waste form resulting from EMT	5,850 kg, 488 ingots	Metal waste cast into ingots in canisters	N/A	N/A	N/A	N/A	N/A	N/A	N/A	N/A	16d, 5h	0.58	(disposed of with sodalite waste form in HLW canisters)	26.4	
4	32C	32A, 32B	Metallic sodium bonded fuel (EBR-II, INTEC, and FFTF) (group 31)	26 MTHM	INL metal waste form resulting from EMT	5,850 kg, 488 ingots	Metal waste cast into ingots in canisters	N/A	N/A	N/A	N/A	N/A	N/A	N/A	16d, 5h	0.58	283	26.4		
4	33B	33A, 33C	Metallic sodium bonded (Fermi-1) (group 31)	34 MTHM	Glass-bonded sodalite waste form from EMT	66,640 kg 167 CWF canisters, 84 HLW canisters	Glass in canisters	N/A	N/A	N/A	N/A	N/A	N/A	N/A	20d, 39h (CWF cylinder) 24d, 120h (HLW canister)	7 (CWF cylinder) 31.4 (HLW canister)	1,169 (CWF cylinders) 2,637 (HLW canisters)	880		
4		33A, 33C			INL metal waste form resulting from EMT	7,650 kg, 638 ingots	Metal waste cast into ingots in canisters	N/A	N/A	N/A	N/A	N/A	N/A	N/A	N/A	16d, 5h	0.58	(disposed of with sodalite waste form in HLW canisters)	26.4	
4	33C	33A, 33B	Metallic sodium bonded fuel (Fermi-1) (group 31)	34 MTHM	INL metal waste form resulting from EMT	7,650 kg, 638 ingots	Metal waste cast into ingots in canisters	N/A	N/A	N/A	N/A	N/A	N/A	N/A	16d, 5h	0.58	370	26.4		
4	41A	41B, 41C, 41D	Calcine waste	4,400 m ³	Calcine waste treated by hot isostatic pressing, including silica, titanium, and calcium sulfate	3,200 HIP cans (approximate) 320 disposal canisters (approximate)	glass ceramic in canisters	N/A	N/A	N/A	N/A	N/A	N/A	N/A	60d, 30h (HIP can) 66d, 204h (disposal canister)	49 (HIP can before treatment) 404 (disposal canister)	129,280 (assumes 320 disposal canisters)	4,500 (HIP can)	Possible RCRA waste	4 to 54 W/can (unknown time)
4	41B	41A, 41C, 41D	Calcine waste	4,400 m ³	Calcine waste treated by hot isostatic pressing <i>without</i> silica, titanium, and calcium sulfate ^f	3,200 HIP cans (approximate) 270 disposal canisters (approximate)	glass ceramic in canisters	N/A	N/A	N/A	N/A	N/A	N/A	N/A	60d, 30h (HIP can) 66d, 204h (disposal canister)	49 (HIP can before treatment) 404 (disposal canister)	109,000 (assumes 270 disposal canisters)	4,500 (HIP can)	Possible RCRA waste	6 to 77 W/can (unknown time)
WG5—Metallic spent fuels																				
5	2		U metal, zirc clad, LEU (group 1, mostly N Reactor)	2,096 MTHM	Multicanister overpack (MCO) 18x15 canister	MCO: 388 18x15: 2	Tubes	N/A	0.5 to 16	N/A	Zirconium	Fair Poor	U metal	None	MCO: 24d, 166.4h 18x15: 18d, 180h	MCO: 43.6 18x15: 26.5	16,971			
5	3		U metal, nonzirc clad, LEU (group 2)	10 MTHM	MCO 18x10 canister	MCO: 7 18x10: 6	Canister of scrap Tube Unknown	N/A	0.2 to 3.3	N/A	Stainless steel Aluminum Unknown	Poor Good Fair N/A	U metal	None Unknown	MCO: 24d, 166.4h 18x10: 18d, 120h	MCO: 43.6 18x10: 18	413			
5	4		U-zirc (group 3)	7 MTHM	18x10 canister 18x15 canister	18x10: 12 18x15: 8	Tube Cylinders Plates Assembly	N/A	0.5 to 92.9	N/A	Zirconium	Fair Good N/A	U metal 2% Zr U-Zr	None	18x10: 18d, 120h 18x15: 18d, 180h	18x10: 18 18x15: 27	432			

Table C-2. Waste form groups used in the evaluation (cont.)

Waste Group	Waste Identifier	Overlaps with	Waste Type ^a	Quantity of Waste Type ^b	Waste Form	Quantity of Packages, Canisters, etc. ^b	Physical Description of Waste Type and Waste Form	BOL Enrichment	EOI enrichment, %	Final Average Assay Burnup (MWd/MTU)	Cladding Composition	Cladding Condition ^c	Fuel Compound Names	Fuel Matrix	Dimensions (in.)	Unit Volume (ft ³)	Total Volume (ft ³)	Unit Loaded mass (lbs.)	Non-radioactive constituents of interest	Thermal output in 2048
5	5		U-Mo (group 4)	4 MTHM	18x10 canister	18x10: 10	Rod Tube Plates in can	N/A	2.5 to 25.7	N/A	Zirconium Aluminum None	Good Poor Fair N/A	U-Mo	None	18x10: 18d, 120h	18x10: 18	180			
5	17		U-Alx, HEU (group 16)	8 MTHM	18x10 canister 18x15 canister	18x10: 548 18x15: 92	Rods array Tubes Plates Pin cluster Assembly Element Canister of scrap Cylindrical sections Stacked disks Multi-pin cluster	N/A	22.0 to 93.2	N/A	Aluminum	Good Fair Poor <blank>	U-Alx	Alum	18x10: 18d, 120h 18x15: 18d, 180h	18x10: 18 18x15: 27	12,348			
5	18		U-Alx, MEU (group 17)	3 MTHM	18x10 canister	18x10: 74	Assembly Element Plates	N/A	9.1 to 20.0	N/A	Aluminum	Good Fair <blank>	U-Alx	Alum	18x10: 18d, 120h	18x10: 18	1,332			
5	19		U ₃ Si ₂ (group 18)	7 MTHM	18x10 canister 18x15 canister	18x10: 93 18x15: 145	Tubes Multi-pin cluster Assembly Canister of scrap Plates	N/A	5.6 to 22	N/A	Aluminum	Good Fair Poor <blank>	U ₃ Si ₂	Alum	18x10: 18d, 120h 18x15: 18d, 180h	18x10: 18 18x15: 27	5,589			
5	22		Pu/U carbide, non-graphite clad, not sodium bonded (group 21)	<1 MTHM	18x10 canister 18x15 canister	18x10: 3 18x15: 3	Canister of scrap Rod Rod hex array	N/A	1.0 to 67.3	N/A	Stainless steel	Good Fair Poor	Pu/U carbide	None	18x10: 18d, 120h 18x15: 18d, 180h	18x10: 18 18x15: 27	135			
5	28		U-zirc hydride, stainless steel/incoloy clad, HEU (group 27)	<1 MTHM	18x10 canister	18x10: 18	Rod Element Rod array	N/A	20.0 to 93.2	N/A	Stainless steel Incoloy	Good Poor	U-ZrH _x U-ZrH _x -Er	None	18x10: 18d, 120h	18x10: 18	324			
5	29		U-zirc hydride, stainless steel/incoloy clad, MEU (group 28)	2 MTHM	18x10 canister	18x10: 70	Element Canister of scrap Rod	N/A	11.9 to 20.0	N/A	Stainless steel Incoloy	Good Poor Fair <blank>	U-ZrH _x U-ZrH _x -Er	None B ₄ C	18x10: 18d, 120h	18x10: 18	1,260			
5	30		U-zirc hydride, alum clad, MEU (group 29)	<1 MTHM	18x10 canister	18x10: 18	Element Rod	N/A	16.8 to 19.9	N/A	Aluminum	Good Fair Poor	U-ZrH _x	None	18x10: 18d, 120h	18x10: 18	324			
5	31		U-zirc hydride, declad (group 30)	<1 MTHM	18x10 canister	18x10: 7	Declad rod	N/A	89.7	N/A	None	N/A	U-ZrH _x	None	18x10: 18d, 120h	18x10: 18	126			
5	35		Misc DOE used nuclear fuel (not previously listed) (group 34)	<1 MTHM	18x10 canister 18x15 canister	18x10: 9 18x15: 1	Canister of scrap Tube Rod Unknown Plates	N/A	1.6 to 89.9	N/A	none, zirconium, unknown, aluminum, stainless steel	fair, poor, N/A, good	ThO ₂ -UO ₂ , U-Th metal, U metal, Am oxide, Pu/U nitride	None, alum (1100), unknown	18x10: 18d, 120h 18x15: 18d, 180h	18x10: 18 18x15: 27	189			

Table C-2. Waste form groups used in the evaluation (cont.)

Waste Group	Waste Identifier	Overlaps with	Waste Type ^a	Quantity of Waste Type ^b	Waste Form	Quantity of Packages, Canisters, etc. ^b	Physical Description of Waste Type and Waste Form	BOL Enrichment	EOL enrichment, %	Final Average Assay Burnup (MWd/MTU)	Cladding Composition	Cladding Condition ^c	Fuel Compound Names	Fuel Matrix	Dimensions (in.)	Unit Volume (ft ³)	Total Volume (ft ³)	Unit Loaded mass (lbs.)	Non-radioactive constituents of interest	Thermal output in 2048
WG6—Sodium-bonded fuels																				
6	32A	32B, 32C	Metallic sodium bonded (EBR-II, INTEC, and FFTF) (group 31)	22 MTHM ^g	Untreated Metallic sodium bonded (EBR-II, INTEC, and FFTF) ^f	22 MTHM	Fuel in sodium Rod Assembly Canister of scrap Scrap Rod array Rod hex array Can	N/A	0.1 to 93.1	N/A	stainless steel, none, unknown	poor, good, N/A, fair	U-10Zr U-Mo U metal U-Pu-Zr UO ₂ Pu/U alloy U-5 fission Pu/U carbide	None	0.3 to 9.1d, 22 to 95h				Sodium Possible RCRA waste	
6	33A	33B, 33C	Metallic sodium bonded (Fermi-1) (group 31)	34 MTHM	Untreated metallic sodium bonded (Fermi-1) ^f	34 MTHM	Fuel in sodium Rod Assembly Canister of scrap Scrap Rod array Rod hex array Can	N/A	0.1 to 93.1	N/A	stainless steel, none, unknown	poor, good, N/A, fair	U-10Zr U-Mo U metal U-Pu-Zr UO ₂ Pu/U alloy U-5 fission Pu/U carbide	None	0.3 to 9.1d, 22 to 95h	21.6 to 144			Sodium Possible RCRA waste	
WG7—DOE oxide fuels																				
7	6		U oxide, zirc clad, intact, HEU (group 5)	<1 MTHM	18x10 canister 18x15 canister	18x10: 3 18x15: 55	Rod Rod array Assembly Plates	N/A	23.2 to 92.2	N/A	Zirconium	Fair Good	UO ₂ ZrO ₂ -CaO Graphite ZrO ₂ None		18x10: 18d, 120h 18x15: 18d, 180h	18x10: 18 18x15: 27	1,539			
7	7		U oxide, zirc clad, intact, MEU (group 6)	2 MTHM	18x10 canister	18x10: 8	Rod Element Rod array	N/A	5.1 to 6.9	N/A	Zirconium	Fair Good	UO ₂	None	18x10: 18d, 120h	18x10: 18	144			
7	8		U oxide, zirc clad, intact, LEU (group 7)	64 MTHM	18x10 canister 18x15 canister MCO	18x10 : 32 18x15: 83 MCO: 18	Tube Rod Rod array Plates Assembly Unknown	N/A	0.6 to 4.9	N/A	Zirconium	Good Fair	UO ₂	None	18x10: 18d, 120h 18x15: 18d, 180h MC: 24d, 166.4h	18x10: 18 18x15: 27 MCO: 43.6	3,602			
7	9		U oxide, stainless steel/hastelloy clad, intact, HEU (group 8)	<1 MTHM	18x10 canister	18x10: 13	Tubes Canister of scrap Rod Plates Assembly	N/A	91.1 to 93.2	N/A	Stainless steel Hastelloy	Good Fair	UO ₂ -BeO ₂ UO ₂	Stainless steel Stainless steel 316L Stainless steel 304B Stainless steel 304 None	18x10: 18d, 120h	18x10: 18	234			
7	10		U oxide, stainless steel clad, intact, MEU (group 9)	<1 MTHM	18x10 canister 18x15 canister	18x10: 3 18x15: 9	Rod Element	N/A	5.5 to 19.9	N/A	Stainless steel	Good Fair	UO ₂ -BeO ₂ UO ₂	ZrO ₂ -CaO None	18x10: 18d, 120h 18x15: 18d, 180h	18x10: 18 18x15: 27	297			
7	11		U oxide, stainless steel clad, intact, LEU (group 10)	<1 MTHM	18x10 canister 18x15 canister	18x10: 1 18x15: 3	Tube Rod Rod array Rod hex array	N/A	0.2 to 2.1	N/A	Stainless steel	Good Fair	UO ₂	None	18x10: 18d, 120h 18x15: 18d, 180h	18x10: 18 18x15: 27	99			

Table C-2. Waste form groups used in the evaluation (cont.)

Waste Group	Waste Identifier	Overlaps with	Waste Type ^a	Quantity of Waste Type ^b	Waste Form	Quantity of Packages, Canisters, etc. ^b	Physical Description of Waste Type and Waste Form	BOL Enrichment	EOI enrichment, %	Final Average Assay Burnup (MWd/MTU)	Cladding Composition	Cladding Condition ^c	Fuel Compound Names	Fuel Matrix	Dimensions (in.)	Unit Volume (ft ³)	Total Volume (ft ³)	Unit Loaded mass (lbs.)	Non-radioactive constituents of interest	Thermal output in 2048
7	12		U oxide, nonalum clad, nonintact or declad, HEU (group 11)	<1 MTHM	18x10 canister 18x15 canister	18x10: 196 18x15: 6	Canister of scrap Assembly Tubes Filters Particulate Plate	N/A	21.1 to 93.3	N/A	Nichrome Hastelloy Stainless steel None	Poor N/A	UO ₂ UO ₂ -BeO ₂ U ₃ O ₈	BEO Stainless steel Nichrome Stainless steel 302B Stainless steel 347 Powder None	18x10: 18d, 120h 18x15: 18d, 180h	18x10: 18 18x15: 27	3,690			
7	13		U oxide, nonalum clad, nonintact or declad, MEU (group 12)	<1 MTHM	18x10 canister 18x15 canister	18x10: 112 18x15: 1	Experiment capsule Canister of scrap Melted fuel	N/A	5.2 to 18.9	N/A	None Zirconium Unknown	Poor N/A	UO ₂	Gd ₂ O ₃ None Stainless steel	18x10: 18d, 120h 18x15: 18d, 180h	18x10: 18 18x15: 27	2,043			
7	14		U oxide, nonalum clad, nonintact or declad, LEU (group 13)	108 MTHM	18x10 canister 18x15 canister	18x10: 10 18x15: 357	Canister of scrap Scrap Rod Rod array Debris	N/A	1.1 to 4.2	N/A	Zirconium Stainless steel	Poor N/A	UO ₂	None	18x10: 18d, 120h 18x15: 18d, 180h	18x10: 18 18x15: 27	9,819			
7	15		U oxide, alum clad, HEU (group 14)	4 MTHM	18x10 canister 24x10 canister	18x10: 209 24x10: 133	Plates Assembly	N/A	58.2 to 89.9	N/A	Aluminum	Good Fair	U ₃ O ₈	Alum	18x10: 18d, 120h 24x10: 24d, 120h	18x10: 18 24x10: 31	7,885			
7	16		U oxide, alum clad, MEU and LEU (group 15)	<1 MTHM	18x10 canister	18 x 10 : 9	Plates Assembly Tubes	N/A	9.0 to 19.3	N/A	Aluminum	Good Fair Poor	U ₃ O ₈	Alum	18x10: 18d, 120h	18x10: 18	162			
7	23		MOX, zirc clad (Group 22)	3 MTHM	18x10 canister	18x10: 6	Rod Canister of scrap Rod array Element	N/A	1.6 to 21.0	N/A	Zirconium	Poor Fair	U-Al _x	Alum	18x10: 18d, 120h	39.6 to 85.2	511			
7	24		MOX, stainless steel clad (group 23)	11 MTHM	18x10 canister 18x15 canister	18x10: 13 18x15: 127	Rod Plates Element Canister of scrap Scrap Rod hex array Melted fuel	N/A	2.1 to 87.3	N/A	Stainless steel	Poor Good Fair	PuO ₂ -UO ₂ PuO ₂	None	18x10: 18d, 120h 18x15: 18d, 180h	18x10: 18 18x15: 27	3,663			
7	25		MOX, non-stainless steel/nonzirc clad (group 24)	<1 MTHM	18x10 canister 18x15 canister	18x10: 2 18x15: 1	Scrap Canister of scrap Unknown	N/A	5.0 to 54.3	N/A	Unknown	N/A Poor	PuO ₂ -UO ₂	None Unknown	18x10: 18d, 120h 18x15: 18d, 180h	18x10: 18 18x15: 27	63			
7	26		Th/U oxide, zirc clad (group 25)	43 MTHM	18x10 canister 18x15 canister 24x15 canister	18x10: 9 18x15: 12 24x15: 27	Rod array Rod hex array Canister of scrap	N/A	10.2 to 98.4	N/A	Zirconium	Good Poor N/A	ThO ₂ -UO ₂ ceramic ThO ₂ -UO ₂	None	18x10: 18d, 120h 18x15: 18d, 180h 24x15: 24d, 180h	18x10: 18 18x15: 27 24x15: 47	1,755			
7	27		Th/U oxide, stainless steel clad (group 26)	8 MTHM	18x10 canister 18x15 canister	18x10: 11 18x15: 1	Canister of scrap Rod	N/A	7.9 to 95.8	N/A	Stainless steel	Fair Poor	ThO ₂ -UO ₂	None	18x10: 18d, 120h 18x15: 18d, 180h	18x10: 18 18x15: 27	225			

Table C-2. Waste form groups used in the evaluation (cont.)

Waste Group	Waste Identifier	Overlaps with	Waste Type ^a	Quantity of Waste Type ^b	Waste Form	Quantity of Packages, Canisters, etc. ^b	Physical Description of Waste Type and Waste Form	BOL Enrichment	EOL enrichment, %	Final Average Assay Burnup (MWd/MTU)	Cladding Composition	Cladding Condition ^c	Fuel Compound Names	Fuel Matrix	Dimensions (in.)	Unit Volume (ft ³)	Total Volume (ft ³)	Unit Loaded mass (lbs.)	Non-radioactive constituents of interest	Thermal output in 2048
WG8—salt, granular solids, powder																				
8	32C	32A, 32B	Metallic sodium bonded (EBR-II, INTEC, and FFTF) (group 31)	26 MTHM	Salt waste from EMT ^f	15 canisters	Salt in canisters	N/A	N/A	N/A	N/A	N/A	N/A	N/A	10.5d, 60h	3	45	264		
8	33C	33A, 33B	Metallic sodium bonded (Fermi-1) (group 31)	34 MTHM	Salt waste from EMT ^f	10 canisters	Salt in canisters	N/A	N/A	N/A	N/A	N/A	N/A	N/A	10.5d, 60h	3	30	264		
8	41D	41A, 41B, 41C	Calcine waste	4,400 m ³	Calcine waste that is disposed of without further treatment ^f	4,900 (100% fill) or 5,400 (90% fill)	solid granular material in canisters	N/A	N/A	N/A	N/A	N/A	N/A	N/A	26d, 121h	37.2	182,280		Possible RCRA waste	24 to 36 W/canister (unknown time)
8	42		Sodium-bearing waste at INL	810,000 gallons	Sodium-bearing waste treated by fluidized bed steam reforming	688 canisters	Solids and powders in canisters	N/A	N/A	N/A	N/A	N/A	N/A	N/A	26d, 120h	37	25,456		Possible RCRA waste	2.5 W/canister
8	43A	43B	Cs/Sr capsules at Hanford	1,335 Cs capsules, 601 Sr capsules	Untreated overpacked Cs/Sr capsules from Hanford ^h	1,335 Cs capsules (leaking CsCl capsules in 23 Type W overpacks) 601 Sr capsules	CsCl salt and SrF ₂ crystalline solid in capsules. Some CsCl powder and some pellets in Type W overpacks.	N/A	N/A	N/A	N/A	N/A	N/A	N/A	CsCl capsules: 2.625d, 20.775h Type W overpack: 3.25d, 21.825h SrF ₂ : 2.625d, 20.1h	CsCl capsules: 0.065 Type W overpack: 0.105 SrF ₂ : .063	126		Possible RCRA waste	CsCl: 56 W/canister; 862 W/ft ³ ; 533 W/ft ³ for type W overpack SrF ₂ : 73 W/canister 1,160 W/ft ³
WG9—Coated particle spent fuels																				
9	20		Th/U carbide, TRISO- or BISO-coated particles in graphite (group 19)	25 MTHM	18x10 canister 18x15 canister	18x10: 1 18x15: 505	Tubes Canister of scrap Carbon coated part	N/A	71.5 to 84.4	N/A	BISO TRISO	Good Poor	ThC ₂ -UC ₂ ThC-UC	Graphite	18x10: 18d, 120h 18x15: 18d, 180h	18x10: 18 18x15: 27	13,653			
9	21		Th/U carbide, monopyrolytic carbon coated particles in graphite (group 20)	2 MTHM	18x15 canister	18x15: 63	Element	N/A	85.7 to 93.1	N/A	Mono-pyrolytic carbon	Poor	ThC ₂ -UC ₂	Graphite	18x15: 18d, 180h	18x15: 27	1,701			
WG10—Naval Fuel																				
10	34		Naval (group 32)	65 MTHM ⁱ	Naval fuel in naval canister	310 long canisters, 90 short canisters	Classified	93 to 97	N/A	N/A	Zircaloy, other (?)	intact (>98%), nonintact (<2%)	N/A	N/A	Short: 66d, 185.5h Long: 66d, 210.5h	Short: 367 Long: 417	162,300	Short: 157,000 Long: 162,000		< 11,800 W/canister < 32 W/ft ³ (short) < 28 W/ft ³ (long)

^a Projected as of 2048.^b Existing or projected.^c Cladding condition: good or fair is considered intact; poor or none is considered nonintact.^d For commercial SNF, both of these waste form disposal pathways are alternative pathways as neither has been finalized, but these represent two endmember pathways to evaluate the technical range of possibilities. Note that under the Standard Contract the US DOE is only obligated to accept bare fuel for disposal and that contract holders who have packaged their spent nuclear fuel into DPC will have to sign a contract amendment with the US DOE to have their DPC accepted by the US DOE.^e Contains known amounts of ¹³⁷Cs and ⁹⁰Sr; contains an unknown amount of ¹³⁵Cs.^f This waste form disposal pathway is an alternative to the planned disposal pathway for this waste type shown in the table.^g For this alternative waste form disposal pathway, there is only about 22 MTHM of untreated waste left as about 4 MTHM have already been processed via electrometallurgical treatment.^h For Cs/Sr capsules, both of these waste form disposal pathways are alternative pathways, as neither has been finalized.ⁱ This waste mass represents the expected generation rate that would have been deliverable to Yucca Mountain in its projected 25 years of operation through 2035.

Appendix D

Safeguards and Security

D-1. Introduction to Safeguards and Security

This appendix provides an overview of considerations for the relative difficulty in implementing safeguards and security for candidate repository/disposal concepts, waste types, and waste forms. In addition to assessing safeguards and security for the candidate disposal concepts, transportation from the originating waste site to the disposal facility, and packaging for transportation and then again for disposal, are also considered. As described in detail in Section 2 and Appendix A of this report, waste types include (1) SNF from commercial, defense, and research power reactors, (2) existing and projected HLW glass from the Hanford, Savannah River, and West Valley sites, and (3) other wastes classified as HLW or that may be disposed of in a HLW repository.

More specifically, this appendix summarizes a preliminary study to (1) identify potential safeguards and security requirements of the regulating agencies of interest (NRC, DOE, and IAEA) and (2) discuss possible metrics for the waste types/groups. Additionally, relevant information to assess the safeguards and security implications for two different disposal paths for the cesium and strontium capsules is reported. A preliminary conclusion following review of regulatory requirements for safeguards and security indicates waste containing SNM such as spent fuel, will require safeguards through the operating life of a repository and may or may not require minimal safeguards following closure. However, HLW without significant SNM would likely not require safeguards during operation or following closure. Therefore, from a safeguards perspective two repository concepts may be attractive, one with safeguards and one without.

D-1.1 Safeguards and Security Requirements

Division of responsibilities for domestic (NRC and DOE) and international (IAEA) regulation of safeguards and security is shown in Figure D-1. As used in this document, domestic safeguards will be referred to as material control and accounting (MC&A) consistent with NRC and DOE regulatory documentation, and IAEA safeguards as “safeguards” consistent with international convention. While the IAEA does provide *guidance* for security, actual *regulation* of security is the sole responsibility of the State (e.g., domestic). The NRC and DOE are responsible for regulating the security of U.S. nuclear facilities. The NRC for commercial owned nuclear facilities and the DOE for government owned facilities. In some cases, as with the Mixed Oxide Fuel Fabrication Facility under construction at the SRS, the facility will be owned by the government but commercially operated. As such, Mixed Oxide Fuel Fabrication Facility security will be a hybrid of NRC and DOE requirements.

As a signatory to the Nuclear Nonproliferation Treaty the U.S. has signed a Voluntary Safeguards Agreement with the IAEA stating that all commercial nuclear facilities in the U.S., not subject to national security exclusions, shall be eligible for IAEA safeguards monitoring. However, while a U.S.-located facility may be eligible for IAEA safeguards, the IAEA must make the final decision whether or not to actually monitor the facility. This decision is usually based on economics related to the best investment for the IAEA’s limited inspection funds, with the conclusion often being “not within a nuclear weapons State.” Unfortunately, these decisions involving eligibility based on national security and final selection based on available IAEA funding require significant time and effort. This time and effort do not bode well for safeguards and security by design, which needs to be implemented in the pre-conceptual design phase. Only waste forms with significant SNM are regulated by domestic MC&A and IAEA safeguards. However, the waste considered for this study, if not subject to domestic MC&A and IAEA safeguards, is still subject to domestic security regulation due to the radiation hazard.

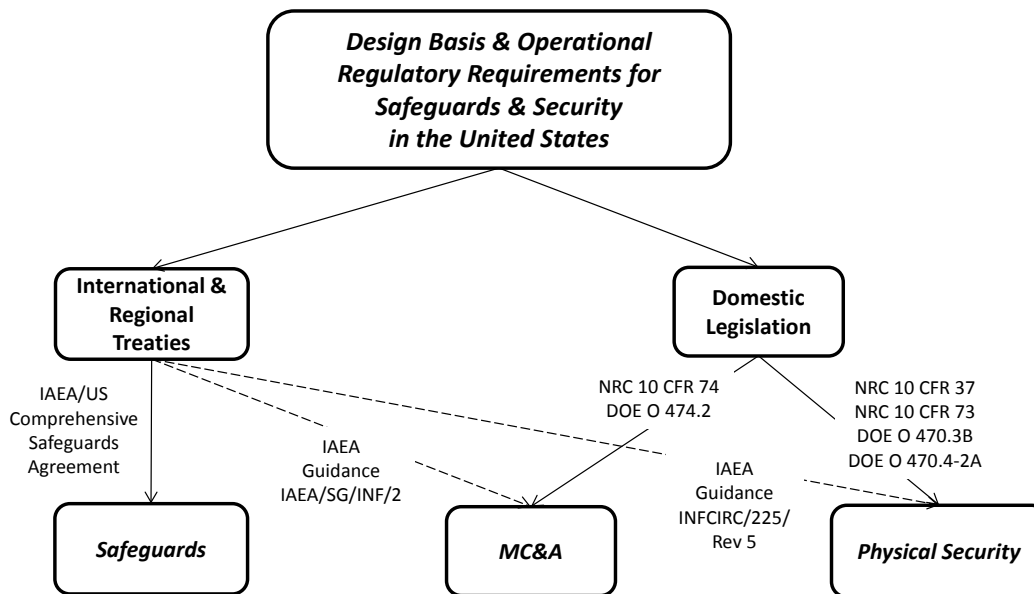

Figure D-1. Domestic and international responsibilities for regulating safeguards and security (example requirements)

Shown in Figure D-1, for each nuclear facility offered by the U.S. for IAEA safeguards and accepted by the IAEA for monitoring, a Comprehensive Safeguards Agreement will be developed that defines the specific requirements for IAEA monitoring. A decision by the U.S to offer a nuclear facility for IAEA safeguards is complex and involves a number of agencies including the DOE, NRC, State Department, and the Department of Defense, in order to assure national security is not compromised. The IAEA also offers guidance for domestic MC&A, specifically IAEA/SG/INF/2 (IAEA 1980) which describes objectives for the State System of Accounting and Control, for which the NRC has responsibilities in the U.S. Additionally, the IAEA provides guidance for domestic security, specifically INFCIRC/225/Rev. 5, once again for which the NRC has regulatory responsibility in the U.S. For commercial facilities and operations in the U.S., NRC regulations for MC&A are defined in 10 CFR Part 74, and NRC regulations for security in 10 CFR Part 73 for SNM and HLW, and 10 CFR Part 37 for radioactive materials other than SNM. For DOE owned and operated facilities and operations in the U.S., DOE requirements for MC&A are defined in DOE O 474.2, and DOE requirements for security in DOE O 470.4-2A for SNM and DOE O 470.3B for radioactive material such as HLW.

For safeguards and security; the transportation, packaging, and disposal facilities/operations are all addressed through the same set of requirements. For instance, NRC 10 CFR Part 74 (Material Control and Accounting of Special Nuclear Material) encompasses MC&A for transportation, packaging, and disposal. For security of SNM radioactive waste, 10 CFR Part 73 (Physical Protection of Plants and Materials) encompasses transportation, packaging, and disposal of SNM. For security of non-SNM radioactive waste, 10 CFR Part 37 (Physical Protection of Category 1 and Category 2 Quantities of Radioactive Material) encompasses transportation, packaging, and disposal. This same approach applies to DOE regulation. This is not to say that safeguards and security for transportation, packaging, and disposal are not discussed at some level in requirements not shown in Figure D-1; however, those shown in Figure D-1 are predominant. For example, the NRC provides requirements for general licensing of specific facility types and operations; however, these are more general than just for safeguards or security alone, and typically reference 10 CFR Parts 37, 73, and 74 for safeguards and security specifics. Examples of these more general NRC regulations include:

- 10 CFR Part 60: Disposal of High-Level Radioactive Waste in Geologic Repositories

- 10 CFR Part 61: Licensing Requirements for Land Disposal of Radioactive Waste
- 10 CFR Part 71: Packaging and Transportation of Radioactive Material
- 10 CFR Part 72: Licensing Requirements for the Independent Storage of Spent Nuclear Fuel and High-Level Radioactive Waste, and Reactor-Related Greater than Class C Waste

This same approach applies to DOE O 474.2 which encompasses MC&A of SNM, DOE O 470.4-2A for security of SNM, and DOE O 470.3B for security of non-SNM radioactive waste. Examples of more general yet applicable DOE regulations include:

- DOE O 435.1: Radioactive Waste Management
- DOE M 441.1-1: Nuclear Material Packaging Manual
- DOE M 460.2-1A: Radiation Material Transportation Practices Manual
- DOE P 470.1A: Safeguards and Security Program

Specific interest has been directed toward safeguards and security implications for the disposition of the cesium and strontium capsules currently located at the Hanford site. Two disposition paths have been identified:

1. Over-packing and disposal of the capsules in a geologic repository. This option would involve the following process steps:
 - Retrieve capsules from storage basins
 - Inspect capsules for integrity
 - Place capsules in a rack to support the capsule within the canister
 - Insert capsule into canister (three to four capsules placed in each canister)
 - Seal canister by welding closed
 - Decontaminate and inspect canisters
 - Overpack sealed canisters into multipurpose canisters
 - Place canisters into storage
 - Monitor and maintain canister

This option requires modifications and upgrade to the WESF. It also requires construction of interim storage. The major operational activities for this option would include the following:

- Remove capsules from wet storage
 - Operate packaging facility
 - Transport multipurpose canisters to on site storage pad and cover with shielding cask
 - Monitor multipurpose canisters in interim storage
 - Transport multipurpose canister to potential repository
2. Incorporating the isotopes into a glass or crystalline matrix for disposal in a geologic repository. This option would consist of vitrifying the capsules contents with tank waste which would involve retrieving the capsules from storage basins; transporting the capsules to the HLW facility in shielded transport casks; dismantling the capsules and removing the cesium and strontium salts; and blending the capsules contents into the HLW stream. This option requires additional modification and

construction within the Hanford HLW facility to accommodate capsule related activities. Operation for this option would be conducted in the HLW vitrification facility and WESF, and include the following:

- Continue storing the capsules in the WESF until all the capsules are removed
- Remove and truck transport the capsules to the Waste Treatment and Immobilization Plant in shielded transport casks
- Cut up the capsules and remove the contents
- Perform chemical processing on the capsules contents as required
- Blend the capsule contents into the vitrification feed stream by metering the dissolved cesium chloride in slurry containing strontium fluoride just before the waste enters the HLW melter
- Decontaminate and shred the empty capsule containers
- Dispose of the shredded capsules container materials as LLW
- Following vitrification, the HLW produced would be stored temporarily and then transported to the potential geologic repository

These capsules while currently under DOE regulation, would be considered NRC Category 1 radioactive material per NRC Table 1, “Category 1 and 2 Threshold,” of Appendix A to 10 CFR Part 37, for disposal in a NRC regulated facility, whether by disposition path Option 1 or Option 2.

In general, NRC MC&A and security requirements are more prescriptive than those provided in the DOE safeguards and security orders; however, requirements of both agencies are essentially performance-based. The IAEA has also indicated it would like to move in the direction of more performance-based requirements. IAEA safeguards responsibilities are somewhat different than domestic (NRC and DOE) such that a direct comparison of requirements can be problematic. For instance, domestic MC&A responsibilities include the “control” of nuclear material, whereas IAEA responsibilities do not include control. However, all (NRC, DOE, and IAEA) have responsibility for nuclear material accountancy. NRC and DOE MC&A and security requirements are both dependent upon categorization of material, although their determination of category level is not identical. DOE also relies on material attractiveness to assess MC&A and security requirements, while currently the NRC does not. The IAEA and NRC use an identical approach to determine category level for assessing safeguards and MC&A requirements, and similar to the NRC, the IAEA does not use material attractiveness.

Regarding future relevant NRC rulemaking, Rivers and Bukharin (2013), said:

“...their staff has worked over the last several years to identify an approach to capturing the concept of material attractiveness into its graded security requirements (similar to DOE). This has involved staff work, a technical study, and outreach to stakeholders. The staff’s current understanding is that the most useful attribute to consider, aside from self-protection, is the level of dilution. It is both measureable and correlated with the attractiveness of nuclear material to adversaries. The staff considers that the current categorization approach should be maintained. However, alternative security measures should be considered for varying levels of dilution, taking into account the bulkiness, heavy weight and lower attractiveness of the material.”

D-1.2 Safeguards and Security Metrics

An attempt has been made for this study to discuss metrics that are the basis of formal NRC and DOE requirements. However, the metrics discussed may be buried within terms such as “categories” and

“material attractiveness” in the actual regulatory documentation. Two metrics have been selected for safeguards and security, essentially one for each. Fissile content has been selected as a metric for safeguards, regardless of the “safeguards” being domestic MC&A more oriented toward nuclear material control, or international (IAEA) safeguards more oriented toward verification that the State does not divert nuclear material. The metric selected for security is risk of in-place sabotage of, or theft of, radioactive material. For this metric dose and dispersibility are the waste characteristics of interest. Radioactive dispersion devices are often thought of as the weapon of choice following theft.

NRC/IAEA—The IAEA and NRC use an identical approach to determine category level for assessing safeguards and MC&A objectives and requirements. The NRC also uses these same categories (NRC Appendix M to 10 CFR Part 110) for determining SNM security requirements. As shown in Table D-1, the amount of SNM (and enrichment in the case of uranium), and activity as described by footnote “d,” are NRC metrics for establishing MC&A requirements. Additionally, the NRC MC&A regulations in 10 CFR Part 74 note that Category IA is defined as direct use material; whereas, all others (IB, II and III) are not, indicating material purity, concentration, and form are also MC&A metrics in a limited sense. NRC regulations do not include the separation difficulty required to achieve improved SNM purity and concentration; however, this is a characteristic of “material attractiveness” used in the DOE regulations. Additionally, footnote “e” indicates that below certain quantities of SNM and uranium enrichment, security is not required; however, activity levels for HLW as specified in related NRC requirements (10 CFR Part 37) will dictate that security measures are taken. Also noted in Table D-2, NRC categorization is equal to IAEA categorization, as specified in INFCIRC/225 Rev. 1. Since publication of the NRC Appendix M to 10 CFR Part 110, INFCIRC/225 Rev. 1 has been updated to Rev 5, but this does not change the metrics selected for this study.

DOE—Shown in Table D-2 (DOE Graded Safeguards), DOE relies on both material attractiveness and categories to assess MC&A and security requirements. Consequently, the DOE approach for MC&A of SNM includes consideration of material attractiveness (which the NRC does not), which includes a component of separation difficulty required to achieve improved SNM purity and concentration. Similar to the approach used by the NRC, the Graded Safeguards also form the bases for DOE SNM security requirements. DOE security for HLW is defined in the classified Order 430.3B, and consequently is not discussed in this report. It is assumed DOE metrics for security of HLW are similar to those of the NRC.

Repository Specific—Two characteristics of the repository that could influence security measures are (1) ease of adversary access to the repository disposal pits or boreholes and (2) length of time that an adversary would have to access the disposal pits or boreholes, and are based upon known construction and operating differences. More specifically, an underground mined repository in soft media such as salt or clay may require vertical shaft access (contrary to vehicle access in granite media), to avoid tunnel collapse since the operating duration may be many decades. Additionally, access is significantly different between an underground mined repository and a borehole repository. Similarly, it is likely a borehole will be sealed upon filling; whereas, access to tunnels/shafts of an underground repository could be maintained for long periods of time.

Table D-1. NRC Appendix M to Part 110—Categorization of Nuclear Material^a

Material	Form	Category		
		I	II	III ^e
1. Plutonium ^b	Unirradiated ^c	2 kg or more	Less than 2 kg but more than 500 g	500 g or less
2. Uranium-235 ^d	Unirradiated: ^c Uranium enriched to 20% ²³⁵ U or more	5 kg or more	Less than 5 kg but more than 1 kg	1 kg or less
	Uranium enriched to 10% ²³⁵ U or more but less than 20%		10 kg or more	Less than 10 kg
	Uranium enriched above natural but less than 20% ²³⁵ U			10 kg or more
3. Uranium-233	Unirradiated ^c	2 kg or more	Less than 2 kg but more than 500 g	500 g or less

^a Irradiated fuel should be protected as category I, II, or III nuclear material depending on the category of the fresh fuel. However, fuel which by virtue of its original fissile material content is included as category I or II before irradiation should only be reduced one category level, while the radiation level from the fuel exceeds 100 rd/h at 1 m unshielded.

^b All plutonium except that with isotopic concentration exceeding 80% in ²³⁸Pu.

^c Material not irradiated in a reactor or material irradiated in a reactor but with a radiation level equal to or less than 100 rd/h at 1 m unshielded.

^d Natural uranium, depleted uranium, thorium, and quantities of uranium enriched to less than 10% not falling into Category III should be protected in accordance with prudent management practice.

^e Physical security determinations will not be required for 15 g or less of plutonium, ²³³U or HEU, or for 1 kg or less of uranium with an enrichment between 10% and 20% in ²³⁵U.

Source: IAEA 1999.

Table D-2. DOE Order 474.2, Graded Safeguards table

	Attractiveness Level	Pu/ ²³³ U Category (kg)				Contained ²³⁵ U / Separated ²³⁷ Np/ Separated ²⁴¹ Am and ²⁴³ Am Category (kg)				All E Materials Category IV
		I	II	III	IV ^a	I	II	III	IV ^a	
Weapons—Assembled weapons and devices	A	All	N/A	N/A	N/A	All	N/A	N/A	N/A	N/A
Pure Products—Pits, major components, button ingots, recastable metal, directly convertible materials	B	≥2	≥0.4<2	≥0.2<0.4	<0.2	≥5	≥1<5	≥0.4<1	<0.4	N/A
High-Grade Materials—Carbides, oxides, nitrates, solutions (≥25 g/L), etc.; fuel elements and assemblies; alloys and mixtures; UF ₄ or UF ₆ (≥50% enriched)	C	≥6	≥2<62	≥0.4<2	<0.4	≥20	≥6<20	≥2<6	<2	N/A
Low-Grade Materials—Solutions (1 to 25 g/L), process residues requiring extensive reprocessing; ²³⁸ Pu (except waste); UF ₄ or UF ₆ (≥20% <50% enriched)	D	N/A	≥16	≥3<16	<3	N/A	≥50	≥8<50	<8	N/A
All Other Materials—Highly irradiated ^c forms, solutions (<1 g/L), compounds; uranium containing <20% ²³⁵ U or <10% ²³³ U (any form, any quantity)	E	N/A	N/A	N/A	Reportable quantities	N/A	N/A	N/A	Reportable quantities	Reportable quantities

NOTES: ^aThe lower limit for Category IV is equal to reportable quantities in DOE O 474.2.

^bThe total quantity of ²³³U = (contained ²³³U – contained ²³⁵U). The category is determined by using the Pu/²³³U side of this table.

^c“highly irradiated” is defined in DOE O 474.2, Attachment 4.

Highly irradiated is material sufficiently radioactive to ensure a high probability of failure of task(s) by an adversary. The determination of high probability of failure of task(s) must be coordinated with site’s risk assessment and/or other assessments performed by the site.

Metrics Considerations for Safeguards and Security Criterion—Section 4 of this report defines the criteria and metrics for use in the evaluation. The criterion of safeguards and security is based on the relative difficulty in implementing safeguards and security for disposal options (candidate disposal concepts and waste form groups). In addition to assessing safeguards and security for the candidate disposal concepts, waste form transportation (from the originating waste site to the disposal facility) and packaging (for transportation and then again for disposal), are also considered. For example, waste forms containing SNM such as spent fuel, will require safeguards through the operating life of a repository and may even require minimal safeguards following closure, in addition to the standard safeguards and security employed throughout the process. Two metrics for this criterion are defined below.

National security implementation difficulty (fissile material content)—This metric is used to assess the need for additional domestic MC&A and international safeguards measures to ensure that there is minimal likelihood of material theft/diversion. This metric is a measure reflecting the fissile content and the related MC&A/safeguards implementation difficulty. This metric should be rated as

Minimal, Moderate, High

Radiological dispersion device (and sabotage) prevention implementation difficulty (dose/dispersal)—This metric is used to assess the need for additional security measures to ensure that there is minimal likelihood that materials could be sabotaged in-place or be taken (e.g., theft) for use in a dispersive device. This metric is a measure reflecting the dose and dispersal risks, and the related security implementation difficulty. This metric should be rated as

Minimal, Moderate, High

Example: Requirements for Storage of Cesium and Strontium Capsules—DOE-owned cesium and strontium capsules are stored under water at the WESF. The cesium/strontium material is in stainless steel capsules which are 2.6 in. in diameter and 20.8 in. long. Dose rates range from 8,600 to 18,000 rem/hr for the ¹³⁷Cs capsules, and 20 to 420 rem/hr for the ⁹⁰Sr capsules. These capsules do not contain significant quantities of SNM; and consequently, are not regulated for MC&A. Commercial radioactive sources are subject to NRC waste classification requirements defined in 10 CFR Part 61 (Part 61.55 addresses Waste Classification. This waste is classified as Class A, B and C and generally can be disposed of at commercial disposal facilities. Unfortunately, many of the radioactive sources (primarily category 1 and 2) are GTCC due to their relatively high radioactivity and cannot be disposed of in these facilities. The DOE is responsible for the disposal of GTCC low level radioactive waste, including sealed sources.

IAEA Nuclear Security Series Report No. 11 (IAEA 2009) discusses security concepts and provides some security recommendations for radioactive sources. Security levels are assigned to the different categories of sources, Table D-3 shows this relationship.

Table D-3. IAEA categories for radioactive sources

Category	Source description	A/D ^a	Security Level
1	Radioisotope thermoelectric generators (RTGs) Irradiators; teletherapy sources Fixed multibeam teletherapy (gamma knife) sources	A/D > 1000	A
2	Industrial gamma radiography sources High/medium dose rate brachytherapy sources	1000 > A/D > 10	B
3	Fixed industrial gauges that incorporate high activity sources; Well logging gauges	10 > A/D > 1	C

Note: ^a“A” represents the activity of the source while “D” represents the radionuclide specific activity of a source which, if not under control, could cause severe deterministic health effects.

The recommended measures for Security Level A are given in tabular form in Table D-4.

For facilities possessing the Code of Conduct Category 1 and 2 quantities of radioactive material, the NRC uses a deterministic approach and specifies protection requirements either through regulations or orders. DOE uses a deterministic approach employing both performance and compliance elements to establish protection requirements. Both the NRC and the DOE have graded regulatory approaches to safety and security for radioactive sources that consider potential radiation risks.

Table D-4. IAEA Security Level A: recommended objectives and measures

Security Function	Security Objective	Security Measures
Detect	Provide immediate detection of any unauthorized access to the secured area/source location.	Electronic intrusion detection system and/or continuous surveillance by operator personnel.
	Provide immediate detection of any attempted unauthorized removal of the source, including by an insider.	Electronic tamper detection equipment and/or continuous surveillance by operator personnel.
	Provide immediate assessment of detection.	Remote monitoring of CCTV or assessment by operator / response personnel.
	Provide immediate communication to response personnel.	Rapid, dependable, diverse means of communication such as phones, cell phones, pagers, radios.
	Provide a means to detect loss through verification.	Daily checking through physical checks, CCTV, tamper indicating devices, etc.
Delay	Provide delay after detection sufficient for response personnel to interrupt the unauthorized removal.	System of at least two layers of barriers (e.g., walls, cages) which together provide delay sufficient to enable response personnel to interdict
Response	Provide immediate response to assessed alarm with sufficient resources to interrupt and prevent the unauthorized removal.	Capability for immediate response with size, equipment, and training to interdict.
Security Management	Provide access controls to source location that effectively restrict access to authorized persons only.	Identification and verification, for example, lock controlled by swipe card reader and personal identification number, or key and key control.
	Ensure trustworthiness of authorized individuals.	Background checks for all personnel authorized for unescorted access to the source location and for access to sensitive information.
	Identify and protect sensitive information.	Procedures to identify sensitive information and protect it from unauthorized disclosure
	Provide a security plan.	A security plan which conforms to regulatory requirements and provides for response to increased threat levels.
	Ensure a capability to manage security events covered by security contingency plans.	Procedures for responding to security-related scenarios.
	Establish security event reporting system.	Procedures for timely reporting of security events.

NRC—The NRC and what are known as the Agreement States have regulatory programs to protect the public health and safety and the environment from the effects of radiation from radioactive material. The regulations impose requirements that licensees must meet to obtain and retain a license. The regulations govern the transport of materials, and the use and storage of materials. After September 11, 2001, the

NRC established a Materials Security Working Group to review existing regulations. In addition, the NRC reviewed their existing regulations regarding security and storage and issued some orders to close any gaps in security and safety. The NRC issued the “Order Imposing Increased Controls” to NRC licensees authorized to possess radioactive material in quantities of concern (parts of the order are sensitive and not publically releasable). Some of the increased controls include:

- Control access at all times to radioactive material quantities of concern (“RAMQC”) and limit access to such radioactive material only to approved individuals who require access to perform their duties. 10 CFR Part 20 provides the primary controls for radiation safety access.
- Only trustworthy and reliable individuals shall have unescorted access to radioactive material. Some guidelines were provided on verifying trustworthiness.
- Service providers shall be escorted at all times unless determined to be trustworthy.
- Establish a documented program to monitor and immediately detect, assess, and respond to unauthorized access to radioactive material quantities of concern. Enhanced monitoring shall be provided during periods of source delivery.
- Licensees shall respond immediately to any actual or attempted theft, sabotage or diversion of radioactive materials. The response shall include requesting assistance from a local law enforcement agency.
- The licensee shall have a pre-arranged plan with the local law enforcement agency for assistance.
- The licensee shall have a dependable means to transmit information between, and among, the various components used to detect, assess and respond.
- Individuals who have unescorted access to radioactive material quantities of concern or safeguards information will be fingerprinted.
- Additional measures about transportation were also mentioned:
 - Use shipment/package tracking system
 - Maintain constant control and/or surveillance during transit
 - Have capability for immediate communications to summon response or assistance. For highway shipments provides for a communications center.
 - Details on actual shipment
 - Background investigations.
- Protection requirements for information generated which describes physical protection of radioactive material quantities of concern.

The NRC also developed an implementation plan to address the issues raised by the Radiation Source Protection and Security Task Force Report (NRC 2012) and periodically reviews the identified areas.

In July 2011, the NRC issued, a policy statement concerning the protection of ¹³⁷Cs sources (76 FR 44378). This statement addresses the NRC’s policy regarding secure use of these sources. Some of the areas mentioned in this policy statement include:

- Acknowledgement that the Task Force Report addressed security of all radioactive sources but singled out some issues specific to cesium chloride sources.

- Disposal of cesium chloride is mentioned in the policy statement. The NRC recognizes that currently there is no disposal capability for commercial sources. The majority of the cesium chloride sources are classified as GTCC.
- Acknowledged the DOE activities related to an environmental impact statement for the disposal of GTCC low-level radioactive waste and GTCC-like waste (DOE 2011c).
- Current security requirements include
 - Access controls
 - Background checks for personnel
 - Monitoring, detecting and responding to unauthorized access
 - Delay
 - Advanced coordination with local law enforcement agencies
 - Tracking of transfers and shipments
 - Establishment of trustworthiness and reliability standards
 - New import/export licensing and reporting to the National Source Tracking System
 - The National Nuclear Security Administration has a voluntary program to retrofit existing cesium chloride irradiators with additional physical security enhancements.

The NRC has recently published 10 CFR Part 37, Physical Protection of Category 1 and Category 2 Quantities of Radioactive Material. This regulation establishes the requirements for the physical protection program for Category 1 and 2 quantity of radioactive material (listed in appendix). The document also includes definitions for relevant terms. Listed below are some of the specific requirements:

- Continuous physical barriers that allow access to the radioactive waste only through established access control points.
- Use a locked door or gate with monitored alarm at the access control point.
- Assess and respond to actual or attempted unauthorized access.
- Immediately notify the local law enforcement agency and request armed response upon determination that there was an actual or attempted theft, sabotage, or diversion of radioactive waste that contains Category 1 or 2 quantities of radioactive material.
- Ensure personnel allowed unescorted access to Category 1 and 2 quantities of radioactive material are trustworthy and reliable. Access authorization program for selected individuals.
- Personnel allowed unescorted access to Category 1 and 2 quantities of radioactive material will have a background investigation that includes fingerprinting, verification of true identity employment history verification, education verification, and character and reputation determination.
- A written security plan shall be developed.
- Individuals implementing the security plan are trained.
- Coordination with local law enforcement agencies.
- Establish security zones.

- Establish and maintain the capability to continuously monitor and detect without delay all unauthorized entries into security zones. Specific requirements are given for monitoring, detection, delay, communications, response.
- A maintenance and testing program will be implemented for security related systems and equipment.
- Additional physical protection measures in transit.
- Inspections will be performed to ensure material is protected.

D-2. References

10 CFR Part 74. Energy: Material Control and Accounting of Special Nuclear Material.

10 CFR Part 110. Energy: Export and Import of Nuclear Equipment and Material.

76 FR 44378, Nuclear Regulatory Commission: NRC-2010-0209, Policy Statement of the U.S. Nuclear Regulatory Commission on the Protection of Cesium-137 Chloride Sources.

DOE (U.S. Department of Energy) 2011c. *Draft Environmental Impact Statement for the Disposal of Greater-Than-Class-C (GTCC) Low-Level Radioactive Waste and GTCC-Like Waste*. DOE/EIS-0375-D. Washington, DC: U.S. Department of Energy.

DOE M 441.1-1. *Nuclear Material Packaging Manual*. Washington, DC: U.S. Department of Energy Office of Nuclear Safety and Environment.

DOE M 460.2-1A. *Radiation Material Transportation Practices Manual*. Washington, DC: U.S. Department of Energy Office of Environmental Management.

DOE O 435.1. *Radioactive Waste Management*. Washington, DC: U.S. Department of Energy Office of Environmental Management.

DOE O 470.4-2A. *Physical Protection*. Washington, DC: U.S. Department of Energy Office of Health, Safety and Security.

DOE O 470.3B. *Graded Security Protection (GSP) Policy*. Washington, DC: U.S. Department of Energy Office of Health, Safety and Security.

DOE O 474.2. *Nuclear Material Control and Accountability*. Washington, DC: U.S. Department of Energy Office of Health, Safety and Security.

DOE P 470.1A. *Safeguards and Security Program*. Washington, DC: U.S. Department of Energy Office of Health, Safety and Security.

IAEA (International Atomic Energy Agency) 1980. *Guidelines for States' Systems of Accounting for and Control of Nuclear Materials*. IAEA/SG/INF/2. Vienna, Austria: International Atomic Energy Agency.

IAEA 1999. *The Physical Protection of Nuclear Material and Nuclear Facilities*. INFCIRC/225/Rev. 4. Vienna, Austria: International Atomic Energy Agency.

IAEA 2009. *Security of Radioactive Sources*. IAEA Nuclear Security Series No. 11. Vienna, Austria: International Atomic Energy Agency.

NRC (U.S. Nuclear Regulatory Commission) 2012. *U.S. Nuclear Regulatory Commission Implementation Plan for the Radiation Source Protection and Security Task Force Report*. Washington, DC: U.S. Nuclear Regulatory Commission.

Rivers, J. and O. Bukharin 2013. “U.S. Nuclear Regulatory Commission Staff’s Approach to Incorporate the Attractiveness of Nuclear Material to Adversaries into Its Graded Approach to Security,” Paper 332. IAEA International Conference on Nuclear Security: Enhancing Global Efforts, Vienna, Austria, 1–5 July 2013.

Appendix E

Output Tabulations

Table E-1. Evaluation results for WG1

WG1		Disposal Concept			
		Salt	Crystalline Repository	Clay/Shale	Deep Borehole
Disposal Option Performance	Likely to meet expected health and safety needs	yes	yes	yes	yes
	Attributes of disposal option	Pros: Thermal conductivity will allow for higher thermal density. Disposal containers can be designed for the repository environment.	Pros: Have disposal containers designed for the repository environment. Cons: Lower thermal conductivity than salt.	Pros: Have disposal container designed for the repository environment. May not need separate backfill.	Pros: Have disposal container designed for the repository environment. Thermal conductivity is not an issue. Cons: Limited to very small packages.
Confidence in Expected Performance Bases	Additional EBS Considerations (compared to disposal of commercial SNF and HLW glass)	None	None	None	None
	Robustness/Confidence in Information Bases (simplicity vs. complexity, difficulty in generating confidence, site-specific vs. generic vs. qualitative; significant knowledge gaps)	Pros: Low permeability, reducing environment. Cons: Gaps in knowledge of response to high thermal loads; greater need for site-specific information than other disposal concepts. green	Pros: Lots of world-wide experience with this geologic medium. green	Pros: Lots of world-wide experience with this geologic medium. green	Cons: No demonstration of the concept. yellow
Operational Feasibility	Ease in ensuring worker health and safety (from waste form generation through disposal)	Cons: Some waste must be repackaged. yellow.	Cons: Some waste must be repackaged. yellow.	Cons: Some waste must be repackaged. yellow.	Cons: Some waste must be repackaged and consolidated. purple
	Special physical considerations (storage, transportation, disposal volume, handling of packages) based on physical characteristics.	Cons: Packages could be difficult to retrieve. green	Pros: Could be relatively easy to retrieve packages. Cons: Might have to emplace backfill after the ventilation period. green	Pros: Could be relatively easy to retrieve packages. green	Cons: Potentially more challenging to retrieve. Calls for the most repackaging and consolidation. yellow
Secondary Waste Generation	Low-level waste generated?	Cons: Significant amounts of LLW generated in the repackaging process. purple	Cons: Significant amounts of LLW generated in the repackaging process. purple	Cons: Significant amounts of LLW generated in the repackaging process. purple	Cons: Significant amounts of LLW generated in the repackaging process. purple
	Mixed waste generated?	minimal green	minimal green	minimal green	minimal green
System-Level Cost	Differential Cost Considerations	Cost is shifted from subsurface to surface for repackaging. This WG assumes repackaging does not occur at the reactor. There would be a cost differential if repackaging were to occur at the reactor.	Cost is shifted from subsurface to surface for repackaging. More packages because of thermal conductivity. More expensive than salt.	Cost is shifted from subsurface to surface for repackaging. This WG assumes repackaging does not occur at the reactor. There would be a cost differential if repackaging were to occur at the reactor. More packages because of thermal conductivity. More expensive than salt.	Cost is shifted from subsurface to surface for repackaging and consolidation. Package material would be cheaper. Many more packages because of small size of package. High uncertainty in cost estimation. This WG assumes repackaging does not occur at the reactor. There would be a cost differential if repackaging were to occur at the reactor.
Technical Readiness	Status of needed waste form generation technology	ready green	ready green	ready green	Cons: Rod consolidation technology needed. yellow
	Status of needed transportation and waste handling systems	ready green	ready green	ready green	ready green
	Status of needed disposal concept technologies	ready green	ready green	ready green	Cons: Not yet fully designed or demonstrated yellow
Safeguards and Security	National Security Implementation Cost and Difficulty (fissile content)	Changes in self-protection limits may change the indicator for this metric. green	Changes in self-protection limits may change the indicator for this metric. green	Changes in self-protection limits may change the indicator for this metric. green	Cons: More small waste packages for MC&A/safeguards. green
	Radiological Dispersion Device Prevention cost and difficulty (dose/dispersion)	green	green	green	Cons: Higher risk due to bare fuel rods and numerous small waste packages yellow
Programmatic and Regulatory Considerations	Consent-based siting considerations	Pros: Have a lot of operational experience in salt. Having repackaging away from the reactor site creates jobs at the repackaging site. There are many salt sites across the country.	Pros: Have international experience in crystalline rock. Having repackaging away from the reactor site creates jobs at the repackaging site. There are many crystalline sites across the country.	Pros: Have international experience in clay/shale rock. Having repackaging away from the reactor site creates jobs at the repackaging site. There are many clay/shale sites across the country.	Pros: Having repackaging away from the reactor site creates jobs at the repackaging site. There are many possible geologic sites around the country. Cons: No operational experience. Would take a lot of real estate.
	Regulatory considerations				Current regulations did not contemplate deep borehole disposal. Possible underground injection control issues.

Table E-2. Evaluation results for WG2

WG2		Disposal Concept			
		Salt	Crystalline Repository	Clay/Shale	Deep Borehole
Disposal Option Performance	Likely to meet expected health and safety needs	yes green	yes green	yes green	
	Attributes of disposal option	Pros: High thermal conductivity allows for high thermal density. Purpose-built overpack will be used. Cons: Challenge to seal the large shaft(s) or ramp(s). Fact that DPCs were not designed for disposal is not as important.	Pros: Purpose-built overpack will be used. Cons: Lower thermal conductivity than salt. High thermal load complicates reliance on bentonite.	Pros: Purpose-built overpack will be used. Cons: Lower thermal conductivity than salt.	
Confidence in Expected Performance Bases	Additional EBS Considerations (compared to disposal of commercial SNF and HLW glass)	May need to consider adding EBS components to address criticality control. green	May need to consider adding EBS components to address criticality control. green	May need to consider adding EBS components to address criticality control. green	
	Robustness/Confidence in Information Bases (simplicity vs. complexity, difficulty in generating confidence, site-specific vs. generic vs. qualitative; significant knowledge gaps)	Pros: Cons: Knowledge gaps regarding the behavior of salt under high thermal loads. yellow	Cons: Unproven overpack performance, lack modeling experience, analysis. purple	Pros: Can rely on far near-field more than in crystalline. Cons: Lack of modeling experience. yellow	
Operational Feasibility	Ease in ensuring worker health and safety (from waste form generation through disposal)	Pros: Repackaging not required. green	Pros: Repackaging not required. green	Pros: Repackaging not required. green	
	Special physical considerations (storage, transportation, disposal volume, handling of packages) based on physical characteristics.	Cons: Challenges with keeping shafts and ramps open. Conveyance options not yet developed. Challenges with retrieval during preclosure. purple	Cons: Conveyance options not yet developed. yellow	Cons: Challenges with keeping emplacement openings, shafts, and ramps open for the necessary time scales for ventilation. Conveyance options not yet developed. Challenges with retrieval during preclosure. purple	Can't be done. Red
Secondary Waste Generation	Low-level waste generated?	Pros: Minimal waste generated green	Pros: Minimal waste generated green	Pros: Minimal waste generated green	
	Mixed waste generated?	Pros: Minimal mixed waste generated. green	Pros: Minimal mixed waste generated. green	Pros: Minimal mixed waste generated. green	
System-Level Cost	Differential Cost Considerations	Additional costs for facilities to handle very large packages. Additional costs for needed thermal management. Saves costs for not repackaging.	Additional costs for facilities to handle very large packages. Additional costs for needed thermal management. Saves costs for not repackaging.	Additional costs for facilities to handle very large packages. Additional costs for needed thermal management. Saves costs for not repackaging.	
Technical Readiness	Status of needed waste form generation technology	Cons: May (or may not) need to construct very large purpose-built overpacks. Needed technology in-process. yellow	Cons: Need to construct very large purpose-built overpacks. Needed technology in-process. yellow	Cons: Need to construct very large purpose-built overpacks. Needed technology in-process. yellow	
	Status of needed transportation and waste handling systems	Conveyance systems considered under operational feasibility) Pros: Transportation occurs in certified containers and no further waste handling is required. green	Conveyance systems considered under operational feasibility) Pros: Transportation occurs in certified containers and no further waste handling is required. green	Conveyance systems considered under operational feasibility) Pros: Transportation occurs in certified containers and no further waste handling is required. green	
	Status of needed disposal concept technologies	Not ready but don't foresee show stoppers. yellow	Not ready but don't foresee show stoppers. yellow	Not ready but don't foresee show stoppers. yellow	
Safeguards and Security	National Security Implementation Cost and Difficulty (fissile content)	Changes in self-protection limits may change the indicator for this metric. green	Changes in self-protection limits may change the indicator for this metric. green	Changes in self-protection limits may change the indicator for this metric. green	
	Radiological Dispersion Device Prevention cost and difficulty (dose/dispersion)	green	green	green	
Programmatic and Regulatory Considerations	Consent-based siting considerations	Cons: Direct disposal of DPCs requires fewer employees because no repackaging. Constrains option space in terms of suitable sites.	Cons: Direct disposal of DPCs requires fewer employees because no repackaging. Constrains option space in terms of suitable sites.	Cons: Direct disposal of DPCs requires fewer employees because no repackaging. Constrains option space in terms of suitable sites.	
	Regulatory considerations	Open regulatory issues associated with criticality screening.	Open regulatory issues associated with criticality screening.	Open regulatory issues associated with criticality screening.	

Table E-3. Evaluation results for WG3

WG3		Disposal Concept			
		Salt	Crystalline Repository	Clay/Shale	Deep Borehole
Disposal Option Performance	Likely to meet expected health and safety needs	yes green	yes green	yes green	yes green
	Attributes of disposal option	Pros: Can pack the canisters densely because the waste is not as hot as SNF.	Pros: Can pack the canisters densely because the waste is not as hot as SNF.	Pros: Can pack the canisters densely because the waste is not as hot as SNF.	Pros: Smaller glass logs would cool faster and would have better properties.
Confidence in Expected Performance Bases	Additional EBS Considerations (compared to disposal of commercial SNF and HLW glass)	none	none	none	none
	Robustness/Confidence in Information Bases (simplicity vs. complexity, difficulty in generating confidence, site-specific vs. generic vs. qualitative; significant knowledge gaps)	green	green	green	Cons: No demonstration of the concept. yellow
Operational Feasibility	Ease in ensuring worker health and safety (from waste form generation through disposal)	green	green	green	green
	Special physical considerations (storage, transportation, disposal volume, handling of packages) based on physical characteristics.	green	green	green	Cons: Would need to handle at least four times as many canisters as the larger HLW canisters. yellow Can dispose of only projected HLW glass, which would have to be poured into canisters specifically designed for deep boreholes, although existing FRG canisters might be able to be disposed of. red
Secondary Waste Generation	Low-level waste generated?	The LLW streams that will be generated by making glass are already accounted for. green	The LLW streams that will be generated by making glass are already accounted for. green	The LLW streams that will be generated by making glass are already accounted for. green	The LLW streams that will be generated by making glass are already accounted for. green
	Mixed waste generated?	The low-activity waste generated is WIR and is a mixed waste and is already accounted for. green	The low-activity waste generated is WIR and is a mixed waste and is already accounted for. green	The low-activity waste generated is WIR and is a mixed waste and is already accounted for. green	The low-activity waste generated is WIR and is a mixed waste and is already accounted for. green
System-Level Cost	Differential Cost Considerations	There may be a fraction of Hanford tank waste that is not managed as HLW glass. Cs/Sr capsules and calcine waste may also not be vitrified.	There may be a fraction of Hanford tank waste that is not managed as HLW glass. Cs/Sr capsules and calcine waste may also not be vitrified.	There may be a fraction of Hanford tank waste that is not managed as HLW glass. Cs/Sr capsules and calcine waste may also not be vitrified.	There may be a fraction of Hanford tank waste that is not managed as HLW glass. Cs/Sr capsules and calcine waste may also not be vitrified. Larger costs incurred because of the need to re-design treatment facilities.
Technical Readiness	Status of needed waste form generation technology	Vitrification complete at West Valley, ongoing at SRS, and technical challenges being addressed at Hanford. yellow	Vitrification complete at West Valley, ongoing at SRS, and technical challenges being addressed at Hanford. yellow	Vitrification complete at West Valley, ongoing at SRS, and technical challenges being addressed at Hanford. yellow	Cons: Would have to re-design the treatment plant(s). purple
	Status of needed transportation and waste handling systems	Transportation casks have not been developed but no significant technical challenges expected. green	Transportation casks have not been developed but no significant technical challenges expected. green	Transportation casks have not been developed but no significant technical challenges expected. green	Transportation casks have not been developed but no significant technical challenges expected. green
	Status of needed disposal concept technologies	Ready green	Ready green	Ready green	Cons: Not yet fully designed or demonstrated yellow
Safeguards and Security	National Security Implementation Cost and Difficulty (fissile content)	green	green	green	green
	Radiological Dispersion Device Prevention cost and difficulty (dose/dispersion)	green	green	green	green
Programmatic and Regulatory Considerations	Consent-based siting considerations				
	Regulatory considerations	Possible RCRA issues.	Possible RCRA issues.	Possible RCRA issues.	Possible RCRA issues.

Table E-4. Evaluation results for WG4

WG4		Disposal Concept			
		Salt	Crystalline Repository	Clay/Shale	Deep Borehole
Disposal Option Performance	Likely to meet expected health and safety needs	yes green	yes green	yes green	yes green
	Attributes of disposal option	Pros: Can pack the canisters densely because the waste is not as hot as SNF. Can dispose of a variety of waste package sizes and types (except for jumbo).	Pros: Can pack the canisters densely because the waste is not as hot as SNF.	Pros: Can pack the canisters densely because the waste is not as hot as SNF.	Pros: Can optimize the waste form size for the borehole because they are not yet made (except for one metal ingot).
Confidence in Expected Performance Bases	Additional EBS Considerations (compared to disposal of commercial SNF and HLW glass)	none green	none green	none green	none green
	Robustness/Confidence in Information Bases (simplicity vs. complexity, difficulty in generating confidence, site-specific vs. generic vs. qualitative; significant knowledge gaps)	Pros: Because there is less reliance on waste form performance, it is easier to have confidence in the option. green	Cons: In the absence of waste form performance information, we would rely on waste package performance. Would have to consider galvanic coupling between the metal waste form and its packaging. yellow	Pros: Because there is less reliance on waste form performance, it is easier to have confidence in the option. green	Pros: Because there is less reliance on waste form performance, it is easier to have confidence in the option. Cons: Not designed or demonstrated. yellow
Operational Feasibility	Ease in ensuring worker health and safety (from waste form generation through disposal)	Assumes sodium-bonded fuel and calcine waste are treated, which requires additional effort to protect worker health and safety. green	Assumes sodium-bonded fuel and calcine waste are treated, which requires additional effort to protect worker health and safety. green	Assumes sodium-bonded fuel and calcine waste are treated, which requires additional effort to protect worker health and safety. green	Assumes sodium-bonded fuel and calcine waste are treated, which requires additional effort to protect worker health and safety. green
	Special physical considerations (storage, transportation, disposal volume, handling of packages) based on physical characteristics.	green	green	green	green
Secondary Waste Generation	Low-level waste generated?	Cons: A moderate amount of waste is generated. yellow	Cons: A moderate amount of waste is generated. yellow	Cons: A moderate amount of waste is generated. yellow	Cons: A moderate amount of waste is generated. yellow
	Mixed waste generated?	Cons: A moderate amount of mixed waste is generated. yellow	Cons: A moderate amount of mixed waste is generated. yellow	Cons: A moderate amount of mixed waste is generated. yellow	Cons: A moderate amount of mixed waste is generated. yellow
System-Level Cost	Differential Cost Considerations	Differential cost between treating these waste and disposing of them directly.	Differential cost between treating these waste and disposing of them directly.	Differential cost between treating these waste and disposing of them directly.	Differential cost between treating these waste and disposing of them directly.
Technical Readiness	Status of needed waste form generation technology	Waste form generation technologies for HIP processing are in process. The sodium-bonded fuel treatment process has already been done, at least for the metal waste form. Glass-bonded sodalite has not been produced at scale. yellow	Waste form generation technologies for HIP processing are in process. The sodium-bonded fuel treatment process has already been done, at least for the metal waste form. Glass-bonded sodalite has not been produced at scale. yellow	Waste form generation technologies for HIP processing are in process. The sodium-bonded fuel treatment process has already been done, at least for the metal waste form. Glass-bonded sodalite has not been produced at scale. yellow	Waste form generation technologies for HIP processing are in process. The sodium-bonded fuel treatment process has already been done, at least for the metal waste form. Glass-bonded sodalite has not been produced at scale. yellow
	Status of needed transportation and waste handling systems	Transportation casks have not been developed but no significant technical challenges expected. green	Transportation casks have not been developed but no significant technical challenges expected. green	Transportation casks have not been developed but no significant technical challenges expected. green	Transportation casks have not been developed but no significant technical challenges expected. green
	Status of needed disposal concept technologies	Ready green	Ready green	Ready green	Cons: Not yet fully designed or demonstrated yellow
Safeguards and Security	National Security Implementation Cost and Difficulty (fissile content)	Note: Fissile content should be no greater than SNF, and may be significantly less for some types. green	Note: Fissile content should be no greater than SNF, and may be significantly less for some types. green	Note: Fissile content should be no greater than SNF, and may be significantly less for some types. green	Note: Fissile content should be no greater than SNF, and may be significantly less for some types. green
	Radiological Dispersion Device Prevention cost and difficulty (dose/dispersion)	Note: Dose and dispersion should be no greater than SNF green	Note: Dose and dispersion should be no greater than SNF green	Note: Dose and dispersion should be no greater than SNF green	Note: Dose and dispersion should be no greater than SNF green
Programmatic and Regulatory Considerations	Consent-based siting considerations				
	Regulatory considerations	RCRA issues for HIP waste, worse for the waste without additives because it will still be characteristically hazardous.	RCRA issues for HIP waste, worse for the waste without additives because it will still be characteristically hazardous.	RCRA issues for HIP waste, worse for the waste without additives because it will still be characteristically hazardous.	RCRA issues for HIP waste, worse for the waste without additives because it will still be characteristically hazardous.

Table E-5. Evaluation results for WG5

WG5		Disposal Concept			
		Salt	Crystalline Repository	Clay/Shale	Deep Borehole
Disposal Option Performance	Likely to meet expected health and safety needs	yes green	yes green	yes green	yes green
	Attributes of disposal option	Pros: Criticality is less of a concern for this disposal concept because of the relative lack of water and the high cross-section of chlorine for capture of thermal neutrons.			Targets and smaller waste types would be a great candidate for this disposal concept.
Confidence in Expected Performance Bases	Additional EBS Considerations (compared to disposal of commercial SNF and HLW glass)	none green	none green	none green	none green
	Robustness/Confidence in Information Bases (simplicity vs. complexity, difficulty in generating confidence, site-specific vs. generic vs. qualitative; significant knowledge gaps)	Pros: Because there is less reliance on waste form performance, it is easier to have confidence in the option. green	Cons: In the absence of waste form performance information, we would rely on waste package performance. Would have to consider galvanic coupling between the metal waste form and its packaging. Issues with criticality control of HEU need to be addressed. yellow	Pros: Because there is less reliance on waste form performance, it is easier to have confidence in the option. green	Pros: Less reliance on waste form performance in a borehole. Cons: Not designed or demonstrated yet. yellow
Operational Feasibility	Ease in ensuring worker health and safety (from waste form generation through disposal)	green	green	green	green
	Special physical considerations (storage, transportation, disposal volume, handling of packages) based on physical characteristics.	Transportation of this waste is problematic, possibly because of some characteristics of the fuel itself. yellow	Transportation of this waste is problematic, possibly because of some characteristics of the fuel itself. yellow	Transportation of this waste is problematic, possibly because of some characteristics of the fuel itself. yellow	Transportation of this waste is likely not difficult because the problematic waste won't fit in boreholes. green Limited amount of this waste form group could be put in deep boreholes because of size restrictions. N Reactor MCOs can't be disposed of this way, nor can some of the DOE SNF (e.g., High-Flux Isotope Reactor waste in DOE SNF group 16). red
Secondary Waste Generation	Low-level waste generated?	minimal green	minimal green	minimal green	minimal green
	Mixed waste generated?	minimal green	minimal green	minimal green	minimal green
System-Level Cost	Differential Cost Considerations				
Technical Readiness	Status of needed waste form generation technology	Neutron absorbers in the waste form need to be evaluated. green	Neutron absorbers in the waste form need to be evaluated. green	Neutron absorbers in the waste form need to be evaluated. green	green
	Status of needed transportation and waste handling systems	yellow	yellow	yellow	green
	Status of needed disposal concept technologies	ready green	ready green	ready green	Cons: Not yet fully designed or demonstrated yellow
Safeguards and Security	National Security Implementation Cost and Difficulty (fissile content)	Note: For some waste types fuel has high fissile content requiring increased MC&A/safeguards. green	Note: For some waste types fuel has high fissile content requiring increased MC&A/safeguards. green	Note: For some waste types fuel has high fissile content requiring increased MC&A/safeguards. green	Note: For some waste types fuel has high fissile content requiring increased MC&A/safeguards. green
	Radiological Dispersion Device Prevention cost and difficulty (dose/dispersion)	Note: Metal fuels are less dispersible than oxide SNF. green	Note: Metal fuels are less dispersible than oxide SNF. green	Note: Metal fuels are less dispersible than oxide SNF. green	Note: Metal fuels are less dispersible than oxide SNF. green
Programmatic and Regulatory Considerations	Consent-based siting considerations				
	Regulatory considerations	Criticality analysis has not yet been performed for all wastes.	Criticality analysis has not yet been performed for all wastes.	Criticality analysis has not yet been performed for all wastes.	Criticality analysis has not yet been performed for all wastes.

Table E-6. Evaluation results for WG6

WG6		Disposal Concept			
		Salt	Crystalline Repository	Clay/Shale	Deep Borehole
Disposal Option Performance	Likely to meet expected health and safety needs				
	Attributes of disposal option				
Confidence in Expected Performance Bases	Additional EBS Considerations (compared to disposal of commercial SNF and HLW glass)				
	Robustness/Confidence in Information Bases (simplicity vs. complexity, difficulty in generating confidence, site-specific vs. generic vs. qualitative; significant knowledge gaps)	Not enough information to know whether it can be disposed of safely. purple	Not enough information to know whether it can be disposed of safely. purple	Not enough information to know whether it can be disposed of safely. purple	Not enough information to know whether it can be disposed of safely. purple
Operational Feasibility	Ease in ensuring worker health and safety (from waste form generation through disposal)				
	Special physical considerations (storage, transportation, disposal volume, handling of packages) based on physical characteristics.				
Secondary Waste Generation	Low-level waste generated?				
	Mixed waste generated?				
System-Level Cost	Differential Cost Considerations	If this waste were to be treated such that the fuel was left intact but the sodium removed, then this would be in WG5. Treatment costs would have to be considered if disposal of this waste is not feasible.	If this waste were to be treated such that the fuel was left intact but the sodium removed, then this would be in WG5. Treatment costs would have to be considered if disposal of this waste is not feasible.	If this waste were to be treated such that the fuel was left intact but the sodium removed, then this would be in WG5. Treatment costs would have to be considered if disposal of this waste is not feasible.	If this waste were to be treated such that the fuel was left intact but the sodium removed, then this would be in WG5. Treatment costs would have to be considered if disposal of this waste is not feasible.
Technical Readiness	Status of needed waste form generation technology				
	Status of needed transportation and waste handling systems				
	Status of needed disposal concept technologies				
Safeguards and Security	National Security Implementation Cost and Difficulty (fissile content)	Note: For some waste types fuel has high fissile content requiring increased MC&A/safeguards. green	Note: For some waste types fuel has high fissile content requiring increased MC&A/safeguards. green	Note: For some waste types fuel has high fissile content requiring increased MC&A/safeguards. green	Note: For some waste types fuel has high fissile content requiring increased MC&A/safeguards. green
	Radiological Dispersion Device Prevention cost and difficulty (dose/dispersion)	Note: Metal fuels are less dispersible than oxide SNF. green	Note: Metal fuels are less dispersible than oxide SNF. green	Note: Metal fuels are less dispersible than oxide SNF. green	Note: Metal fuels are less dispersible than oxide SNF. green
Programmatic and Regulatory Considerations	Consent-based siting considerations				
	Regulatory considerations				

Table E-7. Evaluation results for WG7

WG7		Disposal Concept			
		Salt	Crystalline Repository	Clay/Shale	Deep Borehole
Disposal Option Performance	Likely to meet expected health and safety needs	yes green	yes green	yes green	yes green
	Attributes of disposal option	Pros: Thermal conductivity will allow for higher thermal density. Disposal containers can be designed for the repository environment.	Pros: Have disposal containers designed for the repository environment. Cons: Lower thermal conductivity than salt.	Pros: Have disposal container designed for the repository environment. May not need separate backfill.	Pros: Have disposal container designed for the repository environment. Thermal conductivity is not an issue.
Confidence in Expected Performance Bases	Additional EBS Considerations (compared to disposal of commercial SNF and HLW glass)	None	None	None	None
	Robustness/Confidence in Information Bases (simplicity vs. complexity, difficulty in generating confidence, site-specific vs. generic vs. qualitative; significant knowledge gaps)	Pros: Low permeability, reducing environment. Cons: Gaps in knowledge of response to high thermal loads; greater need for site-specific information than other disposal concepts. green	Pros: Lots of world-wide experience with this geologic medium. green	Pros: Lots of world-wide experience with this geologic medium. green	Cons: No demonstration of the concept. yellow
Operational Feasibility	Ease in ensuring worker health and safety (from waste form generation through disposal)	A small amount of waste has already been packaged. The rest must be packaged. green	A small amount of waste has already been packaged. The rest must be packaged. green	A small amount of waste has already been packaged. The rest must be packaged. green	Cons: Some waste must be repackaged and consolidated. purple
	Special physical considerations (storage, transportation, disposal volume, handling of packages) based on physical characteristics.	Cons: Packages could be difficult to retrieve. Already packaged waste would have to be repackaged for transport. green	Pros: Could be relatively easy to retrieve packages. Cons: Might have to emplace backfill after the ventilation period. green	Pros: Could be relatively easy to retrieve packages. green	Cons: Potentially more challenging to retrieve. Calls for the most repackaging and consolidation. yellow
Secondary Waste Generation	Low-level waste generated?	Insignificant amount of LLW generated in repackaging. green	Insignificant amount of LLW generated in repackaging. green	Insignificant amount of LLW generated in repackaging. green	LLW generated in the repackaging process. yellow
	Mixed waste generated?	minimal green	minimal green	minimal green	minimal green
System-Level Cost	Differential Cost Considerations	Salt is probably cheaper than crystalline rock; can have higher thermal density so don't need as many packages. Cost is shifted from subsurface to surface for repackaging. green			Repackaging of already packaged fuel to put in a deep borehole incurs additional cost.
Technical Readiness	Status of needed waste form generation technology	ready green	ready green	ready green	Cons: Rod consolidation yellow
	Status of needed transportation and waste handling systems	ready green	ready green	ready green	ready green
	Status of needed disposal concept technologies	ready green	ready green	ready green	Cons: Not yet fully designed or demonstrated yellow
Safeguards and Security	National Security Implementation Cost and Difficulty (fissile content)	Note: For some waste types fuel has high fissile content requiring increased MC&A/safeguards. green	Note: For some waste types fuel has high fissile content requiring increased MC&A/safeguards. green	Note: For some waste types fuel has high fissile content requiring increased MC&A/safeguards. green	Note: For some waste types fuel has high fissile content requiring increased MC&A/safeguards. green
	Radiological Dispersion Device Prevention cost and difficulty (dose/dispersion)	green	green	green	Note: Oxides are more dispersible than metal (see WG6). Cons: Higher risk due to bare fuel rods and numerous small waste packages yellow
Programmatic and Regulatory Considerations	Consent-based siting considerations				
	Regulatory considerations				

Table E-8. Evaluation results for WG8

WG8		Disposal Concept			
		Salt	Crystalline Repository	Clay/Shale	Deep Borehole
Disposal Option Performance	Likely to meet expected health and safety needs	yes green	yes green	yes green	yes green
	Attributes of disposal option	Pros: For this waste form group, the limited far-field transport in salt is important. The high degree of isolation of each package from another that is possible is also important.	Pros: Would be relatively easy to spread out the cesium/strontium capsules to avoid thermal issues, assuming they are packaged accordingly. Cons: Possibility of plutonium colloids from the salt waste from the reprocessing of sodium-bonded fuel. Transport in a fracture network is a concern.	Pros: For this waste form group, the limited far-field transport in clay/shale is important. The high degree of isolation of each package from another that is possible is also important.	Pros: These wastes would fit easily in boreholes. Extreme degree of isolation. No reliance on waste package performance.
Confidence in Expected Performance Bases	Additional EBS Considerations (compared to disposal of commercial SNF and HLW glass)	none green	Cons: Because of corrosive chemical components in this waste (e.g., halides), would want to separate the wastes in this group from the wastes in other waste forms groups if disposed of in the same repository. Separation distances need not be great, just sufficient. yellow	Cons: Because of corrosive chemical components in this waste (e.g., halides), would want to separate the wastes in this group from the wastes in other waste forms groups if disposed of in the same repository. Separation distances need not be great, just sufficient. Separation distances less in clay/shale than in crystalline rock. green	none green
	Robustness/Confidence in Information Bases (simplicity vs. complexity, difficulty in generating confidence, site-specific vs. generic vs. qualitative; significant knowledge gaps)	Pros: Because there is less reliance on waste form and waste package performance, it is easier to have confidence in the option. green	Cons: More information needed with regard to transport of these wastes in a crystalline media because of the possibility of colloid transport and the short waste form lifetime. yellow	Pros: Because there is less reliance on waste form performance, it is easier to have confidence in the option. green	Cons: Lack of design and demonstration. yellow
Operational Feasibility	Ease in ensuring worker health and safety (from waste form generation through disposal)	Pros: Avoid potential worker dose resulting from treating these wastes for disposal. Cons: These have respirable fines that would have to be managed during transport and disposal. However, this is a concern only in a low-probability accident event. green	Pros: Avoid potential worker dose resulting from treating these wastes for disposal. Cons: These have respirable fines that would have to be managed during transport and disposal. However, this is a concern only in a low-probability accident event. green	Pros: Avoid potential worker dose resulting from treating these wastes for disposal. Cons: These have respirable fines that would have to be managed during transport and disposal. However, this is a concern only in a low-probability accident event. green	Pros: Avoid potential worker dose resulting from treating these wastes for disposal. Cons: These have respirable fines that would have to be managed during transport and disposal. However, this is a concern only in a low-probability accident event. green
	Special physical considerations (storage, transportation, disposal volume, handling of packages) based on physical characteristics.	Cons: May need special equipment for transporting respirable fines. yellow	Cons: May need special equipment for transporting respirable fines. yellow	Cons: May need special equipment for transporting respirable fines. yellow	Cons: May need special equipment for transporting respirable fines. Surface handling and storage concepts need further consideration because surface storage would likely be needed, introducing security issues. yellow
Secondary Waste Generation	Low-level waste generated?	Pros: No additional LLW generated because these do not have additional treatment for disposal. green	Pros: No additional LLW generated because these do not have additional treatment for disposal. green	Pros: No additional LLW generated because these do not have additional treatment for disposal. green	Pros: No additional LLW generated because these do not have additional treatment for disposal. green
	Mixed waste generated?	Pros: No additional mixed waste generated because these do not have additional treatment for disposal. green	Pros: No additional mixed waste generated because these do not have additional treatment for disposal. green	Pros: No additional mixed waste generated because these do not have additional treatment for disposal. green	Pros: No additional mixed waste generated because these do not have additional treatment for disposal. green
System-Level Cost	Differential Cost Considerations	Differential cost because wastes are not treated. Costs incurred for transportation cask development.	Differential cost because wastes are not treated. Costs incurred for transportation cask development.	Differential cost because wastes are not treated. Costs incurred for transportation cask development.	Differential cost because wastes are not treated. Costs incurred for transportation cask development. Costs incurred for additional safety and security issues at surface.
Technical Readiness	Status of needed waste form generation technology	ready green	ready green	ready green	ready green
	Status of needed transportation and waste handling systems	ready green	ready green	ready green	ready green
	Status of needed disposal concept technologies	ready green	ready green	ready green	Cons: No design or demonstration. yellow

Table E-8. Evaluation results for WG8 (cont.)

WG8		Disposal Concept			
		Salt	Crystalline Repository	Clay/Shale	Deep Borehole
Safeguards and Security	National Security Implementation Cost and Difficulty (fissile content)	Note: Little to no fissile content. green	Note: Little to no fissile content. green	Note: Little to no fissile content. green	Note: Little to no fissile content. green
	Radiological Dispersion Device Prevention cost and difficulty (dose/dispersion)	Note: Higher risk due to highly dispersible material. yellow	Note: Higher risk due to highly dispersible material. yellow	Note: Higher risk due to highly dispersible material. yellow	Note: Higher risk due to highly dispersible material. yellow
Programmatic and Regulatory Considerations	Consent-based siting considerations				
	Regulatory considerations	Untreated calcine is both a listed waste and characteristically hazardous. May be regulatory issues with transporting respirable fines.	Untreated calcine is both a listed waste and characteristically hazardous. May be regulatory issues with transporting respirable fines.	Untreated calcine is both a listed waste and characteristically hazardous. May be regulatory issues with transporting respirable fines.	Untreated calcine is both a listed waste and characteristically hazardous. May be regulatory issues with transporting respirable fines.

Table E-9. Evaluation results for WG9

WG9		Disposal Concept			
		Salt	Crystalline Repository	Clay/Shale	Deep Borehole
Disposal Option Performance	Likely to meet expected health and safety needs	yes green	yes green	yes green	yes green
	Attributes of disposal option	Pros: Thermal conductivity will allow for higher thermal density. Disposal containers can be designed for the repository environment.	Pros: Have disposal containers designed for the repository environment. Cons: Lower thermal conductivity than salt.	Pros: Have disposal container designed for the repository environment. May not need separate backfill.	Pros: Have disposal container designed for the repository environment. Thermal conductivity is not an issue.
Confidence in Expected Performance Bases	Additional EBS Considerations (compared to disposal of commercial SNF and HLW glass)	None	None	None	None
	Robustness/Confidence in Information Bases (simplicity vs. complexity, difficulty in generating confidence, site-specific vs. generic vs. qualitative; significant knowledge gaps)	Pros: low permeability, reducing environment. Cons: gaps in knowledge of response to high thermal loads; greater need for site-specific information than other disposal concepts. green	Pros: Lots of world-wide experience with this geologic medium. green	Pros: Lots of world-wide experience with this geologic medium. green	Cons: No demonstration of the concept. yellow
Operational Feasibility	Ease in ensuring worker health and safety (from waste form generation through disposal)	Pros: No repackaging required. green	Pros: No repackaging required. green	Pros: No repackaging required. green	Pros: No repackaging required. green
	Special physical considerations (storage, transportation, disposal volume, handling of packages) based on physical characteristics.	green	Pros: Could be relatively easy to retrieve packages. Cons: Might have to emplace backfill after the ventilation period. green	Pros: Could be relatively easy to retrieve packages. green	Cons: Potentially more challenging to retrieve. Calls for the most repackaging and consolidation. yellow
Secondary Waste Generation	Low-level waste generated?	minimal green	minimal green	minimal green	minimal green
	Mixed waste generated?	minimal green	minimal green	minimal green	minimal green
System-Level Cost	Differential Cost Considerations				All the waste in this waste form group could be disposed of in deep boreholes if the Fort St. Vrain fuels were to be cored.
Technical Readiness	Status of needed waste form generation technology	ready green	ready green	ready green	ready green
	Status of needed transportation and waste handling systems	ready green	ready green	ready green	ready green
	Status of needed disposal concept technologies	ready green	ready green	ready green	Cons: Not yet fully designed or demonstrated yellow
Safeguards and Security	National Security Implementation Cost and Difficulty (fissile content)	Note: Fuel high fissile content requiring increased MC&A/safeguards. green	Note: Fuel high fissile content requiring increased MC&A/safeguards. green	Note: Fuel high fissile content requiring increased MC&A/safeguards. green	Note: Fuel high fissile content requiring increased MC&A/safeguards. green
	Radiological Dispersion Device Prevention cost and difficulty (dose/dispersion)	Note: Higher risk due to dispersible material. green	Note: Higher risk due to dispersible material. green	Note: Higher risk due to dispersible material. green	Note: Higher risk due to dispersible material. green
Programmatic and Regulatory Considerations	Consent-based siting considerations	Pros: Have a lot of operational experience in salt. There are many salt sites across the country.	Pros: Have international experience in crystalline rock. There are many crystalline sites across the country.	Pros: Have international experience in clay/shale rock. There are many clay/shale sites across the country.	Pros: There are many possible geologic sites around the country. Cons: No operational experience.
	Regulatory considerations				Current regulations did not contemplate deep borehole disposal. Possible underground injection control issues.

Table E-10. Evaluation results for WG10

WG10		Disposal Concept			
		Salt	Crystalline Repository	Clay/Shale	Deep Borehole
Disposal Option Performance	Likely to meet expected health and safety needs	yes green	yes green	yes green	
	Attributes of disposal option	Pros: High thermal conductivity allows for high thermal density. Purpose-built overpack will be used. Cons: Challenge to seal the large shaft(s) or ramp(s).	Pros: Purpose-built overpack will be used. Cons: Lower thermal conductivity than salt. High thermal load complicates reliance on bentonite.	Pros: Purpose-built overpack will be used. Cons: Lower thermal conductivity than salt.	
Confidence in Expected Performance Bases	Additional EBS Considerations (compared to disposal of commercial SNF and HLW glass)	none green	none green	none green	
	Robustness/Confidence in Information Bases (simplicity vs. complexity, difficulty in generating confidence, site-specific vs. generic vs. qualitative; significant knowledge gaps)	Pros: Cons: Knowledge gaps regarding the behavior of salt under high thermal loads. yellow	Cons: Unproven overpack performance, lack modeling experience, analysis. purple	Pros: Can rely on far near-field more than in crystalline. Cons: Lack of modeling experience. yellow	
Operational Feasibility	Ease in ensuring worker health and safety (from waste form generation through disposal)	Pros: Repackaging not required. green	Pros: Repackaging not required. green	Pros: Repackaging not required. green	
	Special physical considerations (storage, transportation, disposal volume, handling of packages) based on physical characteristics.	Cons: Challenges with keeping shafts and ramps open. Conveyance options not yet developed. Challenges with retrieval during preclosure. purple	Cons: Conveyance options not yet developed. yellow	Cons: Challenges with keeping emplacement openings, shafts, and ramps open for the necessary time scales for ventilation. Conveyance options not yet developed. Challenges with retrieval during preclosure. purple	Can't be done. Red
Secondary Waste Generation	Low-level waste generated?	minimal green	minimal green	minimal green	
	Mixed waste generated?	minimal green	minimal green	minimal green	
System-Level Cost	Differential Cost Considerations	Additional costs incurred for repository engineering for large package sizes.	Additional costs incurred for repository engineering for large package sizes.	Additional costs incurred for repository engineering for large package sizes.	
Technical Readiness	Status of needed waste form generation technology	ready green	ready green	ready green	
	Status of needed transportation and waste handling systems	(Conveyance systems considered under operational feasibility) Pros: Transportation occurs in certified containers and no further waste handling is required. green	(Conveyance systems considered under operational feasibility) Pros: Transportation occurs in certified containers and no further waste handling is required. green	(Conveyance systems considered under operational feasibility) Pros: Transportation occurs in certified containers and no further waste handling is required. green	
	Status of needed disposal concept technologies	Not ready but don't foresee show stoppers. yellow	Not ready but don't foresee show stoppers. yellow	Not ready but don't foresee show stoppers. yellow	
Safeguards and Security	National Security Implementation Cost and Difficulty (fissile content)	Note: Greater MC&A/safeguards requirements. green	Note: Greater MC&A/safeguards requirements. green	Note: Greater MC&A/safeguards requirements. green	
	Radiological Dispersion Device Prevention cost and difficulty (dose/dispersion)	green	green	green	
Programmatic and Regulatory Considerations	Consent-based siting considerations	Direct disposal requires fewer employees because no repackaging. Constrains option space in terms of suitable sites.	Direct disposal requires fewer employees because no repackaging. Constrains option space in terms of suitable sites.	Direct disposal requires fewer employees because no repackaging. Constrains option space in terms of suitable sites.	
	Regulatory considerations				

Table E-11. Evaluation results for salt disposal concept

Salt		Waste Group									
		WG1	WG2	WG3	WG4	WG5	WG6	WG7	WG8	WG9	WG10
Overlaps with waste group(s)		WG2	WG1	WG4 (Calcine waste that has been HIP processed) WG8 (calcine waste untreated; Cs/Sr capsules untreated)	WG3 (calcine waste that has been vitrified) WG6 (sodium-bonded fuel) WG8 (salt waste from EMT of sodium-bonded fuel; calcine waste disposed of without treatment)		WG4 (engineered waste forms from EMT of sodium-bonded fuel); WG8 (salt from EMT of sodium-bonded fuel)		WG3 (calcine waste that has been vitrified; Cs/Sr capsules that have been vitrified) WG4 (engineered waste forms from EMT of sodium-bonded fuel; calcine waste that has been HIP processed) WG6 (sodium-bonded fuel)		
Disposal Option Performance	Likely to meet expected health and safety needs	Yes	Yes	Yes	Yes	Yes		Yes	Yes	Yes	Yes
	Attributes of disposal option	Pros: Thermal conductivity will allow for higher thermal density. Disposal containers can be designed for the repository environment.	Pros: High thermal conductivity allows for high thermal density. Purpose-built overpack will be used. Cons: Challenge to seal the large shaft(s) or ramp(s). Fact that DPCs were not designed for disposal is not as important.	Pros: Can pack the canisters densely because the waste is not as hot as SNF.	Pros: Can pack the canisters densely because the waste is not as hot as SNF. Can dispose of a variety of waste package sizes and types (except for jumbo).	Pros: Criticality is less of a concern for this disposal concept because of the relative lack of water and the high cross-section of chlorine for capture of thermal neutrons.		Pros: Thermal conductivity will allow for higher thermal density. Disposal containers can be designed for the repository environment.	Pros: Thermal conductivity will allow for higher thermal density. Disposal containers can be designed for the repository environment.	Pros: Thermal conductivity will allow for higher thermal density. Disposal containers can be designed for the repository environment.	Pros: High thermal conductivity allows for high thermal density. Purpose-built overpack will be used. Cons: Challenge to seal the large shaft(s) or ramp(s).
Confidence in Expected Performance Bases	Additional EBS Considerations (compared to disposal of commercial SNF and HLW glass)	None. green	May need to consider adding EBS components to address criticality control. green	None. green	None. green	None. green		None. green	None. green	None. green	None. green
	Robustness/Confidence in Information Bases (simplicity vs. complexity, difficulty in generating confidence, site-specific vs. generic vs. qualitative; significant knowledge gaps)	Pros: Low permeability, reducing environment. Cons: Gaps in knowledge of response to high thermal loads; greater need for site-specific information than other disposal concepts. green	Pros: Cons: Knowledge gaps regarding the behavior of salt under high thermal loads. yellow	green	Pros: Because there is less reliance on waste form performance, it is easier to have confidence in the option. green	Pros: Because there is less reliance on waste form performance, it is easier to have confidence in the option. green	Not enough information to know whether it can be disposed of safely. purple	Pros: Low permeability, reducing environment. Cons: Gaps in knowledge of response to high thermal loads; greater need for site-specific information than other disposal concepts. green	Pros: Because there is less reliance on waste form and waste package performance, it is easier to have confidence in the option. green	Pros: low permeability, reducing environment. Cons: gaps in knowledge of response to high thermal loads; greater need for site-specific information than other disposal concepts. green	Pros: Cons: Knowledge gaps regarding the behavior of salt under high thermal loads. yellow

Table E-11. Evaluation results for salt disposal concept (cont.)

Salt		Waste Group									
		WG1	WG2	WG3	WG4	WG5	WG6	WG7	WG8	WG9	WG10
Operational Feasibility	Ease in ensuring worker health and safety (from waste form generation through disposal)	Cons: Some waste must be repackaged. yellow.	Pros: Repackaging not required. green	green	Assumes sodium-bonded fuel and calcine waste are treated, which requires additional effort to protect worker health and safety. green	green		A small amount of waste has already been packaged. The rest must be packaged. green	Pros: Avoid potential worker dose resulting from treating these wastes for disposal. Cons: These have respirable fines that would have to be managed during transport and disposal. However, this is a concern only in a low-probability accident event. green	Pros: No repackaging required. green	Pros: Repackaging not required. green
	Special physical considerations (storage, transportation, disposal volume, handling of packages) based on physical characteristics.	Cons: Packages could be difficult to retrieve. green	Cons: Challenges with keeping shafts and ramps open. Conveyance options not yet developed. Challenges with retrieval during preclosure. purple	green	green	Transportation of this waste is problematic, possibly because of some characteristics of the fuel itself. yellow		Cons: Packages could be difficult to retrieve. Already packaged waste would have to be repackaged for transport. green	Cons: May need special equipment for transporting respirable fines. yellow	green	Cons: Challenges with keeping shafts and ramps open. Conveyance options not yet developed. Challenges with retrieval during preclosure. purple
Secondary Waste Generation	Low-level waste generated?	Cons: Significant amounts of LLW generated in the repackaging process. purple	Pros: Minimal waste generated green	The LLW streams that will be generated by making glass are already accounted for. green	Cons: A moderate amount of waste is generated. yellow	minimal green		Insignificant amount of LLW generated in repackaging. green	Pros: No additional LLW generated because these do not have additional treatment for disposal. green	minimal green	minimal green
	Mixed waste generated?	minimal green	Pros: Minimal mixed waste generated. green	The low-activity waste generated is WIR and is a mixed waste and is already accounted for. green	Cons: A moderate amount of mixed waste is generated. yellow	minimal green		minimal green	Pros: No additional mixed waste generated because these do not have additional treatment for disposal. green	minimal green	minimal green
System-Level Cost	Differential Cost Considerations								Differential cost because wastes are not treated. Costs incurred for transportation cask development.		Additional costs incurred for repository engineering for large package sizes.

Table E-11. Evaluation results for salt disposal concept (cont.)

Salt		Waste Group									
		WG1	WG2	WG3	WG4	WG5	WG6	WG7	WG8	WG9	WG10
Technical Readiness	Status of needed waste form generation technology	ready green	Cons: May (or may not) need to construct very large purpose-built overpacks. Needed technology in-process. yellow	Vitrification complete at West Valley, ongoing at SRS, and technical challenges being addressed at Hanford. yellow	Waste form generation technologies for HIP processing are in process. The sodium-bonded fuel treatment process has already been done, at least for the metal waste form. Glass-bonded sodalite has not been produced at scale. yellow	Neutron absorbers in the waste form need to be evaluated. green		ready green	ready green	ready green	ready green
	Status of needed transportation and waste handling systems	ready green	(Conveyance systems considered under operational feasibility) Pros: Transportation occurs in certified containers and no further waste handling is required. green	Transportation casks have not been developed but no significant technical challenges expected. green	Transportation casks have not been developed but no significant technical challenges expected. green	yellow		ready green	ready green	ready green	(Conveyance systems considered under operational feasibility) Pros: Transportation occurs in certified containers and no further waste handling is required. green
	Status of needed disposal concept technologies	ready green	Not ready but don't foresee show stoppers. yellow	ready green	ready green	ready green		ready green	ready green	ready green	Not ready but don't foresee show stoppers. yellow
Safeguards and Security	National Security Implementation Cost and Difficulty (fissile content)	Changes in self-protection limits may change the indicator for this metric. green	Changes in self-protection limits may change the indicator for this metric. green	green	Note: Fissile content should be no greater than SNF, and may be significantly less for some types. green	Note: For some waste types fuel has high fissile content requiring increased MC&A/safeguards. green	Note: For some waste types fuel has high fissile content requiring increased MC&A/safeguards. green	Note: For some waste types fuel has high fissile content requiring increased MC&A/safeguards. green	Note: Little to no fissile content. green	Note: Fuel has high fissile content requiring increased MC&A/safeguards. green	Note: Greater MC&A/safeguards requirements. green
	Radiological Dispersion Device Prevention cost and difficulty (dose/dispersion)	green	green	green	Note: Dose and dispersion should be no greater than SNF green	Note: Metal fuels are less dispersible than oxide SNF. green	Note: Metal fuels are less dispersible than oxide SNF. green	green	Note: Higher risk due to highly dispersible material. yellow	Note: Higher risk due to dispersible material. green	green
Programmatic and Regulatory Considerations	Consent-based siting considerations	Pros: Have a lot of operational experience in salt. Having repackaging away from the reactor site creates jobs at the repackaging site. There are many salt sites across the country.	Cons: Direct disposal of DPCs requires fewer employees because no repackaging. Constrains option space in terms of suitable sites.							Pros: Have a lot of operational experience in salt. There are many salt sites across the country.	Direct disposal requires fewer employees because no repackaging. Constrains option space in terms of suitable sites.
	Regulatory considerations				RCRA issues for HIP waste, worse for the waste without additives because it will still be characteristically hazardous					Untreated calcine is both a listed waste and characteristically hazardous. May be regulatory issues with transporting respirable fines.	

Table E-12. Evaluation results for the crystalline disposal concept

Crystalline Disposal Concept		Waste Group									
		WG1	WG2	WG3	WG4	WG5	WG6	WG7	WG8	WG9	WG10
Overlaps with waste group(s)		WG2	WG1	WG4 (Calcine waste that has been HIP processed) WG8 (calcine waste untreated; Cs/Sr capsules untreated)	WG3 (calcine waste that has been vitrified) WG6 (sodium-bonded fuel) WG8 (salt waste from EMT of sodium-bonded fuel; calcine waste disposed of without treatment)		WG4 (engineered waste forms from EMT of sodium-bonded fuel); WG8 (salt from EMT of sodium-bonded fuel)		WG3 (calcine waste that has been vitrified; Cs/Sr capsules that have been vitrified) WG4 (engineered waste forms from EMT of sodium-bonded fuel; calcine waste that has been HIP processed) WG6 (sodium-bonded fuel)		
Disposal Option Performance	Likely to meet expected health and safety needs	Yes	Yes	Yes	Yes	Yes		Yes	Yes	Yes	Yes
	Attributes of disposal option	Pros: Have disposal containers designed for the repository environment. Cons: Lower thermal conductivity than salt.	Pros: Purpose-built overpack will be used. Cons: Lower thermal conductivity than salt. High thermal load complicates reliance on bentonite.	Pros: Can pack the canisters densely because the waste is not as hot as SNF.	Pros: Can pack the canisters densely because the waste is not as hot as SNF.			Pros: Have disposal containers designed for the repository environment. Cons: Lower thermal conductivity than salt.	Pros: Would be relatively easy to spread out the cesium/strontium capsules to avoid thermal issues, assuming they are packaged accordingly. Cons: Possibility of plutonium colloids from the salt waste from the reprocessing of sodium-bonded fuel. Transport in a fracture network is a concern.	Pros: Have disposal containers designed for the repository environment. Cons: Lower thermal conductivity than salt.	Pros: Purpose-built overpack will be used. Cons: Lower thermal conductivity than salt. High thermal load complicates reliance on bentonite.
Confidence in Expected Performance Bases	Additional EBS Considerations (compared to disposal of commercial SNF and HLW glass)	None	May need to consider adding EBS components to address criticality control. green	none	none green	none green		None	Cons: Because of corrosive chemical components in this waste (e.g., halides), would want to separate the wastes in this group from the wastes in other waste forms groups if disposed of in the same repository. Separation distances need not be great, just sufficient. yellow	None	none green
	Robustness/Confidence in Information Bases (simplicity vs. complexity, difficulty in generating confidence, site-specific vs. generic vs. qualitative; significant knowledge gaps)	Pros: Lots of world-wide experience with this geologic medium. green	Cons: Unproven overpack performance, lack modeling experience, analysis. purple	green	Cons: In the absence of waste form performance information, we would rely on waste package performance. Would have to consider galvanic coupling between the metal waste form and its packaging. yellow	Cons: In the absence of waste form performance information, we would rely on waste package performance. Would have to consider galvanic coupling between the metal waste form and its packaging. Issues with criticality control of HEU need to be addressed. yellow	Not enough information to know whether it can be disposed of safely. purple	Pros: Lots of world-wide experience with this geologic medium. green	Cons: More information needed with regard to transport of these wastes in a crystalline media because of the possibility of colloid transport and the short waste form lifetime. yellow	Pros: Lots of world-wide experience with this geologic medium. green	Cons: Unproven overpack performance, lack modeling experience, analysis. purple

Table E-12. Evaluation results for crystalline disposal concept (cont.)

Crystalline Disposal Concept		Waste Group									
		WG1	WG2	WG3	WG4	WG5	WG6	WG7	WG8	WG9	WG10
Operational Feasibility	Ease in ensuring worker health and safety (from waste form generation through disposal)	Cons: Some waste must be repackaged. yellow.	Pros: Repackaging not required. green	green	Assumes sodium-bonded fuel and calcine waste are treated, which requires additional effort to protect worker health and safety. green	green		A small amount of waste has already been packaged. The rest must be packaged. green	Pros: Avoid potential worker dose resulting from treating these wastes for disposal. Cons: These have respirable fines that would have to be managed during transport and disposal. However, this is a concern only in a low-probability accident event. green	Pros: No repackaging required. green	Pros: Repackaging not required. green
	Special physical considerations (storage, transportation, disposal volume, handling of packages) based on physical characteristics.	Pros: Could be relatively easy to retrieve packages. Cons: Might have to emplace backfill after the ventilation period. green	Cons: Conveyance options not yet developed. yellow	green	green	Transportation of this waste is problematic, possibly because of some characteristics of the fuel itself. yellow		Pros: Could be relatively easy to retrieve packages. Cons: Might have to emplace backfill after the ventilation period. green	Cons: May need special equipment for transporting respirable fines. yellow	Pros: Could be relatively easy to retrieve packages. Cons: Might have to emplace backfill after the ventilation period. green	Cons: Conveyance options not yet developed. yellow
Secondary Waste Generation	Low-level waste generated?	Cons: Significant amounts of LLW generated in the repackaging process. purple	Pros: Minimal waste generated. green	The LLW streams that will be generated by making glass are already accounted for. green	Cons: A moderate amount of waste is generated. yellow	minimal green		Insignificant amount of LLW generated in repackaging. green	Pros: No additional LLW generated because these do not have additional treatment for disposal. green	minimal green	minimal green
	Mixed waste generated?	minimal green	Pros: Minimal mixed waste generated. green	The low-activity waste generated is WIR and is a mixed waste and is already accounted for. green	Cons: A moderate amount of mixed waste is generated. yellow	minimal green		minimal green	Pros: No additional mixed waste generated because these do not have additional treatment for disposal. green	minimal green	minimal green
System-Level Cost	Differential Cost Considerations			There may be a fraction of Hanford tank waste that is not managed as HLW glass. Cs/Sr capsules and calcine waste may also not be vitrified.	Differential cost between treating these waste and disposing of them directly.		If this waste were to be treated such that the fuel was left intact but the sodium removed, then this would be in WG5. Treatment costs would have to be considered if disposal of this waste is not feasible		Differential cost because wastes are not treated. Costs incurred for transportation cask development.		Additional costs incurred for repository engineering for large package sizes.

Table E-12. Evaluation results for crystalline disposal concept (cont.)

Crystalline Disposal Concept		Waste Group									
		WG1	WG2	WG3	WG4	WG5	WG6	WG7	WG8	WG9	WG10
Technical Readiness	Status of needed waste form generation technology	ready green	Cons: Need to construct very large purpose-built overpacks. Needed technology in-process. yellow	Vitrification complete at West Valley, ongoing at SRS, and technical challenges being addressed at Hanford. yellow	Waste form generation technologies for HIP processing are in process. The sodium-bonded fuel treatment process has already been done, at least for the metal waste form. Glass-bonded sodalite has not been produced at scale. yellow	Neutron absorbers in the waste form need to be evaluated. green		ready green	ready green	ready green	ready green
	Status of needed transportation and waste handling systems	ready green	(Conveyance systems considered under operational feasibility) Pros: Transportation occurs in certified containers and no further waste handling is required. green	Transportation casks have not been developed but no significant technical challenges expected. green	Transportation casks have not been developed but no significant technical challenges expected. green	yellow		ready green	ready green	ready green	(Conveyance systems considered under operational feasibility) Pros: Transportation occurs in certified containers and no further waste handling is required. green
	Status of needed disposal concept technologies	ready green	Not ready but don't foresee show stoppers. yellow	Ready green	Ready green	ready green		ready green	ready green	ready green	Not ready but don't foresee show stoppers. yellow
Safeguards and Security	National Security Implementation Cost and Difficulty (fissile content)	Changes in self-protection limits may change the indicator for this metric. green	Changes in self-protection limits may change the indicator for this metric. green	green	Note: Fissile content should be no greater than SNF, and may be significantly less for some types. green	Note: For some waste types fuel has high fissile content requiring increased MC&A/safeguards. green	Note: For some waste types fuel has high fissile content requiring increased MC&A/safeguards. green	Note: For some waste types fuel has high fissile content requiring increased MC&A/safeguards. green	Note: Little to no fissile content. green	Note: Fuel has high fissile content requiring increased MC&A/safeguards. green	Note: Greater MC&A/safeguards requirements. green
	Radiological Dispersion Device Prevention cost and difficulty (dose/dispersion)	green	green	green	Note: Dose and dispersion should be no greater than SNF green	Note: Metal fuels are less dispersible than oxide SNF. green	Note: Metal fuels are less dispersible than oxide SNF. green	green	Note: Higher risk due to highly dispersible material. yellow	Note: Higher risk due to dispersible material. green	green
Programmatic and Regulatory Considerations	Consent-based siting considerations	Pros: Have international experience in crystalline rock. Having repackaging away from the reactor site creates jobs at the repackaging site. There are many crystalline sites across the country.	Cons: Direct disposal of DPCs requires fewer employees because no repackaging. Constrains option space in terms of suitable sites.								Pros: Have international experience in crystalline rock. There are many crystalline sites across the country. Direct disposal requires fewer employees because no repackaging. Constrains option space in terms of suitable sites.
	Regulatory considerations		Open regulatory issues associated with criticality screening.	Possible RCRA issues.	RCRA issues for HIP waste, worse for the waste without additives because it will still be characteristically hazardous.	Criticality analysis has not yet been performed for all wastes.			Untreated calcine is both a listed waste and characteristically hazardous. May be regulatory issues with transporting respirable fines.		

Table E-13. Evaluation results for the clay/shale disposal concept

Clay/Shale Disposal Concept		Waste Group									
		WG1	WG2	WG3	WG4	WG5	WG6	WG7	WG8	WG9	WG10
Overlaps with waste group(s)		WG2	WG1	WG4 (Calcine waste that has been HIP processed) WG8 (calcine waste untreated; Cs/Sr capsules untreated)	WG3 (calcine waste that has been vitrified) WG6 (sodium-bonded fuel) WG8 (salt waste from EMT of sodium-bonded fuel; calcine waste disposed of without treatment)		WG4 (engineered waste forms from EMT of sodium-bonded fuel); WG8 (salt from EMT of sodium-bonded fuel)		WG3 (calcine waste that has been vitrified; Cs/Sr capsules that have been vitrified) WG4 (engineered waste forms from EMT of sodium-bonded fuel; calcine waste that has been HIP processed) WG6 (sodium-bonded fuel)		
Disposal Option Performance	Likely to meet expected health and safety needs	Yes	Yes	Yes	Yes	Yes		Yes	Yes	Yes	Yes
	Attributes of disposal option	Pros: Have disposal container designed for the repository environment. May not need separate backfill.	Pros: Purpose-built overpack will be used. Cons: Lower thermal conductivity than salt.	Pros: Can pack the canisters densely because the waste is not as hot as SNF.	Pros: Can pack the canisters densely because the waste is not as hot as SNF.			Pros: Have disposal container designed for the repository environment. May not need separate backfill.	Pros: For this waste form group, the limited far-field transport in clay/shale is important. The high degree of isolation of each package from another that is possible is also important.	Pros: Have disposal container designed for the repository environment. May not need separate backfill.	Pros: Purpose-built overpack will be used. Cons: Lower thermal conductivity than salt.
Confidence in Expected Performance Bases	Additional EBS Considerations (compared to disposal of commercial SNF and HLW glass)	None	May need to consider adding EBS components to address criticality control. green	none	none green	none green		None	Cons: Because of corrosive chemical components in this waste (e.g., halides), would want to separate the wastes in this group from the wastes in other waste forms groups if disposed of in the same repository. Separation distances need not be great, just sufficient. Separation distances less in clay/shale than in crystalline rock. green	None	none green
	Robustness/Confidence in Information Bases (simplicity vs. complexity, difficulty in generating confidence, site-specific vs. generic vs. qualitative; significant knowledge gaps)	Pros: Lots of world-wide experience with this geologic medium. green	Pros: Can rely on far near-field more than in crystalline. Cons: Lack of modeling experience. yellow	green	Pros: Because there is less reliance on waste form performance, it is easier to have confidence in the option. green	Pros: Because there is less reliance on waste form performance, it is easier to have confidence in the option. green	Not enough information to know whether it can be disposed of safely. purple	Pros: Lots of world-wide experience with this geologic medium. green	Pros: Because there is less reliance on waste form performance, it is easier to have confidence in the option. green	Pros: Lots of world-wide experience with this geologic medium. green	Pros: Can rely on far near-field more than in crystalline. Cons: Lack of modeling experience. yellow

Table E-13. Evaluation results for clay/shale disposal concept (cont.)

Clay/Shale Disposal Concept		Waste Group									
		WG1	WG2	WG3	WG4	WG5	WG6	WG7	WG8	WG9	WG10
Operational Feasibility	Ease in ensuring worker health and safety (from waste form generation through disposal)	Cons: Some waste must be repackaged. yellow.	Pros: Repackaging not required. green	green	Assumes sodium-bonded fuel and calcine waste are treated, which requires additional effort to protect worker health and safety. green	green		A small amount of waste has already been packaged. The rest must be packaged. green	Pros: Avoid potential worker dose resulting from treating these wastes for disposal. Cons: These have respirable fines that would have to be managed during transport and disposal. However, this is a concern only in a low-probability accident event. green	Pros: No repackaging required. green	Pros: Repackaging not required. green
	Special physical considerations (storage, transportation, disposal volume, handling of packages) based on physical characteristics.	Pros: Could be relatively easy to retrieve packages. green	Cons: Challenges with keeping emplacement openings, shafts, and ramps open for the necessary time scales for ventilation. Conveyance options not yet developed. Challenges with retrieval during preclosure. purple	green	green	Transportation of this waste is problematic, possibly because of some characteristics of the fuel itself. yellow		Pros: Could be relatively easy to retrieve packages. green	Cons: May need special equipment for transporting respirable fines. yellow	Pros: Could be relatively easy to retrieve packages. green	Cons: Challenges with keeping emplacement openings, shafts, and ramps open for the necessary time scales for ventilation. Conveyance options not yet developed. Challenges with retrieval during preclosure. purple
Secondary Waste Generation	Low-level waste generated?	Cons: Significant amounts of LLW generated in the repackaging process. purple	Pros: Minimal waste generated green	The LLW streams that will be generated by making glass are already accounted for. green	Cons: A moderate amount of waste is generated. yellow	minimal green		Insignificant amount of LLW generated in repackaging. green	Pros: No additional LLW generated because these do not have additional treatment for disposal. green	minimal green	minimal green
	Mixed waste generated?	minimal green	Pros: Minimal mixed waste generated. green	The low-activity waste generated is WIR and is a mixed waste and is already accounted for. green	Cons: A moderate amount of mixed waste is generated. yellow	minimal green		minimal green	Pros: No additional mixed waste generated because these do not have additional treatment for disposal. green	minimal green	minimal green
System-Level Cost	Differential Cost Considerations	Cost is shifted from subsurface to surface for repackaging. This WG assumes repackaging does not occur at the reactor. There would be a cost differential if repackaging were to occur at the reactor. More packages because of thermal conductivity. More expensive than salt.	Additional costs for facilities to handle very large packages. Additional costs for needed thermal management. Saves costs for not repackaging.	There may be a fraction of Hanford tank waste that is not managed as HLW glass. Cs/Sr capsules and calcine waste may also not be vitrified.	Differential cost between treating these waste and disposing of them directly.		If this waste were to be treated such that the fuel was left intact but the sodium removed, then this would be in WG5. Treatment costs would have to be considered if disposal of this waste is not feasible.		Differential cost because wastes are not treated. Costs incurred for transportation cask development.		Additional costs incurred for repository engineering for large package sizes.

Table E-13. Evaluation results for clay/shale disposal concept (cont.)

Clay/Shale Disposal Concept		Waste Group									
		WG1	WG2	WG3	WG4	WG5	WG6	WG7	WG8	WG9	WG10
Technical Readiness	Status of needed waste form generation technology	ready green	Cons: Need to construct very large purpose-built overpacks. Needed technology in-process. yellow	Vitrification complete at West Valley, ongoing at SRS, and technical challenges being addressed at Hanford. yellow	Waste form generation technologies for HIP processing are in process. The sodium-bonded fuel treatment process has already been done, at least for the metal waste form. Glass-bonded sodalite has not been produced at scale. yellow	Neutron absorbers in the waste form need to be evaluated. green		ready green	ready green	ready green	ready green
	Status of needed transportation and waste handling systems	ready green	(Conveyance systems considered under operational feasibility) Pros: Transportation occurs in certified containers and no further waste handling is required. green	Transportation casks have not been developed but no significant technical challenges expected. green	Transportation casks have not been developed but no significant technical challenges expected. green	yellow		ready green	ready green	ready green	(Conveyance systems considered under operational feasibility) Pros: Transportation occurs in certified containers and no further waste handling is required. green
	Status of needed disposal concept technologies	ready green	Not ready but don't foresee show stoppers. yellow	Ready green	Ready green	ready green		ready green	ready green	ready green	Not ready but don't foresee show stoppers. yellow
Safeguards and Security	National Security Implementation Cost and Difficulty (fissile content)	Changes in self-protection limits may change the indicator for this metric. green	Changes in self-protection limits may change the indicator for this metric. green	green	Note: Fissile content should be no greater than SNF, and may be significantly less for some types. green	Note: For some waste types fuel has high fissile content requiring increased MC&A/safeguards. green	Note: For some waste types fuel has high fissile content requiring increased MC&A/safeguards. green	Note: For some waste types fuel has high fissile content requiring increased MC&A/safeguards. green	Note: Little to no fissile content. green	Note: Fuel has high fissile content requiring increased MC&A/safeguards. green	Note: Greater MC&A/safeguards requirements. green
	Radiological Dispersion Device Prevention cost and difficulty (dose/dispersion)	green	green	green	Note: Dose and dispersion should be no greater than SNF green	Note: Metal fuels are less dispersible than oxide SNF. green	Note: Metal fuels are less dispersible than oxide SNF. green	green	Note: Higher risk due to highly dispersible material. yellow	Note: Higher risk due to dispersible material. green	green
Programmatic and Regulatory Considerations	Consent-based siting considerations	Pros: Have international experience in crystalline rock. Having repackaging away from the reactor site creates jobs at the repackaging site. There are many crystalline sites across the country.	Cons: Direct disposal of DPCs requires fewer employees because no repackaging. Constrains option space in terms of suitable sites.							Pros: Have international experience in clay/shale rock. There are many clay/shale sites across the country.	Direct disposal requires fewer employees because no repackaging. Constrains option space in terms of suitable sites.
	Regulatory considerations		Open regulatory issues associated with criticality screening.	Possible RCRA issues.	RCRA issues for HIP waste, worse for the waste without additives because it will still be characteristically hazardous.	Criticality analysis has not yet been performed for all wastes.			Untreated calcine is both a listed waste and characteristically hazardous. May be regulatory issues with transporting respirable fines.		

Table E-14. Evaluation results for deep borehole disposal concept

Deep Borehole Disposal Concept		Waste Group									
		WG1	WG2	WG3	WG4	WG5	WG6	WG7	WG8	WG9	WG10
Overlaps with waste group(s)		WG2	WG1	WG4 (Calcine waste that has been HIP processed) WG8 (calcine waste untreated; Cs/Sr capsules untreated)	WG3 (calcine waste that has been vitrified) WG6 (sodium-bonded fuel) WG8 (salt waste from EMT of sodium-bonded fuel; calcine waste disposed of without treatment)		WG4 (engineered waste forms from EMT of sodium-bonded fuel); WG8 (salt from EMT of sodium-bonded fuel)		WG3 (calcine waste that has been vitrified; Cs/Sr capsules that have been vitrified) WG4 (engineered waste forms from EMT of sodium-bonded fuel; calcine waste that has been HIP processed) WG6 (sodium-bonded fuel)		
Disposal Option Performance	Likely to meet expected health and safety needs	Yes		Yes green	Yes	Yes green		Yes	Yes green	Yes	
	Attributes of disposal option	Pros: Have disposal container designed for the repository environment. Thermal conductivity is not an issue. Cons: Limited to very small packages		Pros: Smaller glass logs would cool faster and would have better properties.	Pros: Can optimize the waste form size for the borehole because they are not yet made (except for one metal ingot).	Targets and smaller waste types would be a great candidate for this disposal concept.		Pros: Have disposal container designed for the repository environment. Thermal conductivity is not an issue.	Pros: These wastes would fit easily in boreholes. Extreme degree of isolation. No reliance on waste package performance.	Pros: Have disposal container designed for the repository environment. Thermal conductivity is not an issue.	
Confidence in Expected Performance Bases	Additional EBS Considerations (compared to disposal of commercial SNF and HLW glass)	none green		none green	none green	none green		none green	none green	none green	
	Robustness/Confidence in Information Bases (simplicity vs. complexity, difficulty in generating confidence, site-specific vs. generic vs. qualitative; significant knowledge gaps)	Cons: No demonstration of the concept. yellow		Cons: No demonstration of the concept. yellow	Pros: Because there is less reliance on waste form performance, it is easier to have confidence in the option. Cons: Not designed or demonstrated. yellow	Pros: Less reliance on waste form performance in a borehole. Cons: Not designed or demonstrated yet. yellow	Not enough information to know whether it can be disposed of safely. purple	Cons: No demonstration of the concept. yellow	Cons: Lack of design and demonstration. yellow	Cons: No demonstration of the concept. yellow	

Table E-14. Evaluation results for deep borehole disposal concept (cont.)

Deep Borehole Disposal Concept		Waste Group									
		WG1	WG2	WG3	WG4	WG5	WG6	WG7	WG8	WG9	WG10
Operational Feasibility	Ease in ensuring worker health and safety (from waste form generation through disposal)	Cons: Some waste must be repackaged and consolidated. purple		green	Assumes sodium-bonded fuel and calcine waste are treated, which requires additional effort to protect worker health and safety. green	green		Cons: Some waste must be repackaged and consolidated. purple	Pros: Avoid potential worker dose resulting from treating these wastes for disposal. Cons: These have respirable fines that would have to be managed during transport and disposal. However, this is a concern only in a low-probability accident event. green	Pros: No repackaging required. green	
	Special physical considerations (storage, transportation, disposal volume, handling of packages) based on physical characteristics.	Cons: Potentially more challenging to retrieve. Calls for the most repackaging and consolidation. yellow	Can't be done. Red	Cons: Would need to handle at least four times as many canisters as the larger HLW canisters. yellow Can dispose of only projected HLW glass, which would have to be poured into canisters specifically designed for deep boreholes, although existing FRG canisters might be able to be disposed of. red	green	Transportation of this waste is likely not difficult because the problematic waste won't fit in boreholes. green Limited amount of this waste form group could be put in deep boreholes because of size restrictions. N Reactor MCOs can't be disposed of this way, nor can some of the DOE SNF (e.g., High-Flux Isotope Reactor waste in DOE SNF group 16). red		Cons: Potentially more challenging to retrieve. Calls for the most repackaging and consolidation. yellow Cons: Limited to very small packages. Would have to repackage the small amount of waste that is already packaged. red	Cons: May need special equipment for transporting respirable fines. Surface handling and storage concepts need further consideration because surface storage would likely be needed, introducing security issues. yellow	Cons: Potentially more challenging to retrieve. Calls for the most repackaging and consolidation. yellow Cons: Limited to only some of the waste. Fort St. Vrain waste cannot be disposed of as is in boreholes because of size considerations. red	Can't be done. Red
Secondary Waste Generation	Low-level waste generated?	Cons: Significant amounts of LLW generated in the repackaging process. purple		The LLW streams that will be generated by making glass are already accounted for. green	Cons: A moderate amount of waste is generated. yellow	minimal green		LLW generated in the repackaging process. yellow	Pros: No additional LLW generated because these do not have additional treatment for disposal. green	minimal green	
	Mixed waste generated?	minimal green		The low-activity waste generated is WIR and is already accounted for. green	Cons: A moderate amount of mixed waste is generated. yellow	minimal green		minimal green	Pros: No additional mixed waste generated because these do not have additional treatment for disposal. green	minimal green	
System-Level Cost	Differential Cost Considerations	Cost is shifted from subsurface to surface for repackaging and consolidation. Package material would be cheaper. Many more packages because of small size of package. High uncertainty in cost estimation. This WG assumes repackaging does not occur at the reactor. There would be a cost differential if repackaging were to occur at the reactor.		There may be a fraction of Hanford tank waste that is not managed as HLW glass. Cs/Sr capsules and calcine waste may also not be vitrified. Larger costs incurred because of the need to re-design treatment facilities.	Differential cost between treating these waste and disposing of them directly.	If this waste were to be treated such that the fuel was left intact but the sodium removed, then this would be in WG5. Treatment costs would have to be considered if disposal of this waste is not feasible		Repackaging of already packaged fuel to put in a deep borehole incurs additional cost.	Differential cost because wastes are not treated. Costs incurred for transportation cask development. Costs incurred for additional safety and security issues at surface.	All the waste in this waste form group could be disposed of in deep boreholes if the Fort St. Vrain fuels were to be cored.	

Table E-14. Evaluation results for deep borehole disposal concept (cont.)

Deep Borehole Disposal Concept		Waste Group									
		WG1	WG2	WG3	WG4	WG5	WG6	WG7	WG8	WG9	WG10
Technical Readiness	Status of needed waste form generation technology	Cons: Rod consolidation technology needed. yellow		Cons: Would have to re-design the treatment plant(s). purple	Waste form generation technologies for HIP processing are in process. The sodium-bonded fuel treatment process has already been done, at least for the metal waste form. Glass-bonded sodalite has not been produced at scale. yellow	green		Cons: Rod consolidation yellow	ready green	ready green	
	Status of needed transportation and waste handling systems	ready green		Transportation casks have not been developed but no significant technical challenges expected. green	Transportation casks have not been developed but no significant technical challenges expected. green	green		ready green	ready green	ready green	
	Status of needed disposal concept technologies	Cons: Not yet fully designed or demonstrated yellow		Cons: Not yet fully designed or demonstrated yellow	Cons: Not yet fully designed or demonstrated yellow	Cons: Not yet fully designed or demonstrated yellow		Cons: Not yet fully designed or demonstrated yellow	Cons: Not yet fully designed or demonstrated yellow	Cons: Not yet fully designed or demonstrated yellow	
Safeguards and Security	National Security Implementation Cost and Difficulty (fissile content)	Cons: More small waste packages for MC&A/safeguards. green		green	Note: Fissile content should be no greater than SNF, and may be significantly less for some types. green	Note: For some waste types fuel has high fissile content requiring increased MC&A/safeguards. green	Note: For some waste types fuel has high fissile content requiring increased MC&A/safeguards. green	Note: For some waste types fuel has high fissile content requiring increased MC&A/safeguards. green	Note: Little to no fissile content. green	Note: Fuel has high fissile content requiring increased MC&A/safeguards. green	
	Radiological Dispersion Device Prevention cost and difficulty (dose/dispersion)	Cons: Higher risk due to bare fuel rods and numerous small waste packages yellow		green	Note: Dose and dispersion should be no greater than SNF green	Note: Metal fuels are less dispersible than oxide SNF. green	Note: Metal fuels are less dispersible than oxide SNF. green	Note: Oxides are more dispersible than metal (see WG6). Cons: Higher risk due to bare fuel rods and numerous small waste packages yellow	Note: Higher risk due to highly dispersible material. yellow	Note: Higher risk due to dispersible material. green	
Programmatic and Regulatory Considerations	Consent-based siting considerations									Pros: There are many possible geologic sites around the country. Cons: No operational experience.	
	Regulatory considerations	Pros: Having repackaging away from the reactor site creates jobs at the repackaging site. There are many possible geologic sites around the country. Cons: No operational experience. Would take a lot of real estate.		Possible RCRA issues.	RCRA issues for HIP waste, worse for the waste without additives because it will still be characteristically hazardous.	Criticality analysis has not yet been performed for all wastes.			Possible Underground Injection Control issues. Existing regulations did not contemplate borehole disposal. Untreated calcine is both a listed waste and characteristically hazardous. May be regulatory issues with transporting respirable fines.	Current regulations did not contemplate deep borehole disposal. Possible underground injection control issues.	

Appendix F

Additional Insights

F-1. Criteria and Metrics

A disposal option consists of a waste group paired with one of the four geologic disposal concepts. Each disposal option is evaluated against several different criteria and metrics that consider factors such as long-term safety of the disposal option, the robustness of (or confidence in) available information, operational issues, technical readiness, system-level cost, secondary waste production, and safeguards and security. The evaluation of each disposal option against the metrics considers the specific interactions between the particular waste group and the particular disposal concept. Metrics for the study are necessarily qualitative, because of the complexity of the problem and the difficulty of quantifying estimates of the behavior of specific waste forms in generic disposal environments. In lieu of quantitative information about specific disposal sites, design concepts, and waste form behavior in such environments, insights are developed based on the full range of information available to the group, including detailed assessments done by previous repository programs in the U.S. and elsewhere in the world.

Evaluations are performed by a subgroup that represents expertise across the ranges of waste types, waste forms, handling, transportation, storage, safeguards and security, and disposal concepts considered in this work. The analyses subgroup performs the evaluation of the disposal options using the criteria and metrics developed below and all the available information described in the report. The evaluation of each disposal option against the metrics results in ratings for each waste group within each disposal concept that reflects the goodness of fit of each pairing.

Scoring the disposal options against the metrics is necessarily qualitative, but those qualitative aspects are defined within the metrics descriptions. The analyses subgroup discussed each disposal option through all of the criteria and metrics and then provided an integrated assessment (scoring) for the criteria and metrics for each disposal option considered. This provided a consistent set of understanding by the group for the basis of the evaluation. There were no cases where there was a substantial disagreement within the analyses subgroup on how to score any particular metric for a disposal option, although the option of providing specific discussion of any such disagreement was communicated to the group.

In general, there are three levels of metrics results for each criterion described below, and these reflect high-level assessments of strong, moderate, or weak results for the particular criterion and metric rated. For most criteria and their metrics, the evaluation results are color coded as (with corresponding symbol indicators):

- Green = strong or positive result (✓)
- Yellow = moderate result (○)
- Purple = weak/uncertain result (✱)

Note that there is a fourth category that is unique in that it represents a “no go,” or not feasible, result:

- Red = not feasible (✕)

This is meant to be used in very prescriptive cases and was used only for clearly defined incompatibilities that make a particular disposal option untenable. For example, disposal of DPCs in a deep borehole concept is not operationally feasible because DPCs do not fit down such a borehole, and therefore would be rated overall as a “no go” result because of the physical incompatibility of the waste form with the disposal concept. Note also that evaluation of DPCs within a disposal concept that requires hoist emplacement/retrieval entails some large challenges to emplacement, but that situation is not a clear cut case of incompatibility, and as such, would not be classified as a “no go” result. Lastly, in cases where a disposal option was not analyzed, the criterion and metric boxes are grey and marked for indication that such a disposal option was not analyzed (NA).

For each disposal option evaluated, the following criteria are considered (see below for description and metrics associated with each):

- Disposal option performance
- Confidence in Expected Performance Bases
- Operational feasibility
- Secondary waste production
- Technical readiness
- Safeguards and security.

Additional discussions regarding differential-to-baseline system level costs will be provided for the disposal options to identify the first order aspects that would contribute to cost decreases or increases relative to the baseline. Finally, consistent with the goal of the study to provide technical input to strategic decisions and policy decisions regarding disposal options, this study acknowledges programmatic constraints, including legal, regulatory, and contractual requirements, where applicable, but does not use those to constrain the technical evaluations.

F-1.1 Disposal Option Performance

This is the fundamental assessment of the expected behavior of a disposal option in postclosure. If there is an indication that a particular waste group disposed of in a specific disposal concept would not be able to meet expected health and safety requirements then the overall disposal option would have been listed as a red “no go” result. In addition to the overall assessment of safety, consideration in the metrics is also given to the attributes of the particular disposal option that provide the expected postclosure performance and evolution of the system. Further attention is focused on the robustness of the information bases used to evaluate the above aspects to assess confidence in the current state of information, including whether or not any substantial knowledge gaps exist.

F-1.1.1 Likely to Meet Expected Health and Safety Standards

This metric is the essential assessment of whether or not the postclosure behavior of a disposal option would provide the performance needed to meet expected health and safety standards over the millennia. As such, only a yes or no disposition is chosen for this metric, with a “No” being the equivalent of a “No go” assessment (i.e., the option is not feasible if it does not appear to be able to meet safety needs). Results from existing facilities, generic studies, and qualitative safety assessment studies for disposal of the particular waste group within the disposal concepts considered inform this metric assessment.

Yes

No (note this is a “No-Go” evaluation result—that is, the disposal option is not feasible)

F-1.1.2 Identification of Key Attributes of Disposal Option

This is a discussion of key performance attributes such as waste form longevity, thermal conductivity, consequences of chemical effects on metallic barriers, radionuclide transport processes, etc., that provide the primary bases for the expected performance of a disposal option. For each disposal option, discussion focused on key attributes considered and how they positively or negatively contribute to expected performance. No “score” was given for this metric.

F-1.2 Confidence in Expected Performance Bases

F-1.2.1 Additional Engineered Barrier System Considerations (Compared to Disposal of Commercial SNF and HLW glass)

Within this metric, notation of any additional considerations for the EBS of a repository concept beyond those already accounted for in the basic conceptualization (e.g., specific locations for specific waste forms, additional engineered barriers for specific additional isolation needs) would indicate that a particular disposal option is not directly and simply covered by the baseline concept. Such additional considerations are rated as:

Few, Moderate, Many.

F-1.2.2 Robustness/Confidence in Information bases

Within the consideration of postclosure performance, the nature of the documented bases for the assessment of safety should be considered separately as a metric to assess the degree to which the information covers the full range of considerations needed. In this metric, the evaluation considers simplicity vs. complexity of the safety bases, the level of difficulty in generating confidence of the conclusions regarding safety, whether the analyses available are for an existing facility vs. a generic study vs. qualitative estimates, and if there appears to be any clear knowledge gaps for this disposal option. The robustness of the information bases is rated as:

Strong, Moderate, Weak.

F-1.3 Operational Feasibility

The criterion for operational feasibility is composed of two metrics that focus on (1) the safety of workers starting with the generation of the waste form from the waste type all the way through the disposal of the waste form and (2) the physical considerations involved with handling, transporting, storing, emplacing and ultimately disposing of the waste forms.

F-1.3.1 Ease in Ensuring Worker Health and Safety

This metric examines the relative ease of ensuring worker health and safety starting from waste form generation through actual disposal of that waste form. Factors such as the radionuclide content of the waste; the amount of handling, especially if processing is involved, of the waste form; the amount of shielding needed; whether containers are going to be opened; as well as those aspects related to the packaging of the waste form are considered here. The assessment is performed relative to typical activities necessary to ensure worker health and safety. The ease of ensuring worker health and safety is rated as:

Standard, Moderate, Difficult.

F-1.3.2 Special Physical Considerations

Based on physical characteristics of the disposal option (including those needed for storage, transportation, disposal volume, thermal loading considerations, and handling of packages throughout the option), this metric is used to assess whether additional challenges exist for a particular disposal option versus others. The evaluation should cover whether a particular waste group may have fewer additional physical considerations for a particular disposal concept versus an alternative waste form pathway for another disposal concept. Considerations of the physical aspects may focus mainly on alternative waste forms for a particular waste type. For example, if cesium and strontium capsules are directly disposed, they have a smaller volume as a waste form than if they were blended into a glass waste form and

therefore the handling and physical considerations for those two possible waste forms are very different for those different disposal options. The special physical considerations metric is rated as:

Standard, Moderate, Difficult.

F-1.4 Secondary Waste Production

Some waste types could be processed in more than one way. For example, calcine waste may be hot isostatically pressed into a monolithic CWF, or it may be vitrified into a glass waste form, or it may be directly disposed of as calcine waste form. In each of these cases, differing amounts of processing are involved with a variety of additionally generated wastes to be generated that then need to be dispositioned themselves. The metrics below should be assessments of additional wastes generated based on the processes involved with the disposal option being evaluated. This is only be focused on the additional wastes that are generated, such that if HLW glass processing is performed in the same HLW glass production plant, much of the waste from the plant decommissioning is already going to exist regardless of the additional glass generation and is not be ascribed to a particular disposal option unless it is the primary driving process for the HLW glass production. Only the additional waste materials generated related to the specific disposal option is considered.

It should be noted here that the metrics below are focused on the amounts generated outside of the currently planned waste generation that is in place today (e.g., glass waste at Hanford or SRS) and for which standard handling approaches are already developed.

F-1.4.1 Low-Level Waste (A, B, C, or GTCC) Generated

In this instance, a qualitative estimate of the amount of additional LLW (A, B, C, or GTCC) is assessed and used to rate this metric as:

Minimal, Moderate, Large.

F-1.4.2 Mixed Waste Generated

In this instance, a qualitative estimate of the amount of additional mixed (radiological and RCRA-hazardous) waste generated is assessed and used to rate this metric:

Minimal, Moderate, Large.

F-1.5 Technical Readiness (e.g., TRL)

This criterion considers the current state of the technology needed to implement a disposal option from the stage of waste form generation through the closure of a disposal concept. There are three levels identified (which relate roughly to the Technical Readiness Levels assigned to engineered systems), and these levels indicate systems that are ready to be implemented, are in the process of reaching that implementation stage, or are still being developed (i.e., only conceptualized). These readiness levels are assessed as metrics for (1) waste form generation, (2) transportation and handling systems, and (3) the disposal concept technologies.

F-1.5.1 Status of Needed Waste Form Generation

This metric is assessed and rated for each disposal option as:

Ready, In-process, Conceptualized.

F-1.5.2 Status of Needed Transportation and Waste Handling Systems

This metric is assessed and rated for each disposal option as:

Ready, In-process, Conceptualized.

F-1.5.3 Status of Needed Disposal Technologies

This metric is assessed and rated for each disposal option as:

Ready, In-process, Conceptualized.

F-1.6 Safeguards and Security

The criterion of safeguards and security is based on the relative difficulty in implementing safeguards and security for disposal options (candidate disposal concepts and waste groups). In addition to assessing safeguards and security for the candidate disposal concepts, waste form transportation (from the originating waste site to the disposal facility) and packaging (for transportation and then again for disposal) are also considered. For example, waste forms containing SNM such as spent fuel will require safeguards through the operating life of a repository and may even require minimal safeguards following closure, in addition to the standard safeguards and security employed throughout the process. Two metrics for this criterion are defined below.

F-1.6.1 National Security Implementation Difficulty (Fissile Material Content)

This metric is used to assess the need for additional domestic MC&A and international safeguards measures to ensure that there is minimal likelihood of material theft/diversion. This metric is a measure reflecting the fissile content and the related MC&A/safeguards implementation difficulty. This metric is rated as:

Minimal, Moderate, High.

F-1.6.2 Radiological Dispersion Device (and Sabotage) Prevention Implementation Difficulty

This metric is used to assess the need for additional security measures to ensure that there is minimal likelihood that materials could be sabotaged in-place or be taken (e.g., theft) for use in a radiological dispersive device. This metric is a measure reflecting the dose and dispersal risks, and the related security implementation difficulty. This metric is rated as:

Minimal, Moderate, High.

F-1.7 Discussion of Differential to System-Level Cost

The differential system-level cost of a disposal option considers the costs of waste form generation through disposal and closure of the disposal concept. Such considerations include related costs for handling, transportation, storage, packaging, site characterization, licensing, and operations beyond the baseline costs that are discussed in Section 3. Aspects of any disposal option will be common across the range of options and are used as the baseline for this discussion. Qualitatively, a twofold change to baseline cost would indicate that one option is much more expensive than another. Because of the coarse nature of assessing such cost differential at this high level, major cost differentials for a disposal option are discussed and indicated as either decreasing or increasing cost relative to the baseline.

F-1.8 Discussion of Institutional Considerations

Within this study, technical considerations are the primary focus for evaluating the disposal options across the set of waste types, waste forms and the disposal concepts covered herein. These considerations include feasibility of the various processes in order to make assessments and recommendations on viable disposal options. Consistent with the goal of the study to provide input to strategic decisions and policy

decisions regarding disposal options, this study acknowledges programmatic constraints, including legal, regulatory, and contractual requirements, where applicable, but does not use those to constrain the technical evaluations. For example, the identification of waste types requiring deep geologic isolation is based on consideration of overall risk, rather than on specific U.S. legal and regulatory requirements. Any such programmatic constraints would need to be explicitly addressed prior to implementing any strategy or policy that would be based on technical recommendations that are currently subject to additional legal, regulatory, or contractual considerations. These discussions include consideration of consent-based siting issues as well as regulatory aspects themselves.

F-2. Additional Cross-Cutting Characteristics Considerations for Evaluated Waste Groups

F-2.1 Small Waste Forms

The waste forms discussed below and summarized in Table F-1 could have small physical dimensions such that they could be suitable candidates for disposal in deep boreholes.

Table F-1. Volumes of small waste forms suitable for deep borehole disposal

Waste	Volume as disposed of (ft ³)	Approximate number of deep boreholes required for disposal
Salt from EMT of all sodium-bonded fuel	75	1
CWF and MWF from EMT of sodium-bonded fuel	4,650	2
Calcine waste disposed of without further treatment	182,000	52
SBW treated by fluidized bed steam reforming	25,500	7
Cesium/strontium capsules disposed of without further treatment	126	1
Selected DOE-managed SNF (excludes naval SNF, N Reactor SNF, and Fort St. Vrain SNF)	60,100	17
SRS HLW glass designed to be disposed of in a deep borehole	141,000	40
Hanford HLW glass designed to be disposed of in a deep borehole	498,000	140
FRG HLW glass at Hanford	107	1

Salt, granular solids, and powders (waste forms included in WG8)—Wastes that are in the form of salt, granular solids, and powders are also good candidates for disposal in a deep borehole because these wastes have not yet been packaged for disposal. These wastes include salt waste from EMT of sodium-bonded fuel, calcine waste that could be disposed of without further treatment, SBW that has been treated by fluidized bed steam reforming, and cesium/strontium capsules that could be disposed of without further treatment. The salt waste from EMT of sodium-bonded fuel could be disposed of in a single borehole. Assuming the calcine waste was disposed of in 12-in. diameter canisters, this waste could be disposed of in approximately 50 deep boreholes. Assuming the SBW is disposed of in 12-in. diameter canisters, this waste could be disposed of in approximately seven boreholes. The entire set of cesium/strontium capsules could be disposed of in a single borehole.

Engineered waste forms specifically designed to fit in a borehole (included in WG4)—Some engineered waste forms have not yet been fabricated and so could be designed to fit in a deep borehole. These waste forms include glass-bonded sodalite CWF produced from the salt waste stream from EMT of sodium-bonded fuel, and an alloyed MWF (currently in ingot form) that is also produced from the metallic waste stream from EMT of sodium-bonded fuel. The CWF produced after EMT of all sodium-bonded fuel could be disposed of in approximately two boreholes, along with the MWF produced after the same process. This would require modifying the proposed dimensions of these waste forms to those that are appropriate for disposal in a borehole.

DOE spent fuel (waste forms included in WG5, WG7, and WG9)—The DOE has spent fuels that have not yet been packaged for disposal, that consist of scrap, tubes, rods, cylinders, plates, coated particles that are small enough (in many cases) to fit in a deep borehole. Those wastes that have already been packaged (e.g., N Reactor fuel) or that are too large (e.g., Fort St. Vrain fuel hexagonal graphite blocks) are not candidates for disposal in a deep borehole without further processing/handling, which would introduce further costs and risks. Assuming appropriate packaging, the DOE-managed spent fuel could be disposed of in approximately 17 deep boreholes. This estimate excludes N Reactor fuel, the Fort St. Vrain fuel, and naval SNF.

HLW glass (waste forms included in WG3)—This refers primarily to the HLW at both Hanford and Savannah River that is projected to be turned into glass but that has not yet been vitrified. For this projected waste, the molten HLW glass could, in theory, be poured into canisters that have been specifically designed to fit in a deep borehole and be disposed of accordingly. Assuming the same disposal volume for the borehole-bound waste forms as is currently projected, about 140 boreholes would be needed to dispose of 15-ft long Hanford HLW glass logs, and about 40 boreholes would be needed to dispose of 10-ft long SRS HLW glass logs. A significant drawback to disposing of the projected HLW glass in this manner is that the vitrification plants and waste handling facilities would have to be redesigned to accommodate the smaller diameter waste canisters. Additionally, the 34 strontium- and cesium-containing glass logs that were intended to provide a heat source for tests in the FRG also appear to be viable candidates for disposal in a deep borehole, as the logs are contained in canisters with a 30-cm (12-in.) diameter.

F-2.2 Non-Naval HEU Waste Forms

The following non-naval waste forms have HEU (defined as an enrichment of 20% or greater) and/or plutonium, and may need additional Safeguards and Security measures (see discussion above and Table A-5):

- WG5
 - DOE Spent fuel Group 3 (7 MTHM, U-Zirc fuel)
 - DOE Spent fuel Group 4 (4 MTHM, U-Mo fuel)
 - DOE Spent fuel Group 16 (8 MTHM, U-Alx)
 - DOE Spent fuel Group 18 (7 MTHM, U₃Si₂)
 - DOE Spent fuel Group 21 (<1 MTHM, Pu/U carbide, non-graphite clad, not sodium-bonded)
 - DOE Spent fuel Group 27 (<1 MTHM, U-zirc hydride, stainless steel/Incoloy clad)
 - DOE Spent fuel Group 30 (<1 MTHM, U-zirc hydride, declad)
 - DOE Spent fuel Group 34 (<1 MTHM, miscellaneous DOE spent nuclear fuel not previously listed)
- WG6
 - DOE Spent fuel Group 31 (22 MTHM; EBR-II, INTEC, and FFTF; metallic sodium-bonded)

- DOE Spent fuel Group 31 (34 MTHM, Fermi-1 metallic sodium-bonded)
- WG7
 - DOE Spent fuel Group 5 (<1 MTHM, U oxide, zirc clad, intact)
 - DOE Spent fuel Group 8 (<1 MTHM, U oxide, stainless steel/hastelloy clad, intact)
 - DOE Spent fuel Group 11 (<1 MTHM, U oxide, non-alum clad, non-intact or declad)
 - DOE Spent fuel Group 14 (4 MTHM, U oxide, alum clad)
 - DOE Spent fuel Group 22 (3 MTHM, MOX, zirc clad)
 - DOE Spent fuel Group 23 (11 MTHM, MOX, stainless steel clad)
 - DOE Spent fuel Group 24 (<1 MTHM, MOX, non-stainless steel/nonzirc clad)
 - DOE Spent fuel Group 25 (43 MTHM, Th/U oxide, zirc clad)
 - DOE Spent fuel Group 26 (8 MTHM, Th/U oxide, stainless steel clad)
- WG9
 - DOE Spent fuel Group 19 (25 MTHM, Th/U carbide, TRISO- or BISO-coated particles in graphite)
 - DOE Spent fuel Group 20 (2 MTHM, Th/U carbide, monopyrolytic carbon-coated particles in graphite)

Although a HEU waste group was not delineated and evaluated explicitly for each disposal concept, within the evaluated waste groups it was noted that the high fissile content of these fuels will require increased Materials Control and Accountability safeguards regardless of the disposal concept.

F-2.3 Waste Forms with Mixed Waste Characteristics

The following waste forms were identified as being potentially subject to RCRA requirements for management and disposal of hazardous waste, in addition to requirements for management and disposal of radioactive waste:

- Some HLW glass (if not de-listed from RCRA requirements) (WG3)
- Direct-disposed sodium-bonded fuel (i.e., disposed of without treatment) (WG6)
- Direct-disposed calcine waste (i.e., not processed with silica, titanium, and calcium sulfate additives- NOTE: Calcine waste treated by hot isostatic pressing without silica, titanium, and calcium sulfate additives (WG4) may also be subject to RCRA requirements) (WG8)
- Sodium-bearing waste (WG8)
- Direct-disposed cesium/strontium capsules (i.e., not vitrified) (WG8)

Because existing regulatory requirements and statutes are not part of the technical evaluation bases of this study, it is simply noted that disposal options included the above waste forms covered by RCRA requirements have additional challenges either for (1) the licensing process because of additional regulatory requirements, or (2) obtaining changes to existing regulations.

F-3. Comparison of Amounts of Waste Forms

A summary of the volumes of the waste forms and the curies of HLW considered in this study is provided below. By any measure, commercial SNF is the largest component of the waste inventory requiring geologic disposal today, and it will increase in quantity to comprise a vast majority of the volume and radionuclide inventory by 2048. Assuming for the purposes of the analysis that commercial power

generation continues unchanged from today's rate, and that all commercial SNF is eventually packaged in existing-design DPCs for storage, it is estimated that SNF will comprise 85% (by volume) of the total inventory of HLW and SNF in 2048 (Figure F-1). Note that these volumes assume that all HLW is vitrified (including the cesium/strontium capsules) except for the calcine waste, which is assumed to be processed via HIP with additives, and the SBW, which is assumed to be treated by fluidized bed steam reforming, and that all sodium-bonded fuel is assumed to have undergone EMT followed by production of (1) glass-bonded sodalite (i.e., the CWF) from the salt waste stream and (2) alloyed MWF from the metallic waste stream.

It is estimated that the vast majority (i.e., 98% by mass) of the SNF inventory in 2048 will be commercial SNF (Figure F-2), with the remaining 2% of the mass being DOE-managed SNF.

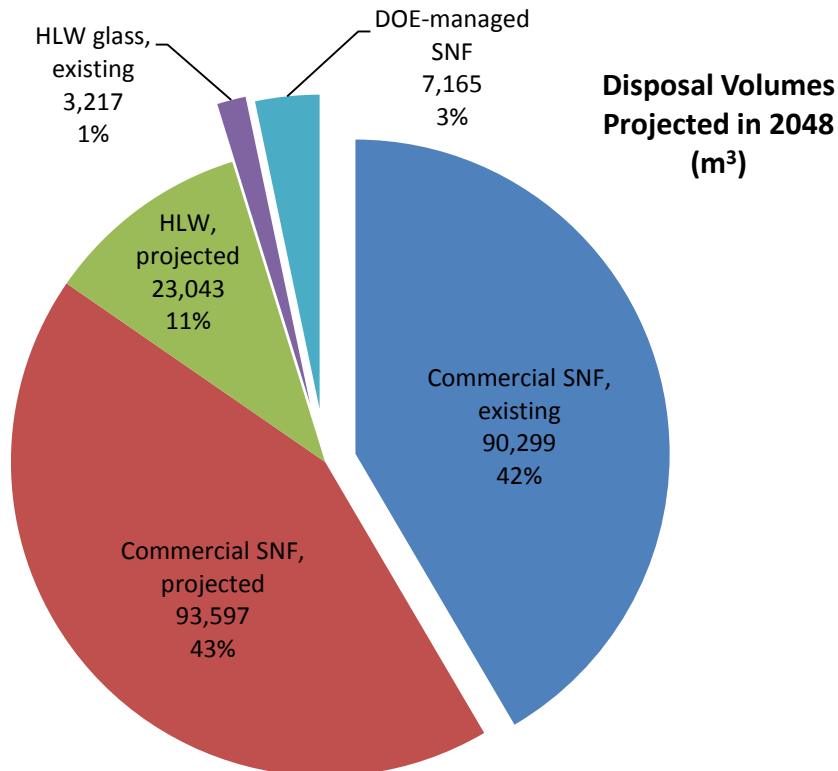

NOTE: Volume estimates assume (1) constant nuclear power generation in commercial reactors and disposal of all commercial SNF in dual-purpose canisters, (2) calcine is processed by hot isostatic pressing with additives, (3) sodium-bearing waste is treated by fluidized bed steam reforming, (4) sodium-bonded fuels undergo electrometallurgical treatment, and (5) all other waste forms are vitrified. For simplicity, all DOE-managed SNF is shown as "existing"; approximately 3,500 m³ of naval SNF remains to be generated.

Figure F-1. Volumes of U.S. SNF and HLW in 2048

The large majority of the volume of DOE-managed SNF (which in itself will be ~3% by volume of the total estimated inventory of HLW and SNF in 2048—see Figure F-1), will be naval fuel (64% by volume—Figure F-3), which is packaged in large containers, followed by uranium metal fuels with Zircaloy cladding (7% by volume), primarily from the N Reactor at the Hanford Reservation. Other DOE-managed SNF, including a broad range of fuel types, comprise the remaining 29% by volume of the total inventory (Figure F-3).

Of the HLW projected to be available for geologic disposal in 2048, the largest fraction (54%) presently exists as tank waste at the Hanford Reservation. Approximately 12% of the total projected volume of

HLW in 2048 exists today in a vitrified form, with nearly all of that at SRS and the balance at WVDP and at Hanford (FRG HLW glass) (Figure F-4). If a case is considered in which the calcine waste were to be vitrified instead of being treated via HIP (with additives), the vitrified calcine would correspond to 10,137 m³ of waste, instead of 3,661 m³ of waste shown in Figure F-4. This would mean that the volume of vitrified calcine would be close to that of Hanford HLW glass (14,089 m³), and vitrified calcine would then be 31% of the waste volume, with Hanford HLW glass comprising 43% of the waste volume.

Of the HLW projected to be available for disposal in 2048, the largest fraction of activity is from HLW at the SRS, as shown in Figure F-5. For all these wastes, approximately 98% of the activity comes from ⁹⁰Sr and ¹³⁷Cs, along with their short-lived daughter products, ⁹⁰Y and ^{137m}Ba, respectively. Table F-2 gives the activities of the wastes shown in Figure F-5.

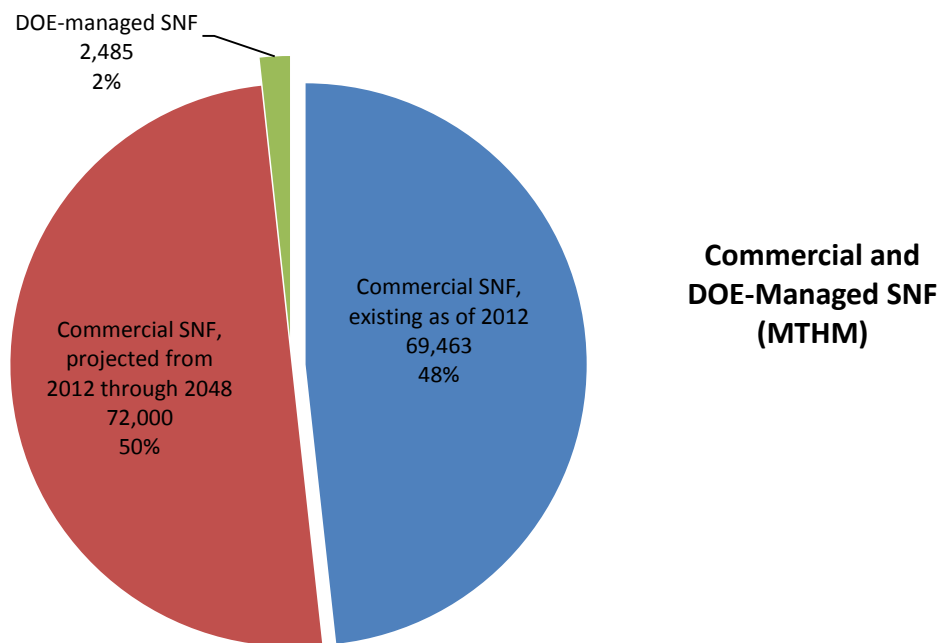

NOTE: For simplicity, all DOE-managed SNF is shown as “existing”; approximately 3,500 m³ of naval SNF remains to be generated.

Figure F-2. Masses of commercial and DOE-managed SNF, existing and projected in 2048, assuming constant rate of nuclear power generation in commercial reactors

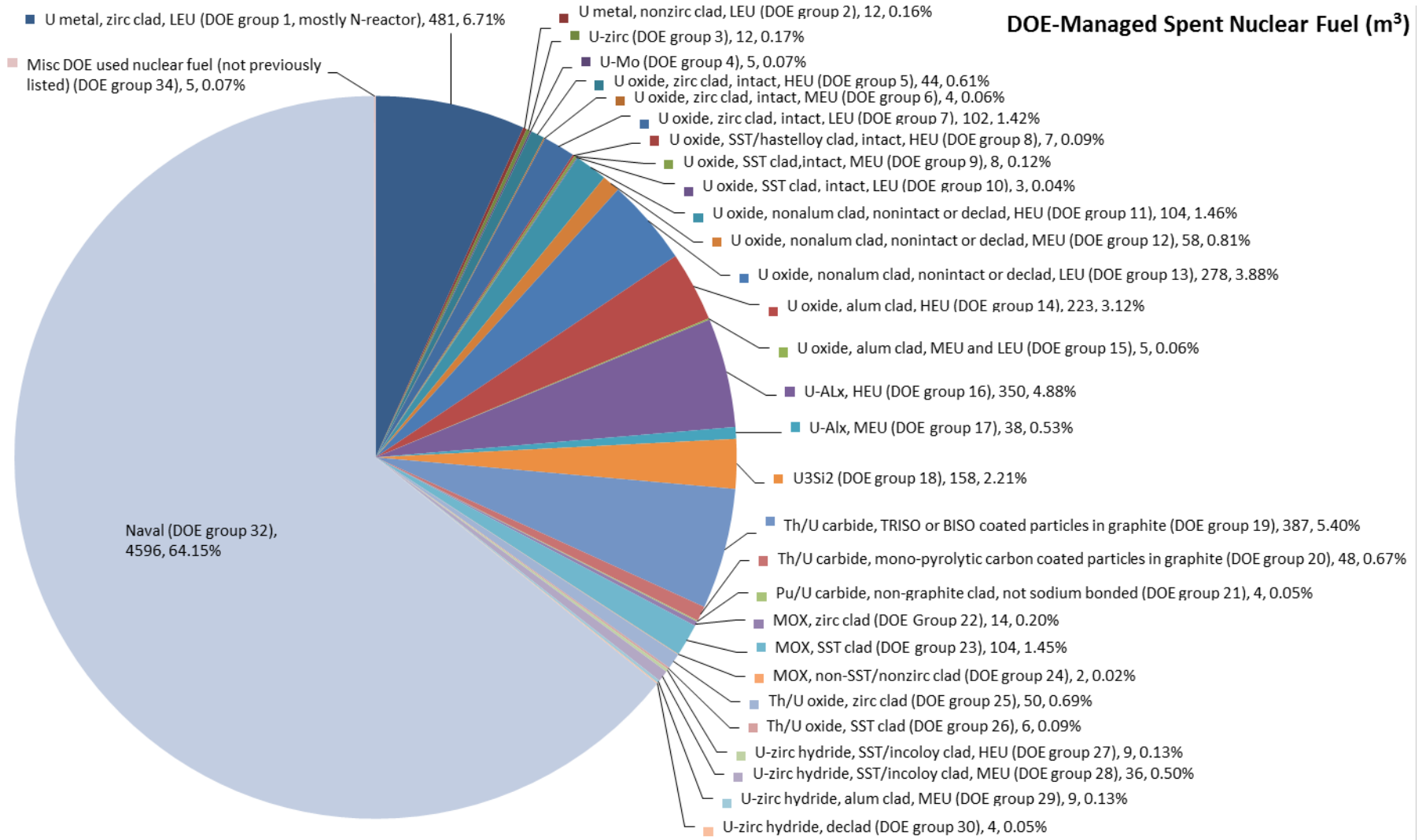

Figure F-3. Volumes of DOE-managed SNF for disposal

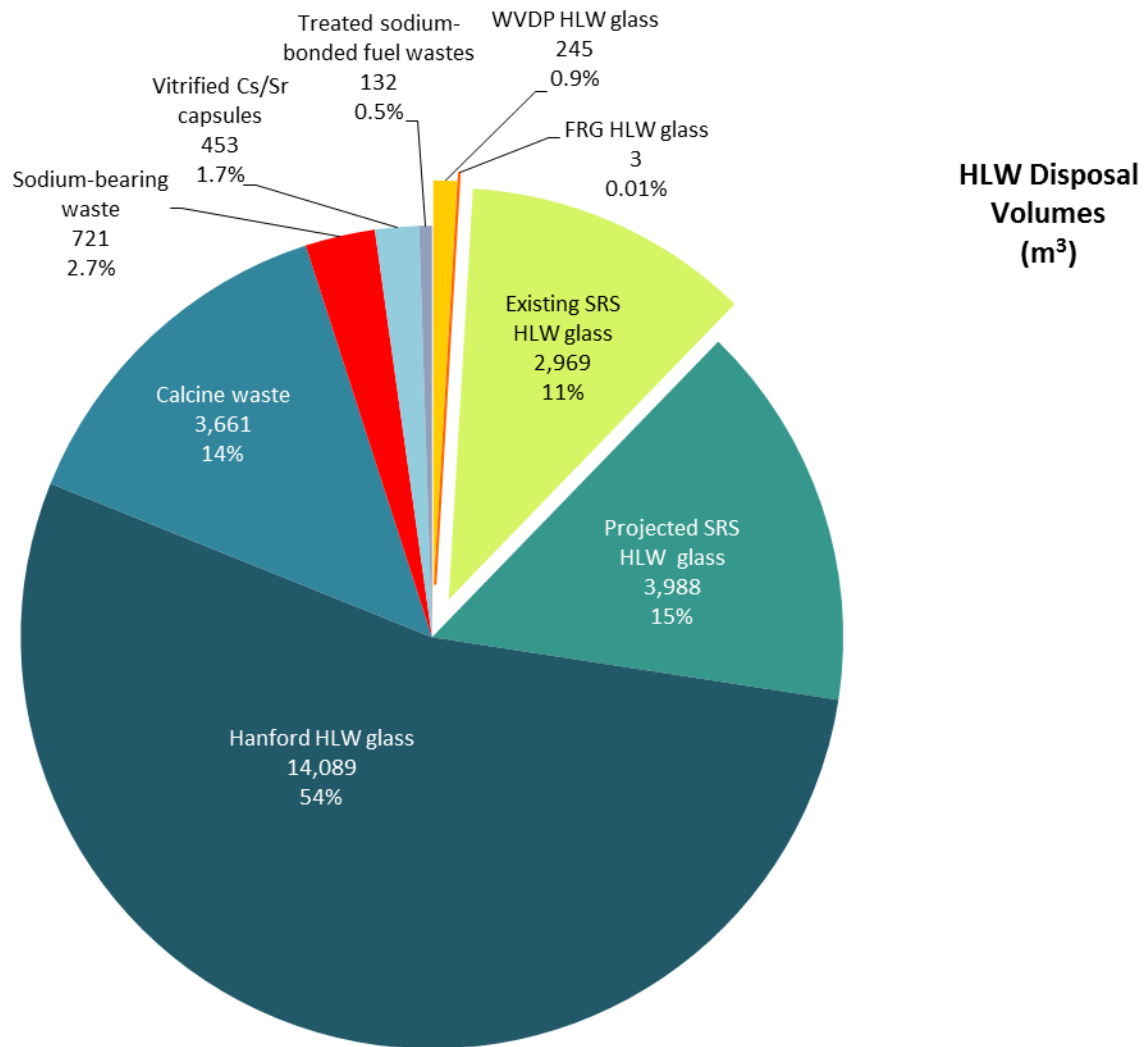

Figure F-4. Volumes of HLW projected to exist in 2048, based on the assumptions that calcine is HIP processed with additives, SBW is treated by fluidized bed steam reforming, and all waste forms other than sodium-bonded fuels at the INL are vitrified

Curies of HLW in 2048

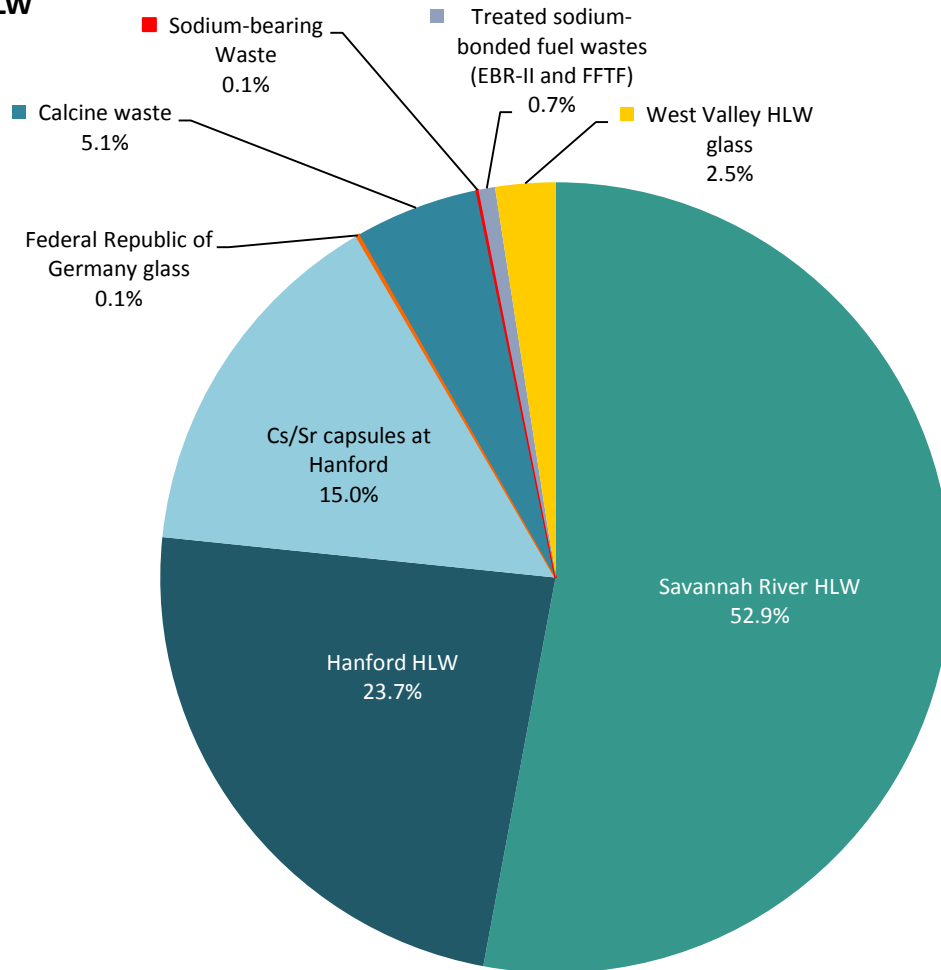

Figure F-5. Relative activity of HLW projected in 2048

Table F-2. Activity of HLW Projected in 2048

Waste Source	Curies Projected in 2048
Savannah River HLW	1.55E+08
Hanford tank HLW	6.95E+07
Cs/Sr capsules at Hanford	4.39E+07
Federal Republic of Germany glass	3.96E+05
Calcine waste	1.48E+07
Sodium-bearing waste	2.38E+05
Waste from EMT of Na-bonded fuel (EBR-II and FFTF)	1.98E+06
West Valley HLW glass	7.19E+06
Total Curies of HLW Projected in 2048	2.93E+08