



U.S. DEPARTMENT OF  
**ENERGY**

**Nuclear Energy**

# **Advanced Small Modular Reactors Materials Activities**

William Corwin  
Department of Energy  
Office of Nuclear Energy  
Office of Advanced Reactor Technologies

**DOE-NE Materials Coordination Webinar  
July 30, 2013**

# SMR Materials Work Packages Address Several Small Advanced Reactor Systems

WP No.	SMR R&D Program WBS Element Description	Remarks
SR-13IN060106	High Temperature Design Methodology - INL	VHTR, Alloy 617 Code Case (with additional funding from NGNP)
SR-13OR060107	High Temperature Design Methodology - ORNL	VHTR, Alloy 617 Code Case
SR-13AN060101	Materials for Advanced SMR Concepts - ANL	Design methodology, SFR materials
SR-13OR060103	Materials for Advanced SMR Concepts - ORNL	Design methodology, SFR materials
SR-13LA060102	Materials and Component Studies for Lead-Bismuth SMR Concepts - LANL	LBE-FR, Delta Loop compatibility testing
SR-13OR060108	SiC-SiC Composite Code Development - ORNL	VHTR, FHR, SFR
SR-13OR060105	Design and Codification Basis for SMR-Specific Materials - ORNL	Gen IV Materials Handbook
SR-13PN060104	Material Issues for SMR Operational Environments - PNNL	Integral PWR

# ASME Code Qualification Activities Address Multiple Reactor Systems

- SMR Program Activities to address key long-term design needs for application of advanced materials (ORNL, ANL & INL)
- High temperature design methodology is an enabling reactor technology
  - Removal of unnecessary conservatism in inelastic design methodology could lead to more flexibility in construction and operation of advanced SMRs
  - Gaining mechanistic understanding of long-term degradation mechanisms such as creep & creep-fatigue damage and thermal aging could provide guidance on extrapolation of accelerated time-at-temperature design data for 60-year design life, and beyond, with higher confidence
- Materials to be addressed
  - Existing ASME Code materials; 9Cr-1Mo-V steel (Grade 91), 316 stainless steel
  - Methodologies applicable to advanced materials being studied under Advanced Reactor Concepts (ARC) Program, optimized Grade 92 (with thermo-mechanical treatment) and Alloy 709 austenitic stainless steel, and Next Generation Nuclear Plant (NGNP) Program, Alloy 617

# Cyclic Softening Impacts Grade 91 and Grade 92 Ferritic-Martensitic Steels

- A cyclic softening curve can be divided into three stages: primary, secondary, and tertiary, similar to a creep curve. In the secondary stage, the cyclic stress follows a linear relationship with cycles, and thus a steady-state cyclic softening rate can be obtained.

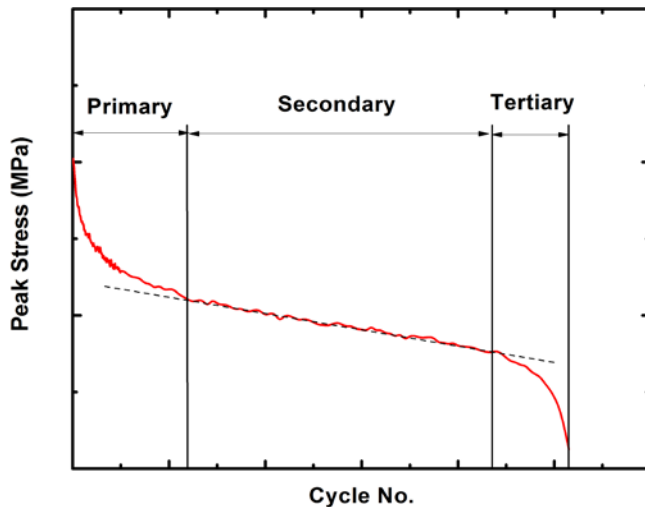

- The cyclic softening rate of G91 is significantly higher than that of optimized G92 under a given creep-fatigue test condition with a strong dependence on the waveform and hold time.

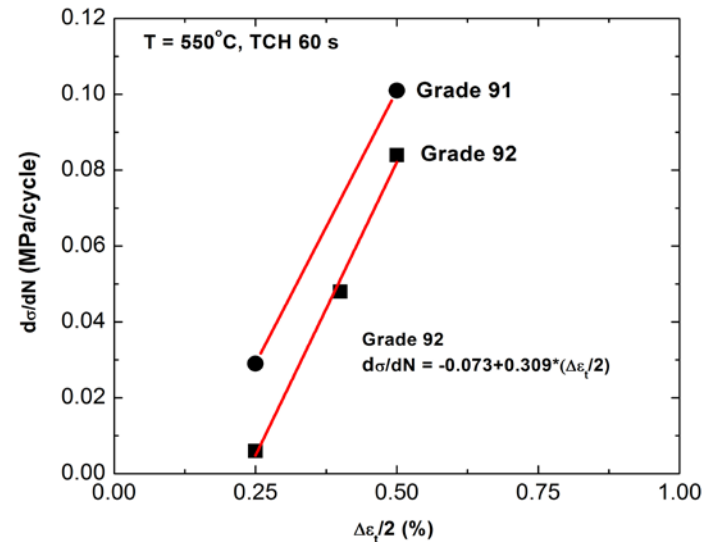

- An improved Cyclic Softening Model is established by combining the thermally-activated rate equation and steady-state cyclic softening rates.

# Damage from Sequential and Concurrent Creep-Fatigue Tests Was Compared

- Sequential and concurrent creep-fatigue tests were conducted to understand the effect of cyclic softening on creep and fatigue properties, and creep-fatigue interaction mechanisms.

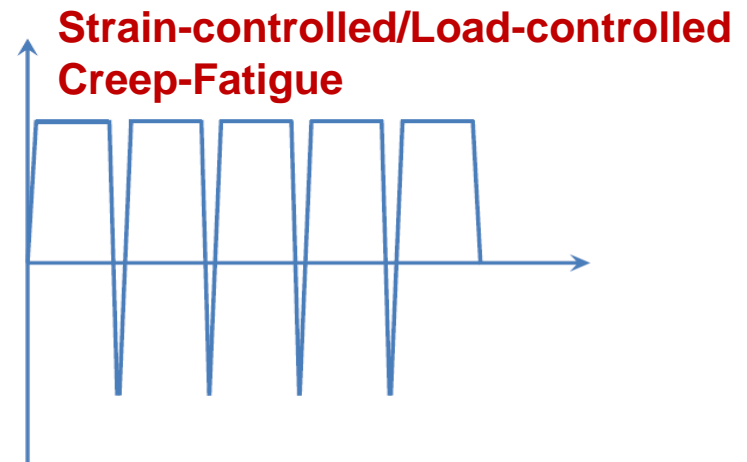
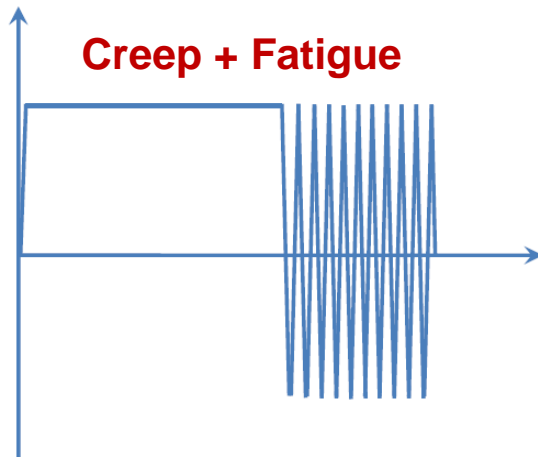
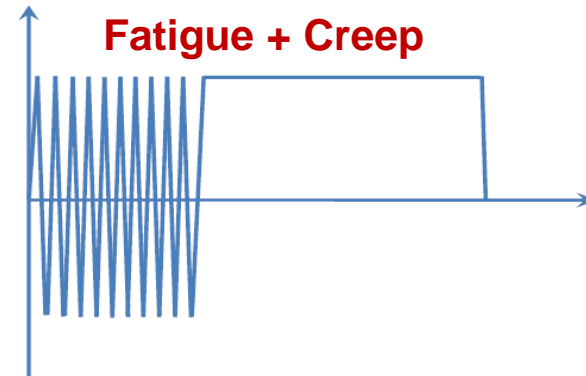
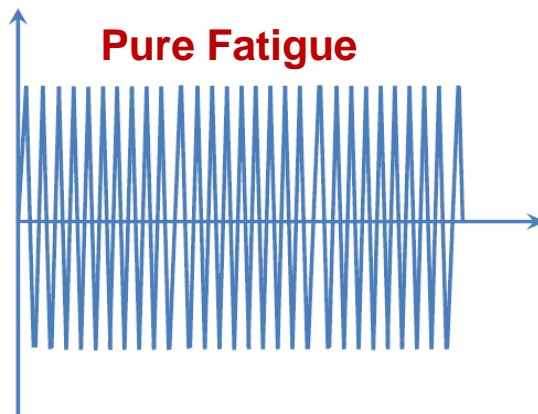

# Creep-Fatigue Interactions in Grade 91 and Grade 92 Ferritic-Martensitic Steels

- Sequential vs concurrent creep-fatigue tests showed that the synergistic interaction of creep and fatigue is most pronounced in load-controlled creep-fatigue loading conditions, followed next by strain-controlled C-F loading. Creep deformation and damage processes are accelerated by periodic cyclic loading.
- A two-step, sequential loading of creep and fatigue has either no effect or a beneficial effect on the creep or fatigue life. Therefore, sequential creep and fatigue tests cannot be used to simulate synergistic effects of creep-fatigue interaction on the life of G91 steel.
- The FY13 NEUP Program will investigate other innovative experimental approaches for C-F damage predominantly in the creep domain.

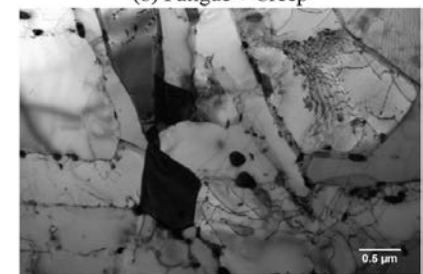
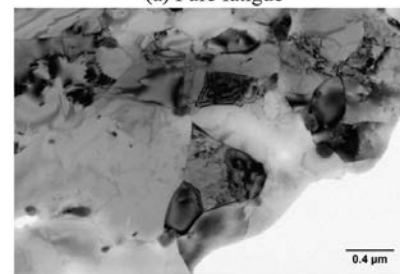
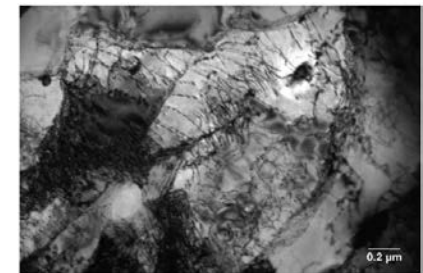
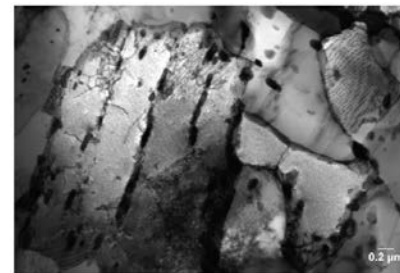
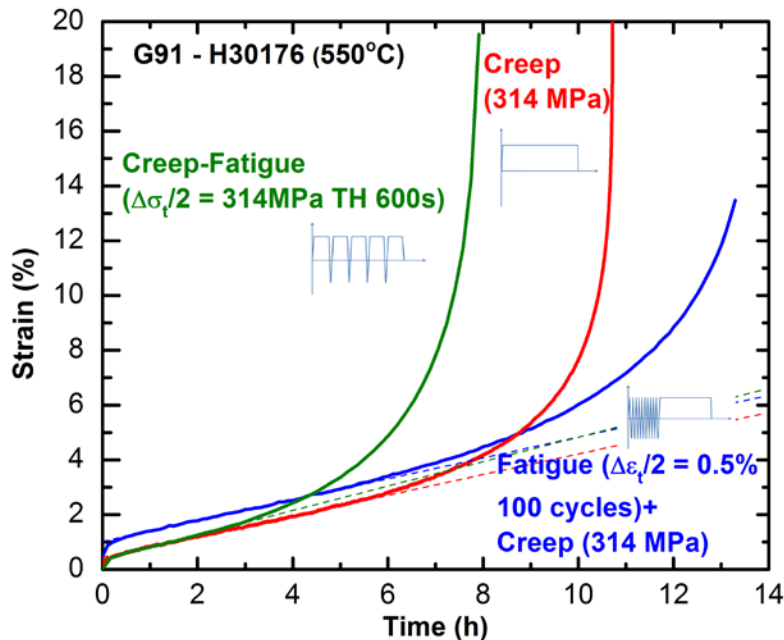

(c) Load-controlled creep-fatigue

(d) Strain-controlled creep-fatigue

# Crack Initiation & Propagation Independently Affect Life Predictions in Gr91

- Crack initiation life follows a power law relationship with the cyclic softening rate. This correlation is independent of metallurgical and mechanical variables, implying importance of cyclic deformation in crack initiation.

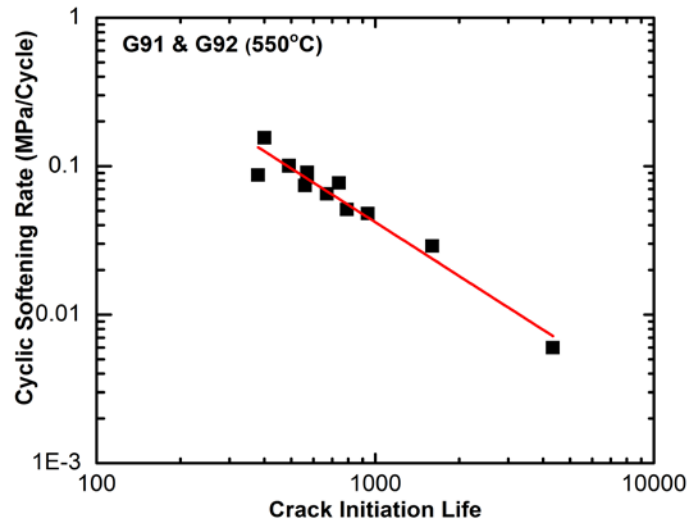

- Grain boundary cavitation observed in G91, in contrast to literature. While creep microcracks initiated primarily at the prior  $\gamma$  grain boundaries in G91, the cavitation sites in G92 are more diversified, possibly explaining better creep- and creep-fatigue-resistance of optimized G92 than G91.
- Creep cracks grow along the loading direction. Fatigue cracks advance in the direction perpendicular to the loading direction. Oxidation plays an important role in fatigue crack initiation and propagation.

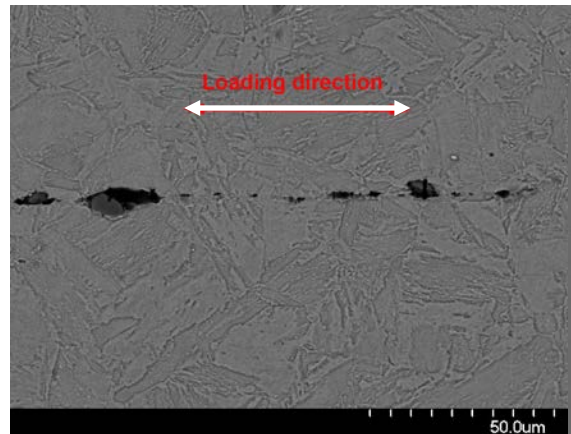

**Creep Damage**

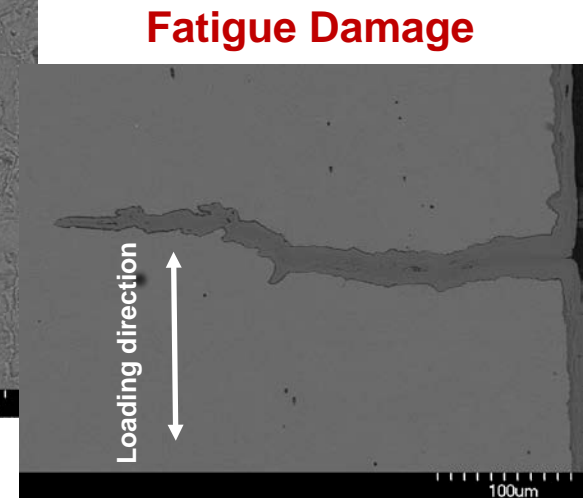

- Crack initiation and crack propagation should be separately considered and modeled, and creep-fatigue-oxidation interaction mechanisms should be considered in both crack initiation and propagation.



# Aging Affects Transition Behavior and Ductile Fracture Toughness of Grade 91

- Cleavage and ductile fracture toughness testing are being carried out to obtain Master Curve  $T_0$  values,  $J_{IC}$ , and tearing modulus on both aged and unaged grade 91 steels. The test conditions are:

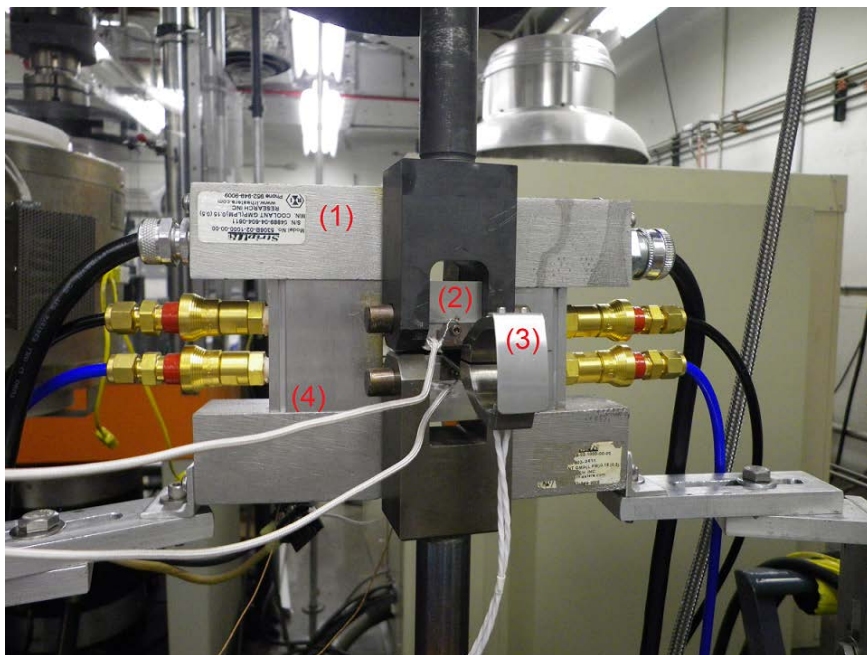

Fracture toughness testing setup. (1) Infrared heating lamp, (2) compact tension specimen, (3) displacement gage, (4) potential probe

Condition	Heat	Aging conditions	Test temps
Unaged	30176	–	24, 300, 500, 600°C
Aged	30394	593°C, 25K hrs	
	30394	704°C, 10K hrs	
	XA3619	538°C, 120K hrs	



# Low Temperature Aging Is More Harmful for Grade 91

- In general, aging at high temperatures slightly improves ductile fracture toughness similar to CVN USE results, but aging at lower temperatures reduces toughness

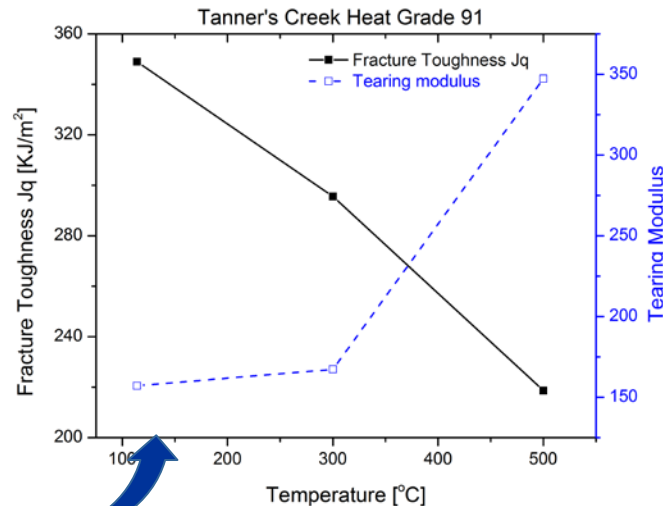
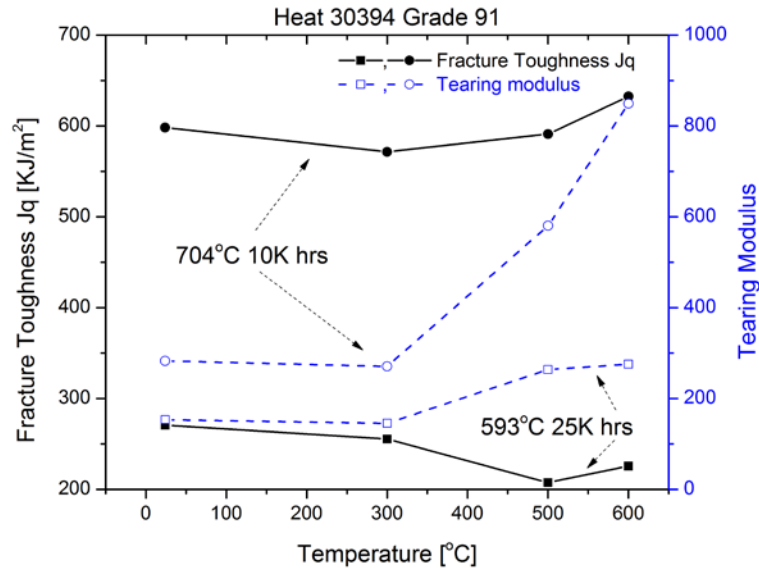
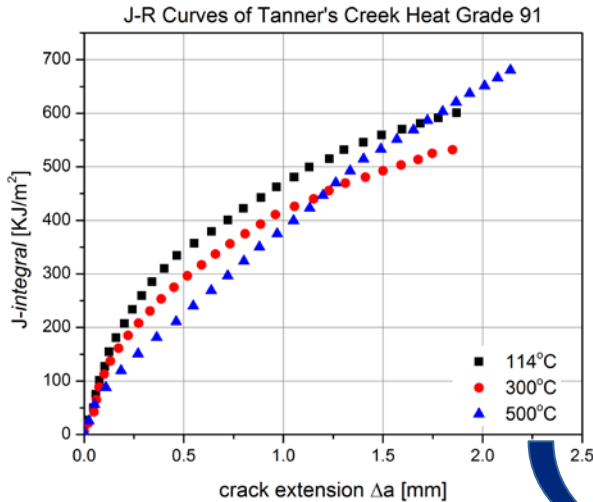

- Material aged at 704C/10K h exhibited better fracture toughness than the material aged at 593C/25K, in agreement with Charpy and transition temperature test results
- Long-term aging at 538C/120K significantly reduced fracture toughness (Jq) and tearing modulus of Grade 91, which was affected by test temperature

# Microstructure-Fracture Properties Correlation Support Aging Models

- A variety of microanalysis techniques, including SEM, TEM, and 3D digital microscopy, is being used to study material microstructure-fracture properties correlation

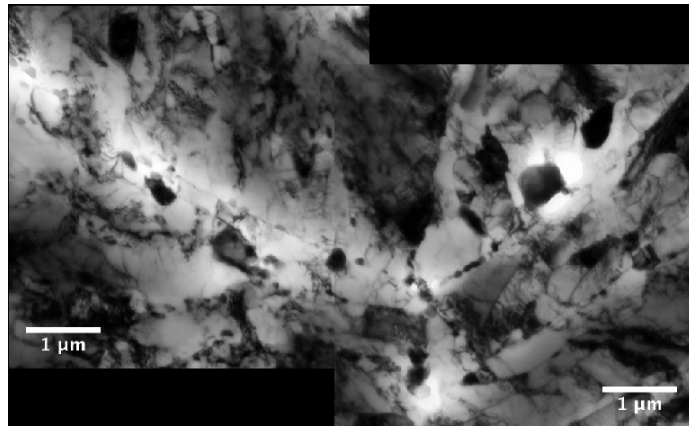

*TEM microstructure characterization of aged grade 91 steel*

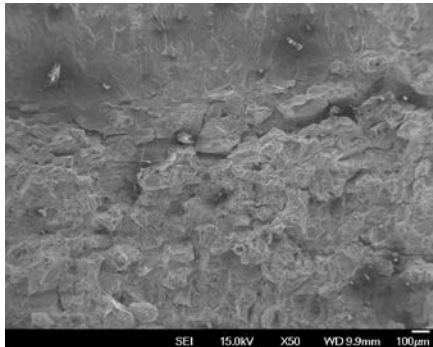

*SEM fractograph*

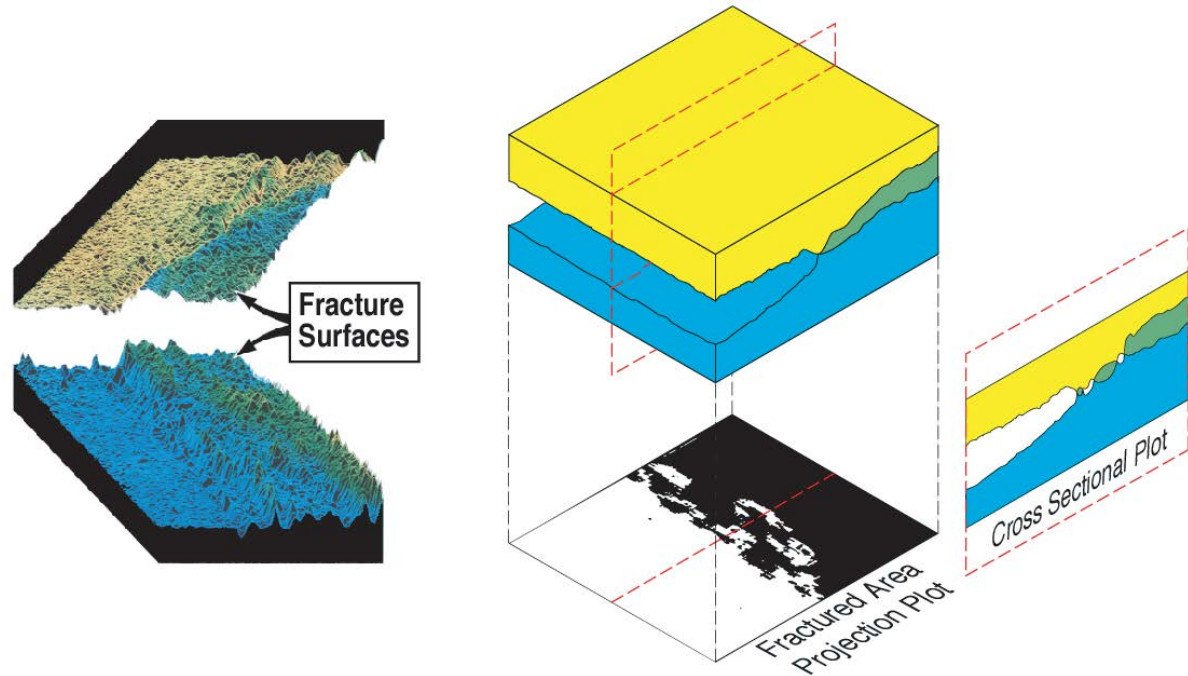

*Fracture surface reconstruction [after SRI International, Advancing Fracture Science with FRASTA]*

# Mechanism-Based Creep Fracture Modeling Used for Long-Life Predictions

- Develop mechanisms-based methodology for constructing long-term (60 years) creep fracture maps to support extension of time-dependent allowable stresses by delineating different creep fracture regimes for long service lives
- Migration of the 2D ABAQUS user subroutines to a public domain 3D parallel finite element code (WARP3D) is complete

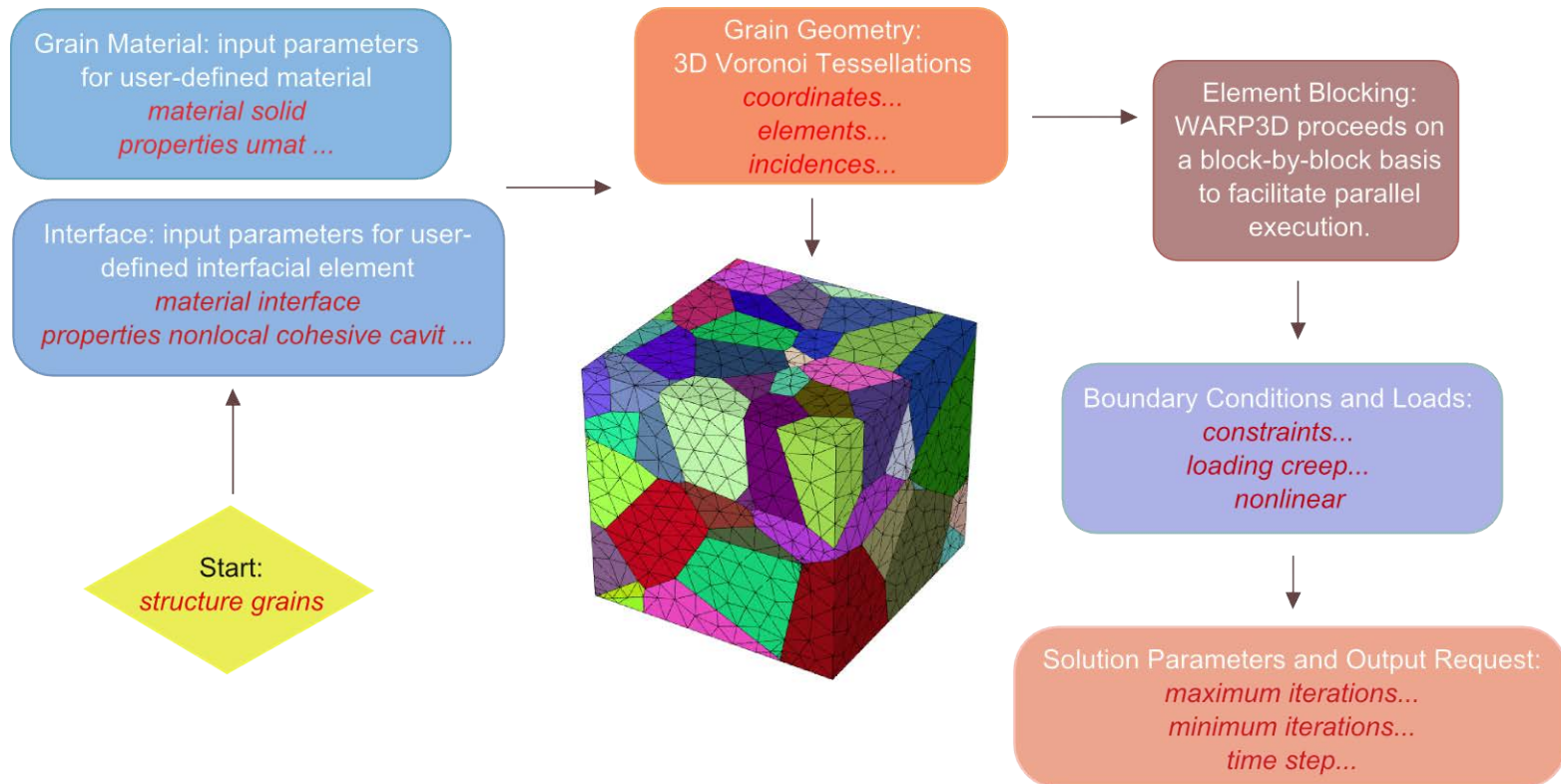

# LANL Delta Loop Being Used to Evaluate Materials for LBE Service

## Design/Performance :

- \* Up to 2 m/s in 2.54 cm diameter  
~ 3 m long test section
- \* Up to 100° C  $\Delta T$  between heater section and heat exchanger exit
- \* Up to 550° C operation in the test section
- \* Capable of free convection flow
- \* All 316L construction
- \* Gas injection system for oxygen control

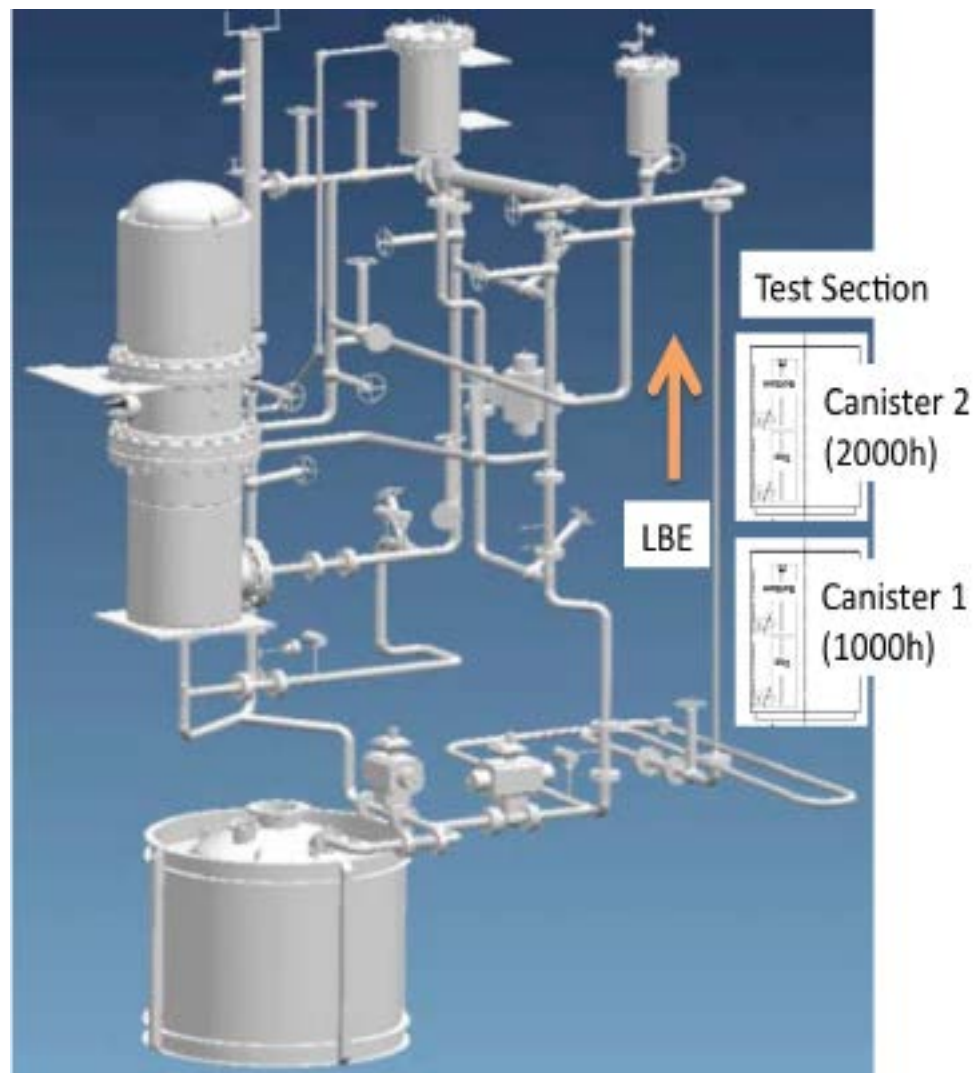



\* **Corrosion resistance:**

**Exposure up to 3000h in flowing LBE at 500°C  
and Oxygen concentration  $10^{-6}$ - $10^{-8}$   
wt%.**

*Thin test coupons are placed in a  
cylindrical holder that is lowered into  
the test section.*

\* **Flow-rate resistance:**

**LBE velocities up to 3.5 m/s**

\* **Total of 144 specimens tested**

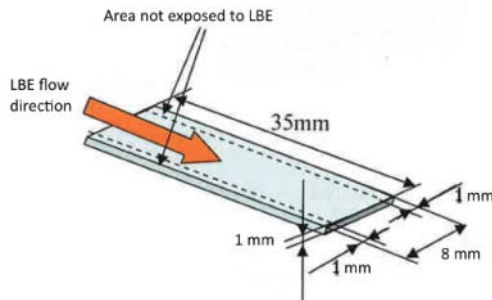

*Canister loaded with 48 specimens*

**Goal: Understand flow velocity and high-temperature effects on  
LBE steel corrosion properties for exposure times >2000h**

# Materials Include Commercial and Model Alloys (Cr, Si & Al), ODS, and New Cladding

## Nuclear Energy

Material	Fe	C	Mn	Si	Cr	Ni	Mo	V	W	Nb	Al	Y2O3	Ti
HT-9 (2048)	Bal.	0.18	0.4	0.2	12.26	0.49	1	0.3	0.46		---	---	---
T91	Bal.	0.105	---	0.43	8.26	0.13	0.95	0.2	---	0.075	---	---	---
EP823 (2054)	Bal.	0.16	0.55	1.09	11.7	0.66	0.74	0.3	0.6		---	---	---
MA956	Bal.	0.04	---	---	20	---	---	---	---	---	4.5	0.5	0.4
PM2000	Bal.	0.01	---	---	20	---	---	---	---	---	5.5	0.5	0.5
1.4970	Bal.	0.11	1.4	0.3	15	15	0.48	---	---	---			0.48
APM	Bal.	< 0.08	< 0.4	< 0.7	20.5-23.5	---	---	---	---	---	5.8	---	---
APMT	Bal.	< 0.08	< 0.4	< 0.7	21		3	---	---	---	5	---	---
Alkrothal 14	Bal.	< 0.08	< 0.5	< 0.7	14-16	---	---	---	---	---	4.3	---	---
Alkrothal 720	Bal.	< 0.08	< 0.7	< 0.7	12-14	---	---	---	---	---	4	---	---
Alloy 4	88	---	---		12	---	---	---	---	---	---	---	---
Alloy 8	87.5	---	---	0.5	12	---	---	---	---	---	---	---	---
Si-Fe "A"	Bal.	0.01	0.04	1.24	0.09	0.08	0.01	< 0.01	0.03	< 0.01	0.005	---	0.003
Si-Fe "B"	Bal.	0.017	0.12	2.55	0.08	0.15	< 0.01	< 0.01	< 0.02	< 0.01	0.003	---	0.006
316 L	Bal.	0.002	1.8	0.46	17.5	12.3	2.3	---	---	---	---	---	---

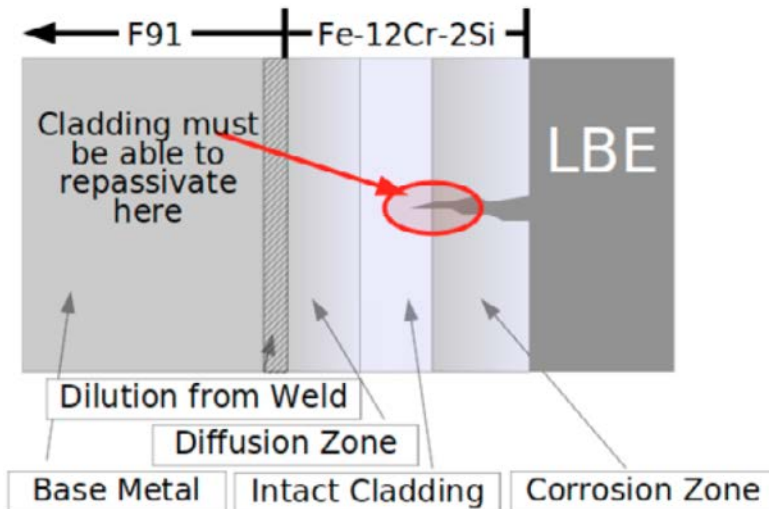

**~ 1mm weld-overlaid Fe-Cr-Si layer on F91 (Fe-9Cr-1MoNbVW) base metal**

*M.P. Short, R. G. Ballinger, Nucl. Tech. 177 (2012) 366*

# Initial LBE Flow Corrosion Results Rank Test Materials

Samples	Oxide thickness
APM	1 $\mu\text{m}$
APMT	5 $\mu\text{m}$
MA956	5 $\mu\text{m}$
EP823	10 $\mu\text{m}$
G92	10 $\mu\text{m}$
HT-9	20 $\mu\text{m}$
ALK14	15 $\mu\text{m}$
ALK720	10 $\mu\text{m}$
PM2000	1 $\mu\text{m}$

- ***Thinnest oxide layer observed with Al-added material (e.g MA-956, Kanthal alloys)***
- ***Double layer oxide observed with high Cr materials***
- ***Addition of Si to materials help oxide stability***
- ***Oxide layer appears stable at high flow rates (3.5 m/s)***

Flow conditions	
T [C]	488
Flow-rate [ $\text{m}^3/\text{h}$ ]	5.3
Velocity [m/s]	3.5
Oxygen concentration [wt%]	2.3 x $10^{-5}$



# ASME Code Development for SiC-SiC Composite in Progress

- **Sec III Div 5 Rules for Construction of High-Temperature Reactors (11/11)**
  - **Class A Non-metallic Core Support Structures, SubPart B Ceramic Composites**

Section	Status	Progress since 2/2013
HHB-1000 Introduction	1 <sup>st</sup> draft complete	
HHB-2000 Materials	1 <sup>st</sup> draft in progress; appendices defined	<ul style="list-style-type: none"> <li>- 1<sup>st</sup> draft being prepared for initial ballot</li> <li>- Mandatory and non-mandatory appendices and other associated documents defined</li> </ul>
HHB-3000 Design	2 <sup>nd</sup> draft in progress	<ul style="list-style-type: none"> <li>- 1<sup>st</sup> ballot for “review and comments” completed</li> <li>- Work on 2<sup>nd</sup> draft initiated</li> </ul>
HHB-4000 Fabrication and Installation	1 <sup>st</sup> draft in progress	
HHB-5000 Examination	1 <sup>st</sup> draft in progress	
HHB-6000 Testing	1 <sup>st</sup> draft in progress	
HHB-8000 Preparation of Reports	Drafting to be initiated	

# Support ASTM SiC-SiC Composite Standards Development in Progress

## ■ ASTM C28 on Advanced Ceramics (SC 28.07 on Ceramic Matrix Composites)

Standards	Status	Progress since 2/2013
Specifications for C-C composite for nuclear applications	Concurrent ballot closed	Revised and submitted for concurrent ballot (2 <sup>nd</sup> subcommittee ballot and 1 <sup>st</sup> main committee ballot); ballot now closed
Specifications for SiC-SiC composite for nuclear applications	1 <sup>st</sup> draft being reviewed	Drafting for 1 <sup>st</sup> subcommittee ballot completed
Test method for axial tensile properties of CMC tubes	To be published as ASTM Standard C1773	Final proofing complete Planning of round robin in progress
Test method for flexural properties of CMC tubes	1 <sup>st</sup> draft being finalized	1 <sup>st</sup> draft completed working group review Planning of validation test initiated

- ASTM standard specifications above will be adopted to ASME composite code
- Leverage with LWRS fuels program and other non-DOE programs
  - *Test methods for hoop tensile properties of CMC tubes, shear strength of ceramic joints, and trans-thickness tensile properties of CMC at elevated temperatures*

# Irradiation & Environmental Effects Studies in Support of Code Development

## ■ Irradiation Resistance

- Reference SiC/SiC composite irradiated in HFIR to >70 dpa
- Good news: No progressive development of swelling & thermal conductivity decrease beyond initial transient –
  - *True saturation in defect accumulation in SiC demonstrated*
  - *Strength of matrix (high purity SiC) seemed to be retained.*
- Bad news: Degradation of composite strength was observed for first time.
  - *Fracture surface indicated degradation of Hi-Nicalon™ Type S fiber*
  - *TEM revealed substantial modification in interphase microstructures*

## ■ Initial assessment of environment effect issues complete—scoping studies warranted

- HTGR and SFR: reaction of carbon interphase is possible in presence of oxygen
- FHR: usual protection mechanism with silica scale won't work; oxidation of SiC possible at high  $P_{O_2}$  and basic salt or with very low  $P_{O_2}$

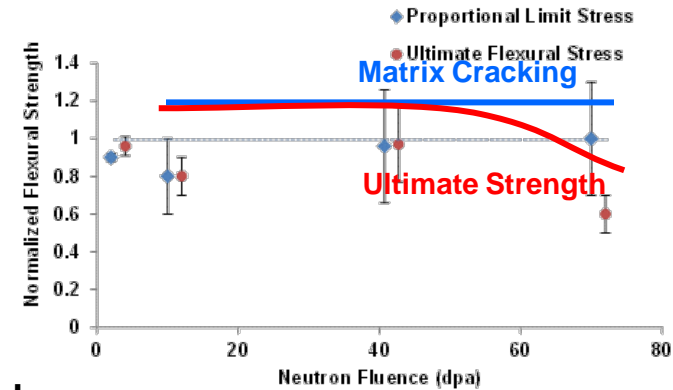

Hi-Nicalon Type-S SiC/SiC  
>70 dpa at 800°C

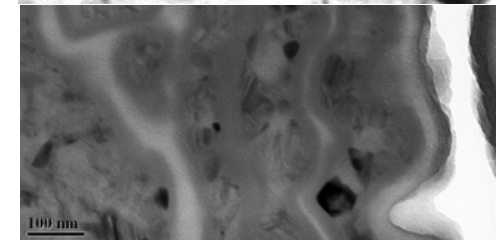
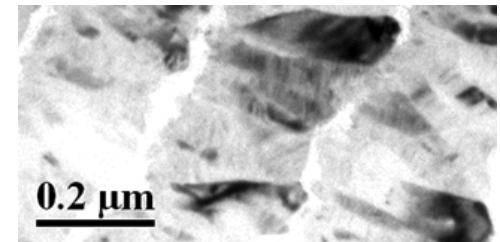

Multilayer PyC interphase:  
Unirr (top) / Irradiated (bottom)

# SiC/SiC Has Potential Applications for Many Nuclear Energy Systems

Reactor Concept	Application	Operating Condition	Is SiC/SiC Essential for Concept?	Project / Design Examples
Fusion	<ul style="list-style-type: none"> <li>Blanket structures</li> <li>Various functions</li> </ul>	<ul style="list-style-type: none"> <li>He, Pb-Li</li> <li>400-1200°C</li> <li>&gt;50 dpa</li> </ul>	<ul style="list-style-type: none"> <li>Essential</li> </ul>	<ul style="list-style-type: none"> <li>ARIES</li> <li>EU-PPCS</li> <li>DREAM</li> </ul>
(V)HTGR	<ul style="list-style-type: none"> <li>Reaction control systems</li> <li>Core support</li> </ul>	<ul style="list-style-type: none"> <li>He</li> <li>600-1200°C</li> <li>Up to ~40 dpa</li> </ul>	<ul style="list-style-type: none"> <li>Needed for high temp/fluence designs</li> </ul>	<ul style="list-style-type: none"> <li>NGNP</li> <li>PBMR</li> <li>GT-HTR300C</li> </ul>
LWR	<ul style="list-style-type: none"> <li>Channel box</li> <li>Grid separator</li> <li>Fuel cladding</li> </ul>	<ul style="list-style-type: none"> <li>Water</li> <li>300-500°C</li> <li>~10 dpa</li> </ul>	<ul style="list-style-type: none"> <li>Option for accident-tolerant core</li> </ul>	<ul style="list-style-type: none"> <li>PWR (WHC)</li> <li>BWR (EPRI)</li> </ul>
FHR/AHTR	<ul style="list-style-type: none"> <li>Core structures</li> <li>Reaction control systems</li> </ul>	<ul style="list-style-type: none"> <li>Liquid salt</li> <li>~700°C</li> <li>&gt;10 dpa</li> </ul>	<ul style="list-style-type: none"> <li>Needed for high temp/fluence designs</li> </ul>	<ul style="list-style-type: none"> <li>AHTR</li> <li>DOE IRP concepts</li> <li>SMR's</li> </ul>
SFR	<ul style="list-style-type: none"> <li>Core structures</li> <li>Fuel cladding/support</li> </ul>	<ul style="list-style-type: none"> <li>Liquid sodium</li> <li>500-700°C</li> <li>&gt;100 dpa</li> </ul>	<ul style="list-style-type: none"> <li>Potential option</li> </ul>	<ul style="list-style-type: none"> <li>CEA</li> </ul>
GFR	<ul style="list-style-type: none"> <li>Core structures</li> <li>Fuel cladding/support</li> </ul>	<ul style="list-style-type: none"> <li>He</li> <li>700-1200°C</li> <li>&gt;100 dpa</li> </ul>	<ul style="list-style-type: none"> <li>Essential</li> </ul>	<ul style="list-style-type: none"> <li>CEA</li> <li>GA EM<sup>2</sup></li> </ul>

# ORNL Design and Codification Basis for SMR-Specific Materials

- ***The Gen IV Materials Handbook started full operation in 2009.***
- ***Mandatory data contributions from 9 GIF Signatories***
- ***Will manage >\$150M of high temperature structural materials data.***
- ***DOE Nuclear Concrete Materials Database and ASME Materials Database are program spinoffs***

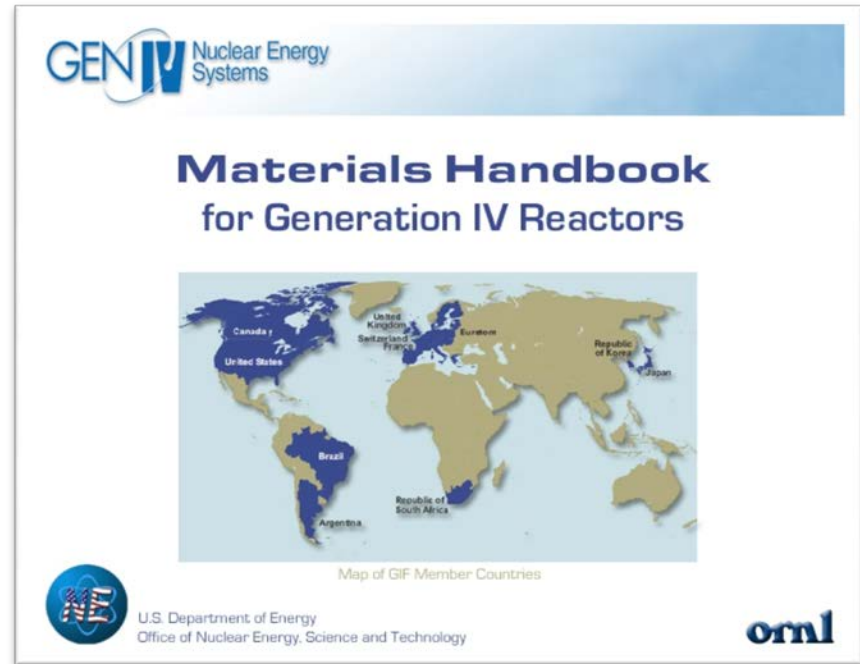

# Handbook Structural Development and Data Contributions in FY13

- Continue GIF R&D report and data management in coordination with NEA
- Completed uploading of >300 individual creep test data records into Metals Volume
- Initiated more creep data contributions after terminology unification through evolutionary uploading.
- Continued Graphite Volume design & development and began evolutionary data uploads

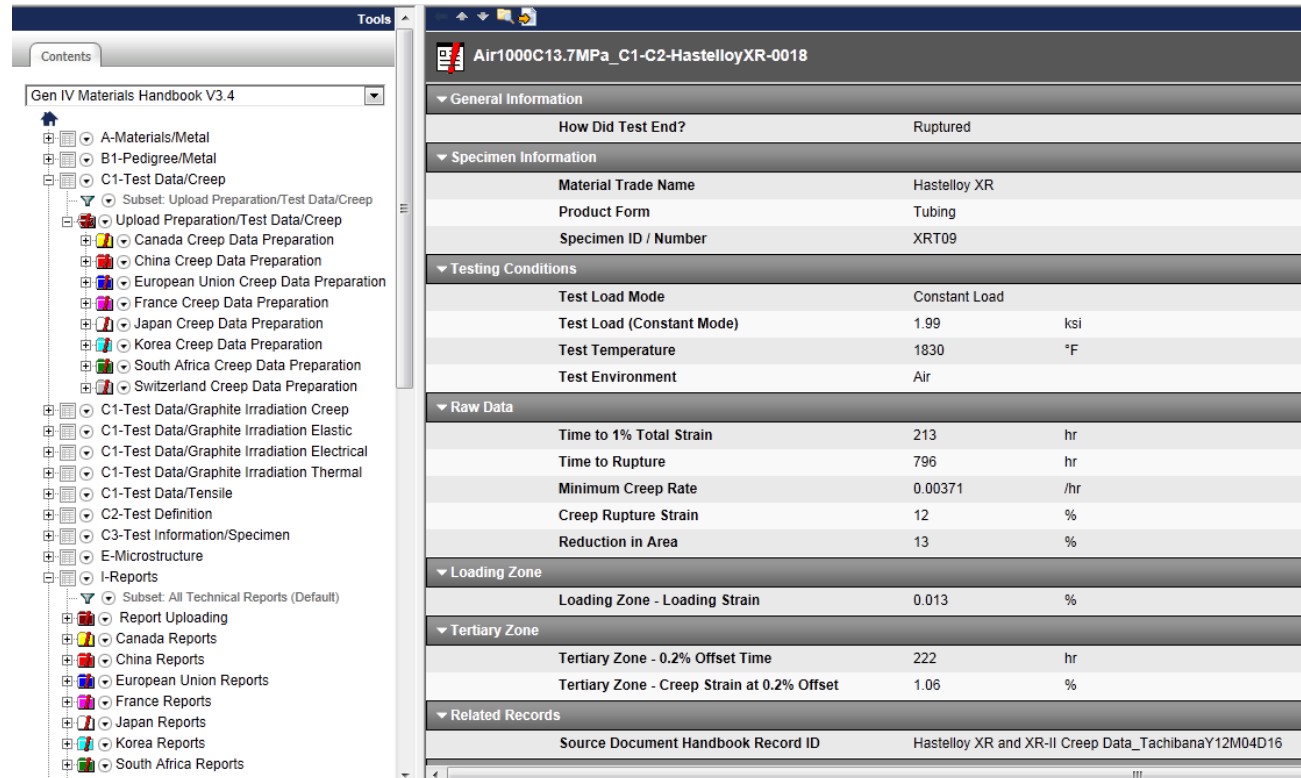

The screenshot displays a software interface with two main panels. The left panel shows a hierarchical tree structure under the heading 'Gen IV Materials Handbook V3.4'. The tree includes categories like 'A-Materials/Metal', 'B1-Pedigree/Metal', and 'C1-Test Data/Creep'. Under 'C1-Test Data/Creep', there is a 'Subset: Upload Preparation/Test Data/Creep' which lists various countries: Canada, China, European Union, France, Japan, Korea, South Africa, and Switzerland, each with a corresponding flag icon. Below this, there are sub-categories for 'C1-Test Data/Graphite Irradiation Creep', 'C1-Test Data/Graphite Irradiation Elastic', 'C1-Test Data/Graphite Irradiation Electrical', 'C1-Test Data/Graphite Irradiation Thermal', 'C1-Test Data/Tensile', 'C2-Test Definition', 'C3-Test Information/Specimen', 'E-Microstructure', and 'I-Reports'. The right panel shows a detailed data table for a specific record: 'Air1000C13.7MPa\_C1-C2-HastelloyXR-0018'. The table is organized into sections: 'General Information' (How Did Test End? Ruptured), 'Specimen Information' (Material Trade Name: Hastelloy XR, Product Form: Tubing, Specimen ID / Number: XRT09), 'Testing Conditions' (Test Load Mode: Constant Load, Test Load (Constant Mode): 1.99 ksi, Test Temperature: 1830 °F, Test Environment: Air), 'Raw Data' (Time to 1% Total Strain: 213 hr, Time to Rupture: 796 hr, Minimum Creep Rate: 0.00371 /hr, Creep Rupture Strain: 12 %, Reduction in Area: 13 %), 'Loading Zone' (Loading Zone - Loading Strain: 0.013 %), 'Tertiary Zone' (Tertiary Zone - 0.2% Offset Time: 222 hr, Tertiary Zone - Creep Strain at 0.2% Offset: 1.06 %), and 'Related Records' (Source Document Handbook Record ID: Hastelloy XR and XR-II Creep Data\_TachibanaY12M04D16).

# Design and Codification Basis for aSMR/ARC Specific Materials – Gen IV Materials Handbook Project

- Evolutionary process of materials property data has proven viable. Considerable creep test data were incrementally collected into the Handbook from GIF countries as terminology clarification and unification progressed.

	Material	Quantity
EU	9Cr-1Mo-V	16
France	9Cr-1Mo-V	2,760
Japan	XR and XR-II	137
Korea	617	45
Switzerland	TiAl and PM2000	11

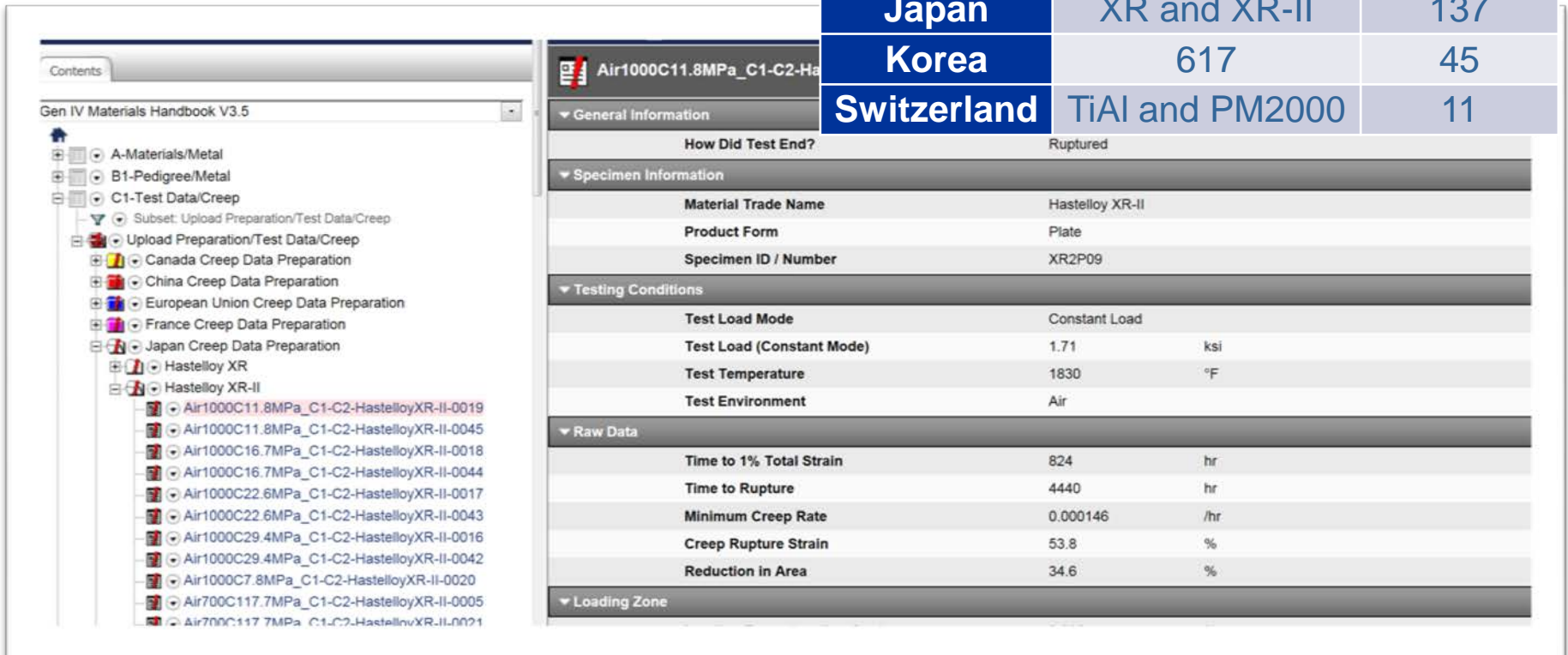

The screenshot displays the Gen IV Materials Handbook V3.5 interface. On the left is a tree view showing the hierarchy of materials, including 'C1-Test Data/Creep' and 'Hastelloy XR-II'. The main panel shows a detailed data entry form for a specific test: 'Air1000C11.8MPa\_C1-C2-Ha...'. The form is divided into several sections:

- General Information:** How Did Test End? Ruptured
- Specimen Information:**
  - Material Trade Name: Hastelloy XR-II
  - Product Form: Plate
  - Specimen ID / Number: XR2P09
- Testing Conditions:**
  - Test Load Mode: Constant Load
  - Test Load (Constant Mode): 1.71 ksi
  - Test Temperature: 1830 °F
  - Test Environment: Air
- Raw Data:**
  - Time to 1% Total Strain: 824 hr
  - Time to Rupture: 4440 hr
  - Minimum Creep Rate: 0.000146 /hr
  - Creep Rupture Strain: 53.8 %
  - Reduction in Area: 34.6 %
- Loading Zone:** (Section header visible)



- **Agreement was reached with Handbook base software vendor and Japan National Institute for Materials Science (NIMS) to add to Handbook a NIMS Database Module with considerable data applicable to aSMR/ARC specific materials including 304SS, 316SS, 800H, T91, T92 etc.**
- **Database interoperability project for development of massive data exchange techniques under the US-EURATOM I-NERI has successfully achieved its goals.**
  - Project review concluded as a successful development.
  - Review board requested an extension for actual data exchange between EU and DOE using the developed techniques and mechanisms.
- **Once Metals and Graphite Volumes are fully functional, the final volume on Ceramics and Composites will be initiated**

# PNNL Assessed Material Issues for SMR Operational Environments

## ■ Scope

- Evaluate material degradation issues unique to the operational environments of light-water SMRs.
- Concerns for specific SMR components and materials identified and research activities to resolve issues recommended.

## ■ Approach

- Review of material issues identified for advanced, large Gen. III+ pressurized water reactors as a starting point for light-water SMRs.
  - *Key component descriptions for Westinghouse AP1000, AREVA U.S. EPR and Mitsubishi APWR designs*
- Critical review of light-water SMR designs and materials issues including direct interactions with technical staff from SMR vendors.
  - *Key component descriptions for mPower™ and NuScale designs including unique differences, challenges due to proprietary issues*
- Recommend key research needs

# Material Issues Assessed for Gen III+ Large LWRs

## Key Components are Described and Issues Evaluated

### *RPV Beltline Example*

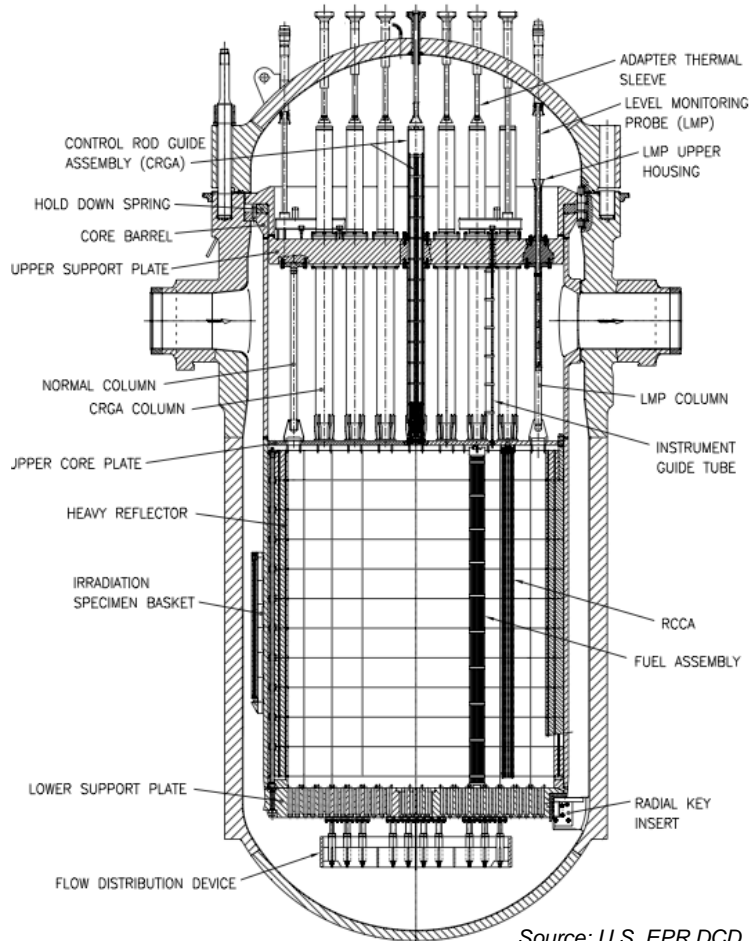

Source: U.S. EPR DCD

#### Material Selection

Low-alloy Steel :  
SA-508 Gr. 3 – Cl. 1

Stainless Steel Cladding:  
308/308L/309/309L/316/316L

#### Environment

$T_{\text{cold}} \sim 537^{\circ}\text{F} - 563^{\circ}\text{F}$ ;  $T_{\text{hot}} \sim 537^{\circ}\text{F} - 563^{\circ}\text{F}$   
“ $T_{\text{cold}}$  heads” used in most designs

Neutron fluence:  
 $\Phi \sim 9 \times 10^{19} \text{ n/cm}^2$  (welded core former)  
 $\Phi \sim 1 \times 10^{19} \text{ n/cm}^2$  (heavy reflector core former)

Well controlled material chemistry, Low Initial  
 $RT_{\text{NDT}} \sim 0^{\circ}\text{F}$

#### Fabrication

All forged ring segments – no vertical welds

Typically only one circumferential weld in or adjacent to active core height

## Examples from mPower™ Results

- Overall potential materials degradation issues are extremely similar to the advanced PWRs.
- Most significant degradation concerns are for radiation damage in beltline LAS shells and welds along with SCC of alloy 690/152/52 components. While the primary concerns are identical to that for advanced PWRs, the mPower™ design has thinner beltline forgings and uses alloy 690 lugs welded to the vessel to support the core and core basket. These differences may warrant additional study.
- Another materials concern was identified for the once-through steam generator with the use of carbon steel tube supports and shroud. No experience for 60 year performance.

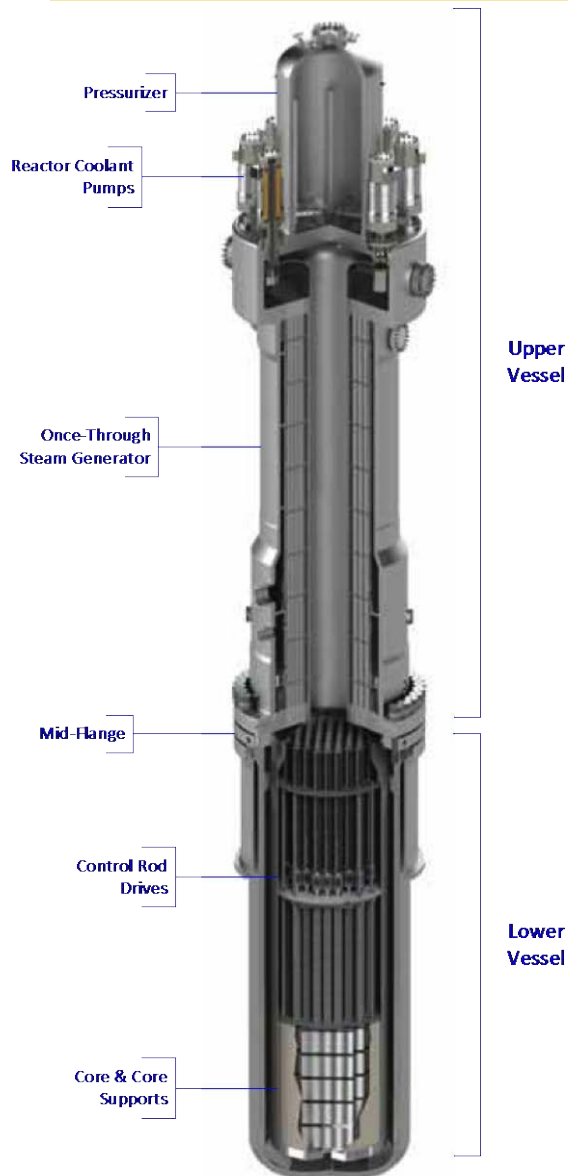

## Examples from NuScale Results

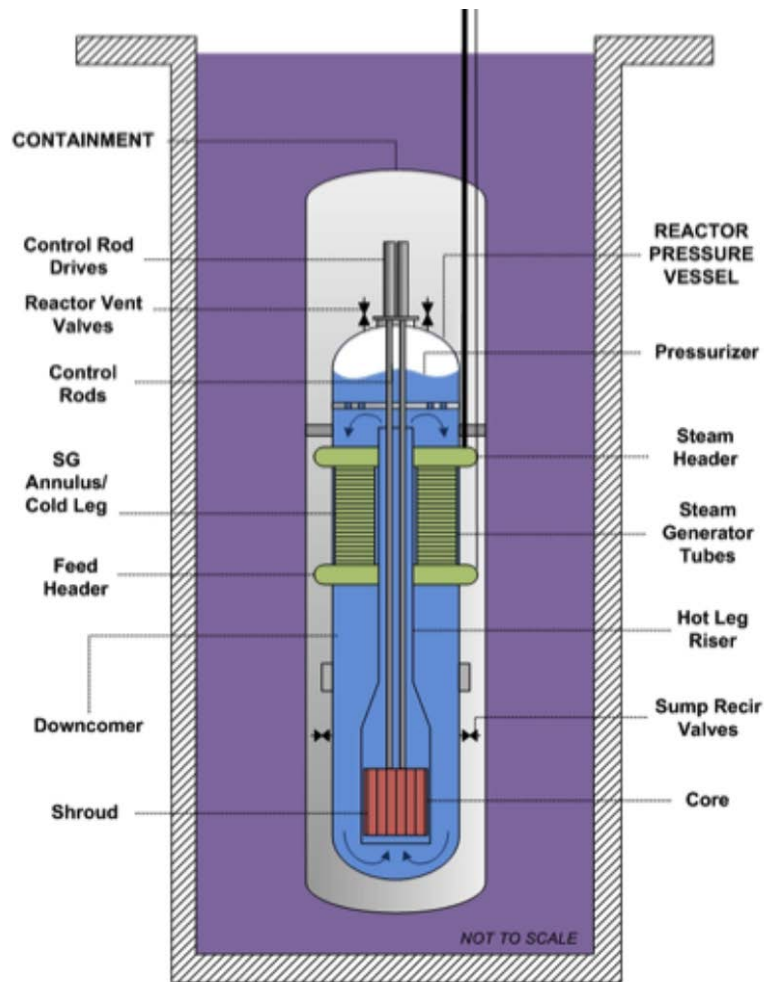

- Overall potential materials degradation issues are similar to the advanced PWRs, however there are several unique aspects to the NuScale design.
- Most significant degradation concerns are again for radiation damage in beltline LAS shells and welds along with SCC of alloy 690/152/52 components. The NuScale design also has thinner beltline forgings and may warrant additional study.
- The helical coil seam generator is quite different than for advanced PWRs and offers potential benefits and several unknowns. Further analysis is needed once design aspects become finalized.

# Assessment of Material Issues for SMR Completed

## ■ Project Summary

- May 2012: Work started at PNNL; contact letters sent to mPower™, NuScale, Westinghouse and Holtec; and subcontracts with LWR, expert consultants (Wayne Lunceford and Dave Sandusky) established.
- August-September 2012: Non-disclosure agreements setup and initial meetings held with mPower™ and NuScale technical staff; review completed on advanced large PWRs by consultants.
- October-November 2012: Completed technical information exchange with vendors; first draft of review completed on materials issues and individual sections sent to vendors for final review.
- January 2013: Vendor reviews of individual sections completed and returned to PNNL, final draft of critical review in preparation.
- Milestone report completed/submitted February 2013.
  - ***Assessment of Materials Issues for Light-Water Small Modular Reactors, D. Sandusky, W. Lunceford, S. M. Bruemmer, and M. A. Catalan, PNNL-22290***