

**Jordan/Malheur Resource Area  
Jonesboro Diversion Dam Replacement Project  
OR-67329**

**Environmental Assessment (EA)  
DOI-BLM-OR-V040-2013-007-EA**



**Prepared by:  
U.S. Department of the Interior  
Bureau of Land Management  
Malheur Resource Area  
100 Oregon Street  
Vale, Oregon 97918**

**Draft EA: November, 2014**

**Final EA (with Appendix C): December 2015**

**BLM**  
Vale District



**As the Nation's principal conservation agency, the Department of the Interior has responsibility for most of our nationally owned public lands and natural resources. This includes fostering the wisest use of our land and water resources, protecting our fish and wildlife, preserving the environmental and cultural values of our national parks and historical places, and providing for the enjoyment of life through outdoor recreation. The Department assesses our energy and mineral resources and works to assure that their development is in the best interest of all our people. The Department also has a major responsibility for American Indian reservation communities and for people who live in Island Territories under U.S. administration.**

# Table of Contents

<b>1</b>	<b>INTRODUCTION</b>	<b>1</b>
1.1	BACKGROUND INFORMATION	1
1.2	LOCATION	2
1.3	PURPOSE AND NEED FOR ACTION	3
1.4	DECISION TO BE MADE	4
1.4.1	<i>BLM</i>	4
1.4.2	<i>Bonneville Power Administration</i>	4
1.5	CONFORMANCE TO LAWS, REGULATIONS, POLICIES, AND PLANS	5
1.6	SCOPING AND POTENTIAL ISSUES	5
<b>2</b>	<b>DESCRIPTION OF PROPOSED ACTION AND ALTERNATIVES</b>	<b>6</b>
2.1	ALTERNATIVE 1: GRANT DIVERSION DAM RIGHT-OF-WAY (PROPOSED ACTION)	7
2.1.1	<i>Project Design</i>	7
2.2	ALTERNATIVE 2: NO ACTION	11
2.3	ALTERNATIVES CONSIDERED BUT NOT ANALYZED IN DETAIL	11
<b>3</b>	<b>AFFECTED ENVIRONMENT AND ENVIRONMENTAL CONSEQUENCES</b>	<b>12</b>
3.1	ISSUES CONSIDERED BUT NOT ANALYZED IN DETAIL	12
3.1.1	<i>Areas of Critical Environmental Concern</i>	12
3.1.2	<i>Climate Change/Air Quality</i>	13
3.1.3	<i>Livestock Grazing</i>	13
3.1.4	<i>Lands and Realty</i>	13
3.1.5	<i>Special Status Plants</i>	13
3.1.6	<i>Wilderness Characteristics and Wilderness Study Areas (WSAs)</i>	13
3.2	ISSUES ANALYZED IN DETAIL	14
3.2.1	<i>Vegetation/Noxious Weeds</i>	14
3.2.2	<i>Recreation Activity</i>	16
3.2.3	<i>Soils and Watershed Resources</i>	16
3.2.4	<i>Watershed Resources</i>	17
3.2.5	<i>Prehistoric and Historic Cultural Resources</i>	19
3.2.6	<i>Wildlife</i>	19
3.2.7	<i>Sensitive, Threatened, or Endangered Species</i>	21
3.2.8	<i>Visual Resources Management (VRM)</i>	24
3.2.9	<i>Wetlands and Riparian Zones</i>	24
<b>4</b>	<b>CUMULATIVE IMPACTS</b>	<b>25</b>
4.1	PAST ACTIONS	26
4.2	PRESENT ACTIONS	29
4.3	REASONABLY FORESEEABLE FUTURE ACTIONS	30
<b>5</b>	<b>LIST OF PREPARERS</b>	<b>30</b>
<b>6</b>	<b>LIST OF AGENCIES OR PEOPLE INVOLVED IN SCOPING</b>	<b>30</b>
<b>7</b>	<b>LITERATURE CITED</b>	<b>31</b>
<b>APPENDICES</b>		
	Appendix A – Design Features.....	33
	Appendix B – Observed Avian Species.....	44
	Appendix C – Comments and Responses.....	46

**MAPS**

Map 1: Location of the request for right-of-way for the diversion dam. ....2  
Map 2: Area for ROW Request to operate and maintain, and replace irrigation structures.....3  
Map 3: Jonesboro FFR pasture - Private and public lands with Jonesboro property fence line. ....8  
Map 4: Area of impact (approximately 0.3 acre). Access road from U.S. Highway 20 is shown. ....9  
Map 5: Location of the Malheur River watershed. ....18  
Map 6: Tributaries redband trout inhabit in the Malheur River Subbasin located near the project are: Calf Creek,  
Hunter Creek, Pole Creek, Black Canyon Creek, and Gold Creek .....28

**TABLES**

Table 1: Critical Elements and Issues generated by Internal and External Scoping. ....6  
Table 2: Species Present and ODA and Malheur County Noxious Weed Classification .....15

# 1 INTRODUCTION

## 1.1 Background Information

The Jordan/Malheur Resource Areas (JMRA) in the Bureau of Land Management (BLM), Vale District, was provided with a Joint Permit Application (NWP-2011-400) from the Burns Paiute Tribe (BPT) in September 2011 to sign as the landowner for in-water work on the Malheur River. To use water rights under State Water Right Certificate #49067, dated to 1883, 1885, 1888, and 1901, BPT operates an in-stream diversion dam located on BLM land. BPT seeks BLM's signature as the landowner for the Joint Permit Application for in-stream work to replace the 1940's era diversion dam, while also adding a fish passage structure. The replacement of this diversion would be funded by the Bonneville Power Administration (BPA) as part of its fish and wildlife mitigation program.

BPA is a federal power marketing agency that is part of the U.S. Department of Energy (DOE) and its operations are governed by several statutes, such as the Pacific Northwest Electric Power Planning and Conservation Act (Northwest Power Act), which directs BPA to protect, mitigate, and enhance fish and wildlife affected by the development and operation of the Federal Columbia River Power System (FCRPS). Pursuant to 40 Code of Federal Regulations (CFR) 1501.6, BPA has agreed to serve as a cooperating agency in the development of this EA to evaluate whether to fund replacement of the diversion dam.

BPA needs to respond to BPT's request for diversion dam replacement funding. Replacing the dam would help improve fish passage and facilitate continued management of BPT wildlife mitigation property. BPA's funding would support its efforts to mitigate for effects of the FCRPS on fish and wildlife in the Mainstem Columbia River and its tributaries pursuant to the Northwest Power Act.

The BPT is a federally recognized Indian Tribe that owns and manages 6,385 acres of Bonneville Power Administration (BPA) wildlife mitigation property. In the JMRA, the BPT leases approximately 21,242 acres of land from the BLM. These acres consist of meadow, wetland, and shrub-steppe habitats.

The existing diversion dam, currently proposed for removal and replacement, was severely damaged as a result of the release of an upstream ice dam after a rain-on-snow event in the spring of 2006. The damaged diversion has blocked fish passage and led to an increase in alterations to channel morphology by creating a scour hole that has eroded the stream bank at the point of diversion. Increased sedimentation and turbidity due to soil erosion has been documented to have several adverse impacts to river systems. Sediments in the water column increase turbidity (cloudiness or haziness) and decrease light penetration. This could potentially affect aquatic species in a number of ways including affecting rate of growth, reducing tolerance to disease, reducing the suitability of spawning habitat and hindering the development of offspring, modifying natural migration patterns, reducing the abundance of food available, and by affecting the efficiency of hunting. In extreme cases sediment load could change channel morphology killing both aquatic invertebrates and vertebrates by reducing oxygen uptake through clogging gills with sediment (Wood and Armitage 1997).

Since the spring of 2006, the BPT has consistently attempted to utilize this structure without major repair. However, due to the damage of the diversion, BPT is currently not able to effectively withdraw enough water to maintain the allotted water rights for this diversion. This has resulted in a reduction in the amount of available water that can be utilized on the BPT wildlife mitigation property. This water is used to irrigate alfalfa fields, grass pasture, and maintain a wet meadow complex for breeding and brooding waterfowl. Irrigation water is used in native plant restoration projects and is an important element to success in arid region. Replacement of the diversion dam would be the only feasible method to repair the structure and prevent increased amounts of soil erosion and bank undercutting, while also allowing the BPT to maintain the water rights.

## 1.2 Location

The location of the proposed project is on BLM-administered land in Malheur County, 11 miles east of Juntura, Oregon, approximately 840 feet south of U.S. Highway 20 on Tax Lot 1000; T20S R39E, SWNW, Section 33 (Map 1). Vegetative composition of the terrain adjacent to the project is semi-desert shrub steppe resulting from cold winters and dry summers. The average annual precipitation ranges from seven to ten inches. Precipitation is primarily in the form of snowfall during winter and early spring rains. The elevation is highly variable, ranging from an elevation of 2,840 feet at river's edge to steep sagebrush covered shale slopes up to 3,800 feet in elevation.

**Map 1: Location of the request for right-of-way for the diversion dam.**

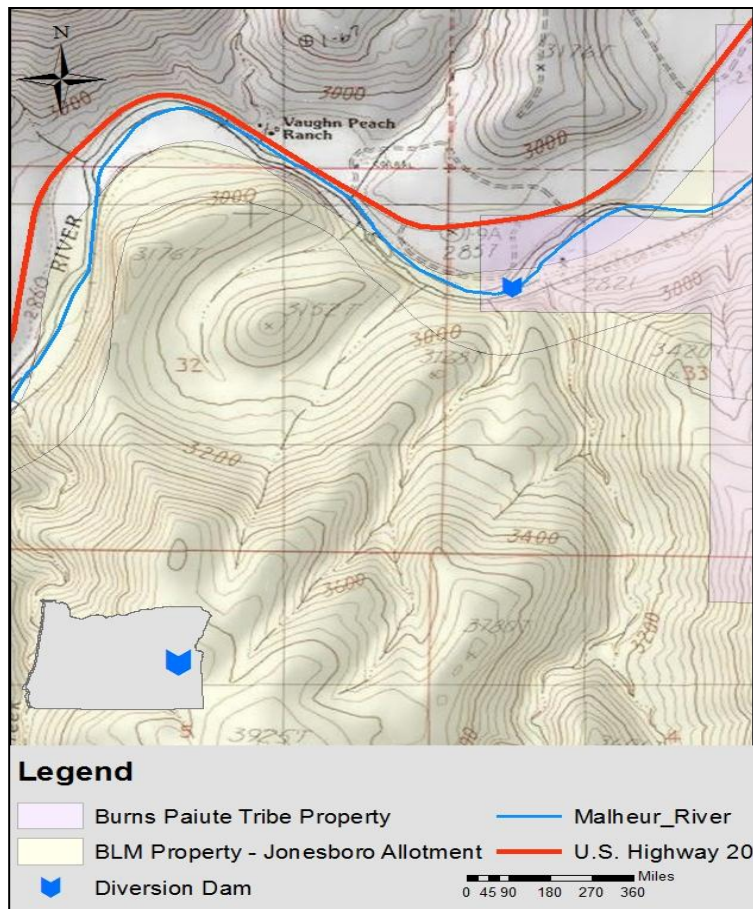

### 1.3 Purpose and Need for Action

The purpose of the action is to respond to a request for a right-of-way (ROW) for the purpose of demolishing, replacing, operating and maintaining an irrigation dam. The need of the action is established by BLM's responsibility under the Federal Land Policy Management Act of 1976 (FLPMA) (USDI-BLM, 2001) to respond to a request for legal access for repair and maintenance.

**Map 2: Area for ROW Request to operate and maintain, and replace irrigation structures.**



## **1.4 Decision to Be Made**

### **1.4.1 BLM**

The BLM has a responsibility under FLPMA and its implementing regulations (43 Code of Federal Regulations (CFR) 1600-9260) to respond to ROW applications. The BLM is also required to comply with the National Environmental Policy Act of 1969 (NEPA) and the Council on Environmental Quality (CEQ) Regulations for implementing NEPA. The BLM's Jordan/Malheur Resource Area has determined that the NEPA process is necessary to evaluate and disclose the potential environmental impacts associated with the proposed action and any reasonable alternatives to the proposed action, including a no action alternative.

The decision to be made by the authorized officer is to determine whether or not to choose the proposed action and grant a ROW for replacement and repair, maintenance, and operation of a diversion dam or reject the proposal (No Action Alternative) based on scoping and public comment issues identified in the NEPA process.

### **1.4.2 Bonneville Power Administration**

BPA must decide whether to provide funding to BPT for its proposal to replace an existing diversion dam. Prior to making this decision, BPA is required under NEPA to assess the potential environmental impacts related to BPA's funding of BPT's proposal. BPA agreed to serve as a cooperating agency in the development of this EA to evaluate whether to fund replacement of the diversion dam and would document its decision in its own decision document at the culmination of the NEPA process.



## 1.5 Conformance to Laws, Regulations, Policies, and Plans

The EA has been prepared in accordance with the following statutes, implementing regulations, and guidance:

- NEPA of 1969, as amended (Public Law [PL] 91-190, 42 U.S.C. 4321 et seq.);
- CEQ (40 CFR 1500 et seq.). Regulations for Implementing the Procedural Provisions of the National Environmental Policy Act;
- United States Department of the Interior (USDI) requirements (Departmental Manual 516, Environmental Quality [USDI 2004]);
- Title V of the FLPMA of October 21, 1976, (90 Stat. 2776; 43 U.S.C. 1761), and the regulations found at 43 CFR 2800 (FLPMA 2001);
- BLM NEPA Handbook (H-1790 1), as updated (BLM, 2008);
- Considering Cumulative Effects under NEPA [CEQ 1997];
- Southeastern Oregon Resource Management Plan and Record of Decision (SEORMP ROD) (USDI-BLM, 2002)
- Pacific Northwest Electric Power Planning and Conservation Act (16 U.S.C. 839 et seq.); and
- Department of Energy NEPA Regulations (10 CFR 1021 et seq.)

All actions approved or authorized by the BLM must conform to the existing land use plan, where one exists (43 CFR 1610.5-3, 516 DM 11.5). Although it is not a NEPA requirement, the BLM includes in all of its NEPA documents a statement about the conformance of the proposed action and alternatives with the existing land use plan. The BLM's planning regulations state that the term "conformity" or "conformance" means that "... a resource management action shall be specifically provided for in the plan, or if not specifically mentioned, shall be clearly consistent with the terms, conditions, and decisions of the approved plan or amendment" (43 CFR 1601.0-5(b)). The SEORMP is the applicable land use plan for proposed ROW and provides guidance (USDI-BLM, 2002, Objective 2 on page 109).

## 1.6 Scoping and Potential Issues

Internal scoping through a BLM Interdisciplinary (ID) Team generated resource issues pertinent to the proposed project. BPA coordinated with related landowners, livestock permittees, Oregon Department of Fish and Wildlife (ODFW), and the BPT to determine if there are any issues or concerns.

Potential issues include:

- How would the repair and construction of the diversion dam affect visual resources?
- What are the impacts to wildlife habitat, migration, or disturbance from repair and construction of the diversion dam?
- Will repair of the diversion dam and construction of a fish passage structure conflict with other recreational uses?
- Will activity from the proposed action impact adjacent landowners?

Those resources found in Table 1 marked as "not present" do not occur in or are adjacent to the ROW. Those elements or resources marked as "present, not affected" may occur in or are adjacent to the ROW, but would not be impacted by the proposed action. Those elements or

resources marked as “present, affected” may be found in or are adjacent to the ROW and may be subject to direct, indirect, and/or cumulative effects from the proposed action.

**Table 1: Critical Elements and Issues generated by Internal and External Scoping.**

Element or Resource	Not Present	Present Not Affected	Present Affected	Issue
Areas of Critical Environmental Concern (ACEC)	X			No designated, proposed, or identified ACECs in or adjacent to project area; Section 3.1.1
Climate Change/Air Quality		X		Discussed in Section 3.1.2
Livestock Grazing		X		Not Affected-Fenced out of river; Section 3.1.3
Lands & Realty	X			Discussed below in Section 3.1.4.
Prehistoric and Historic Cultural Resources		X		Survey complete; There is one eligible site that will be monitored during implementation of the proposed action. Section 3.2.5
Special Status Plants	X			No known species in vicinity; Section 3.1.5
Wilderness Characteristics and Wilderness Study Areas	X			No designated, proposed, or identified wilderness Section 3.1.6
Vegetation/Noxious Weeds			X	Weed spread from short-term soil disturbance; Discussed in Section 3.2.1
Recreational Activity			X	Discussed in Section 3.2.2
Soils & Watershed Resources			X	Discussed in Section 3.2.3
Wildlife/Migratory Birds/Fish			X	Discussed in Section 3.2.6
Sensitive, Threatened or Endangered Species			X	Discussed in Section 3.2.7
Visual Resources Management (VRM)			X	Discussed in Section 3.2.8
Wetlands/Riparian Zones			X	Action takes place in the Malheur River. Discussed in Section. 3.2.9

## 2 Description of Proposed Action and Alternatives

This section of the EA describes the Proposed Action and alternatives, including those that were considered but eliminated from detailed analysis. Two alternatives are considered in detail – the Proposed Action and the No Action Alternative.

## **2.1 Alternative 1: Grant Diversion Dam Right-of-Way (Proposed Action)**

The proposed action is for the BLM to grant a ROW to BPT to access and replace a failing diversion dam and construct a fish passage structure. The project area is located on the Malheur River on BLM-administered land south of U.S. Highway 20 (Map 2). This ROW would also be used to provide access to the newly-constructed dam so that the BPT could perform routine maintenance of the structure. The location of the existing diversion dam is on BLM property approximately 600 feet south of the BPT property line.

When the diversion was originally constructed in the 1940's – 1950's, its location was likely chosen for its streambed characteristics and elevation necessary to send water to adjacent agriculture fields. The parcel of BLM land is enclosed by the perimeter fence for the BPT mitigation property originally installed during the same era as the diversion dam (Map 3). Fences are a common occurrence in the West, primarily due to cattle grazing management and allotments. The proposed project area is in the BLM-administered Jonesboro Fenced Federal Range (FFR) pasture; the original fence installation reflected past livestock management, not property boundaries. Access to BLM land is granted through the BPT mitigation parcel (Map 3).

The BPT would use the ROW to access the new diversion dam to install check boards in early spring (March-April), prior to water releases from the upstream Agency Valley Dam and Beulah Reservoir. Maintenance of the diversion dam would be ongoing during the irrigation season and would require 1-2 visits per month to clean vegetation and debris. Access to the diversion dam would be from U.S. Highway 20 via a two-track access road, while access to the proposed head gate structure would be through BPT land on an old railroad grade (Map 4).

Replacement of the structure and continued operation of the irrigation system would allow BPT to continue wildlife mitigation efforts and habitat restoration work. This work is dependent on irrigation and results in increased habitat for terrestrial species as well as increased success of riparian plant restoration efforts.

Replacement of the structure would also allow for the proper water and pool depth that would allow migratory fish in the system to travel past the structure. Currently, fish cannot migrate upstream through the existing structure so the structure presents a barrier during the irrigation season. Additionally, in its current state, the structure poses a safety hazard in terms of access to components that require regular maintenance.

### **2.1.1 Project Design**

Construction of the replacement diversion dam and fish passage structure including both demolition and rebuild, would take 3-6 weeks and would occur during the in-water work period from November 1 to March 31. Several design features have been included in the replacement structure to minimize the potential impacts to water quality and aquatic fauna. The headgate structure with abutment would reduce stream bank erosion decreasing downstream turbidity (cloudiness or haziness). The fish passage structure is a design feature that would allow for the migration of native fish species that occur. In addition construction methods would be utilized to

minimize impacts to water quality during the construction phase. These include coffer dams, rubber tired vehicles, weed prevention practices, post action seeding of native plants.

**Map 3: Jonesboro FFR pasture - Private and public lands with Jonesboro property fence line.**

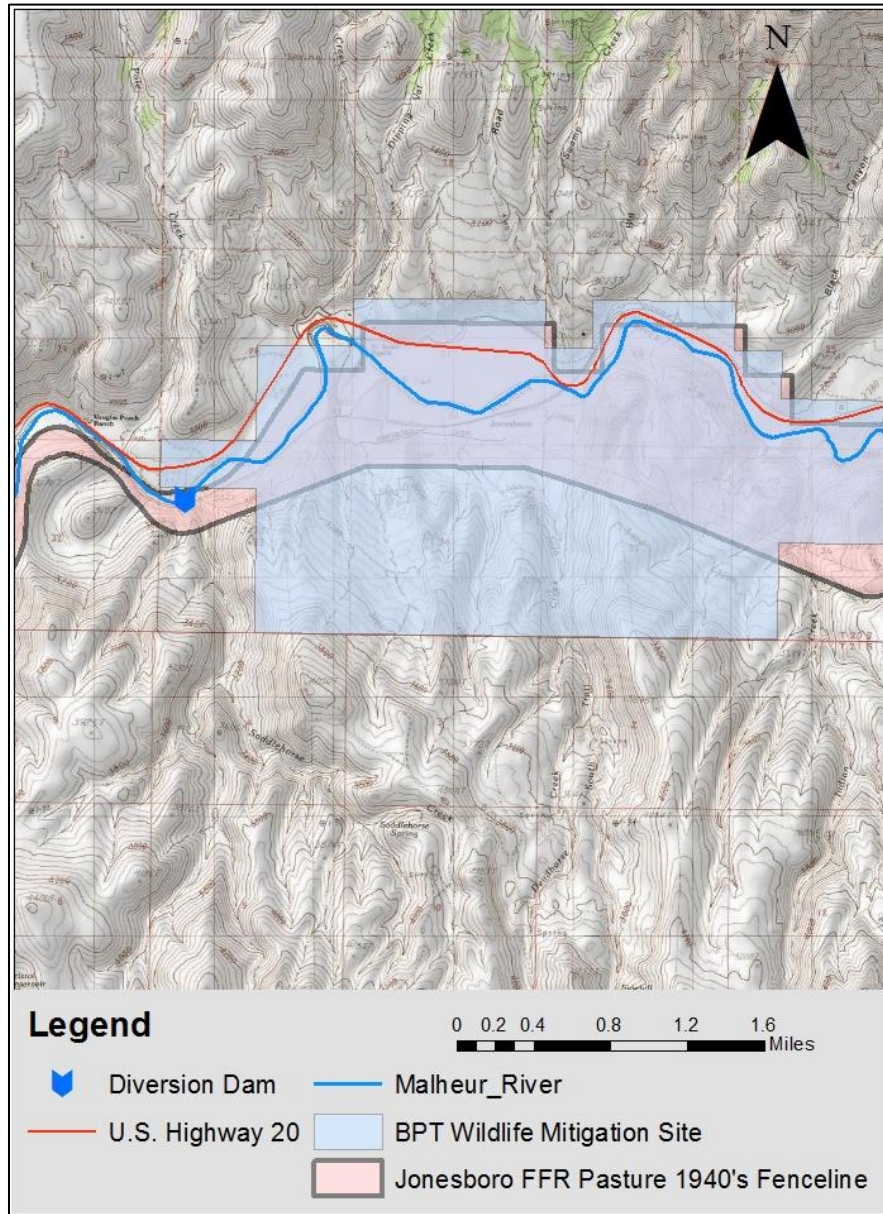

**Map 4: Area of impact (approximately 0.3 acre). Access road from U.S. Highway 20 is shown.**



*Demolition:*

- The existing structure would be demolished using a trackhoe with a hydraulic hammer. Demolition debris would be removed from the river and disposed of in an upland area away from the Malheur River on BPT land. Cofferdams would be constructed to divert the minimal in-stream winter flows away from the work to minimize downstream turbidity impacts. The flows of the Malheur River during the in-water work period are at a seasonal low average of less than 200 cubic feet a second (BOR 2012).

*New Structure:*

- Once the existing structure is removed, a new concrete sill (base of the diversion structure) would be constructed at the location of the existing structure. The engineering plans allow for the new structure to be formed and poured in place or to be cast off-site in sections and assembled at the project location.
  - Excavation for the new structure would be accomplished using a trackhoe. Rubber-tired equipment may enter the river channel for delivery of construction materials and removal of excavated material.
  - Some dewatering may be necessary to facilitate access for placement of concrete formwork or pre-cast concrete sections. Water from dewatering operations would be sent into an irrigation ditch that delivers water to an adjacent property, allowing the discharge water to infiltrate into the ground away from the river. The impact area in the bounds of the ordinary high water mark would be approximately 0.3 acre.
  - The anticipated fill volume would be approximately 575 cubic yards (CY). The fill material would be primarily composed of lava rock riprap (approximately 400 CY). The remaining fill volume would be composed of channel substrate that would be excavated when installing the new stanchion structure and the in-channel riprap. The native channel substrate material would be primarily composed of gravel and cobble, intermixed with sand, and would be used to repair the southeast bank erosion that has been caused by the ongoing failure of the existing structure. Approximately 100 CY of channel substrate material or sediment deposition upstream of the existing structure would be permanently removed to an upland disposal area off site on BPT property. The deposited sediment is primarily fine grained silts, clays, and/or organic materials that are unsuitable for use adjacent to or beneath the new stanchion structure (Appendix A).
  - Excavation for the footings for the new stanchion structure would disturb the existing river channel. Water quality impacts would be mitigated by channeling the river around the active work area using coffer dams. The long term impact of the new structure would be less than the existing structure, as the new structure would provide for improved channel stabilization and upstream fish passage.
  - The area impacted from construction would be approximately 0.3 acre (Map 4).
  - Construction equipment would be washed prior to use to avoid transport of weed seed.
  - Seeding post construction and subsequent surface disturbing maintenance would be done using BLM designated native seed mix.
- During surface-disturbing construction and maintenance activities, the holder shall ensure that all construction equipment and vehicles are cleaned of all vegetation (stems, leaves, seeds and all other vegetative parts) prior to entering public lands in order to minimize the transport and spread of noxious weeds.

*Access:*

- Project access would primarily be confined to a single location on the north bank of the Malheur River. Seeding post construction and subsequent surface disturbing maintenance would be done using BLM designated native seed mix.

*Stipulations for ROW*

- The ROW request includes five components (Map 2):
  - Replacement diversion dam with headgate (0.03 acre)
  - Intake canal (0.053 acre measuring 327 feet by 7 feet)
  - Water return ditch (0.025 acre measuring 105 feet by 10 feet)
  - Existing machine shed previously used as an airplane hangar (0.013 acre measuring 23 feet by 23 feet).
  - ROW size of 1,178 feet by 500 feet for a total of 8.44 acres.
- All in-water work would follow Oregon Department of State Lands, U.S. Army Corp of Engineers permitting, and Oregon Department of Fish and Wildlife (ODFW) processes.
- Maintenance of the diversion dam and associated structures would include:
  - Regular inspection of dam for debris, fish passage structure, headgate, and the waste water return ditch.
  - Regular inspection of bank side vegetation for noxious weeds, and if found, occurrences would be reported to the BLM.
  - Reseeding post construction and subsequent years, as necessary, would occur based on annual disturbance.

## **2.2 Alternative 2: No Action**

Under the No Action Alternative, there would be no construction work—the diversion would not be replaced and the ROW would not be granted and present management of the area would continue. The existing structure would remain in use, exacerbating erosion to the stream channel through scouring and to the bank where there is currently no abutment. The existing dam also impedes fish movement upstream during the irrigation season, especially for redband trout. The blockage isolates redband trout populations and limits habitat available for migration, spawning, and over-wintering. Accessing and using the diversion in its current state would continue to pose safety risks.

## **2.3 Alternatives Considered but Not Analyzed in Detail**

Three alternatives—an alternate location upstream, an alternate location downstream, and an alternate rock weir design—were considered but not analyzed in detail in this EA because they would either disturb unaltered streambed and require construction of a new ditch, or would not allow for the diversion rate allocated under the water right.

*Alternative Location Upstream for the Point of Diversion*

Due to a combination of minimum depth required and the flat bed slope of the river, it would be necessary to move the point of diversion upstream a minimum of 1,100 feet to maintain the current diversion rate. This would create the need to build an additional 1,100 feet of ditch and disturb an unaltered streambed. This would also locate the point of diversion on private land not owned by BPT or the BLM. Because of the additional environmental impacts to the streambed

and surrounding areas, and the need to relocate the point of diversion on to property not owned by the BPT or BLM this alternative was eliminated from further analysis.

#### *Alternative Location Downstream for the Point of Diversion*

Moving the structure downstream onto BPT-owned property would change the necessary elevation to divert water to adjacent fields. The river drops approximately 4 feet from the current site to the property boundary. This amount of drop would increase the necessary water elevation by an equal amount, doubling the size of the project foot print and creating approximately 600 feet of new ditch. Because of the additional environmental impacts to the streambed and surrounding areas, this alternative was eliminated from further analysis.

#### *Alternative Rock Weir Design*

A rock weir structure would be passable by migrating fish, however due to structural limitations, a low elevation rock weir structure would not be able to maintain the necessary minimum water depth of 3.5 feet and the necessary diversion rate needed for the water right. This alternative was eliminated from further analysis because of the lack of water depth and inadequate diversion rate.

### **3 Affected Environment and Environmental Consequences**

This chapter describes, by alternative, the affected environment and environmental consequences to illustrate the differences between the proposed action and the No Action Alternative. This chapter identifies the direct and indirect impacts associated with the proposed right-of-way, the relative severity and duration, and the design features to minimize these impacts.

#### **3.1 Issues Considered but not Analyzed in Detail**

The following resources were discussed during the scoping process and have been identified as either not present or not significantly impacted by the proposed action and therefore will not be fully analyzed.

##### **3.1.1 Areas of Critical Environmental Concern**

Areas of Critical Environmental Concern (ACECs) are areas defined by Section 103(a) of the Federal Land Policy and Management Act of 1976 (FLPMA) “as areas where special management attention is required to protect and prevent irreparable damage to important values, resources, systems or processes, or to protect life and safety from natural hazards”. Section 202(c)(3) of FLPMA mandates that priority be given to the designation and protection of ACECs.

There are no designated or identified ACECs in the project area. There are, however, three ACECs located near but not adjacent to the proposed project area and include Black Canyon ACEC/ Research Natural Areas (RNA), Lake Ridge ACEC/RNA, and South Bull Canyon ACEC/RNA. These areas are located approximately 8, 10, and 8.5 miles, respectively, from the proposed project area and would not be impacted by the project. As a result, no further analysis of potential impacts to ACECs from the proposed action will be completed.



### **3.1.2 Climate Change/Air Quality**

The additional contribution of greenhouse gases to the atmosphere as a result of implementing the proposed action when compared to the No Action Alternative is limited to that contribution from fossil fuel consumption by equipment accessing the site and a few days of heavy equipment activity. When compared to greenhouse gas emissions on a world-wide, national, regional, or local scale, and when compared to the contributions from other sources of greenhouse gases, the potential impacts from the proposed action are low. In addition, a short-term increase in dust would occur during construction and maintenance. Since only a small area (0.3 acres) would be disturbed for a short duration (20-30 days) and the area would be reseeded, the potential impact to air quality is considered low. Best management practices (BMPs) will be followed to minimize impacts to air quality. As a result, no further analysis of climate, climate change, or air quality will be completed.

### **3.1.3 Livestock Grazing**

The project area is in the Jonesboro FFR pasture in the Jonesboro Allotment (Map 3). This pasture is 2,595 acres and is dominated by private land. Public land makes up seven percent of the total acreage. Under objective J of the SEORMP and ROD, this pasture is managed as custodial with no specified management objective (USDI-BLM 2002). The BPT holds the current grazing permit in the Jonesboro allotment. Grazing use is authorized during mid to late summer on irrigated meadows in the Jonesboro FFR. The proposed action would not impact current levels of livestock grazing. As a result, no further analysis of potential impacts to livestock grazing from the proposed action will be completed.

### **3.1.4 Lands and Realty**

The proposed project falls in the Malheur Resource Area. The site is classified as Zone 1 according to Appendix L in the SEORMP. Zone 1 land has been generally identified for retention in public ownership. The proposed action would result in a ROW in this area, but would not remove the property from public ownership. The project site is a small parcel of public land adjacent to private land holdings where exchange or sale under disposal-Zone 3 criteria could be an appropriate option as part of future land management activities. This is not part of the Proposed Action and will not be discussed in this EA.

### **3.1.5 Special Status Plants**

There are no special status plant species (those designated as Federally Threatened or Endangered, Bureau Sensitive or State Threatened or Endangered.) or potential habitat in the proposed project area, therefore the proposed action would have no impact on special status plant species.

### **3.1.6 Wilderness Characteristics and Wilderness Study Areas (WSAs)**

Lands in Vale District were inventoried for wilderness values between 1978 and 1981, in accordance with Section 201 of Federal Land Policy Management Act of 1976. The inventory resulted in the designation of some lands as WSA. Only subsequent legislation can designate

these or other public lands as Wilderness Areas. No WSAs or Wilderness Areas are in the boundary of the ROW. No further analysis of potential impacts to wilderness or WSAs from the ROW or no action alternative will be conducted.

## 3.2 Issues Analyzed in Detail

### 3.2.1 Vegetation/Noxious Weeds

There are two vegetation communities in the project area, riparian shrub and shrub steppe. Riparian shrub is located adjacent to the Malheur River and is dominated by deciduous shrubs that include both hydrophytic (plants adapted to growing in water) and xeric (plants requiring minimal moisture) shrub species, e.g., Woods' rose (*Rosa woodsii*), coyote willow (*Salix exigua*), golden currant (*Ribes aureum*), poison ivy (*Rhus radicans*), box elder (*Acer negundo*), mock orange (*Philadelphus oregonus*), and elderberry (*Sambucus nigra*).

Shrub steppe vegetation communities in the Malheur Resource Area are the types that thrive in cold winters and hot, dry summers. This vegetation community is found on uplands adjacent to the Malheur River. The shrub component is generally dominated by one or more of the following species: sagebrush (*Artemisia* spp.), rabbitbrush (*Ericameria* spp.), bitterbrush (*Purshia tridentata*), wax currant (*Ribes cereum*), purple sage (*Salvia dorrii*), and buckwheat (*Eriogonum* spp.). Herbaceous vegetation often includes native species such as Idaho fescue (*Festuca idahoensis*), bluebunch wheatgrass (*Pseudoroegneria spicata*), Sandberg bluegrass ( ), needle and thread (*Hesperostipa comata*), bottlebrush squirreltail (*Elymus elymoides* ), bulbous bluegrass (*Poa bulbosa*), vetch (*Astragalus* spp.), lupine (*Lupinus* spp.), fleabane (*Erigeron* spp.), arrowleaf balsamroot (*Balsamorhiza sagittata*).

A variety of noxious weeds, with varying percent cover, are scattered throughout the project area. The project area is disturbed due to previous construction activities with a strong component of annual/winter-annual grasses including cheatgrass/downy brome (*Bromus tectorum*) and medusahead rye (*Taeniatherum caput-medusae*). Various annual mustards, including clasping pepperweed (*Lepidium perfoliatum*) and blue mustard (*Chorispora tenella*) are scattered throughout these areas, as are other annuals including Russian thistle (*Salsola iberica*), kochia (*Kochia scoparia*), and lambsquarter (*Chenopodium* ssp.). Poison hemlock (*Conium maculatum*) and Scotch thistle (*Onopordum acanthium*) are common along the river up- and downstream and to the east and west of the proposed project area. The perennial thistle, Canada thistle (*Cirsium arvense*), is found in wetter areas and is present along the river bank. Several perennial noxious weeds, found in isolated patches in the project area, include whitetop or hoary cress (*Lepidium* ssp.) and perennial pepperweed (*Lepidium latifolium*); rush skeletonweed (*Chondrilla juncea*) is found downstream of the proposed project area approximately 6 miles.

Table 2 is a list of invasive and noxious weed species present in the vicinity of the proposed ROW authorization and how these species are designated under the Oregon Department of Agriculture (ODA) noxious weed policy and classification system and the Malheur County classification system. Classification is based on economic and environmental impacts, containment and eradication potential, and extent of invasion. Any of these weeds could

establish in the disturbed area, as they are easily moved around by various means including wind, water, human activities, livestock and wildlife.

**Table 2: Species Present and ODA and Malheur County Noxious Weed Classification**

Weed Species: Common Name	ODA Classification*	Malheur County Classification**	Not Classified
Cheatgrass		C	
Clasping Pepperweed			X
Tumble mustard			X
Blue mustard			X
Lambsquarter			X
Kochia		C	
Russian thistle			X
Canada thistle	B	B	
Scotch thistle	B	B	
Perennial pepperweed	B	B	
Whitetop species	B	B	
Rush skeletonweed	B	B	
Poison hemlock	B	B	
Medusahead rye	B	C	

\*ODA Noxious Weed Policy and Classification System (ODA 2011); <http://oregon.gov/ODA?PIANT/WEEDS>

\*\*Malheur County Classification: <http://www.malheurco.org/weeds>

\*\*\*ODA Class “B” Weed: a weed of economic importance which is regionally abundant, but which may have limited distribution in some counties

\*\*\*\*Malheur County Class “B” Weed: a weed of known economic/environmental importance and of moderate to wide distribution and highly invasive, subject to intensive control or eradication where feasible at the county level

\*\*\*\*\*Malheur County Class “C” Weed: a weed of known economic/environmental importance and of general distribution, that is subject to control or eradication as local conditions warrant.

### 3.2.1.1 Impacts of Alternative 1: Grant Right-of-Way

The Proposed Action would directly impact less than 0.3 acre of existing vegetation. The impacts would include surface disturbance by construction equipment and abutment placement. The vegetation and soil disturbing activities from the Proposed Action would likely create new niches for possible weed invasion.

Project design features would include restoration of the disturbed river bank with a native seed mix approved by the BLM, planting willow cuttings in disturbed sites, and weed control measures implemented post construction (Section 2.1.1). Successful restoration would attempt to minimize impacts to vegetation and effects of the construction. Maintenance of the bank side vegetation, including seeding if necessary, would minimize the potential for weed invasion. The increase of noxious weeds would likely be low because of the small size of the proposed disturbance and project design features that will decrease the risk of noxious weed introduction and spread.

### **3.2.1.2 Impacts of Alternative 2: No Action Alternative**

The No Action Alternative would not impact existing vegetation and provide less opportunity for weed invasion in the short term, because there would be no construction activities. In the long-term, the No Action Alternative could result in an increase of the amount of weed species present due to the bank side soil erosion caused by the existing structure and new bare soil exposure each year. This bare soil provides a suitable place for establishment and spread of weed species.

### **3.2.2 Recreation Activity**

The area is part of an Extensive Recreation Management Area (ERMA). All lands not part of a Special Recreation Management Area (SRMA) fall into this category (USDI-BLM 2010). The resource values and use opportunities for the area include:

- Quality scenery
- Fishing in Malheur River
- Driving and walking/hiking for pleasure
- Wildlife viewing
- Rock hounding
- Photography
- Camping and hunting
- Water use and portage by boaters, kayakers, and rafters

#### **3.2.2.1 Impacts of Alternative 1: Grant Right-of-Way**

Recreational opportunities in the project area are abundant but underutilized. The average number of visits to the area is 81 visits per year. These visits are primarily for upland bird, waterfowl, and big game hunting, as recorded through a visitor log on the adjacent BPT mitigation property (Map 3). Projected impacts to recreationists would be low. There is currently a diversion dam in place and current users are aware of its presence. The expected increase in the footprint associated with the fish passage structure would likely not detract current recreational users, because those who utilize the river already navigate around the diversion dam. The new structure would still allow for reasonable portage similar to current conditions along the north bank.

#### **3.2.2.2 Impacts of Alternative 2: No Action Alternative**

The No Action Alternative would continue current activities in the site and result in no anticipated change in recreation resources.

### **3.2.3 Soils and Watershed Resources**

#### **3.2.3.1 Soils**

The project location consists of Classification Unit 56 soils which are shallow, well drained soils with clayey subsoils, and cemented hard pans (Oregon et al. 1969). They occur on slopes ranging from gentle to moderately steep and are remnants of old fans and high terraces. Elevations range from near 3,000 feet to 6,000 feet. Average annual precipitation is from 8 to 11 inches with a

growing season (32°F) from 50 to 130 days with annual mean temperature of 47°F. This soil has a potential for range seeding and irrigation is limited primarily by depth to hardpan (Oregon et al. 1969).

### **3.2.4 Watershed Resources**

The proposed action is located on the Malheur River at river mile (RM) 86 in the Snake River Basin-Upper Malheur Hydrologic Subbasin, 4th-field Hydrological Unit Code (HUC) number 17050117. The Malheur Subbasin is located in southeastern Oregon. The Malheur River is a tributary to the Snake River, entering at approximately RM 370. The majority of the subbasin is located in northern Malheur County, with the remainder located in Baker, Grant, and Harney counties (Map 5). The Malheur Subbasin is approximately 4,700 square miles in size, elevation ranges from approximately 2,100 feet at the confluence of the Snake River to 8,600 feet in the Strawberry Mountains, the headwaters of the upper Malheur. In the subbasin are approximately 6,500 miles of stream, of which 5,100 miles are classified as intermittent (stream only flows part of the year). An additional 370 miles of irrigation-related ditches and canals are identified, primarily in the lower elevations in the main Malheur and Willow Creek watersheds (NPCC, 2004).

There are several impoundments in the Subbasin, the largest being the Warm Springs Reservoir on the Mainstem of the Malheur River (4,000 acres) and Beulah Reservoir on the North Fork of the Malheur River (1,800 acres) 37 and 30 miles upstream, respectively, from the project site (Map 4). Much of the river flow in the lower Subbasin, originating near Namorf (RM 65), and continuing downstream to the mouth of the Malheur River, is controlled by a complex system of diversions, canals, and siphons. The Bureau of Reclamation's Vale Project, operated and maintained by the Vale-Oregon Irrigation District, is the primary supplier of irrigation water to the basin's roughly 132,000 acres of irrigated lands (NPCC, 2004).

#### **3.2.4.1 Impacts of Alternative 1: Grant Right-of-Way**

Impacts to soils and watershed resources would be low due to the highly disturbed condition of the Malheur River that currently exists. Disturbed soils would be subject to increased wind and water erosion during construction activity and could result in effects such as soil displacement, erosion, loss of moisture holding capacity, loss of microbiotic soil forming processes, and increased runoff potential. Soil productivity and soil-forming processes on approximately 0.3 acre would be altered until the disturbed area is seeded and revegetated. Impacts from the Proposed Action on soils would be localized and temporary and would be mitigated through design features in Section 2.1.1.

Impacts to water resources would be low as the proposed action would take place during winter low flows and during the Malheur River in-water work period as recommended by the ODFW (ODFW 2008). Cofferdams would be utilized and water diverted around the project area during construction using an existing irrigation canal and waste water return. The use of this infrastructure would reduce sediment deposition downstream, as sediments would be deposited in the irrigation canal and water would have time to infiltrate.

**Map 5: Location of the Malheur River watershed.**

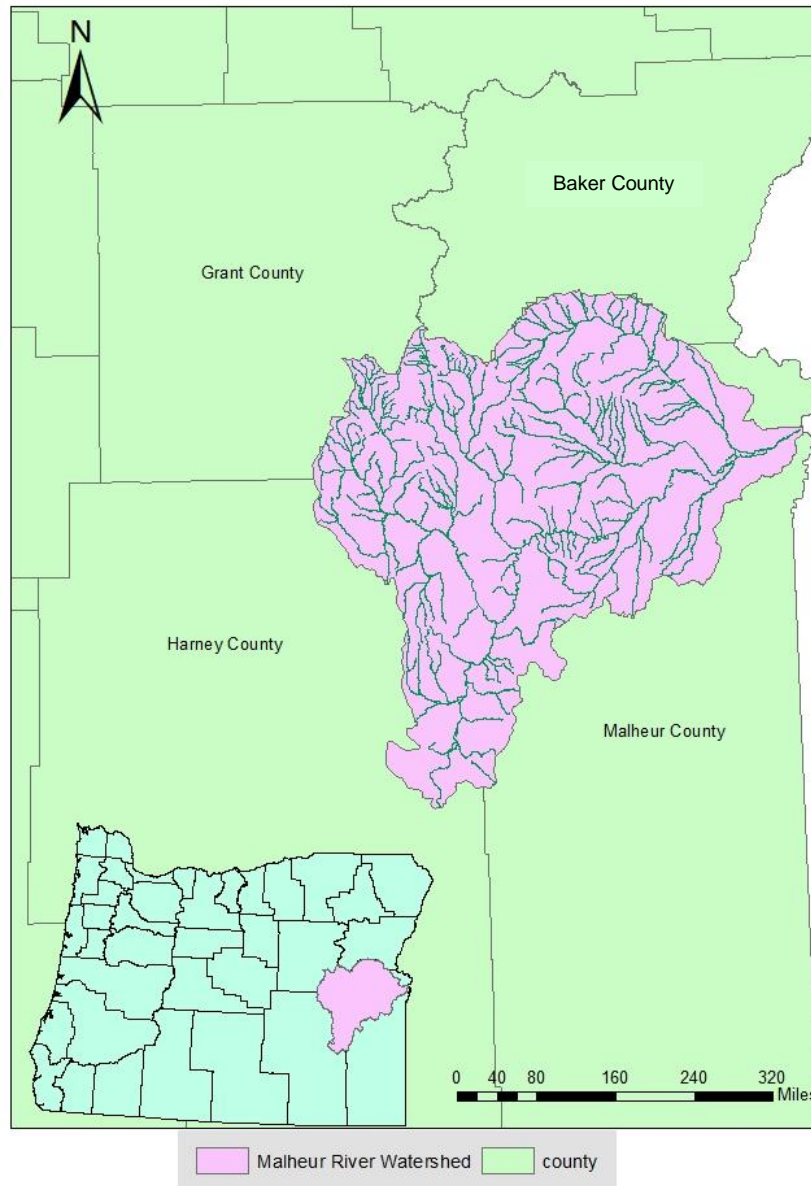

### **3.2.4.2 Impacts of Alternative 2: (No Action Alternative)**

The No Action Alternative would continue current activities at the site. This action would increase channel erosion and continue the scouring of the stream bed. Bank erosion along the south bank would continue without a headgate structure and abutment. Increased sedimentation and turbidity due to soil erosion has been documented to have several adverse impacts to river systems. Sediments in the water column increase turbidity and decrease light penetration, which could potentially affect aquatic species and their habitat. by: affecting rate of growth, reducing tolerance to disease, reducing the suitability of spawning habitat and hindering the development of offspring, modifying natural migration patterns, reducing the abundance of food available, and

by affecting the efficiency of hunting. In extreme cases sediment load could change channel morphology killing both aquatic invertebrates and vertebrates by reducing oxygen uptake through clogging gills with sediment (Wood and Armitage 1997).

### **3.2.5 Prehistoric and Historic Cultural Resources**

The Bonneville Power Administration (BPA) had proposed to fund the Burns Paiute Tribe to implement the wildlife habitat improvement activities, as per the “A Cultural Resource Survey for 2009 Malheur Wildlife Habitat Activities Project (BPA Project #OR2008021, 2/17/2009).

Since BPA’s initial consultation with SHPO (KEC-4, 5/11/2010), and the “no adverse effect” letter from Matt Diederich, (SHPO Case No. 08-2338, 4/1/ 2009) the “Area of Potential Effect” (APE) for the proposed irrigation dam and fish ladder were discovered to be located on Bureau of Land Management (BLM) property.

In January of 2013, the BLM resubmitted a “Cultural Resource Survey of Jonesboro Water Diversion” to the State Historic Preservation Office (SHPO) in compliance with Section 106 requirements. The significance determination of the lithic site 35ML 1563 was reassessed by the Vale District Office BLM Archaeologist and the recommendation was synonymous with the previous “potentially eligible” decision for inclusion into the National Register. as per the: four significance criteria (A-D). The report was submitted with the recommendation that the site will be “avoided” and “monitored” by an onsite archaeologist during all ground disturbing activities, resulting in the project having a “No Effect Determination” on any recorded cultural resources.

The BLM received SHPO’s Conformance Determination, identifying SHPO’s concurrence with the ”No Effect Determination” with the stipulation of implementation of the monitoring plan.

The Burns Paiute Tribe and the BLM had a meeting on Feb. 1, 2013 in Vale OR; where the BLM and the Burns Paiute Tribe discussed the Burns Paiute Tribe fulfilling this monitoring obligation by supplying the on-site archaeologist during the project activities.

### **3.2.6 Wildlife**

#### **3.2.6.1 Wildlife**

Wildlife in the proposed project area is typical of big sagebrush/bluebunch wheatgrass and sagebrush/cheatgrass disturbed habitat types in the northern Great Basin. The project area is utilized by a variety of upland big game species including pronghorn antelope (*Antilocapra americana*), mule deer (*Odocoileus hemionus*), and Rocky Mountain elk (*Cervus elaphus*). The area serves primarily as winter habitat for mule deer, while pronghorn and elk occupy the area sporadically throughout the year. Chukar partridge (*Alectoris chukar*) and California quail (*Callipepla californica*) are year-round residents. Small mammals found in the project area include coyote (*Canis latrans*), badger (*Taxidea taxus*), black-tailed jackrabbit (*Lepus californicus*), deer mouse (*Peromyscus maniculatus*), montane vole (*Microtus montanus*), western harvest mouse (*Reithrodontomys megalotis*), Great Basin pocket mouse (*Perognathus xanthonotus*), and bushy tailed wood rat (*Neotoma cinerea*). Reptile species common to the area include bull snake (*Pituophis catenifer sayi*), western rattlesnake (*Crotalus oreganus*), and several species of lizard.

### 3.2.6.2 Neotropical Migratory Birds

Numerous neotropical migratory birds and several raptor and owl species are common to southeast Oregon and live throughout the area, including: red-tailed hawk (*Buteo jamaicensis*), northern harrier (*Circus cyaneus*), swainson's hawk (*Buteo swainsoni*), ferruginous hawk (*Buteo regalis*), turkey vulture (*Cathartes aura*), golden eagle (*Aquila chrysaetos*), barn owl (*Tyto alba*), great horned owl (*Bubo virginianus*), and American kestrel (*Falco sparverius*). The cliff walls of the Black Canyon of the Malheur River provide potential nesting sites for various raptor species, while adjacent sagebrush stands provide habitat for nesting songbirds. Formal breeding bird surveys have been conducted in the area by the BPT in May and June from 2006 through 2012 and a species list has been generated (Appendix B).

Three Oregon state sensitive Neotropical migratory bird species have been documented near the project site. These are: Lewis' woodpecker (*Melanerpes lewis*), greater sandhill crane (*Grus canadensis tabida*), and the long-billed curlew (*Numenius americanus*).

### 3.2.6.3 Fish

The BPT has conducted formal surveys over multiple years (2002, 2003, and 2004) and seasons on the Malheur River near the project site. The purpose of sampling multiple times was to determine differences in the presence of seasonal fish species presence, specifically bull trout (*Salvelinus confluentus*) and redband trout (*Oncorhynchus mykiss newberrii*), and seasonal relative abundance. Seven native nongame species were present at most sites. The seven core species consistently sampled include bridgelip sucker (*Catostomus columbianus*), largescale sucker (*Catostomus macrocheilus*), chiselmouth chub (*Acrocheilus alutaceus*), longnose dace (*Rhinichthys cataractae*), speckled dace (*Rhinichthys osculus*), northern pikeminnow (*Ptychocheilus oregonensis*), and redband shiner (*Richardsonius balteatus*). In addition to the native nongame fish, various nonnative game fish were observed in much lower numbers (Schwabe et al. 2004).

Nonnative game fish collected from the Malheur River near the project site include white crappie (*Promoxis annularis*), channel catfish (*Ictalurus punctatus*), bullhead catfish (*Ameiurus nebulosus*), and smallmouth bass (*Micropterus dolomieu*). White crappies were collected in 2002, but not in 2003 or 2004. White crappie were documented in Beulah Reservoir and in the tailrace of Beulah Reservoir in 2002 (Schwabe et al. 2003). Most likely, the white crappie came from either Beulah Reservoir or Warm Springs Reservoir. The most likely source of the channel catfish, bullhead catfish, and smallmouth bass is Warm Springs Reservoir. The numbers of nonnative game fish sampled are low regardless of the season, indicating that self-sustaining populations in this reach of the Malheur River are unlikely (Schwabe et al. 2004).

### 3.2.6.4 Impacts of Alternative 1: Grant Right-of-Way

Potential impacts on wildlife include habitat destruction and wildlife disturbance during construction. Impacts to wildlife habitat would result from disturbance of vegetation by heavy equipment. After the diversion structure is completed the area would be revegetated with a BLM-approved native seed mix and weed control post project. Thus, impacts on wildlife habitat would be temporary and would be mitigated through the design features discussed in Section 2.1.1.



Periodic maintenance would be required to keep the dam in a usable condition and to set flashboards prior to the irrigation season. Construction and maintenance activities using heavy equipment would be conducted during the in-water work period from November 1 to March 31 (ODFW 2008). There would be no-to-low impacts to neotropical migratory birds as work would take place when individuals have already migrated south to their winter ranges.

Impacts to fish would be minimized because construction and maintenance activities and the use of heavy equipment would be conducted during the in-water work period from November 1 to March 31 (ODFW 2008). During this time flows are at the lowest and fish would likely have found pools to over-winter. This reach of stream has little change in gradient, is a long riffle, and provides little to no overwintering habitat for fish. Due to winter habitat use patterns, the temporary blockage of fish passage during construction would have a low impact on fish populations.

### **3.2.6.5 Impacts of Alternative 2: (No Action Alternative)**

Under the No Action Alternative, there would be no construction impacts to wildlife, neotropical migratory birds or fish. The No Action Alternative would result in further degradation to the stream channel by increased scour and bank erosion. Long-term effects of stream bank erosion would increase sediment loads, decrease water quality, and increase the establishment of non-native plant species. This projected result would decrease habitat for both aquatic and terrestrial species. The current blockage to upstream migrating fish decreases gene flow and increases the segregation of populations of redband trout in the area.

### **3.2.7 Sensitive, Threatened, or Endangered Species**

One federal ESA-listed threatened fish species, bull trout, and one state species of concern, redband trout, have the potential to occur in the project area. Historic information on bull trout distribution in this area is limited. Based on formal sampling by the BPT, bull trout likely do not currently utilize areas of the Mainstem Malheur River. During the three years, 2002, 2003, and 2004, presence/absence surveys were conducted on the Malheur River, bull trout were not observed. Historically, bull trout were thought to utilize the project area as a migration corridor and overwintering habitat. However, upon the establishment of Beulah and Warm Springs reservoirs, both with dams lacking fish passage structures, bull trout are no longer believed to inhabit the area at any time during the year. In the past, it is possible that bull trout in Beulah Reservoir (approximately 20+ river miles upstream of the project area) were able to escape past the dam downstream during high water years when water was released over the spillway. In 2011, water levels were high enough to make release over the spillway necessary. BPT held a recovery effort and five bull trout were recovered (Poole 2012). If bull trout were to become entrained (incidentally trapped) below Beulah Reservoir they are isolated with no fish passage, poor water and habitat quality, and lack of spawning habitat. Bull trout entrainment is now likely reduced or eliminated due to changes in release practices at Beulah Reservoir from over the spillway to tubes at the base of the reservoir. This makes it unlikely that bull trout will be present downstream in the project area under current conditions.

Redband trout, listed as a sensitive species under Oregon's Endangered Species Act, may seasonally utilize areas of the Malheur River as a migratory corridor. In 2002-2004, fish surveys were completed by BPT on the Malheur River Wildlife Mitigation property (study areas

consisted of approximately seven river miles immediately downstream of the project area). In 2002, 15 trout were collected. Conversely, in 2003, no trout were collected and in 2004 only one trout was collected in a fall sample. The trout collected in 2002 were likely carry-overs from the 2001 stocking of coastal rainbow trout from the Wizard Falls fish hatchery (Shannon Hurn, ODFW personal communication, March 26, 2012). Differences may also be attributed to changes in sampling times and methods. The Malheur River Wildlife Mitigation site was sampled in 2002 using a tote barge with the river at midsummer low flow, when reservoir levels were low and inflow equaled outflow. An additional attempt to sample was made in October 2002, but the river had already begun to freeze making shocking impossible (Schwabe et al. 2003). The 2003 sample was conducted during high water summer flow from irrigation releases (Schwabe et al. 2004). In 2003, a drift boat electro-shocker was used to sample because high water conditions did not permit effective use of the tote barge. Sampling of the Malheur River Wildlife Mitigation site was conducted in the spring of 2004 before irrigation releases from Beulah and Warm Springs Reservoirs and in the fall of 2004 after water releases were shut off from Beulah and Warm Springs Reservoirs. Sampling in the spring was conducted in April and fall sampling was conducted in November. Both sample efforts in 2004 were conducted using a Smith-Root 6-foot long tote barge. The conditions for the fall sample in 2004 compared to 2002 were optimal for trout because the water temperatures were cool and trout migration could be expected (Schwabe et al. 2004).

There is no wildlife species listed under the Endangered Species Act (ESA) that occur at the project area. There are, however, several state sensitive species (those facing threats to their populations or habitats, but not yet considered endangered or threatened) and two federal candidate species (species not yet listed as endangered or threatened under the ESA) that occur adjacent to the project site.

A candidate for ESA-listing is the greater sage-grouse, which may occur in the proposed project area on a yearlong basis. Sage-grouse use a variety of sagebrush habitat types ranging from sparse to heavy sagebrush cover, dependent on life stage. During the breeding season sage-grouse congregate on traditional breeding grounds called leks. Leks typically have sparse sagebrush and grass cover. The nearest greater sage-grouse lek to the project area is approximately seven miles away and the project area is considered neither a core nor low density greater sage-grouse habitat (Hagen, 2011). Sagebrush density and stature is especially important during winter (Homer et al 1993). Areas that have dense canopy cover or sagebrush that is at least 10-12 inches above snow level would provide both food and cover for wintering sage-grouse within the Project Area (Hagen 2011). Alternatively, low sagebrush may also provide some wintering habitat if sagebrush is kept clear of snow (ODFW 2011).

Another candidate species is Columbia spotted frog. Columbia spotted frogs are rarely found far from water and make their homes in or near permanent lakes, ponds, slow-moving streams and marshes in a wide variety of wetlands, forest types, grassland, and sagebrush communities (Welch and MacMahon, 2005). Water bodies that are deep enough that they do not freeze below the surface area are required for over-wintering of adults and juveniles. Columbia spotted frogs prefer thick algae and abundant aquatic vegetation for cover and like to hide in rushes, sedge and grass which are common in shallow waters (Bull and Hayes, 2002).

Based on a review of listed threatened, endangered, proposed, and candidate species provided by the U.S. Fish and Wildlife Service, no other ESA-listed, proposed, or candidate species are known to occur in the project area and thus, there would be no impact on ESA listed or proposed species or on candidate species (greater sage-grouse) from the proposed action.

### **3.2.7.1 Impacts of Alternative 1: Grant Right-of-Way**

The Proposed Action would allow BPT to continue the operation, maintenance, and replacement of the Malheur River diversion dam and associated structures. The negative impacts to sensitive species would be limited to the in water work period from November 1 to March 31st. The species with the highest potential of negative impacts is the redband trout. At this time of year low winter flows are not favorable to migration and redband trout would be confined to habitat suitable to overwintering. As no suitable pools exist at the construction site or in the irrigation system, impacts would likely be low.

The project area does not possess the vegetative qualities (large sagebrush densities) needed to provide suitable wintering habitat for greater sage-grouse. Most of the riparian zone vegetation where the project takes place is dominated by deciduous shrubs unsuitable for winter habitat for greater sage-grouse during the in-water work period. Adjacent upland areas with dense sagebrush canopy likely provide winter habitat for the species. However, work is confined to the waterway and riparian vegetation zone. Therefore there would be no impact on greater sage-grouse or habitat from the proposed action.

The project area provides marginal habitat for Columbia spotted frogs during summer months. The standing or slow moving water in the irrigation ditch would provide potential habitat for foraging and cover, though not for breeding. However, this project does not provide winter habitat for Columbia spotted frog. These frogs need deeper standing or slow moving water that won't freeze, which would not be present in the project area during the construction time. Therefore there would be no impact on Columbia spotted frogs from the proposed action.

### **3.2.7.2 Impacts of Alternative 2: No Action Alternative**

While the No Action Alternative would continue to provide habitat to terrestrial species, it would result in further degradation to the river and the associated aquatic flora and fauna from increased erosion. Currently, the entrance to the associated diversion canal has no structure to prevent bank erosion or soil loss. This results in removal of large sections of stream bank every year. Stream bank loss is exacerbated during high flows. The continued scour and bank erosion would increase downstream turbidity and sediment load. Increased sediment loads are known to adversely affect aquatic plant forms and disrupt food chains, resulting in a multitude of negative effects throughout the system.

The current structure does not have fish passage facilities and blocks upstream migration of redband trout during the irrigation season. The blockage to migrating redband trout isolates populations and limits the ability of the species to adjust to seasonal and yearly variations of the system by effectively limiting the amount of tributaries available for migration, spawning, and over wintering. These impacts would continue under the No Action Alternative.

### **3.2.8 Visual Resources Management (VRM)**

The proposed project lies in a VRM Class II area. The objectives of VRM Class II are as follows:

*Retain the existing character of the landscape. The level of change to landscape characteristics should be low. Management activities may be seen but should not attract the attention of a casual observer. Any changes must conform to the basic elements of form, line, color, and texture found in the predominant natural features of the characteristics landscape (USDI-BLM 2002).*

#### **3.2.8.1 Impacts of Alternative 1: Grant Right-of-Way**

The level of change to the characteristic landscape would be low. Initial surface disturbance from construction and long-term activities may attract attention, but would be temporary and should not dominate the view of the casual observer. Negative effects to the current visual resources would include a new concrete fish passage structure and an additional head gate with abutment. The impact to the visual resources would be low because of the small scale of the project (0.3 acre) and placement design.

#### **3.2.8.2 Impacts of Alternative 2: (No Action Alternative)**

The impact of the No Action Alternative would be similar to the impact of the Proposed Action and is considered low because the existing structure is approximately 3 feet in height and is not be visible until relatively near the site (approximately 250 feet) because the diversion dam is located off the highway and is not easily visible to the public due to the topography of the site.

### **3.2.9 Wetlands and Riparian Zones**

There are no wetlands in the proposed project area. Riparian conditions in the immediate streamside area historically consisted primarily of the hardwood species such as black cottonwood (*Populus trichocarpa*) and narrow leaf cottonwood (*Populus angustifolia*) and several shrubs: willows (*Salix* spp.), red osier dogwood (*Cornus sericea*), hawthorn (*Crataegus douglasii*), chokecherry (*Prunus virginiana*), golden currant (*Ribes aureum*) and Woods' rose (*Rosa woodsii*). Moving laterally away from the stream, the riparian and adjacent upland vegetation consisted primarily of Wyoming big sagebrush, riparian hardwoods, and other sagebrush species (NPCC 2004).

#### **3.2.9.1 Impacts of Alternative 1: Grant Right-of-Way**

There would be no impacts to wetlands from the proposed action. The impact to riparian zones would be low. Initial surface disturbance from construction activities may disturb riparian vegetation at entrance and exit points to the river by heavy equipment. Riparian vegetation would encompass less than the total project area (0.3 acre) and would be altered only until the disturbed area is seeded and revegetated. Until successful completion of stabilization and rehabilitation, riparian zone impacts would be localized and short term.

#### **3.2.9.2 Impacts of Alternative 2: (No Action Alternative)**

The No Action Alternative would continue current activities in the site. This action would increase channel erosion and continue the scouring of the stream bed. Bank erosion along the

south bank would continue without a headgate structure and abutment. This continued erosion would cause further loss to riparian vegetation.

## 4 CUMULATIVE IMPACTS

The CEQ defines cumulative effects as the impact on the environment which results from the incremental impact of the action when added to other past, present, and reasonably foreseeable future actions regardless of what agency (federal or non-federal) or person undertakes such other actions (40 CFR 1508.7). A June 2005 CEQ memorandum states:

*The environmental analysis required under NEPA is forward-looking, in that it focuses on the potential impacts of the proposed action that an agency is considering. Thus, review of past actions is required to the extent that this review informs agency decision making regarding the proposed action. This can occur in two ways:*

*First, the effects of past actions may warrant consideration in the analysis of the cumulative effects of a proposal for agency action. CEQ interprets NEPA and CEQ's NEPA regulations on cumulative effects as requiring analysis and a concise description of the identifiable present effects of past actions to the extent that they are relevant and useful in analyzing whether the reasonably foreseeable effects of the agency proposal for action and its alternatives may have a continuing, additive and significant relationship to those effects. In determining what information is necessary for a cumulative effects analysis, agencies should use scoping to focus on the extent to which information is "relevant to reasonably foreseeable significant adverse impacts," is "essential to a reasoned choice among alternatives," and can be obtained without exorbitant cost (40 CFR 1502.22). Based on scoping, agencies have discretion to determine whether, and to what extent, information about the specific nature, design, or present effects of a past action is useful for the agency's analysis of the effects of a proposal for agency action and its reasonable alternatives. Agencies are not required to list or analyze the effects of individual past actions unless such information is necessary to describe the cumulative effect of all past actions combined. Agencies retain substantial discretion as to the extent of such inquiry and the appropriate level of explanation (Marsh v. Oregon Natural Resources Council, 490 U.S. 360, 376-77 [1989]). Generally, agencies can conduct an adequate cumulative effects analysis by focusing on the current aggregate effects of past actions without delving into the historical details of individual past actions.*

*Second, experience with and information about past direct and indirect effects of individual past actions may also be useful in illuminating or predicting the direct and indirect effects of a proposed action. However, these effects of past actions may have no cumulative relationship to the effects of the proposed action. Therefore, agencies should clearly distinguish analysis of direct and indirect effects based on information about past actions from a cumulative effects analysis of past actions (Connaughton 2005).*

## 4.1 Past Actions

Past actions in the geographic scope of the area are identified below.

### Historic Actions

- Warm Springs Dam constructed in 1919 on the Mainstem of the Malheur River by the Warm Springs Irrigation District.
- Agency Valley Dam constructed in 1935 on the North Fork of the Malheur River.
- Jonesboro diversion dam and irrigation canal installed in approximately 1940.
- 200 to 250 head of cattle wintered along Malheur River every year starting in approximately 1939 to 2000.

### Recent Past Actions

- Fish screen installation on the diversion canal on June 30, 2007.
- Enrollment of 245 acres into the Farm Service Agency Conservation Reserve Enhancement Program.
- Noxious weed control.
- Irrigation management for waterfowl production and protection.
- Alfalfa and grain crops managed for birds and winter forage for deer and elk.

The installation of two upstream dams has impacted the Malheur River system. Much of the river flows in the Malheur River Subbasin are managed by a complex system of reservoirs, diversion canals, and siphons. The largest reservoirs in the system are the 192,400 acre-feet impoundment created by the Warm Springs Dam in 1919 on the mainstem and the 59,900 acre-feet impoundment at Agency Valley Dam in 1935 on the North Fork of the Malheur River. Warm Springs and Agency Valley dams were constructed without fish passage facilities, creating an upstream barrier effectively separating upstream populations of redband trout and bull trout from downstream populations. These barriers are located approximately 37 miles and 30 miles, respectively, upstream from the proposed project.

Redband trout are listed as a sensitive species under Oregon's Endangered Species Act. The health of the redband population in the Malheur River watershed is currently unknown and an interagency group researched life history characteristics (Schwabe et al. 2000). Redband trout are the most prevalent native salmonid (family of fish that includes salmon, trouts, chars, and whitefishes) in the Subbasin. Redband are found in tributaries of the South Fork Malheur, Malheur River below Warm Springs Reservoir, and the tributaries of the North Fork below Beulah Reservoir (also known as Agency Valley Dam). The strongholds for redband trout and bull trout are similar—the North Fork and Upper Malheur River upstream of the reservoirs. Downstream of both reservoirs, habitat is considered marginal for spawning and rearing due to low flows, poor water quality, and irrigation structure blockages (Schwabe et al. 2004). Tributaries that redband trout inhabit in the Malheur River Subbasin near the proposed project include Calf Creek, Hunter Creek, Pole Creek, Black Canyon Creek, and Gold Creek (Map 6). Fish present in these tributaries can either be migratory, rearing, and spawning or a combination. Redband trout do not currently occupy habitats from RM 0 to 69 below the proposed project area.

Historic information on bull trout distribution, a species listed as threatened species under the ESA, in this area is limited. However, prior to dam construction, bull trout would have had access to the Snake River. The lower Malheur River would have had limited habitat for spawning or juvenile rearing due to high stream temperatures, but would have potentially provided a migration corridor and overwintering habitat for adults (Malheur Watershed Council and BPT 2004).

Bull trout primarily occur in the headwaters of the Malheur River. Entrainment has been documented below Beulah Reservoir. Radio telemetry studies have shown that entrained bull trout tend to stay in two river kilometers of the tailrace (Schwabe et al. 2000). Local residents have reported bull trout in the Malheur River near Juntura, Oregon, but it is believed that these individuals will not successfully spawn or rear due to the lack of habitat and the altered seasonal hydrograph.

The current Jonesboro diversion structure is believed to have been installed in the 1940s or 1950s after the Warm Springs and Agency Valley Dams; however, there are no historical records of when the current structure was installed. Based on the dates of adjacent private property water rights served by the Jonesboro diversion structure (1883, 1885, 1888, and 1901) it is likely that prior structures were constructed to divert water from the Malheur River. The current structure does not have fish passage facilities and blocks upstream migration of redband trout during the irrigation season. Additionally, there are no erosion control measures in place, which results in removal of large sections of stream bank each year.

Approximately 200 to 250 head of cattle were wintered along the Malheur River in the Jonesboro FFR pasture for roughly 60 years. Primary use of the Malheur River was for watering cattle. Past management did not account for or construct water gaps to minimize cattle access points, rather, cattle movement was dictated by topography, the entrenched nature of the river due to soil properties, and the loss of floodplain connectivity related to upstream dams. These access points are scattered downstream from the proposed project. These areas have suffered changes to riparian vegetation primarily from cattle trampling. The river bed has exhibited little negative impact from cattle as it is primarily composed of bedrock.

In the mid-1990s, the BPT identified the Jonesboro Ranch FFR as a key component in the restoration of aquatic and terrestrial habitat in the Malheur River basin (U. S. Forest Service, 1993(A) and U.S. Forest Service, 1993(B)). This area is culturally significant to the BPT because it lies in their aboriginal territory. Historically, BPT members gathered roots, hunted, and fished along the Malheur River corridor. As a result, both the BPT and the public had a shared interest in permanently protecting the Project and improving habitat conditions for fish and wildlife species.

**Map 6: Tributaries redband trout inhabit in the Malheur River Subbasin located near the project are: Calf Creek, Hunter Creek, Pole Creek, Black Canyon Creek, and Gold Creek**

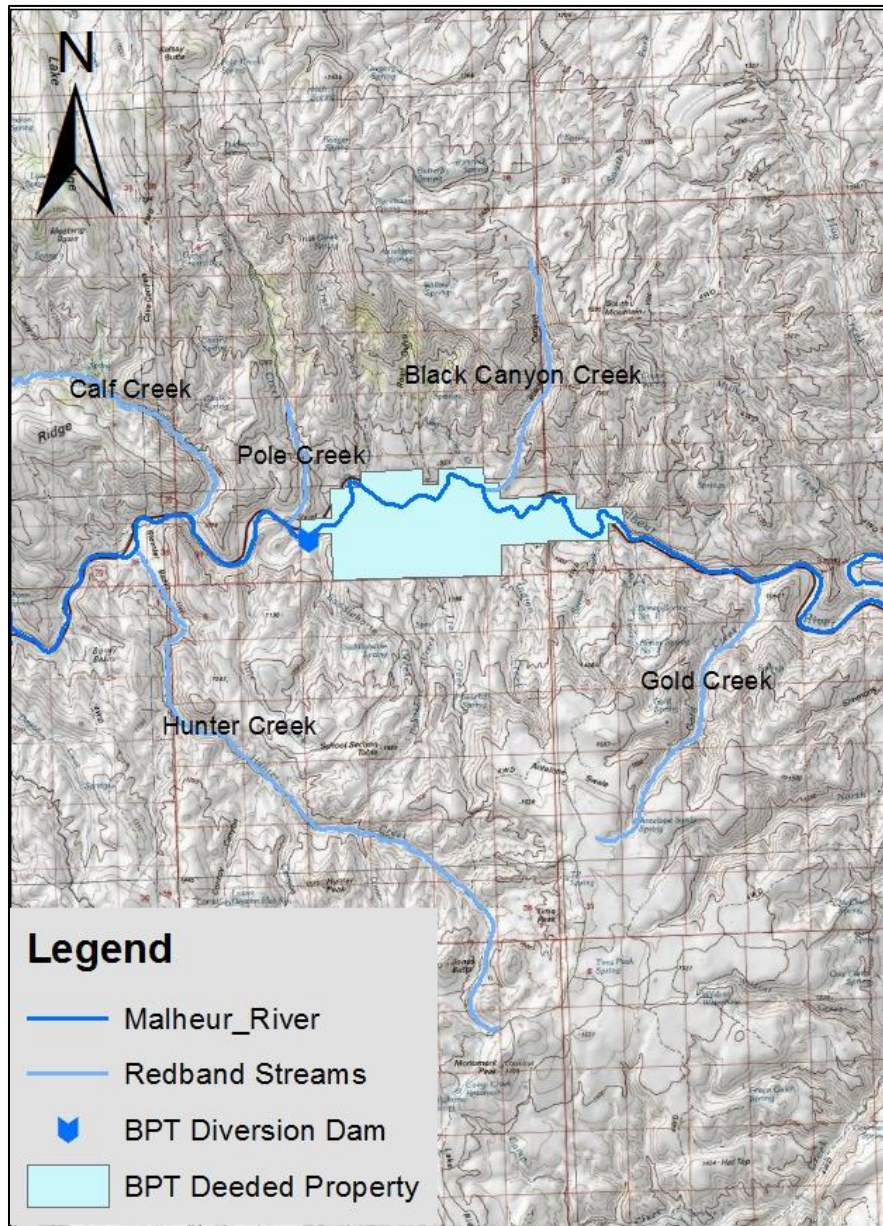

In 1998, the BPT submitted a proposal to BPA to acquire the Jonesboro Ranch, which included the Denny Jones Ranch and other BLM and Oregon Department of State Lands leases and grazing allotments. The project approval process and acquisition negotiations continued for several years until the BPT and BPA entered into a Memorandum of Agreement, which allowed for purchase of the Project in November 2000. The MOA assists BPA in carrying out its



obligations related to this agreement, and to support efforts to mitigate for effects of the FCRPS on fish and wildlife in the Mainstem Columbia River and its tributaries. Pursuant to the agreement, BPT has dedicated permanently these lands to wildlife habitat protection.

Recent past actions of BPT have included several large restoration efforts pursuant to the agreement with BPA to manage lands to the benefit of wildlife. These actions include but are not limited to:

1. Installing fish screens on the intake canal from the Malheur River diversion.
2. Planting 34,935 willow cuttings to stabilize the banks of the Malheur River.
3. Enrollment of approximately 245 acres of land into the Farm Service Agency's Conservation Reserve Enhancement Program. Treatment included over 8,000 native shrub and tree plantings in the riparian zone of the Malheur River.
4. Treatment of noxious weeds on over 500 acres/year via manual, mechanical, and chemical methods.
5. Management of flood-irrigated meadows to facilitate waterfowl production.
6. Planting fields in crops such as annual grains, alfalfa, and native perennial grasses to provide cover and/or forage for birds and large game.
7. Reducing grazing on BLM allotments and excluding cattle from the Mainstem Malheur River and its tributaries.

The cumulative impacts from past actions have positively affected the ecological function of the area. Irrigation of wet meadows has increased waterfowl production, and numbers of neotropical migrants have increased in the area. Bank stability has increased due to BPT efforts to plant willows and remove grazing from the river, and a notable decrease in the numbers of noxious weeds have been documented on the BPT mitigation site. Native perennial bunch grasses are appearing on the landscape providing cover for ground birds and small mammals, as well as bedding and cover for large game. (2014 Kesling, Per Comm.)

## **4.2 Present Actions**

There are no known present actions by the BLM in progress. BPT has several present actions on the adjacent mitigation site. These actions include:

1. Weed control on 400 acres of wet meadow, riparian, and upland habitat through removal, spot spraying, and broadcast spraying.
2. Maintenance of the wet meadow irrigation system (7.9 miles of irrigation ditches are maintained and cleaned daily as needed).
3. Hay alfalfa and grass fields to provide over winter forage for big game and lessen the amount of weeds on site.
4. Remove juniper on upland sites to increase water availability for other plants and tributaries to the Malheur River.
5. Grade and repair Lookout Road on Tribal property to facilitate both Tribal and non-Tribal recreationists.
6. Fence headwaters to Hunter Creek (a redband bearing tributary to the Malheur) and complete riparian plantings to increase water quality downstream.

BPT present actions are consistent with past actions. Land restoration actions of the Tribe would have beneficial cumulative impacts on the Malheur River and adjacent lands for fish, wildlife, and native plant communities when combined with the long term impacts of the Proposed Action.

### **4.3 Reasonably Foreseeable Future Actions**

Currently, there are no reasonably foreseeable future BLM actions. Future BLM grazing permit renewal actions may include potential rangeland development proposals; however, no proposals are currently identified and prior to any such construction additional NEPA analysis would be completed.

BPT future actions would be consistent with past and present actions. Land restoration actions of the Tribe would have beneficial cumulative impacts on the Malheur River and adjacent lands for fish, wildlife, and native plant communities when combined with the long term impacts of the Proposed Action.

With respect to recreational use, no foreseeable increase is projected as the population density in the area is extremely low at 0.1 people per square mile. The surrounding landscape is dominated by public land, with over 62 percent of the landscape in public ownership. With few amenities in the area, the nearest being the town of Juntura, OR, with a population of approximately 160 individuals and 11 miles west of the proposed project, there is likely no foreseeable increase in recreation use.

Geothermal potential in the area is low to moderate, with no known active exploration at this time. The project site sits on the western edge of moderate oil and gas potential. Exploration and development has limited potential in this area. Thus, neither geothermal or oil and gas activities are considered reasonably foreseeable future actions for this cumulative impacts analysis.

## **5 LIST OF PREPARERS**

Kyle Heinrick	Wildlife Biologist, Burns Paiute Tribe
Jason Kessler	Natural Resources Specialist, Burns Paiute Tribe
Jenna Peterson	Environmental Protection Specialist, Bonneville Power Administration
Cheryl Bradford	Cultural Resources Specialist, Bureau of Land Management
Becky Evans	Rangeland Management Specialist, Bureau of Land Management
Susan Fritts	Botanist, Bureau of Land Management
Kari Points	Recreational Specialist, Bureau of Land Management
Lynne Silva	Weeds Specialist, Bureau of Land Management
Trisha Skerjanec	Realty Specialist, Bureau of Land Management

## **6 LIST OF AGENCIES OR PEOPLE INVOLVED IN SCOPING**

Curtis Smith, Southeast District Manager, Oregon Parks & Recreation Department  
Philip Milburn, Oregon Department of Fish & Wildlife  
Dennis Griffin, Oregon State Historic Preservation Office  
Burns Paiute Tribe

## 7 LITERATURE CITED

- Bureau of Land Management. 2008. National Environmental Policy Act Handbook (H-1790-1)
- Bureau of Reclamation (BOR). 2012. USBR Pacific Northwest Region Hydromet/AgriMet System Data Access; Historical Data 2000 to 2012.
- Council for Environmental Quality. 1997. Considering Cumulative Effects under the National Environmental Policy Act.
- Council for Environmental Quality. 2005. Memorandum re: Guidance on the Consideration of Past Actions in Cumulative Effects Analysis.
- Hagen, et al. 2011. Greater Sage-Grouse Conservation Assessment and Strategy for Oregon: A Plan to Maintain and Enhance Populations and Habitat. Oregon Department of Fish and Wildlife. pp 207.
- Kesling, Jason 2014. Burns Paiute Tribe Natural Resources Director. Communicated over 10 year's professional observation on Mitigation Property.
- Malheur Watershed Council and Burns Paiute Tribe. 2004. Malheur River Subbasin Assessment and Management Plan for Fish and Wildlife Mitigation. Northwest Power and Conservation Council, Portland, OR.
- Northwest Power and Conservation Council (NPCC). 2004. Malheur River Subbasin Assessment and Management Plan for Fish and Wildlife Mitigation. NPCC, Portland , OR.
- Oregon Department of Agriculture (ODA). 2011. Noxious Weed Policy and Classification System. Noxious Weed Department, Salem Oregon. <http://oregon.gov/ODA?PLANT/WEEDS>.
- Oregon Department of Fish and Wildlife (ODFW). 2008. Oregon Guide Lines for Timing of In-Water Work to Protect Fish and Wildlife Resources. Salem, Oregon.
- Oregon State Water Resources Board; United States Soil Conservation Service, Oregon State University. 1969. Oregon's Long Range Requirements for Water 1969, Appendix I-10 Malheur River Drainage Basin. Corvallis Agriculture Experimental Station.
- Pacific Northwest Electric Power Planning and Conservation Act. 1980. (16 U.S.C. 839 et seq.).
- Poole, A. 2012. 2011 Efforts to Trap and Haul Bull Trout *Salvelinus confluentus* Entrained Over Agency Valley Dam on the North Fork Malheur River, Oregon. "Evaluation of the life History of Native Salmonids in the Malheur River Basin." Project No. 1997-01900.
- Schwabe, L., M. Tiley, R. Perkins, D. Gonzalez, W. Bowers, R. Rieber, A. Mauer, S. Bush, and C. Tait. 2000. "Evaluation of the Life History of Native Salmonids in the Malheur River Basin", Project No. 1997-01900, 120 electronic pages, (BPA Report DOE/BP-00006313-1).

Schwabe, L., T. Walters, J. Fenton, R. Perkins, J. Wenick, R. Rieber, A. Mauer, A. Miller, J. Soupir, C. Boyd, and C. Tait. 2003. Evaluation of the Lifer History of Native Salmonids in the Malheur River Basin:, Project No. 1997-01900, 143 electronic pages, (BPA Report DOE/BP-00006313-3).

Schwabe, L., T. Walters, J. Fenton, R. Perkins, J. Wenick, R. Rieber, A. Mauer, A. Miller, J. Soupir, C. Boyd, and C. Tait. 2004. Evaluation of the Lifer History of Native Salmonids in the Malheur River Basin: Project No. 1997-01900, 140 electronic pages, (BPA Report DOE/BP-00006313-4).

USDI-BLM. 2010. Bureau of Land Management Recreation Management Information Systems.

USDI-BLM. 2008. Bureau of Land Management National Environmental Policy Act Handbook (H-1790-1). 58 pp.

USDI. 2004. Departmental Manual 516, Environmental Quality.

USDI-BLM. 2002. Southeastern Oregon Resource Management Plan and Record of Decision. U.S. Bureau of Land Management, Vale District, Oregon. 1 v.

USDI-BLM and Office of the Solicitor (editors). 2001. The Federal Land Policy and Management Act, as amended. U.S. Department of the Interior, Bureau of Land Management Office of Public Affairs, Washington, D.C. 69 pp.

U.S. Department of the Interior, Bureau of Land Management and Office of the Solicitor (editors). 2001. The Federal Land Policy and Management Act, as amended. U.S. Department of the Interior, Bureau of Land Management Office of Public Affairs, Washington, D.C. 69 pp.

U.S. Department of Energy. 1970. National Environmental Policy Act Regulations (10 C.F.R. 1021 et seq.)

U.S. Forest Service. 1993. Malheur wild and scenic river management plan. Malheur National Forest, John Day, Oregon. (A).

U.S. Forest Service. 1993. North Fork Malheur scenic river management plan. Malheur National Forest, John Day, Oregon. (B).

Wood, Paul J., P.D. Armitage. 1997. Biological Effects of Fine Sediment in the Lotic Environment. Environmental Management. V. 21, No. 2 pp 203.

**Appendix A – Design Features**

**Malheur River Wildlife Mitigation Fish Passage Project**  
**Design Narrative**  
**March 31, 2011**

The intent of the proposed project is to replace the existing stanchion/check board structure with a structure of similar design that will accommodate fish passage. The existing structure is badly degraded and partially failed, prompting the owner to undertake this project. Fish passage at the proposed structure will be accomplished using a concrete pool and weir fishway structure.

USGS stream gauge data is available for the main stem Malheur River and the North Fork Malheur River upstream of the project site. The project design flow rates were determined by summing the average daily flows of the two upstream gauges. The two gauging stations utilized were:

Gauge Number: 13215000

Location: Malheur River, below Warm Springs Reservoir, near Riverside, OR

Begin Data Date: 6/26/1926

End Data Date: 9/22/2010

Gauge Number: 13217500

Location: North Fork Malheur River at Beulah, OR

Begin Data Date: 6/26/1926

End Data Date: 9/22/2010

The 5<sup>th</sup> and 95<sup>th</sup> stream flow percentiles were calculated from the summed average daily stream flows. During low water years and in the winter, the Malheur River can be essentially dry at the gauging sites for extended periods of time. Therefore, flows less than 10 cfs were excluded from the percentile calculations as being insignificant. Utilizing this method, the below stream flows were determined for the 5<sup>th</sup> and 95<sup>th</sup> percentile flows respectively.

Estimated Stream Flows:

5<sup>th</sup> Percentile= 40 cfs

95<sup>th</sup> Percentile= 1,000 cfs

Based on discussions with the project owners and a HEC-RAS model of the design, we determined that it would be difficult to maintain the water elevation at the river necessary to reasonably facilitate irrigation deliveries at river flows below 150 cfs. Therefore, the project fishway has been designed to meet passage criteria at river flows ranging from 150 cfs to 1,000 cfs.

At river flows less than 150 cfs or greater than 1,000 cfs, the stanchions and check boards should be removed from the river to allow unimpeded upstream fish passage. At flows exceeding approximately 1,500 cfs, localized overtopping of the river bank upstream of the structure will occur, and structure damage is possible if the stanchions and check boards are allowed to remain in place.

Based on the HEC-RAS model, the fishway structure is anticipated to convey at least 10 percent of the total river flow in the fishway with the top of the river check structure set at 24 inches above the concrete sill through the design flow range. However, as actual operating conditions will likely differ

somewhat from modeled conditions, it is also anticipated and recommended that operational guidelines be developed through the course of the initial irrigation season following project startup to maintain minimum fishway flows.

The fishway is comprised of nine pools with six inches of elevation change between each successive pool. The fishway is designed to meet the applicable criteria set forth in O.A.R. 635-412-0035 as follows:

1. Pool Depth: Typical design pool depth exceeds 2 feet.
  - a. Pool Depth at 150 cfs:  $3.1 \pm$  ft.
  - b. Pool Depth at 1,000 cfs:  $4.8 \pm$  ft.
  
2. Pool Volume: Typical design pool volume exceeds the formula  $wQH/4$ .
  - a. Required Pool Volume at 150 cfs: 117 cubic feet  
Design Pool Volume at 150 cfs: 549 cubic feet
  
  - b. Required Pool Volume at 1,000 cfs: 780 cubic feet  
Design Pool Volume at 1,000 cfs: 827 cubic feet
  
3. Maximum Discrete Fishway Velocity Less Than 8 ft/s:
  - a. Maximum Velocity at 150 cfs: 2.1 ft/s.
  - b. Maximum Velocity at 1,000 cfs: 4.0 ft/s.







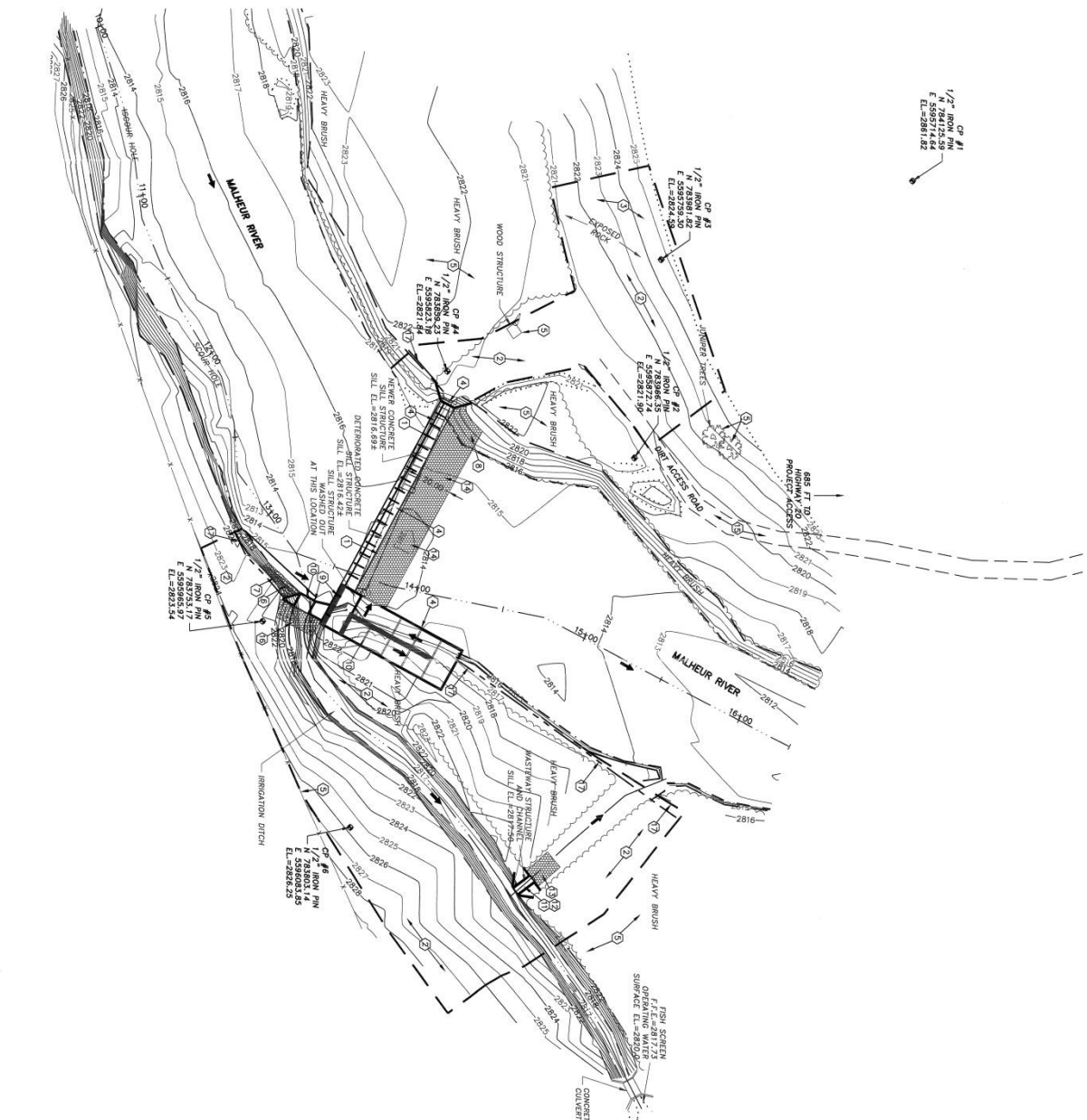

CP #1  
N 7841725.99  
E 5398927.44  
EL. 2881.82

CP #2  
N 783911.62  
E 5398728.30  
EL. 2877.44

CP #3  
N 783911.62  
E 5398927.44  
EL. 2881.82

CP #4  
N 783911.62  
E 5398927.44  
EL. 2881.82

CP #5  
N 783911.62  
E 5398927.44  
EL. 2881.82

CP #6  
N 783911.62  
E 5398927.44  
EL. 2881.82

CP #7  
N 783911.62  
E 5398927.44  
EL. 2881.82

CP #8  
N 783911.62  
E 5398927.44  
EL. 2881.82

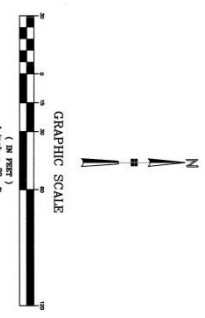

**KEYNOTES**

- 1 REMOVE EXISTING CONCRETE DIVERSION STRUCTURE AND ABUTMENTS, STOCKPILE ON-SITE IN AREA SHOWN
- 2 PROJECT STAGING AREA CONSTRUCTION IMPACTS EXTENDS DOWNSTREAM FROM DIVERSION STRUCTURE. CONSTRUCTION PROJECT ACCESS TO BE DISPOSED OF IN BERMS STOCKPILE
- 3 CONCRETE/BERMS STOCKPILE AREA
- 4 CONCRETE/BERMS STOCKPILE AREA
- 5 RETAIN AND PROTECT
- 6 PLACE FILL MATERIAL TO REGRADE EXISTING BANK, MAX. 1:5:1
- 7 PLACE BRIMP AT BANK FILL AREA FOR 25 L.F. UPSTREAM
- 8 PLACE BRIMP ALONG RIVER BANKS FROM 20 L.F. DOWNSTREAM OF STRUCTURE. SEE DETAIL 27/C-3
- 9 EXCAVATE AND REMOVE DEPOSITED SILT/AND DOWN TO WATER TABLE. REMOVE DEPOSITED SILT/AND DOWN TO WATER TABLE. REMOVE DEPOSITED SILT/AND DOWN TO WATER TABLE. REMOVE DEPOSITED SILT/AND DOWN TO WATER TABLE.
- 10 POSSIBLE ROCK EXCAVATION NECESSARY FOR HEADGATE AND/OR FISHWAY INSTALLATION
- 11 REBERMS STOCKPILE WASTEWAY STRUCTURE AND DISPOSE IN
- 12 NEW CONCRETE WASTEWAY STRUCTURE. SEE DETAIL 57/C-3
- 13 PLACE BRIMP IN WASTEWAY FOR 15 L.F. DOWNSTREAM OF
- 14 PLACE BRIMP DOWNSTREAM OF DIVERSION STRUCTURE. SEE DETAIL 47/C-3. REBERMS CHANNEL BED TO FILL SCOUR HOLE AS NECESSARY
- 15 ACCESS WAGON ROAD AS APPROPRIATE FOR EQUIPMENT
- 16 PLACE BRIMP IN REGRADED IRIGATION DITCH FOR 10 L.F. DOWNSTREAM OF NEW HEADGATE STRUCTURE. SEE DETAIL 37/C-3
- 17 FENCE SHALL REMAIN IN PLACE UNTIL PROJECT AREA HAS BEEN REGRADED BY OWNER. SILT FENCE REMOVAL BY OWNER

**MALHEUR MATERIAL QUANTITY TABLE**

DESCRIPTION	QUANTITY
5/4" TAMMS STRUCTURAL FILL	40 C.Y.
3/4" DIA. ROCK BRIMP	20 C.Y.
CHANNEL SUBSTRATE CUT TO FILL	80 C.Y.
EXCAVATION TO OPENING DISPOSAL	300 C.Y.
EXCAVATION TO OPENING DISPOSAL	250 C.Y.
ROCK EXCAVATION (ESTIMATED MAXIMUM)	25 C.Y.
5" TAMMS STRUCTURAL FILL	60 C.Y.
SILT FENCE	250 L.F.

**EXCAVATION NOTES**

- 1 EXCESS MATERIAL EXCAVATED FOR PLACEMENT OF COMPONENTS ORSONAL LOCATION WITH OWNER AND ENGINEER.



DESIGNED BY: <u>MARK GIES</u>	CHECKED BY: <u>MARK</u>
DRAWN BY: <u>EKS</u>	PLLOT DATE: <u>8/25/2011</u>
DATE: <u>  </u> BY: <u>  </u>	REVISION: <u>  </u> CR'D/ APPR

**MALHEUR RIVER FISH PASSAGE PROJECT  
CIVIL SITE PLAN**

SCALE: 1" = 30'	PROJECT NO. 452-01	DRAWING FILENAME: Malheur TopoD11.dwg 8/25/2011
-----------------	--------------------	---

**Quadrant Consulting, Inc.**  
1904 W. Overland Rd  
Boise, Idaho 83705  
(208) 343-0091 FROM: (208) 343-0092 FAX  
CIVIL ENGINEERING-SURVEYING-CONSTRUCTION MANAGEMENT



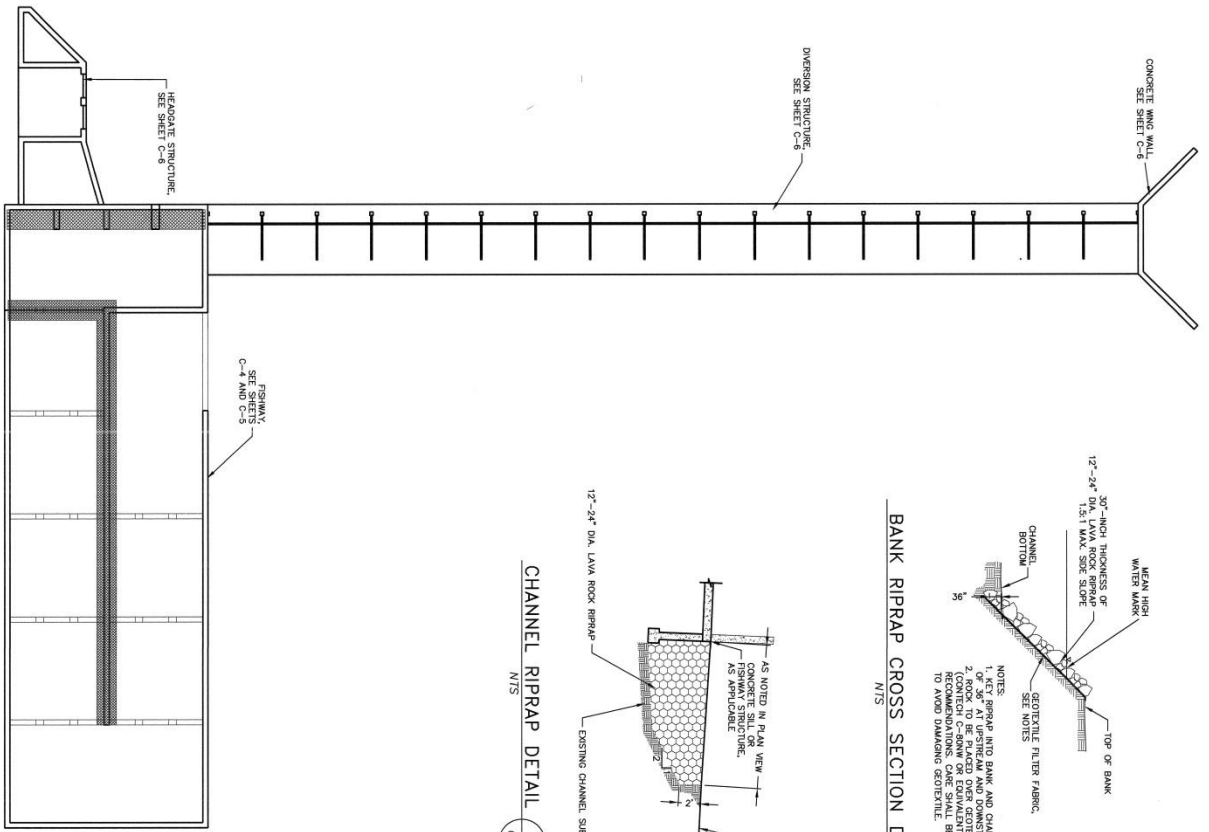

OVERALL DIVERSION STRUCTURE LAYOUT DETAIL  
N/S

1  
C-3

BANK RIPRAP CROSS SECTION DETAIL  
N/S

2  
C-3

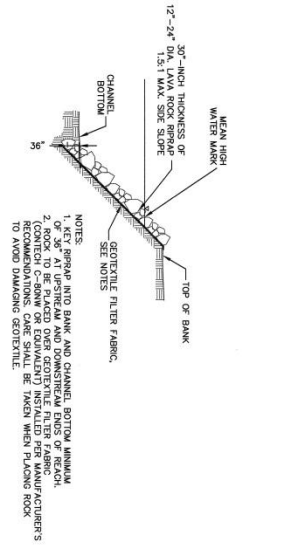

CHANNEL RIPRAP DETAIL  
N/S

4  
C-3

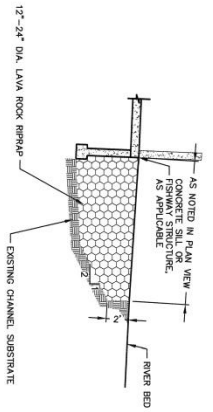

WASTEWAY RIPRAP DETAIL  
N/S

3  
C-3

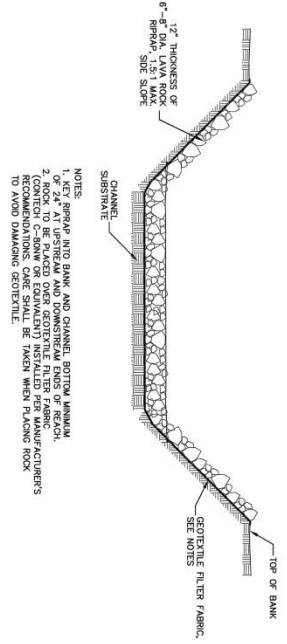

SECTION A-A

18" THICKNESS 6" MINUS NO. 200 SIEVE COMPACTED TO EXCEED 95% ASTM D-698

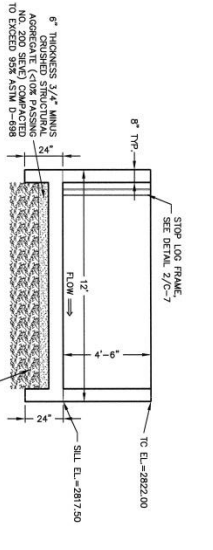

WASTEWAY STRUCTURE DETAIL  
N/S

5  
C-3

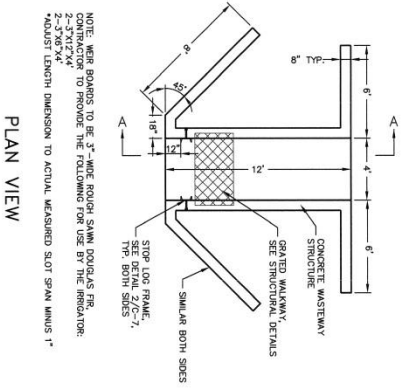

DESIGNED BY: NAK/EKS	CHECKED BY: NAK			
DRAWN BY: EKS	DATE: 8/25/2011			
DATE	BY	REVISION	OK'D	APPR.

**MALHEUR RIVER DIVERSION STRUCTURE  
DETAIL SHEET**

JUNTURA      OREGON

SCALE: NTS      PROJECT NO. 452-01      DRAWING FILENAME: Malheur TopoD11.dwg      8/25/2011

**Quadrant Consulting, Inc.**

1804 W. Overland Rd.  
Boise, Idaho 83706  
(208) 342-0097 PHONE      (208) 342-0092 FAX  
CIVIL ENGINEERING-SURVEYING-CONSTRUCTION MANAGEMENT

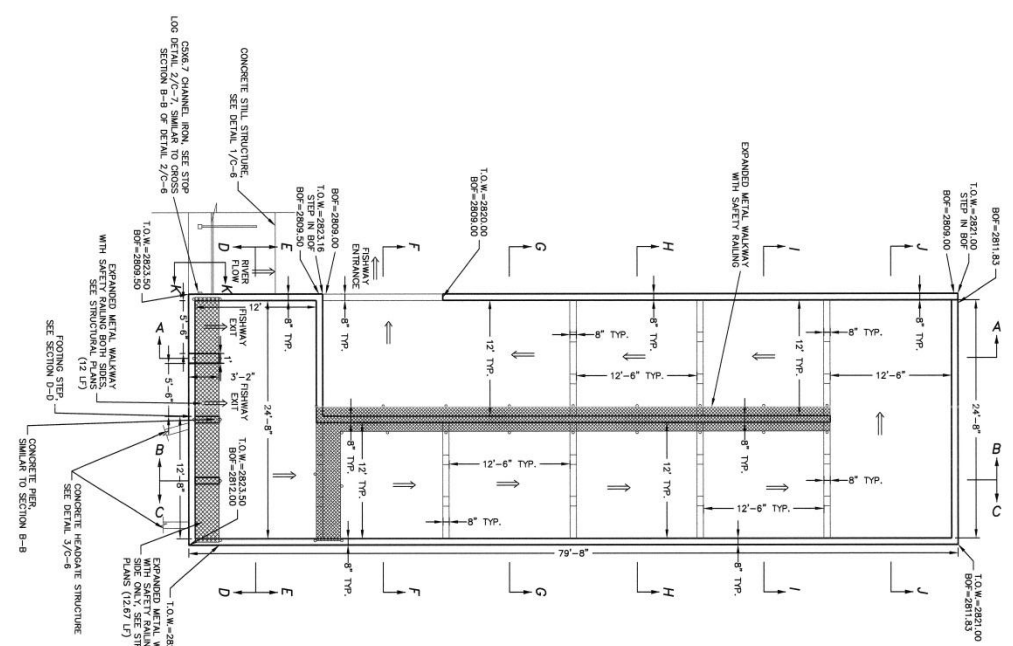

- NOTES:
1. SET STRUCTURAL PLANS FOR REINFORCEMENT DETAILS.
  2. CROSS SECTIONS CONTINUED ON DETAIL 1/2-C-4.
  3. MINIMUM FISHWAY CLEARANCE FROM WEIR EQUALS 6 INCHES.
  4. MINIMUM POOL FRESHWATER IS APPROXIMATELY 3 FEET.

**CROSS SECTION A-A**

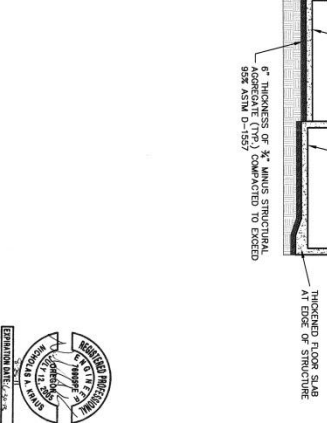

**CROSS SECTION B-B**

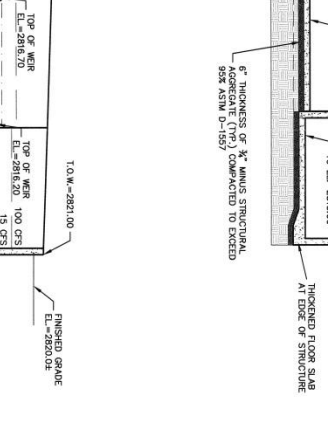

**CROSS SECTION C-C**

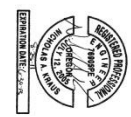
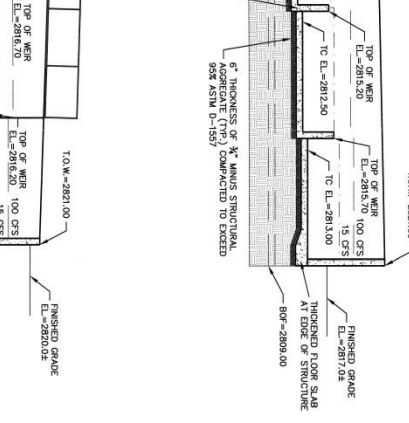

DESIGNED BY: NAK/EKS	CHECKED BY: NAK
DRAWN BY: EKS	PLOT DATE: 8/25/2011
DATE: _____	REVISION: _____
BY: _____	OK'D APPR: _____

**MALHEUR RIVER DIVERSION STRUCTURE**  
DETAIL SHEET

JUNTURA      OREGON

SCALE: NTS      PROJECT NO: 452-01      DRAWING FILENAME: Malheur TopoD11.dwg      8/25/2011

**Quadrant Consulting Inc.**

1504 W. Overton Rd  
Boles, Idaho 83702  
(208) 342-0001 PHONE    (208) 342-0092 FAX  
CIVIL ENGINEERING-SURVEYING-CONSTRUCTION MANAGEMENT

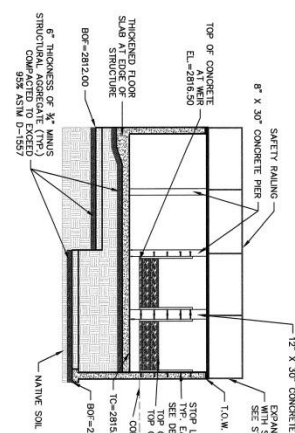

NOTE: STOP LOGS TO BE 3"-WIDE ROUGH SAWN LUMBER. CONTRACTOR TO PROVIDE THE FOLLOWING FOR USE BY THE INNOVATOR:  
 4 @ 3" x 12" x 5'-6" LONG\*  
 \* ADJUST LENGTH DIMENSION TO ACTUAL MEASURED SLOT SPAN MINUS 1.5"

CROSS SECTION D-D

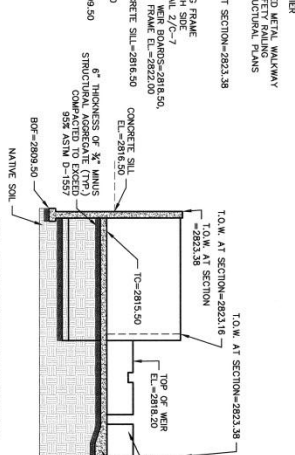

CROSS SECTION E-E

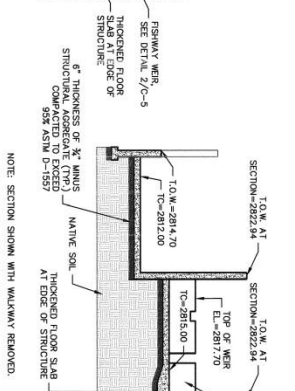

CROSS SECTION F-F

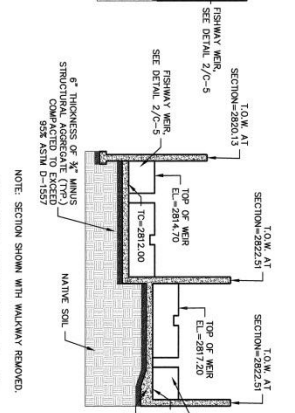

CROSS SECTION G-G

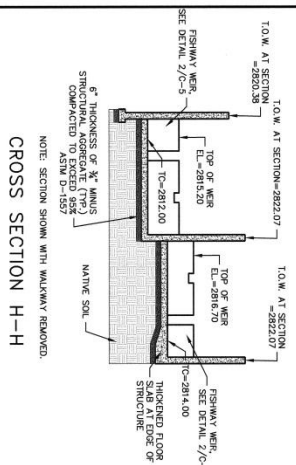

CROSS SECTION H-H

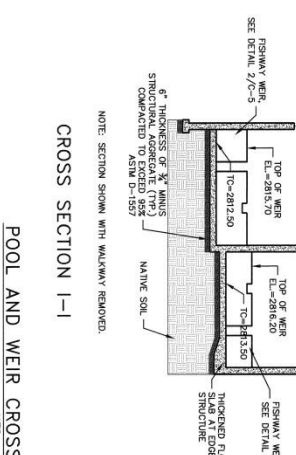

CROSS SECTION I-I

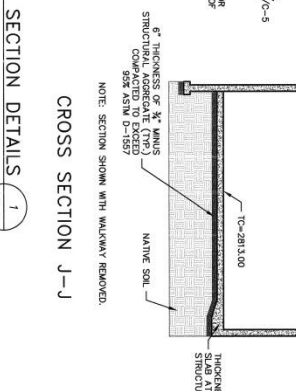

CROSS SECTION J-J

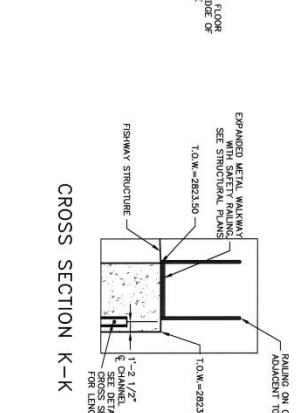

CROSS SECTION K-K

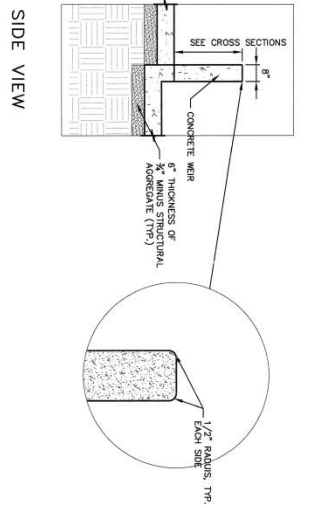
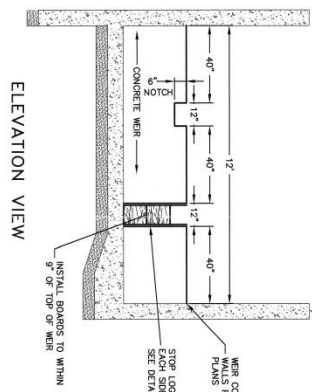

NOTE: STOP LOGS TO BE 3"-WIDE ROUGH SAWN LUMBER. CONTRACTOR TO PROVIDE THE FOLLOWING FOR EACH WEIR SLOT (6 TOTAL) FOR USE BY THE OPERATOR:  
 2 @ 3" x 12" x 12" LONG\*  
 1 @ 3" x 6" x 12" LONG\*  
 \* ADJUST LENGTH DIMENSION TO ACTUAL MEASURED SLOT SPAN MINUS 1.5"  
 NOTE: SEE STRUCTURAL PLANS FOR REINFORCEMENT DETAILS.

FISHWAY WEIR DETAIL



DESIGNED BY: NAK/EKS	CHECKED BY: NAK
DRAWN BY: EKS	DATE: 8/25/2011
DATE:	REVISION:
	OK'D APPR:

**MALHEUR RIVER DIVERSION STRUCTURE**  
**DETAIL SHEET**

JUNJUTRA PROJECT NO. 452-01 DRAWING FILENAME: Malheur TopoD11.dwg 8/25/2011 OREGON

SCALE: NTS

**Quadrant Consulting, Inc.**  
 1904 W. Overland Rd.  
 Boise, Idaho 83705  
 (208) 342-0991 PHONE (208) 342-0992 FAX  
 CIVIL ENGINEERING - SURVEYING - CONSTRUCTION MANAGEMENT

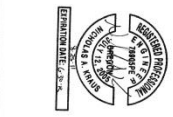

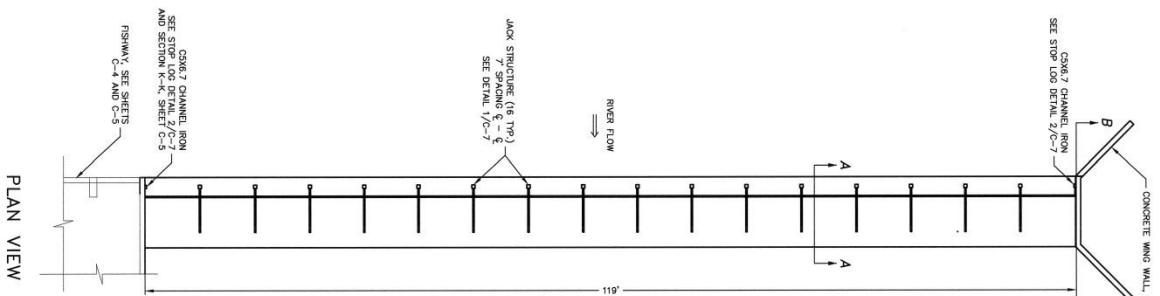

CONCRETE SILL STRUCTURE DETAIL 1  
NTS

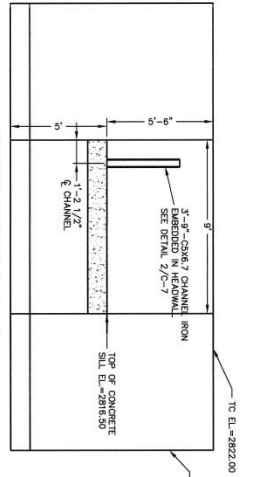

CROSS SECTION B-B  
NOTE:  
1. SEE STRUCTURAL PLANS FOR REINFORCEMENT DETAILS.  
ROCK IS ENCOUNTERED.

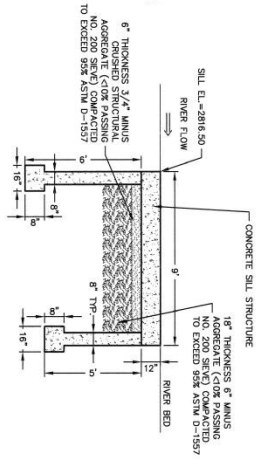

CROSS SECTION A-A

NOTE:  
1. SEE STRUCTURAL PLANS FOR REINFORCEMENT DETAILS.  
2. CONTRACTOR'S OPTION-CUT OFF WALLS MAY BE CAST-IN-PLACE OR SHEET PILE. HORIZONTAL SILL SHALL BE CAST-IN-PLACE. CUT OFF WALL DEPTH MAY BE REDUCED IF SHALLOW BED.  
3. CUT OFF WALL DEPTH MAY BE REDUCED IF SHALLOW BED.  
4. SEE DETAIL 1/C-7 FOR JACK STRUCTURE CONNECTION.

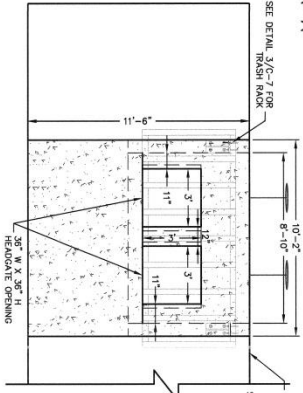

CROSS SECTION A-A

NOTE:  
1. SEE STRUCTURAL PLANS FOR REINFORCEMENT DETAILS.  
2. CUT OFF WALL DEPTH MAY BE REDUCED IF SHALLOW BED. ROCK IS ENCOUNTERED.

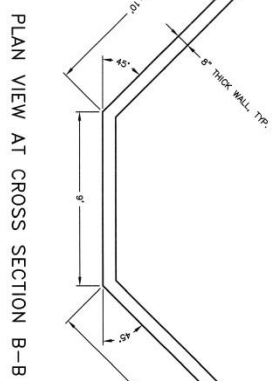

PLAN VIEW AT CROSS SECTION B-B

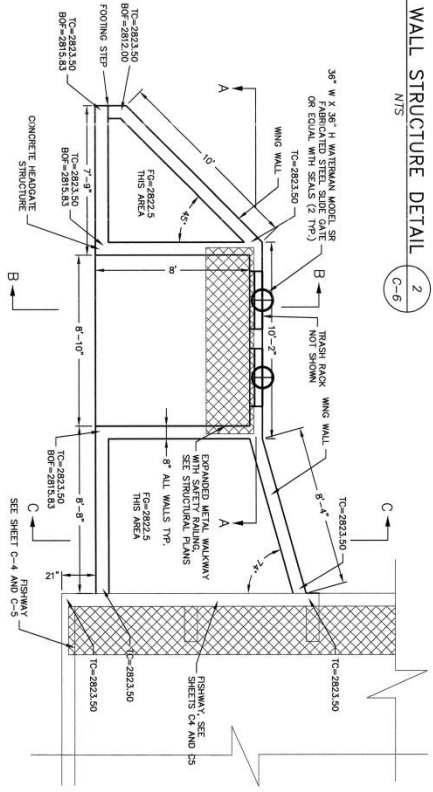

WING WALL STRUCTURE DETAIL 2  
NTS

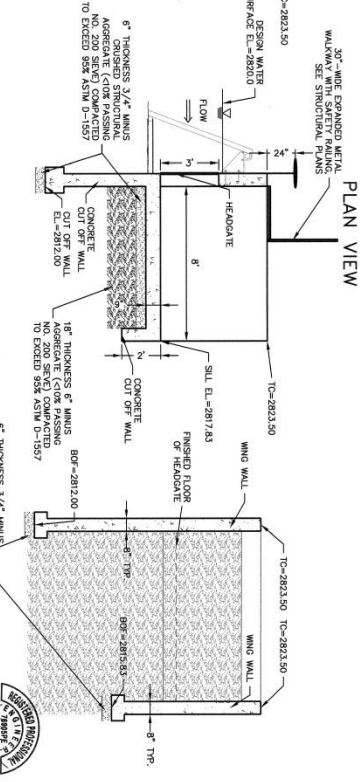

CROSS SECTION B-B

NOTE:  
1. SEE STRUCTURAL PLANS FOR REINFORCEMENT DETAILS.  
2. CUT OFF WALL DEPTH MAY BE REDUCED IF SHALLOW BED. ROCK IS ENCOUNTERED.

HEADGATE STRUCTURE DETAIL 3  
NTS



CROSS SECTION C-C

DESIGNED BY: NAK/EKS	CHECKED BY: NAK
DRAWN BY: EKS	PLLOT DATE: 8/25/2011
DATE:	REVISION:
	OK'D APPRO:

MALHEUR RIVER DIVERSION STRUCTURE  
DETAIL SHEET

JUNTURA	PROJECT NO. 452-01	DRAWING FILENAME: Malheur TopoD11.dwg	OREGON
SCALE: NTS		8/25/2011	

**Quadrant Consulting, Inc.**  
1504 W. Overford Rd  
Bozeman, Idaho 83705  
(208) 342-0091 PHONE (208) 342-0092 FAX  
CIVIL ENGINEERING - SURVEYING - CONSTRUCTION MANAGEMENT

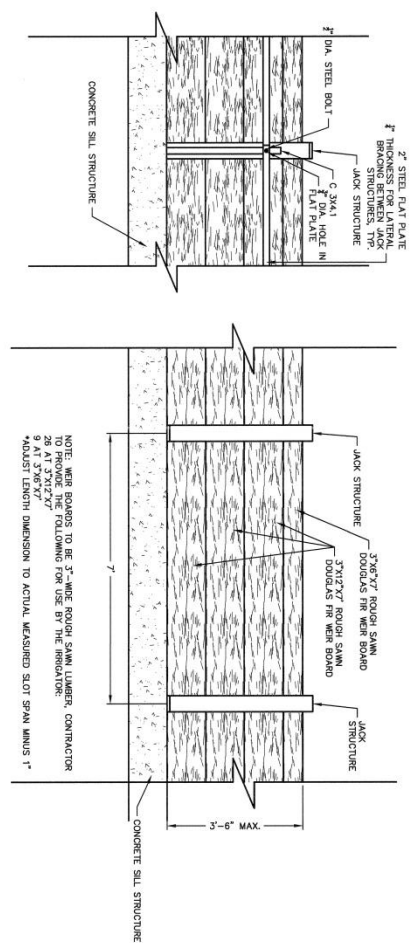

ELEVATION VIEW - BACK

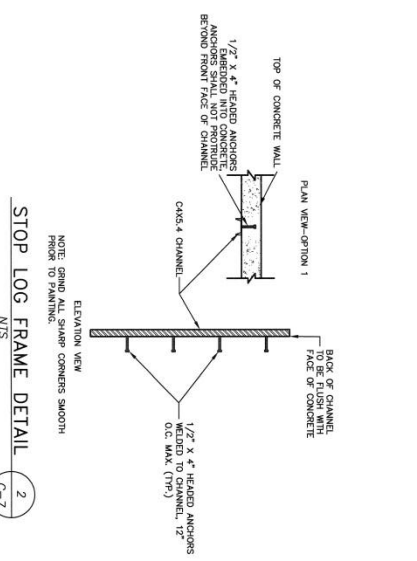

ELEVATION VIEW - FRONT

STOP LOG FRAME DETAIL  
C-7

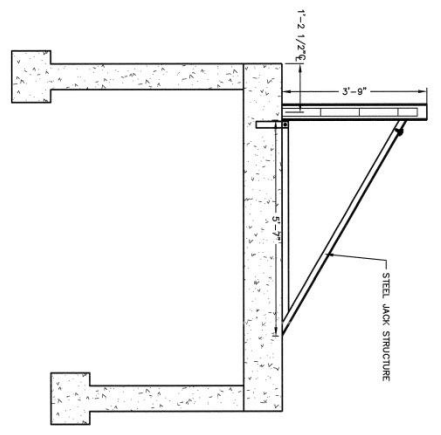
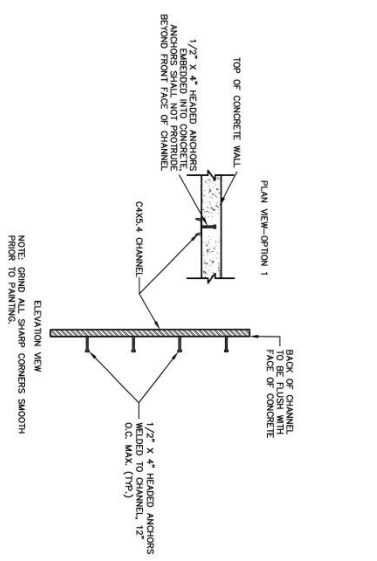

SIDE VIEW

JACK STRUCTURE DETAIL  
C-7

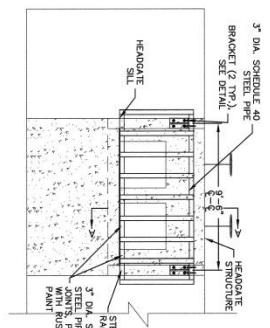

ELEVATION VIEW

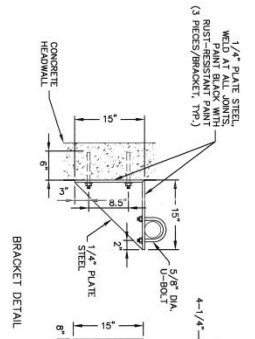

BRACKET DETAIL

GROSS SECTION A-A

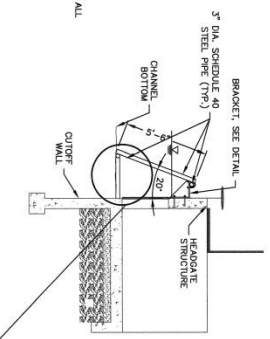

TRASH RACK DETAIL  
C-7

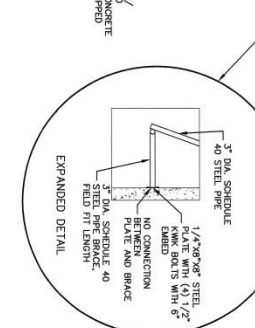

EXPANDED DETAIL

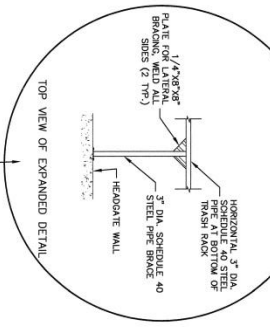

TOP VIEW OF EXPANDED DETAIL



DESIGNED BY: MAK/EKS	CHECKED BY: MAK
DRAWN BY: EKS	PLLOT DATE: 8/25/2011
DATE: BY: REVISION	OK'D APPR:

MALHEUR RIVER DIVERSION STRUCTURE  
DETAIL SHEET

JUNJURA	PROJECT NO. 452-01	DRAWING FILENAME: Malheur Topo011.dwg	OREGON
SCALE: NTS		8/25/2011	

**Quadrant Consulting, Inc.**  
1804 W. Overland Rd.  
Boise, Idaho 83705  
(208) 342-0091 PHONE (208) 342-0093 FAX  
CIVIL ENGINEERING - SURVEYING - CONSTRUCTION MANAGEMENT

## **Appendix B – Observed Avian Species**



**Malheur River Wildlife Mitigation Site  
Observed Avian Species**

American Coot	Great Egret
American Kestrel	Gray Flycatcher
American Robin	Green-Winged Teal
Barn Swallow	Horned Lark
Black-Billed Magpie	Hairy Woodpecker
Black-Crowned Night Heron	Killdeer
Brown-Headed Cow Bird	Lazuli Bunting
Barn Owl	Lark Sparrow
Black-Necked Stilt	Long-Billed Curlew
Brewer's Blackbird	Lewis Woodpecker
Brewer's Sparrow	Mallard
Blue Grouse	Marsh Wren
Bullock's Oriole	Mourning Dove
Blue-Winged Teal	Northern Flicker
Cattle Egret	Northern Harrier
Canada Goose	Northern Shoveler
California Quail	Pied-Billed Grebe
Caspian Tern	Prairie Falcon
Chukar	Red-Tailed Hawk
Cinnamon Teal	Red-Winged Blackbird
Cliff Swallow	Sage Sparrow
Common Merganser	Sandhill Crane
Common Nighthawk	Sora Rail
Common Raven	Song Sparrow
Common Snipe	Western Kingbird
Common Yellowthroat	Western Meadowlark
Double-Crested Cormorant	Western Tanager
Dusky Flycatcher	White-Faced Ibis
Eared Grebe	Wilson's Phalarope
Eastern Kingbird	Yellow Warbler
European Starling	Yellow-Headed Blackbird
Forster's Tern	Yellow-Rumped Warbler
Gadwall	Lesser Goldfinch
Great Blue Heron	

## **Appendix C – Comments and Responses**

1. ***The Malheur Valley Railway commenced construction from the UP main line at Ontario to Vale in 1906. Rails pushed west of Vale in 1912 as part of the Oregon Eastern Railway.*** This railroad bed is directed next to the diversion dam and the EA says the Tribe will use part of it as access. This “Historic/Cultural Structure” is now over 100 years old. Certainly the EA should have mentioned it.

***BLM Response:***

*The EA mentions the railroad right of way and proposes to allow the use of it for access. Access on the railbed is an existing and ongoing use. No new disturbance is proposed. In addition the railroad bed is not within the proposed disturbance area.*

2. In the Recreation section of the EA, I wonder if a “Rails to Trails” activity might be considered in the future? Instead, the EA says no increased recreational activity is projected.

In the old Malheur Newspapers (I won’t copy here) there are wonderful article about building the railroad bridges across the river. The two main bridges still stand, could they be historic and preserved?

We know that the Meek’s Cutoff did not come up the river this far, but a statement to that effect would let us know that someone is looking at the BML6280!

***BLM Response:***

*At this time the BLM has no proposed plans to propose “Rails to Trails” on this portion of the railroad right of way. Allowing the use of this portion of the right of way for access will not prevent future proposals or trail designation.*

*The bridges in question are not within the project area and will not be impacted by the proposed activity. Preservation of these bridges are outside the scope of this document.*

*The purpose of BLM analysis is to address the impacts of the proposed activity on the project area. Only resources that have the potential to have impacts are addressed. Had any proposed or eligible trails been located within the project area the BLM would insured compliance with BLM H-6280 handbook.*

*BLM 6280 will only be addressed in Vale BLM NEPA documents when the trail is:*

- A. *Within the analysis area*
- B. *Designated as a “National Scenic or National Historic Trail (currently Vale District has one listing the Old Oregon Trail) and Trails Under Study or Recommended as Suitable for Congressional Designation (Public)”.* (BLM 6280)