



***NWFSC, Earthen Drainage Channel,
Burley Creek Hatchery
Final Environmental Assessment
Port Orchard, WA***



***NOAA Fisheries/NW Fisheries
Science Center and Bonneville
Power Administration***



***May 5, 2014
12757-01***

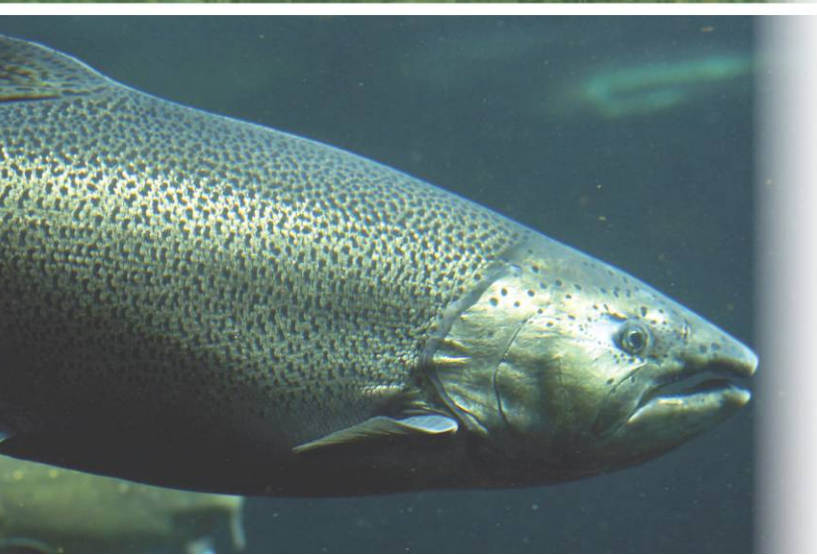

This page is intentionally left
blank for double-sided printing.

***NWFSC, Earthen Drainage Channel, Burley Creek Hatchery
Final Environmental Assessment
Port Orchard, WA***

For further information related to this project, please contact:

Ms. Silvia Espino, Project Scientist
Ahtna Environmental Incorporated
19540 International Boulevard, Suite 201
Seatac, WA 98188

Email: sespino@ahtna.net
Fax: 206-249-8111

This page is intentionally left
blank for double-sided printing.

CONTENTS	<u>Page</u>
SUMMARY AND INTRODUCTION	1
1.0 PURPOSE AND NEED FOR ACTION	5
1.1 Purpose	5
1.2 Need	6
2.0 PROPOSED ACTION AND OTHER ALTERNATIVES CONSIDERED	6
2.1 Proposed Action	6
2.2 Other Alternatives Considered	8
2.3 No-Action Alternative	9
3.0 ENVIRONMENTAL REGULATIONS	10
4.0 EXISTING ENVIRONMENT	11
4.1 Land Use	11
4.2 Geological Resources	11
4.3 Air Quality	13
4.4 Water Resources/Hydrology	13
4.5 Recreational Resources	16
4.6 Cultural/Archaeological Resources	16
4.7 Flora and Fauna	17
4.8 Wetlands	20
4.9 Floodplains	21
4.10 Coastal Zone Management	21
4.11 Farmlands	21
4.12 Noise	22
4.13 Transportation	22
4.14 Essential Fish Habitat	23
4.15 Utilities and Solid Waste	23
4.16 Visual /Aesthetic Resources	23
4.17 Hazardous Materials	24
5.0 RESOURCE ASSESSMENT AND ENVIRONMENTAL IMPACT	24
5.1 Land Use	24
5.2 Geological Resources	24
5.3 Air Quality	25
5.4 Water Resources/Hydrology	25
5.5 Recreational Resources	29

5.6 Cultural/Archaeological Resources	30
5.7 Flora and Fauna	30
5.8 Wetlands	32
5.9 Floodplains	34
5.10 Coastal Zone Management	34
5.11 Farmlands	34
5.12 Noise	35
5.13 Transportation	35
5.14 Essential Fish Habitat	35
5.15 Utilities and Solid Waste	35
5.16 Visual /Aesthetic Resources	35
5.17 Hazardous Materials	36
6.0 CUMULATIVE IMPACTS	36
7.0 IMPACTS AND MITIGATION MEASURES	36
8.0 CONCLUSIONS	37
9.0 LIST OF PREPARERS	37
10.0 REFERENCES	38
APPENDIX A	
RESPONSES AND COMMENTS ON DRAFT EA	
APPENDIX B	
AGENCIES, ORGANIZATIONS, AND PERSONS RECEIVING NOTICE OF	
AVAILABILITY OF THE EA	
APPENDIX C	
PHOTOGRAPHS	
APPENDIX D	
FIGURES AND DRAWINGS	
APPENDIX E	
FINAL WETLAND AND STREAM DELINEATION REPORT AND MITIGATION PLAN	

LIST OF ACRONYMS

AQI	Air Quality Index
AMIP	Adaptive Management Implementation Plan
APE	Area of Potential Effects
BCH	Burley Creek Hatchery
BiOp	Biological Opinion
BMP	Best Management Practices
BPA	Bonneville Power Administration
CFR	Code of Federal Regulations
cfs	cubic feet per second
CSZ	Cascadia Subduction Zone
CZM	Coastal Zone Management
DAHP	Department of Archaeology and Historic Preservation (of Washington State)
DCD	Department of Community Development of Kitsap County
DOC	Department of Commerce
DOE	Department of Energy
EA	Environmental Assessment
EDC	Earthen Drainage Channel
EERI	Earthquake Engineering Research Institute
EFH	Essential Fish Habitat
EM	Emergent Wetland
EPA	Environmental Protection Agency
EPCRA	Emergency Planning and Community Right-to-Know Act
ESA	Endangered Species Act
FCRPS	Federal Columbia River Power System
FEMA	Federal Emergency Management Agency
FHMZ	Fish Health Management Zone
FIRM	Flood Insurance Rate Map
gpm	Gallons per Minute
HPA	Hydraulic Project Approval
JARPA	Joint Aquatic Resource Permit Application
KCC	Kitsap County Code
m	meters
MRS	Manchester Research Station
NEPA	National Environmental Policy Act
NMFS	National Marine Fisheries Service
NOAA	National Oceanic and Atmospheric Administration
NWFSC	Northwest Fisheries Science Center
PEM	Palustrine Emergent Wetland
PHS	Priority Habitats and Species
PIC	Pollution Identification and Correction

PSCAA	Puget Sound Clear Air Agency
PSS	Palustrine Scrub-Shrub
sf	square feet
SR	State Route
STPs	Shovel Test Probes
TMDL	Total Maximum Daily Load
UV	Ultra-violet
WAC	Washington Administrative Code
WADNR	Washington State Department of Natural Resources
WDFW	Washington State Department of Fish and Wildlife
WSS	Web Soil Survey
USACE	United States Army Corps of Engineers
USFWS	United States Fish and Wildlife Service
USGS	United States Geological Survey

NWFSC, EARTHEN DRAINAGE CHANNEL, BURLEY CREEK HATCHERY FINAL ENVIRONMENTAL ASSESSMENT

SUMMARY AND INTRODUCTION

The Northwest Fisheries Science Center (NWFSC) is proposing to construct an earthen drainage channel (EDC) at its Burley Creek Hatchery (BCH) in Kitsap County, Washington, to facilitate increased discharge of treated effluent. Bonneville Power Administration (BPA) is proposing to fund the proposal. This Final Environmental Assessment (EA) was completed in compliance with the National Environmental Policy Act (NEPA) of 1969, the White House Council on Environmental Quality's Regulations, National Oceanic and Atmospheric Administration (NOAA) Administrative Order 216-6 Environmental Review Procedures for Implementing NEPA, and United States Department of Energy (DOE) NEPA regulations: 10 Code of Federal Regulations (CFR) 1021 et seq.

In November 2012, NOAA notified the public, agencies, tribes, and other stakeholders about the availability of a Draft EA analyzing the effects of proposed upgrades at its BCH. While preparing the EA, BPA agreed to become a cooperating agency on the effort, and determined that further technical analysis was necessary in order for both agencies to simultaneously fulfill their obligations under NEPA. As a result, a revised Draft EA that reflects BPA's role as a cooperating agency and additional technical analysis was made available on June 12, 2013, for review by the public, agencies, tribes, and other stakeholders. Substantive comments received during both review periods have been documented, evaluated, and addressed in this Final EA (see Appendix A).

The NWFSC, as part of the NOAA National Marine Fisheries Service (NMFS) of the Department of Commerce (DOC), is a government agency charged with the mission of stewardship for living marine resources. The NWFSC is the lead federal agency for this EA. The BPA is a federal power marketing agency that is part of the United States DOE and its operations are governed by several statutes, such as the Pacific Northwest Electric Power Planning and Conservation Act, which directs BPA to protect, mitigate, and enhance fish and wildlife affected by the development and operation of the Federal Columbia River Power System (FCRPS). Pursuant to 40 CFR 1501.6, BPA has agreed to serve as a cooperating agency in the development of this EA.

In May of 1991, the population of Redfish Lake sockeye salmon (*Oncorhynchus nerka*) hovered on the brink of extinction, and by November 1991 Upper Snake River sockeye salmon were listed as endangered under the Endangered Species Act (ESA). Stories appeared in the media about “Lonesome Larry,” the single adult sockeye returning to Redfish Lake. The dire situation galvanized regulatory and stakeholder groups, resulting in the Redfish Lake Sockeye Captive Broodstock Program, a multi-agency and tribal endeavor. The work started at the NWFSC’s Montlake Facility in 1991, then moved to the Manchester Research Station and associated freshwater satellite locations in 1993. The Big Beef Creek facility served as a main freshwater incubation and rearing site until 2001, when freshwater rearing of these ESA-listed fish was transferred to the BCH. The BCH was leased from Fish Pro Farms, Inc., until 2004, when the BPA purchased the facility and transferred ownership to NOAA under the operation of the NWFSC.

The BCH is a 5-acre fish culture research facility that consists of administrative and fish-rearing structures at the northwest area of the site. Five water wells, a concrete settling basin, and a ultra-violet (UV) treatment vault are located on the western half of the property. In addition, a detention pond is located within the central portion of the property. The eastern portion of the site, where the proposed EDC would be constructed, consists of undeveloped relatively flat land draining to Burley Creek. The facility is used for freshwater final maturation of pre-spawning adults, spawning, incubation, and fry-to-smolt salmon rearing.

BCH relies on pathogen-free groundwater to minimize risks associated with fish disease. In addition, hatchery effluent is treated with either ozone or UV radiation to eliminate the potential development of pathogens. This facilitates fish transfers between fish health management zones (FHMZs). FHMZs are geographic areas involving one or more watersheds whereby the transfer of live fish is permitted only when specific fish health management requirements are met. Facilities like BCH, that have regulated pathogen-free water supplies, are considered islands within an FHMZ and have fewer restrictions on fish transfers out of their respective watershed than do hatcheries that rely on surface water supplies. As groundwater is considered pathogen-free, it enables fish reared in the East Kitsap Peninsula and Puget Sound South of Lake Washington (Burley Creek FHMZ) to be shipped to the Columbia River Basin without the need to lethally test a portion of these fish, classified as endangered under the ESA, for pathogens (WDFW 2006).

Broodstock and hatchery-produced eggs and juvenile fish are protected from predation and vandalism at the BCH by rearing in secure buildings. Freshwater rearing and final maturation occur in circular tanks ranging from 1.5 to 3.7 meters (m) in diameter and in 5.8-m-long raceways. A complete description of

fish culture technology and practices at BCH is included in NOAA Technical Memorandum NMFS-NWFSC-117 (NOAA 2012) which is incorporated by reference to this document.

The operations at the BCH are shifting from its current Redfish Lake sockeye salmon program to an ESA recovery program, consistent with NOAA's 2009 Adaptive Management Implementation Plan to implement NOAA's 2008 Federal Columbia River Power Biological Opinion (BiOp) as amended by a Supplemental Biological Opinion in 2010 (NOAA Fisheries 2008, 2010). With the recovery program, the hatchery would produce eyed eggs (a fish egg containing an embryo that has sufficiently developed so that the black spots of the eyes are visible) and adults for use in on-going stock rebuilding efforts around the region.

Proposed modifications to the hatchery to accommodate the shift in operations would include increasing groundwater withdrawals, increasing effluent discharge, and upgrading the existing discharge system that conveys treated effluent into Burley Creek with an EDC. The EDC and related upgrades would accommodate an increased volume of treated effluent from the existing 500 gallons per minute (gpm) to a proposed 1000 gpm. It also would accommodate the recovery of fish that currently get trapped in the existing effluent pipe. The upgrades would include onsite enhancement of wetland habitat for research, low-cost fish rearing, educational outreach, and mitigation. NWFSC considered four EDC design alternatives, as well as the No Action Alternative, in which the hatchery would not be modified, the effluent drainage system would remain unchanged, and BPA would not provide funding.

Based on anticipated operations and site conditions, the proposed discharge system has been designed to meet the following criteria:

1. Convey a sustained flow of treated effluent at a rate of 1,000 gpm and an intermittent flow of 3,000 gpm (for periods of up to an hour) without overtopping the banks of the EDC.
2. Allow water to infiltrate back into the ground to support aquifer recharge and provide some on-site detention of treated effluent during high-flow events in Burley Creek.
3. Allow access for maintenance and repairs.
4. Prevent juvenile and adult salmonids in Burley Creek from entering the conveyance system.

To create artificial wetland habitat, the proposed conveyance system has been designed to meet four additional criteria:

1. Provide fish and wetland habitat values.
2. Keep hatchery discharge water separate from surface water generated during periods of intense rain to prevent hatchery juvenile salmonids from escaping during flood events.
3. Establish grades that would prevent Burley Creek backwaters, generated from a 100-year flood event, from entering the drainage channel.
4. Provide safe access for workers, researchers, and the general public.

Based on preliminary engineering, environmental analysis, and design development discussions related to the four design concepts (the proposed action and three alternatives as described in Section 2), it was determined the proposed action would best achieve the identified project needs and design criteria with minimal to no impacts associated with a number of resources described in this EA.

Resources that would be unaffected or minimally affected by the proposed action include land use, geology, air quality, recreation, cultural, coastal zone, farmlands, noise, transportation, essential fish habitat, utilities and solid waste, and hazardous materials.

The focus of the EA is on resources that have potential to be affected by the proposed action. These include water resources/hydrology (surface water, groundwater, and water quality), wetlands, floodplains, flora and fauna (ESA species), and visual/aesthetic resources. Potential impacts associated with implementation of the BiOp that could occur at other locations or later in time and independent from the BCH operations would be subject to environmental review and analysis described in other documents.

This EA also considers potential cumulative impacts of the proposed action on its surrounding area of effect which includes lands within the construction limits of the proposed project, the immediate surrounding upland area, and downstream waters of Burley Creek. No other reasonably foreseeable future actions have been identified that could contribute to potential cumulative impacts.

The proposed action would result in minor impacts to resources at and adjacent to the BCH. Wetland enhancements are a key component of the proposed action for mitigating impacts to on site wetlands. In addition, Best Management Practices (BMPs) are proposed during construction for control of soil erosion

and protection of water quality. For example, construction BMPs would include installation of a silt fence along the perimeter of the construction boundary to prevent runoff of sediment from the site into the surrounding wetlands and riparian zone of Burley Creek. Stormwater should not be a major concern as construction is anticipated to occur during the summer months. Truck and equipment entrances to the site would be reinforced by quarry spalls to prevent soil tracking on and off site. In addition, soil stockpiles would be covered and flanked by hay bales if they would be maintained on site for an extended period of time. These and other construction BMPs and environmental compliance measures would be implemented as part of the terms and conditions of the Clean Water Act Section 404 Nationwide Permit 18 (Reference No. NWS-2012-1356) and Washington State Hydraulic Project Approval (Control No. 129225-1), which have been authorized by the USACE and WDFW, respectively. Additionally, environmental compliance monitoring would be conducted during construction to ensure all applicable permit requirements are effectively implemented. A post-construction monitoring program associated with proposed habitat restoration and wetland mitigation measures also would be implemented consistent with permit conditions.

The proposed action would result in a net beneficial effect for ESA species because it would allow for an increased discharge of treated effluent to accommodate the increased holding capacity needed to supply eyed eggs for the recovery of ESA-listed Snake River sockeye salmon. As described in this EA, the No Action Alternative would not result in an increased discharge of treated effluent and ESA-listed Snake River sockeye eyed egg production could not be produced at the hatchery. The project has been designed with the minimum footprint necessary to support the proposed action.

1.0 PURPOSE AND NEED FOR ACTION

1.1 Purpose

The NWFSC is proposing the Earthen Drainage Channel project at the Burley Creek Hatchery to achieve the following purpose:

- Provide safe access for workers, researchers, and the general public;
- Protect fish by preventing their entrance into the existing effluent drainage channel from Burley Creek; improving the ability to recover trapped fish from the effluent channel; and preventing the escapement of fish from the creek to the drainage channel during flood events;

- Maintain and enhance aquatic habitat and water quality by controlling drainage velocities and potential erosion; allowing infiltration of surface waters for aquifer recharge; enhancing wetlands; and improving stream channel complexity and riparian habitat; and
- Provide for potential future education and outreach opportunities.

1.2 Need

The NWFSC needs to modify its existing infrastructure and operations at the BCH by altering the configuration and increasing the capacity of the existing treated effluent discharge system. Once completed, this would accommodate additional water requirements for increased production of eyed eggs and adults of ESA-listed Snake River sockeye salmon. These facility modifications would support stock rebuilding efforts called for in NOAA's 2009 Adaptive Management Implementation Plan to implement the 2008/2010/2014 FCRPS BiOp (http://www.westcoast.fisheries.noaa.gov/fish_passage/fcrps_opinion/federal_columbia_river_power_system.html).

BPA needs to decide whether to provide funding to NWFSC for its proposal to upgrade the BCH effluent system by constructing the EDC and modifying the existing effluent discharge system as part of its efforts to mitigate for effects of the FCRPS on fish and wildlife in the mainstem Columbia River and its tributaries as part of its duty under the Northwest Power Act.

2.0 PROPOSED ACTION AND OTHER ALTERNATIVES CONSIDERED

2.1 Proposed Action

NOAA, in consultation with BPA, has selected the proposed action as the preferred alternative of four designs that were evaluated for this project. Key features of the proposed action include the following;

- Increasing groundwater withdrawals from 500 gpm to 1000 gpm likely from June to November;
- Increasing the volume of treated effluent discharged into Burley Creek from 500 gpm to 1000 gpm during the summer and early fall, with intermittent releases of 3,000 gpm (for periods of up to an hour);
- Providing some onsite detention of treated effluent during high-flow events in Burley Creek;

- Upgrading the hatchery's effluent removal and treatment system, including construction of a new drainage channel and outlet to Burley Creek, to accommodate increased flows for added fish production capabilities;
- Enhancing Wetlands A and B to mitigate for permanent and temporary impacts of construction and to provide enhanced habitat conditions along the new outlet channel to Burley Creek (Sections 4.8 and 5.8 and Appendix E, Figure 6);
- Installing fencing at the northwest portion of the site and permanent signs at 50-foot intervals along the perimeter of the wetland enhancement areas; and
- Installing and maintaining construction BMPs and mitigation measures.

The proposed action can successfully convey treated hatchery effluent off site while providing artificial wetland habitat for research, low-cost fish rearing, and educational outreach (see 35 percent design drawings in Appendix D and additional details below).

The existing well system at the hatchery has sufficient capacity to accommodate the increase in groundwater withdrawals so that no new pumps or wells to provide additional source water for the hatchery would be required. The proposed upgrades for the effluent removal system consist of the following primary components that would flow into one another (see Appendix D, Figures 1-4):

1. A below-grade, straight, 12-inch pipeline about 160 feet long that would direct effluent from the existing settling basin to an existing detention pond or new earthen drainage channel;
2. A curved, shallow earthen drainage channel that would discharge into a flow control structure. The drainage channel would have a bottom elevation of 131.0 ft, a uniform cross section that would be about 500 feet long, 3 feet deep, with 4-to-1-foot side slopes and 6-foot-wide by 1-foot-high (minimum) side berms;
3. A flow control structure capable of withstanding sustained flows of 1,000 gpm and intermittent flows of 3,000 gpm that would direct treated effluent from the EDC into a 3-foot-wide, 40-foot-long meandering rock-lined outfall channel that flows into Burley Creek. The outfall channel would have a bottom elevation of 130.0 feet with a depth of about 0.5 foot to 1 foot at 1,000 gpm.

Other major design features of the proposed action are:

- The width of water in the drainage channel at the surface would be approximately 10 feet over 90 percent or more of the channel length. Wider and narrower sections may be incorporated over the remaining 10 percent of the channel. No section would be narrower than 5 feet at either the surface or bottom.
- The channel would be constructed of native or clean imported porous soils that promote infiltration of water back into the aquifer. Water velocities in the channel would not exceed 0.1 foot per second with a 1,000 gpm flow.
- A berm would be constructed along the sides of the drainage channel to separate water from within the channel from waters outside the channel that develop during periods of heavy winter rain. The height of the berm would be 12–16 inches above the estimated 100-year flood plain elevation to prevent juvenile salmonids from jumping out of the constructed drainage channel and to sufficiently prevent Burley Creek backwaters from a 100-year flood from entering the drainage channel. The top of the berm would be shaped so that personnel can access the length of the channel along the berm. The sides of the berm would be appropriately sloped so personnel can access the channel for maintenance.
- The wall of the existing UV vault would be modified to accommodate a new 12-inch bypass pipe. A valve would be installed to direct flow to either the UV vault or the 12-inch bypass pipe connected to the drainage channel. The head of the drainage channel would be located east of the eastern 7-foot-tall fence and within 30 feet of the UV vault.
- Discharges would be regulated through the existing detention pond, the EDC, a flow control structure the outlet channel to Burley Creek, and (when necessary) an emergency overflow spillway. The outlet structure and emergency spillway would be designed to prevent juvenile and adult salmonids from entering the drainage channel from Burley creek. Onsite detention of treated effluent would help attenuate discharges and minimize increases of water volume in Burley Creek during high-flow periods.

2.2 Other Alternatives Considered

NWFSC, in consultation with BPA, considered three other EDC design alternatives that were eliminated from detailed study. These alternatives considered cost, constructability, cut and fill volumes, and potential impacts to

natural resources. The alternatives have the same basic components or sections as the proposed action, but with various design changes as described below.

2.2.1 Alternative 1: Small Channel

Alternative 1 provided a relatively shallow channel of uniform cross section with a bottom channel depth of five feet, a water depth of about two feet, and 4-to-1 side slopes. A channel bottom elevation of 132.0 feet provided a flow depth of 2.3 feet at 1,000 gpm. This configuration attempted to minimize the amount of excavation and fill during construction. This alternative was eliminated, however, because the channel design's relatively shallow water depth and low-sloped embankments would have constrained the width of the channel bottom compared to other alternatives with steeper side slopes (Moffatt & Nichol 2012b).

2.2.2 Alternative 2: Large Channel

Alternative 2 provided a deeper channel of varying width with a water depth of about four feet and 3-to-1 side slopes. The configuration attempted to maximize the size of the channel and provided increased depth and greater sediment storage. It included a configuration that maximized an "effluent" storage ditch on-site which would not have required mitigation while also providing an opportunity for later fish-rearing studies if the interest or need should arise. This alternative was eliminated because the channel configuration did not provide a variable width and depth or other natural habitat features that would have improved conditions for potential future use of the EDC for fish-rearing studies (Moffatt & Nichol 2012b).

2.2.3 Alternative 3: Hybrid

Alternative 3 was a hybrid configuration with a channel of variable width and depth that included intermediate deeper pools. It provided for the placement of fill in additional upland areas, where possible, and was developed to address possible future habitat (natural fish-rearing) concerns. This alternative was eliminated because its channel configuration did not provide as much in-water fish habitat, channel complexity, habitat features, and fish rearing capacity as would be available under the proposed action (Moffatt & Nichol 2012b).

2.3 No-Action Alternative

Under the No Action Alternative, the EDC would not be constructed. As a result, hatchery operations would continue using the existing infrastructure without

BPA funding. The BCH would be unable to expand the number of sockeye eyed eggs reared onsite because its current effluent discharge system is operating at capacity.

3.0 ENVIRONMENTAL REGULATIONS

NOAA prepared this EA pursuant to regulations implementing NEPA (42 USC 4321 *et seq.*), which require federal agencies to assess the impacts that their actions may have on the environment. NEPA requires preparation of an Environmental Impact Statement (EIS) for major federal actions significantly affecting the quality of the human environment. NOAA has considered the information and analysis presented in this EA and in its Finding of No Significant Impact (FONSI) for the proposed action and has concluded that preparation of an EIS is not warranted.

The following federal statutes, regulations, and requirements are applicable to the proposed action and have been considered in the analysis in this EA:

- Endangered Species Act
- Fish and Wildlife Conservation Act and Fish and Wildlife Coordination Act
- Magnuson-Stevens Fishery Conservation and Management Act
- Migratory Bird Treaty Act and Executive Order 13186
- Bald Eagle and Golden Eagle Protection Act
- Clean Water Act
- Wetlands and Floodplain Protection
- Clean Air Act
- National Historic and Preservation Act of 1966, Antiquities Act of 1906, Historic Sites Act of 1935, Archaeological Data Preservation Act of 1974, Archaeological Resources Protection Act of 1979, Native American Graves Protection and Repatriation Act, Executive Order 13007 Indian Sacred Sites, and American Indian Religious Freedom Act of 1978
- Noise Control Act
- Executive Orders 11988 and 11990

Additionally, the proposed action would be implemented in compliance with all terms and conditions specified in the required permit approvals consistent with applicable federal and state regulations. A Joint Aquatic Resource Permit Application (JARPA) was prepared in December 2012 in accordance with the regulations listed above for the acquisition of the following permits:

- Clean Water Act, Section 404 (Nationwide Permit 18 for minor discharges of dredged or fill material into waters of the United States), administered by the United States Army Corps of Engineers (USACE);
- Clean Water Act, Section 401 (Water Quality Certification) administered by the Washington State Department of Ecology (Ecology); and
- Hydraulic Project Approval (HPA) administered by the Washington Department of Fish and Wildlife (WDFW).

Since NOAA is a federal agency, local government permits and approvals from Kitsap County are not required.

4.0 EXISTING ENVIRONMENT

4.1 Land Use

The BCH is located at 11421 Bethel-Burley Road Southeast in Port Orchard, Washington, on a 5-acre parcel of land in a rural residential area of Kitsap County (Appendix E, Figure 1). The facility consists of administrative and fish-rearing structures, five water wells, a concrete settling basin, and a UV-treatment vault located on the western portion of the site (Appendix C, Photographs 1, 2, and 4). In addition, a detention pond is located in the central portion of the property (Appendix C, Photograph 3). The eastern portion of the site consists primarily of undeveloped land with forested and pasture land cover types (Appendix C, Photograph 5). Surrounding land use is agricultural (active pasture for haying) and single-family residential, zoned at one dwelling unit per 10 acres, per the Kitsap County zoning and comprehensive plan code (Kitsap County Code, 2012).

Existing land use in the vicinity of the facility includes single-family residences, active pasture and farmland, and supporting infrastructure (roads, utilities, schools, and parks). The closest school, Burley Glenwood Elementary School, is located approximately 1 mile west of the BCH. The closest public park is located at the Burley Community Center, approximately 2.5 miles south of the BCH.

4.2 Geological Resources

Positioned on a basin between the Cascade Range and Olympic Mountains, the general area in which the project site is located is referred to as the Puget Lowland (also Puget Sound Lowland). Several periods of glaciation have carved and scoured land that forms today's Puget Lowland. Glacial deposits were

deposited with each glacial retreat. Surface geology can be described as unconsolidated sediments from the Pleistocene continental glacial drift, Quaternary alluvium, dune sand, loess, and artificial fill (WADNR 2011; Troost and Booth 2008; Puget Soundkeeper Alliance 2008).

4.2.1 Seismic

The Burley Creek site area is located within an active seismic area influenced by three known zones: the Cascadia Subduction Zone, the Benioff zone, and the crust of the North American Plate referred to as the Crustal zone. The Cascadia Subduction Zone (CSZ), which reaches north to Vancouver Island, British Columbia, and stretches south to northern California, is an extensive sloping fault separating the North American and Juan de Fuca plates. The CSZ, also known as a Great Subduction Zone, poses the threat of producing magnitude 8 and higher earthquakes approximately every 500 to 600 years; the last earthquake of this magnitude occurred in AD 1700 (USGS 2012).

The Benioff zone is subject to earthquakes resulting from Juan de Fuca rock density changes which then break apart under the plate's own weight, thus causing quakes. Earthquakes in this zone last occurred in 1949 and 1965.

The Crustal zone is capable of producing shallow earthquakes that pose a more serious threat to infrastructure and human safety. Several active faults are located within this zone, such as the Seattle and Olympia faults, both of which have only recently been studied and evaluated for seismic risk.

Historically, the Puget Sound area has experienced magnitude 6.5 or higher earthquakes every 30 to 50 years. Effects of earthquakes produced by the active faults or seismic zones include tsunamis, landslides and rockslides, and uplift of terrain (EERI and WMD EMD 2005). Earthquakes of this magnitude at BCH could cause damage to buildings and other structures, but large-scale soil displacement or flooding that would affect the EDC, if constructed, are unlikely.

4.2.2 Soils

Hand borings and excavated test pits were completed on May 30, 2012, and June 1, 2012, respectively (PanGeo, Inc. 2012). Bellingham silty clay loam is mapped as the primary soil occupying the project area, which was identified on site and verified by the US Department of Agriculture Natural Resources Conservation Service. On-site soils are mapped as approximately 85 percent Bellingham silty loam and approximately 10 percent Norma fine sandy loam. Bellingham silty loam has poor drainage characteristics and high water capacity availability. The upper eight inches are described as dark brown, silty clay loam

and as brown-gray silty clay from 8 to 60 inches. Peat and trace iron oxide staining were detected as shallow as 1.5 feet in depth during on-site soil investigations (PanGEO 2012; WSS 2012).

The mapped soils are considered hydric soils. Hydric soils are formed under saturated conditions, flooding, or ponding long enough during the growing season to develop oxygen-free conditions in the upper soil profile. These soils have the potential for liquefaction if an earthquake were to occur (Kitsap County DCD 2013; WSS 2012). They may also support, or be capable of supporting, facultative and obligate wetland plant species.

4.3 Air Quality

As required by the Clean Air Act, the Environmental Protection Agency (EPA) has implemented primary and secondary standards for harmful pollutants, referred to as criteria pollutants, which affect air quality. Inhalable, coarse particulate matter (particles 10 to 2.5 micrometers [μm] in diameter), fine particulate matter ($<2.5 \mu\text{m}$ in diameter), ozone, nitrogen dioxide, carbon monoxide, sulfur dioxide and lead are the criteria air pollutants. Primary standards for criteria pollutants are intended to protect more vulnerable population segments; i.e., asthmatics, children, etc. The secondary standards offer protection for the overall population, including protection against damage to agriculture, architecture, and animals. These standards set by the EPA are currently up to date and in effect in Kitsap County (PSCAA 2012a).

Nearly every year the Puget Sound Clean Air Agency (PSCAA) and the EPA compile an air quality data summary report. The latest report, completed in 2010, includes several features that help determine the quality of the air in Kitsap County and other surrounding counties. Fine particle matter is a concern in this and surrounding counties. In 2009 and 2010, these counties were not in attainment with the limit for daily levels for fine particles. Another concern in this area is the ozone level. Ozone remains a pollutant that has not notably decreased as other pollutants have. The 2010 Air Quality Data Summary reported the ozone levels according to the standards prior to 2008. Kitsap County meets the ozone standards for this timeframe (PSCAA 2012b).

4.4 Water Resources/Hydrology

4.4.1 Surface Water

Burley Creek flows from north to south along the eastern edge of the BCH. Approximately 2.5 miles south of the project site, Burley Creek flows into Burley

Lagoon, and then to Henderson Bay. The on-site portion of Burley Creek is a meandering, low-flow stream with abundant riparian vegetation, but fairly homogenous substrate (sand and fines, rounded gravel, cobbles) with no visible pool/riffle complexes. Burley Creek is considered a Type-F (fish habitat) waterway (Shannon & Wilson 2013; see Appendix E).

Between 1990 and 2012, the average annual flow at the mouth of Burley Creek (just upstream of Burley Lagoon) ranged from 17 to 45 cubic feet per second (cfs), with a 23-year average of about 30 cfs. Maximum flows ranged from 98 to 675 cfs and averaged 337 cfs over this period. Minimum flows ranged from 5 to 21 cfs with an average of 13 cfs over this period (http://www.kpud.org/geomap/APSFED_DISCHARGE_15_Min.aspx).

Currently, treated effluent from the hatchery is directed to a detention pond where it is then conveyed through an underground 6-inch pipe to Burley Creek at a rate of up to 500 gpm (approximately 1 cfs). This amounts to approximately 20 percent of the total flow measured near the mouth of Burley Creek during the lowest minimum flow event of record (5 cfs) and approximately 3 percent of the 23-year average annual flow.

A small tributary to Burley Creek flows south along the western property boundary in a roadside ditch. Approximately 400 feet south of the BCH's southern property boundary, the tributary flows east toward Burley Creek. This stream provides no known fish habitat (Shannon & Wilson 2013).

4.4.2 Groundwater

During the test pit excavations, groundwater was detected at a depth of 4 to 4.5 feet. Most of the test pits were terminated at approximately 7 to 7.5 feet in depth. Minor seepage was observed at 3.5 feet when hand borings were performed. The amount of water detected varied at different locations as the project area itself slopes east. Due to the gently sloping topography at the project site, water generally flows east toward Burley Creek. Groundwater levels are also dependent on seasons and soils present (PanGEO 2012).

According to facility staff, the groundwater in this area is non-potable due to high concentrations of manganese and iron (Dr. Desmond Maynard, BCH Hatchery Technology Team Leader, personal communication, July 12, 2012).

4.4.3 Water Quality

The Burley Creek watershed has been designated by the state as Extraordinary Primary Contact waters under Washington Administrative Code (WAC) 173-

201A-600. This recognizes that the watershed serves as a tributary to extraordinary quality shellfish harvesting areas. Despite this recognition, the watershed has been monitored on a regular basis by the Kitsap County Health District since 1996 due to exceedances of water quality criteria. Burley Creek drains into Burley Lagoon, which has had limits on shellfish harvesting due to this pollution.

Data available from the Department of Ecology Water Quality Assessment and 303(d) List includes listing identifications for state waters. These listings are categorized based on the degree of impairment. Category 1 waterbodies meet water quality standards. Category 2 is for waters of concern but do not require a water quality improvement project, also known as a Total Maximum Daily Load (TMDL) established by the Clean Water Act. Waterbodies in Category 4b are polluted waters that do not require a TMDL but have a pollution control program. Category 5 includes impaired water bodies that require a TMDL, which are also known as the 303(d) list.

Portions of Burley Creek, located upstream of BCH, have been designated as Category 4b for exceedances of fecal coliform. Remaining 4b listings for Burley Creek are for areas downstream from the BCH. Two portions of Burley Creek, upstream and downstream of BCH, have been designated as Category 5, both for dissolved oxygen violations. The portion of Burley Creek adjacent to the project area has been designated as Category 2 due to exceedances in fecal coliform bacteria. There are two Category 2 listings for Burley Creek due to pH violations; one upstream and one downstream of BCH. There is one Category 2 listing for dissolved oxygen violations located upstream of the project area.

Kitsap County Health District began a Pollution Identification and Correction (PIC) project in the Bear, Burley, and Purdy Creek watersheds in 2000. The PIC program is responsible for assessing Kitsap County surface waters impacted by fecal bacteria and managing cleanup efforts. Through its monitoring program, the health district found that the main sources of impairment to Burley and Purdy Creek were failing septic systems and animal waste. The prevention and restoration project details for Burley Creek and annual monitoring reports are available on the Kitsap County Health District website at <http://www.kitsappublichealth.org//sls.php> (Kitsap Public Health District 2012).

Although bacteria levels have declined overall since 2005, current water quality in Burley Creek is relatively poor with frequent periods of elevated bacteria. Bear Creek, a tributary to Burley Creek, has increasing levels of fecal bacteria, and an ongoing public health advisory was issued in 2010.

4.5 Recreational Resources

The BCH is located in a residential area that has no immediate recreational resources. There is a 30-acre dog park located 1.5 miles southeast of the Hatchery. Long Lake County Park is about 2.5 miles northeast of the site. These parks provide lake access, trails, bicycle routes, and play areas for Kitsap County.

4.6 Cultural/Archaeological Resources

Cultural resources include things and places that demonstrate evidence of human occupation or activity related to history, architecture, archaeology, engineering, and culture. Historic properties, as defined by 36 CFR 800 which are the implementing regulations of the National Historic Preservation Act (NHPA; 16 USC 470 et seq.), are a subset of cultural resources. As such, these properties consist of any district, site building, structure, artifact, ruin, object, work of art, or natural feature important in human history that meets defined eligibility criteria for the National Register of Historic Places (NRHP).

The NHPA requires that cultural resources be inventoried and evaluated for eligibility for listing in the NRHP and that federal agencies evaluate and consider effects of their actions on these resources. Cultural resources are evaluated for eligibility in the NRHP using four criteria commonly known as Criterion A, B, C, or D, as identified in 36 CFR Part 60.4(a-d). These criteria include an examination of the cultural resource's age, integrity (of location, design, setting, materials, workmanship, feeling and association), and significance in American culture, among other things. A cultural resource must meet at least one criterion to be eligible for listing in the NRHP.

In March 2013, a cultural resources site investigation was conducted at the BCH by a professional archaeologist. The study included a pedestrian survey and subsurface investigations within the defined Area of Potential Effects (APE). The APE was defined as those portions of the site to be directly altered by the proposed construction within the parcel boundaries, east of the existing buildings, and west of Burley Creek (AECOM 2013).

Soils from five shovel test probes (STPs) were extracted from within the APE and found to contain no cultural or archaeological deposits. Prior to the site visit, extensive research was conducted to determine the likelihood of discovering any objects of cultural or archaeological importance. Archival research produced a previous investigation south of the APE that involved a 100% surface survey and three STPs. The investigation did not find any cultural or archaeological deposits that were considered to be of significance. The Cultural Resources Investigation Report for the BCH recommended that no additional

cultural resources investigations are warranted unless the project design is substantially modified and/or expanded beyond the existing APE (AECOM 2013).

Following completion of the site investigation, a report was prepared and forwarded to the Washington Department of Archaeology and Historic Preservation (DAHP) for review. Upon review of the findings, the DAHP issued a letter concurring with a “*Determination of No Historic Properties Affected*” by the proposed project (DAHP 2013).

NOAA Fisheries consulted with the following tribes on the Cultural Resources Investigation Report: the Suquamish Tribe of the Port Madison Reservation, Muckleshoot Indian Tribe of the Muckleshoot Reservation, Puyallup Tribe of the Puyallup Reservation, and the Squaxin Island Tribe of the Squaxin Island Reservation.

4.7 Flora and Fauna

4.7.1 Vegetation

The vegetated eastern portion of the BCH is dominated by two distinctive vegetation communities—pasture and riparian. The native pasture grass community consists of common velvetgrass (*Holcus lanatus*), bluegrass species (*Poa* sp.), tall fescue (*Schedonorus phoenix*), tall buttercup (*Ranunculus acris*), meadow foxtail (*Alopecurus pratensis*), and reed canarygrass (*Phalaris arundinacea*). The riparian community, which is located along Burley Creek and the eastern property boundary, consists of Sitka willow (*Salix sitchensis*), red-osier dogwood (*Cornus sericea*), stinging nettle (*Urtica dioica*), lady fern (*Athyrium filix-femina*), and Himalayan blackberry (*Rubus armeniacus*).

4.7.2 Wildlife

The BCH is located in the Puget Sound Lowland, which has a diverse fauna of birds, mammals, reptiles, and invertebrates. The project site, with its mix of rural residential and small farm agriculture, is of a character that is common on the Kitsap Peninsula and likely supports a typical variety of wildlife species. Mammals that are common to this area include black-tailed deer, coyote, opossum, Eastern cottontail rabbits, and a variety of small rodents including mice, rats, moles, gophers, and shrews. Burley Creek and its associated riparian corridor also provide habitat for more water-oriented species such as raccoons and river otter. Birds observed or expected on site include hawks, owls, ducks,

geese, swallows, blackbirds, killdeer, woodpeckers, hummingbirds, sparrows, starlings, and other songbird species.

The United States Fish and Wildlife Service (USFWS) Western Washington Region's website provided information about endangered species, threatened species, critical habitat, and concern and candidate species in Kitsap County. The website lists two wildlife species, marbled murrelet and bull trout, as ESA-listed species present in marine waters of the county (neither of these species, however, are located within the boundaries of the proposed action). Yellow-billed cuckoo were listed as a candidate species. Twelve more species of concern are also identified for the county (USFWS 2013). None of these species are documented as occurring at the BCH, although it is likely that bald eagle and one or more of the three species of bats listed pass through the site at least occasionally during migration and foraging. See Section 4.7.6 for information about ESA-listed species.

4.7.3 Riparian

The portion of Burley Creek adjacent to the fish hatchery has a well-developed corridor of riparian vegetation. The overstory is dominated by three species: red alder (*Alnus rubra*), big-leaf maple (*Acer macrophyllum*), and Pacific willow (*Salix lasiandra*). These trees are mostly young, 30 to 50 feet in height, and sparse enough to provide adequate light penetration for a dense understory of shrubs and herbs. This understory contains typical species for western Washington including salmonberry, Indian plum, stinging nettle, red elderberry, and several species of ferns. The understory also contains the common invasive species Himalayan blackberry and reed canarygrass. Riparian conditions during a site visit on July 12, 2012, appeared good, but with areas of disturbance where partial clearing has been conducted by hatchery staff or adjacent landowners. The riparian corridor is wide enough (100–160 feet) and dense enough to provide high levels of shading of Burley Creek and a corridor for wildlife movement.

4.7.4 Upland

The upland areas of the BCH include the hatchery, which is situated on the western half of the property, and native pasture adjacent to wet pasture (wetland). Upland vegetation consists primarily of velvetgrass, bluegrass, fescue, buttercup, and foxtail. Limited vegetation is present within the western and developed portion of the BCH.

4.7.5 Fish Use

During the field reconnaissance conducted on July 12, 2012, no fish were observed in Burley Creek. According to the Priority Habitats and Species (PHS) interactive tool (WDFW 2012a), coastal cutthroat trout (*Oncorhynchus clarkii*) and steelhead trout (*O. mykiss*) are known to occur in Burley Creek and use it as a migration pathway. Coho salmon (*O. kisutch*) occur in Burley Creek and use the creek for spawning.

According to the WDFW SalmonScape interactive mapper (WDFW 2012b), coho salmon have been documented spawning in Burley Creek and the stock status is considered healthy. In addition, the presence of winter steelhead has been documented. There are no data documenting current or past use of Burley Creek by Dolly Varden (*Salvelinus malma malma*), bull trout (*S. confluentus*), Chinook salmon (*O. tshawytscha*), or chum salmon (*O. keta*).

For further information on ESA-listed fish species, see Section 4.7.6 below.

4.7.6 ESA Species

4.7.6.1 Plants

The Washington State Department of Natural Resources (WADNR) provides a list of rare plant species that are known or expected to occur in Kitsap County (WADNR 2012). Based on a review of the list in April 2013, there are no documented rare plant species, or species proposed for listing on the ESA, at or in the immediate vicinity of the BCH.

4.7.6.2 Animals

The USFWS provided information on two federally ESA-listed species, one candidate species and twelve species of concern for Kitsap County (USFWS 2013). Both federally listed species (bull trout and marbled murrelet) are located outside of the proposed project's action area.

In addition, the NOAA National Marine Fisheries Service (NMFS) lists one ESA-threatened species, steelhead trout, and one candidate species, coho salmon, that are known to occur in Burley Creek near the project area (NOAA 2005; WDFW 2012a). In January 2013, NOAA issued a public notice in the Public Register as required under the ESA for the proposed designation for Puget Sound steelhead critical habitat in the Puget Sound basin. This includes the

waters of Burley Creek. As of the publication date of this final EA, the critical habitat designation is still proposed and has not been designated.

4.8 Wetlands

As shown in figures 5 and 6 of Appendix E, three wetlands (A, B, and C) were identified on the hatchery grounds (Shannon & Wilson 2013). Wetland A is a palustrine scrub-shrub/emergent wetland (PSS/EM) that includes the riparian vegetation community located adjacent to Burley Creek and a large portion of the on-site pasture. This wetland extends off site to the north and may connect to off-site wetland areas in the immediate vicinity of the site. The scrub/shrub vegetation community within the riparian corridor is densely vegetated with willow, dogwood, and a variety of herbaceous species. The emergent and pasture-dominated vegetation community is comprised of foxtail, fescue, and velvetgrass. Positive indicators of hydric soils and wetland hydrology (soils saturated to the surface and evidence of inundation) were observed within the emergent and scrub/shrub portions of Wetland A. Within the emergent and pasture portions of the on-site wetland, a small network of surface drainage channels were also observed (Shannon & Wilson 2013).

Wetland B is a palustrine emergent wetland (PEM) located within the northwest corner of the BCH and immediately north of the hatchery facility. This wetland is dominated by reed canarygrass and foxtail along with other herbaceous vegetation. Positive indicators of hydric soils and wetland hydrology (sediment deposits, algal mats, and inundation) were also documented within Wetland B (Shannon & Wilson 2013).

Wetland C is a small palustrine emergent wetland (PEM) located immediately east of the interior hatchery fence line separating the developed portion of the facility from the pasture and Burley Creek. This wetland is dominated by reed canarygrass and willow. Standing water was observed in this area and soils were assumed to be hydric at this location (Shannon & Wilson 2013).

The identified wetlands were rated using the Ecology Wetland Rating System for Western Washington (Hruby 2004). Wetlands A, B, and C were rated as Category III (out of five categories) wetland systems based on their hydrologic, water quality, and habitat scores (Shannon & Wilson 2013). Category III wetlands are considered to have moderate function levels and moderate habitat values, are disturbed, and are often less diverse or more isolated than higher rated wetlands. Category III wetlands are wetlands that have a score of 30–50 points on the wetlands rating system.

Based on the Kitsap County Code (KCC) Chapter 19.200, Category III wetlands with a habitat score of less than 20 points are required to have a standard 40-foot buffer measured from the wetland edge (Shannon & Wilson 2013). However, the US Army Corps of Engineers, which has jurisdiction over regulated wetlands at the federal level and for this site, do not prescribe buffer width requirements.

4.9 Floodplains

Executive Order 11988, Floodplain Management, requires that impacts on floodplains be assessed and alternatives for protection be evaluated. The Federal Emergency Management Agency (FEMA) identifies areas with a 1 percent or greater chance of being flooded in a given year as 100-year.

Floodplains are limited at the BCH facility. The FEMA Flood Insurance Rate Map (FIRM) Panel Number 460 of Kitsap County Map 53035C0460E (FEMA 2012) identifies the easternmost portion of the BCH in the 100-year floodplain of Burley Creek. The preliminary design for the project assumed a floodplain elevation of 133.75 feet mean lower low water based on FIRM mapping in the project area (Rolluda 2012). All flood waters have been limited to the riparian corridor of Burley Creek over the past 10 years and have not extended to upland areas consistent with the FIRM (Rolluda 2012).

4.10 Coastal Zone Management

Ecology defines the Coastal Zone as all lands and waters from the coastline seaward for three nautical miles. The BCH lies outside of the Coastal Zone Management (CZM) area.

4.11 Farmlands

Prime farmland is classified based on the physical and chemical capabilities of the soil to produce food and other related agricultural crops with minimal help from fertilizer, etc. Unique farmland is prime farmland used to produce specific types of food and crops such as citrus, olives, cranberries, etc. In conjunction with suitable farming methods, this land possesses the combination of soil quality, location, moisture, and growing season to produce these crops adequately. Statewide and locally important farmland is land that is not categorized as prime or unique farmland but has statewide or local importance for certain food production (WSS 2012).

The properties immediately surrounding the BCH are mainly used for hay production (WSS 2012). The BCH and lands approximately 1,000 feet north and south of the BCH are classified as “prime farmland if drained.” Areas located farther than 1,000 feet from the BCH vary from the classifications mentioned above to “not prime farmland.” The BCH is likely not located on drained land, and therefore, would not be classified as prime farmland.

4.12 Noise

Current noise sources consist of typical background noises associated with routine traffic and farm equipment. Noise pollution is generally minimal. The summer months typically have increased noise levels due to road and other construction projects and the operation of farm equipment for land cultivation. Reduced noise levels are typical during the winter, fall, and spring, when agricultural equipment is not operating. No major factories or industrial businesses are located nearby. Traffic on Bethel-Burley Road does, however, produce typical noise levels for major roadways or thoroughfares. See Section 4.13 for more information on Transportation.

Noise produced by the BCH is also minimal, if noticed at all. Hatchery staff have not recorded adverse noise levels at or in the immediate vicinity of the site, nor were noticeable noise levels noted by site investigators during the field visit on July 12, 2012.

4.13 Transportation

The BCH is located on Bethel-Burley Road Southeast, a two-lane thoroughfare connecting the communities of Bethel and Burley, Washington. The site is adjacent to Washington State Route (SR) 16, which connects Interstate 5 in Tacoma with SR 3 in Gorst. SR 16 provides access to Bethel-Burley Road SE via Southeast Mullenix Road (approximately two miles north of the site) and Southeast Burley Olalla Road (approximately one mile south of the site).

Currently, three to four employees operate the BCH on a part-time basis. On average, there are one to two vehicles entering and exiting the site each day (round-trip).

The site is approximately one mile northeast of Burley Glenwood Elementary School with school bus stops on Bethel-Burley Road between Southeast Mullenix Road and Southeast Burley Olalla Road. Public transportation provided by Kitsap Transit does not provide service to Bethel-Burley Road Southeast, and the closest stop is a park-and-ride lot on Southeast Mullenix Road east of SR 16.

4.14 Essential Fish Habitat

The 1996 amendments to the Magnuson-Stevens Fishery Conservation and Management Act set forth the Essential Fish Habitat (EFH) provision to identify and protect important habitats of federally managed marine and anadromous fish and invertebrate species (collectively termed “EFH species”). Permit submittals to federal agencies, such as the USACE, for projects that may adversely affect EFH, are required to consult with NOAA Fisheries and address the potential effects of their actions on EFH.

Essential fish habitat is defined as those waters and substrates necessary to EFH species for spawning, breeding, feeding, or growth to maturity. Waters are defined as aquatic areas and their associated physical, chemical, and biological properties that are used by EFH species, and may include aquatic areas historically used by those species, where appropriate. Substrate is defined as sediment, hard bottom, structures underlying the waters, and associated biological communities (Federal Registry Vol. 67, No. 12, pp. 2343–2383).

Chinook, coho, and pink salmon have designated EFH in the Puget Sound region, but there is currently no essential fish habitat for salmon designated for Burley Creek on or near the BCH (StreamNet 2012). Some or all of these species may occur in the project area, although only coho, coastal cutthroat trout, and steelhead trout have been documented by WDFW (see Section 4.7.5).

4.15 Utilities and Solid Waste

BCH possesses a permit for a 1,125-gallon septic tank with an estimated sewage flow of 105 gallons per day. In addition, the water supply for this property’s operations is obtained from an existing well that has been approved by Kitsap County (Kitsap County Public Health District, 2012). A gravity-fed UV-treatment vault system is currently used as a settling basin. This settling basin contains low sediment levels and is cleaned once per year. Electricity in Kitsap County is provided by Puget Sound Energy. Natural gas is provided by Puget Sound Energy and Cascade Natural Gas Corporation (Port Orchard Chamber of Commerce 2012).

4.16 Visual /Aesthetic Resources

The BCH is located in a rural area that is surrounded by pastures and houses. The hatchery facility itself can be seen from Bethel-Burley Road. However, the eastern portion of the site is located downgradient of the facility and Bethel-Burley Road and typical users of Bethel-Burley Road are generally unable to view

the eastern pasturelands. The eastern pasture is dominated by grasses with individual shrubs and clusters of shrubs scattered throughout the site. The visual character of the site and adjacent properties is rural and dominated by vegetation (trees, shrubs, and grasses) on a relatively flat landscape.

4.17 Hazardous Materials

Hazardous materials data were obtained from the EPA's Cleanups in My Community Map and Ecology's Facility/Site Database (EPA 2012a; Ecology 2012). Based on a review of these data, there are no Federal (Superfund) Leaking Underground Storage Tanks or state cleanup sites listed within 2,000 feet of the project area.

The BCH submitted a Tier Two Emergency and Hazardous Chemical Inventory Report (EPA 2012b) for the period between February 8, 2005, and October 25, 2006. These reports are required by the Emergency Planning & Community Right-to-Know Act (EPCRA) for storage of either 10,000 pounds or more of a hazardous chemical or 500 pounds (or less, depending on the chemical) of an extremely hazardous chemical on site. There have not been sufficient quantities of hazardous chemicals stored on site in the last six years to require a Tier Two report.

Additional hazardous materials not covered by EPCRA may be kept on site and include a liquid oxygen tank and other chemicals used for operation and maintenance of the BCH. However, these materials and quantities do not meet or exceed EPA's reporting levels for hazardous materials.

5.0 RESOURCE ASSESSMENT AND ENVIRONMENTAL IMPACT

5.1 Land Use

Land use would not be affected by the proposed EDC. The BCH would continue to operate as a fish hatchery on the site. Other than construction of the EDC, no additional site development, expansion, or re-zoning activities are currently proposed at the BCH.

5.2 Geological Resources

5.2.1 Seismic

Geology would not be affected by construction of the EDC. The EDC would not alter seismic conditions at or adjacent to the BCH due to the limited ground-disturbing activities related to the proposed action.

5.2.2 Soils

The construction of the EDC would have a minor impact on soil integrity because of the limited soil and ground-disturbing activities associated with the proposed action.

5.3 Air Quality

During construction activities, an increase in vehicular traffic, usage of construction equipment, and dust generated from construction activities would temporarily affect the air quality in the project area and in the immediate vicinity of the project area. Best Management Practices (BMPs) would be implemented to control fugitive dust particles during construction.

Due to the small magnitude of the project, an increase of less than one percent in traffic flow is anticipated following construction of the EDC. Therefore, no long-term effects to air quality are expected.

5.4 Water Resources/Hydrology

5.4.1 Surface Water

Expanded operations at the BCH requires construction of the EDC with a discharge capacity of 1,000 gpm (about 2 cfs) and occasional higher-peak flows. Assuming future discharges into the EDC average 1,000 gpm, the project would discharge about twice as much treated effluent into Burley Creek as is currently released.

Treated effluent flowing through the EDC would be detained approximately 75 minutes (at 1,000 gpm) before being released. This is comparable to the detention time provided by the existing detention pond which would remain available for additional short-term effluent storage when Burley Creek is subject to high-flow events. Settling of solids, equilibration to ambient air temperatures, and any related physical or chemical changes to the effluent from the proposed operations are therefore expected to be similar to the character of existing operations (see Section 5.4.3 regarding water quality impacts).

The proposed EDC outlet to Burley Creek would consist of a rock-lined meandering channel with riprap armoring. This outlet channel would be able to accommodate a normal range of operational flows from the EDC while the proposed emergency overflow spillway would accommodate flood flows. In addition, a flow distribution box would be constructed along the existing 10-inch

pipeline serving the detention pond, which would allow hatchery staff to divert flows to either the EDC or the detention pond. As a result of these features, erosion at the confluence to Burley Creek would be minimized, and some treated effluent would be detained onsite to regulate the rate of effluent discharged during periods of high flow in Burley Creek.

Anticipated impacts of the proposed action on the average, minimum, and maximum flows of Burley Creek are expected to be minor based on 23 years of record (http://www.kpud.org/geomap/APS FED_DISCHARGE_15_Min.aspx). At the mouth of Burley Creek, about two miles downstream from the hatchery, the average annual flow is approximately 30 cfs. The proposed EDC would release up to an additional 500-gpm (about 1 cfs) over current operations or an additional 3 percent above the average annual flow. In summer months when flows are historically low, the addition of 1 cfs would increase base flows about 8 percent above the average annual minimum of 13 cfs. This may have a minor positive effect on the availability of aquatic habitat in Burley Creek adjacent to the BCH, and in downstream reaches. Because annual maximum flows have averaged 337 cfs, 1 cfs of added hatchery discharge would result in a minor change to the high flows that occur in Burley Creek during winter and spring.

During the public review of the Draft EA, comment letters were received from neighboring property owners indicating that flooding and wet soil conditions along the creek and adjoining lands near the hatchery have increased over time, and that this may be associated with discharges from hatchery operations. Concerns were expressed that the proposed increase in treated effluent discharges from future hatchery operations could further contribute to these conditions. To evaluate these concerns, supplemental analyses were conducted of historic and existing hydrologic and wetlands conditions of the Burley Creek corridor with a focus on lands surrounding and including the hatchery site (Hart Crowser 2014).

An evaluation of historic stream gauge data, aerial photographs, and additional flow modeling has confirmed that flooding along the Burley Creek corridor has occurred periodically since at least 1990, and that flooding would have occurred with or without the added increment of effluent discharged from hatchery operations. The analysis also indicates the frequency and magnitude of future flood events would not likely increase due to the relatively small increment of effluent discharged from hatchery operations. Instead, future flood events would continue to reflect existing conditions in Burley Creek and its floodplain, flow passage constraints at culverts, and the flow regime's response to land use changes over time.

When Burley Creek is experiencing typical (or average) flow conditions (non-storm events), its channel has sufficient capacity to contain the added increment of the hatchery's discharge of 1 cfs without overtopping its banks (and even has more than sufficient capacity to contain a 2 cfs increase). During storm events with a return frequency of 1 in 10 years or greater, however, it is expected that Burley Creek would overtop its banks regardless of any discharge from the hatchery. Even if the hatchery was not discharging any effluent, the stream would overtop its banks during large storm events because the stream channel has insufficient capacity to handle such storm flows.

When Burley Creek is at (or near) flood stage, hatchery effluent would be temporarily routed at a low-flow rate to a detention basin to delay its release to the creek. After detaining the effluent for a specified period of time (likely 24 hours or so), the effluent would be slowly released to the creek (by gravity flow) when the channel has sufficient capacity to accommodate the additional increment of discharge (i.e., typically after periods of excessive rain have passed). This would minimize potential downstream effects during high-flow storm events from hatchery effluent.

Results from the evaluation of historic flow records and aerial photographs, hydrologic modeling, and site inspections indicate the periodic flooding of neighboring lands along Burley Creek likely results from the location of these properties within or proximate to the floodplain. In addition, observations of neighboring properties in the hatchery vicinity by a wetland ecologist indicate that portions of these lands have plant communities that are characteristic of wet soil conditions. This appears to be largely influenced by seasonal flooding, the character of the land, flows contributed from a nearby tributary to Burley Creek, and discharges from a roadside ditch along the eastern side of Bethel-Burley Road SE. During site investigations, it was apparent that flows in the roadside ditch periodically become backed up behind an undersized culvert causing waters to overtop the banks of the ditch and flood the adjacent fields. This likely occurs even during relatively small storm events (2-year flood events).

Based on these considerations and analyses, the existing hatchery is not contributing to the flooding of fields on adjacent properties nor would an increase of 1 cfs of hatchery effluent significantly affect future flood conditions.

5.4.2 Groundwater

The completed EDC would require additional groundwater withdrawal from onsite wells to meet the 1,000-gpm flow requirements for the project. This would be achieved by utilizing the full capacity of the existing well system which

would allow withdrawals to increase from 500 to 1,000 gpm. No new pumps or wells are proposed to meet this additional capacity.

A hydrogeological analysis of the BCH onsite well system was conducted in 2008 to evaluate well performance under projected withdrawals required for future operations and to assess the potential interference of increased well production on nearby offsite domestic wells (GeoEngineers 2008). The 2008 study is incorporated by reference into this document and the methods, results, and conclusions of the study are summarized below.

As part of the hydrogeological analysis, well logs associated with four off-site wells within 2,000 feet of the BCH were reviewed from Ecology's Well Log Viewer web site (<http://apps.ecy.wa.gov/wellog/index.asp>). The closest of these off-site wells was drilled to a depth of 113 feet, located 500 feet east of the hatchery, and was completed in a water-bearing zone approximately 90 to 100 feet shallower than the BCH wells. Based on the results of the analysis, it is likely that projected operational drawdowns would result in minor, localized decreases in groundwater levels and availability in and around the BCH.

Because of the shallower depth of the neighboring wells and their spatial relationship to the BCH wells, there would likely be no interference with neighboring wells due to the proposed BCH operations. The projected groundwater withdrawals at the BCH do not represent an impairment of nearby wells to produce water for domestic supply. Furthermore, the analysis indicates that "production may be increased to a total combined rate of 1,000 gpm from Wells 2, 3, and 4 without causing impairment of off-site wells" (GeoEngineers 2008).

There would not be a reduction of groundwater recharge in the area because the EDC would be above ground and would use porous soils for construction allowing water to infiltrate back into the groundwater. Surface water routed through the EDC and flowing into Burley Creek would not affect (raise or lower) the local water table.

5.4.3 Water Quality

Treated effluent releases from the EDC would not result in adverse impacts to water quality in Burley Creek. The discharge outlet would be designed with flow control and energy dissipation features to avoid potential channel erosion. In addition, the effluent would be piped through the existing settling tank and UV-filter structures to an effluent containment channel. This system, in combination with the channel configuration design, would control the rate of effluent discharge and provide water treatment before releases enter Burley Creek.

Because of the small scale of existing fish culture operations at the BCH and the quality and quantity of discharge expected from the proposed EDC, adverse impacts on the downstream water quality of Burley Creek are not expected. Less than 3,000 lbs of fish (consisting of about 600 maturing adults and 700 pre-smolts/fry) are currently “on station” at the hatchery with about twice that amount to be on station under the proposed increased fish culture operations. These quantities are well below the 20,000-pound threshold established for fish hatchery operations under the National Pollutant Discharge Elimination System (NPDES). Most of the existing and proposed poundage of fish consists of non-feeding adults moved on station in June that are either spawned or sent off station by mid-November.

During their residence, these maturing adults do not generate feed waste, excrete solids, or produce soluble metabolic waste at levels that might adversely affect water quality. The existing settling basin serves to eliminate solid waste products generated by the few hundred pounds of fry on station prior to the release of the hatchery’s effluent to Burley Creek. The settled solids are rapidly digested by biological activity within the settling basin. As a result, discharges of treated effluent are not expected to alter the pH of Burley Creek or contribute to fecal coliform bacteria levels.

Since the increased flow of treated effluent from the proposed EDC would typically be released from June to November, it is expected that the additional 500 gpm (1 cfs) of 50° F water during these typical low-flow months would slightly lower water temperatures immediately downstream of Burley Creek, potentially improving water quality for aquatic species. As described in section 5.4.1, treated effluent releases would be only 1 to 3 percent of Burley Creek flows depending on the time of year. Thus, this small increment of additional discharge is likely to have a limited positive effect on the ambient water temperature immediately downstream from the EDC outfall.

5.5 Recreational Resources

No recreational resources would be affected because there are no recreational resources within the immediate vicinity of the project. The public parks previously described in this analysis would not be affected by the project.

The BCH currently hosts educational visits catering to surrounding schools. The proposed EDC includes a pathway that would be used for maintenance. This pathway can also be used to provide access to the channel for educational purposes. Because the BCH already hosts educational events and future recreational or educational events are not expected to increase, the project

would not result in an adverse effect on recreational resources at the site or in the vicinity of the site. Refer to Section 5.1 for more information on Land Use impacts.

5.6 Cultural/Archaeological Resources

Based on results of a cultural resources and archaeological survey conducted on March 1, 2013, no historic, cultural, or archaeological resources are currently known to exist at the BCH (AECOM 2013). The DAHP has concurred with the findings of the survey, including a “Determination of No Historic Properties Affected” for the proposed project (DAHP 2013). The responding tribes that were consulted (see section 4.6) confirmed they had no comments or concerns related to cultural resources or the Cultural Resources Investigation Report. During construction, an Inadvertent Discovery Plan would be developed that includes protocols to follow in the event cultural or archaeological resources are discovered during earth disturbing activities.

5.7 Flora and Fauna

5.7.1 Vegetation

Vegetation within the western portion of the site in the footprint of the proposed EDC would be permanently impacted by the project. This vegetation, comprised predominantly of native pasture grasses, would be replaced with native grasses along the side slopes of the EDC. Areas temporarily impacted during construction would also be reseeded using a native grass seed mixture.

Impacts associated with on-site wetland vegetation communities are described in Section 5.8.

5.7.2 Wildlife

Construction related activities could cause localized, short-term disruptions to wildlife in the project area. In addition, construction would result in the permanent loss of some grassland habitat, and temporary impacts to a small amount of riparian habitat. However, impacts to wildlife from these habitat disruptions are expected to be minor and temporary. Longer term, creation of new riparian and open water habitat by the project is expected to result in a moderate improvement in habitat for wildlife at the site. These habitat improvements, in turn, are likely to result in a minor to moderate benefit to wildlife in the project vicinity.

5.7.3 Riparian

Construction of the narrow outlet channel, which would connect the proposed EDC to Burley Creek, would directly impact 361 sf of riparian habitat along the creek. Here, a small segment of an existing scrub-shrub wetland community and streambank would be converted to the new channel with 300 sf of wetland enhancement area created along its margins . This would permanently convert this portion of the scrub-shrub wetland into other habitat types (e.g., open water, discharge structures). In addition, the project would create new riparian habitat along the proposed EDC. The overall effect of the project is therefore expected to be a minor to moderate improvement in the amount and quality of riparian habitat in the project vicinity.

5.7.4 Upland

The proposed action would result in a conversion of a portion of the site uplands to an EDC supporting fish and wetland habitats. A loss of upland habitat is expected, however, the existing upland conditions where the EDC would be constructed are virtually identical to the surrounding wet pasture on and adjacent to the site. Conversion of this upland habitat would not have an adverse impact on fauna using the site as suitable replacement habitat would be provided by the EDC and from mitigation for wetland impacts. About 5,084 sf of wetland enhancement would result from the project, in accordance with the compensatory mitigation required by the USACE to offset permanent impacts. These wetland enhancements include plantings of native trees and shrubs. Section 5.8 details wetland mitigation and enhancement plans (Shannon & Wilson 2013). Other upland areas within the developed and western portion of the site would remain unchanged by the project.

5.7.5 Fish Use

The primary purpose for construction of the EDC is to accommodate an increased discharge of effluent generated from expanded operations at the BCH. The EDC also would provide an opportunity to temporarily hold select species of non ESA-listed salmonids that currently exist in Burley Creek for educational purposes to teach school children about their life history. Such activities would be coordinated with Washington State Department of Fish and Wildlife (WDFW), NOAA Fisheries, and USFWS regarding fish species and stocks to be held to ensure compatibility with local fish management plans. Fish species that have been documented in Burley Creek (coastal cutthroat trout, steelhead, or coho salmon) would be released into the EDC. Release or escapement of these held fish from the EDC could result in a minor increase in fish use in Burley

Creek. In addition, a control structure would be installed upgradient and west of the outlet channel to prevent fish that are present in Burley Creek from entering the EDC.

5.7.6 ESA Species

Under ESA Section 7, federal agencies are required to ensure that any action they authorize, fund, or carry out would not likely jeopardize survival of a listed species or adversely affect designated critical habitat. The USFWS, NOAA Fisheries, and WDFW were consulted regarding effects of the proposed project on fish and wildlife.

Based on consultations completed with the USFWS and NOAA Fisheries in April 2013, the proposed action would have no adverse effects on ESA-listed species or critical habitats (NOAA 2013). The WDFW confirmed the presence of coho salmon and steelhead in Burley Creek in the vicinity of the BCH and, therefore, requested assurance the proposed EDC design includes an effective fish barrier on the outlet to Burley Creek so that fish are unable to migrate upstream from Burley Creek into the EDC. A fish barrier structure is a key component of the design and would be installed to prevent fish in Burley Creek from entering the EDC.

The overall project would have a positive impact on ESA species in the region by supporting the recovery effort of the Redfish Lake sockeye salmon stock and would aid in long-term recovery efforts for this stock. If this project is not completed, there would be insufficient discharge capacity at the hatchery and NOAA would be unable to supply sockeye eyed eggs needed to support ongoing recovery efforts.

5.8 Wetlands

The project was designed to avoid and minimize impacts to on-site Wetlands A and B and would not impact Wetland C. In order to convey effluent through the EDC to Burley Creek, minor, direct impacts to Wetlands A and B and Burley Creek are unavoidable (see Appendix E, Figure 6).

Placement of the meandering rock-lined outlet channel would permanently impact 31 sf and temporarily impact 579 sf of Wetland A and B to accommodate a 5-foot-wide construction corridor adjacent to the outlet channel (Shannon & Wilson 2013). Installation of the EDC and fencing installed at the northwest portion of the site would permanently impact 732 sf and 452 sf of Wetlands A and B, respectively (Shannon & Wilson 2013).

The wetland mitigation area would receive limited use and given that no changes to lighting or noise levels are anticipated, indirect impacts to wildlife habitat or other wetland functions over time are not anticipated.

Proposed wetland mitigation for the project meets and/or exceeds local, state and federal wetland mitigation requirements. An 8-to-1 mitigation ratio for permanent impacts and a 4-to-1 mitigation ratio for temporary impacts have been applied to this project. A summary of impacts and mitigation is provided below:

Wetland	Impact Area (in square feet)	Type of Impact (permanent or temporary)	Mitigation Ratio	Total Mitigation (in square feet)
A	1,093	Permanent	8-to-1	8,477
A	579	Temporary	4-to-1	2,316
B	452	Permanent	8-to-1	3,616
Total:				14,676

A total of 11,060 sf of wetland enhancement throughout Wetland A has been proposed to mitigate for permanent and temporary impacts associated with the proposed action. This would be supplemented by enhancing 3,616 sf of habitat in Wetland B. Wetland enhancement would include installation of native trees and shrubs (a minimum of 181 trees and 408 shrubs). West of the Burley Creek riparian corridor, the enhancement activities would:

1. Add habitat complexity to and provide continuity between the enhanced wetland and the mature Burley Creek riparian corridor; and
2. Provide shading of the proposed outlet channel from southern exposure as the plantings mature (Shannon & Wilson 2013).

In addition to installation of the wetland enhancement plantings in Wetlands A and B, the wetland enhancement areas would be monitored for a period of 10 years following construction to document and verify the performance of the mitigation area (Shannon & Wilson 2013). Mitigation monitoring would occur in Years 1, 2, 3, 5, 7, and 10 following construction. Monitoring parameters would include survival of installed vegetation and areal cover consisting of native woody vegetation. A detailed discussion of wetland impacts and mitigation can be found in the Final Wetland and Stream Delineation Report and Mitigation Plan (Appendix E).

5.9 Floodplains

Under the proposed action, the easternmost portion of the project area where the rock-lined outlet channel would be installed, intersects the 100-year floodplain of Burley Creek. The majority of the proposed site improvements would take place upland of the 100-year floodplain with the exception of the rock-lined outlet channel.

Executive Orders 11988 and 11990 prescribe compliance requirements for federal actions involving floodplains and wetlands. These include a determination of whether practicable alternatives exist to locating the action in a floodplain or wetland; identification of potential direct and indirect impacts associated with the action; and development of design options to minimize such potential adverse impacts, restore and preserve the natural and beneficial values served by floodplains, and preserve and enhance the natural and beneficial values served by wetlands.

Based on the analysis summarized in this EA and as described in related reports, there are no practicable alternatives to locating the outlet channel in the 100-year floodplain as water conveyed from the BCH through the EDC must be routed to Burley Creek. No structures or features blocking movement of water across the floodplain are proposed. Adverse impacts from the outlet channel have been minimized through the design process so that permanent impacts would be minor and limited to 361 sf within the 100-year floodplain. Temporary impacts would be limited to 579 sf within and immediately adjacent to the floodplain. Temporary impacts would be restored following installation of the EDC and the associated outlet features. Additionally, the outlet channel is designed to be a naturalized meandering channel to complement the surrounding riparian area as well as the enhanced wetland area (approximately 4,700 sf) to be located west of the Burley Creek riparian corridor.

5.10 Coastal Zone Management

The BCH is situated outside of the CZM area, and therefore, the EDC would not adversely affect the coastal zone or coastal zone resources.

5.11 Farmlands

The EDC would not be constructed on active farmland. Therefore, the EDC would not adversely affect farmlands.

5.12 Noise

During construction there may be a small, temporary increase in background noise. The sources of the noise would be from increased traffic and small construction equipment. No long-term changes in noise levels as a result of the proposed action are expected.

5.13 Transportation

Installation and implementation of the EDC is not expected to create traffic impacts. Construction effects would be minor (likely less than 1 percent increase in volume for Bethel-Burley Road), localized (primarily within the one-to two-mile stretch between SR 16 and the site), and temporary (not exceeding the project duration). No increases in staffing or daily vehicular trips are expected following construction of the EDC.

5.14 Essential Fish Habitat

There is no EFH in the project vicinity. Therefore, no impacts to EFH are expected.

5.15 Utilities and Solid Waste

The project would not require an increase in usage of utilities. Therefore, the project would not result in a change in current utility or solid waste use.

5.16 Visual /Aesthetic Resources

There would be limited and minor impacts to the visual character of the BCH and surrounding area with the completion of the EDC. The EDC would convert a portion of the on-site pasture to above-grade berms containing the water conveyance channel. This would change the overall aesthetics of the area and depart from the open pasture in existence at the site. To reduce the alteration of the visual character of the area, native vegetation would be planted on the EDC, which would serve as visual cover for the channel. This would complement the surrounding area by adding to the individual shrubs and shrub clusters existing on the BCH. The EDC and associated rock-lined outlet channel have been designed with the minimal footprint needed to convey flows from the hatchery to Burley Creek thus minimizing aesthetic and visual impacts to the extent possible.

5.17 Hazardous Materials

No federal- or state-listed cleanup sites are documented within 2,000 feet of the BCH and no hazardous materials that require reporting are maintained on site. No hazardous materials would be used for the construction and operation of the EDC. Therefore, there would be no adverse effects from hazardous materials as a result of the proposed action.

6.0 CUMULATIVE IMPACTS

Cumulative impacts are the impacts on the environment that result from the incremental effects of a proposed action combined with other past, present, and reasonably foreseeable future actions regardless of what agency (federal or non-federal) or person undertakes such other actions (40 CFR 1508.7). No reasonably foreseeable future actions are known to be planned or are under construction or planned for construction that would contribute additional discharges or significant pollutant loads to the Burley Creek drainage.

No adverse water quality impacts would result from the discharge of additional treated effluent from the proposed EDC; therefore, the existing water quality character of Burley Creek would not be further degraded. Mitigation for minor impacts to on-site wetlands is provided as a component of the proposed action. Based on these considerations, no cumulative impacts would occur to Burley Creek, to the BCH facility, or on lands in the project vicinity as a result of construction and operation of the proposed action.

7.0 IMPACTS AND MITIGATION MEASURES

As described in this EA, the proposed action would result in minor impacts to resources at and adjacent to the BCH. In addition to the mitigation proposed for wetland impacts (as presented in Appendix E), a suite of construction BMPs would be implemented as part of the proposed action. These include:

1. Installing silt fences along the perimeter of the project to contain and minimize sediment runoff and for erosion control.
2. Installing quarry spalls at truck and equipment entrances to minimize tracking on and off local roads.
3. Covering of soil stockpiles with visqueen and flanking stockpiles with hay bales if they are to be left undisturbed for an extended period of time.
4. Implementing additional BMPs or mitigation measures identified through federal or state permits as appropriate.
5. Monitoring construction to ensure BMPs and mitigation measures are effective.

6. Conducting post-construction monitoring or habitat restoration and wetland mitigation.

8.0 CONCLUSIONS

Based on site investigations, design analysis and recommendations, and existing and proposed site conditions, the proposed action would not adversely affect the resources described in this EA as they relate to the BCH and adjacent areas. The proposed action would result in a net beneficial effect for ESA-listed species outside the Puget Sound region. The proposed EDC would accommodate the increased discharge of treated hatchery effluent. As described in this EA, the No Action Alternative would not allow for increased discharge of effluent from additional sockeye eyed egg production.

The project has been designed with the minimum footprint necessary to support the proposed action and meet NOAA's ESA fish recovery needs. The proposed action avoids, minimizes, and mitigates minor permanent impacts as a result of project completion.

9.0 LIST OF PREPARERS

National Oceanic and Atmospheric Administration

Dr. Desmond J. Maynard – Hatchery Technology Team Leader

Bonneville Power Administration

Jenna Peterson – Environmental Compliance Lead

Hart Crowser, Inc.

Jeffrey Barrett, PhD – Principal in Charge, Fish and Wildlife Biologist

Michael Wert – Project Manager, Senior Fisheries Biologist

Celina Abercrombie – Ecologist

Emily Duncanson – Environmental Scientist

Steve Hall – Wildlife Biologist

Michelle Havey – Fisheries Biologist

Hans Hurn – Biologist

Ahtna Environmental, Inc.

Bernie Wong – Project Manager

Silvia Espino – Geophysicist

10.0 REFERENCES

AECOM, 2013. Cultural Resources Investigation of the Burley Creek Hatchery. Prepared for NOAA Fisheries. April 8, 2013

Department of Archaeology and Historic Preservation (DAHP), 2013. Letter from Robert G. Whitlam, Ph.D., State Archaeologist, to Mike Wert, Hart Crowser. March 25, 2013.

Environmental Protection Agency (EPA), 2012a. Cleanups in My Community Map. Accessed on October 11, 2012. <http://iaspub.epa.gov/apex/cimc/f?p=255:63:20919378625401>

EPA, 2012b. Tier II Chemical Inventory Reports. <http://www.epa.gov/osweroe1/content/epcra/tier2.htm>

Earthquake Engineering Research Institute and the Washington Military Department Emergency Management Division (EERI and WMD EMD), 2005. Scenario for a Magnitude 6.7 Earthquake on the Seattle Fault. June 2005.

Federal Emergency Management Agency (FEMA), 2012. Flood Insurance Map (FIRM), Panel Number 460 of Kitsap County Map 53035C0460E. Accessed on October 9, 2012. <https://msc.fema.gov/webapp/wcs/stores/servlet/FemaWelcomeView?storeId=10001&catalogId=10001&langId=-1>

Federal Registry Vol. 67, No. 12, pp 2343–2383 (to be coded 50 CFR pt 600). January 17, 2002. Magnuson-Stevens Act Provisions; Essential Fish Habitat (EFH). National Oceanic and Atmospheric Administration.

GeoEngineers, 2008. Hydrogeological Analysis of the Water Supply for NOAA's Burley Creek Hatchery. Prepared for National Oceanic and Atmospheric Administration. File No. 0409-007-00. September 29, 2008.

Hart Crowser, 2014. Burley Creek Hatchery, Historic Wetlands and Hydrological Conditions Assessment. Prepared for Ahtna Environmental. January 15, 2014.

Hruby, T., 2004. Washington State Wetland Rating System for Western Washington – Revised. Washington State Department of Ecology Publication #04-06-025.

J.A. Brennan Associates, 2012. Burley Creek Hatchery Earthen Drainage Channel – Preliminary Landscape Design Memo. Prepared for: Rolluda Architects. August 15, 2012.

Kitsap County Code, 2012. Ordinance 496, Title 17.

Kitsap Public Health District, 2012. Kitsap Public Health District: Environment. <http://www.kitsappublichealth.org/environment/sls.php>

Moffatt & Nichol, 2012a. NOAA Burley Creek Hatchery Earthen Channel 35% Civil/Hydraulic Design including Design Narrative Memorandum. August 15, 2012.

Moffatt & Nichol, 2012b. NOAA Burley Creek Hatchery Earthen Channel Hydraulic and Civil Predesign Memorandum. July 2, 2012.

NOAA, 2005. NOAA Fisheries Northwest Region Critical Habitat Designations for West Coast Salmon and Steelhead in Washington. August 2005.

NOAA, 2012. NOAA Technical Memorandum NMFS-NWFSC-117: Fish Culture Technology and Practices for Captive Broodstock Rearing of ESA-listed Salmon Stocks. April 2012.

NOAA, 2013. Letter from Desmond J. Maynard, Ph.D., NOAA Fisheries Research Biologist and Northwest Fisheries Science Center Snake River Sockeye Broodstock Project Manager. April 4, 2013.

NOAA Fisheries, 2008. Endangered Species Act Section 7(a)(2) Consultation Biological Opinion and Magnuson-Stevens Fishery Conservation and Management Act Essential Fish Habitat Consultation. Consultation on Remand for Operation of the Federal Columbia River Power System, 11 Bureau of Reclamation Projects in the Columbia Basin and ESA Section 10(a)(1)(A) Permit for Juvenile Fish Transportation Program (Revised and reissued pursuant to court order, NWF v. NMFS, Civ. No. CV 01-640-RE (D. Oregon). NOAA Fisheries Log Number: F/NWR/2005/05883. May 5.

NOAA Fisheries, 2010. Endangered Species Act Section 7(a)(2) Consultation Supplemental Biological Opinion. Supplemental Consultation on Remand for Operational of the Federal Columbia River Power System, 11 Bureau of Reclamation Projects in the Columbia River Basin and ESA Section 10(a)(1)(A) Permit for Juvenile Fish Transportation Program. NOAA Fisheries Log Number: F/NWR/2010/02096. Date Issued: May 20, 2010.

PanGEO, Inc., 2012. Geotechnical Report Earthen Drainage Channel Burley Creek Hatchery Northwest Fisheries Science Center, Port Orchard, Washington. August 15, 2012.

Port Orchard Chamber of Commerce, 2012. Utilities. Accessed October 2012. <http://www.portorchard.com/joomla/index.php/port-orchard-skprofile/utilities>

Puget Soundkeeper Alliance, 2008. Natural History of Puget Sound: Geology and Glaciation. Accessed September 2012. <http://pugetsoundkeeper.org/about-puget-sound/geology-folder>

Puget Sound Clean Air Agency (PSCAA), 2012a. Air Pollution in the Puget Sound Region. Accessed September 2012. <http://www.pscleanair.org/airq/basics/criteria/>

Puget Sound Clear Air Agency (PSCAA), 2012b. Air Quality Data Summary for 2010. April, 2012.

Rolluda Architects, 2012. NOAA Burley Creek Hatchery Earthen Channel 35% Civil/Hydraulic Design including Design Narrative. August 15, 2012.

Shannon & Wilson, Inc., 2013. Final Wetland and Stream Delineation Report and Mitigation Plan, Burley Creek Hatchery, Kitsap County, Washington. April 22, 2013.

StreamNet, 2012. Burley Creek. Accessed September 6, 2012.

Troost, K.G., and D.B. Booth, 2008. Geology of Seattle and the Seattle Area, Washington. The Geological Society of America Reviews in Engineering Geology.

US Geological Survey (USGS), 2012. Pacific Northwest Earthquake Hazards. <http://earthquake.usgs.gov/regional/pacnw/>

US Fish and Wildlife Service (USFWS), 2013. Listed and Proposed Endangered and Threatened Species and Critical Habitat, Candidate Species and Species of Concern in Kitsap County. <http://www.fws.gov/wafwo/speciesmap/.pdf>

Washington State Department of Ecology (Ecology), 2012. Washington State Department of Ecology Facility/Site Database. <http://www.ecy.wa.gov/fs/>

Washington State Department of Fish and Wildlife (WDFW), 2012a. Priority Habitats and Species (PHS) Program. Accessed September 6, 2012. <http://wdfw.wa.gov/conservation/phs/>

WDFW, 2012b. SalmonScape Interactive Mapping Tool. Accessed September 5, 2012. <http://wdfw.wa.gov/mapping/salmonscape/>

WDFW, 2006. The Salmonid Disease Control Policy of the Fisheries Co-Managers of Washington State (Revised July 2006). Olympia, Washington

Washington State Department of Natural Resources (WADNR), 2011. Geologic Maps of Washington. May 12, 2011.

WADNR 2012. List of Known Occurrences of Rare Plants in Washington, August 2012. <http://www1.dnr.wa.gov/nhp/refdesk/lists/plantsxco/kitsap.html>

Web Soil Survey (WSS), 2012. USDA Natural Resources Conservation Service. September 2012. <http://websoilsurvey.nrcs.usda.gov/app/WebSoilSurvey.aspx>.

Williams, R.W., R.M. Laramie, and J.J. Ames, 1975. A Catalog of Washington Streams and Salmon Utilization. Volume 1 – Puget Sound Region. Washington Department of Fisheries. November 1975.

W:\CLIENTS.WP\00757\01\Burley Creek EA 05-05-2014\BCH_Final EA_05-05-2014.docx

**APPENDIX A
RESPONSES AND COMMENTS ON DRAFT EA**

This page is intentionally left
blank for double-sided printing.

APPENDIX A

RESPONSES AND COMMENTS ON DRAFT EA

In November 2012, NOAA notified the public, agencies, and Tribes about the release of a Draft Environmental Assessment (EA) for public comment associated with proposed upgrades at its Burley Creek Hatchery (BCH). While preparing the EA, Bonneville Power Administration (BPA) agreed to become a cooperating agency on the effort, and determined that further technical analysis was necessary in order for both agencies to simultaneously fulfill their obligations under NEPA. As a result, a revised Draft EA that reflects BPA's role as a cooperating agency and additional technical analysis was made available to the public, agencies, Tribes, and landowners in the vicinity of the hatchery over a 30-day review period starting on June 12, 2013 (see Appendix B). The EA was also posted on NOAA's website, and links were provided on BPA's project website. Substantive comments received during both review periods have been documented, evaluated, and addressed in this Final EA as described below.

Comments were received from one land owner during the 2012 comment period and from four land owners during the 2013 comment period (please refer to the end of this appendix for letters received and comments in their entirety). Comments received involved four primary issues:

1. Concern that the existing hatchery has increased flooding and water inundation on fields along Burley Creek in the vicinity of the hatchery, diminishing the ability to produce hay and periodically flooding owners' driveways. A related concern was that water use and discharge from the hatchery (from 1 cfs to 2 cfs) will further exacerbate flooding along Burley Creek and further affect surrounding fields.
2. Concern that increasing well water withdrawals will affect an adjacent landowner well, and questions regarding who would resolve well water issues.
3. Rebuttal to statements in the fish section there is no documented use of Burley Creek by Chinook or Chum salmon.
4. Requests that the Hatchery work to improve the quality of Burley Creek and the native salmon runs within it.

1. Response to concerns about flooding and Burley Creek and that water use and discharge at the hatchery (from 1 cfs to 2 cfs) will further exacerbate local flooding

Lands in the vicinity of the BCH along the Burley Creek corridor have been subject to historic flooding with much of these lands classified as wetlands. As described in Section 4.11 (Farmlands), lands approximately 1,000 feet north and south of the BCH are classified as “prime farmland if drained.” Areas farther than 1,000 feet from the BCH are either similarly classified or are classified as “not prime farmland.” As described in Section 4.8 (Wetlands), extensive portions of the properties adjacent to the BCH have been classified as wetlands by the US Fish and Wildlife Service as documented in the National Wetlands Inventory (Figure A-1).

In response to concerns regarding potential effects of the BCH on flooding in the Burley Creek corridor, NOAA hired a consultant to analyze historic and existing hydrologic and wetland conditions associated with the surrounding properties (Hart Crowser 2014). Based on the analysis, it was determined that the adjacent lands along Burley Creek (Figure A-2) have been subject to seasonal flooding primarily because of their locations within or proximate to a floodplain. Periodic flooding is further reflected by the characteristic wetland plant communities that have established on these lands as observed by a certified wetland ecologist.

Based on an evaluation of historic flow records, aerial photographs, and additional flow modeling, it was determined that flooding along the Burley Creek corridor has occurred since at least 1990, where the creek has overtopped its banks with flood waters that periodically extend across the Federal Emergency Management Agency (FEMA) floodplain during the 10-Year and higher storm events (see Section 5.4.1, Surface Water). It was further determined that flooding along the creek corridor would have occurred with or without discharges from the hatchery as flood conditions are primarily influenced by the character of these lands and local hydrologic conditions involving soils, general topography and gradient, inflows from a nearby tributary, flow capacities and periodic blockages at nearby culverts, and discharges from a roadside ditch along the eastern side of Bethel-Burley Road SE. During site investigations, it was apparent that flows from this roadside ditch periodically back up due to an undersized culvert causing backwaters to overtop the banks of the ditch and flood onto adjacent fields, particularly along the western boundary of the Farnham property (Figures A-2 and A-3). This likely occurs even during relatively small storm events (2-year flood events).

Results from this analysis indicate the hatchery is not causing, and is not expected to cause, increased flooding of fields adjacent to Burley Creek. Portions of several of the nearby properties are within or proximate to the FEMA

100-year floodplain; are mapped as wetlands by Kitsap County and the US Fish and Wildlife Service; and have a visual character that reflects historic wet conditions. Based on site observations and the wetland classifications of the adjacent properties, soils on the property are periodically wet, at least during the spring growing season regardless of hatchery operations. The existing hatchery is not contributing to the flooding of fields on adjacent properties. In addition, an increase of 1 cfs of hatchery effluent represents less than one percent of the 10-year storm flow and thus would not significantly affect future flood conditions.

The hydrological study conducted for the EA also indicates that culverts associated with nearby landowner access roads may be undersized for the existing flow conditions thereby contributing to backwater effects that may continue to exacerbate future flooding regardless of the small increment of additional discharge from the BCH (Figure A-2). As a result, no mitigation measures relative to culvert improvements at adjacent properties have been incorporated into the proposed EDC project.

Although it has been concluded that proposed improvements at the BCH would not result in increased flooding in the Burley Creek corridor, this does not preclude the federal government and adjacent property owners, either individually or collectively, from contacting local jurisdictions to implement culvert improvements as separate actions from the proposed BCH project. Since local flooding due to undersized culverts could affect hatchery operations, as well as disrupting native fish passage in Burley Creek, fishery biologists at the BCH will contact Kitsap County Public Works and WDFW in mid-2014 to discuss the nature of concerns relative to culvert conditions. Should any developments transpire, fishery biologists will apprise neighboring landowners accordingly, and will request BPA and the NWFSC to coordinate with Kitsap County Public Works and WDFW to formulate a project, funded with public funds, to re-design and install new culverts near the hatchery.

2. Response to concerns that well water withdrawals would affect adjacent landowner well

Potential effects of groundwater withdrawals from the hatchery wells on neighboring private wells was evaluated and described in section 5.4.2 of the EA. Results of hydrogeological analyses and investigations of potential interference of increased well production on nearby wells concluded that projected operational drawdowns would result in minor, localized decreases in groundwater levels and availability in and around the BCH. Because of the shallower depth of the neighboring wells and their spatial relationship to the BCH wells, no interference with neighboring wells is expected due to the

proposed BCH operations. The projected groundwater withdrawals at the BCH would not impair nearby wells from producing water for domestic supply.

3. Response to lack of reference to Burley Creek use by Chinook or Chum salmon

The analysis in the EA is based on official documentation from agency records. NOAA contacted fishery management agency biologists at WDFW who did not indicate any current presence of Chinook or chum salmon in Burley Creek (Gina Piazza, WDFW, personal communication with Hans Hurn, Hart Crowser, September 17, 2012). According to the Washington Streams Catalog (Williams et al. 1975), historical populations of coho, chum, and Chinook salmon were documented in Burley Creek. Prior to the mid-1970s, Burley Creek had the only documented wild stock of Chinook salmon in the Henderson Bay sub-basin. Both the summer and fall varieties of chum salmon were also historically present in the stream. It is possible that runs of Chinook and chum salmon could become re-established in Burley Creek in the future, since fish passage barriers downstream are not known to occur.

4. Response to request that hatchery work should improve the quality of Burley Creek and native salmon runs

Please refer to the last paragraph of Response #1. In addition, habitat restoration measures described in the wetland and stream mitigation plan would provide improved instream and riparian habitat conditions at the outlet of the EDC where it connects to Burley Creek (see Appendix E). This would provide habitat complexity to and provide continuity between the enhanced wetland community at the outlet of the earth drainage channel and the mature Burley Creek riparian corridor. Shading would also be provided to the proposed outflow channel from southern sun exposure as the new plantings mature.



U.S. Fish and Wildlife Service
National Wetlands Inventory

Burley Creek Hatchery

Apr 4, 2014



Wetlands

- Freshwater Emergent
- Freshwater Forested/Shrub
- Estuarine and Marine Deepwater
- Estuarine and Marine
- Freshwater Pond
- Lake
- Riverine
- Other

This map is for general reference only. The US Fish and Wildlife Service is not responsible for the accuracy or currentness of the base data shown on this map. All wetlands related data should be used in accordance with the layer metadata found on the Wetlands Mapper website.

Source: <http://www.fws.gov/wetlands/Data/Mapper.html>

NWFSC, Earthen Drainage Channel, Burley Creek Hatchery Final Environmental Assessment
 Port Orchard, WA

Inventoried Wetlands on Properties adjacent to the Burley Creek Hatchery

12757-01

04/14

Figure

A-1



- Project Location
- Culvert
- Backed-up and Ponding Water
- Stream
- Roadside Drainage

- Sources:
1. Base Map prepared from ArcGIS Online, 2013.
 2. Parcels informatino from Kitsap County GIS department website, dated 11/20/13.
 3. Stream information from Washington State Department of Natural Resources website, dated 3/1/2006.

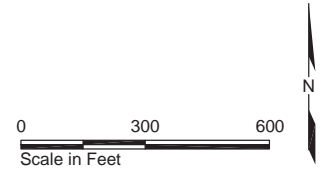

NWFSC, Earthen Drainage Channel, Burley Creek Hatchery Final Environmental Assessment
Port Orchard, WA

Burley Creek Hatchery Site and Adjacent Properties
12757-01 04/14

Figure
A-2

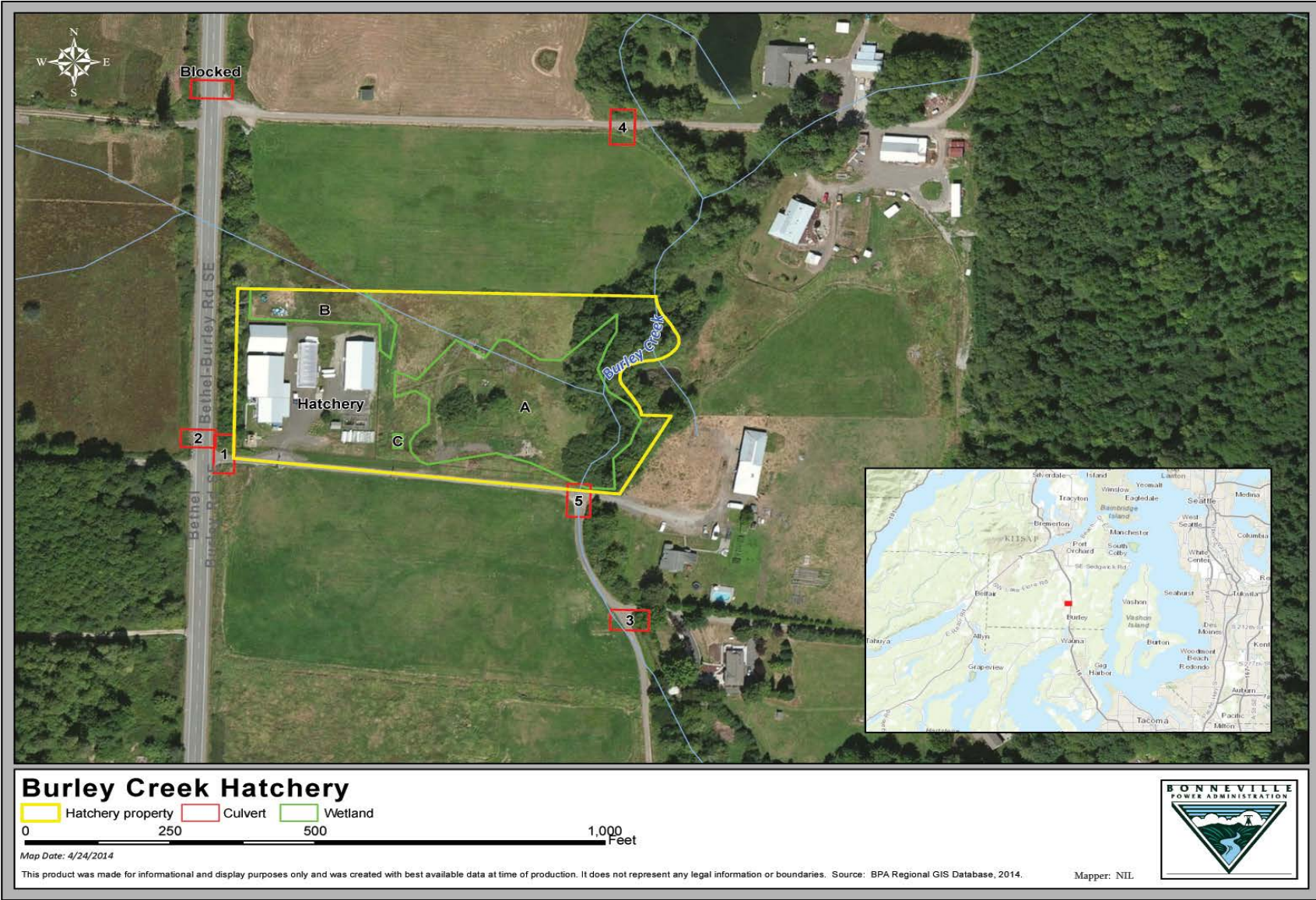

NWFSC, Earthen Drainage Channel, Burley Creek Hatchery Final Environmental Assessment
Port Orchard, WA

Burley Creek Hatchery Onsite Wetlands and Nearby Culvert Locations

12757-01

05/14

Figure

A-3

McCaslin

From: [REDACTED]
Sent: Tuesday, July 09, 2013 5:57 PM
To: Silvia Espino
Subject: Burley Creek Hatchery Project, Kitsap County, WA

Burley Creek Hatchery Project Managers,

The address of our property is [REDACTED] Port Orchard Washington. We live one driveway north of Burley Creek Hatchery.

Before the hatchery was put in, our hay field yielded 300 to 400 bales of hay each summer.

When the hatchery pulls water from deep in the ground up onto the surface and pours it back into Burley Creek, or onto the ground, the additional water coming into the creek from the hatchery does raise the water level. This, in turn, raises the water levels of the properties nearby, causing our lands to become wetter.

A few years ago, an additional well was drilled at the Burley Creek Hatchery. The subsequent effect has been that our hay fields have not been able to produce a marketable crop for the past 2 years, due to the increased ground water level. In Aug/Sep 2007, we plowed and seeded our hay field. We had a good crop in 2008 and 2009, declining crops in 2010 and 2011, and no marketable crop in 2012 and 2013. Now, in the proposal sent to us, we are being told that the output of the hatchery will increase 100%, with peaks as high as 300%, compounding the situation.

During the peaks of the rainy season, the existing creek basin is incapable of handling existing water flow. The water levels become so high that the current culverts cannot pass the flow through. The excess now comes up over the driveway and has been seen as deep as 9 inches across the driveway. It also floods the lower portions of the local hay fields.

Last year, the gentleman who cuts our hay field said, "Your land is now too wet. There is too much swamp grass in your field to use for hay. This was caused by the water level of the property being raised." He is a local farmer himself, and understands the impact that the Burley Hatchery has put on our land. Because of this reason, he will no longer use our field for hay.

This field is not the only part of our property that is being affected. If Burley Hatchery is continued to be allowed to draw water via wells, and continues to dump it on the ground, into a pond, or directly into the creek, the water levels in this valley will continue to rise. This could present problems with our land adjacent to the house and our septic drain field.

The hatchery discharges are already a problem. It is unacceptable that this problem will be allowed to be made worse by increasing the discharge from the hatchery. Our property has already felt the impact by the rising water levels, rendering them useless to produce a quality hay crop.

If this proposal is approved, and the project is commenced, we believe we will be forced to take legal actions.

Sincerely,
Michael and Tami McCaslin

[REDACTED]
[REDACTED]
[REDACTED]
[REDACTED]

Ringer

July 11, 2013

To whom it may concern:

I have looked at the proposal as presented by NWFSC for an earthen Drainage Channel for the Burley Creek Hatchery and I have some concerns and comments. I am a longtime resident (27 years) of the Burley area and a property owner who has 900 feet of Burley Creek. I have watched the stream closely during those years and have enjoyed the salmon runs that utilize the creek. During that time I have seen the runs seriously depleted and the water table of the surrounding properties change drastically. Some of my concerns are as follows:

1. For many years I have done hay on the property of Terry Farnham. His property sits directly to the north of the Burley Creek Hatchery. In spite of promises that the hatchery would not affect his land I have seen it grow increasingly wet. Earlier this month I hayed his field and found that the corner directly adjacent to your buildings has standing water. He had none of these problems prior to the hatchery going in and pumping such a huge volume of water. I am afraid that your proposal will only add more water to his property and others in the area, thereby decreasing its usefulness and value.
2. The hatchery has never done anything to improve the quality of Burley Creek and the salmon runs in it. What can the Burley Creek Hatchery do to improve the runs? You have shipped fry to Idaho but have done nothing to improve the local runs.
3. Your proposal lacks complete facts in areas. One is documented under 4.7.5 Fish Use. You say there is no data documenting current or past use of Burley Creek by Chinook or Chum salmon. In fact there is an active Chinook run in September -October of every year. There is an active Chum run in December of every year. I have even seen the occasional Pink Salmon in Burley Creek. I can supply you with documentation of such runs. Those who have lived in the area for many years talk about a very large Spring Chinook run. Unfortunately this run seems to have died out. With incomplete facts I wonder how implementation of your proposal will affect the creek.

These are just some of my concerns with your proposal. I would love to see you put efforts forward to enhance Burley Creek and its salmon runs. I am leery about what you do propose though.

Sincerely,

John Ringer

Farnham

From: Pennie Farnham [REDACTED]
Sent: Friday, July 12, 2013 11:46 AM
To: Silvia Espino
Cc: [REDACTED]
Subject: Burley Creek Hatchery

To Whom it may concern:

We have reviewed your proposed drainage channel for Burley Creek Hatchery. We live on the property that sit directly next to the hatchery. We have not been pleased with the increase of our land growing wetter. As stated by John Ringer that earlier this month he hayed our field and found that the corner directly adjacent to your buildings had standing water. We are now in the summer dry season and should not have standing water. We have lost several areas of our field due to your pumping of such huge volumes of water. We do believe that your proposal will only add more water to our fields and make our field worthless.

We do not understand how any of this is going to help improve our lands or the quality of Burly Creek, which we have for years worked hard to clean up and keep clean so that we will be able to improve our salmon runs.

Terry and Pennie Farnham

Clark

From: Heath Judy [REDACTED]
Sent: Friday, July 12, 2013 2:47 PM
To: Silvia Espino
Subject: Burley Creek Hatchery Project

Burley Creek Hatchery Project -

In the years since we have moved into the valley, our property value has gone down by nearly 1/3 of it's original value.

Understandably, in this economy all property values have suffered loss. In our area near the hatchery however, we attribute the loss of value in terms of the usability of the land.

This loss of use is directly attributable to the Burley Creek Hatchery. The extra water from the hatcheries wells dumped directly into the creek has raised the water table in the area to such an extent that it has made the nearby hay fields unusable.

Bull rush, or swamp grass as it is sometimes called have taken over once harvestable fields.

These fields were a valuable source of hay in the past. Now, however, due to the activities of the hatchery the fields cannot be harvested.

We are VERY concerned about the hatcheries continued impact on local property owners and on the Burley creek itself.

After reading the report it is apparent that an assessment of the impact to surrounding property owners was not done.

Other than the notice of intent to move forward with the BCH project, we were not contacted.

If this report was thorough and had truly sought to include the impact it was having on the surrounding properties, research would have included interviews and statements of the owners of the surrounding properties.

The lack of contact with Burley Creek neighbors prior to submitting a plan call into question the validity of the research submitted.

Any negative impact to surrounding property owners, including but not limited to, loss of land use, declining property value, or damage to Burley Creek, due to the implementation of this plan will be met with legal action against the approvers of the plan as stated on the published documents pertaining to the BCH project.

As the BCH project is discussed, please keep in mind the properties and lives you may affect as you consider the options.

Sincerely,

Heath Clark
Judy Clark

Winden

From: Steve Winden [REDACTED]
Sent: Tuesday, December 18, 2012 9:58 PM
To: Silvia Espino
Subject: Burley Creek Hatchery EA

Dear Ms. Silvia Espino,

We are concerned long-term residents who own property and dwellings along the Burley Creek. We have recently reviewed the draft regarding the Burley Creek Hatchery EA and have some concerns.

Our private well is approximately 300 feet away from the Burley Creek Hatchery's newest well, and we are concerned with the increase of water being withdrawn from the aquifer and the potential negative impact on our private well. The document section (5.4.2 Groundwater) states that withdrawals will increase from 500 to 1,000 gpm with impairment of off-site well not "expected." If indeed this increase in groundwater withdrawal does affect our well, what entity would resolve this issue?

Another concern as property owners near the Burley Creek Hatchery is increased flooding due to the increased water flow of 1,000 to 3,000 gpm. In our 18 years as property owners at this site, we have seen significant flooding 2-3 times per year in the fall, winter and spring months. The concern exists that this increase in water flow will cause substantial flooding and erosion of our existing road and driveway. We query who will be responsible for possible needed repairs or replacement of our driveway due to the increased water outflow of up to 3,000 gpm from the Burley Creek Hatchery.

While this document provides for the renewed resource of the Snake River salmon species, we have seen a negative impact on the native salmon during flooding and their inability to pass through the recently built fencing around the Burley Creek Hatchery. It appears as though the Burley Creek Hatchery has no regard for the native salmon runs in its attempt to protect the ESA-listed Snake River sockeye salmon.

We would appreciate your response to our concerns on this matter.

Thank you,

Steve and Kelly Winden

**APPENDIX B
AGENCIES, ORGANIZATIONS, AND PERSONS RECEIVING
NOTICE OF AVAILABILITY OF THE EA**

This page is intentionally left
blank for double-sided printing.

Agencies, Organizations, and Persons Receiving Notice of the Availability of the EA

Bonneville Power Administration

PO Box 61409
Vancouver, WA 98662

Great Peninsula Conservancy

3721 Kitsap Way Ste 5
Bremerton, WA 98312

Kitsap County Department of Community Development

Environmental Programs Division
614 Division Street
Port Orchard, WA 98366
Attn: Lisa Lewis, Environmental Planner III
Email: llewis@co.kitsap.wa.us
Phone: (360) 337-5777 ext. 3316

Muckleshoot Indian Tribe

39015 172nd Ave SE
Auburn, WA 98092
Attn: Fisheries Division
Phone: (206) 931-0652
fisheries@muckleshoot.nsn.us

NOAA National Marine Fisheries Service, Northwest Fisheries Science Center

Dr. Desmond J. Maynard
Hatchery Technology Team Leader
Resource Enhancement and Utilization
Technologies Division
P.O. Box 130
Manchester, WA 98353
Des.maynard@noaa.gov
Phone: (360) 871-8313

Puyallup Tribe of Indians

6824 Pioneer Way West
Puyallup, WA 98371
Attn: Fisheries Department
Phone: (253) 680-5560
www.puyallup-tribe.com

Squaxin Island Tribe

Natural Resources Center
2952 SE Old Olympic Highway
Shelton, WA 98584
Phone: (360) 426-9781

Suquamish Tribe

18490 Suquamish Way
Suquamish, WA 98392
Attn: Fisheries Department
Phone: (360) 394-8437

United States Fish and Wildlife Service/National Marine Fisheries Service

Jim Muck
US Fish and Wildlife Service
National Marine Fisheries Service
7600 Sandpoint Way NE
Seattle, WA 98115
jim_muck@fws.gov
Phone: (206) 526-4740

US Army Corps of Engineers

Karen Urelius, Project Manager
Regulatory Branch, Seattle District
P.O. Box 3755
Seattle, WA 98124
Karen.M.Urelius@usace.army.mil
Phone: (206) 764-3482

Washington Department of Fish and Wildlife

Gina Piazza
Area Habitat Biologist
450 Port Orchard Blvd, Suite 290
Port Orchard, WA 98366
Email: Gina.Piazza@dfw.wa.gov
Phone: (360) 895-3965
Fax: (360) 876-1894

Washington State Department of Ecology

SEA Program
Federal Permit Coordinator
P.O. Box 47600
Olympia, WA 98504-7600
ecyrefedpermits@ecy.wa.gov

Betty M. Church, Trustee
Katherine M. and Steven D. Peck
PO Box 471
Burley, WA 98322
Heath E. and Judy R. Clark
11089 Bethel Burley Rd SE
Port Orchard, WA 98367

Joanne E. Dantonio
10736 Bethel Burley Rd SE
Port Orchard, WA 98367

Johann and Petra Eidrich
11550 Bethel Burley Rd SE
Port Orchard, WA 98367

Terry Farnham
11111 Bethel Burley Road SE
Port Orchard, WA 98367

George and Dixie E. Fazio
PO Box 424
Burley, WA 98322

Joseph W. and Denise A. Keehn
2357 Wood Rd SE
Port Orchard, WA 98366

Dennis Lewarch
Tribal Historic Preservation Officer
dlewarch@suquamish.nsn.us
Phone: (360) 394-8529

Tami Lynn McCaslin
11253 Bethel Burley Rd SE
Port Orchard, WA 98366

Frank T. and Maria Moore
PO Box 307
Burley, WA 98322

Laura Murphy
Archaeologist
Phone: (253) 939-3311
laura.murphy@muckleshoot.nsn.us

Sammy L. Myers and
Katherine Hallet Myers, Trustees
1315 SE Lakeway Blvd
Port Orchard, WA 98367

Rosita D. Osborn
114 Felix T. Pangelinan St
Santa Rita, GU 96915

Randell A. and Deborah G. Raub
PO Box 1
Burley, WA 98322

Brandon Reynon
Cultural Resources Specialist
(253) 573-7986
brandon.reynon@puvalluptribe.com

John Richardson and Dana Bauer
11428 Bethel Burley Rd SE
Port Orchard, WA 98367

John Ringer
P.O. Box 507
Burley, WA 98322

Jack R. and Dawn D. Sanzalone
1036 SE Swofford Ln
Port Orchard, WA 98367

Dale D. and Tracy L. Schneewind
11720 Bethel Burley Rd SE
Port Orchard, WA 98367

Marshall Simpson
11433 Bethel-Burley Road
Port Orchard, WA 98367

Scott and Leann Simpson
11439 Bethel Burley Rd
Port Orchard, WA 98367

Susan Irene Spears
1335 SE Swofford Ln
Port Orchard, WA 98367

Robert S. and Lenore Watkins
11465 Bethel Burley Rd
Port Orchard, WA 98366

Andy Whitener
Natural Resources Director
Phone: (360) 432-3802
awhitener@squaxin.us

Steve and Kelly Winden
11427 Bethel-Burley Road
Port Orchard, WA 98367

**APPENDIX C
PHOTOGRAPHS**

This page is intentionally left
blank for double-sided printing.



Photograph 1 – Overview of Burley Creek Hatchery in Port Orchard, Washington (view looking north).



Photograph 2 – The settling basin and UV treatment system for the Burley Creek Hatchery (view looking east).



Photograph 3 – The existing detention pond for the Burley Creek Hatchery (view looking south).



Photograph 4 – Main access gate at the Burley Creek Hatchery (view looking south).



Photograph 5 – The riparian corridor along Burley Creek is dominated by native vegetation (view looking south).

This page is intentionally left
blank for double-sided printing.

**APPENDIX D
FIGURES AND DRAWINGS**

This page is intentionally left
blank for double-sided printing.

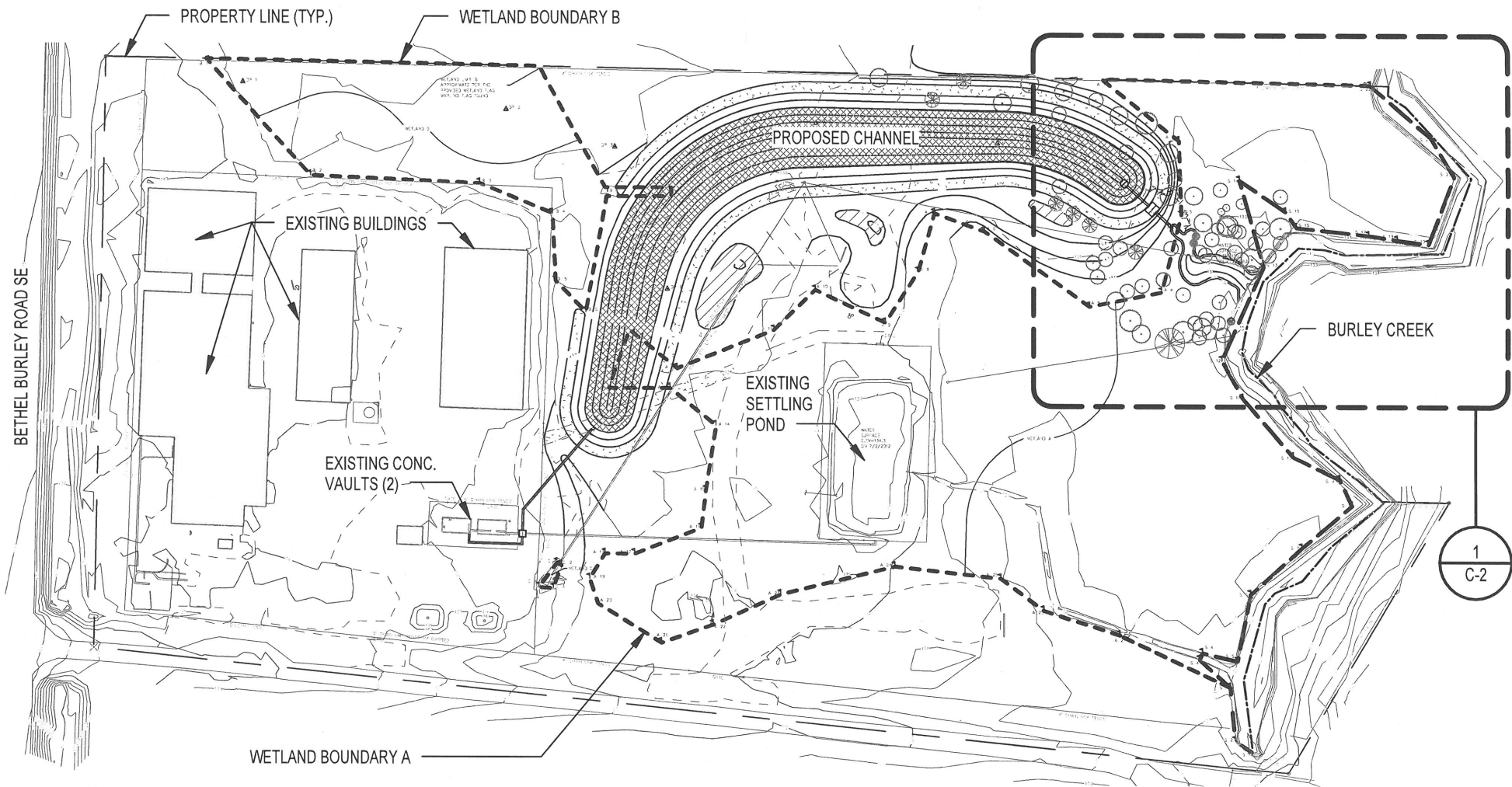

1

VICINITY PLAN

SCALE: 1" = 80'-0"

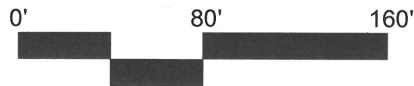

rolluda architects
architecture planning interior design

REFERENCE #: NWS-2012-1356

APPLICANT: NOAA National Marine Fisheries Service, Northwest Fisheries Science Center

ADJACENT PROPERTY OWNERS:

Terry Farnham TPN 362301-2-011-2009

John Ringer TPN 362301-2-021-2007

Marshall Simpson TPN 362301-2-012-2008

Steven and Kelly Winden TPN 362301-2-022-2006

LOCATION: 11421 Bethel-Burley Road SE
Port Orchard, WA 98367
Parcel No. (TPN): 362301-2-019-2001

LAT/LONG: 47°26'38.04"N 122°37'48.95"W

FIGURE 1 OF 4 DATE: 12-13-2012

PROPOSED PROJECT: Design and construction of a new proposed drainage channel with an associated outlet channel to Burley Creek. The channel will route treated effluent water from the existing Burley Creek Hatchery to Burley Creek.

IN: Burley Creek

NEAR/AT: Port Orchard

COUNTY: Kitsap

STATE: WA

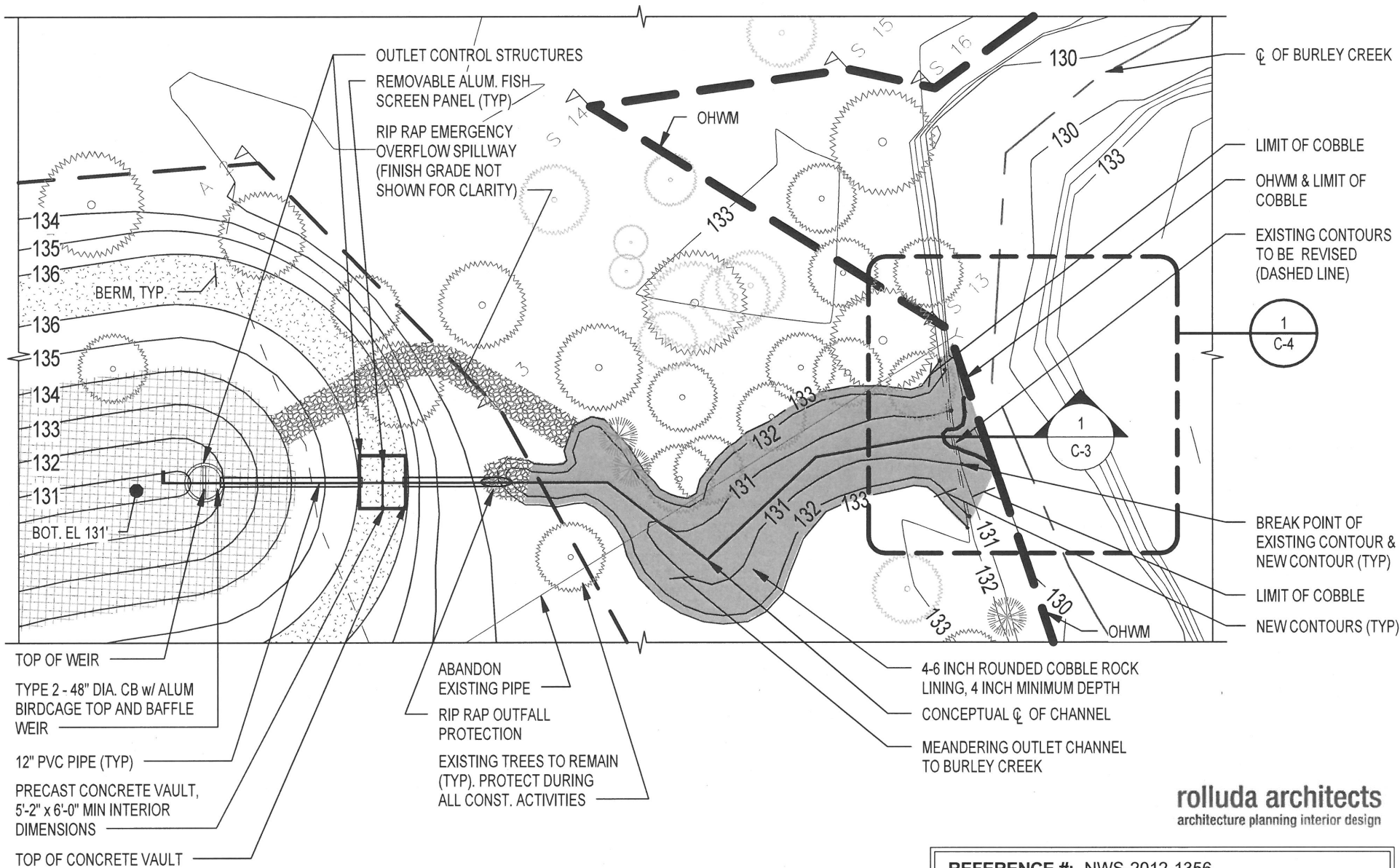

1

ENLARGED PLAN

SCALE: 1/16" = 1'-0"

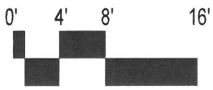

rolluda architects
architecture planning interior design

REFERENCE #: NWS-2012-1356
APPLICANT: NOAA National Marine Fisheries Service, Northwest Fisheries Science Center
PROPOSED PROJECT: Earthen Drainage Channel, Burley Creek Hatchery
LOCATION: Port Orchard, WA
FIGURE 2 OF 4 **DATE:** 12-13-2012

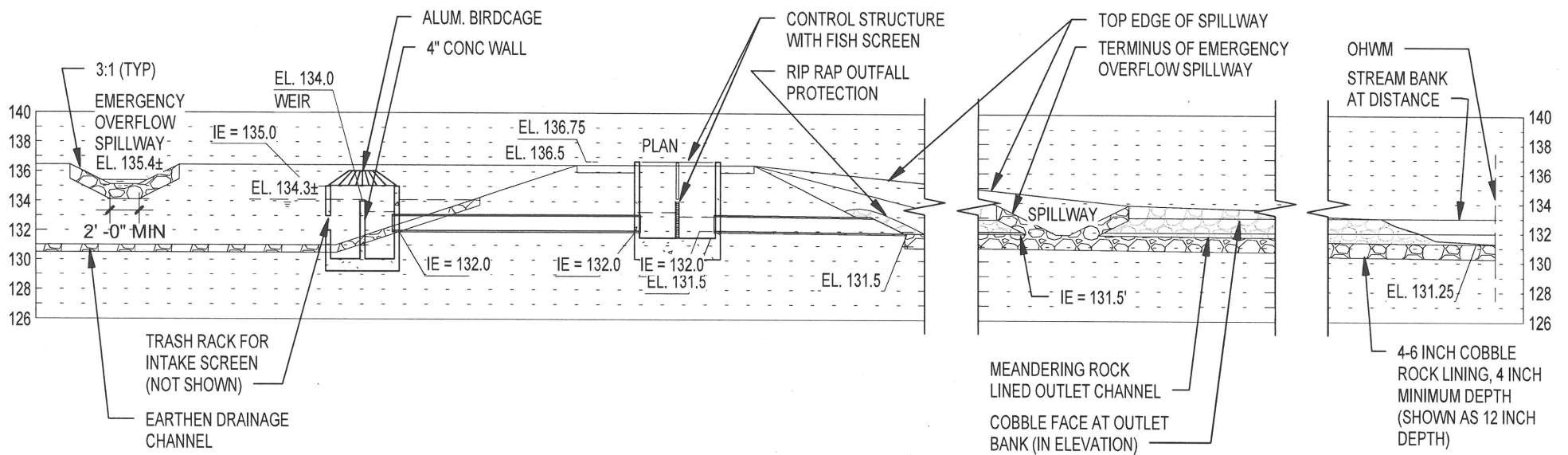

CONTROL SECTION - CONCEPTUAL ELEVATION OF MEANDERING C

1

SCALE: 1" = 10'-0"

rolluda architects
architecture planning interior design

REFERENCE #: NWS-2012-1356
APPLICANT: NOAA National Marine Fisheries Service, Northwest Fisheries Science Center
PROPOSED PROJECT: Earthen Drainage Channel, Burley Creek Hatchery
LOCATION: Port Orchard, WA
FIGURE 3 OF 4 **DATE:** 12-13-2012

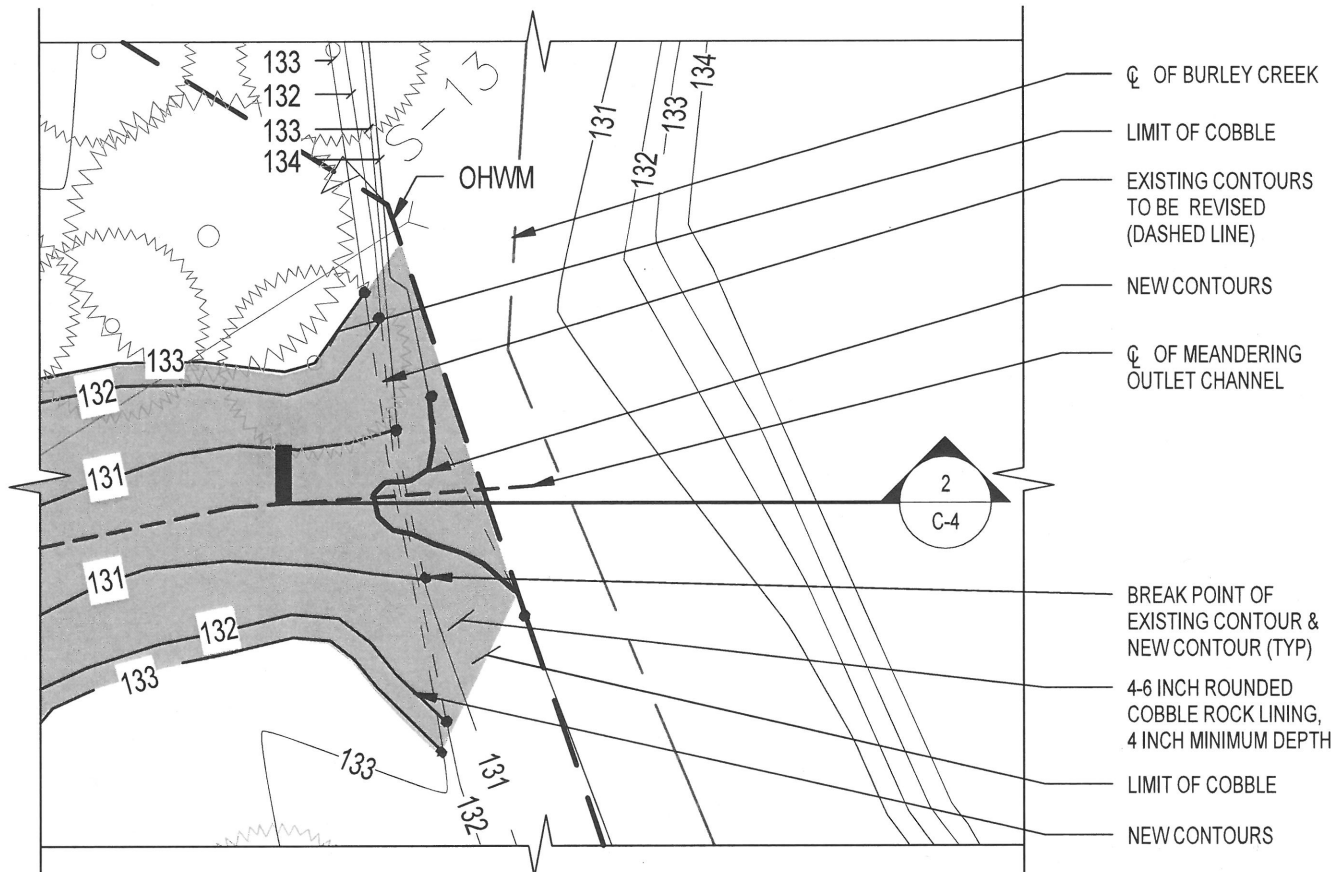

- ☐ OF BURLEY CREEK
- LIMIT OF COBBLE
- EXISTING CONTOURS TO BE REVISED (DASHED LINE)
- NEW CONTOURS
- ☐ OF MEANDERING OUTLET CHANNEL
- BREAK POINT OF EXISTING CONTOUR & NEW CONTOUR (TYP)
- 4-6 INCH ROUNDED COBBLE ROCK LINING, 4 INCH MINIMUM DEPTH
- LIMIT OF COBBLE
- NEW CONTOURS

1

ENLARGED OUTFLOW

SCALE: 1/8" = 1'-0"

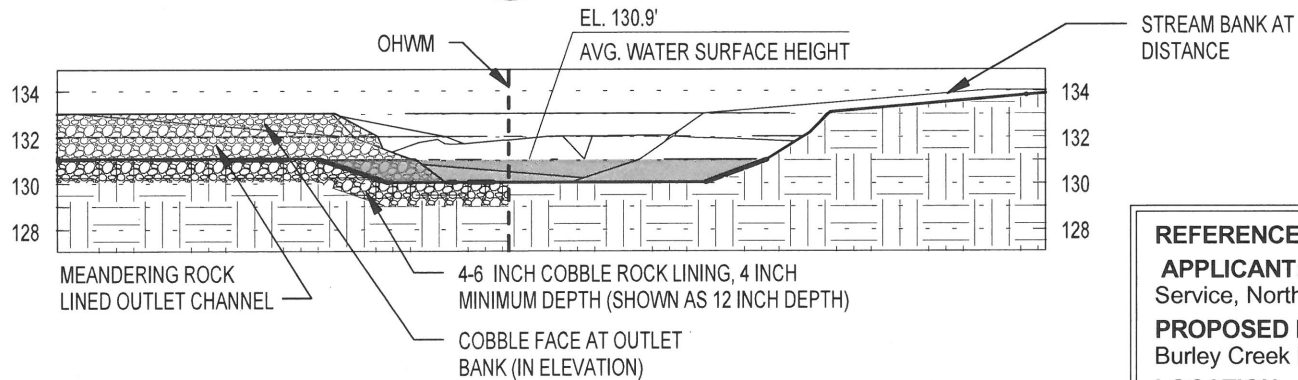
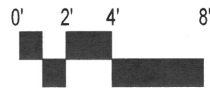

- MEANDERING ROCK LINED OUTLET CHANNEL
- 4-6 INCH COBBLE ROCK LINING, 4 INCH MINIMUM DEPTH (SHOWN AS 12 INCH DEPTH)
- COBBLE FACE AT OUTLET BANK (IN ELEVATION)
- EL. 130.9'
- AVG. WATER SURFACE HEIGHT
- OHWM
- STREAM BANK AT DISTANCE

2

OUTFLOW ELEVATION

SCALE: 1/8" = 1'-0"

rolluda architects
architecture planning interior design

REFERENCE #: NWS-2012-1356

APPLICANT: NOAA National Marine Fisheries Service, Northwest Fisheries Science Center

PROPOSED PROJECT: Earthen Drainage Channel, Burley Creek Hatchery

LOCATION: Port Orchard, WA

FIGURE 4 OF 4 DATE: 12-13-2012

**APPENDIX E
FINAL WETLAND AND STREAM DELINEATION
REPORT AND MITIGATION PLAN**

This page is intentionally left
blank for double-sided printing.

**Final Wetland and Stream Delineation Report
and Mitigation Plan
Burley Creek Hatchery
Kitsap County, Washington**

April 22, 2013

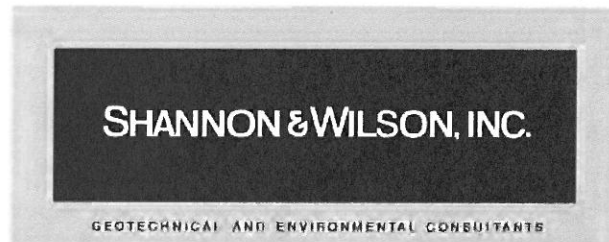

Excellence. Innovation. Service. Value.

Since 1954.

Submitted To:
Mr. Bernie Wong
Ahtna Engineering Services, LLC
19540 International Blvd., Suite 201
Seatac, Washington 98188

By:
Shannon & Wilson, Inc.
400 N 34th Street, Suite 100
Seattle, Washington 98103

21-1-12409-002

TABLE OF CONTENTS

	Page
1.0 INTRODUCTION.....	1
2.0 METHODS.....	2
3.0 DOCUMENT REVIEW.....	3
4.0 RESULTS.....	4
4.1 Wetland A	5
4.2 Wetland B.....	6
4.3 Wetland C.....	6
4.4 Burley Creek	7
4.5 Stream 1.....	7
4.6 Uplands.....	8
5.0 REGULATORY REVIEW	8
5.1 Federal Clean Water Act (CWA), Section 404 Permit	8
5.2 Clean Water Act (CWA), Section 401 Water Quality Certification	9
5.3 State Hydraulic Project Approval (HPA).....	9
5.4 Kitsap County Critical Areas Regulations	10
6.0 FINAL MITIGATION PLAN SUMMARY	12
7.0 PLANTING PLAN	13
8.0 PLANTING SEQUENCE.....	14
9.0 MAINTENANCE.....	15
10.0 MONITORING PLAN.....	15
11.0 COMPENSATORY MITIGATION GOALS AND OBJECTIVES.....	16
12.0 PERMANENT RECOGNITION AND PROTECTION.....	17
13.0 CLOSURE.....	18
14.0 REFERENCES.....	19

TABLE OF CONTENTS (cont.)

TABLES

1 Federal Wetland Impact Compensatory Mitigation Ratios9
2 Kitsap County Wetland Impact Compensatory Mitigation Ratios11
3 Final Compensatory Mitigation Summary.....12
4 Wetland Enhancement Planting Plan.....14

FIGURES

1 Vicinity Map
2 USDA Soils Map
3 Kitsap County Streams and Surface Water Map
4 National Wetland Inventory Map
5 Wetland and Stream Delineation
6 Final Mitigation Plan
7 Planting Typical

APPENDICES

A Wetland Delineation Methodology
B Wetland Determination Data Forms – Western Mountains, Valleys, and Coast
Region
C Wetland Rating Forms – Western Washington
D Important Information About Your Wetland Delineation/Mitigation and/or Stream
Classification Report

**FINAL WETLAND AND STREAM DELINEATION REPORT
AND MITIGATION PLAN
BURLEY CREEK HATCHERY
KITSAP COUNTY, WASHINGTON**

1.0 INTRODUCTION

The National Oceanographic and Atmospheric Administration (NOAA) is proposing to construct an earthen drainage channel from the Burley Creek Hatchery facility to Burley Creek, hereafter referred to as the “project,” as a means to discharge water from the hatchery operations. The new earthen drainage channel is necessary to accommodate the increased effluent commensurate with an increase in their operations.

As we understand it, the design of the proposed earthen drainage channel has gone through several iterations and alternatives based on project goals, site limitations, and funding. The preferred alternative associated with the conceptual design contract is currently referred to as Alternative 4, which includes an earthen drainage channel with balanced cut and fill that largely avoids on-site aquatic areas (e.g., wetlands and streams) with the exception of the outflow associated with the earthen drainage channel. The proposed earthen drainage channel and its outflow will be naturalized through native plantings, variable topography, and meanders.

The proposed earthen drainage channel will be located entirely on the Burley Creek Hatchery site (Kitsap County Parcel No. 362301-2-019-2001) (Figure 1). The site is located northwest of the intersection of Highway 16 (Hwy 16) and SE Burley Ollala Road in unincorporated Kitsap County, Washington, in the NW ¼ of Section 36, Township 23 North, Range 1 East, Willamette Meridian.

The scope of services for our wetland and stream delineation report and conceptual mitigation plan was limited to the following tasks:

- Conduct a background review of information relating to the site. This includes a review of the Kitsap County Soil Survey, U.S. Fish and Wildlife Service (USFWS) National Wetlands Inventory maps, Washington State Department of Fish and Wildlife (WDFW) SalmonScape mapping system, and other relevant background information.
- Complete a wetland delineation of the site using the methodology outlined in the Washington State Department of Ecology’s (Ecology’s) 1997 *Washington State Wetland Identification and Delineation Manual*, U.S. Army Corps of Engineers’ (Corps’) 1987 *Wetland Delineation Manual*, and the *Regional Supplement to the*

Corps of Engineers Wetland Delineation Manual: Western Mountains, Valleys, and Coast Region (May 2010).

- Approximate wetland boundaries located within 300 feet of the property boundary to determine the extent of off-site wetlands and buffers that may impact development on site, in accordance with Kitsap County requirements.
- Rate wetlands identified on site and within 300 feet of the site using Ecology's Washington State Wetland Rating System for Western Washington, in accordance with Kitsap County requirements, to determine the standard buffer widths as defined within the Kitsap County Code (KCC).
- Delineate the ordinary high water mark (OHWM) of Burley Creek and other potential drainages located on the site following the guidance within Ecology's technical report, *Determining the Ordinary High Water Mark on Streams in Washington State*. This includes reviewing hydrologic data available and readily accessible for Burley Creek. All streams identified and delineated will be classified using the water typing system defined within KCC.
- Complete a wetland and stream delineation report describing our findings for your use and files. This report will include a regulatory review of the wetlands and streams present on the site as they pertain to the proposed channel.
- Coordinate with the design team to determine the amount of wetland, stream, and buffer impacts associated with the project.
- Develop a conceptual mitigation report that identifies mitigation areas on site and includes a wetland functions evaluation and conceptual planting plan to comply with city, state, and federal mitigation requirements.

Following the preparation of the Revised Wetland and Stream Delineation Report and Conceptual Mitigation Plan on November 27, 2012, we completed a site visit with the U.S. Army Corps of Engineers (Corps) on February 11, 2013. This Final Wetland and Stream Delineation Report and Mitigation Plan incorporates the revisions required by the Corps to the wetland boundary and mitigation plan for the project.

2.0 METHODS

Shannon & Wilson, Inc. conducted the wetland and stream delineation fieldwork on May 16, 2012, with a subsequent site visit on July 2, 2012. A subsequent site visit with the Corps occurred on February 11, 2013, which resulted in two revisions to the wetland boundary. Potential wetlands were identified using methods described in the *Corps of Engineers Wetlands Delineation Manual* (U.S. Army Corps of Engineers Waterways Experiment Station, 1987), and *Regional Supplement to the Corps of Engineers Wetland Delineation Manual: Western*

Mountains, Valleys, and Coast Region (U.S. Army Corps of Engineers Engineer Research and Development Center, 2010) in accordance with the County's and Ecology's requirements (Ecology, 2011).

Potential wetland areas were determined using the triple-parameter approach, which considers vegetation types, soil conditions, and hydrologic conditions. For an area to be considered wetland, it must display each of the following: (a) dominant plant species that are considered hydrophytic by the accepted classification indicators, (b) soils that are considered hydric under federal definition, and (c) indications of wetland hydrology, in accordance with federal definition. Appendix A provides a detailed description of methodology used.

Wetland boundaries were marked with florescent pink nylon flagging and OHWM flags and data plots were marked with florescent orange nylon flagging.

3.0 DOCUMENT REVIEW

Background information pertaining to the site was collected and reviewed. These information sources included:

- USFWS National Wetlands Inventory (NWI) Wetlands Mapper (<http://www.fws.gov/wetlands/data/Mapper.html>)
- U.S. Department of Agriculture (USDA) Web Soil Survey (WSS) (<http://websoilsurvey.nrcs.usda.gov/app/>)
- Kitsap County Streams and Surface Water Map (http://www.kitsapgov.com/dcd/gis/maps/Standard_Maps/Environmental/Streams_and_Surface_Water_Nov2007.pdf)
- WDFW SalmonScape (<http://wdfw.wa.gov/mapping/salmonscape/>)
- WDFW Priority Habitats and Species (PHS) on the Web (<http://wdfw.wa.gov/mapping/phs/>)
- Title 19, Critical Areas, of the KCC (<http://www.codepublishing.com/wa/kitsapcounty/>)

Soils on site are predominantly mapped as Bellingham silty clay loam with Norma fine sandy loam along the Burley Creek riparian corridor (Figure 2). Both soil series are considered hydric.

The County's Streams and Surface Water Map identifies two Type F streams, Burley Creek and an unnamed stream, as well as potential wetlands mapped on the site. Burley Creek runs north to

south along the eastern end of the site (Figure 3). These conditions are generally consistent with what was observed on site. However, the second unnamed stream mapped by Kitsap County and WDFW as flowing northwest to southeast through the site, differs from the conditions observed on site.

The County has identified Burley Creek and the unnamed stream as Type F streams. According to both the WDFW SalmonScape and WDFW PHS mapping systems, Burley Creek is identified as providing habitat for coast resident cutthroat, steelhead trout, and coho species. There are no known complete barriers to fish passage downstream of the unnamed stream, according to WDFW SalmonScape.

The USFWS NWI Wetlands Mapper and Kitsap County Streams and Surface Water Map depict wetlands on site. However, the extent of wetlands on site depicted on each differs significantly from one another. According to the USFWS NWI Wetlands Mapper, a palustrine forested seasonally flooded wetland (PFOC) is mapped as a thin band of wetland along the banks of Burley Creek while a palustrine emergent seasonally flooded wetland is located in the field north of the site (Figure 4). This differs from the Kitsap County Streams and Surface Water Map which maps a single, large potential wetland that encompasses the whole site and many of the surrounding parcels.

4.0 RESULTS

The Burley Creek Hatchery is predominantly located on the western half of the site, within a fenced in facility near the intersection of Bethel-Burley Road SE and paved driveway. East of the fenced facility are the hatchery's wells and an existing outfall pond where discharge of hatchery water is currently released. The wells and outfall pond are located within a field that gradually slopes down to the east towards Burley Creek.

During our fieldwork, we delineated three wetlands (Wetlands A, B, and C) and one stream (Burley Creek) on site (Figure 5). A second unnamed, channelized stream runs along Bethel-Burley Road SE, immediately east of the site. Six data plots were completed throughout the site to characterize vegetation, soil, and hydrological conditions associated with the onsite uplands and wetlands (Appendix B).

A description of the wetlands and stream within the project area follows. Vegetation is described below by common name, with the scientific name and indicator status in parentheses. Soils are described with the associated Munsell® Color Charts color in parentheses. Wetlands were

characterized according the *Washington State Wetland Rating System for Western Washington* (Ecology, 2004) as required by the County.

4.1 Wetland A

Wetland A is a palustrine scrub-shrub/emergent wetland (PSS/EM) that encompasses the vegetated riparian corridor surrounding Burley Creek and a large portion of the grass field and outfall pond (Figure 5). The wetland extends off site to the north and may connect with Wetland B off site, although this could not be confirmed.

There are two distinctly different vegetation communities within Wetland A. A scrub-shrub vegetation community is located along the banks of Burley Creek and is densely vegetated with Sitka willow (*Salix sitchensis*, FACW) and red-osier dogwood (*Cornus sericea*, FACW) and a diverse understory of herbaceous species including stinging nettle (*Urtica dioica*, FAC), lady fern (*Athyrium filix-femina*, FAC), and Himalayan blackberry (*Rubus armeniacus*, FACU). West of the scrub-shrub vegetated community is an herbaceous strata dominated by foxtail (*Alopecurus pratensis*, FAC), tall fescue (*Schedonorus phoenix*, FAC), and common velvet grass (*Holcus lanatus*, FAC), although willow and other shrubs have established themselves as a thin band around the outfall pond. Hydrophytic vegetated was dominant throughout both the scrub-shrub and herbaceous communities of Wetland A.

Soils within Wetland A were comprised of a very dark gray (10YR3/1) silt loam layer with dark yellowish brown (10YR3/6) redoximorphic features above a layer of gray (10YR5/1) loamy sand with dark yellowish brown (10YR4/6) redoximorphic features. The soil profile satisfied the Redox Dark Surface (F6) hydric soil criteria.

Primary indicators of wetland hydrology within Wetland A included soils saturated to the surface and evidence of inundation and surface water. An elevated groundwater table appears to be the dominant hydrologic source although evidence of periodic surface flows from the hatchery facility included sediment deposits on matted down vegetation and quarry spalls within the western portion of Wetland A. A network of small surface channels is located within that portion of Wetland A located in the palustrine emergent field, west of the scrub shrub vegetated community.

Based on the *Washington State Wetland Rating System for Western Washington*, Wetland A is classified as a Category III wetland with a low habitat function score of 19 (Appendix C).

4.2 Wetland B

Wetland B is a palustrine emergent wetland (PEM) that extends into the grass field on the northwest corner of the site (Figure 5). The wetland extends off site to the north and appears to be hydrologically connected to Stream 1 and its associated wetland.

The onsite portion of Wetland B is dominated by a herbaceous strata which includes reed canarygrass (*Phalaris arundinacea*, FACW) and foxtail (*Alopecurus pratensis*, FAC). The off-site portion of Wetland B is also dominated by herbaceous species.

Soils within Wetland B were comprised of a very dark gray (10YR3/1) silt loam layer with dark yellowish brown (10YR3/6) redoximorphic features above a layer of gray (10YR5/1) loamy sand with yellowish brown (10YR5/6) redoximorphic features. The soil profile satisfied the Redox Dark Surface (F6) hydric soil criteria.

Primary indicators of wetland hydrology within the outer limits of Wetland B included sediment deposits and algal mat or crust. Inundation was also present further downslope of the Data Plot 2, within the interior of the on-site portion of Wetland B.

Based on the *Washington State Wetland Rating System for Western Washington*, Wetland B is classified as a Category III wetland with a low habitat function score of 15 (Appendix C).

4.3 Wetland C

Wetland C is a very small, rectangular palustrine emergent wetland (PEM) located immediately east of the perimeter fence which surrounds NOAA's Burley Creek Hatchery facility (Figure 5). Topography suggests that water is directly discharged to Wetland C and it could have been intentionally created for hatchery related purposes. However, no permanent outfall could be located.

Vegetation within Wetland C is dominated by reed canarygrass (*Phalaris arundinacea*, FACW) with a single willow (*Salix sp.*, FAC) located along its perimeter.

Given how small the wetland is and both its topography and apparent man-made shape, a data plot was not completed within Wetland C. Soils were assumed to be hydric based on the standing water located within Wetland C.

Based on the *Washington State Wetland Rating System for Western Washington*, Wetland C is classified as a Category III wetland with a low habitat function score of 7 (Appendix C).

4.4 Burley Creek

Burley Creek flows north to south along the western edge of the site before exiting through a culvert under a private driveway to the south (Figure 5). The stream is located within the dense scrub-shrub vegetated community associated with Wetland A. At the time of our fieldwork, the width of the active channel and OHWM was approximately 10 to 15 feet wide with steep banks which confine the creek. The channel substrate appeared to be comprised of rounded gravel and cobbles.

According to WDFW's PHS on the Web and SalmonScape mapping systems, Burley Creek provides habitat for coastal resident cutthroat, steelhead trout, coho salmon, Chinook salmon, and chum salmon. However, the reach of Burley Creek immediately adjacent to the site is identified by SalmonScape as providing habitat for winter steelhead and known spawning habitat for coho salmon.

Based on the known presence of salmonids within the reach of Burley Creek immediately adjacent to the site, Burley Creek would be considered a Type F stream.

4.5 Stream 1

Stream 1 flows north to south immediately offsite along the eastern edge of the site and west of Bethel-Burley Road through the offsite portion of Wetland B (Figure 5). Stream 1 crosses a private driveway to the south through a small concrete culvert. Immediately upstream of this culvert and southwest of the Burley Creek Hatchery site, a second unnamed stream joins Stream 1 from the west through a second small culvert. At the time of our fieldwork, Stream 1 was confined to a narrow, linear channel approximately 2 feet wide. The channel substrate appeared to be comprised of sand, silt, and gravels.

According to WDFW's SalmonScape mapping system and Kitsap County Streams and Surface Water Map, Stream 1 is illustrated as entering the site from the north, through Wetland B, and flowing southeast through Wetland A before converging with Burley Creek. These illustrated channel alignments are not currently accurate, although may reflect a historical alignment.

Stream 1 provides no known fish habitat. However, given the stream characteristics it is our opinion that the stream could provide fish habitat if barriers and man-made limitations were removed. Therefore, Stream 1 would be considered a Type F stream.

4.6 Uplands

The uplands throughout the site include the Burley Creek Hatchery facility, which is largely enclosed within a chain link fence, and vegetated uplands dominated by native pasture grasses and other herbaceous species. The vegetation comprising the uplands includes common velvetgrass, bluegrass species (*Poa* sp.), tall fescue (*Schedonorus phoenix*, FAC), tall buttercup (*Ranunculus acris*, FACW), and meadow foxtail (*Alopecurus pratensis*, FACW).

Soils throughout the upland were typically characterized by a surface layer of very dark brown (10 YR2/2) to very dark grayish brown (10 YR3/2) silt loam with redoximorphic features absent or located between 5-10 inches below ground surface. Below this layer, soils included a dark grayish brown (2.5 Y4/2) loamy sand with redoximorphic features present or gray (2.5 Y5/1) silty clay loam with redoximorphic features and inclusions of what appeared to be burned charcoal.

No primary or secondary indicators of hydrology were present.

5.0 REGULATORY REVIEW

Several federal, state, and local regulations apply to development proposals in and/or near wetlands and streams. As the project is entirely located on a federal property, however, NOAA is only obligated to comply with federal law. A summary of applicable regulatory implications follows.

5.1 Federal Clean Water Act (CWA), Section 404 Permit

The Corps implements the federal CWA Section 404 review process, which is required for projects involving discharge of dredge or fill materials into the waters of the United States, including non-isolated wetlands. Any proposed work located within a jurisdictional wetland will require a nationwide permit or an individual permit from the Corps. Given this proposed project and the anticipated, unavoidable impacts to wetlands and streams from the construction of the earthen channel and its outfall, we anticipate that a nationwide permit will be required.

For proposed impacts waters of the U.S. regulated by the Corps, the project would need to demonstrate that avoidance and minimizations measures will be implemented. Unavoidable impacts to wetlands would then need to be mitigated through compensatory mitigation following the joint guidance document, *Wetland Mitigation in Washington State*, prepared by Ecology, the U.S. Environmental Protection Agency (EPA), and the Corps.

Table 1 summarizes the mitigation ratios for permanent impacts to Category 3 wetlands (area of mitigation:area of wetland impact), as described within the joint guidance document.

**TABLE 1
FEDERAL WETLAND IMPACT COMPENSATORY MITIGATION RATIOS**

Category	Wetland Reestablishment or Creation	Wetland Rehabilitation	Wetland Re-establishment/Creation (R/C) and Rehabilitation (RH)	Re-establishment or Creation (R/C) and Enhancement (E)	Wetland Enhancement Only
3	2:1	4:1	1:1 R/C and 2:1 E	1:1 R/C and 4:1 E	8:1

A conceptual mitigation plan has been developed below in Section 6.0 to meet the federal mitigation requirements and guidelines within the joint guidance document.

5.2 Clean Water Act (CWA), Section 401 Water Quality Certification

Ecology has been authorized by the EPA to issue the CWA Section 401 Water Quality Certification for most projects that require a Corps permit under CWA Section 404 (see Section 5.1 above). The purpose of the certification process is to ensure that federally permitted activities comply with the federal CWA, state water quality laws, and any other applicable state laws. CWA Section 401 Water Quality Certification is only required when a CWA Section 404 permit is issued. In the case of this project, a nationwide permit is expected to be necessary from the Corps which would therefore trigger a CWA Section 401 Water Quality Certification.

5.3 State Hydraulic Project Approval (HPA)

For projects occurring on non-federal land, the WDFW issues HPA permits for construction activities that will occur in or over the OHWM of waters of the State, such as Burley Creek. Therefore, ordinarily WDFW would require an HPA for impacts to Burley Creek, including any construction of a new outfall or modifying existing outfalls. These permits allow construction activities to occur provided they comply with conditions within the permit, such as work windows and other minimization measures. As this project is on federal property, NOAA is not required to obtain a HPA although NOAA may choose to coordinate with WDFW to some extent.

At NOAA's request, we contacted Gina Piazza, the WDFW Area Habitat Biologist for all freshwater tributaries in Kitsap County by phone on June 12, 2012. According to Ms. Piazza, she had the following comments regarding the proposed channel and outfall to Burley Creek.

- If the existing detention pond on site is to be abandoned, WDFW would like to see the outfall removed from Burley Creek.
- WDFW would like any new outfall for the earthen channel to be impassable to fish entering from Burley Creek. However, WDFW has no design guidelines or requirements available for this.
- WDFW would like to see erosion control measures and native plantings along the channel.

5.4 Kitsap County Critical Areas Regulations

Kitsap County regulates those areas they consider critical areas, including wetlands and fish and wildlife habitat conservation areas, such as streams, under Title 19 of the KCC (Kitsap County, Washington, 2012).

Chapter 19.200 of the KCC pertains to the County's regulations for impacts to wetlands and their buffers. In accordance with the KCC, Wetlands A - C were rated using Ecology's *Washington State Wetland Rating System, Western Washington*. Following this methodology, Wetlands A - C are all rated as Category III wetlands with habitat function score of less than 20. Given this rating and habitat score, the County requires a 40-foot buffer from the wetland edge.

KCC 19.300 pertains to the County's regulations for impacts to Fish and Wildlife Habitat Conservation Areas, such as streams. The County has adopted the Washington State Department of Natural Resources stream typing system for classifying streams. Given this stream typing system, Burley Creek would be classified as a Type F stream. We presume the unnamed Stream 1 would also be classified as a Type F stream based on the lack of known natural barriers between it and Burley Creek suggesting that it could provide habitat for fish. Type F streams require a 115-foot buffer with an additional 15-foot building setback, although no buildings are proposed as part of this project.

Due to the extent of the wetland and buffer on site, impacts to critical areas from the construction of an earthen channel are likely unavoidable. At NOAA's request, we contacted Lisa Lewis, a planner with the County, to clarify our interpretation of the code and determine whether the earthen channel would be allowed within wetland and stream buffer. Based on our conversation with Ms. Lewis, a naturalized earthen channel is allowed to be constructed within wetlands and wetland and stream buffers provided it complies with KCC 19.200.225(F), which can be summarized as follows:

- Requires stormwater discharges from stormwater facilities or structures to comply with the County’s Stormwater Management code.
- Discharge cannot significantly increase or decrease the receiving water’s flow rate or wetland hydroperiod.
- Pre-treatment of surface water using best management practices is required.
- Would be approved through the County’s Special Use Review process.

Similarly, any maintenance trail that may be included along the perimeter of the earthen channel may be required in wetlands and wetland and stream buffers provided it complies with KCC 19.200.225(G), which can be summarized as follows:

- They are located, to the extent possible, on existing roads or other disturbed areas.
- Designed to minimize disturbance of vegetation, soils, and hydrologic conditions.
- Any amenities, such as benches, shall be designed to minimize impacts to wildlife.
- Located in the outer extent of buffers to the extent possible, with no less than 30 feet between the trail and the wetland edge unless otherwise approved.
- Limited to pedestrian use unless otherwise approved.
- Trail design shall be a maximum of 5 feet wide and made of permeable materials, unless otherwise approved.

Unavoidable impacts to wetlands or wetland and stream buffers need to be compensated for if NOAA chooses to comply with the KCC. Table 2 summarizes the County’s mitigation ratios for permanent impacts to category III wetlands (area of mitigation : area of wetland impact).

**TABLE 2
KITSAP COUNTY WETLAND IMPACT COMPENSATORY MITIGATION RATIOS**

Category	Wetland Reestablishment or Creation	Wetland Rehabilitation	1:1 Wetland Re-establishment/Creation (R/C) and Wetland Enhancement (E)	Wetland Enhancement Only
3	2:1	4:1	1:1 R/C and 2:1 E	8:1

Compensatory mitigation for unavoidable impacts to streams and stream buffers must result in equivalent or greater functions, including biological functions, hydrological functions, geomorphic process and habitat functions. To the maximum extent practical, mitigation for

stream and stream buffer impacts must be located on the impacted stream either on site or within ½ mile of the site.

In the event that impacts to wetlands, wetland buffers, stream, or stream buffers are unavoidable and mitigation is required, a mitigation plan would need to be prepared following the requirements under KCC 21A.24.125, 21A.24.130, and 21A.24.340.

6.0 FINAL MITIGATION PLAN SUMMARY

The proposed project has been designed to avoid and minimize impacts to regulated aquatic areas. However, as the earthen channel is intended to convey effluent from the Burley Creek Hatchery facility to Burley Creek, impacts to Wetland A, Wetland B, and Burley Creek are unavoidable. Under the federal Clean Water Act, compensatory mitigation is required for impacts to these federally regulated aquatic areas.

The mitigation framework described herein has been developed in accordance with the joint guidance document, *Wetland Mitigation in Washington State*, prepared by Ecology, the EPA, and the Corps. Specifically, this mitigation plan proposes to enhance Wetlands A and B for unavoidable permanent impacts to Wetland A, Wetland B, and Burley Creek's riparian corridor following the mitigation ratios suggested in the joint guidance document as summarized in Table 3. Additionally, mitigation has been proposed for unavoidable temporary impacts to Wetland A and Burley Creek's riparian corridor at a reduced ratio from those required for permanent impacts.

**TABLE 3
FINAL COMPENSATORY MITIGATION SUMMARY**

Wetland Name	Wetland Category	Impact Area	Duration of Impact	Mitigation Ratio	Area of Wetland Enhancement
Wetland A	Category III	1,093 sf	Permanent	8:1	8,744 sf
Wetland A	Category III	579 sf	Temporary	4:1	2,316 sf
Wetland B	Category III	452 sf	Permanent	8:1	3,616 sf

Note:

sf = square foot

A conceptual planting plan was prepared by J.A. Brennan Associates and included as Sheet LS-1, Landscape Plan, within the project plan set. This planting plan was developed with our input and as part of a more cohesive landscaping design for the project. Following our site

visit with the Corps on February 11, 2013, we modified the planting plan to accommodate the additional wetland mitigation identified summarized in Table 3.

7.0 PLANTING PLAN

The planting plan proposes to enhance Wetlands A and B by installing native, non-invasive, woody plant species adapted for hydrophytic conditions. While these plants can be installed anywhere within Wetland A, provided the appropriate quantity of enhancement occurs, our recommendation to J.A. Brennan Associates within this conceptual mitigation plan was to generally locate the plantings along the northern wetland boundary, immediately south of the proposed outflow channel. These plantings should be arranged as a patch or finger of native tree and shrub species that extends west from the Burley Creek riparian corridor. Following our site visit with the Corps on February 11, 2013, we expanded upon this proposed mitigation area to accommodate the additional area of required mitigation.

The intent of this arrangement is twofold: (a) add habitat complexity to and provide continuity between the enhanced wetland and the mature Burley Creek riparian corridor, and (b) provide shading to the proposed outflow channel from southern sun exposure as the plantings mature.

Based on the current outflow channel design, which is proposed to be a naturalized meandering channel originating from a flow-controlled outlet on the downstream end of the effluent channel, to Burley Creek, we estimate the total area of unavoidable impacts to be the following:

- 303 square feet (sf) of permanent impacts from the outfall channel,
- 58 sf of permanent impacts from a necessary emergency overflow channel,
- 579 sf of temporary wetland and riparian impacts to construct the outfall channel (assumes a 5-foot corridor of temporary impacts on either side of outflow channel to accommodate a narrow dozer during construction),
- 732 sf of permanent impact to Wetland A and 182 sf of permanent impacts to Wetland B from the earthen channel itself, and
- 270 sf of permanent impacts to Wetland B to accommodate improvements to the hatchery facility itself.

Given these area estimates and the recommended mitigation ratios described within the joint guidance document of 8:1 for compensatory mitigation through wetland enhancement for permanent impacts, the project would require 12,360 sf of wetland enhancement. Furthermore, we propose that an appropriate mitigation ratio for temporary impacts to Wetland A and the mature Burley Creek riparian corridor would be 4:1, which would require an additional 2,316 sf

of wetland enhancement. This results in a total of 14,676 sf of wetland enhancement throughout Wetlands A and B to be located as described above.

Plants within the 14,676 sf wetland enhancement area should be installed in the following densities to achieve a forested climax community: tree species installed at 9 feet on center with shrubs species installed at 6 feet on center. Using these planting densities, we recommend a minimum of 181 trees and 408 shrubs planted throughout the wetland enhancement areas as specified in Table 4.

**TABLE 4
WETLAND ENHANCEMENT PLANTING PLAN**

Quantity	Botanical Name	Common Name	Size	Condition	Spacing
Trees					
37	<i>Alnus rubra</i>	red alder	1 Gal.	Container	9 ft O.C.
36	<i>Fraxinus latifolia</i>	Oregon ash			
36	<i>Malus fucsa</i>	Pacific crabapple			
36	<i>Populus trichocarpa</i>	black cottonwood			
36	<i>Thuja plicata</i>	western red cedar	5 to 6 ft tall		
Shrubs					
68	<i>Cornus sericea</i>	red-osier dogwood	1 Gal.	Container	6 ft O.C.
68	<i>Lonicera involucrata</i>	black twinberry			
68	<i>Physocarpus capitatus</i>	Pacific ninebark			
68	<i>Salix scouleriana</i>	Scouler's willow			
68	<i>Symphoricarpos albus</i>	snowberry			
68	<i>Rosa nutkana</i>	Nootka rose			

Notes:
ft = feet
Gal. = gallon
O.C. = on center

8.0 PLANTING SEQUENCE

The planting sequence should occur generally as follows:

1. Complete grading associated with the earthen channel and outflow.
2. Procure plants, as specified within Table 1 and Figure 7, from a registered nursery or through a licensed landscaper. Note: Procured tree and shrub plant material shall be stored and handled during installation to prevent them from becoming desiccated at all times throughout the wetland enhancement sequence. Backfill

planting holes with native soils and construct watering rings to catch rainfall and runoff.

3. Place plants within the specified wetland enhancement areas in natural, random clusters. Dig holes for plants, twice the size of the container, and score edges of planting hole with shovel (so roots can travel outside hole). Loosen plant roots slightly and place in center of hole, upright and level with ground surface.

Note: It is recommended that plants be procured and installed during the fall season to achieve greater success of plant survival.

9.0 MAINTENANCE

The following maintenance activities should be performed to optimize the success of the mitigation achieving its goals and objectives (see Section 11):

1. Supplemental irrigation shall be provided for the first two years (minimum) after plant installation.
2. Replace *all* plant mortalities during the fall or winter of the first year following plant installation as a component in the contract provisions for landscape establishment.
3. Remove *all* Class A, B, and C Noxious Weeds as defined by the Washington State Noxious Weed Control Board's most current Noxious Weed List (<http://www.nwcb.wa.gov/>) throughout the wetland enhancement areas. All weed removal should be completed by hand and occur during the monitoring program to increase the success of the installed vegetation.

In the event that the wetland enhancement areas becomes reestablished by noxious weed species following one year of hand removal, targeted herbicide application should occur using an aquatic-approved herbicide in accordance with the state and federal approved methodology.

10.0 MONITORING PLAN

The primary purpose of the monitoring plan is to ensure that the plants establish themselves properly throughout the wetland enhancement areas. The Corps require a ten-year monitoring program to assess the completed mitigation plan and provide a basis for determining whether the plants are surviving and the goals of the mitigation plan are being achieved.

The monitoring plan requires an initial baseline (as-built) monitoring event to record the conditions following installation. Subsequent performance monitoring events will occur prior to September 1 during Years 1, 2, 3, 5, 7, and 10 to document plant establishment and growth.

Reports shall be submitted to the Corps following the baseline and performance monitoring event by December 1 of the year in which monitoring occurred.

Reports should consist of the following:

1. The baseline (as-built) monitoring report should include a comprehensive stem count for all woody tree, shrub, and groundcover species within the wetland enhancement areas. Results shall be included within the baseline monitoring report to calculate for future plant survival.
2. A comprehensive stem count should occur during the Year 1 monitoring event. Total plant survival, percent volunteer recruitment, and confirmation that all plant mortalities have been replaced shall be reported.
3. Percent of plant survival and percent areal cover amongst installed shrub and tree species shall be calculated during Years 3 and 5 through vegetation transects or other appropriate vegetation monitoring protocols.
4. Plant vigor and growth shall be visually estimated during each year to assess the growing conditions.
5. Percent invasive cover shall be reported during each year.
6. Maintenance concerns (e.g., plants that need replacing, noxious weed removal, etc.).
7. Direct or indirect wildlife observations of the wetland enhancement areas, including evidence of nesting/denning, browse, audible calls, and scat.
8. Photographs of the wetland enhancement areas shall be taken from locations which can be repeated during future site visits to qualitatively assess the success of the planted area.

11.0 COMPENSATORY MITIGATION GOALS AND OBJECTIVES

The objective for the wetland enhancement plan is to establish a native scrub-shrub wetland habitat with a variety of tree and shrub species which will transition into a diverse shrub and forest community upon reaching its climax condition. Given the often slow growth of plants during the first few years after installation, the goals for reaching the restoration plans objective have been developed accordingly.

Year 1 Goal

- No more than 25 percent plant mortality will occur in Year 1. Following the comprehensive stem count in Year 1, all plant mortalities shall be replaced in accordance with the landscaper's one-year plant guarantee.

Year 2 Goal

- Plant survival will exceed 75 percent or areal cover of native woody vegetation will exceed 15 percent.

Year 3 Goal

- Plant survival will exceed 80 percent or areal cover of native woody vegetation will exceed 20 percent.

Year 5 Goal

- Plant survival will exceed 80 percent or areal cover of native woody vegetation will exceed 35 percent.

Year 7 Goal

- Plant survival will exceed 80 percent or areal cover of native woody vegetation will exceed 45 percent.

Year 10 Goal

- Plant survival will exceed 80 percent or areal cover of native woody vegetation will exceed 65 percent.

Contingency Plan

If any monitoring report reveals that the mitigation has failed in whole or in part, and if that failure is beyond the scope of routine maintenance, a Contingency Plan will be drafted. The Contingency Plan may range in complexity from a list of plants substituted to cross sections of proposed engineered structures. Once approved, it will replace the approved mitigation plan.

12.0 PERMANENT RECOGNITION AND PROTECTION

To recognize and protect the mitigation area in perpetuity, NOAA will obtain the red lined As-Built drawings from the Contractor to develop a site plan highlighting the mitigation area for permanent protection. The plan will be installed onsite, within the Burley Creek Hatchery office, where it will be highly visible. In addition, permanent signs will be installed along the perimeter of the wetland enhancement area at 50-foot intervals reading “Protected Wetland Area” or similar to identify the permanent protection afforded to the mitigation area.

13.0 CLOSURE

The findings and conclusions documented in this report have been prepared for specific application to this project, and have been developed in a manner consistent with that level of care and skill normally exercised by members of the environmental science profession currently practicing under similar conditions in the area, and in accordance with the terms and conditions set forth in our agreement. The conclusions and recommendations presented in this report are professional opinions based on interpretation of information currently available to us, and are made within the operational scope, budget, and schedule constraints of this project. No warranty, express or implied, is made.

Shannon & Wilson, Inc. has prepared Appendix D, "Important Information About Your Wetland Delineation/Mitigation and/or Stream Classification Report," to assist you and others in understanding the use and limitations of our reports.

SHANNON & WILSON, INC.

A handwritten signature in blue ink, appearing to be 'P. W. S.', with a long horizontal flourish extending to the right.

Per Johnson, P.W.S.
Biologist

PCJ:KLW/pcj

14.0 REFERENCES

- Kitsap County, Washington, 2007, Kitsap County Streams and Surface Water Map. Available: http://www.kitsapgov.com/dcd/gis/maps/Standard_Maps/Environmental/Streams_and_Surface_Water_Nov2007.pdf. Accessed July 2012.
- Kitsap County, Washington, 2012, Kitsap County code title 19: critical areas ordinance: Available: <http://www.codepublishing.com/wa/kitsapcounty/>.
- U.S. Department of Agriculture (USDA), Web Soil Survey (WSS), Available: <http://websoilsurvey.nrcs.usda.gov/app/>. Accessed July 2012.
- U.S. Army Corps of Engineers Waterways Experiment Station, 1987, Corps of Engineers wetlands delineation manual: Vicksburg, Miss., U.S. Army Corps of Engineers Waterways Experiment Station, Wetlands Research Program Technical Report Y-87-1, 143 p., available: <http://www.wli.nrcs.usda.gov/delineation/>.
- U.S. Army Corps of Engineers Engineer Research and Development Center, 2010, Regional supplement to the Corps of Engineers wetland delineation manual: western mountains, valleys, and coast region (version 2.0): Vicksburg, Miss., U.S. Army Corps of Engineers Engineer Research and Development Center, Final report ERDC/EL TR-10-3, 152 p.
- U.S. Fish and Wildlife Service (USFWS), 2012, National Wetlands Inventory Wetlands Mapper. Available: <http://www.fws.gov/wetlands/data/Mapper.html>. Accessed: July 2012.
- Washington State Department of Ecology (Ecology), 2004, Washington State wetland rating system for western Washington: Olympia, Wash., Washington State Department of Ecology, Publication no. 04-06-25, 126 p.
- Washington State Department of Ecology (Ecology), 2011, Wetland identification and delineation: Olympia, Wash., Washington Administrative Code (WAC), Section 173-22-35, March 14. Available: <http://apps.leg.wa.gov/wac/>.
- Washington State Department of Ecology (Ecology), U.S. Army Corps of Engineers Seattle District, and U.S. Environmental Protection Agency Region 10, 2006, Wetland Mitigation in Washington State – Part I: Agency Policies and Guidance (Version 1), March. Washington State Department of Ecology Publication #06-06-011a. Olympia, WA.
- Washington State Department of Fish and Wildlife (WDFW), SalmonScape, Available: <http://wdfw.wa.gov/mapping/salmonscape/>. Accessed: July 2012.
- Washington State Department of Fish and Wildlife (WDFW), WDFW Priority Habitats and Species on the Web, Available: <http://wdfw.wa.gov/mapping/phs/>. Accessed: July 2012.

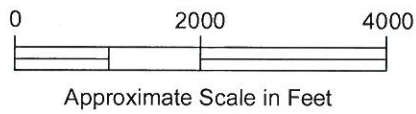
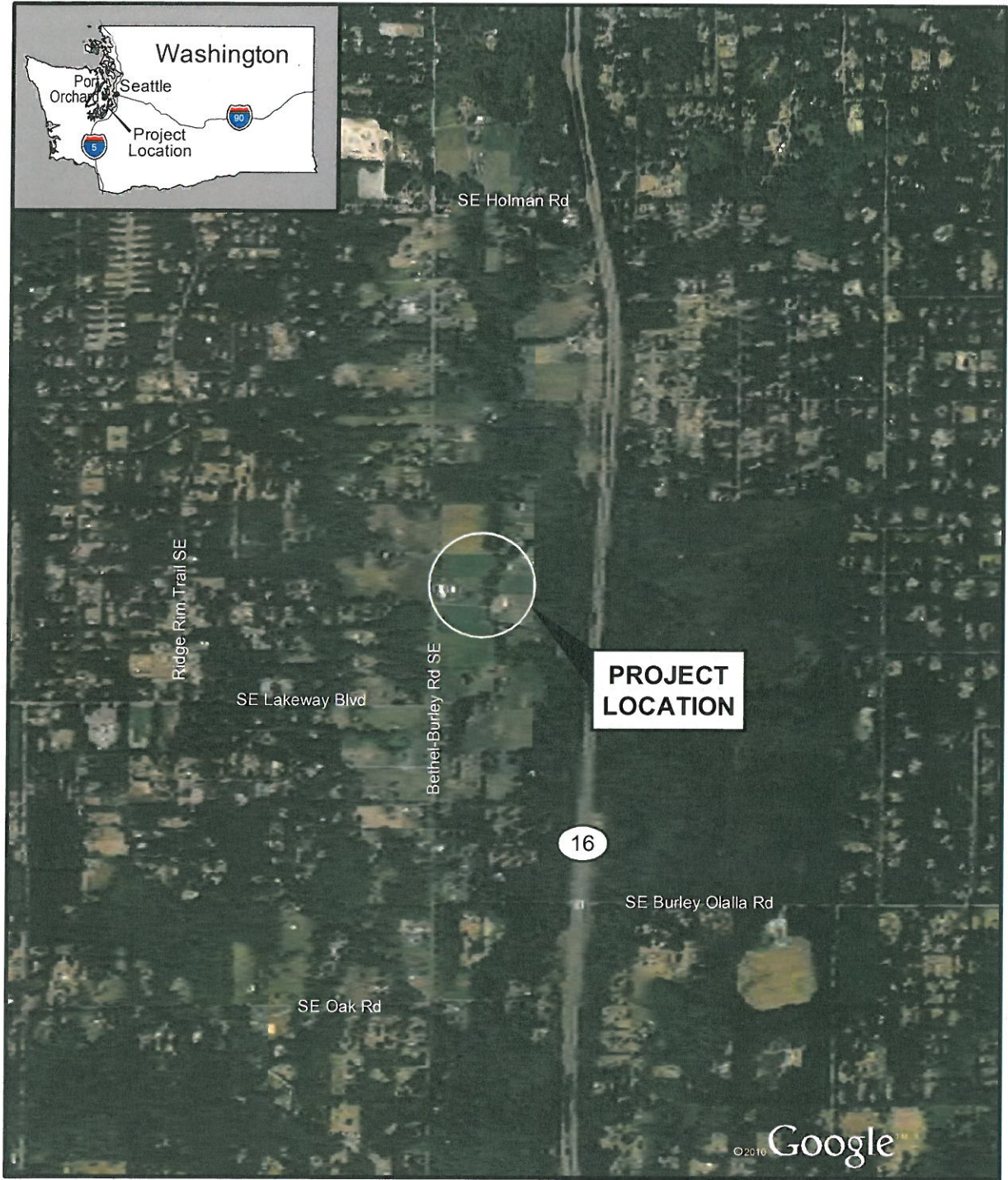

NOTE

Map adapted from aerial imagery provided by Google Earth Pro, reproduced by permission granted by Google Earth™ Mapping Service.

Burley Creek Hatchery Kitsap County, Washington	
VICINITY MAP	
August 2012	21-1-12378-001
SHANNON & WILSON, INC. Geotechnical and Environmental Consultants	FIG. 1

Filename: J:\111\27849\154-12378-001\Fig 2.dwg Date: 08-14-2012 1:09:11

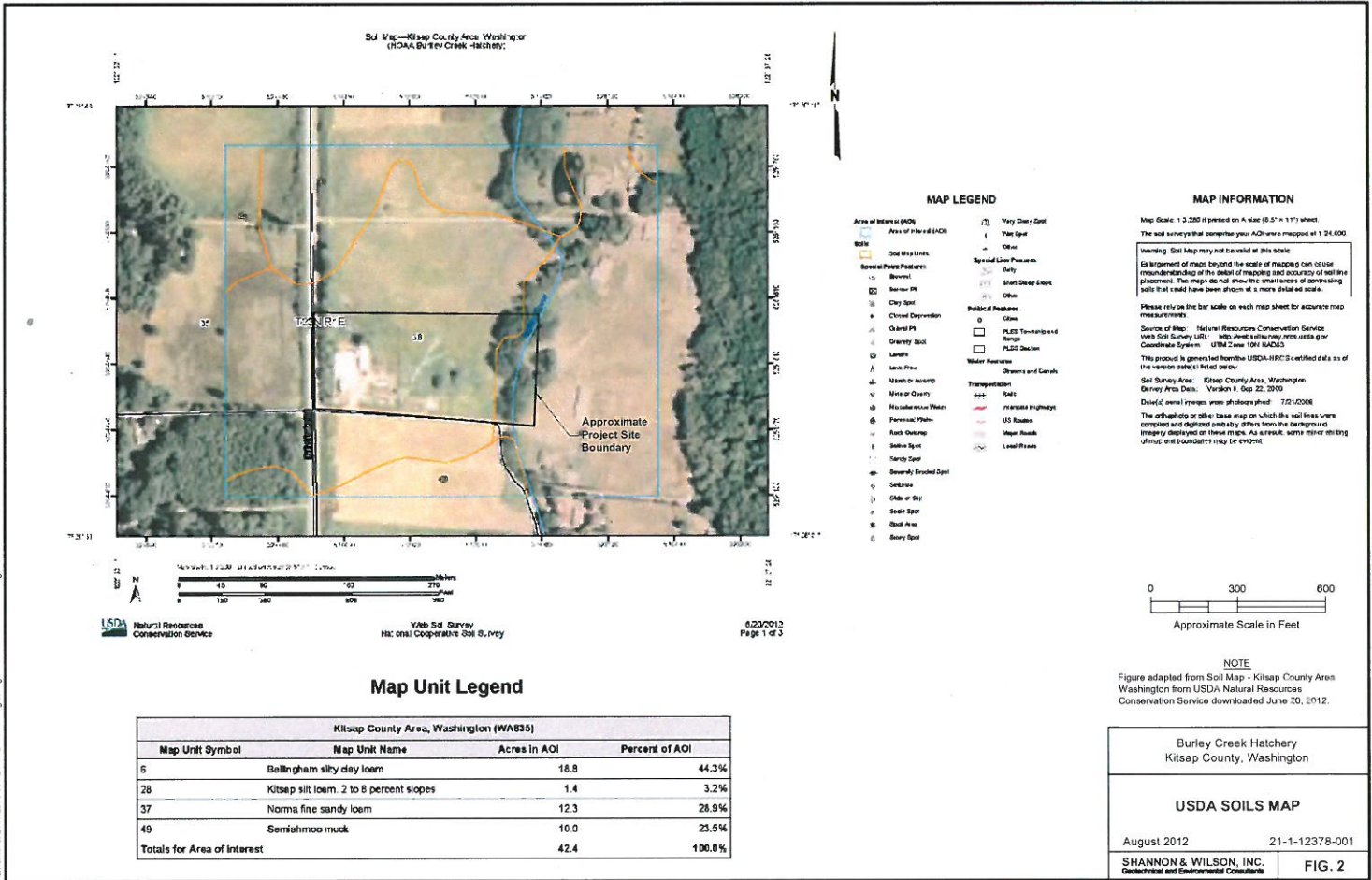

Map Unit Legend

Kitsap County Area, Washington (WA635)			
Map Unit Symbol	Map Unit Name	Acres in AOI	Percent of AOI
6	Bellingham silty clay loam	18.8	44.3%
28	Kitsap silt loam, 2 to 6 percent slopes	1.4	3.2%
37	Norma fine sandy loam	12.3	28.9%
49	Semishmoor muck	10.0	23.5%
Totals for Area of Interest		42.4	100.0%

MAP LEGEND

- Area of Interest (AOI)
- Area of Interest (AOI)
- Soil Map Units
- Special Pattern
- Burley Creek Hatchery
- City Spot
- Closed Depression
- Clay Spot
- Gravelly Spot
- Leach
- Leach Hole
- Marsh
- Mud or Clay
- Mudstone
- Perennial Plant
- Rock Outcrop
- Salt Spot
- Sandy Spot
- Seasonally Flooded Spot
- Setback
- Shrub or Tree
- Soil Spot
- Spot Area
- Stony Spot
- Very Clay Spot
- Wet Spot
- Other
- Special Line Pattern
- Gravel
- Start Deep Drain
- Other
- Physical Features
- Other
- PLES Topographic
- Range
- PLES Section
- Water Features
- Streams and Canals
- Transportation
- State
- Interstate Highway
- US Road
- Major Road
- Local Road

MAP INFORMATION

Map Scale: 1:2,200 if printed on A size (8.5" x 11") sheet.
 The soil surveys that comprise your AOI were mapped at 1:24,000.
 Warning: Soil Map may not be valid at this scale.
 Enlargement of maps beyond the scale of mapping can cause misrepresentation of the detail of mapping and accuracy of soil line placement. The maps do not show the small areas of contrasting soils that could have been shown at a more detailed scale.
 Please refer to the bar scale on each map sheet for accurate map measurements.
 Source of Map: Natural Resources Conservation Service
 Web Soil Survey URL: http://websoilsurvey.nrcs.usda.gov
 Coordinate System: UTM Zone 10N NAD83
 This product is generated from the USDA-NRCS certified data as of the version indicated below.
 Soil Survey Area: Kitsap County Area, Washington
 Survey Area Date: Version 8, Sep 22, 2009
 Date(s) aerial photos were photographed: 7/21/2008
 The orthophoto or other base map on which the soil lines were computerized and digitized probably differs from the background imagery displayed on these maps. As a result, some minor shifting of map element boundaries may be evident.

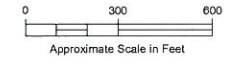

NOTE
 Figure adapted from Soil Map - Kitsap County Area
 Washington from USDA Natural Resources
 Conservation Service downloaded June 20, 2012.

Burley Creek Hatchery
 Kitsap County, Washington

USDA SOILS MAP

August 2012 21-1-12378-001

SHANNON & WILSON, INC.
 Geotechnical and Environmental Consultants

FIG. 2

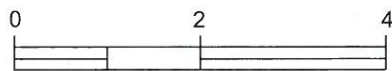
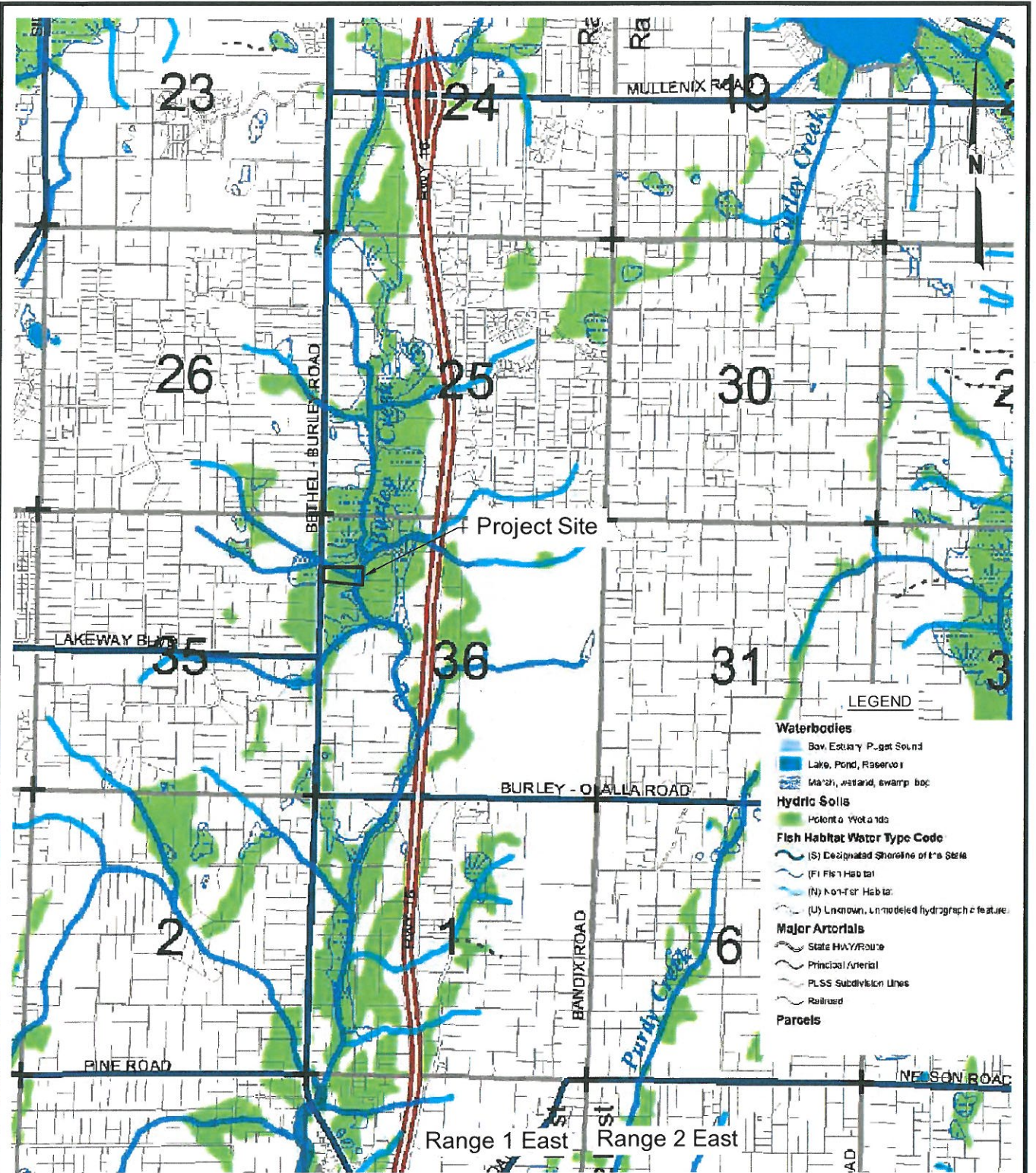

Approximate Scale in Miles

NOTE

Figure adapted from Kitsap County Streams and Surface Water Map by Kitsap County Department of Community Development dated December 13, 2007.

Burley Creek Hatchery
Kitsap County, Washington

KITSAP COUNTY STREAMS AND SURFACE WATER MAP

June 2012

21-1-12378-001

SHANNON & WILSON, INC.
Geotechnical and Environmental Consultants

FIG. 3

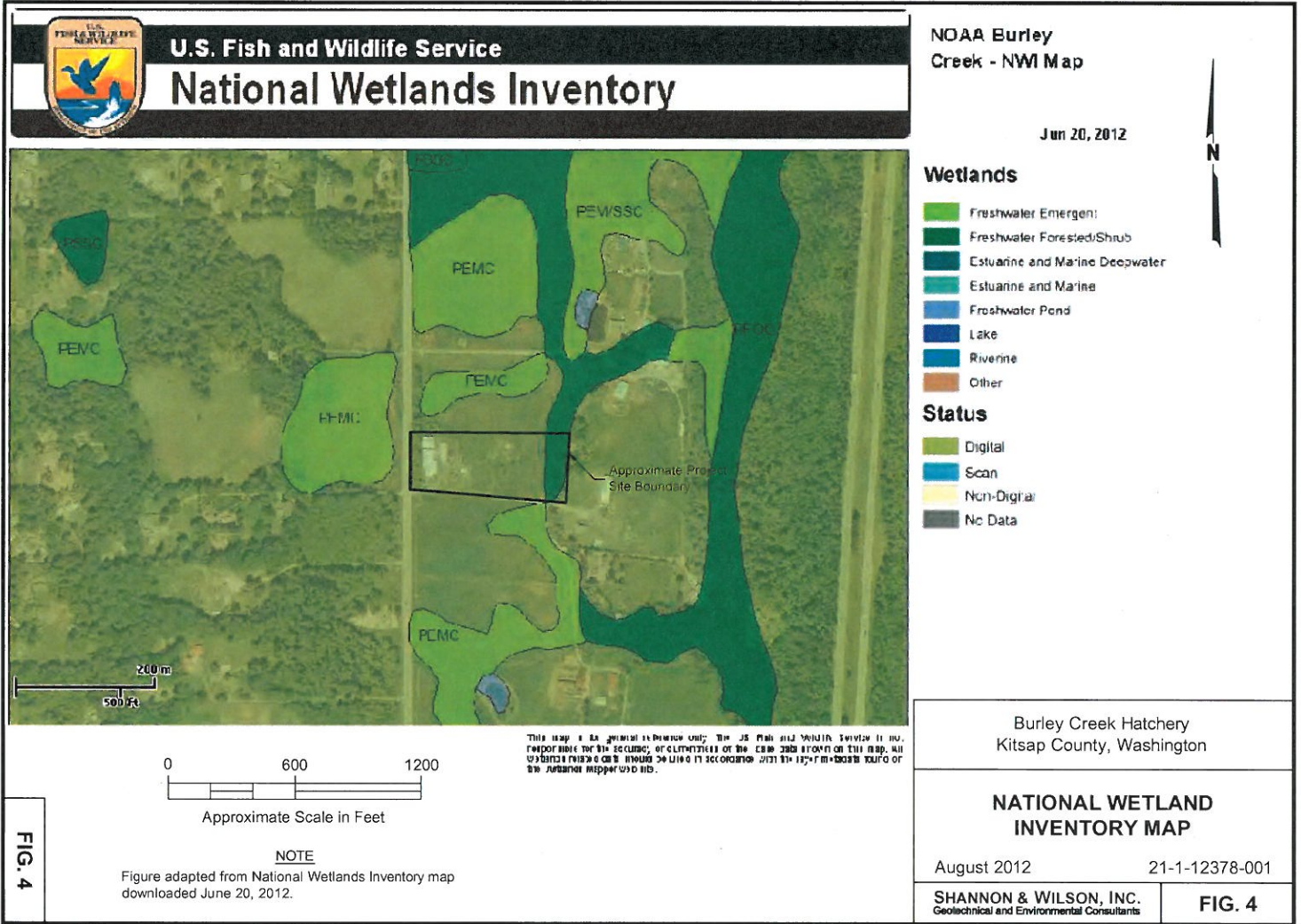
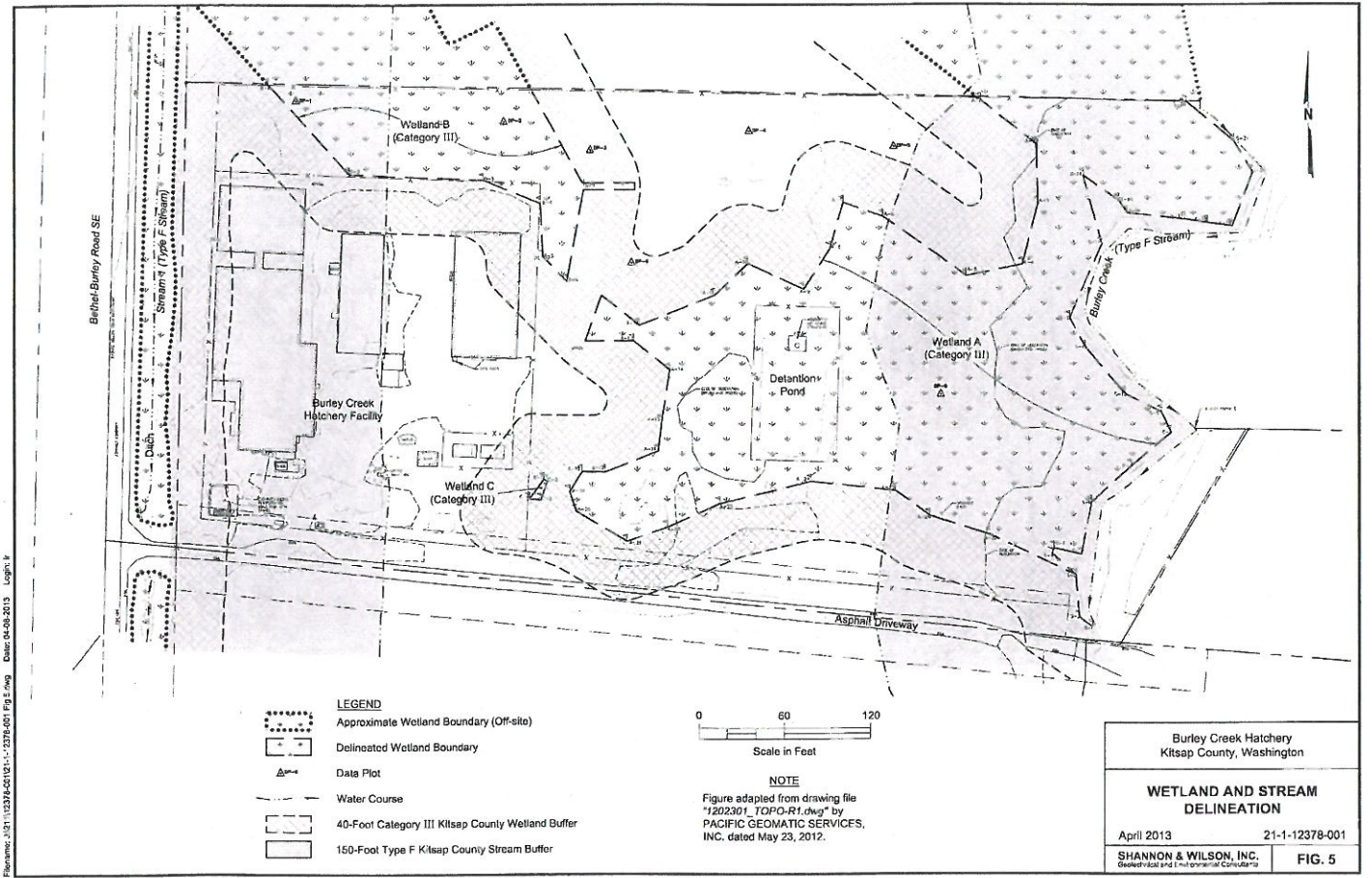
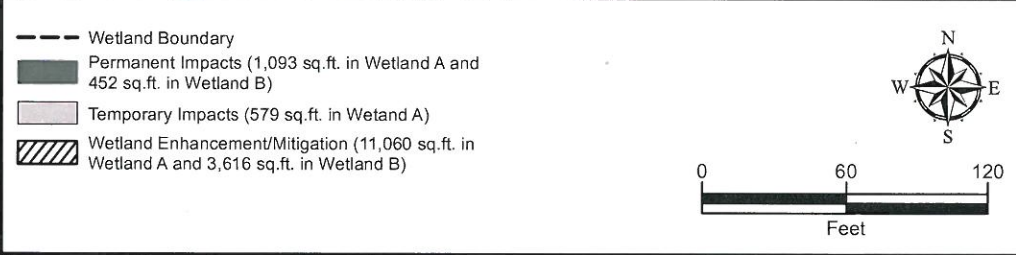
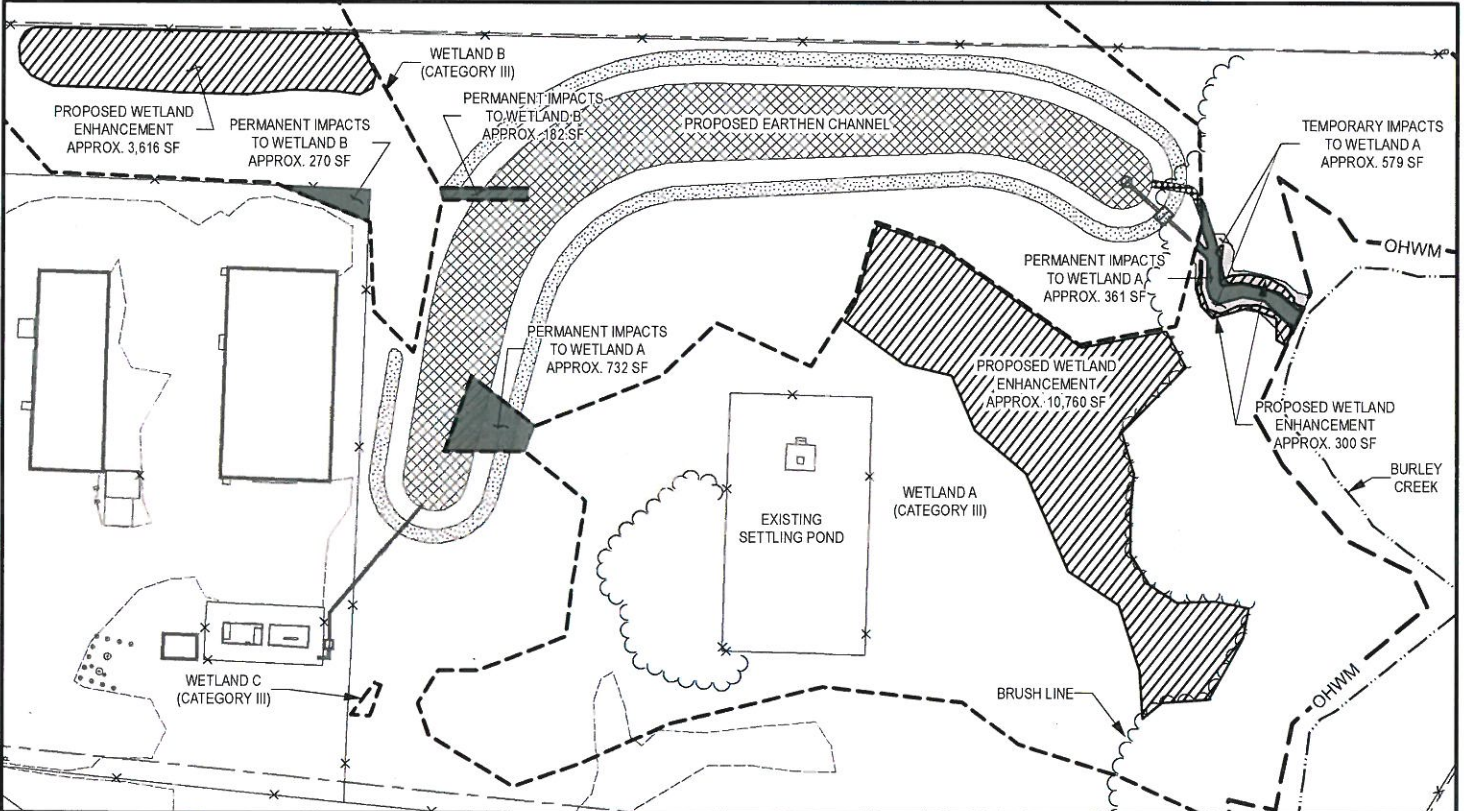

FIG. 4



Reference: N:\133764-01\133764-01-1-2378-001 Fig 5.dwg Date: 04-08-2013 User: k

Burley Creek Hatchery Kitsap County, Washington	
WETLAND AND STREAM DELINEATION	
April 2013	21-1-12378-001
SHANNON & WILSON, INC. <small>Geotechnical and Environmental Consulting</small>	
FIG. 5	



Burley Creek Hatchery Kitsap County, Washington	
FINAL MITIGATION PLAN	
April 2013	21-1-12378-001
SHANNON & WILSON, INC. <small>GEOTECHNICAL AND ENVIRONMENTAL CONSULTANTS</small>	FIG. 6

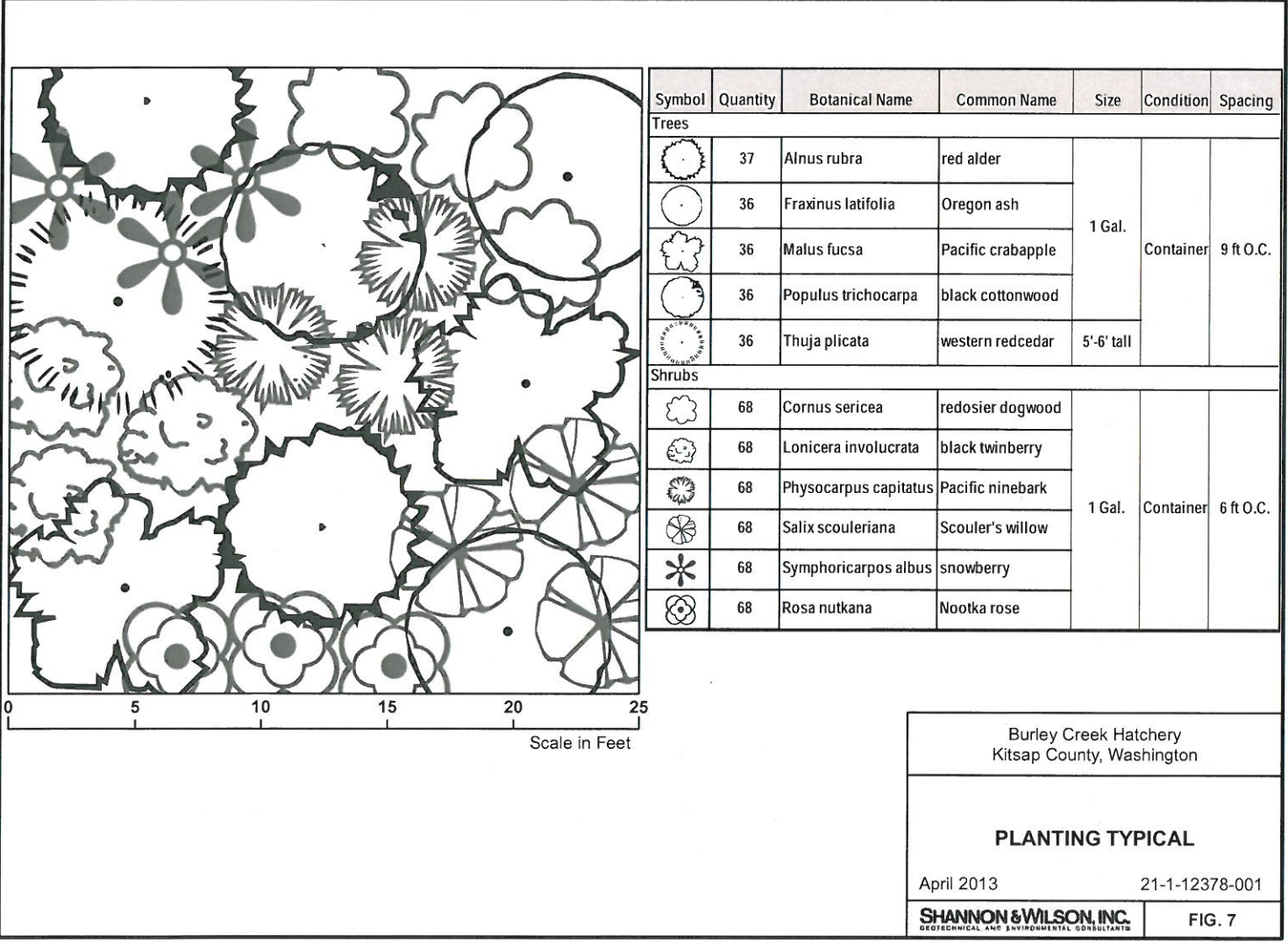

Burley Creek Hatchery
Kitsap County, Washington

PLANTING TYPICAL

April 2013 21-1-12378-001

SHANNON & WILSON, INC.
GEOTECHNICAL AND ENVIRONMENTAL CONSULTANTS

FIG. 7

APPENDIX A
WETLAND DELINEATION METHODOLOGY

APPENDIX A
WETLAND DELINEATION METHODOLOGY

TABLE OF CONTENTS

	Page
A.1 WETLAND VEGETATION	A-1
A.2 HYDRIC SOILS	A-3
A.3 WETLAND HYDROLOGY	A-4
A.4 DISCLAIMER	A-4
A.5 REFERENCES	A-5

TABLE

A-1	Definitions of Plant Indicator Status.....	A-2
-----	--	-----

APPENDIX A

WETLAND DELINEATION METHODOLOGY

The triple-parameter approach, as required in the Washington State Department of Ecology's (Ecology's) 1997 *Washington State Wetlands Identification and Delineation Manual*, the United States Army Corps of Engineers' (the Corps') 1987 *Corps of Engineers Wetland Delineation Manual*, and the Corps' 2010 *Regional Supplement to the Corps of Engineers Wetland Delineation Manual: Western Mountains, Valleys, and Coast Region (Version 2.0)* was used to identify and delineate the wetlands on the site described in this report. The triple-parameter approach requires that vegetation, soils, and hydrology are each evaluated to determine the presence or absence of wetlands. An area is considered to be a wetland if each of the following is met: (a) dominant hydrophytic vegetation is present in the area, (b) the soils in the area are hydric, and (c) the necessary hydrologic conditions within the area are met.

A determination of wetland presence was made by conducting a Routine Delineation. Corresponding upland and wetland plots were recorded to characterize surface and subsurface conditions and more accurately determine the boundaries of on-site wetlands.

A.1 WETLAND VEGETATION

Hydrophytic plants are plant species specially adapted for saturated and/or anaerobic conditions. These species can be found in areas where there is a significant duration and frequency of inundation, which produces permanently or periodically saturated soils. Hydrophytic species, due to morphological, physiological, and reproductive adaptations, have the ability to grow, effectively compete, reproduce, and thrive in anaerobic soil. Indicators of hydrophytic vegetation are based on the wetland indicator status of plant species on the national wetland plant list (Lichvar and Kartez, 2009). Plants are categorized as Obligate (OBL), Facultative Wetland (FACW), Facultative (FAC), Facultative Upland (FACU), or Upland (UPL). Species in the facultative categories (FACW, FAC, and FACU) are recognized as occurring in both wetlands and non-wetlands to varying degrees. Most wetlands are dominated mainly by species rated as OBL, FACW, or FAC (Table A-1).

TABLE A-1
DEFINITIONS OF PLANT INDICATOR STATUS

Plant Indicator Status Categories
Obligate Wetland Plants (OBL) – Plants that occur in wetlands, under natural conditions, approximately 99 percent of the time.
Facultative Wetland Plants (FACW) – Plants that occur in wetlands approximately 67 to 99 percent of the time.
Facultative (FAC) – Plants that are as likely to be found in wetlands as in non-wetlands, approximately 34 to 66 percent of the time in either.
Facultative Upland Plants (FACU) – Plants that occur in non-wetlands approximately 1 to 33 percent of the time.
Obligate Upland Plants (UPL) – Plants that occur in non-wetlands, under natural conditions, approximately 99 percent of the time.
No Indicator (NI) and No Occurrence (NO) – Plants that have either been reviewed but not given an indicator status (NI) or have no known occurrence (NO) in the region. Plants listed as NI and NO can be assigned the indicator status of that plant species from the nearest adjacent region.

Source: National List of Plant Species that Occur in Wetlands: Northwest (Region 9). U.S. Fish and Wildlife Service Biological Report 88(26.9). (Revised 1993)

The approximate percentage of absolute cover for each of the different plant species occurring within the tree, sapling/shrub, woody vine, and herbaceous strata was determined. Trees within a 30-foot radius; sapling/shrubs and woody vines within a 15-foot radius; and herbaceous species within a 5-foot radius of each data point were identified and noted. However, where site conditions merited it, the dimensions of the tree, sapling/shrub, woody vine, and herbaceous strata were modified.

The dominance test is the primary hydrophytic vegetation indicator and it is used in all wetland delineations. Dominant plant species are considered to be those that, when cumulatively totaled in descending order of absolute percent cover, exceed 50 percent of the total absolute cover for each vegetative stratum. Any additional species individually representing 20 percent or greater of the total absolute cover for each vegetative strata are also considered dominant. Hydrophytic vegetation is considered to be present when greater than 50 percent of the dominant plant species within the area had an indicator status of OBL, FACW, or FAC.

If a plant community does not meet the dominance test in areas where hydric soils and wetland hydrology are present, vegetation is reevaluated using the prevalence index, plant morphological adaptations for living in wetlands, and/or abundance of bryophytes (e.g., mosses) adapted to living in wetlands. The prevalence index is a weighted average that takes into account the abundance of all plant species within the sampling area to determine if hydrophytic vegetation is more or less prevalent. Using the prevalence index, all plants within the sampling area are grouped by wetland indicator status and absolute percent cover is summed for each group. Total

cover for each indicator status group is weighted by the following multipliers: OBL=1, FACW=2, FAC=3, FACU=4, UPL=5. The prevalence index is calculated by dividing the sum of the weighted totals by the sum of total cover in the sampling area. A prevalence index of 3.0 or less indicates that hydrophytic vegetation is present.

A.2 HYDRIC SOILS

Hydric soils are defined as soils that formed under conditions of saturation, flooding, or ponding long enough during the growing season to develop anaerobic conditions in the upper part (USDA SCS, 1994). Repeated periods of saturation and inundation for more than a few days, in combination with soil microbial activity, causes depletion in oxygen (anaerobic conditions) and results in delayed decomposition of organic matter and reduction of iron, manganese, and sulfur elements. As a result of these processes, most hydric soils develop distinctive characteristics observable in the field during both wet and dry periods. (USDA NRCS, 2010). These characteristics may be exhibited as an accumulation of organic matter; bluish-gray, green-gray, or low chroma and high value soil colors; mottling or other concentrations of iron and manganese; and/or hydrogen sulfide odor similar to a rotten egg smell.

The USDA Natural Resources Conservation Service (NRCS) has developed official hydric soil indicators as summarized in *Field Indicators of Hydric Soils in the United States* (USDA NRCS, 2010). These indicators were developed to assist in delineation of hydric soils and are based predominantly on hydric soils near the margins of wetlands. Some hydric soils, including soils within the wettest parts of wetlands, may lack any of the approved hydric soil indicators. If a hydric soil indicator is present, the soil is determined to be hydric. If no hydric soil indicator is present, additional site information is used to assess whether the soil meets the definition of hydric soil.

Identification of hydric soils was aided through observation of surface hydrologic characteristics and indicators of wetland hydrology (e.g., drainage patterns). Soil characteristics were observation at several data points, placed both inside and outside the wetland. Holes were dug with a shovel to the depth needed to document an indicator or to confirm the absence of hydric soil indicators. Soil organic content was estimated visually and texturally. Soil colors were examined in the field immediately after sampling. Dry soils were moistened. Soil colors were determined through analysis of the hue, value, and chroma best represented in the Munsell® Soil Color Chart.

A.3 WETLAND HYDROLOGY

Wetland hydrology is determined by observable evidence that inundation or soil saturation have occurred during a significant portion of the growing season repeatedly over a period of years so that wet conditions have been sufficient to produce wetland vegetation and hydric soils. Wetland hydrology indicators give evidence of a continuing wetland hydrologic regime. Wetland hydrology criteria were considered to be satisfied if it appeared that wetland hydrology was present for at least 5 to 12.5 percent (12 to 31 days) of the growing season. The growing season in western Washington is typically considered to be from March 1 to October 31 (244 days). However, the growing season is considered to have begun when: (a) evidence of plant growth has begun on two non-evergreen vascular plants, and (b) the soil reaches a temperature of 41 degrees Fahrenheit at 12 inches. The Seattle District Corps of Engineers requires 14 consecutive days of inundation or saturation for a wetland hydrology to be considered present.

Wetland hydrology was evaluated by direct visual observation of surface inundation or soil saturation in data plots. The area near each data point was examined for indicators of wetland hydrology. Wetland hydrology indicators are categorized as primary or secondary based on their estimated reliability. Wetland hydrology was considered present if there was evidence of one primary indicator or at least two secondary indicators.

Some primary indicators include surface water, a shallow water table or saturated soils observed within 12 inches of the surface, dried watermarks, drift lines, sediment deposits, water-stained leaves, and algal mat/crust. Some secondary indicators include a water table within 12 to 24 inches of the surface during the dry season; drainage patterns; a landscape position in a depression, drainage, or fringe of a water body; and a shallow restrictive layer capable of perching water within 12 inches of the surface.

A.4 DISCLAIMER

This methodology was prepared for reference use only and is not intended to replace Ecology's 1997 *Washington State Wetlands Identification and Delineation Manual*, the 1987 *Corps of Engineers Wetland Delineation Manual*, or the Corps' 2010 *Regional Supplement to the Corps of Engineers Wetland Delineation Manual: Western Mountains, Valleys, and Coast Region* (Version 2.0).

A.5 REFERENCES

- Munsell Color, 1992, Munsell soil color charts: Newburgh, N.Y., Macbeth Division of Kollmorgen Instruments Corporation, 1 v.
- Robert W. Lichvar and John T. Kartesz. 2009. North American Digital Flora: National Wetland Plant List, version 2.4.0 (https://wetland_plants.usace.army.mil). U.S. Army Corps of Engineers, Engineer Research and Development Center, Cold Regions Research and Engineering Laboratory, Hanover, NH, and BONAP, Chapel Hill, NC.
- U.S. Army Corps of Engineers Engineer Research and Development Center, 2010, Regional supplement to the Corps of Engineers wetlands delineation manual: western mountains, valleys and coast region, Version 2.0: Vicksburg, Miss., U. S. Army Corps of Engineers Engineer Research and Development Center, Report ERDC/EL TR-10-3, 153 p.
- U.S. Army Corps of Engineers Walla Walla District, 1993, 1993 supplement to national list of plant species that occur in wetlands: northwest (region 9): Walla Walla, Wash., U.S. Army Corps of Engineers Walla Walla District, informational public notice, 12 p., available: <http://www.wli.nrcs.usda.gov/delineation/>.
- U.S. Army Corps of Engineers Waterways Experiment Station, 1987, Corps of Engineers wetlands delineation manual: Vicksburg, Miss., U.S. Army Corps of Engineers Waterways Experiment Station, Wetlands Research Program Technical Report Y-87-1, 143 p., available: <http://www.wli.nrcs.usda.gov/delineation/>.
- U.S. Department of Agriculture (USDA) Soil Conservation Service (SCS), 1994, Changes in hydric soils of the United States: Washington, D.C., Office of the Federal Register, FR 59 (133): 35680-35681, July 13.
- U.S. Department of Agriculture (USDA) Natural Resources Conservation Services (NRCS), 2010, Field indicators of hydric soils in the United States, Version 7.0, L.M. Vasilas, G.W. Hurt, and C.V. Noble (eds.), USDA, NRCS, in cooperation with the National Technical Committee for Hydric Soils.
- Washington State Department of Ecology, 1997, Washington state wetlands identification and delineation manual: Olympia, Wash., Washington State Department of Ecology, Report 96-94.