

APPENDIX E

FCT DOCUMENT COVER SHEET ¹

Name/Title of Deliverable/Milestone/Revision No.	Summary of Investigations on Technical Feasibility of Direct Disposal of Dual-Purpose Canisters FCRD-UFD-2015-000129
Work Package Title and Number	DR Disposal of Dual Purpose Canisters ^{FT-155N081602}
Work Package WBS Number	1.02.08.16
Responsible Work Package Manager	Ernie Hardin 
Date Submitted	May 15, 2015

Quality Rigor Level for Deliverable/Milestone ²	<input checked="" type="checkbox"/> QRL-3	<input type="checkbox"/> QRL-2	<input type="checkbox"/> QRL-1 Nuclear Data	<input type="checkbox"/> Lab/Participant QA Program (no additional FCT QA requirements)
--	---	--------------------------------	--	---

This deliverable was prepared in accordance with Sandia National Laboratories
(Participant/National Laboratory Name)

QA program which meets the requirements of
 DOE Order 414.1 NQA-1-2000 Other

This Deliverable was subjected to:

- | | |
|--|--|
| <input checked="" type="checkbox"/> Technical Review
Technical Review (TR)
Review Documentation Provided
<input type="checkbox"/> Signed TR Report or,
<input type="checkbox"/> Signed TR Concurrence Sheet or,
<input checked="" type="checkbox"/> Signature of TR Reviewer(s) below
Name and Signature of Reviewers
<u>EMILY STEIN </u> | <input type="checkbox"/> Peer Review
Peer Review (PR)
Review Documentation Provided
<input type="checkbox"/> Signed PR Report or,
<input type="checkbox"/> Signed PR Concurrence Sheet or,
<input type="checkbox"/> Signature of PR Reviewer(s) below |
|--|--|

NOTE 1: Appendix E should be filled out and submitted with the deliverable. Or, if the PICS:NE system permits, completely enter all applicable information in the PICS:NE Deliverable Form. The requirement is to ensure that all applicable information is entered either in the PICS:NE system or by using the FCT Document Cover Sheet.

NOTE 2: In some cases there may be a milestone where an item is being fabricated, maintenance is being performed on a facility, or a document is being issued through a formal document control process where it specifically calls out a formal review of the document. In these cases, documentation (e.g., inspection report, maintenance request, work planning package documentation or the documented review of the issued document through the document control process) of the completion of the activity, along with the Document Cover Sheet, is sufficient to demonstrate achieving the milestone. If QRL 1, 2, or 3 is not assigned, then the Lab / Participant QA Program (no additional FCT QA requirements) box must be checked, and the work is understood to be performed and any deliverable developed in conformance with the respective National Laboratory / Participant, DOE or NNSA-approved QA Program.

Summary of Investigations on Technical Feasibility of Direct Disposal of Dual-Purpose Canisters

Fuel Cycle Research & Development

Prepared for the
U.S. Department of Energy
Used Fuel Disposition Campaign
*Ernest Hardin, Laura Price, Elena Kalinina, Teklu Hadgu, Anastasia Ilgen
and Charles Bryan, Sandia National Laboratories
John Scaglione, Kaushik Banerjee, Justin Clarity, Robert Jubin,
Vladimir Sobes and Rob Howard, Oak Ridge National Laboratory
Joe Carter and Thomas Severynse, Savannah River National Laboratory
Frank Perry, Los Alamos National Laboratory*

May, 2015

FCRD-UFD-2015-000129 Rev. 0



Revision History

Revision	Description
FCRD-UFD-2015-000129 Rev. 0	Sandia programmatic review (for DOE/NE-53 policy review and possible international peer review; SNL tracking number 275569)
FCRD-UFD-2015-000129 Rev. 1	Sandia formal review (SAND2015-8712 R) for unclassified, unlimited release.

CONTEXT FOR THIS STUDY

This is a technical presentation that does not take into account the contractual limitations under the Standard Contract. Under the provisions of the Standard Contract, DOE does not consider spent fuel in canisters to be an acceptable waste form, absent a mutually agreed to contract modification.

DISCLAIMER

This information was prepared as an account of work sponsored by an agency of the U.S. Government. Neither the U.S. Government nor any agency thereof, nor any of their employees, makes any warranty, expressed or implied, or assumes any legal liability or responsibility for the accuracy, completeness, or usefulness, of any information, apparatus, product, or process disclosed, or represents that its use would not infringe privately owned rights. References herein to any specific commercial product, process, or service by trade name, trade mark, manufacturer, or otherwise, does not necessarily constitute or imply its endorsement, recommendation, or favoring by the U.S. Government or any agency thereof. The views and opinions of authors expressed herein do not necessarily state or reflect those of the U.S. Government or any agency thereof.



Sandia National Laboratories is a multi-program laboratory managed and operated by Sandia Corporation, a wholly owned subsidiary of Lockheed Martin Corporation, for the U.S. Department of Energy's National Nuclear Security Administration under contract DE-AC04-94AL85000.

EXECUTIVE SUMMARY

This study has evaluated the technical feasibility of direct disposal in a geologic repository, of commercial spent nuclear fuel (SNF) in dual-purpose canisters (DPCs) of existing designs. The authors, representing several national laboratories, considered waste isolation safety, engineering feasibility, thermal management, and postclosure criticality control. The 3-year study concludes that direct disposal is technically feasible for most DPCs, depending on the repository host geology. Postclosure criticality control, and thermal management strategies that allow permanent disposal within 150 years, are two of the most challenging aspects. This document summarizes technical results from a series of previous reports, and describes additional studies that can be done especially if site-specific information becomes available from one or more prospective repository sites.

Generic (non-site specific) performance assessments have been conducted for generalized disposal concepts in different host media, as part of the Used Fuel Disposition R&D program. These show how regulatory performance objectives on individual protection and groundwater protection could be met; however, they are not detailed enough to discern differences in performance between DPC direct disposal, and disposal of the same SNF in purpose-designed packaging. Such differences could arise because of the quantity of waste in each package, the duration of elevated temperature, and the internal design of the canisters. More detailed simulation of postclosure waste isolation is an important area that can be advanced when site-specific information becomes available. Another area is the R&D needed to incorporate cementitious materials into repository design, which could be beneficial for any disposal concept but more important for disposal of DPC-based packages because of their size and weight. Postclosure criticality control is essentially also a safety question but is addressed below in a separate discussion.

Handling and packaging of DPCs are within the state-of-the-practice in the U.S. nuclear industry, so engineering feasibility and preclosure safety can be assured. The means of transporting DPC-based waste packages underground and emplacing them in disposal tunnels are more developmental, but the equipment would be similar to existing designs for shielded DPC handling equipment. Designs and relevant experience exist for shafts, ramps, and funicular options to transport waste packages underground. In most cases such systems would be largest of their kind and could incorporate novel design features. They would likely include modern technologies for monitoring, feedback and automatic control. Licensing of these preclosure systems, which would likely be performed under a probabilistic regulation similar to 10 CFR 63, would be done without extensive experience history.

The disposal overpack could be a highly important part of the engineered barrier system for DPC direct disposal, for waste isolation and postclosure criticality control. In general, corrosion-allowance and corrosion-resistant overpack materials are available and have been studied previously for repository waste packaging applications. Additional laboratory corrosion testing should be undertaken especially once site-specific information is available on disposal environments. In addition, the reliability of overpack manufacturing and the method for reliability analysis could be improved, thereby reducing the probability of undetected “early failure” that could be associated with criticality, for some disposal concepts.

Thermal management is most feasible for the salt concept and the hard rock unsaturated, unbackfilled concept. Either type of repository could be loaded with DPC-based packages and

closed well within the 150-year timing objective used in the study. Other disposal concepts would likely involve the use of low-permeability backfill to control groundwater movement and roof collapse in the repository. Clay-based backfill has been widely studied and its peak temperature is typically limited to 100°C to limit degradation. For DPC direct disposal, peak backfill temperature of 200°C is likely unless the SNF is aged for hundreds of years before backfilling. Thus, maintaining a broad portfolio of DPC direct disposal options leads to a need for understanding clay materials, or identifying alternative materials, suitable for temperatures of 200°C or greater. This applies to all backfilled disposal concepts except the salt concept, for waste packages that contain more than approximately 5 to 10 MT of SNF, depending on site characteristics and SNF burnup/age. Backfill admixtures such as sand, crushed rock, or granular graphite could be effective in lowering the peak temperature.

Another thermal management issue is the development of predictive models representing coupled thermal-hydrologic-mechanical-chemical processes in prospective host rock and backfill materials (salt, hard rock including granite, and sedimentary clay-bearing). For some materials (e.g., clay-rich sedimentary host rock and clay-based backfill) the phenomenology of coupled processes is complex and models may be less mature and depend strongly on site-specific information. This issue is important for DPC direct disposal because thermal management strategies that limit temperatures or limit the domain of highest temperatures, impact repository design and the time needed to complete disposal.

Postclosure criticality control is challenging because the neutron absorber materials used in existing DPC designs are aluminum based and will readily degrade with long-term exposure to groundwater. DPCs include neutron absorber plates to control criticality as the DPC is loaded in the fuel pool, or if flooded in a transportation accident, and these are short-term applications. It is important to note that the possibility of criticality is negligible unless DPCs are flooded with groundwater. Criticality control strategy for DPCs must rely on: 1) flooding limited to chloride brine (salt repository); or 2) uncredited reactivity margin in the as-loaded DPCs; or 3) groundwater (moderator) exclusion by the overpack and other engineered barriers for the duration of the regulatory performance period (e.g., 10,000 years). Analysis of 215 as-loaded DPCs has shown that virtually all DPCs would be subcritical if flooded with chloride brine, even with complete loss of neutron absorbers. For flooding with fresh water, uncredited margin could be effective for the majority of DPCs. Reliance on moderator exclusion would involve improved reliability of the disposal overpack and possibly other engineered barriers, and repository design and siting to minimize disruption (e.g., by seismic events and faulting).

Another possibility for criticality control, especially for those designs or those as-loaded DPCs for which the above strategy options are impractical, is to reopen the dewatering ports and inject permanent filler materials. A range of filler materials is available such as metal mixtures with low melting points, or fine beads of absorptive and/or moderator exclusion material. Methods would be needed to assure that all voids within the DPCs are filled.

The foregoing discussion has described approaches that would limit the probability of criticality events, such that the incidence would not be significant and would not be included in regulatory performance assessment. However, previous regulatory interactions have established the possibility that criticality events could occur in a licensed repository. Such events could be either excluded from performance assessment on the basis of low consequence, or included in the

assessment. This report describes a technical analysis approach that could support such an outcome.

To summarize, the direct disposal of commercial SNF in DPCs is technically feasible at least for some disposal concepts (salt, and hard rock unsaturated, unbackfilled). Thermal management and postclosure criticality control are two important aspects of disposability, and both of these could be relatively simple to manage for a salt repository. Other media such as crystalline rock exist with sufficient heat dissipation for repository closure in the desired time frame (e.g., 150-year fuel age out-of-reactor). Even in fresh groundwater, postclosure criticality control could be demonstrated for a majority of as-loaded DPCs (generally not burnup-credit designs) using uncredited margin. The proportion of DPCs that would remain subcritical increases with the salinity of repository groundwater (e.g., chloride content at least that of seawater, and up to that of concentrated chloride brine).

CONTENTS

1.	INTRODUCTION.....	1
2.	COMPLETED R&D ACTIVITIES	5
2.1	Safety.....	5
2.1.1	Salt Repository Concept	13
2.1.2	Hard-Rock Unsaturated, Unbackfilled Open Concept	14
2.1.3	Hard Rock Backfilled, Open Concept	14
2.1.4	Sedimentary Backfilled, Open Concept	15
2.1.5	Cavern-Vault Disposal Concept	16
2.2	Engineering Feasibility.....	17
2.2.1	Disposal Overpacks	19
2.2.2	Shielding.....	19
2.2.3	Surface-to-Underground Transportation	19
2.2.4	Underground Transportation	20
2.2.5	Emplacement Methods	20
2.2.6	Buffer and Backfill Materials	21
2.2.7	Water Diversion.....	21
2.2.8	Ground Support	22
2.2.9	Disposal Concept-Specific Engineering Feasibility	22
2.3	Thermal Management.....	25
2.3.1	Salt Repository Concept	26
2.3.2	Hard Rock Unsaturated, Unbackfilled Open Concept.....	26
2.3.3	Hard Rock Backfilled, Open Concept	33
2.3.4	Sedimentary Backfilled, Open Concept	33
2.3.5	Cavern-Vault Disposal.....	36
2.3.6	DPC Cooling and Projected Disposal Timeframes	40
2.3.7	Summary of Thermal Analyses for Disposal Concepts.....	47
2.4	Postclosure Criticality Control.....	48
2.4.1	Overpack Reliability	50
2.4.2	Canister and Basket Degradation and Configuration	55
2.4.3	Impact of Chlorine in Groundwater on SNF Reactivity in DPCs	56
2.4.4	Occurrence of Saline Groundwaters	59
2.4.5	Criticality Calculations for As-Loaded DPCs	60
2.4.6	DPC Filler Materials.....	66
2.5	DPC Direct Disposal Cost	67
3.	DISCUSSION OF FURTHER INFORMATION NEEDS	71
3.1	Safety.....	71
3.1.1	Modeling Waste Isolation Performance	71
3.1.2	Effects of Higher Capacity DPCs	72
3.1.3	Postclosure Criticality Control (for non-salt sites)	72

3.2	Engineering Feasibility	72
3.2.1	Aging Management for DPCs	72
3.2.2	Disposing of DPCs Designed for Vertical Storage in a Horizontal Orientation and Vice Versa	73
3.2.3	Underground Transport and Emplacement Capability	73
3.2.4	Overpack Design and Development	74
3.2.5	Technical Challenges Associated with Extended Repository Ventilation	74
3.3	Thermal Management	75
3.3.1	Backfill Thermal Limits	75
3.3.2	Sinking of Heavy Packages in Plastic Host Media (e.g., salt).....	76
3.3.3	Process Models for Thermally Driven Coupled Processes.....	76
3.4	Postclosure Criticality Control	77
3.4.1	Continued Criticality Analysis for As-Loaded DPCs.....	77
3.4.2	Postclosure Criticality Consequence Analysis Approach.....	78
3.4.3	Criticality-Control DPC Fillers.....	81
4.	SUMMARY OF RESULTS AND INFORMATION NEEDS	82
	REFERENCES	87
	Appendix A – Results of Thermal Analyses with 37- PWR Size DPCs	93
	Appendix B – Validation Study for Crediting Chlorine in Criticality Analysis	98

FIGURES

Figure 1-1.	Example of a dual-purpose canister inside a storage overpack (cask) (modified from Easton 2011).	3
Figure 1-2.	Example of bare fuel in a bolted cask (from Williams 2013).	3
Figure 1-3.	Representative design of DPC canister. NUHOMS 24PHB shown.....	4
Figure 2-1.	Components of a generic disposal system (from Freeze et al. 2013).....	5
Figure 2-2.	Conceptual drawing for the salt repository concept with in-drift emplacement in long parallel drifts, and emplacement of crushed salt backfill.....	7
Figure 2-3.	Schematic of sedimentary disposal concept with in-drift disposal, with expanded drift and package spacings (during ventilation prior to backfilling).	7
Figure 2-4.	Schematic of hard rock disposal concept with in-drift disposal (during ventilation prior to backfilling, or after closure if unbackfilled).....	8
Figure 2-5.	Conceptual diagram for storage/disposal of DPCs in vertical floor vaults, cross-sectional view prior to backfilling the access tunnel at closure.....	8
Figure 2-6.	Comparison of salt interface temperature histories for emplacement of 32-PWR size waste packages directly on the alcove floor (right) vs. in a semi-cylindrical cavity (left) (burnup 40 GW-d/MT, age 50 years, package spacing 30 m).	29
Figure 2-7.	Thermal analysis of DPCs disposal in a hard-rock unsaturated, unbackfilled open-type repository with 50-yr decay storage, 100-yr ventilation, and 10-m waste package spacing.	31
Figure 2-8.	Thermal analysis of DPC disposal in a hard-rock unsaturated, unbackfilled open-type repository with 100-yr decay storage 200-yr ventilation, and 10-m waste package spacing.	31
Figure 2-9.	Thermal analysis of DPC disposal in a hard-rock unsaturated, unbackfilled open-type repository with 50-yr decay storage, 100-yr ventilation, and 20-m waste package spacing.	32
Figure 2-10.	Thermal analysis of DPC disposal in a hard-rock unsaturated, unbackfilled open-type repository with 100-yr decay storage 200-yr ventilation, and 20-m waste package spacing.	32
Figure 2-11.	Thermal analysis of DPC disposal in a hard-rock backfilled, open-type repository with 50-yr decay storage, 100-yr ventilation, and both typical and high thermal conductivity backfill.....	34
Figure 2-12.	Thermal analysis of DPC disposal in a hard-rock backfilled, open-type repository with 100-yr decay storage 200-yr ventilation, and typical and high thermal conductivity backfill.	34

Figure 2-13. Thermal analysis of DPC disposal in sedimentary backfilled, open-type repository with 50-yr decay storage and 100-yr ventilation.....	35
Figure 2-14. Thermal analysis of DPC disposal in a sedimentary backfilled, open-type repository with 100-yr decay storage and 200-yr ventilation.....	35
Figure 2-15. Thermal analysis of DPC disposal with 20 GW-d/MTU burnup in a hard-rock cavern-vault-type backfilled repository.	37
Figure 2-16. Thermal analysis of DPC disposal with 40 GW-d/MTU burnup in a hard-rock cavern-vault-type backfilled repository.	37
Figure 2-17. Thermal analysis of DPC disposal with 60 GW-d/MTU burnup in a hard-rock cavern-vault-type backfilled repository.	38
Figure 2-18. Peak temperature vs. buffer thickness, for the emplacement of DPCs in a hard-rock cavern-vault-type backfilled repository, comparing various buffer thermal conductivities and burnup levels, with fuel age 100 years at closure.	38
Figure 2-19. Peak temperature vs. buffer thickness, for the emplacement of DPCs in a hard-rock cavern-vault-type backfilled repository, comparing various buffer thermal conductivities and burnup levels, with fuel age 150 years at closure.	39
Figure 2-20. Peak temperature vs. buffer thickness, for the emplacement of DPCs in a hard-rock cavern-vault-type backfilled repository, comparing various buffer thermal conductivities and burnup levels, with fuel age 200 years at closure.	39
Figure 2-21. History of cumulative inventory available for disposal in a repository with 6 kW emplacement power limit.	42
Figure 2-22. History of cumulative inventory available for disposal in a repository with 10 kW emplacement power limit.	42
Figure 2-23. History of cumulative inventory available for disposal in a repository with 18 kW emplacement power limit.	43
Figure 2-24. Storage capacity in the scenarios requiring additional storage compared to re-packaging scenarios.	43
Figure 2-25. Average fuel age at emplacement as a function of repository opening date.	44
Figure 2-26. Fuel age at emplacement distribution between DPCs and MPCs.	45
Figure 2-27. Fuel burnup distribution between DPCs and MPCs.....	45
Figure 2-28. History of cumulative inventory cooled to 6 kW or 10 kW, in DPCs and MPCs, with repository opening in 2036 or 2048.	46
Figure 2-29. Heat output vs. age for a 32-PWR DPC, for three values of burnup (20, 40 and 60 GW-d/MT) showing approximate power limits (at repository closure) for different disposal concepts.....	48

Figure 2-30.	Representative event tree from the 2007 analysis showing level of decomposition for the occurrence of a base metal flaw failure mechanism.	51
Figure 2-31.	Reactivity impact of ¹⁰ B areal density variation.	56
Figure 2-32.	Reactivity impact of Cl concentration in groundwater: a) for different levels of neutron absorber; (b) for degraded basket configuration with different burnup levels.....	57
Figure 2-33.	Simplified hypothetical high reactivity configuration.....	58
Figure 2-34.	Reactivity impact of Cl concentration in groundwater for high reactivity configuration.	59
Figure 2-35.	<i>k_{eff}</i> vs calendar year for the loss-of-neutron-absorber case based on actual loading.	63
Figure 2-36.	<i>k_{eff}</i> vs calendar year for the Site C basket degradation case based on actual loading.	64
Figure 2-37.	<i>k_{eff}</i> vs NaCl concentration for the loss-of-neutron-absorber at Sites A, B, E, F and H, and degraded basket (Site C) cases based on actual loading.	65
Figure A-1.	Temperature histories for 37-PWR size packages, for the salt concept, with in-drift emplacement and 30-m spacing, and fully coupled thermal-mechanical solution: 40 GW-d/MT, 50 years out-of-reactor.	94
Figure A-2.	Temperature histories for 37-PWR size packages, for the salt concept, with in-drift emplacement and 30-m spacing, and fully coupled thermal-mechanical solution: 40 GW-d/MT, 50 years out-of-reactor with floor cavity.	94
Figure A-3.	Temperature histories (drift wall and waste package surface) for various SNF burnup levels in 37-PWR size packages, in a hard rock open (unbackfilled) repository with spacings shown, for: (top) 50-year decay storage and 100-years ventilation.....	95
Figure A-4.	Temperature histories (drift wall and waste package surface) for various SNF burnup levels in 37-PWR size packages, in a hard rock open (unbackfilled) repository with spacings shown, for: 100 -year decay storage and 200-year ventilation.	95
Figure A-5.	Thermal analysis of disposal of 37-PWR size DPCs in a hard rock, open (backfilled) repository with 50-yr decay storage, 100-yr ventilation, and both typical and high thermal conductivity backfill.....	96
Figure A-6.	Thermal analysis of disposal of 37-PWR size DPCs in a hard rock, open (backfilled) repository with 100-yr decay storage 200-yr ventilation, and both typical and high thermal conductivity backfill.....	96
Figure A-7.	Thermal analysis of disposal of 37-PWR size DPCs in a sedimentary, open (backfilled) repository with 50-yr decay storage, 100-yr ventilation, and both typical and high thermal conductivity backfill.....	97

Figure A-8. Thermal analysis of disposal of 37-PWR size DPCs in a sedimentary, open (backfilled) repository with 100-yr decay storage 200-yr ventilation, and both typical and high thermal conductivity backfill..... 97

Figure B-1. Sensitivity profiles of k_{eff} for total cross-section of ^{35}Cl as a function of energy. The two application systems are labeled as *noa.sdf* and *deg.sdf*, which represent the no absorber and the degraded fuel basket systems, respectively..... 100

TABLES

Table 2-1.	Descriptions of generic disposal concepts suitable for disposal of SNF in DPCs (from Hardin et al. 2013a).....	11
Table 2-2.	Performance allocation for disposal in salt.	13
Table 2-3.	Performance allocation for disposal in a hard-rock unsaturated, unbackfilled open disposal concept.....	14
Table 2-4.	Performance allocation for disposal in a hard-rock, backfilled, open disposal concept.	15
Table 2-5.	Performance allocation for sedimentary, backfilled, open disposal concept.	16
Table 2-6.	Performance allocation for cavern-vault disposal concept.....	17
Table 2-7.	Dimensions for representative DPCs (canister data from Greene et al. 2013).....	18
Table 2-8.	Selected results from thermal analyses of disposal of SNF in 32-PWR size DPCs in salt.	26
Table 2-9.	List of event trees in the 2007 analysis.	51
Table 2-10.	Event tree end state results for the six failure mechanisms analyzed in SAPHIRE.	52
Table 2-11.	Importance measure results for the top drivers of canister early failure (values for the top drivers are in bold).	53
Table 2-12.	Reactor sites for which dry storage canister disposal criticality was analyzed.....	60
Table 2-13.	Principal set of isotopes for burnup credit postclosure criticality analysis.	62
Table 2-14.	Final statistics in the year 9999 for sites analyzed.	66
Table 2-15.	Properties of four DPC disposal concepts for which cost estimates were developed (Savannah River 2015).	69
Table 2-16.	Cost estimates for DPC disposal concepts.	70
Table 4-1.	Summary crosswalk of information needs for consideration of DPC direct disposal.....	83
Table B-1.	Similarity coefficients for the total cross-section for the most applicable benchmark experiments compared to the no absorber case.	101
Table B-2.	TSURFER results.	102

ACRONYMS

ATHEANA	A Technique for Human Event Analysis
b	barn (unit of nuclear capture cross-section)
BSC	Bechtel-SAIC Co.
BWR	Boiling Water Reactor
CFR	Code of Federal Regulations
DFC	Damage Fuel Can
DOE	United States Department of Energy
DPC	Dual-Purpose Canister
DRZ	Disturbed Rock Zone
EBS	Engineered Barrier System
FSAR	Final Safety Analysis Report
GW-d	Gigawatt-days
HRA	Human Reliability Analysis
IDHEAS	Integrated Decision-Tree Human Event Analysis System
LPB	Low-Plasticity Burnishing
MPC	Multi-Purpose Canister
MT	Metric Tons
MTHM	Metric Tons of Heavy Metal
MTU	Metric Tons Uranium
NBS	Natural Barrier System
NRC	Nuclear Regulatory Commission
pcm	percent mille (dimensionless descriptor of relative change)
PRA	Probabilistic Risk Analysis
PWR	Pressurized Water Reactor
RIR/RII	Risk Increase Ratio or Interval
RRR/RII	Risk Reduction Ratio or Interval
RRW	Risk Reduction Worth
R&D	Research and Development
SAR	Safety Analysis Report
SNF	Spent Nuclear Fuel
TAD	Transport-Aging-Disposal canister
THERP	Technique for Human Error Rate Prediction
UNF	Used Nuclear Fuel
UNF-ST&DARDS	UNF Storage, Transportation & Disposal Analysis Resource and Data System
WIPP	Waste Isolation Pilot Plant
WF	Waste Form
WP	Waste Package

This page intentionally left blank.

1. INTRODUCTION

Spent nuclear fuel (SNF) is accumulating at 72 sites across the U.S., including operating and decommissioned power plants, at the rate of about 2,000 metric tons (MT) per year (Carter and Vinson 2014). This SNF is stored in cooling pools for at least five years and then transferred to dry storage systems to be stored on-site until it can be either transported to a consolidated storage facility or disposed of. As of September, 2014 approximately 23,000 MTU was stored in about 2,000 dry storage systems. If current storage practices continue and no new nuclear power reactors are built, half the total SNF inventory in the U.S. will be in about 5,500 dry storage systems by about 2035, with the entire inventory stored in about 11,000 dry storage systems by 2060 (Hardin et al. 2013a).

Most dry storage systems involve removing the SNF from the fuel pool in a right circular stainless steel canister, drying the contents of the canister, welding the canister shut, and transferring the canister to a stationary dry storage overpack or storage vault (see Figure 1-1). There are also dry storage systems that contain uncanistered SNF in a self-shielded transportable cask, often referred to as “bare fuel” casks (Figure 1-2). Canisters that can be both stored in a licensed storage overpack or vault, and transported via licensed transportation overpacks are referred to as dual-purpose canisters (DPCs). The majority of SNF in existing dry storage in the U.S. is in DPCs, and nearly all new dry storage transfers are to DPCs. The capacity of these canisters has increased over time, and currently the largest model holds as many as 37 pressurized water reactor (PWR) assemblies or 89 boiling water reactor (BWR) assemblies (Greene et al. 2013).

Designs for the most frequently used canisters are similar. The basic design and components for a majority of existing dry storage canisters are shown in Figure 1-3. Among the common DPC designs, all use stainless steel for the canister shell, while many (but not all) use stainless for the fuel basket, shield plugs, and top and bottom containment and structural lids. Overall dimensions are largely determined by the fuel and are therefore similar. Shell thickness is typically 1.5 cm and overall length is typically just less than five meters. Canister weights are variable, with empty canisters weighing from ~13 to 56 MT. The heaviest dry storage systems are early designs and include some bolted casks. The more common DPCs weigh from 15 to 25 MT when empty, and from 34 to 46 MT when fully loaded and sealed. Maximum initial thermal limits range from 12.5 to 40.8 kW (including systems for both PWR and BWR fuel). Thermal limits for the more commonly used systems range from approximately 18 to 37 kW. Burnup for the fuel presently stored in DPCs ranges from a few GW-d/MTU to about 50 GW-d/MTU.

The possibility of disposing of SNF in existing DPCs without cutting them open and re-packaging the SNF is attractive because it could be more cost effective, reduce the complexity of fuel management, result in less cumulative worker dose, and reduce waste. These benefits are possible, but not proven. In addition, because of their large size, disposing of SNF in DPCs presents some technical challenges, which are addressed in this report.

The principal alternative to direct disposal of SNF in existing DPCs is re-packaging into smaller, purpose-designed containers for disposal. Re-packaging would increase flexibility in selecting concepts or sites for disposal, potentially decrease surface decay storage duration (with smaller packages containing less SNF), and avoid any need to modify DPCs for criticality control. However, re-packaging could incur significant additional costs. As an example, the Virginia Electric Power Company (Dominion) has estimated that the total cost of re-packaging some of their dry storage canisters would be \$1.5 million per storage canister: \$150K for unloading,

\$150K for re-loading, \$1M for a new canister, and \$200K for disposal of the old canister (Rice 2011). In addition, they estimated that re-packaging would increase personnel radiation exposure by an estimated 250 person-mrem per canister.

A previous study considering the feasibility of disposal of SNF in DPCs at an unsaturated, open-mode repository (BSC 2003) found that the major concerns are: 1) postclosure criticality; 2) physical dimensions; and 3) vertical handling modifications for canisters designed for horizontal storage. Neutron absorbing materials used for criticality controls (e.g., Boral®) can degrade and mobilize in certain disposal environments, separating from the fuel assemblies. Basket supports can also degrade so that the internal structure supporting the fuel collapses. In addition, burnup credit was found to be important in performing postclosure criticality analyses. These findings were made for a specific disposal concept, which this study has considered in addition to several alternatives (Section 2.1).

More recently, the technical feasibility of DPC direct disposal has been studied by the U.S. Department of Energy (DOE) for the last several years (Howard et al. 2012; Hardin et al. 2012; Hardin 2013; Hardin and Voegele 2013; Hardin and Howard 2013; Hardin et al. 2013a, 2014a). This report summarizes the results of the multi-year study. As such, the purposes of this report are to: 1) summarize completed R&D activities related to DPC direct disposal with respect to safety, engineering feasibility, thermal management, and postclosure criticality control; and 2) recommend any further information needs, particularly site-specific information that would be needed to take DPC direct disposal into account in site screening or siting decisions.

The four broad concerns with respect to the technical feasibility of DPC direct disposal were identified at the beginning of the study: safety, engineering feasibility, thermal management, and postclosure criticality control (Howard et al. 2012). A set of assumptions was developed (Hardin and Howard 2013). The reader is referred to those reports for further information on organization of the study.

Section 2 discusses the status of R&D activities completed to-date. It summarizes results that were previously documented (Hardin et al. 2013a; 2014a) and also summarizes work performed in FY15. Section 3 identifies further information needs. Section 4 answers the question “How many existing DPCs and dry storage-only canisters could be disposed of in a geologic repository without re-packaging?” and provides a summary of information needs identified in Section 3.

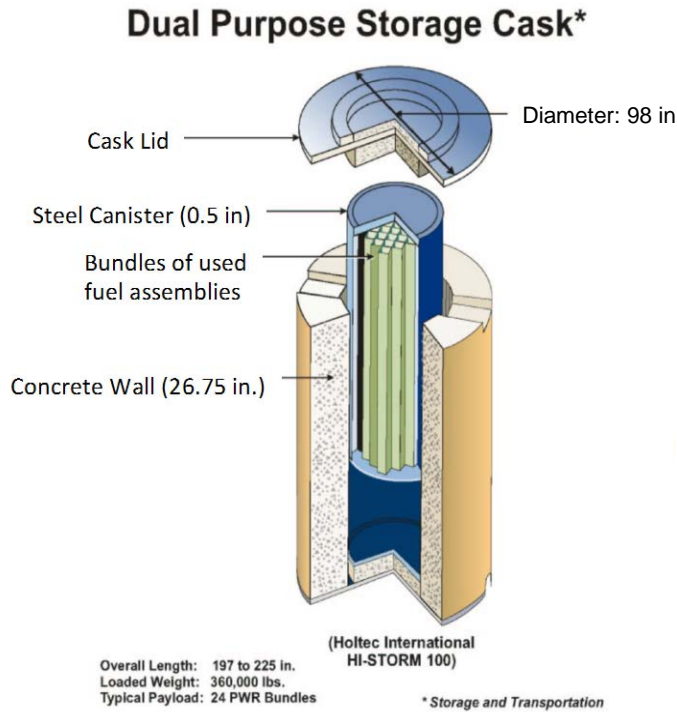

Figure 1-1. Example of a dual-purpose canister inside a storage overpack (cask) (modified from Easton 2011).

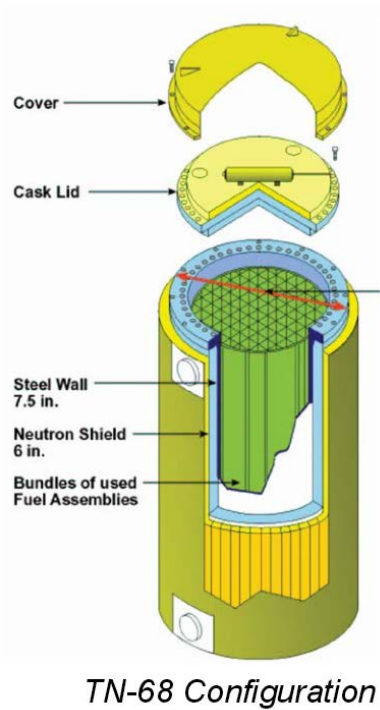

Figure 1-2. Example of bare fuel in a bolted cask (from Williams 2013).

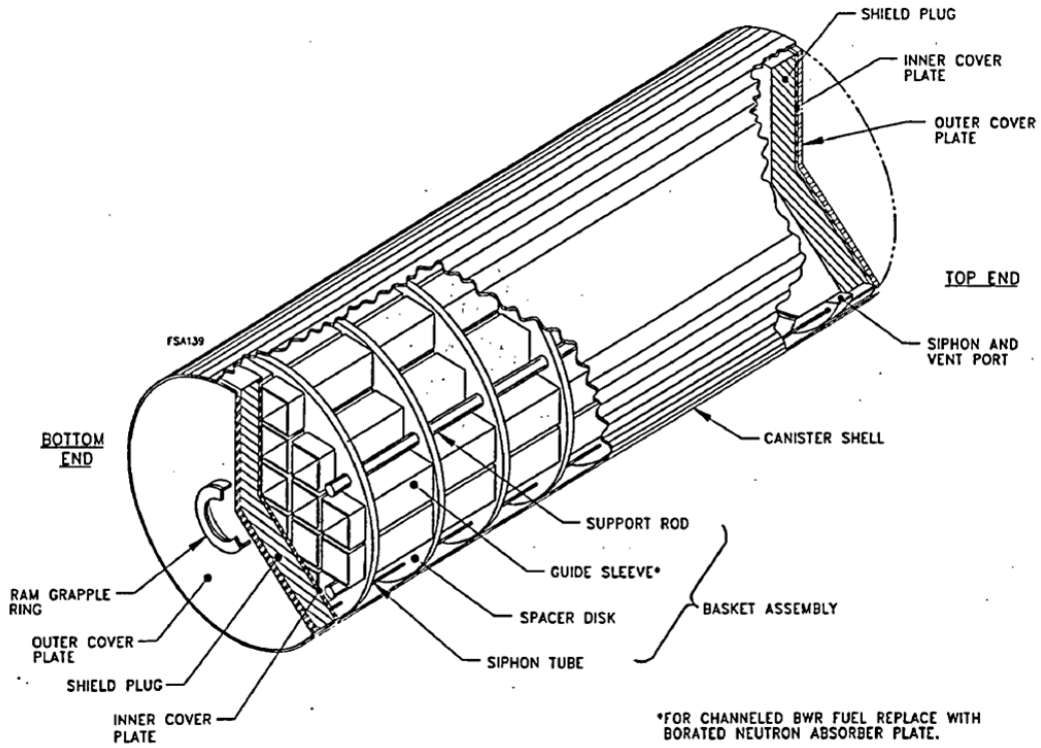

Figure 1-3. Representative design of DPC canister. NUHOMS 24PHB shown.

2. COMPLETED R&D ACTIVITIES

This discussion is organized around the four broad concerns of safety, engineering feasibility, thermal management, and postclosure criticality control. Much of the work was documented previously (Hardin et al. 2013a; 2014a) but some recent (FY15) work is described here: 1) a concept for storage and ultimate disposal of SNF in DPCs in pre-constructed underground vaults; 2) thermal calculations for large (37-PWR size) DPC-based waste packages (Appendix A); 3) reliability of overpacks that could be used for DPC direct disposal; 4) costs of DPC direct disposal; and 5) validation for neutronic calculations that account for chlorine in groundwater (Appendix B).

2.1 Safety

As described by Hardin et al. (2013a) at a high level, the geologic disposal facility can be described as consisting of three components: 1) the engineered barrier system (EBS); 2) the natural barrier system (NBS); and 3) the biosphere, as shown in Figure 2-1 (Freeze et al. 2013). The EBS consists of the waste form, waste package (which would likely consist of a DPC inside a disposal concept-specific disposal overpack or vault), buffer and/or backfill, and seals and/or liner. The NBS consists of a portion of the near-field environment, specifically the disturbed rock zone (DRZ), and the far field which includes the rest of the host rock and the surrounding geologic units. The biosphere is where the potential receptor, typically defined by regulations, resides. The biosphere encompasses the earth surface, the receptor, the receptor’s lifestyle, and the characteristics of the environment where the receptor resides.

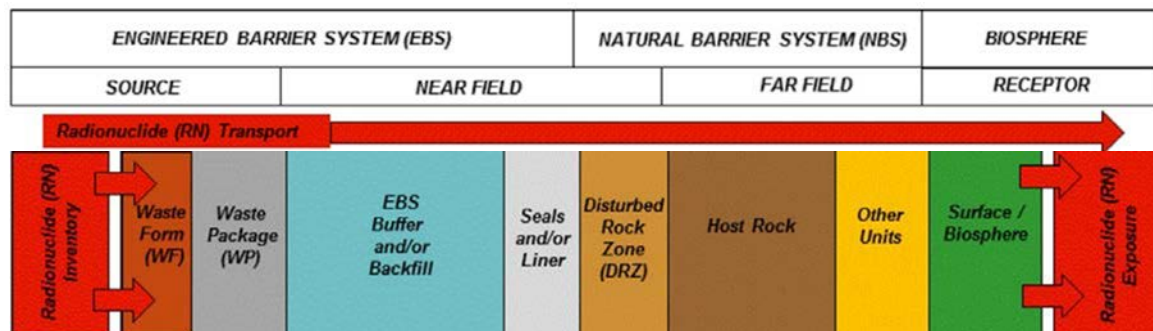

Figure 2-1. Components of a generic disposal system (from Freeze et al. 2013).

As part of assessing the technical feasibility of disposing of SNF in DPCs, several different disposal concepts have been described (Hardin and Voegelé 2013; Hardin et al. 2013a, Section 4). Concepts have been categorized by the type of rock (crystalline, salt, clay/shale, sedimentary, hard-rock), whether the waste was to be in direct contact with the host rock or EBS materials (enclosed or open), and whether openings were backfilled. Conceptual drawings of some of the disposal concepts considered are shown in Figure 2-2 through Figure 2-5. For simplification in the following discussion crystalline and hard rock disposal concepts are combined, and sedimentary and clay/shale concepts are combined.

In assessing the technical feasibility of disposing of SNF in DPCs with respect to safety, the roles of the various features of the EBS and the NBS were examined for their ability to isolate waste from the biosphere for each of the DPC disposal concepts (Hardin et al. 2013a). In

particular, for each disposal concept the safety function of each feature of the EBS and of the NBS was identified, as was the degree of reliance on the feature to isolate radionuclides from the biosphere.

Several factors discussed below that are part of the safety strategy for isolating radionuclides from the biosphere include: 1) engineered components (e.g., disposal overpack) that serve to contain the radionuclides, and can be made from corrosion-resistant (long-life) or corrosion-allowance (shorter life) materials; 2) diffusive radionuclide transport, rather than convective radionuclide transport, in backfill and the host rock that serves to limit the rate at which radionuclides are transported; 3) chemically reducing geochemical conditions at the waste form, and along transport pathways, that tend to reduce the dissolution rate of spent fuel and reduce radionuclide solubility; and 4) radionuclide sorption in the backfill or host rock such that transport of radionuclides is retarded and release of the radionuclides to the biosphere is delayed. As discussed below, each disposal concept would rely on these factors to a different extent.

Inadvertent human intrusion deserves a special discussion here because the final disposal requirements will likely address the consequences of inadvertent human intrusion, and may require that human intrusion be included explicitly in the regulatory performance assessment. Assuming the final disposal requirements are similar to those in 40 CFR 197.25 and 40 CFR 197.26, the assessment of the consequences of human intrusion would consist of a stylized calculation in which a single exploratory borehole penetrates a single waste package and then continues downward to penetrate an aquifer underlying the repository. This would occur only after the waste package degraded sufficiently that penetration could occur without recognition by the drillers. In this regulatory context, the consequence of human intrusion is limited to the release of radionuclides downward through the resulting borehole (and not return of waste-derived materials to the surface). There are two broad implications of this stylized calculation with respect to the discussion of safety: 1) a corrosion-resistant, long-lived waste package delays the time after disposal at which the inadvertent human intrusion is assumed to occur; and 2) the characteristics of the NBS below the repository, through which the radionuclides must be transported to reach the biosphere, are important for estimating the consequences of the inadvertent human intrusion.

On the other hand, if the final disposal requirements are similar to those in 40 CFR 191, the assessment of risk from human intrusion would be guided by Appendix C of that rule. The probability of human intrusion would depend on the geology of the disposal site: in sedimentary formations the incidence of future drilling would not have to exceed 30 boreholes/km² per 10,000 years, or if the repository is not proximal to sedimentary formations the incidence would not have to exceed three boreholes/km² per 10,000 years. The consequences of human intrusion are also limited by assumptions regarding the permeability of the borehole formed, the timing of upward water flow, and the quantity of water released to the ground surface. The main implication of these limits on the risk associated with human intrusion is that a disposal site in sedimentary media has a higher probability of human intrusion than a disposal site that is not in sedimentary media, given the same repository foot print.

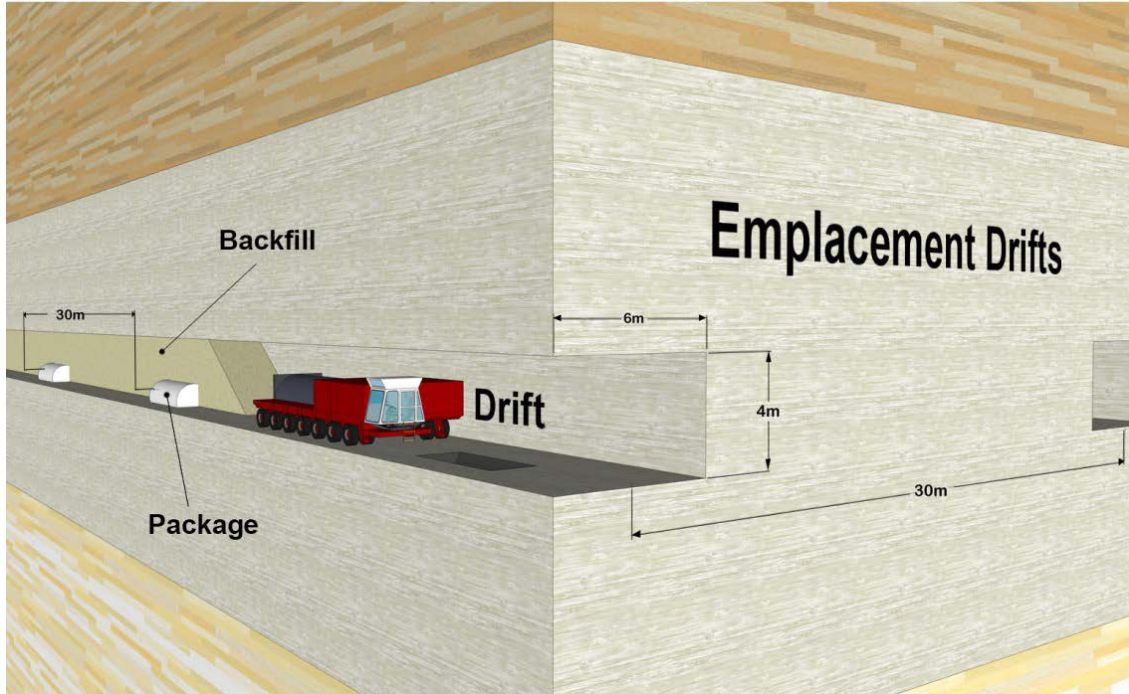

Figure 2-2. Conceptual drawing for the salt repository concept with in-drift emplacement in long parallel drifts, and emplacement of crushed salt backfill.

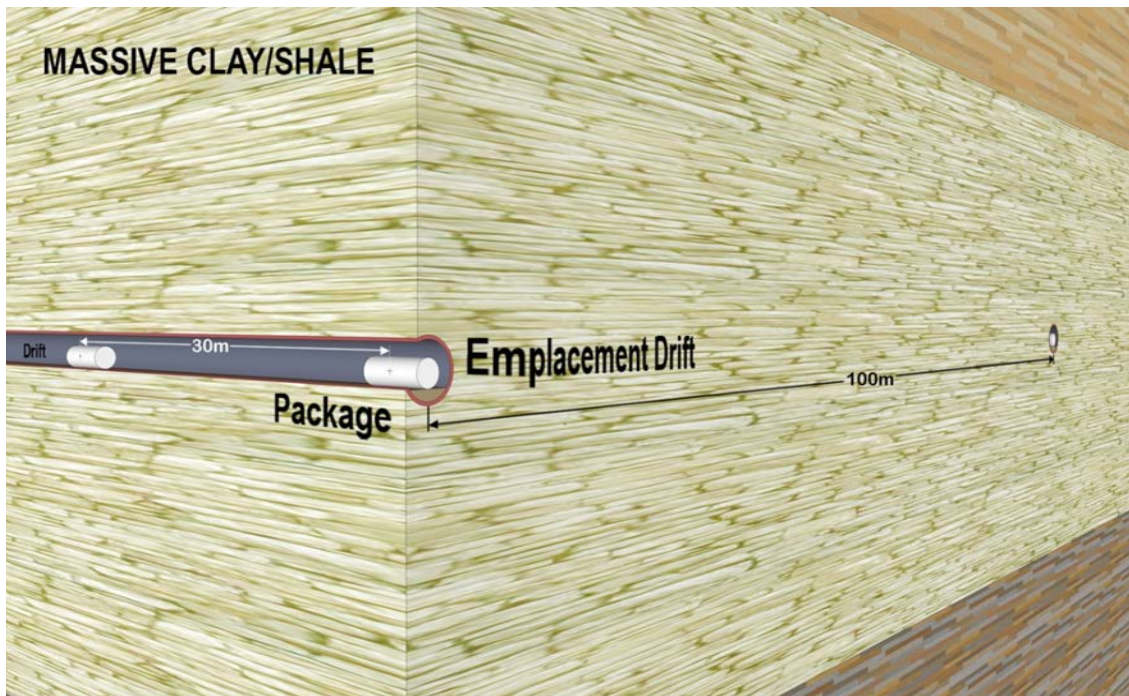

Figure 2-3. Schematic of sedimentary disposal concept with in-drift disposal, with expanded drift and package spacings (during ventilation prior to backfilling).

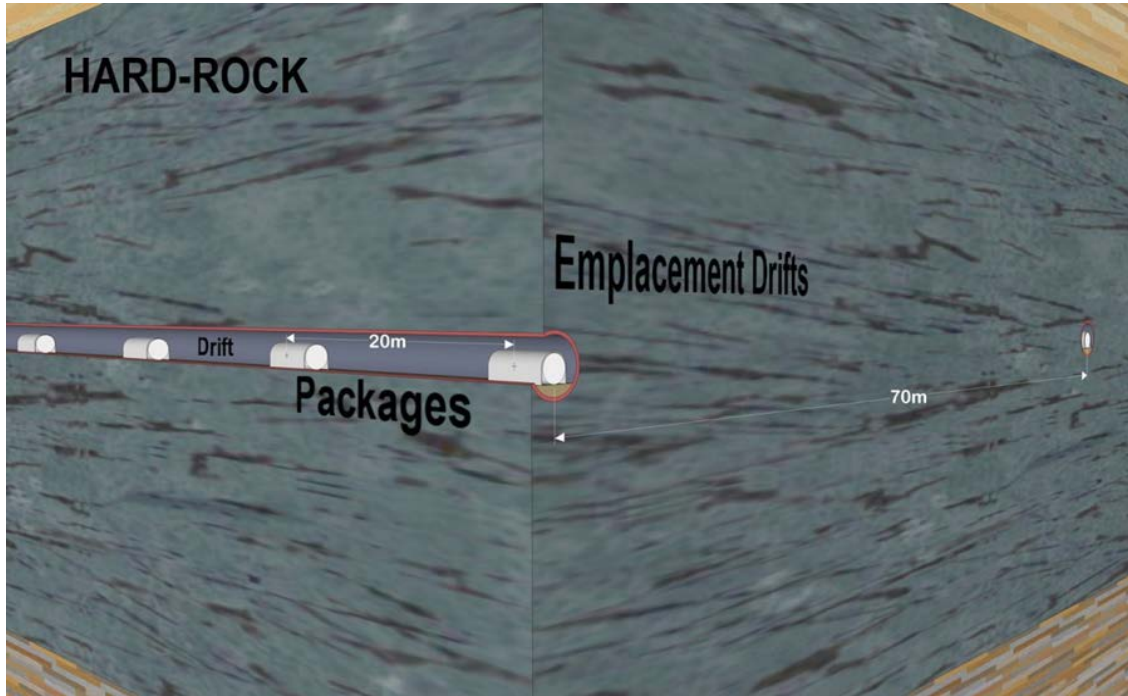

Figure 2-4. Schematic of hard rock disposal concept with in-drift disposal (during ventilation prior to backfilling, or after closure if unbackfilled).

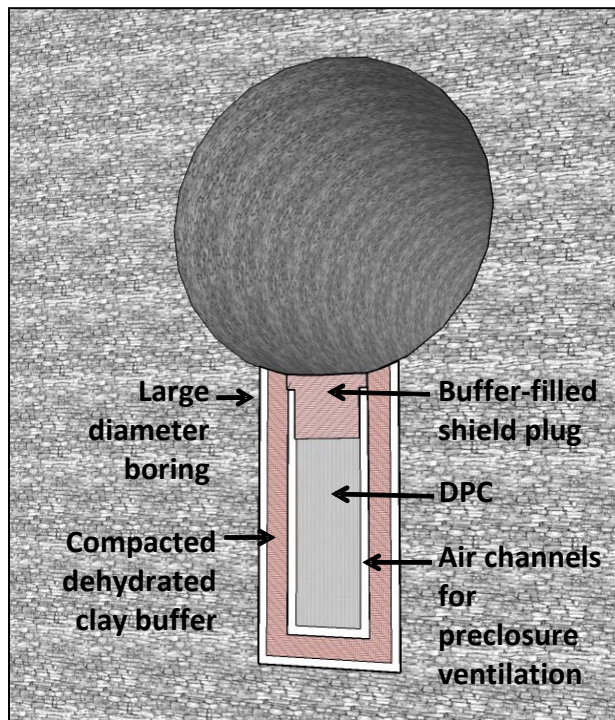

Figure 2-5. Conceptual diagram for storage/disposal of DPCs in vertical floor vaults, cross-sectional view prior to backfilling the access tunnel at closure.

Regardless of which regulatory approach applies to disposal of SNF in DPCs, if criticality cannot be screened from the postclosure performance assessment on the basis of probability, then the consequence of criticality may have to be included in human intrusion calculations.^a For the case of disposal in a salt repository, it is likely that the chloride content of brine that could fill a breached DPC would prevent criticality (Section 2.4).

Enclosed concepts in crystalline rock and clay/shale were found to be not suitable for DPC direct disposal because of the lengthy decay storage that would be required to meet postclosure thermal limits for host rock and buffer materials (Hardin et al. 2012; Hardin et al. 2013a). Therefore, enclosed disposal concepts (other than salt) are not included in the safety strategy discussion. In addition, an unbackfilled (i.e., no engineered backfill), open disposal concept in sedimentary rock was also found not to be suitable for DPC direct disposal because the sedimentary host formation would collapse into the opening, creating a large DRZ. The host rock would be damaged and the permeability could be channeled parallel to drifts. Some clay/shale lithologies might reseal, but not all, and the damage could extend upward through other layered lithologies that do not seal. This was judged to make a significantly weaker safety case (Hardin 2014). The five disposal concepts that are considered in the safety strategy discussion are:

- Salt repository concept
- Hard-rock, unbackfilled, open concept
- Hard-rock, backfilled, open concept
- Sedimentary, backfilled, open concept
- Cavern-vault disposal concept

Major characteristics of these five disposal concepts are shown in Table 2-1 and the safety strategy for each is discussed in the following sections.

^a If the NRC's final disposal requirements are similar to those currently in 10 CFR 63, then the consequences of criticality would not have to be included in the stylized human intrusion calculations if the probability of occurrence of criticality is less than 10^{-5} per year (10 CFR 62.321).

This page intentionally left blank.

Table 2-1. Descriptions of generic disposal concepts suitable for disposal of SNF in DPCs (from Hardin et al. 2013a).

Host Geologic Media/Concept	Salt	Hard-Rock, Unbackfilled, Open	Hard-Rock, Backfilled, Open	Sedimentary, Backfilled, Open	Cavern-Vault
Depth	500 m	200 to 500 m	200 to 500 m	200 to 500 m	200 to 500 m
Hydrologic setting	Saturated	Unsaturated	Saturated or unsaturated	Nominally saturated	Unsaturated or saturated
Host Medium	Domal or bedded salt	Granite, tuff, or other competent rock type	Granite, tuff, or other competent rock type	Sedimentary rock (e.g., mudstone, claystone, shale)	Granite, tuff, or other competent rock type
Ground Support	Rockbolts	Rockbolts; shotcrete as needed	Rockbolts; shotcrete as needed	Shotcrete and steel supports, or pre-cast concrete or steel liner	Rockbolts; shotcrete as needed
Seals and Plugs	Shaft and tunnel plugs and seals	None except crushed rock in shafts/ramps	Shaft and ramp plugs and seals	Shaft & ramp plugs and seals	Shaft & ramp plugs and seals
Emplacement Mode	Horizontal, alcove, or in-drift	Horizontal, in-drift	Horizontal, in-drift	Horizontal, in-drift	Vertical, in-drift (or vert. or horiz. borehole)
WP Target Capacity	Up to 37-PWR size	Up to 37-PWR size	Up to 37-PWR size	Up to 37-PWR size	Up to 37-PWR size
Package Size	≤ 2m D × 5m L	≤ 2m D × 5m L	≤ 2m D × 5m L	< 2m D × 5m L	< 2m D × 5m L
Drift Diameter	Approx. 4m H × 6m W	6.5 m (drifts)	4.5 m (drifts)	4.5 m (drifts)	Approx. 8m H × 6m W
Area (m²/MTHM)	~60	<100	≥100	≥100	≥ 50
Overpack	Steel	Corrosion resistant	Corrosion resistant	Steel	Storage overpack or purpose-built vault
Backfill and/or Buffer	Crushed salt	None except crushed rock in access drifts	Low permeability backfill (all drifts)	Low- permeability backfill (all drifts)	Low-permeability backfill/buffer (all drifts)
Additional EBS Components		Option for engineered water-diversion barriers			

This page intentionally left blank.

2.1.1 Salt Repository Concept

In the salt repository concept, isolation of waste from the biosphere would rely primarily on the characteristics of the host salt formation. Intact salt is impermeable and fractures produced by excavation are self-healing. The DRZ and crushed salt backfill are expected to reconsolidate over hundreds to thousands of years after closure, eventually creeping around the waste packages and encapsulating them. The salt, whether domal or bedded, contains very little water and what little water exists is in the form of chloride brine. The scarcity of groundwater, and the low permeability of the salt, provide assurance of waste isolation from the biosphere. In addition, the waste package and the far-field seals would be relied on to prevent water intrusion until the backfill and the DRZ have reconsolidated. Corrosion of waste packages would slow down or cease once the readily available water is consumed by corrosion reactions. A performance allocation for DPC direct disposal in salt is summarized in Table 2-2.

For analysis of human intrusion in salt, the composition of liquid introduced during borehole drilling would be brine. It is common practice to drill with brine in salt-bearing intervals, so as to control dissolution (which can lead to complications with borehole completion). Whereas oil-based (or diesel fuel based) mud has been used in the past for the same reasons, the practice is now uncommon. Accordingly, inadvertent penetration and flooding of waste packages associated with future drilling would introduce chloride brine similar to natural brine in the host geologic section.

Table 2-2. Performance allocation for disposal in salt.

Feature	Assumed Performance	Safety Function	Reliance on Feature
Waste Form	2×10^{-5} /yr fractional degradation rate, no credit for cladding	None	None
Waste Package	Limited corrosion allowed	Contain radionuclides	Low to medium
Backfill	Reconsolidates	Contain radionuclides, or limit or delay release of radionuclides	High
Seals/Liner	Effective at preventing water intrusion until the DRZ has reconsolidated	Contain radionuclides, or limit or delay release of radionuclides	Medium
Disturbed Rock Zone	Reconsolidates	Contain radionuclides, or limit or delay release of radionuclides	High
Host Rock	Diffusive transport with no sorption of radionuclides	Contain radionuclides, or limit or delay release of radionuclides	High
Aquifer	Provides dilution volume	None	None

2.1.2 Hard-Rock Unsaturated, Unbackfilled Open Concept

In a hard-rock, unbackfilled, open disposal concept, isolation of the waste from the biosphere would rely primarily on the waste package and any associated engineered water-diversion barriers. The unsaturated host rock provides an oxidizing environment, and corrosion-resistant materials would be needed to ensure a long-lived disposal overpack. The primary functions of the overpack and any engineered water diversion barriers would be to limit water contact with the waste, and to limit release of radionuclides. The SNF composition (UO₂ ceramic pellets in corrosion-resistant metal cladding) would also limit the release of radionuclides. The strength of hard rock would allow emplacement drifts to remain open many years with minimal maintenance, so that repository ventilation could remove heat. Movement of water through unsaturated hard rock can be slow, thereby delaying the transport of released radionuclides. Radionuclide sorption, dissolution, and precipitation may occur and depend on the chemical conditions present in the host rock. A performance allocation for DPC direct disposal with a hard-rock unsaturated, unbackfilled open disposal concept is summarized in Table 2-3. An example performance assessment including analysis of human intrusion and other disruptive events, is provided in a previous repository license application (DOE 2008).

Table 2-3. Performance allocation for disposal in a hard-rock unsaturated, unbackfilled open disposal concept.

Feature	Assumed Performance	Safety Function	Reliance on Feature
Waste Form	2×10^{-5} /yr fractional degradation rate, no credit for cladding	Limit or delay release of radionuclides	Medium
Waste Package	Corrosion resistant	Contain radionuclides	High
Engineered Water Diversion Barrier	Corrosion resistant	Contain radionuclides	Medium
Seals/Liner	None	None	None
Disturbed Rock Zone	Free drainage	None	None
Host Rock	Advective transport with sorption of radionuclides	Limit or delay release of radionuclides	Medium
Aquifer	Provides dilution volume	None	None

2.1.3 Hard Rock Backfilled, Open Concept

The primary difference between the hard-rock *unbackfilled* open disposal concept and the hard-rock *backfilled* open disposal concept is that the former would be set in a free-draining unsaturated host medium, while the latter could be set in either saturated or unsaturated media, in host rock that could be free-draining or have low permeability. The backfilled concept would have low permeability backfill installed around the waste packages, prior to repository closure. The backfill would be needed in saturated or in low permeability media to prevent preferential flow of water through the network of repository openings. It could be clay-based, provide a reducing environment, and protect waste packages from drift collapse, seismic shaking, or other

events. Far-field plugs and seals would also be needed to limit flow of water in or out of the backfilled repository, whereas the unbackfilled concept could require only plugs to deter unauthorized access. Host rock or backfill that was chemically reducing would lower the SNF dissolution rate and lower the solubility of many radionuclides in the host rock, compared to oxidizing conditions. A performance allocation for DPC direct disposal with a hard-rock backfilled, open disposal concept is summarized in Table 2-4.

Table 2-4. Performance allocation for disposal in a hard-rock, backfilled, open disposal concept.

Feature	Assumed Performance	Safety Function	Reliance on Feature
Waste Form	2×10^{-5} /yr fractional degradation rate, no credit for cladding	Limit or delay release of radionuclides	Medium
Waste Package	Corrosion resistant	Contain radionuclides	High
Backfill	Low permeability, diffusion-dominated radionuclide transport	Contain radionuclides	Medium
Seals/Liner	Barriers to advective flow, located away from thermal effects	Contain radionuclides, or limit or delay the release of radionuclides	Medium
Disturbed Rock Zone	Free drainage	None	None
Host Rock	Advective transport with sorption of radionuclides	Limit or delay release of radionuclides	Medium
Aquifer	Provides dilution volume	None	None

2.1.4 Sedimentary Backfilled, Open Concept

In a sedimentary (e.g., clay-bearing) backfilled, open disposal concept, isolation of the waste from the biosphere would rely primarily on low permeability backfill and the host rock. Radionuclide transport would be diffusion dominated, radionuclides would sorb onto the backfill and the host rock, and geochemical conditions would be reducing. Under such conditions, reliance on the waste package to provide radionuclide isolation does not need to be as great, compared to other disposal concepts. In addition, the backfill would stabilize the host rock, limiting or preventing additional rock damage as the openings collapsed over time. A performance allocation for DPC direct disposal with a sedimentary backfilled, open disposal concept is presented in Table 2-5.

As noted in Section 2.1 the potential consequences of inadvertent human intrusion may be addressed by a stylized scenario or by a calculation based on some number of future boreholes. In a sedimentary geologic setting, drilling often uses oil-based mud to prevent formation damage from hydrating clays. Such muds have hydrogen density comparable to water, and low solubility for ionic chloride, and could therefore behave as moderators in a flooded waste package. The longevity of DPC basket materials, including neutron absorbers, could be potentially much greater in oil-based mud than in aqueous environments. The potential for subsequent flooding

with groundwater after initial drilling penetration would depend on the site-specific details of the assessment.

Table 2-5. Performance allocation for sedimentary, backfilled, open disposal concept.

Feature	Assumed Performance	Safety Function	Reliance on Feature
Waste Form	2×10^{-5} /yr fractional degradation rate, no credit for cladding	Limit or delay release of radionuclides	Medium
Waste Package	Corrosion resistant or corrosion allowed	Contain radionuclides	Medium
Backfill	Diffusive transport	Limit or delay release of radionuclides	Medium
Seals/Liner	Isolate drift segments from each other	Contain radionuclides, or limit or delay the release of radionuclides	Medium
Disturbed Rock Zone	Free drainage	None	None
Host Rock	Diffusive transport with sorption of radionuclides in a reducing environment	Limit or delay release of radionuclides	High
Aquifer	Provides dilution volume	None	None

2.1.5 Cavern-Vault Disposal Concept

In this concept DPCs would be emplaced in pre-constructed vaults situated in an underground cavern (Figure 2-5). The vaults would be shielded to allow worker access to the drifts, and convectively self-ventilating so that heat would be readily removed by forced ventilation of the drifts. They would be designed to maintain DPCs in storage for at least 100 years. For disposal, all the open volume in the vaults and the access drifts including access drifts, ramps, and shafts, would be backfilled with low-permeability clay-based material. A previous study (Hardin et al. 2013a, Section 4.7) identified two general concepts: purpose-built vaults that would accept DPCs, and galleries that would accept DPCs in the same vertical stand-alone storage overpacks used for dry storage at the surface. Although these storage systems can be transported they are not designed for repeated moves over large distances, or transport underground. Also, they have not been purpose designed for sealing at repository closure. Hence, the former, purpose-built underground vault concept is selected for further discussion here.

Vaults would be similar to surface storage concepts such as the NUHOMS® systems (horizontal) or the subterranean Hi-Storm 100 system (vertical), but with added features (e.g., low-permeability buffer) for waste isolation after closure (Hardin et al. 2013a). Vertical and horizontal vaults would be similar, having a steel-lined cavity for a DPC, a buffer constructed around the cavity, and a shield plug (Figure 2-5). Buffer material would have mechanical stability, low permeability, and long lifetime in the disposal environment, comprising materials such as compacted, dehydrated swelling clay. The buffer material could be protected from hydration during preclosure operations (at least 100 years) by sheathing it in a thin metal capsule

designed to fail by corrosion after repository closure, or to be perforated as part of closure operations. The shield plug would also be filled with buffer material and sheathed.

Low reliance would be placed on the DPC or the steel liner to isolate radionuclides from the biosphere. Rather, reliance would be placed on the low permeability buffer and backfill surrounding the DPCs. The host rock need not have low permeability, but the geologic setting could be unsaturated, or have very old, stagnant groundwater. The host rock type is not specified, but would likely be crystalline or hard rock because of the preclosure operational lifetime, and the large spans involved. A performance allocation for DPC direct disposal with a cavern-vault disposal concept is presented in Table 2-6.

Table 2-6. Performance allocation for cavern-vault disposal concept.

Feature	Assumed Performance	Safety Function	Reliance on Feature
Waste Form	2×10^{-5} /yr fractional degradation rate, no credit for cladding	Limit or delay release of radionuclides	Medium
Waste Package	Corrosion allowed	Contain radionuclides	Low
Backfill	Low permeability, swelling	Contain radionuclides, or limit or delay release of radionuclides	High
Seals/Liner	Low permeability	Contain radionuclides, or limit or delay the release of radionuclides	None
Disturbed Rock Zone	Potential advective transport pathway	None	None
Host Rock	Advective transport with sorption	Limit or delay release of radionuclides	Medium
Aquifer	Provides dilution volume	None	None

2.2 Engineering Feasibility

This discussion of the engineering feasibility of DPC direct disposal is summarized from previous reports (Hardin et al. 2012; 2013a; 2014a). It first focuses on potential engineering challenges such as disposal overpack design and performance, shielding, transport to and within the underground repository, emplacement, buffer and backfill materials, water diversion, and ground support. This is followed by a discussion of how these challenges could affect the various disposal concepts.

Assessment of engineering feasibility began with the potential size of DPC-based waste packages, compared with the transport-aging-disposal (TAD) canisters and waste packaging planned previously (DOE 2008). A representative sample of existing DPCs with capacities ranging from 24 to 37 PWR assemblies (Table 2-7) shows that:

- Loaded DPC weight ranges from 32 to 53 MT
- Weight of the loaded DPC plus a disposal overpack equivalent to 7-cm of steel ranges from 49 to 73 MT

- Weight of the loaded DPC, disposal overpack, and a transporter shield equivalent to 18-cm of additional steel ranges from 101 to 132 MT
- Weight of the loaded DPC in the designated transportation overpack ranges from 143 to 206 MT

By comparison, the TAD canister maximum loaded weight would be 49.3 MT; the calculated weight in a 7-cm steel overpack would be 69 MT; and the weight of the loaded TAD, disposal overpack, and an 18-cm thick transporter shield would be 129 MT. The shielded transfer cask design for the TAD canister is to-be-determined. These results show that DPC-based waste packages would be similar in weight to waste packages planned previously. They would also be similar in size; the outer diameters for the representative DPCs (Table 2-7) are approximately 8 to 23 cm (5% to 14%) greater than the TAD canister diameter (169 cm).

Table 2-7. Dimensions for representative DPCs (canister data from Greene et al. 2013).

Representative PWR Canisters	Vendor	# PWR Assemblies	Loaded Weight (MT)	Canister Outer Dia. (cm)	Canister Length (cm)	Waste Package Weight with 7-cm Steel Overpack (MT)	Total Weight with Added 18-cm Steel Shield (MT)	Transportation Overpacks Used With Representative Canisters	Weight of Loaded Canister and Transportation Overpack (MT)
MPC-24	Holtec International	24	41	174.0	483.4	59	116	HI-STAR 100	166.1
MPC-32	Holtec International	32	41	174.0	483.4	59	116	HI-STAR 100	168.1
MPC-37	Holtec International	37	53	191.8	459.7	73	132	HI-STAR 190	142.9
NUHOMS-24PS	Transnuclear	24	36	170.7	473.2	53	108	MP187	158.6
NUHOMS-32PTH	Transnuclear	32	49	177.3	490.2	69	127	MP197HB	171.0
NUHOMS-37PTH-S	Transnuclear	37	49	177.3	462.3	67	123	MP197HB	170.7
TSC-Class 1	NAC International	24	32	170.4	444.8	49	101	UTC	145.7
MAGNASTOR PWR TSC	NAC International	37	47	180.3	469.4	65	122	MAGNATRAN	205.7
Min.			32	170	445	49	101		143
Max.			53	192	490	73	132		206

2.2.1 Disposal Overpacks

With the exception of the cavern-vault disposal concept, DPCs would be sealed in disposal overpacks, and the function of containment integrity would be assigned to the overpack only. The overpack would provide structural support to the DPC, and would have the hardware and features needed for handling the DPC as it is transported from the surface to its final disposal location in the repository. The overpack would need to maintain its integrity long enough to facilitate retrieval as required by current regulation (10 CFR 60.111(b)(1)) for approximately 50 years after waste emplacement operations are initiated. It should be noted that the retrieval requirement does not preclude the use of backfill (10 CFR 60.111(b)(2)).

Several different materials have been proposed for overpacks, depending on the safety strategy for the waste package in the particular disposal concept (Section 2.1). Corrosion-resistant materials include titanium, nickel-chromium alloys, stainless steels, and copper; some of these have very low rates of general corrosion but are susceptible to localized corrosion mechanisms (pitting, stress-corrosion cracking, crevice corrosion, etc.) (Ilgen et al. 2014a). Corrosion-resistant materials can provide long containment lifetimes for waste packages, on the order of 10^5 to 10^6 years. In contrast, corrosion-allowance materials such as low-alloy steel may provide containment lifetime on the order of 10^3 to 10^5 years, depending on the disposal environment. In general, corrosion-allowance materials have higher rates of general corrosion than do corrosion-resistant materials, but are not as susceptible to localized corrosion. In addition, corrosion-resistant materials are generally more expensive than corrosion-allowance materials. Another possibility is the use of corrosion-resistant amorphous metal and ceramic thermal spray coatings. These are developmental, but could be cost-effective options for enhancing the corrosion resistance of waste packages (Hardin et al. 2013a).

2.2.2 Shielding

The thin wall of the DPC is designed for containment during handling, storage, and transportation, and does not provide shielding from gamma and neutron radiation emitted by SNF. Shielding during storage and transportation is provided by specialized overpacks. Shielding will be a key factor considered in designing the repository layout, the surface-to-underground transport system, the underground transport system, the emplacement mode, repository backfilling operations, the disposal overpack, etc. Providing adequate shielding is within the current state of the practice of SNF management and should be technically feasible when considering DPC direct disposal.

2.2.3 Surface-to-Underground Transportation

One factor to be considered in looking at the engineering feasibility of disposing of SNF in DPCs, regardless of the disposal concept, is transporting DPC-based waste packages from the surface to the underground. As stated above, the package and shielding could weigh up to 132 MT, or as much as 175 MT if the full weight of a vehicle transporting the package is included. Transport of packages from the surface to where they are to be emplaced would be via a vertical shaft, a straight ramp, or a spiral ramp (Fairhurst 2012). Each of these has advantages and disadvantages, and the choice of a conveyance is also affected by the characteristics of the specific site under consideration, as discussed below.

If a vertical shaft were used, the hoist used to lower DPC-based packages would need a payload capacity approaching 175 MT. No existing hoists have such capacity, although friction hoists

with payload capacity up to 175 MT have been proposed (Hardin et al. 2013c). As a point of reference, the hoist at the Waste Isolation Pilot Project (WIPP) has a payload of 41 MT and a depth of 650 m, while key systems for a hoist designed for a payload of 85 MT have been tested at Gorleben, Germany (Fairhurst 2012; Hardin et al. 2013c). The use of a vertical shaft with a hoist minimizes exposure to water-bearing formations above the repository, and has a power system located outside of the shaft thereby reducing the likelihood of a fire in the shaft. On the other hand, the use of a vertical shaft with a hoist introduces the possibility of an accident involving free fall. The use of multiply redundant cables and braking systems could significantly reduce the probability of free fall, and the hoist system would include monitoring and automated controls to detect and mitigate the potential initiating events (Fairhurst 2012).

With a straight ramp, either a rail-based system or a rubber-tire based system could be used to transport DPC-based packages underground. A rail system that does not use cables and counterweights, could be used only if the grade is less than approximately 2.5% (Fairhurst 2012). Such a system was proposed at Yucca Mountain where entry from the surface to the repository would be a shallow ramp in mountainous terrain. If the grade of a straight ramp is greater than 2.5% either a rubber-tire based conveyance or a different rail-based system such as a funicular could be used. A rubber-tire based vehicle can negotiate concrete surfaces with grade up to approximately 10% depending on the coefficient of friction. A funicular has been proposed for the Cigeo repository in France, with an incline of 15 to 30% and a payload of up to 200 MT (Fairhurst 2012). A straight ramp could easily be 5 km long to access a depth of 500 m. It could have greater exposure to water-bearing formations compared to a vertical shaft. Whereas rubber-tire based conveyances would have one or more motors or engines attached, the drive mechanism for a funicular could be located on the surface.

A spiral ramp keeps the ramp portal near the repository, but could have similar exposure to water-bearing formations. A rubber-tire based conveyance would be needed to transport loaded waste packages in a spiral ramp. For example, a 24-tire Cometto® transporter with 90-MT payload, was tested on a 10 to 13% grade at the Äspö underground laboratory. Larger payloads could be accommodated with the addition of more driving/braking wheels and a larger engine (Fairhurst 2012).

2.2.4 Underground Transportation

The same technologies that are used to transport waste down a ramp from the surface to the underground (i.e., a rail-based or rubber-tire based) can also be used to transport the DPC to its final disposal position underground. A rail-based system offers more precision in placing packages for disposal, but has the potential to derail, is sensitive to rockfall, and could incur large construction costs. A rubber-tire based system would not require the installation of rails, but might require an appropriate running surface such as reinforced concrete, and is capable of colliding with walls and other equipment. For unshielded in-drift emplacement, the system used for emplacing waste packages would be remotely operated at least on the last leg within the emplacement drift.

2.2.5 Emplacement Methods

The emplacement mode for DPC disposal could be either open or enclosed, and horizontal or vertical. The “open” emplacement mode consists of waste packages emplaced horizontally on the drift floor, possibly held in place by a low-standing pallet or fixture, and oriented parallel to the drift axis to simplify design of the emplacement vehicle. A shielded emplacement vehicle

could resemble that proposed for Yucca Mountain (DOE 2008). The emplacement drift would remain open for cooling, remote inspection, and maintenance during repository operations. Backfilling could be done just before permanent closure. The “open” mode allows for a simple design and relatively simple emplacement of packages, but backfilling (if required) would be performed remotely in a thermally hot, radiological environment.

The “enclosed” modes considered in this study are the salt repository concept, and the cavern-vault concept, described above. Panels in a salt repository would be backfilled during emplacement, and closed immediately. The cavern-vault concept would provide shielding throughout repository operations, allowing drift maintenance, inspection and monitoring, and final closure activities to be performed directly by workers in the access drifts.

2.2.6 Buffer and Backfill Materials

The salt repository concept, and the backfilled concepts in hard rock and sedimentary rock, would include backfill in direct contact with the waste packages. The cavern-vault concept would have backfilled drifts, and a layer of buffer material built into each vault. These backfill/buffer materials would have low permeability, and they could control geochemical conditions at the waste package, and delay or limit the release of radionuclides to the host rock. Clay-based materials such as Wyoming bentonite have been extensively studied as buffer and backfill because of swelling on hydration, and low permeability ($\sim 10^{-20}$ m²). Mixtures of clay-based materials and other materials, such as crushed rock, sand, and graphite have also been investigated as buffer or backfill materials because of greater shear strength, lower cost, or increased thermal conductivity. For the salt concept all backfill would be crushed salt.

Thermal conductivity is low for compacted, dehydrated bentonite (e.g., 0.6 W/m-K) or pelletized granular bentonite (as low as 0.3 W/m-K) so that adding buffer or backfill material around the waste package significantly increases its temperature. Even after hydration thermal conductivity is in the range 1.3 to 1.5 W/m-K for compacted buffer material (Hardin et al. 2012; Appendix D) and less for more porous backfill. Performance of clay-rich materials is thought to be sensitive to temperature, especially in the presence of water, and a target peak temperature target of 100°C or lower has been used in repository R&D programs internationally. This target in turn determines a waste package thermal power limit that may require aging for hundreds of years, for DPC direct disposal.

Crushed salt backfill is not as sensitive to temperature, and has a peak temperature tolerance of at least 200°C. This temperature limit is associated with decrepitation of intact salt samples, and may not be important for crushed salt. Higher temperature tolerance could be possible based on testing data (BMW 2008).

2.2.7 Water Diversion

For unsaturated disposal concepts in free-draining media, engineered water diversion barriers such as drip shields can be installed to divert downward percolating water from contacting waste packages (Hardin et al. 2013a; DOE 2008). By contrast, for saturated disposal concepts water can be diverted only using low permeability materials, which typically become saturated so that groundwater contacts the waste packages.

2.2.8 Ground Support

The disposal concepts discussed here would require underground openings large enough to accommodate waste transport and handling, emplacement, monitoring, and repository closure. Some concepts would involve up to 100 years of ventilation, followed by backfilling, so long-term stability is important, with little or no maintenance in waste emplacement areas (Hardin et al. 2013a).

Excavation and ground support methods for all prospective host media are readily available. Opening span is one of the important factors that determine ground support requirements (Hardin et al. 2013a, Table 4-1). For most media circular openings are preferred because of the inherent stability, and because they can be excavated by tunnel boring machine. Rectangular openings in softer rock types could be excavated by roadheader (Hardin et al. 2013a). Given the extent of excavations for any repository for commercial SNF, mechanized mining of some type would be selected. The various disposal concepts would use a range of ground support and lining methods such as rock bolts, wire mesh, shotcrete, steel sets or ribs, and segmented pre-fabricated concrete. Details would be specific to each concept and would depend on the local history of mining and construction.

2.2.9 Disposal Concept-Specific Engineering Feasibility

The various factors related to engineered feasibility that are presented in Section 2.2.1 through Section 2.2.8 are discussed below with respect to each of the disposal concepts considered. The same five disposal concepts that were considered in Section 2.1 are also considered here:

- Salt repository
- Hard-rock unsaturated, unbackfilled open concept
- Hard-rock backfilled open concept
- Sedimentary backfilled open concept
- Cavern-vault disposal concept

2.2.9.1 Salt Repository Concept

As discussed in Section 2.1.1, in a salt repository concept the salt itself is the primary component that is relied on to isolate radionuclides from the biosphere, not the waste package. The waste package disposal overpack is expected to maintain its integrity through the period of repository operations and the period of retrievability. Therefore, the waste package disposal overpack can be constructed from corrosion-allowance materials such as carbon steel (Hardin et al. 2013a). Even corrosion-allowance materials might corrode very slowly because of the limited water available in a disposal environment in salt.

For waste package transport and emplacement, shielding would be built into the transport and emplacement equipment. After package emplacement on the floor (or in a semi-cylindrical cavity in the floor, to improve heat transfer) crushed salt would be placed around the waste packages, providing shielding.

Surface-to-underground transport could be either by shaft or ramp, and the choice would likely depend on site-specific factors such as the presence of an aquifer. In such a case, a shaft might be preferred because it minimizes the excavated area exposed to water-bearing strata and is therefore easier to seal when the repository is closed. Shaft sinking through aquifers was

accomplished with difficulty at Gorleben, Germany, and was proposed for the Deaf Smith County, Texas salt repository project (DOE 1987).

Underground transportation of DPC-based waste packages would likely use a rubber-tire based system because of the challenges of maintaining rail alignment in salt (Carter et al. 2011) and because of the relative ease of mining a smooth, level running surface.

Ground support would likely consist of rock bolts, similar to what has been done at the WIPP. Waste packages would not be ventilated, and backfill would be installed at the time of emplacement. The host salt would creep inward and eventually enclose the waste packages over tens to hundreds of years. Experience at WIPP and in salt mines has shown that it would be possible to maintain openings during the operational period with the use of rock bolts and re-contouring the openings (Hardin et al. 2013a).

2.2.9.2 Hard-Rock Unsaturated, Unbackfilled Open Concept

As discussed in Section 2.1.2, in a hard-rock unsaturated, unbackfilled open disposal concept, isolation of the waste could rely heavily on the waste package (and other engineered barriers). Accordingly, the disposal overpack would be constructed from corrosion-resistant materials, as would any metallic water-diversion barrier.

Surface-to-underground transportation of the DPC could be by either shaft or ramp, and the choice would likely be based on site-specific factors. A repository in the unsaturated zone would likely be shallow compared to other concepts, with depth of only a few hundred meters, so that ramp access could be feasible.

Each waste package would be transported in a shielded transport vehicle to its disposal position, with remote operation for the final leg within the emplacement drift. The transport vehicle could be either rail-based (like the Yucca Mountain concept) or rubber-tire based (with a suitable running surface such as concrete or compacted ballast). Waste packages would be placed on the floor or a low pallet, aligned with the drift axis. No buffer or backfill would be used.

Drifts in hard rock tend to be stable over the 50 to 100 years that could be needed for ventilation after waste emplacement (depending on the characteristics of the SNF). Sufficient ground support would be provided by rock bolts, wire mesh or cloth, and shotcrete where needed.

2.2.9.3 Hard-Rock Backfilled, Open Concept

The primary engineering difference from the unbackfilled concept above would be installation of low-permeability backfill at closure, after 50 to 100 years of ventilation. Installation would be performed remotely using equipment such as conveyors, pneumatic delivery, or auger feeds. In addition, with the appropriate selection of backfill material, the disposal overpack might be designed from material that is somewhat less corrosion resistant than that used for the unbackfilled concept. Other engineering aspects of the backfilled disposal concept would be similar to those for the unsaturated, unbackfilled concept (Section 2.2.9.2).

2.2.9.4 Sedimentary Backfilled, Open Concept

As discussed in Section 2.1.4, for a sedimentary backfilled, open disposal concept isolation of waste would rely heavily on the backfill and the host rock. These would have low permeability, provide a reducing geochemical environment, readily sorb radionuclides, and exhibit fracture-

healing behavior. The disposal overpack could be made of corrosion-resistant or corrosion-allowance materials, depending on design choices and the specific type of sedimentary rock.

As with the hard-rock backfilled concept, remotely operated equipment would be used to transport each waste package in a shielded transport vehicle, to its disposal position.

Surface-to-underground transportation could be accomplished either using a shaft or ramp, depending on the depth and the extent of the host geologic formation, the specific characteristics of the sedimentary rock sequence, and the geography of available locations for surface facilities.

Underground transportation of DPCs could be either rail-based or rubber-tire based. For either, in clay-rich host rock the floor and walls would be supported and protected from abrasion and slaking by shotcrete, cast concrete, or pre-cast concrete segments. The transport vehicle would be operated remotely for the last leg, in the emplacement drift.

Waste packages would be emplaced directly on the drift floor, and the drift would be ventilated for 50 to 100 years. Backfill would be emplaced after this ventilation period, requiring remote emplacement equipment such as conveyors, pneumatic delivery, or auger feeds. In addition, with the appropriate selection of backfill material, the disposal overpack could be constructed of material that is somewhat less corrosion resistant than that used for the unbackfilled concept.

The question of whether emplacement drifts in clay/shale can be constructed efficiently and remain stable for at least 50 years was addressed in some detail by Hardin (2014). Based on experience with tunnels in service for highways, railroads, and water conveyance in the U.S. and Europe, the answer is affirmative. The types of liners that have been used for tunnels in clay/shale include shotcrete, steel ribs or sets, pre-fabricated concrete (reinforced and unreinforced), cast-in-place concrete, lagging, wire fabric, and rock bolts (Table 2-1, Hardin et al. 2014a). The type of ground support needed would depend on the strength and other properties of the host rock.

2.2.9.5 Cavern-Vault Disposal Concept

As discussed in Section 2.1.5, in a cavern-vault disposal concept isolation of the waste from the biosphere would depend primarily on the low permeability buffer and backfill materials installed around the DPCs. In the vault concept discussed here, the vaults would be specially built for the geologic setting. The underground storage and disposal installation would be shielded, allowing workers to directly install backfill at repository closure without having to use remotely operated equipment.

A shallow cavern could be built in the unsaturated zone, which could improve waste isolation by limiting the amount of water contacting waste. Transportation of DPCs from the surface, and within the cavern, could be via a shallow ramp that would allow the use of heavy-haul equipment similar to that used to transport DPCs on the surface. Deeper repository settings in the saturated zone are also plausible.

The ventilation period would be at least 100 years, and access drifts and other underground openings would need to remain stable for that time, although maintenance could be readily accomplished with worker access (without moving waste packages). With high quality rock ground support requirements could be minimal. Given the lengthy ventilation period, high-use openings such as ramps and service drifts could require additional ground support such as steel liner plates or fully grouted rock bolts.

2.3 Thermal Management

The heat generated by the SNF in DPCs would be managed so that temperatures inside and outside the waste packages meet various specified limits. Various approaches can be used, alone and in combination, to manage this heat: surface decay storage, underground decay storage with ventilation (for open disposal concepts), drift spacing, waste package spacing, selection of host media for the repository, and backfill selection (if used). These factors have been reviewed extensively (Hardin et al. 2012; 2013a; 2013c). The findings from these studies are summarized below.

The greatest challenge would be limiting the temperature of clay-based buffer or backfill materials, and of clay-rich sedimentary host rock. These materials and media have relatively low thermal conductivity and low peak temperature tolerance. Peak temperature limits of 100°C or lower have been proposed for such materials (Hardin et al. 2012, Section 1.4.1), which would be problematic to achieve for DPC direct disposal (see Sections 2.2.6 and 3.3.1).

For crystalline hard rock a peak temperature tolerance of 200°C could be expected, by analogy to Yucca Mountain tuffs (Hardin et al. 1997). This limit would likely represent the opening of microcracks by differential thermal expansion of heterogeneous grains. For salt, a host rock temperature limit of 200°C is used here although higher limits may be acceptable (BMW 2008).

A temperature limit of 350°C for cladding during permanent disposal was established in previous analyses (DOE 2008). This limit is intended to limit cladding degradation by mechanisms such as creep rupture. It is based on a temperature limit of 400°C established for normal conditions of SNF storage by the U.S. Nuclear Regulatory Commission (NRC) (NRC 2003a).

Another limit that is important for thermal management is the time allowed for surface decay storage, aging, and repository ventilation of DPC-based waste packages. This duration is inversely related to peak repository temperature. It has generally been assumed in this study that DPCs can be stored above ground for no more than 100 years. The basis for this limit is the period of time for which storage licenses can be granted and the period of time for which extensions of the license may be sought. Section 3.1.2 of Hardin and Howard (2013) has further discussion regarding this 100-year target.

Also, the time for which a repository can remain open for ventilation (if intended) is important in meeting the thermal limits discussed above. In Hardin et al. (2012) ventilation periods as long as 300 years were considered, whereas for DPC direct disposal a target of 50 years was used (Hardin et al. 2013a; 2014a; Hardin and Howard 2013). It is recognized that a 300-year ventilation period is not realistic, but it is helpful for understanding the potential benefits from extended ventilation. This assumption is discussed further in Section 3.1.2 of Hardin and Howard (2013).

Based on thermal analyses, enclosed disposal modes (i.e., packages in close contact with buffer material at the time of emplacement) are not recommended for disposal of SNF in DPCs, except for disposal in salt. Analysis of the disposal of 32-PWR size DPCs in a typical clay/shale medium with ample spacings, “optimistic” thermal properties, and typical SNF of 150-year age at repository closure, showed that the peak buffer temperature would be 166°C (Hardin et al. 2013a, Section 4.3). If peak temperature targets are not met with such a case, then they are unlikely to be met with any similar, plausible case. Disposal of SNF in DPCs in an enclosed

mode (except salt) would require hundreds of years of surface decay storage to limit peak buffer temperature to 100°C.

The results from investigating the thermal effects of disposing of SNF in 32-PWR size DPC-based waste packages (Hardin et al. 2012; 2013a; 2014a; Hardin 2013) are presented below, organized by disposal concept. Subsequent analysis (Hadgu et al. 2015) showed that the thermal results for 37-PWR size DPCs are similar to those discussed here, with higher temperatures as expected, and similar temperature histories (Appendix A).

2.3.1 Salt Repository Concept

In addition to a peak temperature tolerance of at least 200°C, salt also has relatively high thermal conductivity (5.2 W/m-K for WIPP salt at ambient temperature and 3.2 W/m-K at 200°C). These properties taken together have a large impact on thermal management for DPC-based waste packages in a salt repository.

The thermal analysis of SNF disposal in 32-PWR size DPCs was done using the finite element method to accommodate emplacement geometry, consolidation of the crushed salt backfill, and the temperature dependence of thermal conductivity (Hardin et al. 2012). Selected results from thermal analyses of 32-PWR size DPC-based packages are summarized in Table 2-8. In the model, waste packages are emplaced in semi-cylindrical floor cavities (Figure 2-2) so that the bottom half of each package is in contact with intact salt to improve heat transfer. Use of the floor cavities lowers peak temperatures by 10 to 20 C° (Figure 2-6). Results summarized in Table 2-8 indicate that 30-meter package spacing, decay storage on the order of 50 to 70 years, and use of floor cavities could limit peak salt temperature to 200°C.

Table 2-8. Selected results from thermal analyses of disposal of SNF in 32-PWR size DPCs in salt.

Burnup (GW-d/MT)	Age Out-of-Reactor (yr)	Heat Output at Emplacement (kW)	Spacing (x and y directions, m)	Approximate Peak Salt Temperature (°C)
40	50	10.2	20	210
60	50	15.8	20	330
40	60	8.8	20	190
60	100	8.2	20	210
40	50	10.2	30	140
60	70	11.8	30	162

Finite-element models (Hardin et al. 2013a; 2013c) show that the peak salt temperature is correlated with the waste package thermal power at emplacement. This relationship allows the selection of a waste package emplacement power limit, which for a salt repository is approximately 10 kW. Peak salt temperature occurs at the waste package surface, within just a few years after emplacement. Repository spacings combine to affect temperature tens to hundreds of years later, as the salt between waste packages warms.

2.3.2 Hard Rock Unsaturated, Unbackfilled Open Concept

A hard rock unsaturated, unbackfilled open repository would be ventilated to remove heat for 50 to 100 years after emplacement. The results from thermal analysis of 32-PWR size DPC-based

waste packages are shown in Figures 2-7 through 2-10. These figures show temperature histories for both the rock wall and the waste package surface, for various SNF burnup levels (20, 40, and 60 GW-d/MT), two waste package spacings (10 and 20 meters), and two fuel-age conditions (150 and 300 years at closure). For all the variations calculated, the peak temperature in the host rock is well below the 200°C target for hard rock.

This page intentionally left blank.

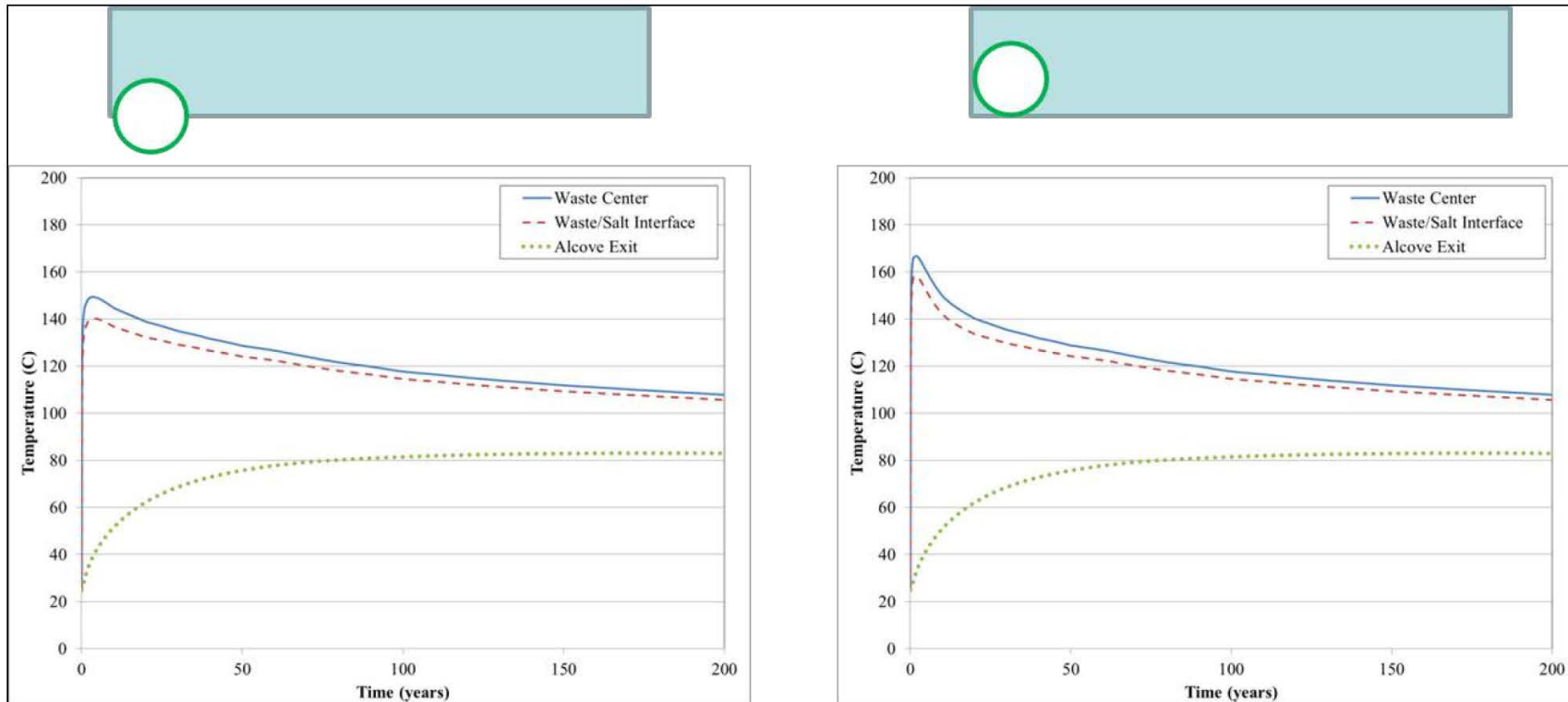

Figure 2-6. Comparison of salt interface temperature histories for emplacement of 32-PWR size waste packages directly on the alcove floor (right) vs. in a semi-cylindrical cavity (left) (burnup 40 GW-d/MT, age 50 years, package spacing 30 m).

This page intentionally left blank.

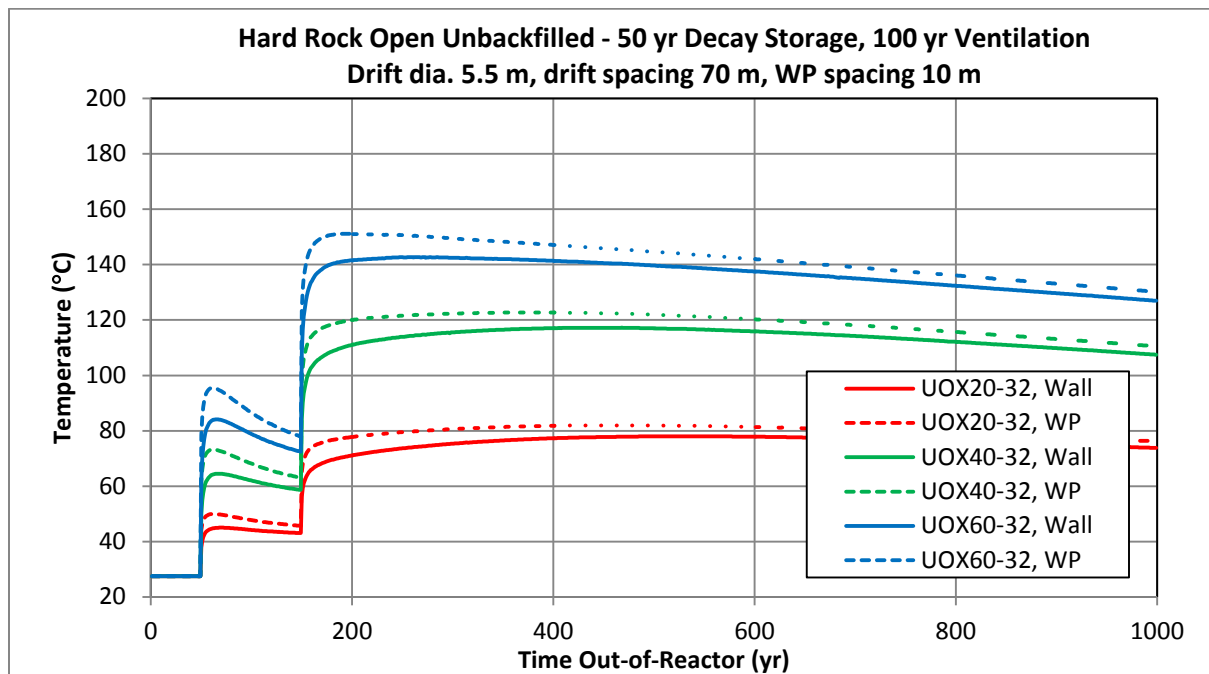

Figure 2-7. Thermal analysis of DPCs disposal in a hard-rock unsaturated, unbackfilled open-type repository with 50-yr decay storage, 100-yr ventilation, and 10-m waste package spacing.

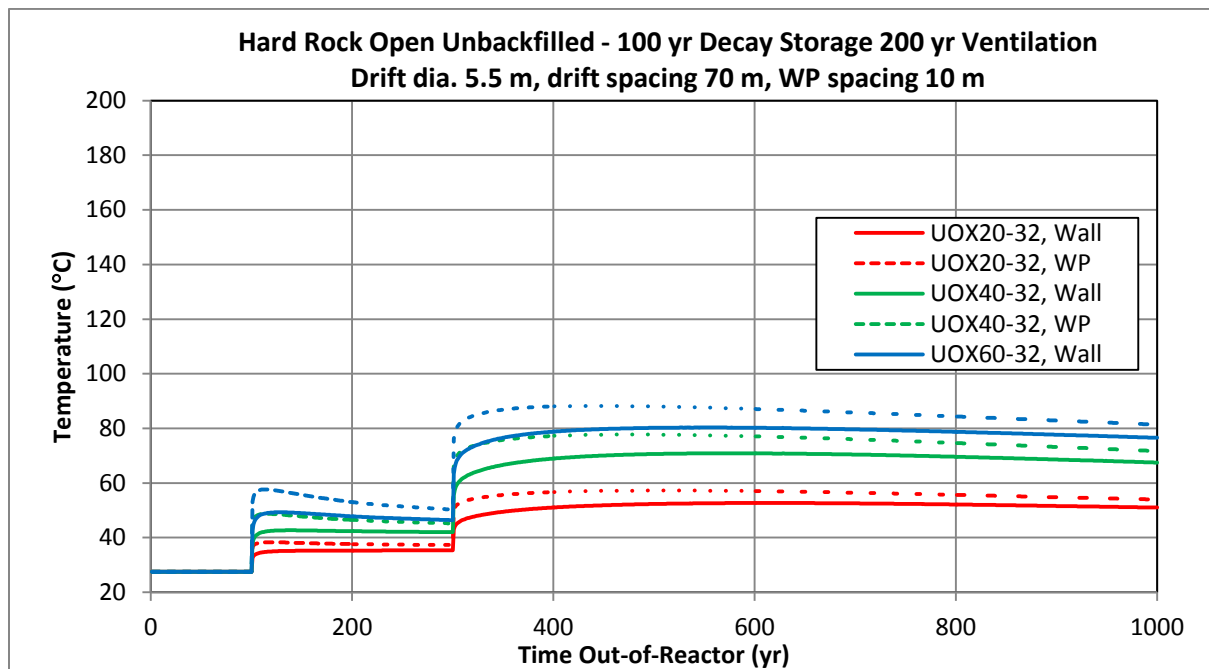

Figure 2-8. Thermal analysis of DPC disposal in a hard-rock unsaturated, unbackfilled open-type repository with 100-yr decay storage 200-yr ventilation, and 10-m waste package spacing.

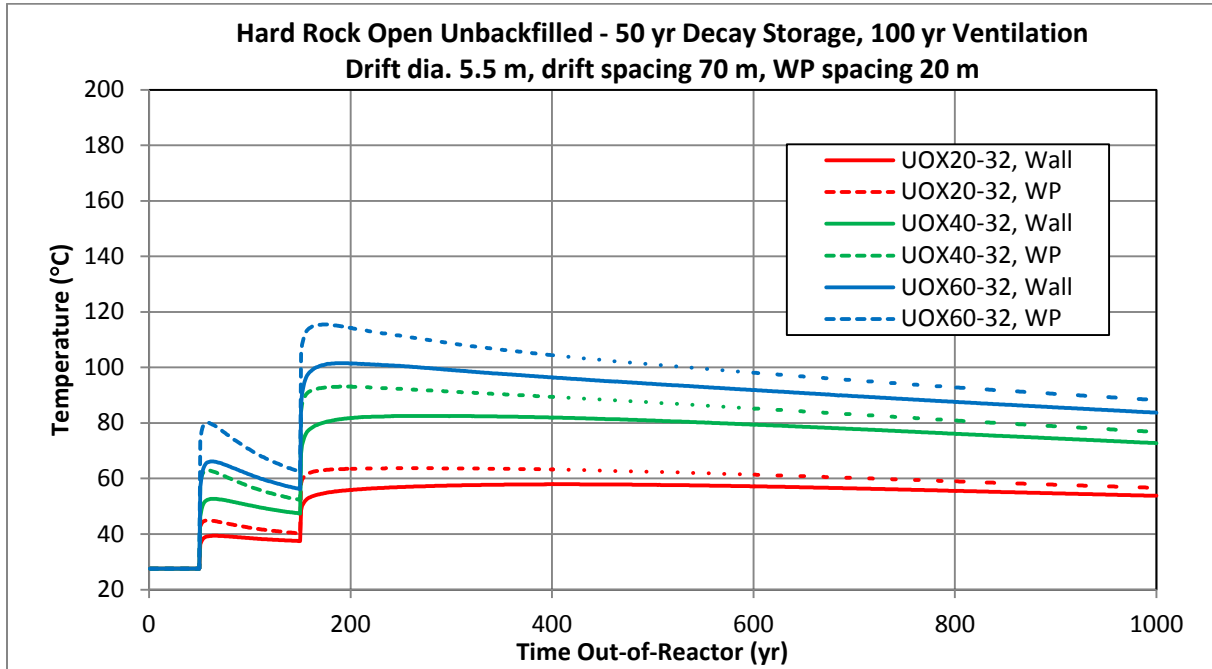

Figure 2-9. Thermal analysis of DPC disposal in a hard-rock unsaturated, unbackfilled open-type repository with 50-yr decay storage, 100-yr ventilation, and 20-m waste package spacing.

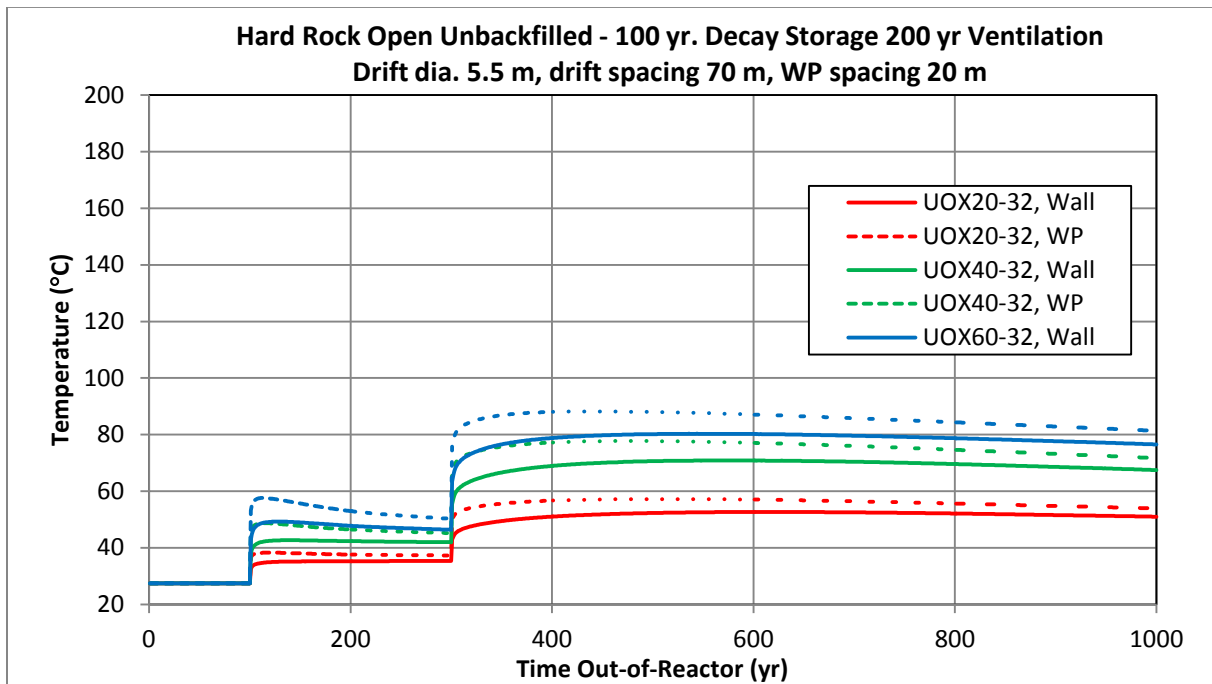

Figure 2-10. Thermal analysis of DPC disposal in a hard-rock unsaturated, unbackfilled open-type repository with 100-yr decay storage 200-yr ventilation, and 20-m waste package spacing.

2.3.3 Hard Rock Backfilled, Open Concept

A hard rock backfilled, open repository would be ventilated to remove heat for 50 to 100 years after waste emplacement, after which a low-permeability clay-based backfill would be emplaced. Representative thermal analyses for 32-PWR size, DPC-based waste packages are shown in Figures 2-11 and 2-12, for various SNF burnup levels (20, 40, and 60 GW-d/MT), two fuel-age conditions (150 and 300 years at closure), and two values of backfill thermal conductivity (a typical value of 0.6 W/m-K for a compacted, dehydrated clay and a hypothetical value of 1.43 W/m-K for hydrated clay). These figures show that the temperature of the backfill in contact with the waste package (indicated by waste package temperatures in the figures) exceeds the 100°C backfill temperature limit for all combinations of fuel burnup and backfill thermal conductivity except for lower burnup (20 GW-d/MT) with the hypothetical hydrated clay backfill. Increasing drift spacing and waste package spacing decreases drift wall temperatures but has little effect on backfill peak temperature.

The thermal management strategy for this disposal concept could include: 1) reducing drift diameter and/or the effective backfill/buffer thickness; 2) increasing the thermal conductivity for backfill material; and/or 3) establishing a higher temperature tolerance (e.g., 200°C) for backfill material. Backfill materials with peak temperature tolerance of at least 200°C are recommended to maintain a range of geologic setting options for disposal of large heat-generating waste packages such as those that would be used for DPCs (Section 3.3.1).

2.3.4 Sedimentary Backfilled, Open Concept

A backfilled, open repository in sedimentary (clay-rich) rock would be ventilated to remove heat for 50 to 100 years after emplacement, after which a low-permeability clay-based backfill would be emplaced around the waste packages. Results from thermal analyses for 32-PWR size, DPC-based packages are shown in Figures 2-13 and 2-14, for various SNF burnup levels (20, 40, and 60 GW-d/MT), two fuel-age conditions (150 and 300 years at closure), and two values of backfill thermal conductivity (a typical value of 0.6 W/m-K for a compacted, dehydrated clay and a hypothetical value of 1.43 W/m-K for hydrated clay). These figures indicate that the temperature of the backfill in contact with the waste package (indicated by waste package temperatures in the figures) exceeds the 100°C target for all combinations of fuel burnup and backfill thermal conductivity except lower burnup fuel (20 GW-d/MT) with the hypothetical hydrated backfill, for the 300-year case.

Similar to the hard rock backfilled, open disposal concept discussed above, the viability of this concept would depend on a backfill thermal strategy, supported by backfill material R&D (Section 3.3.1).

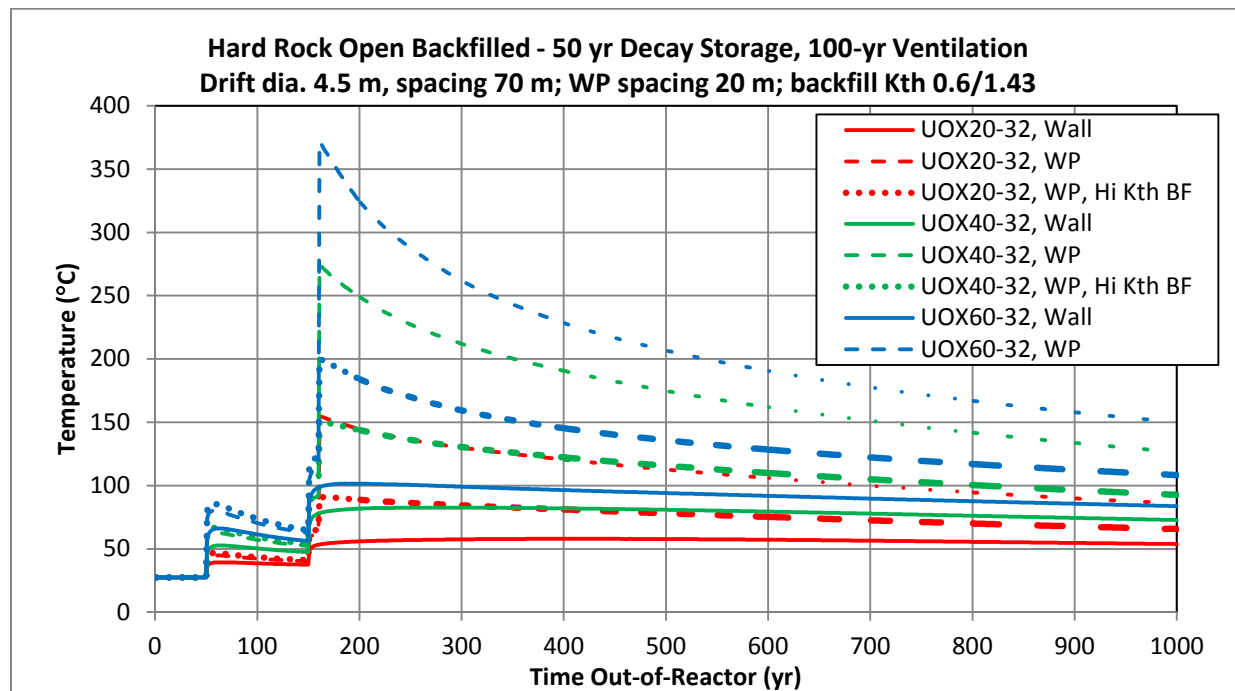

Figure 2-11. Thermal analysis of DPC disposal in a hard-rock backfilled, open-type repository with 50-yr decay storage, 100-yr ventilation, and both typical and high thermal conductivity backfill.

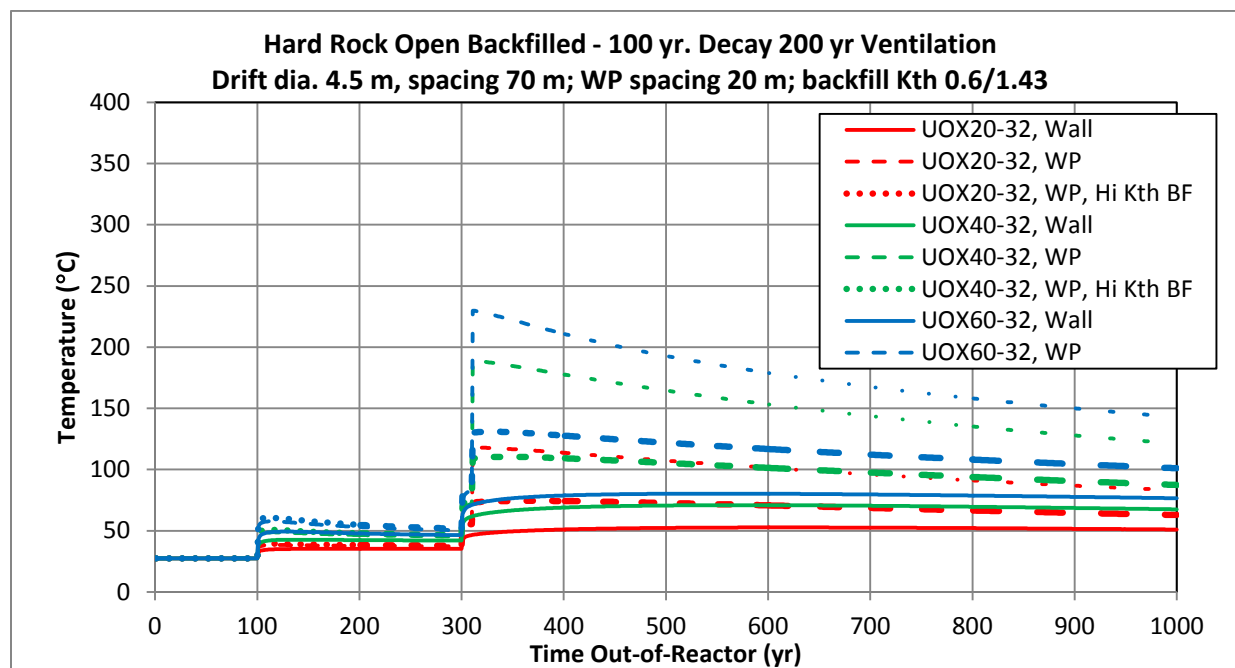

Figure 2-12. Thermal analysis of DPC disposal in a hard-rock backfilled, open-type repository with 100-yr decay storage 200-yr ventilation, and typical and high thermal conductivity backfill.

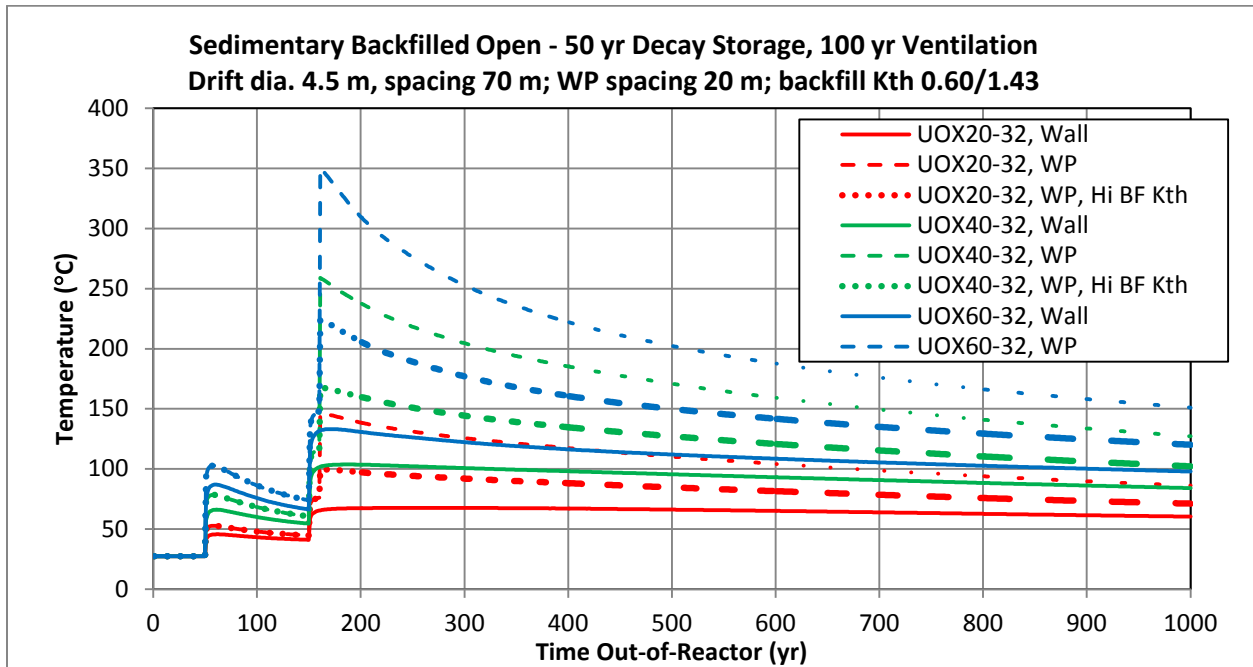

Figure 2-13. Thermal analysis of DPC disposal in sedimentary backfilled, open-type repository with 50-yr decay storage and 100-yr ventilation.

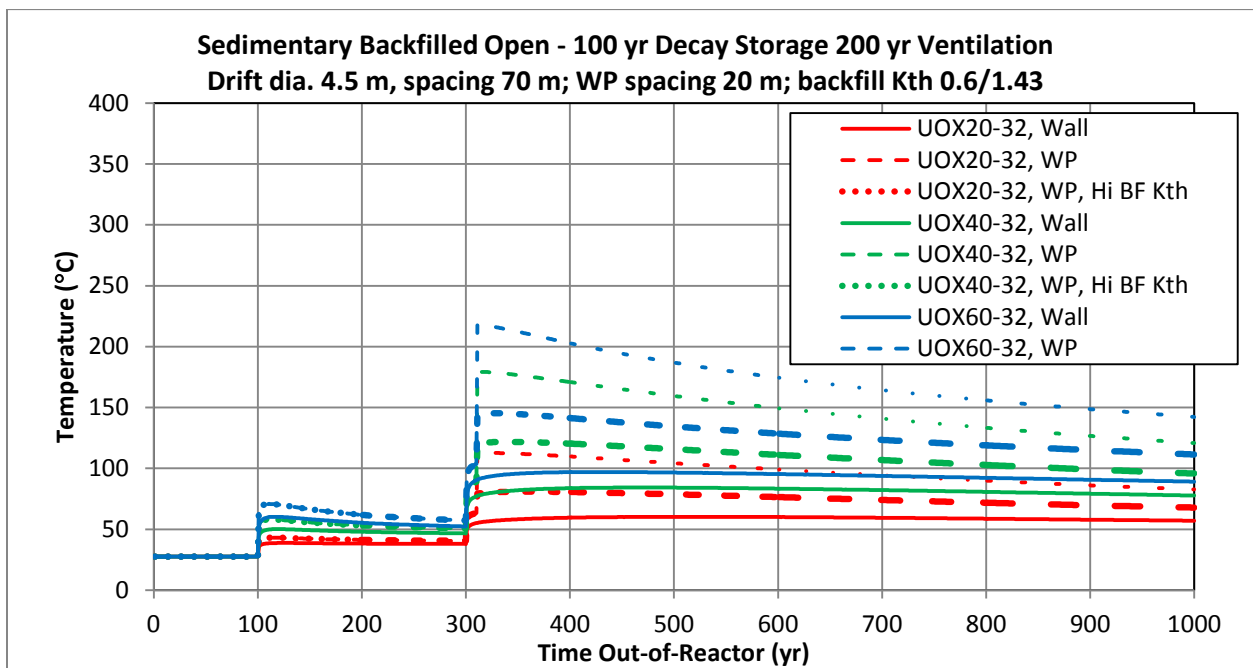

Figure 2-14. Thermal analysis of DPC disposal in a sedimentary backfilled, open-type repository with 100-yr decay storage and 200-yr ventilation.

2.3.5 Cavern-Vault Disposal

In the underground vault concept an air gap around each emplaced DPC would allow for heat removal by natural convection before repository closure. Heated air would then be removed by forced ventilation of the access drifts. At closure the air channels within each vault would be filled by pumping in a thick clay-rich slurry, and the access drifts would be filled with swelling clay-based backfill. The drift backfill would hydrate first, and the buffer around the DPC would hydrate when the liners and sheathing failed due to corrosion.

Thermal analysis was conducted using a semi-analytical method programmed in Mathcad® (Hardin et al. 2012, Section 3; Greenberg et al. 2012). The approach is similar to the mathematical solution for vertical or horizontal emplacement of waste packages (e.g., KBS-3 concept). For this analysis the host medium was assumed to be hard rock with thermal conductivity of 2.5 W/m-K. Access drift spacing was set to 70 m and waste package spacing to 20 m, similar to previous analyses for hard rock (Hardin et al. 2013a). Heat was produced by 32-PWR size DPCs with fuel burnup of 20, 40 or 60 GW-d/MT. A surface storage period of 50 years was assumed, followed by ventilation of 50, 100 and 150 years after DPC-based package emplacement. Buffer thermal conductivity of 0.6 W/m-K (compacted, dehydrated state) and thickness of 0.35 m were used initially, then buffer thermal conductivity of 1.43 and 2.0 W/m-K, and thicknesses of 0.7 m and 1.0 m, were used for sensitivity analysis.

With lowest burnup (20 GW-d/MT) and nominal values for buffer conductivity and thickness, the peak package temperature is about 115°C after 50 years of ventilation, decreasing to less than 100°C for the longer ventilation times (Figure 2-15). The corresponding plots for intermediate burnup (40 GW-d/MT) show peak temperature of 207°C after 50 years, decreasing to 137°C after 150 years (Figure 2-16). For the highest burnup (60 GW-d/MT) temperatures are higher, with a peak temperature of about 289°C after 50 years of ventilation (Figure 2-17). Thus, for nominal buffer conductivity and thickness, the 100°C peak temperature target would be met only for low-burnup SNF and fuel age greater than 100 years at repository closure. For intermediate and higher burnup the target cannot be met even with a fuel age of 200 years.

Figures 2-18 through 2-20 present a parametric study of peak buffer temperature dependence on buffer thickness and thermal conductivity for 50, 100 and 150 years of ventilation, respectively. For 50 years of ventilation (plus 50 years of surface decay storage) the peak temperature reduction from buffer thermal conductivity is generally greater than that from buffer thickness. For higher buffer thermal conductivity values, the effect of buffer thickness is further reduced. This suggests that buffer admixtures such as graphite, or buffer hydration early in the performance period, could effectively limit peak temperature. Earlier buffer hydration would be expected in a saturated site with hydrostatic pressure. For the longest 150-year ventilation period (Figure 2-20) peak buffer temperature limits could be realized for all but the hottest conditions without buffer admixture or hydration, and the hottest conditions could be managed with enhanced buffer conductivity.

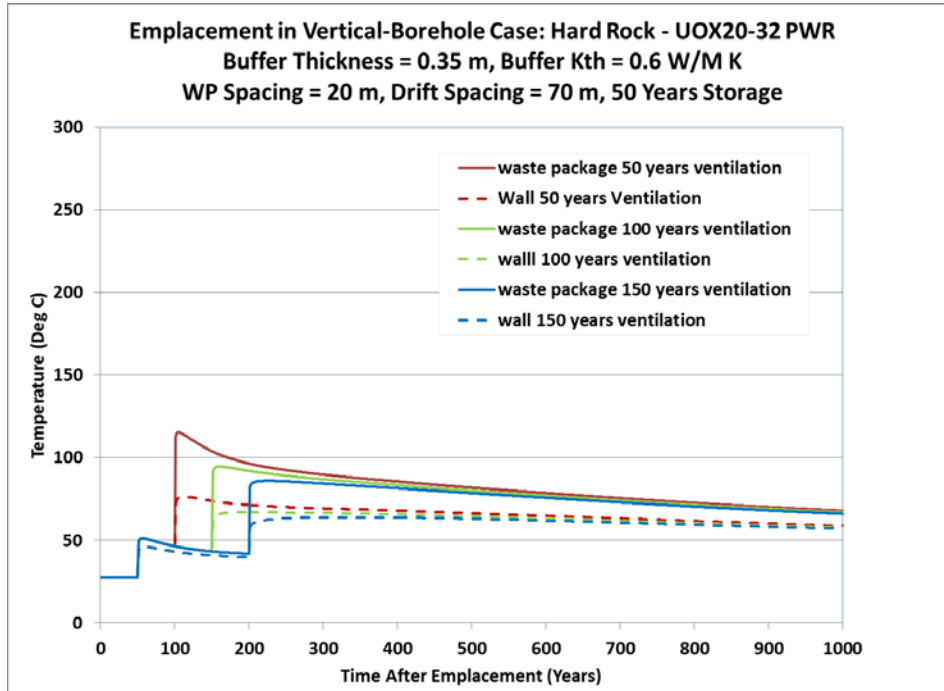

Figure 2-15. Thermal analysis of DPC disposal with 20 GW-d/MTU burnup in a hard-rock cavern-vault-type backfilled repository.

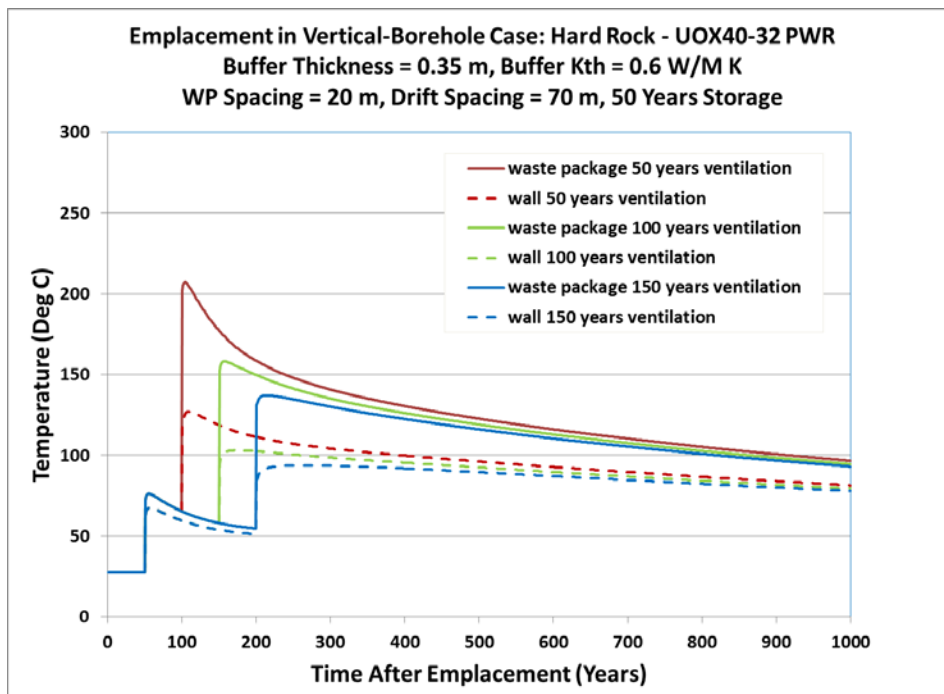

Figure 2-16. Thermal analysis of DPC disposal with 40 GW-d/MTU burnup in a hard-rock cavern-vault-type backfilled repository.

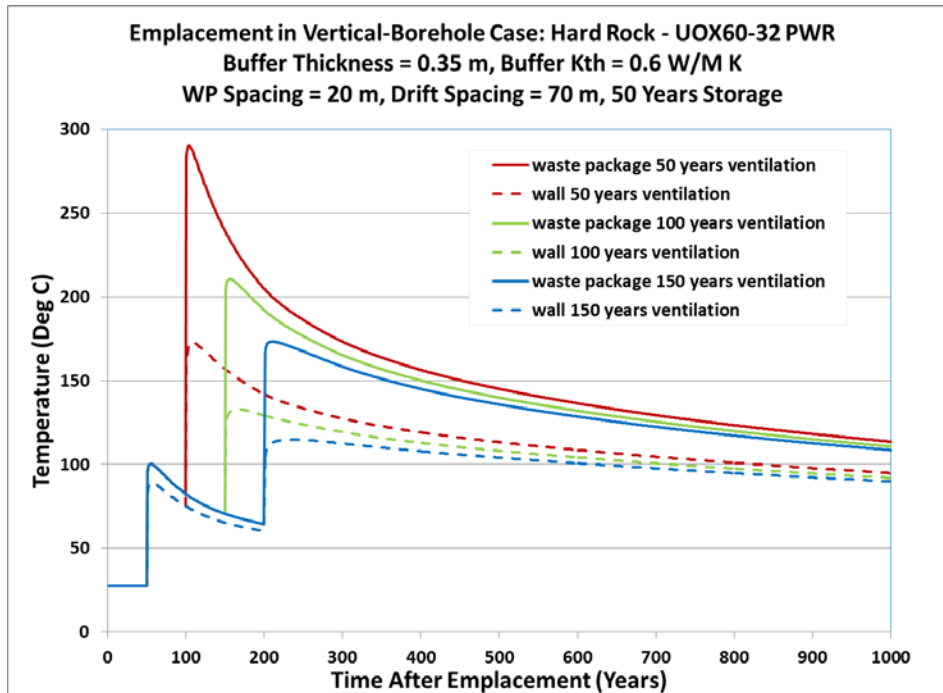

Figure 2-17. Thermal analysis of DPC disposal with 60 GW-d/MTU burnup in a hard-rock cavern-vault-type backfilled repository.

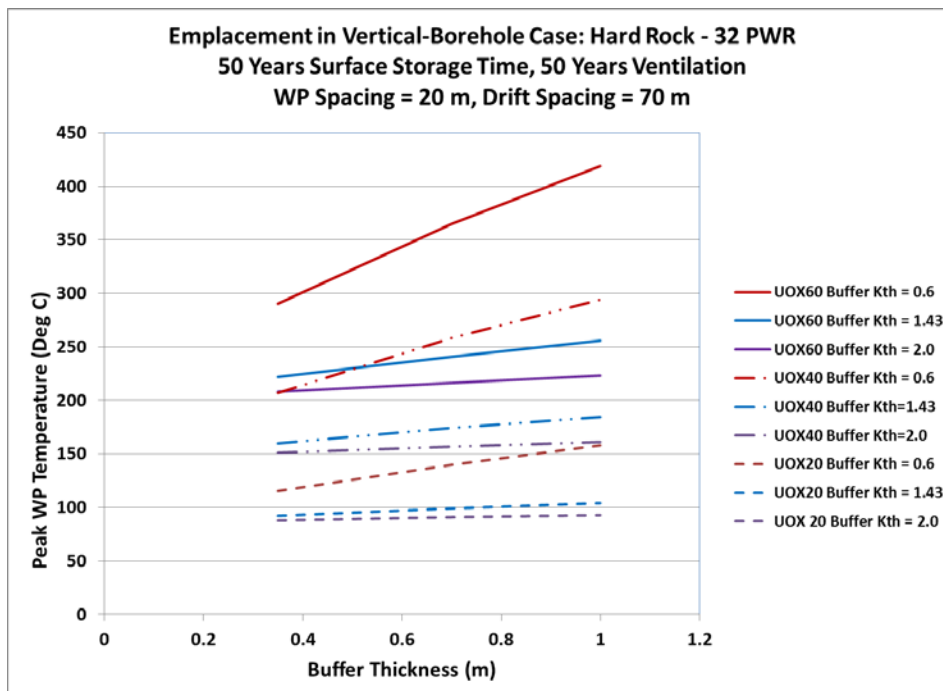

Figure 2-18. Peak temperature vs. buffer thickness, for the emplacement of DPCs in a hard-rock cavern-vault-type backfilled repository, comparing various buffer thermal conductivities and burnup levels, with fuel age 100 years at closure.

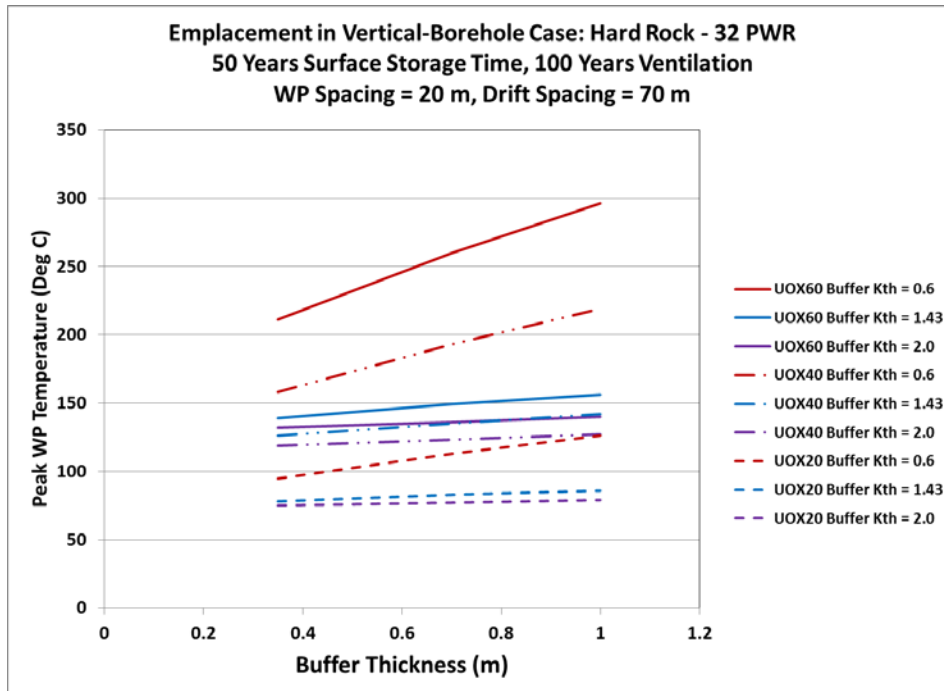

Figure 2-19. Peak temperature vs. buffer thickness, for the emplacement of DPCs in a hard-rock cavern-vault-type backfilled repository, comparing various buffer thermal conductivities and burnup levels, with fuel age 150 years at closure.

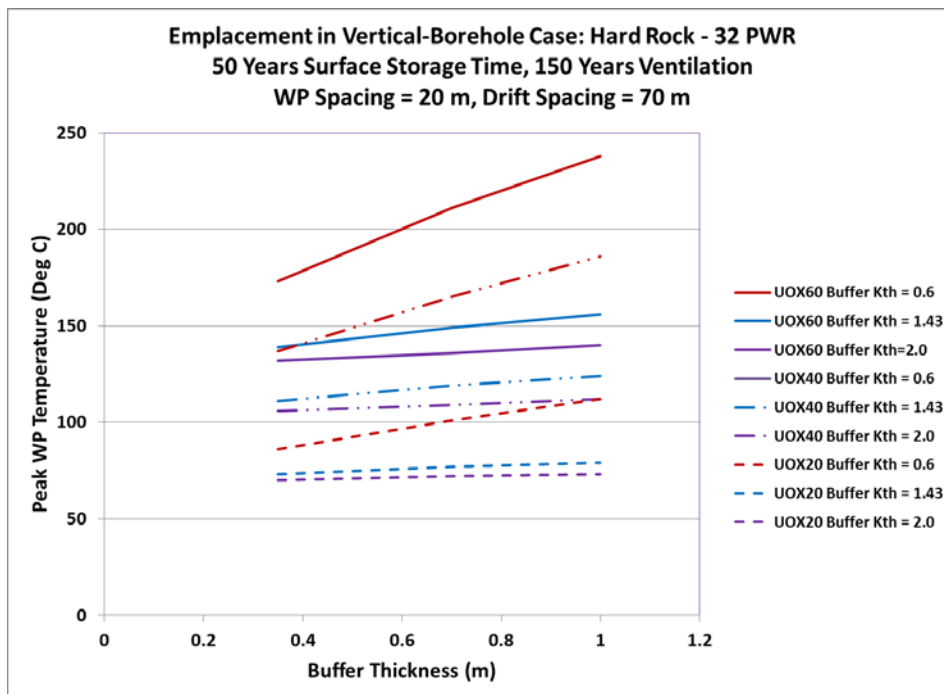

Figure 2-20. Peak temperature vs. buffer thickness, for the emplacement of DPCs in a hard-rock cavern-vault-type backfilled repository, comparing various buffer thermal conductivities and burnup levels, with fuel age 200 years at closure.

2.3.6 DPC Cooling and Projected Disposal Timeframes

As discussed above, DPCs could need to be stored for decades (or longer) before they are cool enough for emplacement, or for repository closure once emplaced. System-level logistical modeling of SNF management from power plants to the repository was used to project the cooling histories of existing and future DPCs, and the timeframes for disposal. Modeling scenarios considered three generic disposal media with different emplacement thermal power limits (Hardin et al. 2014b):

- 6 kW for emplacement in clay-rich sedimentary media, with extended repository ventilation
- 10 kW for packages of any size emplaced in salt with a 200°C peak salt temperature limit
- 18 kW was used for the Yucca Mountain concept, and is considered applicable to any hard rock unsaturated, unbackfilled concept

Logistical simulations were performed using the simulation code TSL-CALVIN (Nutt et al. 2012). A total commercial SNF inventory of approximately 140,000 MTU was projected, consisting of SNF produced to-date and projected future SNF discharges through 2055 (assuming 20-year reactor life extensions and no new builds). All DPCs and “storage only” canisters were assumed to be transportable and disposable.

Baseline scenarios projected eventual packaging of all commercial SNF in DPCs, and other scenarios introduced a future transition to packaging in multi-purpose canisters (MPCs) instead. The MPC definition used here is the same as that used internationally: a sealed canister intended for storage, transport, and disposal. The purpose of introducing MPCs was to evaluate the potential improvement in disposal schedule if MPCs are introduced at various future times. In the scenarios with MPCs, it was assumed that the disposal environment will be understood so that MPCs can be designed, licensed and implemented 5 years before repository opening. Small MPCs (4PWR/9BWR) were used to ensure that cooling time for MPCs would be minimal thus maximizing the effect on the disposal schedule.

The logistical simulations were set up as follows:

- SNF at power plants is loaded into the type of DPCs currently used at that site, or into MPCs after transition.
- DPCs (or MPCs, as applicable) are transported to an interim storage facility beginning when that facility opens in 2025.
- DPCs (or MPCs) remain at the interim storage facility until a repository is available.
- Starting with the first year of repository operations, the DPCs (or MPCs) are transported to the repository if they meet the emplacement power limit, at a rate up to the repository throughput limit (i.e., repository acceptance rate).
- DPCs (or MPCs) are disposed of at the repository as soon as they arrive.
- The interim storage facility remains operational until the last SNF is transported to the repository.

The repository opening date was treated as an uncertain parameter. Although the extant commercial SNF management strategy (DOE 2013) calls for a repository to open in 2048, a number of uncertain factors could impact this date. To address uncertainty, repository opening dates of 2036 (early start), 2048 (planned start), and 2060 (late start) were considered.

Eighteen scenarios were simulated, with the three emplacement thermal power limits; two alternative fuel loading strategies (DPCs only, and DPCs and MPCs); and three repository opening dates. The following data were obtained from the simulations:

- The amount of SNF in DPCs and MPCs that is available each year for disposal.
- Maximum capacity and operating duration of an interim storage facility.
- Fuel age and burnup at emplacement.

Interim storage facility operational duration and maximum storage capacity obtained from these scenarios were compared to the corresponding re-packaging alternatives in which all DPCs are re-packaged for disposal. Re-packaging of all DPCs (into purpose-designed disposal canisters) provides a good reference for assessing the costs and benefits associated with DPC direct disposal. Re-packaging minimizes the interim storage facility operational duration and capacity because it minimizes the decay storage duration needed for disposal. Details of the re-packaging scenarios and interim storage requirements were documented by Kalinina (2014). The results summarized below focus on cooling time histories for various emplacement power limits, and fuel age and burnup at disposal.

2.3.6.1 DPC Cooling Time Needed for Various Emplacement Power Limits

The cumulative amounts of SNF that would be cool enough to meet the repository emplacement power limits are shown in Figure 2-21 (6 kW), Figure 2-22 (10 kW), and Figure 2-23 (18 kW) for the repository opening dates: 2036, 2048, and 2060. The dashed vertical lines in each figure show the time of completion of the corresponding re-packaging scenarios. These figures demonstrate the importance of the emplacement power limits for DPC direct disposal. All of the 18 kW scenarios could be completed at the same time as the corresponding re-packaging scenarios, while the 10 kW scenarios would require some additional cooling time, and the 6 kW scenarios would require significant additional cooling time.

Introducing MPCs could be important for the 6 kW and 10 kW scenarios with repository opening dates in 2036 and 2048. Switching to MPCs increases the amount of SNF available for earlier disposal, especially for the 6 kW scenarios. If the repository were delayed until 2060, switching to MPCs would have no impact on the SNF availability for disposal regardless of the repository emplacement power limit, because so few MPCs would be loaded.

Additional interim storage capacity would be needed for the DPC-only scenarios with 6 kW (repository opening in 2036 or 2048) and 10 kW (repository opening in 2036) emplacement power limits (Figure 2-24). All the other scenarios would require little or no additional storage capacity.

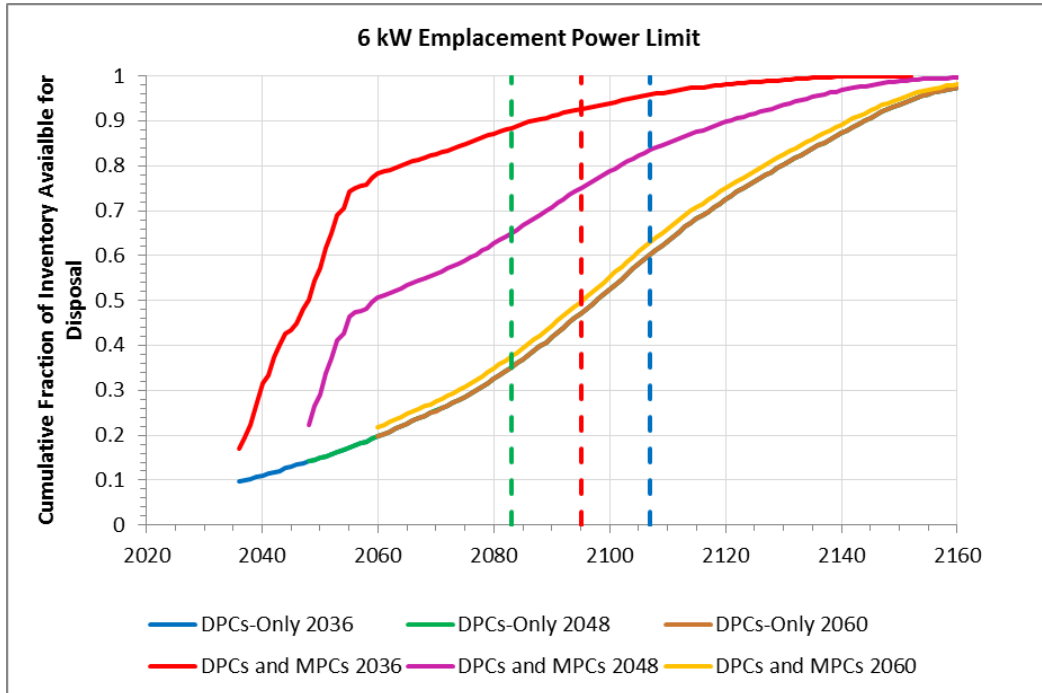

Figure 2-21. History of cumulative inventory available for disposal in a repository with 6 kW emplacement power limit.

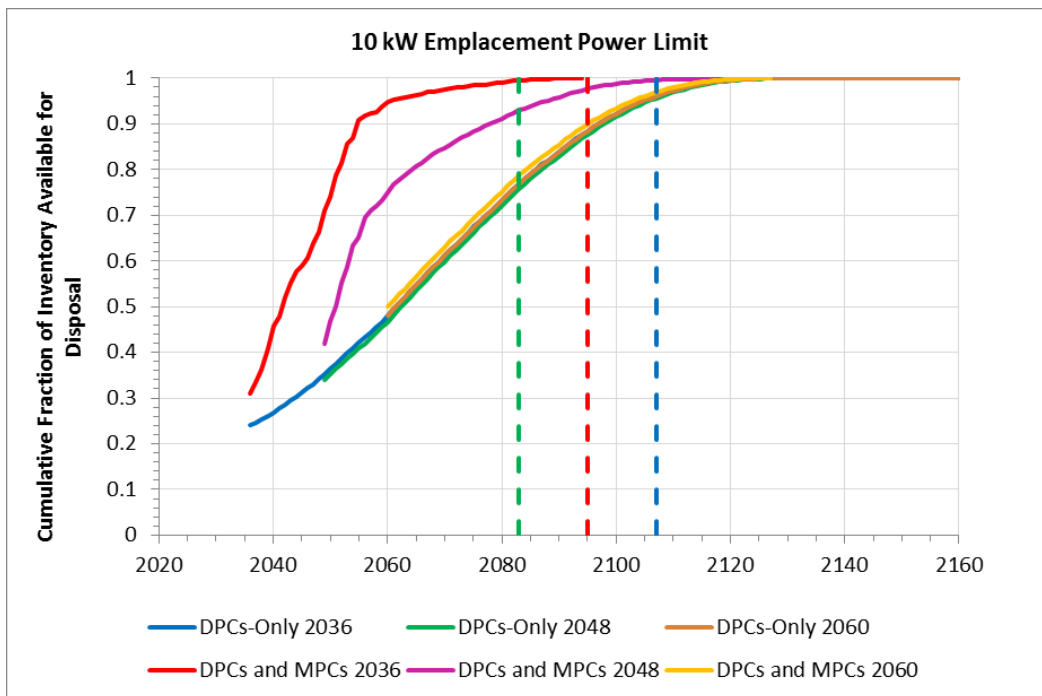

Figure 2-22. History of cumulative inventory available for disposal in a repository with 10 kW emplacement power limit.

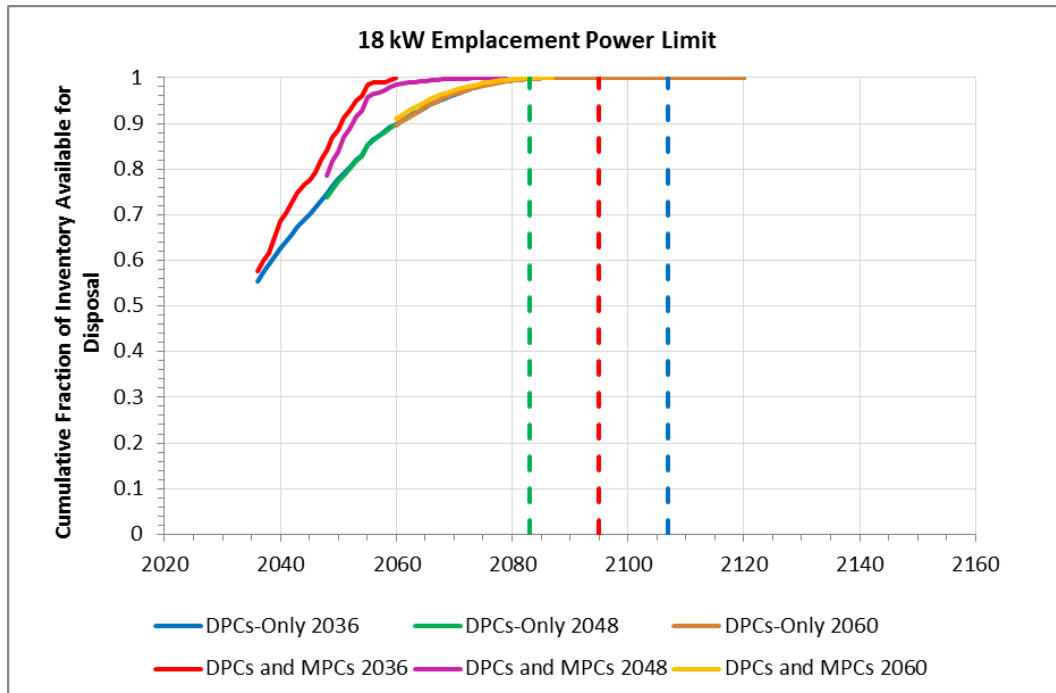

Figure 2-23. History of cumulative inventory available for disposal in a repository with 18 kW emplacement power limit.

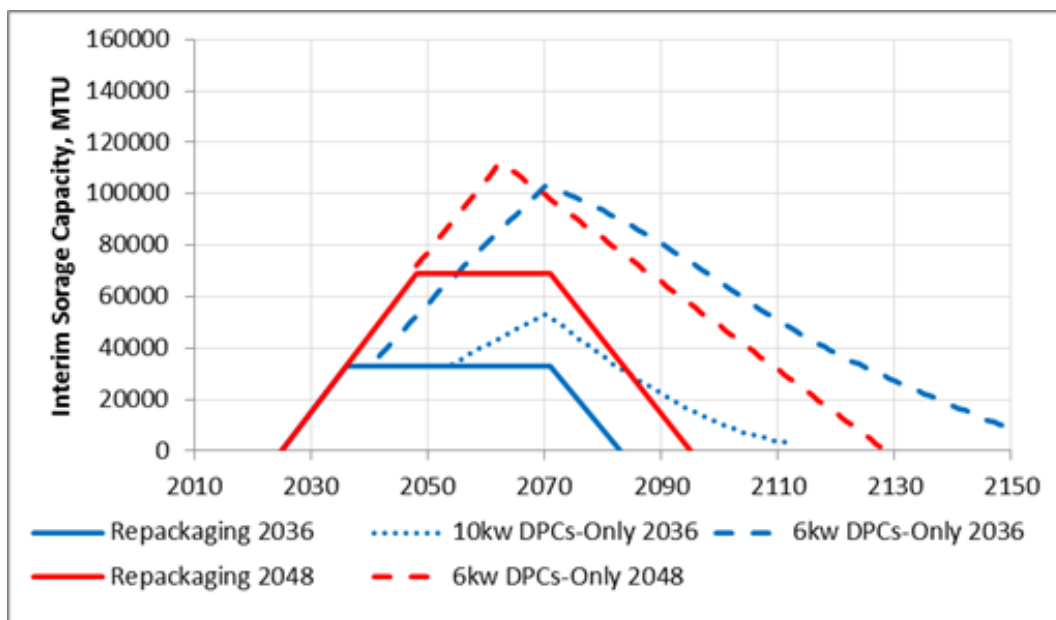

Figure 2-24. Storage capacity in the scenarios requiring additional storage compared to re-packaging scenarios.

2.3.6.2 Fuel Age and Burnup at Emplacement

Average fuel age at emplacement (averaged per metric ton) is shown in Figure 2-25 as a function of the repository opening date. This metric could be important if it becomes infeasible to maintain storage in existing DPCs without canister mitigation or direct disposal, due to the condition of canisters or the condition of high-burnup SNF. The 6 kW DPCs-only scenarios result in fuel age at emplacement of approximately 80 years or older. Introducing MPCs reduces the fuel age at emplacement in 6 kW scenarios with the repository opening in 2036 and 2048, but has little or no impact on for the 10 kW and 18 kW scenarios.

Figure 2-26 and Figure 2-27 show the differences in fuel age and burnup, respectively, at emplacement in a repository, separated for the inventory in DPCs and that in MPCs. The results presented here are for the 6 kW scenario with repository opening in 2036, for which the differences are maximized. This scenario demonstrates the greatest potential benefits from introducing MPCs, in terms of lower fuel age at emplacement and earlier disposal of high-burnup SNF. The majority of SNF in MPCs would be 30 years old or younger at emplacement, while that in DPCs would be 50 years old or older. The burnup of the SNF in MPCs would be 45 GW-d/MTU or greater, while that in DPCs would be 35 to 45 GW-d/MTU or less.

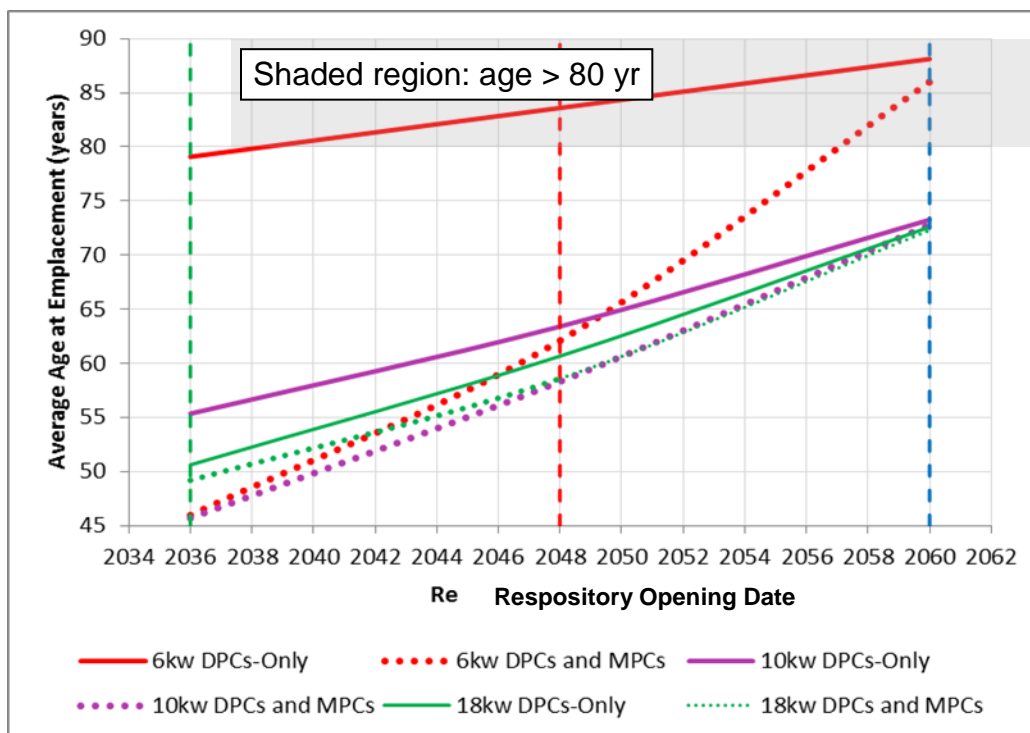

Figure 2-25. Average fuel age at emplacement as a function of repository opening date.

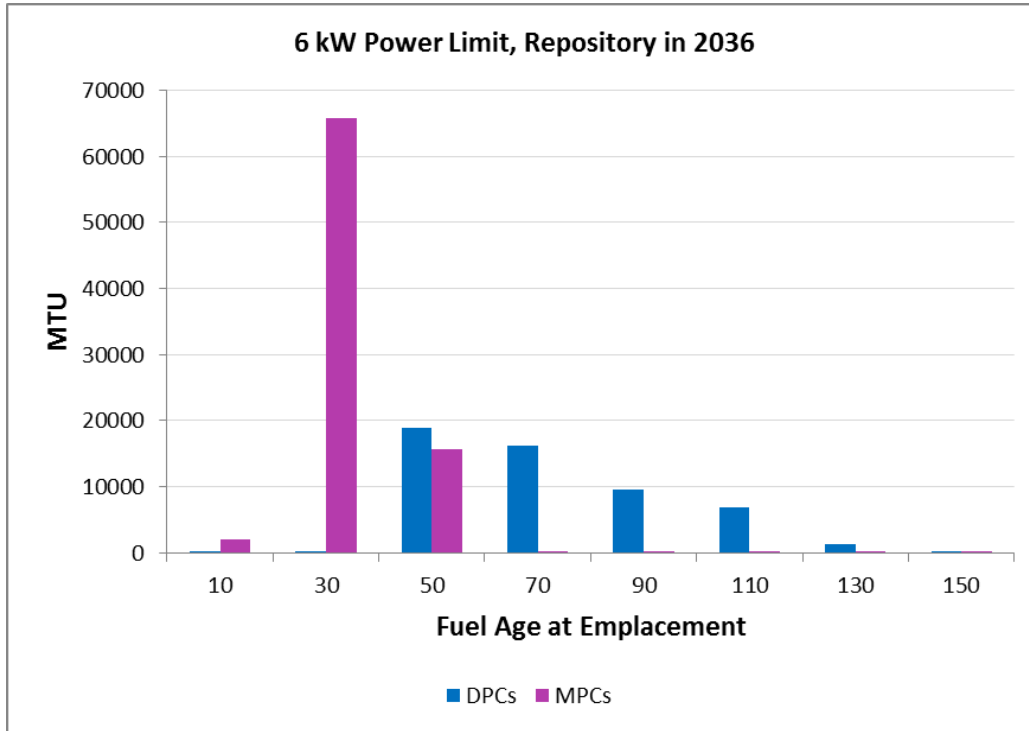

Figure 2-26. Fuel age at emplacement distribution between DPCs and MPCs.

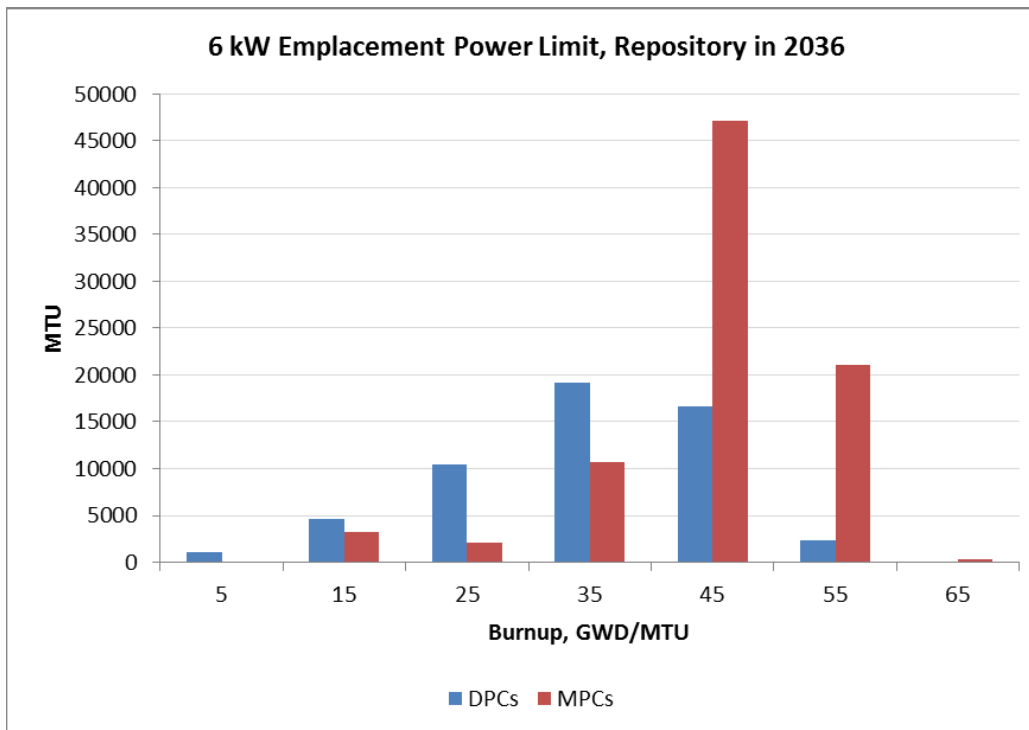

Figure 2-27. Fuel burnup distribution between DPCs and MPCs.

2.3.6.3 Impacts from Prospective Transition to MPCs

Future transition to MPCs affects the scenarios with repository opening dates in 2036 and 2048, except those with the 18 kW emplacement power limit for which there is no effect. The SNF inventory in MPCs is approximately 60% of the total SNF, for repository opening in 2036 (and MPC transition in 2031) and 32% for repository opening in 2048 (MPC transition in 2043). The scenarios with repository opening in 2060 are not affected because only 2% of SNF inventory would be in MPCs.

Figure 2-28 shows cumulative inventory cooled to 6 kW or 10 kW power limits with repository opening in 2036 and 2048, plotted separately for DPCs and MPCs. The difference in cooling times between DPCs and MPCs is greatest for the 6 kW emplacement power limit because the aging time for DPC disposal is longer. There is also a difference in cooling times for the 10 kW emplacement power limit with repository in 2048, because there are more DPCs loaded later with higher burnup fuel.

The scenario that maximizes the differences in disposition of DPCs and MPCs is that with the 6 kW emplacement power limit and repository opening in 2048 (Figure 2-28). The additional cooling time for the last DPC would be approximately 81 years longer (in 2174) than for the last MPC (in 2093). The scenarios with early repository opening (2036) are similar but with less difference (61 years).

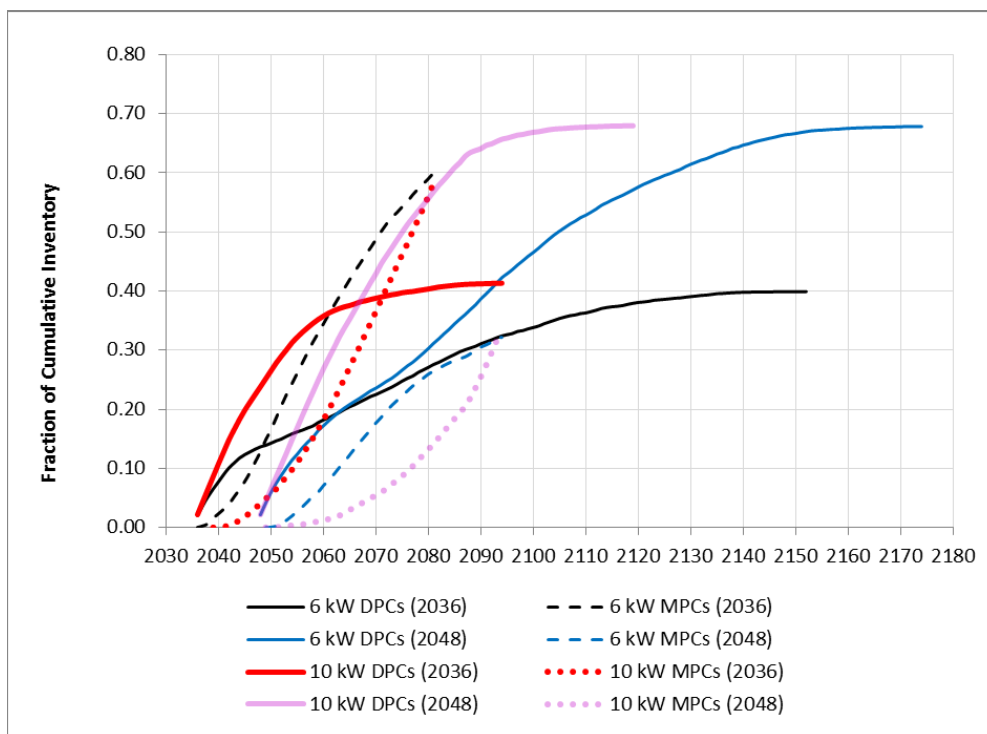

Figure 2-28. History of cumulative inventory cooled to 6 kW or 10 kW, in DPCs and MPCs, with repository opening in 2036 or 2048.

These results suggest that SNF in MPCs would not require decay storage and could be disposed of as soon as a repository becomes operational. Also, lower emplacement power limits produce the greatest difference in the timing of disposal for MPCs vs. DPCs, with respect to when they cool enough to meet emplacement power limits.

2.3.6.4 Conclusions of Logistical Study

The conclusions presented here apply to the logistical analysis of DPC direct disposal, with and without transition to loading only MPCs.

- For the 18 kW emplacement power limit, all DPCs (loaded through 2055) would be cool enough for emplacement by about 2080.
- For the 10 kW emplacement power limit, the hottest DPCs would be cool enough for emplacement by about 2120, but with transition to MPCs, little additional cooling time would be needed compared to re-packaging (repository opening in 2048).
- For the 6 kW emplacement power limit, the hottest DPCs would be cool enough for emplacement by about 2170, but with transition to MPCs, less cooling time would be needed.
- Potential benefits from transition to MPCs, in terms of earlier disposal of all commercial SNF, are greatest for lower emplacement power limits and earlier repository opening dates.
- MPCs would be used almost exclusively for relatively young (fuel age less than 30 years at disposal) and higher burnup fuel.
- In all scenarios involving MPCs, the SNF in MPCs would not require additional decay storage and could be cool enough for emplacement as soon as a repository becomes operational. The differences among these MPC scenarios are mainly related to cooling of DPCs.
- Disposal of commercial SNF could be split into two campaigns, first MPCs then DPCs, by maximizing the differences between SNF loaded into each type of canister. Such a strategy is represented by the repository opening date of 2048 (to the precision of this analysis) with either the 6 kW or 10 kW emplacement power limits. With earlier repository opening dates there would be fewer DPCs with lower burnup. With later start dates there would be far fewer MPCs. Thus, the current strategy date of 2048 for repository opening (with MPC transition in 2043 for this study) leads to comparable division of total SNF in DPCs and MPCs, and these populations cool to the point where they can be emplaced in a repository during different time periods.

2.3.7 Summary of Thermal Analyses for Disposal Concepts

Another way to summarize the results of thermal analyses discussed above is to look at the waste package thermal power limits at repository *closure*, for different disposal concepts, and compare these limits to DPC thermal decay curves to arrive at the needed aging time. The results of such a comparison are shown in Figure 2-29, which shows histories of average power for a 32-PWR package for three burnup values, and the closure power limits associated with peak temperature targets for specified disposal configurations in salt and hard rock (200°C), and backfilled concepts (up to 200°C). The figure shows that for the salt and hard rock unbackfilled concepts, host rock peak temperature limits can be readily met within approximately 100 years from fuel discharge. Accordingly, the salt repository concept and the hard rock concepts discussed above

are best suited for DPC-based waste packages. The hard-rock and sedimentary backfilled concepts are so dominated by backfill temperature constraints that they are plotted together although the host media would likely have different heat dissipation. With backfill, significant aging (surface decay storage plus repository ventilation) on the order of hundreds of years would be needed to accommodate DPC-based waste packages, especially those containing high-burnup SNF.

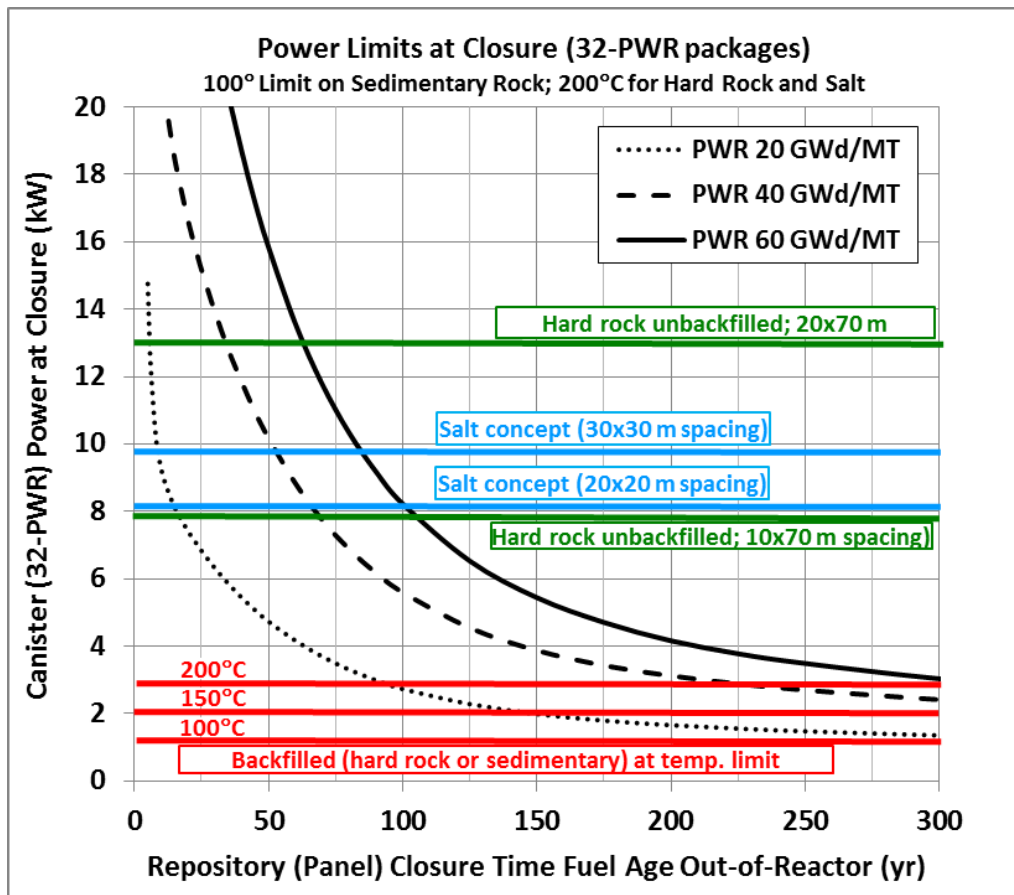

Figure 2-29. Heat output vs. age for a 32-PWR DPC, for three values of burnup (20, 40 and 60 GW-d/MT) showing approximate power limits (at repository closure) for different disposal concepts.

2.4 Postclosure Criticality Control

Postclosure criticality control is challenging because the neutron absorber materials used in existing DPC designs are aluminum based and will readily degrade with long-term exposure to groundwater. Neutron absorbing features (e.g., plates or rods) are designed to control criticality as the DPC is loaded in the fuel pool, or if flooded in a transportation accident. These are short-term applications compared to the thousands of years over which DPC internals could be exposed to groundwater. It is important to note that the possibility of criticality is negligible unless DPCs are flooded with groundwater.

The DOE developed a general methodology for addressing postclosure criticality control, to support the postclosure performance assessment for the Yucca Mountain license application (DOE 2003). The approach can likely be used as a basis for other repository assessments going forward. The methodology consists of:

- Evaluation of the probabilities of occurrence for the range of possible waste package/waste form configurations
- Evaluation of the probabilities of criticality for those configurations that have potential for criticality
- Estimation of consequences for those potential critical configurations that cannot be screened from further consideration by low probability
- Estimation of the impact on repository performance objectives from any such consequences
- Identification of candidates for additional criticality control measures if the 10 CFR 63.113(b) criteria for risk to the accessible environment cannot be met.

For criticality (or any other feature, event, or process) to be screened from the postclosure performance assessment on the basis of low probability (following 10 CFR 63^b), the probability of occurrence of the criticality event must be less than 10^{-4} over 10,000 years (or 10^{-8} per year). If criticality events or configurations cannot be screened out on low probability, then the consequences are estimated in terms of the effects on repository performance objectives (e.g., dose to the reasonably maximally exposed individual). Those criticality events or configurations that have negligible effects on such performance can be excluded from the regulatory performance assessment, while those that cannot be shown to have negligible effects must be included.

The following sections summarize work that has been done in this study to estimate the likelihood of criticality for SNF disposal in DPCs. Section 2.4.1 discusses increasing the reliability of the disposal overpack, a moderator exclusion strategy. Section 2.4.2 discusses possible in-package configurations should the waste package become flooded by groundwater. Section 2.4.3 analyzes the effect on reactivity from chlorine (as chloride) in the groundwater, then Section 2.4.4 describes the occurrence of saline groundwater in different types of potential repository host media. Section 2.4.5 presents the results of as-loaded criticality calculations for SNF in 215 existing DPCs stored at eight power plant sites (or former sites), taking into account the possibility of flooding with fresh water or with chloride brine. Finally, Section 2.4.6 discusses an evaluation of fillers that could be injected into existing DPCs, primarily for criticality control.

^b For the purposes of this report and this study, it is assumed that the regulatory framework for the disposal of SNF in DPCs will be similar to existing site-specific regulations 40 CFR 197 and 10 CFR 63.

2.4.1 Overpack Reliability

“Early failure” is a hypothetical condition assigned to a small fraction of waste packages in repository performance assessment, for which undetected defects in manufacture are assumed to cause accelerated containment failure (e.g., by accelerated corrosion processes). In a previous performance assessment (DOE 2008) the overall probability of early failure from all causes identified was approximately 10^{-4} per waste package. The consequence of early failure was assumed to be complete failure to perform any containment functions starting at repository closure. Integrated over approximately 10,000 waste packages, this represented a high probability of early failure for each probabilistic repository realization. Extrapolating these results to direct disposal of DPCs in saturated geologic settings with groundwater of fresh composition, early failure could lead to a high probability of at least one criticality event. To determine whether and how this extrapolation could be improved, the previous analysis was reviewed, methods to address the top drivers of early failure probability were identified, and the previous analysis was reviewed in light of recent information on modeling human reliability (Groth et al. 2015). A summary of that review is presented here.

2.4.1.1 Results from Previous Analysis of Early Failure

In the previous analysis (SNL 2007) the probability of early failure of a waste package outer corrosion barrier due to manufacturing defects was analyzed by a traditional probabilistic risk assessment (PRA) approach with event trees to model failure scenarios and fault trees to model the root causes of failures. In total, thirteen defect causes were documented: weld flaws, base metal flaws, improper weld filler material, improper stress relief for lid (low plasticity burnishing), improper heat treatment, improper weld-flux material, poor weld-joint design, contaminants, improperly located welds, missing welds, handling-induced defects, emplacement errors, and administrative or operational errors. Six of those causes were screened out on low probability or low consequence. Administrative or operational errors were treated as contributors to the other failure mechanisms. The remaining causes that were analyzed for waste package early failure were:

1. Weld flaws
2. Improper base metal selection
3. Improper heat treatment of outer corrosion barrier shell
4. Improper heat treatment of outer corrosion barrier lid
5. Improper stress relief of outer corrosion barrier lid
6. Waste package mishandling damage
7. Improper weld filler material.

Six of these causes (items 2 through 7) were modeled using event trees and fault trees. Weld flaws were modeled separately using physical models, and the results were not combined with the other early failure causes. Each of the six failure mechanisms was modeled as the initiating event in an event tree. For all event trees, the target end state(s) was “DAMAGED-WP.” The event trees also contained one to three events that would identify the occurrence of the failure mechanism and lead to a “REJECTED-WP” end state. Figure 2-30 shows one of the event trees from the earlier analysis (SNL 2007) and Table 2-9 summarizes the level of detail developed in all six models. As can be seen, the failure mechanism was decomposed at a high level (low detail). Both pivotal events in this tree were directly assigned probabilities of occurrence (i.e., they do not have associated fault trees). The most complex event trees from this analysis

contained four pivotal events after occurrence of the failure mechanism. The pivotal events and basic events in the event trees and fault trees are largely human-caused. Most of these events were quantified with the Technique for Human Error Rate Prediction (THERP) methodology.

The calculations performed in the previous analysis were replicated in this review, and were found to have been performed correctly. However, the level of decomposition of the manufacturing process was quite general and typical of screening-level analyses. The failure mechanisms considered were mostly human failure events with one human-driven opportunity for recovery. There were no events in the model that credited engineered systems designed to prevent or mitigate the effects of human errors.

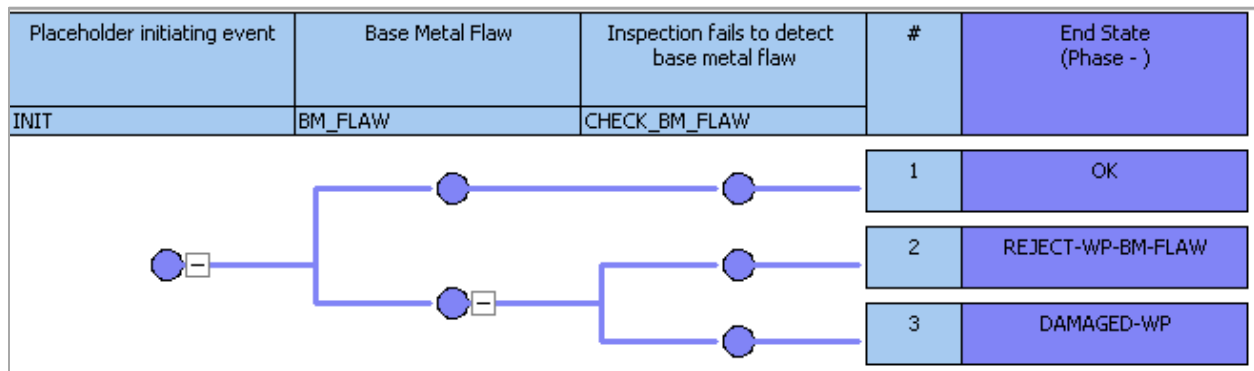

Figure 2-30. Representative event tree from the 2007 analysis showing level of decomposition for the occurrence of a base metal flaw failure mechanism.

Table 2-9. List of event trees in the 2007 analysis.

Number of >>>	Top events in event tree	End states in event tree	Damaged-WP end states	Fault trees	Direct input of probability	Basic events in fault trees	Distribution used for probability
Improper base metal selection	2	3	1	0	2	--	Lognormal
Improper heat treatment of outer corrosion barrier	5	6	2	4	1	2 2 2, 3	
Improper heat treatment of outer corrosion barrier lid	5	6	2	3	2	2 2, 3	Lognormal
Improper stress relief of outer corrosion barrier lid (low plasticity burnishing)	3	4	1	1	2	3	Lognormal
Waste package mishandling damage	2	3	1	1	1	8	Lognormal
Improper weld filler material	2	4	1	0	2	--	Lognormal

For this review, the computer program SAPHIRE was used to re-calculate the probabilities shown in Table 2-10. Note that three processes have failure probabilities roughly two orders of magnitude greater than the other four, namely: heat treatment of the shell, heat treatment of the lid, and low plasticity burnishing.

Table 2-10. Event tree end state results for the six failure mechanisms analyzed in SAPHIRE.

Event Tree	Probability in SAPHIRE (mean)	Probability in SAPHIRE (point estimate)	Probability in SAPHIRE (median)
Base metal flaw	1.251e-7	1.25e-7	7.960e-8
Heat treatment shell	3.726e-5	3.234e-5	1.423e-5
Heat treatment lid	3.497e-5	3.106e-5	1.354e-5
Low plasticity burnish	3.769e-5	4.290e-5	7.274e-6
Mishandling	9.708e-7	9.60e-7	2.857e-7
Weld filler flaws	1.251e-7	1.25e-7	7.960e-8
Total Damaged-WP (Sum of above)	1.11E-04	1.075e-04	3.55E-05

SAPHIRE was then used to conduct an importance analysis of the early failure model to identify the primary drivers of the probability of failure. Importance measures provide quantitative means for understanding how model parameters (e.g., failure mechanisms) affect reliability. These importance measures can provide insight into which components dominate the reliability calculation, which components are safety-critical, and how much reliability improvement could result from significant changes in a single component. In general, the best practice is to use one risk-reduction focused measure, and one risk-increased focused measure, and compare the results from both analyses.

Two of the four importance measure available in SAPHIRE were used to conduct the importance analyses: Risk Reduction Ratio or Interval (RRR/RRI), and Risk Increase Ratio or Interval (RIR/RII). These two importance measures are defined using the following definitions:

- $F(x)$ is the original probability of the end state ($p\{\text{Damaged-WP}\}$)
- $F(0)$ is the probability of the end state with the event probability set to 0 (perfectly reliable).
- $F(1)$ is the probability of the end state with the event probability set to 1 (failed)

Risk Reduction Ratio (RRR) or Interval (RRI) are two related measures expressing how much risk would decrease if the basic event probability were zero (i.e., the component is perfect and never fails). Both measures are also referred to as risk reduction worth (RRW). RRI is also called inspection importance because it denotes which components are most important to inspect.

$$RRR = F(x) / F(0)$$

$$RRI = F(x) - F(0)$$

When RRR equals 1.0, then there is no reduction in risk. Larger RRR values indicate larger decreases in risk if the component is made more reliable.

Risk Increase Ratio (RIR) or Interval (RII) are two related measures expressing how much risk would increase if the basic event probability is equal to 1 (i.e., the component fails). Both measures are also referred to as RAW (Risk Achievement Worth).

$$RIR = F(1) / F(x)$$

$$RII = F(1) - F(x)$$

When RIR=1.0, the risk stays the same. Larger RIR values denote larger increases in risk if the component fails.

The SAPHIRE code was used to conduct an importance analysis on the DAMAGED-WP end state from the previous analysis (SNL 2007). Eight basic events were discussed in that analysis, and the top five were evaluated for both types of importance measures (Table 2-11). Two processes dominate the unreliability of the waste package: heat treatment and low plasticity burnishing (LPB); this is seen in both the event tree results (Table 2-10) and in the importance measure results (Table 2-11).

Table 2-11. Importance measure results for the top drivers of canister early failure (values for the top drivers are in bold).

Name	#	Prob.	RRR (RRI)	RIR (RII)	Description
HT_OPERATOR_ERROR	7	3.00E-03	1.81 (4.81E-05)	149 (1.59E-02)	Heat treatment process operator fails to respond to alarm
LPB_CHECK	3	1.60E-01	1.66 (4.29E-05)	3.10 (2.25E-04)	Inspection fails to detect LPB failure after LPB process
LPB_ACR	3	8.10E-02	1.66 (4.29E-05)	5.53 (4.87E-04)	Checker detects operator's failure to respond to annunciator
LPB-OPERATOR	1	3.00E-03	1.57 (3.89E-05)	121 (1.29E-02)	Operator fails to responds to annunciator
HT_INSPECT	6	1.60E-01	1.18 (1.66E-05)	1.81 (8.71E-05)	Inspection detects improper heat treatment cooldown?
LPB-IC	1	3.00E-04	1.04 (3.89E-06)	122 (1.30E-02)	Instrumentation & control system fails to alarm
TIMER_FAILURE	4	1.20E-04	1.02 (1.80E-06)	140 (1.49E-02)	Timer alarm fails to alarm
LPB-SENSOR	1	1.00E-05	1.00 (1.30E-07)	122 (1.30E-02)	Pressure monitor to LPB hydraulic system fails

Based on the RRR, the five events that would most improve the reliability of the canister are: HT_OPERATOR_ERROR, LPB_CHECK, LPB_ACR, LPB-OPERATOR, and HT-INSPECT. These five events are the top candidates for improvements, because they have the greatest impact on the mean probability of early failure.

Unfortunately, the RRR results indicate that no single change to the system would drive disposal overpack unreliability below 10^{-8} failures/package. The highest RRR in the early failure analysis is 1.81, for HT_OPERATOR_ERROR (heat treatment process operator fails to respond to an alarm). This RRR indicates that risk would reduce by a factor of 1.81 if the probability of HT_OPERATOR_ERROR was 0 (i.e., the operator performed perfectly). This type of change is

not sufficient to reach the low-probability screening threshold for overpack early failure. Additionally, it is unlikely that any human event could be made perfect; in many human reliability analysis (HRA) methods, the lowest human error probability (HEP) available is approximately 10^{-5} to 10^{-6} .

Based on the RIR results, the five events that would most reduce reliability of the canister are: HT_OPERATOR_ERROR, TIMER_FAILURE, LPB-IC and LPB-SENSOR and LPB-OPERATOR. The RIR results indicate that these five events are critical aspects of reliability assurance in the DPC process. If any of these events were removed, the mean probability of early failure would increase by two orders of magnitude.

2.4.1.2 Challenges, Opportunities, and Research Directions

There are numerous modeling conservatisms in the previous early failure analysis. First, the PRA model used to calculate the early-failure probabilities includes a simple representation of the capability to detect defects and to initiate recovery or restorative actions during the manufacturing process. There are no events in the model that credit engineered measures designed to prevent or mitigate the effects of human errors. Second, the THERP method used in the study for HRA (NRC 2003b) was developed several decades ago and does not reflect the current state-of-the-art. This older approach is inconsistent with more recent understanding of human behavior and the relationship between that behavior and performance of an industrial system.

A promising opportunity for improving the previous modeling approach is to develop a new PRA model at a more rigorous level of detail, using an updated HRA approach. Two NRC HRA methods, A Technique for Human Event Analysis (ATHEANA) (NRC 2000a), and Integrated Decision-Tree Human Event Analysis System (IDHEAS) (NRC 2012) could be used. Another opportunity would be to update the probabilities using a newer HRA method. As shown in the importance analysis results (Table 2-11), updating any single probability in the model would not substantially reduce the probability of early failure. However, the use of a new HRA method would systematically change all of the probabilities in the model. A third option for increasing the reliability of the overpack involves designing, installing, and crediting engineered systems that prevent or mitigate the effects of human errors, and designing the manufacturing process to include additional checks or monitoring systems during critical aspects of the process (e.g., during heat treatment and low plasticity burnishing). From a reliability perspective, adding well-designed monitoring systems to the disposal overpack manufacturing process could permit significant (several orders of magnitude) reduction in the unreliability of the canisters.

It is currently unclear whether eliminating conservatisms in the early failure probability model, implementing the suggested updates to the model, and implementing an enhanced manufacturing process for a single corrosion-resistant engineered barrier would reduce the probability of early failure below 10^{-8} per disposal overpack. Such reduction could allow early failure of the waste package to be excluded from the postclosure performance assessment. A backup approach could be to design independent, redundant corrosion-resistant barriers, and credit engineered systems that prevent or mitigate human errors in the manufacture of each. The joint probability of significant defects could be significantly reduced. Whether or not early failure is excluded from performance assessment, better understanding of the probability of early failure (and resulting criticality events) would be helpful in analyzing risk from criticality events.

2.4.2 Canister and Basket Degradation and Configuration

To determine the potential for criticality in a DPC, an evaluation of criticality control parameters relevant to disposal of SNF in DPCs was conducted to understand the impacts of key parameters and sensitivities on system reactivity. A series of analyses was performed with representative, as-loaded DPCs containing PWR and BWR fuel (210 PWR DPCs and 5 BWR DPCs were analyzed), to understand the magnitudes of system reactivity changes caused by material degradation, changes in geometry, and groundwater chemistry impacts.

The potential for criticality begins with waste package breach (or early failure) and flooding by groundwater. Once groundwater enters a DPC, neutron moderation will increase, but subcriticality will be maintained by the neutron absorber material. The neutron absorber (e.g., panel) material used in most existing DPCs is Boral[®], composed of B₄C particles and aluminum Alloy 1100 that are hot-rolled together to form a neutron-absorbing core. This core is then bonded to two outer layers of aluminum Alloy 1100. Various corrosion tests have been performed on this material because it is used in existing canisters and in spent fuel pools. Tests conducted for fuel-pool chemical conditions showed a 0.28 mil-per-year rate of cladding material loss, which equates to about a 40-year service life in the presence of water, before the neutron-absorbing layer begins to degrade (EPRI 2008). Considering that the repository performance period is likely to be at least 10,000 years, it is likely that the Boral[®] neutron absorber material will fail to perform its criticality control function if the package is breached and the internals are exposed to groundwater.

While different geologic settings and material degradation mechanisms might yield a large number of potential configurations, two stylized configurations representing degraded states have been selected and analyzed. The degradation mechanisms for both neutron absorber and basket structure components over repository timeframes are not well understood, but these stylized configurations are conservative representations of interim stages in progressive degradation of the basket:

- Total loss of neutron absorber from unspecified degradation and transport processes.
- Loss of the internal basket structure (including neutron absorber components) resulting in elimination of assembly-to-assembly spacing.

With careful use these are intended to bound most credible configurations that could occur during the postclosure performance period. The nature of basket degradation should be revisited in the future when corrosion data are available for site-specific disposal conditions.

Criticality analyses were performed using these configurations (herein called degradation scenarios) for DPCs flooded with fresh water, and with groundwater containing different dissolved aqueous species (Banerjee et al. 2015). First, the reactivity effect from gradual loss of the neutron absorber material was analyzed (Banerjee et al. 2015). Figure 2-31 presents the reactivity reduction in terms of negative Δk_{eff} (i.e., change in neutron multiplication factor) for a 32-PWR canister as a function of ¹⁰B areal density in the neutron absorber panels, assuming the DPC is flooded with fresh water. For all the cases, Δk_{eff} for each step was calculated with respect to the k_{eff} corresponding to 0% of the minimum ¹⁰B areal density. This 32-PWR canister analyzed for Figure 2-31 contains 17×17 fuel assemblies. The analysis used a uniform loading, i.e., all fuel assemblies were identical in all 32 locations. Figure 2-31 indicates that loss of neutron absorber up to a certain threshold ¹⁰B areal density would not significantly increase reactivity. However, when the loss of neutron absorber passes a threshold, significant reactivity increase is expected.

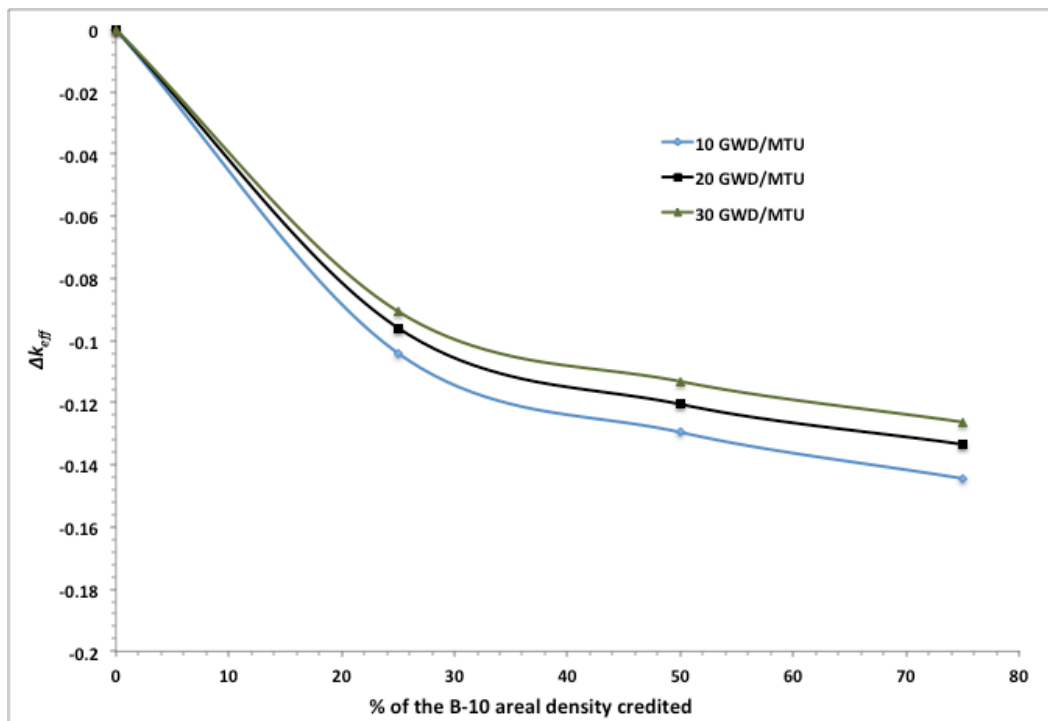

Figure 2-31. Reactivity impact of ¹⁰B areal density variation.

2.4.3 Impact of Chlorine in Groundwater on SNF Reactivity in DPCs

As noted above, flooding with groundwater is necessary before there can be a significant likelihood of DPC criticality. However, the groundwater (or pore water) in the host geologic setting will contain various dissolved aqueous species. Dissolved solutes in groundwater could: 1) act as neutron absorbers (e.g., ³⁵Cl and ⁶Li); and 2) displace moderating elements (e.g., by decreasing the number density for H₂O). Various geologic settings for a repository are under consideration, including crystalline or hard rock types, sedimentary rock (e.g., clay/shale), and salt (Hardin et al. 2012). Reviews of groundwater literature (Wang et al. 2012; Winterle et al. 2012) show that dissolved species in groundwater vary widely (see Section 2.4.4). It was observed that the following are the most common dissolved aqueous species in various pore water compositions:

Ca, Li, Na, Mg, K, Fe, Al, Si, Ba, B, Mn, Sr, Cl, S, Br, N, and F.

The reactivity effect from each dissolved aqueous species was analyzed separately by varying the concentration over a wide range to assess the impact on system reactivity. These reactivity curves, expressed as functions of concentration, can be used to determine the reactivity impact for a specified change in the concentration of any element (Banerjee et al. 2015). The results determined that Cl is the only naturally abundant, neutron-absorbing element in groundwater that can offer significant reactivity reduction.

Among the dissolved aqueous species listed above only Cl, Li, and B have the potential to significantly decrease reactivity because of their large neutron absorption cross-sections, and Cl

is by far the most effective based on its abundance in groundwater (as chloride). Figure 2-32 presents the impact of Cl concentration in groundwater on the reactivity of DPCs for the two stylized degradation configurations. The stylized scenarios were analyzed using uniform loading with different burnup levels (Banerjee et al. 2015). The negative Δk_{eff} indicates reactivity reduction with respect to the k_{eff} for flooding with fresh water.

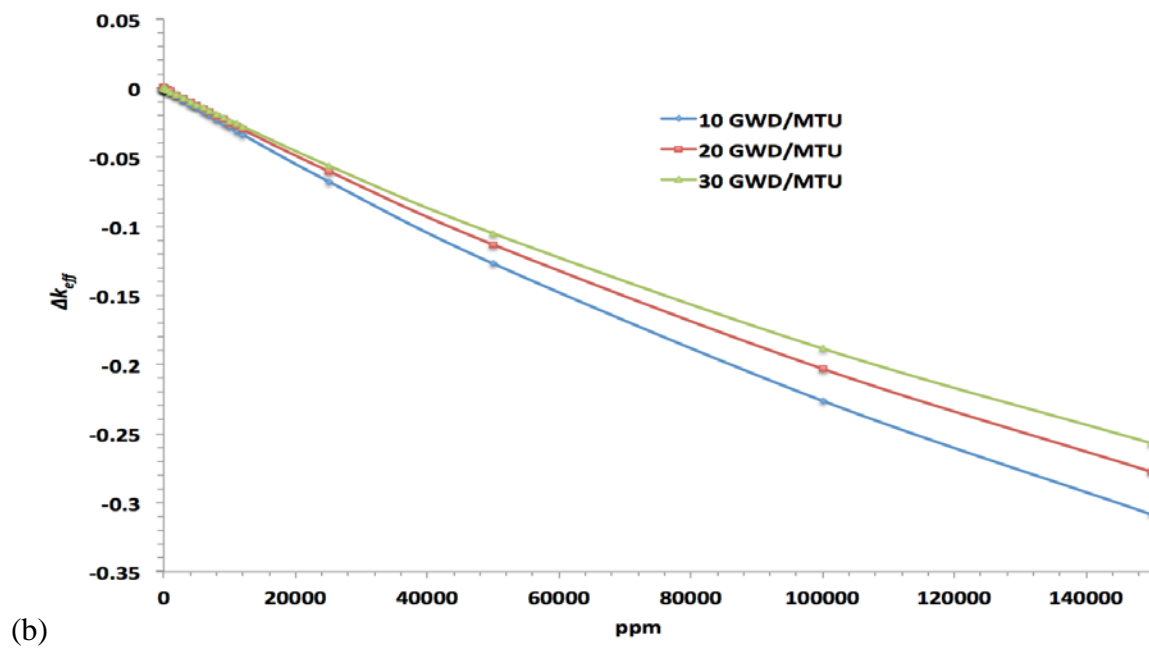
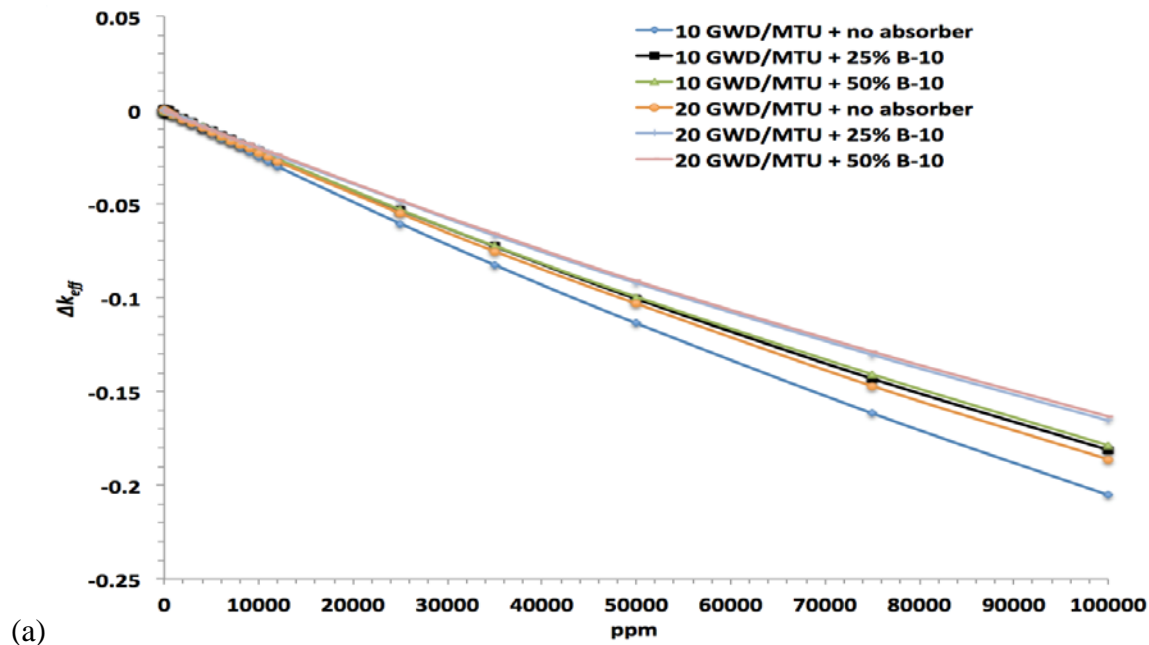

Figure 2-32. Reactivity impact of Cl concentration in groundwater: a) for different levels of neutron absorber; (b) for degraded basket configuration with different burnup levels.

Because of the large potential negative reactivity effect of Cl, a simplified hypothetical high-reactivity configuration was analyzed to further investigate the effect. The configuration includes complete loss of basket structure and loss of lattice arrangement (Figure 2-33). It is not intended to be realistic, but was developed as a conservative configuration to estimate the lower limit on Cl concentration in groundwater that would be needed to maintain subcriticality. This configuration consists of intact fuel rods from the fuel assemblies distributed on a triangular pitch within the canister boundary, and the following assumptions:

- Fuel rods from 32 17×17 assemblies (8,448 rods) were dispersed throughout the canister system, and adjusted to 8,619 rods so that an infinite hexagonal array at the specified pitch completely fills the canister.
- Guide tubes are not represented.
- The fuel rods are modeled as fresh UO₂ fuel with 4 wt% and 5 wt% ²³⁵U enrichment, and also with three uniform burnup distributions of 10, 20 and 30 GW-d/MTU.

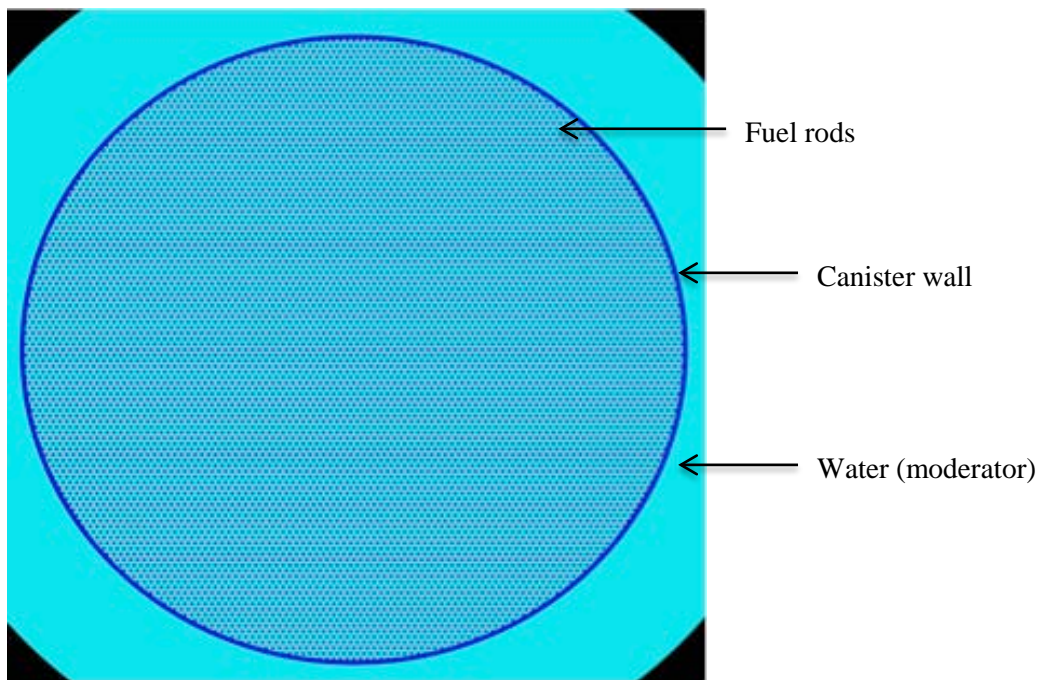

Figure 2-33. Simplified hypothetical high reactivity configuration.

Figure 2-34 presents the reactivity as a function of Cl concentration for this configuration. A saturated NaCl brine has a concentration of approximately 6 molal (~158,000 ppm on this scale), which could ensure subcriticality of fresh fuel with 4% enrichment, or irradiated fuel with 5% enrichment and at least 10 GW-d/MTU burnup. Because concentrated Cl brine would be needed to ensure subcriticality of these cases, the bounding-type approach is useful mainly for consideration of DPC direct disposal in salt.

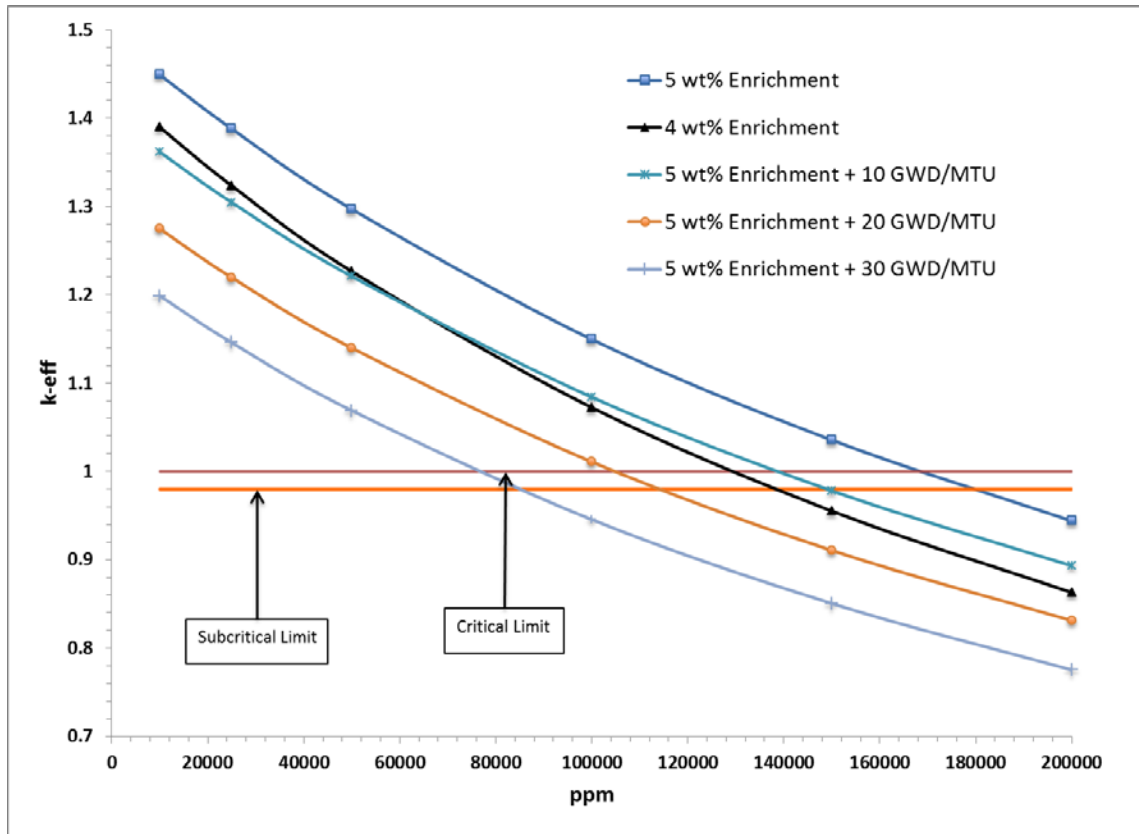

Figure 2-34. Reactivity impact of Cl concentration in groundwater for high reactivity configuration.

2.4.4 Occurrence of Saline Groundwaters

To address the apparent importance of saline groundwaters to postclosure criticality control, a survey of groundwater composition in different types of potential host media was undertaken by Frank Perry of Los Alamos National Laboratory (Hardin et al. 2014a). The following discussion focuses first on crystalline and clay/shale media, then on saliniferous formations such as the evaporite sequence at the WIPP.

Previous analyses showed that chlorine (as chloride) concentration in groundwater, in the range 10,000 to 33,000 mg/L, could have a significant effect on as-loaded criticality of existing DPCs (Section 2.4.5.2). Accordingly, the survey identified and discussed occurrences of groundwater with chloride concentrations equivalent to seawater (19,000 ppm on this scale), and concentrations of at least 2 molal (as NaCl; 62,000 ppm).

High-salinity pore waters occur at depth in both crystalline rock and shale under certain geologic conditions. Pore waters with chloride concentration greater than that of 2 molal NaCl are common in geologically ancient crystalline basement terranes at depths greater than 500 m. These saline waters primarily originated through a long history of water-rock interactions following infiltration by marine brines, for example, brines derived from overlying sedimentary rocks. The origin of highly saline waters in shale generally involves more complex processes, but shales with concentrations greater than the equivalent of 2 molal NaCl are likely to be found in

sedimentary basins with bedded salt deposits or histories of marine shale deposition that concentrated chloride through evaporative processes and post-depositional water-rock interactions. In both crystalline and sedimentary environments, highly saline waters tend to be old and stagnant as a result of density differences and low rock permeabilities that inhibit mixing with more dilute waters.

The correlation with age suggests that high-chloride waters may not be common in geologically young granites that occur more frequently in the U.S. (i.e., post-Archean) or for granites in tectonically active regions (potentially allowing more connectivity between shallow and deep waters). More data may be available for pore water compositions in major sedimentary basins in the U.S. that contain marine sediments. High-chloride shales have been documented in the Michigan Basin and likely occur in both the Appalachian and Williston Basins, although the extent of these occurrences is not well documented. Based on similarity of geologic environments, high-chloride shales would be expected to occur in the Permian Basin, but no data have been identified to support this conjecture. In summary, high-chloride brines are found in some, but not all crystalline and clay/shale media that are potentially suitable repository host media.

For evaporite sequences such as those found in the Permian Basin, pore waters are saline because chloride salt layers are common, and permeability of the entire evaporite sequence is low (thus inhibiting dissolution and leaching). Thus, waters postulated to flow into the WIPP repository from interbeds within the Salado section were assigned the composition of high-chloride brines (see DOE 2004, Chapter 8). As noted above, in saliniferous basins the presence of salt layers affects the pore water composition in interbedded strata, even those with clastic origin.

2.4.5 Criticality Calculations for As-Loaded DPCs

The analyses presented in this section assume that waste package breach occurs at a relatively early time in the repository, allowing flooding of the canister to produce significant moderation and to degrade the internal components. Note that if water can be excluded or significantly delayed from entering the repository or from entering a package, there is little potential for criticality. Criticality analyses are performed (using fresh water) for the two stylized degradation scenarios introduced above (loss-of-absorber and basket degradation) and for as-loaded DPCs presently located at eight power plant sites in the U.S. The eight sites include seven PWR sites and one BWR site (Site F). Table 2-12 summarizes the attributes of the analyzed sites.

Table 2-12. Reactor sites for which dry storage canister disposal criticality was analyzed.

Reactor site	A	B	C	D	E	F	G	H
Decommissioned	✓	✓	✓	✓		✓		
Operating					✓		✓	✓
PWR	✓	✓	✓	✓	✓		✓	✓
BWR						✓		

DPC fuel baskets generally have one of two designs: the “egg-crate” type fabricated from metal plates in reticular arrangement, and “tube-and-spacer-disk” structures fabricated from thin-wall tubes (holding each fuel assembly) held in place by a series of thicker, perpendicular metal spacer disks. Illustrations of the different basket structures are available (Hardin et al. 2013a). The egg-crate structures could retain structural integrity if the plates retain much of their mechanical thickness during long-term exposure to groundwater. The tube-and-spacer-disk structures could continue to hold fuel assemblies apart for significantly longer time than the egg-crate designs even after degradation of the tubes, by the action of the spacer disks. In this analysis, the stylized scenarios from Section 2.4.2 were assigned to DPC types based on whether basket structural components are mostly stainless steel (loss-of-absorber scenario) or carbon steel (basket degradation with loss of absorber). All sites except Site C use DPCs with stainless steel structural components, and were assigned the loss-of-absorber scenario. For Site C, degradation of the coated carbon steel spacer disks was assumed, resulting in close-packed configuration of the tubes holding fuel assemblies, in addition to the loss of neutron absorber material. Degraded material (corrosion products) was not represented in the models as their composition and formation rate would likely depend on site-specific groundwater composition, and it is conservative to omit them from the criticality calculations.

2.4.5.1 Baseline Analysis of As-Loaded Criticality with Fresh Water

The final safety analysis report (FSAR) or safety analysis report (SAR) for a particular storage or transportation system documents the bounding models and calculations used to demonstrate that the system meets the regulatory requirements under all credible and hypothetical conditions (e.g., 10 CFR 71.55 and 71.73). Note that FSAR/SAR calculations and specifications are typically bounding in nature, so that canisters or casks can be certified for a range of fuel characteristics without imposing complicated loading requirements. As a result, licensed DPC-based systems are generally associated with uncredited reactivity safety margins. The calculations summarized in this report replicate those documented in the FSARs to the extent practical, but with assembly-specific, as-loaded fuel characteristics, to estimate uncredited margin. This section shows how uncredited margin could offset reactivity increase from canister flooding and stylized degradation scenarios.

The approach described here is commonly referred to as taking burnup credit. Burnup credit criticality safety analysis for SNF in storage systems requires the determination of isotopic number densities for fuel assemblies at the time of discharge from the reactor and as a function of decay time. Assembly-specific burnup has been factored into each of the canister evaluations presented. The SNF isotopic compositions used for the as-loaded criticality evaluations are those recommended (DOE 2003) for disposal burnup credit criticality analyses. Table 2-13 presents the principal set of isotopes for postclosure burnup credit criticality analysis. Following the previous approach (DOE 2003) the principal isotopes for burnup credit include a subset of the isotopes present in irradiated commercial fuel. They were selected considering the nuclear, physical, and chemical properties of the irradiated commercial fuel isotopes, such as cross-sections and half-lives of the isotopes; the amounts present in irradiated fuel; and the physical state (solid, liquid, or gas); as well as volatility and solubility. Isotopic decay and in-growth, as well as relative importance of isotopes for criticality (combination of cross-sections and concentrations), were also considered in this selection process. No isotopes with significant positive reactivity effects (fissile isotopes with significant concentrations) were removed from the set. Thus, the selection of isotopes for burnup credit analysis is considered conservative.

Table 2-13. Principal set of isotopes for burnup credit postclosure criticality analysis.

⁹⁵ Mo	¹⁴⁵ Nd	¹⁵¹ Eu	²³⁶ U	²⁴¹ Pu
⁹⁹ Tc	¹⁴⁷ Sm	¹⁵³ Eu	²³⁸ U	²⁴² Pu
¹⁰¹ Ru	¹⁴⁹ Sm	¹⁵⁵ Gd	²³⁷ Np	²⁴¹ Am
¹⁰³ Rh	¹⁵⁰ Sm	²³³ U	²³⁸ Pu	^{242m} Am
¹⁰⁹ Ag	¹⁵¹ Sm	²³⁴ U	²³⁹ Pu	²⁴³ Am
¹⁴³ Nd	¹⁵² Sm	²³⁵ U	²⁴⁰ Pu	

Computational analyses of as-loaded DPCs was evaluated using a comprehensive and integrated data and analysis tool—UNF-Storage, Transportation & Disposal Analysis Resource and Data System (UNF-ST&DARDS)—developed and managed by Oak Ridge National Laboratory (Scaglione et al. 2013) through a collaborative effort among several national laboratories and industry participants. UNF-ST&DARDS employs the depletion, decay, and criticality analysis modules of the SCALE code system (ORNL 2011).

The major conservative assumptions applied to the as-loaded criticality analyses are as follows:

- **Depletion** – Depletion parameters that affect neutron energy spectrum during irradiation are conservatively selected to produce SNF isotopic compositions that result in increased residual reactivity levels at discharge (e.g., including the burnable poison rod inserted in the fuel assembly guide tubes throughout the irradiation time for PWR, control blade insertion for BWR).
- **Criticality** – Control elements (control rod assemblies, burnable poison rod assemblies, etc.) are conservatively not represented in the criticality calculations except for Sites E and H. Additionally, burnup is not credited for damaged fuel in damaged fuel cans (DFCs). Instead, the canister’s design basis assembly or bounding assembly for the DFC, as determined in the FSAR, is modeled for damaged fuel. However, high burnup assemblies (>45 GW-d/MTU) in a DFC are modeled as intact with accumulated burnup. Bounding burnup-dependent axial profiles were used for PWR assemblies (Wagner et al. 2003a), and a uniform axial burnup profile was used for BWR assemblies (Banerjee et al. 2015).

The as-loaded neutron multiplication factors (k_{eff}) as functions of time, for DPCs from all eight sites analyzed by Banerjee et al. (2015), for the loss-of-absorber scenario are summarized in Figure 2-35. As discussed above, the degraded basket analysis was performed for Site C (Figure 2-36). Results are provided for times distributed between calendar years 2001 and 9999 (i.e., approximately 8000 years). An important result of these calculations is that most of the DPCs are subcritical in the loss-of-absorber scenario. Note that after the initial decrease, reactivity increases gradually to 10,000 years and beyond due to radioactive decay and in-growth, reaching a second reactivity peak (Wagner et al. 2003b).

The main sources of reactivity margin (relative to licensing design basis analyses) investigated in this analysis include:

- Burnup credit for actinide and fission product nuclides previously demonstrated to exhibit a significant effect on fuel reactivity.
- Use of actual as-loaded DPCs.
- Radionuclide inventory decay.

For simplicity, computational biases and uncertainties were not developed but were simply assumed to be 2% (Δk_{eff}), resulting in a subcritical limit of $k_{eff} < 0.98$, which is used here as a representative acceptance criterion for as-loaded calculations. However, if analyses like these will support future disposal licensing, additional validation and assessment of biases would be needed (see Appendix B).

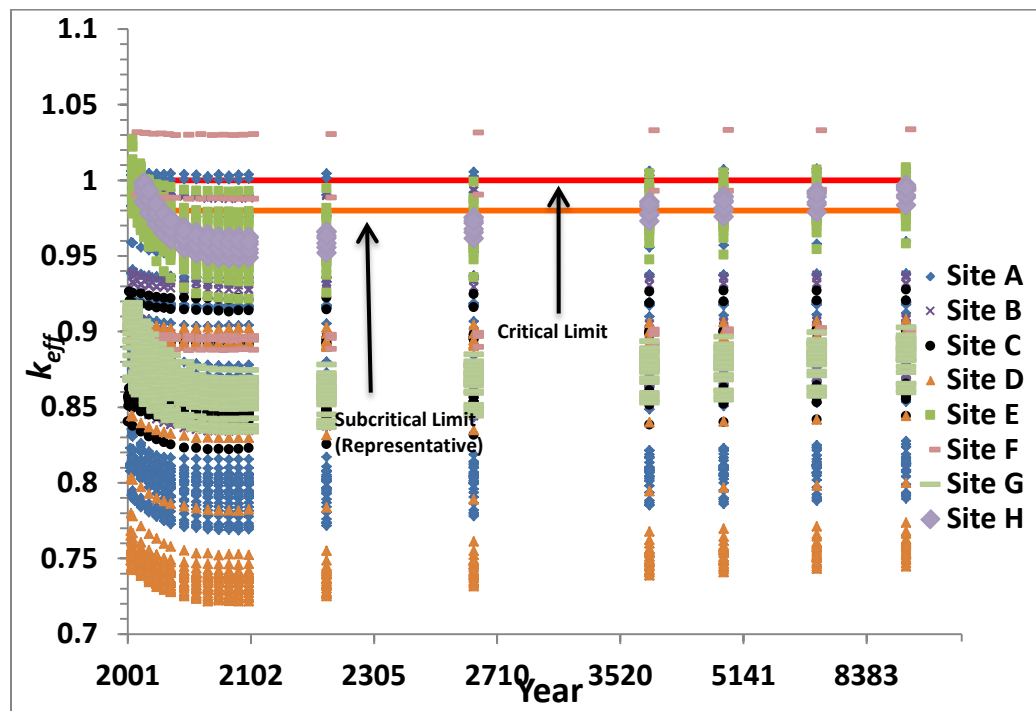

Figure 2-35. k_{eff} vs calendar year for the loss-of-neutron-absorber case based on actual loading.

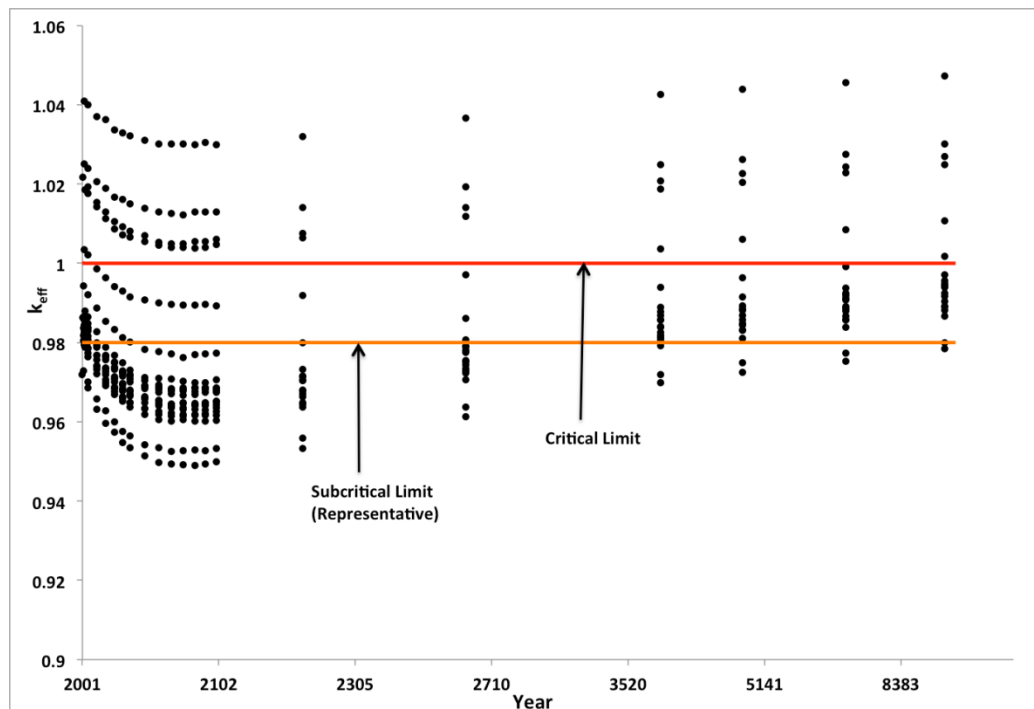

Figure 2-36. k_{eff} vs calendar year for the Site C basket degradation case based on actual loading.

2.4.5.2 As-loaded Criticality Analysis with Chloride in Groundwater

The impact of Cl (as NaCl) concentration in groundwater on the reactivity of as-loaded DPCs is summarized here from Banerjee et al. (2015). Figure 2-37 presents the reactivity as a function of NaCl concentration, in calendar year 9999, for the DPCs from Sites A, B, E, F, and H (loss-of-absorber scenario) and from Site C (basket degradation scenario). Only DPCs that yielded k_{eff} of 0.98 or greater with fresh water were analyzed with the NaCl solution (i.e., Sites D and G had no DPCs above 0.98 for the loss-of-absorber configuration). Figure 2-37 indicates that a ~0.9 molal solution of NaCl (approximately twice the concentration in seawater) would be sufficient to maintain k_{eff} below 0.98 for all DPCs at the sites analyzed. It is also important to note that a saturated NaCl brine, as typically encountered in salt formations, has a concentration of approximately 6 molal, so that all DPCs analyzed would be subcritical.

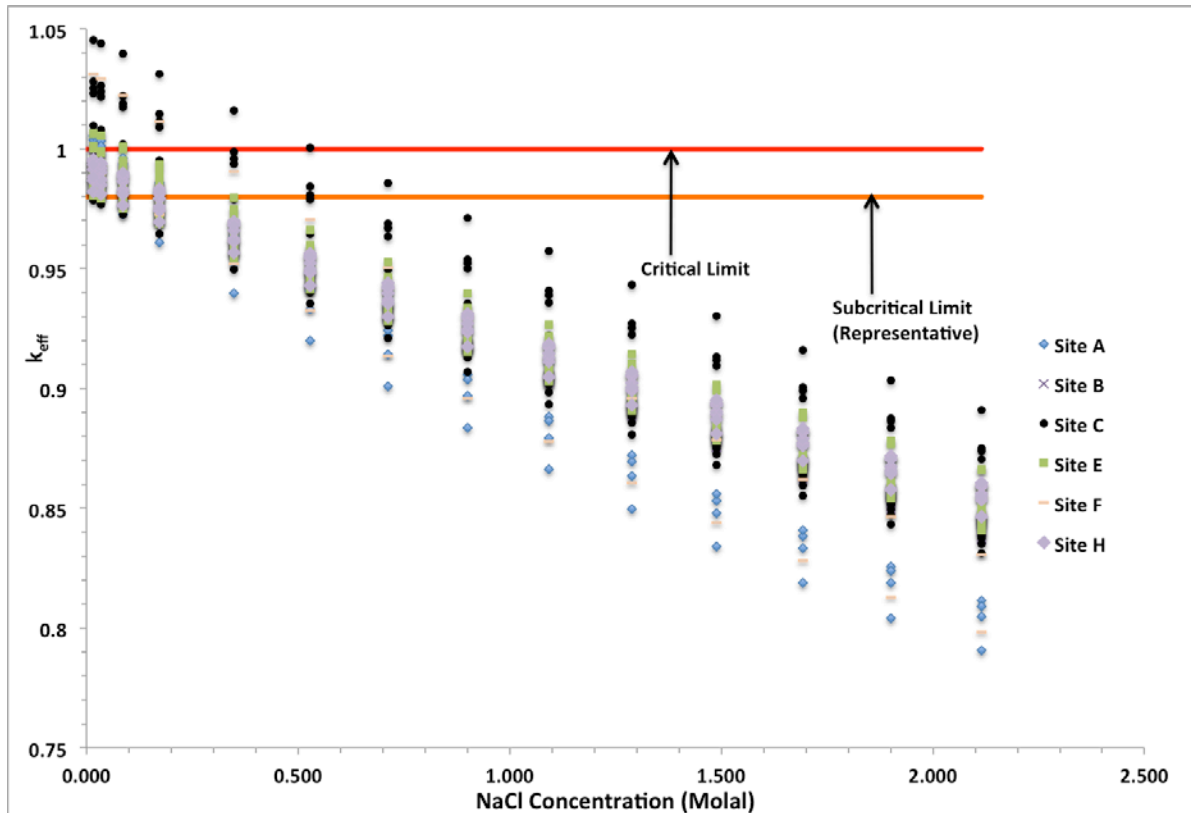

Figure 2-37. k_{eff} vs NaCl concentration for the loss-of-neutron-absorber at Sites A, B, E, F and H, and degraded basket (Site C) cases based on actual loading.

Table 2-14 summarizes the results from the as-loaded DPC analysis. A total of 215 DPCs were evaluated from the eight sites. All 215 DPCs would exceed the subcritical limit for the loss-of-absorber scenario configuration, when using the FSAR (design-basis) fuel loading limits, generally fresh fuel. Taking into account the as-loaded assembly burnup characteristics, only 34 of 215 are critical for the loss-of-absorber scenario (using this scenario for Site C), flooded with fresh water. This increases to 53 of 215 if the degraded basket scenario is used for Site C. Note that these percentages are based on the DPCs evaluated to-date, which include many from decommissioned sites, which predominantly represent first-generation DPCs. The proportions of existing DPCs that are found to be critical for these scenarios are expected to increase as more DPCs are evaluated.

Table 2-14. Final statistics in the year 9999 for sites analyzed.

Description	Site A	Site B	Site C (loss of neutron absorber)	Site C (degraded basket)	Site D	Site E	Site F	Site G	Site H	Σ^c
Number of canisters ^a	60	39	20	20	34	26	5	24	7	215
Number of canisters with $k_{eff} > 0.98$ (design basis analysis)	60	39	20	20	34	26	5	24	7	215
Number of canisters with $k_{eff} > 0.98$ (as-loaded analysis)	4	3	0	19	0	18	2	0	7	53
Maximum k_{eff}^b	1.0079 ±0.00026	1.00309 ±0.00022	0.92761 ±0.00026	1.04728 ±0.00024	0.90809 ±0.00024	1.00842 ±0.00025	1.03377 ±0.00021	0.90264 ±0.00020	0.99678 ±0.00019	
Approximate chlorine requirement ^d	12,000 (mg Cl per liter)	12,000 (mg Cl per liter)	N/A	31,000 (mg Cl per liter)	N/A	13,000 (mg Cl per liter)	19,000 (mg Cl per liter)	N/A	12,000 (mg Cl per liter)	
^a Note that the number of canisters corresponds to the number evaluated and does not necessarily represent the total at a particular site ^b Source: UNF-ST&DARDS unified database. ^c Sum across all sites (counting Site C only once). ^d On this scale seawater is ~19,000 mg Cl/liter (0.5 molal), a 2 molal NaCl brine is ~62,000 mg Cl/liter, and a 6 molal NaCl brine (saturated at 20°C) is ~158,000 mg Cl/liter.										

2.4.6 DPC Filler Materials

This section summarizes an evaluation of treating DPCs prior to disposal by adding filler materials (Jubin et al. 2014). Addition of filler materials could prevent potential postclosure criticality by moderator displacement and/or neutron absorption. Note that in this discussion the terminology “criticality control” implies maintaining subcritical conditions.

The most promising filler materials for use in DPCs to control postclosure criticality were found to be: 1) low-melting-point metals such as Pb/Sn, Sn/Ag/Cu or Sn/Zn; and 2) small solid particles such as glass beads, including glass beads that contain depleted or natural uranium (e.g., as UO₂). In the case of low-melting-point metals, provisions would be needed to pre-heat each DPC and its contents to a uniform temperature of 225 to 250°C to ensure that the liquid flowed to all parts of the container.

Two potential filling methods are possible: 1) using the drain and vent ports accessed by removing the welded covers; and 2) removal of the lid from each DPC. The first approach would use both ports to optimize filler delivery and allow exit of the displaced phase. For solid particulate fillers, some provision for vibrating the entire DPC could be needed to ensure

adequate settling and complete filling. The second approach would involve cutting open the canisters using a method such as lathing (skiving). Depending on the approach chosen, a separate hot cell facility could be needed for receipt, opening, filling, closure and final testing of the filling result. In any case, containment would be required to control potential radiological releases when DPCs were opened and during filling and subsequent closure operations.

An important conclusion from criticality analyses of filler materials was that a filler, irrespective of whether it is a neutron absorber, should occupy most of the free DPC volume to provide criticality control over the duration of the repository performance period.

2.5 DPC Direct Disposal Cost

This section summarizes estimates of the total cost for disposal of 140,000 MTU of commercial SNF in DPCs, using four different disposal concepts (SRNL 2015). The disposal concepts are based on the description by Hardin and Kalinina (2015). Cost estimates for vault-type cavern disposal were not generated because of the relatively immature nature of the concept. Cost estimation also considered disposal concepts with smaller (non-DPC) waste packages, for which results are not presented here.

Estimates of total system life cycle cost include design, construction, start-up, operations, closure, and postclosure costs associated with receipt, handling, packaging and emplacement of the waste, backfill and closure of drifts, and continuing support for regulatory compliance and performance/environmental monitoring. The estimates do not include activities associated with site selection, pre-packaging of waste in suitable thin-wall containers for disposal (except DPCs which are already packaged), decay storage, transportation of the waste containers to the repository, changing applicable regulations, completing licensing activities, or community consultation.

Major factors contributing to repository cost include:

- The number of waste packages to be handled and emplaced
- The waste package design and materials of construction
- The repository size (determined by package and drift spacings needed to meet thermal objectives for specific host media)
- Drift backfill and closure materials and methods
- The need for post-emplacment ventilation of disposal drifts for heat removal

Table 2-15 provides the salient details for DPC direct disposal, for the four disposal concepts (SRNL 2015). The repository depth for these four disposal options was assumed to be 500 m. DPCs would be received and packaged in repository-specific disposal overpacks. Waste packages would be transported via shaft or ramp (depending on the concept) and emplaced horizontally on the drift floor. Costs include preclosure ventilation (except for the salt concept), and backfilling where required. High and low estimates (Table 2-16) are based on a set of contingency factors applied uniformly to all options.

This page intentionally left blank.

Table 2-15. Properties of four DPC disposal concepts for which cost estimates were developed (SRNL 2015).

Property	Salt	Hard rock, unbackfilled, open	Hard rock, backfilled, open	Sedimentary, backfilled, open
Hydrologic Setting	Nominally saturated	Unsaturated	Saturated	Saturated
Ground Support Material	Minimal (bolts and wire cloth)	Rock bolts, wire cloth and shotcrete as needed	Rock bolts, wire cloth and shotcrete as needed	Rock bolts, wire cloth and shotcrete, with steel sets and additional shotcrete as needed
Seals and plugs	Shaft & tunnel plugs and seals	Shaft & tunnel plugs and seals	Shaft & tunnel plugs and seals	Shaft & tunnel plugs and seals
Overpack material	Steel	Corrosion resistant (e.g., Hastelloy or titanium)	Corrosion resistant (e.g., Hastelloy or titanium)	Corrosion resistant (e.g., Hastelloy or titanium)
Overpack total wall thickness	5 cm	7 cm	7 cm	7 cm
Drift diameter	4 m H × 6 m W	6.5 m	4.5 m	4.5 m
Spacing (plan view)	30 m (drifts); 30 m (packages, center-center)	81 m (drifts) ; 10 m (packages, center-center)	70 m (drifts); 20 m (packages, center-center)	70 m (drifts); 20 m (packages, center-center)
Backfill material	Crushed “mine-run” salt	NA	Granular and compacted bentonite with admixtures and/or controlled hydration to increase thermal conductivity after emplacement	Granular and compacted bentonite with admixtures and/or controlled hydration to increase thermal conductivity after emplacement
Line or point loading	Point	Point	Point	Point

Table 2-16. Cost estimates for DPC disposal concepts.

Disposal Concept	Estimated Cost (\$M) – Low	Estimated Cost (\$M) - High
Salt Repository Concept	31,600	43,000
Hard Rock Unsaturated, Unbackfilled Open Concept	43,900	58,700
Hard Rock Backfilled Open Concept	40,000	53,500
Sedimentary Backfilled, Open Concept	43,800	58,700

3. DISCUSSION OF FURTHER INFORMATION NEEDS

This discussion is intended to guide future feasibility evaluations, and especially those that could be performed once site-specific information is available for one or more potential repository sites. It draws on previously developed insights (Hardin et al. 2014a, Section 10). Organization of the information is based on the same four topics used since inception of DPC direct disposal technical feasibility evaluations: safety (postclosure waste isolation), engineering feasibility, thermal management, and postclosure criticality control.

3.1 Safety

Important factors that would help to ensure postclosure safety for DPC direct disposal (Hardin et al. 2013a, Section 11) include: 1) diffusion-controlled radionuclide transport in the engineered and natural barriers; 2) near-field transport properties that are relatively insensitive to temperature, or for which temperature effects can be modeled with confidence; 3) limited radionuclide transport in backfill and/or the host rock (particularly the far field); and 4) attributes that limit potential postclosure criticality. These characteristics would actually benefit any geologic repository. When prospective repository sites are identified, site-specific data will support more resolution of differences in postclosure safety associated with DPC direct disposal. The following sections elaborate some of these factors and identify site-specific data that would be helpful in future decisions concerning DPC direct disposal.

3.1.1 Modeling Waste Isolation Performance

A need was identified early in the feasibility evaluation for performance models that can discern differences in repository waste isolation performance for direct disposal of commercial SNF in DPCs compared to packaging purpose-designed for disposal. Such differences would be associated with waste package capacity, details of inner canister construction (compared to DPCs), and thermal loading. The evaluation found that the required realism and model fidelity would require site-specific information, or in other words, that generic (non-site specific) models would reflect assumed site conditions that would overwhelm the differences sought in the assessment. Accordingly, generic calculations were not performed in the evaluation. Some general insights were provided on how performance might differ with DPC direct disposal, and a description of a performance assessment modeling base case was developed (Hardin et al. 2013b).

Another finding of the evaluation is that cementitious materials are needed for repository construction, and that additional technical basis is needed to describe the effects of these materials and their degradation products on waste isolation. Cementitious materials were not used in proximity to waste disposal, in a previous repository design (DOE 2008). A geologic repository for all projected U.S. spent fuel could involve up to 300 km of tunnels, especially in clay/shale media (Hardin et al. 2014a, Section 2). With tunneling on this scale, economical materials such as concrete or shotcrete are desirable for construction and ground support. Possible impacts on long-term waste isolation performance from use of cementitious materials, need to be understood for development of these disposal concepts to proceed. This need applies to all geologic disposal concepts, but may be more critical for DPC disposal because larger opening spans, waste package and drift spacings, support loads, etc. could be involved.

3.1.2 Effects of Higher Capacity DPCs

Once breach of a DPC-based waste package occurs, more SNF would be exposed to the disposal environment than for breach of a smaller container. The onset of subsequent diffusive radionuclide transport is controlled by aqueous concentration, not total contaminant mass released (or quantity of SNF exposed), unless transport from the waste form to the environment is advective. Advection is expected to be insignificant for low-permeability host media (except possibly for human intrusion scenarios) but might occur locally due to natural spatial variability, and/or in response to changes in boundary conditions. The possibility for advective transport is a factor of interest in the safety of DPC direct disposal, related to quantity of SNF per package, because of the increased potential to produce spikes in transport of mobile radionuclides (e.g., fission products) to the environment.

3.1.3 Postclosure Criticality Control (for non-salt sites)

The foregoing modeling discussion does not include criticality which must be either included or excluded from the safety analysis on technical grounds. Section 2.4 summarizes the basis for excluding criticality for all DPC-based waste packages in a salt repository. For other disposal concepts criticality can be excluded based on moderator exclusion by engineered and natural barriers, or based on as-loaded burnup-credit analysis of waste packages flooded with groundwater using stylized degradation scenarios. A majority of existing DPCs may be subcritical following the latter approach, especially with saline groundwater, using the analysis summarized in Section 2.4.

For site conditions and as-loaded DPC fuel characteristics that lead to criticality of flooded packages ($k_{eff} > 0.98$) criticality could still be excluded for current DPC designs through the following measures:

- Update analysis of human reliability in engineered barrier manufacture and handling (e.g., disposal overpacks) thus lowering the probability of “early failure” that could lead to flooding and criticality.
- For unsaturated disposal environments, use engineered barriers that prevent water from flooding waste packages even after they are breached by corrosion or other processes.
- Develop the repository concept to minimize the hazards from disruptive events, and the probability of damage to waste packages and other engineered barriers (e.g., use of backfill to mitigate seismic ground motion hazards).

As pointed out by BSC (2003) existing DPCs are typically licensed without accounting for burnup credit. This is helpful to the case for disposability because it means that burnup credit analysis can take advantage of uncredited reactivity margin. However, it also means that SNF burnup was not measured for DPC loading, and that reactor records of assembly burnup would ultimately be the basis for disposal criticality analysis. The accuracy of such records could be a factor in implementing DPC criticality analyses for disposal.

3.2 Engineering Feasibility

3.2.1 Aging Management for DPCs

Commercial SNF is projected to be produced over at least 95 years in the U.S. With a permanent disposal solution still many years away, this means that once a repository is operating, that fuel age will vary from recently discharged to at least 50 years. Any fuel characteristic that depends

on age out-of-reactor will also vary over this range. For DPC direct disposal the range may be further extended if longer aging is needed to meet repository emplacement thermal power limits. For a repository to begin operations, disposal may require that the repository is organized in panels, each of which can be closed before repository operations are finally complete.

This feasibility evaluation started with an assumption that SNF would age for up to 100 years from reactor discharge, followed by emplacement in a repository and optional ventilation for up to 50 additional years (Hardin et al. 2013a, Section 2). Subsequent thermal management analyses showed that for some disposal concepts, longer aging and/or ventilation would be needed especially for higher burnup SNF. The assumed 150-year maximum age at repository panel closure could be met with the salt concept and the hard rock unsaturated, unbackfilled concept (Section 2.3). For all disposal concepts, but especially those that would extend this maximum age significantly (e.g., to 300 years), there is a coupled concern that DPCs in storage will maintain containment until it is time for emplacement in a repository.

Logistical simulation of cooling time is important for any proposed concept for DPC direct disposal. Such simulations project the full quantity and characteristics of commercial SNF to be produced in the U.S., and estimate the duration of SNF decay storage (i.e., aging) needed to meet emplacement power limits. If aging is limited, then they can show what emplacement power limit must be accommodated by the disposal concept, for successful disposal. Logistical simulations also track SNF from discharge to disposal, and associate fuel characteristics such as burnup, with system metrics such as aging time until disposal. The tools can be used to identify the impacts from any new requirements on fuel age and burnup in storage or during transportation that could limit the implementation of DPC direct disposal.

3.2.2 Disposing of DPCs Designed for Vertical Storage in a Horizontal Orientation and Vice Versa

The NUHOMS® (Transnuclear, Inc.) DPCs are designed only for horizontal transfer, after initial vertical loading in a fuel pool. These DPCs do not include vertical lifting features that would be used for loading into a disposal overpack in vertical orientation. As observed by BSC (2003): “If the NUHOMS DPCs are also to be directly disposable, a method of loading them into waste packages will also need to be developed.”

3.2.3 Underground Transport and Emplacement Capability

Surface handling and packaging technologies for DPC-based waste packages are within the state-of-practice in the nuclear industry, but the means of transporting these packages underground and emplacing them in designated disposal drifts are developmental. Shaft hoist, ramp transporter, standard rail, and funicular options have been identified (Hardin et al. 2013a, Section 3.4) but each of these would require engineering development including design, fabrication, and testing. In most cases the equipment would be the largest of its kind, and could incorporate novel design features. It would need to be licensed under a repository regulation that would likely be probabilistic (i.e., similar to 10 CFR 63), without specific experience history to inform event probabilities. Accordingly, challenges include engineering development and the basis for probabilistic licensing. Such a first-of-a-kind licensing basis would need to incorporate the protective aspects of monitoring, feedback, and automatic control systems used in modern system designs (see Hardin et al. 2013c).

In-drift emplacement of DPC-based packages directly on the floor of emplacement drifts, possibly using a pallet or milled rock surface for support, is the simplest mode of emplacement. A ramp transporter system could also be designed for emplacement, eliminating the need for one or more transfer stations underground. This combined approach was used in the conceptual design for a transport-emplacement-vehicle (DOE 2008).

Self-shielded waste packages are inherently safer for workers, especially for backfilling emplacement drifts, and for remediating off-normal events such as roof collapse or equipment failure. Self-shielding was used in the original SNF salt repository concept (DOE 1987) and is part of the Swiss reference SNF disposal concept and the Belgian reference HLW disposal concept (Hardin et al. 2013a). Heavy shielding would be part of the underground transporter and emplacement machine design for unshielded packages, so the main difference in making it part of the package instead, would be the additional material, fabrication, and shipping costs.

3.2.4 Overpack Design and Development

The disposal overpack could be the most important part of the engineered barrier system for DPC direct disposal, from the perspective of postclosure criticality control. For concepts that include additional engineered water diversion or containment barriers, such as the hard rock unsaturated, unbackfilled concept, those additional barriers could also be included in this discussion.

The corrosion behavior of DPC shell and basket materials, and prospective disposal overpack materials, in representative disposal chemical environments, was reviewed in this study (Ilgen et al. 2014a; Hardin et al. 2014a, Sections 8.1 through 8.5). In general, corrosion-allowance and corrosion-resistant overpack materials are available and have been studied previously for repository waste packaging applications. These studies should continue, including laboratory corrosion testing especially once site-specific information is available for one or more prospective repository sites (Ilgen et al. 2014b).

Overpack reliability is discussed, with recommendations, in Section 2.4.1. The cost and effectiveness of dual-barrier, high-reliability overpacks for DPC direct disposal should be investigated further when site-specific information is available. For example, failures from manufacturing defects could be dominated by waste package failures from disruptive events, depending on the engineered barrier system design and site characteristics, potentially obviating any benefit from improving manufacturing reliability.

Another insight gained from review of previous reliability analyses is that failures due to undetected manufacturing defects do not occur instantly, or necessarily early during the repository performance period. Waste packages will be inspected at the time of repository closure to ascertain that they are intact and sealed. Subsequent “early failures” could be essentially rate-dependent corrosion failures that will take hundreds to thousands of years to cause overpack breach. More realistic characterization could reduce the importance of these processes in screening of events such as criticality that depend on waste package breach during the regulatory performance period (e.g., 10,000 years).

3.2.5 Technical Challenges Associated with Extended Repository Ventilation

The open, ventilated disposal concepts for DPC direct disposal in hard rock and sedimentary rock depend on underground opening stability for at least 50 years, and possibly much longer if needed for thermal management. The variability of rock types and host geologic settings means

that site-specific information is needed to evaluate stability. This could be especially important for clay-rich sedimentary media (clay, mudstone, siltstone, shale, etc.) which exhibit wide variability in properties. Existing underground openings in prospective repository host formations should be examined and monitored to understand stability that can be expected, and to determine maintenance requirements for a repository.

3.3 Thermal Management

Potential host geologic media can be categorized according to thermal conductivity and peak temperature tolerance. Salt formations have the highest conductivity (approaching 5 W/m-K) and temperature tolerance of at least 200°C, limited by the tendency for decrepitation at approximately 250°C or higher (which may be reflected in a lower temperature limit). Hard rock consisting of granite, volcanic tuff, or other igneous or metamorphic rock types, typically has thermal conductivity in the range 2 to 3 W/m-K, and peak temperature tolerance of approximately 200°C, limited by weakening from thermally driven microfracturing. A third category consists of sedimentary rock types which have much lower thermal conductivity (typically 1 to 2 W/m-K) and peak temperature tolerance of approximately 100°C, limited by changes in the physical state of clay minerals or intergranular cements. Considering host rock thermal response only, the first two categories are more straightforward and would require shorter duration of decay storage and repository ventilation, for DPC direct disposal. One important question discussed below in relation to coupled processes is the effect on waste isolation of heating a narrow region of the host rock around each waste package to peak temperatures greater than 100°C. In addition, the use of backfill presents other challenges as discussed below.

Peak temperatures for larger-capacity packages could be controlled by decay storage and repository ventilation, but post-peak temperature would remain higher for hundreds to thousands of years (Hardin et al. 2013a). SNF aging attenuates short-lived fission products, but larger packages contain more heat-generating actinides with intermediate half-lives, such as Am-241. Thus, although peak host rock temperature (at the drift wall) could be managed and might be the same for different size packages, for those that contain more SNF the peak temperature further into the host rock may be greater, and elevated temperature could persist longer throughout the host rock. In backfill, the extent (e.g., in the axial direction between packages) and duration of elevated temperatures could also be greater. These differences could eventually impact radionuclide transport if the controlling rock and backfill characteristics are thermally sensitive.

3.3.1 Backfill Thermal Limits

Thermal modeling for this study has shown that if backfill is installed in emplacement drifts at repository closure (fuel age 150 years out-of-reactor), that peak temperatures will approach 150°C for low-burnup SNF and may exceed 200°C for high-burnup (see Section 2.3). Peak temperature limits of 100°C or lower for clay-rich backfill materials have been selected by some international programs (summarized by Hardin et al. 2012) but a limit above 100°C could help to shorten the duration of surface decay storage and repository ventilation. Also, the effects on waste isolation performance from locally higher peak temperatures in the backfill, in the immediate vicinity of waste packages, need to be evaluated to optimize thermal management (especially using site-specific host rock properties).

Another approach to limiting backfill peak temperature would be to formulate backfill with higher thermal conductivity. For example, peak backfill temperatures could be lowered significantly by saturating the clay buffer or backfill material after waste emplacement (see Section 2.3 for calculations with backfill thermal conductivity of 1.43 W/m-K). Saturating the entire repository at in situ groundwater hydrostatic pressure could avoid boiling at temperatures of 200°C or greater. Hydration of dehydrated smectite clay in a repository is a process that involves a period of thermally driven, multi-phase, thermal-hydrologic-chemical process activity (Hardin and Voegele 2013, Appendix B).

Another option to increase backfill thermal conductivity is admixtures of granular clay with sand, crushed rock, or materials such as graphite (Hardin et al. 2012; 2013a). Hydration after emplacement is needed for such materials to achieve maximum thermal conductivity, which could approach 2 W/m-K. There are two R&D questions here: how to formulate the backfill, and how to emplace and hydrate it so as to achieve the desired thermal properties. A different option would be to use low-permeability, non-swelling, non-clay materials that do not require hydration but have greater temperature tolerance (Hardin and Voegele 2013, Appendix B).

3.3.2 Sinking of Heavy Packages in Plastic Host Media (e.g., salt)

Recent analysis has shown that vertical movement (sinking) of heavy waste packages in salt, associated with thermal expansion of the host rock and thermally activated creep, may not be significant (Clayton et al. 2013). However, the Munson-Dawson constitutive model used for that analysis, and most other constitutive models currently used in salt creep analysis, are not conditioned on low-stress, low strain-rate test data. Such data are needed for evaluating the potential for slow vertical movement of waste packages (e.g., 1 meter per 10,000 yr; Hardin et al. 2014a, Section 7). Low-stress, low strain-rate data have been collected in Europe on a limited basis because up to a year is needed for each test. For emplacing large, heavy DPC-based waste packages in salt, an effort is needed to understand and corroborate the European results, and to provide new data for salt from the U.S. The investigation should involve modeling the mechanical response of any proposed host salt sequence, including (for bedded salt) anhydrite interbeds and clastic units that may not exhibit such low strain-rate deformability.

3.3.3 Process Models for Thermally Driven Coupled Processes

The effects from thermally driven processes are potentially important to waste isolation performance in all potential host media, and for various disposal concepts not limited to DPC direct disposal. However, these effects are particularly important for clay-rich host media and clay-based engineered materials that can undergo chemical and physical changes in the presence of water, at elevated temperature. Processes such as hydration, swelling, cementation, dilation, and creep can be pronounced in these media.

Thermal management considerations include how thermal loading affects the hydration time for clay backfill (which in turn affects thermal conductivity), the alteration of clay-based materials, and development of a DRZ around emplacement openings. The possibility of over-heating a narrow region of host rock around each waste package to temperatures greater than 100°C could have a significant impact on repository layout and therefore on cost (Hardin et al. 2013a, Section 5.3). Models that address these considerations for clay-rich sedimentary media have been demonstrated (Hardin et al. 2014a, Section 6) but are still under development. The complexity of phenomenological responses in clay-rich materials means that model development and completion will depend on the availability of site-specific data.

Thermally driven coupled processes may be important for other repository host media as well. One example is brine movement in response to rock deformation and thermal loading in a salt repository. Whereas brine migration has been identified as potentially important to waste isolation performance, updated analysis of coupled processes may show that it is not. Salt formations contain only small amounts of water. The lithostatic stress state achieved after repository closure cannot drive brine movement. Thermal gradients decay over hundreds of years, and moisture that migrates into the near field will be consumed by corrosion of steel waste packages (as proposed here for DPC disposal). These processes have been evaluated, and multi-year model development is in process (Kuhlman 2014).

3.4 Postclosure Criticality Control

The postclosure criticality discussion in Section 2.4 can be summarized as follows, organized according to the disposal concept and type of host geologic medium:

- **Salt concept** – Groundwater in salt formations is usually saturated chloride brine, such that all existing DPCs would be subcritical if flooded (and storage-only canisters, if they can be transported to the repository). Criticality consequence analysis would likely not be needed. Site-specific information is important to verify that formation waters contain sufficient chloride, and that inadvertent human intrusion or other disruptive events would either not cause flooding, or would cause flooding only with chloride brine.
- **Hard-rock unsaturated, unbackfilled open concept** – A range of approaches is available starting with moderator exclusion by the waste package and other long-lived engineered and/or natural barriers acting together. If flooding of DPCs cannot be excluded based on low probability, then the as-loaded criticality analysis approach described below and in Section 2.4 could be used, possibly with site-specific groundwater composition.
- **Hard-rock backfilled, open concept (including cavern-vault)** – Assuming that backfill would be used because of saturated groundwater conditions, the as-loaded criticality analysis approach would be appropriate, possibly with site-specific groundwater composition.
- **Sedimentary backfilled, open concept** – Also assuming that backfill would be used because of saturated groundwater conditions, the as-loaded criticality analysis approach would be appropriate, possibly with site-specific groundwater composition.

For non-salt concepts, for any DPCs still shown by the analysis to be critical when flooded, a criticality consequence approach could be applied as discussed below.

3.4.1 Continued Criticality Analysis for As-Loaded DPCs

For postclosure criticality control with any disposal concept, information collection is needed for all existing and future as-loaded DPCs. The UNF-ST&DARDS tool should be used to compile information on DPC configuration and fuel characteristics, and perform all of the types of criticality analyses described in Section 2.4. Confirmation of subcriticality may even be important for the salt repository concept, using site-specific information on groundwater composition. More than 2,000 DPCs have been deployed in the U.S., and only the 215 DPCs described in this report have been analyzed for postclosure criticality potential using stylized degradation scenarios. This gap is primarily due to sparse availability of as-loaded data for DPCs; the effort of handling the data and performing the criticality calculations is secondary.

3.4.2 Postclosure Criticality Consequence Analysis Approach

This section describes an approach that could be used to analyze the consequences from criticality events. If the consequences from an estimated number of events have no significant effect on waste isolation, as quantified using performance assessment that accounts for criticality-driven changes in the disposal system, then criticality could be excluded on low consequence. Criticality consequences could also be included in the regulatory performance assessment, based on validated technical analysis.

A framework for evaluating the risk from postclosure criticality, for DPC direct disposal, is outlined by Scaglione et al. (2014). That report presents a roadmap for analysis that can be adjusted as necessary based on site-specific information, and using interim results. Although site selection and considerable analysis effort would be needed to support a license application, the process described makes it possible to evaluate the likelihood of criticality and the potential impacts from criticality on key repository performance parameters.

The roadmap (Figure 3-1) identifies analysis activities that can be performed during repository site selection, for assessing postclosure criticality risk. Descriptions for these key activities are provided below.

Criticality Analysis Roadmap					
Feasibility Assessment	Identify sources of water and potential for pooling in DPC by host media				
	Perform DPC model development to establish baseline	Develop and apply misload analysis methodology	Assess radiolysis rates required for significant impact to in-package chemistry	Groundwater analyses for different geologies	Identify performance assessment parameters directly influenced by criticality consequence
	Review neutron absorber and basket material performance data for existing DPCs	Development of BWR burnup credit methodology		Evaluation of chemistry ranges inside DPCs and corrosion rates on primary components	Develop probability based sampling framework for generic distributions
	Perform envelope analysis on key parameters that lead to criticality	Evaluate probability of criticality		Develop geochemistry models accounting for in-package chemistry effects	Establish model for evaluating reaction kinetics and impacts on PA parameters
	Evaluate envelope parameters against geochemistry model results to refine credible range		Evaluate criticality consequence effects on repository distributions		Generate risk curves per influence parameter
Licensing Determination	Criticality validation (e.g., experiments with Cf in solution, relevant configurations)	Justify and incorporate site-specific parameter distributions		Justify use of non-bounding assumptions	Validate site-specific geochemistry models

Figure 3-1. Illustration of criticality analysis map.

3.4.2.1 Develop Criticality Consequence Methodology for Non-Salt Repositories

A number of models and software codes are available to describe and simulate aspects of a criticality event, but the capability to simulate criticality excursions in a geologic repository has not been demonstrated. Criticality scenario development and simulation with fully coupled nuclear dynamics and thermal hydraulics, and boundary conditions representing the geologic setting, are needed for consequence analysis. The capability to model the time-dependent reactivity feedback effects of Doppler broadening and moderator density changes in a discretized domain is needed to better understand and simulate the evolution of criticality events. Validated tools are also needed to evaluate modeling assumptions and for uncertainty analyses. Credible criticality scenarios need to be identified and analyzed to quantify parameters that describe the impacts on disposal system performance. The framework for criticality consequence analysis should be focused on impacts to repository model parameters that are important to overall waste isolation performance. The probabilities and consequences of criticality events, if significant to overall repository performance, would then be implemented into performance assessment using those parameters.

Categories of parameters relevant to repository performance that could be impacted by a criticality event include: radionuclide inventory, temperature, groundwater flow rate and spatial distribution of flow, waste form alteration, and radionuclide transport (changes in near-field geochemistry as affected by temperature, radiolysis, and transport). The progress of a criticality event would be strongly tied to water flow rates in and out of a DPC-based waste package. Heat generation and the episodic nature of criticality would impact waste package degradation and repository hydrogeology. Degradation of the DPC internals, possibly influenced by criticality, could determine when criticality ceases.

Based on previous work (e.g., Mohanty 2004) it is anticipated that the consequences of criticality in the repository would produce minor changes in the parameters that are important in performance assessment. However, significant effort is needed to quantify and validate the projected consequences, and to achieve acceptance of the results.

Once an integrated model is implemented, tested, and verified, scoping analysis of criticality consequences would be the next step. This analysis would identify the processes by which criticality could affect the repository engineered and natural barriers, and the parameters that describe and control those processes in performance assessment models. In particular, the analysis would identify process limits within which criticality can be sustained over time, and the potential impacts from heat generation, radiolysis, and transmutation on repository waste isolation performance.

3.4.2.2 Implement Criticality Probability Analysis for Non-Salt Repository

A number of activities could support analysis of postclosure criticality and are independent of repository host geology. These activities will inform estimates for the probability of criticality in different host geologic settings, and better focus future research efforts. They are briefly listed below; details can be found in the roadmap report (Scaglione et al. 2014):

- **Develop stylized scenarios for criticality analysis** – Document and justify stylized scenarios for analysis of non-degraded and partially degraded DPCs (e.g., loss-of-absorber and basket degradation). The current basis for degradation scenarios is described in Section 2.4.2, and further assessment is needed to describe and justify each one in

more detail. Basket degradation is of particular interest because DPCs differ widely in the thickness of basket components and the materials used. Future effort is needed to advance the conclusions reached here. Development of stylized scenarios should also select and document the performance period for screening features, events, and processes such as postclosure criticality (e.g., 10,000 years) and describe the potential impact on analysis results from other performance periods that could be proposed for new repository regulations. The likelihood of occurrence of in-package postclosure criticality is sensitive to the postclosure performance assessment screening period for features, events, and processes because of rate-dependent degradation of package internals (i.e., for the basket degradation case), and because the reactivity of typical SNF reaches a maximum at a fuel age of approximately 25,000 years (Wagner and Parks 2003).

- **Develop an in-package degradation model** – Develop a chemical and physical model of in-package degradation that can support the stylized scenarios for analysis of criticality probability and consequences. Such a model could account for the environment outside the package, the size of breaches in the disposal overpack, rate-dependent degradation of basket materials and SNF, mass balance, radiolysis, basket structural integrity, and chemical transport (e.g., advection and diffusion) into and out of a breached package.
- **Compile and analyze as-loaded DPC data** – Canister-specific data on DPC geometry and actual fuel loading, in the UNF-ST&DARDS tool, are also needed for criticality consequence analysis (Scaglione et al., 2013). This is in addition to using canister-specific as-loaded data for screening which DPCs have the potential for criticality after flooding with groundwater and degradation of neutron absorbers (Section 3.4.1).
- **Develop analysis methodology for potential SNF mis-loads** – Potential errors in fuel loading include misidentification of assemblies or misplacement of assemblies in a DPC. The possibility of mis-loads is acknowledged and addressed for storage and transportation analyses that use burnup credit, and was considered in previous repository criticality analyses (DOE 2008). The potential for mis-loads to impact criticality needs to be considered in the analysis of DPC direct disposal. Methodology development is needed specific to the existing and future inventory of DPCs, for example, to determine whether mis-loads should be considered deterministically or probabilistically.
- **Develop a burnup-credit approach for BWR SNF** – The NRC Interim Staff Guidance ISG-8 Rev. 3 (NRC 2002) is specific to PWR fuel. Similar guidance enabling burnup credit for BWR fuel in storage and transport analyses has not been developed. Regulatory standard review plans for SNF transport and dry storage (NRC 2000b; 2010) do not allow credit for BWR fuel burnup or credit for fixed burnable absorbers. The lack of information on operational fuel characteristics such as void, control blade, and fuel temperature histories, means there are insufficient data for code validation. A recent sensitivity study on BWR burnup credit (Mueller et al. 2013) can be used to support the envelope analysis described by Scaglione et al. (2014), but the BWR SNF burnup credit approach needs further refinement. Without a validated approach, the type of as-loaded burnup credit analysis used for PWR fuel in DPCs cannot be used for BWR fuel in DPCs.
- **Evaluate effects from radiolysis** – Degradation of DPC fuel baskets may depend on the extent of radiolysis, which can impact in-package chemistry. The potential for radiolysis comes mostly from alpha radiation, which is shielded from affecting the canister internals

unless the fuel is significantly degraded. If radiolysis does not affect basket degradation until the fuel is degraded, then it need not be considered because there is insignificant potential for criticality once the SNF is degraded (and collapsed into debris with less moderator).

3.4.3 Criticality-Control DPC Fillers

As indicated in Section 2.4.3.3, filling DPCs prior to disposal with materials designed to enhance criticality control is an alternative approach that could make DPC direct disposal more viable. Fillers could also potentially enhance waste isolation performance, heat dissipation, and structural stability of the fuel. This topic was previously identified as a key R&D need for DPC disposal evaluation (Hardin et al. 2013a). Jubin et al. (2014) indicated that there has been relatively little experimental work conducted on the filling of dry storage canisters with molten and particulate materials. Two recommended follow-on activities are:

- Assess the availability of candidate materials, and compatibility with the materials of DPC construction and with fuel assemblies
- Perform a demonstration of the proposed filling operation at a fractional scale

For the use of solid particles, tests similar to those conducted by Atomic Energy of Canada Limited could demonstrate the capability to fill voids within fuel assemblies and between compartments in DPCs. Such tests should look at both glass beads and glass beads containing uranium. Desired data would include packing density as a function of particle size, post-test identification of voids and particle size classification, and the need for vibration. For both liquid/molten and solid fillers, demonstrations are needed using access to both the drain and vent ports, and access only to the vent port.

If the use of fillers becomes a programmatic requirement, canister designs could be developed that would include modifications to reduce the time, cost, and complexity of filling operations.

4. SUMMARY OF RESULTS AND INFORMATION NEEDS

A common question regarding direct disposal of SNF in DPCs is: “How many existing DPCs and dry storage-only canisters could be disposed of in a geologic repository without re-packaging?” The answer depends strongly on postclosure criticality control. Thermal management constraints can be accommodated by longer decay storage or aging, and disposal concepts are available that could complete disposal of all DPCs with fuel age at emplacement of not more than 100 years (Section 2.3). Moreover, disposal solutions with better heat dissipation also have more flexibility for postclosure criticality control. Accordingly, the answer given here will be limited to criticality control considerations.

The following multi-part answer first assumes that DPCs can be disposed of only with exclusion of criticality on low probability. It then is expanded to include possible outcomes if criticality can be excluded on low consequence or if criticality consequences can be included in the performance assessment.

Salt repository – All existing DPCs and storage-only canisters could be subcritical in a salt repository when flooded with saturated chloride brine, unless: 1) burnup credit cannot be taken (e.g., for BWR fuel); or 2) breached waste packages could flood with groundwater substantially more dilute than saturated NaCl brine. In either of these cases virtually all canisters containing PWR SNF, and many containing BWR SNF could potentially be subcritical, based on interpretation and extrapolation of the as-loaded criticality analyses presented here.

Non-salt disposal concepts – Roughly half of DPCs containing PWR SNF could be found to be subcritical using as-loaded burnup-credit analysis. Most of these DPCs could be represented by the loss-of-absorber stylized scenario, but for those DPCs with structural components that readily corrode in groundwater (about 35% of existing PWR DPCs) the basket degradation scenario would apply and subcriticality would be more difficult to demonstrate. For BWR SNF an accepted approach is needed for burnup credit (uniform burnup profiles were assumed for Site F in this report). Assuming that a burnup credit approach is found and accepted for regulatory analysis, a similar proportion of BWR DPCs could be found to be subcritical. The DPCs analyzed in this study can be used as a sample: in Table 2-14, 162 of 215 DPCs overall are subcritical when flooded with fresh water. Making allowance for determination of calculation biases and mis-load effects, and for the early DPC designs used in the sample, roughly half of existing DPCs could be subcritical. This conjecture improves significantly if the groundwater has the chloride concentration of seawater or greater (in Table 2-14, 196 of 253 DPCs overall are subcritical when flooded with water at 19,000 mg Cl/liter).

If criticality can be excluded on low consequence, or if the consequences can be included in performance assessment, then virtually all DPCs and storage-only canisters could be disposed of using any of the repository concepts considered in this study. The approach could involve more management risk because criticality tends to be controversial and the technical approach described in Section 3.4 is developmental. However, as stated previously the possibility of using criticality consequence analysis in repository licensing was previously found to be acceptable (DOE 2003).

The information needs from Section 3 depend to varying extent on the disposal concepts, and may or may not depend on the availability of repository site-specific information. Table 4-1 presents a summary of information needs organized by disposal concept in a way that can be readily used for future decision making.

Table 4-1. Summary crosswalk of information needs for consideration of DPC direct disposal.

	Salt concept	Hard-rock unsaturated, unbackfilled	Hard rock backfilled (incl. cavern-vault)	Sedimentary backfilled
Safety				
Site-specific attributes: 1) Diffusion-controlled radionuclide transport in the engineered and natural barriers; 2) Near-field transport properties that are relatively insensitive to temperature, or for which temperature effects can be modeled with confidence; 3) Limited radionuclide transport in backfill and the host rock (particularly the far field); and 4) Attributes that limit potential postclosure criticality.	Site-specific information is needed to evaluate DPC direct disposal, for whichever disposal concept is considered.			
Performance models: Models that can discern differences in waste isolation performance for direct disposal of commercial SNF in DPCs compared to packaging purpose-designed for disposal. Such differences would be associated principally with waste package capacity, details of inner canister construction, and thermal loading. Generic models (non-site specific) could be improved, but the technical case for DPC direct disposal could ultimately depend on models populated with site-specific information.	Site-specific information is needed to evaluate DPC direct disposal, for whichever disposal concept is considered.			
Use of cementitious materials: Repository construction could be facilitated, at significantly lower cost and increased operational safety, with the use of concrete, shotcrete and cement-based grout in emplacement drifts or other locations that may interact after closure with waste packages or waste forms, or with radionuclide transport pathways from the repository. Generic analyses would be developed first, then updated when site-specific information becomes available.	Cementitious materials are not used in the salt repository concept (except in non-emplacment openings that cannot interact).	Potentially needed for cementitious materials, using relevant site-specific information to evaluate fate and transport of cementitious materials and leachate.	Definitely needed for cementitious materials used in construction, and using relevant site-specific information.	
Engineering Feasibility				
Aging management: Understanding of any fuel characteristic that depends on age, that could impact the viability of fuel management strategies that require extended decay storage.	Potentially needed if aging up to approximately 100 years is problematic because of canister or fuel condition.		Definitely needed because the combined duration of decay storage and repository ventilation could approach 300 years in backfilled concepts.	

	Salt concept	Hard-rock unsaturated, unbackfilled	Hard rock backfilled (incl. cavern-vault)	Sedimentary backfilled
Engineering Feasibility, continued				
<p>Logistical simulation: Projections of SNF production and cooling time for disposal are needed to compare disposal concepts and prospective sites. Logistical models need not be site specific, but should be updated, and may include site-specific transportation details.</p>	Information need is applicable to all disposal concepts, and may include site-specific repository location information.			
<p>Vertical handling of canisters designed for horizontal handling: As observed by BSC (2003): “If the NUHOMS® DPCs are also to be directly disposable, a method of loading them into waste packages will also need to be developed.”</p>	Information need is applicable to all disposal concepts, and is generic (non-site specific).			
<p>Surface-to-underground transport: Shaft hoist, ramp transporter and funicular options are conceptual. A system for transporting DPCs would likely be the largest of its kind, incorporating modern features for safety monitoring and automatic control, but without experience history in underground application.</p>	Information need is applicable to all disposal concepts, and is generic (non-site specific).			
<p>Emplacement vehicle for in-drift emplacement: Develop designs for emplacement systems in different media, emphasizing potential savings from running directly on rock or ballast floor surfaces in lieu of steel or reinforced concrete.</p>	Information need is applicable to all disposal concepts, and could be site-specific with respect to options for constructing the floor in emplacement drifts.			
<p>Self-shielding waste packages: Worker safety and system reliability issues could be improved if waste packages are self-shielding, especially where concepts call for backfilling of radiologically hot waste packages.</p>	Definitely needed for generic evaluation.	Potentially needed (but no backfilling of disposal drifts)	Definitely needed for generic evaluation.	
<p>Corrosion testing data for DPC basket materials: Corrosion testing is needed to reduce uncertainty on DPC basket degradation mechanisms and rates for chemically reducing conditions, for more defensible assignment of the basket degradation stylized criticality analysis scenario.</p>	Not needed due to low probability of criticality.	Potentially needed if reducing conditions persist after waste packages breach.	Definitely needed because reducing conditions are likely to prevail, and as-loaded criticality analysis is the first approach for criticality screening.	
<p>Corrosion testing data for corrosion-resistant overpacks: Test data are sparse for behavior of corrosion-resistant materials (e.g., Ti, Cu, Hastelloys) under chemically reducing conditions. Important for screening criticality in saturated, reducing conditions.</p>	Not needed because corrosion-allowance materials would be used; also criticality has low probability.	Not needed because overpack corrosion environment is oxidizing, for which better data exist.	Definitely needed for disposal concept development and repository performance modeling, with reducing conditions, and reliance on as-loaded criticality analysis.	

	Salt concept	Hard-rock unsaturated, unbackfilled	Hard rock backfilled (incl. cavern-vault)	Sedimentary backfilled
Engineering Feasibility, continued				
Overpack reliability (“early failure”) analysis: Potentially important for postclosure criticality control unless breach due to early failure is dominated by breach from other causes such as disruptive events, which depends on site-specific information.	Not needed due to low probability of criticality.	Potentially needed, if justified from site-specific information with respect to the incidence of overpack breach from all causes during the repository performance period.		
Underground stability for extended repository ventilation: Further consideration of 50 to 100 year opening lifetime, with minimal maintenance, depends on site-specific information such as that which could be collected from drill cores or existing tunnels.	Potentially needed, only for service drifts.	Potentially needed only if rock creep or “static fatigue” is important based on site-specific rock characteristics.		Definitely needed, using site-specific information.
Thermal Management				
Host rock properties: Further consideration depends on site-specific rock characteristics.	Potentially needed for confirmation of site-specific properties.		Potentially needed but thermal management will likely be dominated by backfill limits.	
Backfill properties, degradation, and temperature tolerance: Peak temperature tolerance on the order of 200°C, or significantly greater thermal conductivity (on the order of 1.43 W/m-K for saturated, compacted clay) is needed to limit decay storage time.	Not needed; crushed salt is understood and tolerance of 200°C is ample.	Not needed; backfill is not used.	Definitely needed, and may involve site-specific information if host rock has very low thermal conductivity, or if host rock derived material will be used in backfill.	
Sinking of heavy packages in plastic host media: A concern for bedded salt, even if the sinking velocity is on the order of 0.1 mm per year.	Definitely needed to assess the importance of recently published low-stress, low-strain rate creep data.	Not needed because hard rock will likely not creep, and the in-drift emplacement scheme will support waste packages at the drift floor (and not suspend them in another material such as backfill).		Potentially needed because some clay/shale media can creep (e.g., units of the Pierre Shale).
Process models for thermally driven coupled processes: Preliminary generic models have been demonstrated, but fidelity and validation are needed especially for sedimentary (clay/shale) media, which may exhibit significant responses to excavation, ventilation, heating, and hydration.	Potential need for predicting brine migration effects	Models exist (DOE 2008) but are site-specific and could be updated.	Definitely needed to represent backfill changes.	Definitely needed to model site-specific host rock responses, and backfill.
Postclosure Criticality Control				
Criticality analysis for as-loaded DPCs: Use the documented analysis approach with the UNF-ST&DARDS tool and stylized DPC degradation scenarios.	Potentially needed to confirm subcriticality using site-specific groundwater data.	Potentially needed using site-specific groundwater data, if moderator exclusion is ineffective.	Definitely needed as the first choice for criticality screening on low probability (and for limiting the predicted incidence of criticality events).	

	Salt concept	Hard-rock unsaturated, unbackfilled	Hard rock backfilled (incl. cavern-vault)	Sedimentary backfilled
Postclosure Criticality Control, continued				
Document stylized scenarios: Establish the loss-of-absorber and basket degradation scenarios as acceptable stylized scenarios for all DPCs. Justify selection of a repository performance period for criticality evaluations.	Information need is applicable to all disposal concepts, and is generic (non-site specific).			
In-package degradation model: Needed to model criticality consequences. Also needed for performance models discussed above. Slight sensitivity to site-specific information such as thermal properties and groundwater composition.	Not needed to analyze postclosure criticality using stylized scenarios.	Potentially needed for criticality consequence modeling if site-specific information is available.		
Develop mis-load analysis approach: Methodology development is needed specific to existing and future DPCs, for example, to determine if mis-load should be described deterministically or probabilistically.	Information need is applicable to all disposal concepts, and is generic (non-site specific).			
Develop burnup credit approach for BWR SNF: Without such an approach, as-loaded criticality analysis will be ineffective for low-probability screening involving BWR fuel (which constitutes approximately a third of all SNF in the U.S.). Also, if BWR DPC criticality is analyzed using fresh fuel, a greater brine concentration would be needed to assure subcriticality in salt.	Definitely needed for all concepts because as-loaded subcriticality determination depends on burnup credit for many as-loaded DPCs (even in a salt repository).			
Evaluate effects from radiolysis: Important if radiolysis affects basket degradation (the stylized basket degradation scenario would apply to more DPCs). However, radiolysis may not be significant until fuel cladding is degraded, which happens slowly.	Not needed to analyze postclosure criticality using stylized scenarios.	Potentially needed unless in-package conditions affecting stainless steel corrosion rates are already oxidizing.	A determination of radiolysis significance (with respect to SNF cladding condition) is definitely needed because stainless steel degradation rates are redox dependent.	
DPC fillers evaluation: Mock-up scaled testing would be needed to evaluate whether DPCs can be adequately filled with molten metal mixtures or solid particles.	Not needed to analyze postclosure criticality using stylized scenarios.	Potentially needed as an alternative to criticality consequence analysis, for those DPCs still shown to be critical with as-loaded analysis. Filler placement testing would be generic, although selection could rely on site-specific information.		
Accuracy of reactor records for SNF: SNF will be produced in the U.S. over a period of at least 90 years. Accuracy of available assembly burnup records could be a factor for SNF from decommissioned plants, particularly for SNF that is presently stored in systems for which the licensing basis does not depend on burnup (i.e., fresh fuel).	Information need is applicable to all disposal concepts, and is generic (non-site specific).			

REFERENCES

- Banerjee, K., Clarity, J.B., and Scaglione, J.M. 2015. *Dual Purpose Canister Reactivity and Groundwater Absorption Analyses*. FCRD-UFD-2014-000520, Rev. 1. U.S. Department of Energy, Office of Used Nuclear Fuel Disposition.
- BMW (Federal Ministry of Economics and Technology) 2008. *Final disposal of high-level radioactive waste in Germany—The Gorleben Project*. Public Relations/IA8. Berlin, Germany. www.bmwi.de
- Briggs, B. 2013. *International Handbook of Evaluated Criticality Safety Benchmark Experiments*. Report NEA No. 7166.
- BSC (Bechtel SAIC Company) 2003. *The Potential of Using Commercial Dual Purpose Canisters for Direct Disposal*. TDR-CRW-SE-000030, Rev. 0, Office of Civilian Radioactive Waste Management, Las Vegas, NV: Bechtel SAIC Company.
- Carter, J.T., F. Hansen, R. Kehrman, T. Hayes. 2011. *A Generic Salt Repository for Disposal of Waste from an Spent Nuclear Fuel Recycle Facility*, SRNL-RP-2011-000149 Rev. 0, Aiken, S. C.: Savannah River National Laboratory.
- Carter, J. and D. Vinson. 2014. *Nuclear Fuels Storage and Transportation Planning Project Inventory Basis*. FCRD-NFST-2013-000263, Rev.2, SRNL-STI-2014-00441, Aiken S. C: Savannah River National Laboratory.
- Chadwick, M.B., M. Herman, P. Obložinský, M.E. Dunn, Y. Danon, A.C. Kahler, D.L. Smith, B. Pritychenko, G. Arbanas, R. Arcilla, R. Brewer, D.A. Brown, R. Capote, A.D. Carlson, Y.S. Cho, H. Derrien, K. Guber, G.M. Hale, S. Hoblit, S. Holloway, T.D. Johnson, T. Kawano, B.C. Kiedrowski, H. Kim, S. Kunieda, N.M. Larson, L. Leal, J.P. Lestone, R.C. Little, E.A. McCutchan, R.E. MacFarlane, M. MacInnes, C.M. Mattoon, R.D. McKnight, S.F. Mughabghab, G.P.A. Nobre, G. Palmiotti, A. Palumbo, M.T. Pigni, V.G. Pronyaev, R.O. Sayer, A.A. Sonzogni, N.C. Summers, P. Talou, I.J. Thompson, A. Trkov, R.L. Vogt, S.C. van der Marck, A. Wallner, M.C. White, D. Wiarda, P.G. Young, 2011. "ENDF/B-VII.1: Nuclear Data for Science and Technology: Cross Sections, Covariances, Fission Product Yields and Decay Data." *Nucl. Data Sheets* **112**(2011)2887.
- Clayton, D.R., M.J. Martinez and E.L. Hardin 2013. *Potential Vertical Movement of Large Heat-Generating Waste Packages in Salt*. Sandia National Laboratories, Albuquerque, NM. SAND2013-3596.
- DOE (U.S. Department of Energy) 1987. *Site characterization plan conceptual design report for a high-level nuclear waste repository in salt, vertical emplacement mode*. DOE/CH/46656-15 (2 volumes). Washington, D.C.: U.S. Department of Energy. December, 1987.
- DOE (U.S. Department of Energy). 2003. *Disposal Criticality Analysis Methodology Topical Report*. YMP/TR-004Q, Revision 2. Las Vegas, NV: U.S. Department of Energy, Office of Civilian Radioactive Waste Management.
- DOE (U.S. Department of Energy) 2008. *Yucca Mountain Repository License Application for Construction Authorization*. DOE/RW-0573. Washington, D.C.: U.S. Department of Energy.
- DOE (U.S. Department of Energy) 2013. *Strategy for the Management and Disposal of UNF and High Level Radioactive Waste*, Washington, D.C.: U.S. Department of Energy, January 2013.

- Easton, E. 2011. "Developing a Regulatory Framework for Extended Storage and Transportation." Presentation for the National Transportation Stakeholder Forum. May 10-12, 2011. Denver, CO. energy.gov/sites/prod/files/em/Easton_NTSF_2011.pdf
- EPRI (Electric Power Research Institute) 2008. *Feasibility of Direct Disposal of Dual-Purpose Canisters: Options for Assuring Criticality Control*, 1016629. EPRI, Palo Alto, CA.
- EPRI (Electric Power Research Institute) 2009. *Handbook of Neutron Absorber Materials for Spent Nuclear Fuel Transportation and Storage Applications*, 1019110. EPRI, Palo Alto, CA.
- Fairhurst, C. 2012. *Current Approaches to Surface-Underground Transfer of High-Level Nuclear Waste*. Itasca Consulting Group, Minneapolis, MN.
- Freeze, G., M. Voegele, P. Vaughn, J. Prouty, W.M. Nutt, E. Hardin and D. Sevougian 2013. *Generic Deep Geologic Disposal Safety Case*. FCRD-UFD-2013-000146, Rev. 1. U.S. Department of Energy, Office of Used Nuclear Fuel Disposition.
- Greene, S. R., J. S. Medford and S. A. Macy 2013. *Storage and Transport Cask Data for Used Commercial Nuclear Fuel*. ATI-TR-13047. Energx. Oak Ridge, TN.
- Groth, K.M., F.P. Hannigan, H. Liao and T.A. Wheeler 2015. *Report on Review of Waste Package Reliability Estimates for Geologic Disposal*. FCRD-UFD-2015-000714. U.S. Department of Energy, Office of Used Nuclear Fuel Disposition.
- Guber, K.H., R. O. Sayer, T. E. Valentine, L. C. Leal, R. R. Spencer, J. A. Harvey, P.E. Koehler and T. Rauscher 2002. "New Maxwellian Averaged Neutron Capture Cross Sections for $^{35,37}\text{Cl}$." *Phys Rev. C* 65, 058801.
- Hadgu, T., D. Clayton and E. Hardin 2015. *Cavern/Vault Disposal Concepts and Thermal Calculations for Direct Disposal of 37-PWR Size DPCs*. FCRD-UFD-2015-000715. U.S. Department of Energy, Office of Used Nuclear Fuel Disposition.
- Hardin, E.L., D.A. Chesnut, T.J. Kneafsey, K. Pruess, J.J. Roberts and W. Lin 1997. *Synthesis Report on Thermally Driven Coupled Processes*. UCRL-ID-128495. OSTI ID: 16624. Livermore, CA: Lawrence Livermore National Laboratory. October 15, 1997.
- Hardin E., T. Hadgu, D. Clayton, R. Howard, H. Greenberg, J. Blink, M. Sharma, M. Sutton, J. Carter, M. Dupont and P. Rodwell 2012. *Repository Reference Disposal Concepts and Thermal Load Management Analysis*. FCRD-UFD-2012-000219, Rev. 2. U.S. Department of Energy, Office of Used Nuclear Fuel Disposition.
- Hardin, E. 2013. *Spent Fuel Canister Disposability Baseline Report*. FCRD-UFD-2014-000330 Rev. 0. U.S. Department of Energy, Office of Used Nuclear Fuel Disposition.
- Hardin, E. and R. Howard 2013. *Assumptions for Evaluating Feasibility of Direct Geologic Disposal of Existing Dual Purpose Canisters*. FCRD-UFD-2012-000352 Rev. 1. U.S. Department of Energy, Office of Used Nuclear Fuel Disposition.
- Hardin, E. and M. Voegele 2013. *Alternative Concepts for Direct Disposal of Dual-Purpose Canisters*. FCRD-UFD-2013-000102 Rev. 0. U.S. Department of Energy, Office of Used Nuclear Fuel Disposition.

Hardin, E.L., D.J. Clayton, R.L. Howard, J.M. Scaglione, E. Pierce, K. Banerjee, M.D. Voegelé, H.R. Greenberg, J. Wen, T.A. Buscheck, J.T. Carter, T. Severynse and W.M. Nutt 2013a. *Preliminary Report on Dual-Purpose Canister Disposal Alternatives (FY13)*. FCRD-UFD-2013-000171 Rev. 1. U.S. Department of Energy, Office of Used Nuclear Fuel Disposition.

Hardin, E.L., C.R. Bryan and M.D. Voegelé 2013b. *Features, Events and Processes and Performance Assessment Scenarios for Alternative Dual-Purpose Canister Disposal Concepts*. FCRD-UFD-2013-000172. U.S. Department of Energy, Office of Used Nuclear Fuel Disposition.

Hardin, E., D. Clayton, M. Martinez, G. Nieder-Westermann, R. Howard, H. Greenberg, J. Blink and T. Buscheck 2013c. *Collaborative Report on Disposal Concepts*. FCRD-UFD-2013-000170 Rev. 0. U.S. Department of Energy, Office of Used Nuclear Fuel Disposition.

Hardin, E. 2014. *Review of Underground Construction Methods and Opening Stability for Repositories in Clay/Shale Media*, FCRD-UFD-2014-000330 Rev. 0. U.S. Department of Energy, Office of Used Nuclear Fuel Disposition.

Hardin, E., C. Bryan, A. Ilgen, E. Kalinina, K. Banerjee, J. Clarity, R. Howard, R. Jubin, J. Scaglione, F. Perry, L. Zheng, J. Rutqvist, J. Birkholzer, H. Greenberg, J. Carter and T. Severynse 2014a. *Investigations of Dual-Purpose Canister Direct Disposal Feasibility (FY14)*. FCRD-UFD-2014-000069 Rev. 0. U.S. Department of Energy, Office of Used Nuclear Fuel Disposition.

Hardin, E.L., D.J. Clayton, R.L. Howard, J. Clarity, J.M. Scaglione, J.T. Carter, W.M. Nutt and R.W. Clark, 2014b. "Evaluation of Direct Disposal of Spent Fuel in Existing Dual-Purpose Canisters." American Nuclear Society, La Grange Park, IL. *RadWaste Solutions*. V.21, N.1, pp. 26-39.

Hardin, E. and E. Kalinina 2015. *Cost Estimation Inputs for Spent Nuclear Fuel Geologic Disposal Concepts*. SAND2015-0687. Sandia National Laboratories, Albuquerque, NM. February, 2015.

Howard, R., J.M. Scaglione, J.C. Wagner, E. Hardin and W.M. Nutt 2012. *Implementation Plan for the Development and Licensing of Standardized Transportation, Aging, and Disposal Canisters and the Feasibility of Direct Disposal of Dual Purpose Canisters*. FCRD-UFD-2012-000106 Rev. 0. U.S. Department of Energy, Office of Used Nuclear Fuel Disposition.

Ilgen, A., C. Bryan, S. Teich-McGoldrick and E. Hardin 2014a. *DPC Materials and Corrosion Environments*. FCRD-UFD-2014-000597. U.S. Department of Energy, Office of Used Nuclear Fuel Disposition.

Ilgen, A., D. Enos, C. Bryan, R. Rechard and E. Hardin 2014b. *Experimental Plan for DPC/Overpack Performance in a Repository*. FCRD-UFD-2014-000596. U.S. Department of Energy, Office of Used Nuclear Fuel Disposition.

Jubin, R., K. Banerjee and T. Severynse 2014. *Potential Dual-Purpose Canister (DPC) Filler Materials*. FCRD-UFD-2014-000521 Rev. 0. U.S. Department of Energy, Office of Used Nuclear Fuel Disposition.

Kalinina, E.A., 2014. *System-Level Logistics for Dual Purpose Canister Disposal*, FCRD-UFD-2014-000517, June 2014.

Kuhlman, K.L. 2014. *Summary Results for Brine Migration Modeling Performed by LANL, LBNL, and SNL for the UFD Program*. FCRD-UFD-2014-000071. U.S. Department of Energy, Office of Used Nuclear Fuel Disposition

Leclaire, N., I. Duhamel, F.X. Le Dauphin, J. Piot, I. Villetard de Laguerie, F. Lespinasse and B.B. Briggs 2011. "MIRTE: An Experimental Program Designed to Test the Reactivity Worth of Several Structural Materials." *Proc. Int. Conf. Nuclear Criticality and Safety (ICNC2011)*. Edinburgh, Scotland.

Marshall, W.J. and B.T. Rearden 2013. "The SCALE Verified, Archived Library of Inputs and Data—VALID." American Nuclear Society. Nuclear Criticality Safety Division, Annual Meeting. Wilmington, NC. September 30-October 3, 2013.

Mohanty, S., R. Codell, J.M. Menchaca, R. Janetzke, M. Smith, P. LaPlante, M. Rahimi and A. Lozano 2004. *System-Level Performance Assessment of the Proposed Repository at Yucca Mountain Using the TPA Version 4.1 Code*. CNWRA 2002-05 Rev. 2. Prepared for the U.S. Nuclear Regulatory Commission by the Center for Nuclear Waste Regulatory Analyses, San Antonio, TX. Revision 2. March, 2004.

Mueller, D.E., S.M. Bowman, W.J. Marshall and J.M. Scaglione 2013. *Review and Prioritization of Technical Issues Related to Burnup Credit for BWR Fuel*. NUREG/CR-7158 (ORNL/TM-2012/261). Prepared for the U.S. Nuclear Regulatory Commission by Oak Ridge National Laboratory, Oak Ridge, TN. February, 2013.

NEA (Nuclear Energy Agency of the Organization for Economic Cooperation and Development) 2014. *International Handbook of Evaluated Reactor Physics Benchmark Experiments*. Report NEA No. 7173.

NRC (U.S. Nuclear Regulatory Commission) 2000a. *Technical Basis and Implementation Guidelines for A Technique for Human Event Analysis (ATHEANA)*, NUREG-1624, Rev. 1. U.S. Nuclear Regulatory Commission, Washington, DC.

NRC (U.S. Nuclear Regulatory Commission) 2000b. *Standard Review Plan for Transportation Packages for Spent Nuclear Fuel*. NUREG-1617. U.S. Nuclear Regulatory Commission, Washington, DC.

NRC (U.S. Nuclear Regulatory Commission) 2002. *Burnup Credit in the Criticality Safety Analyses of PWR Spent Fuel in Transport and Storage Casks*. Interim Staff Guidance – 8, Revision 2. Spent Fuel Project Office.

NRC (U.S. Nuclear Regulatory Commission) 2003a. *Cladding Considerations for the Transportation and Storage of Spent Fuel*. Interim Staff Guidance – 11 Revision 3. Spent Fuel Project Office.

NRC (U.S. Nuclear Regulatory Commission) 2003b. *Yucca Mountain Review Plan: Final Report*. NUREG-1804. U.S. Nuclear Regulatory Commission, Washington, DC.

NRC (U.S. Nuclear Regulatory Commission) 2010. *Standard Review Plan for Spent Fuel Dry Storage Systems at a General License Facility*. NUREG-1536 Rev. 1. Office of Nuclear Material Safety and Safeguards. July, 2010.

NRC (U.S. Nuclear Regulatory Commission) 2012. *NRC/EPRI Draft Report on An Integrated Decision-Tree Human Event Analysis System (IDHEAS) Method for NPP Internal At-Power Operation*. U.S. Nuclear Regulatory Commission, Washington, DC.

Nutt, M., Morris, E., Puig, F., Kalinina, E., and Gillespie, S., 2012. Transportation Storage Logistics Model – CALVIN (TSL-CALVIN), FCRD-NFST-2012-000424, October 2012.

ORNL (Oak Ridge National Laboratory) 2011. *SCALE: A Comprehensive Modeling and Simulation Suite for Nuclear Safety Analysis and Design*. ORNL/TM-2005/39, Version 6.1. Radiation Safety Information Computational Center, Oak Ridge National Laboratory, Oak Ridge, TN.

Radulescu, G., I.C. Gauld, G. Ilas and J.C. Wagner 2012. *An Approach for Validating Actinide and Fission Product Burnup Credit Criticality Safety Analyses–Isotopic Composition Predictions*. NUREG/CR-7108 (ORNL/TM-2011/509). Prepared for the U.S. Nuclear Regulatory Commission by Oak Ridge National Laboratory, Oak Ridge, TN. April, 2012.

Rice, J.A. 2011. Letter: J.A. Rice, Vice President – Nuclear Engineering, Virginia Electric and Power Company, to the U.S. Nuclear Regulatory Commission. “Virginia Electric and Power Company North Anna Power Station Units 2 and 2 Exemption Request for NUHOMS HD Dry Shielded Canisters Loaded to Incorrect Heat Load Limits Supplemental Information.” September 28 2011. (Available on the NRC ADAMS system, Accession No. ML11286A143)

SRNL (Savannah River National Laboratory) 2015. *Generic Repository Cost Estimates*, FCRD-UFD-2015-000740, Rev. 0. Aiken, SC: Savannah River National Laboratory

Sayer, R.O., K.H. Guber, L.C. Leal, N.M. Larson, and T. Rauscher 2003. *R-Matrix Evaluation of Cl Neutron Cross Sections up to 1.2 MeV*. ORNL/TM-2003/50. Oak Ridge National Laboratory, Oak Ridge, TN. March, 2003.

Scaglione, J.M., D.E. Mueller, J.C. Wagner and W.J. Marshall 2012. *An Approach for Validating Actinide and Fission Product Burnup Credit Criticality Safety Analyses–Criticality (k_{eff}) Predictions*, NUREG/CR-7109 (ORNL/TM-2011/514). Prepared for the U.S. Nuclear Regulatory Commission by Oak Ridge National Laboratory, Oak Ridge, TN. April, 2012.

Scaglione, J.M., R.A. Lefebvre, K.R. Robb, J.L. Peterson, H. Adkins, T.E. Michener and D. Vinson 2013. “Integrated Data and Analysis System for Commercial Used Nuclear Fuel Safety Assessments.” *Proceedings of the 17th International Symposium on the Packaging and Transportation of Radioactive Materials (PATRAM)*. August 18-23, 2013, San Francisco, CA.

Scaglione, J.M., R.L. Howard, A.A. Alsaed, C.R. Bryan and E.L. Hardin 2014. *Criticality Analysis Process for Direct Disposal of Dual Purpose Canisters*. ORNL/LTR-2014/80. Oak Ridge National Laboratory, Oak Ridge, TN. March, 2014.

SNL (Sandia National Laboratories) 2007. *Analysis of Mechanisms for Early Waste Package/Drip Shield Failure*. ANL-EBS-MD-000076 REV 00. Prepared for the U.S. Department of Energy, Office of Civilian Radioactive Waste Management, Las Vegas, NV. June 2007.

Sobes, V., L. Leal and G. Arbanas 2014. “Nuclear Data Adjustment with SAMMY Based on Integral Experiments.” American Nuclear Society, Winter Expo, Anaheim, CA.

Wagner, J.C., M.D. DeHart and C.V. Parks 2003a. *Recommendations for Addressing Axial Burnup in PWR Burnup Credit Analyses*. NUREG/CR-6801 (ORNL/TM-2001/273). Prepared

for the U.S. Nuclear Regulatory Commission by Oak Ridge National Laboratory, Oak Ridge, TN. March, 2003.

Wagner, J.C. and C.V. Parks 2003b. *Recommendations on the Credit for Cooling Time in PWR Burnup Credit Analyses*. NUREG/CR-6781 (ORNL/TM-2001/272). Prepared for the U.S. Nuclear Regulatory Commission by Oak Ridge National Laboratory, Oak Ridge, TN. January, 2003.

Wang, Y., T. Hadgu, S. Painter, D. Harp, S. Chu, T. Wolery and J. Houseworth 2012. *Integrated Tool Development for Used Fuel Disposition Natural System Evaluation—Phase I Report*. FCRD-UFD-2012-000229. U.S. Department of Energy, Office of Used Nuclear Fuel Disposition.

Williams, J. 2013. *NWTRB Workshop – Inventory*. Presentation to the Nuclear Waste Technical Review Board, Washington DC, November 18-19 2013. Available at: <http://www.nwtrb.gov/meetings/2013/nov/williams.pdf>.

Winterle, J., G. Ofoegbu, R. Pabalan, C. Manepally, T. Mintz, E. Pearcy, K. Smart, J. McMurry, R. Pauline and R. Fedors 2012. *Geological Disposal of High-Level Radioactive Waste in Salt Formations*. Prepared for the U.S. Nuclear Regulatory Commission by the Center for Nuclear Waste Regulatory Analyses (Contract NRC-02-07-006). San Antonio, TX. March, 2012.

Appendix A – Results of Thermal Analyses with 37- PWR Size DPCs

The thermal analyses results shown in Section 2.3 were for 32-PWR size DPCs, which is a common size currently in use. However, larger canisters that can hold up to 37 PWR assemblies or 89 BWR assemblies, are being built and put in service. The figures in this appendix show the results of thermal analyses for these larger canisters for disposal in: 1) a salt repository; 2) a hard rock unsaturated, unbackfilled repository; 3) a hard rock backfilled repository; and 4) a sedimentary backfilled repository. Figures A-1 and A-2 are results obtained using the finite element solution to simulate the salt repository concept. Figures A-3 to A-8 are from simulations using a semi-analytical solution programmed in Mathcad®. Further details can be found in Hadgu et al. (2015).

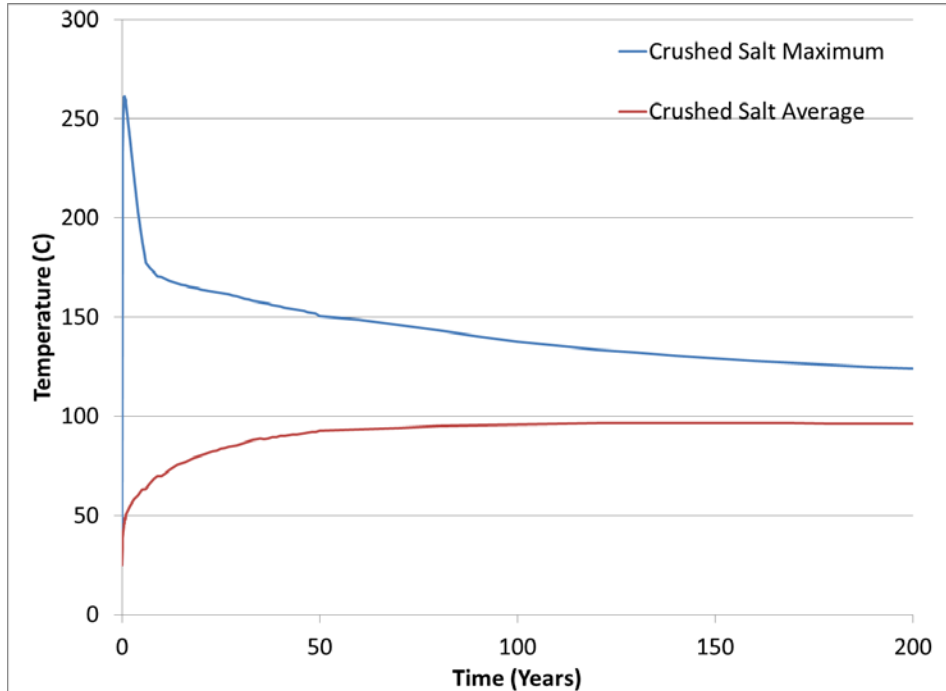

Figure A-1. Temperature histories for 37-PWR size packages, for the salt concept, with in-drift emplacement and 30-m spacing, and fully coupled thermal-mechanical solution: 40 GW-d/MT, 50 years out-of-reactor.

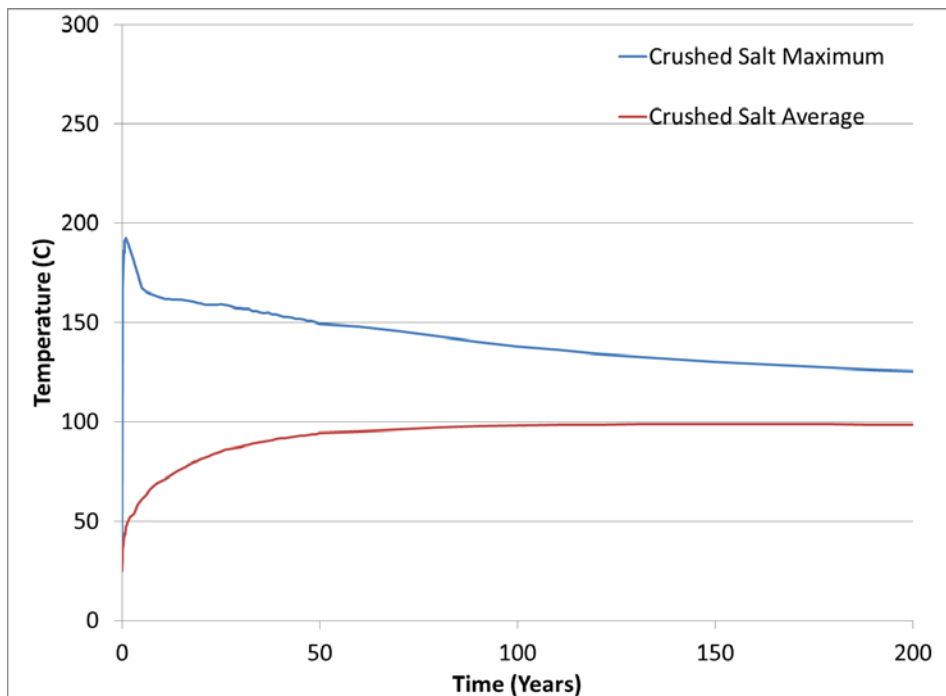

Figure A-2. Temperature histories for 37-PWR size packages, for the salt concept, with in-drift emplacement and 30-m spacing, and fully coupled thermal-mechanical solution: 40 GW-d/MT, 50 years out-of-reactor with floor cavity.

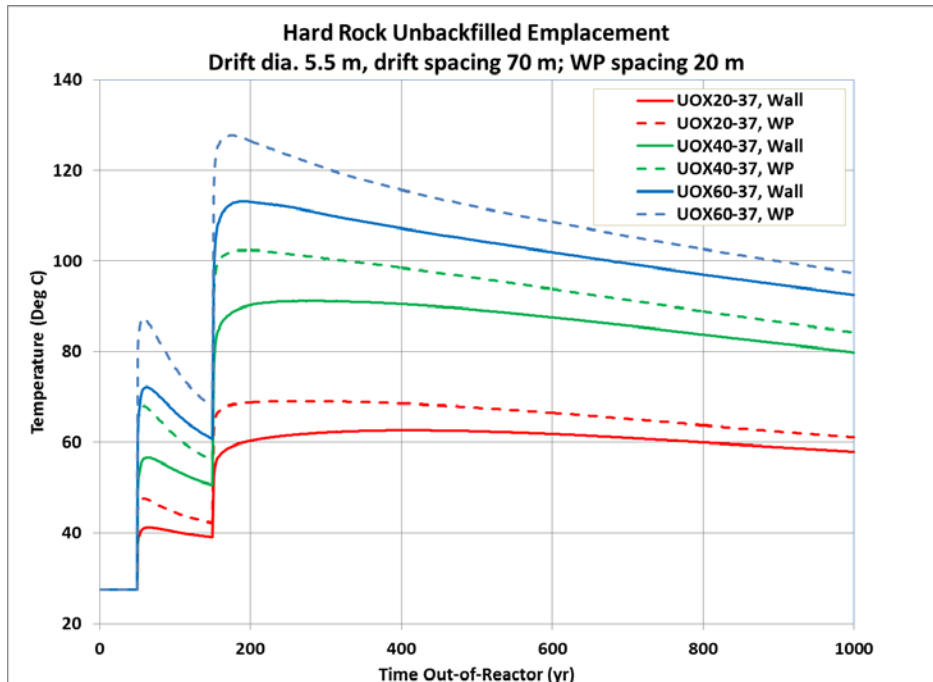

Figure A-3. Temperature histories (drift wall and waste package surface) for various SNF burnup levels in 37-PWR size packages, in a hard rock open (unbackfilled) repository with spacings shown, for: (top) 50-year decay storage and 100-year ventilation.

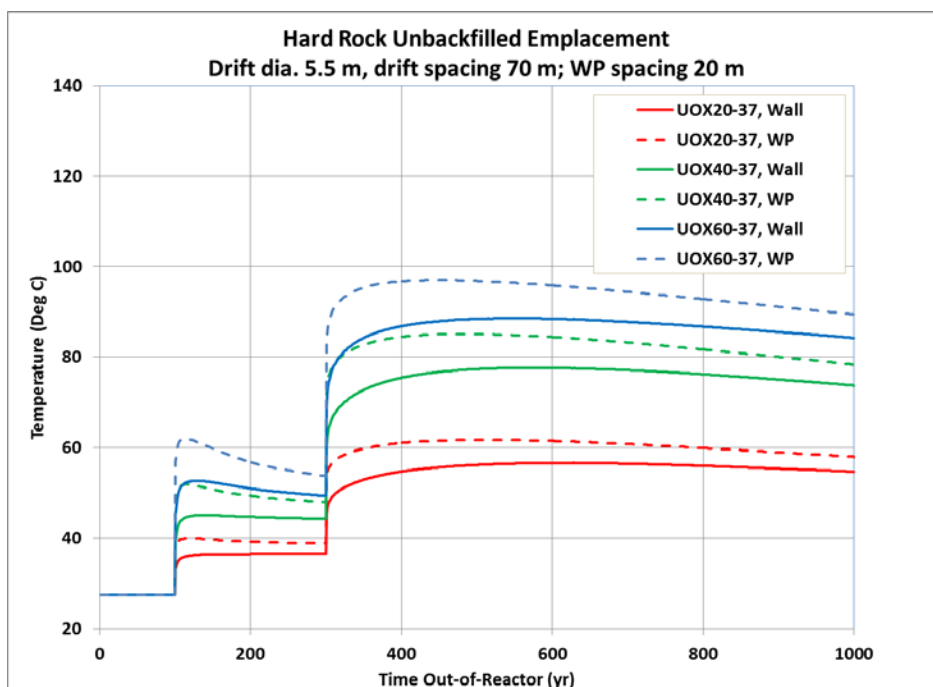

Figure A-4. Temperature histories (drift wall and waste package surface) for various SNF burnup levels in 37-PWR size packages, in a hard rock open (unbackfilled) repository with spacings shown for: 100-year decay storage and 200-year ventilation.

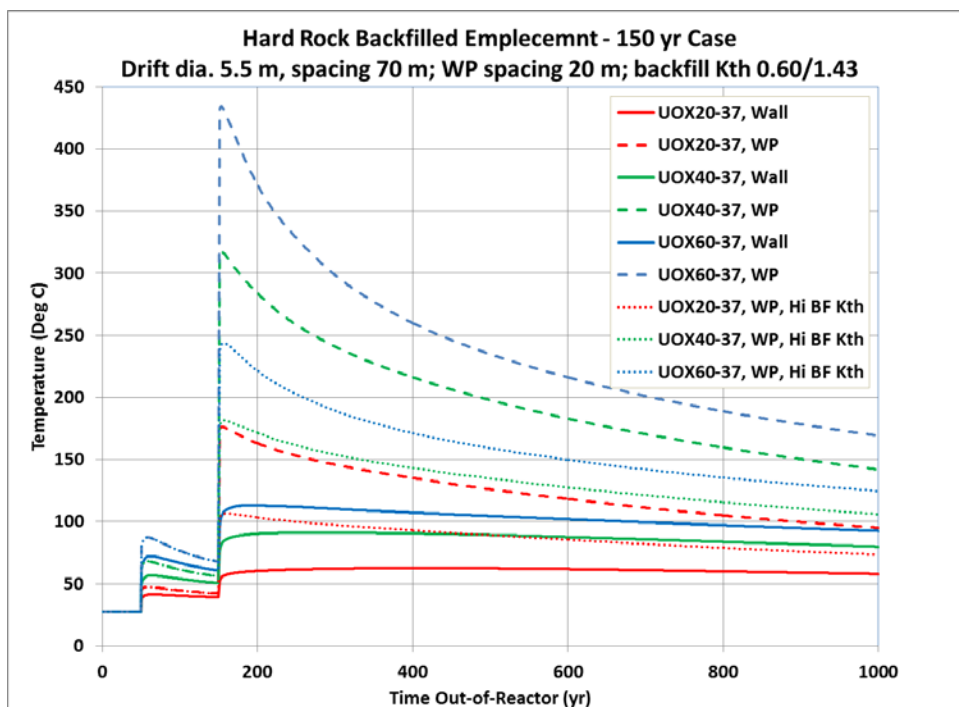

Figure A-5. Thermal analysis of disposal of 37-PWR size DPCs in a hard rock, open (backfilled) repository with 50-yr decay storage, 100-yr ventilation, and both typical and high thermal conductivity backfill.

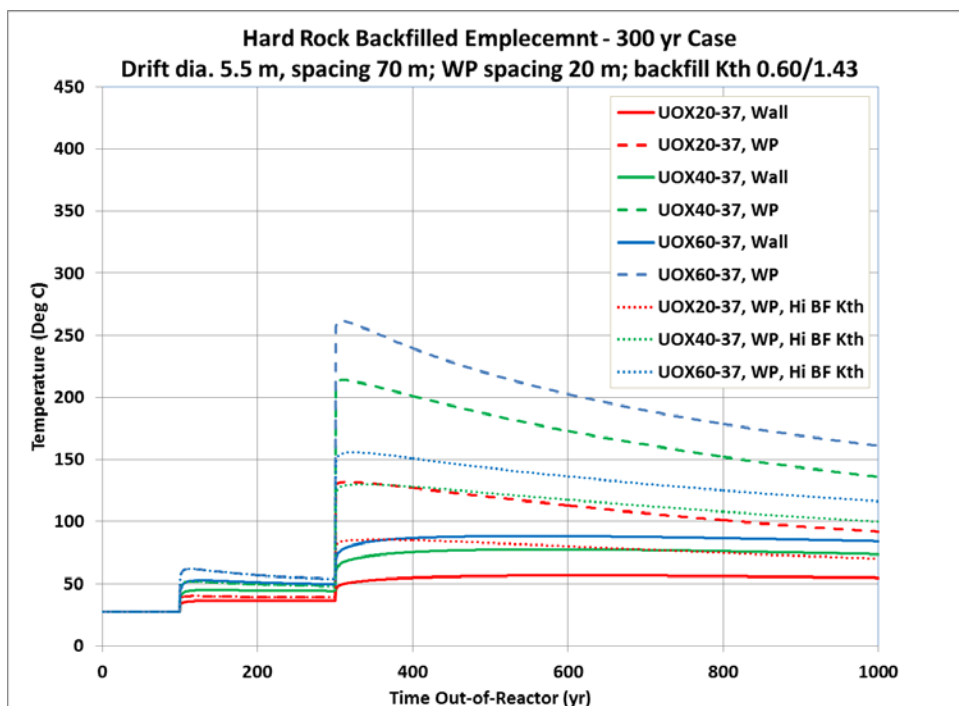

Figure A-6. Thermal analysis of disposal of 37-PWR size DPCs in a hard rock, open (backfilled) repository with 100-yr decay storage 200-yr ventilation, and both typical and high thermal conductivity backfill.

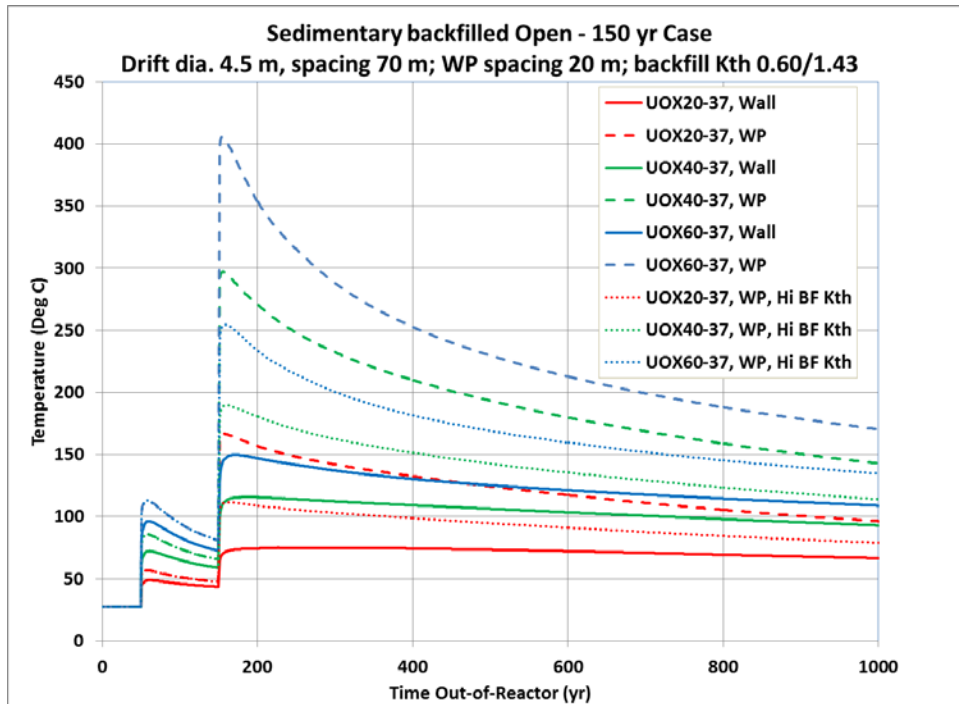

Figure A-7. Thermal analysis of disposal of 37-PWR size DPCs in a sedimentary, open (backfilled) repository with 50-yr decay storage, 100-yr ventilation, and both typical and high thermal conductivity backfill.

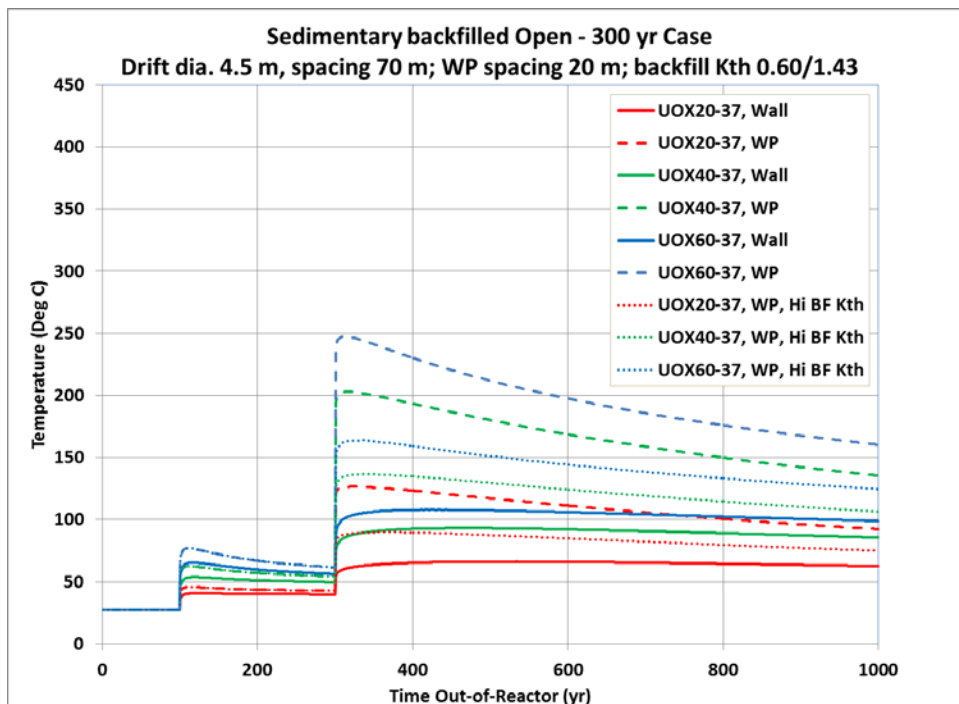

Figure A-8. Thermal analysis of disposal of 37-PWR size DPCs in a sedimentary, open (backfilled) repository with 100-yr decay storage 200-yr ventilation, and both typical and high thermal conductivity backfill.

Appendix B – Validation Study for Crediting Chlorine in Criticality Analysis

It has been demonstrated that chloride is the most important groundwater solute with significant neutron absorption. The available literature was surveyed for critical benchmark experiments that could be used in a validation study to support crediting chlorine as part of criticality analyses for SNF disposal. This section summarizes the results from a study (Sobes et al. 2015) of the available integral experiments worldwide that could be used for validation of DPC disposal criticality evaluations that include credit for chlorine.

Two specific configurations (corresponding to the stylized degradation scenarios described in Section 2.4.2) were considered as the application models to be covered by the validation study. Both were defined for a 32-PWR size DPC with a stainless steel canister and basket structure, loaded with representative 17x17 PWR assemblies. The two application models were selected such that the amount of chlorine in the models resulted in a slightly supercritical configuration. This chlorine concentration sets a target concentration that would be desirable in critical experiments used for validation. The ultimate goal of selecting a set of integral experiments is to match the bias of the experiments and applications as closely as possible.

Natural chlorine has only two stable isotopes, 75.76% ^{35}Cl and 24.24% ^{37}Cl . Comparing the thermal capture cross-sections of the two isotopes (^{35}Cl : 43.60 b and ^{37}Cl : 0.432 b) it is obvious that only the ^{35}Cl isotope is important for neutron absorption.

The nuclear data library considered in this study is the ENDF/B-VII.1 (Chadwick et al. 2011). The resolved resonance region evaluation for both isotopes of chlorine, which also governs the thermal energy region, was completed in 2003 by Oak Ridge National Laboratory (Sayer et al. 2003). The evaluation was subsequently updated in 2007. As noted by Guber et al. (2002) the goal of the 2003 evaluation was to address several deficiencies in the previous evaluation for chlorine, but it is important to note that the updated resolved resonance evaluations were never benchmarked with a set of integral experiments.

A portion of the computations for this analysis was done with the SCALE 6.1 code package (ORNL 2011). In particular, the codes KENO, TSUNAMI-3D, TSURFER and AMPX were used. A modification of the code SAMINT (Sobes et al. 2014) was used to isolate only the effect of the single chlorine isotope for some of the parameters traditionally computed by TSURFER.

Six critical configurations that could be helpful in validating the capture cross-section of chlorine in the thermal energy region were identified as part of the French MIRTE 2.2 program (Leclaire et al. 2011). Of the six configurations, two contain a concentrated NaCl solution (300 g/l) and four have cruciform PVC separators in the core. However, these were commercial proprietary experiments and the results were not available for this analysis.

The *International Handbook of Evaluated Reactor Physics Benchmark Experiments* (NEA 2014) does not include configurations with chlorine sensitivities similar to the two applications. Other than the *International Handbook of Evaluated Criticality Safety Benchmark Experiments* (IHECSBE) (Briggs 2013), no other source was found that contained potentially applicable evaluated critical experiments with chlorine sensitivities similar to the applications for this analysis.

A total of 141 critical configurations containing chlorine were identified in the 2013 edition of IHECSBE. Despite the large number of prospective benchmarks, very few have a similar chlorine sensitivity profile shape and magnitude as the application systems for this analysis.

The sensitivity profiles of k_{eff} for the different chlorine reactions as a function of neutron energy were calculated for the two application models using TSUNAMI-3D from SCALE 6.1. Figure B-1 presents the sensitivity profiles for the total cross-section of chlorine for the two application systems, as well as for several of the most similar benchmarks.

The HEU-SOL-THERM (HST-044-003) system is the only benchmark to have a larger sensitivity for chlorine than the degraded fuel basket application system. Notice also that the sensitivity profile of HST-044-003 peaks at a higher energy than the two application systems. While that sensitivity profile has a large magnitude, the shape does not fully resemble that of the two application systems. The LEU-COMP-THERM (LCT-045-019) benchmark gives an almost perfect match to the loss-of-absorber application. Unfortunately, most of the 141 critical benchmarks with chlorine are like HST-008-004 in the sense that they have a very similar shape of the sensitivity profile but a much smaller magnitude. In fact, HST-008-004 is in the top 10 benchmarks when it comes to a quantitative analysis of the similarity between sensitivity profiles.

The 11 most suitable critical configurations are listed in Table B-1. They originate from four different experiments: LCT45, HST44, HST08, and UST03. Description and interpretation of similarity coefficients is discussed in ORNL (2011). Furthermore, the chlorine content appears as three different materials in the 11 configurations. The chlorine is found in a Plexiglas reflector for the LCT45 and HST08, in PVC rods for HST44, and as a constituent of paint coating the inside of the solution cylinders in UST03. Based on the chlorine form, it is obvious that none of the experiments have a series of similar configurations where only the chlorine amount changes. All of these factors combine to make validation through traditional trending analysis (regression) difficult. Furthermore, if only the benchmark experiments that have a sensitivity profile for chlorine representative of the application systems are considered, the small sample size results in poor statistics. In this case, neither the normality of the data nor a significantly non-zero trend can be determined.

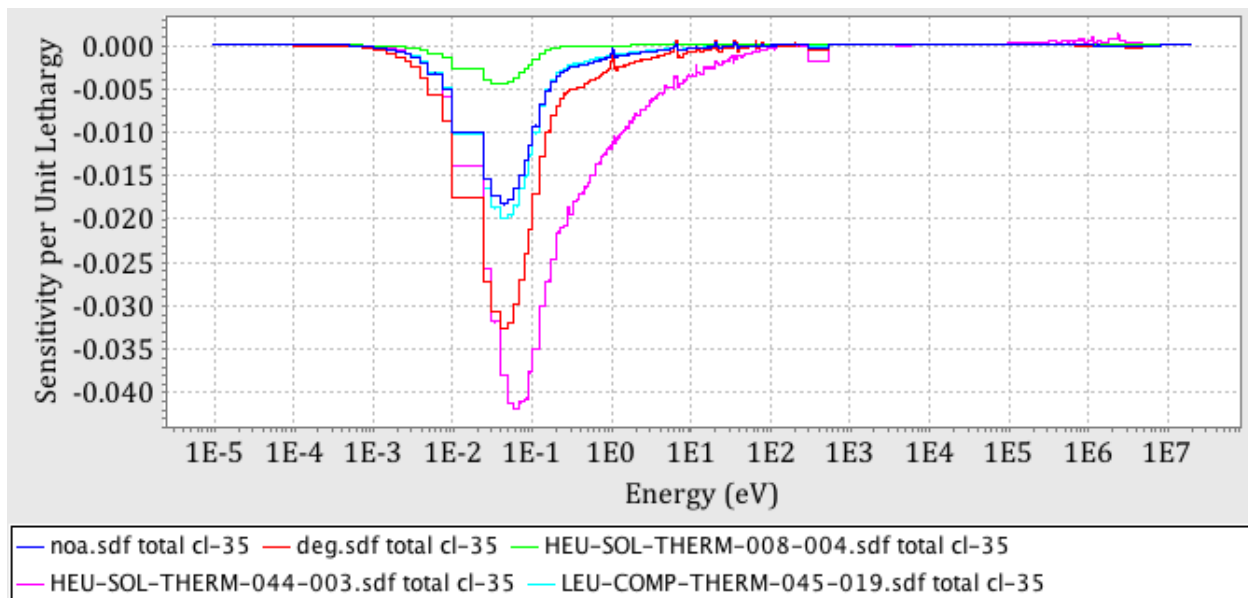

Figure B-1. Sensitivity profiles of k_{eff} for total cross-section of ^{35}Cl as a function of energy. The two application systems are labeled as *noa.sdf* and *deg.sdf*, which represent the no absorber and the degraded fuel basket systems, respectively.

Sobes et. al. (2015) concluded that validation through traditional trending analysis is not possible with the current, freely available, evaluated set of critical benchmark experiments. However, TSURFER analysis is well suited for identifying the level of bias and bias uncertainty based on the available benchmark models.

TSURFER performs a simultaneous adjustment of the cross-section data for all of the isotopes within the given covariance data using the generalized linear least-squares approach. TSURFER tries to minimize the cross-section changes and the k_{eff} discrepancies for a given set of integral experiments. Since TSURFER adjusts all of the cross-section data simultaneously for all of the isotopes, a wide range of integral benchmarks should be used. Alternatively, all of the discrepancy in the k_{eff} could be attributed to an error in a small set of isotopes; in reality, many isotopes contribute to the k_{eff} bias of each integral benchmark. Therefore, the entire set of 394 models in the SCALE Verified, Archived Library of Inputs and Data (VALID) (Marshal and Rearden 2013) was used as the background set of integral experiments to establish the appropriate multigroup cross-section changes for all of the isotopes in the two application systems apart from ^{35}Cl . No thermal neutron spectrum experiments containing chlorine were part of the VALID library. Two different sets of integral experiments were set up:

- Set of 394 VALID models in addition to the 11 most applicable benchmarks identified in Table II of the library, and
- Set of 394 VALID models and all of the 141 benchmarks that contained chlorine.

Note that with the following convention of bias (systematic bias), a positive bias for the chlorine is a conservative bias with respect to the safety analysis case.

Table B-1. Similarity coefficients for the total cross-section for the most applicable benchmark experiments compared to the no absorber case.

Experiment	G	C	E	Sensitivity
LCT45-18	0.998	0.999	0.999	0.048
LCT45-19	0.998	0.999	0.999	0.048
LCT45-06	0.989	0.999	0.999	0.052
HST44-02	0.916	0.992	0.917	0.066
UST03-02 ^a	0.808	0.999	0.999	0.021
HST44-03	0.740	0.999	0.922	0.135
UST03-04	0.719	0.992	0.999	0.018
UST03-05	0.691	0.999	0.999	0.017
HST08-04	0.488	0.998	0.992	0.010
HST08-12	0.406	0.998	0.991	0.008
LCT45-03	0.401	0.998	0.992	0.008
^a U233-SOL-THERM (UST)-03-02				

The propagated chlorine uncertainty was calculated using the SAMINT code. It is evident from Table B-2 that the exact numbers for the calculated bias and bias uncertainty depend on which set of benchmark experiments is used in the analysis. However, the same pattern emerges regardless of the set of integral experiments used. The propagated k_{eff} uncertainty from all of the isotopes for both application systems is around 550 pcm. The ^{35}Cl uncertainty contributes approximately 50 pcm uncertainty to the k_{eff} of the loss-of-absorber case and 100 pcm to the k_{eff} uncertainty of the basket degradation case. In all cases, both the bias from all of the nuclear data and the bias just from the ^{35}Cl are less than the calculated uncertainty. Furthermore, it is clear that the uncertainty in the chlorine cross-section can be considered to bound the bias. A similar argument has been previously made for fission product isotopes that had very limited or no critical experiments available (Scaglione et al. 2012).

Table B-2. TSURFER results.

	No absorber	Degraded basket
Initial k_{eff}	1.00940 +/- 0.00544	1.05220 +/- 0.00552
238 group propagated Cl initial uncertainty ^a	0.00058	0.00109
44 group propagated Cl initial uncertainty	0.00056	0.00102
Using all VALID benchmarks and the 11 most applicable chlorine containing benchmarks using ENDF/B-VII.1 covariance data for ³⁵Cl with a flat flux collapse		
Total bias	-0.00127	-0.00066
Final k_{eff}	1.01070 ± 0.00148	1.05290 ± 0.00144
³⁵ Cl bias	0.00037	0.00070
44 group propagated Cl final uncertainty	0.00052	0.00094
Using all VALID benchmarks and the 141 chlorine containing benchmarks using ENDF/B-VII.1 covariance data for ³⁵Cl with a flat flux collapse		
Total bias	-0.00016	0.00032
Final k_{eff}	1.00960 ± 0.00110	1.05190 ± 0.00141
³⁵ Cl bias	0.00021	0.00040
44 group propagated chlorine final uncertainty	0.00053	0.00096
^a One standard deviation is presented as a measure of uncertainty.		