



AMM

Advanced Methods for Manufacturing

Newsletter

Issue 10 • October 2019

Isabella van Rooyen Joins AMM Program

Dr. Isabella van Rooyen has been named National Technical Director for the Department of Energy (DOE) Office of Nuclear Energy (NE) Advanced Methods for Manufacturing (AMM) program. Dr. van Rooyen is a Distinguished Staff Scientist in the Fuel Design and Development Department at Idaho National Laboratory (INL) and holds a Ph.D. in Physics, MSc in Metallurgy, and an MBA. Dr. van Rooyen joined INL in 2011 where, among others, she has led advanced electron microscopy and micro analysis examinations for the Advanced Gas Reactor TRISO Fuel Development Program. Prior to joining INL, Dr. van Rooyen held various technical leadership roles in the nuclear, aerospace, and automotive industries in South Africa, with over 12 years in the nuclear arena, which included the Pebble Bed Modular Reactor Company and South African Nuclear Energy Corporation SOC Limited.



Isabella van Rooyen
National Technical Director

Dr. van Rooyen has hands-on experience in advanced manufacturing processes, such as laser materials processing, casting processes, powder metallurgy (sintering, hot isostatic pressing, etc.), welding, and additive manufacturing. Her additive manufacturing experience on laser-based technology in the mining and aerospace industries, prior to joining INL, resulted in receiving funding for DOE Technology Commercialization and DOE Energy I-Corps Cohort 5-projects on "Additive Manufacturing as an Alternative Fabrication Technique for Uranium Silicide Fuel." She has authored over 40 peer-reviewed journal publications,

more than 50 conference papers and presentations, has filed three patent applications on additive nuclear fuel and heat exchanger manufacturing processes (2017, 2018, 2019), and has secured multiple competitive funding awards.

Dr. van Rooyen is passionate about leapfrogging technologies with the power of mentoring for the betterment of mankind, and, she is passionate about her role in this important program. High on her agenda, in line with the AMM program strategy, is to enable the nuclear energy industry with relevant, innovative, and cost effective technologies.

The AMM program will hold its annual program review meeting on November 4, 2019 in the form of a webinar. The purpose of this meeting is to review the currently funded projects. Presentations will be available on the NE's website after the webinar.

In This Issue

- Pulsed Thermal Tomography Nondestructive Examination of Additively Manufactured Reactor Materials and Components p. 2
- Irradiation studies on electron beam welded PM-HIP pressure vessel steel p. 5
- Small Modular Reactor Pressure-vessel Manufacturing and Fabrication-technology Development p. 8
- 3-D Printing of Nuclear Fuel Assembly Nozzles and End-Spacer Grids p. 11

For more program information, including recent publications, please visit www.energy.gov/ne

Pulsed Thermal Tomography Nondestructive Evaluation of Additively Manufactured Reactor Structures



Alexander Heifetz
Argonne National
Laboratory



Boris Khaykovich
MIT Nuclear
Reactor Laboratory



William Cleary
Westinghouse
Electricity

Additive manufacturing (AM) for nuclear energy applications is an emerging method for cost-efficient manufacturing aimed at replacing aging nuclear reactor parts and reducing costs for new construction of advanced reactors. However, there are still challenges for widespread deployment of AM in nuclear reactors, particular the ability to perform nondestructive evaluation (NDE) of AM parts. Because of the intrinsic features of AM process for fabricating stainless steel and nickel super alloys metallic parts, such as direct laser sintering (DLS), defects can appear consisting of low-density regions or pores. Porosity can be introduced into AM parts due to incomplete melting of the powder particles or insufficient overlapping of the melt pools. Oscillations in the surface of the melt pool caused by rapid heating and cooling result in powder ejection and splattering of the melt, resulting in surface roughness and porosity. Furthermore, improper cooling rates can cause the formation of non-equilibrium phases and residual stresses, requiring post-process heat treatments. The pore is potentially a seed for crack formation in the structure due to non-uniform expansion of

the material in response to thermal and mechanical stresses in nuclear reactor. Pores have been observed in destructive examinations to be on the order of 20 μm and larger.

Currently, limited options exist for nondestructive examination (NDE) of AM structures, either during or after manufacturing. During manufacturing phase, spatial constraints of the 3-D printer limit deployment of many conventional NDE systems, such as radiography. Furthermore, in DLS manufacturing, a metallic part is covered by un-sintered powder. This prevents the use of contact methods, such as ultrasound, and obscures signals from non-contact methods, such as passive thermography. In post-manufacturing phase, complex shapes composed of planar geometrical primitives with lack of rotational symmetry make it difficult to perform digital radiography. Contact NDE techniques, such ultrasound, would be difficult because AM structures have rough surfaces that affect probe coupling. In addition, NDE methods such as ultrasound and eddy currents require time-consuming

Continued on next page

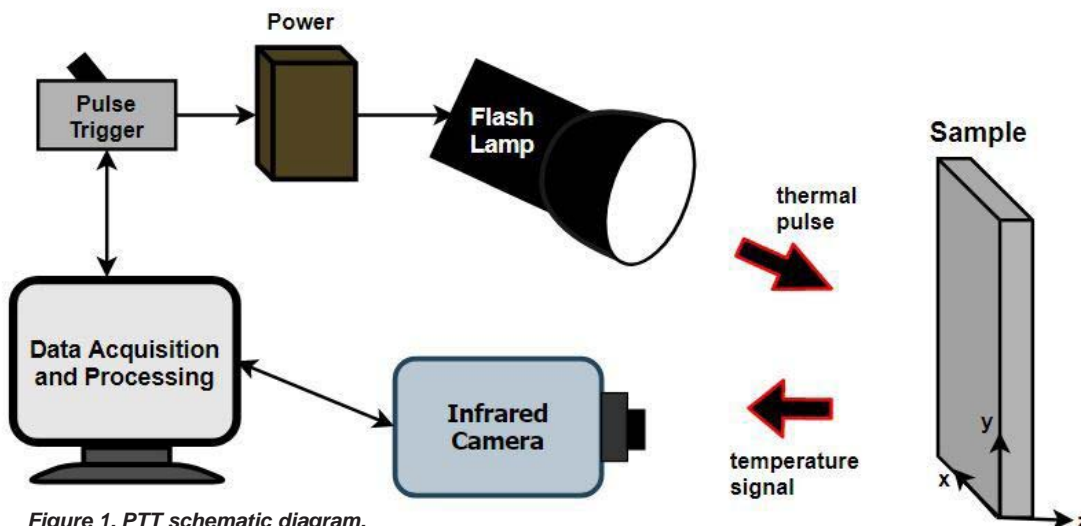

Figure 1. PTT schematic diagram.

Continued from previous page

point-by-point raster scanning of specimens. As a solution to NDE of AM structures, Argonne is developing pulsed thermal tomography (PTT) models and depth inversion algorithms for 3-D imaging and flaw detection. PTT obtains reconstruction of material internal defects by monitoring surface temperature transients following thermal pulse applied to material surface. The method is non-contact, with measurements performed from a stand-off distance from one side of the specimen. An imaging camera with megapixel array of detector elements acquires an image of a large section of material. This allows for detection of flaws with minimal amount of mechanical scanning.

A schematic depiction of the PTT setup is shown in Figure 1. The method consists of illuminating material with white light flash lamp, which rapidly deposits heat on the material surface. Heat transfer then takes place from the heated surface to the interior of the sample, resulting in a continuous decrease of the surface temperature. A megapixel fast frame infrared (IR) camera records time-resolved images of surface temperature distribution $T(x,y,t)$. Therefore, the acquired thermal-imaging data consist of a series of 2-D images of the sample's surface temperature at consecutive time instants. Using a unique inversion algorithm developed at Argonne, one can obtain 3-D reconstruction of material effusivity $e(x,y,z)$, which is a measure of how material exchanges heat with its surroundings.

Results

As an example of PTT capabilities, we show tomographic imaging of an Inconel 718 (IN718) nozzle plate produced at Westinghouse using direct laser sintering (DLS) AM method.

The plate is 17-mm (2/3-in) thick with approximately 8-in. by 8-in. cross section. A photograph of the nozzle plate is shown in the left panel of Figure 2. Total data acquisition time to image through the plate was 20.93 s. Figure 3 shows a screen capture of 3-D reconstruction with ImageJ software. The parallel plane slices and vertical cross sections were assembled into a 3-D viewing format. Warmer and colder colors indicate higher and lower effusivity, respectively. The large concentric circles in the figure correspond to spacer anchors, which are used for alignment of the plate during additive manufacturing process. The cursor shown by the cross-hairs in Figure 1 allows the user to view the parallel plane slices in the main window by diving into the stack of frames. For the cursor location in the main window, the horizontal line through the parallel plane slice selects a depth-resolved cross-section plane, which can be viewed in the smaller window at the bottom window. The vertical line of the cursor in the main window selects another depth-resolved cross-section plane, which can be viewed in a smaller right window on the right.

To evaluate capability of PTT in detection of pores in AM metallic materials, stainless steel 316 and Inconel 718 specimens with internal calibrated defects were developed with DLS fabrication method. The specimens are 6 in. \times 3 in. plates with 0.4 in. (10 mm) thickness. Porosity defects were created in the form of hemispheres of sizes ranging 1 mm to 8 mm diameter and located depths below the surface ranging from 1 mm to 5 mm. Computer drawing of the specimens with design of internal porosity defects is shown in Figure 4. A photograph of the AM SS316 and IN718 metallic plates with internal defects is shown in Figure 5. A representative result of PTT imaging of porosity defect in SS316 plate is displayed in Figure 6. The left panel of Figure

Continued on next page

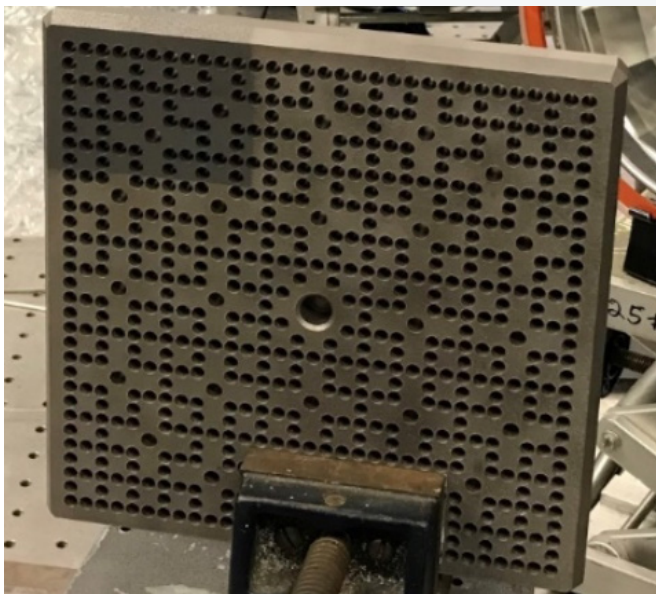

Figure 2. Photograph of 3-D printed IN718 nozzle plate.

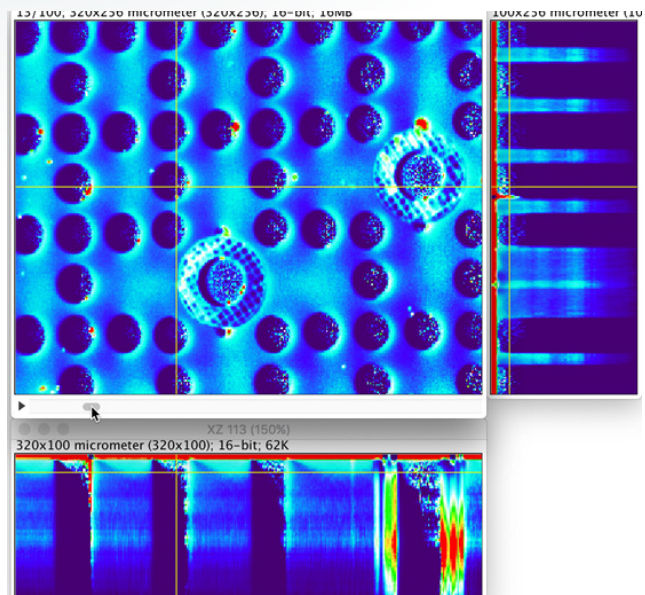

Figure 3. Screen capture of reconstructed 3-D image of Inconel 718 nozzle plate.

Continued from previous page

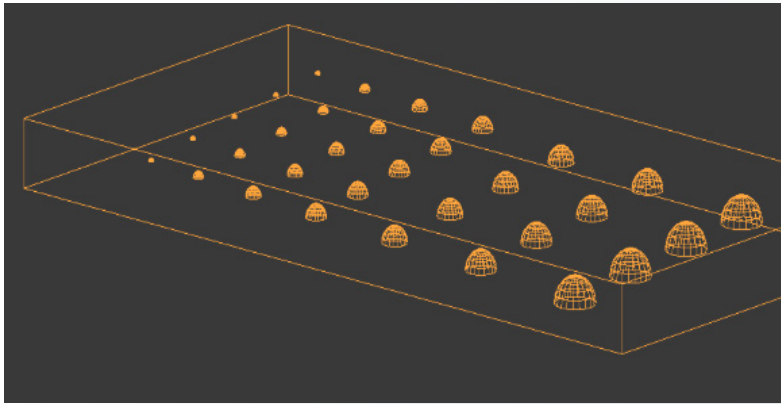

Figure 4. Computer drawing of calibrated porosity defects design.

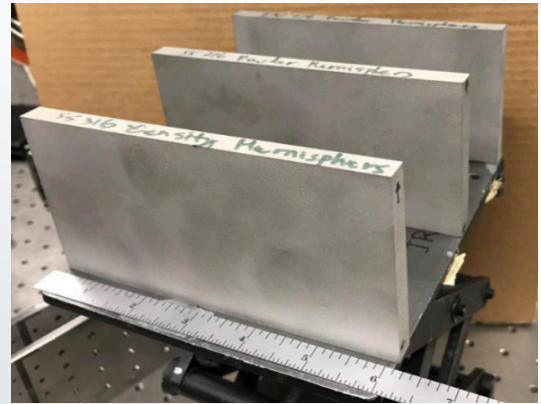

Figure 5. Photograph of AM SS136 and IN718 plates.

6 shows the legend of the defect size (labeled at the right) and depth (labeled at the top) and diameter distribution. The imaged area of the plate is indicated with a red rectangle. The right panel of Figure 6 shows reconstructed parallel slice at 1 mm depth obtained with PTT. The defects from 1 mm diameter (top right) to 4 mm diameter (bottom right) are clearly visible. The smallest defect size of 1 mm is pointed out with the red arrow.

Conclusion

Preliminary results indicate that PTT can obtain 3-D reconstructions of AM structures made from Inconel and stainless steel alloys, which are primary structural materials for light water and advanced reactors. Experimentally

detected smallest flaw size is 1-mm-diameter hemispherical shape porosity region, located 1 mm below the plate surface. Future work will investigate detection of smaller-size flaws in AM structures, as well as detection and quantification of cracks. In addition, qualification study of portable PTT system will be performed in low-radiation prototypical reactor scenario using MIT research reactor.

Acknowledgement

This project is sponsored by NEET Advanced Methods in Manufacturing (AMM) program. Other contributors from Argonne include J. G. Sun, Thomas Elmer, Dmitry Shribak, Brian Saboriendo, Tiffany Liu, and Sasan Bakhtiari.

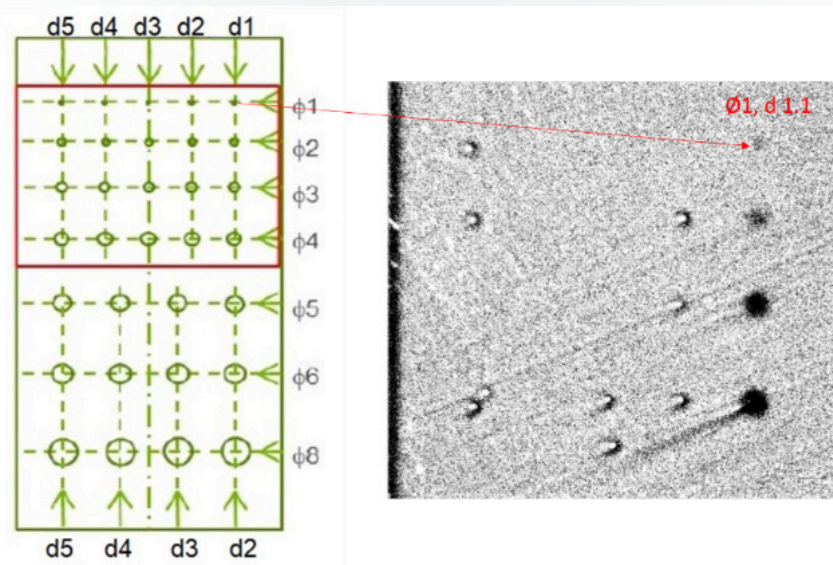

Figure 6. (Left) Imaged area of the plate. (Right) Reconstructed parallel plane slices at 1 mm depth, showing pores 1 mm to 4 mm in diameter.

Irradiation studies on electron beam welded PM-HIP pressure vessel steel



Janelle P. Wharry
Purdue University



David W. Gandy
EPRI



Will Kyffin
Nuclear-AMRC

The recent Nuclear Regulatory Commission design certification of the first small modular reactor (SMR) has amplified the necessity to introduce innovative methods of pressure vessel manufacturing to ensure SMR construction is realized on schedule and at reasonable cost. Amongst the manufacturing and joining techniques being considered, electron beam (EB) welding and powder metallurgy with hot isostatic pressing (PM-HIP) together offer the greatest potential to revolutionize pressure vessel manufacture by accelerating production time to as little as 12 months and reducing costs by up to 60% compared to conventional methods! EB welding reduces embrittlement and produces weld in a fraction of the time as conventional nuclear arc welding processes. Additionally, the use of PM-HIP base materials enables reactor component fabrication near-net shape, reducing reliance on machining and joining, simplifying component inspections, and further reducing production time to enhance economic competitiveness. The combination of EB welding and PM-HIP

enables production of high-quality pressure vessel components with no evidence of a weld seam or heat affected zone (HAZ) after a solution anneal, quench, normalization, and tempering (SQNT) treatment. Hence, there is express interest amongst nuclear industry stakeholders to qualify the combination of EB welding and PM-HIP technologies for pressure vessel construction for SMRs, light water reactors (LWRs), and advanced reactor concepts.

This project will assess the performance, safety, and structural and mechanical integrity of EB weldments on PM-HIP pressure vessel steel under service-relevant irradiation conditions. Specifically, this program will focus on PM-HIP pressure vessel steel A508 containing autogenous single-pass EB welds. Welds will undergo either PWHT, SQNT, or no heat treatment. Specimens will be neutron irradiated in the Advanced Test Reactor (ATR) at the Idaho National Laboratory (INL) to a fluence of 0.5 dpa at 300°C.

Continued on next page

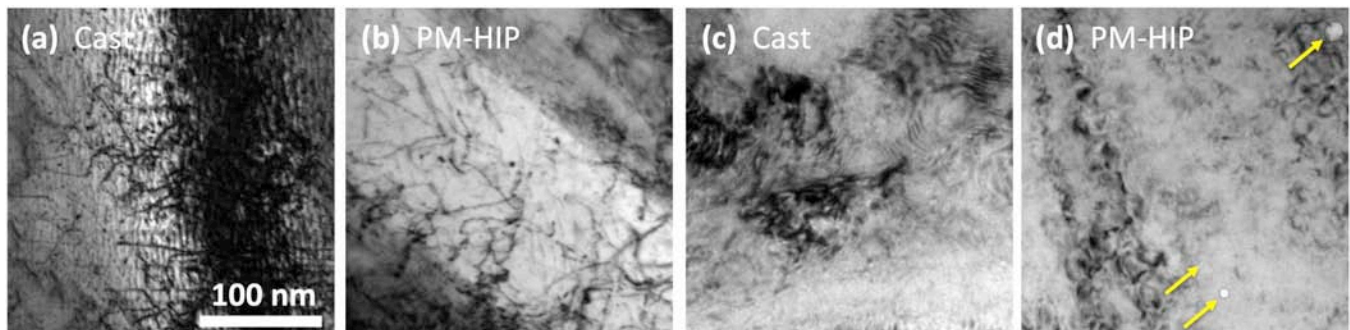

Figure 1: TEM micrographs of Ni⁺ ion irradiated forged and PM-HIP Alloy 625 showing (a-b) dislocation loops and lines, and (c-d) voids, if present; same scale bar for all images.

Continued from previous page

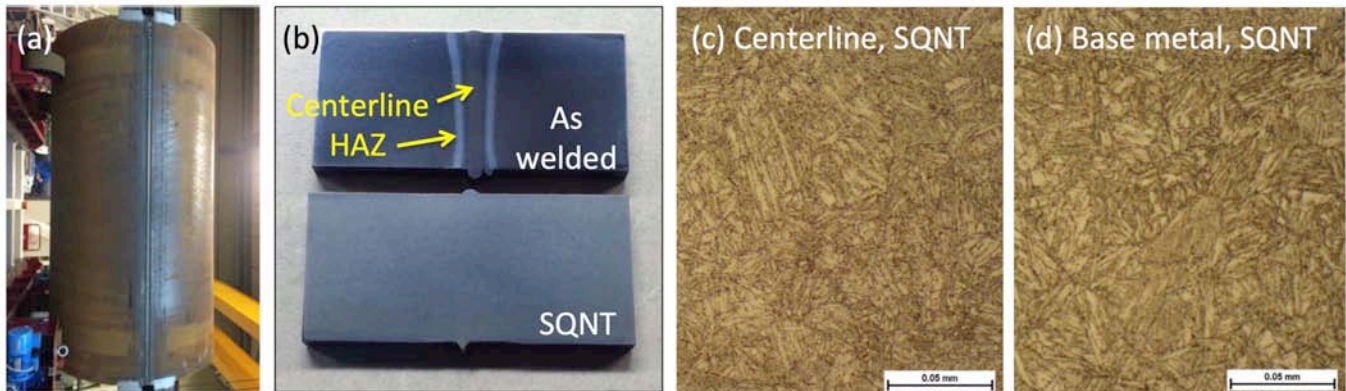

Figure 2: (a) EB weld demonstration on 3 m long, 110 mm thickness pressure vessel mockup made in under 90 minutes; effect of SQNT on (b) appearance of weld and HAZ appearance, and grain structure at (c) weld centerline and (d) base metal.

Background & Preliminary Results

PM-HIP is a forming and fabrication technique that consolidates metallic powders under high temperature and pressure, into a three-dimensional component near-net shape. Powders are typically consolidated at temperatures of 1000-1200°C and isostatic pressures of 50-300 MPa (7,000-45,000 psi), initiating a solid-state diffusion bonding process to produce fully dense and homogeneous microstructures. The component is slow cooled to eliminate local thermal stresses and transients typical of the thermomechanical processing applied to castings or forgings. PM-HIP materials generally exhibit superior mechanical performance than their cast or forged counterparts due to limited grain growth during processing. PM-HIP also reduces embrittlement by limiting growth of secondary phases and more precisely controlling the pickup of tramp elements.

Irradiated microstructures of PM-HIP alloys remain poorly understood. Some of the only results to date are from the Pls' recent scoping study to evaluate 450°C, 100 dpa Ni+ ion irradiation effects on the microstructures of PM-HIP and forged Ni-base Alloy 625. Initial findings suggest fewer dislocation loops and lines are present in the irradiated PM-HIP material than in the forged specimen (Fig 1a-b), but that more voids are found in the PM-HIP material than in the forging (arrows in Fig 1c-d). However, ion irradiation-induced void swelling is known to occur heterogeneously, so additional evidence is needed before drawing conclusions about the relative irradiation susceptibility of PM-HIP compared to forged alloys.

EB welding is a fusion welding process utilizing a high-energy electron beam as the source of heat to create local melt and flow of the materials being joined. EBW is typically performed under vacuum conditions, where the electrons can be accelerated to gain sufficient kinetic energy. These conditions also minimize tramp element pickup at the weld, inherently reducing embrittlement. The electron beams are narrow and of high intensity, producing highly localized welding with rapid heating and cooling, resulting in a small and often non-detectable heat affected zone (HAZ), and having weld centerline grain structures consistent with those of the base metal.

EB weld speed and power are critical process parameters that significantly affect the weld microstructure, microchemistry, and formation of defects. One must also optimize the post-weld heat treatment to attain desired mechanical performance. The Co-Pls have optimized EB weld parameters and designed a SQNT treatment of 1120°C solution anneal, water quench, 870°C normalization, and 650°C tempering. These conditions have eliminated the EB weld HAZ (Fig 2b), with weld centerline grain structures identical to those in the base metal (Fig 2c-d). A 607°C post-weld heat treatment has also exhibited promising microstructural results.

Plan of Work

Post-irradiation microstructure characterization will include scanning electron microscopy (SEM) to investigate grain and phase structure, transmission electron microscopy (TEM) to measure dislocation loops and voids, and atom

Continued on next page

Continued from previous page

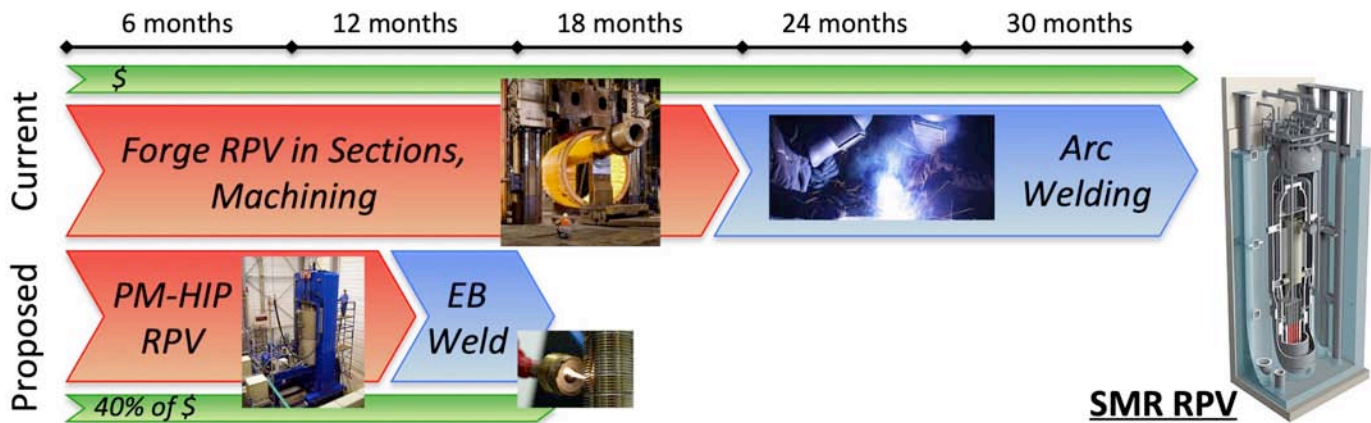

Figure 3: This project will enable the revolutionary combination of PM-HIP and EB welding to reduce pressure vessel fabrication time and cost.

probe tomography (APT) to quantify irradiation-induced nano-precipitates. Small-scale mechanical tests including nanoindentation and shear punch testing will evaluate irradiation effects on elastic properties and hardness. Work will establish a multiscale understanding of the variation of irradiation effects across the weldment.

Finally, the team will carry out fracture toughness testing of irradiated miniature CT specimens from all regions of the weldment (centerline, HAZ, and base metal). Fracture testing will inform quantitative fracture toughness, qualitative fracture mode, and the irradiation-induced ductile-to-brittle transition temperature (DBTT) shift. Mechanisms of the irradiation induced DBTT shift will be understood through the microstructure and small-scale mechanical tests. Finally, experimental results will validate GRIZZLY cohesive zone and crystal plasticity models for pressure vessel DBTT, enabling code case development.

Outcomes & Impact

This project has the potential to revolutionize reactor pressure vessel manufacturing through dramatic time and cost reductions. Pressure vessel manufacturing and assembly is a substantial rate-limiting step in the construction of new nuclear power systems, including

SMRs. Using currently qualified methods, pressure vessel manufacture requires forging of heavy components, machining these components to specifications, and conventional arc welding - altogether, these processes require more than two years to complete. The proposed project investigates alternative advanced manufacturing and joining approaches, namely the coupling of vessel fabrication near-net shape via PM-HIP with high-speed EB welding. Together, these novel approaches can reduce vessel fabrication time and cost by as much as 60%, (Fig 3). This dramatic time and cost savings will have transformative impact that crosscuts all DOE-NE programs and will help reinvigorate the commercial nuclear power industry as well as domestic manufacturing.

Acknowledgements

The team acknowledges the Electric Power Research Institute (EPRI) and the Nuclear Advanced Manufacturing Research Centre (AMRC) at the University of Sheffield for material fabrication and welding.

SMR Vessel Manufacture/Fabrication/Demonstration Project



David W. Gandy
EPRI



Marc Albert
EPRI



Will Kyffin
Nuclear-AMRC



Matt Cusworth
Nuclear-AMRC



Keith Bridger
Bridger Welding
Engineering

Many of the same manufacturing/fabrication technologies that were employed for light water reactor (LWR) plants built 30 to 50 years ago are also being employed today to build advanced light water reactors (ALWRs). Manufacturing technologies have not changed dramatically for the nuclear industry even though more-efficient production processes are available that could significantly reduce the overall cost of components. New technologies that can accelerate production and reduce costs are vital for the next generation of plants, small modular reactors (SMR), and advanced reactor (GEN-IV) plants to ensure they can be competitive in the current and future market.

This project aims to demonstrate and test several new technologies with the goal of producing critical assemblies for a two-thirds scale demonstration SMR reactor pressure vessel (RPV). Through the use of electron beam welding (EBW), powder metallurgy-hot isostatic pressing (PM-HIP),

diode laser cladding (DLC), bulk additive manufacturing, and advanced machining, the Electric Power Research Institute (EPRI), the United Kingdom (U.K.)-based Nuclear Advanced Manufacturing Research Centre (Nuclear-AMRC), and a number of other industrial team members seek to demonstrate that critical sections of an SMR RPV can be manufactured and fabricated in less than 12 months and at a cost savings of more than 40% compared to today's technologies. The project aims to demonstrate and test the impact that each of these technologies can have on future production of SMRs, and explore the relevance of the technologies to the production of ALWRs, SMRs, ARs, ultra-supercritical fossil, and supercritical CO₂ plants. The project, if successful, may accelerate deployment of SMRs in both the United States (U.S.) and ultimately throughout the world.

Continued on next page

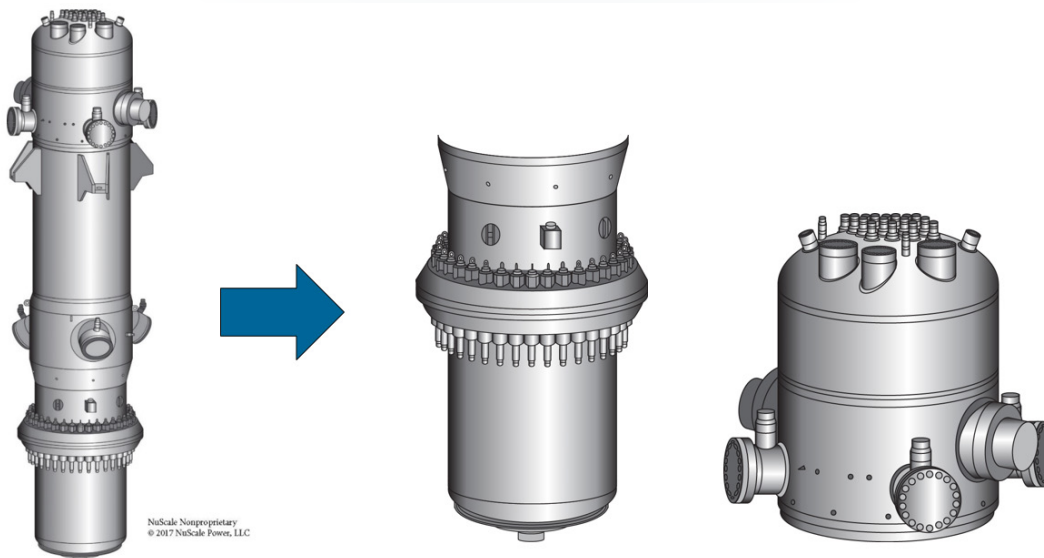

NuScale Nonproprietary
© 2017 NuScale Power, LLC

Figure 1. Upper and lower assemblies of the NuScale Power reactor are being assembled at 2/3 scale under this program.

Continued from previous page

Tasks

In the AMM Newsletter—Issue 5 (1), the project tasks for the current project were described. Task 1 of the project is focused on manufacture and fabrication of the lower assembly (Figure 1) of the NuScale reactor at 2/3-scale (2–5). The lower assembly consists of a lower RPV head, a lower RPV flange shell, upper and lower flanges, and an upper transition shell. Each of these components will be produced and assembled by Q2-2020.

Current Status

- Produced three 2/3-scale, one-half diameter lower reactor heads (~70 in. (1780 mm) in diameter) via PM-HIP (Figure 2).
- Manufactured four major forgings including an upper and lower RPV flange, the lower RPV shell, and the pressurizer shell.
- Produced one RPV transition shell section (1/5th diameter) (Figure 3) using PM-HIP. Two additional HIP capsules have been fabricated and will be filled and HIP'ed by the end of 2019.
- Established and demonstrated electron beam welding parameters and geometry for SA508 Grade 3 Class 1 girth welds.
- Completed a 2/3-scale diameter (~70 inches) RPV shell-to-flange mockup full-diameter girth weld in 47 minutes (Figure 4).
- Developed the diode laser cladding parameters for 308L stainless steel and Alloy 82 applications.

In the coming weeks, the investigators plan to complete machining and joining of two lower reactor head sections via electron beam welding and complete machining and heat treatment of the upper and lower flanges and lower RPV shell. The lower flange will then be welded to the lower RPV shell and the assembly will be welded to the lower reactor head. Additionally, five sections of the upper RPV transition shell will be joined with vertical welds and then welded to the upper RPV flange. This will complete the lower assembly (Figure 1).

Impact, Value, and Implications

If successful, the impact of the current SMR manufacturing/fabrication project will be dramatic in terms of cost reduction, quality, and schedule. The following are a few of the projected outcomes from the project:

- Demonstrate an advanced welding technology, EBW for fabrication of reactor components, which is expected to reduce welding time by 90% over conventional welding processes and methods.



Figure 2. A 2/3-scale, one-half diameter lower reactor head (~70 in. (1780 mm) in diameter, 6910 lbs (3135 kgs) was also produced via PM-HIP.

- Demonstrate PM-HIP methods to manufacture difficult-to-produce sections of the SMR (upper and lower reactor heads, plenum, access covers, etc.) in as little as a few months each.
- Possibly eliminate in-service inspection requirements for no fewer than five (out of seven) full-diameter circumferential welds using the EBW process and solution annealing.
- Develop/demonstrate diode laser cladding (DLC) technologies that can apply thin (~1 mm) layers of cladding using robotics. The overall volume of material required for cladding will be reduced by 75% resulting in a substantial cost savings across the entire vessel inner and outer clad surfaces.

Continued on next page

Continued from previous page



Figure 3. A one-fifth diameter RPV transition shell shown inside of the HIP vessel (with support frame) just prior to HIP'ing.

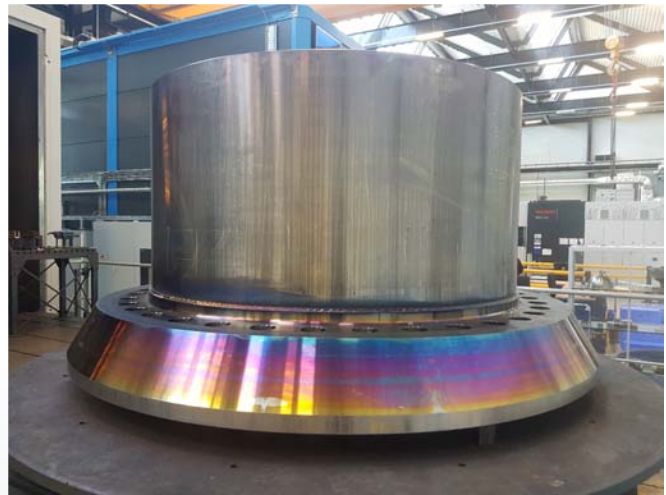

Figure 4. A 2/3-scale diameter (~70 in.) RPV shell-to-flange mockup full-diameter girth weld was completed in 47 min.

Acknowledgements

The principal investigators would like to recognize Vern Pence and Derick Botha (NuScale Power), Victor Samarov, Alex Bissikalov, and Charlie Barre (Synertech- PM), and Michael Blackmore (Sheffield Forgemasters-UK) who have been instrumental in production of major components in this project.

References

1. D. Gandy, et al., "SMR Reactor Vessel Manufacture/ Fabrication/Demonstration Project," AMM Newsletter, Issue 5, March 2017, pp. 8–10.
2. D. Gandy, et al, "Advanced Manufacturing to Enable the Next Generation of Nuclear Plants," ANS/ICAPP 2018, Charlotte, North Carolina, April 8–11, 2018.
3. EPRI Report 3002008030, Innovative Manufacturing Process for Nuclear Power Plant Components via Powder Metallurgy, Final Report, Electric Power Research Institute, September 2016.

4. D. Gandy, et al., "Small Modular Reactor Vessel Manufacture/Fabrication Using PM-HIP and Electron Beam Welding Technologies," HIP17, 12th International Conference on Hot Isostatic Pressing, Sydney Australia, December 5–8, 2017.
5. D. Gandy, "PM-HIP Research for Structural and Pressure Retaining Applications within the Electric Power Industry," Third International Workshop on Structural Materials for Innovative Nuclear Systems (SMINS-3), Idaho Falls, October 2013.

The NSUF continues to provide funding and facility support for this project.

3-D Printing of Nuclear Fuel Assembly Nozzles and End-Spacer Grids

Direct metal laser melting (DMLM) additive manufacturing (AM) is being employed to fabricate commercial nuclear fuel assembly bottom nozzles with debris filtering and fuel rod capture features. Additive manufacturing (aka 3-D printing) is becoming more common as a manufacturing option in other industries. This project is to prove that this technology is a viable option for fabrication of commercial nuclear fuel assembly components.

In Phase I of this project, the material properties of AM Inconel-718 were compared to wrought material properties. Destructive testing showed that yield, ultimate, and elongation material properties for AM Inconel-718 were similar to wrought materials properties. This testing showed that AM Inconel-718 has sufficient strength to handle the loading conditions associated with commercial nuclear fuel assembly bottom nozzles.

The next step in the Phase I effort was to design and fabricate multiple prototype nozzle designs (see Figure 1). These nozzles incorporated torturous flow passages that allow free passage of water but trap debris. Torturous path debris filters can be particularly effective in capturing wires and other types of debris that can cause fuel rod failures. The prototype nozzle designs were tested for debris capturing effectiveness (Figure 2) and for pressure drop



George Pabis
Principal Investigator,
Innovative Technologies
International, Inc.

(Figure 3). The data from these tests was used to optimize the torturous path design and to benchmark computational fluid dynamic (CFD) models (Figure 4).

Fuel rod locking tests were also performed on multiple prototype bottom nozzle designs. These tests validated the fuel rod locking function as well as the ability to release the rod from the locking feature. Additionally, the locking features were tested for strength to ensure that they could secure the fuel rod under reactor operating conditions. Data from these tests were used to optimize the locking feature designs and to benchmark finite element models (FEM) of the locking features.

Current Status

Innovative Technologies (aka NovaTech) carried the momentum generated in Phase I into the Phase II work. With the goal of producing a full-scale fuel assembly mockup with the new AM bottom nozzle, NovaTech had to address guide tube connections, instrument tube connections, reactor core interfaces, and fuel handling interfaces. In parallel with these engineering requirements, NovaTech contacted the stakeholders who could use the new AM bottom nozzle. NovaTech has met with and gained the support of U.S. nuclear fuel manufacturers as well as nuclear reactor operators who could operate this AM bottom nozzle in their plant.

Before NovaTech can ensure that the AM bottom nozzle will successfully operate in a nuclear reactor, additional testing is required. This testing includes material irradiation testing, fuel rod vibration testing, and full-scale flow testing.

Continued on next page

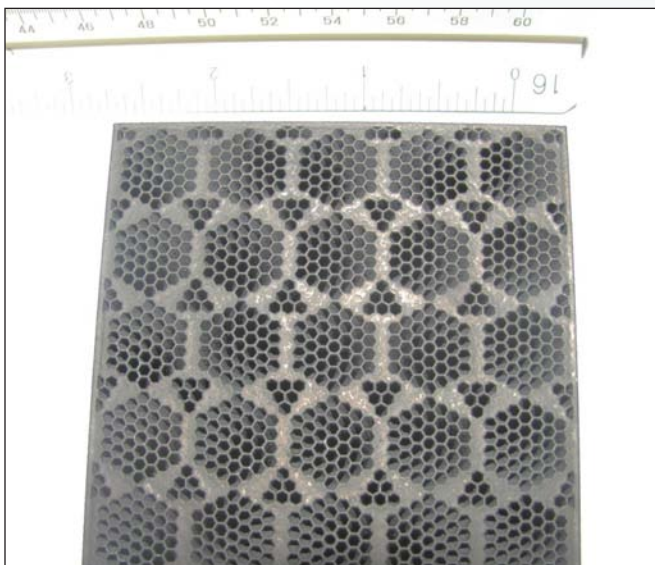

Figure 1. Prototype bottom nozzle.



Figure 2. Debris used to test torturous path filtering effectiveness.

Continued from previous page

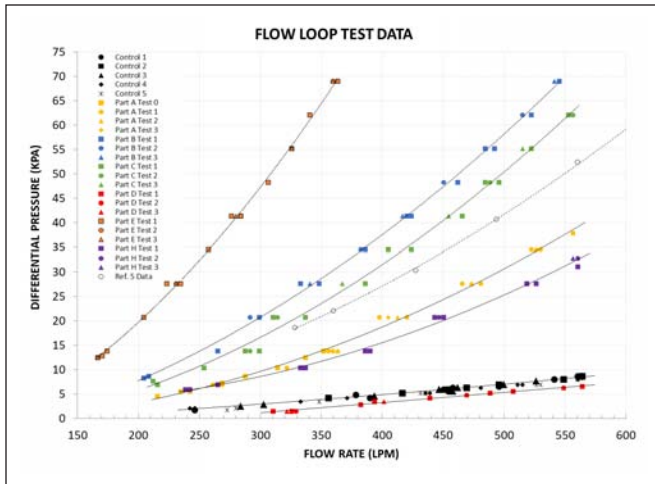

Figure 3. Prototype bottom nozzle pressure drop test data.

To address the effects that the intense irradiation environment might have on the AM Inconel-718, NovaTech has partnered with Oak Ridge National Laboratories (ORNL). Together with ORNL, NovaTech has prepared a “rabbit” with 24 specimens that will be irradiated to approximately 6 dpa in the high flux isotope reactor (HFIR) (Figure 5).

Fuel rod vibration testing will be conducted in NovaTech’s small cold flow loop. A series of tests will be conducted under conditions that simulate both direct flow through the test assembly as well as cross-flow conditions. A pair of lasers will map the horizontal motion of a 5x5 array of fuel rods under the different flow conditions. Fuel rod vibration test results from a standard fuel assembly test bundle will be compared to a test bundle with the AM bottom nozzle design to ensure that the new AM bottom nozzle design is performing as designed.

Full-scale flow testing will be conducted in NovaTech’s large cold flow loop. NovaTech is fabricating a full-scale prototype fuel assembly that includes the new AM bottom nozzle combined with production-grade fuel assembly components, including a ballast that matches the fuel pellet density. The full-scale flow testing will validate the pressure drop performance of the new AM bottom nozzle and verify that there are no performance issues.

At the end of the Phase II project, a new nozzle design fabricated using additive manufacturing should be ready for insertion into a commercial reactor for final testing prior to batch implementation.

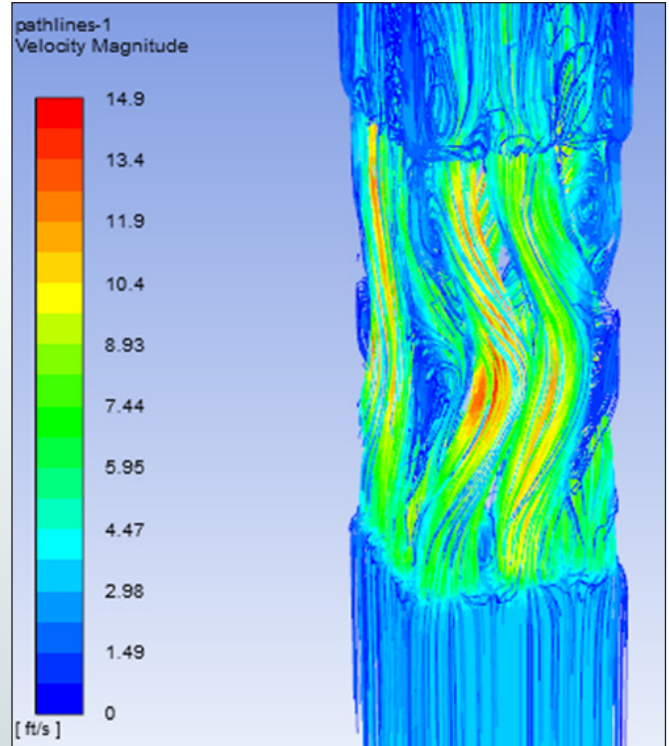

Figure 4. CFD model of prototype bottom nozzle.

Conclusion

The additive manufacturing process allows the designer to consider more complicated geometry that can improve the flow characteristics and debris capture capability of the bottom nozzle. The bottom nozzle can also incorporate fuel rod locking features that may make it possible to eliminate the bottom grid on the fuel assembly, thus reducing cost.

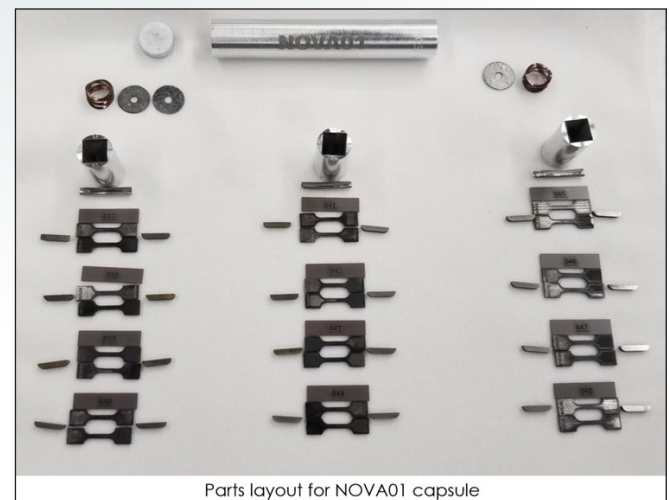

Figure 5. HFIR rabbit with specimens.

To submit information or suggestions, contact Tansel Seleklers at Tansel.Seleklers@nuclear.energy.gov or Dr. Isabella van Rooyen at isabella.vanrooyen@inl.gov.