

FreedomCAR & Fuel Partnership



U.S. DEPARTMENT OF
ENERGY

USCAR
UNITED STATES COUNCIL FOR AUTOMOTIVE RESEARCH LLC



ConocoPhillips

ExxonMobil



Shell Hydrogen



**SOUTHERN CALIFORNIA
EDISON**
An EDISON INTERNATIONAL® Company

FreedomCAR and Fuel Partnership

2009

Highlights of Technical Accomplishments

Table of Contents

Item	Page
Preface	iv
<u>Vehicle Technologies</u>	
Advanced Combustion & Emissions Control	
• <i>High Efficiency Clean Combustion (HECC) Shows Potential to Reduce Fuel Penalty for Diesel Particulate Control by 25%</i>	1
• <i>E85 Engine Achieves Greater Torque and Similar Fuel Economy Compared to a Larger Diesel Engine</i>	2
• <i>Simulations Provide New Insight into the Potential Benefits and Limitations of Compression Ignition Engines in Hybrid Vehicles</i>	3
• <i>Understanding of Lean NO_x Trap Chemistry Enables Improved On-Board Diagnostics</i>	4
• <i>Fuel Injector Motion Linked to Structure of Spray</i>	5
• <i>Boosted Gasoline HCCI Achieves 2x Load Increase over Previous Best</i>	6
Electrical & Electronics	
• <i>Current Source Inverter for HEVs and FCVs</i>	7
• <i>Active Filter Approach to Reducing the Traction Inverter Capacitor</i>	8
• <i>Wide Bandgap Characterization</i>	9
• <i>Characterization of Thermal Interface Material Performance</i>	10
• <i>Rapid Parametric Modeling Process for Thermal Management and Electronics Packaging Technologies</i>	11
• <i>High Efficiency Soft-Switching Inverter</i>	12
Electrochemical Energy Storage	
• <i>Advanced Separators for HEV/PHEV Applications</i>	13
• <i>New High-Voltage High-Capacity Composite-Structure Cathode Is Being Commercialized</i>	14
• <i>Six Amp-hour HEV Prismatic Cell</i>	15
• <i>19 Amp-hour Prismatic Cell</i>	16
• <i>Life Improvements for PHEV Li-ion Battery</i>	17
• <i>Development of a Li-ion Cell for Plug-in Hybrid Vehicles with Improved Life and Safety Characteristics</i>	18
• <i>First-Principles Calculation Leads to Extremely High Rate LiFePO₄</i>	19
• <i>USABC Lower-Energy, Energy Storage Systems Requirements for Power Assist HEVs</i>	20
• <i>Smart Battery Status Monitor</i>	21
• <i>Technology Life Verification Testing</i>	22
• <i>A Molecular Dynamics Model of Charge Transfer across a Solid-Liquid Interface</i>	23

Table of Contents (continued)

<i>Item</i>	<i>Page</i>
Fuel Cells	
• <i>Membrane Conductivity Interim Target Met with Functional Composite System</i>	24
• <i>Dimensionally Stable Membranes</i>	25
• <i>NanoCapillary Network Proton Conducting Membranes for High Temperature Hydrogen/Air Fuel Cells</i>	26
• <i>Platinum Loading Targets Achieved with NSTF-Containing MEA</i>	27
• <i>Eight-Fold Improvement in Activity of Non-Precious Metal Catalyst</i>	28
• <i>New Water Transport and GDL Characterization Techniques Developed</i>	29
• <i>Development of Angström-Scale Analysis for Composition and Structure of Catalyst Particles</i>	30
• <i>Effects of Fuel and Air Impurities on PEM Fuel Cell Performance</i>	31
• <i>Mass Production Cost Estimation for H₂ Fuel Cell Systems for Automotive Applications</i>	32
Materials	
• <i>Development of a Lightweight Composite Seat</i>	33
• <i>Light-Weight Magnesium-Intensive Engine</i>	34
• <i>Full-scale Recycling Validation Plant for Recovering Polymers Starts Operation</i>	35
• <i>Future Generation Passenger Compartment - Validation</i>	36
• <i>Infrared Inspection of Resistance Spot Welds Non-Destructive Inspection</i>	37
• <i>Low Cost Titanium Materials for Suspension Applications</i>	38
Vehicle Systems Analysis	
• <i>PHEV and HEV Fleet Testing</i>	39
• <i>Cost-effective Vehicle Electrification</i>	40
• <i>Plug-in Hybrid Engine Thermal State and Resulting Efficiency</i>	41
<u>Fuel Infrastructure Technologies</u>	
Fuel Pathway Integration	
• <i>Well-to-Wheels Analysis</i>	42
• <i>Analysis of Hydrogen Integration in Non-Transportation Sectors</i>	43
• <i>Geologic Hydrogen Storage Issues</i>	44
Hydrogen Delivery	
• <i>H2A Hydrogen Delivery Scenario Analysis Model</i>	45

Table of Contents (continued)

<i>Item</i>	<i>Page</i>
Hydrogen Production	
• <i>Maximizing Sunlight Utilization Efficiency and Productivity in Photosynthesis</i>	46
• <i>Hydrogen Production in Programmatic Advances</i>	47
• <i>Scale-up of Hydrogen Transport Membranes for IGCC and FutureGen Plants</i>	48
<u>Crosscutting Technologies</u>	
Codes & Standards	
• <i>Separation Distance – Code Unification</i>	49
• <i>NFPA 2 Hydrogen Technologies Code</i>	50
Onboard Hydrogen Storage	
• <i>Alane Regenerated at Low Pressure</i>	51
• <i>Low Cost Pathway to Production and Regeneration of Ammonia Borane</i>	52
• <i>Characterization of Hydrogen Adsorption by NMR</i>	53
• <i>Chemical Hydrogen Storage Center of Excellence Progress in Amino Borohydrides</i>	54
• <i>Best Practices for Characterizing Hydrogen Storage Properties of Materials</i>	55
• <i>Neutron Characterization of Hydrogen Storage Materials</i>	56
• <i>Development of Metal Hydrides for Reversible On-Board Hydrogen Storage</i>	57
• <i>Robust Computational Methods to Predict Metal Hydrides for Reversible Hydrogen Storage</i>	58
• <i>Hydrogen Storage Media Through Nanostructured Polymeric Materials</i>	59
• <i>Fundamental Calculations to Advance Chemical Hydrogen Storage</i>	60
• <i>Improved Hydrogen Release from Amineborane with Additives</i>	61

Preface

This report summarizes key technical accomplishments achieved in support of the FreedomCAR and Fuel Partnership in 2009.

Established in 2002 as the FreedomCAR Partnership, this effort began as a cooperative research partnership between the United States Department of Energy (DOE) and the United States Council for Automotive Research LLC (USCAR), a consortium composed of Chrysler Group LLC, Ford Motor Company and General Motors Company. In 2005, the partnership expanded to include five energy companies (BP America, Chevron Corporation, ConocoPhillips, ExxonMobil Corporation and Shell Hydrogen LLC) under a new name, the FreedomCAR and Fuel Partnership. Two electric utilities, DTE Energy and Southern California Edison, joined the effort in 2009, and with their addition, the partnership established a new Grid Interaction Technical Team.

The accomplishments described in this report support the overall FreedomCAR and Fuel Partnership goals, which are based on the following “Freedoms:”

- Freedom from dependence on imported oil
- Freedom from pollutant emissions
- Freedom for Americans to choose the kind of vehicle they want to drive, and to drive where they want, when they want
- Freedom to obtain fuel affordably and conveniently

Prior year accomplishments reports are available on the FreedomCAR and Fuel Partnership page on the USCAR website at www.uscar.org and the DOE website at www.vehicles.energy.gov/about/partnerships/freedomcar/index.html.

The partnership selected material for the 2009 Highlights of Technical Accomplishments Report from many hundreds of projects. The one-page highlight descriptions that comprise the report are arranged by Technical Team focus area and fall into three groups:

Vehicle Technical Teams - Members from USCAR and DOE

- Advanced Combustion & Emissions Control
- Electrical and Electronics
- Electrochemical Energy Storage
- Fuel Cells
- Materials
- Vehicle Systems Analysis

Energy Technical Teams - Members from energy company partners and DOE

- Fuel Pathway Integration
- Hydrogen Delivery
- Hydrogen Production

Joint Technical Teams - Members from USCAR, energy and utility company partners and DOE

- Codes and Standards
- Onboard Hydrogen Storage
- Grid Interaction*

Each accomplishment represents a significant milestone or breakthrough achieved in 2009. The work presented may have begun in previous years and, in some cases, represents interim achievements rather than final project goals.

Through cooperation and partnership, industry and government-supported advanced automotive technology research has made tremendous progress over the last eight years. Technologies that were only concepts are now approaching initial commercial readiness. With continued progress resulting from the joint efforts of government, industry and academic partners, America will remain a global leader in the development of advanced automotive technologies that can enable a clean and sustainable transportation energy future.

Note: Common abbreviations used through this report

ANL – Argonne National Laboratory

BNL – Brookhaven National Laboratory

EPA – Environmental Protection Agency

EV – Electric Vehicle

FCV – Fuel Cell Electric Vehicle

HEV – Hybrid Electric Vehicle

INL – Idaho National Laboratory

LANL – Los Alamos National Laboratory

NIST – National Institute of Standards and Technology

NREL – National Renewable Energy Laboratory

ORNL – Oak Ridge National Laboratory

PHEV – Plug-In Hybrid Electric Vehicle

PNNL – Pacific Northwest National Laboratory

SRNL – Savannah River National Laboratory

* The new Grid Interaction Technical Team (GITT) met for the first time to establish its technical priorities in 2009; as such, the partnership will highlight GITT technical accomplishments in future reports.

2009 FreedomCAR and Fuel Partnership Highlight

High Efficiency Clean Combustion (HECC) Shows Potential to Reduce Fuel Penalty For Diesel Particulate Control by 25%

Oak Ridge National Laboratory

Diesel powered vehicles in the United States are now sold with Diesel Particulate Filter (DPF) technology to meet U.S. EPA emission regulations for Particulate Matter (PM) emissions. The DPF technology has dramatically changed diesel engine emissions with more than a 95% reduction in PM emissions for new vehicles. However, there is a fuel penalty associated with DPF operation due to the need to periodically oxidize the stored PM at temperatures exceeding 600°C. This is accomplished by adding fuel to the exhaust system to heat the DPF substrate in combination with an upstream diesel oxidation catalyst. Minimizing this fuel penalty can help to ensure the greatest possible fuel efficiency improvements with diesel engine technology.

The fuel penalty for PM emissions control on an experimental diesel engine was reduced from 4.2% to 3.1% over an approximated light-duty drive cycle by intermittently switching from conventional combustion to a High Efficiency Clean Combustion (HECC) mode. Fuel use was estimated using a weighted average method based on steady-state operating conditions representative of the light-duty drive cycle.

To attain this improvement, Oak Ridge National Laboratory (ORNL) researchers studied the use of HECC modes, which have lower engine-out Oxides of Nitrogen (NO_x) and PM emissions compared to conventional operation. The reduction in engine-out PM for HECC operation substantially decreases the rise rate in differential pressure across the DPF, and correspondingly, the required frequency of DPF regeneration events. This leads to lower fuel use for the DPF, and thus an improvement in overall engine-system efficiency. This investigation made use of a light-duty diesel engine with a catalyst system composed of a diesel oxidation catalyst, DPF, and lean NO_x catalyst. DPF regeneration was initiated at an engine backpressure of 2 kPa. Results of this comparison are shown in Figure 1.

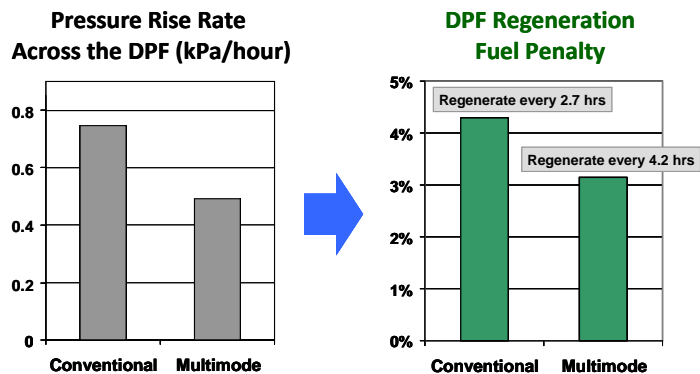

Figure 1: Differential pressure rise rate across DPF and resulting fuel penalty for conventional operation compared to the multimode case, which includes HECC operation when possible. Fuel penalty is defined as the additional fuel needed to regenerate the DPF divided by the total fuel used in the accumulation time.

2009 FreedomCAR and Fuel Partnership Highlight

E85 Engine Achieves Greater Torque and Similar Fuel Economy Compared to a Larger Diesel Engine

Ford Motor Company, AVL Powertrain Engineering Inc,
Ethanol Boosting Systems LLC

Ethanol is an ideal fuel for turbocharged direct injection engines due to its high inherent octane and high heat of vaporization, which vastly extends the knock-free engine operating range. However, ethanol has a relatively low heating value per volume, which results in a dramatic reduction in vehicle range and fuel economy in miles per gallon (mpg). A dual fuel concept, which applies Port Fuel Injection (PFI) of gasoline and Direct Injection (DI) of E85, addresses this concern by using gasoline PFI for starting and light-medium loads and E85 DI *only as required* at high loads to avoid knock. Since E85 DI suppresses knock, the engine's compression ratio can be increased and higher boost levels can be used. The resulting very high torque levels allow aggressive downsizing of the engine displacement for improved vehicle fuel economy.

A 5.0L multi-cylinder E85-optimized dual fuel engine tested at Ford's dynamometer labs has demonstrated three fundamental advantages for E85 compared to gasoline: absence of knock, near-zero soot emissions due to the oxygenated nature of the fuel, and no incidence of irregular combustion or pre-ignition, even at very high torque levels of 930 ft lb, equivalent to 32 bar Brake Mean Effective Pressure (BMEP). These torque levels are much higher than a larger diesel engine (see Figure 1).

Vehicle simulation projections based on engine data indicate that an E85 optimized dual fuel engine can achieve diesel fuel economy while providing enhanced vehicle performance (see Figure 2) as measured by gradeability (maximum grade achieved in top gear at 65 mph). Additionally, since the E85 engine operates at stoichiometric conditions and uses a conventional three way catalyst, it can achieve stringent emission levels with low after-treatment cost.

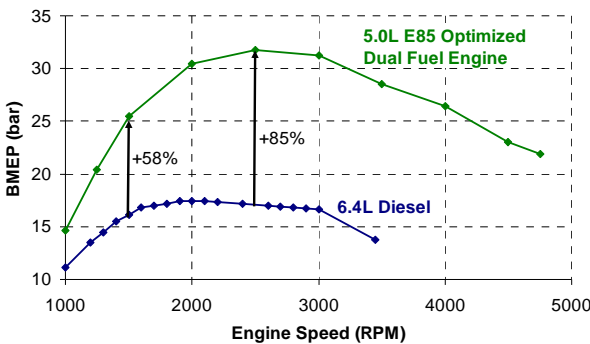

Figure 1: Measured BMEP (normalized torque) for E85 optimized dual fuel engine compared to a modern diesel engine.

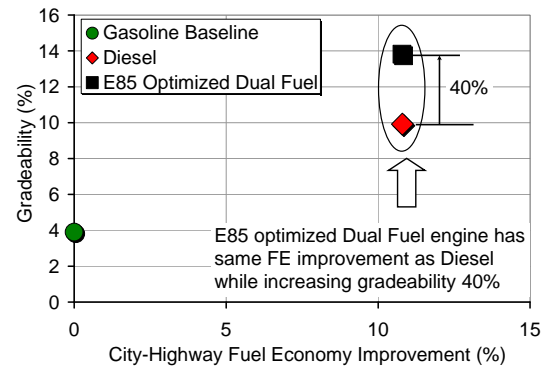

Figure 2: Simulated fuel economy and performance of an E85 optimized dual fuel engine compared to gasoline and diesel engines.

2009 FreedomCAR and Fuel Partnership Highlight

Simulations Provide New Insight into the Potential Benefits and Limitations of Compression Ignition Engines in Hybrid Vehicles

Oak Ridge National Laboratory

Researchers at Oak Ridge National Laboratory (ORNL) have utilized specialized Department of Energy (DOE) computer models to generate the first non-proprietary, full-vehicle performance simulations of Hybrid and Plug-in Hybrid Electric Vehicles (HEVs and PHEVs) with Compression Ignition (CI) engines and lean NO_x emissions controls. These simulations account for the thermal and emissions transients associated with the characteristic start/stop engine operation of hybrid vehicles and show that current lean NO_x control technology may significantly reduce the fuel efficiency benefits of CI engines in hybrid powertrains. The vehicle model was based on an Argonne National Laboratory (ANL) validated model found in the Powertrain Systems Analysis Toolkit (PSAT). All simulations used a 1.5-L displacement engine (gasoline and diesel), 1450 kg vehicle weight, 5 kWh battery and the same PHEV control strategy.

CI diesel engines have well-known fuel efficiency advantages compared to spark ignition engines in conventional vehicles, but it is not clear how hybrid vehicles can realize these efficiency advantages. A potential limitation of current CI engines is that they require some form of lean NO_x aftertreatment. One approach to address this limitation is the use of a Lean NO_x Trap (LNT). LNTs are a promising NO_x control technology, but they require additional fuel to function, and additional fuel requirements are especially difficult to determine for hybrid vehicles, given the frequent engine starts and stops experienced in typical driving. Recent results indicate that LNT NO_x control may offset as much as half of the potential fuel efficiency advantages of CI diesel engines, as shown in the figure. Normalized energy usage shown in the figure is relative to the gasoline PHEV over five consecutive Urban Dynamometer Driving Schedules (UDDS). The priority of the PHEV control strategy was to use electrical energy until a power demand exceeds a threshold value. For all cases shown, the first three UDDS cycles operated in a charge-depletion mode and the last two cycles operated in a charge-sustaining mode due to low battery state of charge.

Other NO_x control technologies such as selective catalytic reduction are expected to require less additional fuel and are currently under intense investigation. Regardless of the NO_x control technology, hybrid vehicles with CI engines will also require exhaust particulate controls, which were not included in the present study but are expected to create additional fuel usage.

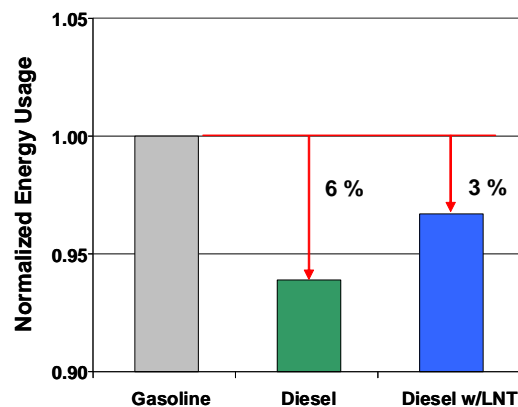

Comparison of energy usage for simulations of a compact passenger car PHEV with conventional gasoline, diesel and diesel with LNT NO_x aftertreatment.

2009 FreedomCAR and Fuel Partnership Highlight

Understanding of Lean NO_x Trap Chemistry Enables Improved On-Board Diagnostics

Oak Ridge National Laboratory, Pacific Northwest National Laboratory

Oak Ridge and Pacific Northwest National Laboratories (ORNL and PNNL) used highly specialized experimental measurements to relate Water-Gas Shift Reaction (WGS) chemistry in Lean NO_x Traps (LNTs) to catalyst sulfation and aging. This information is important to a new On-Board Diagnostic (OBD) strategy developed by Cummins Inc. (patent application 20080168824), which provides real-time monitoring of LNT aging using existing exhaust gas oxygen sensors. It is expected that such active control will significantly reduce the fuel penalty, degradation and aftertreatment costs associated with LNT NO_x emissions control in advanced diesel and lean gasoline engines by enabling better desulfation management and eliminating the need to oversize LNTs.

LNTs remove NO_x from lean engine exhaust but are degraded by fuel-borne sulfur. High-temperature desulfation events are required to recover LNT performance; however, these can cause irreversible catalyst damage and have an associated fuel-penalty. The patented control strategy minimizes these detrimental effects by only commanding desulfation events when and for as long as needed. Using specialized techniques, ORNL and PNNL determined how sulfation and thermal aging shifts the LNT's WGS. Figure 1 shows the impact of sulfation on WGS-generated hydrogen. A combined understanding of how sulfation impacts the NO_x storage and WGS functions and how hydrogen biases oxygen (lambda) sensor readings enables the new strategy for on-board tracking of the LNT catalyst state.

Improved active control allows tightening of engineering design and operation margins. Specifically, there is less need to overdesign LNT hardware (i.e., using larger sizes and excess precious metal loadings). Moreover, minimizing high-temperature desulfations also decreases the associated fuel penalty and increases the effective catalyst life.

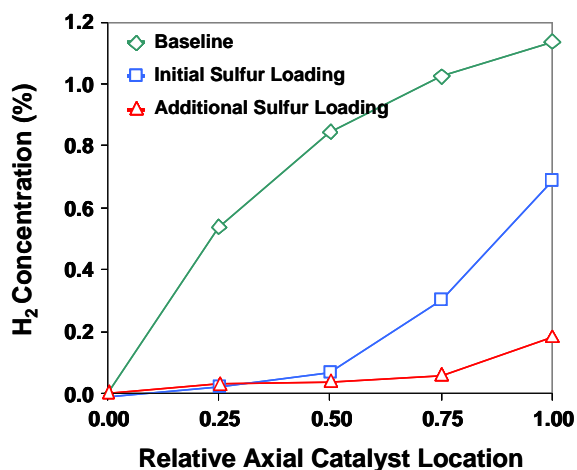

Figure 1: Effect of sulfur concentration on the WGS and correspondingly H₂ generation at relative axial locations in the catalyst. As sulfur exposure increases, less H₂ is produced via WGS with the effect being most dramatic in the front half of the catalyst.

2009 FreedomCAR and Fuel Partnership Highlight

Fuel Injector Motion Linked to Structure of Spray

Argonne National Laboratory

Computational spray modeling is one of the enabling technologies for achieving high engine efficiency with low emissions. Accurate models allow researchers to test many different fueling strategies, combustion regimes and engine geometries without investing the time and money to build prototypes. However, today's models are based on very limited experimental data, and they cannot be used to make accurate predictions of engine performance.

Researchers from Argonne's Center for Transportation Research used x-rays from the Advanced Photon Source to reveal how motion of the parts inside an automotive fuel injector affects the spray pattern it produces. First, they took high-speed x-ray movies of the internal components of a fuel injector, tracking their 3D motion without disturbing their normal operation. An example image is shown in Figure 1a. The most significant discovery was that the needle valve displayed large eccentric "wobbling" motions when it opened to inject fuel into the engine, as plotted in Figure 1c. These eccentric motions can change the fuel flow from the injector, altering the normal spray pattern and possibly affecting engine performance. Next, x-rays were used to study the spray pattern of the fuel as it emerged from the injector. It was found that the fuel density in the spray oscillates with time (Figure 1b), and that these oscillations are synchronized with the motion of the needle valve inside the injector. This discovery is the first time that valve motion has been linked to spray structure.

Robert Bosch GmbH believes that eccentric needle motions contribute to spray asymmetry and has developed new nozzle designs to minimize the problem. However, Argonne's measurements show that the new nozzles reduce but do not eliminate the eccentric motion. Bosch is using the Argonne data to improve its computational modeling of injector flow. This unique data provides a comprehensive picture of spray formation, from the exact geometry and motion of the internal parts to a detailed measurement of the spray pattern produced by the injector.

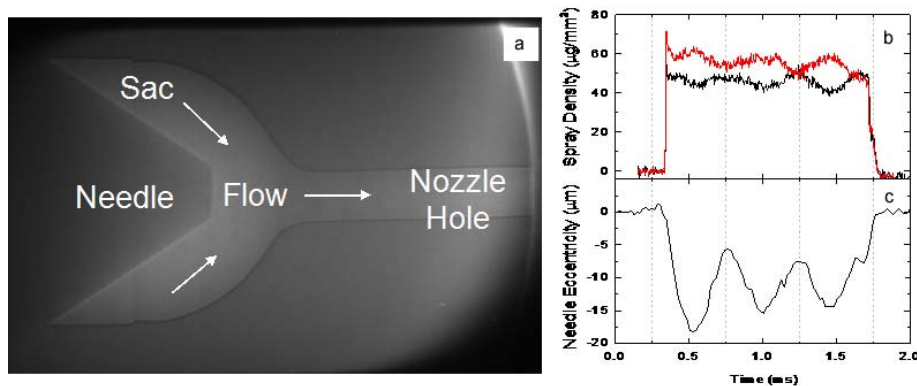

Figure 1: X-ray image of the needle valve region of a diesel fuel injector (left) and a plot showing how eccentric motion of the needle generates oscillations in the density of the fuel spray (right).

2009 FreedomCAR and Fuel Partnership Highlight

Boosted Gasoline HCCI Achieves 2x Load Increase over Previous Best

Sandia National Laboratories

Homogeneous Charge Compression Ignition (HCCI) engines can provide both high efficiencies and low NO_x and particulate emissions, but their limited power output remains a significant barrier to widespread implementation. The load limitation occurs because cylinder-pressure rise rates increase with fuel/air ratio, eventually causing engine knock. Intake-pressure boosting can increase the power output without increasing fuel/air ratio; however, its application to HCCI has been limited because boost enhances the autoignition process, which can cause combustion timing to be overly advanced, reducing efficiency and increasing the knocking propensity.

In this work, the potential of boosted HCCI was systematically investigated for intake pressures from 100 kPa (naturally aspirated) to 325 kPa absolute. Experiments were conducted at 1200 rpm using a fully premixed charge with a conventional 87-octane gasoline. As shown in Fig. 1, the highest load for naturally aspirated conditions was a Gross Indicated Mean Effective Pressure (IMEP_g) of about 5 bar. The maximum load could be increased with boost, but it was limited to IMEP_g = 8.8 bar when only reduced intake temperature was used to try to prevent uncontrolled combustion, as indicated by the gray line. Adding cooled Exhaust Gas Recirculation (EGR) in combination with reduced intake temperature allowed a substantial further increase in load up to IMEP_g = 16.3 bar for an intake pressure of 325 kPa. This high-load point had high combustion and indicated thermal efficiencies (99% and 47%, respectively), no soot and ultra-low NO_x emissions (< 0.015 g/kg-fuel). In addition, maximum pressure-rise rates were kept sufficiently low to prevent knock, and combustion stability was excellent. These results show that well-controlled, boosted HCCI can provide high efficiency, clean combustion and power levels near those of turbocharged diesels. Future efforts will focus on determining the robustness of boosted HCCI over a broad range of conditions.

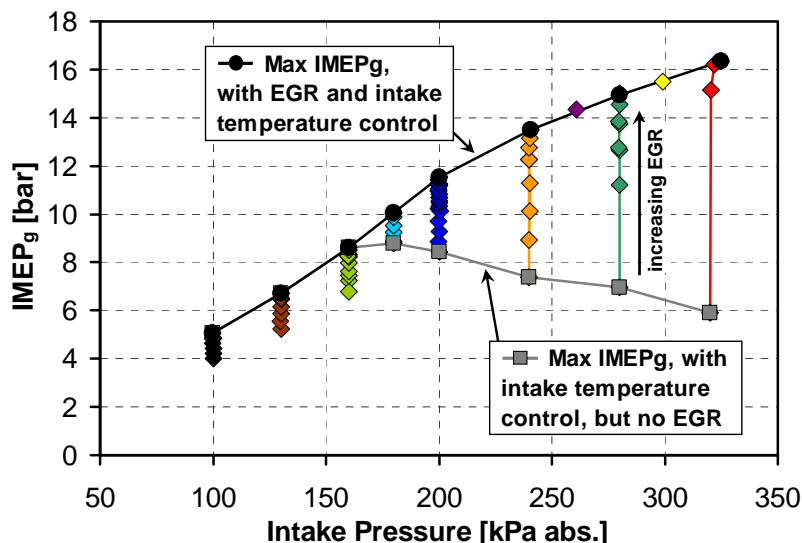

Figure 1: Maximum IMEP_g at various intake pressures with and without EGR. The additional combustion retard provided by EGR allowed significantly higher loads.

2009 FreedomCAR and Fuel Partnership Highlight

Current Source Inverter for HEVs and FCVs

Oak Ridge National Laboratory

Voltage Source Inverters (VSI) using film capacitors are universally employed to drive the electric traction motor in HEVs, and PHEVs. Though well established, this technology has many drawbacks. It requires an expensive and bulky Direct Current (DC) bus capacitor, and produces high Electromagnetic Interference (EMI), detrimental stresses on the motor insulation, high frequency losses and bearing leakage currents. Long term reliability issues also exist due to possible shoot through conditions. Additionally, to increase the output voltage of a VSI, a larger battery pack must be used or a DC to DC converter must be incorporated into the system. Both of these options result in unwanted cost, weight and volume.

To overcome the limitations of VSIs, ORNL researchers have utilized new reverse blocking semiconductor devices and designed, fabricated and tested a 55kW Current Source Inverter (CSI) which:

- integrates the functions of the boost converter and inverter
- enables a low voltage battery to control a PM motor
- performs regeneration functions
- improves fault tolerance
- substantially reduces capacitor requirements

Hardware testing has been completed in both motoring (boost and buck modes) and regen operation. Results demonstrate;

- Capacitance reduction to 200uF (2000uF for VSI)
- Output voltage capability range from 0-3.5 times (0-.99X for VSI)
- Output voltage THD of 6.7%-12.2% (70-200% for VSI)
- 6.1 kW/kg, 12.8 kW/L (4.3 kW/kg, 7.1 kW/L for Camry Hybrid VSI)

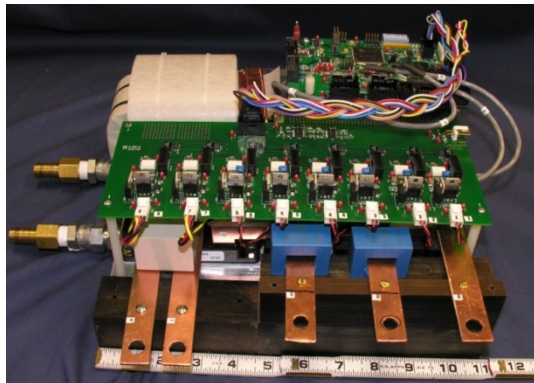

Figure 1: ORNL Current Source Inverter

Successful tests of the CSI prototype showing the improvements over the VSI have led to an expansion of this effort in FY10. ORNL will be teaming with Michigan State University (MSU) to merge the CSI technology with previous ORNL/MSU work on Z-source technology inverters. The new design will be capable of functioning as a universal charger for PHEVs allowing charging from single (120V/240V) or three phase supplies.

By incorporating all three power electronics functions, boost, inverter, and charger, into a single module, significant advancements will be made in achieving the FreedomCAR targets in regards to reducing size, weight and costs.

2009 FreedomCAR and Fuel Partnership Highlight

Active Filter Approach to Reducing the Traction Inverter Capacitor

Oak Ridge National Laboratory

The Direct Current (DC) link capacitor is an essential component for power conditioning the traction drive system for HEVs, PHEVs, and EVs. It functions to reduce voltage transients that are detrimental to battery life and impose stresses on the semiconductors in the inverter. Current film capacitors used in the power electronics for advanced automotive applications are temperature limited and must be substantially derated as operational temperatures rise. Additionally, they comprise roughly 35% of the inverter volume, and can account for up to 23% of its weight and cost. It would be beneficial in achieving the FreedomCAR targets to minimize or eliminate this bulky component. ORNL has explored an active filter approach that performs the same function, is smaller in size, can be better utilized at higher temperatures, and would increase the reliability and lifetime of the inverter to aid in achieving the FreedomCAR targets.

ORNL has developed a MATLAB Simulink model of an active filter and performed simulations to ascertain the feasibility and tradeoffs associated with the use of an Active Power Filter (APF) for reducing the amount of capacitance on the DC bus (Fig. 1 and 2).

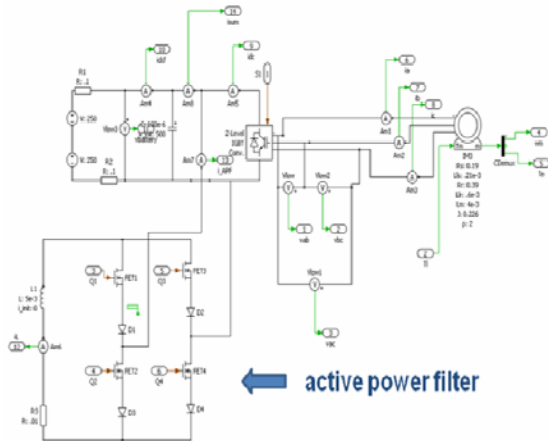

Figure 1: Schematic of Active Filter

As part of this effort a control algorithm was developed and optimized for this application. Utilizing this method, the DC bus capacitor can be dramatically minimized from 2200uF to 100uF which would reduce the capacitor volume by a factor of 22. However, due to the high operation frequency and large inductor current, as well as the associated losses with the additional switches, this method for achieving reduced capacitor requirements has proven to have unacceptable efficiency with today's silicon device technology. As new generation, lower loss devices are developed (e.g. SiC, GaN) this technique may prove to be a viable alternative to greatly reducing the size of the DC bus capacitor.

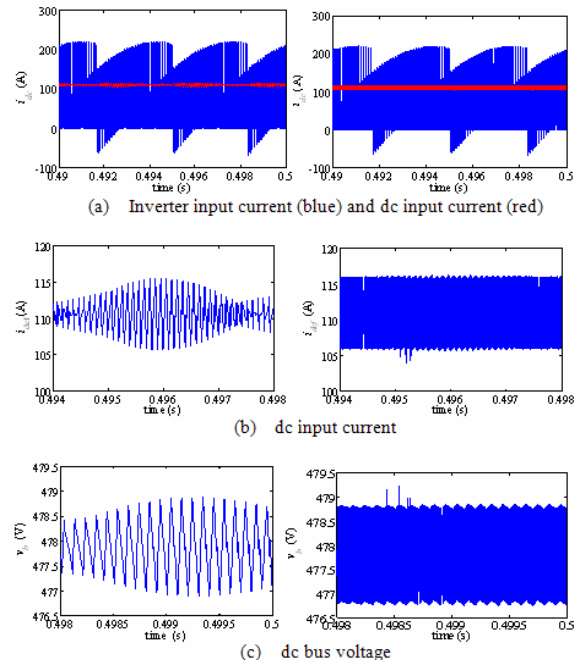

Figure 2: Simulation results

2009 FreedomCAR and Fuel Partnership Highlight

Wide Bandgap Characterization

Oak Ridge National Laboratory

Present Power Electronics (PE) systems and components require costly thermal management systems to perform in automotive environments. As a result there is an increasing need for higher temperature operation of PE components in automotive applications. The ability for components to operate reliably at elevated temperatures can result in cost and weight savings through reduced heat sinks and the elimination of secondary cooling loops. Additionally, components capable of increased frequency operation can result in decreased requirements for passive components, leading to further reductions in cost, weight and volume. Wide Bandgap (WBG) semiconductor devices, specifically Silicon Carbide (SiC) and Gallium Nitride (GaN), are emerging component technologies that enable increased temperature and frequency operation as well as efficiency and reliability improvements.



Oak Ridge National Laboratory has established an automated Wide Bandgap Characterization Test Station (Figure 1) which accurately performs static and dynamic characterization analyses of new devices over expanded temperature ranges. Utilizing the parameters obtained through testing, models of these components can be created which can then be employed in simulations to access the benefits of their operation in power electronics applications.

Figure 1: WBG Characterization Test Station

Numerous WBG devices and modules have been tested to date. Simulations show that the use of these devices can result in greater than 30% reduction in losses in the power electronics system of a Hybrid Electric Vehicle (Figures 2 and 3). A comprehensive database of these tests and device parameters is maintained at the ORNL Power Electronics & Electric Power Systems Research Center.

The Wide Bandgap Characterization Test Station allows the detailed understanding of promising new WBG technologies, enabling comprehensive studies of their losses, control techniques, and necessary heat removal mechanisms. This ability will enable early assessments of inverter packages to achieve the FreedomCAR targets for efficiency, packaging, size and weight.

Temperature	10 kHz			20 kHz		
	Inverter Efficiency [%]					
	Si	SiC	Gain	Si	SiC	Gain
70°C	96.3	97.4	1.1	93.1	95.3	2.2
105°C	95.5	97.3	1.8	91.6	95.2	3.6

Figure 2: Database Si/SiC Inverter Efficiency Comparison

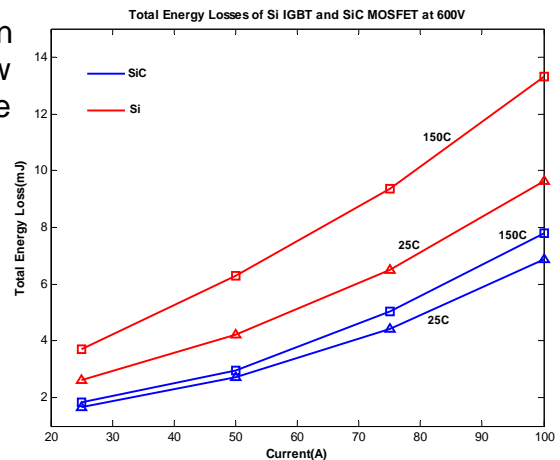

Figure 3: Si and SiC Switch Energy Loss Comparisons

2009 FreedomCAR and Fuel Partnership Highlight

Characterization of Thermal Interface Material Performance

National Renewable Energy Laboratory

Thermal Interface Materials (TIMs) pose a major bottleneck to heat removal from power electronics packages. In a conventional power electronics package, a grease layer is typically used to couple the Direct Bond Copper (DBC) substrate to a heat sink. This grease layer has the highest thermal resistance of any layer in the electronics package. Reducing the thermal resistance of the TIM can help achieve the FreedomCAR goals of increased power density and lower system cost. A key to reducing the thermal resistance is having accurate and consistent data on the performance from the wide range of materials available under various conditions of temperature, pressure, and thickness.

NREL has developed an objective and consistent material thermal performance database using ASTM standard test methods. The database includes results from commercially available and novel research materials including greases, Phase Change Materials (PCMs), filler pads, graphite, indium, thermoplastics, and carbon nanotubes. Overall, over 40 materials spanning the classes of materials mentioned above were tested. Several high-thermal performance greases, PCMs, and thermoplastic adhesives have been identified along with quantifying the state of art / industry and performance gaps that must be closed by TIM supply base.

NREL has worked closely with industry partners to develop the database and conveyed results through collaborations and interactions with automotive industry suppliers such as: Delphi, Semikron, and UQM; TIM manufacturers such as Parker Chomerics, Shinetsu, and Honeywell; and automotive OEMs. The scope of collaboration included testing samples provided by industry partners, exchange of experimental results obtained via different test methods, development of new experimental techniques, and defining practical industry requirements for TIMs. NREL is now working with OEMs, suppliers, and the research community to apply lessons learned and capabilities from the TIM work to the latest developments in electronics packaging.

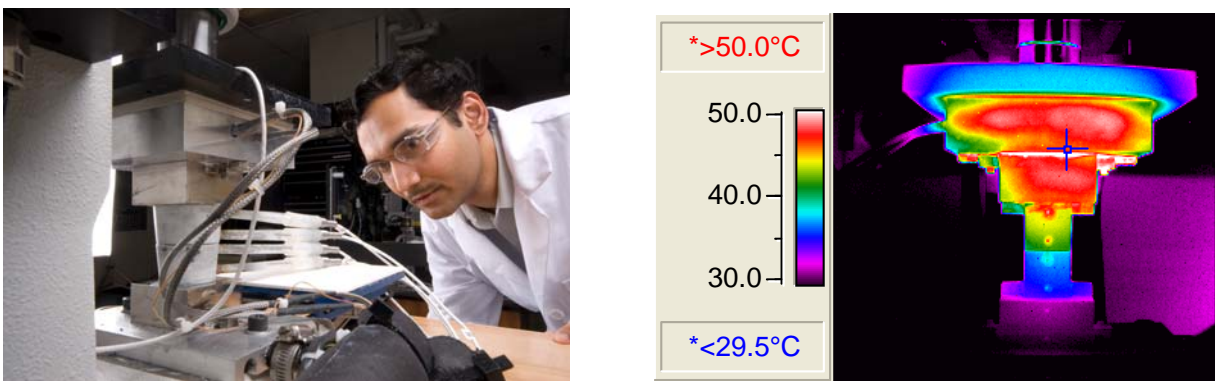

Figure 1: ASTM Test Bench for Characterizing Thermal Resistance of Interface Materials and Infrared image showing temperature gradient across the TIM test fixture

2009 FreedomCAR and Fuel Partnership Highlight

Rapid Parametric Modeling Process for Thermal Management and Electronics Packaging Technologies

National Renewable Energy Laboratory

Power electronics are a critical subsystem to condition the flow of electrical energy between the battery pack and electric motor in electric vehicle drive systems. As power flows through the electronic devices heat is generated, which if not properly dissipated can degrade performance and cause failure. The performance of the thermal control system for power electronics is directly tied to the power electronics packaging configuration and the selected thermal management technology. The optimal heat transfer mechanism depends on the combination of package configuration and cooling technologies, which requires evaluating the package and heat exchanger as an integrated system.

NREL researchers worked closely with engineers at Delphi Corporation to develop and apply a rapid parametric modeling process for characterizing power semiconductor thermal performance in terms of package configuration and heat exchanger performance. Next, a generalized version of the modeling methodology was demonstrated using an innovative commercially-available package to illustrate the process. Results were published and presented at the 2009 IEEE Vehicle Powertrain and Propulsion Conference.

The combined analysis method helps to ensure that one area of the system is not overdesigned, adding unnecessary cost, weight, and size. The collaboration with Delphi helped to down-selecting heat transfer technologies for a Delphi advanced high-temperature inverter package. The developed techniques will support new collaboration efforts between NREL, industry, and ORNL related to cooling alternatives for new power electronics packaging technologies.

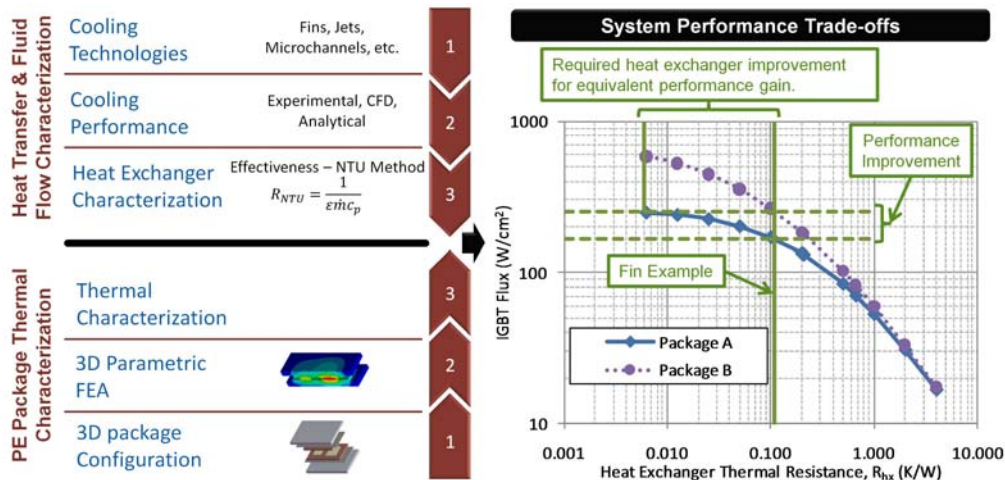

Figure 1: Power electronics thermal package performance modeling process

2009 FreedomCAR and Fuel Partnership Highlight

High Efficiency Soft-Switching Inverter

Virginia Polytechnic Institute and State University

State-of-the-art electric vehicles require a separate 70°C inverter cooling system to avoid power transistor junction over-temperature conditions because the engine coolant, typically at temperatures of 105°C, does not provide sufficient cooling. A team led by the Virginia Polytechnic Institute and State University (Virginia Tech) is developing an advanced soft-switching inverter to reduce power loss and its associated transistor junction temperature rise so that the inverter can operate at the engine coolant temperature conditions, thereby eliminating the need for a costly dedicated inverter cooling.

Researchers at Virginia Tech and Powerex have developed a hybrid soft switching module that combines the best features of power Metal–Oxide–Semiconductor Field-Effect Transistor (MOSFET) and Insulated-Gate-Bipolar Transistor (IGBT) technologies for device switching and conduction loss reduction. Test results indicate an average of 13% conduction loss reduction and 80% switching loss reduction. The design also includes a variable timing controlled soft-switching technique to improve light-load efficiency. Engineers at Azure Dynamics performed the inverter testing with calorimeter and verified that the newly developed soft-switching inverter achieved a peak efficiency of 99%, and was greater than 98% efficient for most of the load range. This translates to a 50% inverter loss reduction as compared to an existing hard-switching inverter.

High efficiency operation lowers the transistor junction temperature and enables the use of engine coolant to reduce inverter system-level cost. The projected hot-spot junction temperature at 55-kW operation is below 120°C, which is well within safe operating temperature of 150°C and allows significant improvement of the inverter life expectancy.

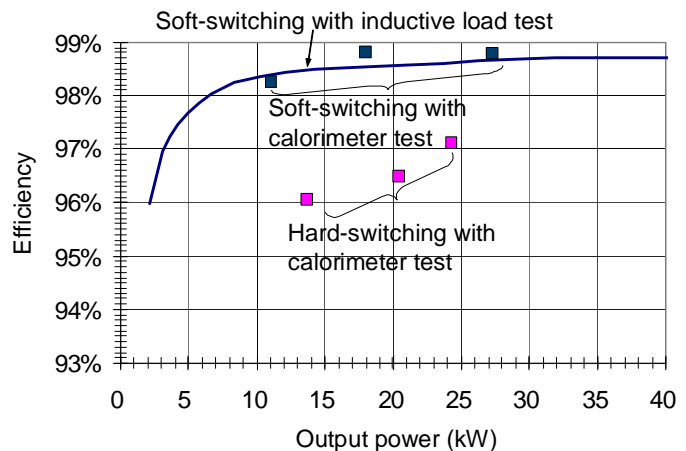
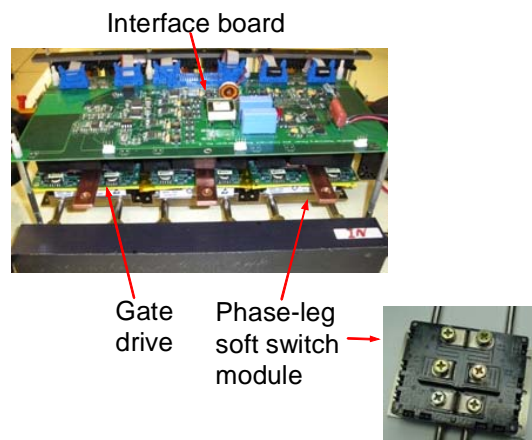

Photograph of the advanced soft-switching inverter using a hybrid integrated cooling soft-switch module and variable timing control to achieve high-efficiency operation

2009 FreedomCAR and Fuel Partnership Highlight

Advanced Separators for HEV/PHEV Applications

ENTEK Membranes LLC

Separators are an integral part of the performance, safety and cost of Li-ion batteries. ENTEK is focused on manufacturing separators with an interconnected three-dimensional inorganic network that prevents high temperature shrinkage and internal shorts. ENTEK has produced a 20-30 micrometer thick, inorganic-filled separator that shrank less than 5% after heating the separator in an inert atmosphere for one hour at 200°C.

These separators have been produced without compromising other desirable properties such as high porosity (> 50%), excellent wettability and extremely low impedance values. The excellent stability of the separator at high temperature is expected to improve abuse tolerance of Li-ion cells (e.g. internal short circuit). Future work is focused on evaluating the cycle life, discharge rate capability and abuse tolerance of Li-ion cells built with such separators.

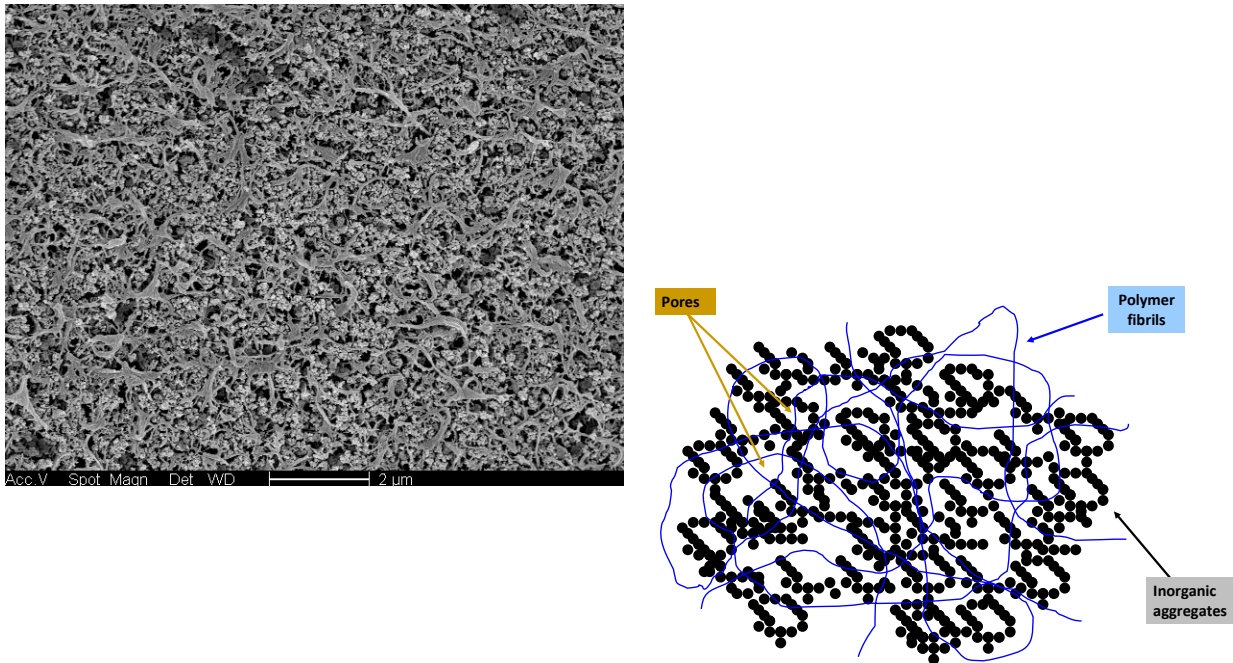

Figure 1: Scanning electron micrograph and schematic drawing of an inorganic-filled separator

2009 FreedomCAR and Fuel Partnership Highlight

New High-Voltage High-Capacity Composite-Structure Cathode Material Is Being Commercialized

Argonne National Laboratory, Envia Systems

Argonne National Laboratory (ANL) has developed a family of composite structure layered cathode materials that exhibit enhanced stability. Members of this family can operate at higher voltages and achieve much higher specific capacities (≥ 250 mAh/g) than conventional cathode materials (120-150 mAh/g). These cathode materials enable higher energy density batteries and longer all electric range for PHEVs. Recent efforts at ANL have focused on enhancing the rate capability of these materials for use in PHEV applications. Significant progress was made in this area through the use of various types of surface treatments and coatings. Data on a treated material is shown in Figure 1, where 225 mAh/g is achieved at the C/2 discharge rate. Some of the surface treatments produce materials that achieve 214 mAh/g at the 1C discharge rate. Over the last two years, these materials were licensed for commercial production by BASF.

Additionally, Envia Systems worked with ANL on these high-capacity cathode materials to develop a new lithium-ion battery system that exhibits significantly higher energy density. Together, Envia Systems and ANL were selected to receive a 2009 R&D 100 Award for this new high energy density battery technology.

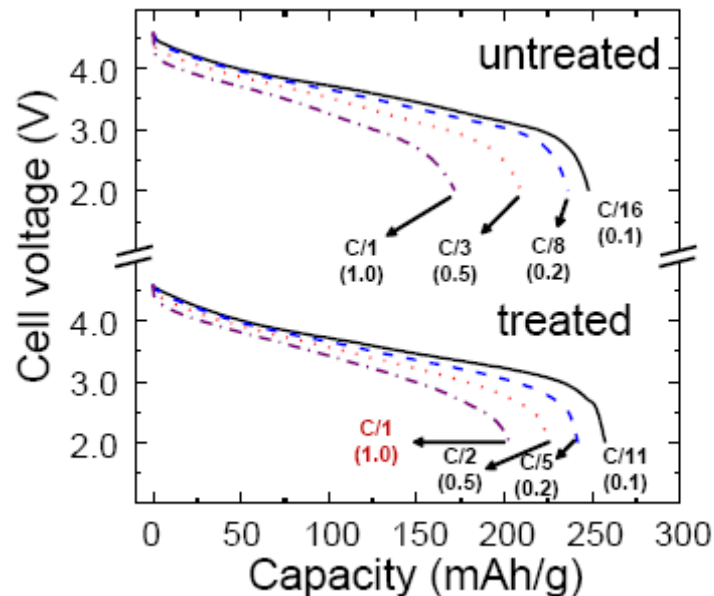

Figure 1: Sample plot showing improved rate capability from ANL's surface-coated high-capacity cathode material

2009 FreedomCAR and Fuel Partnership Highlight

Six Amp-hour HEV Prismatic Cell

A123 Systems HEV Program

A123 Systems has developed a six Amp-hour (Ah) HEV prismatic cell based on its proprietary doped nano-lithium iron-phosphate cathode, with the objective of producing a high-power, low-cost HEV cell that meets or exceeds all U.S. Advanced Battery Consortium (USABC) goals.

Initial performance tests have proven this to be a very high power cell, enabling a significant cost reduction that compares favorably with the previous cylindrical A123 32113 HEV cell and meets or exceeds USABC HEV performance requirements. This prismatic configuration, shown in Figure 2 below, delivers performance, reflected in Figure 1, with fewer cells, which leads to a lower total system cost.

Prototype cells will be provided to USABC for confirmation testing prior to the conclusion of the HEV program.

Product	Prismatic (HEV)
Capacity	6.3 Ah
Nominal voltage	3.3 V
Nominal energy	20 Wh
Mass (approx.)	235 g
Dimensions	161 x 143 x 6.2mm
Dischrg Power @ 25C, 10s, 50% SOC, 1.6V	>900 W
Power density	>4000 W/Kg
Specific energy	85 Wh/Kg

Figure 1: A123 prismatic cell specifications

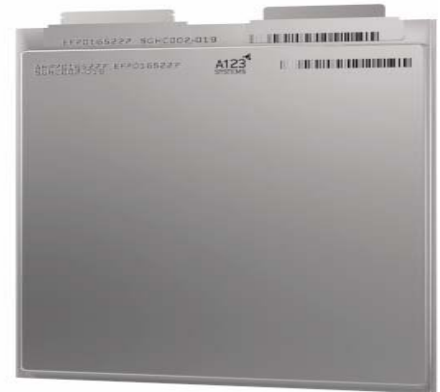

Figure 2: Photo of A123 prismatic cell

2008 FreedomCAR and Fuel Partnership Highlight

19 Amp-hour Prismatic Cell

A123 Systems PHEV Program

A123 Systems has improved system level battery modules that use its 19 Amp-hour (Ah) prismatic cell for 10 and 40 mile PHEV applications. Module design improvements focused on further enhancing cycle and calendar life of the A123 prismatic cells by adopting a low volume compression system to ensure continuous and optimal pressure on each cell. A 30% increase in the number of cycles was achieved in a 100% Depth-of-Discharge screening test when applying constant pressure to the cycling cells.

Significant progress was also made in the area of Design Validation and United Nations / Department of Transportation (UN/DOT) testing of the Prismatic Module A-Phase Design through Q2'09. Notable accomplishments include: UN/DOT altitude simulation, thermal cycling, vibration, shock, short circuit and overcharge test on three module configurations (6S3P, 11S3P, 16S3P). Design Validation testing at the "mini-module" level (1S3P) included nail penetration, overcharge, short circuit, thermal stability, per U.S. Advanced Battery Consortium FreedomCAR Specification. All the results fell into EUCAR level 4 rating or lower.



Figure 1: A123 family of PHEV battery modules (212 to 4869 Watt Hours)



Figure 2: PHEV battery module compression system - end plates and bands

2009 FreedomCAR and Fuel Partnership Highlight

Life Improvements for PHEV Li-ion Battery

Compact Power and LG Chem PHEV Program

Development of a high specific energy, long-life and safe Li-ion battery is an essential prerequisite for the electrification of the transportation industry as well as other energy storage applications. The CPI/LGC team has been developing a high specific energy cell having superior abuse-tolerance for use in PHEV applications. The cell is based on spinel/layered oxide blend having a proprietary separator for improved abuse-tolerance.

One of the key challenges to achieve the above objective is to develop a cell that has long cycle- and calendar-life under PHEV applications. Cells were fabricated and delivered that show the 5,000 cycle target of the FreedomCAR and Fuel Partnership is achievable. To further optimize cycle- and calendar-life as well as specific energy, new cell compositions were formulated, and the next generation cells were delivered to National Laboratories for validation of these performance criteria. Factors that critically determine the cycle- and calendar-life of these mixed oxide based cells have been identified and taken into consideration in designing these cells. Packs using these cells will soon be built and delivered.

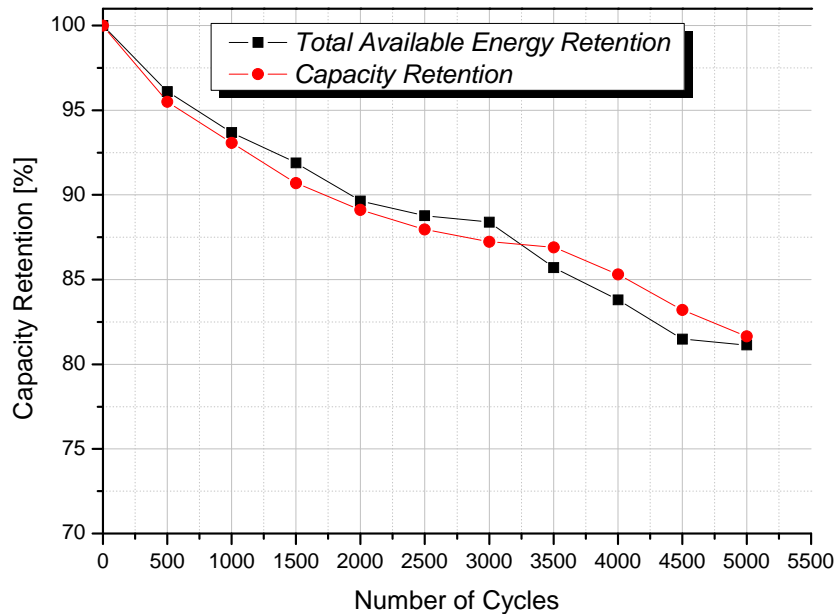

2009 FreedomCAR and Fuel Partnership Highlight

Development of a Li-ion Cell for Plug-in Hybrid Vehicles with Improved Life and Safety Characteristics

ENERDEL PHEV Program

In 2009, ENERDEL supplied scaled-up versions of cells that use $\text{Li}_4\text{Ti}_5\text{O}_{12}$ (LTO) negative-electrode and $\text{LiMn}_{1.5}\text{Ni}_{0.5}\text{O}_4$ (LMNO) positive-electrode materials for lithium-ion batteries. The program demonstrated the life of 1-mAh coin cells to 1500 cycles with 100% capacity retention and developed larger, 3-Ah CD-sized cells without sacrificing capacity or discharge-rate performance. The production scale-up of the LTO/LMNO cell has been one of the major tasks of this program.

LTO is a promising material that provides significantly improved safety and life performance over traditional carbon-based negatives. The inherent safety of LTO is well recognized and relates to LTO operating 1.5 V away from potentially damaging lithium dendrite formation that could cause cell failure (graphite, for example, sits very close at 0.08 V.) The potential of long life relates to LTO's "zero strain" characteristic, which avoids large volume changes during operation (unlike graphite which undergoes phase transformations during usage). Relatively abundant raw materials allow LTO to be a low-cost alternative to current negative electrodes.

The LTO negative electrode is matched with a novel high-voltage positive electrode developed by Argonne National Laboratory. The combined LTO/LMNO cell provides an impressive 3.2 V cell voltage, which is far superior to other LTO cells that only produce 2.5 V. The higher voltage cells will result in a battery capable of meeting 10-mile plug-in hybrid electric vehicle requirements. Figure 1 shows the resistance of four scaled up, 3-Ah cells vs. depth of discharge in pulse-power tests. Figure 2 shows capacity retention vs. discharge rate. The good rate capability (80% capacity retention at six times the one-hour discharge rate) relates to the cell's low dependence of resistance on depth of discharge. Future efforts will focus on further improving the cycling behavior of the 3-Ah cells.

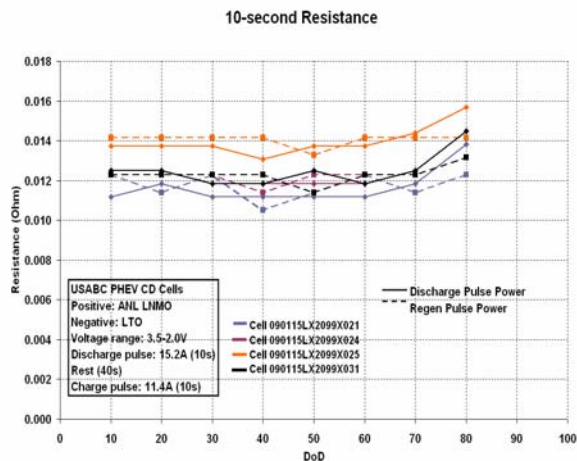

Figure 1: Cell Resistance vs. Depth of Discharge (DoD)

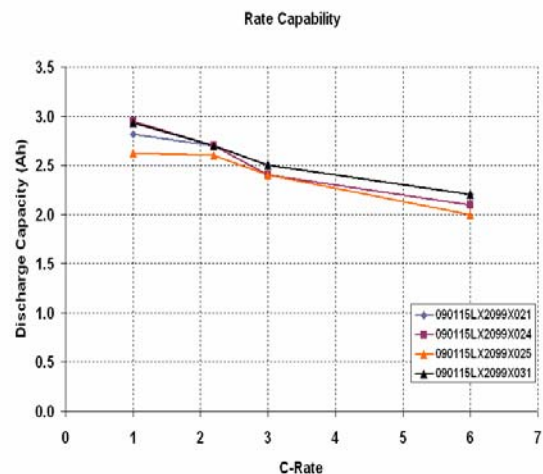

Figure 2: Cell Discharge Capacity vs. Rate

2009 FreedomCAR and Fuel Partnership Highlight

First-Principles Calculation Leads to Extremely High-Rate LiFePO₄

Massachusetts Institute of Technology

Batteries for vehicles must be able to deliver pulses of high power for durations of seconds and energy over several hours. For some electric vehicles, the ability to charge the battery in a fraction of an hour is highly desirable.

Batteries with LiFePO₄ as the cathode are being considered for use in electrified passenger vehicles because cells with this material show a benign response to some abuse conditions. A problem with its implementation is that it is not considered a high charge rate material.

Simulations of the Li migration barrier within and on the surface of LiFePO₄ were conducted by the Massachusetts Institute of Technology (MIT) team, who found that extremely fast charge and discharge rates should be possible. The team then formulated such a material and that demonstrated the theoretical predictions. Experimental results for the new formulation are shown in Figure 1. The ability to predict macroscopic behavior with microscopic simulations as demonstrated in this project is a critical capability that may lead to new material discoveries and engineering approaches for much improved performance.

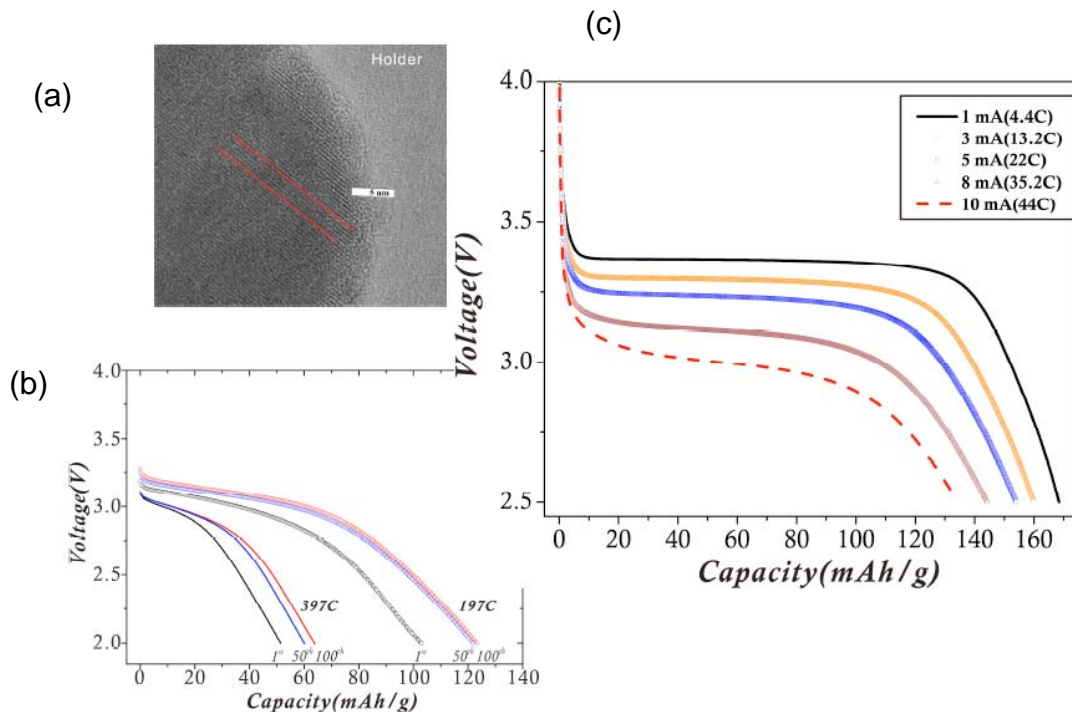

Figure 1: Nano-material with optimized surface treatment gives very high power density. (a) is a TEM image of a particle showing an amorphous film of ~ 5 nm thickness, (b) shows the improved rate capability of the particle when synthesized at 197 °C versus 397 °C (lower synthesis temperatures lead to smaller particles) and (c) shows the discharge voltage curves of the material when discharged from 4.4 to 44 C.

2009 FreedomCAR and Fuel Partnership Highlight

USABC Lower-Energy, Energy Storage Systems Requirements for Power Assist HEVs

National Renewable Energy Laboratory

The battery or energy storage system (ESS) for a hybrid electric vehicle (HEV) must be large enough to support fuel-saving hybrid functions but not so large that it adds excessive cost to the vehicle. The ESS requirements/targets set by the U.S. Advanced Battery Consortium (USABC) provide one way to encourage development and manufacture of appropriately sized HEV components. At the USABC's request and with support from Department of Energy (DOE), National Renewable Energy Laboratory (NREL) recently analyzed the impact of various ESS sizes on the fuel use in power assist HEVs. The NREL analysis showed that the HEVs can achieve significant fuel savings with a lower-energy ESS than the previous targets had required.

The existing targets require a 300 Whr available energy or 425 Wh ESS energy window for vehicle use. By demonstrating that HEV fuel savings can be achieved with a smaller ESS (as shown in the figure below), the NREL analysis opens the door for smaller batteries or alternate technologies such as symmetric or asymmetric capacitors to provide a cost-effective storage solution. The analysis was confirmed by dynamometer test data on commercial HEVs. As a result, the USABC issued a request for proposal information (RFPI) in December of 2009 for a lower energy ESS for power assist HEVs, calling for an energy window for vehicle use of 165 Wh (among other targets).

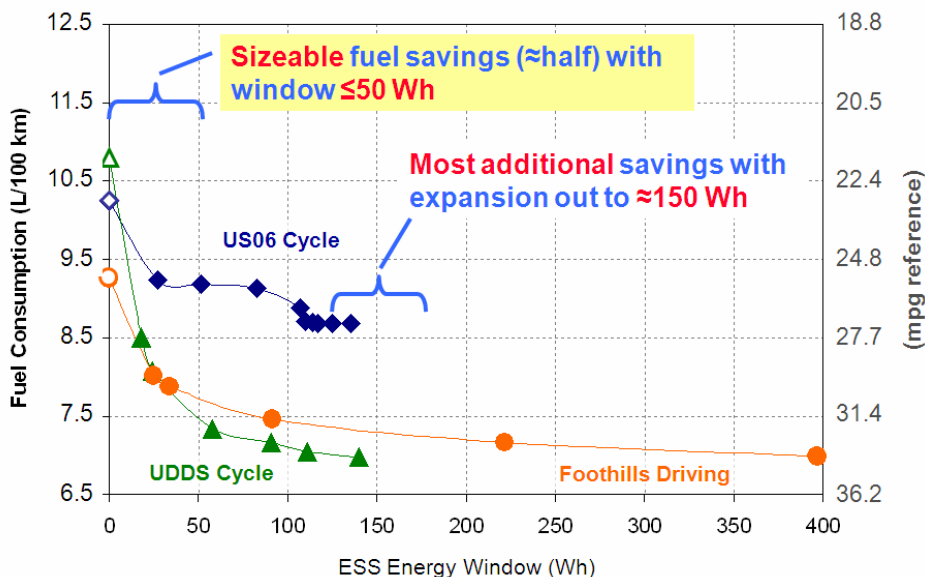

Figure 1: Relationship between simulated fuel consumption and in-use HEV energy window for one vehicle design over several drive cycles—UDDS (city), US06 (aggressive/high-speed) and Foothills (up and down grade)

2009 FreedomCAR and Fuel Partnership Highlight

Smart Battery Status Monitor

Idaho National Laboratory, University of Montana, Qualtech

The Smart Battery Status Monitor is a system that will accurately predict the state-of-health and remaining useful life of electrochemical energy storage devices. The enabling component of this system is a quick, inexpensive and accurate measure of impedance, which is related to the available power and remaining life of the battery.

Idaho National Laboratory (INL), in collaboration with Montana Tech of the University of Montana and Qualtech Systems, Inc. has developed an in-situ impedance measurement technique known as Fast Summation Transformation (FST). Unlike the standard approach, FST (patent pending) is a computationally simple algorithm that measures impedance within 10 seconds using a robust hardware platform that can be embedded within a vehicle or other high-value application. Previously, impedance measurements could take an hour to complete and required costly and delicate equipment operating in a laboratory environment. Figure 1 shows excellent agreement between standard impedance measurements and FST measurements for a representative commercial cell that was aged with a charge sustaining cycle-life profile at 60% SOC and 50°C. Impedance measurements were taken every two weeks during the accelerated aging. As shown, the FST measurements successfully capture the impedance information in the key mid-frequency range.

Rapid, inexpensive, in-situ impedance measurement is a significant need in the battery market that is presently unsatisfied. This methodology is the critical tool for evaluating battery state-of-health for any industry utilizing high-value battery applications (automotive, military, space, medical, electric utilities, etc.). The next phases in the development of the Smart Battery Status Monitor work are to upgrade the hardware platform for larger battery systems and add predictive life models in conjunction with expert-learning software.

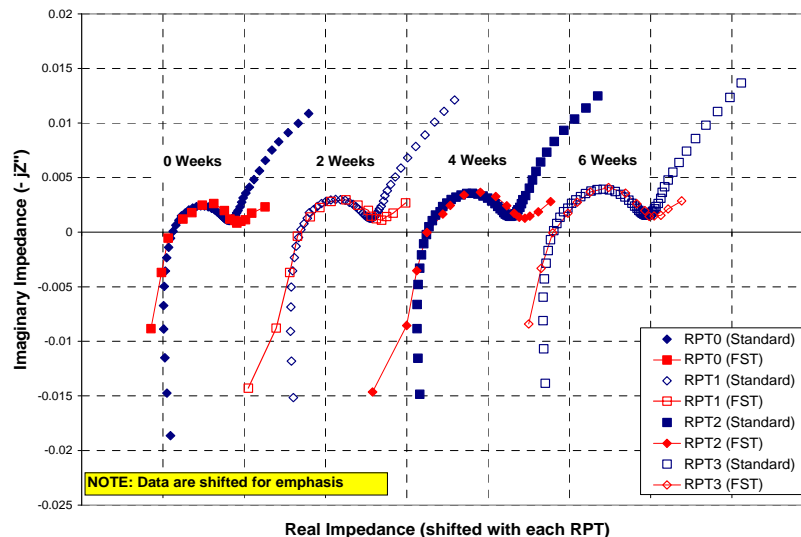

Figure 1: Comparison between typical impedance measurements and FST

2009 FreedomCAR and Fuel Partnership Highlight

Technology Life Verification Testing

Idaho National Laboratory, Argonne National Laboratory,
Sandia National Laboratories, Lawrence Berkeley National Laboratory

The purpose of Technology Life Verification Testing (TLVT) is to estimate the overall battery life expectancy with high statistical confidence under typical stress conditions within a short period of testing. Testing is based on a complete full factorial matrix that takes into account known degradation mechanisms and stress factors (e.g., temperature, SOC, etc.). Experimental results are first simulated using Monte Carlo techniques, then verified with actual test data. Both accurate performance models and error models are critical for successful life estimation.

The *Battery Life Estimator Manual: Linear Modeling and Simulation* (INL/EXT-05-15136) was published in August 2009. This manual provides a description of a default linearizable model as well as methods of estimating parameter values. It also discusses Monte Carlo simulations and lack-of-fit assessment using experimental data for estimating cell life. Additionally, the manual provides a user guide for a new software package that was developed to estimate calendar life based on the default model, though users could also provide an alternative model if it is linearizable. Figure 1 shows a sample cell distribution based on simulated results using the software tool. In this simulation case, more than half of the cells give an estimated life of 12 or more years, with the highest population group predicting an 11 year life.

The next task in this effort is to develop a non-linearizable model form and successfully implement it into the software. A TLVT validation effort will also be initiated in 2010 using experimental cells.

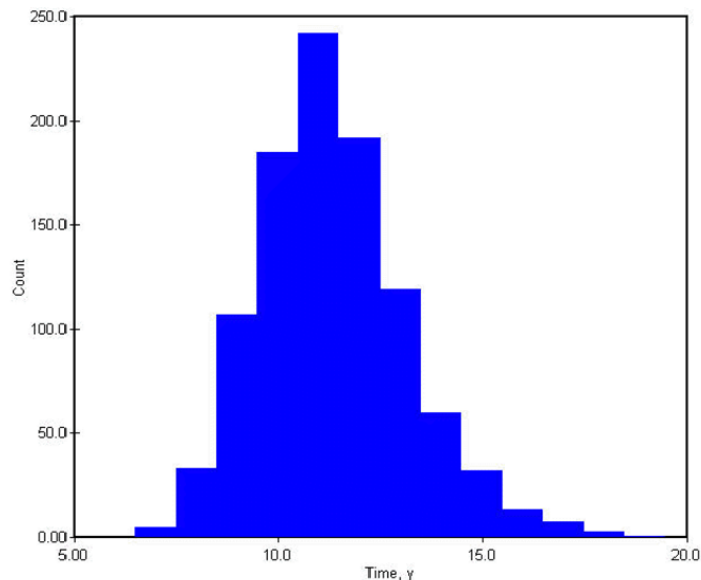

Figure 1: Sample cell life distribution from Monte Carlo simulations

2009 FreedomCAR and Fuel Partnership Highlight

A Molecular Dynamics Model of Charge Transfer across a Solid-Liquid Interface

University of Utah

A critical performance metric for electrified vehicles is the ability to operate at sub-zero temperatures. Today's Li-ion batteries provide limited power at low temperatures. Several investigators have linked this problem to the activation barrier of lithium ions across the electrode/electrolyte interface.

Understanding the process at the atomic level may help identify a solution for poor low-temperature performance of Li-ion batteries. Molecular dynamic simulations are ideal for this level of understanding, but until recently, investigators have succeeded in predicting transport properties only in the bulk of the material and not at the interface between two materials.

As a first step toward an atomistic understanding of interfacial processes, molecular dynamics was used to investigate a handful of common carbonate electrolytes next to graphite. The simulations showed a similar lithium transference energy barrier for each of the electrolytes of 12 to 19 kcal/mol, consistent with the experimental activation energies of 16.4 to 17 kcal/mol determined by the Army Research Laboratory. A sample simulation space and a lithium desolvation free energy plot are shown in Figures 1 and 2. This breakthrough step in calculating the free-energy barriers at an interface between two disparate materials could lead to new materials with predictably lower barriers for Li-ion transport, and therefore, batteries that display acceptable rate performance at low temperatures.

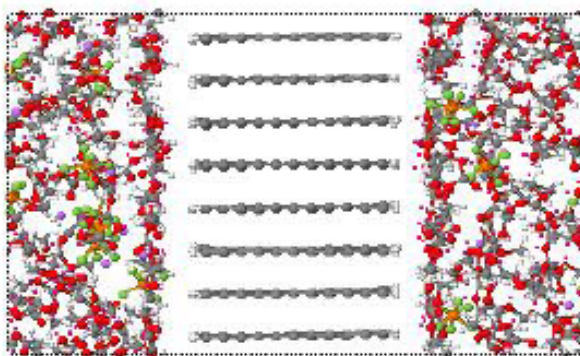

Figure 1: Sample of electrolyte/carbon simulation space

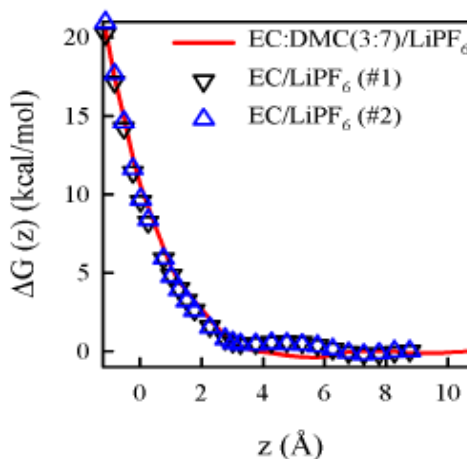

Figure 2: Profile of Li-desolvation free-energy next to graphite at room temperature for electrolytes of three compositions

2009 FreedomCAR and Fuel Partnership Highlight

Membrane Conductivity Interim Target Met with Functional Composite System

Fuel Cell Energy

Fuel Cell Energy (FCE) has exceeded the 2009 High-Temperature Membrane target of 100mS/cm at 120°C and 50% Relative Humidity (RH) using a membrane comprising functional additives. The composite comprises the copolymer, a water-retention additive and a proton conductivity enhancing or functionalized additive.

The co-polymer is an advanced Perfluorinated Sulfonic Acid (PFSA) with about three times the conductivity of state-of-the-art polymers. The conductivity enhancer is a functionalized additive designed to provide an alternate conduction pathway, especially at extreme temperatures. The higher conductivity was achieved by increasing the number of functional groups and by improving the polymer formulation. During the past year, additive development focused on particle size reduction and improvements in the dispersion and uniformity of the composite membrane. FCE developed process modifications to stabilize particle size during the introduction of the additives into the composite membrane. Additionally, FCE studied the interaction between the water retaining additive and the proton conductivity enhancer and, subsequently, modified the additives to immobilize the proton conductivity enhancer on the water retaining additive particles. Figure 1 shows the effect of the additives on membrane conductivity.

FCE has not yet evaluated the durability of the composite membrane. If it is deemed necessary, FCE plans to include a support structure into the composite membrane to provide mechanical stabilization.

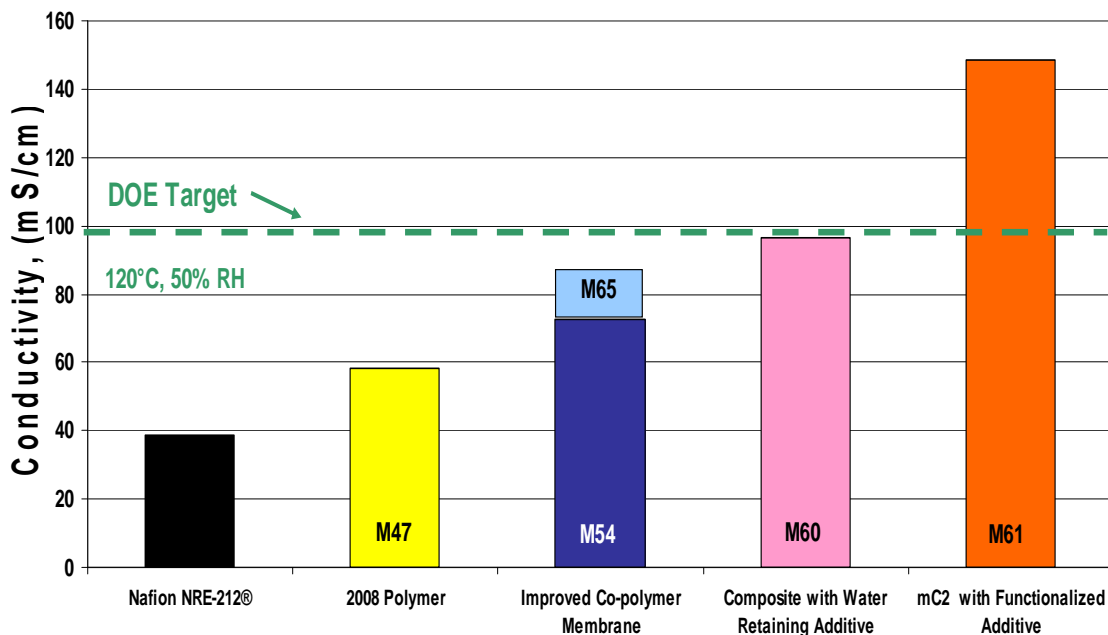

Figure 1: Additive Effect on Achievement of DOE Target at 120°C and 50% RH

2009 FreedomCAR and Fuel Partnership Highlight

Dimensionally Stable Membranes

Giner Electrochemical Systems

Giner Electrochemical Systems has created composite high-temperature fuel cell membranes by casting a high swelling, conductive polymer into an inert, dimensionally stable substrate. Two types of substrates have been evaluated, 2-Dimensional (2-D) and 3-Dimensional (3-D), with the 3-D supports showing better potential to meet DOE cost targets. By using the dimensionally stable substrate, Giner has developed membranes that do not exhibit the high planar swelling that leads to extreme mechanical stress and, ultimately, failure of membranes made using only the conductive polymer. Giner was recognized in 2008 for making a composite membrane that met the DOE conductivity target at 80°C (0.1 S/cm at 50%RH); see red line in Figure 1. However, this membrane became soluble in liquid water at high temperatures. The key accomplishment in 2009 is that Giner has made an insoluble membrane using its 3-D substrate and a low Equivalent Weight (EW) perfluorosulfonic acid polymer, which meets the 80°C conductivity target (shown by the blue line in Figure 1) and is approaching the conductivity target at 120°C as well. Giner's dimensionally stable composite membranes have also performed well in DOE's humidity cycling accelerated mechanical durability test, surviving more than 10,000 dry-wet cycles at 80°C. If these membranes can meet DOE cost and durability targets, they may move out of the lab for consideration in products.

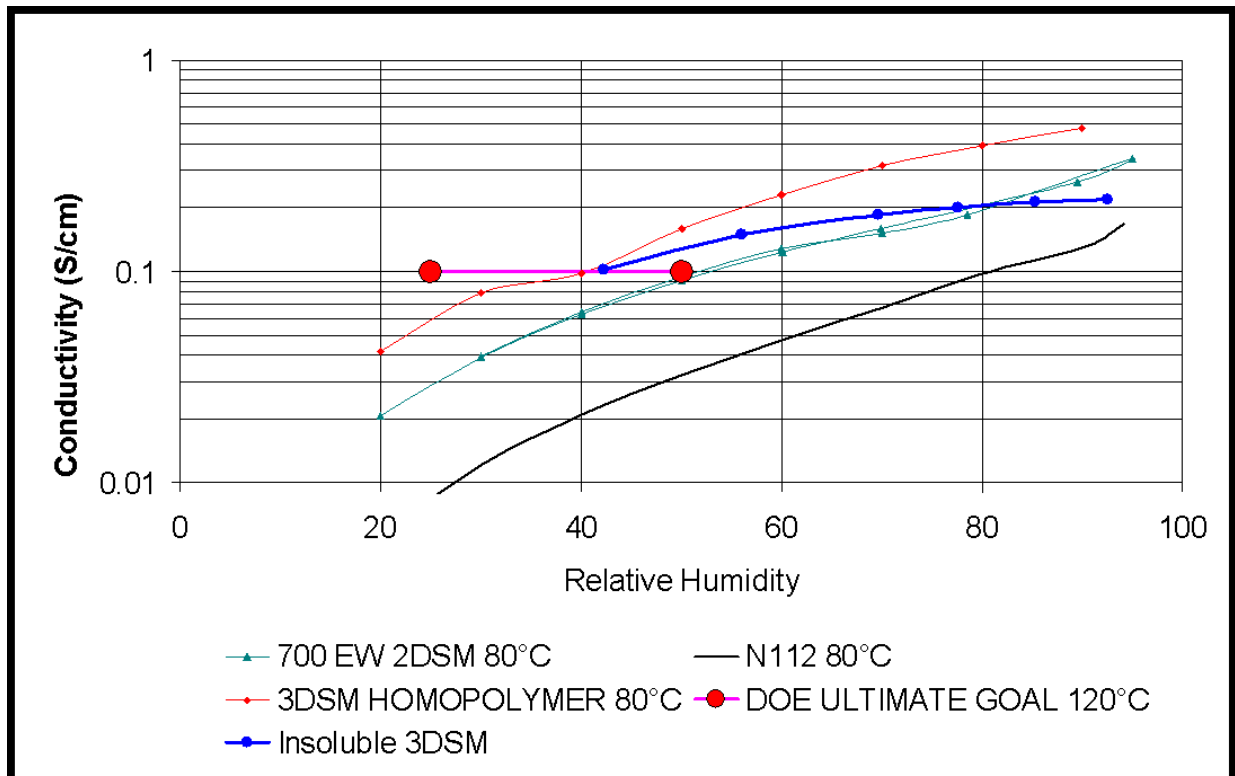

Figure 1: Proton Conductivity of Giner Electrochemical Systems Composite Membranes as a function of Relative Humidity at 80°C

2009 FreedomCAR and Fuel Partnership Highlight

NanoCapillary Network Proton Conducting Membranes for High Temperature Hydrogen/Air Fuel Cells

Vanderbilt University

Vanderbilt University has been using a “forced assembly” approach to fabricate a phase-separated fuel cell membrane composed of conductive nanofibers embedded in an inert polymer matrix and decouple the mechanical and proton-conducting functions of the membrane. Starting with a low Equivalent Weight (EW) polymer that one would expect to begin disintegrating under extended fuel cell operation, the Vanderbilt team added functionalized inorganic particles known as sulfonated Octaphenyl Polyhedral Oligomeric Silsesquioxanes (sPOSS) to enhance conductivity. The team made fibers of the polymer/SPOSS mixture using a technique called electrospinning to create a porous mat that was then thermally treated (causing all the nanofibers to connect), compressed and filled with an inert urethane-based resin. The nanofibers provide the network for proton conduction and the resin provides mechanical stability. The resulting membrane meets the DOE conductivity target at 80°C (shown in Figure 1) and approaches the conductivity target at 120°C as well – a key accomplishment. Figure 1 also shows that there is a significant increase in conductivity across the entire relative humidity range by adding up to 35% SPOSS. Vanderbilt has also shown that these composite membranes have good mechanical strength. If these membranes can meet DOE cost and durability targets they may move out of the lab for consideration in products.

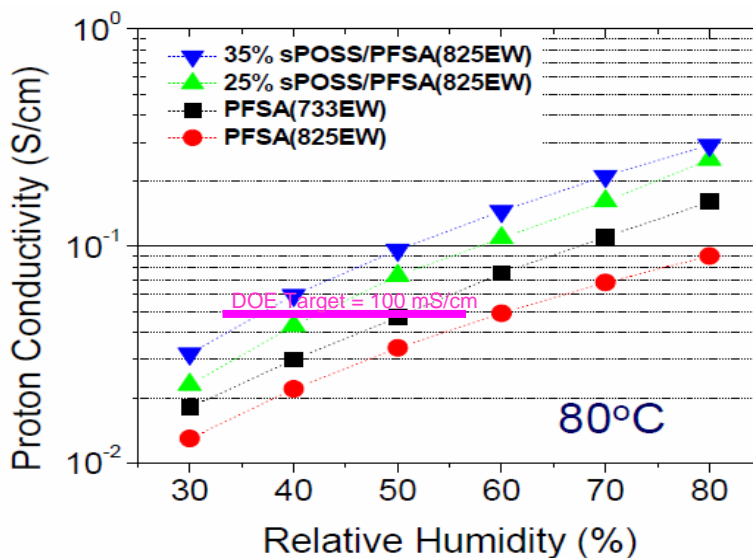

Figure 1: Proton Conductivity of Vanderbilt University Composite Membranes as a function of Relative Humidity at 80°C.

2009 FreedomCAR and Fuel Partnership Highlight

Platinum Loading Targets Achieved with NSTF-Containing MEA

3M

3M Company has demonstrated a Membrane Electrode Assembly (MEA) meeting both DOE targets for Platinum Group Metal (PGM) loading and specific power density (0.2 mg PGM/cm² and 0.2 g PGM/kW, respectively). 3M improved cell performance with reduced Pt loading by improving mass transport to the catalyst at high current density and reducing Proton Exchange Membrane (PEM) thickness. 3M's catalyst coated membrane consists of a Nano Structured Thin Film (NSTF) PtCoMn ternary alloy on both the anode and cathode sides of a 3M MEA. Figure 1 illustrates polarization curves in 50 cm² single cells for MEAs with total PGM loading of 0.15 mg PGM/cm², compared to 2008 curves with loading of 0.25 mg PGM/cm². Figure 2 shows the improvement in specific power density from 2008 to 2009 and the DOE 2015 target, which was achieved in both *ex-situ* rotating disk and single cell experiments.

3M has met or exceeded all of the currently-specified DOE electrocatalyst and MEA performance and durability targets for 2015 using the same MEA components tested in single cells, with the exception of mass activity measured in a fuel cell at 900 mV by the DOE-recommended protocol. The mass activity target was met using a modified procedure designed to measure the unoxidized NSTF PtCoMn catalyst. 3M's NSTF MEAs have passed DOE accelerated durability tests for voltage cycling and high potential stability. NSTF MEA lifetime of more than 7000 hours was also reproducibly demonstrated in a single cell test. Future work is required to demonstrate robustness at cold and wet operating conditions and to meet membrane durability targets with these MEAs.

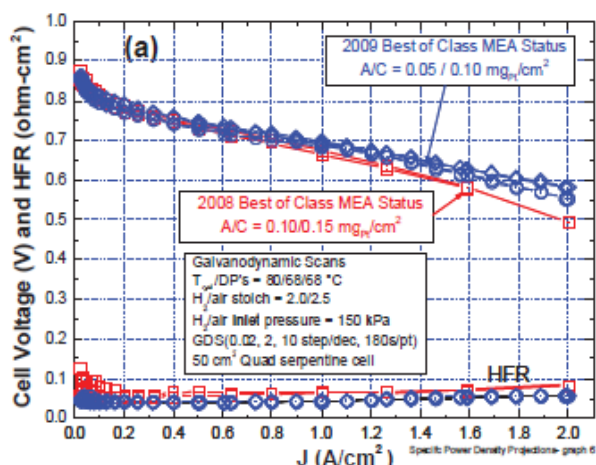

Figure 1: Comparison of 2008 and 2009 Galvanodynamic Polarization Curves Showing Improved Performance at Lower PGM Loading

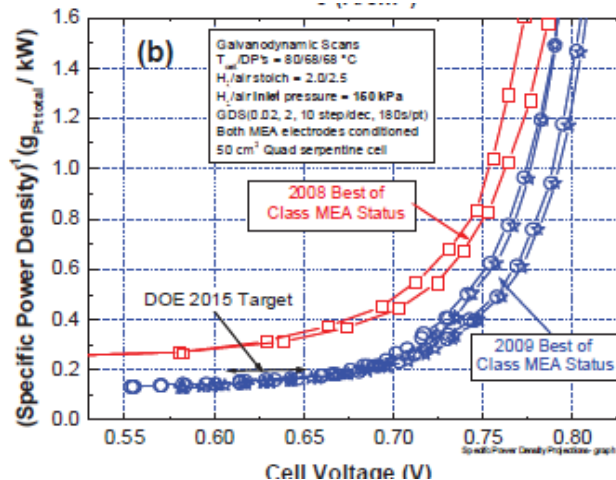

Figure 2: Comparison of 2008 and 2009 Specific Power Density Curves Showing Achievement of the 2015 FreedomCAR Target

2009 FreedomCAR and Fuel Partnership Highlight

Eight-Fold Improvement in Activity of Non-Precious Metal Catalyst

Los Alamos National Laboratory

Los Alamos National Laboratory has synthesized new non-precious metal catalysts with eight times greater activity for oxygen reduction than prior non-precious metal catalysts. This accomplishment is a significant advance toward removing precious metals from Proton Exchange Membrane Fuel Cells (PEMFCs) and lowering cost.

Catalyst synthesis began with *in-situ* polymerization of a nitrogen-containing compound (aniline or cyanamide) with a carbon support, followed by the addition of metal (Fe, Co or Fe₃Co), pyrolysis and acid leaching. Pyrolysis enabled active sites to form, while acid leaching was crucial for reducing the production of unwanted hydrogen peroxide. Figure 1 shows a thin layering of Polyaniline (PANI) graphene sheets over the metal; materials characterization confirmed the proximity of metals to the catalyst surface.

Both *ex-situ* rotating disc electrode measurements and *in-situ* fuel cell measurements confirmed the activity increase versus prior samples that had been made with ethylenediamine. Catalysts derived from PANI-Fe₃Co-C demonstrated 34 A/cm³ at 0.8 V_{iR-free} and 30 psig O₂ (Figure 2), as well as stable performance for 700 hours at 0.4 V. Catalysts derived from cyanamide demonstrated 68 A/cm³ at 0.8 V_{iR-free}, 30 psig O₂. These materials are within a factor of 2-4 of meeting the 2010 DOE target for non-precious metal catalyst activity (130 A/cm³ at 0.8 V_{iR-free}, 22 psig absolute O₂).

Attributes remaining to be demonstrated for these catalysts include higher activity, stability with voltage cycling and decreased thickness of the catalyst layer to avoid mass transport losses.

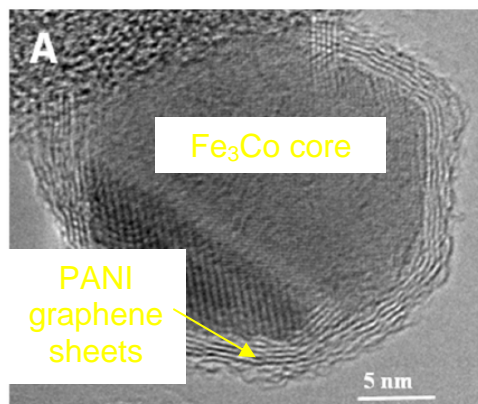

Figure 1: HR-TEM Image Showing PANI Grapheme Coating an Fe₃Co Core

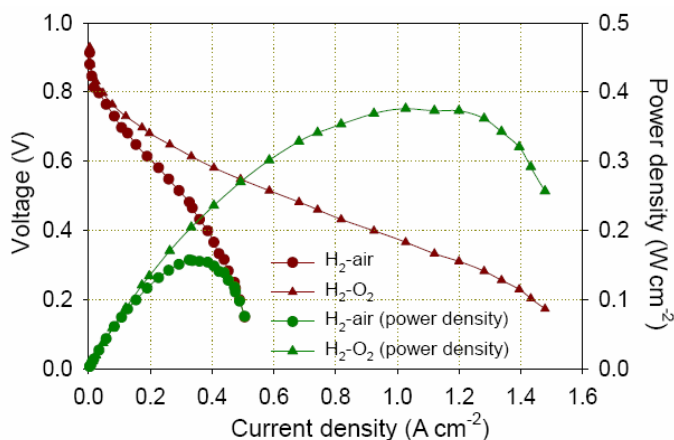

Figure 2: Performance Curves for PANI-Fe₃Co-C (34 A/cm³ at 0.8 V_{iR-free})

2009 FreedomCAR and Fuel Partnership Highlight

New Water Transport and GDL Characterization Techniques Developed

Rochester Institute of Technology, General Motors and Michigan Technological University

Many of the limitations for automotive fuel cell performance and durability stem from ineffective water transport within the fuel cell stack. The team lead by Rochester Institute of Technology (RIT) has developed a suite of experimental and modeling tools that enable a better understanding of how water behaves in an operating cell. These tools have been successfully applied to identify optimum material sets, cell designs and operating strategies to enable stable fuel cell operation. The team has developed a new printed circuit board device to allow simultaneous measurement of water, current, High Frequency Resistance (HFR) and temperature in a neutron radiography experiment, and stereo Scanning Electron Microscopy (SEM) imaging techniques that allow for determining the distribution of pore depth and volume in the Gas Diffusion Layer (GDL). The SEM image analysis has the potential to replace traditional porosimetry techniques for characterizing GDLs.

Figure 1 illustrates the simultaneous *in-situ* measurement of temperature, water, current, and HFR distribution during operation. These real time measurements enabled identification of water accumulation locations and water removal dynamics during shutdown. They found that GDLs with lower thermal conductivity and channels with hydrophilic coating facilitate water removal. GDL aging did not significantly change water hold-up or purge effectiveness. Using these techniques they validated a shutdown purge procedure for successful freeze-start.

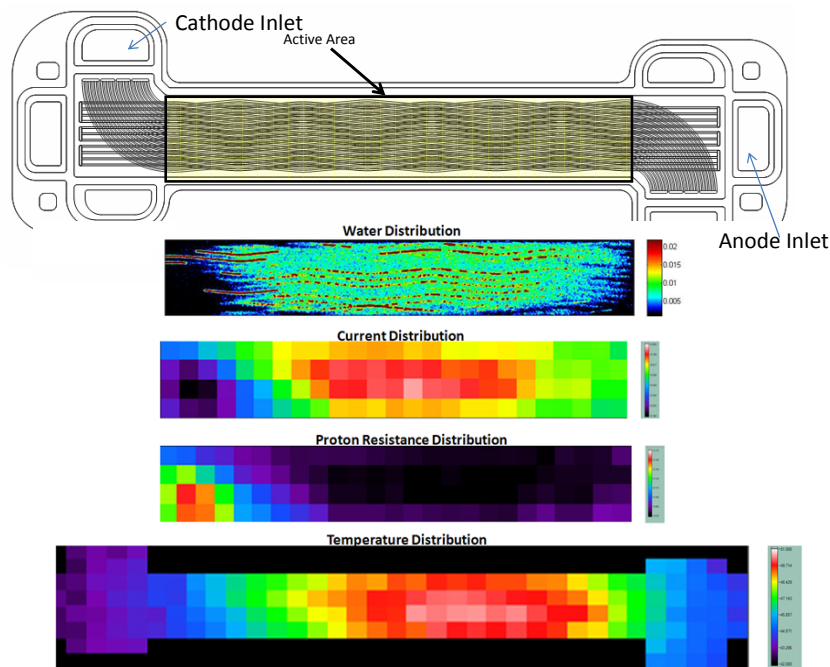

Figure 1: Simultaneous In-Situ Measurement of Temperature, Water Distribution, Current Distribution and HFR

2009 FreedomCAR and Fuel Partnership Highlight

Development of Angström-Scale Analysis for Composition and Structure of Catalyst Particles

Oak Ridge National Laboratory

One of the more promising concepts for reducing cost and precious metal content in fuel cell catalysts is a "core-shell" catalyst. In which just a thin shell of an active precious metal surrounds an inexpensive base metal core within each nanoparticle. Oak Ridge National Laboratory (ORNL) has developed a tool for confirming a core-shell structure, using an Angström (10^{-10} m) scale analysis technique.

A conventional Scanning Transmission Electron Microscope (STEM) is capable of imaging catalyst particles with a resolution of 1.2-1.5 nm. Given that fuel cell catalyst particles usually have a diameter of 2-5 nm, this resolution is not sufficient to identify a core-shell composition. Recently, however, ORNL has been able to distinguish atoms of differing atomic number (Z) using a technique called High Angle Annular Dark Field STEM (HAADF-STEM). Sometimes referred to as "Z-contrast imaging," this technique has been shown to have sub-Angström scale resolution through the correction of spherical aberration. Figure 1 shows the clarity with which a higher Z shell can be identified versus a lower Z core. Figure 2 shows metal composition as determined with a silicon drift detector.

The HAADF-STEM technique is being expanded beyond just imaging dry catalyst particles and into imaging catalyst particles in environments similar to those of the fuel cell. A microscope holder has been designed to allow the catalyst particles to be imaged in both air and water environments. At present, water environments allow a resolution of about 3 nm.

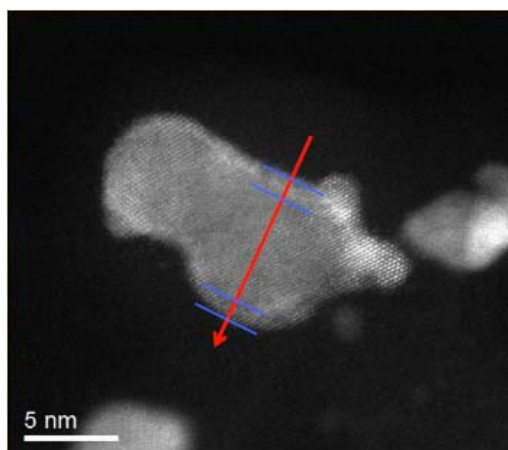

Figure 1: Line scan from Z-contrast imaging distinguishes the Pt-enriched shell surrounding the Pd-core within a nanoparticle

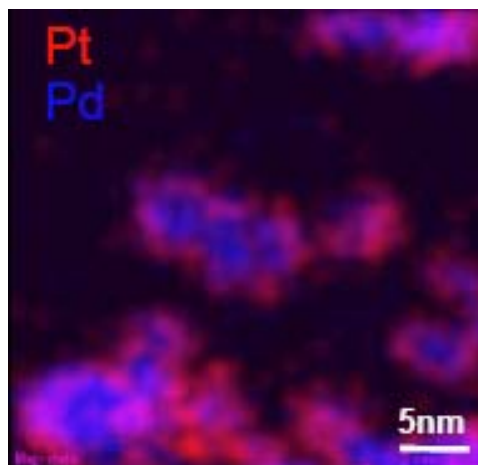

Figure 2: Silicon Drift Detector used to identify metal composition

2009 FreedomCAR and Fuel Partnership Highlight

Effects of Fuel and Air Impurities on PEM Fuel Cell Performance

Los Alamos National Laboratory

Los Alamos National Laboratory (LANL) has been studying the effects of impurities in both the hydrogen fuel stream and the air stream. Impurities compromise the performance and durability of fuel cells. This work is critical to help set the fuel quality specifications, determine what on-board air purification systems are required and develop *in-situ* recovery methods for contaminant removal. LANL has focused on the effects of H₂S, NH₃ and hydrocarbons in the fuel stream and SO_x and NO_x in the air stream.

The team at LANL had several key accomplishments in 2009. For example, they found that there were no long term performance losses for a cell running a dynamic drive cycle with 10 ppb H₂S in the fuel stream, compared to a baseline sample with ultrapure H₂ fuel. LANL also discovered that significant performance losses are caused by 5 ppm SO₂ in the air stream, as shown in Figure 1. The performance losses were only partially recovered by turning off the SO₂. SO₂ poisoning was found to be caused by sulfur adsorption on the cathode Pt catalysts, and the amount of sulfur adsorbed is strongly dependent on the cell voltage. LANL discovered that significant performance losses are also caused by 5 ppm NO₂ in the air stream, as shown in Figure 2. The degree of performance loss was found to depend on cell humidity, with greater losses at dryer conditions. Unlike SO₂, which poisons the cathode catalyst, the NO₂ is converted on the cathode to NH₃, which in turn poisons the membrane, as shown by the increasing ohmic resistance with time in Figure 2. This degradation mechanism is reversible and performance can be fully recovered by eliminating the NO₂.

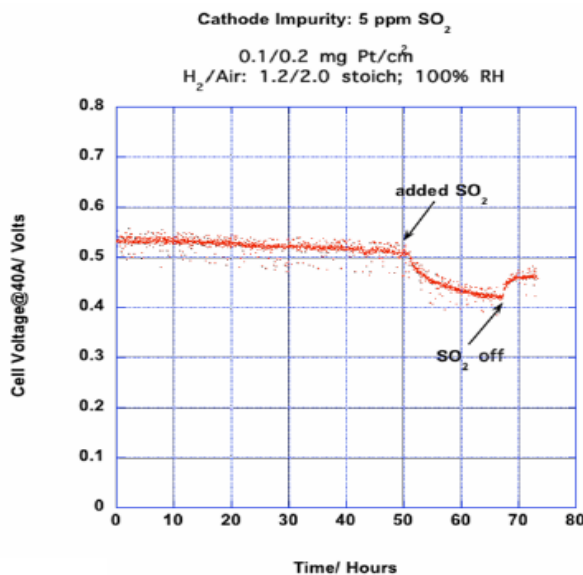

Figure 1: Effect of Fuel Cell Performance with 5 ppm SO₂ at 1A/cm²

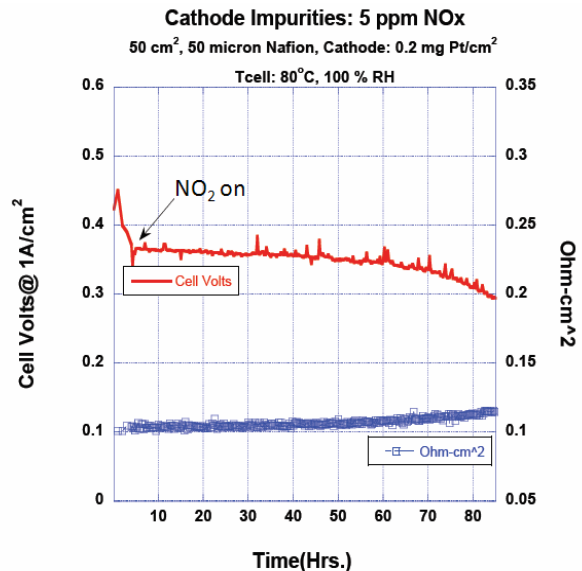

Figure 2: Effect of Fuel Cell Performance with 5 ppm NO₂ at 1A/cm²

2009 FreedomCAR and Fuel Partnership Highlight

Mass Production Cost Estimation for H₂ Fuel Cell Systems for Automotive Applications

Directed Technologies, Inc.

Directed Technologies, Inc. (DTI) has developed a rigorous cost model to estimate the cost of a fuel cell system at various production volumes. The model has become increasingly representative of state-of-the-art fuel cell technologies, reflecting automotive systems and requirements. The current cost estimate of ~\$61/kW demonstrates that fuel cells are rapidly approaching the \$30/kW system target for 2015. Figure 1 shows DTI's volume-based fuel cell system cost projections for the past four years. DTI has also projected that a 2015 fuel cell system, based on technology under development in DOE programs, would cost ~\$45/kW.

While there has been significant proprietary work conducted to understand the key cost drivers of fuel cell systems, work by DTI provides an open literature analysis of the issues that most directly impact fuel cell system cost. DTI uses a bottom-up cost estimation methodology to project high-volume (i.e., 500,000 units/year) manufactured cost for the fuel cell power system. These results are vetted by developers, key stakeholders and industry experts, and then refined based on their feedback. This is an on-going and iterative process that helps DOE focus research and development efforts on the areas that will provide the largest cost savings. For example, DTI has shown that at a production rate of 1,000 units/year, the membrane will make up nearly half of the stack cost; whereas, at 500,000 units/year, the catalyst is by far the highest cost item. Thus, while it is universally agreed that catalyst cost must be reduced to meet high volume system cost targets, focusing on low cost membranes will be critical for initial low volume fuel cell vehicle introduction.

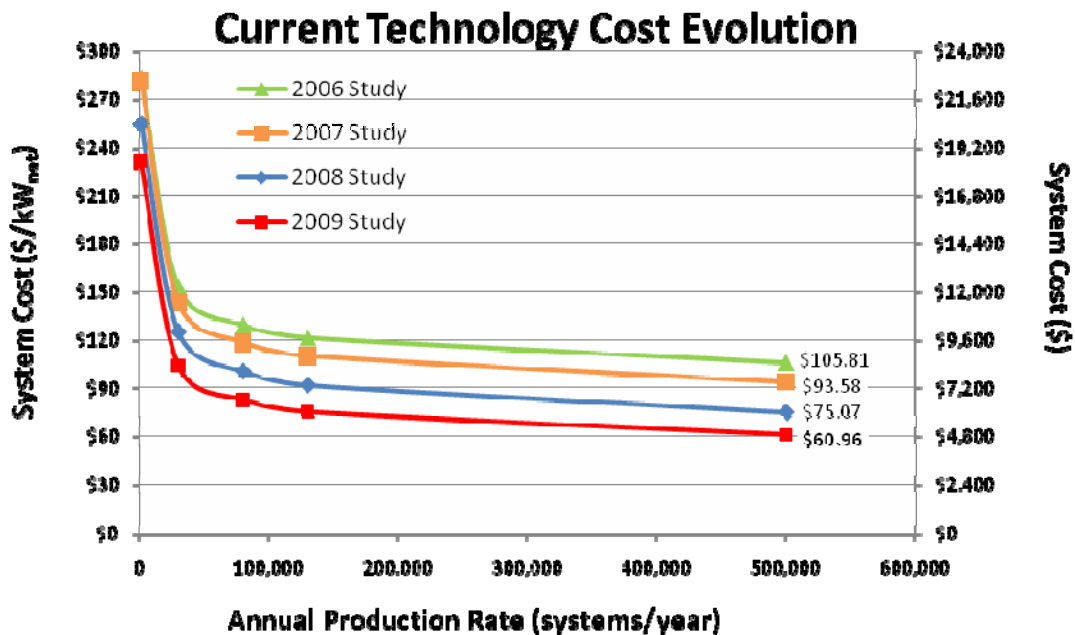

Figure 1: Cost for an 80-Kilowatt Automotive Fuel Cell System as a Function of Production Volume

2009 FreedomCAR and Fuel Partnership Highlight

Development of a Lightweight Composite Seat

Automotive Composite Consortium

Reducing vehicle mass increases vehicle efficiency and reduces greenhouse gases. The primary objective of the Lightweight Composite Seat project is to develop materials, processes and designs to yield a light-weight, low-cost composite structure that still meets the loading requirements of a second row automotive seat.

Second row outboard stand-alone seats are the target applications with volumes up to 340k units per year. Only the back frame, cushion frame and the pivoting recline/folding joint are included in the scope. Attachments for headrests, seat risers and seat belts are also considered. The project investigated predominately glass fiber reinforced composites due to cost considerations, but it considered local reinforcement with carbon fiber and other materials including metal in order to achieve a 30% weight save versus the components being replaced.

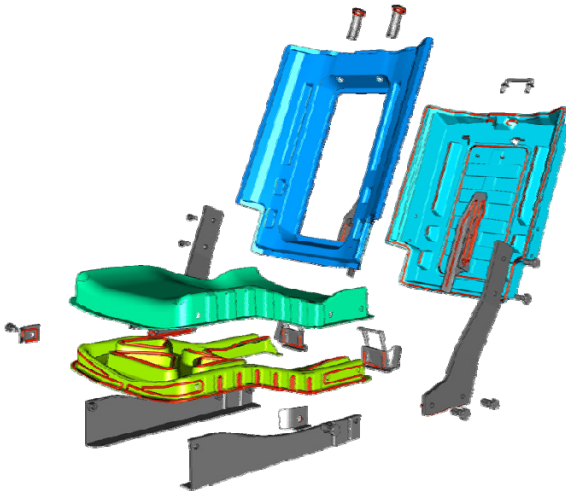

Figure 1: Composite Seat Design

A composite seat structure (Figure 1) comprising bonded composite shells of 40% glass reinforced polypropylene has been designed. The design also utilizes bonded steel reinforcements for managing local point loads at the attachments. The design has been analyzed and optimized to meet all seat loading requirements including:

- Front and Rear Impact
- Cargo Retention
- Headrest (FMVSS 202A)
- Seat Belt Pull (FMVSS 207/210)
- Child Seat (FMVSS 225)
- Knee Loading

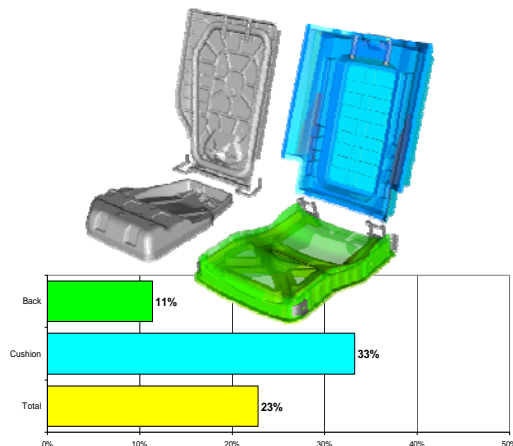

Figure 2: Weight Comparison

The design saves 25% (1.74 kg) of the weight of the steel comparator seat. The seat cushion saves 33% (1.29 kg) and the seat back assembly saves 11% (0.40 kg). See Figure 2. Preliminary costing of the lightweight seat indicates a cost penalty of about \$1 per pound saved. This is within the competitive range for weight saving ideas. Future work includes repeating the cost modeling exercise with new design and materials, designing and building molding tools and metal reinforcements, manufacturing composite parts and reinforcements and assembling seats. The completed seats will be tested for verification of the design.

2009 FreedomCAR and Fuel Partnership Highlight

Light-Weight Magnesium-Intensive Engine

USAMP: Automotive Metals Division

In 2009, the technical work of the Magnesium Powertrain Cast Components (MPCC) Project was completed. The Project demonstrated that there are no technical showstoppers to prevent production implementation of magnesium powertrain components. This can lead to significant vehicle mass savings. The MPCC project was created to determine the readiness of magnesium (Mg) alloys for cost-effective mass reduction in powertrain systems. Starting with a production V6 aluminum engine, the MPCC team redesigned the cylinder block, oil pan and front cover for Mg; determined the materials requirements; identified the best alloys for each component; designed and built tooling to cast the components; and in 2008 and 2009, assembled and engine dynamometer-tested Mg-intensive engines.

The Project realized 29% mass reduction for the Mg components, much greater than the original 15% target. Mass reduction was cost neutral for the oil pan and front cover but cost \$4 per lb for the cylinder block based on Mg at \$1.75 per lb. This cost premium is largely dependent on price volatility of Mg. When the Project began, Mg was priced at nominally \$1.20 per lb, which, per the cost model, would have enabled mass reduction of the block for \$2 per lb and the oil pan and front cover for a cost savings of \$2 per lb – well within the target of \$2 per lb mass reduction.

Fully assembled, Mg-intensive engines passed four dynamometer tests. Hot and cold scuff tests demonstrated the viability of the wear-resistant bore coating (in place of heavy iron liners). Two 600+ hour tests demonstrated the durability of the oil pan and front cover and the coolant corrosion resistance of the Mg cylinder block.

Root cause analysis of bulkhead cracking in the one Mg-intensive engine that failed dynamometer testing identified cracking as due to tensile overload of the Mg because lack of interfacial strength between the Mg bulkhead and iron inserts prevented load transfer. FEA confirmed this failure mechanism and indicates that preventing future failures is feasible (i.e., not a showstopper).

Noise-Vibration-Harshness (NVH) assessment of the Mg-intensive engine relative to the Al production engine showed no difference between Mg and Al for the oil pan and front cover. Exchange of Mg for Al in the cylinder block did increase NVH, but the majority of increase was attributable to design change instead of the material change.

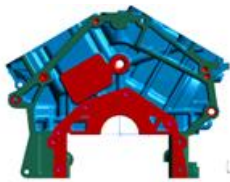

Figures (left to right) show a schematic of the deep skirt cylinder block design (for which US Patent 7,284,528 was issued to USAMP 10-27-07) , the cast Mg block, oil pan and front engine cover, which were cast and tested in the MPCC Project.

2009 FreedomCAR and Fuel Partnership Highlight

Full-scale Recycling Validation Plant for Recovering Polymers Starts Operation

Argonne National Laboratory

Automotive lightweighting polymers are presently being landfilled. Of the five million tons of shredder residue generated annually in the United States, about 30% is polymers. Recovering these polymers while retaining their properties will have many advantages including: (1) recycled automotive polymers increase materials supply options and decrease costs for automakers, (2) decrease the carbon footprint of lightweighting materials over product life-cycle and (3) save the embodied energy of the recovered materials.

A full-scale validation plant based on Argonne National Laboratory's (ANL) process for recovering polymers and residual metals from shredder residue started operation at a commercial recycler's facility during the 4th quarter of 2009 and is undergoing testing. The design capacity of the plant is 20 ton/hour of shredder residue.

In addition, a full-scale validation plant based on Troy Polymers' process to convert scrap polyurethane foams to polyols is scheduled to start up in the 1st quarter of 2010. Some of the development work was conducted as part of the initial CRADA between USCAR's Vehicle Recycling Partnership and ANL..

Building and operating the full-scale validation plants are the first steps for commercializing these technologies. Successful operation demonstrates the technical feasibility.

The technology developed for recycling these polymers serves as a springboard for developing technologies to recycle other materials, including lightweighting metals and carbon fiber composites.



Figure 1: 5000 Pound/hr Flotation Tanks for Recovering Plastics from Shredder Residue

2009 FreedomCAR and Fuel Partnership Highlight

Future Generation Passenger Compartment - Validation

USAMP: Auto-Steel Partnership – ASP241

The Future Generation Passenger Compartment - Validation project demonstrated the ability to achieve a 15-20% mass savings of the passenger compartment at nearly cost parity based on a production viable four-door, five-passenger sedan. This was accomplished by the intensive use of Advanced High-Strength Steels combined with state-of-the-art design optimization and manufacturing approaches. The design solution applied new load paths using the front seats to meet these increased requirements while lowering mass. The design solution was determined to be robust to seat location variations (Figures 1 and 2). Also, manufacturing feasibility evaluations assessed the solution to be acceptable for high volume manufacturing.

The project results and conclusions are:

- Load path, combined with grade and gauge optimization, yielded mass savings of 15%.
- Seat load path sensitivity to seat location appears manageable.
- Extensive application of adhesive shows promise, but further study is required to determine the optimal adhesive patterns / business trade-offs.
- An expansion of the analysis beyond the passenger compartment may yield further mass savings.

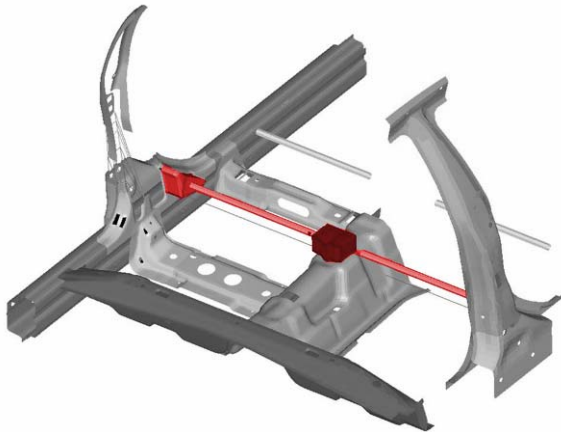

Figure 1: New Cross-car Front Seat Load path shown in red

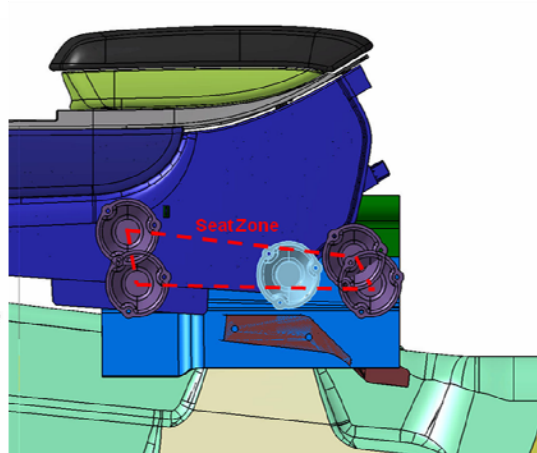

Figure 2: Potential location of New Cross-car beam based on range of seat motion

2009 FreedomCAR and Fuel Partnership Highlight

Infrared Inspection of Resistance Spot Welds Non-Destructive Inspection

Oak Ridge National Laboratory

The primary objective of the Infrared Inspection of Resistance Spot Welds Non-Destructive Inspection (IR-NDI) of Automotive Structures project is the development of rapid, robust and reliable quality inspection techniques that can be employed in the manufacturing plant to enable vehicle lightweighting materials.

Welding is the most widely used technology for assembling auto body structures. It is critical that automakers are able to reliably determine the integrity of those spot welds. Traditionally, destructive tests and prybar checks have been used to audit the welds. With increased use of higher strength Advanced High Strength Steels to reduce vehicle mass, those methods are more difficult and physically taxing to use. For this reason non-destructive weld quality inspection is more desirable than ever. Any weld quality inspection technique must be fast, highly cost-conscious, extremely low in false rejection rate and not interfere with the highly automated welding fabrication process. This project addresses this critical industry need through the development of IR based on-line weld quality monitoring technology.

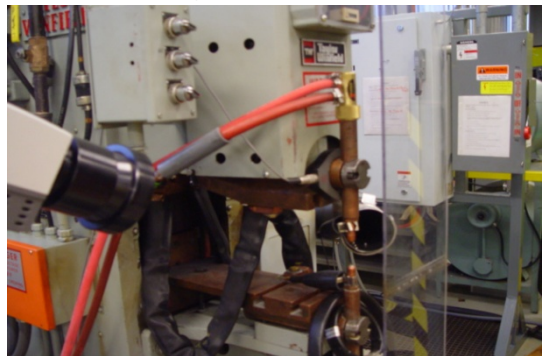

Infrared Imaging of Resistance Spot Welds

Heat generated during the resistance spot welding process can be used to monitor the weld quality. Working with USCAR and using preliminary results supported by the High Temperature Materials Laboratory user projects, ORNL has successfully developed an on-line inspection technique using infrared thermography. A well designed test matrix was prepared at ORNL and spot weld coupons were made at Arcelor-Mittal Steel. Post-mortem Infrared (IR) inspections using several heating and cooling techniques were carried out to assess the weld quality. Methods chosen were able to clearly distinguish between good, cold, small, undersized and Just Below Expulsion (JBE) welds and group them based on the heat flow through the weld nuggets.

Future work has been planned to explore the applicability of this technique to weld in aluminum and to develop image processing and new software algorithms to improve the inspection speed.

2009 FreedomCAR and Fuel Partnership Highlight

Low Cost Titanium Materials for Suspension Applications

Pacific Northwest National Laboratory

In 2009, the *Low Cost Titanium for Feedstock* project demonstrated that a novel low cost titanium powder could be processed to a bar stock with an unprecedented combination of cost, strength and ductility that can be used for suspension applications. Titanium's low density and elastic properties make it a near perfect material for reducing the mass of springs and has been shown to reduce the mass of suspension applications by more than 50% in solid bar and 72% in hollow bar (Figure 1).

The primary barrier to the use of titanium in automotive suspension applications has been cost. For this demonstration, bar stock was fabricated from a low cost titanium powder produced by ADMA Products, Inc. (Hudson, OH) using very low cost alloying additions and an energy-saving solid state consolidation process. Solid state consolidation prevents liquid phase segregation encountered during conventional melt processing, thereby allowing for the use of high quantities of low cost iron rather than more costly molybdenum or chromium typically used in used high strength titanium suspension alloys. In addition to the alloying cost advantages, solid state consolidation is performed at 1250°C, rather than the 1750°C required to melt titanium, reducing the energy needed to produce a billet (Figure 2). Also, because of the low temperature processing, the billet microstructure is highly refined and can be directly rolled to bar stock without costly low yield forging processes required to refine the microstructure of conventional melt processed titanium.

The bars rolled during this project were produced at nearly 100% yield from billet rather than the typical 50 to 60% encountered in conventional melt processing (Figure 3). The final result was titanium alloy bar stock with strengths greater than that of steel (240,000 lb/in²), at a density of 55% of that of steel and at a cost predicted to be near \$4.50 per pound for the finished product.

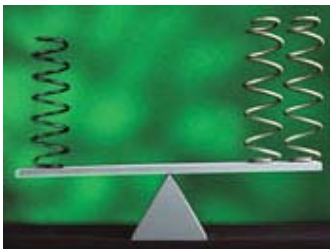

Figure 1: Timet VW Lupo titanium Springs (right) demonstrating a 50% mass savings



Figure 2: Solid state consolidated billets produced from low cost powder



Figure 3: As-hot-rolled bars prior to coiling produced at nearly 100% yield from low cost titanium powder

2009 FreedomCAR and Fuel Partnership Highlight

PHEV and HEV Fleet Testing

Idaho National Laboratory

Testing advanced technology vehicles in both standardized and “in-use” operating conditions provides a valuable opportunity to validate modeling and laboratory results, as well as highlight issues, concerns and real world capabilities. The Idaho National Laboratory (INL) tests Plug-in Hybrid Electric (PHEV) and Hybrid Electric Vehicles (HEV) through the DOE’s Advanced Vehicle Testing Activity (AVTA).

In collaboration with 80 testing partners, 216 PHEVs, including 12 PHEV models (by battery manufacturer) located in 23 states, Canada, and Finland, have been fleet-, track-, and dynamometer-tested.

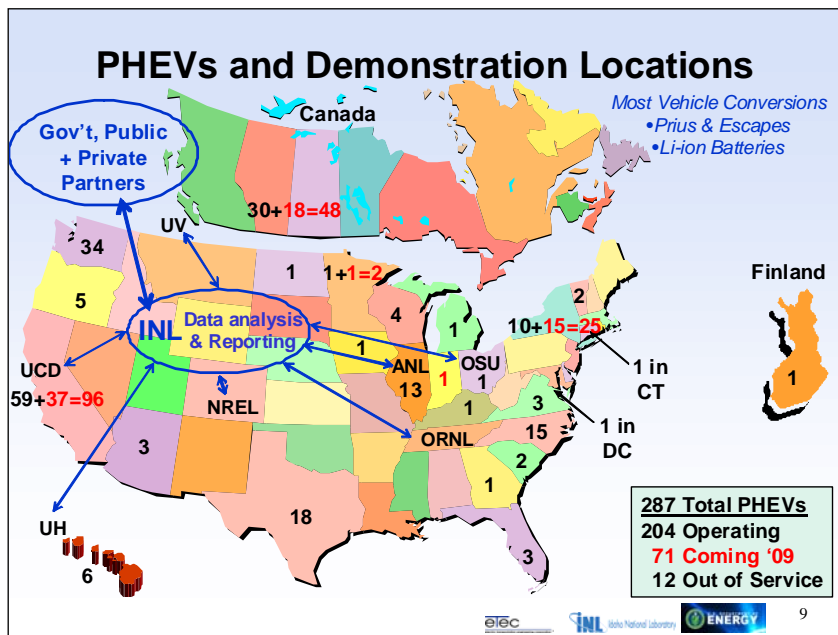

Figure 1: Locations of INL's / AVTA's 216 PHEVs tested

The ATVA PHEV results and accomplishments at the end of fiscal year 2009 include:

- Over 1 million PHEV test miles accumulated
- In charge depleting mode PHEV mpg results are closely tied ($R^2 = 0.9935$) to extremes in ambient temperature. (Reductions as high as 70% were recorded)
- Both high and low ambient temperature extremes significantly impact PHEV mpg results as well as charging strategies and effectiveness
- Fleets recorded up to an 85% mpg increase when PHEVs were fully charged

Additionally, ATVA HEV testing has accumulated 4.7 million test miles on 47 HEVs, including 18 different HEV models. HEV testing results include:

- HEV mpg decreases an average of 21.5% (9 mpg) when air conditioning is used, with a per model decrease range of 8 to 28.4% (4.4 to 15.8 mpg)
- The AVTA's sixteen HEV battery reports published in FY09 demonstrate that most HEV batteries fail to achieve DOE battery performance goals.

2009 FreedomCAR and Fuel Partnership Highlight

Cost-effective Vehicle Electrification

National Renewable Energy Laboratory

Electrifying transportation can reduce or eliminate dependence on foreign fuels, emission of greenhouse gases and emission of pollutants. One challenge is finding a pathway for vehicles that gains wide market acceptance to achieve a meaningful benefit.

This study evaluates a variety of pathways to vehicle electrification. Prior to the analysis, the vehicle performance, cost and battery life models were checked to match today's technologies and cost. Next, a variety of vehicle electrification scenarios were run. One scenario sized the battery to last the life of the vehicle. A second assumed battery replacement – that the battery will be replaced during the life of the vehicle. A third assumed opportunity charging – that the vehicle will be able to recharge after every trip rather than just at the end of the day. A fourth assumed both battery replacement and opportunity charging. A final case assumed that the vehicle will be powered by external electric power, similar to the trolleybuses in Boston, San Francisco and Philadelphia, during half of their travel. All assumed \$3.56 per gallon gasoline and \$0.10/kWh electricity.

As seen in Figure 1, the vehicle powered by external electric power, labeled EHEV, was cost effective using today's batteries. This vehicle gained the fuel consumption benefits of a PHEV with a smaller battery and the lower upfront cost of an HEV. Additional analyses indicates that reduced battery cost, from \$700/kWh to \$300/kWh, or improved life by a factor of 10 also would make PHEVs cost effective, pointing to the need for continued battery research and development for EVs and PHEVs.

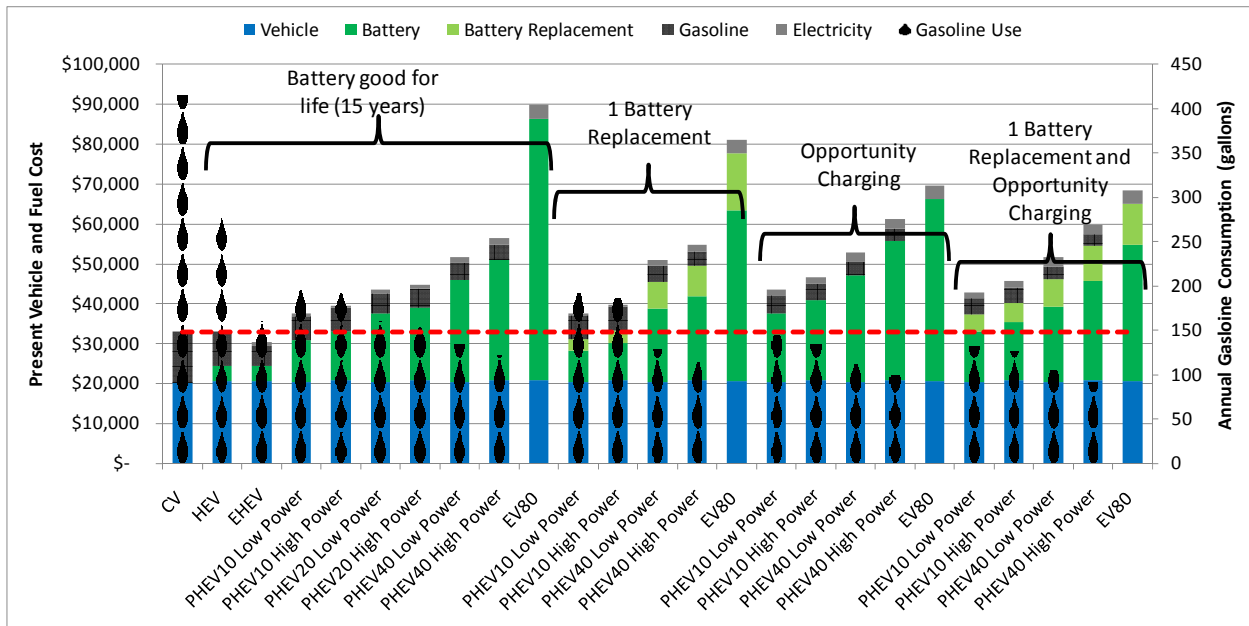

Figure 1: Cost effectiveness of vehicle electrification using current battery technology

2009 FreedomCAR and Fuel Partnership Highlight

Plug-in Hybrid Engine Thermal State and Resulting Efficiency

Argonne National Laboratory

Testing Plug-in Hybrid Vehicles (PHEV) over standardized and real world drive cycles has shown relatively large fuel consumption differences between ambient cold starts and hot starts. Losses on the order of 25-40% have been observed from ambient 20°C cold starts to optimal hot temperature urban drive cycle operation (Figure 1). This is especially critical for PHEVs, when long durations between engine operation result in reduced engine temperature. Testing under this project begins to quantify these temperature effects and identifies areas for future vehicle efficiency studies and improvements to PHEVs.

Argonne researchers have applied response surface methodology techniques for PHEV experimental test data to characterize the thermal effect on efficiency [Figure 2]. Combined with a technique for predicting the engine thermal state from its initial temperature, this unique methodology accurately predicts the fuel efficiency over a drive cycle from ambient cold starts to fully operational temperature. Current work focuses on developing a displacement-independent engine model that will allow vehicle simulations to account for engine thermal efficiency effects. Analysis from this methodology led to the following conclusions:

- Engine efficiency significantly increases with increasing engine temperature.
- Projected optimal engine temperature is ~25% more efficient than a 22°C ambient cold start.
- The initial enrichment spike encountered during a cold start accounts for a ~3% fueling increase compared to a warm engine. Greater accumulated losses (~20%) follow this cold start enrichment until the engine reaches optimum temperature.
- Between the range of 25°C to 60°C, each 5°C increase in initial engine temperature decreases fuel consumption by 3.2%~1.9%, respectively. This fuel usage reduces as temperature increases, ultimately reaching an asymptote.
- For the experimental PHEV, ten minute soak times may result in ~5 degree variations in temperature (dependent upon powertrain operating temperature).
- Losses associated with the electric components, rolling losses, and transaxles are minimal relative to engine and transmission thermal losses.

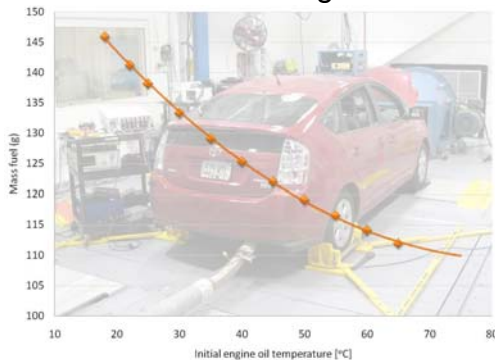

Figure 1: Modeled UDDS fuel consumption as a function of initial engine temperature

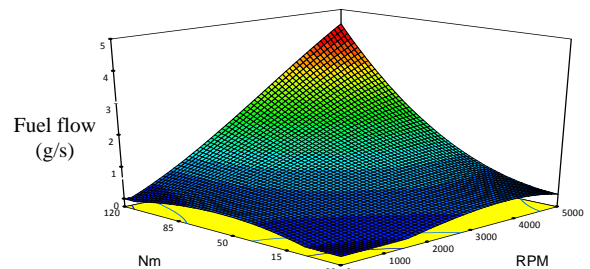

Figure 2: Fueling rate response surface at 22°C engine temperature

2009 FreedomCAR and Fuel Partnership Highlight

Well-to-Wheels Analysis

Fuel Pathways Integration Technical Team

The Fuel Pathways Integration Technical Team (FPITT) reviewed the Department of Energy's well-to-wheels (WTW) analysis methods, assumptions and data with the goal of identifying issues and gaps based on the energy industry perspective. A comprehensive report has been prepared describing the assumptions, data, results, issues and gaps for the analysis of the current technical status of seven hydrogen production and delivery pathways: 1) distributed reforming of natural gas, 2) distributed electrolysis using grid electricity, 3) central biomass gasification with delivery of liquid hydrogen via truck, 4) central biomass gasification with pipeline delivery of gaseous hydrogen, 5) central natural gas reforming with pipeline delivery of gaseous hydrogen, 6) central electrolysis using wind-based electricity with pipeline delivery of gaseous hydrogen and 7) central coal gasification with pipeline delivery of gaseous hydrogen. The sensitivity of the costs, energy use and emissions for each pathway to various hydrogen production and delivery parameters was assessed and reported; an example is shown in Figure 1. Key gaps in the analysis that apply to multiple pathways include:

- The amount of hydrogen storage required at the forecourt site needs to be determined more definitively.
- The tradeoffs between hydrogen quality and fuel cell performance are not well understood, particularly for stationary fuel cell applications.
- Caverns may not be available in most locations for hydrogen storage, and the need for hydrogen gas clean-up after geologic storage is not well understood.
- The estimated contribution of hydrogen distribution pipelines to the cost of hydrogen needs to be refined.

The report, *Hydrogen Pathways: Cost, Well-to-Wheels Energy Use, and Emissions for the Current Technology Status of Seven Hydrogen Production, Delivery, and Distribution Scenarios*, NREL/TP-6A1-46612, is available at <http://www.nrel.gov/docs/fy10osti/46612.pdf>.

Figure 1: Cost Sensitivities for Central Biomass Gasification Production with Gaseous Hydrogen Delivery by Pipeline, with Examples of Analysis Gaps

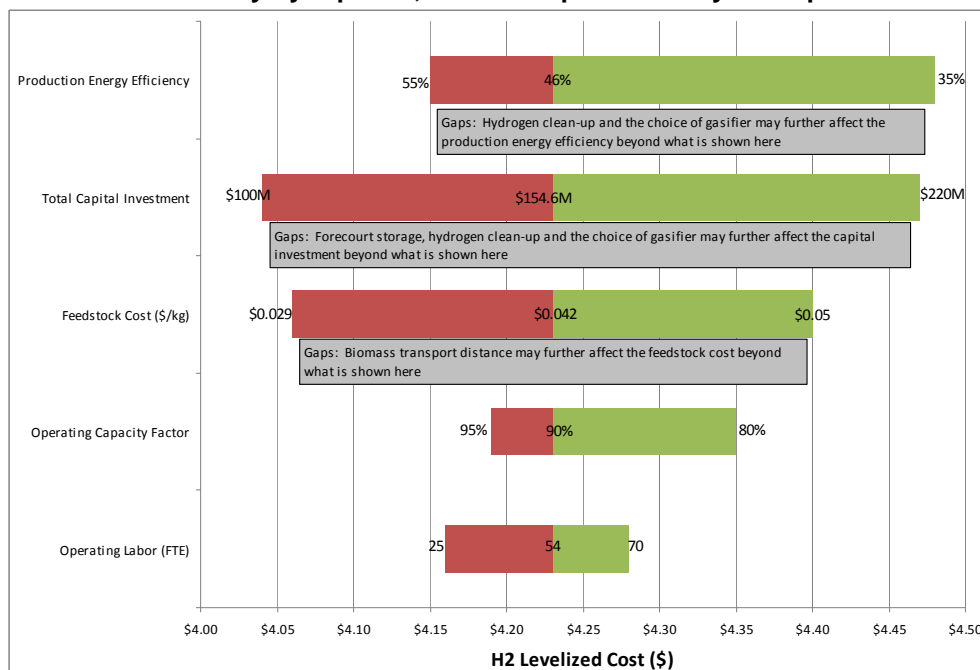

Source: NREL/TP-6A1-46612

2009 FreedomCAR and Fuel Partnership Highlight

Analysis of Hydrogen Integration in Non-Transportation Sectors

Fuel Pathways Integration Technical Team

Because hydrogen fueling station utilization may not be high enough at low penetrations of hydrogen-powered vehicles to support a favorable business case, DOE has been evaluating the viability of producing hydrogen using stationary fuel cells in combined heat and power applications, with FPITT providing an industry perspective. To facilitate such analysis, the National Renewable Energy Laboratory developed the Fuel Cell Power Model for conducting techno-economic analysis of combined heat, hydrogen and power (CHHP) systems. The model, which is currently configured to analyze molten carbonate fuel cell (MCFC) and phosphoric acid fuel cell (PAFC) systems, utilizes building electricity and heat demand profiles along with grid electricity and fuel price schedules to determine how much hydrogen can be produced by the selected fuel cell system, and how much that hydrogen may cost. By inserting a database of building demand profiles in the Fuel Cell Power Model, DOE is able to analyze the influence of building type and location on the economics of a CHHP system, identify building type characteristics that are favorable for CHHP application, and identify geographic characteristics that are favorable or unfavorable for CHHP application. For example, Figures 1 and 2, below, show areas of the U.S. where the fuel cell CHP electricity price might be competitive with commercial electricity from the grid without and with government incentives.

Argonne National Laboratory is developing concurrently a new version of the Greenhouse Gases, Regulated Emissions and Energy Use in Transportation (GREET) Model to assess the energy use and emissions of CHHP systems.

Figure 1: Comparison of Fuel Cell Electricity Generation Costs to Grid Electricity Costs Without Federal Tax Incentives

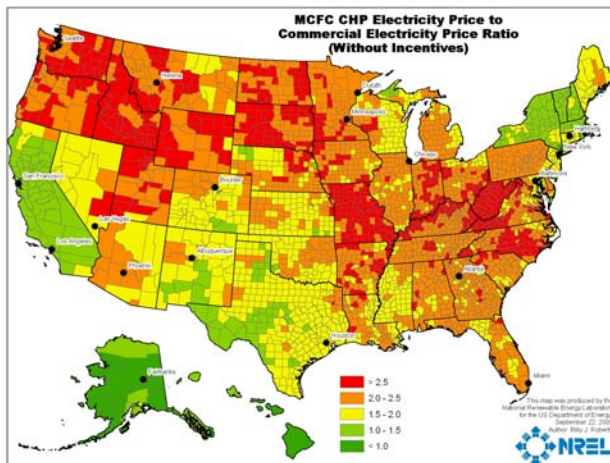
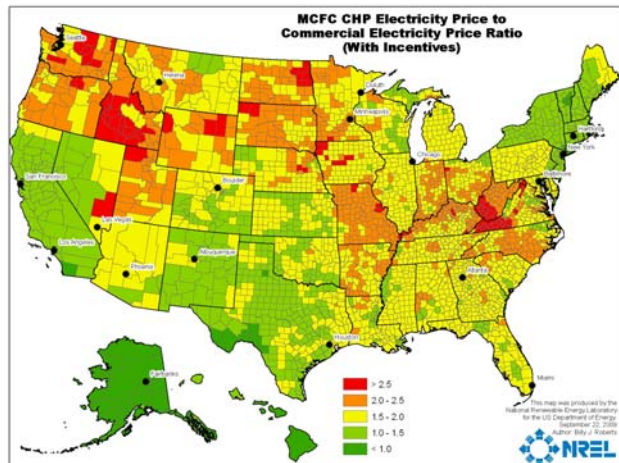

Figure 2: Comparison of Fuel Cell Electricity Generation Costs to Grid Electricity Costs With Federal Tax Incentives



Source: National Renewable Energy Laboratory

2009 FreedomCAR and Fuel Partnership Highlight

Geologic Hydrogen Storage Issues

Fuel Pathways Integration Technical Team

It has not been established if there is sufficient geologic hydrogen storage capacity to support a full-scale build-out of hydrogen infrastructure. This impacts technoeconomic analyses of hydrogen fuel pathways. Recognizing this gap in DOE's analytic framework, FPITT provided an industry perspective on the use of salt domes for hydrocarbon and hydrogen storage as well as non-proprietary information on the potential for hydrogen storage in U.S. salt domes. Only one salt dome is currently used for hydrogen storage in the U.S.: ConocoPhillips' Clemens dome. The Clemens dome has been used for over 20 years and is one of only two hydrogen storage domes in the world. Its capacity is 3.5 million barrels, and the hydrogen structure is 2,000 feet deep. The surface pressure is 2,000 psi. Although hydrogen loss from the dome is minimal, other issues exist with salt dome storage. First, bedded salt cannot be used for hydrogen storage due to integrity issues and horizontal layers from which hydrogen can be lost; thus, dome salt is needed. Second, the salt dome experiences approximately 0.25% shrinkage per year and is subject to subsidence (sinking and/or collapse of rock layers above the dome). Third, the difference in pressure relative to a hydrogen pipeline and potential hydrogen contamination issues must be addressed. Finally, salt dome capacity in the U.S. appears to be limited. Additional analysis of geologic hydrogen storage is needed. Based on this analysis, salt dome storage capacity may not be sufficient or strategically located for hydrogen storage, requiring other formations to be assessed for storage such as depleted oil and gas reservoir formations. These formations will require further analysis of quality, cleanup requirements and impact on hydrogen cost.

Figure 1: Major U.S. Salt Deposit Locations



Source: "An Introduction to Salt Caverns & Their Use for Disposal of Oil Field Wastes," Argonne National Laboratory. Downloaded from <http://www.netl.doe.gov/technologies/oil-gas/publications/brochures/SaltCav.pdf>

2009 FreedomCAR and Fuel Partnership Highlight

H2A Hydrogen Delivery Scenario Analysis Model

Argonne National Laboratory, National Renewable Energy Laboratory

ANL and NREL incorporated four new features into the Hydrogen Delivery Scenario Analysis Model (HDSAM) to enhance its simulations. A number of options exist for transporting hydrogen from a central production facility to an end user. These options include gaseous hydrogen delivery in pipelines, high pressure tube trailers or a combination of both; liquefaction and transport of liquid hydrogen; and the use of novel carriers such as absorbents or liquid chemical hydrides.

To guide hydrogen delivery research, all major factors that drive the cost, energy efficiency and greenhouse gas (GHG) emissions associated with hydrogen delivery need to be understood. HDSAM was developed for that purpose. This year, several important improvements were made to the model:

- Adding the capability to model 700 bar gaseous refueling. This capability includes cooling at the refueling station to – 40°C for fast fills.
- Adding the capability to model Cryo-compressed Hydrogen (CCH₂) refueling for use with high pressure (250 bar) supercritical hydrogen storage on the vehicle.
- Expanding the gaseous hydrogen tube trailer modeling capability to include the advanced higher pressure composite tube trailers that are under development and are beginning to be used. This modeling includes tube trailers with pressure ratings from 180 bar to 550 bar which can deliver 240-1000 kg of hydrogen.
- Refining some of the current technology default values such as cryogenic liquid hydrogen truck losses during hydrogen delivery at refueling stations.

The two figures below show the HDSAM results using some of the new capabilities: 350 bar refueling, 700 bar refueling with advanced 350 bar tube-trailer delivery, a combination of this tube-trailer with pipeline transport to the city gate and liquid delivery with CCH₂ refueling. The Sacramento, CA simulation shows that delivery costs decrease rapidly as market penetration (hydrogen volume) increases and begin to level out at 10% to 15% penetration. Also, the 700 bar refueling adds about \$0.50/kg of hydrogen to the cost of hydrogen delivery compared to 350 bar refueling. CCH₂ refueling costs are equivalent to gaseous hydrogen delivery with 350 bar refueling but with lower energy efficiency and higher GHG emissions. The \$3/kg delivery cost at high market penetrations is significantly higher than the target delivery cost of \$1/kg.

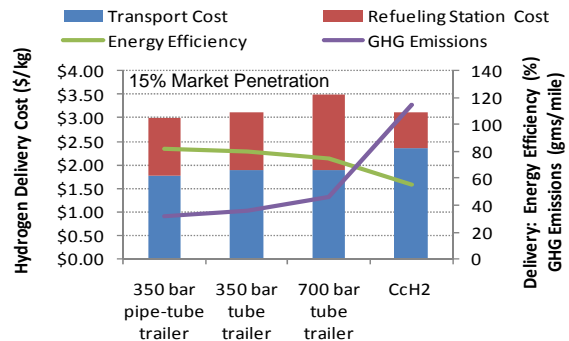
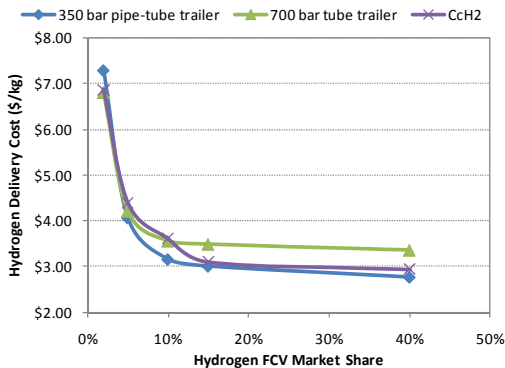

Based on Sacramento, CA with the hydrogen plant 62 miles from the city's border

2009 FreedomCAR and Fuel Partnership Highlight

Maximizing Sunlight Utilization Efficiency and Productivity in Photosynthesis

University of California, Berkeley

This project has significantly increased the solar-to-chemical energy conversion efficiency by microalgal cultures from 3% to 15%, reaching half of the theoretical maximum of 30%. The solar-to-chemical energy conversion efficiency in photosynthesis is determined by the amount of absorbed incident light and the efficiency by which the microbes convert the energy of the absorbed photons to chemical energy. The effort entails application of biotechnology approaches to minimize, or truncate, the light-harvesting chlorophyll antenna size in photosynthetic organisms. A truncated chlorophyll antenna would minimize shading of cells deeper in the mass culture, or dense canopy, which permits greater penetration of sunlight, increases sunlight utilization efficiency and improves photosynthetic productivity.

The work employs the model green microalgae *Chlamydomonas reinhardtii* and state-of-the-art DNA insertional mutagenesis, screening, cloning and biochemical and molecular genetic analyses for the isolation and characterization of genes conferring the “truncated Chl antenna size” property to this model photosynthetic microorganism. Genes identified from this work can be readily applied to all other photosynthetic organisms (microalgae and plants) to generate a “truncated Chl antenna size” so as to improve solar energy conversion efficiency and photosynthetic productivity in the organism of interest. The investigators have also isolated and characterized a new “truncated chlorophyll antenna size” mutant that could increase the light utilization efficiency to about 25% once cloning of this gene is successful. It is evident that advances made in this work will benefit not only hydrogen, but also biodiesel, biomass and all other solar-based bio-product generation efforts.

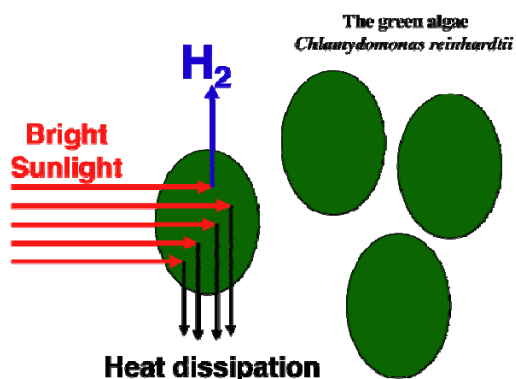

Figure 1: Illustration of fully pigmented cells that over-absorb and wastefully dissipate bright sunlight, while effectively shading cells deeper in the mass culture.

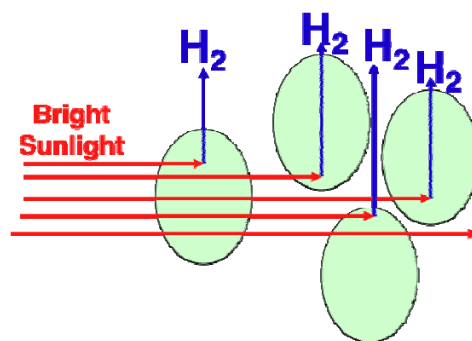

Figure 2: Truncated chlorophyll antenna cells permitting greater transmittance of sunlight through the high-density culture or canopy, thus enabling better solar energy utilization and productivity by the culture.

2009 FreedomCAR and Fuel Partnership Highlight

Hydrogen Production Programmatic Advances

Hydrogen Production Technical Team

Five important documents were developed in 2009 that further the implementation of renewable hydrogen production:



The Hydrogen Production Roadmap identifies the key challenges and priority Research and Development (R&D) needs associated with various hydrogen fuel production technologies. The aim of the roadmap is to identify research pathways leading to hydrogen production technologies that produce near-zero net greenhouse gas (GHG) emissions and use renewable energy sources, nuclear energy and coal (with carbon capture and storage). The full roadmap, "Technology Pathways to the Future," is available at:

http://www1.eere.energy.gov/hydrogenandfuelcells/pdfs/h2_production_roadmap.pdf and the "Overview of Technology Options" is available at http://www1.eere.energy.gov/hydrogenandfuelcells/pdfs/h2_tech_roadmap.pdf.



Technoeconomic Boundary Analysis of Biological Pathways to Hydrogen Production explores the limits that the technology can theoretically achieve and future work recommendations for thirteen different biological hydrogen production systems. The project considers multiple pathways for the biological production of gaseous hydrogen, including photobiological H₂ production from a variety of genetically engineered algae and cyanobacteria, dark fermentation of waste photobiological organisms, dark fermentation of lignocellulosic biomass, and the microbial electrolysis of fermentative waste. Additionally, the integration of multiple systems for added hydrogen production and reduced cost is considered. The document is available at: <http://www1.eere.energy.gov/hydrogenandfuelcells/pdfs/46674.pdf>.



Technoeconomic Analysis of Photoelectrochemical (PEC) Hydrogen Production is an evaluation of several postulated configurations of PEC hydrogen production systems. It documents the engineering and cost characteristics of four PEC hydrogen production systems representing potential future systems and includes the basic science of the technology; the engineering designs for H₂ production, purification and compression; system capital costs and hydrogen production costs. The document is available at:

http://www1.eere.energy.gov/hydrogenandfuelcells/pdfs/pec_techoeconomic_analysis.pdf



Lifecycle Cost Analysis of Hydrogen versus other Technologies for Electrical Energy Storage compares strategies proposed for integrating large amounts of renewable energy by using energy storage to absorb excess electricity-generating capacity during low demand and/or high rates of generation and then reconverting this stored energy into electricity during periods of high demand and/or low renewable generation. This analysis develops a cost survey of the most promising energy storage technologies and compared them against several configurations using hydrogen as the energy carrier. The document is available at:

<http://www1.eere.energy.gov/hydrogenandfuelcells/pdfs/46719.pdf>.



Current (2009) State-of-the-Art Hydrogen Production Cost Estimate Using Water Electrolysis documents the consensus technical conclusion from a panel of independent industry experts of the estimated current (2009) state-of-the-art cost of producing hydrogen from both alkaline and PEM water electrolyzers for distributed and central production. The document is available at:

<http://www.hydrogen.energy.gov/pdfs/46676.pdf>

2009 FreedomCAR and Fuel Partnership Highlight

Scale-up of Hydrogen Transport Membranes for IGCC and FutureGen Plants

Eltron Research & Development, Inc.

Eltron Research and Development, Inc. (Eltron) developed a Hydrogen Transport Membrane (HTM) that shows potential to lower the cost of electricity, increase efficiency and capture more carbon dioxide (CO₂) from coal-fired integrated gasification combined cycle (IGCC) plants compared to conventional technology. The technology presents the added advantage of allowing CO₂ to be separated at high pressures offering ease of storage.

Eltron's HTM technology uses composite metal alloys or cermet (ceramic/metallic) materials for separating hydrogen (H₂) from coal-derived shifted synthesis gas. Eltron's Phase I accomplishments include:

- Achievement of DOE 2010 hydrogen separation flux targets, sulfur tolerance (20 ppm), predicted economic life, operating conditions and product purity in bench-scale tests (1.5 lbs/day) using engineered HTM materials. Separation flux results have been independently verified by the National Energy Technology Laboratory;
- Hydrogen recovery rate of 90 percent with essentially 100 percent H₂ purity, while simultaneously enabling 90-95 percent CO₂ capture at high pressure, minimizing CO₂ compressions costs;
- Capability to withstand high differential pressures of up to 1,000 pounds per square inch gauge without structural failure, allowing for successful integration into advanced high pressure coal gasification plants, in addition to being compatible with commercial gas clean-up technology.

Phase II plans include proceeding with the scale-up of the HTM module involving design, construction, and performance evaluation of a 100-200-lb/day process development unit (PDU) in order to validate the concept.



Figure 1: 1.5 lbs/day hydrogen separation test unit

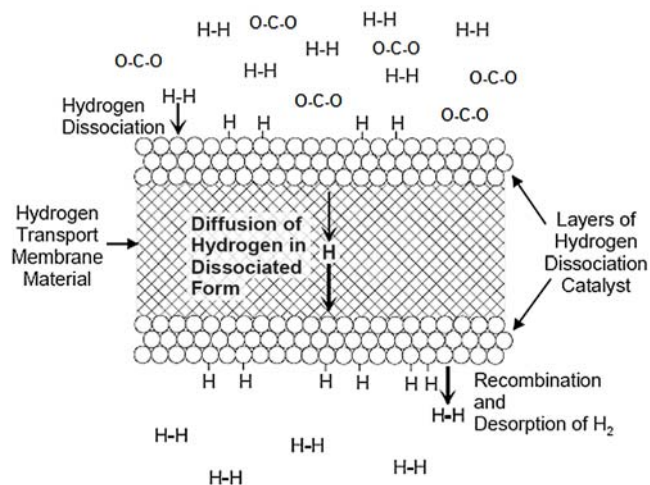

Figure 2: Design concept of the hydrogen transport membrane

2009 FreedomCAR and Fuel Partnership Highlight

Separation Distances – Code Unification

Sandia National Laboratories

Sandia National Laboratories' (Sandia) science-based, risk-informed approach to specifying separation distances has been utilized to develop a new separation distance table for bulk gaseous hydrogen storage in National Fire Protection Association (NFPA) 55 and 2. The purpose of NFPA code will be to provide fundamental safeguards for the generation, installation, storage, piping, use and handling of hydrogen in compressed gas or cryogenic liquid form. As a result of further advocacy by the Sandia team, this table was recently approved for incorporation into NFPA 52. The new table appeared in print in the 2010 versions of NFPA 55 and 52 and includes a 50 percent reduction in safety distances for a two-hour fire barrier wall, based on Sandia research.

Code language was also submitted to the International Code Council (ICC) to have the International Fire Code (IFC) reference the new NFPA 55 table for bulk gaseous hydrogen separation distances. This code language was approved at the ICC meeting in Baltimore October 24 – November 11, 2009.

In addition, the Sandia team has been successful in advocating the adoption of its hazard models and the framework of its risk assessment approach in the International Standards Organization (ISO) TC 197 Working Group efforts.

Sandia's approach to developing separation distances has been documented in a Sandia Report¹ and provides an example for future risk-informed code development efforts. The report discusses Sandia's interaction with NFPA 55 and NFPA 2 Task Group 6 for the leak frequency and quantitative risk analysis as well as the experimentally verified science-based hazard models used to create the new separation distance table.

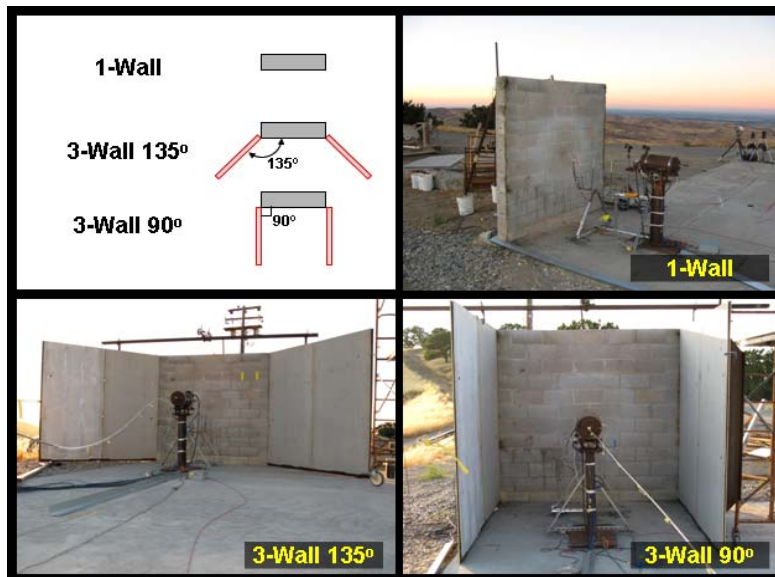

Barrier wall configurations utilized for risk analysis experiments

¹ Jeff LaChance, William Houf, Bobby Middleton, and Larry Fluer, "Analyses to Support Development of Risk-Informed Separation Distances for Hydrogen Codes and Standards," Sandia Report SAND2009-0874, March 2009.

2009 FreedomCAR and Fuel Partnership Highlight

NFPA 2 Hydrogen Technologies Code

National Renewable Energy Laboratory, Sandia National Laboratories,
Los Alamos National Laboratory

A major accomplishment in 2009 was the development of the National Fire Protection Association (NFPA) 2 Hydrogen Technologies Code document—a consolidation and expansion of all existing NFPA code and standard requirements that address hydrogen technology applications. It is the first comprehensive hydrogen technologies code in the United States. It will address infrastructure, including infrastructure to support vehicles, as well all other stationary and portable hydrogen technology applications.

NFPA 2 Hydrogen Technologies Code will simplify the project development process and code compliance process by making all hydrogen codes and standards requirements available in a single document.

DOE has supported the development of NFPA 2 in several ways. The National Renewable Energy Laboratory representatives have acted as principal members on the NFPA Hydrogen Technologies Technical Committee and have led task groups working on the development of the draft NFPA 2. Sandia and Los Alamos National Laboratory representatives have provided technical data and performed the analyses required to incorporate risk-informed requirements in the NFPA 2 document.

In March 2009, the NFPA issued the final draft of NFPA 2 Hydrogen Technologies Code soliciting public proposals. The NFPA Hydrogen Technology Technical Committee reviewed proposals and will issue an official Report in December 2009. A final document is anticipated in January 2011.

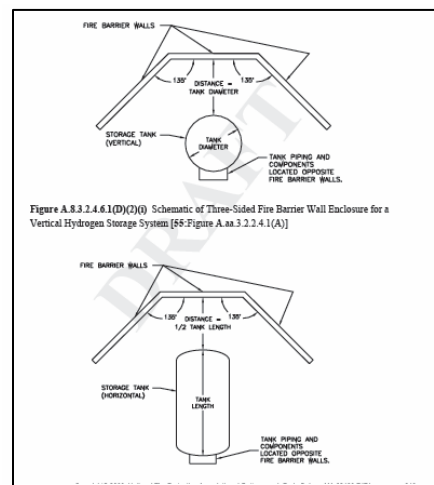
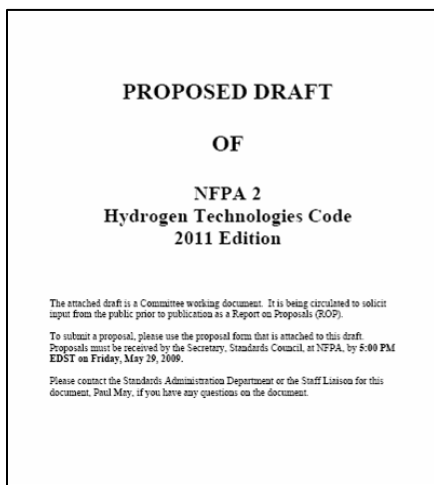

Images from the Draft NFPA 2: Hydrogen Technologies Code 2011 Edition

2009 FreedomCAR and Fuel Partnership Highlight

Alane Regenerated at Low Pressure

Brookhaven National Laboratory, Savannah River National Laboratory

Alane, or aluminum hydride (AlH_3), holds 10% hydrogen by weight and twice the density of liquid hydrogen by volume and releases hydrogen at near fuel cell temperature, but it cannot be regenerated by the simple application of moderate hydrogen pressure. Previous work has shown that $>7,000$ atmospheres of pressure is required. From the perspective of using alane to store hydrogen on vehicles, this is not an economically viable method to regenerate the used alane. Researchers at Brookhaven and Savannah River National Laboratories (BNL and SRNL, respectively) have pioneered two processes for regenerating alane using chemical and electrochemical methods instead of high pressure.

The electrochemical method developed at SRNL regenerates alane directly using a non-aqueous electrolyte, hydrogen and electric voltage at ambient pressure conditions. Key to this process was use of sodium alanate (NaAlH_4) or a similar salt in the electrolyte. Electrical efficiencies of 75% appear to be possible for this step of recycling alane. Multi-gram scale regeneration of high-quality alane has been demonstrated. An analogous process may function to regenerate other complex hydrides.

In the chemical approach from BNL, the formation of alane is made more favorable by the addition of ligands – neighboring molecules that surround and stabilize alane as it forms. Several amine-based systems were developed to regenerate alane at relatively low energy input. The team's calculations identified several stabilizing compounds. The most promising of these were tested experimentally and several were found to be viable. In one implementation, the hydrogen in the alane-ligand complex can be removed directly by heating. In others, the ligand can be exchanged with another ligand, which itself is easy to remove. In this case reformed alane is left in pure form.

For the future, both teams are working on lowering the cost and energy of recycling alane by improving the regeneration system and minimizing the number of operations required.

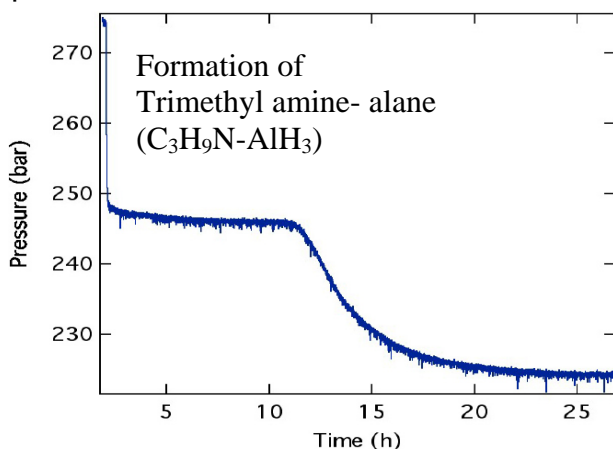

Figure 1: In the presence of trimethyl amine, spent alane absorbs hydrogen at moderate pressure in two steps, one very fast and the second significantly slower



Figure 2: Formation of grams of alane-ligand complex in an electrochemical cell

2009 FreedomCAR and Fuel Partnership Highlight

Low Cost Pathway to Production and Regeneration of Ammonia Borane

The Dow Chemical Company

Ammonia Borane (AB), NH_3BH_3 , is a unique hydrogen storage material with high hydrogen content (approximately 18 weight % and 96 g-H₂/L by volume on a material basis) and favorable operating temperatures. However, it is not possible to directly rehydrogenate the spent fuel, thus off-board chemical processing is required. Cost effective AB regeneration, as well as initial AB production, are key to the application of AB as an on-board hydrogen storage material.

The Dow Chemical Company (Dow Chemical), a member of the DOE Chemical Hydrogen Storage Center of Excellence, conducted detailed engineering and cost analyses for AB regeneration and first fill. The cost analyses identified dominating cost factors and helped the Center partners to identify areas where improvements will provide the most benefits. The AB regeneration cost analysis was based on the thiol digestion scheme from Los Alamos National Laboratory (LANL), and the AB regeneration cost was estimated at \$7-8/kg H₂, compared with the DOE 2010/2015 target of \$2-3/gge. High mass flow and separation requirements dominate capital and utility costs, accounting for 75% of the total regeneration costs (Figure 1). As a result, LANL re-evaluated its AB regeneration approach and developed a simpler scheme where separation steps were reduced. Optimizing the reaction yields and conditions remain a challenge. Also, a preliminary AB first fill cost analysis (Figure 2) indicates that raw materials are 80% of the cost using Purdue's ammonium formate metathesis process. Assuming \$5/kg NaBH₄ starting material, first fill production cost is estimated at \$9/kg AB. The current DOE 2010 storage system cost target might be met if the raw material cost can be reduced. Dow Chemical continues to work on alternative low cost NaBH₄ production since it is a starting material for AB and other boron-based fuels including several metal hydride materials.

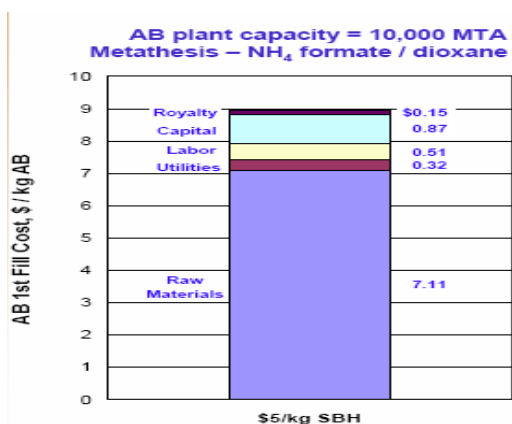

Figure 1: Capital and utility dominate AB regeneration costs

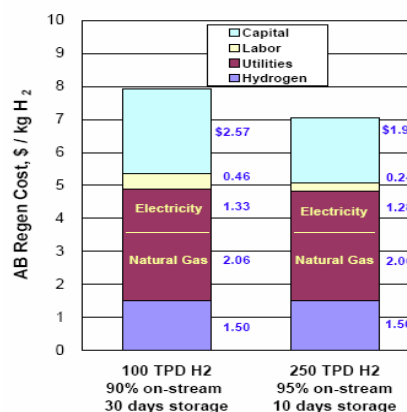

Figure 2: NaBH₄/raw material dominate AB first fill costs

2009 FreedomCAR and Fuel Partnership Highlight

Characterization of Hydrogen Adsorption by NMR

University of North Carolina at Chapel Hill

Proton Nuclear Magnetic Resonance (NMR) measures hydrogen content and provides a microscopic picture of adsorbed hydrogen that complements macroscopic techniques. NMR serves as a useful tool for optimizing synthesis and processing conditions. Researchers at the University of North Carolina (UNC) developed a quantitative and selective NMR method for measuring hydrogen adsorption capacity at pressures from 0.001 to 100 atm and temperatures between 77 K and ambient. NMR can also provide microscopic structure information, such as pore dimensions, and establishes correlations between structure and hydrogen adsorption. This provides useful insights for researchers to design and fine tune materials.

In 2009, UNC examined three types of materials: doubly interpenetrated Zn-Metal Organic Frameworks (MOFs), activated Polyether Ether Ketone (PEEK) and Carbon Nanohorns (CNH). UNC concluded that hydrogen is strongly bound to the MOF with high capacity (approximately 6 wt% at 100 K and 100 atm H₂ pressure). Based on recently developed porosymmetry methodology, NMR is also used to evaluate the impact of treatment methods on the pore structure in PEEK carbons and carbon nanohorns. The team is investigating boron substituted carbon-based materials, nanostructured polymers, and correlating NMR porosity measurements with CO₂ isotherm results.

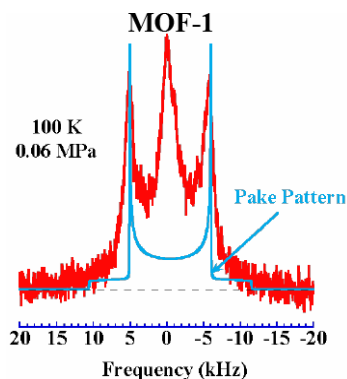

Figure 1: The central peak is associated with H₂ molecules in the void space. The double “horned” Pake pattern reflects averaged intramolecular dipolar interaction or binding energy.

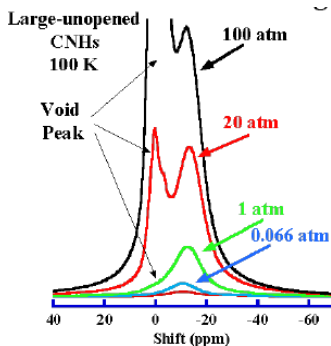

Figure 2: Proton NMR spectra illustrating hydrogen permeating into samples of large CNHs (the baseline to compare to Figure 3). H₂ adsorbs in the interstitial pores that are narrow enough to accommodate adsorbed H₂ only.

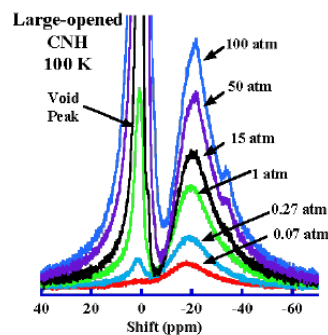

Figure 3: Proton NMR spectra of large-opened treated (oxidized) CNHs. The line associated with confined H₂ is shifted upfield. The oxidation created holes in walls of the CNH. The H₂ can now exchange between the interstitial and endohedral spaces.

2009 FreedomCAR and Fuel Partnership Highlight

Chemical Hydrogen Storage Center of Excellence Progress in Amino Borohydrides

Various physical forms of Amino Borohydrides (AB) have been studied as hydrogen storage media. Some of these have demonstrated the potential to meet DOE weight and volume density targets, operating temperature and release kinetics. The team made important advances including improved hydrogen release kinetics and the discovery of a potentially higher efficiency and lower cost off-board regeneration scheme.

In the improvement of kinetics, heterogeneous catalysts have been shown to effectively increase the hydrogen release rate of AB at temperatures below 100 °C (desirable for automotive operation). Previously the team demonstrated 10 wt. % hydrogen release in 30 min. at 70 °C using a platinum catalyst. This year the team used more affordable transition metal catalysts (Ti through Zn) to achieve rapid hydrogen release rates. These new results suggest the potential to exceed DOE's hydrogen release target of 0.02 (g/s)/kW but at much lower costs. The relative improvements in AB release kinetics are represented graphically in Figure 1. The graph shows that the release rates have improved by more than two orders of magnitude since 2006.

Another critical issue towards the successful implementation of AB as a hydrogen storage material is the development of an efficient and cost-effective off-board regeneration process. Based on detailed engineering and cost analyses, researchers have focused on developing simplified regeneration schemes with reduced mass flow and separation requirements. Most recently, the team developed a new regeneration scheme using hydrazine as both a digesting and reducing agent. This process consolidates the regeneration to two steps with lower costs.

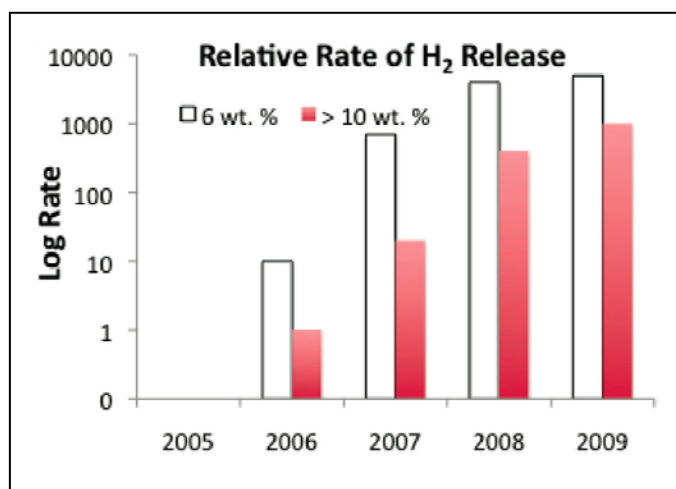

Figure 1: Hydrogen release rates from ammonia borane have been improved 100 -1,000 fold from the first formulations in 2006

2009 FreedomCAR and Fuel Partnership Highlight

Best Practices for Characterizing Hydrogen Storage Properties of Materials

Hydrogen Technology Consulting LLC

There is a need for common metrics and best practices when measuring hydrogen storage properties of new materials under development. Best practices aid in the design and synthesis of hydrogen storage materials that meet or exceed the DOE goals for practical hydrogen utilization. Trusted results are critical for comparison of novel storage materials both within the U.S. program as well as to international materials developments.

To this end, a best practices reference document has been formulated to detail the recommended procedures and limitations in making critical performance measurements on hydrogen storage materials. This reference document serves as a resource to improve the accuracy and efficiency of data collection. Such measurements are central to evaluating various materials systems against the technical storage targets. Each technical section of the document establishes clear definitions and methodologies for precise determinations of storage properties and introduces and provides solutions or guidelines for commonly encountered issues. All information is externally reviewed by several diverse experts representing each of the three primary materials class (i.e. metal hydrides, sorbents and chemical hydrides). A prime best practices example is the clear definition of different physisorption capacity terms and an explanation of the observed drop in excess capacity with increasing pressure (See Figure). The current Best Practices document may be downloaded at:

http://www1.eere.energy.gov/hydrogenandfuelcells/pdfs/bestpractices_h2_storage_materials.pdf

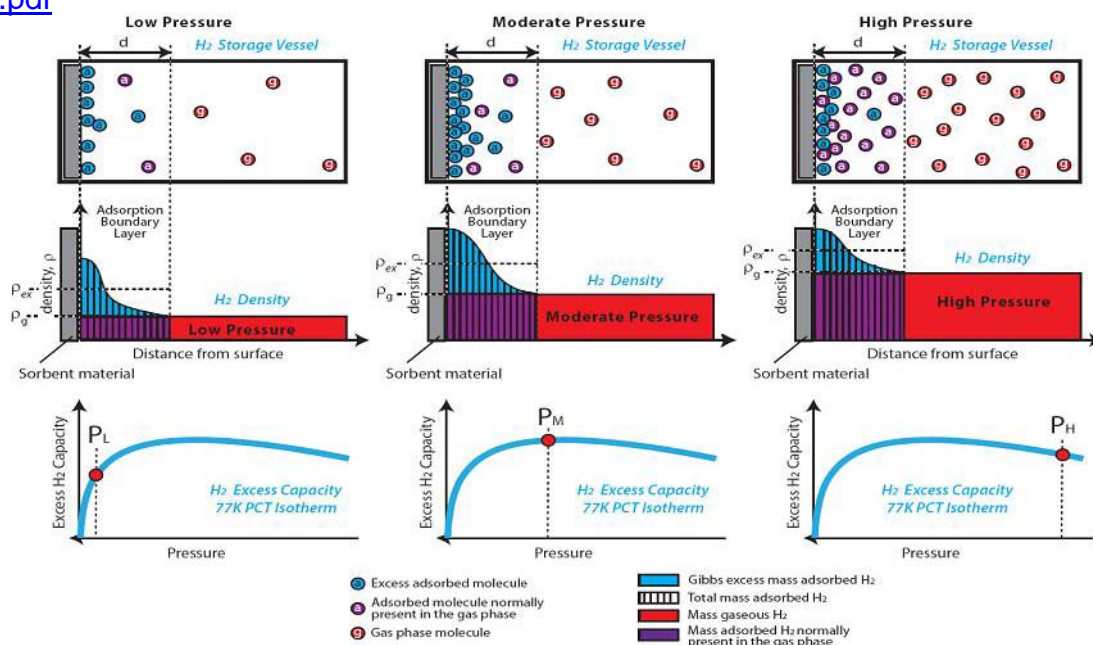

Figure 1: Explanation of excess capacity for hydrogen sorbents

2009 FreedomCAR and Fuel Partnership Highlight

Neutron Characterization of Hydrogen Storage Materials

National Institute of Standards and Technology (NIST)

The NIST team has provided critical support to the Metal Hydride and Hydrogen Sorption Centers of Excellence in the development of hydrogen storage materials through state-of-the-art neutron characterizations. Neutron techniques, such as neutron diffraction and Prompt Gamma Activation Analysis (PGAA), are particularly useful because they determine the environment, position and quantity of hydrogen in solid materials. Furthermore, the use of such methods as Neutron Vibrational Spectroscopy (NVS) provides insight into the chemical state of the hydrogen.

In collaboration with the Metal Hydride Center, the structures of $\text{Li}_2\text{B}_{12}\text{H}_{12}$, $\text{Na}_2\text{B}_{12}\text{H}_{12}$ and $\text{CaB}_{12}\text{H}_{12}$ were determined using a combination of computational and experimental methods. These materials are critical intermediates in borohydride decomposition (commonly investigated storage materials). A similar combined analysis approach was also used to characterize a novel hydride material, $\text{Ca}(\text{AlH}_4)(\text{BH}_4)$. NVS and PGAA were used to study aerogel scaffolds with and without borohydride impregnation. These measurements provided important information on the presence of hydrogen and its interaction with the scaffold material.

In collaboration with the Hydrogen Sorption Center, neutron characterization methods were used to determine the structures and hydrogen locations in advanced metal organic frameworks. These characterization techniques demonstrated that hydrogen spillover is not important in platinum-nanohorn structures.

The NIST team demonstrated a unique neutron imaging application that can assist in the development of solid state hydrogen storage beds. The spatial dependence of hydrogen release can be imaged in real time by sequential loading of both hydrogen and deuterium isotopes, an example is shown in Figure 1. The progression of hydrogen release or loading can be observed along the tube's axis.

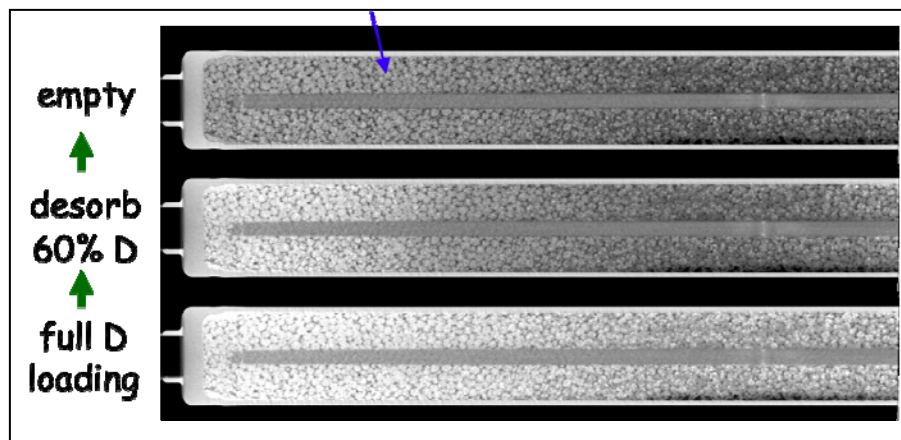

Figure 1: Neutron imaging of a $\text{LaNi}_{4.78}\text{Sn}_{0.22}$ hydride bed with 10% Al foam loaded with deuterium

2009 FreedomCAR and Fuel Partnership Highlight

Development of Metal Hydrides for Reversible On-Board Hydrogen Storage

Sandia National Laboratories

Complex Metal Hydrides (MH) have received considerable attention for hydrogen storage stemming from their high hydrogen content as well as their potential for reversible hydrogen uptake and release. While these properties are desirable for on-board supply of hydrogen fuel, the rate (kinetics) of hydrogen release (or uptake) is often too slow and/or energy requirements (thermodynamics) dictate excessively high hydrogen release temperatures. Various approaches for improving the thermodynamic and/or kinetic properties of complex hydrides have been used. However, the search for an effective MH composition that simultaneously meets all requirements remains a challenge.

A novel method enabling the discovery of new complex MHs relies on an efficient method of rapidly screening through a vast possibility of compositions. The collaborative team at Sandia National Laboratories (SNL), leading the Metal Hydride Center of Excellence (MHCoe), has expanded its unique discovery-based approach involving theory-directed synthesis and characterization (Figure 1). In particular, the team has recently extended the use of predictive calculations for both the identification of new MH structures and accurate characterization of thermodynamics and reaction pathways. These modeling efforts have helped to guide and streamline experimental activities, focusing on those which are most promising. Three recent accomplishments highlight this combined experimental-computational effort. First, new low-temperature alkali-transition metal borohydrides have been identified via modeling and were subsequently synthesized. Second, previously unknown borohydride reaction intermediates (B_nH_m species) have been discovered experimentally and their importance explained by modeling. Third, experimental research on $Ca(BH_4)_2$ has been discontinued based on identification of the irreversible B_nH_m intermediate phase (Figure 2).

While this modeling-driven method has proven useful for directing research, the ultimate discovery of an effective MH material remains to be accomplished. Expansion of this effort to include effective computational screens for catalysts to address the often poor MH kinetics will strengthen the MHCoe's effort.

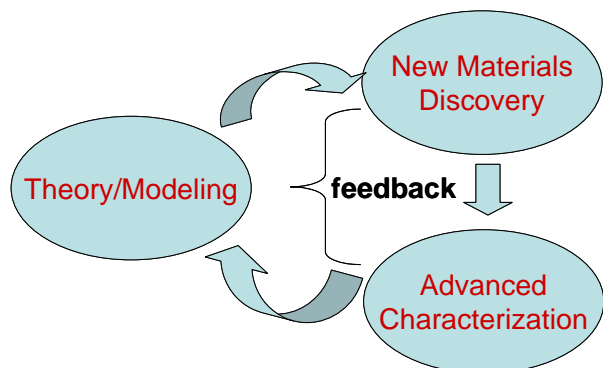

Figure 1: SNL's iterative approach for new materials discovery

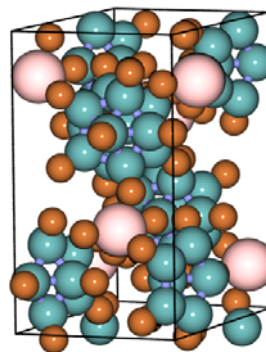

Figure 2: Theory predicted and validated structure of $Ca[B_{12}H_{12}]$

2009 FreedomCAR and Fuel Partnership Highlight

Robust Computational Methods to Predict Metal Hydrides for Reversible Hydrogen Storage

University of Pittsburgh, Georgia Institute of Technology

Metal Hydrides (MH) capable of reversibly uptaking and releasing large quantities of hydrogen are highly desirable for on-board hydrogen storage. While many MH materials are known, none currently has the right mix of properties for practical use; thus the search for new metal hydrides with the right properties is an area of extensive research and development. One of the key properties in determining the practicality of a MH material is the temperature required for hydrogen uptake and release. The temperature is related to the thermodynamics of the hydrogen uptake and release reactions and has traditionally been determined through experimental work.

In support of efforts through the DOE Hydrogen Storage Metal Hydride Center of Excellence (MHCoE), researchers at the University of Pittsburgh and Georgia Institute of Technology have jointly developed a novel computational method to rapidly screen MH materials and mixtures of MH materials and predict their hydrogen uptake and release thermodynamics. This approach allows identification of MH materials and their combinations with the most promise to meet the hydrogen storage goals. To this end, researchers have efficiently screened over 20 million discreet combinations of lightweight elements to identify the MH materials and combinations predicted to have the appropriate thermodynamics – narrowing the potential list from millions to a few tens to hundreds of MH materials.

While the initial screening and identification of promising MH materials have allowed the MHCoE experimentalists to focus their research efforts, the University of Pittsburgh and Georgia Tech researchers continue to improve their methodology. For instance, their approach is based on first principles Density Functional Theory (DFT), requiring knowledge of the material's solid state crystal structure, which is not always known. Collaborating with researchers at Sandia National Laboratory and the University of Missouri-St. Louis, they have included use of novel methods to predict the ground state structure of materials. They are also working to expand the methodology to include gas phase reactants, such as ammonia, diborane and hydrocarbons. Further improvements identified include effective computational screening for catalysts to address the often poor MH uptake and release kinetics.

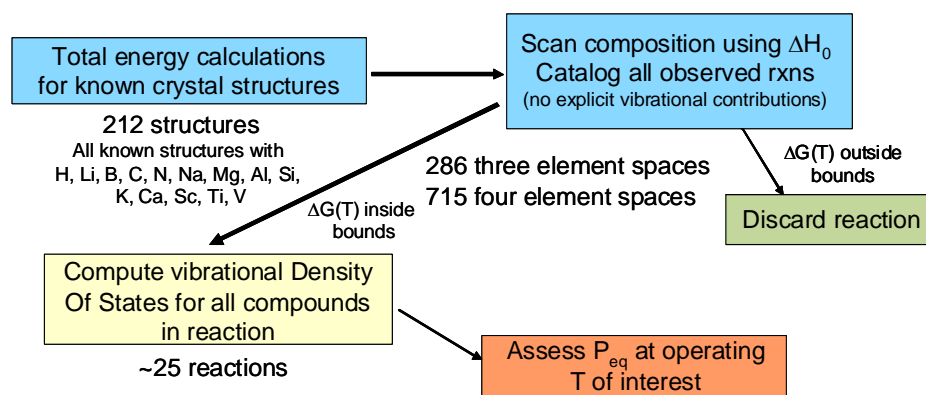

Figure 1: SNL's iterative approach for new materials discovery

2009 FreedomCAR and Fuel Partnership Highlight

Hydrogen Storage Media through Nanostructured Polymeric Materials

Argonne National Laboratory, University of Chicago

Nanostructured polymers are a class of adsorbents that have potential to meet the DOE system performance and cost targets. Researchers from Argonne National Laboratory (ANL) and the University of Chicago focused on improving hydrogen capacity and operating temperature by enhancing Specific Surface Area (SSA, e.g. m^2/g), pore size distribution and heat of adsorption through rational design and synthesis, guided by computational modeling and advanced characterization.

In 2009, the team synthesized and characterized over 50 different structures in three classes of polymers (Figure 1). These polymers exhibit SSAs as high as $1900 \text{ m}^2/\text{g}$ and tunable pore sizes from 0.6 to 0.9 nm. The team also achieved an excess hydrogen uptake of 5 wt% at 77K (at 40 bar), a 150% improvement over 2008 results. Compared with other adsorbents, polymers have excellent thermal stability and tolerance to gas contaminants such as moisture. Polymers also have unique chemical and physical properties that allow them to maintain SSA during pelletization for better volumetric storage capacity (Figure 2). Furthermore, they can be produced at a commercial scale with the existing industrial infrastructure. The future effort will attempt to improve the hydrogen-adsorbent interaction through pore size control and optimization. The team is also exploring new synthesis methods for metal-containing polymers to further enhance the heat of adsorption of hydrogen.

Polymer Structures

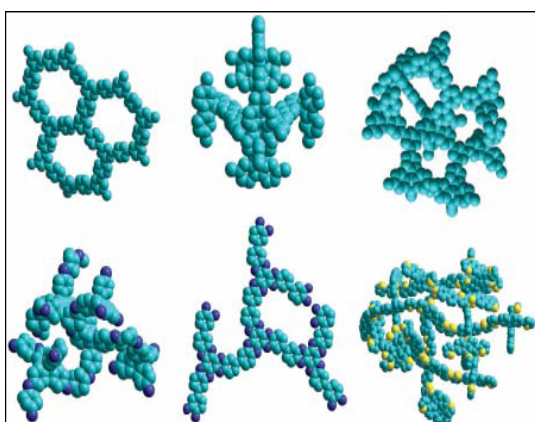

Figure 1: 3-D Structures of Selected Polymers Prepared by ANL and University of Chicago Team

Effects of Pelletization

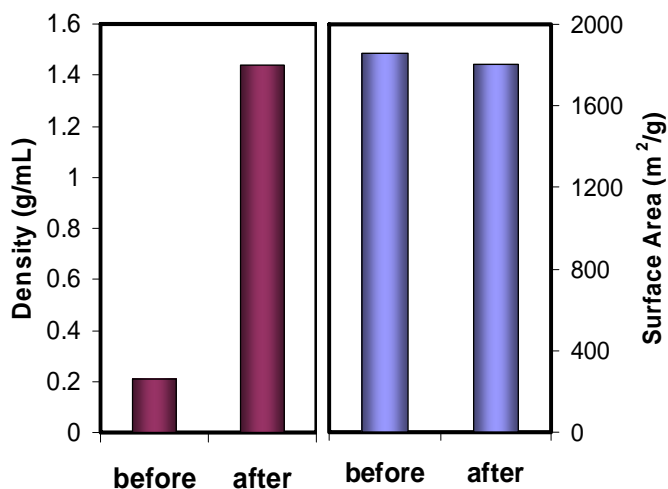

Figure 2: Compression of polymer does not cause major changes in SSA or microporosity

2009 FreedomCAR and Fuel Partnership Highlight

Fundamental Calculations to Advance Chemical Hydrogen Storage

University of Alabama

The University of Alabama has made significant advances in predicting and validating the thermodynamics of new hydrogen chemical hydride storage materials and several regeneration mechanisms. Their efforts have provided meaningful support to other projects working on similar materials. The team concentrated on the properties of ammonia borane and alane complexes with the potential for improved hydrogen release kinetics.

The University of Alabama provided technical support to the DOE Chemical Hydrogen Storage Center of Excellence (CHCoE) through computational chemistry of thermodynamics, kinetics and spectroscopic data analysis. Their efforts helped: 1) reduce design and development time for new materials; 2) predict novel hydrogen release mechanisms; and 3) design efficient fuel regeneration processes. Key issues addressed include accuracy/reliability of models for real systems, demonstration of hydrogen release reactions under expected operating conditions and improved energy balance for the release and regeneration of hydrogen storage systems.

Further studies of hydrogen release kinetics of alane in hydride regeneration schemes identified multiple transition states (see Figure 1) and new compounds based on BH_3 -imidazole structure as well as new routes to other promising storage materials such as Ammonia Borane (AB).

The team will continue to use computational chemistry to improve hydrogen release, improve regeneration of spent fuel and develop novel compounds, mechanisms and experimental pathways of new routes for AB first fill synthesis concepts.

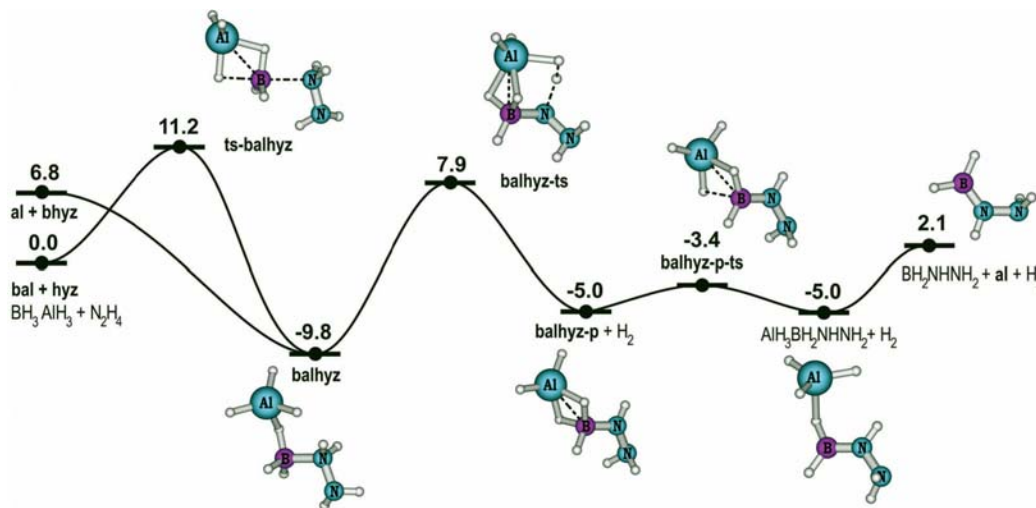

Figure 1: Calculated energy profiles showing the pathways for H₂-release from AlH₃ + BH₃ + N₂H₄

2009 FreedomCAR and Fuel Partnership Highlight

Improved Hydrogen Release from Amineborane with Additives

University of Pennsylvania

Efficient on-board storage of hydrogen requires a system that provides hydrogen at high densities by volume and weight, allows hydrogen release with modest or no energy input and uses an energy efficient and cost effective method to recharge the material back to its original state. Amineborane (AB) is a unique hydrogen storage material that provides high hydrogen content and can release hydrogen on demand at mild operating temperatures ranging from ambient to 110 °C. Unfortunately, it releases hydrogen slowly and it is difficult to regenerate spent material to re-form original AB.

Researchers at the University of Pennsylvania (in conjunction with the DOE Chemical Hydrogen Storage Center of Excellence) have significantly improved the rate and extent of hydrogen release from this material. Specifically, three principal approaches were used including (a) ionic liquids, (b) chemical promoters including base materials such as “proton sponge” and (c) metal-catalysts. These have increased the rates and extent of hydrogen release from that of pure AB. Fast hydrogen release (0.19 (g/s)/kW) and high capacity (11.4 wt% material based) were demonstrated at 110 °C with the addition of ionic liquid (Figure 1). Proton sponge and other base materials increased the release rate of the second hydrogen equivalent (release step) from AB at 85 °C. At a slightly higher temperature (95 °C), only 1% base material is needed (Figure 2). Metal catalysts also increased the rate of AB hydrogen release in ionic liquids (Figure 3).

In order to utilize AB as an on-board storage technology, it is necessary to develop a cost effective and energy efficient method to regenerate the spent material back into AB. UPenn has been working with its Center partners to further advance the development of regeneration of AB from spent fuel. The boron halide reduction step in the regeneration scheme was demonstrated to be simple, quantitative and allows the separation and recovery of all products.

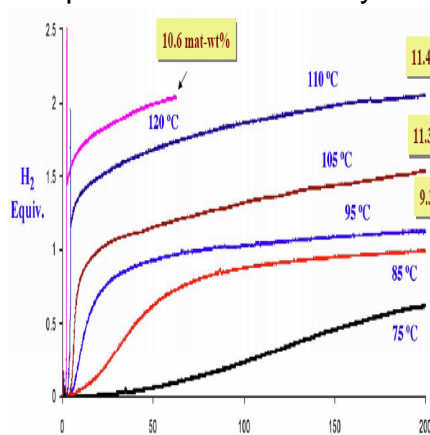

Figure 1: AB H₂ release is rapid above 95 °C in 20 wt% ionic liquid

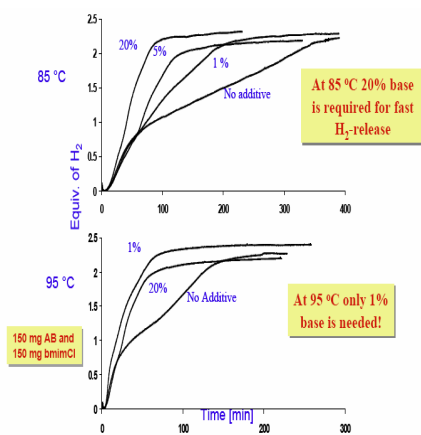

Figure 2: Less base needed at higher T

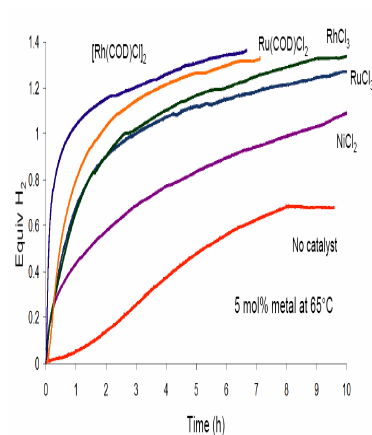

Figure 3: Metal catalysts increase the rate of AB H₂ release in ionic liquid