

NOVATEK

Advanced Drilling Systems for EGS
May 2010

Stinger Diamond

Load

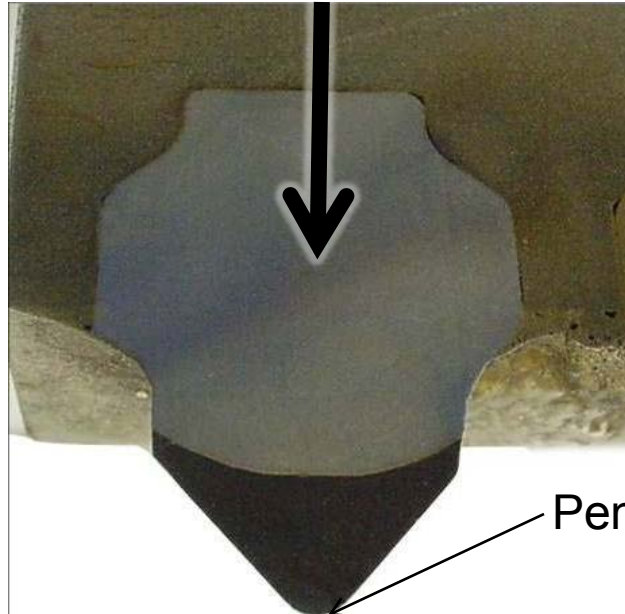

Penetrates



1st System Technology: Stinger PDC

Revolutionary Cutter

- Ultra thick diamond
- Innovative conical geometry

Value Proposition

- 10X impact strength of conventional PDC enabling cutter to drill through hard formations
- 11X abrasion resistance/wear life of conventional PDC resulting in longer bit life and less tripping
- Cutter versatility enables a multi-formation bit, drastically reducing bit models and inventory
- Presents new mode of cutting the formation that results in more coarse/larger cuttings—represents more efficient drilling
- Maintains sharper cutting structure much longer than conventional shear PDC resulting in lower ongoing bit forces while drilling

Milestones Achieved

- Performance proven in construction & mining industry for over 2 years, achieving 30X+ the wear life over conventional tungsten carbide elements
- Multiple TerraTek tests with JackStinger bits drilling under pressurized conditions across multiple formation types successfully completed
- Multiple lab tests successfully completed proving out impact and wear characteristics



Comparison Test – Wear Progression (10 pass
increments)
(50 passes @ .050" in Sierra white granite)



VTL Test Results Comparing Shear & Stinger PDC

Linear Distance Traveled (Feet) Before Failure

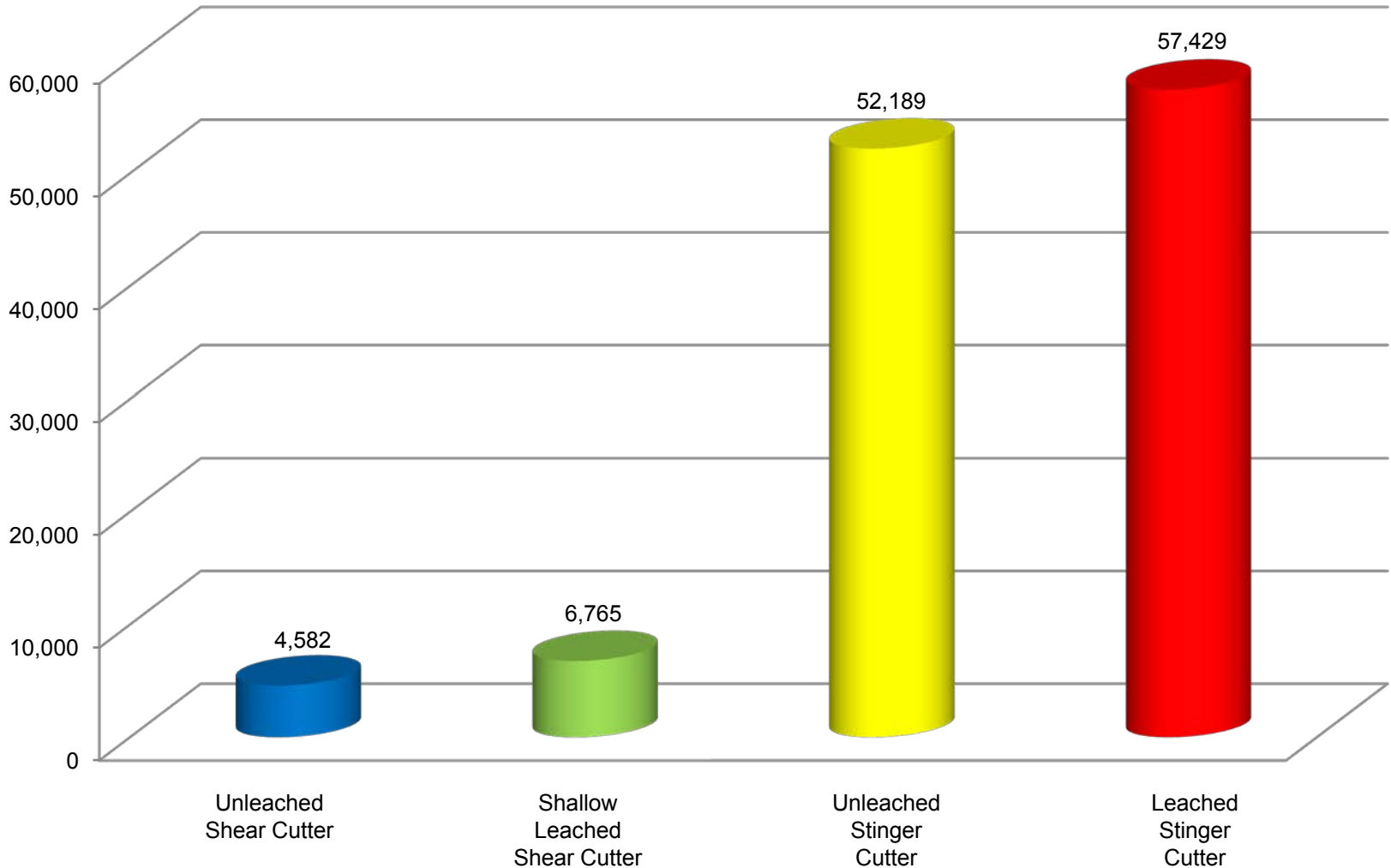

Impact Test Comparison

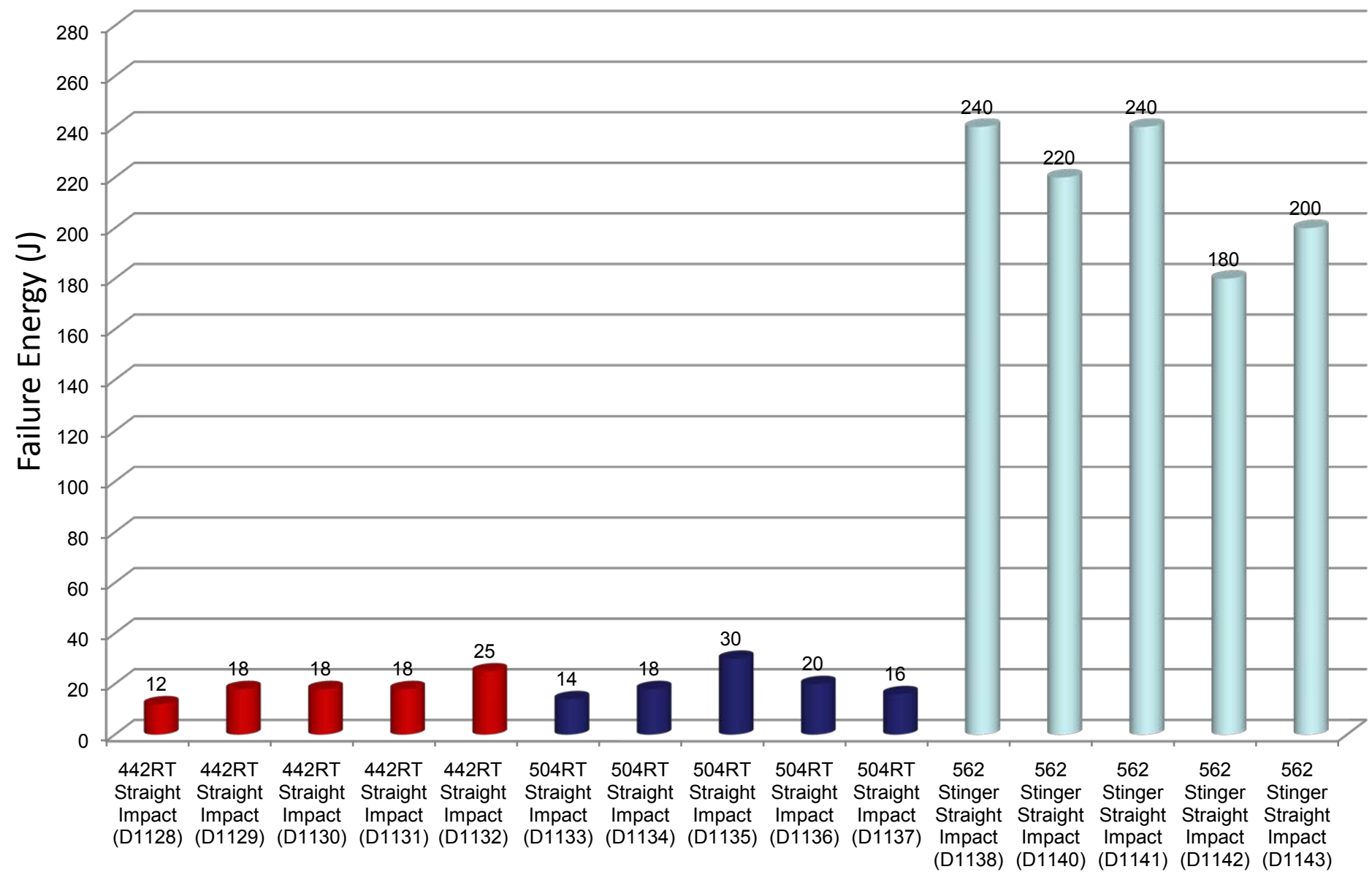

Drilling Simulation Performance – Sandstone Comparison

5000 psi Confining Pressure

JackBit 8.0 in TerraTek-Sandstone

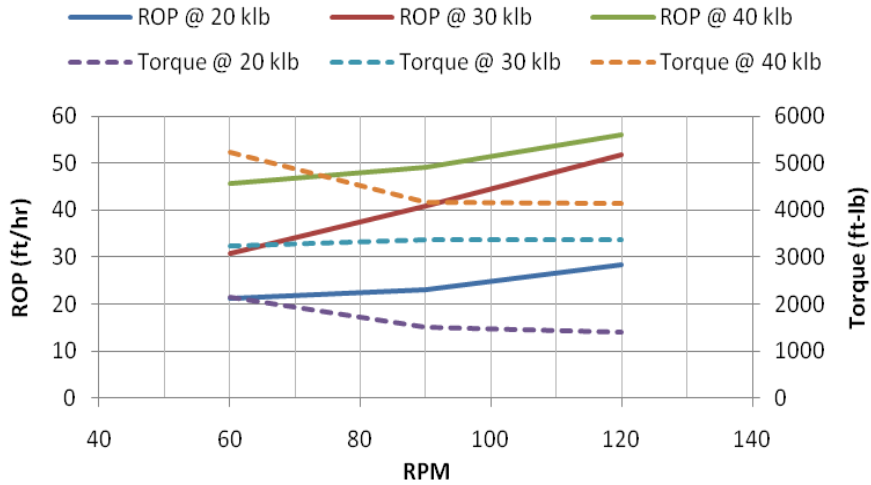

JackBit 8.1 in TerraTek-Sandstone

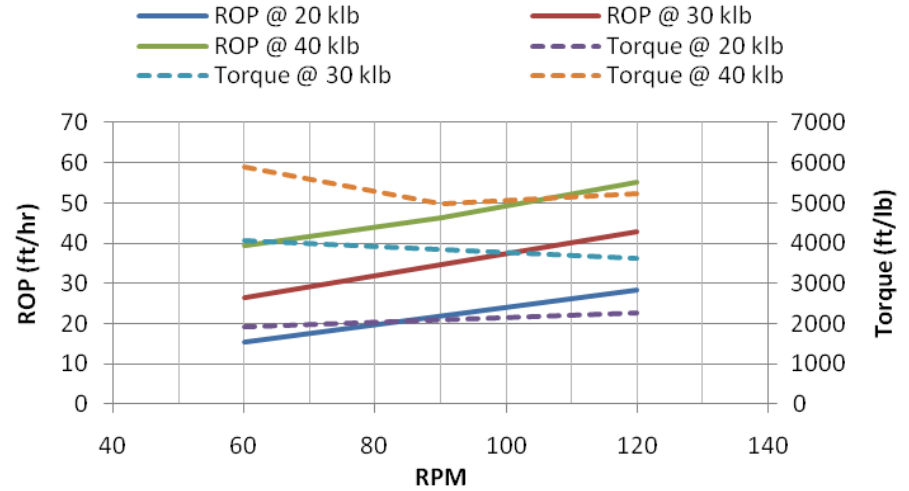

JackBit 9.0 TerraTek Sandstone

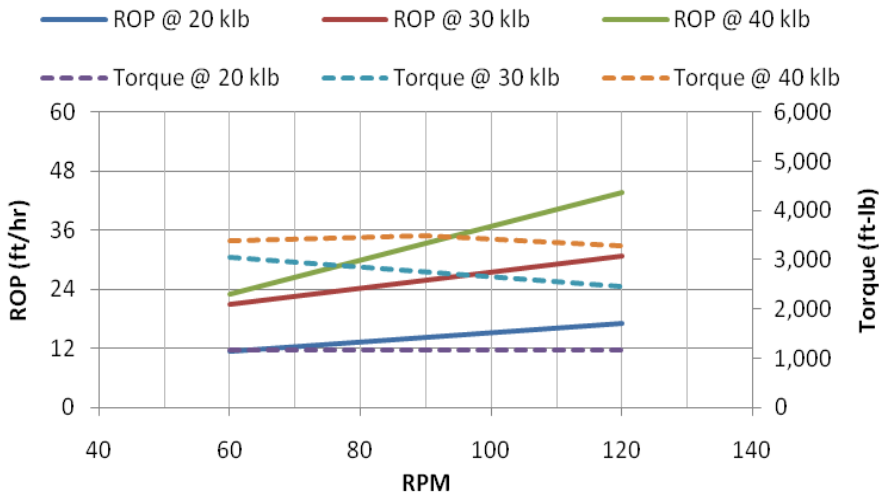

JackBit 9.1 in TerraTek-Sandstone

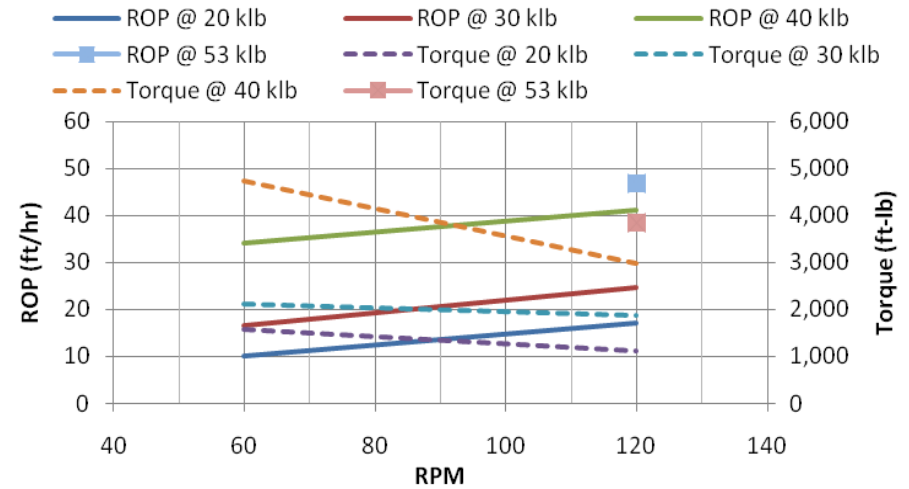

JB 8202 Field Test

Ward County, TX
March 2010



PDC Shear bit



Stinger JackBit

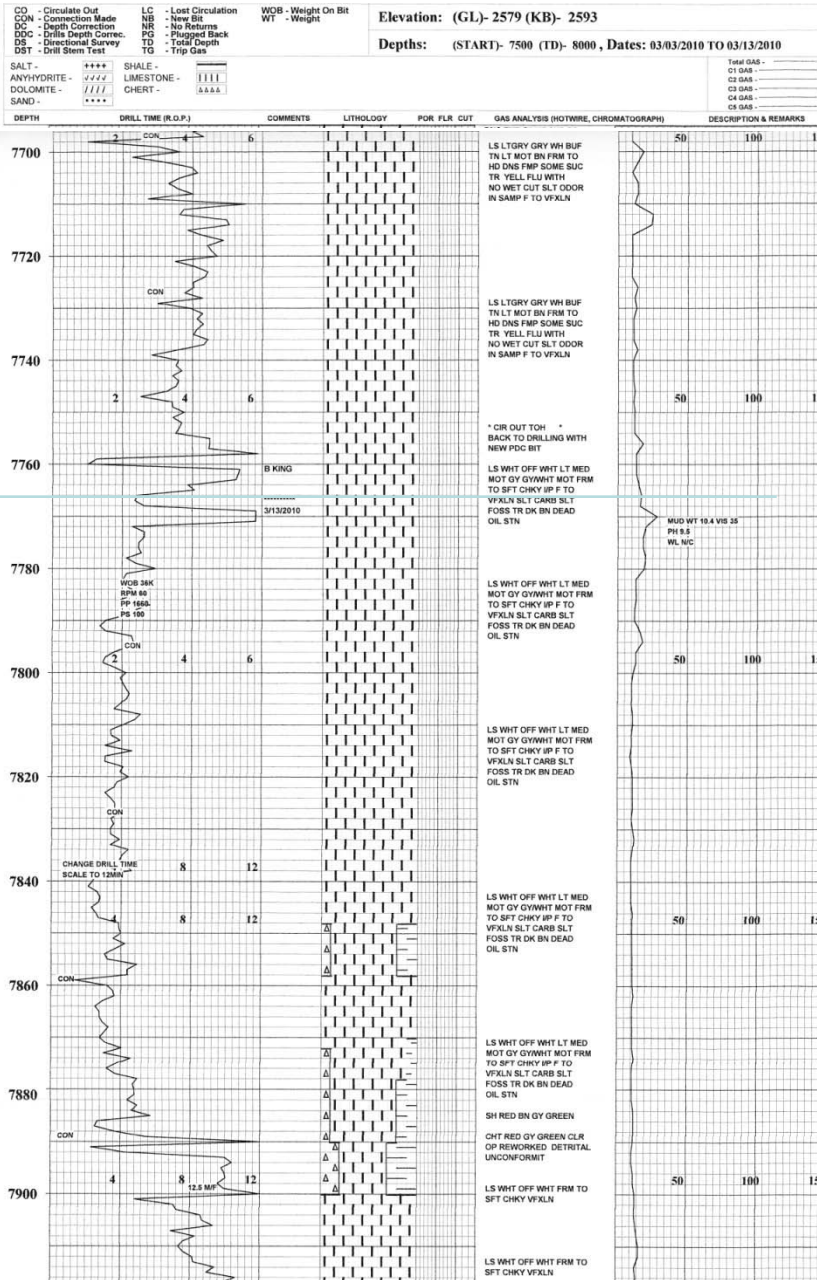

Shear PDC bit at 7740 ft,
ROP was ~22 ft /hr



Stinger bit at 7840 ft,
ROP was ~23 ft /hr



Stinger bit at 7880 ft,
ROP was ~20 ft /hr

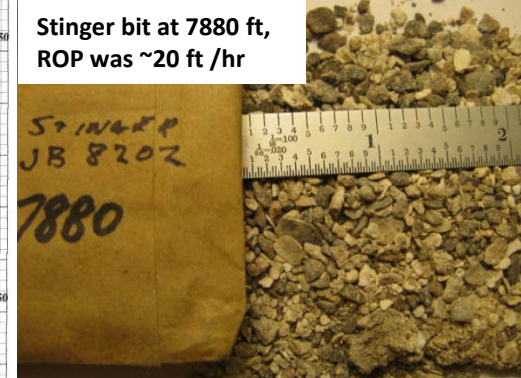

Stinger Bit Dull Report

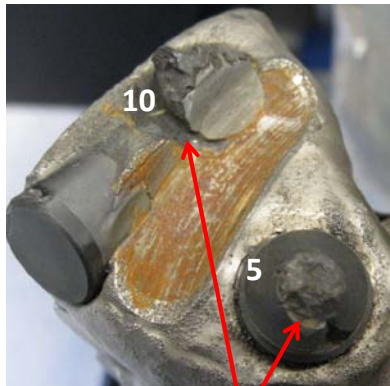

Uncharacteristically rough
PCD fracture surface

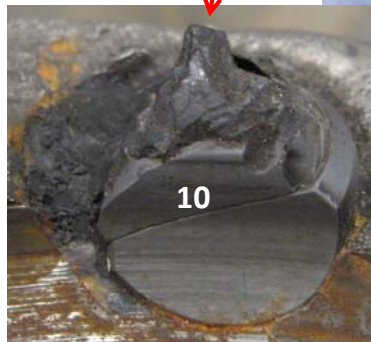

JackBit 12.01 Dull Bit Analysis

- Ring-out on Stinger 9
- Possible junk damage
- Possible thermal degradation (brazing)
- Overexposed stingers (not seated)

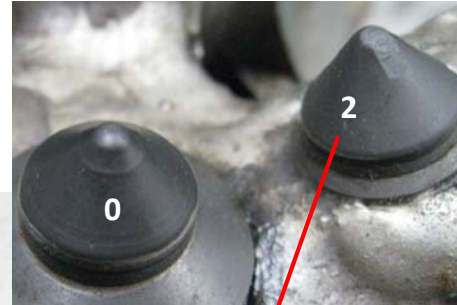

Excessive wear for interior
Stingers in 60 ft of drilling
(~23 passes on VTL)

Apparent re-melting +
peeling failure of high
temperature Braze-Bond

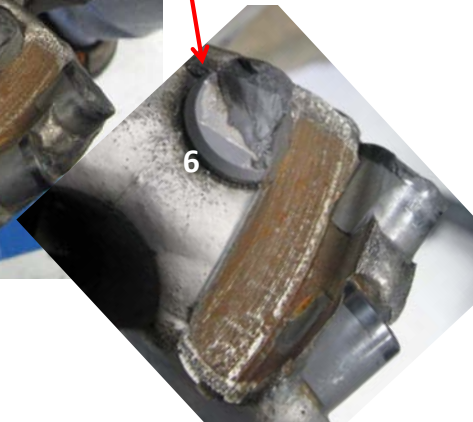

2nd System Technology: JackHammer

Elegant Hammering Device

- Flow activated hammering mass
- Very short sub connected to any modified bit
- Hammering mass hits Jack element protruding from middle of bit

Value Proposition

- Jack un-confines formation at borehole center causing formation failure
- Substantial increase in ROP
- Small sub can connect to almost any modified bit
- Relatively small hammering mass operating at optimized frequency has diminished effect on other BHA tools

Milestones Achieved & Current Status

- Generation #3 prototype built and tested
- 30%+ ROP increase achieved while drilling in cement caissons
- Generation #4 tool currently under development
- High pressure testing to occur Q4 2009
- Field testing in 2010

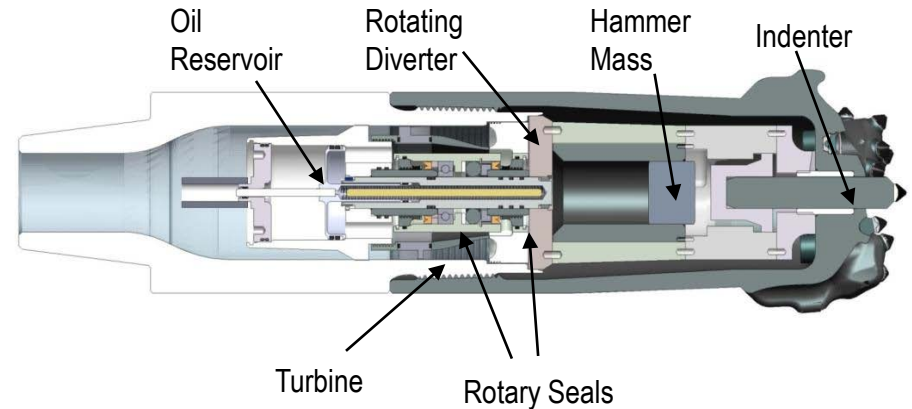

3rd System Technology: JackSteering RST

High Performance Rotary Steering Tool

- Revolutionary rotary steering tool that uses 'lead-the-bit' technology
- Both Intelliserve and mud-pulse compatible

Value Proposition

- Shorter length increases proximity of LWD tools to the drill bit
- More cost effective to build; Reduces repair and maintenance costs
- Customised low cost solution can replace conventional mud-motor / bent-sub based drilling on US land and other onshore locations

Milestones Achieved & Current Status

- JackSteering concept proven to achieve industry standard build rates
- Motor driven prototype built and tested successfully
- Turbine driven prototype built and tested successfully achieving 7.5 degree build per 100ft.
- Field tests planned for Q3 2010

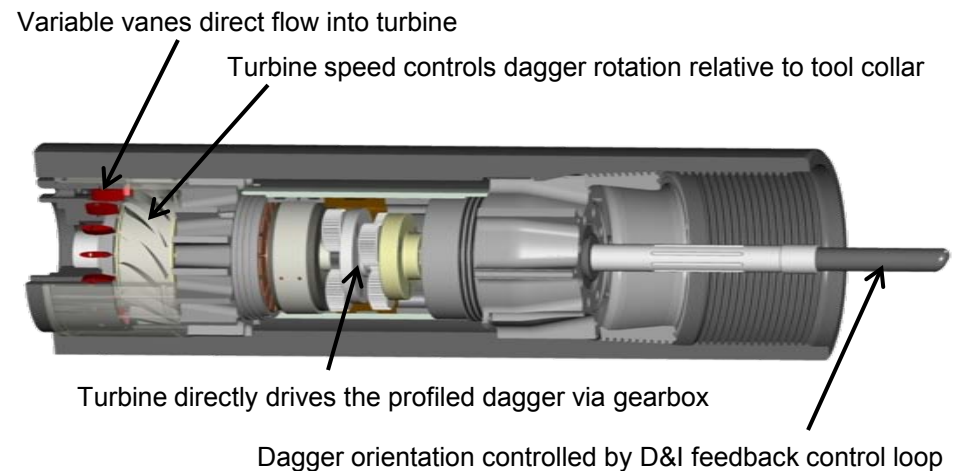
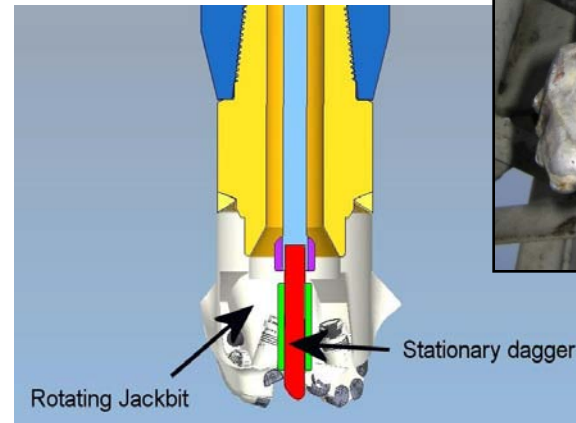

Novatek Flow Test Facility



Horizontal Drill Test Facility

