

# Mass Production Cost Estimation of Direct H<sub>2</sub> PEM Fuel Cell Systems for Transportation Applications: 2018 Update

December 2018

Prepared By:

Brian D. James

Jennie M. Huya-Kouadio

Cassidy Houchins

Daniel A. DeSantis



## Sponsorship and Acknowledgements

This material is based upon work supported by the Department of Energy under Award Number DE-EE0007600. The authors wish to thank Dr. Dimitrios Papageorgopoulos, Mr. Greg Kleen, Dr. Adria Wilson, and Dr. Simon Thompson of DOE's Office of Energy Efficiency and Renewable Energy (EERE), Fuel Cell Technologies Office (FCTO) for their technical and programmatic contributions and leadership.

## Disclaimer

This report was prepared as an account of work sponsored by an agency of the United States Government. Neither the United States Government nor any agency thereof, nor any of their employees, makes any warranty, express or implied, or assumes any legal liability or responsibility for the accuracy, completeness, or usefulness of any information, apparatus, product, or process disclosed, or represents that its use would not infringe privately owned rights. Reference herein to any specific commercial product, process, or service by trade name, trademark, manufacturer, or otherwise does not necessarily constitute or imply its endorsement, recommendation, or favoring by the United States Government or any agency thereof. The views and opinions of authors expressed herein do not necessarily state or reflect those of the United States Government or any agency thereof.

## Authors Contact Information

Strategic Analysis Inc. may be contacted at:

Strategic Analysis Inc.  
4075 Wilson Blvd, Suite 200  
Arlington VA 22203  
(703) 527-5410  
www.sainc.com

The authors may be contacted at:

Brian D. James, BJames@sainc.com, (703) 778-7114



This work is licensed under <http://creativecommons.org/licenses/by/4.0/>. Per the license, permission to use, share, or adapt contents of this report is granted as long as attribution is given to Strategic Analysis Inc.

# Table of Abbreviations

---

ANL	Argonne National Laboratory
APTA	American Public Transportation Association
atm	atmospheres
BDI	Boothroyd Dewhurst Incorporated
BOL	beginning of life
BOM	bill of materials
BOP	balance of plant
$C_{air}$	Air Management System Cost (Simplified Cost Model)
$C_{BOP}$	Additional Balance of Plant Cost (Simplified Cost Model)
CC	capital costs
CCE	catalyst coated electrode
CCM	catalyst coated membrane
CEM	integrated compressor-expander-motor unit (used for air compression and exhaust gas expansion)
$C_{Fuel}$	Fuel Management System Cost (Simplified Cost Model)
$C_{Humid}$	Humidification Management System Cost (Simplified Cost Model)
CM	compressor motor
CNG	compressed natural gas
$C_{stack}$	Total Fuel Cell Stack Cost (Simplified Cost Model)
$C_{thermal}$	Thermal Management System Cost (Simplified Cost Model)
DFMA <sup>®</sup>	design for manufacture and assembly
DOE	Department of Energy
DOT	Department of Transportation
DSM <sup>™</sup>	dimensionally stable membrane (Giner membrane support)
DTI	Directed Technologies Incorporated
EEC	electronic engine controller
EERE	DOE Office of Energy Efficiency and Renewable Energy
EOL	end of life
ePTFE	expanded polytetrafluoroethylene
EW	equivalent weight
FCT	EERE Fuel Cell Technologies Program
FCTT	Fuel Cell Technical Team
FCV	fuel cell vehicle
Ford	Ford Motor Company Inc.
FTA	Federal Transit Administration
FUDS	Federal Urban Driving Schedule
G&A	general and administrative
GDE	gas diffusion electrode

GDL	gas diffusion layer
GM	General Motors Inc.
H <sub>2</sub>	hydrogen
HFPO	hexafluoropropylene oxide
HDPE	high density polyethylene
HDV	heavy duty vehicle
HVAF	high-velocity adiabatic forming
ID	inner diameter
IR/DC	infra-red/direct-current
kN	kilo-Newtons
kW	kilowatts
kW <sub>e_net</sub>	kilowatts of net electric power
LCA	life cycle analysis
LCCA	life cycle cost analysis
LT	low temperature
MDV	medium duty vehicle
MBRC	miles between road calls
MEA	membrane electrode assembly
mgde	miles per gallon of diesel equivalent
mpgge	miles per gallon of gasoline equivalent
mph	miles per hour
NREL	National Renewable Energy Laboratory
NSTF	nano-structured thin-film (catalysts)
OD	outer diameter
ODS	optical detection system
OPCO	over-pressure, cut-off (valve)
PDF	probability distribution function
PEM	proton exchange membrane
PET	polyethylene terephthalate
Pt	platinum
PVDF	polyvinylidene fluoride
PtCo/HSC	platinum-cobalt on high surface area carbon
PtCoMn	platinum-cobalt-manganese
QC	quality control
Q/ΔT	heat duty divided by delta temperature
R&D	research and development
RFI	request for information
SA	Strategic Analysis, Inc.
TIM	traction inverter module
TVS	Twin Vortices Series (of Eaton Corp. compressors)
UTK	University of Tennessee-Knoxville
V	volt



# Foreword

---

Energy security is fundamental to the mission of the U.S. Department of Energy (DOE) and hydrogen fuel cell vehicles are part of a comprehensive portfolio of options that have the potential to reduce the need for oil and reduce emissions in the transportation sector. Fuel cell vehicles<sup>1</sup> can operate on hydrogen, which can be produced domestically, emitting fewer greenhouse gasses and pollutants than conventional technologies. Transitioning from standard internal combustion engine (ICE) vehicles to hydrogen-fueled fuel cell vehicles (FCVs) could greatly reduce greenhouse gas emissions, air pollution emissions, and ambient air pollution, especially if the hydrogen fuel is derived from wind-powered electrolysis or steam reforming of natural gas.<sup>2,3</sup> A diverse portfolio of energy sources can be used to produce hydrogen, including nuclear, coal, natural gas, geothermal, wind, hydroelectric, solar, and biomass. Thus, fuel cell vehicles offer an environmentally clean and energy-secure pathway for transportation.

This research evaluates the cost of manufacturing transportation fuel cell systems (FCSs) based on low temperature (LT) proton exchange membrane (PEM) FCS technology. Fuel cell systems will have to be cost-competitive with conventional and advanced vehicle technologies to gain the market-share required to influence the environment and reduce petroleum use. Although the DOE is currently focusing on broad applications, the program has historically focused on light duty vehicles and established detailed cost targets for automotive fuel cell systems and components to achieve parity with conventional technologies. To help achieve these cost targets, the DOE has devoted funding to analyze and track the cost of automotive fuel cell systems as progress is made in technology. The purpose of these cost analyses is to identify significant cost drivers so that R&D resources can be most effectively allocated toward cost reduction. The analyses are annually updated to track technical progress in terms of cost and to indicate how much a typical automotive fuel cell system would cost if produced in large quantities (up to 500,000 vehicles per year).

Bus and medium/heavy duty vehicle (MDV/HDV) truck applications represent another area where fuel cell systems have an opportunity to make a national impact on oil consumption and air quality. Consequently, SA began analyzing fuel cell buses in 2012 and preparing annually updated cost projections of PEM fuel cell passenger buses power systems. In 2018, SA began conducting cost analyses of fuel cell MDV truck power systems. HDV trucks may be investigated in future analyses, but the work contained in this document is specific to MDV fuel cell truck systems. Fuel cell systems for light-duty automotive, buses, and MDV/HDV trucks share many similarities and indeed may even utilize identical stack hardware. Thus the analysis of bus and MDV/HDV fuel cell power plants is a logical extension of

---

<sup>1</sup> Honda FCX Clarity fuel cell vehicle: <http://automobiles.honda.com/fcx-clarity/>; Toyota fuel cell hybrid vehicles: [http://www.toyota.com/about/environment/innovation/advanced\\_vehicle\\_technology/FCHV.html](http://www.toyota.com/about/environment/innovation/advanced_vehicle_technology/FCHV.html)

<sup>2</sup> Jacobson, M.Z., Colella, W.G., Golden, D.M. "Cleaning the Air and Improving Health with Hydrogen Fuel Cell Vehicles," *Science*, 308, 1901-05, June 2005.

<sup>3</sup> Colella, W.G., Jacobson, M.Z., Golden, D.M. "Switching to a U.S. Hydrogen Fuel Cell Vehicle Fleet: The Resultant Change in Energy Use, Emissions, and Global Warming Gases," *Journal of Power Sources*, 150, 150-181, Oct. 2005.

the light-duty automotive power system analysis. Primary differences between automotive FCVs and the buses/MDV/HDV applications include the installed power required (80 kilowatts of net electric power ( $\text{kW}_{e\_net}$ )<sup>4</sup> for automotive vs.  $\sim 160\text{kW}_{e\_net}$  for a 40 foot transit bus, and 160-360 $\text{kW}_{e\_net}$  for MDV/HDV trucks), desired power plant durability (nominally 5,000 hours lifetime for automotive vs. 25,000 hours lifetime for buses and trucks), and annual manufacturing rate (up to 500,000 systems/year for an individual top-selling automobile model vs.  $\sim 4,000$  systems/year for total transit bus sales in the U.S. and up to 250,000 systems/per year for class 8 truck sales in the U.S.).<sup>5, 6</sup> The larger size of the truck market makes it an attractive market segment for fuel cell application.

The capacity to produce fuel cell systems at high manufacturing rates does not yet exist, and significant investments will have to be made in manufacturing development and facilities in order to enable it. Once these investment decisions are made, it will take several years to develop and fabricate the necessary manufacturing facilities. Furthermore, the supply chain will need to develop, which requires negotiation between suppliers and system developers, with details rarely made public. For these reasons, the DOE has consciously decided not to analyze supply chain scenarios at this point, instead opting to concentrate its resources on solidifying the tangible core of the analysis, i.e. the manufacturing and materials costs.

The DOE uses these analyses as tools for R&D management and tracking technological progress in terms of cost. Consequently, non-technical variables are held constant to elucidate the effects of the technical variables. For example, the cost of platinum is typically held constant to insulate the study from unpredictable and erratic platinum price fluctuations. Sensitivity analyses are conducted to explore the effects of non-technical parameters.

To maximize the benefit of our work to the fuel cell community, Strategic Analysis Inc. (SA) strives to make each analysis as transparent as possible. The transparency of the assumptions and methodology serve to strengthen the validity of the analysis. We hope that these analyses have been and will continue to be valuable tools to the hydrogen and fuel cell R&D community.

---

<sup>4</sup> Unless otherwise stated, all references to vehicle power and cost ( $\$/\text{kW}$ ) are in terms of kW net electrical ( $\text{kW}_{e\_net}$ ).

<sup>5</sup> Total buses sold per year from American Public Transportation Association 2012 Public Transportation Fact Book, Appendix A Historical Tables, page 25, <http://www.apta.com/resources/statistics/Documents/FactBook/2012-Fact-Book-Appendix-A.pdf>. Note that this figure includes all types of transit buses: annual sales of 40-foot transit buses, as are of interest in this report, would be considerably lower.

<sup>6</sup> Davis, Stacy C., Williams, Susan E., Boundy, Robert G., and Moore, Sheila, "Chapter 4: Heavy Trucks," in 2016 Vehicle Technologies Market Report, written by Oakridge National Laboratory for the DOE Vehicle Technologies Office, 113-131, 2016. Accessed July 17, 2017.

[http://cta.ornl.gov/vtmarketreport/pdf/2016\\_vtmarketreport\\_full\\_doc.pdf](http://cta.ornl.gov/vtmarketreport/pdf/2016_vtmarketreport_full_doc.pdf)

# Table of Contents

- 1 Overview ..... 13
- 2 Project Approach ..... 16
  - 2.1 Integrated Performance and Cost Estimation ..... 17
  - 2.2 Cost Analysis Methodology ..... 18
    - 2.2.1 Stage 1: System Conceptual Design ..... 20
    - 2.2.2 Stage 2: System Physical Design..... 20
    - 2.2.3 Stage 3: Cost Modeling ..... 20
    - 2.2.4 Stage 4: Continuous Improvement to Reduce Cost ..... 22
  - 2.3 Vertical Integration and Markups ..... 22
  - 2.4 Inflation and Reporting Cost..... 26
- 3 Overview of the Medium Duty Truck System ..... 26
  - 3.1 Current Fuel Cell Truck Demonstrations ..... 28
- 4 System Schematics and Bills of Materials ..... 30
  - 4.1 2017 Automotive System Schematic ..... 30
  - 4.2 2018, 2020, and 2025 Automotive System Schematic..... 31
  - 4.3 2018 Medium Duty System Schematic ..... 32
  - 4.4 2020/2025 Medium Duty System Schematic ..... 33
- 5 System Cost Summaries..... 34
  - 5.1 Cost Summary of the 2018 Automotive System ..... 34
  - 5.2 Cost Summary of the 2020 and 2025 Auto Systems ..... 39
  - 5.3 Cost Summary of the 2018 Medium Duty Truck System ..... 43
  - 5.4 Cost Summary of the 2020 and 2025 Medium Duty Truck Systems..... 48
- 6 Automotive Power System Changes and Analysis since the 2017 Report ..... 53
  - 6.1 2018 Polarization Model ..... 54
    - 6.1.1 2018 Polarization Model and Resulting Polarization Curves ..... 54
    - 6.1.2 Q/ $\Delta$ T Constraint ..... 56
    - 6.1.3 Parasitic Loads and Gross Power..... 57
  - 6.2 2020 and 2025 Polarization Assumptions ..... 58
  - 6.3 d-PtCo/HSC Catalyst Synthesis..... 59
  - 6.4 Bipolar Plate Laser Welding ..... 61
  - 6.5 Balance of Plant Changes ..... 64

6.5.1	Compressor/Expander/Motor (CEM) System Changes .....	64
6.5.2	H <sub>2</sub> Recirculation System Change .....	65
6.5.3	Air Management System Changes .....	65
7	Automotive Power System Side Analyses .....	67
7.1	Physical Vapor Deposition (PVD) Coating of Catalyst Powders .....	67
7.2	Electrospinning Membrane and Electrode Materials .....	73
7.2.1	Electrospun Membrane Support .....	73
7.2.2	Co-Spun Membrane Support and Ionomer .....	76
7.2.3	Electrospun Electrodes .....	82
7.2.4	Electrospun CCMs.....	84
7.2.5	Electrospun CCM Polarization Performance.....	84
8	Model Validation Study: Toyota Mirai .....	86
8.1	Validation of System Design: DFMA <sup>®</sup> Analysis of Toyota Mirai Fuel Cell System .....	86
8.1.1	Mirai Operating Conditions and stack sizing.....	88
8.1.2	Mirai Stack Components.....	89
8.1.3	Mirai Stack Cost Results.....	90
8.1.4	Mirai BOP Components .....	91
8.1.5	Mirai BOP Cost Results .....	93
8.1.6	Total System Cost Comparison .....	94
8.1.7	Validation of System Design Conclusions .....	95
8.2	Validation of System Price .....	95
9	Description of 2018 Automotive Fuel Cell System Manufacturing Assumptions and Cost Results ...	98
9.1	Fuel Cell Stack Materials, Manufacturing, and Assembly .....	98
9.1.1	Bipolar Plates .....	98
9.1.2	Membrane .....	109
9.1.3	Fuel Cell Catalyst .....	116
9.1.4	Dispersed Catalyst Ink and Application to Membrane .....	126
9.1.5	Catalyst Coated Membrane Acid Washing .....	131
9.1.6	Gas Diffusion Layer.....	134
9.1.7	MEA Sub-Gaskets .....	139
9.1.8	Sub-gasket Formation.....	146
9.1.9	Hot Pressing CCM and GDLs.....	148

9.1.10	MEA Cutting, and Slitting.....	150
9.1.11	End Plates.....	152
9.1.12	Current Collectors .....	155
9.1.13	Coolant Gaskets/Laser-welding.....	157
9.1.14	End Gaskets.....	161
9.1.15	Stack Compression .....	164
9.1.16	Stack Assembly.....	165
9.1.17	Stack Housing.....	167
9.1.18	Stack Conditioning and Testing.....	168
9.2	Balance of Plant (BOP).....	170
9.2.1	Air Loop.....	170
9.2.2	Humidifier & Water Recovery Loop .....	176
9.2.3	Coolant Loops.....	197
9.2.4	Fuel Loop.....	199
9.2.5	System Controller .....	201
9.2.6	Sensors.....	203
9.2.7	Miscellaneous BOP .....	204
9.2.8	System Assembly.....	209
9.2.9	System Testing .....	210
9.2.10	Cost Contingency.....	210
10	Medium Duty Fuel Cell Truck Power System .....	211
10.1	MDV Truck Power System Overview.....	211
10.1.1	Comparison with Automotive Power System .....	211
10.2	MDV System Performance Parameters.....	212
10.2.1	Power Level.....	212
10.2.2	Polarization Performance Basis.....	212
10.2.3	Catalyst Loading .....	215
10.2.4	Catalyst Ink.....	215
10.2.5	Parasitic Load Requirements.....	215
10.2.6	Operating Pressure.....	216
10.2.7	Stack Operating Temperature.....	216
10.2.8	Q/ $\Delta$ T Radiator Constraint .....	217

10.2.9	Cell Active Area and System Voltage .....	217
10.3	Air Compression Units .....	217
10.3.1	Roots-Type Air Compressor-Motor for 2018 System .....	218
10.3.2	Roots-Type Air Compressor-Expander-Motor for 2020 System .....	219
10.3.3	Centrifugal Air Compressor with Radial In-Flow Expander for 2025 System.....	219
10.4	MDV System Balance of Plant Components .....	220
11	Capital Equipment Cost (LDV Stacks).....	223
12	Quality Control Procedures.....	226
13	Automotive Simplified Cost Model Function .....	228
14	Life Cycle Analysis (LCA).....	232
14.1	Platinum Recycling Cost .....	232
14.2	2018 Automotive Life Cycle Analysis Assumptions and Results .....	234
14.3	2020 & 2025 Automotive Life Cycle Analysis Results .....	240
15	Sensitivity Studies .....	242
15.1	Single Variable Analysis .....	242
15.1.1	Single Variable 2018 Automotive Analysis.....	242
15.1.2	Single Variable 2020 Automotive Analysis.....	243
15.1.3	Single Variable 2025 Automotive Analysis.....	245
15.1.4	Single Variable 2018 Medium Duty Truck Analysis .....	246
15.1.5	Single Variable 2020 Medium Duty Truck Analysis .....	247
15.1.6	Single Variable 2025 Medium Duty Truck Analysis .....	248
15.1.7	Automotive Analysis at a Pt price of \$1100/troy ounce .....	249
15.2	Monte Carlo Analysis .....	249
15.2.1	Monte Carlo 2018 Current Automotive Analysis .....	249
15.2.2	Monte Carlo 2020 Automotive Analysis .....	253
15.2.3	Monte Carlo 2025 Automotive Analysis .....	257
15.2.4	Monte Carlo 2018 Medium Duty Truck Analysis.....	259
15.2.5	Monte Carlo 2020 Medium Duty Truck Analysis.....	262
15.2.6	Monte Carlo 2025 Medium Duty Truck Analysis.....	264
15.2.7	Extension of Monte Carlo Sensitivity.....	266
16	Future System Cost Projection .....	267
17	SA Recommendations for Future Study .....	269

18	Key Progress in Automotive Analyses.....	271
19	Key Progress in Medium Duty Vehicle Analyses.....	273
20	Appendix A: 2020 & 2025 Auto System Cost Results .....	276
20.1	Fuel Cell Stack Materials, Manufacturing, and Assembly Cost Results.....	276
20.1.1	Bipolar Plates .....	276
20.1.2	Membrane .....	278
20.1.3	Pt on Carbon Catalyst .....	279
20.1.4	Catalyst Coated Membrane Acid Wash.....	281
20.1.5	Gas Diffusion Layer.....	282
20.1.6	MEA Sub-Gaskets Total.....	282
20.1.7	Hot Pressing GDL to Catalyst Coated Membrane.....	285
20.1.8	Cutting, and Slitting .....	286
20.1.9	End Plates.....	288
20.1.10	Current Collectors.....	289
20.1.11	Coolant Gaskets/Laser-welding.....	291
20.1.12	End Gaskets .....	292
20.1.13	Stack Assembly.....	293
20.1.14	Stack Housing .....	295
20.1.15	Stack Conditioning and Testing .....	296
20.2	2020 & 2025 Auto Balance of Plant (BOP) Cost Results.....	297
20.2.1	Air Loop.....	297
20.2.2	Humidifier & Water Recovery Loop .....	297
20.2.3	Coolant Loops.....	309
20.2.4	Fuel Loop.....	310
20.2.5	System Controller.....	311
20.2.6	Sensors.....	311
20.2.7	Miscellaneous BOP .....	311
20.2.8	System Assembly.....	314
21	Appendix B: 2018, 2020 & 2025 MDV System Cost Results.....	315
21.1	Fuel Cell Stack Materials, Manufacturing, and Assembly Cost Results.....	315
21.1.1	Bipolar Plates .....	315
21.1.2	Membrane .....	318



21.1.3	Pt on Carbon Catalyst .....	319
21.1.4	Catalyst Coated Membrane Acid Wash .....	322
21.1.5	Gas Diffusion Layer .....	322
21.1.6	MEA Sub-Gaskets Total.....	323
21.1.7	Hot Pressing GDL to Catalyst Coated Membrane.....	326
21.1.8	Cutting, and Slitting .....	327
21.1.9	End Plates.....	328
21.1.10	Current Collectors.....	329
21.1.11	Coolant Gaskets/Laser-welding.....	330
21.1.12	End Gaskets .....	332
21.1.13	Stack Assembly .....	333
21.1.14	Stack Housing .....	334
21.1.15	Stack Conditioning and Testing .....	335
21.2	2020 & 2025 MDV Balance of Plant (BOP) Cost Results.....	336
21.2.1	Air Loop.....	336
21.2.2	Humidifier & Water Recovery Loop .....	337
21.2.3	Coolant Loops.....	348
21.2.4	Fuel Loop.....	349
21.2.5	System Controller.....	350
21.2.6	Sensors.....	351
21.2.7	Miscellaneous BOP .....	352
21.2.8	System Assembly.....	354

# 1 Overview

This 2018 report covers fuel cell cost analysis of a light-duty vehicle (automotive) for the current year (2018), and for two projected years 2020 and 2025. This report is the second annual report<sup>7</sup> of a comprehensive automotive fuel cell cost analysis to be conducted by Strategic Analysis (SA), under a 2016 award granted by the U.S. Department of Energy (DOE). SA previously conducted a similar analysis under a contract to DOE (DE-EE0005236) between 2008 and 2016 where annual update reports<sup>8,9,10,11,12,13,14,15,16</sup> were written for each year. This current report, although under a different DOE award, is a continuation of the previous efforts and thus shares a high degree of commonality with the previous approach and reporting formatting. The report is meant to be comprehensive and thus repeats much of the text description from earlier reports in areas that have not changed from the previous year.

In this multi-year project, SA estimates the material and manufacturing costs of complete 80 kW<sub>e\_net</sub> direct-hydrogen Proton Exchange Membrane (PEM) fuel cell systems suitable for powering light-duty automobiles, 160 kW<sub>e\_net</sub> systems of the same type suitable for powering 40-foot transit buses, and 160kW<sub>e\_net</sub> medium-duty trucks. (MDV fuel cell power systems are expected to be very similar to HDV power systems. The 2018 analysis specifically examines MDV fuel cell systems although HDV systems may be considered in future analysis years). Figure 1 specifies the scheduled analyses planned for each analysis year. For 2018, automotive system analyses for 2018, 2020, and 2025 technology years are

---

<sup>7</sup> “Mass Production Cost Estimation of Direct H<sub>2</sub> PEM Fuel Cell Systems for Transportation Applications: 2017 Update” Brian D. James, Jennie M. Huya-Kouadio, Cassidy Houchins, & Daniel A. DeSantis, Strategic Analysis, Inc., December 2017.

<sup>8</sup> James BD, Kalinoski JA, Baum KN. Mass production cost estimation for direct H<sub>2</sub> PEM fuel cell systems for automotive applications: 2008 update. Arlington (VA): Directed Technologies, Inc. 2009 Mar. Contract No. GS-10F-0099J. Prepared for the US Department of Energy, Energy Efficiency and Renewably Energy Office, Hydrogen Fuel Cells & Infrastructure Technologies Program.

<sup>9</sup> James BD, Kalinoski JA, Baum KN. Mass production cost estimation for direct H<sub>2</sub> PEM fuel cell systems for automotive applications: 2009 update. Arlington (VA): Directed Technologies, Inc. 2010 Jan. Contract No. GS-10F-0099J. Prepared for the US Department of Energy, Energy Efficiency and Renewably Energy Office, Hydrogen Fuel Cells & Infrastructure Technologies Program.

<sup>10</sup> “Mass Production Cost Estimation for Direct H<sub>2</sub> PEM Fuel Cell Systems for Automotive Applications: 2010 Update,” Brian D. James, Jeffrey A. Kalinoski & Kevin N. Baum, Directed Technologies, Inc., 30 September 2010.

<sup>11</sup> “Mass Production Cost Estimation for Direct H<sub>2</sub> PEM Fuel Cell Systems for Automotive Applications: 2011 Update,” Brian D. James, Kevin N. Baum & Andrew B. Spisak, Strategic Analysis, Inc., 7 September 2012.

<sup>12</sup> “Mass Production Cost Estimation for Direct H<sub>2</sub> PEM Fuel Cell Systems for Automotive Applications: 2012 Update,” Brian D. James, Andrew B. Spisak, Strategic Analysis, Inc., 18 October 2012.

<sup>13</sup> “Mass Production Cost Estimation of Direct H<sub>2</sub> PEM Fuel Cell Systems for Transportation Applications: 2013 Update” Brian D. James, Jennie M. Moton & Whitney G. Colella, Strategic Analysis, Inc., January 2014.

<sup>14</sup> “Mass Production Cost Estimation of Direct H<sub>2</sub> PEM Fuel Cell Systems for Transportation Applications: 2014 Update” Brian D. James, Jennie M. Moton & Whitney G. Colella, Strategic Analysis, Inc., January 2015.

<sup>15</sup> “Mass Production Cost Estimation of Direct H<sub>2</sub> PEM Fuel Cell Systems for Transportation Applications: 2015 Update” Brian D. James, Jennie M. Huya-Kouadio, & Cassidy Houchins, Strategic Analysis, Inc., December 2015.

<sup>16</sup> “Mass Production Cost Estimation of Direct H<sub>2</sub> PEM Fuel Cell Systems for Transportation Applications: 2016 Update” Brian D. James, Jennie M. Huya-Kouadio, & Cassidy Houchins, Strategic Analysis, Inc., December 2016.

conducted in addition to an MDV fuel cell truck analysis. The fuel cell bus system cost analysis is deferred until 2019.

Year	Project Year	Technology	Proposed/Completed Analyses
2017	1	80kW Light Duty Vehicle (LDV)	Current (2017), 2020, 2025
		Med/Heavy Duty Truck	Scoping Study
		LDV System or Stack Component	Validation Study
2018	2	LDV	Current (2018), 2020, 2025
		MD Truck #1	Current (2018), 2020, 2025
2019	3	LDV	Current (2019), 2020, 2025
		Buses	Current (2019), 2020, 2025
2020	4	LDV	Current (2020), 2025
		MD/HD Truck System #2 or update of #1	Current (2020), 2025
2021	5	LDV	Current (2021), 2025
		Update to Buses & Trucks as needed	Current (2021), 2025

**Figure 1. Timeline of analyses planned for each of the five years of the project.**

To assess the cost benefits of mass manufacturing, six annual production rates are examined for each automotive technology level: 1,000, 10,000, 20,000, 50,000, 100,000, and 500,000 systems per year. Since total U.S. 40 foot bus sales are currently ~4,000 vehicles per year, manufacturing rates of 200, 400, 800, and 1,000 systems per year are considered for the bus cost analysis. Over 200,000 combined class 4-7 truck US sales volumes are specified in the Vehicle Market Report by Oak Ridge National Lab.<sup>17</sup> SA analysis is conducted for 200, 500, 1,000, 10,000, 50,000, and 100,000 MDV fuel cell systems per year.

A Design for Manufacturing and Assembly (DFMA<sup>®</sup>) methodology is used to prepare the cost estimates. However, departing from DFMA<sup>®</sup> standard practice, a markup rate for the final system assembler to account for the business expenses of general and administrative (G&A), R&D, scrap, and profit is not currently included in the cost estimates. However, markup is added to components and subsystems produced by lower-tier suppliers and sold to the final system assembler. For the automotive application, a high degree of vertical integration is assumed for fuel cell production. This assumption is consistent with the scenario of the final system assembler (e.g. General Motors (GM) or Ford Motor Company [Ford]) producing virtually all of the fuel cell power system in-house, and only purchasing select stack or balance of plant components from vendors. Under this scenario, markup is not applied to most components (since markup is not applied to the final system assembly). In contrast, the fuel cell bus and truck applications are assumed to have a very low level of vertical integration. This assumption is consistent with the scenario where the fuel cell bus or truck company buys the fuel cell power system from a hybrid system integrator who assembles the power system (whose components, in turn, are manufactured by subsystem suppliers and lower tier vendors). Under this scenario, markup is applied to

<sup>17</sup> <https://www.osti.gov/scitech/biblio/1255689-vehicle-technologies-market-report>

most system components. (Indeed, multiple layers of markup are applied to most components as the components pass through several corporate entities on their way to the bus manufacturer.)

In general, the system designs do not change with production rate, but material costs, manufacturing methods, and business-operational assumptions do vary. Cost estimation at very low manufacturing rates (below 1,000 systems per year) presents particular challenges. Traditional low-cost mass-manufacturing methods are not cost-effective at low manufacturing rates due to high per-unit setup and tooling costs, and lower manufacturing line utilizations. Instead, less defined and less automated operations are typically employed. For some repeat parts within the fuel cell stack (e.g. the membrane electrode assemblies [MEAs] and bipolar plates), such a large number of pieces are needed for each system that even at low system production rates (1,000/year), hundreds of thousands of individual parts are needed annually. Thus, for these parts, mass-manufacturing cost reductions are achieved even at low system production rates. However, other fuel cell stack components (e.g. end plates and current collectors) and all FCS-specific balance of plant (BOP) equipment manufactured in-house do not benefit from this manufacturing multiplier effect, because there are fewer of these components per stack (i.e. two endplates per stack, etc.).

The 2018 system reflects the authors' best estimate of current technology and, with only a few exceptions, is not based on proprietary information. Public presentations by fuel cell companies and other researchers, private conversations with vendors and automotive OEMs, along with an extensive review of the patent literature are used as a primary basis for modeling the design and fabrication of the technologies.

In 2015, Toyota came out with the Mirai commercial fuel cell vehicle and with it a significant amount of information on the Mirai fuel cell system. In 2017, SA seized the opportunity to compare and understand the differences between what was publically provided on the Mirai and SA's baseline system. In 2018, SA updated the cost of the Mirai based on new information obtained in the last year. Changes to SA's 2017 cost assessment of the Mirai system appears in the Model Validation Section 8: the reader is referred to SA's 2017 cost report for additional system details. SA assessment of the Mirai fuel cell power system is based on fully-public, but incomplete, information: thus while every effort was taken to be accurate, some Mirai design details may be in error. Nonetheless, the Mirai analysis serves as an important snapshot of demonstrated, on-the-road technology. Additionally, it serves as a useful tool to compare against the SA baseline systems. Because the automotive timeline from concept to production is typically 2-3 years (and most likely longer for fuel cell technologies), the Mirai should not be directly compared against the baseline 2017 or 2018 systems, as the Mirai represents reliable technology at the point of its design freeze (several years ago) whereas the 2017 and 2018 baseline systems represents state of the art technology in 2017 and 2018. Taken together, the analysis of these systems provides a sense of the likely range of costs for mass-produced automotive and bus fuel cell systems and of the dependence of cost on system performance, manufacturing, and business-operational assumptions.

## 2 Project Approach

The overall goal of this analysis is to transparently and comprehensively estimate the manufacturing and assembly cost of PEM fuel cell power systems for light-duty vehicle (i.e. automotive), MDV/HDV, and transit bus applications. The analysis is to be sufficiently in-depth to allow identification of key cost drivers. Systems are to be assessed at a variety of annual manufacturing production rates.

To accomplish these goals, a three-step system approach is employed:

- 1) System conceptual design wherein a functional system schematic of the fuel cell power system is defined.
- 2) System physical design wherein a bill of materials (BOM) is created for the system. The BOM is the backbone of the cost analysis accounting system and is a listing and definition of subsystems, components, materials, fabrication and assembly processes, dimensions, and other key information.
- 3) Cost modeling where Design for Manufacturing and Assembly (DFMA<sup>®</sup>) or other cost estimation techniques are employed to estimate the manufacturing and assembly cost of the fuel cell power system. Cost modeling is conducted at a variety of annual manufacturing rates.

Steps two and three are achieved through the use of an integrated performance and cost analysis model. The model is Excel spreadsheet-based, although external cost and performance analysis software is occasionally used for inputs. Argonne National Laboratory models of the electrochemical performance at the fuel cell stack level are used to assess stack polarization performance.

The systems examined within this report do not reflect the designs of any one manufacturer but are intended to be representative composites of the best elements from a number of designs. The automotive system is normalized to a system output power of 80 kW<sub>e\_net</sub> and the bus system to 160 kW kW<sub>e\_net</sub>. System gross power is derived from the parasitic load of the BOP components.

The project is conducted in coordination with researchers at Argonne National Laboratory (ANL) who have independent configuration and performance models for similar fuel cell systems. Those models serve as quality assurance and validation of the project's cost inputs and results. Additionally, the project is conducted in coordination with researchers at the National Renewable Energy Laboratory (NREL) who are experts in manufacturing quality control and bus fuel cell power systems. Furthermore, the assumptions and results from the project are annually briefed to the U.S. DRIVE Fuel Cell Technical Team (FCTT) so as to receive suggestions and concurrence with assumptions. Finally, the basic approach of process-based cost estimation is to model a complex system (e.g. the fuel cell power system) as the summation of the individual manufacturing and assembly processes used to make each component of the system. Thus, a complex system is defined as a series of small steps, each with a corresponding set of (small) assumptions. These individual small assumptions often have manufacturing existence proofs which can be verified by the manufacturing practitioners. Consequently, the cost analysis is further validated by documentation of all modeling assumptions and their sources.

## 2.1 Integrated Performance and Cost Estimation

The fuel cell stack is the key component within the fuel cell system and its operating parameters effectively dictate all other system components. As stated, the systems are designed for a net system power. An integrated performance and cost assessment procedure is used to determine the configuration and operating parameters that lead to lowest system cost on a \$/kW basis. Figure 2 lists the basic steps in the system cost estimation and optimization process and contains two embedded iterative steps. The first iterative loop seeks to achieve computational closure of system performance<sup>18</sup> and the second iterative loop seeks to determine the combination of stack operational parameters that leads to lowest system cost.

Step Number	Step Description
1)	Define system basic mechanical and operational configuration.
2)	Select target system net power production.
3)	Select stack operating parameters (pressure, catalyst loading, cell voltage, air stoichiometry).
4)	Estimate stack power density (W/cm <sup>2</sup> of cell active area) for those parameters.
5)	Estimate system gross power (based on known net power target and estimation of parasitic electrical loads).
6)	Compute required total active area to achieve gross power.
7)	Compute cell active area (based on target system voltage).
8)	Compute stack hydrogen and air flows based on stack and system efficiency estimates.
9)	Compute size of stack and balance of plant components based on these flow rates, temperatures, pressures, voltages, and currents.
10)	Compute actual gross power for above conditions.
11)	Compare “estimated” gross power with computed actual gross power.
12)	Adjust gross power and repeat steps 1-9.
13)	Compute cost of power system.
14)	Vary stack operating parameters and repeat steps 3-13.

**Figure 2. Basic steps within the system cost estimation and optimization process**

Stack efficiency<sup>19,20</sup> at rated power of the automotive systems was previously set at 55%, to match past DOE targets. However, in 2013, a radiator size constraint in the form of  $Q/\Delta T$  was imposed (see Section 6.1.2), and stack efficiencies were allowed to fluctuate so as to achieve minimum system cost while also satisfying radiator constraints.

<sup>18</sup> The term “computational closure” is meant to denote the end condition of an iterative solution where all parameters are internally consistent with one another.

<sup>19</sup> Stack efficiency is defined as voltage efficiency X H<sub>2</sub> utilization = Cell volts/1.253 X 100%.

<sup>20</sup> Multiplying this by the theoretical open circuit cell voltage (1.253 V) yields a cell voltage of 0.661 V at peak power.

The main fuel cell subsystems included in this analysis are:

- Fuel cell stacks
- Air loop
- Humidifier and water recovery loop
- High-temperature coolant loop
- Low-temperature coolant loop
- Fuel loop (but not fuel storage)
- Fuel cell system controller
- Sensors

Some vehicle electrical system components explicitly excluded from the analysis include:

- Main vehicle battery or ultra-capacitor<sup>21</sup>
- Electric traction motor (that drives the vehicle wheels)
- Traction inverter module (TIM) (for control of the traction motor)
- Vehicle frame, body, interior, or comfort-related features (e.g., driver's instruments, seats, and windows)

Many of the components not included in this study are significant contributors to the total fuel cell vehicle cost; however, their design and cost are not necessarily dependent on the fuel cell configuration or stack operating conditions. Thus, it is our expectation that the fuel cell system defined in this report is applicable to a variety of vehicle body types and drive configurations.

## 2.2 Cost Analysis Methodology

As mentioned above, the costing methodology employed in this study is the Design for Manufacture and Assembly technique (DFMA<sup>®</sup>)<sup>22</sup>. Ford has formally adopted the DFMA<sup>®</sup> process as a systematic means for the design and evaluation of cost-optimized components and systems. These techniques are powerful and flexible enough to incorporate historical cost data and manufacturing acumen that has been accumulated by Ford since the earliest days of the company. Since fuel cell system production requires some manufacturing processes not normally found in automotive production, the formal DFMA<sup>®</sup> process and SA's manufacturing database are buttressed with budgetary and price quotations from experts and vendors in other fields. It is possible to identify low-cost manufacturing processes and component designs and to accurately estimate the cost of the resulting products by combining historical knowledge with the technical understanding of the functionality of the fuel cell system and its component parts. This DFMA<sup>®</sup>-style methodology helps to evaluate capital cost as a function of annual production rate. This section explains the DFMA<sup>®</sup> cost modeling methodology further and discusses FCS stack and balance of plant (BOP) designs and performance parameters where relevant.

---

<sup>21</sup> Fuel cell automobiles may be either "purebreds" or "hybrids" depending on whether they have battery (or ultracapacitor) electrical energy storage or not. This analysis only addresses the cost of an 80 kW fuel cell power system and does not include the cost of any peak-power augmentation or hybridizing battery.

<sup>22</sup> Boothroyd, G., P. Dewhurst, and W. Knight. "Product Design for Manufacture and Assembly, Second Edition," 2002.



The cost for any component analyzed via DFMA<sup>®</sup> techniques includes direct material cost, manufacturing cost, assembly costs, and markup. Direct material costs are determined from the exact type and mass of material employed in the component. This cost is usually based upon either historical volume prices for the material or vendor price quotations. In the case of materials or devices not widely used at present, the manufacturing process must be analyzed to determine the probable high-volume price for the material or device. The manufacturing cost is based upon the required features of the part and the time it takes to generate those features in a typical machine of the appropriate type. The cycle time can be combined with the “machine rate,” the hourly cost of the machine based upon amortization of capital and operating costs, and the number of parts made per cycle to yield an accurate manufacturing cost per part. Operating costs include maintenance and spare parts, any miscellaneous expenses, and utility costs (typically electricity at \$0.08/kWh).

Labor is factored into the calculation of the machine rate and is simply applied as the hourly rate at which a full-time equivalent (FTE) laborer is paid on a manufacturing line multiplied by the number of FTEs. The nominal fully loaded labor rate is \$45/hr. In discussions with Marianne Mintz at ANL, SA decided to include additional labor hours to account for line tender time (i.e. labor of a worker to re-supply materials and perform other miscellaneous tasks not done by the machine operator). This was estimated to be 25% of an FTE for a majority of the processing steps within stack production and is applied to each production line (i.e. if four parallel lines are required to meet annual production demands,  $4 \times 0.25 = 1$  FTE is added to the cost analysis).

The assembly costs are based on the amount of time to complete the given operation and the cost of either manual labor or of the automatic assembly process train. The piece cost derived in this fashion is quite accurate as it is based on an exact physical manifestation of the part and the technically feasible means of producing it as well as the historically proven cost of operating the appropriate equipment and amortizing its capital cost. Normally (though not in this report), a percentage markup is applied to the material, manufacturing, and assembly cost to account for profit, general and administrative (G&A) costs, research and development (R&D) costs, and scrap costs. This percentage typically varies with production rate to reflect the efficiencies of mass production. It also changes based on the business type, on the amount of value that the manufacturer or assembler adds to the product, and on market conditions.

Cost analyses were performed for mass-manufactured systems at six production rates for the automotive FC power systems (1,000, 10,000, 20,000, 50,000, 100,000, and 500,000 systems per year), four production rates for the bus systems (200, 400, 800, and 1,000 systems per year), and six production rates for the medium-duty truck systems (200, 500, 1,000, 10,000, 50,000, and 100,000 systems per year). System designs did not change with production rate, but material costs, manufacturing methods, and business-operational assumptions (such as markup rates) often varied. Fuel cell stack component costs were derived by combining manufacturers’ quotes for materials and manufacturing with detailed DFMA<sup>®</sup>-style analysis.

For some components (e.g. the bipolar plates and the coolant and end gaskets), multiple designs or manufacturing approaches were analyzed. The options were carefully compared and contrasted, and then examined within the context of the rest of the system. The best choice for each component was included in the 2018 baseline configuration. Because of the interdependency of the various

components, the selection or configuration of one component sometimes affects the selection or configuration of another. To handle these combinations, the DFMA<sup>®</sup> model was designed with switches for each option, and logic was built in that automatically adjusts variables as needed. As such, the reader should not assume that accurate system costs could be calculated by merely substituting the cost of one component for another, using only the data provided in this report. Instead, data provided on various component options should be used primarily to understand the decision process used to select the approach for the baseline configurations.

The DFMA<sup>®</sup>-style methodology proceeds through four iterative stages: (1) System Conceptual Design, (2) System Physical Design, (3) Cost Modeling, and (4) Continuous Improvement to Reduce Cost.

### **2.2.1 Stage 1: System Conceptual Design**

In the system conceptual design stage, a main goal is to develop and verify a chemical engineering process plant model describing the FCS. The FCSs consume hydrogen gas from a compressed hydrogen storage system or other hydrogen storage media. This DFMA<sup>®</sup> modeling effort does not estimate the costs for either the hydrogen storage medium or the electric drive train. This stage delineates FCS performance criteria, including, for example, rated power, FCS volume, and FCS mass, and specifies a detailed drive train design. An Aspen HYSYS<sup>™</sup> chemical process plant model is developed to describe mass and energy flows, and key thermodynamic parameters of different streams. This stage specifies required system components and their physical constraints, such as operating pressure, heat exchanger area, etc. Key design assumptions are developed for the PEM fuel cell vehicle (FCV) system, in some cases, based on a local optimization of available experimental performance data.

### **2.2.2 Stage 2: System Physical Design**

The physical design stage identifies bills of materials (BOMs) for the FCS at a system and subsystem level, and, in some cases, at a component level. A BOM describes the quantity of each part used in the stack, the primary materials from which the part is formed, the feedstock material basic form (i.e. roll, coil, powder, etc.), the finished product basic form, whether a decision was made to make the part internally or buy it from an external machine shop (i.e. make or buy decision), the part thickness, and the primary formation process for the part. The system physical design stage identifies material needs, device geometry, manufacturing procedures, and assembly methods.

### **2.2.3 Stage 3: Cost Modeling**

The cost modelling approach applied depends on whether (1) the device is a standard product that can be purchased off-the-shelf, such as a valve or a heat exchanger, or whether (2) it is a non-standard technology not yet commercially available in high volumes, such as a fuel cell stack or a membrane humidifier. Two different approaches to cost modeling pervade: (1) for standard components, costs are derived from industry price quotes and reasonable projections of these to higher or lower manufacturing volumes. (2) For non-standard components, costs are based on a detailed DFMA<sup>®</sup> analysis, which quantifies materials, manufacturing, tooling, and assembly costs for the manufacturing process train.

### 2.2.3.1 Standardized Components: Projections from Industry Quotes

For standardized materials and devices, price quotations from industry as a function of annual order quantity form the basis of financial estimates. A learning curve formula is applied to the available data gathered from industry:

$$P_Q = P_I * F_{LC}^{\left(\frac{\ln\left(\frac{Q}{Q_I}\right)}{\ln 2}\right)} \quad (1)$$

where  $P_Q$  is the price at a desired annual production quantity  $[Q]$  given the initial quotation price  $[P_I]$  at an initial quantity  $Q_I$  and a learning curve reduction factor  $[F_{LC}]$ .  $F_{LC}$  can be derived from industry data if two sets of price quotes are provided at two different annual production quantities. When industry quotation is only available at one annual production rate, a standard value is applied to the variable  $F_{LC}$ .

### 2.2.3.2 Non-standard Components: DFMA® Analysis

When non-standard materials and devices are needed, costs are estimated based on detailed DFMA® style models developed for a specific, full physical, manufacturing process train. In this approach, the estimated capital cost  $[C_{Est}]$  of manufacturing a device is quantified as the sum of materials costs  $[C_{Mat}]$ , the manufacturing costs  $[C_{Man}]$ , the expendable tooling costs  $[C_{Tool}]$ , and the assembly costs  $[C_{Assy}]$ :

$$C_{Est} = C_{Mat} + C_{Man} + C_{Tool} + C_{Assy} \quad (2)$$

The materials cost  $[C_{Mat}]$  is derived from the amount of raw materials needed to make each part, based on the system physical design (material, geometry, and manufacturing method). The manufacturing cost  $[C_{Man}]$  is derived from a specific design of a manufacturing process train necessary to make all parts. The manufacturing cost  $[C_{Man}]$  is the product of the machine rate  $[R_M]$  and the sum of the operating and setup time:

$$C_{Man} = R_M * (T_R + T_S) \quad (3)$$

where the machine rate  $[R_M]$  is the cost per unit time of operating the machinery to make a certain quantity of parts within a specific time period,  $T_R$  is the total annual runtime, and  $T_S$  is the total annual setup time. The cost of expendable tooling  $[C_{Tool}]$  is derived from the capital cost of the tool, divided by the number of parts that the tool produced over its life. The cost of assembly  $[C_{Assy}]$  includes the cost of assembling non-standard components (such as a membrane humidifier) and also the cost of assembling both standard and non-standard components into a single system.  $C_{Assy}$  is calculated according to

$$C_{Assy} = R_{Assy} * \sum T_{Assy} \quad (4)$$

where  $R_{Assy}$  is the machine rate for the assembly train, i.e. the cost per unit time of assembling components within a certain time period and  $T_{Assy}$  is the part assembly time.

#### **2.2.4 Stage 4: Continuous Improvement to Reduce Cost**

The fourth stage of continuous improvement to reduce cost iterates on the previous three stages. This stage weighs the advantages and disadvantages of alternative materials, technologies, system conceptual design, system physical design, manufacturing methods, and assembly methods, so as to iteratively move towards lower cost designs and production methods. Feedback from industry and research laboratories can be crucial at this stage. This stage aims to reduce estimated costs by continually improving on the three stages above.

### **2.3 Vertical Integration and Markups**

Vertical integration describes the extent to which a single company conducts many (or all) of the manufacturing/assembly steps from raw materials to finished product. High degrees of vertical integration can be cost efficient by decreasing transportation costs and turn-around times, and reducing nested layers of markup/profit. However, at low manufacturing rates, the advantages of vertical integration may be overcome by the negative impact of low machinery utilization or poor quality control due to inexperience/lack-of-expertise with a particular manufacturing step.

The automotive fuel cell system retains the assumption of high vertical integration but the bus and truck systems assume a non-vertically integrated structure. This is consistent with the much lower production rates of the bus systems (200 to 1,000 systems per year) and truck systems (200 to 100,000 systems per year) compared to those of auto systems (1,000 to 500,000 systems per year). Truck systems (depending on vehicle class) have intermediate production rates (tens to hundreds of thousands per year) but given the customization of trucks for specific duty applications, we judge a non-vertically integrated structure most appropriate. Figure 3 graphically contrasts these differing assumptions. Per long-standing DOE directive, markup (i.e. business cost adders for overhead, general & administrative expenses, profit, research and development expenses, etc.) are not included in the power system cost estimates for the final system integrator but are included for lower-tier suppliers. Consequently, very little markup is included in the automotive fuel cell system cost because the final integrator performs the vast majority of the manufacture and assembly (i.e. the enterprise is highly vertically integrated). In contrast, bus and truck fuel cell systems are assumed to have low vertical integration and thus incur substantial markup expense. Indeed, there are two layers of markup on most components (one for the actual manufacturing vendor and another for the hybrid system integrator).

Standard DFMA<sup>®</sup> practice calls for a markup to be applied to a base cost to account for general and administrative (G&A) expenses, research and development (R&D), scrap, and company profit. While markup is typically applied to the total component cost (i.e. the sum of materials, manufacturing, and assembly), it is sometimes applied at different levels to materials and processing costs. The markup rate is represented as a percentage value and can vary substantially depending on business circumstances, typically ranging from as low as 10-15% for pass-thru components, to 100% or higher for small businesses with low sales volume.

Within this analysis, a set of standard markup rates is adopted as a function of annual system volume and markup entity. Portraying the markup rates as a function of actual sales revenue would be a better correlating parameter as many expenses represented by the markup are fixed. However, that approach is more complex and thus a correlation with annual manufacturing rate is selected for simplicity. Generic markup rates are also differentiated by the entity applying the markup. Manufacturing markup represents expenses borne by the entity actually doing the manufacturing and/or assembly procedure. Manufacturing markup is assessed at two different rates: an “in-house” rate if the manufacturing is done with machinery dedicated solely to production of that component and a “job-shop” rate if the work is sent to an outside vendor. The “in-house” rate varies with manufacturing rate because machine utilization varies directly (and dramatically) with manufacturing volume. The “job-shop” rate is held constant at 30% to represent the pooling of orders available to contract manufacturing businesses.<sup>23</sup> A pass-thru markup represents expenses borne by a company that buys a component from a sub-tier vendor and then passes it through to a higher tier vendor. Integrator’s markup represents expenses borne by the hybrid systems integrator that sets engineering specifications, sources the components, and assembles them into a power system (but does not actually manufacture the components). More than one entity may be involved in supply of the finished product. Per DOE directive, no markup is applied for the final system assembler.

### Assumptions Regarding Extent of Vertical Integration

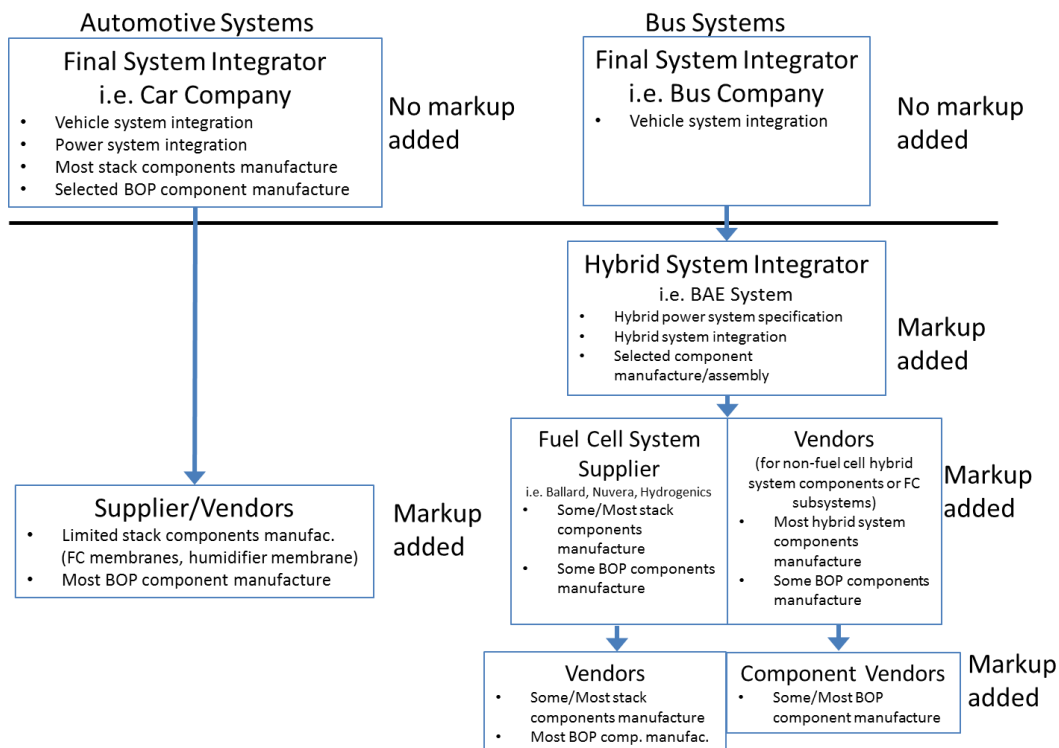


Figure 3: Comparison of bus and auto system vertical integration assumptions

<sup>23</sup> The job-shop markup is not really constant as large orders will result in appreciable increases in machine utilization and thus a (potential) lowering of markup rate. However, in practice, large orders are typically produced in-house to avoid the job-shop markup entirely and increase the in-house “value added”. Thus in practice, job-shop markup is approximately constant.

Figure 4 lists the generic markup rates corresponding to each entity and production volume. When more than one markup is applied, the rates are additive. These rates are applied to each component of the automotive and bus systems as appropriate for that component’s circumstances and generally apply to all components except the fuel cell membrane, catalyst, humidifier, and air compressor subsystem. Markup rates for those components are discussed individually in the component cost results below.

Business Entity	Annual System Production Rate								
	200	400	800	1000	10k	20K	50k	100k	500k
Manufacturer (in-house)	58.8%	54.3%	50.1%	48.9%	37.5%	34.6%	31.2%	28.8%	23.9%
Manufacturer (job-shop)	30%	30%	30%	30%	30%	30%	30%	30%	30%
Pass-Thru	20.2%	19.6%	19.1%	19.0%	17.3%	16.9%	16.3%	15.8%	14.9%
Integrator	20.2%	19.6%	19.1%	19.0%	17.3%	16.9%	16.3%	15.8%	14.9%

**Figure 4. Generic markup rates for auto, bus, and truck cost analysis**

The numeric levels of markup rates can vary substantially between companies and products and is highly influenced by the competitiveness of the market and the manufacturing and product circumstances of the company. For instance, a large established company able to re-direct existing machinery for short production runs would be expected to have much lower markup rates than a small, one-product company. Consequently, the selection of the generic markup rates in Figure 4 is somewhat subjective. However, they reflect input from informal discussions with manufacturers and are derived by postulating a power curve fit to key anchor markup rates gleaned from manufacturer discussions. For instance, a ~23% manufacturer markup at 500k systems per year and a 100% markup at a few systems/year are judged to be reasonable. A power curve fit fills in the intervening manufacturing rates. Likewise, a 30% job shop markup rate is deemed reasonable based on conversations and price quotes from manufacturing shops. The pass-thru and integrator markups are numerically identical and much less than the manufacture’s rate as much less “value-added” work is done. Figure 5 graphically displays the generic markup rates along with the curve fit models used in the analysis.

For the automotive systems, the application of markup rates is quite simple. The vast majority of components are modeled as manufactured by the final system integrator and thus no markup is applied to those components (by DOE directive, the final assembler applies no markup). The few automotive components produced by lower-tier vendors (e.g. the CEM and the PEM membrane) receive a manufacturer’s markup.

For the bus and truck systems, the application of markup rate is more complex. System production volume is much lower than for automotive systems, and thus it is most economical to have the majority of components produced by lower-tier job-shops. Consequently, the straight job-shop 30% markup is applied for job-shop manufacturing expenses. Additionally, a pass-thru markup is added for expenses of the fuel-cell-supplier/subsystem-vendor, and an integrator markup is added for expenses of the hybrid

integrator. These markups are additive. Like the auto systems, no markup is applied for the final system integrator.

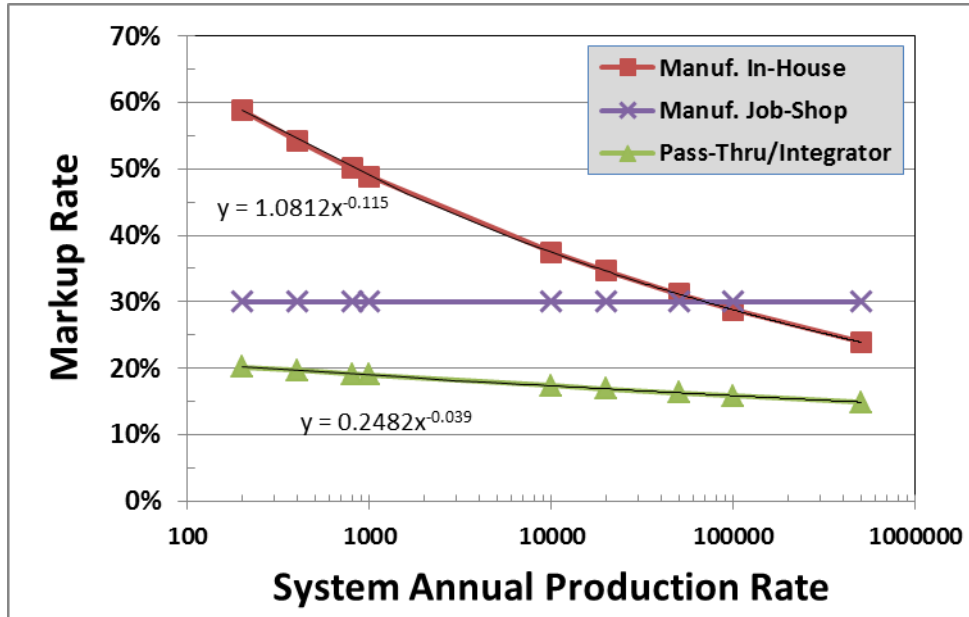


Figure 5. Graph of markup rates

Component level markup costs are reported in various sections of this report. Note that job-shop markup costs are included in the manufacturing cost line element, whereas all other markup costs (pass-thru and integrator) are included in the markup cost line element.



## 2.4 Inflation and Reporting Cost

In SA fuel cell system cost projections in years prior to 2018, costs were reported in nominal year dollars. Prior to 2012, inflation was applied to quotations for materials, manufacturing equipment, and system components that were obtained prior to the reported year. After 2012, SA switched to a methodology where manufacturing equipment and system component costs would not be affected year to year. This was to reduce the fluctuations from quotations so as to focus on the impact of cost changes relating to improvements in technology. SA began updating material costs (other than Pt) every few years to reflect market changes that would have an impact on the real cost to produce a fuel cell stack.

The DOE Fuel Cell Technologies Office manages multiple projects that estimate the cost of various fuel cell and hydrogen technologies including this work on fuel cells in transportation, on-board hydrogen storage, hydrogen production (generation, delivery, and stationary storage), and stationary fuel cell systems to name a few. When these sectors overlap, it is helpful to report cost projections using the same basis year dollars. Consequently, in 2018 the DOE Fuel Cell Technologies Office directed that all cost-estimating projects report costs in 2016 dollars. Therefore, all costs stated in this report are reported in 2016 dollars with the exception of quoted capital costs for machinery and materials that are in current 2018\$.<sup>24,25</sup> To adjust the values in this study to 2016\$, a ratio of values for July 2016 and July 2018 were used ( $193.5/205.9 = 0.94$ ). These values are from the Bureau of Labor Statistics, shown in Figure 6.

Year	Jan	Feb	Mar	Apr	May	Jun	Jul	Aug	Sep	Oct	Nov	Dec
2016	189.9	188.8	189.2	190.3	191.7	193.8	193.5	192.6	193.2	193.7	192.4	193.7
2017	195.4	196.0	196.3	198.0	197.0	197.8	197.6	198.4	199.6	199.4	200.4	199.9
2018	201.0	201.3	202.1	202.8	205.0	205.7	205.9	205.5	205.5			

**Figure 6. Table of Producer Price Index (PPI) commodity data for finished goods series ID: WPUFD49207, retrieved September 2018 (<https://data.bls.gov/cgi-bin/surveymost?wp>)**

## 3 Overview of the Medium Duty Truck System

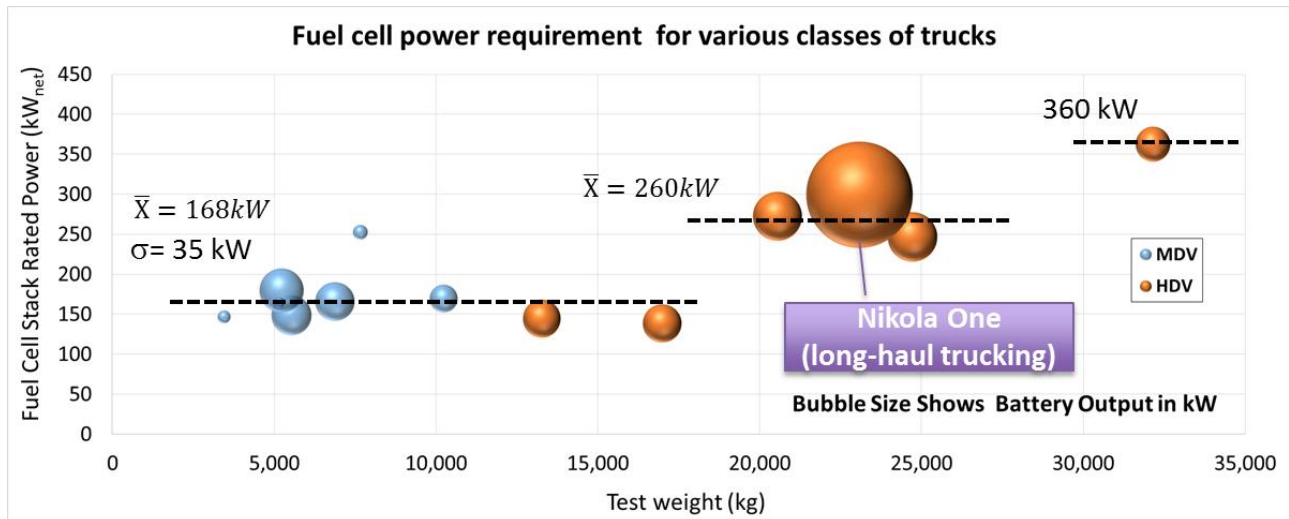
Medium duty fuel cell truck power systems are examined in this report for representative technology corresponding to 2018, 2020, and 2025. Due to the wide variety of truck applications and power sizes, a scoping study was conducted in 2017 to examine the truck applications and weight classes most appropriate for study and to assess their general system characteristics.

In support of the SA scoping study in 2017, ANL provided data from their Fuel Cell Electric Truck (FCET) study regarding the power levels required by both MDV and HDV fuel cell trucks.<sup>26</sup> The ANL study was based on commercial fleet vehicle operation data for 12 different truck applications and weight classes

<sup>24</sup> Capital costs and material costs are reported in nominal 2018\$ so the reader can more easily gauge the reasonableness of the values without having to convert from 2016\$.

<sup>25</sup> All cost values in this work were affected by a shift to 2016 dollars including the cost of Pt. The cost was maintained at \$1,500/tr.oz but now in 2016 dollars when previously it was \$1,500/tr.oz. in nominal year dollars.

(seen in Figure 7). All of these trucks, with the exception of the Nikola One truck, are based on a FC dominant system where the fuel cell is sized for peak sustained power and the battery is sized for brief power augmentation. However, most upcoming demonstrations size the FC for range extension where the FC charges the battery, the FC is sized for average power, and the battery is sized for peak power. SA chose FC dominant systems as the truck baseline power architecture on which to perform a detailed DFMA<sup>®</sup> cost estimate because this architecture is judged most likely to be employed in future production systems. Future work may incorporate a comparison for a FC dominant versus battery dominant system.



**Figure 7. Graph of ANL’s truck sizing work and Nikola One long-haul truck**

As can be seen in Figure 7, three power levels (168 kW, 260 kW, and 360 kW) capture the majority of MDV/HDV FCET applications. Coincidentally, these sizes are approximate multiples of 80-90 kW stacks and thus offer synergies with LDV stack manufacture. Feedback from bus FCS manufacturers suggests that the FCSs in buses, with minor adjustments, could be used in FCETs. A Class 6 MDV system is analyzed for the 2018 analysis year, but there is no single application or vocation chosen for the system. Instead, the power plant is meant to be representative of numerous MDV applications.

The MDV cost analysis in this report is based on a 160 kW<sub>net</sub> fuel cell truck power plant. Selection of a 160 kW<sub>net</sub> power level is also convenient because it is the same power level as the bus system and twice the power of the nominal 80 kW<sub>net</sub> systems used for the light-duty automotive analysis, thereby easily facilitating comparisons to the bus and two auto power plants.

Given that this application for fuel cell technology is still nascent, it will take time for fuel cell truck sales to ramp up. While there have been significant orders for Ballard MDV systems (500 x 30kW stacks<sup>27</sup>) and Nikola Motors HDV systems (8,000 x 300kW system pre-orders), the manufacture of these systems is

<sup>27</sup> “Hydrogen and Fuel Cell On-Road Freight Workshop at ACT Expo”, California Hydrogen Business Council, June 18, 2018.

planned for the 2021-2025 time frame. Consequently, a wide range of annual production rates were considered in the cost analysis to capture both low volume production in the next few years, and future high volume production. High volume production is deemed plausible as it is assumed that a single fuel cell system developer would likely make stacks for various types of systems built up from 80kW stacks and may even ship those systems internationally. Since total US MDV 2016 truck sales (Class 4-7) reached ~200,000, an annual production rate of half that for pooled orders of a common fuel cell stack is plausible.<sup>28</sup> Consequently, in 2018, 200, 500, 1,000, 10,000, 50,000, and 100,000 MDV trucks per year are selected as the annual manufacturing rates to be examined in the cost study.

### **3.1 Current Fuel Cell Truck Demonstrations**

There are multiple demonstrations ongoing for fuel cell medium/heavy duty trucks, however, the only complete demonstrated system is Toyota's HD drayage truck using Mirai FC stacks. Toyota has demonstrated nearly 10,000 miles of drayage operation at the Ports of Long Beach with their "Alpha" truck containing two Mirai fuel cell stacks.<sup>29</sup> Figure 8 lists the various truck fuel cell demonstrations known to the authors and grouped by fuel cell system manufacturer. Additionally, Hyundai recently announced plans to develop a fuel cell powered 5-ton garbage truck.<sup>30</sup>

---

<sup>28</sup> <https://www.osti.gov/scitech/biblio/1255689-vehicle-technologies-market-report>

<sup>29</sup> <https://www.autoblog.com/2018/07/31/toyota-next-iteration-fuel-cell-semi-truck/>

<sup>30</sup> <http://www.koreaherald.com/view.php?ud=20180813000493>

	US Hybrid	Hydrogenics	Loop Energy	Ballard	Plug Power	Toyota	Power Cell
FC System Sizes	80kW (FCe80) (MD) 160kW (HD) – Acquired UTC PEM FC	Celerity 60kW (2 x 30kW) module (MD/HD)	56kWgross (50kWnet)	30kW (MD) 85kW (HD)	20kW (2x10kW)	228kW (HD) (2 Mirai stacks)	300kW (HD)
Truck Application	Drayage	Parcel delivery and refuse	Port/Distrib. Yard and Drayage	Regional/Local Drayage Class 8	Parcel Delivery (FedEx-style truck)	Drayage Class 8	Line-Haul
Demonstrations/ Collaborations	Nissan (REX), Jiangsu Dewei Advance Matrls. Co.	Transpower, UPS, CTE (Center for Transportation and the Environment)	Peterbilt, CNGTC	Kenworth, BAE, Total Transportation Services (TTSI), CTE, Dongfeng, Lightning Systems	FedEx, Workhorse Group (DOE project)	Project Portal Semi: Kenworth T680 tractor	Nikola Motors, Fitzgerald Gliders Group, Ryder System, Thompson Caterpillar
FC Dominant/ FC Range Extender (REX)	Both	Both	REX	REX	REX	FC Dominant	REX (FC runs ~50% of time)
Operating Temp	50C	70C	58-62C	~72C			
Pressure	~1 atm			~1.9 atm (est.)		<=2.5 atm	
H <sub>2</sub> Storage/range	25kg 200 miles	UPS: 10kg 125 miles/day		350 bar, 25kg 110-125 mi/day	350 bar 11.6kg H2 150-270 miles/route	200 miles	100kg 800-1,200 mi/fill
Other Notes	4k FC prod./month (planned), 30kWh battery	140kWh battery UPS: 20+yr lifetime, no external humidification	10yr lifetime	100kWh Battery – Kenworth/BAE  500 orders for Dongfeng (MD) 300 orders for Ford Transit	Battery: 80kWh TM4 Traction Motor 200 kW 2100 N-m	Battery: 12kWh, ~275kW	750kW total pwr Battery: 320kWh, 50k trucks/yr (planned) Range: 100-200 miles pure electr.

**Figure 8. Table of fuel cell manufacturers performing demonstrations for fuel cell medium and heavy-duty trucks.**

## 4 System Schematics and Bills of Materials

System schematics are a useful method of identifying the main components within a system and how they interact. System flow schematics for each of the systems in the current report are shown below. Note that for clarity, only the main system components are identified in the flow schematics. As the analysis has evolved throughout the course of the annual updates, there has been a general trend toward system simplification. This reflects improvements in technology to reduce the number of parasitic supporting systems and thereby reduce system cost. The path to system simplification is likely to continue, and, in the authors' opinion, remains necessary to achieve or surpass cost parity with internal combustion engines.

The authors have conducted annually updated DFMA<sup>®</sup> analysis of automotive fuel cell systems since 2006. Side by side comparison of annually updated system diagrams is a convenient way to assess important changes/advances. The 2017, 2018, 2020, and 2025 diagrams for the automotive systems are shown below.

### 4.1 2017 Automotive System Schematic

The system schematic for the 2017 light-duty vehicle (auto) fuel cell power system appears in Figure 9 as a reference for comparison with the currently analyzed systems.

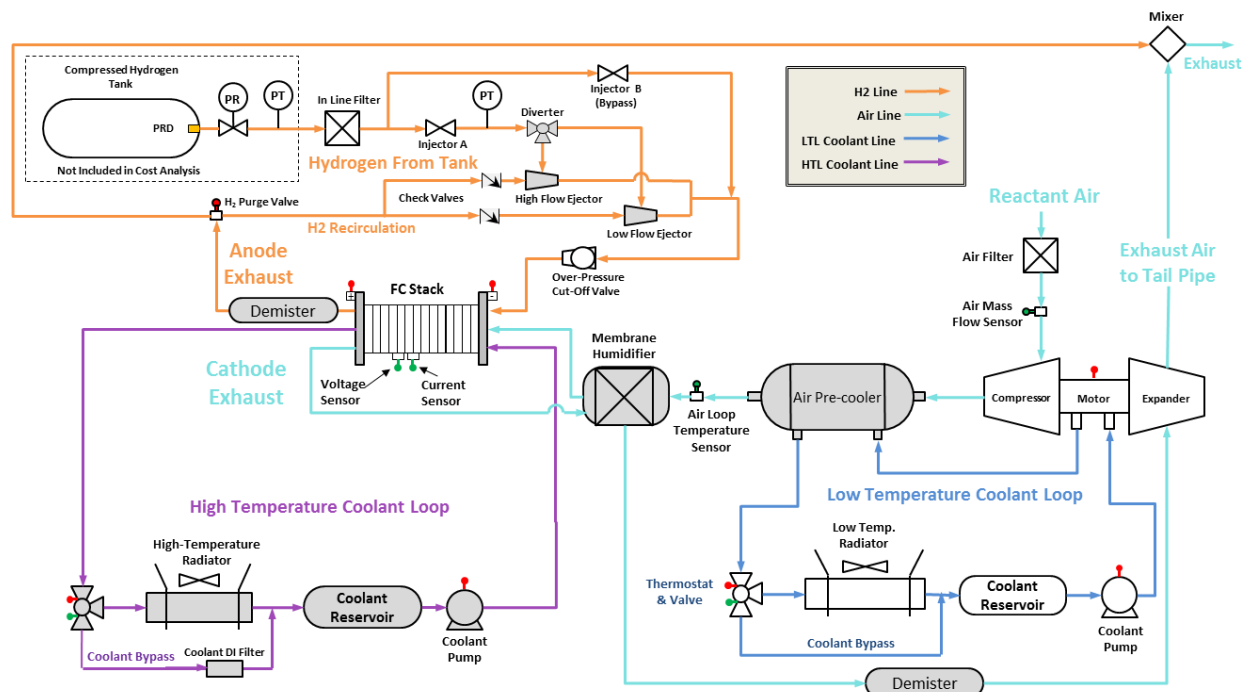


Figure 9. Flow schematic for the 2017 automotive fuel cell system

## 4.2 2018, 2020, and 2025 Automotive System Schematic

The system schematic for the 2018, 2020, and 2025 light-duty vehicle (auto) fuel cell power systems appear in Figure 10. A few changes were made between the 2017 and 2018 system designs including:

- addition of an air bypass valve at the stack inlet and an air shut-off valve at the stack outlet to align with commercial systems like the Toyota Mirai.
- addition of an air bleed orifice to regulate the flow of a small amount of air to float the air foil bearings of the compressor and expander shafts and to cool the air compressor motor.
- addition of a differential pressure sensor on the air bleed line to allow capture of the air bleed and to align with ANL's fuel cell performance model.
- the H<sub>2</sub> recirculation system shifted from a dual ejector to a lower cost pulsed-ejector system (injector upstream of an H<sub>2</sub> ejector).

All other components remain similar between the 2018 and 2020/2025 automotive systems. Advancements in performance, materials, and manufacturing technique are described in subsequent sections.

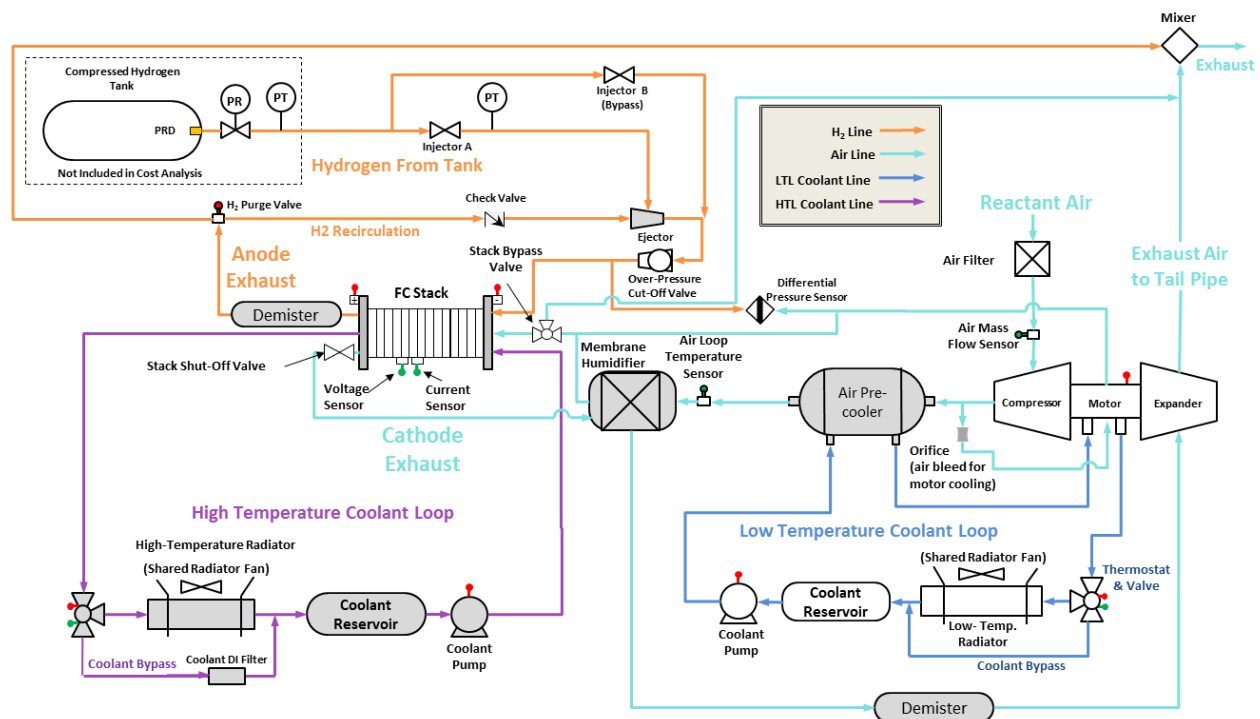


Figure 10. Flow schematic for the 2018, 2020, and 2025 automotive fuel cell systems

### 4.3 2018 Medium Duty System Schematic

The system schematic for the 2018 MDV fuel cell power system appears in Figure 11. Power system hardware and layout are very similar to the 2018 auto system with the exception of a few key differences: two fuel cell stacks and accompanying components, and no expander on the air exhaust.

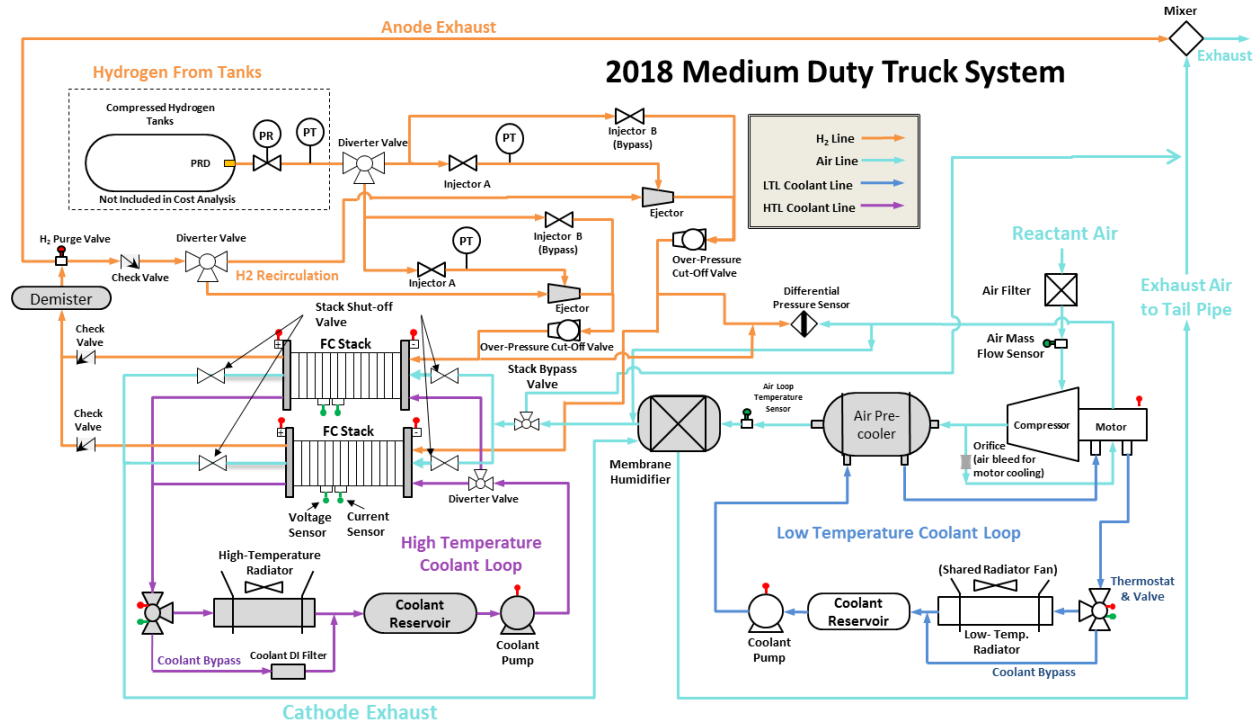


Figure 11. Flow schematic for the 2018 MDV fuel cell system



## 4.4 2020/2025 Medium Duty System Schematic

The system schematic for the 2020/2025 MDV fuel cell power systems appears in Figure 12. Power system hardware and layout are analogous to the 2018 MDV system with the exception of the future systems containing an expander on the air compressor/motor assembly.

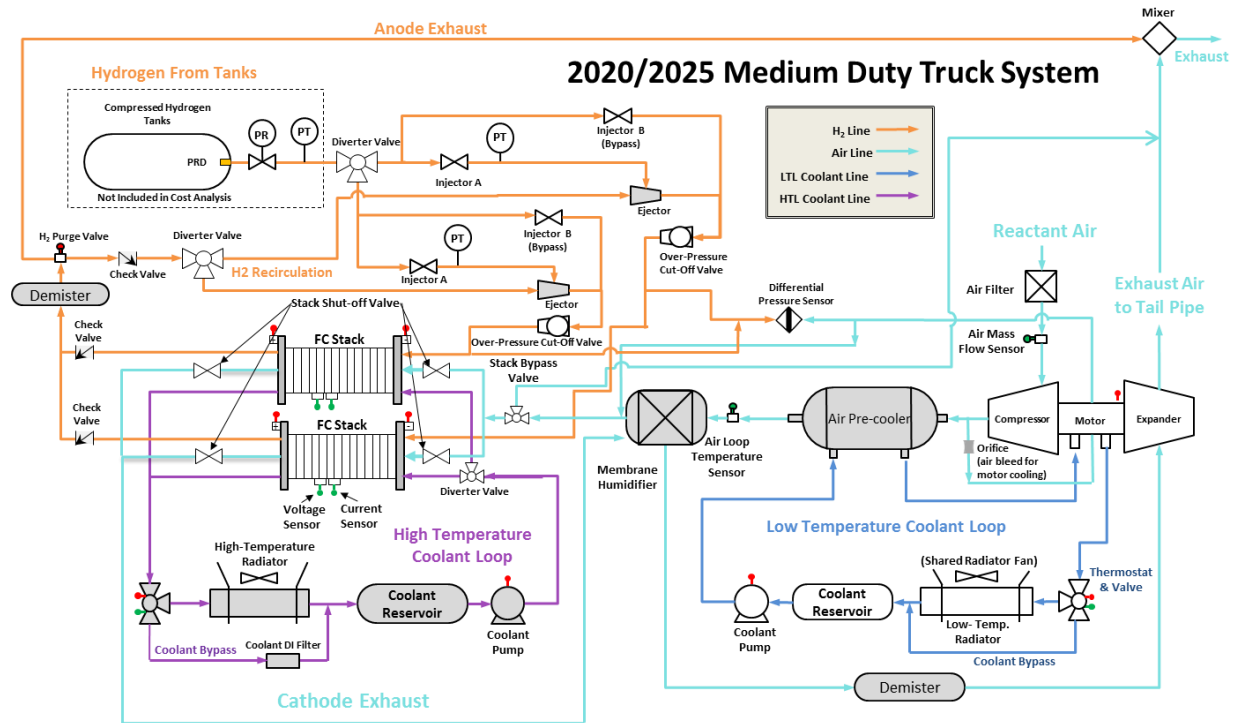


Figure 12. Flow schematic for the 2020 and 2025 MDV fuel cell systems

## **5 System Cost Summaries**

Complete fuel cell power system configurations are defined to allow preparation of comprehensive system Bills of Materials, which in turn allow comprehensive assessments of system cost. Key parameters for the 2017, 2018, 2020, and 2025 automotive fuel cell power systems are shown in Figure 13 below, with cost result summaries detailed in subsequent report sections. Key parameters for the 2018, 2020, and 2025 medium-duty truck power systems are shown in Figure 26, with cost result summaries detailed in the following report sections.

### **5.1 Cost Summary of the 2018 Automotive System**

Results of the cost analysis for the 2018 automotive technology system at each of the six annual production rates are shown below. Figure 14 details the cost of the stacks, Figure 15 details the cost of the balance of plant components, and Figure 16 details the cost summation for the system. Figure 17 shows a graph of the stack and total system cost at all manufacturing rates including error bars based on Monte Carlo sensitivity analysis. Assumptions pertaining to the Monte Carlo analysis are detailed in section 15.2. It should be noted that the 2018 error bars are much narrower than in previous year analyses (prior to 2017) and primarily result from SA's selection of narrower Pt loading and power density ranges which, in 2018, solely reflect variations in manufacturing processes (i.e. membrane fabrication, catalyst synthesis, catalyst coating) rather than variations in system design (as used in pre-2017 studies).

While the cost results, particularly the \$/kW results, are presented to the penny level, this should not be construed to indicate that level of accuracy in all cases. Rather, results are presented to a high level of monetary discretization to allow discernment of the direction and approximate magnitude of cost changes. Those minor impacts might otherwise be lost to the reader due to rounding and rigid adherence to rules for significant digits, and might be misconstrued as an error or as having no impact.

	2017 Auto Technology System	2018 Auto Technology System	2020 Auto System	2025 Auto System (High Innovation)
Power Density (mW/cm <sup>2</sup> )	1,095	1,183	1,250 (1,160)	1,500
Total Pt loading (mgPt/cm <sup>2</sup> )	0.125	0.125	0.125	0.088
Pt Group Metal (PGM) Total Content (g/kW <sub>gross</sub> )	0.114	0.106	0.099 (0.107)	0.059 (0.065)
Net Power (kW <sub>net</sub> )	80	80	80	80
Gross Power (kW <sub>gross</sub> )	87.9	88.4	88.4 (87.9)	88.4 (87.9)
Cell Voltage (V)	0.663	0.657	0.657 (0.663)	0.657 (0.663)
Operating Pressure (atm)	2.5	2.5	2.5	2.5
Stack Temp. (Coolant Exit Temp) (°C)	94	95	95 (94)	95 (94)
Air Stoichiometry	1.5	1.5	1.5	1.5
Q/ΔT (kW <sub>th</sub> /°C)	1.45	1.45	1.45	1.45
Active Cells	377	380	380 (377)	380 (377)
Cell Active Area (cm <sup>2</sup> )	213	197	185 (200)	155
Active to Total Area Ratio	0.625	0.625	0.625	0.65
Stack Specific Power (kW <sub>gross</sub> /kg)	NA	3.70	3.94	4.79
System Specific Power (kW <sub>gross</sub> /kg)	NA	0.96	0.97	1.02
Membrane Material	14-micron Nafion® (850EW) supported on ePTFE	14-micron Nafion® (850EW) supported on ePTFE	10-micron Nafion® (850EW) supported on Electrospun PPSU (ePTFE)	High performance membrane (cost based on 10 μm Nafion® supported on Electrospun PPSU) (Giner DSM)
Radiator/ Cooling System	Aluminum Radiator, Water/Glycol Coolant, DI Filter, Air Precooler	Aluminum Radiator, Water/Glycol Coolant, DI Filter, Air Precooler	Aluminum Radiator, Water/Glycol Coolant, DI Filter, Air Precooler	Aluminum Radiator, Water/Glycol Coolant, DI Filter, Air Precooler
Bipolar Plates and Coating	SS 316L with TreadStone LiteCell™ Coating (Dots-R)	SS 316L with TreadStone LiteCell™ Coating (Dots-R)	SS 304L with Vacuum Coating (modeled as TreadStone TIOX)	SS 304L with Vacuum Coating (modeled as TreadStone TIOX) (No Coating)
BPP Forming/Joining	Progressive Stamping/Welding	Progressive Stamping/Welding	Hydroforming (Progressive Stamping)/Welding	Hydroforming (Progressive Stamping)/Welding
Air Compression	Centrifugal Compressor, Radial-Inflow Expander	Centrifugal Compressor, Radial-Inflow Expander	Centrifugal Compressor, Radial-Inflow Expander	Centrifugal Compressor, Radial-Inflow Expander (with adv. mech. design)
Gas Diffusion Layers	150 microns (105 μm GDL, 45 μm MPL, uncompressed)	150 microns (105 μm GDL, 45 μm MPL, uncompressed)	150 microns (105 μm GDL, 45 μm MPL, uncompressed)	150 microns (105 μm GDL, 45 μm MPL, uncompressed)
Catalyst & Application	Slot Die Coating of: Cath.: Dispersed 0.1 mgPt/cm <sup>2</sup> PtCo/HSC-e (Cost modeled as: d-PtNi <sub>3</sub> ) Anode: Dispersed 0.025mgPt/cm <sup>2</sup> Pt/C	Slot Die Coating of: Cath.: Dispersed 0.1 mgPt/cm <sup>2</sup> PtCo/HSCAnode: Dispersed 0.025mgPt/cm <sup>2</sup> Pt/C	Slot Die Coating of: Cath.: Dispersed 0.107 mgPt/cm <sup>2</sup> PtCo/HSC Anode: Dispersed 0.018mgPt/cm <sup>2</sup> Pt/C	Slot Die Coating of advanced performance catalyst. Cost modeled as: Cath.: Dispersed 0.07 mgPt/cm <sup>2</sup> d-PtCo/HSC Anode: Dispersed 0.018mgPt/cm <sup>2</sup> Pt/C (Assume catalyst cost still dominated by Pt price and no major improvements in application)
CCM Preparation	Gore Direct-Coated Membrane with dual-side slot-die coated electrodes, acid washing	Gore Direct-Coated Membrane with dual-side slot-die coated electrodes, acid washing	Gore Direct-Coated Membrane with dual-side slot-die coated electrodes, acid washing	Gore Direct-Coated Membrane with dual-side slot-die coated electrodes, acid washing
Air Compressor/Expander/ Motor Efficiency	Compressor: 71% Expander: 73% Motor/Controller: 80%	Compressor: 71% Expander: 73% Motor/Controller: 80%	Compressor: 71% Expander: 73% Motor/Controller: 80%	Compressor: 71% Expander: 73% Motor/Controller: 80%
Air Humidification	Plate Frame Membrane Humidifier (with 5 micron ionomer membranes)	Plate Frame Membrane Humidifier (with 5 micron ionomer membranes)	Plate Frame Membrane Humidifier (with 5 micron ionomer membranes)	Plate Frame Membrane Humidifier (with 5 micron ionomer membranes)
Hydrogen Humidification	None	None	None	None
Anode Recirculation	2 fixed geometry ejectors	Pulse ejector with bypass	Pulse ejector with bypass	Pulse ejector with bypass

<b>Exhaust Water Recovery</b>	None	None	None	None
<b>MEA Containment</b>	R2R sub-gaskets, GDL hot-pressed to CCM	R2R sub-gaskets, GDL hot-pressed to CCM	R2R sub-gaskets, GDL hot-pressed to CCM	R2R sub-gaskets, GDL hot-pressed to CCM
<b>Coolant &amp; End Gaskets</b>	Laser Welded(Cooling)/ Screen-Printed Polyolefin Elastomer (End)	Laser Welded(Cooling)/ Screen-Printed Polyolefin Elastomer (End)	Laser Welded(Cooling)/ Screen-Printed Polyolefin Elastomer (End)	Laser Welded(Cooling)/ Screen-Printed Polyolefin Elastomer (End)
<b>Freeze Protection</b>	Drain Water at Shutdown	Drain Water at Shutdown	Drain Water at Shutdown	Drain Water at Shutdown
<b>Hydrogen Sensors</b>	0 for FC System <sup>31</sup>	0 for FC System	0 for FC System	0 for FC System
<b>End Plates/ Compression System</b>	Composite Molded End Plates with Compression Bands	Composite Molded End Plates with Compression Bands	Composite Molded End Plates with Compression Bands	Composite Molded End Plates with Compression Bands
<b>Stack Conditioning (hrs)</b>	2	2	2	1

Figure 13. Summary chart of the 2017 and 2018/2020/2025 fuel cell systems (values in red are for 2020 and 2025 values used in the previous analysis year, 2017)

		2018 Auto System					
<b>Annual Production Rate</b>	<b>Sys/yr</b>	1,000	10,000	20,000	50,000	100,000	500,000
<b>System Net Electric Power (Output)</b>	<b>kWnet</b>	80	80	80	80	80	80
<b>System Gross Electric Power (Output)</b>	<b>kWgross</b>	88.37	88.37	88.37	88.37	88.37	88.37
Bipolar Plates (Stamped)	\$/stack	\$1,554	\$486	\$421	\$408	\$404	\$388
MEAs							
Membranes	\$/stack	\$1,477	\$448	\$351	\$249	\$193	\$115
d-PtCo Catalyst Ink & Application (Dispersion)	\$/stack	\$1,898	\$1,069	\$841	\$719	\$646	\$591
CCM Acid Wash	\$/stack	\$519	\$60	\$59	\$40	\$34	\$29
GDLs	\$/stack	\$1,741	\$468	\$310	\$191	\$140	\$84
M & E Hot Pressing	\$/stack	\$35	\$19	\$16	\$8	\$8	\$8
M & E Cutting & Slitting	\$/stack	\$0	\$20	\$12	\$6	\$5	\$3
MEA Sub-Gaskets	\$/stack	\$876	\$236	\$151	\$107	\$95	\$85
Coolant Gaskets (Laser Welding)	\$/stack	\$1,138	\$533	\$137	\$111	\$78	\$77
End Gaskets (Screen Printing)	\$/stack	\$1	\$1	\$1	\$1	\$1	\$1
End Plates	\$/stack	\$66	\$53	\$45	\$42	\$39	\$34
Current Collectors	\$/stack	\$5	\$5	\$5	\$5	\$5	\$4
Compression Bands	\$/stack	\$9	\$8	\$8	\$6	\$5	\$5
Stack Housing	\$/stack	\$59	\$11	\$8	\$7	\$6	\$5
Stack Assembly	\$/stack	\$75	\$61	\$48	\$40	\$37	\$35
Stack Conditioning	\$/stack	\$78	\$28	\$28	\$26	\$26	\$15
<b>Total Stack Cost</b>	<b>\$/stack</b>	<b>\$9,533</b>	<b>\$3,504</b>	<b>\$2,441</b>	<b>\$1,965</b>	<b>\$1,722</b>	<b>\$1,479</b>
<b>Total Stacks Cost (Net)</b>	<b>2016\$/kWnet</b>	<b>\$119.16</b>	<b>\$43.80</b>	<b>\$30.51</b>	<b>\$24.57</b>	<b>\$21.52</b>	<b>\$18.49</b>
<b>Total Stacks Cost (Gross)</b>	<b>2016\$/kWgross</b>	<b>\$107.87</b>	<b>\$39.65</b>	<b>\$27.62</b>	<b>\$22.24</b>	<b>\$19.48</b>	<b>\$16.74</b>

Figure 14. Detailed stack cost for the 2018 automotive technology system

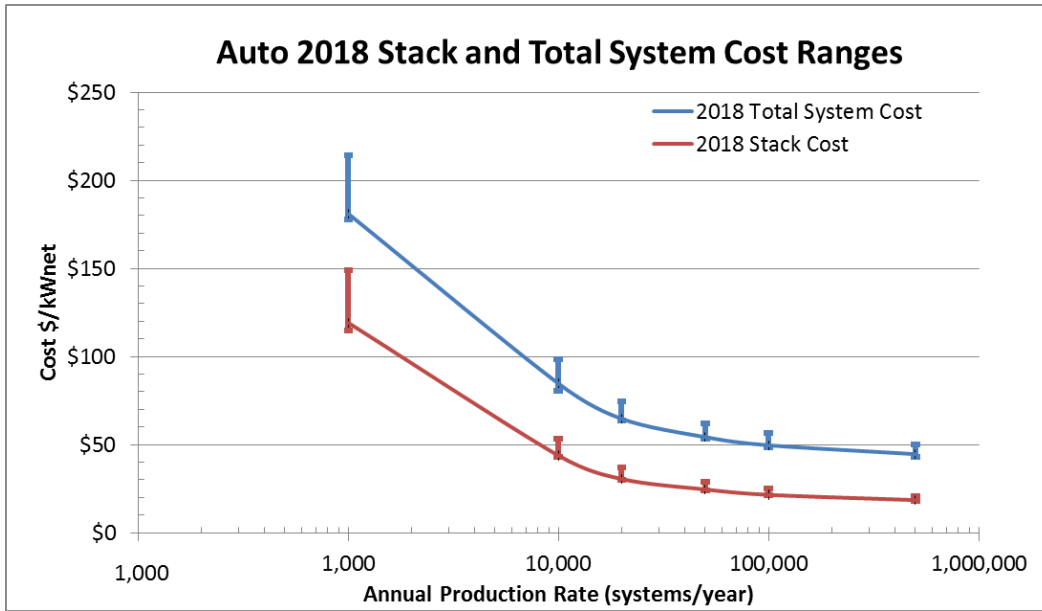
<sup>31</sup> The 2 hydrogen sensors under the hood still remain within the system, however they are not carried under the fuel cell system cost anymore.

		2018 Auto System					
Annual Production Rate	Sys/yr	1,000	10,000	20,000	50,000	100,000	500,000
System Net Electric Power (Output)	kWnet	80	80	80	80	80	80
System Gross Electric Power (Output)	kWgross	88.37	88.37	88.37	88.37	88.37	88.37
<b>BOP Components</b>							
Air Loop	\$/system	\$2,097	\$1,612	\$1,282	\$1,122	\$1,086	\$1,033
Humidifier & Water Recovery Loop	\$/system	\$1,116	\$298	\$210	\$164	\$136	\$108
High-Temperature Coolant Loop	\$/system	\$451	\$419	\$392	\$347	\$331	\$310
Low-Temperature Coolant Loop	\$/system	\$82	\$78	\$74	\$68	\$65	\$61
Fuel Loop	\$/system	\$403	\$313	\$284	\$249	\$229	\$207
System Controller	\$/system	\$162	\$143	\$130	\$97	\$91	\$78
Sensors	\$/system	\$199	\$148	\$136	\$121	\$112	\$93
Miscellaneous	\$/system	\$253	\$161	\$135	\$123	\$118	\$114
<b>Total BOP Cost</b>	<b>\$/system</b>	<b>\$4,763</b>	<b>\$3,172</b>	<b>\$2,643</b>	<b>\$2,292</b>	<b>\$2,167</b>	<b>\$2,004</b>
<b>Total BOP Cost</b>	<b>\$/kW (Net)</b>	<b>\$59.54</b>	<b>\$39.65</b>	<b>\$33.04</b>	<b>\$28.65</b>	<b>\$27.09</b>	<b>\$25.05</b>
<b>Total BOP Cost</b>	<b>\$/kW (Gross)</b>	<b>\$53.90</b>	<b>\$35.89</b>	<b>\$29.91</b>	<b>\$25.94</b>	<b>\$24.52</b>	<b>\$22.68</b>

Figure 15. Detailed balance of plant cost for the 2018 automotive technology system

		2018 Auto System					
Annual Production Rate	Sys/yr	1,000	10,000	20,000	50,000	100,000	500,000
System Net Electric Power (Output)	kWnet	80	80	80	80	80	80
System Gross Electric Power (Output)	kWgross	88.37	88.37	88.37	88.37	88.37	88.37
<b>Component Costs/System</b>							
Fuel Cell Stack (High Value)	\$/system	\$11,900	\$4,253	\$2,967	\$2,318	\$1,996	\$1,666
Fuel Cell Stack	\$/system	\$9,533	\$3,504	\$2,441	\$1,965	\$1,722	\$1,479
Fuel Cell Stack (Low Value)	\$/system	\$9,194	\$3,449	\$2,410	\$1,936	\$1,691	\$1,444
Balance of Plant (High Value)	\$/system	\$5,491	\$3,791	\$3,078	\$2,682	\$2,531	\$2,338
Balance of Plant	\$/system	\$4,763	\$3,172	\$2,643	\$2,292	\$2,167	\$2,004
Balance of Plant (Low Value)	\$/system	\$4,427	\$2,668	\$2,459	\$2,132	\$2,008	\$1,844
System Assembly & Testing	\$/system	\$189	\$99	\$90	\$85	\$85	\$83
<b>Cost/System (High Value)</b>	<b>\$/system</b>	<b>\$17,134</b>	<b>\$7,861</b>	<b>\$5,962</b>	<b>\$4,956</b>	<b>\$4,506</b>	<b>\$4,009</b>
<b>Cost/System</b>	<b>\$/system</b>	<b>\$14,485</b>	<b>\$6,775</b>	<b>\$5,174</b>	<b>\$4,342</b>	<b>\$3,974</b>	<b>\$3,567</b>
<b>Cost/System (Low Value)</b>	<b>\$/system</b>	<b>\$14,207</b>	<b>\$6,452</b>	<b>\$5,108</b>	<b>\$4,266</b>	<b>\$3,880</b>	<b>\$3,447</b>
<b>Total System Cost</b>	<b>2016\$/kWnet</b>	<b>\$181.07</b>	<b>\$84.69</b>	<b>\$64.67</b>	<b>\$54.28</b>	<b>\$49.67</b>	<b>\$44.58</b>
<b>Cost/kWgross</b>	<b>2016\$/kWgross</b>	<b>\$163.91</b>	<b>\$76.66</b>	<b>\$58.54</b>	<b>\$49.14</b>	<b>\$44.96</b>	<b>\$40.36</b>

Figure 16. Detailed system cost for the 2018 automotive technology system



**Figure 17. 2018 Automotive Stack and Total System Cost at all manufacturing rates. Error bars are based on Monte Carlo sensitivity analysis and denote the middle 90% confidence range of results.**

## 5.2 Cost Summary of the 2020 and 2025 Auto Systems

Results of the cost analysis of the 2020 and 2025 auto technology system at 1,000, 10,000, 20,000, 50,000, 100,000, and 500,000 systems per year production rates are shown below. Figure 18 and Figure 22 detail the cost of the stacks, Figure 19 and Figure 23 detail the cost of the balance of plant components, and Figure 20 and Figure 24 detail the cost summation for the two systems. Figure 21 and Figure 25 show graphs of projected stack and total system cost at all manufacturing rates including error bars based on Monte Carlo sensitivity analysis. Assumptions pertaining to the Monte Carlo analysis are detailed in sections 15.2.

		2020 Auto System					
Annual Production Rate	Sys/yr	1,000	10,000	20,000	50,000	100,000	500,000
System Net Electric Power (Output)	kWnet	80	80	80	80	80	80
System Gross Electric Power (Output)	kWgross	88.37	88.37	88.37	88.37	88.37	88.37
<b>Bipolar Plates (Stamped)</b>							
	\$/stack	\$1,252	\$395	\$328	\$298	\$288	\$275
<b>MEAs</b>							
	\$/stack	\$1,009	\$287	\$174	\$122	\$89	\$50
	\$/stack	\$1,775	\$1,020	\$793	\$681	\$610	\$551
	\$/stack	\$488	\$56	\$54	\$28	\$27	\$22
	\$/stack	\$1,635	\$457	\$302	\$185	\$135	\$80
	\$/stack	\$35	\$12	\$12	\$7	\$7	\$6
	\$/stack	\$0	\$20	\$11	\$6	\$4	\$3
	\$/stack	\$880	\$231	\$147	\$104	\$91	\$81
	\$/stack	\$1,137	\$532	\$136	\$110	\$78	\$76
	\$/stack	\$1	\$1	\$1	\$1	\$1	\$1
	\$/stack	\$62	\$50	\$43	\$39	\$37	\$32
	\$/stack	\$5	\$5	\$4	\$4	\$4	\$4
	\$/stack	\$9	\$8	\$8	\$6	\$5	\$5
	\$/stack	\$59	\$11	\$8	\$7	\$6	\$5
	\$/stack	\$75	\$61	\$48	\$40	\$37	\$35
	\$/stack	\$78	\$28	\$28	\$26	\$26	\$15
<b>Total Stack Cost</b>	<b>\$/stack</b>	<b>\$8,502</b>	<b>\$3,173</b>	<b>\$2,096</b>	<b>\$1,664</b>	<b>\$1,444</b>	<b>\$1,241</b>
<b>Total Stacks Cost (Net)</b>	<b>2016\$/kWnet</b>	<b>\$106.27</b>	<b>\$39.66</b>	<b>\$26.20</b>	<b>\$20.79</b>	<b>\$18.05</b>	<b>\$15.51</b>
<b>Total Stacks Cost (Gross)</b>	<b>2016\$/kWgross</b>	<b>\$96.20</b>	<b>\$35.90</b>	<b>\$23.71</b>	<b>\$18.82</b>	<b>\$16.34</b>	<b>\$14.04</b>

Figure 18. Detailed stack cost for the 2020 auto technology system

		2020 Auto System					
Annual Production Rate	Sys/yr	1,000	10,000	20,000	50,000	100,000	500,000
System Net Electric Power (Output)	kWnet	80	80	80	80	80	80
System Gross Electric Power (Output)	kWgross	88.37	88.37	88.37	88.37	88.37	88.37
<b>BOP Components</b>							
	\$/system	\$2,097	\$1,612	\$1,282	\$1,122	\$1,086	\$1,033
	\$/system	\$1,117	\$339	\$210	\$164	\$136	\$108
	\$/system	\$451	\$397	\$392	\$347	\$331	\$310
	\$/system	\$82	\$73	\$74	\$68	\$65	\$61
	\$/system	\$403	\$312	\$284	\$249	\$229	\$207
	\$/system	\$162	\$143	\$130	\$97	\$91	\$78
	\$/system	\$199	\$148	\$136	\$121	\$112	\$93
	\$/system	\$253	\$161	\$135	\$123	\$118	\$114
<b>Total BOP Cost</b>	<b>\$/system</b>	<b>\$4,763</b>	<b>\$3,183</b>	<b>\$2,643</b>	<b>\$2,292</b>	<b>\$2,167</b>	<b>\$2,004</b>
<b>Total BOP Cost</b>	<b>\$/kW (Net)</b>	<b>\$59.54</b>	<b>\$39.79</b>	<b>\$33.04</b>	<b>\$28.65</b>	<b>\$27.09</b>	<b>\$25.05</b>
<b>Total BOP Cost</b>	<b>\$/kW (Gross)</b>	<b>\$53.90</b>	<b>\$36.02</b>	<b>\$29.91</b>	<b>\$25.94</b>	<b>\$24.52</b>	<b>\$22.68</b>

Figure 19. Detailed balance of plant cost for the 2020 auto technology system

		2020 Auto System					
Annual Production Rate	Sys/yr	1,000	10,000	20,000	50,000	100,000	500,000
System Net Electric Power (Output)	kWnet	80	80	80	80	80	80
System Gross Electric Power (Output)	kWgross	88.37	88.37	88.37	88.37	88.37	88.37
<b>Component Costs/System</b>							
Fuel Cell Stack (High Value)	\$/system	\$10,692	\$3,841	\$2,543	\$1,951	\$1,662	\$1,392
Fuel Cell Stack	\$/system	\$8,502	\$3,173	\$2,096	\$1,664	\$1,444	\$1,241
Fuel Cell Stack (Low Value)	\$/system	\$8,177	\$3,111	\$2,052	\$1,629	\$1,412	\$1,212
Balance of Plant (High Value)	\$/system	\$5,489	\$3,803	\$3,075	\$2,678	\$2,527	\$2,334
Balance of Plant	\$/system	\$4,763	\$3,183	\$2,643	\$2,292	\$2,167	\$2,004
Balance of Plant (Low Value)	\$/system	\$4,427	\$2,679	\$2,133	\$2,133	\$2,009	\$1,845
System Assembly & Testing	\$/system	\$189	\$99	\$90	\$85	\$85	\$83
Cost/System (High Value)	\$/system	\$15,940	\$7,468	\$5,542	\$4,595	\$4,179	\$3,740
Cost/System	\$/system	\$13,455	\$6,455	\$4,829	\$4,041	\$3,696	\$3,328
Cost/System (Low Value)	\$/system	\$13,170	\$6,111	\$4,739	\$3,948	\$3,590	\$3,206
Total System Cost	2016\$/kWnet	\$168.18	\$80.69	\$60.36	\$50.51	\$46.20	\$41.60
Cost/kWgross	2016\$/kWgross	\$152.25	\$73.04	\$54.64	\$45.73	\$41.82	\$37.66

Figure 20. Detailed system cost for the 2020 auto technology system

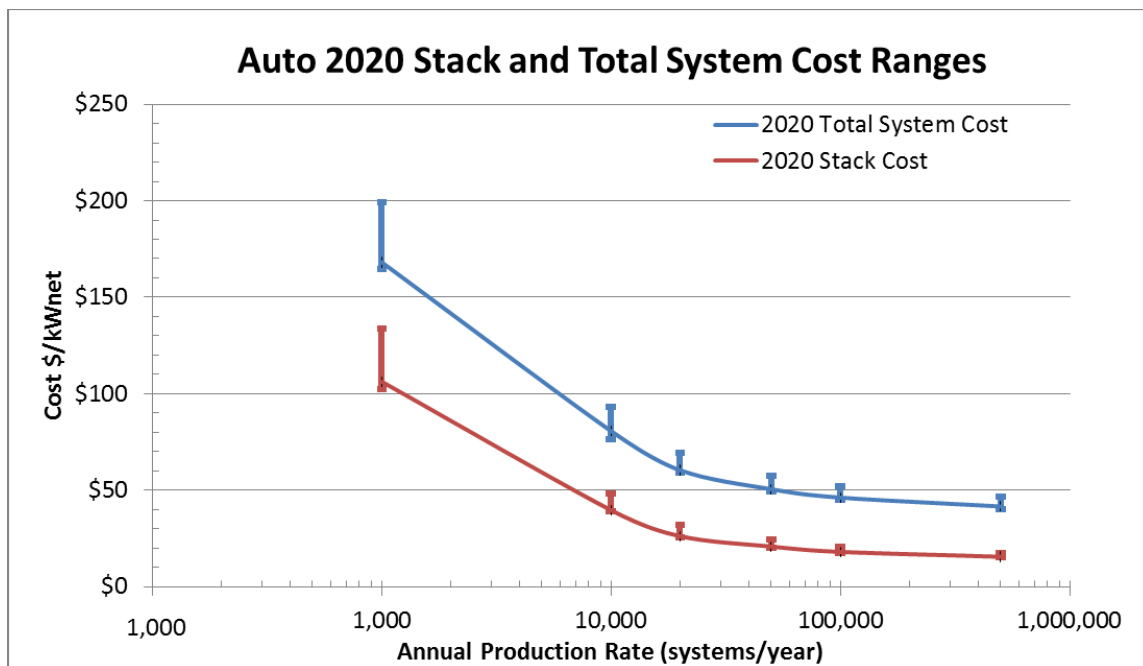


Figure 21. 2020 Auto Stack and Total System Cost at all manufacturing rates. Error bars are based on Monte Carlo sensitivity analysis and denote the middle 90% confidence range of results.



		2025 Auto System					
Annual Production Rate	Sys/yr	1,000	10,000	20,000	50,000	100,000	500,000
System Net Electric Power (Output)	kWnet	80	80	80	80	80	80
System Gross Electric Power (Output)	kWgross	88.37	88.37	88.37	88.37	88.37	88.37
Bipolar Plates (Stamped)	\$/stack	\$1,208	\$359	\$293	\$262	\$254	\$241
MEAs							
Membranes	\$/stack	\$992	\$224	\$151	\$118	\$79	\$46
d-PtCo Catalyst Ink & Application (Dispersion)	\$/stack	\$1,533	\$762	\$562	\$467	\$396	\$334
CCM Acid Wash	\$/stack	\$485	\$54	\$52	\$27	\$26	\$19
GDLs	\$/stack	\$1,373	\$428	\$281	\$169	\$122	\$70
M & E Hot Pressing	\$/stack	\$31	\$10	\$10	\$6	\$5	\$5
M & E Cutting & Slitting	\$/stack	\$0	\$20	\$12	\$5	\$3	\$2
MEA Sub-Gaskets	\$/stack	\$868	\$218	\$133	\$92	\$80	\$68
Coolant Gaskets (Laser Welding)	\$/stack	\$1,134	\$529	\$134	\$109	\$77	\$72
End Gaskets (Screen Printing)	\$/stack	\$1	\$1	\$1	\$1	\$1	\$0
End Plates	\$/stack	\$52	\$42	\$35	\$32	\$30	\$26
Current Collectors	\$/stack	\$5	\$4	\$4	\$4	\$4	\$4
Compression Bands	\$/stack	\$9	\$8	\$8	\$6	\$5	\$5
Stack Housing	\$/stack	\$59	\$10	\$7	\$6	\$5	\$4
Stack Assembly	\$/stack	\$75	\$61	\$48	\$40	\$37	\$35
Stack Conditioning	\$/stack	\$62	\$14	\$14	\$14	\$13	\$7
<b>Total Stack Cost</b>	<b>\$/stack</b>	<b>\$7,889</b>	<b>\$2,745</b>	<b>\$1,744</b>	<b>\$1,357</b>	<b>\$1,139</b>	<b>\$940</b>
<b>Total Stacks Cost (Net)</b>	<b>2016\$/kWnet</b>	<b>\$98.62</b>	<b>\$34.31</b>	<b>\$21.80</b>	<b>\$16.97</b>	<b>\$14.23</b>	<b>\$11.75</b>
<b>Total Stacks Cost (Gross)</b>	<b>2016\$/kWgross</b>	<b>\$89.27</b>	<b>\$31.06</b>	<b>\$19.74</b>	<b>\$15.36</b>	<b>\$12.88</b>	<b>\$10.64</b>

Figure 22. Detailed stack cost for the 2025 auto technology system

		2025 Auto System					
Annual Production Rate	Sys/yr	1,000	10,000	20,000	50,000	100,000	500,000
System Net Electric Power (Output)	kWnet	80	80	80	80	80	80
System Gross Electric Power (Output)	kWgross	88.37	88.37	88.37	88.37	88.37	88.37
<b>BOP Components</b>							
Air Loop	\$/system	\$1,925	\$1,483	\$1,220	\$1,069	\$1,034	\$982
Humidifier & Water Recovery Loop	\$/system	\$1,117	\$339	\$210	\$164	\$136	\$108
High-Temperature Coolant Loop	\$/system	\$451	\$397	\$392	\$347	\$331	\$310
Low-Temperature Coolant Loop	\$/system	\$82	\$73	\$74	\$68	\$65	\$61
Fuel Loop	\$/system	\$403	\$255	\$284	\$249	\$229	\$207
System Controller	\$/system	\$162	\$143	\$130	\$97	\$91	\$78
Sensors	\$/system	\$199	\$148	\$136	\$121	\$112	\$93
Miscellaneous	\$/system	\$253	\$161	\$135	\$123	\$118	\$114
<b>Total BOP Cost</b>	<b>\$/system</b>	<b>\$4,591</b>	<b>\$2,998</b>	<b>\$2,581</b>	<b>\$2,240</b>	<b>\$2,115</b>	<b>\$1,953</b>
<b>Total BOP Cost</b>	<b>\$/kW (Net)</b>	<b>\$57.38</b>	<b>\$37.47</b>	<b>\$32.26</b>	<b>\$28.00</b>	<b>\$26.44</b>	<b>\$24.42</b>
<b>Total BOP Cost</b>	<b>\$/kW (Gross)</b>	<b>\$51.95</b>	<b>\$33.92</b>	<b>\$29.20</b>	<b>\$25.35</b>	<b>\$23.94</b>	<b>\$22.10</b>

Figure 23. Detailed balance of plant cost for the 2025 auto technology system

		2025 Auto System					
Annual Production Rate	Sys/yr	1,000	10,000	20,000	50,000	100,000	500,000
System Net Electric Power (Output)	kWnet	80	80	80	80	80	80
System Gross Electric Power (Output)	kWgross	88.37	88.37	88.37	88.37	88.37	88.37
<b>Component Costs/System</b>							
Fuel Cell Stack (High Value)	\$/system	\$9,542	\$3,337	\$2,148	\$1,610	\$1,333	\$1,082
Fuel Cell Stack	\$/system	\$7,889	\$2,745	\$1,744	\$1,357	\$1,139	\$940
Fuel Cell Stack (Low Value)	\$/system	\$7,528	\$2,677	\$1,693	\$1,320	\$1,103	\$913
Balance of Plant (High Value)	\$/system	\$5,317	\$3,561	\$3,014	\$2,627	\$2,476	\$2,284
Balance of Plant	\$/system	\$4,591	\$2,998	\$2,581	\$2,240	\$2,115	\$1,953
Balance of Plant (Low Value)	\$/system	\$4,334	\$2,588	\$2,436	\$2,113	\$1,989	\$1,826
System Assembly & Testing	\$/system	\$189	\$99	\$90	\$85	\$85	\$83
Cost/System (High Value)	\$/system	\$14,646	\$6,753	\$5,095	\$4,210	\$3,804	\$3,381
Cost/System	\$/system	\$12,669	\$5,842	\$4,415	\$3,682	\$3,339	\$2,977
Cost/System (Low Value)	\$/system	\$12,387	\$5,560	\$4,347	\$3,610	\$3,255	\$2,883
Total System Cost	2016\$/kWnet	\$158.37	\$73.02	\$55.19	\$46.03	\$41.74	\$37.21
Cost/kWgross	2016\$/kWgross	\$143.36	\$66.11	\$49.96	\$41.67	\$37.78	\$33.68

Figure 24. Detailed system cost for the 2025 auto technology system

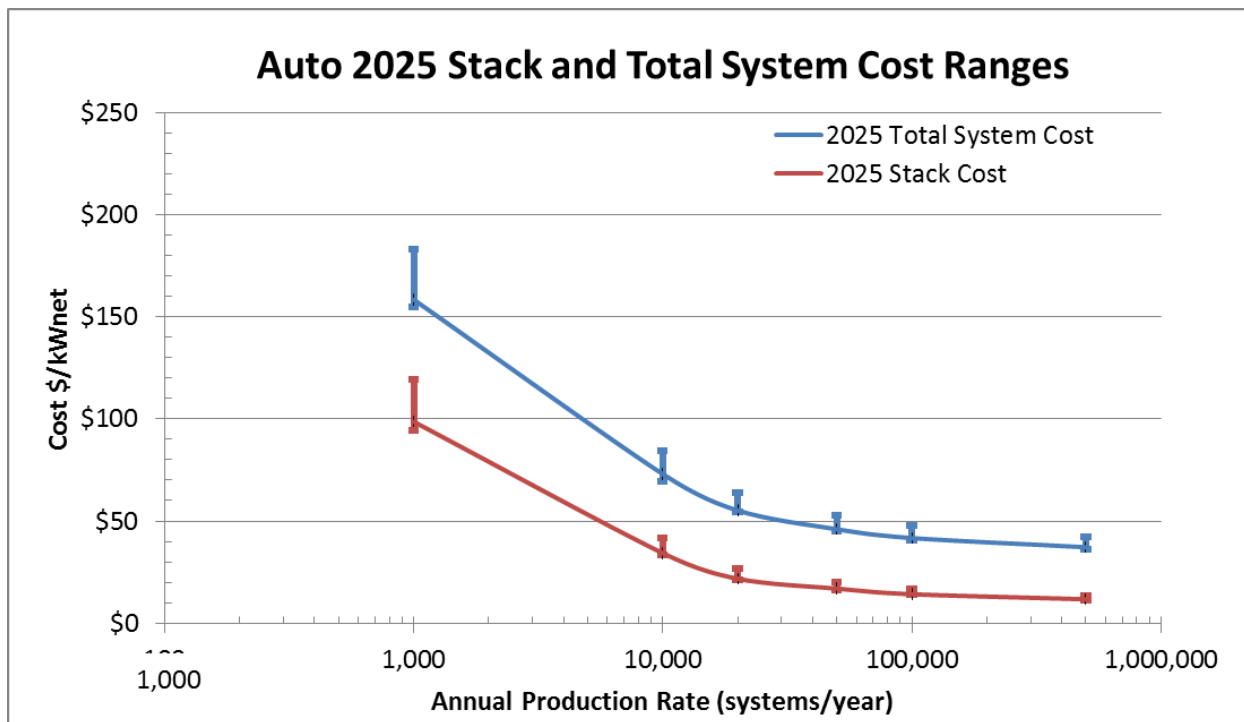


Figure 25. 2025 Auto Stack and Total System Cost at all manufacturing rates. Error bars are based on Monte Carlo sensitivity analysis and denote the middle 90% confidence range of results.

### **5.3 Cost Summary of the 2018 Medium Duty Truck System**

Results of the cost analysis for the 2018 medium duty truck technology system at each of the six annual production rates are shown below. Figure 27 details the cost of the stacks, Figure 28 details the cost of the balance of plant components, and Figure 29 details the cost summation for the system. Figure 30 shows a graph of the stack and total system cost at all manufacturing rates including error bars based on Monte Carlo sensitivity analysis. Assumptions pertaining to the Monte Carlo analysis are detailed in section 15.2.

	2016 Bus Technology System	2018 MDV Technology System	2020 MDV System	2025 MDV System (High Innovation)
Power Density (mW/cm <sup>2</sup> )	739	1,178	1,200	1,350
Total Pt loading (mgPt/cm <sup>2</sup> )	0.5	0.35	0.35	0.3
Pt Group Metal (PGM) Total Content (g/kW <sub>gross</sub> )	0.719	0.321	0.316	0.242
Net Power (kW <sub>net</sub> )	160	160	160	160
Gross Power (kW <sub>gross</sub> )	194.7	196.5	189.3	185.2
Cell Voltage (V)	0.659	0.68	0.68	0.68
Operating Pressure (atm)	1.9	2.35	2.35	2.35
Stack Temp. (Coolant Exit Temp) (°C)	72	63	63	63
Air Stoichiometry	1.8	1.5	1.5	1.5
Q/ΔT (kW <sub>th</sub> /°C)	5.4	7.2	6.9	6.8
Active Cells per System	758	736	736	736
Cell Active Area (cm <sup>2</sup> )	348	227	214	186
Active to Total Area Ratio	0.625	0.625	0.625	0.65
Stack Specific Power (kW <sub>gross</sub> /kg)	NA	3.74	3.81	4.41
System Specific Power (kW <sub>gross</sub> /kg)	NA	0.98	0.96	1.0
Membrane Material	20-micron Nafion® (1100EW) supported on ePTFE	14-micron Nafion® (850EW) supported on ePTFE	14-micron Nafion® (850EW) supported on ePTFE	14-micron Nafion® (850EW) supported on electrospun support
Radiator/ Cooling System	Aluminum Radiator, Water/Glycol Coolant, DI Filter, Air Precooler	Aluminum Radiator, Water/Glycol Coolant, DI Filter, Air Precooler	Aluminum Radiator, Water/Glycol Coolant, DI Filter, Air Precooler	Aluminum Radiator, Water/Glycol Coolant, DI Filter, Air Precooler
Bipolar Plates and Coating	SS 316L with TreadStone LiteCell™ Coating (Dots-R)	SS 316L with TreadStone LiteCell™ Coating (Dots-A)	SS 316L with Vacuum Coating (modeled as TreadStone TIOX)	SS 316L with Vacuum Coating (modeled as TreadStone TIOX)
BPP Forming/Joining	Progressive Stamping/Welding	Progressive Stamping/Welding	Hydroforming or HVAF/Welding	Hydroforming or HVAF/Welding
Air Compression	Eaton-Style Multi-Lobe Compressor, Without Expander	Eaton-style compressor (no expander)	Eaton-style compressor, Eaton-style expander	Centrifugal Compressor, Radial-Inflow Expander
Gas Diffusion Layers	Carbon Paper Macroporous Layer with Microporous Layer (DFMA® cost of Avcarb GDL)	150 microns (105 μm GDL, 45 μm MPL, uncompressed)	150 microns (105 μm GDL, 45 μm MPL, uncompressed)	150 microns (105 μm GDL, 45 μm MPL, uncompressed)
Catalyst & Application	Slot Die Coating of: Cath.: Dispersed 0.4 mgPt/cm <sup>2</sup> Pt/C Anode: Dispersed 0.1mgPt/cm <sup>2</sup> Pt/C	Slot Die Coating of: Cath.: Dispersed 0.3 mgPt/cm <sup>2</sup> PtCo/HSC Anode: Dispersed 0.05mgPt/cm <sup>2</sup> Pt/C	Slot Die Coating of: Cath.: Dispersed 0.3 mgPt/cm <sup>2</sup> PtCo/HSC Anode: Dispersed 0.05mgPt/cm <sup>2</sup> Pt/C	Slot Die Coating of advanced performance catalyst. Cost modeled as: Cath.: Dispersed 0.25 mgPt/cm <sup>2</sup> d-PtCo/HSC Anode: Dispersed 0.05mgPt/cm <sup>2</sup> Pt/C
CCM Preparation	None	Gore Direct-Coated Membrane with dual-side slot-die coated electrodes, acid washing	Gore Direct-Coated Membrane with dual-side slot-die coated electrodes, acid washing	Gore Direct-Coated Membrane with dual-side slot-die coated electrodes, acid washing
Air Compressor/Expander/Motor Efficiency	Compr.: 58% (multi-lobe) Exp.: NA Motor/Controller: 95%	Compr.: 58% (multi-lobe) Exp.: NA Motor/Controller: 95%	Compr.: 58% (multi-lobe) Exp.: 59% (multi-lobe) Motor/Controller: 95%	Compr.: 71% (centrifugal) Exp.: 73% (radial in-flow) Motor/Controller: 80%
Air Humidification	Plate Frame Membrane Humidifier (with 5 micron ionomer membranes)	Plate Frame Membrane Humidifier (with 5 micron ionomer membranes)	Plate Frame Membrane Humidifier (with 5 micron ionomer membranes)	Plate Frame Membrane Humidifier (with 5 micron ionomer membranes)
Hydrogen Humidification	None	None	None	None
Anode Recirculation	Dual Ejector System	Pulse ejector with bypass	Pulse ejector with bypass	Pulse ejector with bypass
Exhaust Water Recovery	None	None	None	None
MEA Containment	Screen Printed Seal on MEA sub-gaskets, GDL hot-pressed to CCM	R2R sub-gaskets, GDL hot-pressed to CCM	R2R sub-gaskets, GDL hot-pressed to CCM	R2R sub-gaskets, GDL hot-pressed to CCM

<b>Coolant &amp; End Gaskets</b>	Laser Welded(Cooling)/ Screen-Printed Adhesive Resin (End)	Laser Welded(Cooling)/ Screen-Printed Polyolefin Elastomer (End)	Laser Welded(Cooling)/ Screen-Printed Polyolefin Elastomer (End)	Laser Welded(Cooling)/ Screen-Printed Polyolefin Elastomer (End)
<b>Freeze Protection</b>	Drain Water at Shutdown	Drain Water at Shutdown	Drain Water at Shutdown	Drain Water at Shutdown
<b>Hydrogen Sensors</b>	3 for FC System <sup>32</sup>	1 for FC System <sup>33</sup>	1 for FC System	1 for FC System
<b>End Plates/ Compression System</b>	Composite Molded End Plates with Compression Bands	Composite Molded End Plates with Compression Bands	Composite Molded End Plates with Compression Bands	Composite Molded End Plates with Compression Bands
<b>Stack Conditioning (hrs)</b>	2	2	2	1

Figure 26. Summary chart of the 2016 bus and 2018/2020/2025 medium-duty fuel cell systems

		2018 MDV System						
<b>Annual Production Rate</b>	<b>Sys/yr</b>	200	500	1,000	10,000	50,000	100,000	
<b>System Net Electric Power (Output)</b>	<b>kWnet</b>	160	160	160	160	160	160	
<b>System Gross Electric Power (Output)</b>	<b>kWgross</b>	196.46	196.46	196.46	196.46	196.46	196.46	
<b>Stack Components</b>								
	<b>Bipolar Plates</b>	<b>\$/stack</b>	\$1,861	\$1,747	\$1,633	\$807	\$701	\$681
	<b>MEAs</b>							
	Membrane	<b>\$/stack</b>	\$3,813	\$1,889	\$1,216	\$585	\$344	\$295
	Catalyst Ink & Application	<b>\$/stack</b>	\$3,920	\$3,230	\$2,905	\$2,223	\$1,842	\$1,718
	CCM Acid Wash	<b>\$/stack</b>	\$831	\$520	\$364	\$112	\$49	\$34
	GDLs	<b>\$/stack</b>	\$3,248	\$2,722	\$1,900	\$469	\$207	\$156
	M & E Hot Pressing	<b>\$/stack</b>	\$85	\$31	\$25	\$15	\$12	\$12
	M & E Cutting & Slitting	<b>\$/stack</b>	\$9	\$4	\$4	\$4	\$3	\$4
	MEA Gaskets (Frame or Sub-Gasket)	<b>\$/stack</b>	\$629	\$509	\$394	\$317	\$190	\$163
	Coolant Gaskets (Laser Welding)	<b>\$/stack</b>	\$580	\$440	\$486	\$271	\$141	\$103
	End Gaskets (Screen Printing)	<b>\$/stack</b>	\$2	\$2	\$2	\$1	\$1	\$1
	End Plates	<b>\$/stack</b>	\$113	\$102	\$95	\$71	\$66	\$61
	Current Collectors	<b>\$/stack</b>	\$9	\$8	\$8	\$8	\$8	\$7
	Compression Bands	<b>\$/stack</b>	\$16	\$14	\$13	\$11	\$9	\$8
	Stack Insulation Housing	<b>\$/stack</b>	\$255	\$110	\$63	\$20	\$16	\$16
	Stack Assembly	<b>\$/stack</b>	\$145	\$127	\$119	\$67	\$49	\$46
	Stack Conditioning	<b>\$/stack</b>	\$313	\$128	\$76	\$70	\$67	\$49
	<b>Total Stack Cost</b>	<b>\$/stack</b>	\$15,827	\$11,583	\$9,305	\$5,051	\$3,705	\$3,354
	<b>Total Cost for all 2 Stacks</b>	<b>\$/2 stacks</b>	\$31,655	\$23,165	\$18,609	\$10,102	\$7,410	\$6,708
	<b>Total Stacks Cost (Net)</b>	<b>\$/kWnet</b>	\$197.84	\$144.78	\$116.31	\$63.14	\$46.31	\$41.93
	<b>Total Stacks Cost (Gross)</b>	<b>\$/kWgross</b>	\$161.13	\$117.91	\$94.72	\$51.42	\$37.72	\$34.15

Figure 27. Detailed stack cost for the 2018 MDV technology system

<sup>32</sup> In 2016, a total of 4 hydrogen sensors were assumed to be on-board a FC vehicle: 2 under the hood in fuel cell compartment (within the 2016 cost estimate), 1 in the passenger cabin (not in the 2016 cost estimate), and 1 in the fuel system (not in the 2016 cost estimate). An additional sensor was added to the bus system, due to the larger fuel cell compartment, resulting in a total of 5 hydrogen sensors on-board the modeled FC bus.

<sup>33</sup> In the 2017 and 2018 auto cost analyses, the number of sensors in the fuel cell compartment of the automobile was reduced to zero (from a previous level of 2). Consequently, the MDV sensor estimate is one more than the auto and is thus set at one sensor (for all three technology years).

		2018 MDV System					
Annual Production Rate	Sys/yr	200	500	1,000	10,000	50,000	100,000
System Net Electric Power (Output)	kWnet	160	160	160	160	160	160
System Gross Electric Power (Output)	kWgross	196.46	196.46	196.46	196.46	196.46	196.46
<b>BOP Components</b>							
Air Loop	\$/system	\$9,142	\$8,050	\$7,512	\$5,277	\$4,153	\$3,706
Humidifier & Water Recovery Loop	\$/system	\$2,146	\$1,773	\$1,598	\$1,118	\$934	\$841
High-Temperature Coolant Loop	\$/system	\$2,049	\$1,961	\$1,896	\$1,693	\$1,559	\$1,504
Low-Temperature Coolant Loop	\$/system	\$227	\$219	\$212	\$191	\$177	\$171
Fuel Loop	\$/system	\$1,147	\$1,045	\$977	\$779	\$668	\$627
System Controller	\$/system	\$266	\$256	\$250	\$230	\$218	\$213
Sensors	\$/system	\$748	\$659	\$600	\$444	\$363	\$334
Miscellaneous	\$/system	\$952	\$773	\$700	\$581	\$529	\$508
<b>Total BOP Cost</b>	<b>\$/system</b>	<b>\$16,677</b>	<b>\$14,736</b>	<b>\$13,744</b>	<b>\$10,312</b>	<b>\$8,601</b>	<b>\$7,905</b>
<b>Total BOP Cost</b>	<b>\$/kW (Net)</b>	<b>\$104.23</b>	<b>\$92.10</b>	<b>\$85.90</b>	<b>\$64.45</b>	<b>\$53.75</b>	<b>\$49.41</b>
<b>Total BOP Cost</b>	<b>\$/kW (Gross)</b>	<b>\$84.89</b>	<b>\$75.01</b>	<b>\$69.96</b>	<b>\$52.49</b>	<b>\$43.78</b>	<b>\$40.24</b>

Figure 28. Detailed balance of plant cost for the 2018 MDV technology system

		2018 MDV System					
Annual Production Rate	Sys/yr	200	500	1,000	10,000	50,000	100,000
System Net Electric Power (Output)	kWnet	160	160	160	160	160	160
System Gross Electric Power (Output)	kWgross	196.46	196.46	196.46	196.46	196.46	196.46
<b>Component Costs/System</b>							
Fuel Cell Stacks (High Value)	\$/system	\$36,370	\$27,581	\$21,629	\$11,277	\$8,171	\$7,362
Fuel Cell Stacks (Nominal Value)	\$/system	\$31,655	\$23,165	\$18,609	\$10,102	\$7,410	\$6,708
Fuel Cell Stacks (Low Value)	\$/system	\$30,715	\$22,183	\$17,805	\$9,839	\$7,224	\$6,519
Balance of Plant (High Value)	\$/system	\$20,347	\$17,953	\$16,640	\$12,435	\$10,357	\$9,520
Balance of Plant (Nominal Value)	\$/system	\$16,677	\$14,736	\$13,744	\$10,312	\$8,601	\$7,905
Balance of Plant (Low Value)	\$/system	\$15,144	\$13,399	\$12,499	\$9,454	\$7,889	\$7,296
System Assembly & Testing	\$/system	\$423	\$282	\$234	\$186	\$176	\$172
<b>Cost/System (High Value)</b>	<b>\$/system</b>	<b>\$55,652</b>	<b>\$44,421</b>	<b>\$37,368</b>	<b>\$23,441</b>	<b>\$18,411</b>	<b>\$16,811</b>
<b>Cost/System (Nominal Value)</b>	<b>\$/system</b>	<b>\$48,756</b>	<b>\$38,184</b>	<b>\$32,588</b>	<b>\$20,600</b>	<b>\$16,186</b>	<b>\$14,785</b>
<b>Cost/System (Low Value)</b>	<b>\$/system</b>	<b>\$47,397</b>	<b>\$36,906</b>	<b>\$31,404</b>	<b>\$19,864</b>	<b>\$15,551</b>	<b>\$14,212</b>
<b>Total System Cost</b>	<b>2016\$/kWnet</b>	<b>\$304.72</b>	<b>\$238.65</b>	<b>\$203.68</b>	<b>\$128.75</b>	<b>\$101.17</b>	<b>\$92.41</b>
<b>Cost/kWgross</b>	<b>\$/kWgross</b>	<b>\$248.17</b>	<b>\$194.36</b>	<b>\$165.88</b>	<b>\$104.86</b>	<b>\$82.39</b>	<b>\$75.26</b>

Figure 29. Detailed system cost for the 2018 MDV technology system

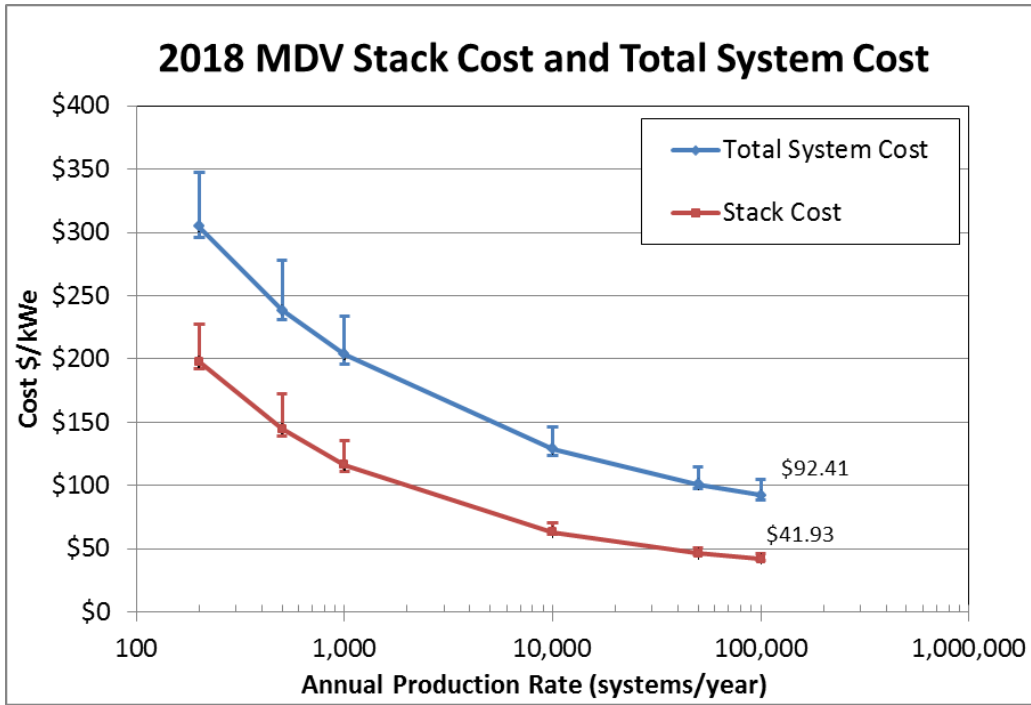


Figure 30. 2018 MDV Stack and Total System Cost at all manufacturing rates. Error bars are based on Monte Carlo sensitivity analysis and denote the middle 90% confidence range of results.

## 5.4 Cost Summary of the 2020 and 2025 Medium Duty Truck Systems

Results of the cost analysis for the 2020 and 2025 medium-duty truck technology systems at each of the six annual production rates are shown below. Figure 31 and Figure 35 detail the cost of the stacks, Figure 32 and Figure 36 detail the cost of the balance of plant components, and Figure 33 and Figure 37 detail the cost summation for the systems. Figure 34 and Figure 38 show graphs of the stack and total system cost at all manufacturing rates including error bars based on Monte Carlo sensitivity analysis. Assumptions pertaining to the Monte Carlo analysis are detailed in section 15.2.

		2020 MDV System					
Annual Production Rate	Sys/yr	200	500	1,000	10,000	50,000	100,000
System Net Electric Power (Output)	kWnet	160	160	160	160	160	160
System Gross Electric Power (Output)	kWgross	189.27	189.27	189.27	189.27	189.27	189.27
<b>Stack Components</b>							
Bipolar Plates	\$/stack	\$1,864	\$1,571	\$1,398	\$672	\$573	\$551
MEAs							
Membrane	\$/stack	\$3,788	\$1,871	\$1,201	\$576	\$338	\$290
Catalyst Ink & Application	\$/stack	\$3,770	\$3,092	\$2,775	\$2,120	\$1,755	\$1,637
CCM Acid Wash	\$/stack	\$809	\$505	\$354	\$109	\$48	\$34
GDLs	\$/stack	\$3,108	\$2,596	\$1,861	\$458	\$201	\$150
M & E Hot Pressing	\$/stack	\$76	\$28	\$23	\$14	\$12	\$11
M & E Cutting & Slitting	\$/stack	\$9	\$4	\$4	\$4	\$3	\$3
MEA Gaskets (Frame or Sub-Gasket)	\$/stack	\$611	\$495	\$383	\$303	\$169	\$157
Coolant Gaskets (Laser Welding)	\$/stack	\$571	\$434	\$485	\$270	\$141	\$102
End Gaskets (Screen Printing)	\$/stack	\$2	\$2	\$2	\$1	\$1	\$1
End Plates	\$/stack	\$108	\$97	\$91	\$67	\$62	\$58
Current Collectors	\$/stack	\$9	\$8	\$8	\$7	\$7	\$7
Compression Bands	\$/stack	\$16	\$14	\$13	\$11	\$9	\$8
Stack Insulation Housing	\$/stack	\$255	\$110	\$62	\$19	\$16	\$16
Stack Assembly	\$/stack	\$145	\$127	\$119	\$67	\$49	\$46
Stack Conditioning	\$/stack	\$304	\$124	\$74	\$69	\$65	\$48
<b>Total Stack Cost</b>	<b>\$/stack</b>	<b>\$15,442</b>	<b>\$11,078</b>	<b>\$8,853</b>	<b>\$4,768</b>	<b>\$3,449</b>	<b>\$3,118</b>
<b>Total Cost for all 2 Stacks</b>	<b>\$/2 stacks</b>	<b>\$30,885</b>	<b>\$22,156</b>	<b>\$17,707</b>	<b>\$9,537</b>	<b>\$6,897</b>	<b>\$6,235</b>
<b>Total Stacks Cost (Net)</b>	<b>\$/kWnet</b>	<b>\$193.03</b>	<b>\$138.48</b>	<b>\$110.67</b>	<b>\$59.60</b>	<b>\$43.11</b>	<b>\$38.97</b>
<b>Total Stacks Cost (Gross)</b>	<b>\$/kWgross</b>	<b>\$163.18</b>	<b>\$117.06</b>	<b>\$93.55</b>	<b>\$50.39</b>	<b>\$36.44</b>	<b>\$32.94</b>

Figure 31. Detailed stack cost for the 2020 MDV technology system



		2020 MDV System					
Annual Production Rate	Sys/yr	200	500	1,000	10,000	50,000	100,000
System Net Electric Power (Output)	kWnet	160	160	160	160	160	160
System Gross Electric Power (Output)	kWgross	189.27	189.27	189.27	189.27	189.27	189.27
<b>BOP Components</b>							
Air Loop	\$/system	\$7,821	\$6,877	\$6,439	\$4,522	\$3,538	\$3,146
Humidifier & Water Recovery Loop	\$/system	\$2,185	\$1,809	\$1,631	\$1,144	\$954	\$859
High-Temperature Coolant Loop	\$/system	\$1,999	\$1,913	\$1,850	\$1,652	\$1,522	\$1,468
Low-Temperature Coolant Loop	\$/system	\$219	\$210	\$204	\$184	\$171	\$165
Fuel Loop	\$/system	\$1,147	\$1,045	\$977	\$779	\$668	\$627
System Controller	\$/system	\$266	\$256	\$250	\$230	\$218	\$213
Sensors	\$/system	\$748	\$659	\$600	\$444	\$363	\$334
Miscellaneous	\$/system	\$952	\$773	\$700	\$581	\$529	\$508
<b>Total BOP Cost</b>	<b>\$/system</b>	<b>\$15,337</b>	<b>\$13,544</b>	<b>\$12,651</b>	<b>\$9,535</b>	<b>\$7,962</b>	<b>\$7,320</b>
<b>Total BOP Cost</b>	<b>\$/kW (Net)</b>	<b>\$95.86</b>	<b>\$84.65</b>	<b>\$79.07</b>	<b>\$59.59</b>	<b>\$49.76</b>	<b>\$45.75</b>
<b>Total BOP Cost</b>	<b>\$/kW (Gross)</b>	<b>\$81.03</b>	<b>\$71.56</b>	<b>\$66.84</b>	<b>\$50.38</b>	<b>\$42.07</b>	<b>\$38.67</b>

Figure 32. Detailed balance of plant cost for the 2020 MDV technology system

		2020 MDV System					
Annual Production Rate	Sys/yr	200	500	1,000	10,000	50,000	100,000
System Net Electric Power (Output)	kWnet	160	160	160	160	160	160
System Gross Electric Power (Output)	kWgross	189.27	189.27	189.27	189.27	189.27	189.27
<b>Component Costs/System</b>							
Fuel Cell Stacks (High Value)	\$/system	\$35,170	\$26,119	\$20,489	\$10,594	\$7,566	\$6,796
Fuel Cell Stacks (Nominal Value)	\$/system	\$30,885	\$22,156	\$17,707	\$9,537	\$6,897	\$6,235
Fuel Cell Stacks (Low Value)	\$/system	\$29,907	\$21,121	\$16,822	\$9,141	\$6,623	\$5,937
Balance of Plant (High Value)	\$/system	\$17,796	\$15,705	\$14,605	\$10,977	\$9,167	\$8,427
Balance of Plant (Nominal Value)	\$/system	\$15,337	\$13,544	\$12,651	\$9,535	\$7,962	\$7,320
Balance of Plant (Low Value)	\$/system	\$14,064	\$12,436	\$11,620	\$8,820	\$7,380	\$6,818
System Assembly & Testing	\$/system	\$385	\$258	\$214	\$170	\$161	\$155
<b>Cost/System (High Value)</b>	<b>\$/system</b>	<b>\$52,099</b>	<b>\$40,939</b>	<b>\$34,346</b>	<b>\$21,289</b>	<b>\$16,589</b>	<b>\$15,121</b>
<b>Cost/System (Nominal Value)</b>	<b>\$/system</b>	<b>\$46,606</b>	<b>\$35,958</b>	<b>\$30,572</b>	<b>\$19,242</b>	<b>\$15,020</b>	<b>\$13,711</b>
<b>Cost/System (Low Value)</b>	<b>\$/system</b>	<b>\$45,392</b>	<b>\$34,743</b>	<b>\$29,435</b>	<b>\$18,505</b>	<b>\$14,427</b>	<b>\$13,140</b>
<b>Total System Cost</b>	<b>2016\$/kWnet</b>	<b>\$291.29</b>	<b>\$224.74</b>	<b>\$191.07</b>	<b>\$120.26</b>	<b>\$93.88</b>	<b>\$85.69</b>
<b>Cost/kWgross</b>	<b>\$/kWgross</b>	<b>\$246.24</b>	<b>\$189.98</b>	<b>\$161.52</b>	<b>\$101.66</b>	<b>\$79.36</b>	<b>\$72.44</b>

Figure 33. Detailed system cost for the 2020 MDV technology system

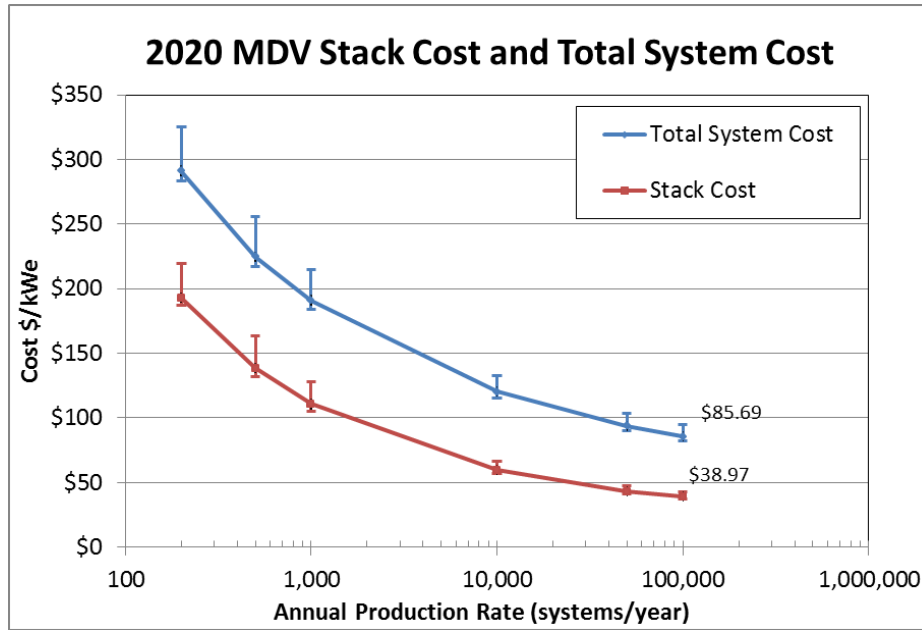


Figure 34. 2020 MDV Stack and Total System Cost at all manufacturing rates. Error bars are based on Monte Carlo sensitivity analysis and denote the middle 90% confidence range of results.

		2025 MDV System					
Annual Production Rate	Sys/yr	200	500	1,000	10,000	50,000	100,000
System Net Electric Power (Output)	kWnet	160	160	160	160	160	160
System Gross Electric Power (Output)	kWgross	185.24	185.24	185.24	185.24	185.24	185.24
<b>Stack Components</b>							
Bipolar Plates	\$/stack	\$1,804	\$1,500	\$1,326	\$538	\$463	\$445
<b>MEAs</b>							
Membrane	\$/stack	\$3,459	\$1,622	\$963	\$407	\$221	\$196
Catalyst Ink & Application	\$/stack	\$3,051	\$2,447	\$2,174	\$1,652	\$1,368	\$1,279
CCM Acid Wash	\$/stack	\$754	\$471	\$330	\$102	\$45	\$31
GDLs	\$/stack	\$2,788	\$2,308	\$1,768	\$430	\$186	\$138
M & E Hot Pressing	\$/stack	\$75	\$28	\$23	\$14	\$11	\$11
M & E Cutting & Slitting	\$/stack	\$9	\$5	\$5	\$5	\$4	\$4
MEA Gaskets (Frame or Sub-Gasket)	\$/stack	\$559	\$360	\$288	\$225	\$137	\$129
Coolant Gaskets (Laser Welding)	\$/stack	\$549	\$422	\$484	\$270	\$133	\$97
End Gaskets (Screen Printing)	\$/stack	\$2	\$2	\$1	\$1	\$1	\$1
End Plates	\$/stack	\$92	\$82	\$77	\$55	\$51	\$48
Current Collectors	\$/stack	\$8	\$7	\$7	\$7	\$6	\$6
Compression Bands	\$/stack	\$16	\$14	\$13	\$11	\$9	\$8
Stack Insulation Housing	\$/stack	\$254	\$109	\$61	\$18	\$15	\$15
Stack Assembly	\$/stack	\$145	\$127	\$119	\$67	\$49	\$46
Stack Conditioning	\$/stack	\$298	\$122	\$73	\$68	\$65	\$47
<b>Total Stack Cost</b>	<b>\$/stack</b>	<b>\$13,861</b>	<b>\$9,626</b>	<b>\$7,714</b>	<b>\$3,871</b>	<b>\$2,764</b>	<b>\$2,499</b>
<b>Total Cost for all 2 Stacks</b>	<b>\$/2 stacks</b>	<b>\$27,722</b>	<b>\$19,252</b>	<b>\$15,428</b>	<b>\$7,741</b>	<b>\$5,528</b>	<b>\$4,998</b>
<b>Total Stacks Cost (Net)</b>	<b>\$/kWnet</b>	<b>\$173.26</b>	<b>\$120.32</b>	<b>\$96.43</b>	<b>\$48.38</b>	<b>\$34.55</b>	<b>\$31.24</b>
<b>Total Stacks Cost (Gross)</b>	<b>\$/kWgross</b>	<b>\$149.66</b>	<b>\$103.93</b>	<b>\$83.29</b>	<b>\$41.79</b>	<b>\$29.84</b>	<b>\$26.98</b>

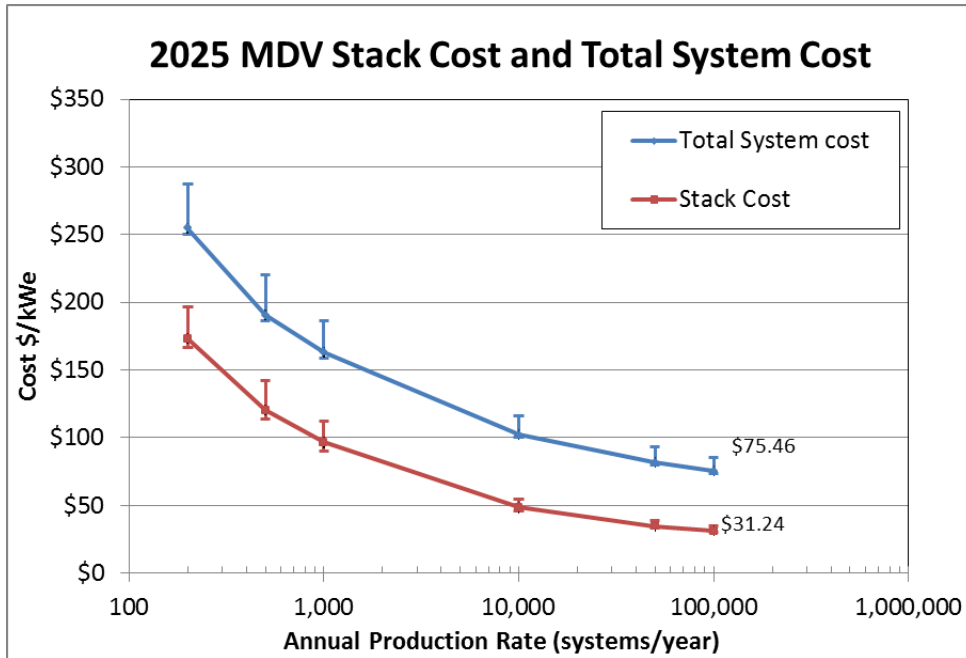
Figure 35. Detailed stack cost for the 2025 MDV technology system

		2025 MDV System					
Annual Production Rate	Sys/yr	200	500	1,000	10,000	50,000	100,000
System Net Electric Power (Output)	kWnet	160	160	160	160	160	160
System Gross Electric Power (Output)	kWgross	185.24	185.24	185.24	185.24	185.24	185.24
<b>BOP Components</b>							
Air Loop	\$/system	\$5,200	\$4,377	\$4,316	\$3,499	\$3,017	\$2,792
Humidifier & Water Recovery Loop	\$/system	\$2,177	\$1,801	\$1,623	\$1,137	\$947	\$852
High-Temperature Coolant Loop	\$/system	\$1,971	\$1,886	\$1,824	\$1,629	\$1,501	\$1,448
Low-Temperature Coolant Loop	\$/system	\$194	\$186	\$181	\$163	\$151	\$147
Fuel Loop	\$/system	\$1,147	\$1,045	\$977	\$779	\$668	\$627
System Controller	\$/system	\$266	\$256	\$250	\$230	\$218	\$213
Sensors	\$/system	\$748	\$659	\$600	\$444	\$363	\$334
Miscellaneous	\$/system	\$952	\$773	\$700	\$581	\$529	\$508
<b>Total BOP Cost</b>	<b>\$/system</b>	<b>\$12,654</b>	<b>\$10,985</b>	<b>\$10,471</b>	<b>\$8,461</b>	<b>\$7,394</b>	<b>\$6,921</b>
<b>Total BOP Cost</b>	<b>\$/kW (Net)</b>	<b>\$79.09</b>	<b>\$68.65</b>	<b>\$65.44</b>	<b>\$52.88</b>	<b>\$46.21</b>	<b>\$43.25</b>
<b>Total BOP Cost</b>	<b>\$/kW (Gross)</b>	<b>\$68.31</b>	<b>\$59.30</b>	<b>\$56.53</b>	<b>\$45.68</b>	<b>\$39.92</b>	<b>\$37.36</b>

Figure 36. Detailed balance of plant cost for the 2025 MDV technology system

		2025 MDV System					
Annual Production Rate	Sys/yr	200	500	1,000	10,000	50,000	100,000
System Net Electric Power (Output)	kWnet	160	160	160	160	160	160
System Gross Electric Power (Output)	kWgross	185.24	185.24	185.24	185.24	185.24	185.24
<b>Component Costs/System</b>							
Fuel Cell Stacks (High Value)	\$/system	\$31,494	\$22,721	\$17,939	\$8,786	\$6,254	\$5,622
Fuel Cell Stacks (Nominal Value)	\$/system	\$27,722	\$19,252	\$15,428	\$7,741	\$5,528	\$4,998
Fuel Cell Stacks (Low Value)	\$/system	\$26,728	\$18,209	\$14,446	\$7,395	\$5,316	\$4,786
Balance of Plant (High Value)	\$/system	\$15,350	\$13,336	\$12,612	\$10,099	\$8,802	\$8,234
Balance of Plant (Nominal Value)	\$/system	\$12,654	\$10,985	\$10,471	\$8,461	\$7,394	\$6,921
Balance of Plant (Low Value)	\$/system	\$12,085	\$10,504	\$9,982	\$8,083	\$7,036	\$6,615
System Assembly & Testing	\$/system	\$385	\$258	\$214	\$170	\$161	\$155
<b>Cost/System (High Value)</b>	<b>\$/system</b>	<b>\$46,038</b>	<b>\$35,245</b>	<b>\$29,840</b>	<b>\$18,578</b>	<b>\$14,875</b>	<b>\$13,707</b>
<b>Cost/System (Nominal Value)</b>	<b>\$/system</b>	<b>\$40,760</b>	<b>\$30,494</b>	<b>\$26,113</b>	<b>\$16,373</b>	<b>\$13,083</b>	<b>\$12,074</b>
<b>Cost/System (Low Value)</b>	<b>\$/system</b>	<b>\$40,094</b>	<b>\$29,776</b>	<b>\$25,351</b>	<b>\$16,026</b>	<b>\$12,788</b>	<b>\$11,800</b>
<b>Total System Cost</b>	<b>2016\$/kWnet</b>	<b>\$254.75</b>	<b>\$190.59</b>	<b>\$163.21</b>	<b>\$102.33</b>	<b>\$81.77</b>	<b>\$75.46</b>
<b>Cost/kWgross</b>	<b>\$/kWgross</b>	<b>\$220.05</b>	<b>\$164.62</b>	<b>\$140.97</b>	<b>\$88.39</b>	<b>\$70.63</b>	<b>\$65.18</b>

Figure 37. Detailed system cost for the 2025 MDV technology system



**Figure 38. 2025 MDV Stack and Total System Cost at all manufacturing rates. Error bars are based on Monte Carlo sensitivity analysis and denote the middle 90% confidence range of results.**

## 6 Automotive Power System Changes and Analysis since the 2017 Report

This annual report contains updates to an ongoing multi-year analysis and is meant to capture the cost impact of new technologies, design and process improvements, and corrections to past cost analysis.

<sup>34,35</sup>

The major changes in 2018 result from increasing power density (from 1,095 to 1,183 mW/cm<sup>2</sup>), updating bipolar plate laser welding station design assumptions, switching from d-PtNi/C to d-PtCo/HSC synthesis cost, updating of the H<sub>2</sub> recirculation configuration from a dual ejector to a pulsed-ejector system, removing the fuel loop in-line filter, adding an air pressure sensor and valves, and updating the pricing of the air CEM. As in previous updates, SA collaborated with ANL to identify and incorporate a stack operating point optimized for low system cost (i.e. selection of catalyst loading, pressure, humidity, and stoichiometric flow rate for minimum system cost).

Noteworthy changes since the previous analysis conducted in 2017 and their corresponding effects on system cost at 500,000 systems per year are listed in Figure 39 below.

Change	Reason	Change from previous value (\$/kW)	Cost (\$/kW) (@ 500k sys/yr) 2016\$
2017 Final Cost Estimate (2016\$)		NA	\$42.22
	Power density increased from 1,095 to 1,183 mW/cm <sup>2</sup> based on ANL optimization of performance parameters.	(\$0.85)	\$41.37
BPP	Updates made to laser welding capital cost and station design. Added leak check for BPP.	\$0.49	\$41.86
MEA	Adjustment to limit roll length of membrane material to 500m. Switch from d-PtNi/C to d-PtCo/HSC	\$0.86	\$42.72
BOP Changes	Removal of fuel loop in-line filter. Switch from dual ejector to pulsed ejector H <sub>2</sub> recirculation system. Addition of differential pressure sensor at stack inlet, air bleed orifice for cooling of air foil bearings, 3-way stack bypass valve, and stack shut-off valve.	\$0.26	\$42.98
Air CEM	Incorporated inflation to reflect past year analysis in 2009. Incorporated ambient relative humidity at air compressor inlet.	\$1.60	\$44.58
2018 Final Cost Estimate (2016\$)			\$44.58

**Figure 39. Changes in automotive power system cost at 500,000 systems per year since 2017**

<sup>34</sup> SA's previous contract with DOE (DE-EE0005236) was completed in 2016. The current analysis closely matches the methodology and results formatting of the previous contract analysis and mimics much of the text.

<sup>35</sup> "Mass Production Cost Estimation of Direct H<sub>2</sub> PEM Fuel Cell Systems for Transportation Applications: 2016 Update," Brian D. James, Jennie M. Huya-Kouadio & Cassidy Houchins, Strategic Analysis, Inc., September 2016.

## 6.1 2018 Polarization Model

Each analysis year, stack performance is examined to incorporate any performance improvements from new materials or processing techniques. In 2018, SA selected dealloyed-Platinum Cobalt (d-PtCo) on high surface area carbon (HSC), developed by General Motors (GM), as the cathode catalyst for baseline system for all three years (2018/2020/2025). The anode catalyst remains Platinum on carbon (Pt/C) for all three analysis years.

### 6.1.1 2018 Polarization Model and Resulting Polarization Curves

The GM cathode catalyst, d-PtCo/HSC, is higher performing than previously studied catalysts due to selection of an advanced High Surface (area) Carbon (HSC) support. Although this catalyst was also nominally used in 2017, ANL was unable to perform a complete optimization performance analysis in 2017 due to lack of experimental data at operating conditions suitable for input into ANL's model and the timing in which to complete the analysis. Consequently, for the 2017 performance projection, ANL used a combination of their computational d-PtNi/HSC performance model and GM's experimental PtCo/HSC data to project the reduction of power density based on alignment of stack inlet pressure (from 2.5atm at the outlet to 2.5atm at the inlet) and stoichiometric ratio (2 down to 1.5). Based on this analysis, the 2017 baseline system was set at a power density of 1,095mW/cm<sup>2</sup>.

In 2018, ANL further collaborated with GM through FC-PAD and other DOE projects to obtain differential cell data using a state-of-the-art MEA with 0.1 mg/cm<sup>2</sup> Pt loading in d-PtCo/HSC cathode and 0.025 mg/cm<sup>2</sup> Pt loading in anode catalyst supported on Vulcan carbon. They used the data to develop an integral cell model for GCtool and conduct system analysis. Optimization was conducted using their Non-neural net model to determine the optimal stack operating conditions: a numerical model allowing average stack cell voltage to be projected based on five variables (current density, cathode catalyst loading, air stoichiometry, stack pressure, and coolant temperature at the stack outlet). This model also incorporates water balance within the cell and allows optimization of cell inlet humidity levels for optimal performance.

ANL iteratively runs their polarization model in conjunction with an ANL fuel cell system model and a simplified system cost model (provided by SA) to determine the system operating conditions which lead to lowest overall system cost. The optimized stack conditions for low system cost (for a d-PtCo/HSC cathode catalyst) were then provided to SA along with the projected range in power density (1,183 +/- 55 mW/cm<sup>2</sup>) based on variation within GM's experimental data. The 2018 optimized stack operating conditions are compared to the 2017 baseline system conditions in Figure 40. GM's polarization curve and SA's operating points for 2016, 2017, and 2018 are graphically compared in Figure 41.

While the 2017 cost model for the d-PtCo cathode catalyst closely mimicked the synthesis of d-PtNi/HSC, the cost model was updated in 2018 to include updated processing parameters specifically for the synthesis of d-PtCo/HSC. Further details are provided in Section 9.1.3. The anode catalyst for both 2017 and 2018 baseline systems is dispersed Pt/C. The exact composition of the GM anode catalyst is not known but is assumed to be a low loading Pt/C catalyst (0.025mgPt/cm<sup>2</sup>).

Operating Parameter	2017 Baseline Conditions	2018 Baseline Conditions
Cell Voltage	0.663 volts/cell	0.657 volts/cell
Current Density	1,651 mA/cm <sup>2</sup>	1,801 mA/cm <sup>2</sup>
Power Density	1,095 mW/cm <sup>2</sup>	1,183 mW/cm <sup>2</sup>
Peak Stack Pressure	2.5 atm (Inlet)	2.5 atm (Inlet)
Total Catalyst Loading	0.125 mgPt/cm <sup>2</sup>	0.125 mgPt/cm <sup>2</sup>
Coolant Exit Temp	94°C	95°C
Air Stoichiometric Ratio	1.5	1.5
Q/ΔT	1.45	1.45

Figure 40. Table of 2017 and 2018 auto fuel cell system operating conditions for d-PtCo/HSC.

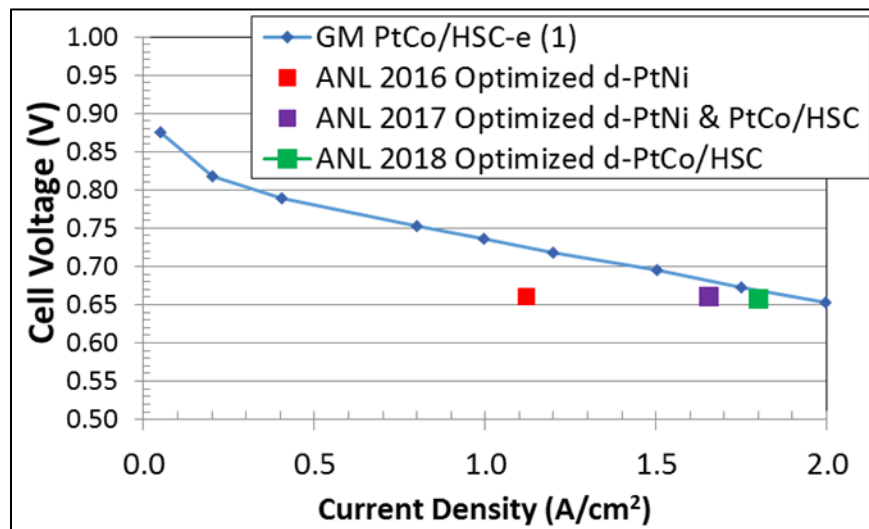
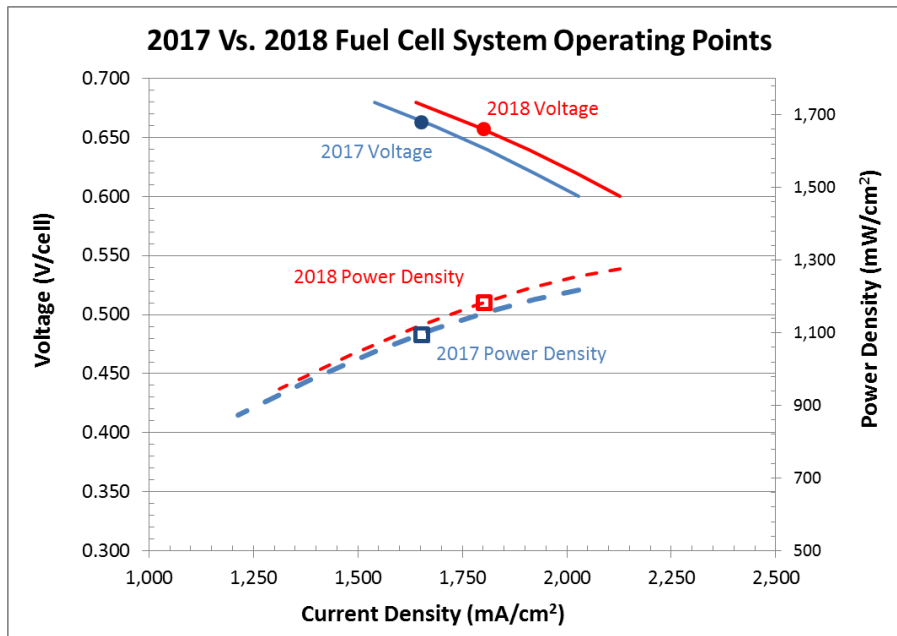


Figure 41. Graph of polarization curve from GM test data (blue), 2016, 2017, and 2018 operating points.

In comparison to the previous 2017 baseline system, the 2018 baseline system increased in performance. Cell voltage did not change significantly compared to 2017 conditions but the power density increased slightly. Figure 42 graphically compares the 2017 and 2018 polarization curves and design operating points.



**Figure 42. 2017 vs. 2018 polarization modeling results.**  
**(2017 System Operating Point: 0.663 V at 1,651 mA/cm<sup>2</sup> with 213 cm<sup>2</sup>/cell active area,**  
**2018 System Operating Point: 0.657 V at 1,801 mA/cm<sup>2</sup> with 197 cm<sup>2</sup>/cell active area)**

### 6.1.2 Q/ΔT Constraint

As directed by DOE and consistent with DOE’s 2012 MYRD&D plan, a radiator Q/ΔT constraint was placed on the system beginning in 2013. Q/ΔT is a measure of radiator size, where Q is the fuel cell radiator’s heat rejection duty. The variable Q is a function of the temperatures and mass flows of the stack inlet and outlet streams, stack efficiency (i.e. how much heat is generated within the stack), and the extent of liquid product water produced (i.e. how much energy goes into changing the product water from liquid to vapor). ΔT is the difference between the stack coolant exit temperature (typically 80-94 °C) and the worst case ambient air temperature (assumed to be 40 °C). Radiator size scales with Q/ΔT, thus a large Q/ΔT indicates that the stack needs a large radiator to reject waste heat. The DOE 2018 target for Q/ΔT is <1.45 kW<sub>th</sub>/°C and consequently this limit is imposed on the 2018 automotive analysis. All analyses prior to 2013 did not impose a Q/ΔT limit and the 2012 value was ~1.7 kW<sub>th</sub>/°C implying a larger radiator than the automotive community (and DOE) feels is reasonable to incorporate into a light duty automobile.

While the computation of Q/ΔT appears simple (as it is merely the ratio of two easily understood parameters), it is more complex in practice. Q/ΔT is quite sensitive to both Q and ΔT and Q varies considerably depending on the extent of water condensation at the cathode. Water condensation is a function of temperature and gas flows within the cell and is more accurately analyzed by the ANL full performance model than by the SA cost model. However, the Q/ΔT ≤1.45 kW<sub>th</sub>/°C constraint recommended by the FCTT was based on a simplified, short-hand computation method that assumes all product water remains in the vapor phase. Thus from 2015-2018, per DOE directive, the optimization constraint is also assessed by this definition.



$$\frac{Q}{\Delta T} = \frac{P_{gross} (1.25 - V_{cell})}{V_{cell} (T_{coolant} - T_{ambient})}$$

Where  $P_{gross}$  is the gross power of fuel cell stack,  $V_{cell}$  is cell voltage at rated power, 1.25 represents the open circuit cell voltage at representative operating conditions, and  $T_{coolant}$  and  $T_{ambient}$  are the coolant temperature out of the fuel cell stack and ambient temperature (40 °C), respectively.

### 6.1.3 Parasitic Loads and Gross Power

Changes to the baseline operating conditions directly affect the parasitic load and the mass and volume of the fuel cell system. The changes to parasitic loads and pressure drop within the system since 2017 are summarized in Figure 43.

The pressure at the inlet and outlet of each component must be specified in order to accurately size the compressor and the expander, and to calculate the resulting parasitic power losses for the system. The air compressor outlet pressure is determined by the desired stack inlet pressure (2.5 atm) plus any pressure drop within the BOP components upstream of the stack. The air pressure drops through the pre-cooler and the membrane humidifier were adjusted to ANL model values, ~0.03 atm for each. The same pressure drop was applied to the humidifier after the stack and through the demister, overall reducing the pressure drop after the stack. The increase in compressor shaft power results from two factors: 1) the decrease in cell voltage (from 0.663 to 0.65V/cell) makes the system slightly less efficient, thereby requiring more air, and 2) the inclusion of water vapor (due to relative humidity) in the inlet air to the compressor, which increases the compressor's mass flow.

The coolant pump power is calculated based on the heat rejection required by the stack and the coolant flow rate. The coolant fan power is based on a 130 W fan with fan efficiency of 45%, fan motor efficiency of 90%, and DC-DC converter efficiency of 95%.

<b>Air Pressure (atm)</b>	<b>2017 Value</b>	<b>2018 Value</b>
Air Compressor Outlet	2.57	2.57
Air Precooler Outlet	2.54	2.54
Membrane Humidifier Outlet (into stack)	2.50	2.50
Stack Outlet	2.26	2.26
Membrane Humidifier Outlet (into Demister)	2.23	2.23
Air Demister Outlet	2.19	2.19
<b>Parasitic Load (kW)</b>		
Air Compressor Shaft Power	10.16	10.51
Expander Power Out	4.64	4.63
Air Compressor Motor (net of expander)	6.89	7.35
High-Temperature Coolant Loop Pump	0.51	0.52
High-Temperature Coolant Loop Radiator Fan	0.35	0.35
Low-Temperature Coolant Loop Pump	0.05	0.05
Other (Controller, Instruments, etc.)	0.1	0.1
<b>Total Parasitic Loads</b>	<b>7.90</b>	<b>8.37</b>

**Figure 43. Table comparing pressure drop and parasitic loads from 2017 to 2018 values**

## 6.2 2020 and 2025 Polarization Assumptions

The FCTT provided detailed feedback on system definitions for both the 2020 and 2025 systems. In 2017, the 2020 system was assumed to use GM’s PtCo/HSC-f cathode catalyst with polarization performance based on a similar PtCo/HSC-e de-rating approach to align both pressure and air stoichiometry for optimized cost conditions. The PtCo/HSC-f performance was considered superior to the PtCo/HSC-e performance used as the basis for the 2017 system but was not fully characterized, leading it to be used for the future (2020) system but not for the then current (2017). Since that time, testing has shown the HSC-f carbon support to have insufficient durability, effectively eliminating as a basis for future performance projections. However, the consensus view of the 2018 FCTT was to recommend use of an even higher power density for the 2020 system based on unspecified, company confidential knowledge. Thus the 2018 analysis projects a slight increase in the 2020 power density compared to last year’s projection (1,183 to 1,250 mW/cm<sup>2</sup>). The FCTT suggested 2025 power density be set at 1,500 mW/cm<sup>2</sup> along with a simultaneous Pt loading reduction (0.088 compared to 0.125 mg/cm<sup>2</sup>) based on GM-tested PtCo/HSC catalysts. After discussion, these parameters were unanimously agreed to by SA, DOE, and the FCTT, thereby finalizing selection of 2020 and 2025 operating conditions. A comparison of 2018, 2020, and 2025 operating conditions is shown in Figure 44.

Operating Parameter	2018 Values	2020 Values	2025 Values
Cell Voltage	0.657 volts/cell	0.657 volts/cell	0.657 volts/cell
Current Density	1,801 mA/cm <sup>2</sup>	1,918 mA/cm <sup>2</sup>	2,283 mA/cm <sup>2</sup>
Power Density	1,183 mW/cm <sup>2</sup>	1,250 mW/cm <sup>2</sup>	1,500 mW/cm <sup>2</sup>
Peak Stack Pressure	2.5 atm (Inlet)	2.5 atm (Inlet)	2.5 atm (Inlet)
Total Catalyst Loading	0.125 mgPt/cm <sup>2</sup>	0.125 mgPt/cm <sup>2</sup>	0.088 mgPt/cm <sup>2</sup>
Coolant Exit Temp	95°C	95°C	95°C
Air Stoichiometric Ratio	1.5	1.5	1.5
Q/ΔT	1.45 kW <sub>th</sub> /°C	1.45 kW <sub>th</sub> /°C	1.45 kW <sub>th</sub> /°C

**Figure 44. Comparison of operating parameters for 2018 baseline, 2020, and 2025 systems.**

### 6.3 d-PtCo/HSC Catalyst Synthesis

While the 2017 analysis was reported as representing d-PtCo/HSC cathode catalyst, performance and cost were based on prior analysis representing d-PtNi/C, with a simple Co for Ni material cost substitution. This was considered valid by ANL as the synthesis method was expected to be nearly identical.

For 2018, a full DFMA<sup>®</sup> analysis was conducted for d-PtCo/HSC. The catalyst synthesis steps are outlined in Figure 45 (top) and compared to the d-PtNi/C synthesis steps used in 2017 (bottom). Many of the steps are identical to the d-PtNi/C synthesis but two key differences are noted. First, carbon is replaced by a high surface area carbon (HSC) created via a high-temperature heat treatment of low-cost carbon black.<sup>36</sup> Previous studies by ANL suggest that the use of HSC is the key factor in the increased performance demonstrated between the 2016 and 2017 baseline systems. Second, whereas the previous synthesis used a single precipitation reactor to deposit both the Pt and metal (Ni) constituents onto the substrate carbon, the new synthesis method uses two precipitation reactors to create the catalyst precursor (one to deposit Pt and one to deposit Co). For the analysis, SA used GM's final report<sup>37</sup> in addition to a patent co-authored by Johnson Matthey and GM that lists specific examples of material composition for similar catalysts.<sup>38</sup>

Projected cost of the HSC is shown in Figure 46. The cost rises to very high levels at low production rates due to low equipment utilization and/or small batch sizes. However, in reality, orders would be pooled to enhance HSC production beyond any one customer demand. Consequently, HSC price is capped at nominally \$1,000/kg based on an industry-supplied approximation of the current price.

A cost summary of the d-PtCo/HSC cathode catalyst synthesis appears in Figure 47. Steps 1-4 represent the new or altered processing steps compared to the 2017 analysis. Note that the cost summary is

<sup>36</sup> Timcal Limited and Johnson Matthey Fuel Cells Limited Patent Application US2014/0295316 A1: Carbon Supported Catalyst

<sup>37</sup> A. Kongkanand, F. Wagner, "High-Activity Dealloyed Catalyst", General Motors Technical Report under DOE Award No. DE-EE0000458, 2014.

<sup>38</sup> US Patent Application US 2016/0104898 A1: Catalyst

shown on the basis of \$/system which takes into consideration the lower catalyst mass needed in 2018 by virtue of a higher power density. Overall, catalyst price decreases only slightly (\$14.90/system, \$0.19/kW, ~0.3% at 500k systems/year).

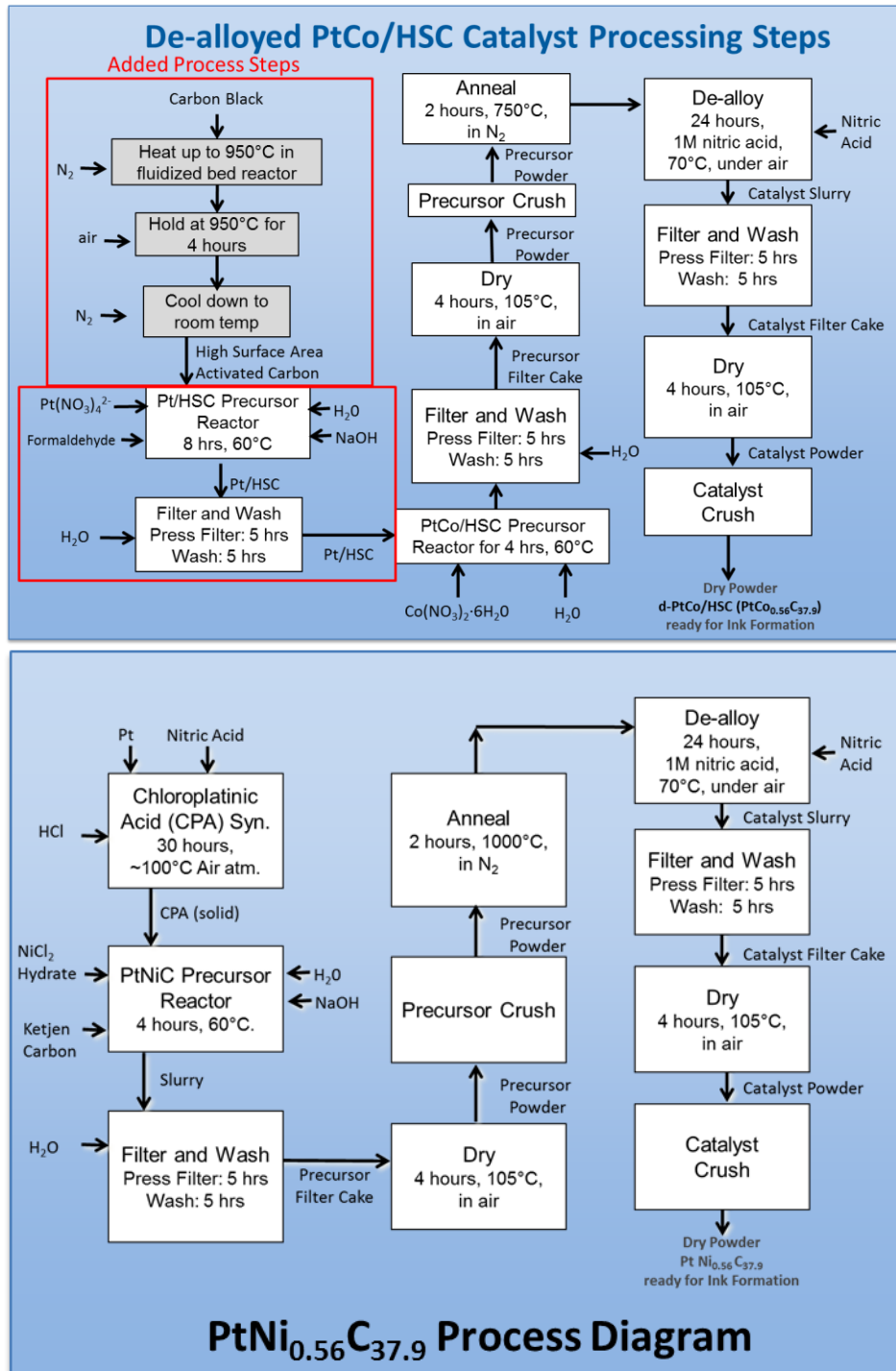


Figure 45. d-PtCo/HSC (top) and d-PtNi/C (bottom) cathode catalyst process diagrams

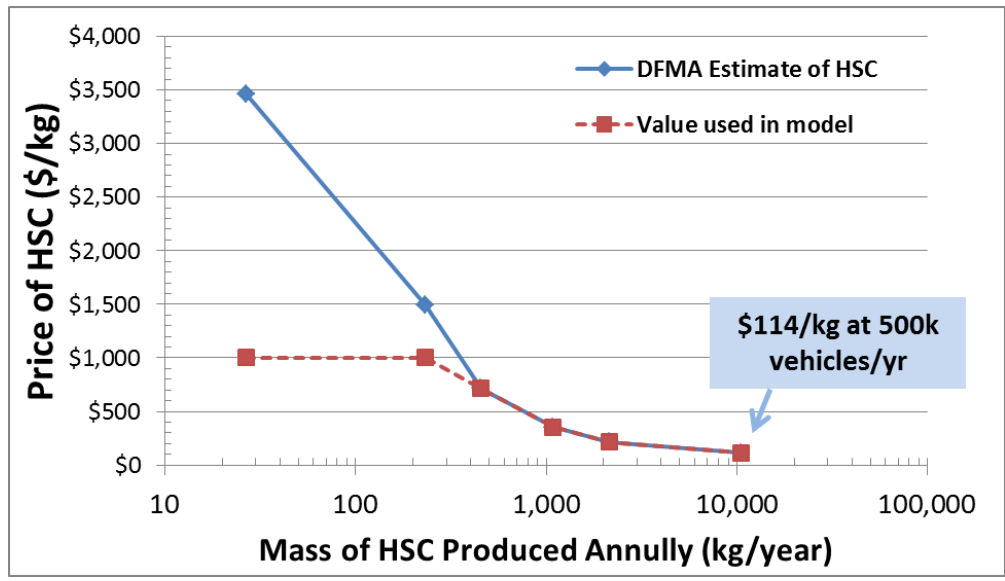


Figure 46. Projected Cost of High Surface Area Carbon (HSC)

d-PtCo/HSC 2018 Cost Estimate:

PtCo/C Cathode Catalyst Powder Synthesis		Annual System Production Rate					
Component Costs per 80kWnet Fuel Cell System		1,000	10,000	20,000	50,000	100,000	500,000
Step 1: Pt/HSC Precursor	\$/system	\$712.27	\$637.43	\$574.26	\$504.11	\$484.61	\$464.40
Step 2: Pt/HSC Filtration	\$/system	\$14.76	\$5.91	\$2.82	\$1.30	\$0.73	\$0.29
Step 3: Pt/HSC Wash	\$/system	\$5.67	\$2.59	\$1.27	\$0.61	\$0.44	\$0.30
Step 4: Catalyst PtCo/HSC Precursor	\$/system	\$14.09	\$8.06	\$5.02	\$3.28	\$2.30	\$1.13
Step 5: Precursor Filtration	\$/system	\$17.24	\$8.63	\$4.74	\$1.96	\$0.99	\$0.20
Step 6: Precursor Wash	\$/system	\$6.46	\$2.36	\$1.07	\$0.46	\$0.26	\$0.08
Step 7: Precursor Drying	\$/system	\$44.54	\$15.99	\$7.22	\$3.05	\$1.60	\$0.39
Step 8: Precursor Crushing	\$/system	\$23.34	\$8.35	\$4.28	\$1.78	\$0.92	\$0.20
Step 9: Precursor Vacuum Annealing	\$/system	\$122.99	\$44.39	\$20.16	\$8.63	\$4.67	\$2.66
Step 10: Catalyst Dealloying	\$/system	\$59.03	\$32.88	\$18.13	\$8.11	\$4.64	\$1.63
Step 11: Catalyst Filtration	\$/system	\$16.83	\$8.23	\$4.47	\$1.85	\$0.94	\$0.19
Step 12: Catalyst Wash	\$/system	\$6.46	\$2.36	\$1.07	\$0.46	\$0.26	\$0.08
Step 13: Catalyst Vacuum Dry	\$/system	\$45.10	\$16.83	\$7.69	\$3.49	\$2.06	\$1.24
Step 14: Catalyst Crushing	\$/system	\$23.53	\$8.85	\$4.57	\$2.09	\$1.22	\$0.26
Step 15: Catalyst Quality Control Testing	\$/system	\$6.27	\$8.92	\$5.48	\$5.10	\$5.00	\$4.31
Step 16: Cathode Catalyst Packaging	\$/system	\$10.55	\$3.89	\$2.12	\$0.94	\$0.55	\$0.21
<b>Total Catalyst Synthesis Cost</b>	<b>\$/system</b>	<b>\$1,129.12</b>	<b>\$815.68</b>	<b>\$664.37</b>	<b>\$547.21</b>	<b>\$511.21</b>	<b>\$477.57</b>

d-PtNi/C 2017 Cost Estimate:

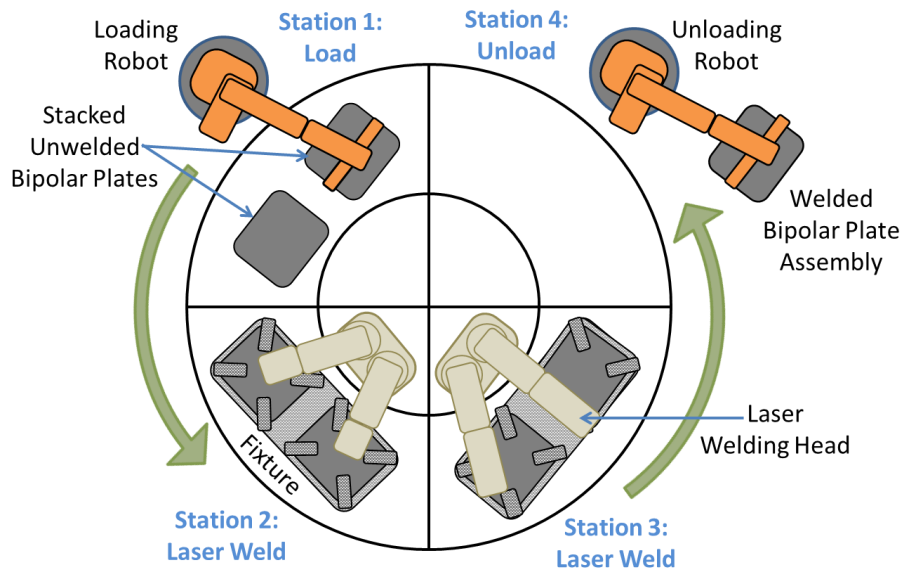
<b>Total Catalyst Synthesis Cost</b>	<b>\$/system</b>	<b>\$1,096.30</b>	<b>\$751.25</b>	<b>\$625.73</b>	<b>\$539.29</b>	<b>\$517.67</b>	<b>\$492.47</b>
--------------------------------------	------------------	-------------------	-----------------	-----------------	-----------------	-----------------	-----------------

Figure 47. Catalyst Cost Summary for d-PtCo/HSC and Comparison to the 2017 d-PtNi/C Catalyst System

## 6.4 Bipolar Plate Laser Welding

The baseline 2018, 2020, and 2025 automotive systems were updated to include greater detail and a higher level of clarity regarding laser welding of the bipolar plates.

Based on discussions with Lincoln Electric regarding the capital cost of system equipment, SA suspected that SA's previous capital cost estimates failed to capture the full cost of the entire welding system. (Previous estimates were also based on vendor quotes, but were less detailed and did not include as many cost categories.) Additionally, it was suspected that the system configurations outlined by Lincoln Electric might not achieve the high productivity per line necessary to avoid a very high number of parallel welding lines at high volume automotive production (i.e. get the effective welding time down to ~2 sec per bipolar plate assembly).



**Figure 48. Bipolar plate laser welding turn-table system**

Lincoln Electric's system configuration, shown in Figure 48, is a turn-table system with four stations: 1) Load parts 2) laser weld 3) laser weld 4) unload parts. Each welding station contains a specialty fixture that holds 1-4 parts and contains pressure sensors to ensure adequate clamping pressure is applied during laser welding. A dedicated laser welding head and Precitec laser welding monitor are allotted to each plate. The turn-table system is inside a protective Class 1 base chamber with cameras and motion-sensor safety systems in place to turn off the lasers if someone should enter the chamber. A list of the components, capital cost, and number of components required at each production volume is listed in Figure 49. Lincoln Electric provided a range of capital costs, with the high cost based on a purchase quantity of only one or two systems. For high volume manufacturing (>10k sys/yr), the lower end of the capital cost range is assumed for each piece of equipment to reflect a price discount for multiple system purchases. It should be noted that the number of simultaneous production systems also changes between production volumes and thus the total cost for the manufacturing plant would be the Total System Capital Cost times the number of simultaneous systems.

<b>Production Volume</b>	<b>Systems per year</b>	<b>1,000</b>	<b>10,000</b>	<b>20,000</b>	<b>50,000</b>	<b>100,000</b>	<b>500,000</b>
Number of Welding Stations per System	Stations	1	1	1	2	2	2
Number of Parts per Station	Parts/station	1	2	2	2	4	4
<b>Number of Simultaneous Prod. Systems</b>	<b>Systems</b>	<b>1</b>	<b>3</b>	<b>5</b>	<b>8</b>	<b>8</b>	<b>40</b>
<b>Laser Welding Machinery</b>							
Laser Resonator Capital Cost per Laser	\$/Laser	\$75,000	\$75,000	\$35,000	\$35,000	\$35,000	\$35,000
Focus Head Capital Cost per Laser	\$/Laser	\$40,000	\$40,000	\$30,000	\$30,000	\$30,000	\$30,000
Number of Lasers per system		1	2	2	4	8	8
Class 1 Base Station Capital Cost	\$/system	\$175,000	\$175,000	\$75,000	\$75,000	\$75,000	\$75,000
<b>Total Laser Welding Machinery Capital Cost</b>	<b>\$/system</b>	<b>\$290,000</b>	<b>\$405,000</b>	<b>\$205,000</b>	<b>\$335,000</b>	<b>\$595,000</b>	<b>\$595,000</b>
<b>Plate Handling Machinery</b>							
Material Handling System Capital Cost	\$/system	\$125,000	\$125,000	\$100,000	\$100,000	\$100,000	\$100,000
Part Handling Fixture Capital Cost	\$/Fixture	\$70,000	\$105,000	\$75,000	\$75,000	\$112,500	\$112,500
Parts per fixture		1	2	2	2	4	4
Number of Fixtures per System		1	1	1	2	2	2
Total Fixture Capital Cost	\$/system	\$70,000	\$105,000	\$75,000	\$150,000	\$225,000	\$225,000
Robot Capital Cost	\$/robot	\$105,861	\$105,861	\$86,722	\$86,722	\$86,722	\$86,722
Number of robots per system		2	2	2	2	2	2
Total Robot Capital Cost	\$/system	\$211,722	\$211,722	\$173,444	\$173,444	\$173,444	\$173,444
<b>Total Plate Handling Machinery Capital Cost</b>	<b>\$/system</b>	<b>\$406,722</b>	<b>\$441,722</b>	<b>\$348,444</b>	<b>\$423,444</b>	<b>\$498,444</b>	<b>\$498,444</b>
<b>Precitec Laser Welding Monitor – QC</b>							
Number of Laser Welding Monitors per system		1	2	2	4	8	8
Capital Cost per Laser Welding Monitor	\$/Monitor	\$92,500	\$92,500	\$45,000	\$45,000	\$45,000	\$45,000
<b>Total Welding Monitor Capital Cost</b>	<b>\$/system</b>	<b>\$92,500</b>	<b>\$185,000</b>	<b>\$90,000</b>	<b>\$180,000</b>	<b>\$360,000</b>	<b>\$360,000</b>
<b>Capital Cost Contingency</b>	<b>%</b>	<b>20%</b>	<b>20%</b>	<b>20%</b>	<b>20%</b>	<b>20%</b>	<b>20%</b>
<b>Total System Capital Costs</b>	<b>\$/system</b>	<b>\$947,066</b>	<b>\$1,238,066</b>	<b>\$772,133</b>	<b>\$1,126,133</b>	<b>\$1,744,133</b>	<b>\$1,744,133</b>

**Figure 49. Description of bipolar plate laser welding configurations at each production volume.**

Lincoln Electric suggested an index time of 4.5 seconds, inclusive of the time to rotate the turn-table and clamp/unclamp the parts but not including welding time: this is significantly longer than the 2017 value of 2.5 seconds. Effective cycle times are listed for each configuration in Figure 50. At high volume with 4 plates per station, the effective cycle time is projected to be as low as ~2.6 sec per bipolar plate assembly. Overall, the cost for laser welding bipolar plates increased about \$0.40/kW<sub>net</sub> compared to 2017 cost estimates, and is considered to be more accurate due to greater modeling detail and vendor quotation support.

Production Volume	Systems per year	1,000	10,000	20,000	50,000	100,000	500,000
Number of Welding Stations per system		1	1	1	2	2	2
Number of Parts per Station		1	2	2	2	4	4
Laser Welding Speed	m/s	0.13	0.13	0.13	0.13	0.13	0.13
Laser Welding Length	cm	143	143	143	143	143	143
Index Time Between Plates	sec	4.5	4.5	4.5	4.5	4.5	4.5
Duration of welding at each station (to be added to index time)	sec per station	11.43	11.43	11.43	5.72	5.72	5.72
Total index time (welding time + index time for mult. Parts)	sec	15.93	15.93	15.93	10.22	10.22	10.22
Effective Cycle Time per Welded Assembly	sec/welded assembly	15.93	7.97	7.97	5.11	2.55	2.55

Figure 50. Bipolar plate laser welding cycle times

## 6.5 Balance of Plant Changes

### 6.5.1 Compressor/Expander/Motor (CEM) System Changes

The automotive compressor-expander-motor concept was last examined in detail by SA in ~2009. Given the age of the analysis, the design concept was revisited and Honeywell contacted to explore what, if any, updates should be made. After consideration, the basic hardware configuration was confirmed as still being appropriate. However, two issues emerged: motor/controller efficiency and inflation.

The combined motor-controller electrical efficiency has been held at 80% from 2009 to 2017 based on Honeywell data. No new test data could be found in support of a change. However, discussions with both ANL and Honeywell confirmed that different controller designs could achieve substantially higher efficiencies (>90%). Despite initial interest from the FCTT to increase the motor-controller efficiency, it was decided to maintain the efficiency at 80% based on 1) the possibility that increased efficiency would only be achieved with a different motor controller design which, in turn, might increase motor controller cost and 2) not wanting to project an overly optimistic set of assumptions (as described below).

The 2018 analysis (for all three analysis years) bleeds air from the compressor (8% of stack air) to float the air bearings and cool the CEM motor. This air is “recycled” by re-mixing it with the main stack air so that no air is compressed without ultimately being used within the stack: to not recycle would result in a substantial cost increase (due to a larger compressor and motor). While air bleed recycle is technically feasible, it is challenging to manage the air-flow with only a small pressure difference: it has not been demonstrated on an FCV to date. Consequently, the team (SA/ANL/DOE/FCTT) decided to incorporate air bleed recycle into the configuration but to maintain the CEM motor/motor controller combined efficiency at 80% so as not to project an overly optimistic/aggressive set of assumptions.

The original CEM cost analysis was conducted in 2008 with cost reported in 2008\$. Normally, capital cost and material prices are re-examined every few years so that the reported costs are appropriately in nominal year dollars for the year of the analysis. However, the CEM price had not been adjusted since its



original estimation. This was corrected in the 2018 analysis by applying an inflation multiplier of 1.147 (based on the PPI index from 2009 to 2018) to the CEM cost to approximate the cost in 2018\$. A factor of 0.9398 was then applied to deflate the cost into 2016\$ (based on the PPI index from 2018 to 2016). Overall, the system cost increased by \$0.73/kW<sub>net</sub>. As noted above, the physical design and efficiency of the CEM were not altered.

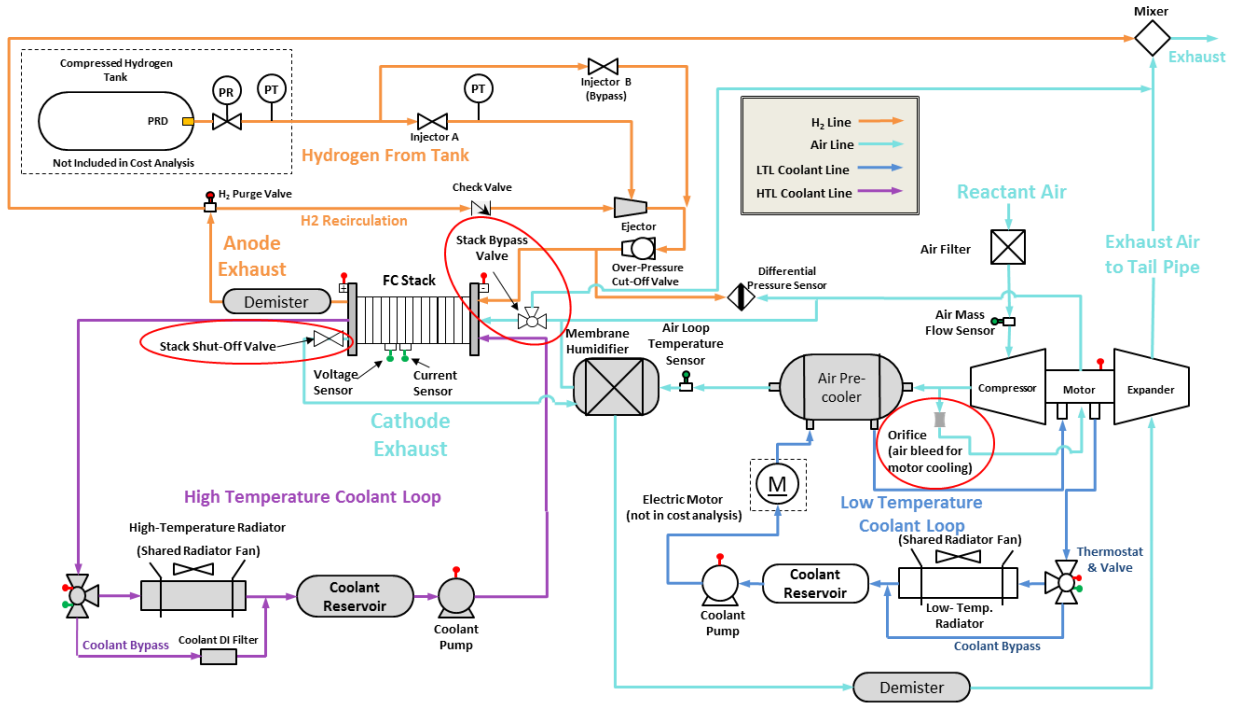
### **6.5.2 H<sub>2</sub> Recirculation System Change**

Discussions with ANL highlighted the concept of a minimum H<sub>2</sub> flow requirement to remove liquid water build-up in the bipolar plate flow channels. ANL modeling suggests that conventional fixed and variable-geometry ejectors cannot provide sufficient hydrogen recirculation at low power levels to remove the liquid. However, ANL analysis indicates that a hydrogen blower or pulsed-ejector system is adequate to handle recirculation requirements at low power. SA's 2017 analysis indicates that the pulsed-ejector system cost is significantly less expensive than a hydrogen blower and slightly lower cost than a dual-ejector system (used prior to the 2018 baseline system). Therefore, the pulsed-ejector configuration is selected for the 2018, 2020, and 2025 auto systems. This change to a pulsed-ejector system resulted in a \$0.70/kW<sub>net</sub> cost reduction.

### **6.5.3 Air Management System Changes**

Three small changes were made to the air management system in 2018. Figure 51 highlights these changes circled in red. These changes include:

- 1) Addition of a stack shutoff valve at the cathode exit to prevent backflow of air during system shutdown.
- 2) Addition of a stack bypass valve immediately before the cathode inlet. This bypass allows the compressor mass flow (controlled by rpm) to differ from the stack mass flow and provides further stack isolation during system shutdown.
- 3) A small flow orifice was added to the line leading from the compressor outlet to the motor inlet. The airflow serves to both float the foil bearings of the compressor/expander and to cool the motor.



**Figure 51. 2018 auto system diagram showing the added valves and orifice added to the air management system.**

## 7 Automotive Power System Side Analyses

Several side studies were conducted during 2018 that were not directly incorporated in the analyzed systems. However, the side studies provide useful information for selection of the baseline systems and may be incorporated into future baseline systems when performance has been demonstrated to meet or exceed the current status.

### 7.1 Physical Vapor Deposition (PVD) Coating of Catalyst Powders

As an alternative to the baseline aqueous precipitation method of catalyst synthesis, SA was tasked to evaluate the capital cost of equipment and processing cost for a PVD catalyst fabrication process. As part of DOE's award DE-EE0007675, Ford Motor Co., Oak Ridge National Laboratory (ORNL), and Exothermics are working to develop a new Pt/NbO<sub>x</sub>/HSC catalyst powder synthesized by PVD coating of Pt and Nb onto high surface area carbon powder. The potential advantages of a PVD vacuum process are improved reproducibility, lower costs, no impurities from precursors or solvents, elimination of post-processes such as annealing, and elimination of solvent waste. Exothermics has a large production volume system in place, however, the system design and process is proprietary. Therefore, SA searched publically available documentation on designs for a high volume PVD powder coating system, the goal being creation of a non-proprietary system design upon which to base the cost analysis.

As shown in Figure 52, four different approaches to PVD deposition on powders were found in the literature. The Milman Barrel Sputter Machine<sup>39</sup> is a dual-barrel system that allows the inner concentric barrel to be removed from the system. This can be advantageous in reducing the downtime of the unit through rapid replacement of the coated powders and no extra time needed for cleaning (Pt recovery) of metal coating on the inner surface of the inner barrel. The Polygonal Barrel Sputtering Unit<sup>40</sup> is a similar concept where an internal polygonal barrel is rotated inside an outer barrel. The Furuya Metals Japanese patent<sup>41</sup> describes a single-barrel type system that incorporates many internal powder adjustment arms with all motors and wheels external to the vacuum chamber. The Hitachi patent Drum Sputtering Device<sup>42</sup> is a dual-barrel system that allows an angled rotation of the powder inside the internal drum. It also includes holding chambers to remove coated powder and insert new uncoated powder without breaking vacuum.

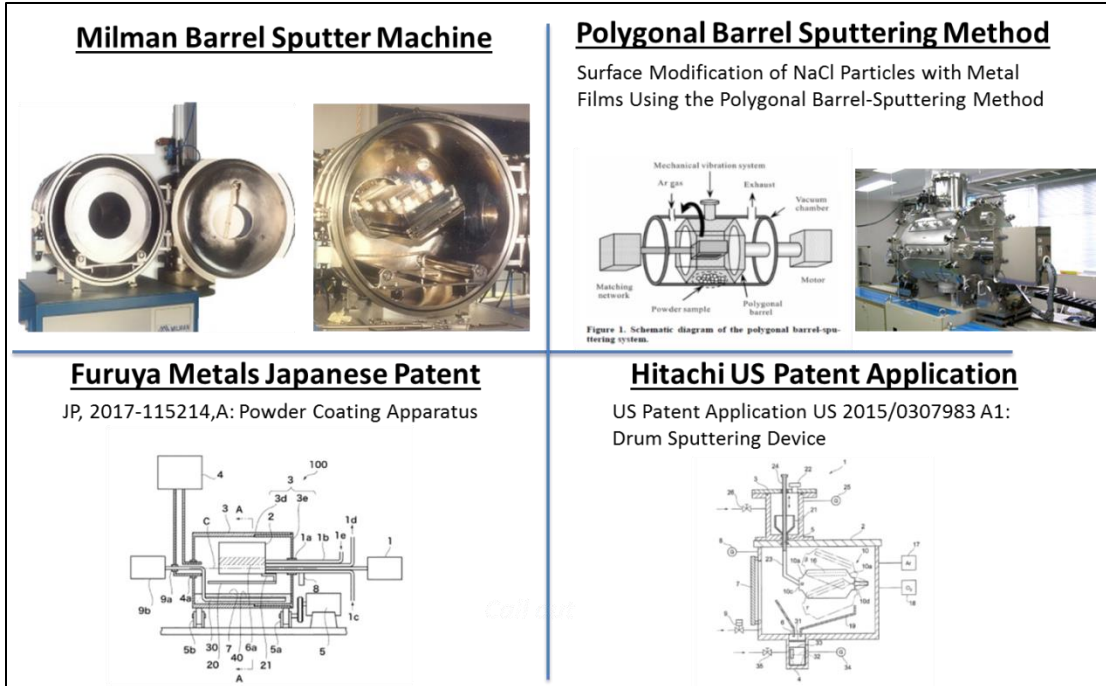
---

<sup>39</sup> <http://www.milmanthinfilms.com/barrel-sputtering-equipment/barrel-sputtering-equipment>

<sup>40</sup> <https://www.pillar.co.jp/en/product/research02.php>

<sup>41</sup> JP,2017-115214,A: Powder Coating Apparatus

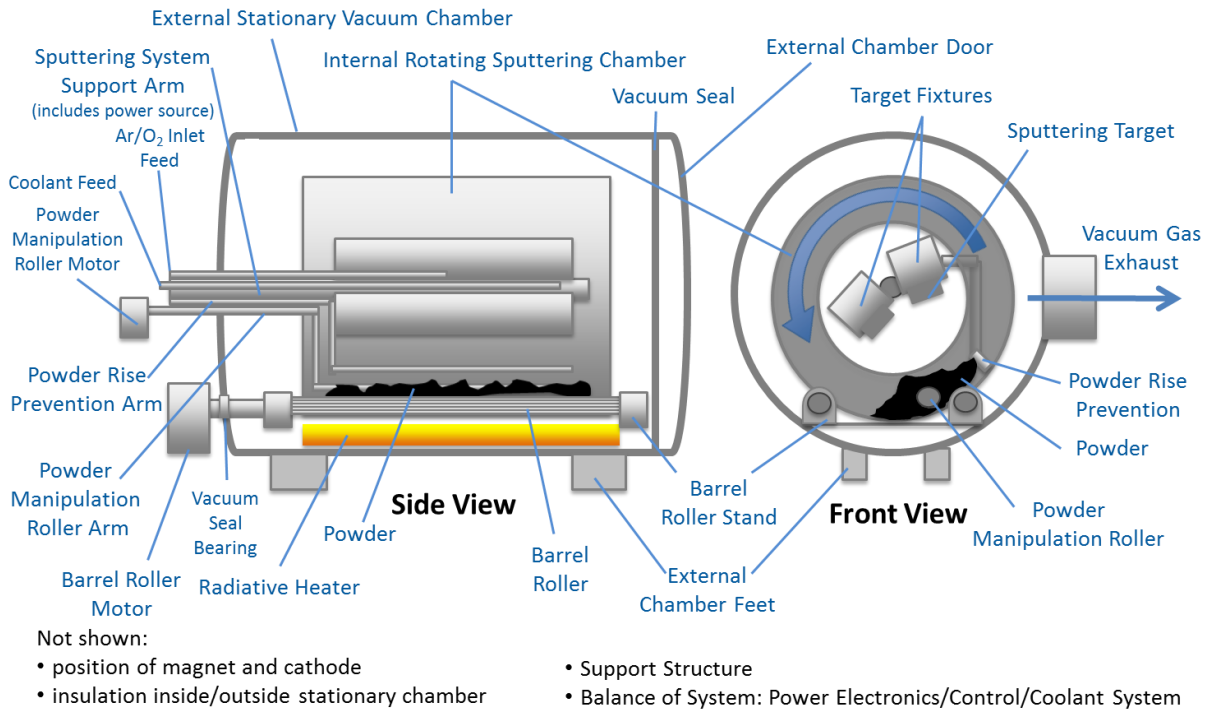
<sup>42</sup> US Patent Application US 2015/0307983 A1: Drum Sputtering Device



**Figure 52. Four types of PVD systems used to coat powders.**

As recommended by Ford, SA selected a dual-barrel system configuration as the basis for a cost analysis. The dual-barrel configuration facilitates removal/resupply of carbon and catalyst from the inner barrel and thus is consistent with high-volume operation and assessing the cost potential of the novel PVD system. Figure 53 illustrates the features of SA's modeled dual barrel system bill of materials and system capital cost estimate are based. The design concept draws upon features from multiple systems and does not represent the hardware of any single vendor.

# Dual Barrel System Design



**Figure 53. Diagram of SA's design of a dual-barrel PVD system.**

Two pathways were used to estimate the capital cost of the PVD system. The first pathway was to seek quotes from vendors for the entire system based on SA's preliminary design. A quote of \$1.6 million was received from Mustang Vacuum. The second pathway summed the estimated costs for each line item in the bill of materials, affording insight into the main cost contributors. Some component costs were based on price quotes from vacuum chamber companies while others were based on estimates derived from previous SA analyses. Assembly and testing costs were estimated based on an approximate number of labor hours, number of workers, and labor rate. Additional cost for non-recurring engineering, cost contingencies on the equipment and engineering work, and company markup were included in the estimate. The total cost from the second method was \$1.4 million, very close to the quote obtained from Mustang. A summary breakdown in total capital cost is shown in Figure 54.

Component	Description	Capital Cost	Cost Basis
<b>Total Part/Materials</b>	Sum of capital cost components.	\$555,119	
<b>Assembly</b>	Assembly of the individual parts into a final, fully-operational system.	\$27,000	120 hours X 3 workers X \$75/h loaded
<b>System Testing</b>	Testing of the unit including initial pump-down, and deposition of a sample material, sample analysis, and unit cleaning before going to the customer.	\$24,000	160 hours X 2 workers X \$75/h loaded
<b>Contingency (15%)</b>	Contingency for non-enumerated/unknown expenses.	\$90,918	
<b>Custom Engineering Work</b>	Engineering work specific to the individual customers unit.	\$8,000	80 hours X 1 workers X \$100/h loaded
<b>Contingency (15%)</b>	Contingency for non-enumerated/unknown expenses.	\$105,755	15% contingency
<b>Non-Recurring Engineering</b>	Basic design/engineering work to develop the commercial product line.	\$20,000	\$200k amortized over 10 units
<b>Company Markup</b>		\$540,798	66.7% markup (consistent with company 40% gross margin)
<b>Total System Capital Cost</b>		<b>\$1,371,590</b>	

**Figure 54. PVD catalyst coating system capital cost breakdown**

Using the estimated capital cost of \$1.4 million, a DFMA<sup>®</sup> analysis was conducted for the sputtering process and Pt recycling. General processing parameters supplied by Ford were used as inputs to the model, however, not all parameters were provided and SA estimates were used for the remaining parameters. Catalyst material composition was provided by Ford, as shown in Figure 55. Figure 56 lists the assumptions for processing steps and corresponding processing times for sputtering the two metals onto the carbon support.

Material Assumptions				
	Carbon	Niobium Oxide (NbO <sub>2</sub> )	Pt	Totals
Composition (Wt%)	65%	10%	25%	100%
Densities (g/cc)	2.3	4.6	7.86	NA
Mass per batch (kg)	45.5	7	17.5	70
Volume per batch (L)	20.08	1.52	2.23	23.8

**Figure 55. Material composition of sputtered Pt and Nb on carbon support**

Step#	Process Step	Time (hours)
1	Load internal chamber (with carbon) into vacuum chamber and refill targets as needed	2
2	Heat at 175C to drive off moisture while drawing down vacuum to 10mTorr	12
3	Feed Ar and O <sub>2</sub> into chamber during Niobium deposition at >100°C (Ar/O <sub>2</sub> ratio between 10/1 and 20/1 (Argon using 26/1 ratio)	17.7
4	Raise temp to 200°C to off-gas Ar/O <sub>2</sub> mixture	3
5	Feed pure Ar while depositing Pt	44.2
6	Passivation step (run small % of O <sub>2</sub> )	10
7	Re-pressurize to atmospheric conditions	5
8	Unload internal chamber from vacuum	2
Total Cycle Time		95.9

**Figure 56. Processing steps used in DFMA<sup>®</sup> analysis for PVD coating Pt and Nb on carbon support**

Discussions with Ford revealed the potential cost impact of Pt loss during the PVD process and the need for a careful consideration of precious metal capture and recycle. SA conducted a DFMA<sup>®</sup> analysis of a conceptual process to collect fugitive Pt and Nb on a sacrificial cylinder liner (made of Kapton<sup>®</sup> polyimide film) from which the Pt could be easily recycled. About 2% of the deposited Pt and Nb metal is estimated to fall-upon/adhere to the Kapton<sup>®</sup> liner inside the barrel of the vacuum chamber. Every ten cycles, the Kapton<sup>®</sup> is removed for recycling of the Pt and Nb. To separate the metals from the liner, the liner is dissolved in a water-NaOH solution (1 hour batch time). The metal-laden solution then passes through a centrifuge to separate the metals from solution. Pt can then be separated from the Nb through a smelting process. SA conducted only a brief and simplified analysis of this process and projects the operation cost to be \$50/tr.oz. of Pt recovered. The recovered value of precious metals on the liner is \$249/kg<sub>catalyst</sub> based on 95% (wt) recovery of the Pt and Nb metals from the liner. This is a significant fraction of the cost of the catalyst thereby indicating an economic need for precious metal recycling.

At 35g per system, overall catalyst cost ranges from \$440 (at 500k sys/year) to \$941 (at 1k sys/year) per system depending on production volume, when produced in 70 kg batches. Catalyst produced in 30kg batch size is only modestly higher, reflecting the high material cost of the catalyst. When comparing to the baseline d-PtCo/HSC catalyst, the net difference is only about \$0.47/kW<sub>net</sub>, as seen in Figure 57. Overall, PVD deposition onto carbon powder is determined to be a viable, cost-competitive catalyst synthesis method suitable for high production volumes. It offers the possibility of moderate cost reduction compared to the baseline synthesis method, assuming electrochemical performance of the catalyst is equal to (or greater than) that of the catalyst produced from the baseline method.

## Comparison to Baseline Catalyst

		Baseline PtCo/HSC	Alternative PVD PtNb/HSC
Catalyst Usage (mass to inking station)	gCatalyst/system	30.25	34.56
Pt mass fraction	gPt/gCatalyst	28.56%	25%
Pt Usage (mass to inking station)	gPt/system	8.639	8.639
Cathode Loading	mgPt/cm2	0.1	0.1
Catalyst yield (on total process)	Net/Gross	95%	100%
<b>Cost Summary</b>			
Pt Cost (net)	\$/system	\$446.30	\$426
Processing Cost	\$/system	\$32.33	\$14.83
QC	\$/system	\$4.31	\$4.31
Packaging	\$/system	\$0.22	\$0.22
Total	\$/system	\$483.16	\$445.19
Delta to Baseline	\$/system	NA	-\$37.97
	\$/kW	NA	-\$0.47

These 2 steps complete the catalyst synthesis and apply to both approaches.

**Figure 57. Cost comparison of baseline d-PtCo/HSC catalyst synthesis cost and sputtering Pt and Nb on HSC support**



## 7.2 Electrospinning Membrane and Electrode Materials

The catalyst coated membrane (CCM) remains one of the most significant cost components of the FC stack and finding ways to reduce this cost has led to DOE contracts in the area of alternative membranes and electrodes. One contract (DE - EE0006362) awarded to GM, 3M, and Vanderbilt from 2013-2016 has demonstrated that electrospun membranes can achieve similar performance to conventional ePTFE-supported Nafion® membranes. The second contract, awarded in 2016 to Vanderbilt University, Nissan, and Georgia Tech (DE-EE0007653), shows that electrospun electrodes have improved performance and durability over conventional spray coated electrodes. Due to this growing interest in electrospun materials for the CCM, SA was tasked in 2018 to investigate the cost of three electrospun components: an electrospun membrane support, co-spun membrane support and ionomer, and electrospun electrodes.

### 7.2.1 Electrospun Membrane Support

In 2017, SA evaluated the cost of an electrospun membrane support to be used as a direct replacement of the ePTFE support currently used as within Gore membranes. This analysis postulated PVDF as the electrospinning polymer support material and utilized an Elmarco needle-free Nanospider electrospinning machine. In 2018, this analysis was re-evaluated to consider an alternative material and machine.

In the 2017 analysis, SA estimated the capital cost of the Elmarco electrospinning machine to be \$2M. However, in 2018 a subsequent price quote from Elmarco for their Nanospider came in at \$4.9M, substantially higher. SA next pursued a quotation from Inovenso for their Nanospinner 416 (~\$360k for base system). The two machines differ in how the fiber is electrospun, as well as differing in production rate and subsystems included in the price quote. The Elmarco Nanospider machine utilizes a needle-free process of coating an electrode wire rather than spinning a fiber from a nozzle. The patented technology is based on the discovery that a Taylor Cone can be created from a thin film of polymer. In this case, the thin film polymer is coated onto an electrode wire and the fiber that is spun is deposited onto a carrier film below the electrode wire. The high cost of the Elmarco machine also includes periphery equipment for HVAC controls and slurry mixing, components not included in the Inovenso Nanospinner base machine. Additionally, the Elmarco Nanospider also has a slightly higher mass deposition rate than the Inovenso's needle-type system. The Nanospinner 416 contains rows of nozzles across the width of the web that laydown fibers in the range of 10 ml of slurry per hour per nozzle (110 nozzles in base unit). The capital cost of this machine is approximately \$430k (including ~\$70k of additional nozzles beyond those that come with the base machine). When including quality control equipment and cost for a clean room, the total cost is close to \$700k. SA is not able to reconcile the high capital cost of the Elmarco Nanospider with the lower cost of the Inovenso system nor is a detailed cost breakdown available from Elmarco. Consequently, the Inovenso Nanospinner was chosen for the cost analysis as it appears to meet the technical requirement and is cost competitive.

The material switched from PVDF to PPSU based on a US patent by Pintauro et al<sup>43</sup> that suggests a PPSU material may be a superior membrane support material due to its mechanical strength and reduced effect on ionic conductivity. The patent also includes examples of the composition of the support material slurry. Figure 58 lists the DFMA<sup>®</sup> analysis assumptions (vetted with Inovenso and Peter Pintauro) used in SA’s price estimate. With the use of hydrocarbon solvents, additional equipment is required to handle fumes given off during the electrospinning process. As part of a Clean Planet’s program<sup>44</sup>, solvents can be recycled and sold back to the manufacturer at 20% reduced cost of new material. This price is inclusive of any equipment needed to recycle the solvents.

SA Model Parameters for Membrane Support	Value
Membrane Thickness	10 microns
Volume Percent Void	78%
Layer Mass	3.6g/m <sup>2</sup>
Support Material Cost: PPSU (25 Wt% of slurry)	\$1-30/kg
Solvent 1 Cost: N-methyl-2pyrrolidone (60wt% of slurry)	\$1/kg
Solvent 2 Cost: Acetone (15 Wt% of slurry)	\$2/kg
PET Backer Substrate Cost	\$0.22-\$0.50/m <sup>2</sup>
Electrospinning System Total Capital Cost	\$700k
Inovenso Nanospinner 416 Base Cost (110 nozzles)	\$360k
Additional Nozzles Cost (44 nozzles)	\$70k
ISO 5 Cleanroom Cost	\$205k
Optical Detection QC Cost	\$65k
Output Capacity: 2.7 g/hr per nozzle x 154 nozzles	416 g/hr
Line Rate	1.3 m/min
Web Width	1m
Markup	Materials: 19-25% Manufact.: 46-73%

**Figure 58. Electrospun membrane DFMA<sup>®</sup> analysis assumptions**

The per nozzle output capacity of the slurry material can be adjusted for a particular material. Although SA assumed a 10ml/hr (2.7g/hr) output capacity, this material composition has not been tested with the Inovenso Nanospinner machine. The Nanospinner is capable of 0.1 to 1,000ml/hr (with various nozzles), so the assumed 10ml/hr is certainly at the low end of the range. Since a majority of the price comes from manufacturing (materials are very low cost), the cost of the electrospun support is highly dependent on the flow rate. Figure 59 shows that if the flow rate is doubled from 10ml/hr to 20ml/hr, the cost is almost cut in half (from \$1.75 to \$0.92/m<sup>2</sup>) at high volume.

<sup>43</sup> US Patent 9,350,036 B2, 2016 “Composite Membranes, Methods of Making Same, and Applications of Same”, P. Pintauro, A. Park, J. Ballengee.

<sup>44</sup> <http://cleanplanetchemical.com/solvent-recycling/pricing/>

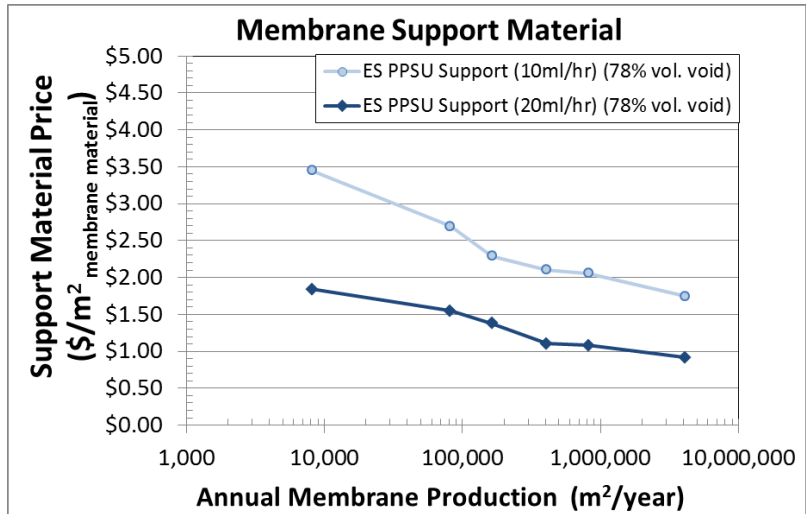


Figure 59. Electrospun (ES) PPSU membrane support price at two output capacities.

Figure 60 shows the comparison of ePTFE (95% volume void), Giner’s DSM support (50% volume void), and the electrospun PPSU (78% and 95% volume void) support materials between 10k and 500k systems per year production.<sup>45</sup> If electrospun PPSU (~\$0.50/m<sup>2</sup> for 95% volume void at high volume) were to replace ePTFE (~\$6/m<sup>2</sup> at high volume) as the membrane support material (and given the same performance), it would achieve approximately \$0.70/kW<sub>net</sub> savings in system cost. While SA continues to assume ePTFE to be the membrane support material for the 2018 baseline system, electrospun membrane supports are chosen for the 2020 and 2025 automotive systems.

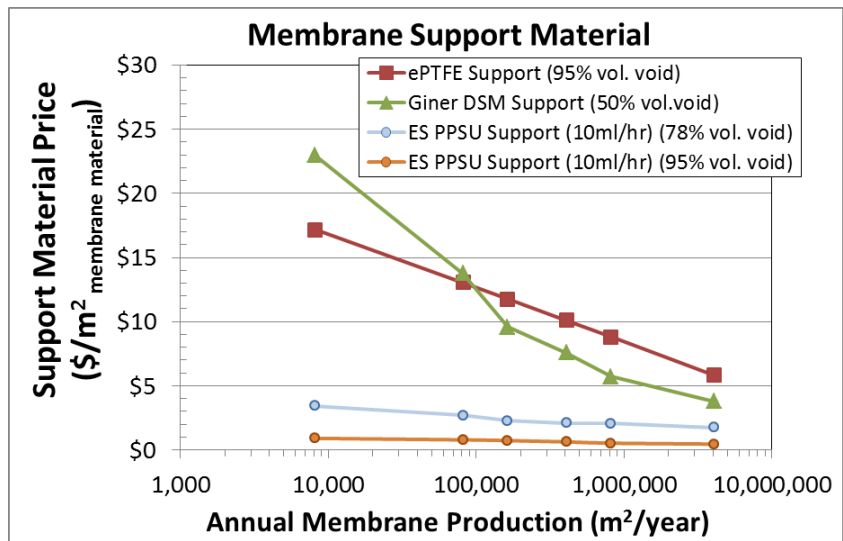


Figure 60. Comparison of membrane support materials over production volume: ePTFE, Giner DSM, and electrospun PPSU.

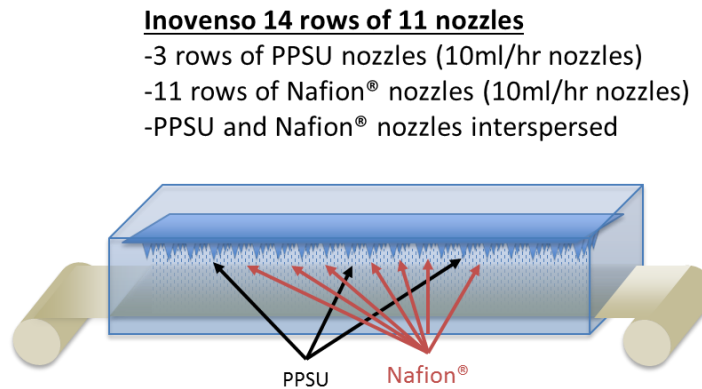
<sup>45</sup> While each membrane support differs in void fraction, the electrochemical performance of the finished supported membrane is expected to be largely insensitive (at least for void fraction greater than 50%). Void fraction can be controlled by compression of the support prior to membrane fabrication. Void fraction also affects the amount of ionomer used in the finished membrane.

## 7.2.2 Co-Spun Membrane Support and Ionomer

A complete electrospun membrane can be formed by co-spinning of the ionomer and support materials (rather than just the support material), followed by a compaction process to densify the membrane and eliminate voids and pinholes, and removal of Polyethylene Oxide (PEO), an additive to improve electrospinnability. SA modeled these three processes to estimate the price of a complete membrane.

### 7.2.2.1 Co-Spun Nanofibers

The co-spun membrane contains both ionic conducting Nafion<sup>®</sup> and PPSU support polymer. Co-spinning refers to electrospinning two separate materials onto a backer through separate nozzles at the same time so as to form a layer made of two different nanofiber materials. The Inovenso 416 allows roll-to-roll deposition and contains multiple rows of electrospinning nozzles which can alternate in slurry material (i.e. alternating rows of PPSU and Nafion<sup>®</sup> nozzles as shown in Figure 61). Material and processing parameters for the co-spun membrane are listed in Figure 62. The assumed slurry composition for the support and ionomer materials are based on Pintauro's patent<sup>46</sup>.



**Figure 61. Diagram of co-spun Nafion<sup>®</sup> and PPSU.**

<sup>46</sup> US Patent 9,350,036 B2, 2016 "Composite Membranes, Methods of Making Same, and Applications of Same", P. Pintauro, A. Park, J. Ballengee.

SA Model Parameters for Co-Spun Membrane	Value
Membrane Thickness	10 microns
Volume Percent Nafion®	78%
Dried Layer Mass (PPSU: 3.6 g/m <sup>2</sup> )( Nafion®/PEO: 15.4 g/m <sup>2</sup> )	19.4 g/m <sup>2</sup>
<b>Support Slurry</b>	
Support Material Cost: PPSU (25 Wt% of support slurry)	\$1-30/kg
Solvent 1 Cost: N-methyl-2pyrrolidone (60wt% of support slurry)	\$1-2/kg
Solvent 2 Cost: Acetone (15 Wt% of support slurry)	\$2-3/kg
<b>Ionomer Slurry</b>	
Ionomer Material Cost: Nafion® (30wt% of ionomer slurry)	\$114 - \$364/kg
Additive Material Cost: PEO (0.1wt% of ionomer slurry)	\$3-9/kg
Solvent 1 Cost: N-Propanol (46.6wt% of ionomer slurry)	\$0.50-2/kg
Solvent 2 Cost: Water (23.3wt% of ionomer slurry)	\$1.75/kg
PET Backer Substrate Cost	\$0.20-\$0.50/m <sup>2</sup>
<b>Electrospinning System Total Capital Cost</b>	
Inovenso Nanospinner 416 Base Cost (110 nozzles)	\$360k
Additional Nozzles Cost (44 nozzles)	\$70k
ISO 5 Cleanroom Cost	\$205k
Optical Detection QC Cost	\$65k
<b>Output Capacity</b>	
PPSU: 2.7 g/hr per nozzle x 33 nozzles	89 g/hr
Ionomer: 3.1 g/hr per nozzle x 121 nozzles	375 g/hr
Line Rate	0.28 m/min
Web Width	1m
Markup	Materials: 19-25% Manufact.: 46-73%

**Figure 62. Processing parameters for electrospun membrane.**

Based on the slurry composition, the mass of material required for a 10µm thick dried membrane, and the system's maximum deposition rate (1.54 L of slurry per hour), one Inovenso unit is capable of supplying 20k vehicles per year. At 500k vehicles per year (about 4M m<sup>2</sup> per year), this equates to about 29 simultaneous production lines. The total cost for electrospinning the membrane is about \$7.21/m<sup>2</sup>, 68% of which is from manufacturing and tooling. At the end of this electrospinning process, there are two types of nanofibers deposited onto a backer. The next step is to densify the membrane through compaction and heating.

### 7.2.2.2 Compaction of Co-Spun Membrane

Pintauro and Ballengee<sup>47</sup> evaluated complete electrospun membranes and determined the optimal conditions for the compaction process. Their process demonstrated fast processing times with little effect on swelling, mechanical strength, and conductivity. One key aspect of the compaction process is choosing the material that will remain as nanofibers and allow the other material to flow around those nanofibers. The co-spun (or dual-fiber) mat can be processed in two different ways (shown below in Figure 63) to form a dense membrane layer. The resulting geometry is different for each process and can affect the performance of the membrane. The two compaction options are:

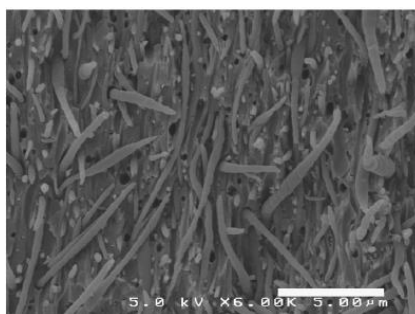
<sup>47</sup> J.B. Ballengee, P.N. Pintauro, "Preparation of nanofiber composite proton exchange membranes from dual fiber electrospun mats", Journal of Membrane Science 442 (2013) 187-195.

- Option 1: Hot pressing, then annealing of the dual-fiber material so that the Nafion<sup>®</sup> polymer fibers are melted and surround the PPSU support fibers that remain intact in final form. This creates a membrane with PPSU nanofibers embedded within a dense layer of Nafion<sup>®</sup> (described as Nafion<sup>®</sup>/PPSU-fibers).
- Option 2: Compaction of the dual-fiber mat, followed by exposure to chloroform vapor to breakdown or soften the PPSU material. When annealed, the PPSU fibers melt and flow around the Nafion<sup>®</sup> nanofibers that remain intact in final form. This creates a membrane with Nafion<sup>®</sup> nanofibers embedded within a dense layer of PPSU (described as Nafion<sup>®</sup>-fibers/PPSU).

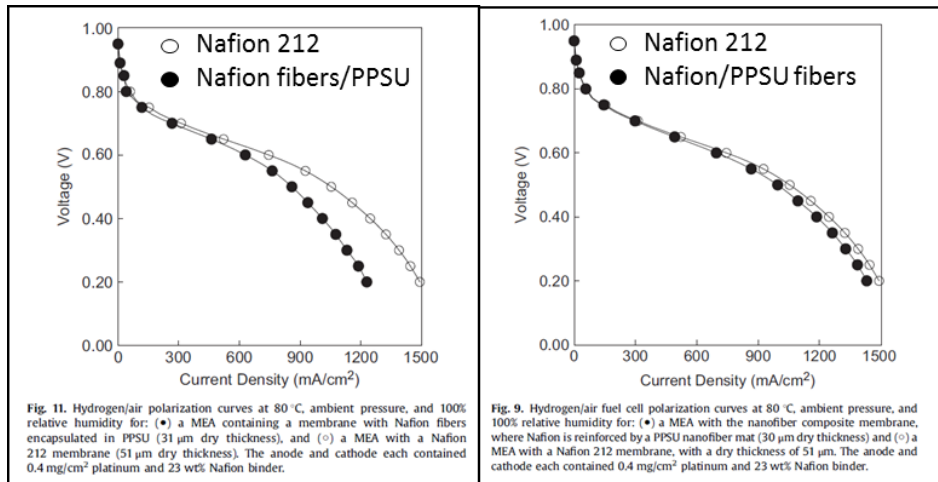
Membrane	Compaction Process Conditions
Nafion <sup>®</sup> /PPSU-fibers	<ol style="list-style-type: none"> <li>Hot-press 40s at 127°C</li> <li>Anneal 5 min at 210°C</li> </ol>
Nafion <sup>®</sup> -fibers/PPSU	<ol style="list-style-type: none"> <li>Compact mat for 10s at 25°C</li> <li>Expose to 50°C chloroform vapor for 3 min</li> <li>Anneal 5 min at 210°C</li> </ol>

**Figure 63. Two processes for compaction of a co-spun membrane using PPSU and Nafion<sup>®</sup>.** Source: J.B. Ballengee, P.N. Pintauro, "Preparation of nanofiber composite proton exchange membranes from dual fiber electrospun mats", *Journal of Membrane Science* 442 (2013) 187-195. (Table 5)

Nafion<sup>®</sup>/PPSU-fibers were seen to be the better option over Nafion<sup>®</sup>-fibers/PPSU for the co-spun membrane due to simpler processing conditions (does not require exposure to chloroform), showing slightly improved performance (lower mass transport overpotential, as seen in Figure 65), and achieving a higher proportional stress limit. An SEM image of the dense Nafion<sup>®</sup>/PPSU-fibers membrane from Pintauro's work is shown in Figure 64.



**Figure 64. SEM image of dense nanofiber composite membrane with Nafion<sup>®</sup> reinforced by PPSU nanofibers.** Source: J.B. Ballengee, P.N. Pintauro, "Preparation of nanofiber composite proton exchange membranes from dual fiber electrospun mats", *Journal of Membrane Science* 442 (2013) 187-195.



**Figure 65. (Left) Graph of polarization curve for Nafion®-fibers/PPSU and (Right) graph of polarization for Nafion®/PPSU-fibers in comparison to Nafion® 212 unsupported membrane.**

**Source: J.B. Ballengee, P.N. Pintauro, "Preparation of nanofiber composite proton exchange membranes from dual fiber electrospun mats", Journal of Membrane Science 442 (2013) 187-195.**

It should be noted that the compaction process conditions listed in Figure 63 were the optimal conditions for compaction based on 56 vol% of Nafion® in the membrane. For the present study, SA assumes a 78 vol% of Nafion®, utilizing the process to form a membrane with PPSU nanofibers embedded in a dense layer of Nafion® (Nafion®/PPSU-fibers). The optimal compaction conditions are not expected to change significantly with higher ionomer fraction (although they change slightly).

The modeled high-production rate compaction process for Nafion®/PPSU-fibers involves unwinding of the co-spun/dual-fiber membrane, hot pressing, annealing, and re-roll of the dense membrane (Figure 66). Total capital cost is estimated to be \$324k for the unwind/rewind stands, hot press, and annealing oven. Given the 40s duration of compaction, an indexed system with a static hot press is proposed. The indexed process accounts for 6 seconds to open and close the press, 40 seconds to compact, and 10 seconds to index. With eight membranes pressed simultaneously, the effective cycle time is about 7 seconds per part. In order to anneal the membrane at 210°C for 5 minutes, the length of the oven would need to be 8 m long (an effective line rate of 1.6m/min). The cost of this process at 4M m<sup>2</sup> per year is \$0.70/m<sup>2</sup>.

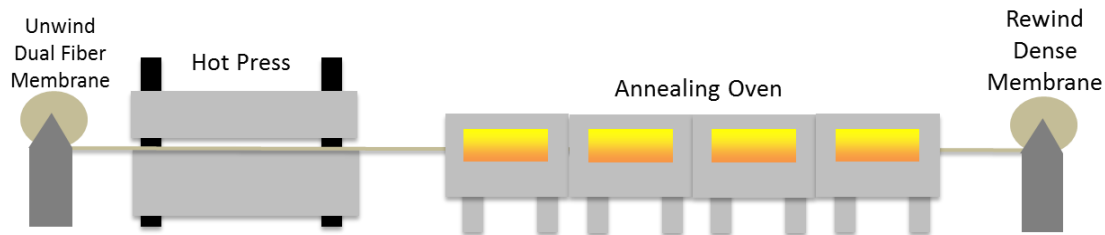


Figure 66. Diagram of compaction process for co-spun membrane.

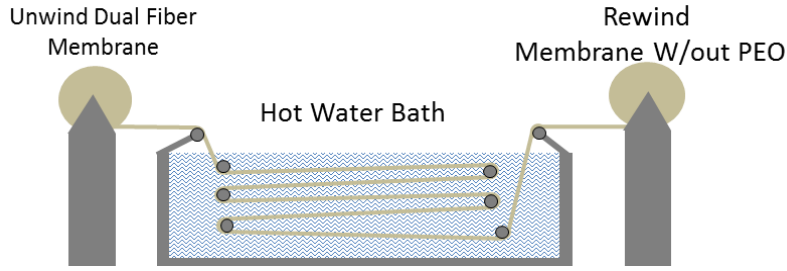
### 7.2.2.3 Polyethylene Oxide (PEO) Removal from Co-Spun Membrane

PEO is added as a dispersant to improve electrospinnability of Nafion® (PFSA polymers require a carrier polymer like PEO to form a true solution rather than a micellar dispersion in organic solvents). In Pintauro's patent<sup>48</sup> description, PEO is later removed during protonation of the membrane (soaking in sulfuric acid) because the presence of PEO can lower ionic conductivity. However, SA's DFMA® cost analysis assumes use of the protonated form of Nafion® prior to electrospinning, thereby obviating the post-spinning protonation step. PEO is required whether the ionomer material is protonated or not, and in both cases, the amount of PEO is very small (<1wt% of compacted ionomer polymer). Per Pintauro's suggestion, PEO removal is modeled as soaking of the electrospun fibers in a hot water bath (slightly less than boiling temperature for 5-10min) and may be performed before or after the compaction step.

Figure 67 shows the PEO removal process configuration. The capital cost of equipment is based on Chemcut equipment for a roll-to-roll acid etching bath. The Chemcut equipment is sized for one pass at 76cm web width. Given the electrospun material is 1m web width, a 25% increase in cost is applied to the Chemcut machine. Since the machine is designed for acid etching, alternative materials of construction would be used for a simple water bath. SA assumes a cost reduction of 50% in going from an acid etching machine to a water bath. Total net cost reduction is thus 25%. To achieve a 7.5 min dwell time and 8.4m machine length, 4 switchbacks are assumed to achieve a total washing length of 42m with a web processing speed of 5.6m/min. An additional \$20k is added to the system for each switchback to account for the height change in equipment. The total capital cost is assumed to be \$433k and the resulting cost at 4M m<sup>2</sup> year is estimated to be ~ \$0.39/m<sup>2</sup>. This represents only 3% of the total cost for a co-spun membrane material at high production volume.

<sup>48</sup> US Patent 9,350,036 B2, 2016 "Composite Membranes, Methods of Making Same, and Applications of Same", P. Pintauro, A. Park, J. Ballengee.

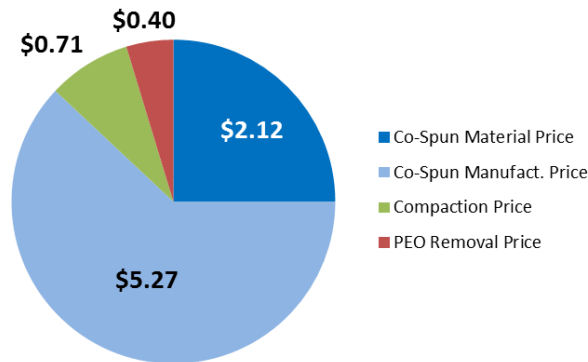




**Figure 67. PEO removal utilizing roll-to-roll hot water bath.**

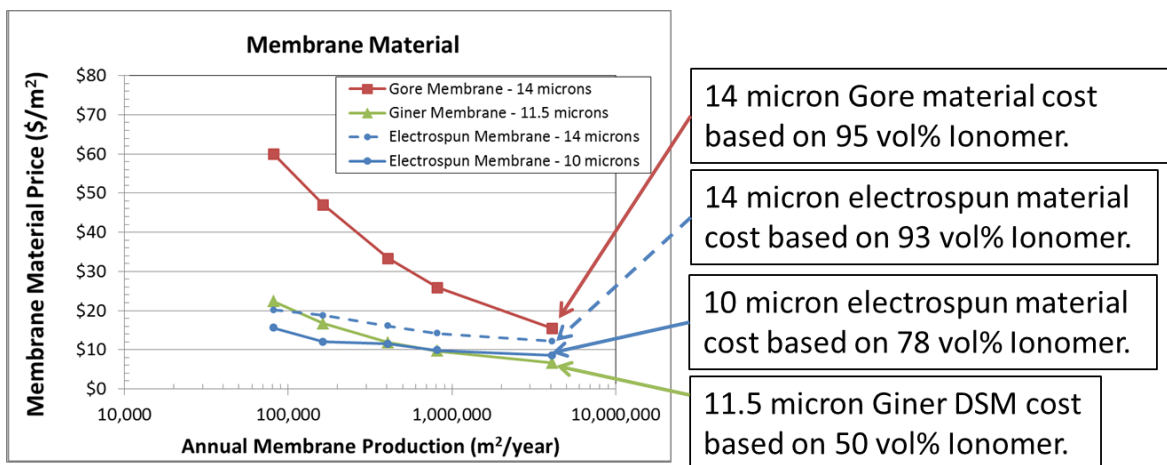
**7.2.2.4 Co-Spun Membrane Cost Results**

The total cost of a complete electrospun 10 micron thick membrane with 78 vol% Nafion® and a PPSU nanofiber support is \$8.55/m<sup>2</sup> at 4M m<sup>2</sup> per year. The pie chart in Figure 68 shows the breakdown in co-spun materials, manufacturing, compaction, and PEO removal. The co-spun material and manufacturing dominate the price of the membrane.



**Figure 68. Breakdown in co-spun membrane price (\$/m<sup>2</sup>) at 4M m<sup>2</sup> per year**

When comparing the dual-fiber electrospun compacted membrane to the Gore-type membrane with ePTFE support, the price is about \$3/m<sup>2</sup> lower cost at high production volume (at the same thickness and similar ionomer vol%), as seen in Figure 69. At lower production volumes, the price of the co-spun membrane can be less than the Gore membrane. At high volume, the Giner DSM is the lowest price due to the lowest vol% of ionomer. These prices are all on a \$/m<sup>2</sup> basis and do not take into account any performance differences between the membranes.



**Figure 69. Comparison of Gore Direct-Coat, Giner DSM, and electrospun membranes at two thicknesses and ionomer vol%.**

### 7.2.3 Electrospun Electrodes

SA conducted a DFMA<sup>®</sup> cost analysis of electrospinning catalyst electrodes for pressing against the surface of the membrane. The electrospun materials are coated onto a PET backer sheet and then hot pressed to the membrane. Pintauro et al.<sup>49</sup> tested many configurations of catalyst deposition with electrospinning and compared them to spray coating. Electrospun electrodes were found to result in higher performance at high relative humidity (100% RH). Spray coating tended to have better performance at low relative humidity (40% RH). Pintauro et al. also included a detailed description of the material composition and electrospinning process parameters: these formed the basis for SA’s model parameters for the electrospun cathode (listed in Figure 70).

<sup>49</sup> US Patent Application 0250431 A1, 2017 “Polymer Solution, Fiber Mat, and Nanofiber Membrane-Electrode-Assembly Therewith, and Method of Fabricating Same”, P. Pintauro, W. Zhang, M. Brodt, A. Park, J. Ballengee, R. Wycisk.

<b>SA Model Parameters for Electrospun Cathode</b>	<b>Value</b>
Pt Loading	0.125 mgPt/cm <sup>2</sup>
Mass of Dried PtCo/HSC Catalyst and Polymer (Nafion® + PAA)	28.6 g/m <sup>2</sup>
Dried Layer Mass (PPSU: 3.6 g/m <sup>2</sup> )( Nafion®/PEO: 15.4 g/m <sup>2</sup> )	1.25 g/m <sup>2</sup>
<b>Cathode Slurry</b>	
PtCo/HSC (7wt% of slurry)	\$15.89k/kg – \$30.47k/kg
Ionomer Material Cost: Nafion® (3wt% of slurry)	\$114 - \$364/kg
Additive: Poly Acrylic Acid (PAA) (3wt% of slurry)	\$2-6/kg
Solvent 1 Cost: Isopropanol (58wt% of slurry)	\$1/kg
Solvent 2 Cost: Water (29wt% of slurry)	\$1.75/kg
<b>Electrospinning System Total Capital Cost</b>	
Inovenso Nanospinner 416 Base Cost (110 nozzles)	\$360k
Additional Nozzles Cost (44 nozzles)	\$70k
ISO 5 Cleanroom Cost	\$205k
Optical Detection QC Cost	\$65k
<b>Output Capacity</b>	
PPSU: 5.46 g/hr per nozzle x 154 nozzles	841 g/hr
Line Rate	0.49 m/min
Web Width	1m
Markup	Non-Pt Materials: 19-25% Manufact.: 40-70%

**Figure 70. Processing parameters for electrospun cathode**

In comparing electrospun cathodes to slot die coated cathodes, prices are nearly identical at high volume. As seen in the graph in Figure 71, the electrospun cathode is higher cost at all production rates due to the slower processing time compared to slot die coating. Despite the machinery capital cost being much higher (\$900k-\$6M) and having additional material yields, the slot die coating line is faster (3-25m/min compared to ~0.5m/min for electrospinning) leading to lower cost than an electrospun cathode.

Electrospun anodes have also been modeled and show very little cost difference from slot die coating, particularly at high production volumes. In conversations with Peter Pintauro, there is little effect on performance when electrospinning the anode.

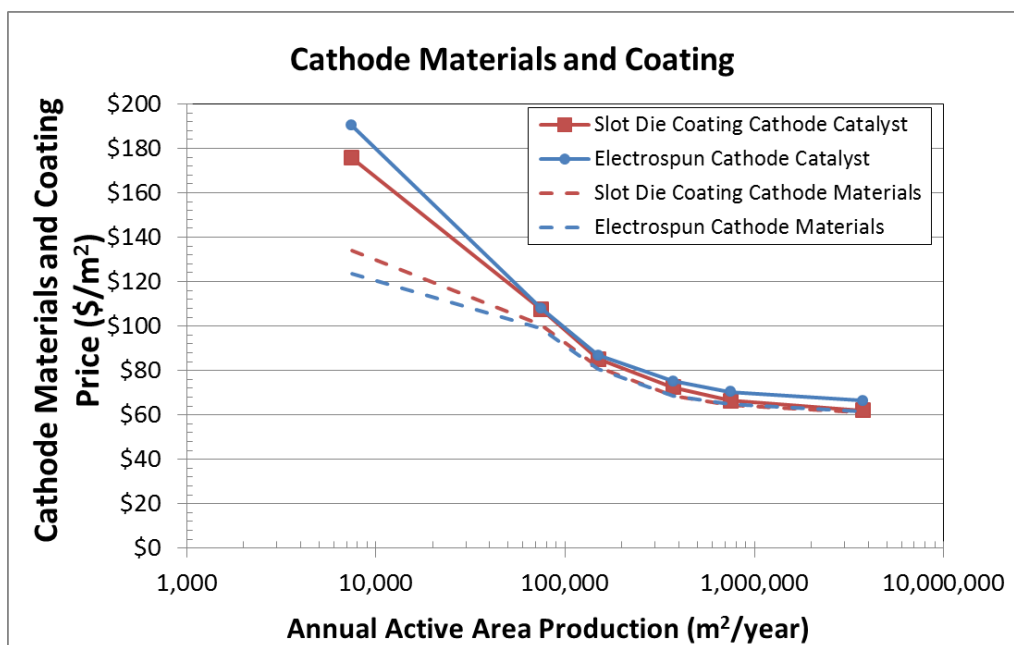


Figure 71. Comparison of slot die coating and electrospun cathode pricing over annual production

#### 7.2.4 Electrospun CCMs

The full CCM could be made of electrospun materials when combining electrospun supports, membranes, and electrodes. Alternately, various individual components of the CCM can be electrospun and combined with conventionally fabricated components, i.e. an electrospun membrane support used in a Gore-type membrane with slot die coated electrodes or a co-spun membrane with slot die coated electrodes.

At all but the highest production volume, the combination of a co-spun membrane and electrospun cathode (with slot die coated anode) leads to the lowest total CCM cost. This is graphically illustrated in Figure 72 (red curve) and is primarily due to the low cost of co-spinning the membrane. At high volume, this combination of components is not the lowest cost pathway on a \$/m<sup>2</sup> basis for producing the CCM: rather, an electrospun support with Gore-like membrane and slot die coated cathode is the lowest cost method at 4M m<sup>2</sup> per year production. The high production volume prices do not vary much because the CCM is dominated by Pt catalyst material pricing. This cost comparison does not include hot pressing of the CCM that is required for all designs.

#### 7.2.5 Electrospun CCM Polarization Performance

Based on the above-described cost analysis, electrospinning appears to be an economical alternative method for producing fuel cell CCMs, but only if they perform well within the stack. Pintauro<sup>50</sup> has shown very promising performance results for electrospun electrodes and has achieved a power density

<sup>50</sup> Pintauro, P., "Fuel Cell Membrane-Electrode Assemblies with Ultra-Low Pt Nanofiber Electrodes", Department of Chemical and Biomolecular Engineering at Vanderbilt University, 2018 U.S DOE Fuel Cell Technologies Program Annual Merit Review and Peer Evaluation Meeting, June 14, 2018.

of 998 mW/cm<sup>2</sup> compared to 544 mW/cm<sup>2</sup> for spray-coated PtCo cathode. This performance improvement is attributed to lower O<sub>2</sub> gas transport resistance. With this improvement in performance, the cost could be reduced considerably compared to conventional CCMs. Not only will the area of CCM material decrease per stack, a smaller cell area would lead to lower cost GDLs, bipolar plates, and gasketing. However, this cost analysis of electrospun materials is based on power density parity with ePTFE-supported CCMs and does not account for any potential polarization differences.

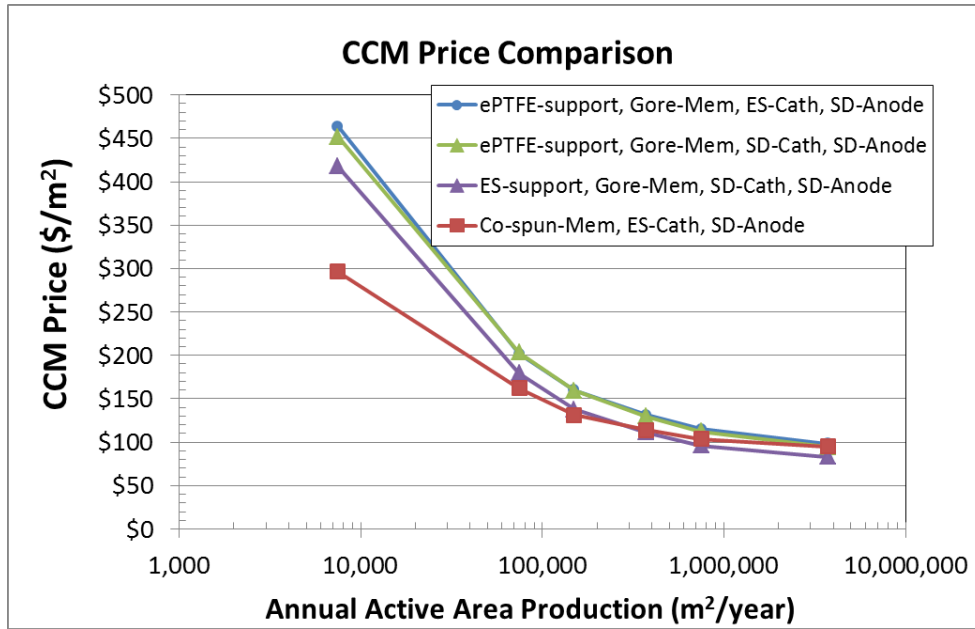


Figure 72. Comparison of various processing methods to form the CCM; electrospinning (ES) and slot die coating (SD)

## 8 Model Validation Study: Toyota Mirai

In 2017, SA was tasked with conducting a validation of a currently manufactured, representative, industry accepted hydrogen FCS, subsystem, or component for production passenger vehicles. The Toyota Mirai fuel cell vehicle was chosen as the system for the Validation Study. While Toyota has declined to participate, the validation study is still able to achieve 1) validation of the system design, and 2) validation of model price projections against Toyota's MSRP for the Mirai.

In 2018, SA updated the Mirai system operating conditions to reflect recently obtained performance data.<sup>51,52</sup> Specifically, air compressor motor power was determined to be much lower than previously estimated (14kW instead of 23kW). This led to upward revision of the Mirai estimated net power which, in turn, led to a reduction of the projected system cost (\$210/kW<sub>net</sub> instead of \$233/kW<sub>net</sub>). Exact Pt loading, membrane thickness, and bipolar plate coating thickness were also measured and updated within SA's cost model. Updated results are summarized below and further details on modeled components for the Mirai study may be found in SA's 2017 annual report.<sup>53</sup> All values in this section are in 2016\$.

### 8.1 Validation of System Design: DFMA® Analysis of Toyota Mirai Fuel Cell System

The unveiling of the Toyota Mirai fuel cell vehicle provides a unique opportunity for SA to compare the baseline automotive system to a mass-produced FCS. While Toyota has not released details of the power system operating conditions, much top-level component information is publicly available. SA is able to make educated guesses for many aspects of the Mirai system based on Toyota news releases and publications<sup>54</sup>, discussions with OEMs and the DOE Fuel Cell Tech Team, and the patent literature.<sup>55, 56</sup> Given reported stack sizing and operating techniques such as power output, number of cells, and internal cell humidification, SA was able to make educated guesses for a complete set of operating conditions that is deemed reasonable by the DOE Fuel Cell Tech Team.

Stack humidification (external vs. internal) is one of the key differences between SA's baseline system and the Toyota Mirai system. In the Mirai stack, a thinner than typical PEM membrane facilitates

---

<sup>51</sup> Lohse-Busch, H., "Technology Assessment of a Fuel Cell Vehicle: 2017 Toyota Mirai", Vehicle Systems Research Group at Argonne National Laboratory, 2018 U.S DOE Fuel Cell Technologies Program Annual Merit Review and Peer Evaluation Meeting, June 13, 2018.

<sup>52</sup> Borup, R., More, K., Weber, A., "FC-PAD: Fuel Cell Performance and Durability Consortium", Presentation at 2018 US DOE Fuel Cell Technologies Program Annual Merit Review and Peer Evaluation Meeting, June 14, 2018.

<sup>53</sup> "Mass Production Cost Estimation of Direct H<sub>2</sub> PEM Fuel Cell Systems for Transportation Applications: 2017 Update" Brian D. James, Jennie M. Huya-Kouadio, Cassidy Houchins, & Daniel A. DeSantis, Strategic Analysis, Inc., December 2017.

<sup>54</sup> Konno, Norishige, Seiji Mizuno, Hiroya Nakaji, and Yuji Ishikawa. "Development of Compact and High-Performance Fuel Cell Stack." SAE International Journal of Alternative Powertrains 4, no. 2015-01-1175 (2015): 123-129.

<sup>55</sup> Tabata, Toshiharu, Tomoaki Terada, Takahiro Nagata, Susumu Enomoto, Yosuke Horiuchi, Hiroaki Takahashi, Tetsuo Kawamura, and Hideyasu Kawai. Conductive Carbon Carrier for Fuel Cell, Electrode Catalyst for Fuel Cell and Solid Polymer Fuel Cell Comprising Same. US8372562 (B2), issued February 12, 2013.

<sup>56</sup> Fujii, Toshiro, and Yoshiyuki Nakane. Electric pump. US7980830 (B2), issued July 19, 2011.

product water transport across the membrane and into the H<sub>2</sub> flow. An H<sub>2</sub> recirculation blower is then used to circulate humidified H<sub>2</sub> from the anode exhaust back to the anode inlet, where it can humidify the membrane at the stack inlet, a region where there is otherwise limited product water.

There are three aspects of this validation of system design analysis: 1) Detailed definition of the Mirai system and stack design, 2) DFMA<sup>®</sup> analysis and cost sensitivities of unknown aspects of the system, and 3) side-by-side comparison and evaluation of the component and cost differences between SA's baseline automotive system and the Toyota Mirai system.

The baseline automotive DFMA<sup>®</sup> model is used as the analysis framework of the Mirai system, as they have much in common. Many of the lower cost components for which there is little or no detail provided by Toyota, are adopted without change from the baseline system. Additionally, many design assumptions are held constant between systems when there were no documented changes reported for the Mirai. Larger impact values are incorporated into a sensitivity study to estimate the ranges of the potential Mirai cost impact. For example, the bipolar plate thickness is unknown so a range in thicknesses (affecting titanium cost) is postulated to estimate the spread of potential bipolar plate costs. Figure 73 details specific modeled differences between the Toyota Mirai fuel cell system and the baseline automotive fuel cell system.

Component	SA Baseline System	Change made to model Toyota Mirai System
BPP	Stamped stainless steel	Exchanged stainless steel for titanium
BPP Coating	TreadStone Coating	Exchanged for amorphous carbon coating
Coolant Gaskets	Laser Welding of BPPs	Exchanged with injection molded EPDM BPP gasket
MEA Sealing	2-part Subgasket	Exchanged with injection molded EPDM frame gasket
Compression	Compression bands	Removed compression bands (uses constant dimension compression)
Housing	Vacuum thermoformed polypropylene	Exchanged for aluminum casting
End Plates	Compression molding of LYTEX <sup>®</sup> composite	Exchanged with sand cast aluminum
Gas Distribution Manifold	Not Included	Added component for gas distribution connection to stack (external to housing). Sand cast aluminum plate with insertion molded resin.
Humidifier	External plate frame membrane humidifier	Removed humidifier (uses internal humidification via a thin membrane, BPP flow channels, and H <sub>2</sub> recirculation blower)
Air compressor	Honeywell centrifugal compressor/expander	Exchanged with Roots-type compressor (modeled as two-shaft Eaton-style system without expander)
H <sub>2</sub> Recirculation Blower	Not Included (2 passive ejectors are used for recirculation)	Added electrically driven gear-type compressor based on Toyota Industries Corporation patent

**Figure 73. List of changes made to the baseline DFMA<sup>®</sup> model to represent a Toyota Mirai system**

The estimated cost for the Toyota Mirai FCS is \$210/kW<sub>net</sub> at 1,000 systems per year production and is approximately 24% higher than the \$159/kW<sub>net</sub> projected cost of SA's baseline automotive system

(scaled to 96 kW<sub>net</sub> at 1,000 systems per year). This section of the report will describe the design and cost differences between the Mirai FCS and the baseline system; however, there are two main fundamental concepts that must be acknowledged while comparing systems:

- 1) The baseline auto DFMA<sup>®</sup> model is modified each year to optimize the cost of the system. While performance parameters are considered, durability for state-of-the-art technology may not yet be proven in a complete integrated system.
- 2) The design of the baseline auto system is primarily designed (on paper) with high production in mind and the design kept constant for all lower manufacturing volumes. In contrast, the Mirai is presumably primarily designed (in hardware) with low production in mind. Consequently, the design of the Mirai is more likely to change with increased production volumes as the limitations of early production/development are alleviated.

Production rates (and presumably sales) are reported to be ~700/year in 2014 (the first year of production) and ~3,000/year in 2016.<sup>57</sup> SA's model of the Mirai system was adjusted to include cost projections at both 1,000 and 3,000 units per year production rates. Cost results are shown in the following section for both volumes.

### **8.1.1 Mirai Operating Conditions and stack sizing**

Power density is estimated at 1,150 mW/cm<sup>2</sup>, a value derived from the estimated total active area (9.9 m<sup>2</sup>/stack) and the Toyota reported gross power (114 kW).<sup>58</sup> The calculation for the cell active area is based on Toyota's documented stack sizing (37 L, at 1.34 mm thickness per cell) and number of cells (370 cells/stack)<sup>58</sup>, SA's estimate for ratio of active cell height to active cell width (0.5:1), SA's estimate for the housing thickness (1 cm), and SA's estimate of the cell active to total area ratio (0.4:1). The net power of the stack is not specified by Toyota; however, system modeling of the air compressor and other ancillary loads from the system suggests a net power of 96 kW. Ancillary loads include 16 kW for the air compressor, 1 kW for the H<sub>2</sub> recirculation blower, and 1 kW for the coolant loop pumps and fans. Stack voltage is indicated in a Toyota document to be 220 V.<sup>59</sup> Estimated Mirai operating conditions are listed in Figure 74. The SA estimated cell dimensions are shown in Figure 75.

Note that power density is normally a key parameter for determination of the size and cost of the stack, and that the Mirai power density in this study is derived rather than stated by Toyota. While this would suggest enhanced uncertainty in cost projection, for this particular analysis the power density (and also voltage operating point) are of lesser importance because the physical dimensions for the stack are defined and the total plate area of the BPPs is fairly well established. Note, however, that deviations

---

<sup>57</sup> Online article "Japan gambles on Toyota's hydrogen powered car," by Robin Harding and Kana Inagaki at the Financial Times, March 28, 2017. <https://www.ft.com/content/328df346-10cb-11e7-a88c-50ba212dce4d?mhq5j=e1>

<sup>58</sup> Konno, Norishige, Seiji Mizuno, Hiroya Nakaji, and Yuji Ishikawa. "Development of Compact and High-Performance Fuel Cell Stack." SAE International Journal of Alternative Powertrains 4, no. 2015-01-1175 (2015): 123-129.

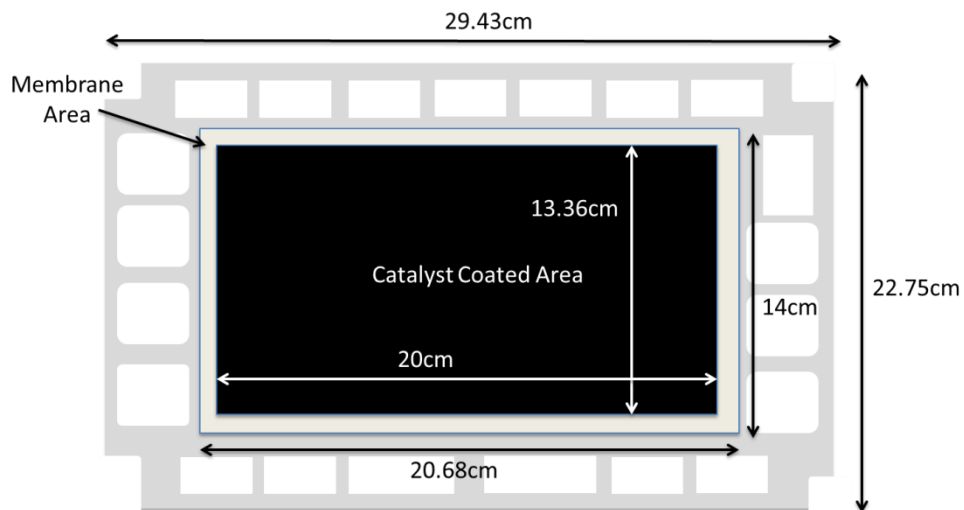
<sup>59</sup> Yumiya, H., Kizaki, M., Asai, H., "Toyota Fuel Cell System," Article from the 28<sup>th</sup> International Electric Vehicle Symposium and Exhibition in Goyang, Korea, May 2015.



from the estimated power density would impact membrane total area required and catalyst cost (as Pt usage is determined by active area and assumed catalyst loading).

Estimated Mirai Operating Condition	
Stack Power Net/Gross	96 kW/114 kW
Cell Voltage	0.6 V, 370 cells/stack
Current Density	1.934 A/cm <sup>2</sup>
Power Density	1,150 mW/cm <sup>2</sup>
Stack Pressure	est. <=2.5 atm
Total Pt loading	0.365 mg/cm <sup>2</sup>
Peak Cell Temp	est. ~80 °C
Total Active Area per system	9.9 m <sup>2</sup>
Active to Total Area ratio	0.4
Active/Total plate area	267 cm <sup>2</sup> /669 cm <sup>2</sup>
Q/ΔT	3.14 kW/°C

Figure 74. Table of estimated Toyota Mirai operating conditions for SA side study



*Not Drawn to Scale*

Figure 75. SA estimated Mirai cell dimensions

### 8.1.2 Mirai Stack Components

There are multiple stack components provided to Toyota by lower-tier vendors. These include bipolar plate material, rubber gaskets, GDLs, catalyst, and membrane material. The table below in Figure 76 describes many of these stack components and their publically identified Mirai supplier. Information on the material and technique used to manufacture the catalyst and the rubber gaskets is used in the Mirai DFMA<sup>®</sup> cost analysis. Cost quotes for GORE-SELECT<sup>®</sup> membranes were not obtained for this study; rather cost was based on use of the baseline membrane process. When including components provided by

external vendors, a markup is applied to the manufacturing cost to estimate a price to Toyota Motor Company (TMC).

Component Description	Vendor	Reference
PtCoCe/C catalyst includes increased durability with graphitized carbon black and free radical quenchers (cerium oxide)	Cataler	Cataler Website: <a href="http://www.cataler.co.jp/en/innovation/index.php">http://www.cataler.co.jp/en/innovation/index.php</a> Patent: US 8,372,562 B2 (2013) Patent: US 8,338,051 B2 (2012)
GORE-SELECT® membrane (10 µm thick)	W.L. Gore	<a href="http://www.gore.com/en_xx/products/electronic/fuelcells/fuelcells_series57_available.html">http://www.gore.com/en_xx/products/electronic/fuelcells/fuelcells_series57_available.html</a>
GDL carbon paper	Toray	<a href="http://www.toray.com/news/carbon/detail.html?key=D144E85F1C996C5149257D950007222B">http://www.toray.com/news/carbon/detail.html?key=D144E85F1C996C5149257D950007222B</a>
Flat rolled specialty titanium bipolar plate material	Kobelco	<a href="http://www.kobelco.co.jp/english/releases/2015/1190697_14516.html">http://www.kobelco.co.jp/english/releases/2015/1190697_14516.html</a>
Bipolar plate forming using Fine Hold Stamping	Toyota Boshoku	<a href="https://www.toyota-boshoku.com/global/content/wp-content/uploads/TBreport_2015E-1.pdf">https://www.toyota-boshoku.com/global/content/wp-content/uploads/TBreport_2015E-1.pdf</a> <a href="http://www.toyota-boshoku.com/common/global/pdf/p19_22_2008.pdf">http://www.toyota-boshoku.com/common/global/pdf/p19_22_2008.pdf</a> Patent: US 9,227,239 B2 (2016)
Pi-conjugated amorphous carbon coating on bipolar plates (80nm thick)	Toyota Process In-House	<a href="http://ecst.ecsdl.org/content/75/14/423.abstract">http://ecst.ecsdl.org/content/75/14/423.abstract</a>
Rubber gaskets for coolant gasket and MEA gasket	Sumitomo Riko	<a href="https://www.sumitomoriko.co.jp/english/companynews/pdf/2014/n51910191.pdf">https://www.sumitomoriko.co.jp/english/companynews/pdf/2014/n51910191.pdf</a> Patent Application: US 2015/0380694 A1 (2015)
Stack Manifold Parts	Kuraray	<a href="http://www.kuraray.com/release/2015/150825.html">http://www.kuraray.com/release/2015/150825.html</a>
H2 Detector: FH2-HY04	FiS (a Nissha Company)	<a href="http://www.nissha.com/english/news/2014/12/12th_1.html">http://www.nissha.com/english/news/2014/12/12th_1.html</a>

Figure 76. Second tier vendor list for Mirai components with references

### 8.1.3 Mirai Stack Cost Results

This section covers the results of a side-by-side comparison of the Toyota Mirai stack and SA's baseline DFMA® stack model scaled to 96 kW<sub>net</sub> at production rates of 1,000 and 3,000 systems per year. The stack cost for the Mirai is about \$14,100/stack compared to \$10,140/stack for the 96 kW<sub>net</sub> baseline system at 1,000 systems per year. Figure 77 enumerates the cost elements within the Mirai stack and Figure 78 is a bar chart comparing the component costs for the two systems. A majority of the cost difference is explained by a few key features:

- The Mirai's titanium BPPs have higher material cost than the stainless steel used in the baseline.
- The Mirai's higher (estimated) Pt loading (0.365 mg/cm<sup>2</sup> compared to 0.125 mgPt/cm<sup>2</sup> for the baseline) is likely driven by the desire to ensure durability, although the baseline system includes an etching on the cathode catalyst (specifically for enhanced durability) when the Mirai system does not.
- The Mirai's balance of stack cost is higher than the SA baseline balance of stack due to extra components in the Mirai stack (including a manifold for gas feed connections).
- All other Mirai stack components that use the same process and methods as the baseline system are slightly higher cost due to the larger total active area required per stack (9.9 m<sup>2</sup> for the Mirai for 114 kW<sub>gross</sub>) compared to 8.96 m<sup>2</sup> for the baseline system (for 106 kW<sub>gross</sub>), both for 96 kW<sub>net</sub>.

Annual Production Rate		Sys/yr	1,000	3,000
System Net Electric Power (Output)		kW <sub>net</sub>	96	96
System Gross Electric Power (Output)		kW <sub>gross</sub>	114	114
Stack Components				
	Bipolar Plates (Stamped)	\$/stack	\$4,746	\$4,239
	MEAs			
	Membranes	\$/stack	\$2,724	\$1,474
	PtCoCe Catalyst Ink & Application	\$/stack	\$3,298	\$2,459
	GDLs	\$/stack	\$2,405	\$1,161
	M & E Hot Pressing	\$/stack	\$35	\$21
	Bipolar Plate and MEA Gaskets	\$/stack	\$954.64	\$895.96
	End Gaskets (Screen Printing)	\$/stack	\$1	\$1
	End Plates	\$/stack	\$76	\$76
	Manifold	\$/stack	\$271	\$271
	Current Collectors	\$/stack	\$7	\$7
	Stack Housing	\$/stack	\$55	\$55
	Cell Performance Testing	\$/stack	\$2	\$2
	Stack Assembly	\$/stack	\$77	\$75
	Stack Conditioning	\$/stack	\$60	\$59
<b>Total Stack Cost</b>		<b>\$/stack</b>	<b>\$14,712</b>	<b>\$10,796</b>
<b>Total Stacks Cost (Net)</b>		<b>\$/kW<sub>net</sub></b>	<b>\$153.25</b>	<b>\$112.46</b>
<b>Total Stacks Cost (Gross)</b>		<b>\$/kW<sub>gross</sub></b>	<b>\$129.16</b>	<b>\$94.78</b>

Figure 77. Breakdown in Mirai stack cost at 1,000 and 3,000 systems per year production

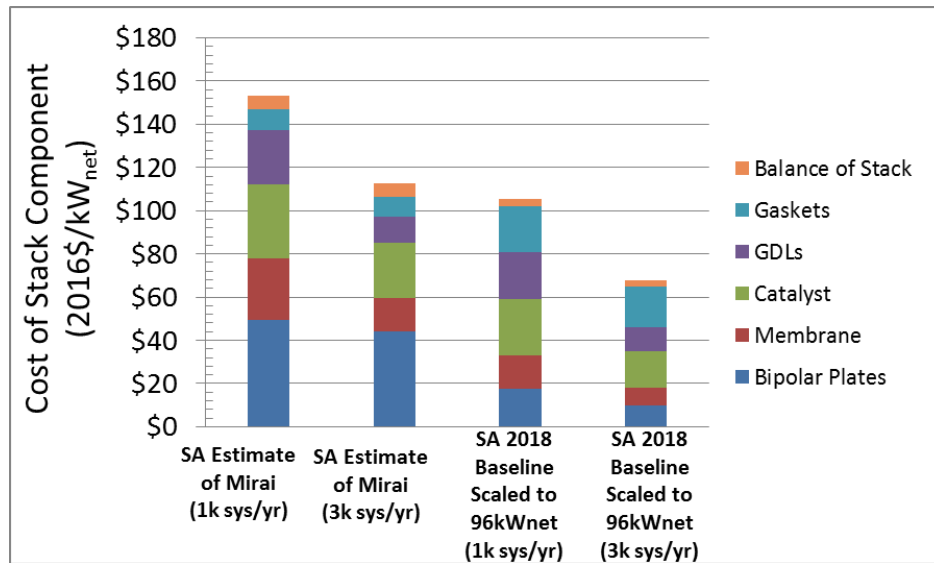


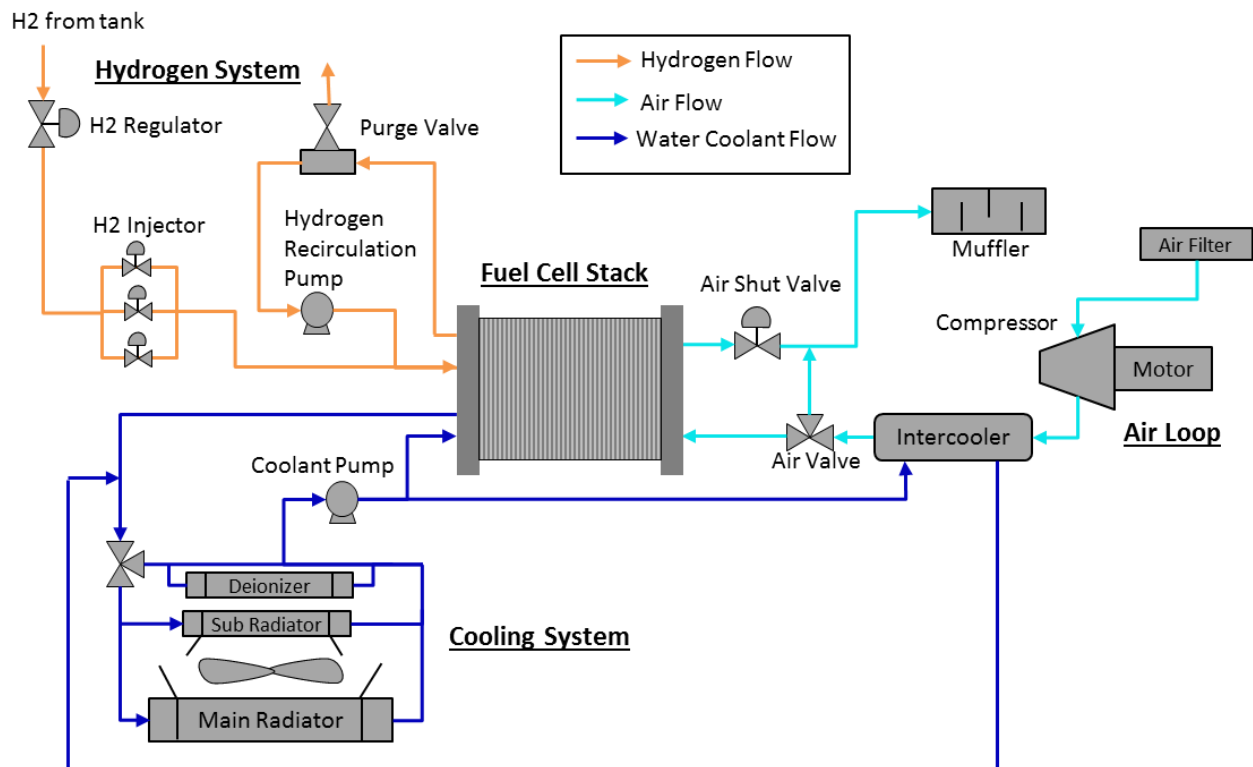
Figure 78. Comparison of SA's estimate of Mirai stack cost with SA baseline auto system scaled to 96 kW<sub>net</sub> at both 1,000 and 3,000 systems per year.

#### 8.1.4 Mirai BOP Components

Figure 79 is a diagram of the Toyota Mirai fuel cell system as used for cost modeling purposes. The Mirai system contains no expander in the air loop and no external humidifier or low-temperature coolant loop for the air compressor (after air compression the air is cooled by the intercooler using the same water coolant loop as the stack). The air compressor is based on a Roots-type blower with cost based on

DFMA<sup>®</sup> analysis previously conducted for the bus fuel cell system (Roots blower, electric motor, and motor controller, with scaling to the appropriate power level required for the Mirai).

As is consistent with past SA cost analyses, the hydrogen regulator is considered part of the hydrogen storage system and is not included as part of the Mirai's BOP cost analyzed here. The injector component for flow control, upstream of the hydrogen recirculation loop, is some type of integrated unit functioning as three solenoid valves: its cost is simplistically modeled as three times the cost of a single hydrogen injector cost used in the baseline system.<sup>60</sup> The cost of these components could reasonably be tabulated with the hydrogen storage system but are included in the fuel cell subsystem for completeness. Whereas the baseline system uses a pulsed-ejector to recirculate hydrogen, the Mirai uses an electrically driven hydrogen recirculation pump to facilitate hydrogen and water recycle within the stack. A DFMA<sup>®</sup> analysis was completed for the Mirai hydrogen recirculation pump as described in SA's 2017 report.<sup>61</sup>



**Figure 79. Toyota Mirai system diagram derived from EVS28 KINTEX, Korea, May 3-6, 2015**

<sup>60</sup> The H<sub>2</sub> injector used in the Mirai system is made by Aisan (<http://www.aisan-ind.co.jp/en/products/greenvehicle.html>). The cost is estimated at ~\$130 but this is a preliminary value and will likely change with further investigation.

<sup>61</sup> "Mass Production Cost Estimation of Direct H<sub>2</sub> PEM Fuel Cell Systems for Transportation Applications: 2017 Update" Brian D. James, Jennie M. Huya-Kouadio, Cassidy Houchins, & Daniel A. DeSantis, Strategic Analysis, Inc., December 2017.

## Toyota Fuel Cell System (TFCS)<sup>62</sup>

### 8.1.5 Mirai BOP Cost Results

The Mirai's BOP cost breakdown is listed in Figure 80 and shows the air loop and fuel loop as primary contributors to cost. Figure 81 shows a side-by-side BOP cost comparison between the Mirai and SA baseline (scaled to 96 kW<sub>net</sub> at 1,000 and 3,000 systems per year). The BOP cost for the Mirai is about \$5,300/BOP compared to \$5,000/BOP for the 96 kW<sub>net</sub> baseline system at 1,000 systems per year.

As described previously, the baseline system uses a pulsed-ejector for H<sub>2</sub> recirculation while the Mirai system incorporates a hydrogen recirculation pump. Due to internal humidification, the Mirai does not require an external humidifier like the one used within the baseline system. This trade-off in BOP components makes the systems surprisingly close in BOP cost, making it quite clear that variation in the stack components is the primary source of the power system cost variance.

Annual Production Rate		Sys/yr	1,000	3,000
System Net Electric Power (Output)		kW <sub>net</sub>	96	96
System Gross Electric Power (Output)		kW <sub>gross</sub>	114	114
<b>BOP Components</b>				
	Air Loop	\$/system	\$2,428	\$2,320
	High-Temperature Coolant Loop	\$/system	\$682	\$682
	Low-Temperature Coolant Loop	\$/system	\$66	\$66
	Fuel Loop	\$/system	\$1,075	\$995
	System Controller	\$/system	\$149	\$149
	Sensors	\$/system	\$501	\$380
	Miscellaneous	\$/system	\$417	\$310
<b>Total BOP Cost</b>		<b>\$/system</b>	<b>\$5,318</b>	<b>\$4,901</b>
<b>Total BOP Cost</b>		<b>\$/kW (Net)</b>	<b>\$55.39</b>	<b>\$51.05</b>
<b>Total BOP Cost</b>		<b>\$/kW (Gross)</b>	<b>\$46.69</b>	<b>\$43.03</b>

Figure 80. Breakdown in Mirai BOP sub-systems at 1,000 and 3,000 systems per year

<sup>62</sup> <http://www.a3ps.at/site/sites/default/files/downloads/evs28/papers/A8-04.pdf>

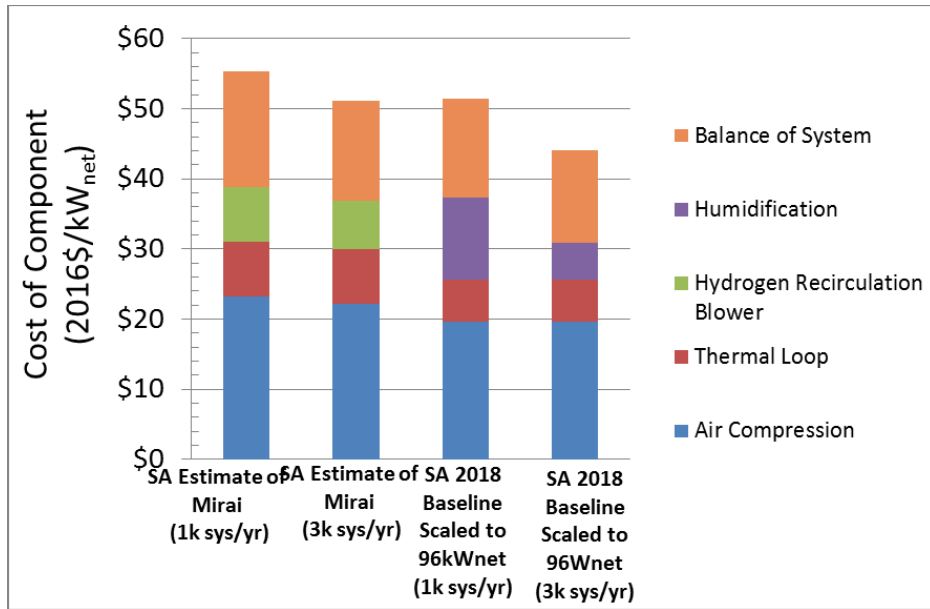


Figure 81. Comparison of Mirai BOP cost with SA baseline model scaled to 88.5 kWnet.

### 8.1.6 Total System Cost Comparison

The total Mirai FCS cost is estimated to be ~\$210/kW<sub>net</sub> with about 73% of the cost from the stack cost (at 1,000 systems per year production). Figure 82 shows the Mirai system next to the baseline auto system scaled to 96 kW<sub>net</sub> for 1,000, 3,000, and 100,000 systems per year. At 100,000 systems per year, the Mirai stack cost still represents about 70% of the total cost compared to almost a 50% split between stack and BOP cost for the 2018 baseline system scaled to 96kW<sub>net</sub>.

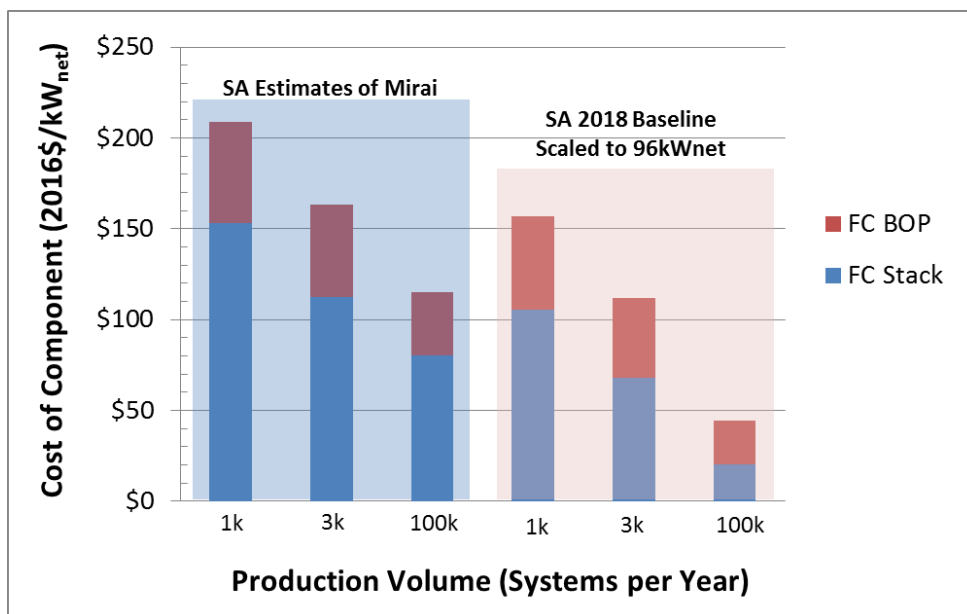


Figure 82. Comparison of Mirai total system cost with SA baseline model scaled to 96 kWnet at 1,000, 3,000, and 100,000 systems per year

### 8.1.7 Validation of System Design Conclusions

Successful cost modeling is predicated on an adequate understanding of the system-design/fabrication-methods to translate them into a realistic cost estimate. Consequently, one element in conducting a Validation Study is to assess the adequacy of system understanding. The previous sections have reported component details, sources of information, and methods used to derive parameters not explicitly reported in the literature.

In summary, we find:

- Sufficient open source data was available on system configuration and component designs to conduct detailed DFMA<sup>®</sup> analysis
- SA engineering calculations are in alignment with published Mirai documents
- SA modeling process was successfully applied
- Conclusion: SA model is successfully validated for system/component design

From this analysis, the Toyota Mirai is likely to cost in the range of \$200-\$220/kW<sub>net</sub> at 1,000 systems per year based on single variable sensitivity. The range may be even larger if multi-variable sensitivity were used. In comparison to the 2018 baseline system, at the same net power level, the baseline system is lower in both stack and BOP costs. The differences in the designs and resulting cost are described in Section 8.1. The main conclusion that the authors take away from the validation of system design analysis is that the two systems have many similarities and explainable differences. Therefore, the baseline system design has been validated against the Toyota Mirai system design. The next section compares the projected system cost to the Toyota reported price as a method to validate model cost results.

## 8.2 Validation of System Price

Toyota has not provided their fuel cell system manufacturing cost. Consequently, to allow comparison, SA translated manufacturing cost into a projected system price, inclusive of overhead, markup, warrant, profit, etc.). This cost-to-price translation is shown in Figure 83 and allows comparison with the Mirai's publicly reported MSRP. As stated previously, the Toyota Mirai was first sold in 2014 at about 700 systems per year, with more recent references suggesting a production volume of ~3,000 systems manufactured in 2016.<sup>63</sup> SA's model of the Mirai system was adjusted to include both 1,000 and 3,000 units per year production. At 3,000 vehicles per year, SA estimates the FC manufacturing cost to be ~\$165/kW<sub>net</sub> (\$15,821 per system) for the 114 kW<sub>gross</sub> (96 kW<sub>net</sub>) Mirai system and \$6,040 for the H<sub>2</sub> storage system.<sup>64</sup> Assumptions for the Mirai costs are listed in Figure 83 and graphically shown in Figure 84. This equates to ~\$56,199 per system in total at 3,000 systems per year.

---

<sup>63</sup> Online article "Japan gambles on Toyota's hydrogen powered car", by Robin Harding and Kana Inagaki at the Financial Times, March 28, 2017. <https://www.ft.com/content/328df346-10cb-11e7-a88c-50ba212dce4d?mhq5j=e1>

<sup>64</sup> H<sub>2</sub> storage system based on separate DFMA<sup>®</sup> analysis of Toyota Mirai's two-tank system featuring a similar winding pattern and approximate carbon composite weight based on ANL studies.

System Component	1,000 Sys/yr production	3,000 Sys/yr production
SA's DFMA <sup>®</sup> results for Mirai FC system manufacturing cost	\$20,180	\$15,821
SA's DFMA <sup>®</sup> results for Mirai H <sub>2</sub> storage system manufacturing cost <sup>65</sup>	\$8,002	\$6,040
Markup for production overhead (17% of FC and Storage Cost) <sup>66</sup>	\$4,790	\$3,716
Other auto components (assumes manufacturing cost + any production overhead markups):		
Battery (based on 1.6kWh with 35kW peak power) <sup>67</sup>	\$1,800	\$1,800
Electric Motor/Inverter Drive (based on 110kW peak, 60kW continuous) <sup>68</sup>	\$3,600	\$3,600
Gear Box <sup>68</sup>	\$400	\$400
Glider <sup>68</sup>	\$11,000	\$11,000
Regenerative Braking System/HVAC System <sup>68</sup>	\$800	\$800
Markup for marketing and warranty (23.5% of total) <sup>66</sup>	\$10,759	\$9,273
Markup for corporate overhead and profit (9% of total) <sup>66</sup>	\$4,349	\$3,748
<b>Total estimated MSRP<sup>69</sup></b>	<b>\$65,681</b>	<b>\$56,199</b>

**Figure 83. Breakdown of components of estimated MSRP for Toyota Mirai at 1k & 3k sys/yr.**

The Toyota Mirai MSRP is \$57,500 in 2017, making the validation of the Toyota Mirai price very close to the Mirai MSRP.<sup>70,71</sup>

<sup>65</sup> Houchins, C., James, B.D., "Hydrogen Storage System Cost Analysis: Summary of FY 2017 Activities", Strategic Analysis annual report for US DOE Fuel Cell Technologies Office, under award DE-EE0007601, August 2017.

<sup>66</sup> Vyas, A., Santini, D., Cuenca, R., "Comparison of Indirect Cost Multipliers for Vehicle Manufacturing", Center for Transportation Research, Energy Systems Division, Argonne National Laboratory, April 2000.

<sup>67</sup> Equation from 2011 NREL report ( $\$22/\text{kW} * \text{Battery Peak Power} + \$700/\text{kWh} * \text{Battery Total Energy} + \$680$ ), Substituted  $\$227/\text{kWh}$  for  $\$700/\text{kWh}$ .  $\$277/\text{kWh}$  based on Electrek 2017 article listed below.

<http://www.nrel.gov/docs/fy11osti/49127.pdf>

<https://electrek.co/2017/01/30/electric-vehicle-battery-cost-dropped-80-6-years-227kwh-tesla-190kwh/>

<sup>68</sup> Greene, D., "Status and Prospects of the Global Automotive Fuel Cell Industry and Plans for Deployment of Fuel Cell Vehicles and Hydrogen Refueling Infrastructure", Oak Ridge National Laboratory, Report for the US Department of Energy, July 2013. (Table 4)

<sup>69</sup> The markup values are a mix between ANL's report and David Greene's report. ANL markups are % share of total MSRP, while David Greene's report suggests markups as % of total costs.

<sup>70</sup> <https://ssl.toyota.com/mirai/fcv.html>

<sup>71</sup> Toyota also includes 3-years of hydrogen fuel with the purchase of a Mirai. The cost of this fuel is variable but is estimated at  $\sim \$1,250$  per year. The Toyota MSRP after fuel adjustment is thus  $\sim \$53,750$ .



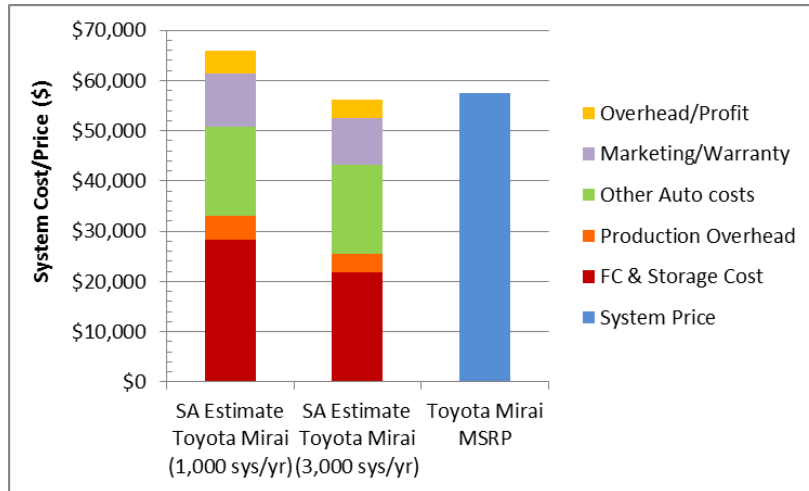


Figure 84. Comparison of SA estimates of the Mirai price and Toyota's MSRP of the Mirai.

## 9 Description of 2018 Automotive Fuel Cell System Manufacturing Assumptions and Cost Results

### 9.1 Fuel Cell Stack Materials, Manufacturing, and Assembly

#### 9.1.1 Bipolar Plates

Each stack in the system consists of hundreds of active cells, each of which contains two bipolar plates. A one-to-one (1:1) ratio of active cells to cooling cells is assumed, to facilitate better temperature uniformity throughout the stack. Consequently, one side of the bipolar plate is a cooling cell flow field and the other side is an active cell flow field. Specially-designed end gaskets are used to block off the flow into the gas channel side of the cooling plates.

In previous estimates, the cathode and anode flow field sides of the bipolar plates were envisioned as having identical flow patterns and being symmetrical. Consequently, only one bipolar plate design was needed and the cells could be flipped 180 degrees to alternate between cathode flow fields and anode flow fields. However, based on feedback from Ballard Power Systems Inc. given in previous years, different designs are assumed for the anode plates compared with the cathode plates.

Because each system contains hundreds of bipolar plates, hundreds of thousands of plates are needed even at the lowest production rate. This high level of production of a repeating component even at low system production levels means that bipolar plate mass-manufacturing techniques are applicable across a wide range of system production rates.

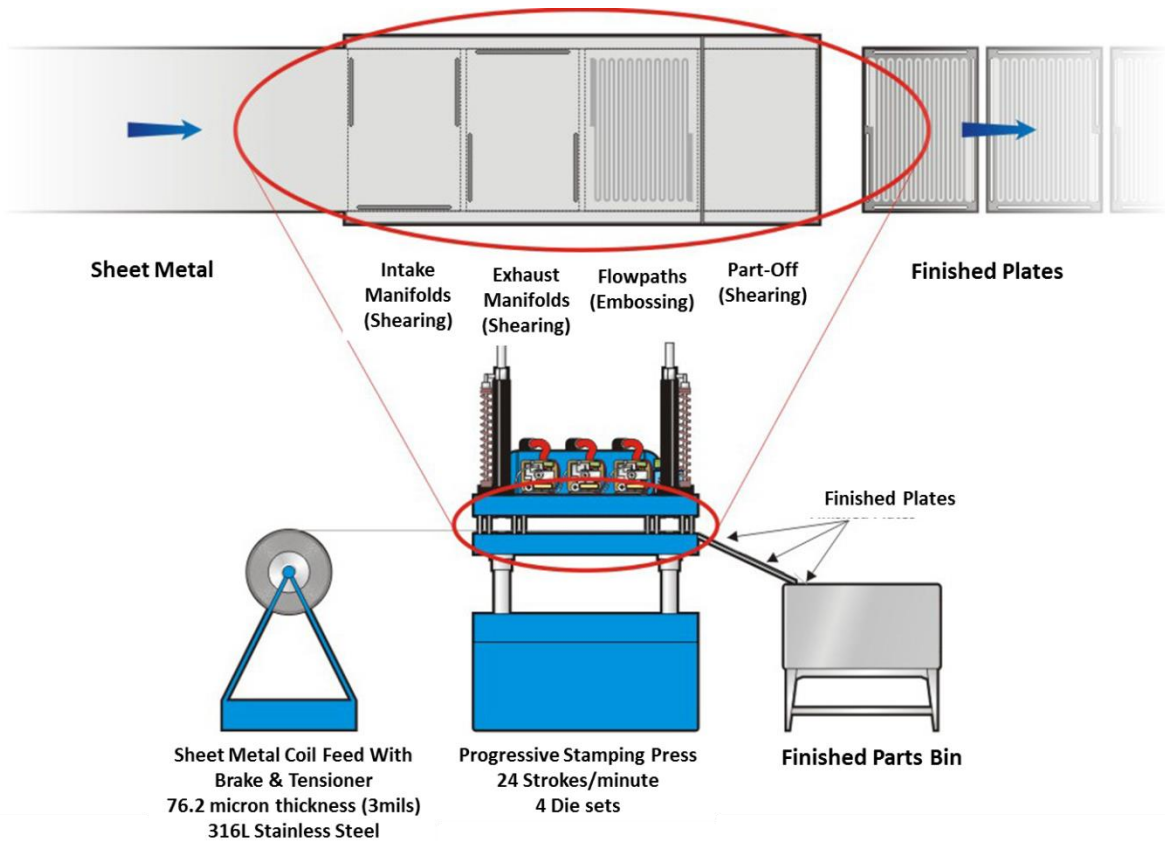
The stamped metal plates were selected because of consistent industry feedback suggesting that this material and manufacturing method is the most common approach currently implemented with success. Other options for bipolar plate forming include hydroforming (Grabener, Borit Hydrogate™), high-velocity adiabatic forming (Cell Impact), embossing, coining, etching, machining, and molding (injection, compression).

##### ***9.1.1.1 Progressive Die Stamping of the Bipolar Plates***

Sheet metal stamping is selected for production of the bipolar plates and is inferred to be employed by GM, Dana Reinz, and Mercedes Benz.<sup>72</sup> Since ~760 plates are needed per system and multiple features are required on each plate (flow fields, manifolds, etc.), progressive die stamping is a logical choice for manufacturing method. In progressive die stamping, coils of sheet metal (20km, 10 ton SS316L coils) are fed into stamping presses having a series of die stations, each one sequentially imparting one or more features into the part as the coil advances. The parts move through the stationary die stations by indexing and a fully formed part emerges from the last station. As shown in Figure 85, the four main sequential die stations envisioned are (1) shearing of the intake manifolds, (2) shearing of the exhaust manifolds, (3) embossing of the flow field paths, and (4) shearing off of the part.

---

<sup>72</sup> The composition and manufacturing method for production of GM bipolar plates is a trade secret and is not known to the authors. However, a review of GM issued patents reveals that they are actively engaged in metallic plate research.



**Figure 85. Bipolar plate stamping process diagram**

Costs for bipolar plate progressive die stamping were obtained following the standard SA methodology described above. In summary, capital costs, maintenance costs, and electric power requirements were derived from manufacturer price and performance quotes and also survey data supplied within Boothroyd Dewhurst Inc. (BDI) proprietary software. These data were then used to estimate true annual operating costs when the manufacturing line is operated at less than full capacity and 100% utilization. The cost estimation process and assumptions are described more fully below.

**Capital Cost and Press Tonnage:** Press clamping force is the primary factor influencing both the size and cost of a metal forming press. Prior to 2016, price quotes and performance data for AIRAM Press Co. Ltd pneumatic presses ranging from 50 tons to 210 tons of clamping force were analyzed to develop a function describing the approximate purchase cost as a function of clamping force. Several companies suggested that SA use a higher stamping force (and by association, a longer stamping cycle time, machinery capital cost, and tooling cost). The press force for the stamping machine increased to 1, 100 tons (10,000 kN) for a 315 cm<sup>2</sup> total plate area due to more complicated flow paths and embossing, rather than shallow bending, of the flow field. This press force is for a single plate formed per stroke. At high volume, the stamping machine is assumed to stamp two plates simultaneously, therefore increasing the force of stamping by 2. Based on industry feedback, the base capital cost of the press was roughly estimated as \$1,000/ton of press force. The cost of supporting equipment required for press operation was then added to the base press cost. Some of the supporting equipment has a fixed cost regardless of press size, while other supporting equipment costs scale with press size. A sheet metal coil

feeder was judged necessary and its cost was found to be largely independent of press size. To ensure part accuracy, a sheet metal straightener was added, although it may prove to be ultimately unnecessary due to the thin material used (76.2 microns, or 3 mils). The total cost of the stamping press system is about \$2.6M and is inclusive of the stamping press, automation, robots, and quality control equipment.

Press force needed in the progressive die is a function of the material thickness, the material tensile strength, the perimeter of cutting, and the perimeter and depth of bending or other forming. In early modeling efforts, the press force was computed based on the assumption that the channels in the plate active area were merely formed by bending. Thus, in the 2006 report<sup>73</sup>, it was estimated that a 65-ton press was necessary to produce the bipolar plates. However, as noted above, embossing rather than bending is required for the flow field channels. Embossing (similar to coining or swaging<sup>74</sup>) moves the material laterally, requiring more force, and is calculated based on the ultimate tensile strength, the area formed, and a constraint factor.<sup>75</sup> The constraint factor can vary by plate design, but for this analysis, it is carried as 1.

**Press Speed:** The speed of the press (in strokes per minute) varies with press size (kilo-Newtons (kN)): a small press is capable of higher sustained operating speeds than a large press. Press speed is a function of press size, and this relationship is shown in the curve fit to ARAM Data in Figure 86. At 10,000 kN (used as baseline press force for a single BPP), the press speed is about 28 strokes/min. At 22,000 kN (used as baseline press force for two simultaneously pressed BPPs), the press speed is about 22 strokes/min.

---

<sup>73</sup> "Mass Production Cost Estimation for Direct H<sub>2</sub> PEM Fuel Cell Systems for Automotive Applications," Brian D. James & Jeff Kalinoski, Directed Technologies, Inc., October 2007.

<sup>74</sup> Use of the word "swaging" is meant to denote a more substantial lateral movement of metal during the process than is typically observed within bending or stamping operations.

<sup>75</sup> Boothroyd, G., P. Dewhurst, and W. Knight. "Product Design for Manufacture and Assembly, Third Edition," 2011.

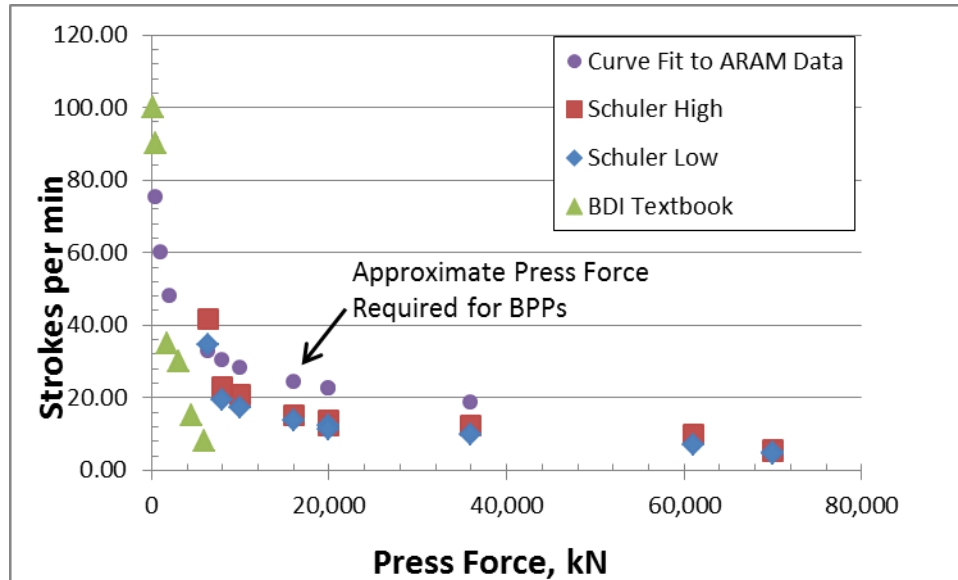
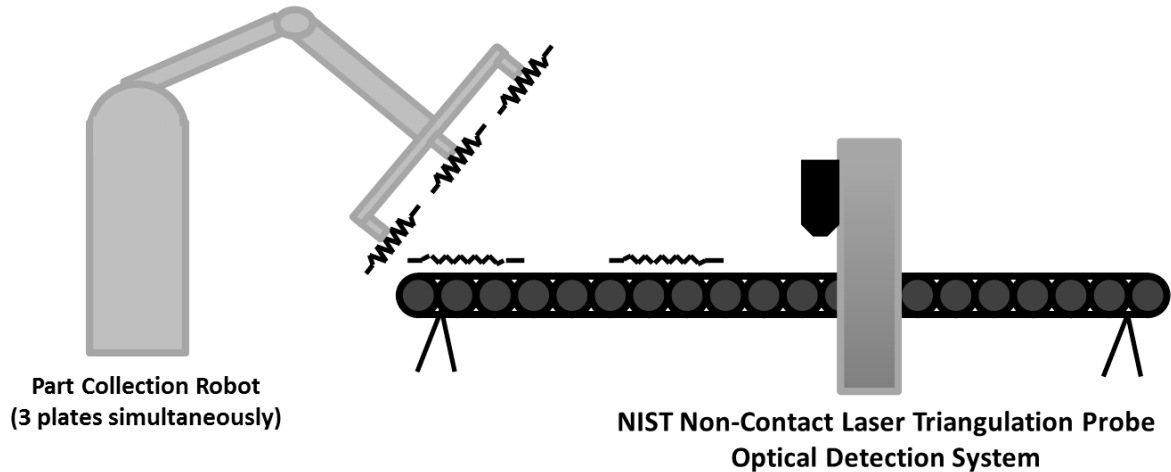


Figure 86. Press speed vs. press force

**Quality Control System:** A non-contact laser triangulation probe developed by NIST provides detailed information concerning flow field depth, plate size, thickness and defects for the stamped bipolar plate. As shown in Figure 87, the sensor must be able to scan three plates at a time in order to match the speed of the stamping press, which is producing nearly three plates every two seconds. The measurement area for each sensor is 600 mm by 300 mm, significantly larger than the size of a single plate. The line speed has been proven at roughly 300 mm/second but further R&D could increase the effective speed to an estimated maximum of 2 m/sec. Since the probes are inexpensive, they add little additional capital cost; consequently, three sensors are envisioned for the system to ensure adequate measurement overlap for each plate and to match the stamping speed.

At 1,000 systems per year, the bipolar plates are stacked manually (extra FTE added for this process). Therefore the optical system is removed from the QC at 1,000 systems per year as the worker is manually stacking plates and can observe any placement anomalies. This reduced the QC system to only the laser triangulation probe capital cost (\$70k). The optical system was estimated at \$30k and kept only for the high production volumes.



**Figure 87. Bipolar plate part collection and quality control: NIST Non-Contact Laser Triangulation Probe, Optical Detection System**

**Maintenance:** The same press operated at higher speeds tends to require maintenance more frequently. Based on discussion with industry vendors, the minimum life of a set of these stamping machine wear parts was estimated to be 10 million cycles, with a total replacement cost estimated to be 20 to 25% of complete press initial capital cost depending on machine size. Since the above cycle life is the minimum number of cycles but could be substantially more, an approximation is applied to this latest modeling iteration such that the maintenance cost of the press is estimated to be 15% of initial press capital cost every 10 million cycles. This approach deviates from SA’s historically-implemented methodology, which estimates maintenance costs as a percentage of initial capital costs per year rather than per cycle. Applying a similar cycle-based lifetime criterion, feeder equipment maintenance is estimated to be 5% of initial feeder capital cost every 10 million cycles.

**Utilities:** Prior to 2016, the principal sources of demand for electricity in the progressive die process train were the air compressor for the pneumatic press and the electric motor for turning the coil feeder. After updating the stamping force in 2016, a larger stamping press using two torque motors is used (opposed to the pneumatic type stamping press used previously). The max capacity power requirement for a 10,000 kN machine is roughly 1 MW.<sup>76</sup> It is postulated that the stamping press would on average use 33% of the max capacity (~335 kW). Further data will need to be obtained in order to define a mathematical relationship to describe electric power consumption as a function of press size.

**Machine Rate:** Using the above information for total line capital, maintenance, and utility costs, mathematical expressions can be generated that relate machine rates with various size presses at varying utilization. In 2017, the hours of operation increased from 3,360 hours per year (based on 2 shifts of 7 hours and 240 days per year) to 6,000 hours per year (based on 3 shifts of 8 hours and 250

<sup>76</sup> Based on 16,000 kN Schuler progressive stamping machines that utilizes two torque motors, each with 500kW power: [https://www.schulergroup.com/technologien/produkte/pressen\\_twin\\_servo/index.html](https://www.schulergroup.com/technologien/produkte/pressen_twin_servo/index.html)

days per year). This change represents the expectation that manufacturers would depart of standard hours of operation in an attempt to reduce cost and reduce the high number of simultaneous production lines (from ~70 lines to ~40 lines). At high volume, the benefit of forming two plates across the width of coil reduced the required number of simultaneous production lines from 40 to 25 lines (not exactly cut in half because the stamping speed decreases with increased press force). Basic input parameters are summarized in Figure 89 and Figure 90.

**Die Cost:** Die costing is estimated according to the equations outlined in the Boothroyd and Dewhurst section on sheet metal stamping. As expected, complex stamping operations require more intricate, and therefore more expensive, dies. The first two, and final, press steps are simple punching and shearing operations and therefore do not require expensive dies. The flowpath-forming step involves forming a complex, possibly serpentine, shape, which requires a highly complex die that is significantly more expensive (requiring approximately 5,000 hours of machining time) than the dies for other steps in the process (requiring a combined 150 hours of machining time). This step also requires the majority of press force. The die cost is estimated to be ~\$660k for a single plate die (previously ~\$100k) and \$1.3M for a double plate die, listed below in Figure 88 (under “Tooling”). Note that “secondary operations” refers to the coating process that will be further discussed in Section 9.1.1.3.

Annual Production Rate	1,000	10,000	20,000	50,000	100,000	500,000
Materials (\$/stack)	\$207	\$207	\$207	\$204	\$204	\$204
Manufacturing (\$/stack)	\$536	\$77	\$77	\$72	\$72	\$64
Tooling (\$/stack)	\$83	\$54	\$54	\$55	\$55	\$52
Secondary Operations: Coating (\$/stack)	\$729	\$148	\$83	\$77	\$74	\$68
<b>Total Cost (\$/stack)</b>	<b>\$1,554</b>	<b>\$486</b>	<b>\$421</b>	<b>\$408</b>	<b>\$404</b>	<b>\$388</b>
<b>Total Cost (\$/kWnet)</b>	<b>\$19.43</b>	<b>\$6.08</b>	<b>\$5.27</b>	<b>\$5.10</b>	<b>\$5.05</b>	<b>\$4.85</b>

Figure 88. Cost breakdown for stamped bipolar plates

**Die Lifetime:** Over time, the repetitive use of the dies to form the metallic bipolar plates will cause these tools to wear and lose form. Consequently, the dies require periodic refurbishing or replacement depending on the severity of the wear. Based on communication with American Trim, titanium nitride dies for progressive bipolar plate stampings are estimated to last in the tens of millions of cycles. Thus, a die (tooling) lifetime of 10 million cycles is specified, with a die cost of \$660,000.

Annual Production Rate	1,000	10,000	20,000	50,000	100,000	500,000
Equipment Lifetime (years)	15	15	15	15	15	15
Interest Rate	10%	10%	10%	10%	10%	10%
Corporate Income Tax Rate	40%	40%	40%	40%	40%	40%
Capital Recovery Factor	0.175	0.175	0.175	0.175	0.175	0.175
Equipment Installation Factor	1.4	1.4	1.4	1.4	1.4	1.4
Maintenance/Spare Parts (% of CC)	13%	13%	13%	13%	13%	13%
Miscellaneous Expenses (% of CC)	2%	2%	2%	2%	2%	2%
Power Consumption (kW)	335	342	342	342	342	342

Figure 89. Machine rate parameters for bipolar plate stamping process

Annual Production Rate	1,000	10,000	20,000	50,000	100,000	500,000
Capital Cost (\$/line)	\$1,343,017	\$1,469,739	\$1,469,739	\$2,611,899	\$2,611,899	\$2,611,899
Costs per Tooling Set (\$)	\$660,731	\$660,731	\$660,731	\$1,321,462	\$1,321,462	\$1,321,462
Tooling Lifetime (cycles)	10,000,000	10,000,000	10,000,000	10,000,000	10,000,000	10,000,000
Simultaneous Lines	1	1	2	3	6	26
Laborers per Line	1.25	0.5	0.5	0.5	0.5	0.5
Line Utilization	8.0%	80.3%	80.3%	83.8%	83.8%	96.7%
Cycle Time (s)	2.13	2.13	2.13	2.67	2.67	2.67
Effective Total Machine Rate (\$/hr)	\$1,182.61	\$170.07	\$170.09	\$254.55	\$254.58	\$227.28
Stainless Steel Cost (\$/kg)	\$13.19	\$13.19	\$13.19	\$13.19	\$13.19	\$13.19

Figure 90. Bipolar plate stamping process parameters

Conversations with multiple bipolar plate vendors suggest substantial variation in BPP stamping cost due to variation in processing assumptions. Figure 91 (from SA’s 2015 report) shows the wide range of BPP cost estimates gathered from vendor discussions. The stamped metal plates were selected because of consistent industry feedback suggesting that this material and manufacturing method is the most common approach currently implemented with success.

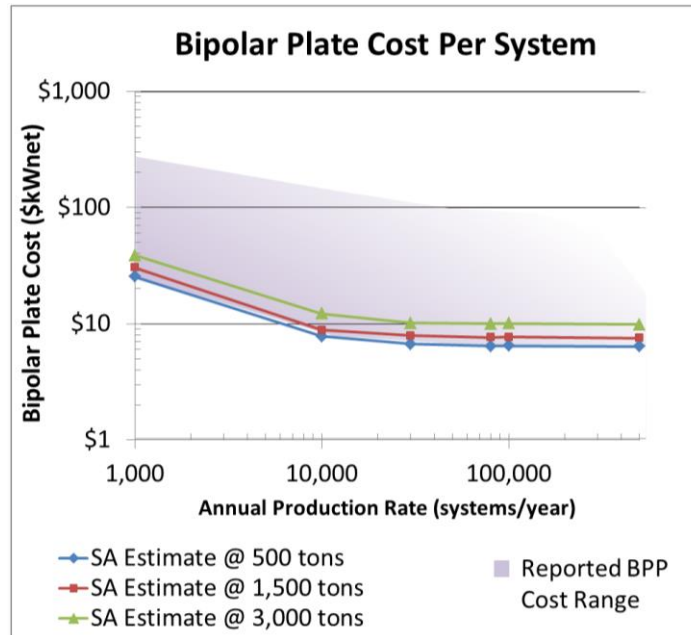


Figure 91. Range in OEM cost and SA’s estimate of BPP cost at three stamping forces over all production volumes.

### 9.1.1.2 Hydroforming of the Bipolar Plates for Future Systems

The baseline 2018 system assumes use of progressive stamping to form the stainless steel bipolar plates. However, hydroforming is also a viable alternative to form very thin metal plates and was found to have potential lower cost than progressive stamping at high production volume. Therefore, SA chose to use hydroforming as the forming method for future cases 2020 and 2025. Input on capital cost and processing conditions from both Borit NV of Belgium (Hydrogate™ process) and Graebener Maschinentchnik GmbH & Co. KG of Germany (PowerTower® process) were combined to create a representative model of bipolar plate hydroforming.



SA also evaluated a high-velocity adiabatic forming (HVAF) process for bipolar plate creation as practiced by Cell Impact AB (Sweden). HVAF utilizes a high-velocity hydraulic piston traveling ~8m/s to punch-form features into the plates. HVAF has proven to be very similar in cost to hydroforming and also may have the ability to form more complex designs compared to hydroforming. Further details on HVAF may be found in SA's 2017 annual report.<sup>77</sup>

The hydroforming process combines continuous metal coil feed with a hydrostatic press to form low residual stress flat plates. Compared to traditional stamping presses, the hydroforming process offers:

- Reduced press capital cost (due to a compact press system and single station operation)
- Reduced tooling costs since only one forming step (rather than a sequence) and one forming die is required (rather than both a top and bottom die).
- Potentially increased die life due to reduction of metal-on-metal impacts.
- Low cycle times (specifically when accounting for forming of multiple parts in one press cycle).
- Greater feasibility of forming multiple parts in a single operation (i.e. more formed parts per cycle).
- Forming of BPP with a reduced number of stations. (The BPP flow field may be formed in a single operation, but the manifold piercings and part cut must be done in a separate operation (mechanical stamping, laser cutting, etc..))
- Ability to form detailed features that may not be dimensionally possible with conventional stamping.

Because the hydroforming process uses high-pressure fluid to deform the sheet metal parts, it is ill-suited for piercing operations. Consequently, cutting of the BPP manifold holes and part cut-out must be conducted in a separation operation. High-precision laser cutting is currently used for small to medium production volumes, but mechanical cutting (i.e. a stamping press for manifold striking and edge trimming) is projected for higher volumes. (Coiling of the formed BPPs is considered infeasible as it would deform the flow fields: consequently, any stamping operation must be done in-line with the hydroforming process.) Press tonnage to cut the manifolds and trim the part is low compared to the tonnage required for flow field formation. Consequently, the stamping press is expected to be quite small and (relatively) inexpensive. All stamped features are anticipated to be captured in a single die-set. At very high volumes, the integration of cutting steps into the hydroforming step may be cost-effective, but this has not been demonstrated and is not cost modeled in any of the systems.

Figure 92 and Figure 93 contrast a conventional 5-stage inline progressive die stamping process train (as used in the baseline 2018 design) with a generic hydroforming process (followed by a conventional stamping operation for manifold forming and part cut-off). As shown, the hydroforming process has considerable advantages in capital cost of the press and die. The cost impact of hydroforming's slower forming speed is off-set by the greater number of parts formed per stroke. Overall, the hydroforming

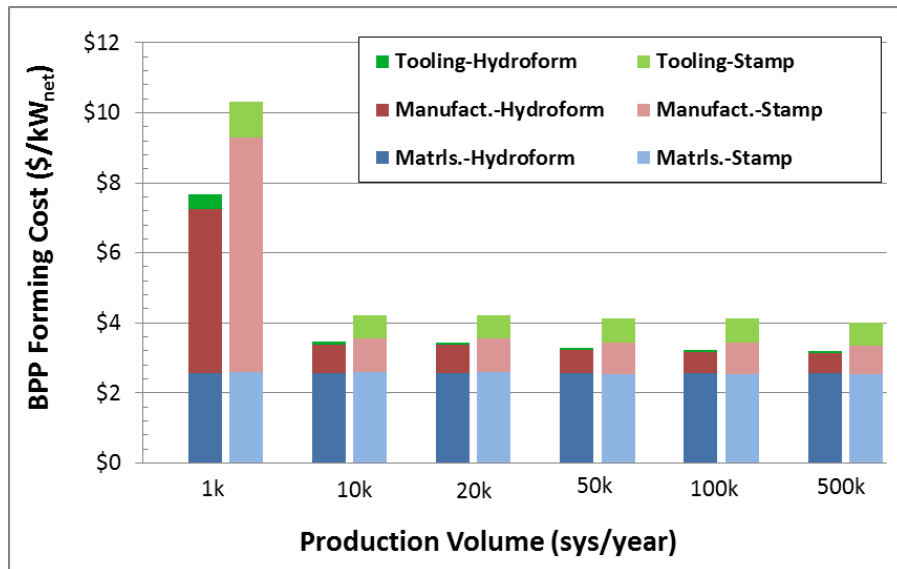
---

<sup>77</sup> "Mass Production Cost Estimation of Direct H<sub>2</sub> PEM Fuel Cell Systems for Transportation Applications: 2017 Update" Brian D. James, Jennie M. Huya-Kouadio, Cassidy Houchins, & Daniel A. DeSantis, Strategic Analysis, Inc., December 2017.

process is projected to yield lower part cost at all production rates. At 500k systems/year, hydroforming offers a potential cost reduction of almost \$1/kW compared to baseline stamping. Despite the lower cost for hydroforming, progressive die stamping is selected for the 2018 baseline system as it currently the most commonly used process for metal BPP production.

	SA Baseline (5-stage Progressive Die Stamping)	Generic Hydroforming
Plate Active Area	312 cm <sup>2</sup>	312 cm <sup>2</sup>
Plate Total Area	500 cm <sup>2</sup>	500 cm <sup>2</sup>
Plates per stamp	2	4
Number of Forming Presses (and stamps) per Plate	5	2
Stamping/Hydroform/Impact Force on BPP	1,100 kN or 1,236 tons for 1 plate 2,200kN or 2,500 tons for 2 plates	~50,000kN (5,000 tons)
Plate Material	316 SS, 3 mils	316 SS, 3 mils
Forming Machine Capital Cost	\$0.3M Automation \$2.4M Prog. press <u>\$0.1M Quality Control</u> \$2.8M Total	\$0.3M Forming automation \$0.775M Hydroforming press \$0.2M Cutting automation \$0.15M Cutting press <u>\$0.1M Quality Control</u> \$1.5M Total
Forming Cycle Time	2.74 sec per 2 plates (1.37 sec effective cycle time)	6.75 sec per 4 plates (1.7 sec effective cycle time)
Labor	0.5 workers per press	0.4 workers per press
Single Machine used for Forming and Cutting	Yes	No
Die Set Lifetime	10M cycles (forming & cutting)	10M cycles (forming) 10M cycles (cutting)
Die Set Cost	\$1.3M for 2-plate area (forming & cutting)	\$80k (forming) \$180k (cutting)
Capital Amortization Life	15 years	15 years

**Figure 92. Parameter comparison of progressive die stamping with generic hydroforming process.**



**Figure 93. Cost comparison of progressive die stamping with the hydroforming process.**

Of note is the high number of forming process trains required to produce 500k systems/year: 26 for progressive die stamping and 33 for hydroforming (even after moving from 3,360 hrs/year to 6,000 hrs/year). As previously discussed, these are higher numbers of parallel process trains than desired and are not deemed a feasible arrangement (while still maintaining plate tolerances).

### 9.1.1.3 Alloy Selection and Corrosion Concerns

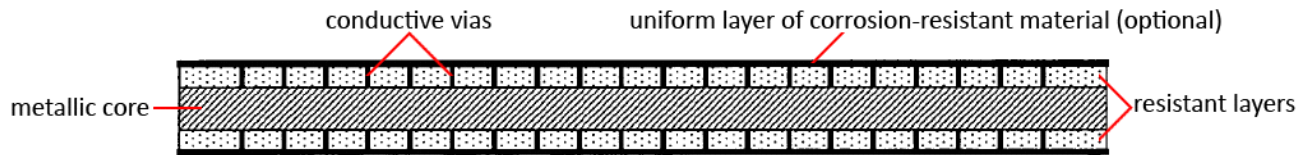
One of the challenges presented by using metallic plates is that they are more susceptible to corrosion than carbon-based plates. For this reason, alloy selection is very important. There is much uncertainty in the fuel cell community as to which alloy and surface treatments are needed to provide adequate corrosion resistance. Although some believe that suitable stainless steel alloys exist that adequately address this problem, others insist that protective coatings are necessary. If the right coating method were selected, it may be possible to use a cheaper and/or lighter (but less corrosion-resistant) material for the plates, which could help offset the cost of coating. In determining the coating method and/or plate material, consideration must be given to the different corrosion environments each plate will encounter: hydrogen and coolant for the anode plates, and oxygen and coolant for the cathode plates.

Literature and patent reviews and conversations with researchers indicate that coatings/surface treatments may not be needed and that 316L stainless steel (or another commercial alloy of similar cost) is appropriate. However, further input from the FCTT suggested that coatings *are* necessary. At the direction of the Fuel Cell Tech Team, coatings were included in the system cost and are based on a 76.2-micron (3-mil) stainless steel 316L alloy metallic bipolar plates coated using a proprietary process from TreadStone Technologies, Inc.

An anti-corrosion coating is applied to both sides of the bipolar plates based on TreadStone's proprietary LiteCell™ process. A DFMA® analysis was conducted based on information from TreadStone's

patent US 7,309,540, as well as information transferred under a non-disclosure agreement, with close collaboration with C.H. Wang and Gerry DeCuollo of TreadStone Technologies, Inc.

According to the patent, the coating consists of “one or more resistant layers, comprising conductive vias through the resistant layer(s)” (see Figure 94). The resistant layer provides excellent corrosion protection, while the vias provide sufficient electrical conduction to improve overall conductivity through the plate.



**Figure 94. Conductive vias shown in US patent 7,309,540 for TreadStone Technologies, Inc. anti-corrosion coating**

The resistant layer is applied via a physical vapor deposition (PVD) process. Details of the manufacturing process are considered proprietary, so only limited explanation is provided here.

In 2016, the coating process was updated to reflect TreadStone DOTS-R “dot” anti-corrosion coating technology. The postulated coating application follows a two-step process: 1) PVD application of a continuous proprietary anti-corrosion layer, and 2) low-cost proprietary deposition of a non-continuous layer of proprietary conductive material (~5-10% surface coverage). Both layers are applied after bipolar plate stamping. The conductive layer is only applied to one side of the plates because only one side requires low contact resistance.

At 1,000 systems per year, a smaller system is envisioned for the PVD process to improve utilization of the coating equipment. Quotations were obtained from Vergason Technologies for a smaller deposition area machine requiring a manual load system. Extra labor was added in addition to a slower processing time. However, at a lower capital cost and higher utilization (>30%), the cost for the TreadStone coating decreased.

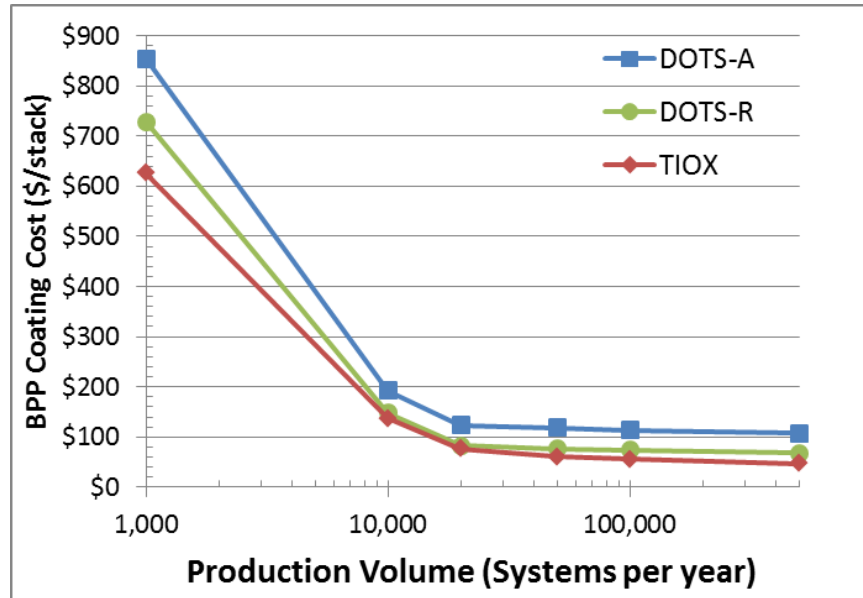
The cost breakdown for the DOTS-R TreadStone process is shown in Figure 95. The coating cost is observed to be primarily a function of annual production rate, with cost spiking at low quantities of only 1,000 systems per year. This is a reflection of low utilization of the coating system, and the application cost could perhaps be reduced with an alternate application technique.

Annual Production Rate	1,000	10,000	20,000	50,000	100,000	500,000
Materials (\$/stack)	\$12	\$12	\$12	\$12	\$12	\$12
Manufacturing (\$/stack)	\$716	\$136	\$71	\$65	\$61	\$56
<b>Total Cost (\$/stack)</b>	<b>\$729</b>	<b>\$148</b>	<b>\$83</b>	<b>\$77</b>	<b>\$74</b>	<b>\$68</b>
<b>Total Cost (\$/kWnet)</b>	<b>\$9.11</b>	<b>\$1.85</b>	<b>\$1.04</b>	<b>\$0.96</b>	<b>\$0.92</b>	<b>\$0.85</b>

**Figure 95. Cost breakdown for TreadStone LiteCell™ DOTS-R bipolar plate coating process**

In 2017, Treadstone’s 3<sup>rd</sup> type of coating, TIOX, was cost analyzed and compared to DOTS-A and DOTS-R. There are three steps involved with the new process: 1) PVD of proprietary alloy(s), 2) chemical etching,

and 3) heat treatment. Final cost results of the TIOX coating show a slightly lower cost compared to TreadStone’s DOTS-R coating, however, the TIOX coating is still under performance and durability testing and therefore is used for the 2020 and 2025 systems rather than the 2018 baseline system. It should be noted that the TIOX coating is quite different compared to the DOTS-A and DOTS-R because the TIOX coating does not contain any precious metals. This helps to reduce the cost of the coating materials and, as seen in Figure 96, results in lower cost compared to the previous DOTS-A and DOTS-R.



**Figure 96. Comparison of TreadStone DOTS-A, DOTS-R, and TIOX BPP coating costs**

Additionally for the 2020 and 2025 systems, the BPP plate material is switched to SS304L as material costs are slightly lower (SS 304L=\$12.22/kg, SS 316 = \$13.19/kg). While SS 316 is the conventional material of choice for BPPs due to its superior corrosion resistance, both SS 316 and SS 304 are currently used in BPPs. Consequently, SS 316 is used in the 2018 baseline system to reflect the predominant material in use, and SS 304 is used for the future systems when confidence and performance of the (TIOX) coating systems will (presumably) be higher.

### 9.1.2 Membrane

The total cost of the fuel cell membrane (uncatalyzed) is estimated as the summation of three components:

1. ionomer (input material cost)
2. ePTFE substrate or electrospun PPSU support (input material cost)
3. manufacturing cost of casting into membrane form

Each component is described in detail below.

### 9.1.2.1 Ionomer Cost

Ionomer cost is based upon a 2010 Dow Chemical/GM reference report<sup>78</sup> on high-volume manufacture of Nafion-like long side chain perfluorosulfonic acid proton exchange membranes from hexafluoropropylene oxide (HFPO) raw material. In this report, ionomer material and manufacturing costs are analyzed at extremely high volumes: as high as 6,000 MT/year (although only ~400 MT/year of material is needed for 500k vehicles/year). The combination of extremely high production volume and simpler manufacturing process—the industry report models membrane casting rather than application to an ePTFE substrate—results in a reported finished membrane cost much lower than calculated by the SA model. Rather than using the direct results of the Dow cost report, the 2012 FCTT recommended that the membrane continue to be modeled as an ePTFE-supported membrane and that we adapt the Dow ionomer price to plant sizes more in line with expected annual demand. Consequently, for the 2012-2016 analyses, a production-volume-dependent scaling relationship was derived from the Dow report data and used to estimate ionomer price at various fuel cell system annual production rates.

In 2017, further feedback from industry indicated a movement toward use of lower equivalent weight (EW) ionomers which leads to higher cost (as lowering ionomer EW requires greater amounts of hexafluoropropylene oxide (HFPO)). Specifically, the Dow Chemical/GM study was based on an 1100EW ionomer whereas most state-of-the-art membranes are using between 700-800EW. The lower EW increases the amount of HFPO and HFPO makes up a majority of the raw material cost of the ionomer. Future plans include a DFMA<sup>®</sup>-style analysis of the ionomer as a function of EW. However in the interim, a simplified cost factor approach is used to estimate the cost of alternative EW ionomers. Usage of HFPO is inversely proportional to the EW value and thus an increase in cost for lower EW ionomer can be approximated via the equation below (assuming raw materials account for half of the total ionomer price). This applied factor of 1.23 for 750EW does not take into account additional processes required in current ionomer fabrication methods; a detailed analysis would be required to estimate such a factor. Projected ionomer cost curve is shown in Figure 97 for both 750EW and 1100EW. 750EW is used for the baseline, 2020, and 2025 analyses. Data points on the graph correspond to the six annual system manufacturing rates analyzed in the study. There is substantial uncertainty in future ionomer pricing, with some community observers suggesting that ionomer price could be substantially higher (eg. 4 times higher (\$400-500/kg) at 200 tonnes/year). The impact of this wide range in ionomer pricing is quite significant, as seen in the Tornado Chart in Section 15.1.

$$\text{Cost(EW)} = \text{Cost}(1,100 \text{ EW}) * 0.5 * \left[ 1 + \left( \frac{1,100}{\text{EW}} \right) \right]$$

$$\text{Cost}(750\text{EW}) = \text{Cost}(1100\text{EW}) * 1.23$$

---

<sup>78</sup> "High Volume Cost Analysis of Perfluorinated Sulfonic Acid Proton Exchange Membranes," Tao Xie, Mark F. Mathias, and Susan L. Bell, GM, Inc., May 2010.

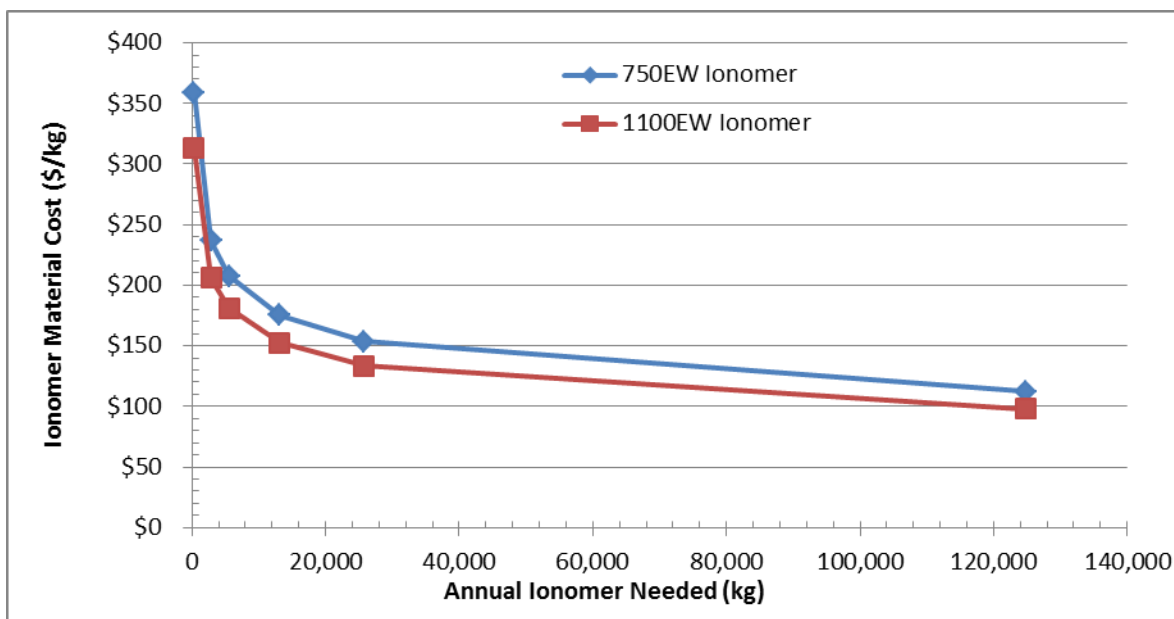


Figure 97. Ionomer material cost curve

### 9.1.2.2 ePTFE Cost

An expanded polytetrafluoroethylene (ePTFE) porous layer is modeled as a mechanical substrate for the ionomer membrane. Use of an ePTFE supported fuel cell membrane is well documented in the literature and is a continuation of past SA cost analysis practice. A ground-up DFMA<sup>®</sup> cost analysis of ePTFE was initiated but it soon became evident that such an analysis was impractical as the specific (and crucial) processing steps<sup>79</sup> were closely guarded industry secrets unavailable as inputs into the cost analysis. While ePTFE is manufactured in high production volume for the textiles industry (e.g. Gore-Tex), there are different qualities available and also potentially different processing steps for fuel cell applications. For this reason, a quote based cost estimate is used within the 2018 analysis.

Quotes from multiple ePTFE manufacturers were obtained, all on the basis of confidentiality. These cost quotes (without attribution to their source) are shown in Figure 98. W.L. Gore & Associates, Inc., the predominant supplier of ePTFE to the fuel cell industry, did not provide a cost quotation, although they did review this cost analysis.

A wide range of prices is observed in Figure 98 due to both differences between manufacturers and uncertainty in projection to high manufacturing volumes. ePTFE prices are affected by the quality and cost of the starting PTFE material and one manufacturer suggested that only the better quality “fuel cell grade” of PTFE was suitable for fuel cell applications. The lower red curve in Figure 98 represents an ePTFE price quote from a Chinese supplier of textile grade ePTFE which probably isn’t well suited to fuel cell applications but is included in the graph to illustrate the ePTFE price floor. The other price quotations are from U.S. suppliers. Price quotes were obtained for both 10 micron and 25 micron ePTFE

<sup>79</sup> ePTFE uses a particular grade of non-expanded PTFE as a precursor material and then applies a multi-stage, presumably bi-axially, mechanical stretching regiment to attain an optimized node and fibril end structure of the 95+% porous ePTFE. Exact parameters of those stretching steps, along with proprietary heat treatments or other non-disclosed steps, are highly confidential to W.L. Gore and other fuel cell ePTFE manufacturers.

thickness but prices did not vary appreciably, indicating that the majority of cost was in the processing steps. A mid-range price of ePTFE is used in the cost analysis, with the upper and lower bound price quotes used as limits in the sensitivity analysis.

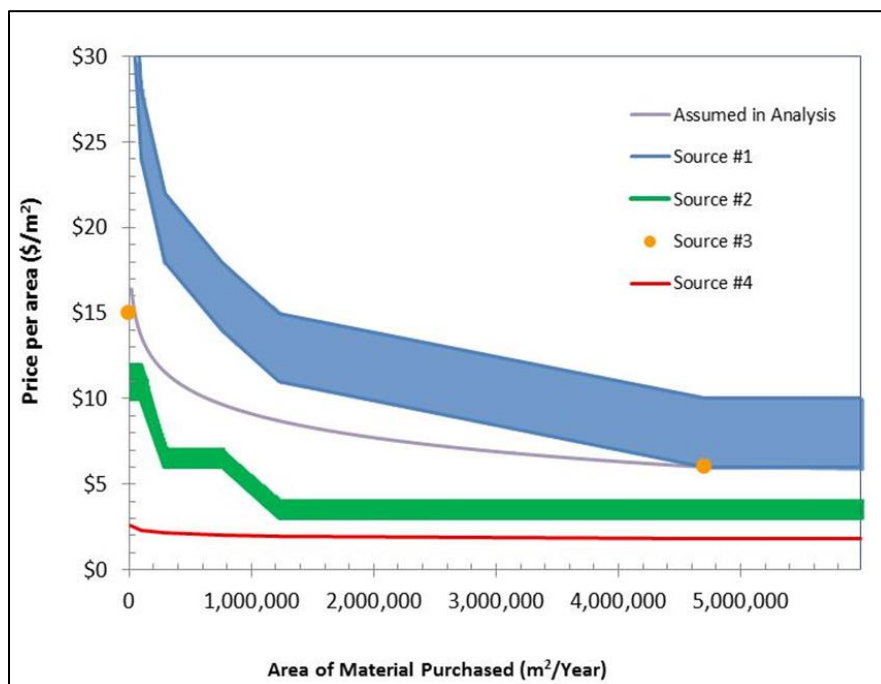


Figure 98. ePTFE price quotations and data selected for use in SA DFMA<sup>®</sup> models

### 9.1.2.3 Membrane Manufacturing Cost

The 2018 membrane manufacturing method is based on Step 2 of the Direct-Coat Gore MEA process (updated analysis found in SA's 2017 Annual Report<sup>80</sup>). It is modeled as a factory-based roll-to-roll process involving two die slot coating steps and two drying steps. The first layer is a very thin (1 μm dried thickness) ionomer layer containing water, ionomer, and water-insoluble alcohol and is completely dried prior to application of the 2<sup>nd</sup> ionomer layer. The 2<sup>nd</sup> ionomer layer (containing ionomer and alcohol) is coated onto the 1<sup>st</sup> ionomer layer and the ePTFE laid on top (viscosities of the solution is optimized so the ePTFE sinks and becomes fully occluded). The 2<sup>nd</sup> layer is then fully dried (9 μm final thickness). While based on entirely open-source data, SA worked closely with Gore to understand the Direct-Coat process and model it as accurately as possible without access to proprietary details.

As schematically detailed in Figure 99, the membrane fabrication process consists of eight main steps:

**1) Unwinding of Substrate for First Ionomer Layer:** An unwind stand with tensioners is used to feed the ePTFE-like substrate backer into the process line. A web width of ~ 1 m is deemed feasible for both the membrane fabrication line and the subsequent catalyzation at high volume.

<sup>80</sup> "Mass Production Cost Estimation of Direct H<sub>2</sub> PEM Fuel Cell Systems for Transportation Applications: 2017 Update" Brian D. James, Jennie M. Huya-Kouadio, Cassidy Houchins, & Daniel A. DeSantis, Strategic Analysis, Inc., December 2017.



**2) First Ionomer Slot Die Coat:** The ionomer is coated onto the backer roll using a slot die coating machine.

**3) First Oven Drying:** The web dries via continuous curing oven. A drying time of 1 min is postulated at 140 °C. Since the web is traveling quickly (19 m/min), considerable web run length is required (19 m).

**4) Rewind of First Ionomer Layer:** Rewind of the substrate with the 1<sup>st</sup> ionomer layer completes the first layer.

**5) Unwinding for Second Ionomer Layer:** The first cured ionomer layer on the substrate is unrolled.

**6) Second Layer Coating:** The 2<sup>nd</sup> ionomer layer is applied to the 1<sup>st</sup> ionomer layer just prior to unwinding an ePTFE layer onto the 2<sup>nd</sup> ionomer layer to achieve full occlusion of the ePTFE pores and an even thickness, pinhole-free membrane.

**7) Second Oven Drying:** The web is dried with a second continuous curing oven after the second layer coating. The second layer is much thicker and thus has a higher mass per area than the first layer (518 g/m<sup>2</sup> compared to 40 g/m<sup>2</sup>), resulting in a heating time of 5.5 min at 140 °C. At 19 m/min, the length of the oven is ~104 m long.

**8) Rewind of Second Ionomer Layer:** The finished membrane is wound onto a spool for transport to the catalyzation process line.

**Ionomer Solution Composition**

1<sup>st</sup> Ionomer solution:

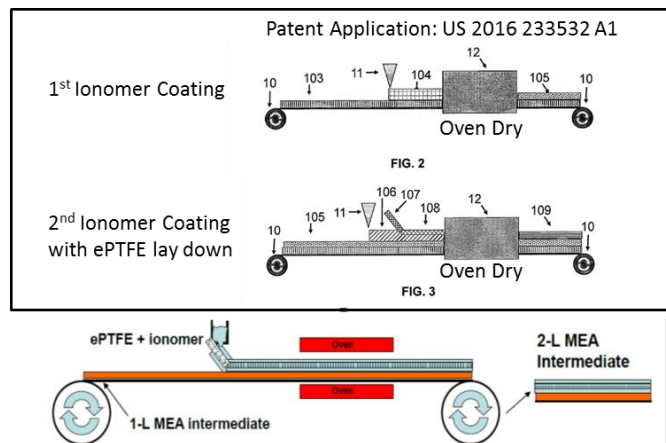
- 5wt% Nafion
- 90wt% water
- 5% mixture of hexanol and isopropanol

2<sup>nd</sup> Ionomer solution:

- 5wt% Nafion
- 47.5wt% isopropanol
- 47.5wt% methanol

**Cost model drying times**

- 3min + 2.7min = 5.7 minutes total
- @ 140°C (Gore patent application)



**Figure 99. Membrane fabrication station material composition and drying times (left), and coating schematic for two individual coating/drying steps as specified in Gore’s Patent Application US 2016 233532A1.**

Key assumptions are noted below.

**Capital Cost:** Capital costs are based on industry input and are confirmed by Gore. The sizing of equipment varies (different web width sizes from ~25 cm to ~100 cm) along with capital cost. The breakdown in capital cost at 500,000 systems per year is listed below in Figure 100.

Membrane Fabrication Equipment	Capital Cost Breakdown
2x Slot Die Coaters (19m/min) (excludes ovens) 0.9m width	\$2.4M
2x Ionomer Pump Carts	\$50k
1 <sup>st</sup> Ionomer Coat Oven (19m)	\$1.2M
2 <sup>nd</sup> Ionomer Coat Oven (72m)	\$7M
Optical Diagnostic QC System	\$189k
Clean Room - 6,504ft <sup>2</sup>	\$4.4M
<b>Total Capital Cost</b>	<b>\$15M</b>

**Figure 100. Assumed capital cost breakdown at 500k systems/year production.**

**Web speed:** Slot die coating processes can be very fast, but the limiting factor in membrane fabrication is the oven drying of the wet ionomer. To investigate the appropriate line speed, a trade-off in cost of the oven and line speed was evaluated. The longer the oven, the higher the capital cost. At 19 m/min, the cost of the membrane process was at a minimum. Any slower and two lines would be needed to satisfy the quantity of material needed at high volume. Due to the various sizing of equipment and amount of material needed, the web speeds are slower at lower volumes, down to 1m/min at 1,000 systems per year.

**Peak Equipment Utilization:** Input from a membrane supplier raised the point that average plant utilization would be significantly affected under scenarios of rapid demand growth. At lower volumes, the equipment is slightly underutilized (~25% – 30% utilization), but at 500,000 vehicles per year case, plant utilization is up to 57%.

**Production/Cutting Yield:** There are appreciable cutting losses associated with the roll-to-roll manufacturing process, which directly affect the membrane material costs. ePTFE yield was assessed at 75% to 95%. Material loss is defined by four different losses: 1) fluid loss within machinery or fluid lines, 2) edge losses removed after production, 3) machine start-up and shut-down losses, and 4) coating defect/contamination (unplanned wastage). For ionomer, all four losses are considered, making the overall yield between 67% and 94%. For ePTFE, there is no fluid loss, so the overall yield is between 75% and 95%.

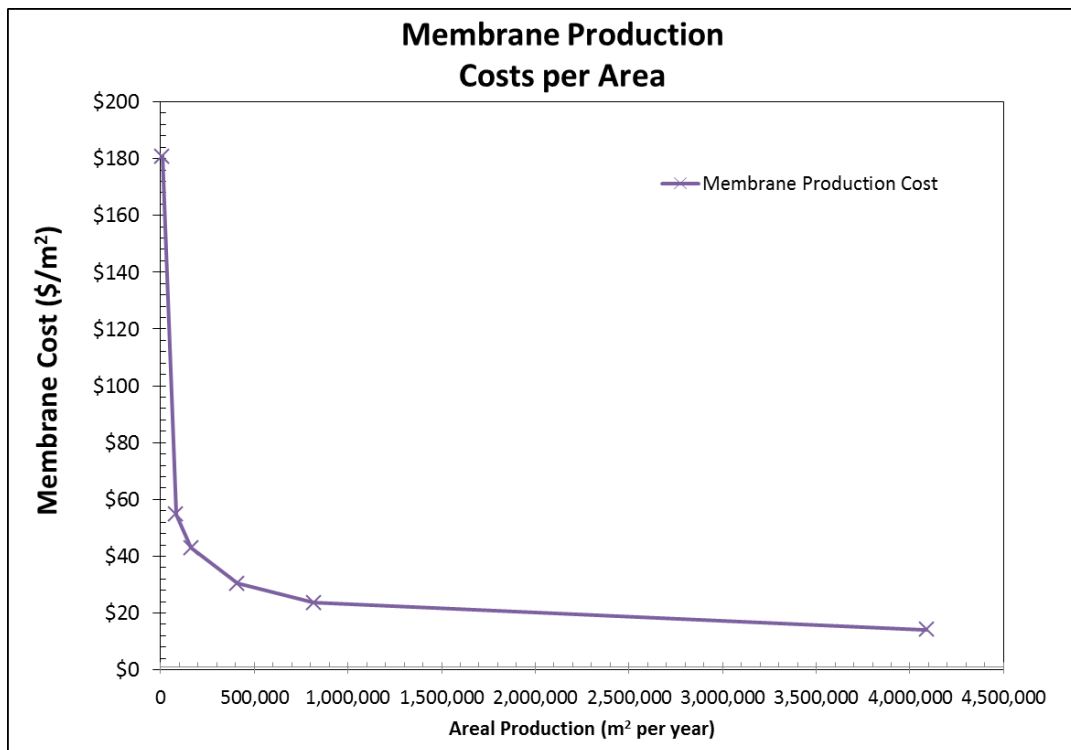
**Workdays and Hours:** The maximum plant operating hours are assumed to be 24 hours per day, 337 days per year. Two weeks for scheduled maintenance and two weeks for unscheduled maintenance are the only downtime accounted for, resulting in 8,088 productive hours per year.

**Cost Markup:** The standard methodology throughout the analysis has been not to apply manufacturer markups, in keeping with the vertically integrated manufacturing assumption, and the directives of the

DOE on this costing project. However, since it is likely that the membrane producer will not be vertically integrated, a markup is included in our membrane cost estimate. Furthermore, because the membrane is a critical component of the stack, significantly higher margins are allocated than are typical to the automotive industry where there is a large supplier base with virtually interchangeable products competing solely on price. Markup on the manufacturing process varies from 46% to 73% that include manufacturing building space, OH, profit, and R&D. A range in markup rate between 19% and 25% is applied to the materials. Gore did not comment on any of these markup values; consequently, the markup values are solely SA estimates.

**Revenue:** Annual membrane fabricator revenue is not an input in the analysis. Rather it is an output. However, it is worth noting that even at high membrane production rates, company revenues are still only about \$75M per year. This is a modest company size and supports the notion of allowing higher-than-average markups as a means to entice people into the business.

Membrane production cost is plotted against membrane annual volume in Figure 101 below.



**Figure 101. Membrane production cost vs. annual membrane manufacturing volume**

**Quality Control:** An Optical Detection System (ODS) is used for detecting membrane defects on the order of 20  $\mu\text{m}$  such as pinholes, folds, bends, scratches, and thickness non-uniformity in the ionomer. At high volumes, the entire membrane fabrication process is assumed to be completed at 91 cm web width and requires 12 cameras to cover the entire web width at the targeted detection resolution. A high web processing speed is accommodated by a camera with a high refresh rate (125 kHz).

### 9.1.2.4 Total Membrane Cost

Figure 102 summarized cost results for the un-catalyzed ePTFE supported membrane.

Annual Production Rate	1,000	10,000	20,000	50,000	100,000	500,000
Material (\$/stack)	\$378	\$236	\$207	\$166	\$142	\$94
Manufacturing (\$/stack)	\$632	\$128	\$89	\$52	\$33	\$14
Tooling (\$/stack)	\$3	\$1	\$1	\$1	\$1	\$1
Markup (\$/stack)	\$465	\$82	\$54	\$30	\$17	\$7
<b>Total Cost (\$/stack)</b>	<b>\$1,477</b>	<b>\$448</b>	<b>\$351</b>	<b>\$249</b>	<b>\$193</b>	<b>\$115</b>
<b>Total Cost (\$/kWnet)</b>	<b>\$18.47</b>	<b>\$5.59</b>	<b>\$4.39</b>	<b>\$3.11</b>	<b>\$2.41</b>	<b>\$1.44</b>

Figure 102. Cost breakdown for the membrane (un-catalyzed)

Annual Production Rate	1,000	10,000	20,000	50,000	100,000	500,000
Equipment Lifetime (years)	14	14	14	14	14	14
Interest Rate	10%	10%	10%	10%	10%	10%
Corporate Income Tax Rate	40%	40%	40%	40%	40%	40%
Capital Recovery Factor	0.179	0.179	0.179	0.179	0.179	0.179
Equipment Installation Factor	1.4	1.4	1.4	1.4	1.4	1.4
Maintenance/Spare Parts (% of CC)	10%	10%	10%	10%	10%	10%
Miscellaneous Expenses (% of CC)	7%	7%	7%	7%	7%	7%
Power Consumption (kW)	143	436	604	972	1176	2501

Figure 103. Membrane Production Machine Rate Parameters

Annual Production Rate	1,000	10,000	20,000	50,000	100,000	500,000
Capital Cost (\$/Line)	\$1,291,599	\$2,753,264	\$3,931,649	\$5,792,609	\$7,036,425	\$15,121,226
Simultaneous Lines	1	1	1	1	1	1
Laborers per Line	1.25	1.25	1.25	1.25	1.25	1.25
Line Utilization	23.6%	28.1%	28.5%	32.3%	42.5%	65.8%
Effective Total Machine Rate (\$/hr)	\$352.65	\$600.70	\$821.20	\$1,064.75	\$1,008.36	\$1,447.46
Line Speed (m/s)	0.013	0.033	0.067	0.067	0.100	0.317
ePTFE Substrate Cost (\$/m <sup>2</sup> )	\$18.26	\$13.88	\$12.52	\$10.76	\$9.39	\$6.18
Ionomer Cost (\$/kg)	\$363.94	\$239.71	\$210.28	\$177.53	\$155.42	\$113.88

Figure 104. Membrane Production Process Parameters

The 2020 and 2025 systems also assume a slot die coating of ionomer on ePTFE for the membrane manufacturing process.

### 9.1.3 Fuel Cell Catalyst

Numerous catalysts have been proposed for PEM fuel cells, including:

- PtCo/C (Brookhaven National Lab/ChemCat, Toyota/Tanaka/GM)
- PtNi (3M, Johnson Matthey/General Motors)
- PtMnCo (3M-NSTF)
- Pt/C (typically an anode catalyst)
- PGM-free catalysts (i.e. polyaniline-derived Fe-N-C (PANI) (Los Alamos National Lab))

As described previously in Section 6.1.1, a GM's dispersed de-alloyed PtCo/HSC cathode catalyst is used for the 2018 baseline catalyst system and is applied in catalyst ink form via a slot die coating deposition

method. The synthesis of the dry powder (before being made into a catalyst ink) is described in detail in Section 6.3 and is very similar to the d-PtNi/C catalyst synthesis modeled in 2016 and 2017. This process is described in this section. The cost of platinum, one of the greatest influencers on stack cost, is assumed to be \$1,500/troy ounce for all three analysis years.

### 9.1.3.1 Platinum Cost

The cost of catalyst ink is dominated by the raw material cost of platinum. At the direction of the DOE, platinum cost for the 2018 analysis is maintained at the 2014-2017 level of \$1,500 per troy ounce (and represents a price increase from the \$1,100/troy ounce used in 2013 and prior SA analyses). Maintaining Pt price at a constant value between years of the cost analysis removes Pt market fluctuations from the projections and allows clearer evaluation of the impact of technology changes. However, as shown in Figure 105, the market price of Pt has been trending lower over the last 5 years and is currently substantially below the \$1,500/troy ounce Pt price used in the cost analysis. Additionally, as seen in Figure 106, the distributions over a ten-year period has shifted from a single peak distribution around ~\$1,500/troy ounce (from the 2008-2015 data set) to a bi-modal distribution around ~\$1,100 and \$1,500/troy ounce (from the 2008-2018 data set). Consideration will be given to reducing the Pt pricing assumption for future years of the analysis, but Pt cost is held at \$1,500/troy ounce for the 2018 analysis.

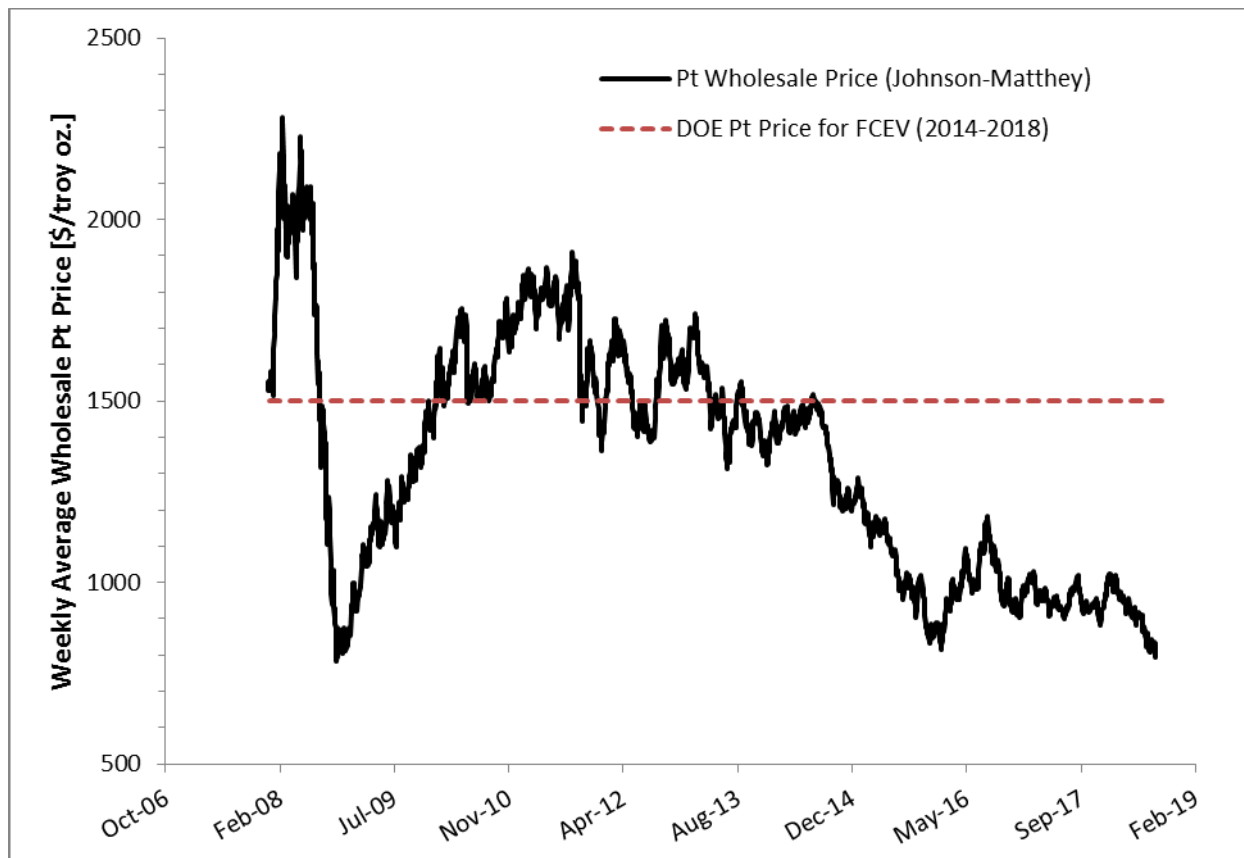


Figure 105. Ten-year graph of monthly Pt prices

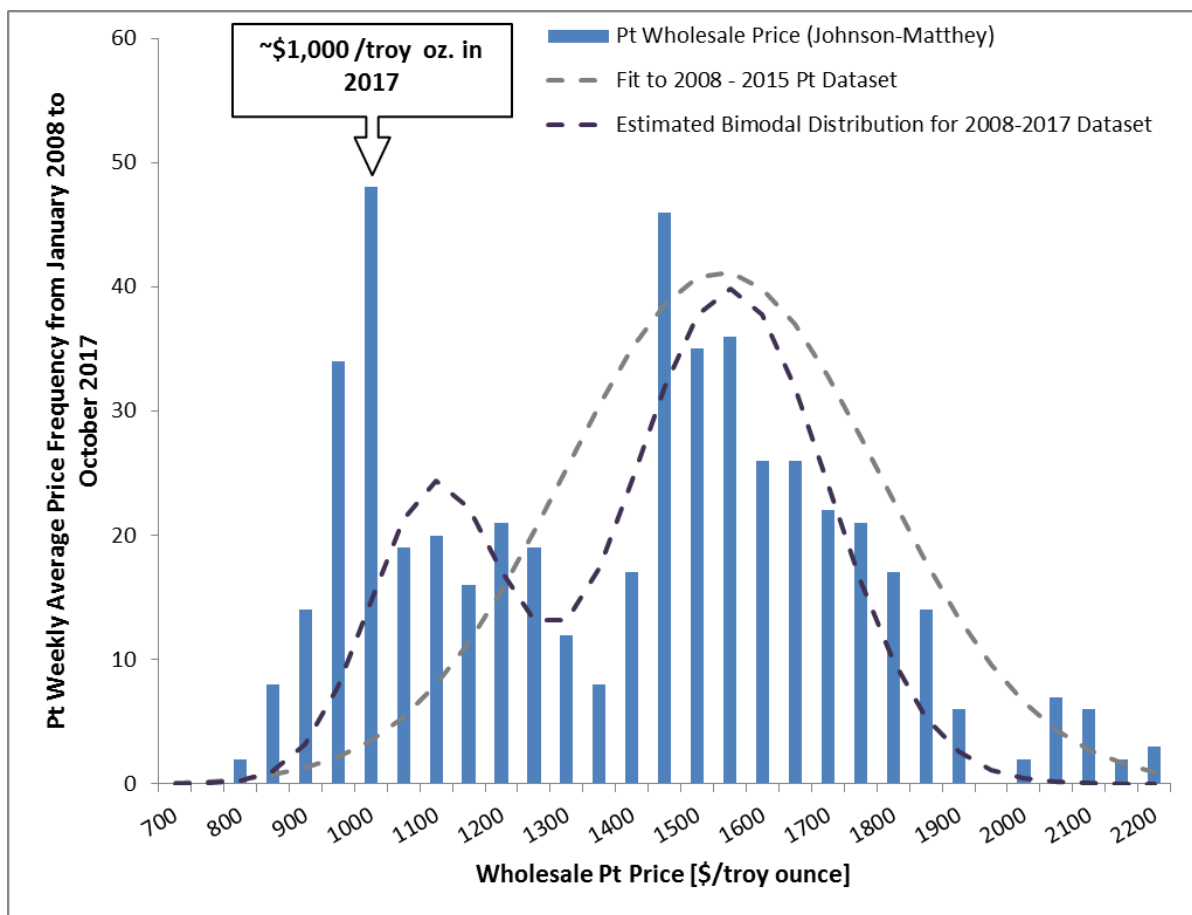


Figure 106. Pt price distribution over ten years (2008-2017)

### 9.1.3.2 Catalyst Powder Synthesis

#### 9.1.3.2.1 De-alloyed PtCo/HSC Synthesis (Cathode Catalyst)

The de-alloyed PtCo/HSC analysis draws from open literature sources and vendor discussions for definition of representative processing steps. While inspired by the de-alloyed binary catalyst of General Motors (GM)<sup>81</sup>, the analysis does not purport to model the GM catalyst synthesis exactly and may differ from GM catalysts in important and unknown ways.

The d-PtCo/HSC binary catalyst powder synthesis processing steps are outlined in Figure 107. An important aspect, leading to a large cost reduction in 2017, is the carbon material on which the catalyst is supported. The high surface area carbon (HSC) support is the key element responsible for the high power density (1,183mW/cm<sup>2</sup> at 0.657V per cell) and lower Pt loading (0.125mgPt/cm<sup>2</sup>) compared to previous years. Instead of using a direct material cost for HSC, SA modeled the process to manufacture

<sup>81</sup> A. Kongkanand, F. Wagner, "High-Activity Dealloyed Catalyst", General Motors Technical Report under DOE Award No. DE-EE0000458, 2014.

high surface area activated carbon derived from carbon black. The processing steps are based on a Johnson Matthey patent application.<sup>82</sup>

A variety of Pt donor compounds are available as inputs to catalyst synthesis. In 2017, chloroplatinic acid (CPA) was selected as a representative starting reactant as its production method is described in the literature and it is a common Pt catalyst precursor. However, the Pt compound used for the 2018 system is  $\text{Pt}(\text{NO}_3)_4$ , based on the co-authored GM and Johnson Matthey patent.<sup>83</sup>  $\text{Pt}(\text{NO}_3)_4$  is a commercial product and thus its price was obtained from vendor quotes: a DFMA<sup>®</sup>-style production analysis was not conducted.

The  $\text{Pt}(\text{NO}_3)_4$  reactant is reacted with the high surface area carbon (HSC), formaldehyde, water and NaOH within a precipitation reactor to form the Pt/HSC precursor. The Pt to carbon ratio for the cathode catalyst is 30 wt% Pt on HSC. All reactors are limited in size to 1,000 L to reflect industry difficulties in scaling to larger reactor batch sizes. To facilitate quality control and product tracking, batch sizes are generally maintained between processing steps. The precipitate precursor slurry (solid precursor in excess acid liquids) is run through a press filter and washed with water and then dried. To incorporate the Co,  $\text{Co}(\text{NO}_3)_2 \cdot 6\text{H}_2\text{O}$  and water are added to the Pt/HSC precursor in a second precipitation reactor and reacted to form PtCo/HSC. This PtCo/HSC precursor precipitate passes through a filter wash, and is then dried and crushed, resulting in the PtCo/HSC precursor powder. Drying ovens are limited to 50 kg of catalyst and are modeled as a 0.25 inch powder thickness on stacked horizontal trays with 1 inch tray vertical spacing. Based on literature<sup>84</sup> parameters, precursor powders are often annealed at 1,000 °C, however additional feedback from LANL suggests an annealing temperature of 750°C is more appropriate. This annealing step is needed to improve the activity and stability of the catalyst powder. While there is not unanimity in the industry as to whether vacuum ovens are required, the previously modeled atmosphere ovens were converted to vacuum ovens for annealing in 2016. Vacuum ovens have much longer cycle times since they rely on radiative rather than convective heat transfer. Consequently, the impact of this change is both in increased oven capital cost and substantially increased cycle time (previously 3.6 hour cycles for atmosphere ovens, now 24+ hours for vacuum ovens). The de-alloying step uses nitric acid to etch away cobalt over 24 hours. Filter, wash, dry, and catalyst crush steps are needed to form the final catalyst d-PtCo<sub>0.56</sub>/C<sub>37.9</sub> powder used in the catalyst electrode inks.

---

<sup>82</sup> Timcal Limited and Johnson Matthey Fuel Cells Limited Patent Application US2014/0295316 A1: Carbon Supported Catalyst

<sup>83</sup> US Patent Application US 2016/0104898 A1: Catalyst

<sup>84</sup> Wang, C., et al., "Design and synthesis of bimetallic electrocatalyst with multilayered Pt-skin surfaces", Journal of the American Chemical Society, 2011. 133(36): p. 14396-14403.

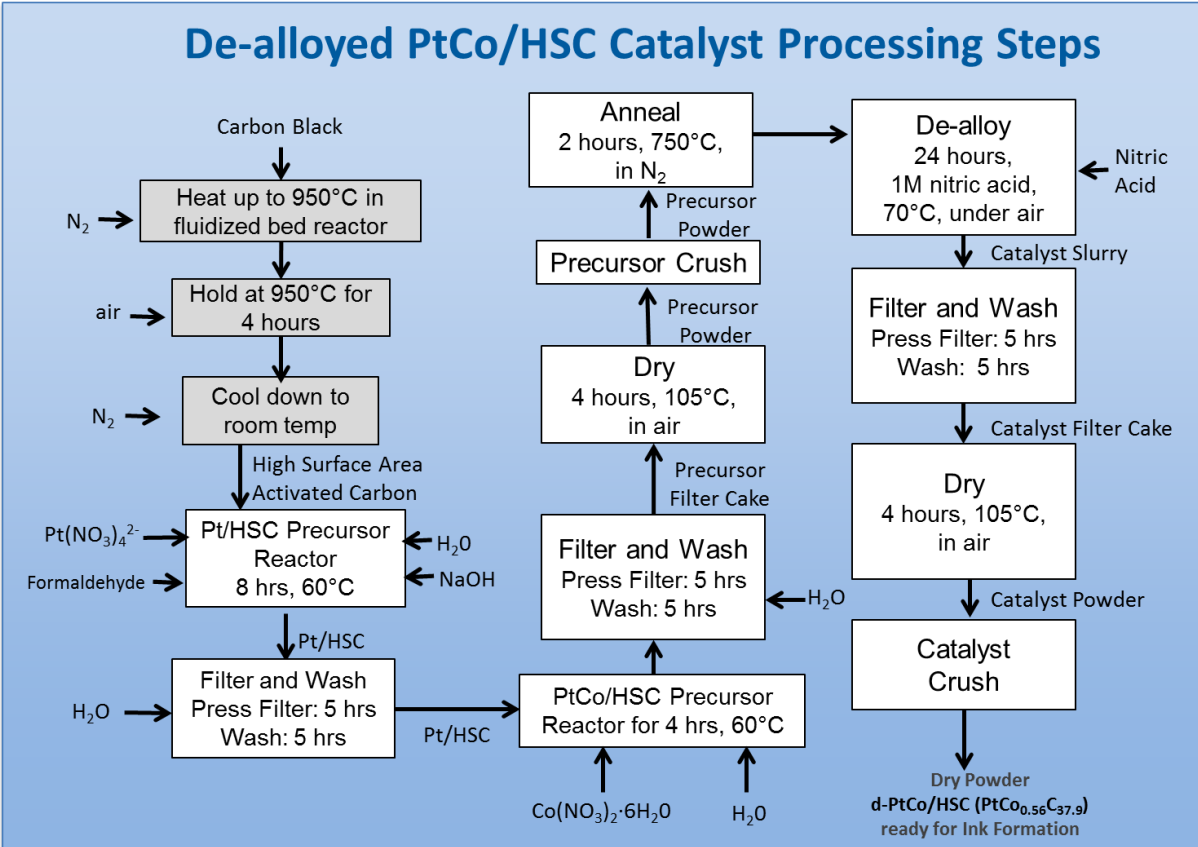


Figure 107. Processing steps for de-alloyed binary d-PtCo/HSC cathode catalyst powder synthesis

Additional processing information for catalyst synthesis:

- Pt Handling Charge:** A 2% handling charge is added to the Pt cost to capture broker's fees, physical security, and administrative expenses related to precious metal handling. This percentage markup is considered a reasonable representation of costs regardless of whether the catalyst maker engaged in an internal Pt arbitrage system themselves or bought from a middleman.
- Quality Control:** A per-batch cost of \$3,300 is added for a series of powder tests (Pt loading, elemental analysis, water content, BET surface area, particle size, XRD, etc.). Batch sizes range from ~4 to ~36 kg.
- Process Yield:** A 95% yield is applied to the entire synthesis process (except for Pt metal which is recycled). Thus processing costs and non-Pt material costs are all incurred for a gross amount of catalyst ~5% higher than the net catalyst delivered. Pt recovery of the "extra" catalyst is 94%: thus 6% (100%-94%) of the Pt contained in the ~5% extra catalyst (i.e. gross-net catalyst) was lost.
- Packaging:** A packaging cost was added and is simplistically modeled as bags and boxes for cathode and anode catalyst in sizes of 5 to 100 kg.



### 9.1.3.2.2 Pt/C Synthesis (Anode Catalyst)

The anode catalyst is composed of platinum on carbon with a much more simplified process (shown in Figure 108) than the cathode de-alloyed catalyst. Brand and specifications of the anode carbon are not known but the anode carbon is modeled as high surface area carbon with the same pricing as is used for the cathode catalyst (\$116/kg at high volume up to \$1,000/kg at low volume). The proportion of Pt to carbon on the anode catalyst is 20% wt.

## Pt/C Anode Catalyst Processing Steps

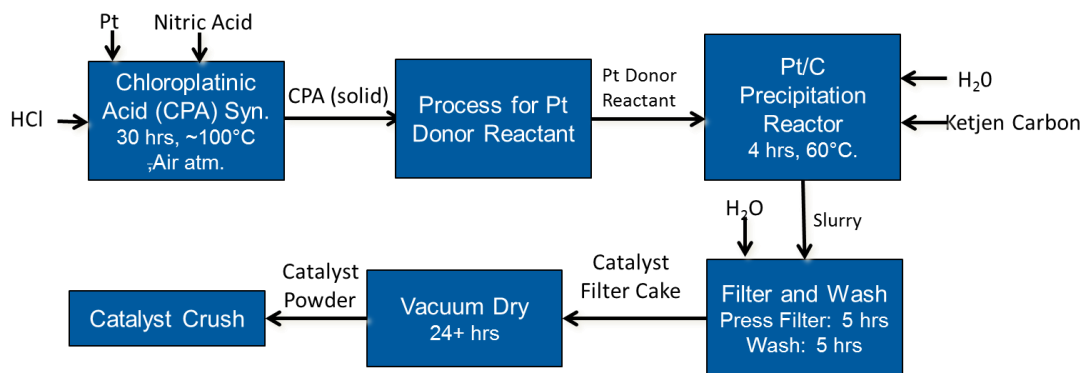


Figure 108. Processing steps for Pt/C anode catalyst powder synthesis

Chloroplatinic acid (CPA) is selected as a representative starting reactant for the Pt/C anode catalyst synthesis as its production method is described in the literature and it is a common Pt catalyst precursor. However, discussions with catalyst manufacturers suggest that CPA is not used directly in the precipitation reactor but is rather used to make another unrevealed Pt-salt that is used in the reactor. Thus the unknown salt compound is modeled at a cost equal to CPA plus some additional processing expense. Based on industry feedback and in the absence of detailed knowledge regarding this unknown processing step, the modeled cost is assessed at 2x the computed CPA cost (excluding Pt).

While CPA is relatively common, it is not typically produced in production quantities. Consequently, a DFMA®-style analysis was conducted. Preparing the CPA involves dissolving platinum sponge into a 4:1 mix of hydrochloric and nitric acids (*aqua regia*) via the reaction:



The CPA ( $\text{H}_2\text{PtCl}_6$ ) is brownish-red in color and is isolated by evaporating the solution to a thick syrup, which becomes solid at room temperature. Cost of the CPA was obtained by combining Pt material cost with CPA preparation cost, derived from a DFMA® analysis. The CPA is used to create the Pt donor reactant in an additional process before the Pt/C precursor. As mentioned previously, this processing step is considered to be the same processing cost as the CPA fabrication process (without Pt material cost). Further costs associated with precipitating the Pt donor reactant onto the carbon were obtained using DFMA®.

### 9.1.3.3 Catalyst Markup Rate

While material and production costs are estimated based on the DFMA<sup>®</sup> methodology, catalyst markup rates are based on catalyst supplier pricing data: specifically, markup rates are calculated from the difference between DFMA<sup>®</sup> materials/processing cost and the catalyst vendor price. This approach yields a representative price (since it is based on vendor input) but also supplies important detail regarding cost drivers (from the DFMA<sup>®</sup> analysis). Additionally, the derived markup rates were analyzed for reasonableness and greater understanding by re-creating them as the sum of a series of business expenses. The expenses are the authors' estimates based on qualitative vendor input and thus are notional and subject to re-interpretation. However, it is felt that the process of defining cost categories and enumerating expenses can lead to greater understanding and the potential for future cost reduction.

The markup rates are set at 0% at 1k systems/year, and 256% to 189% at 10k to 500k systems/year. The rates consist of the following cost elements:

- At 1k systems/year:
  - 0% markup to reflect either of two potential scenarios:
    - business expenses are being borne by the corporate entity so as to grow the market in the early years (a form of “forward-pricing”)
    - (because the cost curve is steep at low production volumes) the price of 2 (or more) catalysts produced at low volume is less than half the cost of only 1 produced at that same volume.
- At 10k to 500k systems/year:
  - Base markup of 59-70% (as applied prior to 2016 for 10k to 500k systems/year) to reflect corporate personnel expenses, profit, warranty, advertising, etc.
  - Research and Development (R&D) expenses of \$1M to \$8M per year to reflect the anticipated catalyst research that would be conducted whether or not large-scale catalyst sales occur
  - Fire department expenses of \$500K to \$4M per year to reflect a catalyst company fire department specially trained and equipped to respond to catalyst product related emergencies (e.g. powder metal fires, acid accidents, toxic gas releases). (The local municipal fire department may be available to assist but may not possess the specialized knowledge, training, or equipment to respond effectively.)
  - Safety/Environmental department expenses of \$70k to \$600k per year to reflect staff expenses to monitor and enforce catalyst related safety protocols within the lab and manufacturing facility and the attendant statutory records and filings
  - Physical security department costs of \$350k to \$3M per year to reflect staff and equipment expenses to provide round the clock security (for the high-value Pt stored in the facilities)
  - Wastewater department costs of \$120k to \$600k per year to reflect expenses related to toxic/contaminated waste streams generated from experimentation and catalyst production.

These markup rates are approximations and are expected to vary considerably between companies. Additional vetting of the markup rates is planned for future stages of the project. They are presented here as a representative set of rates, varying with production rate, that lead to a more accurate prediction of catalyst prices charged by the catalyst company. Estimation of the rates is complicated by the expectation that the catalyst company will most likely be a large firm with multiple product lines. Thus expenses for fire, safety, security, wastewater, and administration may be shared among product lines. The extent and circumstances of sharing are expected to vary between companies. The annual costs detailed above are thus the annual expenses apportioned to the fuel cell catalyst: total company expenses for each category would presumably be (much) higher.

Figure 110 plots the expected catalyst annual sales revenue broken down by cost element (production costs, markup expenses, and Pt costs). Production revenues<sup>85</sup> (as assessed by detailed DFMA<sup>®</sup> analysis) are quite low, only \$670k/year at 1k systems/year and even only \$28M per year at 500k systems/year. This low base of production costs virtually mandates that markup rates will be a high percentage.

As expected from the magnitude (~200%) of the markup rates, markup rate expenses are much larger than production costs at low system production levels and of more comparable value at high system production levels. However, both expense categories are dwarfed by Pt costs. Thus analysis of a representative catalyst company shows an interesting dichotomy: even at high production levels, the catalyst company has (relatively) modest value-added revenue (~\$28M/year) but very high total revenue (~\$314M/year), depending on whether the cost of Pt is included. Thus the markup rates are high percentages because they are based on a low level of (non-Pt) production costs, but the rates would be dramatically lower if Pt costs were included in the base.

Finally, it is noted that the catalyst markup rates used (~200%) are significantly higher than standard automotive industry markup rates (generally 15%-20%). Since the fuel cell catalyst suppliers are also (generally) auto catalyst (catalytic converter) suppliers and the auto industry is extremely price conscious, it is reasoned that the higher level of markup has been scrutinized by the auto industry and found to reflect legitimate costs (and not unreasonably high profits). However, should the markup rates be lowered in the future, cost of the baseline fuel cell system would presumably be reduced.

---

<sup>85</sup> As noted in the previous section, a 2% handling charge is applied to the Pt cost. This amounts to ~\$8M/year at 500k systems/year and is book-kept under material cost rather than under processing or markup cost.

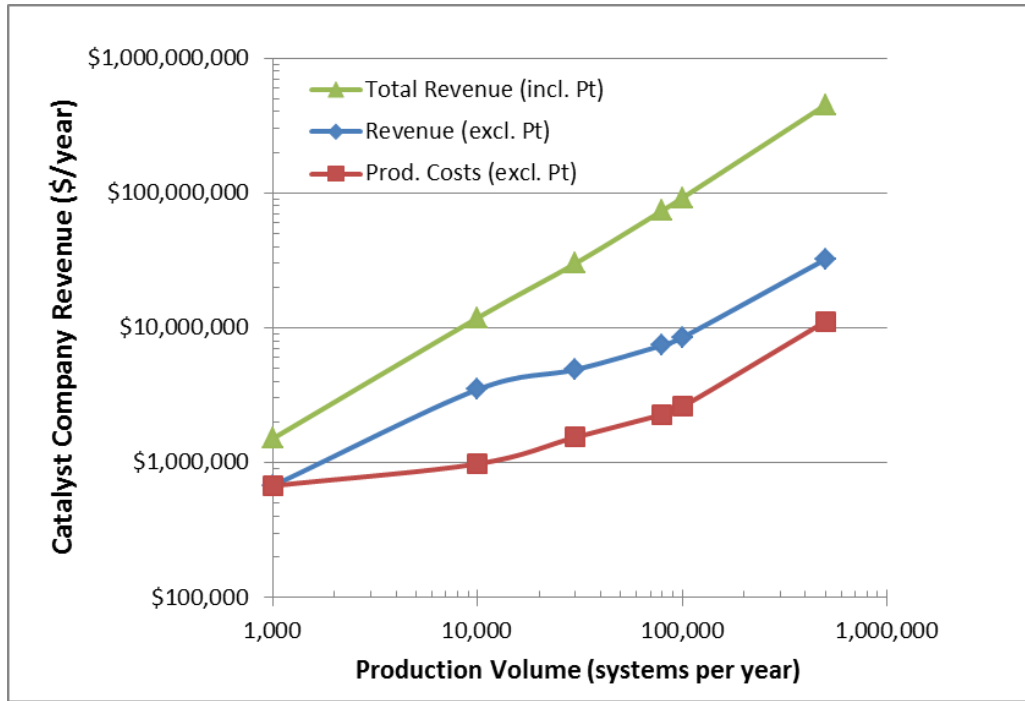


Figure 109. Projected Catalyst Company Revenues from Catalyst Sales

#### 9.1.3.4 Catalyst Synthesis Cost Results

Final cost results of the cathode de-alloyed catalyst powder synthesis and anode catalyst powder synthesis process are shown in Figure 110 and Figure 112, respectively, where the tables show the cost of each processing step at all manufacturing rates. Figure 111 shows a further breakdown of cathode materials, manufacturing, markup, and total cost for each processing step at both 1,000 and 500,000 systems per year manufacturing rates. Highlighted in Figure 111 are the dominant cost of Pt (circled in red), other material costs (circled in blue), and the most expensive processing step (circled in green).

PtCo/C Cathode Catalyst Powder Synthesis		Annual System Production Rate					
Component Costs per 80kWnet Fuel Cell System		1,000	10,000	20,000	50,000	100,000	500,000
Step 1: Pt/HSC Precursor	\$/system	\$712.27	\$637.43	\$574.26	\$504.11	\$484.61	\$464.40
Step 2: Pt/HSC Filtration	\$/system	\$14.76	\$5.91	\$2.82	\$1.30	\$0.73	\$0.29
Step 3: Pt/HSC Wash	\$/system	\$5.67	\$2.59	\$1.27	\$0.61	\$0.44	\$0.30
Step 4: Catalyst PtCo/HSC Precursor	\$/system	\$14.09	\$8.06	\$5.02	\$3.28	\$2.30	\$1.13
Step 5: Precursor Filtration	\$/system	\$17.24	\$8.63	\$4.74	\$1.96	\$0.99	\$0.20
Step 6: Precursor Wash	\$/system	\$6.46	\$2.36	\$1.07	\$0.46	\$0.26	\$0.08
Step 7: Precursor Drying	\$/system	\$44.54	\$15.99	\$7.22	\$3.05	\$1.60	\$0.39
Step 8: Precursor Crushing	\$/system	\$23.34	\$8.35	\$4.28	\$1.78	\$0.92	\$0.20
Step 9: Precursor Vacuum Annealing	\$/system	\$122.99	\$44.39	\$20.16	\$8.63	\$4.67	\$2.66
Step 10: Catalyst Dealloying	\$/system	\$59.03	\$32.88	\$18.13	\$8.11	\$4.64	\$1.63
Step 11: Catalyst Filtration	\$/system	\$16.83	\$8.23	\$4.47	\$1.85	\$0.94	\$0.19
Step 12: Catalyst Wash	\$/system	\$6.46	\$2.36	\$1.07	\$0.46	\$0.26	\$0.08
Step 13: Catalyst Vacuum Dry	\$/system	\$45.10	\$16.83	\$7.69	\$3.49	\$2.06	\$1.24
Step 14: Catalyst Crushing	\$/system	\$23.53	\$8.85	\$4.57	\$2.09	\$1.22	\$0.26
Step 15: Catalyst Quality Control Testing	\$/system	\$6.27	\$8.92	\$5.48	\$5.10	\$5.00	\$4.31
Step 16: Cathode Catalyst Packaging	\$/system	\$10.55	\$3.89	\$2.12	\$0.94	\$0.55	\$0.21
<b>Total Catalyst Synthesis Cost</b>	<b>\$/system</b>	<b>\$1,129.12</b>	<b>\$815.68</b>	<b>\$664.37</b>	<b>\$547.21</b>	<b>\$511.21</b>	<b>\$477.57</b>

Figure 110. Cost of each processing step for the cathode de-alloyed catalyst at production rates between 1,000 and 500,000 systems/year.

		All at 100k systems per year				All at 500k systems per year			
Component Costs per 80kWnet Fuel Cell System		Materials	Manuf.	Markup	Total	Materials	Manuf.	Markup	Total
Platinum Cost		\$451.38	\$0.00	\$0.00	\$451.38	\$441.55	\$0.00	\$0.00	\$441.55
Step 1: Pt/HSC Precursor	\$/system	\$6.65	\$3.55	\$23.04	\$33.24	\$3.39	\$4.51	\$14.95	\$22.85
Step 2: Pt/HSC Filtration	\$/system	\$0.00	\$0.22	\$0.51	\$0.73	\$0.00	\$0.10	\$0.19	\$0.29
Step 3: Pt/HSC Wash	\$/system	\$0.00	\$0.14	\$0.31	\$0.44	\$0.00	\$0.10	\$0.20	\$0.30
Step 4: Catalyst PtCo/HSC Precursor	\$/system	\$0.50	\$0.20	\$1.59	\$2.30	\$0.30	\$0.09	\$0.74	\$1.13
Step 5: Precursor Filtration	\$/system	\$0.00	\$0.31	\$0.69	\$0.99	\$0.00	\$0.07	\$0.13	\$0.20
Step 6: Precursor Wash	\$/system	\$0.00	\$0.08	\$0.18	\$0.26	\$0.00	\$0.03	\$0.05	\$0.08
Step 7: Precursor Drying	\$/system	\$0.00	\$0.49	\$1.11	\$1.60	\$0.00	\$0.14	\$0.26	\$0.39
Step 8: Precursor Crushing	\$/system	\$0.00	\$0.28	\$0.64	\$0.92	\$0.00	\$0.07	\$0.13	\$0.20
Step 9: Precursor Vacuum Annealing	\$/system	\$0.00	\$1.43	\$3.24	\$4.67	\$0.00	\$0.92	\$1.74	\$2.66
Step 10: Catalyst Dealloying	\$/system	\$0.28	\$1.14	\$3.22	\$4.64	\$0.28	\$0.29	\$1.07	\$1.63
Step 11: Catalyst Filtration	\$/system	\$0.00	\$0.29	\$0.65	\$0.94	\$0.00	\$0.06	\$0.12	\$0.19
Step 12: Catalyst Wash	\$/system	\$0.00	\$0.08	\$0.18	\$0.26	\$0.00	\$0.03	\$0.05	\$0.08
Step 13: Catalyst Vacuum Dry	\$/system	\$0.00	\$0.63	\$1.43	\$2.06	\$0.00	\$0.43	\$0.81	\$1.24
Step 14: Catalyst Crushing	\$/system	\$0.00	\$0.38	\$0.85	\$1.22	\$0.00	\$0.09	\$0.17	\$0.26
Step 15: Catalyst Quality Control Testing	\$/system	\$0.00	\$1.53	\$3.47	\$5.00	\$0.00	\$1.49	\$2.82	\$4.31
Step 16: Cathode Catalyst Packaging	\$/system	\$0.04	\$0.13	\$0.38	\$0.55	\$0.04	\$0.03	\$0.14	\$0.21
<b>Total Cost</b>	<b>\$/system</b>	<b>\$458.86</b>	<b>\$10.87</b>	<b>\$41.48</b>	<b>\$511.21</b>	<b>\$445.57</b>	<b>\$8.44</b>	<b>\$23.56</b>	<b>\$477.57</b>
<b>Total Cost</b>	<b>\$/g</b>	<b>\$14.85</b>	<b>\$0.35</b>	<b>\$1.34</b>	<b>\$16.55</b>	<b>\$14.73</b>	<b>\$0.28</b>	<b>\$0.78</b>	<b>\$15.79</b>

Figure 111. Detailed cost breakdown for each cathode de-alloyed catalyst processing step at 100,000 and 500,000 systems per year.

Final cost results of anode catalyst powder synthesis process are shown in Figure 112, showing the cost of each processing step at all manufacturing rates.

Anode Pt/C Catalyst Powder Synthesis		Annual System Production Rate					
Component Costs per 80kWnet Fuel Cell System		1,000	10,000	20,000	50,000	100,000	500,000
Step 1: Catalyst PtC Synthesis	\$/system	\$178.73	\$170.23	\$156.28	\$136.91	\$126.55	\$114.45
Step 2: Anode Catalyst Filtration	\$/system	\$13.82	\$5.40	\$2.57	\$1.18	\$0.61	\$0.14
Step 3: Anode Catalyst Wash	\$/system	\$6.53	\$2.46	\$1.13	\$0.48	\$0.27	\$0.09
Step 4: Anode Catalyst Vacuum Drying	\$/system	\$45.47	\$17.09	\$7.81	\$3.32	\$1.89	\$0.86
Step 5: Anode Catalyst Crushing	\$/system	\$23.83	\$8.95	\$4.63	\$1.99	\$1.12	\$0.27
Step 6: Anode Catalyst QC Testing	\$/system	\$9.40	\$11.15	\$6.47	\$3.67	\$3.57	\$3.04
Step 7: Anode Catalyst Packaging	\$/system	\$6.67	\$2.54	\$1.97	\$0.83	\$0.45	\$0.12
<b>Total Anode Catalyst Synthesis Cost</b>	<b>\$/system</b>	<b>\$284.45</b>	<b>\$217.81</b>	<b>\$180.85</b>	<b>\$148.38</b>	<b>\$134.46</b>	<b>\$118.97</b>

Figure 112. Cost of each processing step for the anode catalyst at production rates between 1,000 and 500,000 systems/year.

### 9.1.3.5 Total Catalyst Synthesis and Material Cost

Figure 113 and Figure 114 summarize cost results for the catalyst synthesis process and materials on cathode and anode.

Annual Production Rate	1,000	10,000	20,000	50,000	100,000	500,000
Gross Amount of Catalyst Needed per system (g/system)	38.27	33.42	32.79	31.27	30.89	30.25
Material (\$/gram of catalyst)	\$17.25	\$15.65	\$15.40	\$15.00	\$14.85	\$14.73
Manufacturing (\$/gram of catalyst)	\$12.25	\$1.75	\$1.02	\$0.50	\$0.35	\$0.28
Markup (\$/gram of catalyst)	\$0.00	\$7.01	\$3.84	\$1.99	\$1.34	\$0.78
<b>Total Cost (\$/gram of catalyst)</b>	<b>\$29.50</b>	<b>\$24.41</b>	<b>\$20.26</b>	<b>\$17.50</b>	<b>\$16.55</b>	<b>\$15.79</b>

Figure 113. Cost summary for de-alloyed cathode catalyst synthesis and materials

Annual Production Rate	1,000	10,000	20,000	50,000	100,000	500,000
Gross Amount of Catalyst Needed per system (g/system)	13.66	11.93	11.71	11.16	11.03	10.80
Material (\$/gram of catalyst)	\$12.01	\$10.94	\$10.87	\$10.56	\$10.34	\$10.09
Manufacturing (\$/gram of catalyst)	\$8.81	\$1.33	\$0.80	\$0.39	\$0.27	\$0.20
Markup (\$/gram of catalyst)	\$0.00	\$5.98	\$3.78	\$2.34	\$1.59	\$0.73
<b>Total Cost (\$/gram of catalyst)</b>	<b>\$20.82</b>	<b>\$18.25</b>	<b>\$15.45</b>	<b>\$13.29</b>	<b>\$12.19</b>	<b>\$11.02</b>

**Figure 114. Cost summary for Pt/C anode catalyst synthesis and materials**

### 9.1.4 Dispersed Catalyst Ink and Application to Membrane

There are numerous methods to apply the catalyst ink into the membrane electrode assembly. Some systems apply the catalyst ink (either directly or via decal transfer) onto the membrane to form a catalyst coated membrane (CCM). Others apply the catalyst ink directly onto the gas diffusion layer (GDL) to form a gas diffusion electrode (GDE).

SA analysis from 2006 to 2010 was based on the CCM-based inking application (specifically slot die coating of the catalyst ink directly onto a moving membrane web via a Coatema VertiCoater system). Such an approach had the advantage of being one of the least costly application techniques judged adequate for high production rates and reasonably high MEA performance. In 2011, SA switched to a new method of catalyst deposition that had shown significant improvements in power density and reported durability at low Pt loadings. Developed at 3M, the Nanostructured Thin Film Catalyst (NSTF) deposition process begins with vapor sublimation of a layer of crystalline finger-like projections, or “whiskers”, to create a high surface area substrate on which the active catalysts may be deposited. Vapor deposition methods are utilized to deposit a very thin layer of platinum and other metals (cobalt and manganese) onto the whiskers in a very precise and uniform manner. The resulting catalyst coated whiskers can then be pressed into the fuel cell membrane to form a porous mat electrode intimately bonded to the membrane. This NSTF catalyst application method was used in SA analyses from 2011 to 2014. In 2015, the baseline reverted back to a slot die coating method for applying the de-alloyed binary catalyst to the membrane and is continued to be used in the 2018 baseline.

In 2014/2015, SA examined two types of slot die coating methods: 1) dual-sided simultaneous slot die coating of anode and cathode onto the membrane, and 2) single-sided sequential (anode then cathode) slot die coating. Feedback from industry indicated differing opinions as to the best method of applying the catalyst ink. The simultaneous coating process would seem to be the obviously lower cost pathway given its 2x processing time advantage. However, at low production rates, the higher capital cost of the simultaneous coating system more than offsets its speed advantage and makes it more expensive than sequential coating. It is estimated that the two application methods would yield similar performance and are compared to each other in that respect. Both methods were examined for each volume of the baseline system and results show that sequential single-sided coating is lower cost only at 1,000 systems per year.

Multiple slot die coating companies provided information on dual-sided simultaneous and single-sided sequential coating techniques and input parameters. The results of the analysis reflect a combination of

different machines with respective capital costs and operating conditions. Due to the proprietary nature of the detailed cost breakdown, SA is unable to provide this information. However, top-level operating parameters are shown in Figure 115 and specify coating web width and web speeds of both dual-sided and single-sided coating machines. In all cases, the process starts with ultrasonic mixing of the dry catalyst powder (15 wt% PtNi<sub>3</sub>/C) with methanol (37.5 wt%), water (37.5 wt%), and ionomer (10 wt% Nafion) to form catalyst ink slurry.<sup>86</sup>

In some dual-sided coating cases the membrane is carried vertically through a set of rollers after coating so as to avoid web sag and eliminate/minimize roller contact with the wet slurry. Other machines execute dual sided horizontal coating (within one meter distance between anode and cathode coatings). In both cases, the catalyst coated membrane is dried under multiple sets of heaters before being rewound onto a take-up spool. The membrane that is coated vertically allows the CCM a long unsupported span during which the coating can dry before touching a roller. The horizontal coating includes flotation drying, eliminating any smearing or damage to the CCM before it is dried. The vertical and horizontal dual-sided simultaneous slot die coating methods are described in Figure 116 and Figure 117, respectively. The capital cost of equipment for all methods includes an ultrasonic mixer, web handling equipment (unwind, tension control, and rewind), coating machine (frame, backing roll, slot die, and fluid delivery), and drying system (supply and exhaust fans).

Parameter	Sequential Slot Die Coating Machine	Dual-Sided Vertical Coating Machine	Dual-Sided Horizontal Coating Machine
Power Consumption	80kW	60kW	500kW <sup>87</sup>
Line Speed	12m/min	13m/min	25m/min
Web Roll Length	1,500m	1,500m	1,500m
Web Width	30cm	50cm	90cm
Number of Laborers	1	1	3

**Figure 115. Table of Slot Die Coating parameters comparing three different machines**

<sup>86</sup> Assuming ionomer to carbon ratio of 1.

<sup>87</sup> Electrical power used for heating the air for drying is 455kW or 91% of the total 500kW. All other components in process require the remaining 45kW or 9% of the total 500kW.

## Dual-Sided Simultaneous Slot Die Coating (Vertical)

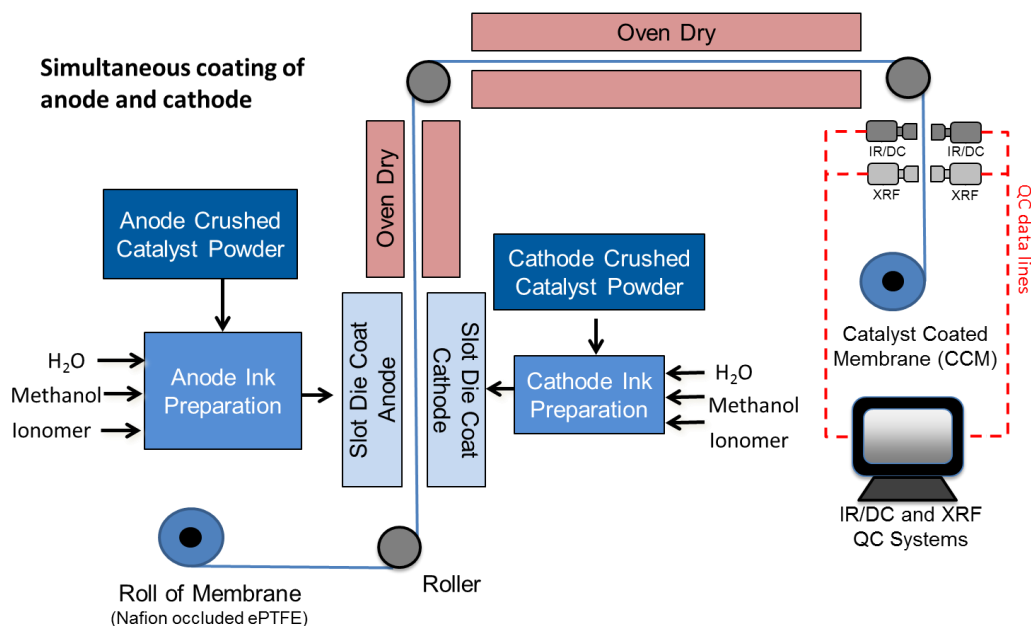


Figure 116. Vertical dual-sided simultaneous slot die coating of de-alloyed PtCo/HSC catalyst process flow diagram

## Dual-Sided Simultaneous Slot Die Coating (Horizontal)

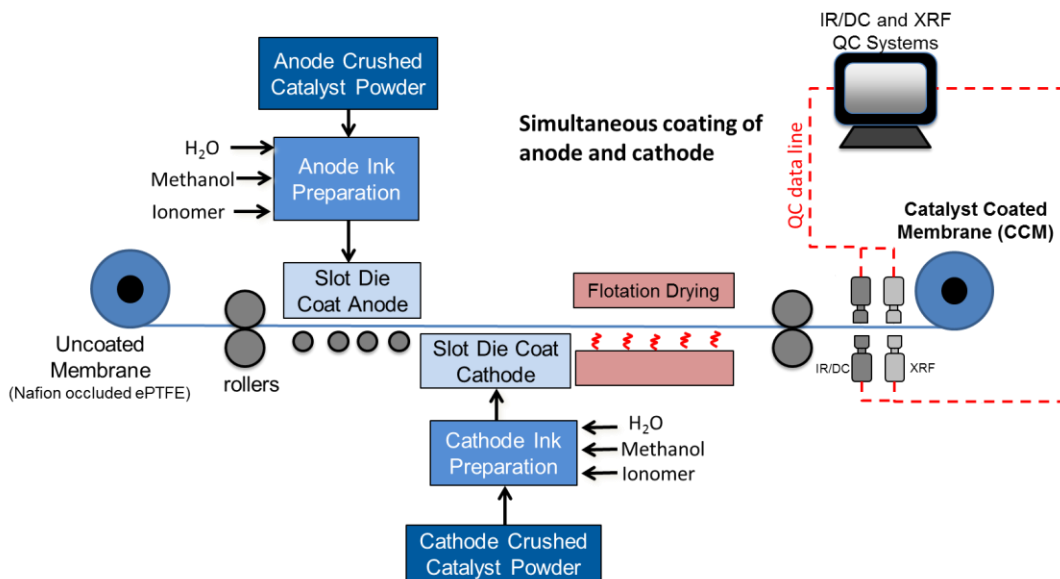


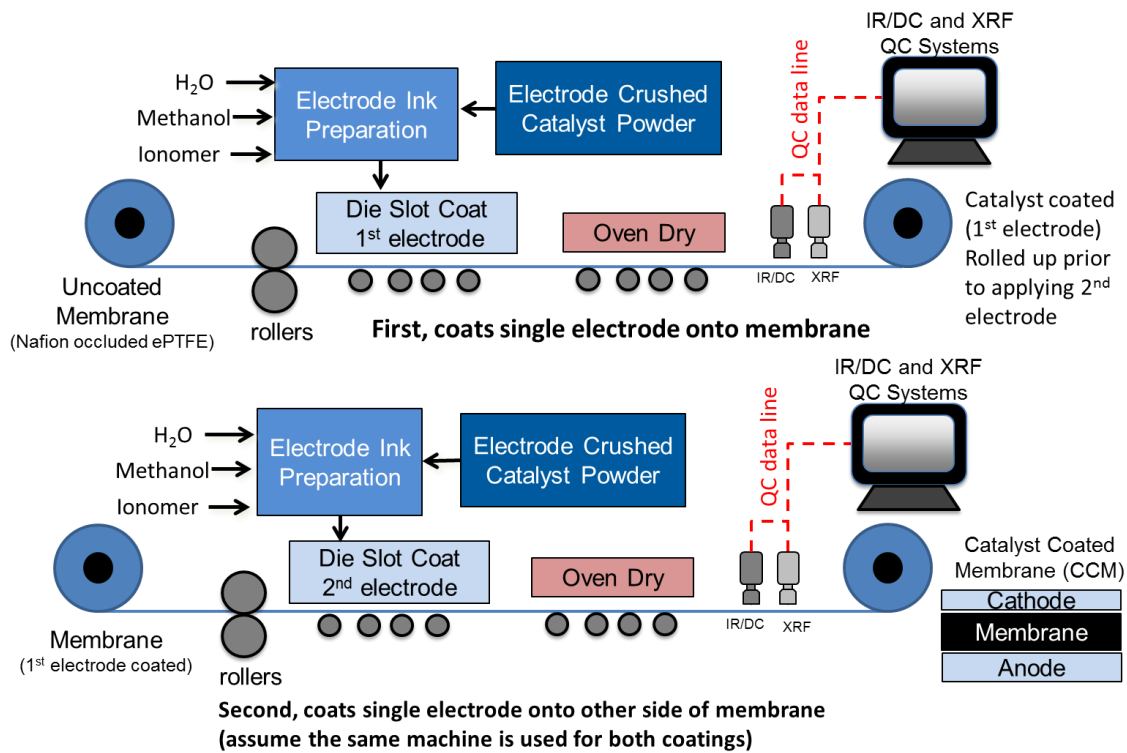
Figure 117. Horizontal dual-sided simultaneous slot die coating of de-alloyed PtCo/HSC catalyst process flow diagram

The second slot die coating method (sequential or single-sided coating) is illustrated in Figure 118. In the first step, the anode ink is prepared within an ultrasonic mixer by mixing dry anode catalyst powder with



water, methanol, and ionomer. In the second step, the membrane is unrolled while the anode ink is slot die coated onto the continuously moving membrane. This single layer is dried under heaters and rolled onto a take-up spool. The coating operation is then repeated in a second slot die coater to apply the cathode ink to the opposite face of the membrane. It is possible to use one coating line to alternately apply anode and cathode layers. Therefore, the cost analysis is based on use of one coater for both lines (anode and cathode). For the sequential process, extra time is required to coat two sides (compared to simultaneous coating), and longer roll change-out times are needed (due to sequential operation). Additionally, there may be difficulties with registering the web, particularly after it goes through the drying oven a single time.

## Sequential Slot Die Coating Catalyst



**Figure 118. Flow Diagram of Sequential Slot Die Coating of Electrodes**

Patch, island coating, window coating, “window frame”, or interrupted coating all describe coating techniques to pattern the ink onto the web rather than provide a 100% fully coated coverage. Such non-100% coverage coating is not assumed in this analysis. Patch coating is generally desirable in that it reduces catalyst coating on areas of the membrane that will not be active within the fuel cell, thereby reducing catalyst cost. Within the DFMA<sup>®</sup> model, SA does not include this capability for two reasons 1) the sub-gasket process assumes a continuous coating of the membrane that is cut into separate parts and realigned with appropriate spacing between active areas, 2) when presented to the Fuel Cell

Technical Team, it is assumed to be a future capability of slot die coating that has not been demonstrated successfully at high volumes while maintaining polarization performance. However, it should also be noted that this patch coating has been used by Toyota to coat their catalyst on membranes for the Mirai stacks.<sup>88</sup> It has been demonstrated at the low volume (1,000-3,000 systems per year), and SA will continue to track the feasibility for high volume scenarios.

One significant change between 2016 and 2017 year analyses was the reduction in catalyst change out and roll change out times. Previously one hour was assumed reasonable for combined catalyst and roll change out time, however, this practically doubled the processing time per roll. In discussions with a slot die coating vendor, this time would be almost negligible compared to the time to coat one roll. This change shows up in the manufacturing cost, reducing it to half the cost compared to 2016. Additionally, markup was added to the coating process to account for security and safety requirements in handling precious metal catalyst.

The quality control equipment associated with the slot die coating process includes IR/DC and XRF. An IR/DC system is used to assess the uniformity of the electrode layers at a single location within the slot die coating production sequence. The IR/DC system<sup>89</sup> operates by placing two conductive rollers across the width of the web a short distance from one another. An electric current is fed to one of the rollers, and then down the length of the electrode layer (anode and cathode) to be collected by the other roller. An IR camera mounted above the electrode and peering down onto the moving web is used to visually assess the temperature signature of the electrode and detect anomalies that would be indicative of electrode thickness variation, improper catalyst loading, improper particle size, non-uniform platinum distribution, or other general defects.<sup>90</sup> Due to the simplicity of the signal processing required, IR camera systems can easily match the line speed of the catalyst deposition (25 m/min). To achieve appropriate resolution (at 500k systems/year), six IR cameras are needed at each analysis site to achieve a 1m total field of view (the web width) at a 25 m/min web speed. Two systems are needed per line for all production volumes using dual-sided coating method corresponding to viewing of 1) the anode after drying, and 2) the cathode after drying. This equates to a total of 12 IR cameras for a dual-sided coating line. Only one system is needed for sequential single-sided coating at 1k systems per year as it is assumed that the IR/DC equipment is viewing one catalyst layer at a time after coating. X-Ray Fluorescence (XRF) is included as an additional QC feature for the catalyst coating processing that was not originally included in the 2014 NSTF catalyst application. It was recommended by NREL to be included for the baseline as it is currently used in addition to IR/DC QC by many CCM suppliers. XRF is appropriate for the determination of material composition (i.e. Pt loading and content of material) and electrode thickness that can directly affect performance.

---

<sup>88</sup> Suzuki, Toshiyuki, "Fuel Cell Stack Technology of Toyota," Toyota Motor Corporation presented as an invited talk at the Electrochemical Society Conference, 2016. <http://ecst.ecsdl.org/content/75/14/423.abstract>

<sup>89</sup> Niccolo V. Aieta, Prodip K. Das, Andrew Perdue, Guido Bender, Andrew M. Herring, Adam Z. Weber, Michael J. Ulsh, "Applying infrared thermography as a quality-control tool for the rapid detection of polymer-electrolyte-membrane-fuel-cell catalyst-layer-thickness variations", Journal of Power Sources, Volume 211, 1 August 2012, Pages 4-11.

<sup>90</sup> Private conversation with Michael Ulsh, NREL.

### 9.1.4.1 Total Catalyst Ink and Application Cost

Machine rate and process parameters are shown in Figure 119 and Figure 120. The overall cost breakdown at various production rates is summarized in Figure 121.

Annual Production Rate	1,000	10,000	20,000	50,000	100,000	500,000
Equipment Lifetime (years)	13	14	14	13	13	13
Interest Rate	10%	10%	10%	10%	10%	10%
Corporate Income Tax Rate	40%	40%	40%	40%	40%	40%
Capital Recovery Factor	0.186	0.180	0.180	0.186	0.186	0.186
Equipment Installation Factor	1.40	1.40	1.40	1.40	1.40	1.40
Maintenance/Spare Parts (% of CC)	5%	5%	5%	5%	5%	5%
Miscellaneous Expenses (% of CC)	1%	1%	1%	1%	1%	1%
Power Consumption (kW)	87	121	121	1020	1020	1020

Figure 119. Slot die coating application process parameters

Annual Production Rate	1,000	10,000	20,000	50,000	100,000	500,000
Capital Cost (\$/Line)	<b>Proprietary</b>					
Coating Web Width (cm)	26	50	50	91	91	91
Simultaneous Lines	1	1	1	1	1	2
Laborers per Line	1.25	1.25	1.25	3.25	3.25	3.25
Line Utilization	46.8%	24.4%	47.8%	12.7%	25.1%	61.4%
Effective Total Machine Rate (\$/hr)	\$247.20	\$824.38	\$453.14	\$4,724.89	\$2,504.40	\$1,158.27
Line Speed (m/s)	0.1	0.2	0.2	0.4	0.4	0.4

Figure 120. Machine rate parameters for slot die coating process

Annual Production Rate	1,000	10,000	20,000	50,000	100,000	500,000
Material (\$/stack)	\$1,272	\$967	\$787	\$661	\$616	\$578
Manufacturing (\$/stack)	\$369	\$64	\$35	\$39	\$21	\$9
Markup (\$/stack)	\$256	\$37	\$19	\$19	\$9	\$4
<b>Total Cost (\$/stack)</b>	<b>\$1,898</b>	<b>\$1,069</b>	<b>\$841</b>	<b>\$719</b>	<b>\$646</b>	<b>\$591</b>
<b>Total Cost (\$/kWnet)</b>	<b>\$23.72</b>	<b>\$13.36</b>	<b>\$10.51</b>	<b>\$8.99</b>	<b>\$8.08</b>	<b>\$7.38</b>

Figure 121. Cost summary for slot die coating process (includes Pt catalyst cost)

### 9.1.5 Catalyst Coated Membrane Acid Washing

Since 2013, ANL has been working toward optimization of cathode electrode catalyst materials in order to meet DOE targets for Pt loading ( $<0.125 \text{ mg/cm}^2$ ) and performance ( $>1,000 \text{ mW/cm}^2$  @ 675 mV).<sup>91</sup> Catalysts with alloyed Pt and a 3d transition-metal (e.g. Co and Ni) suffer from high mass transport resistance due to transition-metal alloy cation migration to the catalyst surface under low humidity operation. Acid washing the CCM is an effective post-treatment step to remove excess transition-metal,

<sup>91</sup> Myers, D., Kariuki, N., Ahluwalia, R., Wang, X., and Peng, K., "Rationally Designed Catalyst Layers for PEMFC Performance Optimization", Argonne National Lab Annual Progress Report for the U.S. Department of Energy, 2015.

which decreases the observed transport resistance due to excess transition metal.<sup>92</sup> In 2016, acid washing of the CCM was included in the DFMA<sup>®</sup> cost analysis by adapting a lab process provided by Zhiwei Yang at United Technologies Research Center (UTRC). The current lab process involves the soaking of individual CCM pieces in a heated acid bath of 0.5 M sulfuric acid for ~3 hours, then washing in DI water several times (3 x 1 hour cycles) before drying. In a high rate manufacturing scenario, the process would likely be optimized for a roll-to-roll process, where washing times and possibly number of water wash steps could be reduced. However, this type of roll-to-roll process has not yet been demonstrated for slower processing times. Therefore, to maintain the same processing times as has been demonstrated in the lab, a batch process is postulated where a 1,500 m roll of CCM material is loosely wound with a porous spacer material and submerged in a bath. Figure 122 is a block diagram of the postulated high volume acid washing process while Figure 123 displays a graphical depiction of the process. The acid is pumped into the bath, heated to 60 °C (~30 min), and held at that temperature for 2.5 hours. The acid is then drained and fresh DI water is pumped into the same chamber and heated to 60 °C and held for about 1 hour. The water washing step is then repeated twice before the washed CCM is removed from the chamber. This equates to about 6 hours of processing. While one roll goes through this process, the previous roll is unwound and dried under heaters and then re-wound for the sub-gasket process. The effective areal acid washing rate is about 4m<sup>2</sup>/min at the highest volume. The preliminary analysis of this concept assumes acid disposal costs equal to 50% of the acid purchase price and 3-4 re-use cycles of the acid (before flowing fresh acid).

There are numerous opportunities for process optimization and cost reduction. Acid and water can be pumped through the wound coil described above to enhance effectiveness. Acid/water washing times can be decreased through process optimization. Roll-to-roll processing (instead of batch processing) can be implemented. Acid usage amount can be reduced. Acid disposal costs can be significant and the extent of acid reuse (before it becomes unacceptably saturated with contaminants) is not clear. Consequently, maximizing acid reuse is a cost reduction strategy. In another scenario envisioned, the CCM could be initially washed with recycled acid (perhaps for 2 hours) and then washed with fresh acid at the end (perhaps for the last half hour).

---

<sup>92</sup> R. K. Ahluwalia, X. Wang, J-K Peng, N. N. Kariuki, D. J. Myers, S. Rasouli, P. J. Ferreira, Z. Yang, A. Martinez-Bonastre, D. Fongalland, and J. Sharman, "Durability of De-Alloyed Platinum-Nickel Cathode Catalyst in Low Platinum Loading Membrane-Electrode Assemblies Subjected to Accelerated Stress Tests", *J. Electrochem. Soc.* 2018 165(6): F3316-F3327.

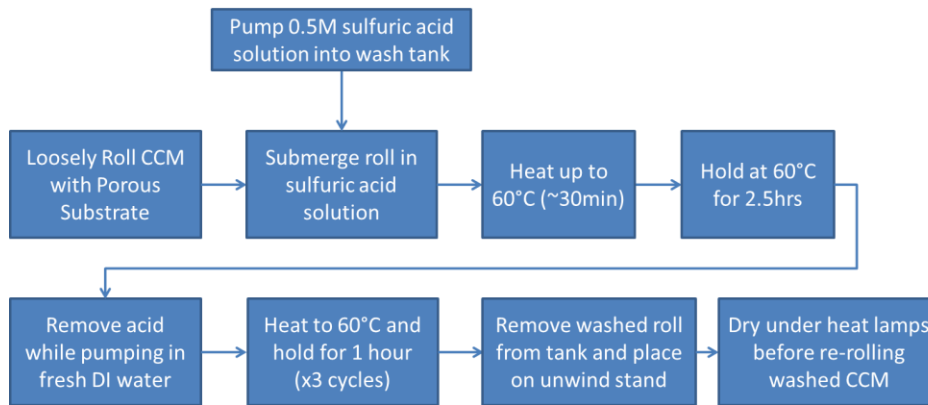


Figure 122. Block Diagram of CCM Acid Wash Process

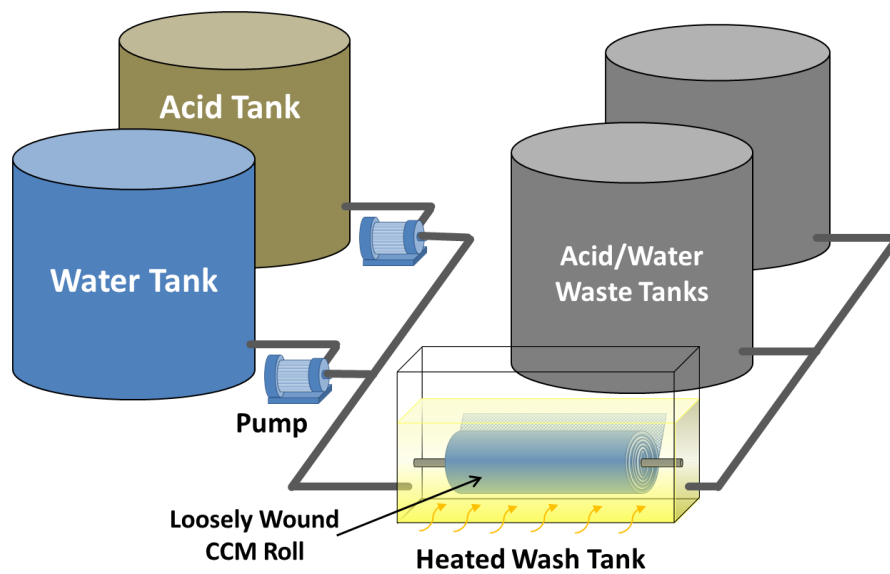


Figure 123. Diagram of CCM Acid Wash Process

Machine rate and process parameters for acid washing are shown in Figure 124 and Figure 125. The overall cost breakdown at various production rates is summarized in Figure 126.

Annual Production Rate	1,000	10,000	20,000	50,000	100,000	500,000
Equipment Lifetime (years)	15	15	15	15	15	15
Interest Rate	10%	10%	10%	10%	10%	10%
Corporate Income Tax Rate	40%	40%	40%	40%	40%	40%
Capital Recovery Factor	0.175	0.175	0.175	0.175	0.175	0.175
Equipment Installation Factor	1.40	1.40	1.40	1.40	1.40	1.40
Maintenance/Spare Parts (% of CC)	10%	10%	10%	10%	10%	10%
Miscellaneous Expenses (% of CC)	7%	7%	7%	7%	7%	7%
Power Consumption (kW)	20	20	20	30	30	30

Figure 124. Acid Wash Process Parameters

Annual Production Rate	1,000	10,000	20,000	50,000	100,000	500,000
Capital Cost (\$/Line)	\$692,000	\$692,000	\$692,000	\$907,000	\$907,000	\$907,000
Simultaneous Lines	1	1	2	3	5	22
Laborers per Line	0.58	0.58	0.58	0.58	0.58	0.58
Line Utilization	33%	99%	97%	79%	93%	99%
Effective Total Machine Rate (\$/hr)	\$290.73	\$114.13	\$116.41	\$170.15	\$149.75	\$141.92
Batch Cycle Time (hrs)	6.0	6.0	6.0	6.0	6.0	6.0
Roll Length (m)	500.0	500.0	500.0	500.0	500.0	500.0
Roll Width (m)	0.3	0.5	0.5	0.9	0.9	0.9
Effective Acid Wash Rate (m <sup>2</sup> /min)	0.4	0.7	0.7	1.3	1.3	1.3

Figure 125. Machine Rate Parameters for CCM Acid Wash

Annual Production Rate	1,000	10,000	20,000	50,000	100,000	500,000
Material (\$/stack)	\$9	\$3	\$3	\$1	\$1	\$1
Manufacturing (\$/stack)	\$299	\$36	\$36	\$26	\$22	\$20
Markup (\$/stack)	\$211	\$22	\$20	\$13	\$11	\$8
<b>Total Cost (\$/stack)</b>	<b>\$519</b>	<b>\$60</b>	<b>\$59</b>	<b>\$40</b>	<b>\$34</b>	<b>\$29</b>
<b>Total Cost (\$/kW<sub>net</sub>)</b>	<b>\$6.48</b>	<b>\$0.75</b>	<b>\$0.73</b>	<b>\$0.50</b>	<b>\$0.42</b>	<b>\$0.36</b>

Figure 126. Cost Summary for CCM Acid Wash

### 9.1.6 Gas Diffusion Layer

The gas diffusion layer (GDL) costs for 2011 and previous analyses were based on a price quote for a vendor macroporous layer combined with a DFMA<sup>®</sup> analysis of a microporous layer addition. This resulted in a GDL cost of ~\$11/m<sup>2</sup> at 500k systems/year (~\$2.54/kW<sub>net</sub>).

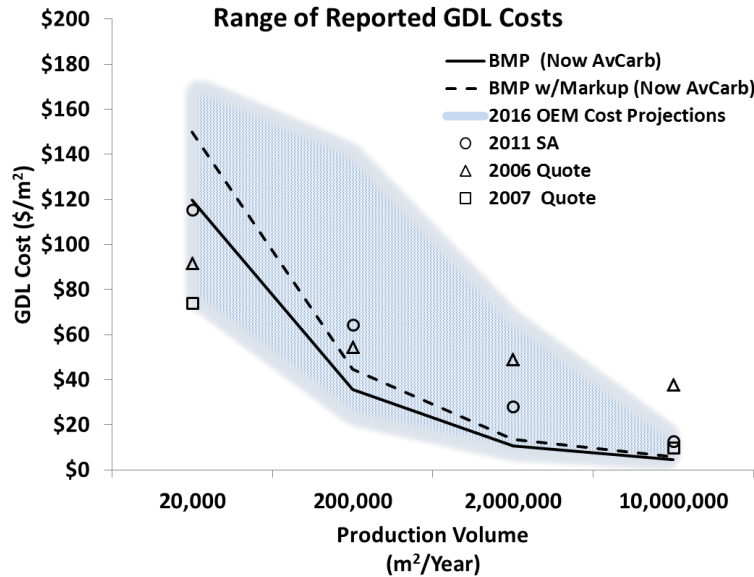
Between 2012 and 2015, the GDL cost estimates were based on DOE-funded research by Ballard Power Systems for cost reduction of a teflonated ready-to-assemble GDL consisting of a non-woven carbon base layer with two microporous layers.<sup>93</sup> The Ballard analysis<sup>94</sup> estimated a cost of ~\$4.45/m<sup>2</sup> at 10M m<sup>2</sup>/year (approximately equivalent to 500k systems/year in 2015) and a cost of \$56/m<sup>2</sup> at less than 100k m<sup>2</sup>/year (approximately equivalent to 5k systems/year in 2015). Based upon these data points, a learning curve exponent of 0.6952 was derived and used to estimate the GDL cost at intermediate production rates.

Discussion with fuel cell companies and vendors about GDL costs and the prices OEMs expect to pay for GDLs resulted in a wide range of values. Figure 127 shows a comparison of the ranges of GDL costs OEMs report against vendor quotes, previous SA analyzed GDL cost, and costs derived from a DOE-supported GDL manufacturing project.<sup>95</sup>

<sup>93</sup> "Reduction in Fabrication Costs of Gas Diffusion Layers," Jason Morgan, Ballard Power Systems, DOE Annual Merit Review, May 2011.

<sup>94</sup> Personal communication with Jason Morgan of Ballard Power Systems, 24 July 2012.

<sup>95</sup> "Reduction in Fabrication Costs of Gas Diffusion Layers," Jason Morgan, Ballard Power Systems, DOE Annual Merit Review, May 2011.



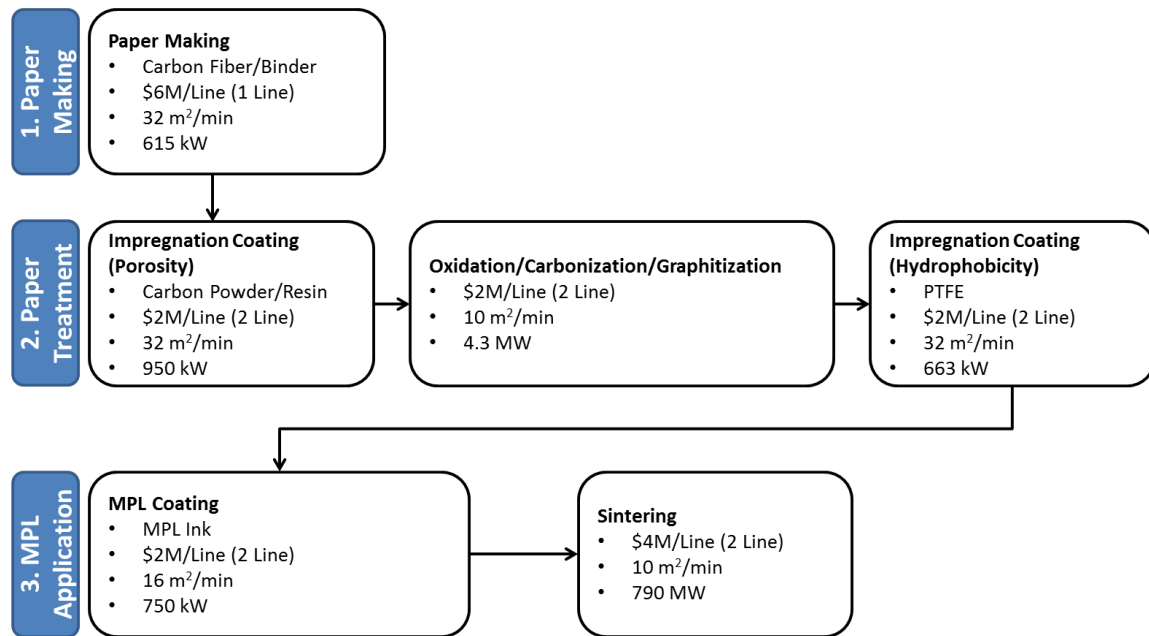
**Figure 127. Comparison of GDL costs used in previous SA analysis and as reported by OEMs and GDL suppliers.**

To provide better insight into cost drivers and to have a more flexible basis for GDL cost, a ground-up DFMA® style model was added to the stack analysis in 2016 and used for the 2018 baseline systems.

The model is based on Ballard Material Products process flow which shares similarities with other GDL manufacturers. Figure 128 graphically illustrates the three main steps of GDL production:

- 1) Carbon fiber papermaking,
- 2) Treating the carbon fiber paper for hydrophobicity and pore size, and
- 3) Application of the microporous layer.

The carbon fiber paper is made using conventional wet-laid papermaking techniques where chopped carbon fiber is dispersed in a solvent (typically water) along with a dispersant such as polyvinyl alcohol, laid onto a web, dried, and re-spooled. Porosity of the carbon fiber paper is adjusted by carbon powder and/or resins, followed by heat treatment in oxidizing conditions, then in graphitizing conditions. Surface properties are adjusted by adding a hydrophobic coating such as fluorinated ethylene propylene (FEP). Finally, a microporous layer (MPL) is applied through an inking step and sintered to compress the MPL to achieve the desired final porosity.



**Figure 128. Gas diffusion layer manufacturing process flow diagram for a facility producing GDL to supply 500,000 vehicles per year.**

Analyses prior to 2016 used GDL manufacturing cost whereas now the analysis more correctly uses GDL price reflecting our understanding the GDL would not be vertically integrated. For 2018, it is assumed that the GDL is supplied to the OEM by a vendor and therefore includes a 25% markup to the manufacturing cost to depict price to the OEM. Figure 129 graphically portrays the GDL price used in the analysis as a function of annual GDL production.

Materials and manufacturing breakdown for each of the GDL fabrication steps are shown in Figure 130.<sup>96</sup>

<sup>96</sup> Low volume takes into account reduced capital cost of equipment for lower throughput (m<sup>2</sup>/hour) compared to high volume machinery. Material cost at all volumes is assumed to remain the same on a \$/m<sup>2</sup> basis.



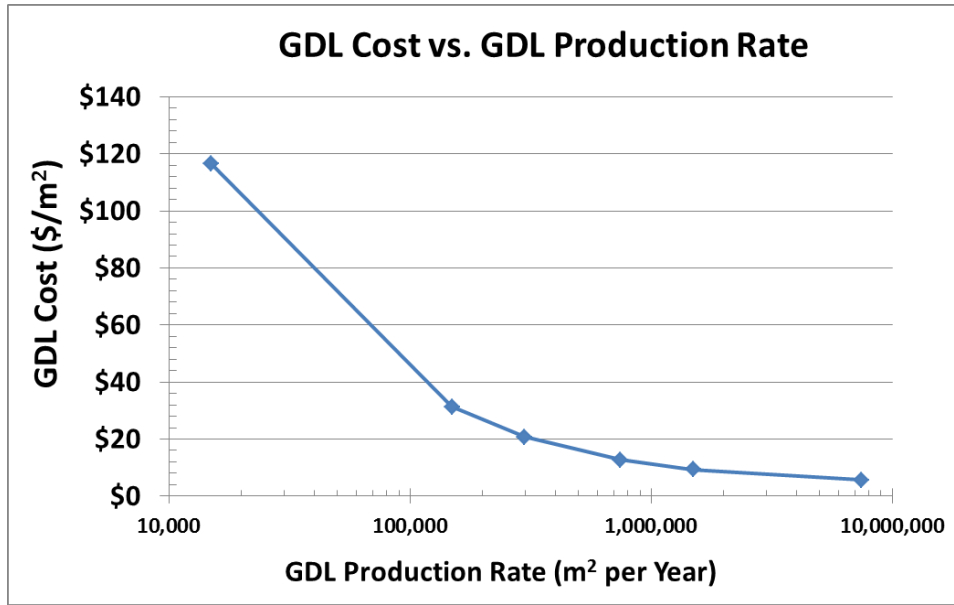


Figure 129. Price OEMs pay for GDL as a function of production rate

Low Volume Estimates			GDL		GDL	
Annual GDL Production	m2/year		200,000	700,000	2,000,000	10,000,000
<b>Paper Making</b>	\$/m2		\$3.85	\$1.60	\$1.66	\$0.80
Material	\$/m2		\$0.55	\$0.55	\$0.55	\$0.55
Manufacturing	\$/m2		\$3.30	\$1.05	\$1.11	\$0.26
<b>Impregnation Coating (Porosity)</b>	\$/m2		\$1.76	\$1.00	\$0.90	\$0.61
Material	\$/m2		\$0.49	\$0.49	\$0.49	\$0.49
Manufacturing	\$/m2		\$1.28	\$0.51	\$0.41	\$0.13
<b>Oxidation/Carbonization/Graphitization</b>	\$/m2		\$5.69	\$3.68	\$1.15	\$1.01
Material	\$/m2		\$0.29	\$0.29	\$0.29	\$0.29
Manufacturing	\$/m2		\$5.40	\$3.39	\$0.86	\$0.72
<b>Impregnation Coating (Hydrophobicity)</b>	\$/m2		\$1.52	\$0.75	\$0.65	\$0.37
Material	\$/m2		\$0.25	\$0.25	\$0.25	\$0.25
Manufacturing	\$/m2		\$1.27	\$0.50	\$0.40	\$0.12
<b>MPL Coating</b>	\$/m2		\$1.54	\$1.17	\$0.76	\$0.55
Material	\$/m2		\$0.31	\$0.31	\$0.31	\$0.31
Manufacturing	\$/m2		\$1.23	\$0.86	\$0.45	\$0.24
<b>Sintering</b>	\$/m2		\$5.12	\$1.69	\$0.86	\$0.57
Material	\$/m2		\$0.00	\$0.00	\$0.00	\$0.00
Manufacturing	\$/m2		\$5.12	\$1.69	\$0.86	\$0.57
<b>Real Estate</b>	\$/m2		\$1.56	\$0.50	\$0.89	\$0.28
<b>Markup</b>	%		25%	25%	23%	23%
Material	\$/m2		\$1.88	\$1.88	\$1.88	\$1.88
Manufacturing	\$/m2		\$17.60	\$8.00	\$4.10	\$2.02
Facilities	\$/m2		\$1.56	\$0.50	\$0.89	\$0.28
<b>Total Cost Without Markup</b>	\$/m2		\$21.04	\$10.38	\$6.87	\$4.18
<b>Total Cost With Markup</b>	\$/m2		\$26.30	\$12.98	\$8.58	\$5.23

Figure 130. Materials and manufacturing cost for GDL fabrication processes for two low volume (left) and two high volume (right) production levels

At 11.5M m<sup>2</sup>/year of GDL, the manufacturing cost is estimated to be \$4.14/m<sup>2</sup>, very close to Ballard Material Products estimate of \$4.18/m<sup>2</sup> used for the baseline system in previous years. The differences

between the two estimates are GDL thickness<sup>97</sup>, assumptions for labor, electricity, and discount rates. A markup of 25% was estimated<sup>98</sup> to reflect the price the stack integrator would pay, making the total GDL price \$5.17/m<sup>2</sup>. At 500,000 systems per year, only 7.5M m<sup>2</sup>/year of GDL is needed for the 2018 system, therefore the cost at high volume is \$5.64/m<sup>2</sup>.

The graph in Figure 131 shows the model results over the annual GDL purchase volume for two scenarios: 1) an advanced, roll-to-roll, high volume manufacturing scenario (blue squares) and 2) a conventional, semi-batch, lower volume manufacturing scenario (red squares). For comparison, the Ballard GDL Price (on graph as blue circles) is the cost used in previous year analyses inclusive of a 25% markup for profit. In addition, OEM price projections shown in Figure 127 are included in the graph.

GDL production rates were modeled from a GDL manufacturer's perspective and based on process equipment for a facility sized to produce 10,000,000 m<sup>2</sup> of GDL per year. This leads to the GDL production and vehicle production rates not lining up exactly. Since the total amount of GDL used changes with stack power density, and because the GDL manufacturing rate doesn't scale exactly with stack production rates, a curve fit for GDL price is used in the DFMA<sup>®</sup> stack cost model. At the lowest volume, the OEM price was used as this reflects an average price that accounts for all costs OEMs would pay for GDL including scrap, shipping, etc. At intermediate production rates, SA's modeled conventional GDL price was used in the price curve. Finally, the advanced, high volume manufacturing cost was used for volumes greater than 2 million m<sup>2</sup>/year annual GDL production (equivalent to 80,000 to 500,000 systems/year).

---

<sup>97</sup> Ballard Material Products quotation in 2012 did not specify a GDL thickness. However Jason Morgan's 2011 report on GDL fabrication suggests ~200 microns total, uncompressed. The GDL material modeled in SA's DFMA<sup>™</sup> analysis assumes a 150 micron total, uncompressed thickness (105 micron carbon paper thickness and 45micron MPL thickness).

<sup>98</sup> A 25% GDL markup rate is judged to be reasonable based on the approximate company-wide and divisional gross margins shown in SGL's 2015 annual report.

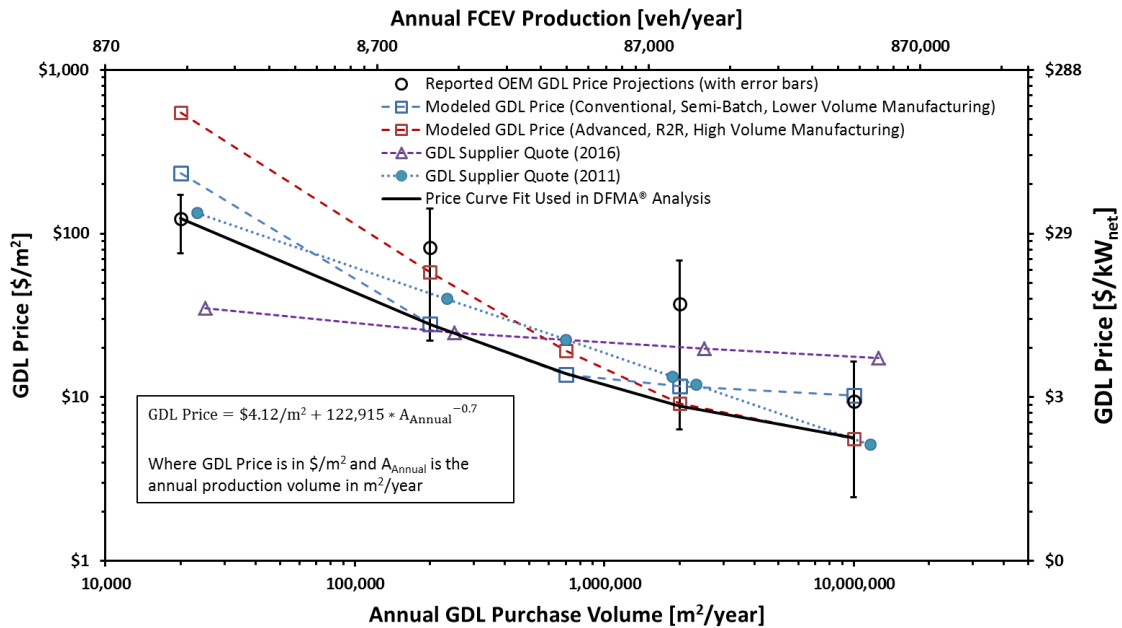


Figure 131. Graph of GDL price over annual GDL purchase volume, showing low and high volume model results and price curve fit used in the baseline.

The overall cost for GDL for the baseline system at each vehicle production volume is shown in Figure 132.

Annual Production Rate	1,000	10,000	20,000	50,000	100,000	500,000
GDL Cost (\$/m <sup>2</sup> )	\$116.53	\$31.34	\$20.78	\$12.77	\$9.35	\$5.64
GDL Cost (\$/stack)	\$1,741	\$468	\$310	\$191	\$140	\$84
<b>Total Cost (\$/stack)</b>	<b>\$1,741</b>	<b>\$468</b>	<b>\$310</b>	<b>\$191</b>	<b>\$140</b>	<b>\$84</b>
<b>Total Cost (\$/kWnet)</b>	<b>\$21.76</b>	<b>\$5.85</b>	<b>\$3.88</b>	<b>\$2.38</b>	<b>\$1.75</b>	<b>\$1.05</b>

Figure 132. Cost breakdown for GDL

### 9.1.7 MEA Sub-Gaskets

Prior to 2012, the fuel cell systems analyzed by SA were assumed to use MEA frame gaskets for gas and liquid sealing between the membrane and the bipolar plate.<sup>99</sup> The frame gaskets were insertion-molded around the periphery of the MEA and added substantial cost due to high cycle time and the relatively high cost of custom injection-moldable sealant. Consequently, during the 2012 analysis, an examination was conducted of fuel cell manufacturer processes and patents to identify an alternative lower cost

<sup>99</sup> "Mass Production Cost Estimation for Direct H2 PEM Fuel Cell Systems for Automotive Applications: 2010 Update," Brian D. James, Jeffrey A. Kalinoski & Kevin N. Baum, Directed Technologies, Inc., 30 September 2010.

sealing approach. The use of sub-gaskets was identified as a promising alternative and was selected for the 2012 to 2018 fuel cell systems.

The sub-gasket sealing approach consists of thin layers of PET gasketing material, judiciously cut into window-frame shapes and laminated to themselves and the periphery of the MEA to form a contiguous and flat sealing surface against the bipolar plate. A thin bead of adhesive sealing material is screen-printed onto the bipolar plates to form a gas- and liquid-tight seal between the bipolar plate and the sub-gasket material. The bipolar plate design has been changed to incorporate a raised surface at the gasket bead location to minimize the use of the gasket material. Screen printing of the gasket bead onto the bipolar plates is a well-understood and demonstrated process. The sub-gasket layers are bonded to the MEA in a roll-to-roll process, shown in Figure 133, based upon a 3M patent application.<sup>100</sup> While the construction is relatively simple in concept, fairly complex machinery is required to handle and attain proper placement and alignment of the thin sub-gasket and MEA layers. This sub-gasket process has four main steps:

1. Formation of a catalyst coated membrane (CCM) web
2. Attachment of CCMs to the first half of the sub-gasket ladder web
3. Attachment of the second half of the sub-gasket ladder web to the half sub-gasketed CCM
4. Attach GDLs to sub-gasketed membrane to form five-layer MEAs (in roll form)

---

<sup>100</sup> "Fuel Cell Subassemblies Incorporating Sub-gasketed Thrifted Membranes," US2011/0151350A1

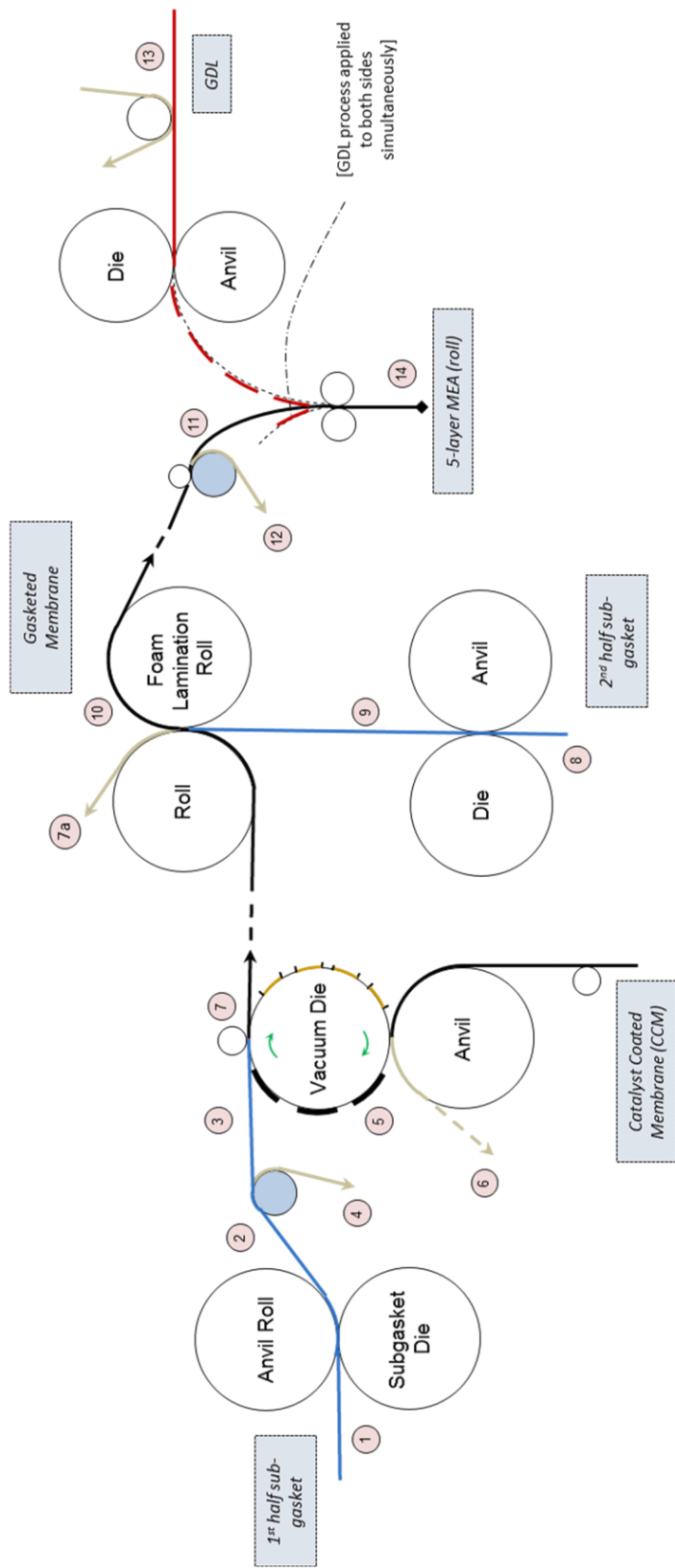


Figure 133. Roll-to-roll sub-gasket application process

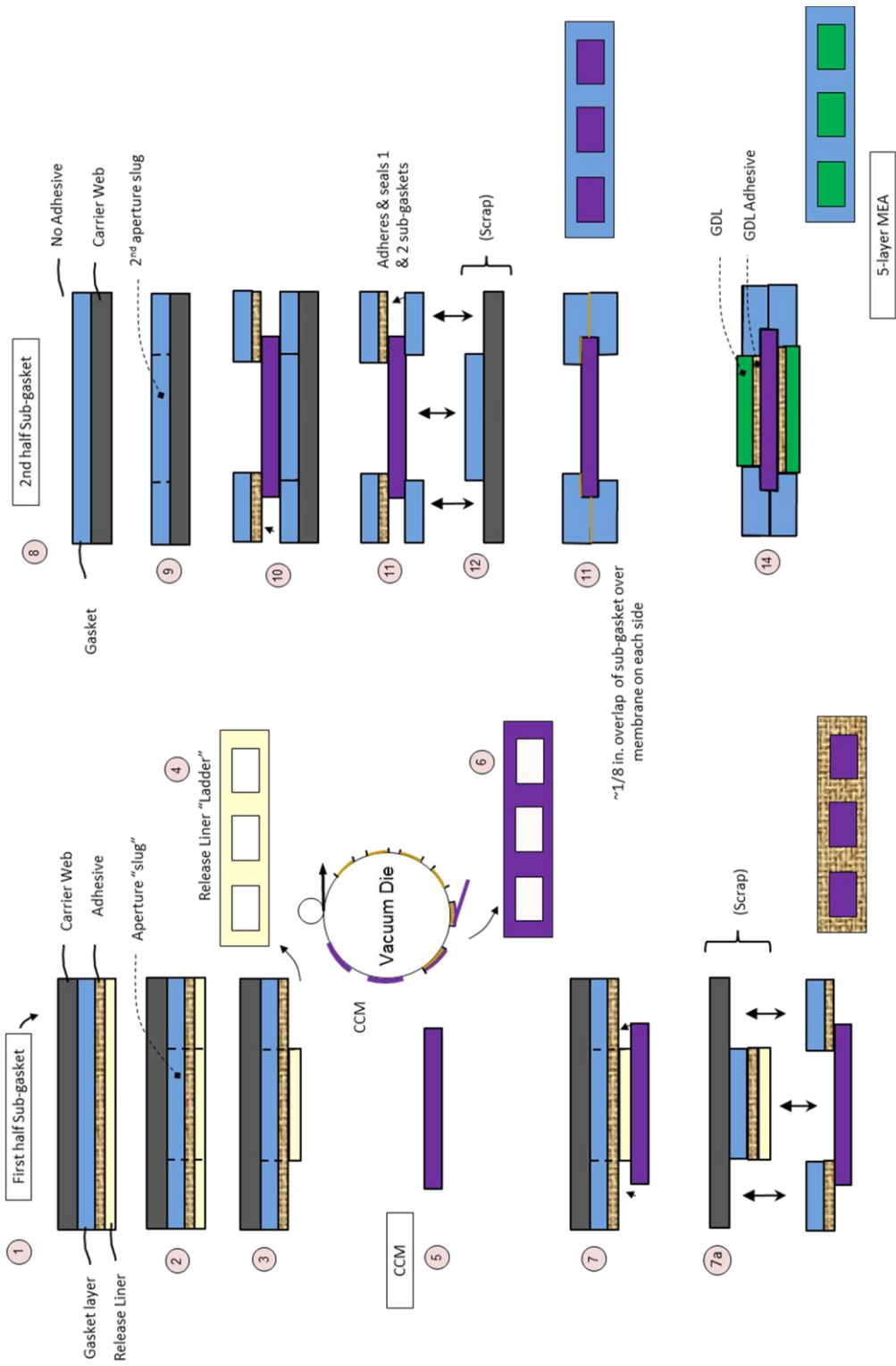


Figure 133. (continued)

The process uses a proprietary 3M “pressure sensitive adhesive,” which is modeled at a notional \$20/kg based on high-end generic adhesive surrogates. The sub-gasket layer consists of two layers of 0.1mm PET film at \$1.67/m<sup>2</sup> based on a high-volume internet price quote. These materials experience significant waste using this process, as the center section of both the sub-gasket layers (corresponding to the fuel cell active area) and the adhesive liner is scrapped. The process capital equipment is based on component analogy to membrane web processing units and is assumed to operate at a line speed of 30m/min with five line workers.

While the process train illustrated in Figure 133 is based on a 3M patent, the implementation of it for cost modeling purposes differs in two important respects. First, the process shows a “ladder” of scrap CCM being left over (component 6) after the vacuum die cutter separates the CCM active area (component 5) from the CCM roll. This amount of CCM wastage would normally be approximately equal to the difference between the bipolar plate total area and the membrane active area: a substantial scrap fraction.<sup>101</sup> Consequently, to minimize this CCM wastage, additional machinery utilizing timed vacuum transfer is postulated for cost modeling purposes to allow the active area CCM pieces to be cut from the CCM roll contiguously (i.e. with no scrap between pieces) and then placed appropriately to fit into the picture portion of the picture-frame sub-gaskets. While this approach adds mechanical complexity and capital cost, it is a relatively standard process and it avoids the high CCM scrap rates that otherwise would occur. Second, the 3M patent is silent on the issue of how many cells are processed simultaneously in the web width direction. While 1 cell wide is inferred, use of multiple cells across the width is a reasonable engineering extrapolation. Cost computations are based on a nominal 1 meter web width that can process 5 cells simultaneously. This adds mechanical complexity and capital cost but overall leads to reduced part cost due to an increased processing rate.

A thin bead of polyolefin elastomer sealing material is screen printed onto the bipolar plates to form a gas and liquid tight seal between the bipolar plate and the sub-gasket material. This process is directly analogous to the screen-printed coolant gaskets analyzed in past cost analyses.<sup>102</sup> The cost of this screen printing step is combined with that of the sub-gasket procedure described above, and presented as a single cost result in Figure 14.

In 2015, an alternative processing method was implemented for the sub-gasket at 1,000 systems per year production. The sub-gasket process assumed for high volume has quite high capital cost with very high throughput resulting in very low utilization at low volumes. For low volume, an alternative robotic stacking approach was used where the material for each of the sub-gasket components is cut to the cell size and stacked with a robot. This change in process affects the processing methods of the hot pressing and cutting and slitting. More on these changes are described in their respective sections. Figure 134 shows the step-by-step process (view of through-cell cross-sections) for the low volume sub-gasket technique.

---

<sup>101</sup> For an active to total area ratio of 0.625, scrap as a percentage of active area would be  $0.375/0.625 = 60\%$ .

<sup>102</sup> The reader is directed to section 4.4.9.3 of the 2010 update of the auto fuel cell cost analysis for a more detailed discussion. “Mass Production Cost Estimation for Direct H<sub>2</sub> PEM Fuel Cell Systems for Automotive Applications: 2010 Update,” Brian D. James, Jeffrey A. Kalinoski & Kevin N. Baum, Directed Technologies, Inc., 30 September 2010.

In switching to a discretized operation of robotic stacking at low volume, the capital cost reduces to \$800k with an 88.5% utilization of equipment at 1,000 systems per year. This change affects the cutting/slitting cost at (low volume) which is unnecessary since the MEAs are already in discrete cells. The manufacturing cross-over point for this process (the point at which the high throughput roll-to-roll process becomes less expensive than robotic stacking) is approximately 2,000 systems per year (25k m<sup>2</sup> MEA area per year), as shown in Figure 135. At such a low cross-over point, a vehicle OEM may be willing to accept the sub-optimal high-cost roll-to-roll process at 1,000 systems per year, confident that cost savings are in the near future.



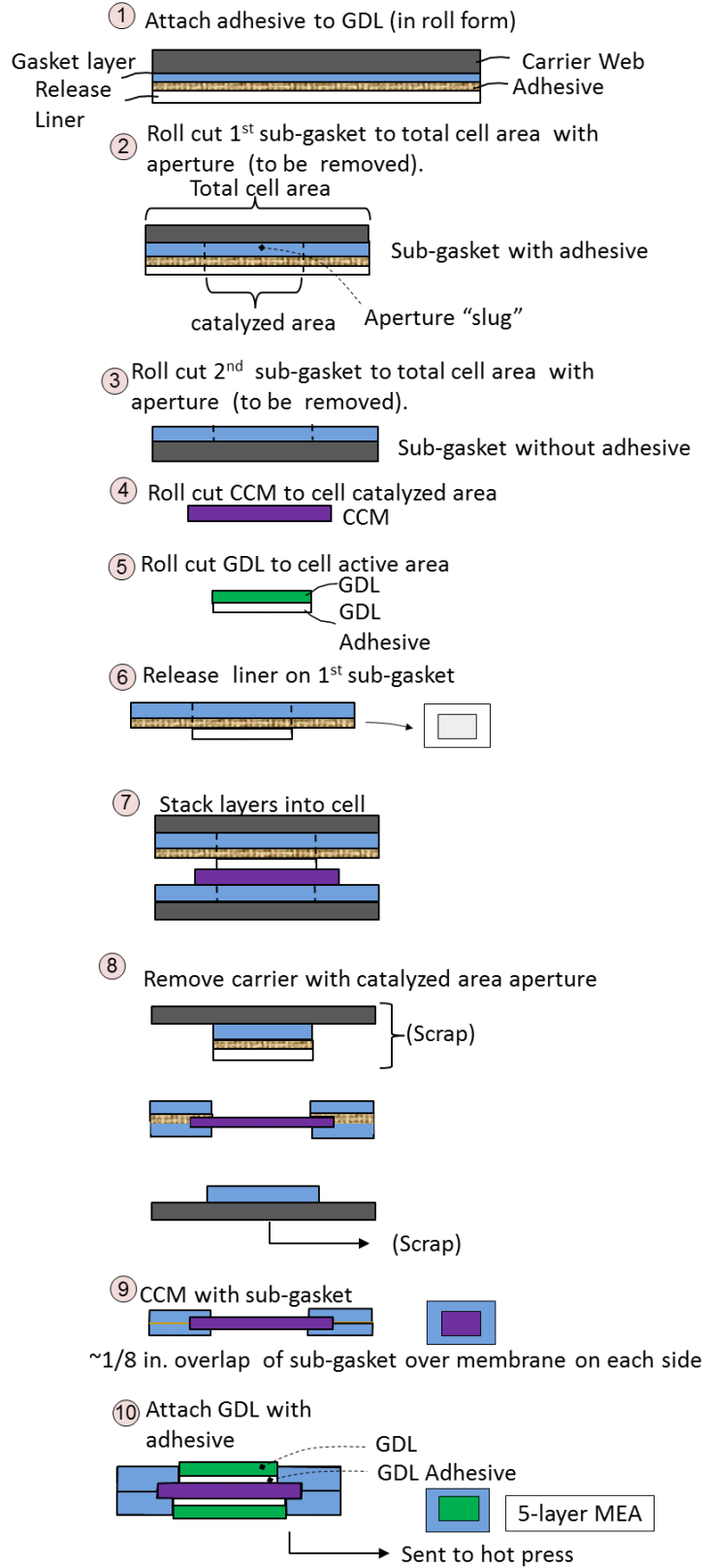


Figure 134. Labeled processing steps for sub-gasket manufacturing at low volumes

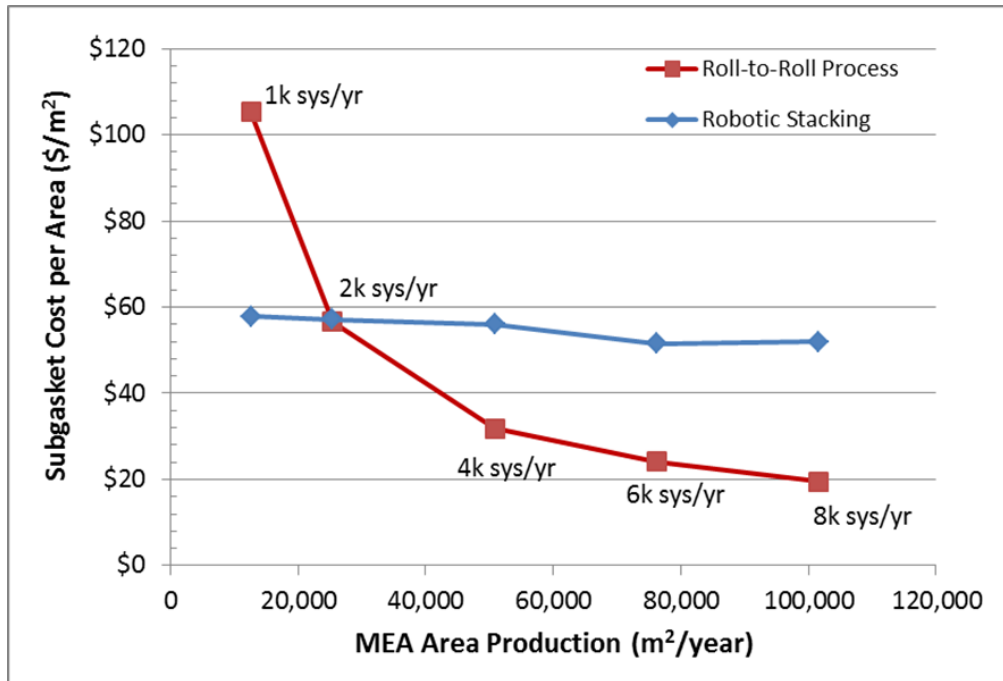


Figure 135. Graph showing cost cross-over for low volume to high volume sub-gasket process

**Quality Control:** An optical detection system (ODS) QC system is used on the sub-gasket process to detect misalignment of sub-gasket and membrane, folds, bends, tears, or scratches in the membrane or sub-gasket material. The sub-gasketed MEA is laid on a conveyor belt during inspection and passed beneath a camera. The capital cost of the QC system is adjusted at each manufacturing rate to account for changes in web width (cell material across width), and whether a conveyor system is required. At low volume (only 1,000 systems per year) the ODS system is assumed to be vertically mounted above the MEA with sub-gasket while being stacked due to the assembly process being discrete, not continuous. Therefore, the conveyor system for the QC of sub-gaskets was removed when there was no need for a continuous process at low volume.

### 9.1.8 Sub-gasket Formation

Details of the MEA sub-gasket formation process appear in Figure 136 and Figure 137 with cost results shown in Figure 138.

Annual Production Rate	1,000	10,000	20,000	50,000	100,000	500,000
Equipment Lifetime (years)	15	13	13	13	13	13
Interest Rate	10%	10%	10%	10%	10%	10%
Corporate Income Tax Rate	40%	40%	40%	40%	40%	40%
Capital Recovery Factor	0.175	0.186	0.186	0.186	0.186	0.186
Equipment Installation Factor	1.4	1.4	1.4	1.4	1.4	1.4
Maintenance/Spare Parts (% of CC)	10%	10%	10%	10%	10%	10%
Miscellaneous Expenses (% of CC)	7%	7%	7%	7%	7%	7%
Power Consumption (kW)	101	101	101	101	101	101

Figure 136. MEA Sub-gasket process parameters

Annual Production Rate	1,000	10,000	20,000	50,000	100,000	500,000
Capital Cost (\$/Line)	\$844,129	\$2,888,600	\$2,888,600	\$2,938,600	\$2,938,600	\$2,938,600
Simultaneous Lines	1	1	1	1	1	2
Laborers per Line	2	5	5	5	5	5
Line Utilization	89.2%	6.7%	13.1%	17.2%	33.5%	78.7%
Effective Total Machine Rate (\$/hr)	\$227.33	\$5,760.92	\$3,077.42	\$2,439.13	\$1,372.70	\$725.89
Line Speed (m/s)	0.3	0.5	0.5	0.5	0.5	0.5
Kapton Tooling Cost (\$/m2)	\$6.47	\$3.56	\$3.40	\$3.30	\$3.27	\$3.24
Subgasket Material Cost (\$/m2)	\$1.67	\$1.67	\$1.67	\$1.67	\$1.67	\$1.67

Figure 137. MEA Sub-gasket machine parameters

Annual Production Rate	1,000	10,000	20,000	50,000	100,000	500,000
Material (\$/stack)	\$38	\$38	\$38	\$38	\$38	\$38
Manufacturing (\$/stack)	\$641	\$122	\$64	\$26	\$15	\$7
Tooling (Kapton Web) (\$/stack)	\$11	\$6	\$5	\$4	\$4	\$4
Total Cost (\$/stack)	\$689	\$165	\$106	\$68	\$56	\$48
Total Cost (\$/kWnet)	\$8.62	\$2.07	\$1.33	\$0.85	\$0.70	\$0.60

Figure 138. Cost breakdown for MEA Sub-gasket

#### 9.1.8.1 Screenprinted Sub-gasket Seal

Details of the screen-printed sub-gasket seal application step appear in Figure 139 and Figure 140 with cost results shown in Figure 141.

Annual Production Rate	1,000	10,000	20,000	50,000	100,000	500,000
Screen Printing Machine Type	DEK Horizon	DEK PV 1200	DEK PV 1200	DEK PV 1200	DEK PV 1200	DEK PV 1200
Equipment Lifetime (years)	15	15	15	15	15	15
Interest Rate	10%	10%	10%	10%	10%	10%
Corporate Income Tax Rate	40%	40%	40%	40%	40%	40%
Capital Recovery Factor	0.175	0.175	0.175	0.175	0.175	0.175
Equipment Installation Factor	1.4	1.4	1.4	1.4	1.4	1.4
Maintenance/Spare Parts (% of CC)	3%	1%	1%	1%	1%	1%
Miscellaneous Expenses (% of CC)	12%	12%	12%	12%	12%	12%
Power Consumption (kW)	61	166	166	166	166	166

Figure 139. Screenprinted Sub-gasket process parameters

Annual Production Rate	1,000	10,000	20,000	50,000	100,000	500,000
Screen Printing Machine Type	DEK Horizon	DEK PV 1200	DEK PV 1200	DEK PV 1200	DEK PV 1200	DEK PV 1200
Capital Cost (\$/Line)	\$392,735	\$1,458,755	\$1,458,755	\$1,458,755	\$1,458,755	\$1,458,755
Simultaneous Lines	1	1	1	2	4	17
Laborers per Line	0.50	0.50	0.50	0.50	0.50	0.50
Line Utilization	30.8%	32.4%	64.8%	81.0%	81.0%	95.3%
Effective Total Machine Rate (\$/hr)	\$175.50	\$533.01	\$284.64	\$234.90	\$234.90	\$205.03
Line Speed (m/s)	1.00	1.00	1.00	1.00	1.00	1.00
Index Time (s)	\$9.62	\$4.00	\$4.00	\$4.00	\$4.00	\$4.00
Resin Cost (\$/kg)	\$40.00	\$40.00	\$40.00	\$40.00	\$40.00	\$40.00

Figure 140. Screenprinted sub-gasket machine parameters

Annual Production Rate	1,000	10,000	20,000	50,000	100,000	500,000
Material (\$/stack)	\$16	\$16	\$16	\$16	\$16	\$16
Manufacturing (\$/stack)	\$171	\$55	\$29	\$24	\$24	\$21
<b>Total Cost (\$/stack)</b>	<b>\$187</b>	<b>\$70</b>	<b>\$45</b>	<b>\$40</b>	<b>\$40</b>	<b>\$37</b>
<b>Total Cost (\$/kWnet)</b>	<b>\$2.33</b>	<b>\$0.88</b>	<b>\$0.56</b>	<b>\$0.50</b>	<b>\$0.50</b>	<b>\$0.46</b>

Figure 141. Cost breakdown for screen-printed sub-gasket

### 9.1.8.2 Total MEA Sub-gasket & Seal Cost

The total cost of the sub-gasket (sub-gasket formation plus screen printed seal) appears in Figure 142.

Annual Production Rate	1,000	10,000	20,000	50,000	100,000	500,000
Material (\$/stack)	\$53	\$53	\$53	\$53	\$53	\$53
Manufacturing (\$/stack)	\$811	\$177	\$93	\$50	\$39	\$28
Tooling (Kapton Web) (\$/stack)	\$11	\$6	\$5	\$4	\$4	\$4
<b>Total Cost (\$/stack)</b>	<b>\$876</b>	<b>\$236</b>	<b>\$151</b>	<b>\$107</b>	<b>\$95</b>	<b>\$85</b>
<b>Total Cost (\$/kWnet)</b>	<b>\$10.95</b>	<b>\$2.94</b>	<b>\$1.89</b>	<b>\$1.34</b>	<b>\$1.19</b>	<b>\$1.06</b>

Figure 142. Cost breakdown for total MEA sub-gasket

### 9.1.9 Hot Pressing CCM and GDLs

Bonding of the three layers of the MEA (the catalyst-coated membrane plus GDL on either side) is desirable for intimate electronic/ionic contact, proper alignment of the parts, and ease of subsequent MEA handling. In switching from an NSTF-based catalyst coating process to a slot die coating process, an alternative method was needed to bond the GDLs to the CCM. Industry feedback<sup>103</sup> confirmed that the procedure of hot pressing the CCM and GDL to bond the parts was incompatible with the NSTF catalyst layer.<sup>104</sup> Consequently, for the 2014 cost analysis (NSTF-based), the layers of the MEA were crimped together periodically along the edges (between the MEA gasketing process and the cutting and slitting process) to sufficiently hold the assembly together. For NSTF, hot pressing is incompatible because there is no ionomer material in the catalyst to melt to the GDL. However, for the 2015 to 2018 baseline systems (catalyst ink based, not NSTF), hot pressing to bond the ionomer in the catalyst ink to the GDL layers was added back into the analysis.

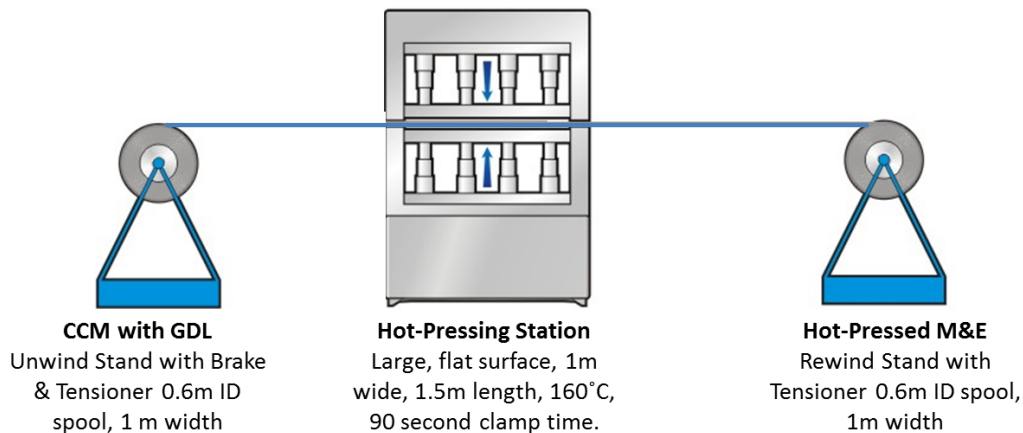
As described in Figure 143, the hot-pressing process starts with the roll that comes off the sub-gasket line; the gasketed catalyzed membrane sandwiched between two GDLs. Each of the two wind stands (wind and unwind) is equipped with a brake and a tensioner. The sandwiched MEA travels through the hot press and then is rewound back into a roll. The press is heated to 160°C, and is indexed with a press time of 90 seconds. It takes 3 seconds to open the press, advance the roll to the next section, and re-

<sup>103</sup> Personal communication with Mark Debe of 3M, November 2011.

<sup>104</sup> Previous cost analysis postulated bonding of the GDL and catalyst coated membrane through a hot pressing procedure since the ionomer within the catalyst ink composition could serve as a bonding agent for the GDL. However, there is no ionomer in the NSTF catalyst layer and thus hot pressing would not be effective for NSTF MEA's.

close the press, making the cycle time 93 seconds. The section advance time could be quicker, but because of the limited tensile strength of the materials, 3 seconds is appropriate. Furthermore, 3 seconds is only 1/30th of the press time, and for an already-inexpensive process, the savings in speeding up the section advance would be minimal. The press is 100 cm wide by 150 cm in length, so approximately 18 to 22 cells get hot-pressed at a time, depending on the cell geometry. The idea of hot pressing the MEA with the sub-gasket is a potential problem. This assumption was not based on what is currently done in practice and has not been demonstrated in industry. However, the PET film melting point is 250°C while the hot pressing is only at 160°C and the press die is portioned to only press the GDL and not the gaskets.

At 1,000 systems per year, the cells are prematurely cut into single cell units, requiring an alternative delivery method to the hot pressing machine. Normally an automated process would only require a worker ¼ of their time, but for the 1,000 system per year production rate, SA assumed a full-time worker that manually inserts the MEA into the press and then visually inspects them afterward for holes, delamination, etc. As is described in the cutting and slitting section, no additional cutting or slitting is required for the MEA at 1k systems per year because the cells are already in final form. The visual inspection of the cell by the worker after the hot pressing is important because it takes the place of the Optical Detection System (ODS) QC inspection after the cutting and slitting process.



**Figure 143. Hot-pressing process diagram for pressing two GDL layers and the CCM.**

### **9.1.9.1 Hot Pressing CCM and GDLs Cost Breakdown**

Machine rate and process parameters are shown in Figure 144 and Figure 145. The overall cost breakdown at various production rates is summarized in Figure 146.

Annual Production Rate	1,000	10,000	20,000	50,000	100,000	500,000
Equipment Lifetime (years)	15	15	15	15	15	15
Interest Rate	10%	10%	10%	10%	10%	10%
Corporate Income Tax Rate	40%	40%	40%	40%	40%	40%
Capital Recovery Factor	0.175	0.175	0.175	0.175	0.175	0.175
Equipment Installation Factor	1	1	1	1	1	1
Maintenance/Spare Parts (% of CC)	5%	5%	5%	5%	5%	5%
Miscellaneous Expenses (% of CC)	7%	7%	7%	7%	7%	7%
Power Consumption (kW)	15	16	16	16	16	16

Figure 144. Hot-pressing process parameters

Annual Production Rate	1,000	10,000	20,000	50,000	100,000	500,000
Capital Cost (\$/Line)	\$56,062	\$126,795	\$126,795	\$126,795	\$126,795	\$126,795
Simultaneous Lines	1	2	3	4	7	32
Laborers per Line	1	1	1	1	1	1
Line Utilization	8%	63%	84%	79%	90%	99%
Effective Total Machine Rate (\$/hr)	\$130.38	\$45.78	\$40.36	\$41.44	\$39.26	\$37.96
Total Cycle Time (seconds)	105	95	95	95	95	95

Figure 145. Machine rate parameters for hot-pressing process

Annual Production Rate	1,000	10,000	20,000	50,000	100,000	500,000
Manufacturing (\$/stack)	\$35	\$18	\$16	\$8	\$8	\$8
Tooling (\$/stack)	\$1	\$0	\$0	\$0	\$0	\$0
Total Cost (\$/stack)	\$35	\$19	\$16	\$8	\$8	\$8
Total Cost (\$/kWnet)	\$0.44	\$0.23	\$0.20	\$0.10	\$0.10	\$0.10

Figure 146. Cost summary for hot-pressing process

### 9.1.10 MEA Cutting, and Slitting

As shown in Figure 147, the rolls of hot-pressed MEA are fed through cutters and slitters to trim to the desired dimensions for insertion into the stack. The 100-cm-wide input roll (width at 500k systems per year) is slit into ribbon streams of the appropriate width (again, depending on cell geometry). The streams continue through to the cutters, which turn the continuous material into individual rectangles. These rectangles are then sorted into magazine racks.

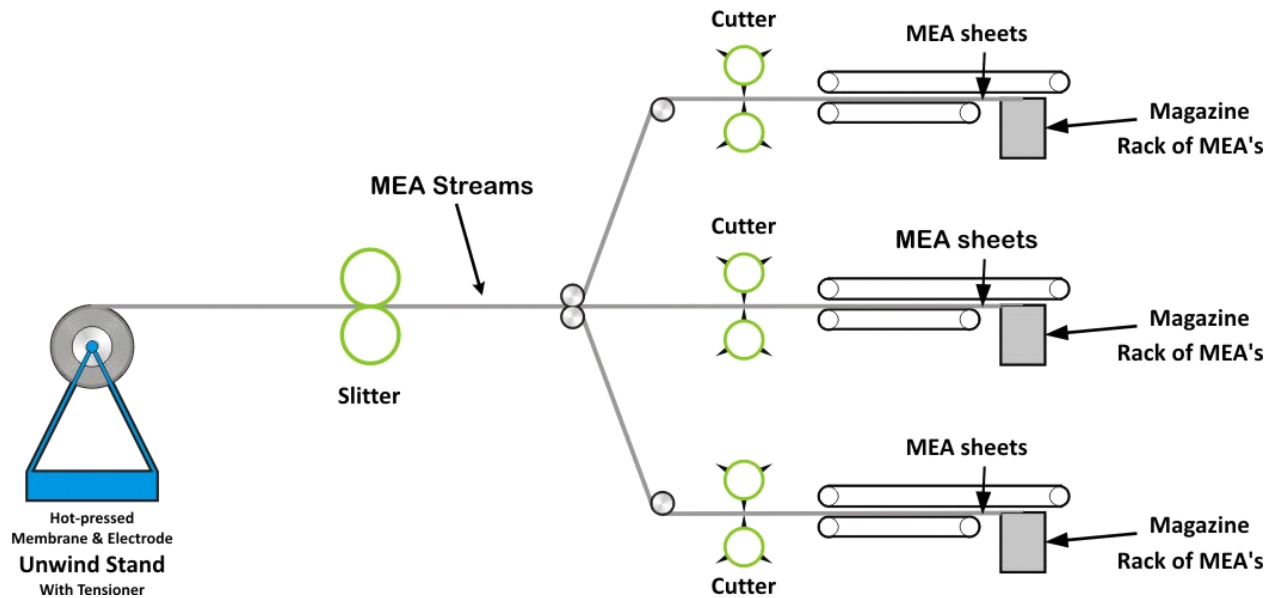


Figure 147. Cutting & slitting process diagram

Figure 148 and Figure 149 further detail the process parameters. This process is not used at all production rates. At 1,000 systems per year, there is no cutting and slitting due to the fact that the cells are already discretized for the sub-gasket process. Figure 150 summarizes the overall cost of the cutting and slitting operation.

Annual Production Rate	1,000	10,000	20,000	50,000	100,000	500,000
Equipment Lifetime (years)	10	14	14	14	14	14
Interest Rate	10%	10%	10%	10%	10%	10%
Corporate Income Tax Rate	40%	40%	40%	40%	40%	40%
Capital Recovery Factor	0.205	0.180	0.180	0.180	0.180	0.180
Equipment Installation Factor	1.4	1.4	1.4	1.4	1.4	1.4
Maintenance/Spare Parts (% of CC)	10%	10%	10%	10%	10%	10%
Miscellaneous Expenses (% of CC)	7%	7%	7%	7%	7%	7%
Power Consumption (kW)	18	18	18	18	18	18

Figure 148. Cutting & Slitting process parameters

Annual Production Rate	1,000	10,000	20,000	50,000	100,000	500,000
Capital Cost (\$/line)	\$270,967	\$399,136	\$399,136	\$449,136	\$449,136	\$449,136
Costs per Tooling Set (\$)	\$5,606	\$5,606	\$5,606	\$5,606	\$5,606	\$5,606
Tooling Lifetime (cycles)	200,000	200,000	200,000	200,000	200,000	200,000
Simultaneous Lines	1	1	1	1	1	1
Laborers per Line	0.5	0.5	0.5	0.5	0.5	0.5
Line Utilization	1.2%	3.8%	7.4%	9.3%	18.5%	92.6%
Effective Total Machine Rate (\$/hr)	\$3,059.68	\$1,348.81	\$698.10	\$631.66	\$328.27	\$85.06
Line Speed (m/s)	1.1	1.2	1.3	1.3	1.3	1.3

Figure 149. Machine rate parameters for Cutting & Slitting process

Annual Production Rate	1,000	10,000	20,000	50,000	100,000	500,000
Manufacturing (\$/stack)	\$117	\$16	\$8	\$4	\$2	\$0
Tooling (\$/stack)	\$15	\$4	\$4	\$3	\$3	\$3
<b>Total Cost (\$/stack)</b>	<b>\$132</b>	<b>\$20</b>	<b>\$12</b>	<b>\$6</b>	<b>\$5</b>	<b>\$3</b>
<b>Total Cost (\$/kWnet)</b>	<b>\$1.66</b>	<b>\$0.25</b>	<b>\$0.15</b>	<b>\$0.08</b>	<b>\$0.06</b>	<b>\$0.04</b>

**Figure 150. Cost breakdown for Cutting & Slitting process**

### 9.1.11 End Plates

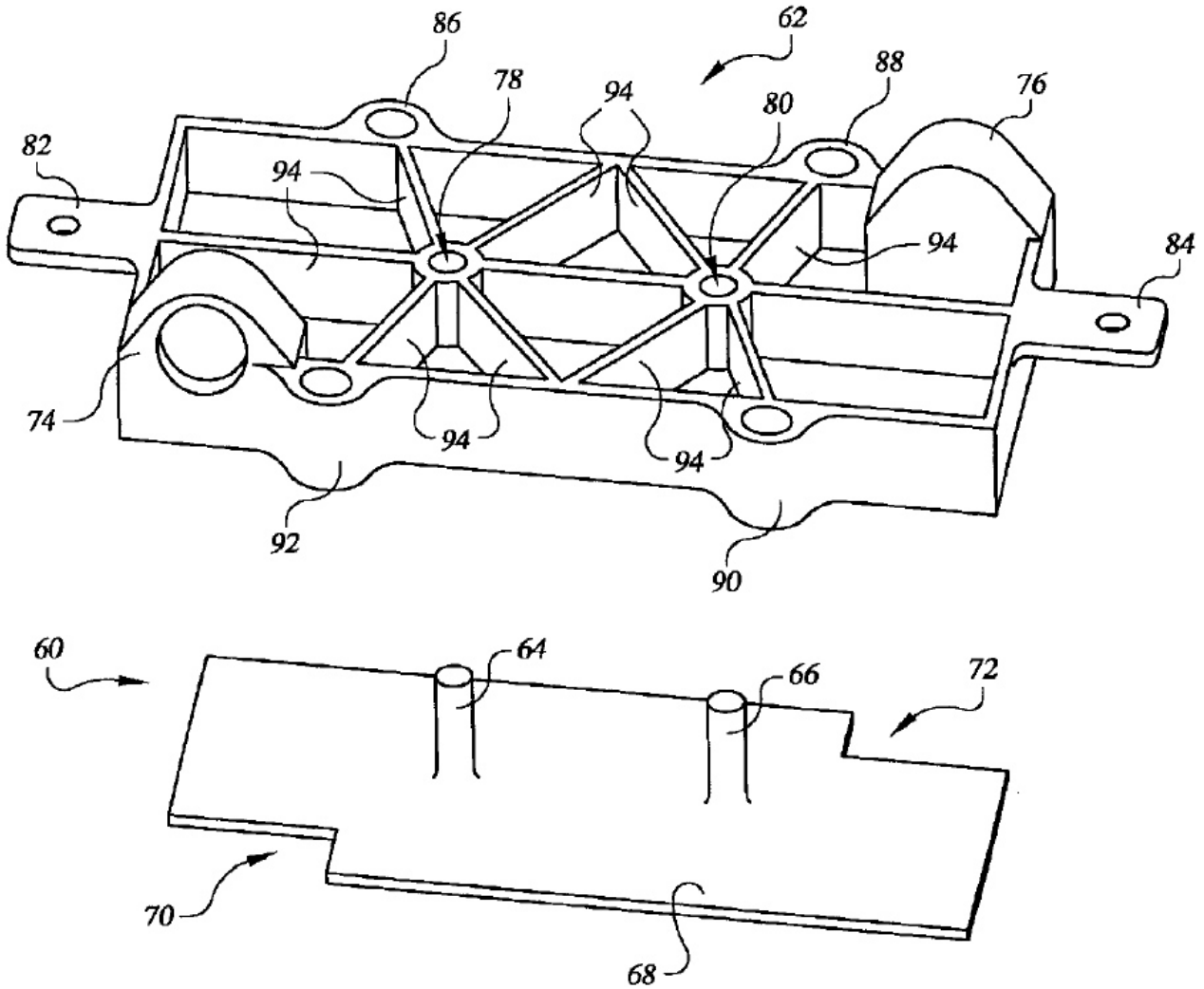
In a typical PEM fuel cell stack, the purposes of an end plate are threefold:

- Evenly distribute compressive loads across the stack
- Cap off and protect the stack
- Interface with the current collector

Typically there is also a separate insulator plate at each end to electrically insulate the stack from the rest of the vehicle. However, the SA end plate design, based on a UTC patent (see Figure 151 ), eliminates the need for separate insulators. Thus, the SA modeled end plates also serve a fourth function: electrical insulation of the ends of the stack.

The end plate is made from a compression-molded composite (LYTEX 9063), is mechanically strong (455 MPa) to withstand the compressive loading, and is sufficiently electrically non-conductive ( $3 \times 10^{14}$  ohm-cm volume resistivity). Use of this material allows for an end plate with lower cost and lower thermal capacity than the typical metal end plates, with the additional benefit of having very low corrosion susceptibility. The benefits of lower cost and corrosion resistance are obvious, and the low thermal capacity limits the thermal energy absorbed during a cold start, effectively accelerating the startup period.





**Figure 151. End plate concept (Figure courtesy of US patent 6,764,786)**

LYTEX 9063 is a high performance engineered structural composite (ESC) molding compound consisting of epoxy and glass fiber reinforcement. It is designed for military and aerospace structural applications requiring excellent mechanical properties, retention of properties at elevated temperatures, good chemical resistance, and excellent electrical properties. For all of these reasons, it is ideally suited for this application.

The end plates are manufactured via compression molding. A summary of the procedure is as follows:<sup>105</sup>

- Remove enough LYTEX from cold storage for one day's usage. Allow it to warm to room temperature.
- Clean mold thoroughly. Apply a uniform thin coating of a mold release. (Note: Once the mold is conditioned for LYTEX, only periodic reapplications are required.)

<sup>105</sup> Based on Quantum Composites recommended procedures for LYTEX molding.

- Adjust mold temperature to 300 °F (148 °C).
- Adjust molding pressure on the material to 1,500 psi (105 kg/cm).
- Remove protective film completely from both sides of the LYTEX.
- Cut mold charge so the LYTEX covers approximately 80% of the mold area and is about 105% of the calculated part weight.
- Dielectrically preheat the LYTEX quickly to 175 °F (80 °C).
- Load material into mold and close the mold.
- Cure for 3 minutes
- Remove part from mold. Because of low shrinkage and high strength, the part may fit snugly in the mold.
- Clean up mold and begin again.
- Re-wrap unused LYTEX and return to cold storage.

In 2015, alternative low production volume techniques were investigated including job shop of non-repeat stack components. End plates were found to be an excellent candidate for job shop due to the low volume of parts and status as a low proprietary level component. Details of the end plate processing parameters are shown in Figure 152 and Figure 153.

<b>Annual Production Rate</b>	<b>1,000</b>	<b>10,000</b>	<b>20,000</b>	<b>50,000</b>	<b>100,000</b>	<b>500,000</b>
<b>Equipment Lifetime (years)</b>	15	15	15	15	15	15
<b>Interest Rate</b>	10%	10%	10%	10%	10%	10%
<b>Corporate Income Tax Rate</b>	40%	40%	40%	40%	40%	40%
<b>Capital Recovery Factor</b>	0.175	0.175	0.175	0.175	0.175	0.175
<b>Equipment Installation Factor</b>	1.4	1.4	1.4	1.4	1.4	1.4
<b>Maintenance/Spare Parts (% of CC)</b>	10%	10%	10%	10%	10%	10%
<b>Miscellaneous Expenses (% of CC)</b>	12%	12%	12%	12%	12%	12%
<b>Power Consumption (kW)</b>	25	25	48	50	50	55

**Figure 152. End plate compression molding process parameters**

As seen in Figure 154, the material represents the majority of the end plate costs, ranging from 86% to 96%, depending on the production rate.

Annual Production Rate	1,000	10,000	20,000	50,000	100,000	500,000
Capital Cost (\$/line)	\$206,949	\$206,949	\$343,897	\$363,461	\$363,461	\$402,589
Costs per Tooling Set (\$)	\$25,802	\$25,802	\$73,942	\$79,602	\$79,602	\$90,438
Tooling Lifetime (cycles)	300,000	300,000	300,000	300,000	300,000	300,000
Simultaneous Lines	1	1	1	1	1	3
Laborers per Line	0.75	0.75	0.75	0.75	0.75	0.75
Cycle Time (s)	310.16	310.16	345.72	350.80	350.80	360.96
Cavities/Platen	2	2	9	10	10	12
Effective Total Machine Rate (\$/hr)	\$1,140.91	\$147.68	\$412.25	\$211.44	\$124.82	\$105.71
LYTEX Cost (\$/kg)	\$32.05	\$26.84	\$25.45	\$23.71	\$22.48	\$19.86
Job Shop or Manufactured	Job Shop	Job Shop	Job Shop	Job Shop	Manufactured	Manufactured
Job Shop Line Utilization (%)	39.6%	62.7%	49.7%	66.0%	58.0%	82.9%
Job Shop Machine Rate (\$/min)	\$2.35	\$1.77	\$2.90	\$2.48	\$2.70	\$2.29
Manufactured Line Utilization (%)	2.6%	25.7%	12.7%	29.0%	58.0%	82.9%
Manufactured Machine Rate (\$/min)	\$19.02	\$2.46	\$6.87	\$3.52	\$2.08	\$1.76
Line Utilization Used (%)	39.6%	62.7%	49.7%	66.0%	58.0%	82.9%
Manufacturing Rate Used (\$/min)	\$2.35	\$1.77	\$2.90	\$2.48	\$2.08	\$1.76

Figure 153. Machine rate parameters for compression molding process

Annual Production Rate	1,000	10,000	20,000	50,000	100,000	500,000
Material (\$/stack)	\$52	\$44	\$42	\$39	\$37	\$32
Manufacturing (\$/stack)	\$12	\$9	\$3	\$3	\$2	\$2
Tooling (\$/stack)	\$2	\$0	\$0	\$0	\$0	\$0
Total Cost (\$/stack)	\$65.58	\$52.70	\$45.35	\$41.62	\$39.12	\$34.22
Total Cost (\$/kWnet)	\$0.82	\$0.66	\$0.57	\$0.52	\$0.49	\$0.43

Figure 154. Cost breakdown for end plates

### 9.1.12 Current Collectors

The function of the current collectors is to channel the electrical current that is distributed across the active area of the stack down to the positive and negative terminals. In the SA modeled design, based on the UTC patent (Figure 151) and shown in Figure 155, two copper current studs protrude through the end plates to connect to a copper sheet in contact with the last bipolar plate.

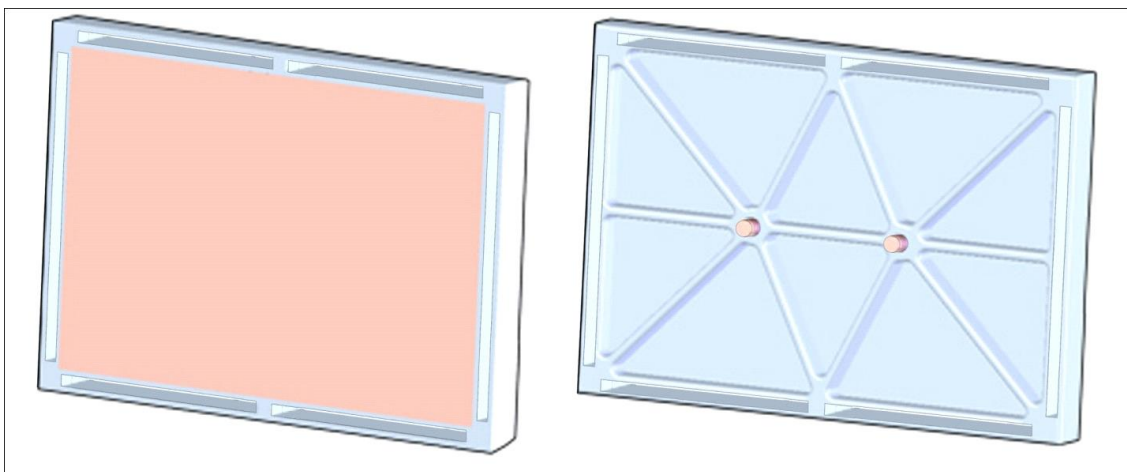


Figure 155. End plate and current collector<sup>106</sup>

<sup>106</sup> Some details of the port connections are not shown in the illustration.

The current collectors were designed to fit snugly within the end plate. A shallow (0.3 mm) cavity in the end plate provides room for the 1 mm thick copper sheet, sized to the active area of the cells. The remaining 0.7 mm of the sheet thickness protrudes from the end plate, and the end plate gasket seals around the edges.

The face of the current collector is pressed against the coolant side of the last bipolar plate in the stack. With the compression of the stack, it makes solid electrical contact with the bipolar plate, and thus can collect the current generated by the stack.

The other side of the current collector is flush against the inner face of the end plate. Two copper studs protrude through their corresponding holes in the end plate, where they are brazed to the current collector sheet. On the outside of the end plate, these studs serve as electrical terminals to which power cables may be attached.

Manufacturing the current collectors is a fairly simple process. A roll of 1 mm thick copper sheeting is stamped to size, and 8 mm diameter copper rod is cut to 2.43 cm lengths. The ends of the rods are then brazed to one face of the sheet. At low production (1,000 systems per year), a manual cutting process is used. All other manufacturing rates use an automated process that cuts parts from a roll of copper sheet stock.

Similar to the end plates, current collector cost estimates are based on job shopping to attain a lower cost. Details of current collector processing parameters are shown in Figure 156 and Figure 157. Cost results are shown in Figure 158.

<b>Annual Production Rate</b>	<b>1,000</b>	<b>10,000</b>	<b>20,000</b>	<b>50,000</b>	<b>100,000</b>	<b>500,000</b>
<b>Equipment Lifetime (years)</b>	10	10	15	15	15	15
<b>Interest Rate</b>	10%	10%	10%	10%	10%	10%
<b>Corporate Income Tax Rate</b>	40%	40%	40%	40%	40%	40%
<b>Capital Recovery Factor</b>	0.205	0.205	0.175	0.175	0.175	0.175
<b>Equipment Installation Factor</b>	1.4	1.4	1.4	1.4	1.4	1.4
<b>Maintenance/Spare Parts (% of CC)</b>	13%	13%	13%	13%	13%	13%
<b>Miscellaneous Expenses (% of CC)</b>	2%	2%	2%	2%	2%	2%
<b>Power Consumption (kW)</b>	16	16	22	22	22	22

**Figure 156. Current collector manufacturing process parameters**

Annual Production Rate	1,000	10,000	20,000	50,000	100,000	500,000
Costs per Tooling Set (\$)	\$1,688	\$1,688	\$1,688	\$1,688	\$1,688	\$1,688
Tooling Lifetime (cycles)	400,000	400,000	400,000	400,000	400,000	400,000
Capital Cost (\$/line)	\$31,848	\$65,779	\$162,193	\$162,193	\$162,193	\$162,193
Simultaneous Lines	1	1	1	1	1	1
Laborers per Line	1.00	1.00	0.50	0.50	0.50	0.50
Line Utilization	0.1%	0.5%	0.3%	0.6%	1.3%	6.2%
Effective Total Machine Rate (\$/hr)	\$7,262.06	\$1,625.50	\$7,536.79	\$3,065.44	\$1,545.01	\$329.76
Index Time (s)	3.00	3.00	0.50	0.50	0.50	0.50
Copper Cost (\$/kg)	\$15.78	\$12.92	\$12.02	\$10.84	\$9.94	\$7.86
Job Shop or Manufactured	Job Shop	Job Shop	Job Shop	Job Shop	Job Shop	Job Shop
Job Shop Line Utilization (%)	37.1%	37.5%	37.3%	37.6%	38.3%	43.2%
Job Shop Machine Rate (\$/min)	\$1.26	\$1.51	\$1.64	\$1.63	\$1.61	\$1.49
Manufactured Line Utilization (%)	0.1%	0.5%	0.3%	0.6%	1.3%	6.2%
Manufactured Machine Rate (\$/min)	\$121.03	\$27.09	\$125.61	\$51.09	\$25.75	\$5.50
Line Utilization Used (%)	37.1%	37.5%	37.3%	37.6%	38.3%	43.2%
Manufacturing Rate Used (\$/min)	\$1.26	\$1.51	\$1.64	\$1.63	\$1.61	\$1.49

Figure 157. Machine rate parameters for current collector manufacturing process

Annual Production Rate	1,000	10,000	20,000	50,000	100,000	500,000
Material (\$/stack)	\$4.64	\$4.11	\$4.07	\$4.01	\$3.97	\$3.88
Manufacturing (\$/stack)	\$0.14	\$0.15	\$0.04	\$0.04	\$0.04	\$0.04
Tooling (\$/stack)	\$0.11	\$0.01	\$0.01	\$0.01	\$0.01	\$0.01
Secondary Operations (\$/stack)	\$0.49	\$0.49	\$0.49	\$0.49	\$0.49	\$0.49
Total Cost (\$/stack)	\$5	\$5	\$5	\$5	\$5	\$4
Total Cost (\$/kWnet)	\$0.07	\$0.06	\$0.06	\$0.06	\$0.06	\$0.06

Figure 158. Cost breakdown for current collector manufacturing process

### 9.1.13 Coolant Gaskets/Laser-welding

Coolant gaskets seal between the facing coolant-flow sides of the bipolar plates, around the perimeter of the flow fields, and thus prevent coolant from leaking into the air or hydrogen manifolds. There is a coolant gasket in every repeat unit, plus an extra at the end of the stack. Thus each stack has hundreds of coolant gaskets.

Three coolant gaskets methods have been previously analyzed:

- insertion molding to apply the coolant gasket
- screen printing of the coolant gasket
- laser welding

Laser welding of the bipolar plate edges (to eliminate the need of a separate coolant gasket) has been selected for every system analyzed since 2008 and is also selected for the 2018 design.

Laser welding is an option that only applies to use with metallic bipolar plates. The idea of welding two plates together to form a seal is a popular approach in the fuel cell industry and is an alternative to

gasketed or adhesive bonding approaches. Conversations with Richard Trillwood of Electron Beam Engineering of Anaheim, California indicate that grade 316L stainless steel is exceptionally well-suited to laser welding. Additionally, the thinness of the plates allows welding from the plate face, which is significantly quicker and thus less expensive than edge welding around the perimeter.

Laser welding provides a number of distinct advantages compared to traditional gasketing methods. The welds are extremely consistent and repeatable, and do not degrade over time as some gaskets do. It also has extremely low power requirements, and very low maintenance and material costs.

**Extent of weld length:** Prior to the 2016 analysis, laser welding was conducted only around the perimeter of the plates and around the manifolds. However, this failed to take into consideration the additional welding required over the active area of the cell to ensure excellent electrical conduction between the plates. Conversations with vendors indicated that this length of welding can vary considerably based on plate design and application: if applied to the entire contact area welding length would dramatically increase. However, based on specific examples from a leading practitioner, welding over the active area is modeled as 2 mm welds every 2 cm with 1 cm lateral spacing. This equates to approximately 5% of the plate-to-plate contact area over the active area and is consistent with feedback from the FCTT. In total (including the perimeter and manifolds), per plate welding length is 1.4m.

**Welding speed:** Peak welding speed can be very fast (>1m/s) but the effective speed varies considerably based on the weld path, need to re-position the welding head or the part, and the necessity of avoiding over-heating of the part (if weld paths are tightly spaced).

Trillwood suggests that the welding speed is limited to a range of 60 to 100 inches per minute, with a maximum of three parts being welded simultaneously. However, according to *Manufacturing Engineering & Technology*,<sup>107</sup> laser welding speeds range from 2.5 m/min to as high as 80 m/min. An average effective welding speed of 7 m/min (0.125m/s) is selected as a conservative middle value and was also recommended by a BPP vendor in 2016.

**Maintenance and Weld Spatter:** Consumables include argon gas, compressed air, and a cold water supply. Maintenance involves lamp replacement every three months, lens cleaning, and general machine repair. The laser welding process produces small droplets of airborne liquid metal (“spatter”) which can accumulate on the weld fixture and necessitate occasional cleaning. Industry has reported this to be an operational concern as it forces line stoppage for cleaning.

**Weld time, Number of welding stations and laser galvanometers:** Conversations with Steve Hatkevitch of American Trim elucidated an engineering pathway to reduced laser welding index time. As currently modeled, welding of a 1.4 m length at 0.125 m/s would take 11.4 seconds. This is considerably slower than the expected BPP stamping rate and would lead to a very high number of welding units to achieve high rate system production. Fortunately, welding can be broken into multiple stations much like progressive stamping where only a portion of the work is conducted at each station and the index time between advancements correspondingly reduced. Additionally, multiple laser work heads, or mirror

---

<sup>107</sup> *Manufacturing Engineering & Technology*, by Kalpakjian & Schmid (5th edition), p. 957.

galvanometers<sup>108</sup> (galvos), can be simultaneously supplied from a single laser source and used to increase the effective welding rate at each workstation. Furthermore, welding of more than one plate at each station allows the considerable clamping and index time to be amortized over the multiple plates, rather than adding directly to effective cycle time. The use of multiple stations, each with multiple galvanometers, has several advantages: 1) it allows more versatile clamping of the plates as the clamping system can cover up portions of the plate that will be welded in another station, 2) multiple galvos<sup>109</sup> allow minimization or elimination of x-y movements of the galvos or of the plates thereby increasing effective welding speed and reducing capital cost (i.e. multiple galvos may allow 100% line of sight coverage of the portions to be welded without repositioning), 3) multiple stations allow flexibility in the welding path to avoid localized plate overheating, and 4) multiple stations/galvos allow a dramatic reduction in the effective index time of the parts.

The combined effect of these changes increases the total plate on-beam welding time from 6 seconds per weldment (prior to 2016) to ~10.87 seconds on-beam per weldment (in 2018). In 2018, at high production rates, the incorporation of multiple work stations (2), multiple welded assemblies per station (4), lasers per welding station (4), and one galvanometer per laser allows a weld duration cycle time of about 5.4 seconds per station (10.87sec over two stations, not counting clamping and translation time between stations). Furthermore, additional 2018 feedback from Lincoln Electric suggested a higher station-to-station index time of 4.5 seconds (moving and clamping/unclamping time) compared to 2.5 seconds used in 2017. Overall, the total index time of parts coming off the line sums to 9.9 sec (5.4sec+4.5sec). This results in an effective per part cycle time of 2.48 seconds (compared to 1.97 seconds in 2017). Additional information and table showing station assumptions at each production rate can be viewed in Section 6.4.

**Equipment Capital Cost:** Based on industry input from Lincoln Electric, the capital cost of the welding process train was updated to reflect additional processing line components. Total system capital cost reflects the summation of the following sub-groups: Laser Welding Machinery, Plate Handling Machinery, and Precitec Laser Welding Monitor. A detailed list of components by production volume is shown in Figure 49 of Section 6.3.

At high production rates, cost of the welding station process line is estimated at \$1.7M. A detailed analysis of equipment and process flow is beyond the scope of this report. However, conversations with laser welding specialists revealed a five laser welding systems for a battery application that cost \$1-1.5M and a more complex (5 station) fuel cell laser welding system that cost ~\$4M. These were one-of-a-kind systems and are expected to have considerable engineering design costs built into their price. In contrast, at moderate fuel cell production rates, multiple welding process lines are required and the

---

<sup>108</sup> Mirror galvanometers are devices that direct a laser beam by a mirror controlled by a galvanometer sensing unit.

<sup>109</sup> Four galvanometers are selected for full plate coverage without the need for movement of the galvanometers or the plate. For the designed plate geometry this would require an effective field of view (FOV) of up to 130mm. While some laser welding system suppliers say this is feasible, others say the effective FOV is limited to 90mm X 90mm. Should the FOV limit be lower than what is assumed, more galvos and capital cost would be incurred.

design costs would presumably not be incurred on the additional units. Consequently, the 2018 estimate of ~\$1.7M is considered reasonable.

Clamping of the BPP to ensure plate contact during welding is identified as a key parameter for welding success. There are many clamping techniques that can be employed that may lead to substantial performance impacts. Lincoln Electric was able to provide a cost of \$60-\$80k for a single part fixture with multiple integrated pressure sensors. These sensors monitor clamp force to ensure sufficient force for good contact, but not too much that might damage the plates. Identification and demonstration of BPP clamping and fixturing systems for high rate production is a recommended area of research.

Quality control of laser welds on BPPs is crucial for proper sealing. In addition to the Precitec laser welding monitor, it is postulated that periodic leak checking would be required on the BPP weldments. Vendors suggest that up to a 9 standard deviation ( $\sigma$ ) level of reproducibility could be enforced for welded BPPs. Cost of a very simple leak check cost was added in 2018 and is modeled as \$150k for capital cost of testing equipment with 7 bipolar plate assemblies (BPAs) tested simultaneously for 10 minutes. At low volume, 100% of the BPAs are tested. Although only 0.5% of the BPAs are tested at high volume, that is still 283 BPAs that are tested per hour. The cost ranges from \$1.92/BPA at low volume to roughly a penny per BPA at high volume.

Even with the above changes, 40 parallel lines of welding process trains are needed to achieve a 500k systems/year production rate. Vendors report that such a high level of parallel lines is inconsistent with achievement of high part-to-part plate uniformity: an as-yet-undefined new high rate welding system is needed.

Figure 159 details key process parameters.

<b>Annual Production Rate</b>	<b>1,000</b>	<b>10,000</b>	<b>20,000</b>	<b>50,000</b>	<b>100,000</b>	<b>500,000</b>
<b>Equipment Lifetime (years)</b>	15	15	15	15	15	15
<b>Interest Rate</b>	10%	10%	10%	10%	10%	10%
<b>Corporate Income Tax Rate</b>	40%	40%	40%	40%	40%	40%
<b>Capital Recovery Factor</b>	0.175	0.175	0.175	0.175	0.175	0.175
<b>Equipment Installation Factor</b>	1.4	1.4	1.4	1.4	1.4	1.4
<b>Maintenance/Spare Parts (% of CC)</b>	10%	10%	10%	10%	10%	10%
<b>Miscellaneous Expenses (% of CC)</b>	12%	12%	12%	12%	12%	12%
<b>Power Consumption (kW)</b>	6	7	7	9	12	12

**Figure 159. Coolant gasket laser welding process parameters**

Figure 160 shows the machine rate parameters, and Figure 161 shows the cost breakdown.



Annual Production Rate	1,000	10,000	20,000	50,000	100,000	500,000
Capital Cost (\$/line)	\$947,066	\$1,238,066	\$772,133	\$1,126,133	\$1,744,133	\$1,744,133
Parts per station	1	2	2	2	4	4
Effective Cycletime per Welded assembly	15.4	7.7	7.7	5.0	2.5	2.5
Simultaneous Lines	1	3	5	8	8	40
Laborers per Line	0.5	1	1	1	1	1
Line Utilization	48%	81%	97%	98%	98%	98%
Effective Total Machine Rate (\$/hr)	\$293.78	\$258.34	\$156.45	\$205.58	\$293.20	\$293.20
Material Cost (\$/kg)	\$0.00	\$0.00	\$0.00	\$0.00	\$0.00	\$0.00

**Figure 160. Machine rate parameters for gasket laser-welding process**

Annual Production Rate	1,000	10,000	20,000	50,000	100,000	500,000
Material (\$/stack)	\$0	\$0	\$0	\$0	\$0	\$0
Manufacturing (\$/stack)	\$449	\$197	\$120	\$102	\$72	\$72
Tooling (\$/stack)	\$2	\$2	\$2	\$2	\$2	\$2
Secondary Operations: Leak Check (\$/stack)	\$687	\$334	\$16	\$7	\$4	\$3
<b>Total Cost (\$/stack)</b>	<b>\$1,138</b>	<b>\$533</b>	<b>\$137</b>	<b>\$111</b>	<b>\$78</b>	<b>\$77</b>
<b>Total Cost (\$/kWnet)</b>	<b>\$14.22</b>	<b>\$6.66</b>	<b>\$1.71</b>	<b>\$1.38</b>	<b>\$0.97</b>	<b>\$0.97</b>

**Figure 161. Cost breakdown for coolant gasket laser welding**

#### 9.1.14 End Gaskets

The end gaskets are very similar to the coolant gaskets but are sandwiched between the last bipolar plate and the end plate, rather than between two bipolar plates. This means that welding is not an option, as the end plates are non-metallic. They also have a slightly different geometry than the coolant gaskets, due to their function as a seal against reactant gasses rather than the coolant. Like the coolant gaskets, they were initially modeled using insertion molding, but were switched to a screen printing approach beginning in 2008. The largest difference between coolant gaskets and end gaskets is simply the quantity needed; with only two end gaskets per stack, there are far fewer end gaskets than coolant gaskets. Screen printing of the end gaskets is selected for the 2018 design.

Conversations with DEK International confirmed initial SA assumptions and various screen printers were examined for their efficacy at five production levels. To screen print a seal onto a bipolar plate, a single plate, or a pallet holding several plates, is first fed into the machine by conveyor. Once in the screen printer, it is locked into place and cameras utilize fiducial markers on either the plate itself or the pallet for appropriate alignment. A precision emulsion screen is placed over the plates, allowing a wiper to apply the sealing resin. After application, the resin must be UV cured to ensure adequate sealing.

Two different scenarios were examined in the screen printing process. In the first, one plate would be printed at a time, reducing costs by halving the need for handling robots to align plates. It would also avoid the necessity of a pallet to align multiple plates in the screen printer. The second scenario requires two handling robots to place four plates onto prefabricated self-aligning grooves in a pallet, ensuring proper alignment in the screen printer. The advantage of this technique is reduced cycle time per plate. However, it would result in increased capital costs due to more expensive screen printers, increased necessity for handling robots and precise mass-manufacture of pallets. Small variations in the grooves of pallets would lead to failure of the screen printer to align properly or apply the resin appropriately.

**Printers:** Three different screen printer models were examined as recommended by representatives from the DEK Corporation. The Horizon 01i machine was suggested for one-plate printing. The Europa VI and the PV-1200 were both evaluated for four plate printing. Comparison of the screen printers can be seen in Figure 162. After cost-analysis, it was determined that, despite the reduced cycle time (12.26 second to 4 seconds), the PV-1200 and Europa VI machines were more expensive, even at higher volumes. The Horizon was cheapest at all production levels.

		Screen Printers (DEK)		
Machine		Horizon	Europa VI	PV-1200
Cycle Time	s	9.63	12.26	4
Cost	\$	\$150,000	\$200,000	\$1,000,000
Power Consumption	kW	3.5	3.5	0.7
Print Area	in <sup>2</sup>	400	841	841

**Figure 162. Screen printer comparison**

**Resin:** The selected resin is a polyolefin elastomer. Formerly in 2016 and earlier, the resin formula was based on information gleaned from Dana Corporation US patent 6,824,874. The patent outlines several resins that would be suitable to provide an effective seal between bipolar plates and resin “A” was selected for its formulaic simplicity. In 2017, Freudenburg recommended (and it was later acknowledged as appropriate by the FCTT) that SA use a polyolefin elastomer with a rough cost of \$40/kg.

**UV Curing:** Following printing, a short conveyor is needed to transfer the printed plate to a UV curing system. Consultation with representatives from UV Fusion Systems Inc. of Gaithersburg, Maryland, along with information from the Dana Corporation resin patent indicated that the VPS 1250 lamp carrying 350 Watt type D and type H+ bulbs<sup>110</sup> would be adequate to cure the resin. If it is only necessary to cure a single plate, then one seven inch type D, and one seven inch type H+ bulb should be used. In order to ensure full UV coverage, for a 24 inch pallet holding four plates, three side-by-side ten inch bulbs of both types would be employed.

Patent research indicates that roughly two seconds of exposure for each type of lamp is sufficient for curing. When using the PV-1200 screen printer the curing time for both lamps matches the cycle time for the screen printer. If using the Horizon printer, the cure time is less than half the cycle time for the printer, yet in both situations, the plates could be indexed to match the screen printer cycle time. A shutter would be built into the lamp to block each bulb for half of the time the plate is within the system to ensure adequate exposure of both light types. Rapidly turning the bulbs on and off is more destructive to the bulb life than continuous operation, making a shutter the preferred method of alternating light sources.

Cost estimation for UV curing system includes the cost of lamps, bulbs, power supply rack, light shield to protect operators, and blowers for both lamp operation and heat reduction.

<sup>110</sup> Type D and Type H+ bulbs refer to the specific light wavelength emitted. Both wavelengths are needed for curing.

**Maintenance:** Communication with DEK has indicated that, if properly cared for, the screen printers have a lifetime of twenty years, but on average are replaced after only eight years due to poor maintenance practices. The modeled lifetime is specified as ten years. Regular maintenance, including machine repair, cleaning, and replacement of screens every 10,000 cycles costs an estimated \$10,000 per year.

**Utilities:** Relatively little power is used by the printers. A belt-drive system that collects and releases parts is the primary power consumer of the screen printers. Additional consumption comes from the alignment system, the wiper blade, and the screen controls. Depending on the specifications of the individual printer, power consumption varies from 0.7 to 3.5 kW. On the other hand, the UV curing system has higher power demand. The total power usage, ranging from 61 to 166 kW, is primarily consumed by the lamps, but also by the exhaust blowers and the modular blowers for the lamps.

**Low Volume Job Shop:** Due to the small number of end gaskets required in a stack (2), the machine utilization can be quite low at 1,000 systems per year. Even when a smaller screen printing unit is used, the cost does not go below \$52/part at 1,000 systems per year (2,000 parts per year). The table in Figure 163 shows how the cost could be significantly reduced if the part was outsourced to a third party vendor or “Job-Shop”. Note that although both the in-house and job-shop costs are labeled as “costs”, the job-shop “cost” contains job-shop markup and thus represents their selling price. Job shopping the end gasket component provides the OEM a cost benefit due to the higher utilization of equipment.

Machine	“Small” Machine (Keywell KY-912GL)	“Production” Machine (DEK Horizon)
<b>Projected In-House (1k sys/yr) Cost, \$/part</b>	\$52.23/part (0.05% util.)	\$76.63 (0.16% util.)
<b>Projected Job-Shop (1k sys/yr) Cost, \$/part</b>	\$0.11/part (37% util.)	\$0.50/part (37% util.)

**Figure 163. Table showing two types of screen printing machines for “In-House” and “Job-Shop” and the associated cost per part of the end gasket with corresponding machine utilization.**

Figure 164 shows the key process parameters, as selected for the end-gasket model. The capital cost includes the cost of the screen printer, plus a UV curing system, plate handling robots, and a conveyor belt. Figure 165 shows the assumed machine rate parameters and Figure 166 the cost breakdown. Being a non-repeat component, the end gasket benefits from lower cost when job shopped, like the end plate and current collector. The machine rate table compares the effective machine rates for in-house manufacture versus job shopping and shows the job shop option to always be less expensive except at 500,000 systems/year.

Annual Production Rate	1,000	10,000	20,000	50,000	100,000	500,000
Equipment Lifetime (years)	15	15	15	15	15	15
Interest Rate	10%	10%	10%	10%	10%	10%
Corporate Income Tax Rate	40%	40%	40%	40%	40%	40%
Capital Recovery Factor	0.175	0.175	0.175	0.175	0.175	0.175
Equipment Installation Factor	1.4	1.4	1.4	1.4	1.4	1.4
Maintenance/Spare Parts (% of CC)	3%	3%	3%	3%	3%	3%
Miscellaneous Expenses (% of CC)	12%	12%	12%	12%	12%	12%
Power Consumption (kW)	61	61	61	61	61	61

Figure 164. End gasket screen printing process parameters

Annual Production Rate	1,000	10,000	20,000	50,000	100,000	500,000
Screen Printing Machine Type	DEK Horizon	DEK Horizon	DEK Horizon	DEK Horizon	DEK Horizon	DEK Horizon
Capital Cost (\$/line)	\$392,735	\$392,735	\$392,735	\$392,735	\$392,735	\$392,735
Gaskets Printed Simultaneously	1	1	1	1	1	1
Runtime per Gasket (s)	9.62	9.62	9.62	9.62	9.62	9.62
Simultaneous Lines	1	1	1	1	1	1
Laborers per Line	0.5	0.5	0.5	0.5	0.5	0.5
Line Utilization	0.2%	1.6%	3.2%	8.1%	16.1%	80.5%
Effective Total Machine Rate (\$/hr)	\$28,195	\$2,856	\$1,443	\$594	\$311	\$84
Material Cost (\$/kg)	\$40.00	\$40.00	\$40.00	\$40.00	\$40.00	\$40.00
Job Shop or Manufactured	Job Shop	Job Shop	Job Shop	Job Shop	Job Shop	Manufactured
Job Shop Line Utilization (%)	37.2%	38.6%	40.2%	45.1%	53.1%	80.5%
Job Shop Machine Rate (\$/min)	\$3.26	\$3.16	\$3.05	\$2.79	\$2.46	\$1.83
Manufactured Line Utilization (%)	0.2%	1.6%	3.2%	8.1%	16.1%	80.5%
Manufactured Machine Rate (\$/min)	\$469.92	\$47.60	\$24.05	\$9.90	\$5.18	\$1.40
Line Utilization Used (%)	37.2%	38.6%	40.2%	45.1%	53.1%	80.5%
Manufacturing Rate Used (\$/min)	\$3.26	\$3.16	\$3.05	\$2.79	\$2.46	\$1.40

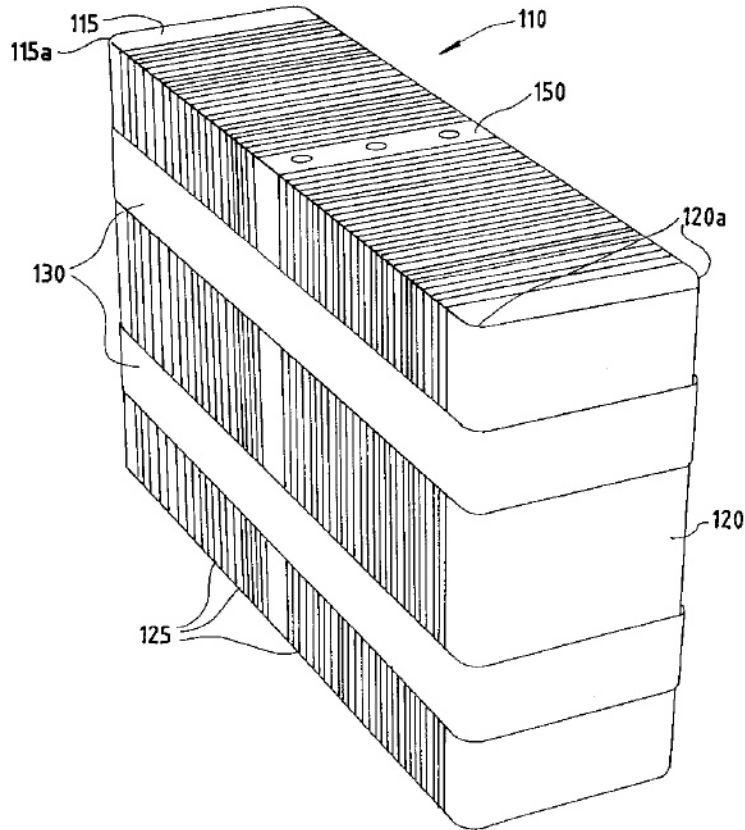
Figure 165. Machine rate parameters for end gasket screen printing process

Annual Production Rate	1,000	10,000	20,000	50,000	100,000	500,000
Material (\$/stack)	\$0.10	\$0.10	\$0.10	\$0.10	\$0.10	\$0.10
Manufacturing (\$/stack)	\$1.00	\$0.96	\$0.93	\$0.85	\$0.75	\$0.43
Tooling (\$/stack)	\$0.00	\$0.00	\$0.00	\$0.00	\$0.00	\$0.00
Total Cost (\$/stack)	\$1.10	\$1.06	\$1.03	\$0.95	\$0.85	\$0.53
Total Cost (\$/kWnet)	\$0.01	\$0.01	\$0.01	\$0.01	\$0.01	\$0.01

Figure 166. Cost breakdown for end gasket screen printing

### 9.1.15 Stack Compression

Traditional PEM fuel cells use tie-rods, nuts, and Belleville washers to supply axial compressive force to ensure fluid sealing and adequate electrical connectivity. However, the use of metallic compression bands is assumed, as used by Ballard Power Systems and described in US Patent 5,993,987 (Figure 167). Two stainless steel bands of 2 cm width are wrapped axially around the stack and tightened to a pre-determined stack compressive loading, and then the ends of the bands are tack welded to each other. The end plates' low conductivity allows them to act as insulators, to prevent shorting of the stack. Custom recesses in the end plates are used to provide a convenient access to the lower surface of the bands to enable welding. The edges of the bipolar plates do not contact the compressive bands as this would electrically short the stack. The costs are reported as part of the stack assembly section, as shown in Figure 171.



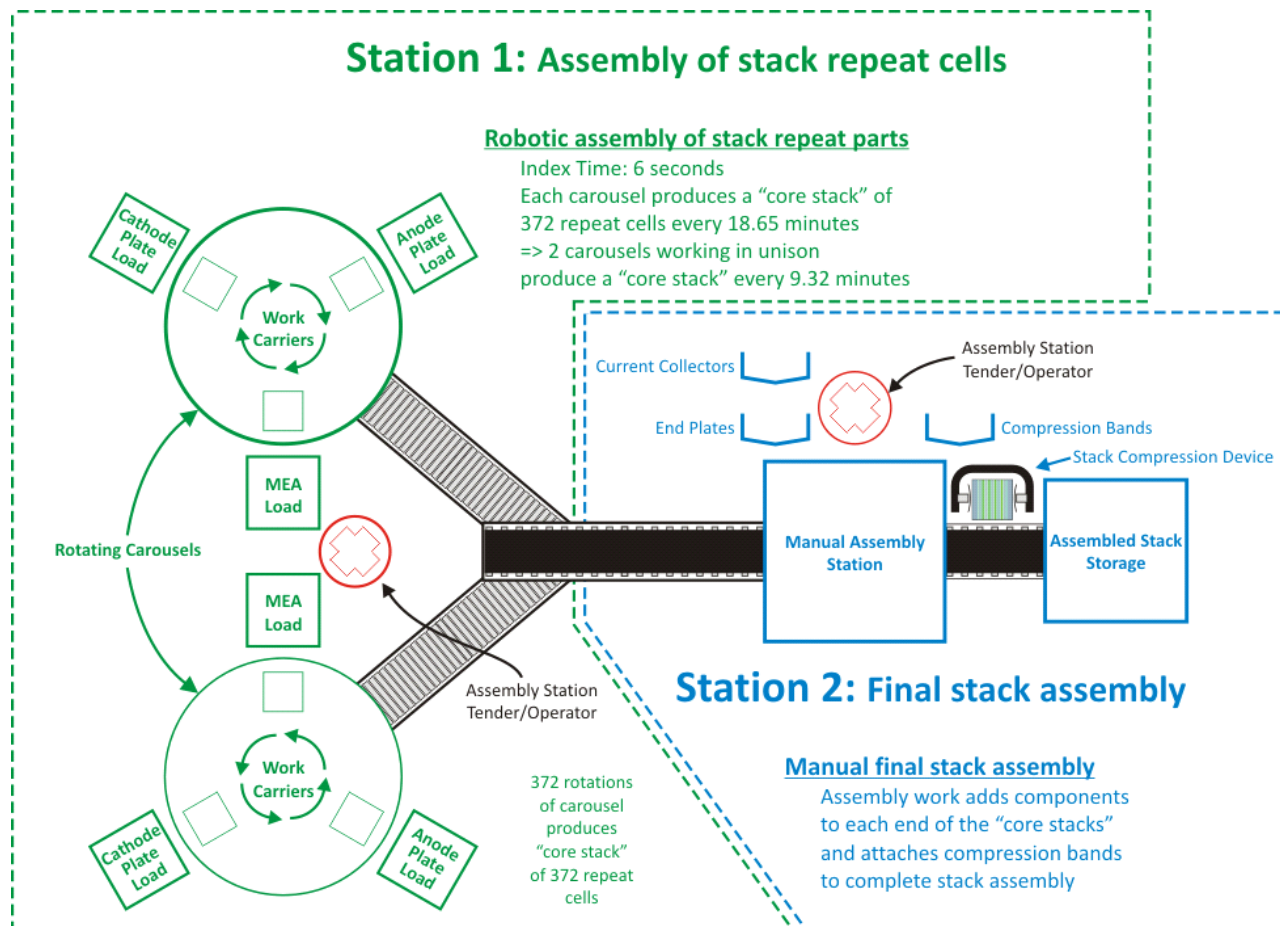
**Figure 167. Stack compression bands concept (Figure courtesy of US patent 5,993,987)**

### 9.1.16 Stack Assembly

Stack assembly costs were based on the amortized workstation costs and the estimated times to perform the required actions. Two methods of stack assembly were analyzed: manual and semi-automated.

At the lowest production rate of 1,000 systems per year, manual assembly was selected. Manual assembly consists of workers using their hands to individually acquire and place each element of the stack: end plate, insulator, current collector, bipolar plate, gasketed MEA, bipolar plate, and so on. An entire stack is assembled at a single workstation. The worker sequentially builds the stack (vertically) and then binds the cells with metallic compression bands. The finished stacks are removed from the workstation by conveyor belt.

At higher production levels, stack assembly is semi-automatic, requiring less time and labor and ensuring superior quality control. This is termed “semi-automatic” because the end components (end plates, current conductors, and initial cells) are assembled manually but the ~380 active cell repeat units are assembled via automated fixture. Figure 168 details the layout of the assembly workstations and Figure 169 and Figure 170 list additional processing parameters.



**Figure 168. Semi-automated stack assembly work flow diagram**

Following assembly, each stack is transported to a leak-check station where the three sets of fluid channels (hydrogen, air, and coolant) are individually pressurized with gas and monitored for leaks. This test is very brief and meant only to verify gas and liquid sealing. Full performance testing of the stack will occur during stack conditioning.

As shown in Figure 171, stack assembly is quite inexpensive, ranging from \$1.00/kW<sub>net</sub> at the most to only \$0.47/kW<sub>net</sub>. The only material costs are those of the compressive metal bands.

Annual Production Rate	1,000	10,000	20,000	50,000	100,000	500,000
Equipment Lifetime (years)	5	15	15	15	15	15
Interest Rate	10%	10%	10%	10%	10%	10%
Corporate Income Tax Rate	40%	40%	40%	40%	40%	40%
Capital Recovery Factor	0.306	0.175	0.175	0.175	0.175	0.175
Equipment Installation Factor	1.4	1.4	1.4	1.4	1.4	1.4
Maintenance/Spare Parts (% of CC)	10%	10%	10%	10%	10%	10%
Miscellaneous Expenses (% of CC)	7%	7%	7%	7%	7%	7%
Power Consumption (kW)	1	7	7	7	7	7

**Figure 169. Stack assembly process parameters**

Annual Production Rate	1,000	10,000	20,000	50,000	100,000	500,000
Assembly Method	Manual	Semi-Auto	Semi-Auto	Semi-Auto	Semi-Auto	Semi-Auto
Capital Cost (\$/line)	\$11,212	\$821,339	\$821,339	\$821,339	\$821,339	\$821,339
Simultaneous Lines	1	2	3	6	11	52
Laborers per Line	1.00	0.50	0.50	0.50	0.50	0.50
Line Utilization	49.1%	51.9%	69.1%	86.4%	94.3%	99.7%
Effective Total Machine Rate (\$/hr)	\$48.96	\$185.67	\$145.22	\$120.85	\$112.72	\$107.85
Index Time (min)	98	21	21	21	21	21

Figure 170. Machine rate parameters for stack assembly process

Annual Production Rate	1,000	10,000	20,000	50,000	100,000	500,000
Compression Bands (\$/stack)	\$9	\$8	\$8	\$6	\$5	\$5
Assembly (\$/stack)	\$75	\$61	\$48	\$40	\$37	\$35
<b>Total Cost (\$/stack)</b>	<b>\$85</b>	<b>\$69</b>	<b>\$55</b>	<b>\$45</b>	<b>\$42</b>	<b>\$40</b>
<b>Total Cost (\$/kWnet)</b>	<b>\$1.06</b>	<b>\$0.87</b>	<b>\$0.69</b>	<b>\$0.57</b>	<b>\$0.53</b>	<b>\$0.50</b>

Figure 171. Cost breakdown for stack assembly

### 9.1.17 Stack Housing

The stack insulation housing is a plastic housing that encases the stack. It is meant primarily for protection from physical damage caused by road debris and liquids, as well as for protection from electrical shorting contacts and a small amount of thermal insulation. It is modeled as vacuum-thermoformed polypropylene. It is 0.5 cm thick, and is separated from the stack by a 1 cm gap. At high production rate, the cycle time is seven seconds: three for insertion, and four for the vacuum thermoforming. Processing parameters are shown in Figure 172 and Figure 173. A cost breakdown of the stack housing production is shown below in Figure 174.

Annual Production Rate	1,000	10,000	20,000	50,000	100,000	500,000
Equipment Lifetime (years)	8	8	8	15	15	15
Interest Rate	10%	10%	10%	10%	10%	10%
Corporate Income Tax Rate	40%	40%	40%	40%	40%	40%
Capital Recovery Factor	0.229	0.229	0.229	0.175	0.175	0.175
Equipment Installation Factor	1.4	1.4	1.4	1.4	1.4	1.4
Maintenance/Spare Parts (% of CC)	5%	5%	5%	5%	5%	5%
Miscellaneous Expenses (% of CC)	6%	6%	6%	6%	6%	6%
Power Consumption (kW)	30	30	30	35	35	40

Figure 172. Stack housing vacuum thermoforming process parameters

Annual Production Rate	1,000	10,000	20,000	50,000	100,000	500,000
Capital Cost (\$/line)	\$50,000	\$50,000	\$50,000	\$250,000	\$250,000	\$655,717
Costs per Tooling Set (\$)	\$96,352	\$96,352	\$96,352	\$96,352	\$96,352	\$96,352
Tooling Lifetime (years)	3	3	3	3	3	3
Cavities per platen	1	1	1	1	1	1
Total Cycle Times (s)	71	71	71	15	15	7
Simultaneous Lines	1	1	1	1	1	1
Laborers per Line	1.00	1.00	1.00	1.00	1.00	0.50
Line Utilization	0.6%	5.9%	11.8%	6.3%	12.6%	28.9%
Effective Total Machine Rate (\$/hr)	\$1,136.85	\$156.88	\$102.44	\$468.25	\$258.32	\$265.09
Material Cost (\$/kg)	\$1.48	\$1.48	\$1.48	\$1.48	\$1.48	\$1.48

Figure 173. Machine rate parameters for stack housing vacuum thermoforming process

Annual Production Rate	1,000	10,000	20,000	50,000	100,000	500,000
Material (\$/stack)	\$4	\$4	\$4	\$4	\$4	\$4
Manufacturing (\$/stack)	\$21	\$3	\$2	\$2	\$1	\$0
Tooling (\$/stack)	\$34	\$3	\$2	\$1	\$0	\$0
<b>Total Cost (\$/stack)</b>	<b>\$59</b>	<b>\$11</b>	<b>\$8</b>	<b>\$7</b>	<b>\$6</b>	<b>\$5</b>
<b>Total Cost (\$/kWnet)</b>	<b>\$0.74</b>	<b>\$0.13</b>	<b>\$0.10</b>	<b>\$0.09</b>	<b>\$0.07</b>	<b>\$0.06</b>

Figure 174. Cost breakdown for stack housing

### 9.1.18 Stack Conditioning and Testing

PEM fuel cell stacks have been observed to perform better in polarization tests if they first undergo “stack conditioning.” Consequently, a series of conditioning steps are modeled based on a regulation scheme discussed in GM Global Technology Operations LLC’s (subsidiary of General Motors (GM)) US patent 9,099,703 B2.<sup>111</sup> The GM patent describes voltage variation (current cycling), a fuel/oxidant stoichiometry, and temperature for conditioning. The conditioning would occur immediately after stack assembly at the factory. Because the conditioning process finishes with a final performance verification, the conditioning process also serves a stack quality control purpose and no further system checkout is required.

Figure 175 details the stack conditioning steps. The GM patent states that while prior-art conditioning times were 1-15 hours, the GM accelerated break-in methodology is able to achieve 70% of the performance benefit in 1.5 hours (with expectation of achieving 100% performance after additional hours). Two hours of conditioning time is selected for cost modeling.

<sup>111</sup> US Patent 9,099,703 B2, Rapaport et. al., “Fast MEA Break-In and Voltage Recovery”, August 4, 2015.



Step	Description	H <sub>2</sub> Stoic.	Air Stoic.	Temp(°C)	Voltage (V)	Current Density (A/cm <sup>2</sup> )
1	Shorting check (prior to voltage cycling)					
2	Room temp voltage cycling: Once voltage stops increasing, move to step 3, otherwise repeat step 2.	1.5	1.1	22	0.1-0.4	0.1-0.2
3	35°C voltage cycling: Once voltage stops increasing, move to step 4, otherwise repeat step 3.	1.5	1.1	35	0.1-0.4	0.2-0.3
4	50°C voltage cycling: Once voltage stops increasing, move to step 5, otherwise repeat step 4.	1.5	1.1	50	0.1-0.4	0.3-0.4
5	65°C voltage cycling: Once voltage stops increasing, move to step 6, otherwise repeat step 5.	1.5	1.1	65	0.1-0.4	0.4-0.5
6	80°C voltage cycling: Once voltage stops increasing, move to step 7, otherwise repeat step 6.	1.5	1.1	80	0.1-0.4	0.5-0.7
7	95°C voltage cycling: Once voltage stops increasing, move to step 8, otherwise repeat step 7.	1.5	1.1	95	0.1-0.4	0.7-0.85
8	Performance verification: If performance level adequate, move to step 9, otherwise, repeat step 7 and 8.					
9	H <sub>2</sub> Take-over test: confirm absence of cross-over leaks after voltage cycling					

**Figure 175. Stack conditioning process based on US patent 9,099,703 B2 (“Fast MEA Break-In and Voltage Recovery”)**

Conditioning cost is based on proprietary capital cost quotation of a programmable load bank to run the stacks up and down the polarization curve according to the power-conditioning regimen. The fuel cells load banks are assumed to condition two stacks simultaneously (between 30k and 100k systems per year production) and eight stacks simultaneously at 500k systems per year. Since the stacks can be staggered in starting time, peak power can be considerably less than 2 or 8 times the individual stack rated power of ~88.2 kW<sub>gross</sub>. It is estimated that simultaneous peak power would be approximately 270 kW at 500,000 fuel cell systems per year. Hydrogen usage is estimated based on 50% fuel cell efficiency and \$3/kg hydrogen. SA’s standard machine rate methodology yields machine rates as low as \$0.28/min for each load bank. Process parameters are shown in Figure 176 and Figure 177. Total costs for stack conditioning are shown in Figure 178. Note that considerable power is generated, and rather than dumping the load to a resistor bank, it may be advantageous to sell the electricity back to the grid. This would require considerable electrical infrastructure and is expected to provide only a relatively small benefit; sale of electricity to the grid is not included in our cost estimates.

For the 2020 system analysis, the same parameters are assumed as the 2017 baseline for conditioning the stack. For 2025, the time for condition was cut in half to represent further optimization and possibly completed conditioning after the first month of operation. Therefore reducing all cost of conditioning by half.

Annual Production Rate	1,000	10,000	20,000	50,000	100,000	500,000
Equipment Lifetime (years)	19	19	19	19	19	19
Interest Rate	10%	10%	10%	10%	10%	10%
Corporate Income Tax Rate	40%	40%	40%	40%	40%	40%
Capital Recovery Factor	0.159	0.159	0.159	0.159	0.159	0.159
Equipment Installation Factor	1.4	1.4	1.4	1.4	1.4	1.4
Maintenance/Spare Parts (% of CC)	10%	10%	10%	10%	10%	10%
Miscellaneous Expenses (% of CC)	7%	7%	7%	7%	7%	7%
Power Consumption (kW)	2	3	3	3	3	9

Figure 176. Stack conditioning process parameters

Annual Production Rate	1,000	10,000	20,000	50,000	100,000	500,000
Capital Cost (\$/line)	<b>Proprietary</b>					
Simultaneous Lines	1	2	4	9	18	22
Laborers per Line	0.4	0.4	0.4	0.4	0.4	0.4
Line Utilization	99.2%	86.8%	86.8%	96.5%	96.5%	98.6%
Effective Total Machine Rate (\$/hr)	\$41.70	\$29.41	\$29.27	\$28.05	\$28.02	\$62.87
Test Duration (hrs)	2	2	2	2	2	2

Figure 177. Machine rate parameters for stack conditioning process

Annual Production Rate	1,000	10,000	20,000	50,000	100,000	500,000
Conditioning/Testing (\$/stack)	\$78	\$28	\$28	\$26	\$26	\$15
Total Cost (\$/stack)	\$78	\$28	\$28	\$26	\$26	\$15
Total Cost (\$/kWnet)	\$0.98	\$0.35	\$0.34	\$0.33	\$0.33	\$0.18

Figure 178. Cost breakdown for stack conditioning

## 9.2 Balance of Plant (BOP)

While the stack is the heart of the fuel cell system, many other components are necessary to create a functioning system. In general, our cost analysis utilizes a DFMA®-style analysis methodology for the stack but a less detailed methodology for the balance of plant (BOP) components. Each of the BOP components is discussed below along with its corresponding cost basis.

### 9.2.1 Air Loop

The air loop of the fuel cell power system consists of five elements:

- Air Compressor, Expander and Motor (CEM) Unit
- Air Mass Flow Sensor

- Air Temperature Sensor
- Air Filter and Housing
- Stack Bypass 3-Way Valve (new for 2018 analysis)
- Stack Shut-Off Valve (2-Way) (new for 2018 analysis)
- Air Ducting
- Air Bleed Orifice (new for 2018 analysis)

These components are described in the subsections below. The cost breakdown is shown below in Figure 179.

Annual Production Rate	1,000	10,000	20,000	50,000	100,000	500,000
Compressor, Expander & Motor (\$/system)	\$1,766	\$1,318	\$996	\$852	\$825	\$801
Mass Flow Sensor (\$/system)	\$20	\$18	\$16	\$12	\$11	\$10
Air Temperature Sensor (\$/system)	\$9	\$8	\$8	\$6	\$5	\$5
Filter and Housing (\$/system)	\$53	\$53	\$53	\$53	\$53	\$53
Stack Bypass 3-Way Valve (\$/system)	\$50	\$38	\$37	\$35	\$34	\$24
Stack Shut-Off Valve (2-Way)(\$/system)	\$63	\$44	\$42	\$39	\$38	\$27
Air Ducting (\$/system)	\$127	\$124	\$122	\$116	\$111	\$105
Air Bleed Orifice (\$/system)	\$9	\$9	\$9	\$9	\$9	\$9
<b>Total Cost (\$/system)</b>	<b>\$2,097</b>	<b>\$1,612</b>	<b>\$1,282</b>	<b>\$1,122</b>	<b>\$1,086</b>	<b>\$1,033</b>
<b>Total Cost (\$/kWnet)</b>	<b>\$26.22</b>	<b>\$20.15</b>	<b>\$16.03</b>	<b>\$14.03</b>	<b>\$13.58</b>	<b>\$12.91</b>

Figure 179. Cost breakdown for air loop

### 9.2.1.1 Compressor-Expander-Motor Unit & Motor Controller

The air compression system is envisioned as an integrated air compressor, exhaust gas expander, and permanent magnet motor. An electronic CEM controller is also included in the system. For the 2018 system analysis, the CEM is based on a Honeywell design for a high rpm, centrifugal compressor, radial inflow expander integrated unit.

In the 2008 and prior year system cost analyses, the fuel cell CEM unit was based on a multi-lobe compressor and expander from Opcon Autorotor of Sweden with cost based on a simplified DFMA<sup>®</sup> analysis in which the system was broken into seven cost elements: wheels/lobes, motor, controller, case, bearings, variable geometry, and assembly/test.

For the 2009 analysis, an all-new, extremely detailed CEM cost estimate was conducted in collaboration with Honeywell. It is a bottom-up cost analysis based directly on the blueprints from an existing Honeywell design, which pairs a centrifugal compressor and a radial-inflow expander, with a permanent-magnet motor running on air bearings at 100,000 rpm. After analyzing the base design, engineers from both SA and Honeywell simplified and improved the design to increase its performance and lower cost, to better reflect a mass-production design. Ultimately, six different configurations were examined; three main configurations, plus a version of each without an expander.

The six different configurations examined are listed in Figure 180. “Design #1” is based on an existing Honeywell design, which runs at 100,000 rpm. Design #2 is an optimized version of Design #1 running at 165,000 rpm, in order to reduce its size. Design #3 is a further-optimized future system, based on Design

#2 but with slightly more aggressive design assumptions. Designs #4, 5, and 6 are identical to Designs #1, 2, and 3 respectively, but with the expander removed.

	<b>Baseline: 100k rpm</b>	<b>Current: 165k rpm</b>	<b>Future: 165k rpm</b>
<b>With Expander</b>	Design 1	Design 2 (2018 and 2020 cost estimate)	Design 3 (2025 cost estimate)
<b>Without Expander</b>	Design 4	Design 5	Design 6

**Figure 180. Matrix of CEM design configurations**

The cost estimate utilizes a combination of DFMA<sup>®</sup> methodology and price quotes from established Honeywell vendors. Excluding repeat parts, the existing Honeywell turbocompressor design (Design #1) has 104 different components and assemblies. Each of these components is categorized into one of three different tiers. “Tier 1” consists of the 26 largest/most-significant components in need of the most careful cost analysis. “Tier 2” corresponds to the 42 mid-level components for which a vendor quote is sufficient. The “Tier 3” components are the minor components such as screws and adhesives that are insignificant enough that educated guesses are sufficient in lieu of vendor quotes. Honeywell engineers solicited price quotes from their existing supplier base for components in the top two tiers, as well as for some of the components in Tier 3, and supplied these values to SA for review and analysis.

In some cases, the high-volume quotes were judged to be inappropriate, as they were merely based on repeated use of low-production-rate manufacturing methods rather than low-cost, high-manufacturing-rate production and assembly methods. Consequently, these quotes were replaced with cost estimates based on a mix of DFMA<sup>®</sup> techniques and our best judgment.

After having completed the initial cost summation for Design #1, the unit costs seemed prohibitively high. Consequently, Honeywell engineers reviewed their design and created a list of potential improvements. SA augmented the list with some DFMA<sup>®</sup>-based suggestions, the list was vetted by both parties, and the design changes incorporated into the cost model. Changes deemed reasonable to describe as “current technology” were applied to Design #2, and the more aggressive improvements were used to define Design #3. The most important of these improvements is the switch from 100,000 to 165,000 rpm, which facilitates a reduction in the size of the CEM by roughly 35%, thereby saving greatly on material (and to a lesser extent, manufacturing) costs, while also providing the intrinsic benefits of reduced size. These improvements are listed in Figure 181, showing that Design #2 is used for the 2018 cost estimate.

Each of the six CEM designs were analyzed across the range of five production rates (1,000 to 500,000 systems per year): this yields 30 different cost estimates for each of the 100+ components. Summed together, they provide 30 different estimates for the CEM cost. The five Design #2 estimates provide the compressor costs across the range of production rates.

For the 2010 update, the CEM cost model was fully integrated into the fuel cell system cost model, and adjusted to scale dynamically based on the pressure and power requirements of the system. This was achieved via a complex system of multipliers that are applied differently for almost every different component since there are a wide variety of combinations and permutations for costing methods across the range of components, and not everything scales at the same rate. For example, as the pressure ratio increases and the CEM increases in size, the diameter of the turbine wheel increases, and its volume increases at a rate proportional to the square of its diameter. The diameter of the compressor wheel scales at a different rate than that of the turbine (expander) wheel, and the shaft length and motor mass each scale at yet another rate. The geometric scaling factors were derived from data that Honeywell provided showing dimensions of key components across a range of performance parameters such as pressure ratio, mass flow rate, and shaft power.

Design #	2018 and 2020 Cost Estimate		2025 Cost Estimate			
	1	2	3	4	5	6
	With Expander			Without Expander		
	Baseline (100k rpm)	Current (165k rpm)	Future (165k rpm)	Baseline (100k rpm)	Current (165k rpm)	Future (165k rpm)
Removed Turbine (Expander)				X	X	X
Increased speed from 100,000 to 165,000 rpm		X	X		X	X
Improved turbine wheel design		X	X		X	X
Improved variable nozzle technology		X	X		X	X
Lower cost electrical connectors		X	X		X	X
Design change to integrate housing into single casting			X			X
Integrate/eliminate mounting bosses on main housing			X			X
Compressor housing design change to re-route cooling air over motor			X			X
Improved foil bearing design			X			X
Back-to-back compressor wheel			X			X
Removed washers/face bolts			X			X
Improved bearing installation/design			X			X
Improved labyrinth seal			X			X
Changed fasteners to more common, inexpensive design			X			X
Changed threaded inserts to more common, inexpensive design			X			X
Reduced testing of machine/cast parts			X			X
Aluminum turbine wheel			X			X

Figure 181. List of Improvements for the 6 compressor configurations

The materials cost of each component increases proportionately with the volume of material needed, and the manufacturing costs scale separately, at rates dependent on the manufacturing processes involved and the specifics of each process.

For components whose cost estimates are derived partially or completely from price quotes rather than full DFMA<sup>®</sup> analysis (such as those in Tier 2 and Tier 3), assumptions were made about the fractional split

between the component's material and manufacturing costs, so that each fraction can be scaled independently.

With this new scaling and integration into the main fuel cell system cost model, the size and cost of the CEM now scale dynamically based on the performance requirements of the system. If a new electrical component is added to the BOP that increases the parasitic load (and thus increases the gross power required) the CEM will automatically scale to accommodate the change in power.

The SA/Honeywell CEM analysis also examined the motor controller, for which the same design was deemed applicable to control all six compressor designs. Unlike with the custom parts involved in the compressor, the motor controller uses almost exclusively off-the-shelf parts that are already manufactured at high volume. As such, there is limited value in conducting a detailed DFMA<sup>®</sup> analysis, so the cost analysis is primarily based on vendor quotation. The original Honeywell controller design was a standalone unit with its own air or water cooling. However, in order to cut costs, it is now assumed that the CEM controller is integrated into the water-cooled electronics housing for the overall fuel cell system controller. Thirty percent of the controller base cost is assumed to correspond to logic functions, with the remaining 70% corresponding to power management. Accordingly, to scale the controller cost for different input powers (as is necessary when varying stack operating parameters to determine the lowest possible system cost), the 30% of the baseline controller cost (i.e. the portion for logic circuitry) is held at a constant cost, the remaining 70% of baseline cost (i.e. the portion for power management) is assumed to scale linearly with input power.

Since the detailed DFMA<sup>®</sup> analysis was conducted in 2009/2010, SA decided to update the CEM model with input from Honeywell. In 2018, SA consulted with Honeywell to determine if design changes were needed to represent current year (2018) technology: no changes from the SA 2009 design were noted. However, it was noted that the cost estimates had not changed since 2009 and were considered low. Consequently, SA incorporated an inflation multiplier of 1.147 to inflate the CEM and motor controller cost from 2009 to 2018. This increased the CEM/controller cost by \$1.32/kW<sub>net</sub> in 2018. The projected cost for the 2020 and 2025 CEM and motor controllers were similarly inflated. Additionally, another inflation multiplier (0.9398) was applied to the CEM cost to align with the 2018 change in reported costs into 2016\$. The overall increase in CEM/controller cost is about \$0.73/kW<sub>net</sub>.

The CEM and motor controller costs for the various configurations are shown below in Figure 182 for the various 2018 system CEM options. Design #2 is selected for the 2018 cost analysis. Note that the costs at 10k and 30k systems per year are reported as identical values. This is a slight inaccuracy based on not scaling the 10k/year cost estimates.

The same design as the 2018 current system is used for the 2020 year case, Design #2. The 2025 system, however, assumes a more advanced Future Design #3 system. The cost difference is quite small between Design #2 and Design #3 (\$46/system).

Design	Sys/yr	2018 CEM				2018 Motor Controller				2018 Total
		Cost	Assy	Markup	Inflation	Cost	Assy	Markup	Inflation	Cost
Design #1 Baseline Tech. 100,000 RPM	1,000	\$1,235.74	\$21.61	15%	1.147	\$462.75	\$7.20	10%	1.147	\$2,251.77
	10,000	\$548.09	\$10.81			\$384.88	\$3.60			\$1,227.53
	20,000	\$548.09	\$10.81			\$384.88	\$3.60			\$1,227.53
	50,000	\$428.82	\$10.81			\$372.23	\$3.60			\$1,054.23
	100,000	\$421.86	\$10.81			\$355.59	\$3.60			\$1,024.05
	500,000	\$411.20	\$10.81			\$343.33	\$3.60			\$994.52
Design #2 Current Tech. 165,000 RPM	1,000	\$867.42	\$21.61	15%	1.147	\$462.75	\$7.20	10%	1.147	\$1,765.87
	10,000	\$372.29	\$10.81			\$384.88	\$3.60			\$995.61
	20,000	\$372.29	\$10.81			\$384.88	\$3.60			\$995.61
	50,000	\$275.64	\$10.81			\$372.23	\$3.60			\$852.15
	100,000	\$271.14	\$10.81			\$355.59	\$3.60			\$825.22
	500,000	\$264.58	\$10.81			\$343.33	\$3.60			\$801.09
Design #3 Future Tech. 165,000 RPM	1,000	\$736.48	\$21.61	15%	1.147	\$462.75	\$7.20	10%	1.147	\$1,593.13
	10,000	\$324.94	\$10.81			\$384.88	\$3.60			\$933.15
	20,000	\$324.94	\$10.81			\$384.88	\$3.60			\$933.15
	50,000	\$235.73	\$10.81			\$372.23	\$3.60			\$799.50
	100,000	\$231.83	\$10.81			\$355.59	\$3.60			\$773.35
	500,000	\$226.10	\$10.81			\$343.33	\$3.60			\$750.33
Design #4 Baseline Tech. 100,000 RPM No Expander	1,000	\$895.90	\$21.61	15%	1.147	\$462.75	\$7.20	10%	1.147	\$1,803.44
	10,000	\$364.83	\$10.81			\$384.88	\$3.60			\$985.76
	20,000	\$364.83	\$10.81			\$384.88	\$3.60			\$985.76
	50,000	\$256.20	\$10.81			\$372.23	\$3.60			\$826.50
	100,000	\$252.59	\$10.81			\$355.59	\$3.60			\$800.74
	500,000	\$247.58	\$10.81			\$343.33	\$3.60			\$778.66
Design #5 Current Tech. 165,000 RPM No Expander	1,000	\$714.76	\$21.61	15%	1.147	\$462.75	\$7.20	10%	1.147	\$1,564.48
	10,000	\$271.19	\$10.81			\$384.88	\$3.60			\$862.23
	20,000	\$271.19	\$10.81			\$384.88	\$3.60			\$862.23
	50,000	\$180.34	\$10.81			\$372.23	\$3.60			\$726.43
	100,000	\$177.77	\$10.81			\$355.59	\$3.60			\$702.04
	500,000	\$173.91	\$10.81			\$343.33	\$3.60			\$681.47
Design #6 Future Tech. 165,000 RPM No Expander	1,000	\$596.69	\$21.61	15%	1.147	\$462.75	\$7.20	10%	1.147	\$1,408.71
	10,000	\$235.33	\$10.81			\$384.88	\$3.60			\$814.93
	20,000	\$235.33	\$10.81			\$384.88	\$3.60			\$814.93
	50,000	\$151.61	\$10.81			\$372.23	\$3.60			\$688.52
	100,000	\$149.55	\$10.81			\$355.59	\$3.60			\$664.81
	500,000	\$146.42	\$10.81			\$343.33	\$3.60			\$645.21

Figure 182. CEM cost results

### 9.2.1.2 Air Mass Flow Sensor

A high-performance (~2% signal error) automotive hot-wire mass flow sensor is used for measuring the air flow rate into the fuel cell system. Since these devices are already produced in very high quantities, little change in cost is expected between high and low production rates.

### 9.2.1.3 Air Filter and Housing

Some fuel cell manufacturers filter inlet air both for particles and for volatile organic compounds (VOCs). However, while particle filters are needed, it is not clear that VOC filters are necessary. Consequently, a standard automotive air particle filter and polymer filter housing are assumed for cost modeling purposes.

### 9.2.1.4 Stack Bypass 3-Way Valve

Inspired by the Toyota Mirai system, a stack bypass valve was added to the baseline system right before the inlet of the cathode. This bypass allows the air compressor mass flow (controlled by rpm) to differ from the stack air mass flow and provides further stack isolation during system shutdown.

### 9.2.1.5 Stack Shut-Off Valve (2-Way)

A stack shut-off valve was incorporated into the system at the cathode exit to prevent backflow of air during system shutdown.

### 9.2.1.6 Air Ducting

The air ducting is modeled as conformal polymer tubes to guide the cathode air in and out of the stack.

### 9.2.1.7 Air Bleed Orifice

A small flow orifice was added to the air line leading from the compressor outlet to the motor inlet. The airflow serves to both float the foil bearings of the compressor/expander and to cool the motor.

## 9.2.2 Humidifier & Water Recovery Loop

The humidifier and water recovery loop consists of four components:

- Air Precooler
- Two Demisters
- Humidifier

Total subsystem cost is shown in Figure 183. Further details of each subsystem component appear below.

Annual Production Rate	1,000	10,000	20,000	50,000	100,000	500,000
Air Precooler (\$/system)	\$38	\$38	\$38	\$38	\$38	\$38
Demister (\$/system)	\$124	\$31	\$24	\$16	\$15	\$12
Membrane Air Humidifier (\$/system)	\$955	\$229	\$148	\$110	\$83	\$58
<b>Total Cost (\$/system)</b>	<b>\$1,116</b>	<b>\$298</b>	<b>\$210</b>	<b>\$164</b>	<b>\$136</b>	<b>\$108</b>
<b>Total Cost (\$/kWnet)</b>	<b>\$13.96</b>	<b>\$3.72</b>	<b>\$2.63</b>	<b>\$2.05</b>	<b>\$1.69</b>	<b>\$1.35</b>

Figure 183. Cost breakdown for humidifier & water recovery loop

### 9.2.2.1 Air Precooler

The air precooler sits between the air compressor and the membrane humidifier, where it cools the hot compressed air to the humidifier's optimal inlet temperature. The design is based on the ANL-supplied key parameters for a compact liquid/air cross-flow intercooler, and the dimensions are scaled based on the specific heat transfer requirements. The unit is 100% aluminum and uses an array of 0.4-mm-thick tubes with 0.08-mm-thick fins spaced at 24 fins per inch, which cool the air with a very minimal pressure drop (0.1 psi). Because the cost impact of the precooler is small, a full DFMA<sup>®</sup> analysis was not conducted. Instead, the mass and volume of the radiator core were determined by heat transfer



calculations conducted at ANL, and the materials cost of the unit was estimated based on detailed geometry assumptions and the cost of aluminum (\$6.82/kg). The materials cost was then simply doubled to account for the cost of manufacturing. As a result of this simplified costing methodology, air precooler cost does not vary with annual production rate. Air precooler cost is detailed in Figure 184.

Annual Production Rate	1,000	10,000	20,000	50,000	100,000	500,000
Material (\$/system)	\$19	\$19	\$19	\$19	\$19	\$19
Manufacturing (\$/system)	\$19	\$19	\$19	\$19	\$19	\$19
<b>Total Cost (\$/system)</b>	<b>\$38</b>	<b>\$38</b>	<b>\$38</b>	<b>\$38</b>	<b>\$38</b>	<b>\$38</b>
<b>Total Cost (\$/kWnet)</b>	<b>\$0.48</b>	<b>\$0.48</b>	<b>\$0.48</b>	<b>\$0.48</b>	<b>\$0.48</b>	<b>\$0.48</b>

Figure 184. Cost breakdown for air precooler

### 9.2.2.2 Demisters

The demisters remove liquid water droplets from the anode and cathode exhaust streams. The anode exhaust demister was added to the system in 2017 to better align with ANL’s system configuration. At the cathode exhaust, the demister prevents erosion of the turbine blades in the expander. Both the anode and cathode demisters are assumed to be identical for simplicity, designed by SA. The demister housing consists of two threaded, hollow 2-mm-thick polypropylene frustums that unscrew from one another to allow access to the filter inside. The filter is a nylon mesh Millipore product designed for water removal and costing \$5.84 each at high volume (assuming 81 cm<sup>2</sup> per demister). The polypropylene adds only ~15 cents of material cost per part, and at high volume, the injection molding process is only 20 cents per part. Because the housing is so inexpensive, the filter dominates the total demister cost (\$5.88/demister, or \$0.07/kW<sub>net</sub> at 500,000 systems per year).

Figure 185 and Figure 186 show demister processing parameters. Figure 187 details demister cost results. The cost results are shown for total demisters per system (2), therefore the cost per demister should be half of the values in Figure 187.

Annual Production Rate	1,000	10,000	20,000	50,000	100,000	500,000
Equipment Lifetime (years)	15	15	15	15	15	15
Interest Rate	10%	10%	10%	10%	10%	10%
Corporate Income Tax Rate	40%	40%	40%	40%	40%	40%
Capital Recovery Factor	0.175	0.175	0.175	0.175	0.175	0.175
Equipment Installation Factor	1.4	1.4	1.4	1.4	1.4	1.4
Maintenance/Spare Parts (% of CC)	5%	5%	5%	5%	5%	5%
Miscellaneous Expenses (% of CC)	6%	6%	6%	6%	6%	6%
Power Consumption (kW)	21	21	21	21	21	31

Figure 185. Demisters injection molding process parameters

Annual Production Rate	1,000	10,000	20,000	50,000	100,000	500,000
Capital Cost (\$/line)	\$288,522	\$288,522	\$288,522	\$288,522	\$288,522	\$318,221
Costs per Tooling Set (\$)	\$16,193	\$16,193	\$16,193	\$16,193	\$16,193	\$26,305
Tooling Lifetime (cycles)	1,000,000	1,000,000	1,000,000	1,000,000	1,000,000	1,000,000
Cavities per platen	1	1	1	1	1	2
Total Cycle Time (s)	6	6	6	6	6	7
Simultaneous Lines	1	1	1	1	1	1
Laborers per Line	0.50	0.50	0.50	0.50	0.50	0.50
Line Utilization	0.3%	2.2%	4.3%	10.6%	21.2%	56.4%
Effective Total Machine Rate (\$/hr)	\$11,274.47	\$1,446.36	\$756.53	\$333.36	\$190.73	\$107.66
Material Cost (\$/kg)	\$1.33	\$1.33	\$1.33	\$1.33	\$1.33	\$1.33

Figure 186. Machine rate parameters for demisters injection molding process

Annual Production Rate	1,000	10,000	20,000	50,000	100,000	500,000
Material (\$/system)	\$23	\$20	\$18	\$14	\$13	\$11
Manufacturing (\$/system)	\$97	\$10	\$5	\$2	\$1	\$0
Tooling (\$/system)	\$4	\$0	\$0	\$0	\$0	\$0
Total Cost (\$/system)	\$124	\$31	\$24	\$16	\$15	\$12
Total Cost (\$/kWnet)	\$1.55	\$0.38	\$0.30	\$0.21	\$0.18	\$0.15

Figure 187. Cost breakdown for demisters

### 9.2.2.3 Membrane Humidifier

The 2012 and prior year cost analyses were based on a tubular membrane design from Perma Pure LLC (model FC200-780-7PP) as shown in Figure 188.

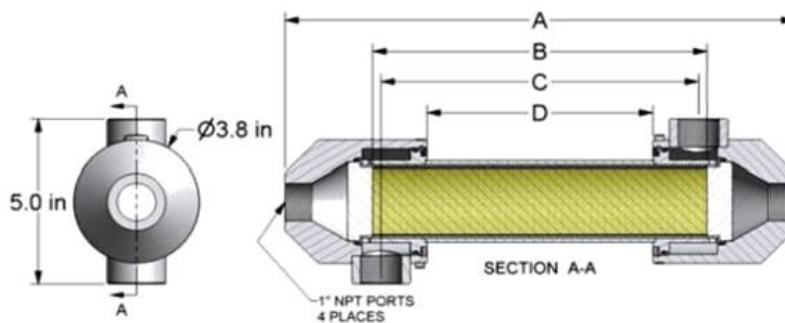


Figure 188. Perma Pure FC200-780-7PP humidifier

In 2013, the plate frame air humidifier was examined as a potentially lower cost and smaller volume alternative to the previously modeled tubular membrane humidifier. Compared to tubular membrane designs, the plate frame membrane humidifiers allow a thinner membrane (5 microns) to be used. Since membrane thickness correlates with required membrane area for a given amount of water transport, plate frame humidifiers are expected to be more compact and lower cost than tubular humidifiers.

The design and projected manufacturing methods for the 2013-2018 plate frame humidifier are based on publicly available information from W.L Gore & Associates, Inc. and dPoint Technologies Inc.<sup>112</sup> Both companies were consulted and provided input during the cost analysis process but information transfer was entirely public domain and non-proprietary. The resulting design is thus a Strategic Analysis Inc. interpretation of the Gore/dPoint Technologies unit and may differ in design and manufacturing process from the actual unit. However, it is expected that the key cost influencing aspects have been adequately captured in the cost analysis.

The modeled Gore plate frame humidifier design is composed of multiple stacked cell pouches made of a 4-layer composite membrane with stainless steel flow fields inside the pouch and stainless steel rib spacers between each pouch in the stack. The total process consists of eight steps:

1. Fabrication of Composite Membranes
2. Fabrication of Stainless Steel Flow Fields and Separators
3. Pouch Formation
4. Stainless Steel Rib Formation
5. Stack Formation
6. Formation of the Housing
7. Assembly of the Composite Membrane and Flow Fields into the Housing
8. System Testing

The cost for the membrane humidifier is estimated to be about \$69 for a 50 cell pouch stack (sized for an 80-kW<sub>e</sub> automotive fuel cell system operating at 1.5 air stoichiometry) including housing, assembly, and testing at 500,000 systems per year. Over 50% of the total cost is attributed to materials, primarily the composite membrane.

2018 cost results are based on a humidifier containing 0.84 m<sup>2</sup> of membrane area (0.675 m<sup>2</sup> x 1.25 oversizing for degradation) based on ANL modeling analysis for membrane water transport at the 2018 fuel cell operating conditions. Much discussion surrounded selection of this membrane area.

Past analysis has sought to reconcile various estimates of required humidifier membrane area. Separately funded experimental testing was conducted at Ford on the Gore/dPoint humidifier and showed very good correlation with ANL modeling predictions.<sup>113</sup> Both experimental and modeling results showed that ~2 m<sup>2</sup> of humidifier membrane area was required for an 80 kW<sub>e</sub> fuel cell system at the 2013 DOE specified operating conditions. However, when ANL applied their performance model at the 2013 SA/ANL specified system operating conditions, the required membrane area dropped to 0.5 m<sup>2</sup>. This significant membrane area reduction was due primarily to higher pressure, lower air flow, and higher temperature conditions included in the model. Additionally, Gore raised a concern that membrane performance degradation was not factored into any of the modeled estimates.

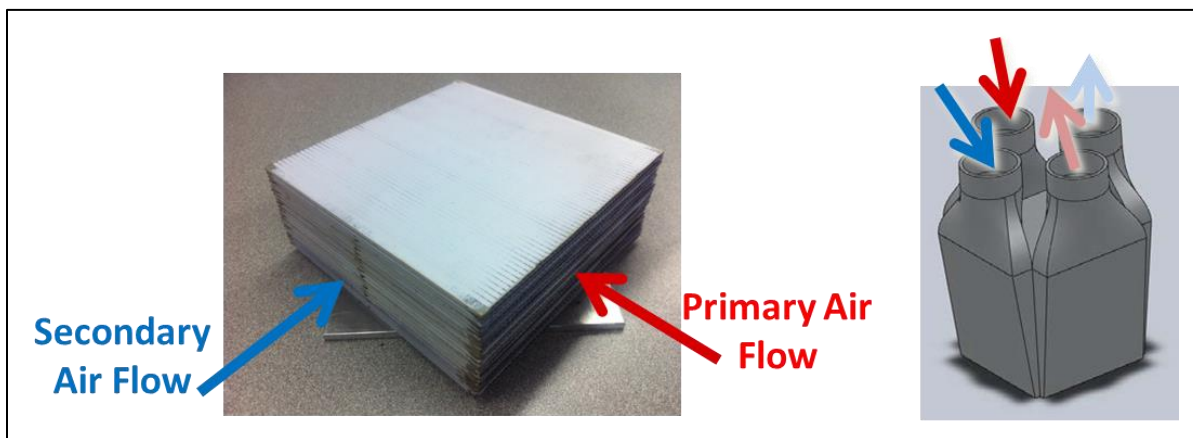
---

<sup>112</sup> Johnson, William B. "Materials and Modules for Low-Cost, High Performance Fuel Cell Humidifiers," W.L. Gore & Associates, Inc., presentation at the 2012 DOE Hydrogen and Fuel Cell Program Annual Merit Review, Washington, DC, 17 May 2012.

<sup>113</sup> Ahluwalia, R., K., Wang, X. , *Fuel Cells Systems Analysis*, Presentation to the Fuel Cell Tech Team, Southfield, MI, 14 August, 2013.

Consequently, in 2013 a value of 1.6 m<sup>2</sup> humidifier membrane area was selected for SA cost modeling to reflect both a deliberate humidifier oversizing (to offset the expected but quantitatively unknown rate of degradation) and a conservative estimate. dPoint was consulted on this area selection and expressed acceptance. Gore continues to prefer the use of 2 m<sup>2</sup> membrane area (or even greater). In 2014, the automotive fuel cell air stoichiometric ratio increased from 1.5 to 2, therefore the amount of membrane area was linearly scaled from 1.6m<sup>2</sup> at air stoic of 1.5 to 2.13 m<sup>2</sup> at air stoic 2. In 2015, the air stoic went back down to 1.5, although SA did not scale with stoic but rather used a calculated membrane area provided by ANL (0.92m<sup>2</sup>). SA added a 1.25 oversizing factor to account for degradation over the life of the humidifier, yielding 1.15m<sup>2</sup> for the 2015 baseline total humidifier area. In 2016, ANL’s optimized operating conditions resulted in a 1.4 air stoich with decreased humidity at the cathode inlet (from 82% RH in 2015 down to 68% RH in 2016). The dispersed binary catalyst experimental testing results have shown improved performance at low RH and due to acid washing of CCM (see Section 9.1.5). The addition of 1.25 oversizing factor is still included for the 2018 baseline (0.675 m<sup>2</sup> x 1.25 = 0.84 m<sup>2</sup>).

For the automotive application, the modeled design is composed of 43 “cell pouches” where each cell pouch is a loop of membrane with a metal spacer within the loop. The dimension of each cell pouch is 10 cm by 10 cm, summing to a total humidifier membrane area of 0.84 m<sup>2</sup>. The cell pouches allow dry primary inlet air to flow through the inside of the pouch and humid secondary outlet oxygen-depleted air from the cathode to flow cross-wise over the outside of the pouch (as seen in Figure 189). Stamped metal “ribs” are used to separate the pouches and thus enable gas flow between the pouches. The cell pouches are arranged in a simple aluminum cast-metal housing to direct the gas flows.



**Figure 189. Images from W.L. Gore & Associates presentation<sup>114</sup> showing (Left) stack of cell pouches with primary flow (dry air) flowing through the cell pouches and secondary flow (wet air) flowing over/under and between pouches and (Right) humidifier housing with four ports: primary and secondary flow inlet and outlet ports.**

<sup>114</sup> Johnson, William B. “Materials and Modules for Low-Cost, High Performance Fuel Cell Humidifiers,” W.L. Gore & Associates, Inc., presentation at the 2012 DOE Hydrogen and Fuel Cell Program Annual Merit Review, Washington, DC, 17 May 2012.

### 9.2.2.3.1

#### 9.2.2.3.2 *Membrane Humidifier Manufacturing Process*

The manufacturing process for the plate frame membrane humidifier is modeled as eight steps:

1. Fabrication of Composite Membranes
2. Fabrication of Etched Stainless Steel Flow Fields
3. Pouch Formation
4. Stainless Steel Rib Formation
5. Stack Formation
6. Formation of the Housing
7. Assembly of the Composite Membrane and Flow Fields into the Housing
8. Humidifier System Testing

Manufacturing details and cost components for each process are described in the following sections.

#### **Fabrication of Composite Humidifier Membranes**

The postulated process for the manufacture of the composite humidifier membrane is based on a slot die coating roll-to-roll system.

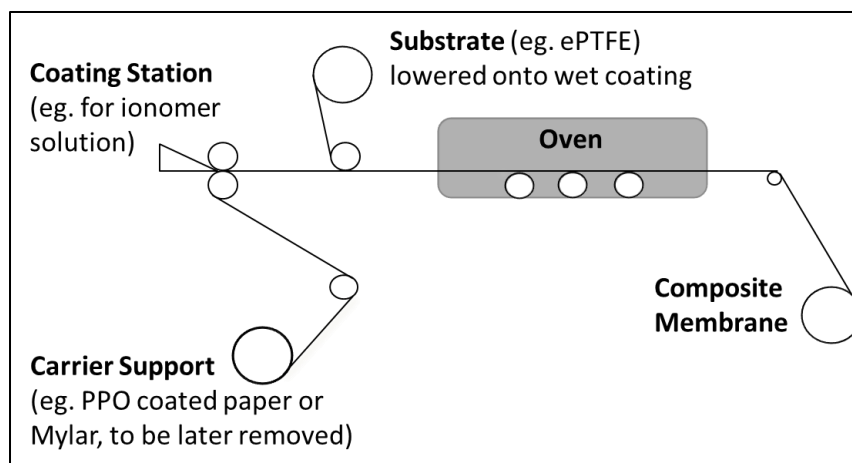
- a. A 10  $\mu\text{m}$  thick ePTFE layer is unrolled onto a Mylar backer.
- b. A 5  $\mu\text{m}$  thick slot die coated layer of Nafion<sup>®</sup> ionomer is laid on top of the ePTFE.
- c. A second layer of 10 $\mu\text{m}$  thick ePTFE is unrolled onto the ionomer layer.
- d. The stacked layers are passed through a continuous curing oven.
- e. In the final step, all three layers are hot laminated to a 180 $\mu\text{m}$  polyethylene terephthalate (PET) non-woven porous layer, also known as a gas diffusion layer (GDL).

The ePTFE layers bracket and mechanically support the very thin, and thus high water flux, ionomer layer and are arranged in a symmetrical orientation to minimize stresses during thermal cycling and thereby enhance lifetime. The much thicker PET layer provides additional mechanical support and abrasion resistance. Figure 190 shows a schematic of the postulated fabrication process inspired by a Ballard patent for composite membrane manufacturing<sup>115</sup> and a Gore patent for integral composite membranes.<sup>116</sup>

---

<sup>115</sup> Ballard Patent: U.S. Patent 6,689,501 B2

<sup>116</sup> Gore Patent: "Integral composite Membrane" U.S. Patent 5,599,614.



**Figure 190. Design for ionomer addition to ePTFE, followed by oven drying to form a composite membrane from combination of Ballard Patent (U.S. Patent 6,689,501 B2) and Gore patent (U.S. Patent 5,599,614).**

Key elements of composite membrane fabrication process include:

- Adding a porous substrate (eg. ePTFE) onto a wet impregnate solution (eg. ionomer) (shown in Figure 190).
- Coating ionomer directly onto a porous substrate (eg. Slot die coating onto the top of the ePTFE) (not shown in Figure 190).
- Adding a second porous substrate (eg. ePTFE) onto the top of a wet solution layer (eg. ionomer) (not shown in Figure 190).

The process is modeled using a 1m web width at a baseline speed of 10m/min (based on DuPont patent).<sup>117</sup> Curing oven residence time is a total of 9 minutes (3 minutes at 40 °C, 3 minutes at 60 °C and 3 minutes at 90 °C), also based on the DuPont patent. The total capital cost of manufacturing equipment for the composite membrane is approximately \$3M with the cost breakdown and cost basis listed in Figure 191.

The membrane production for 1,000 air humidifiers is roughly 700 m<sup>2</sup>. At such a low volume of membrane production, the slot die coating process is heavily underutilized. However, SA postulates that the humidifier manufacturer would most likely have multiple products and customers with similar membrane requirements. Therefore, the cost of membrane per m<sup>2</sup> is based on aggregate process line production rather than on the production of only one product. To model this aggregate production, a 5x multiplier is placed on the membrane fabrication at the 1,000 systems/year level for purposes of computing membrane cost per square meter. This reduces the cost of membrane for the humidifier by approximately \$8/kW<sub>net</sub>.

Figure 192 and Figure 193 show membrane processing parameters. Cost results are shown in Figure 194 and reveal that (at 500,000 systems per year) material cost is the largest cost contributor, with ePTFE cost being the dominating cost element. Consequently, ePTFE cost was carefully assessed and found to

<sup>117</sup> DuPont Patent US 7,648,660 B2

vary substantially from vendor to vendor, partly due to variations in ePTFE precursor materials and processing steps (together referred to as ePTFE “quality”). A discussion of the range of ePTFE costs used within the cost analysis appears in Section 9.1.2.2.

Component	Capital Cost	Basis
<b>Web Casting Operation</b>		
Base slot die coating system	\$800k	Frontier Industrial Technology Inc. quote
Additional Pump Cart	\$25k	Frontier Industrial Technology Inc. quote
ePTFE Unwind stands	2 x \$60k	Machine Works Inc. quote
Customization Adder	2x	Conservatism for custom machinery
<b>Total Web Casting Capital Cost</b>	<b>\$1.9M</b>	
Additional heating zones	\$37k	Modified Wisconsin Ovens quote
Tensioner for laminator	\$60k	Estimated based on similar machinery
Laminator	\$619k	Modified Andritz Kuster quote
Clean Room	\$133k	Industrial ROM estimate
Quality Control Equipment	\$165k	Line Cameras to provide 100micron anomaly resolution after ionomer addition and 350 micron resolution of each ePTFE layer.
<b>Total Capital (uninstalled)</b>	<b>\$2.9M</b>	

Figure 191. Capital cost of manufacturing equipment required for the composite membrane fabrication process at 500k sys/yr.

Annual Production Rate	1,000	10,000	20,000	50,000	100,000	500,000
Equipment Lifetime (years)	15	15	15	15	15	15
Interest Rate	10%	10%	10%	10%	10%	10%
Corporate Income Tax Rate	40%	40%	40%	40%	40%	40%
Capital Recovery Factor	0.175	0.175	0.175	0.175	0.175	0.175
Equipment Installation Factor	1.4	1.4	1.4	1.4	1.4	1.4
Maintenance/Spare Parts (% of CC)	10%	10%	10%	10%	10%	10%
Miscellaneous Expenses (% of CC)	7%	7%	7%	7%	7%	7%
Power Consumption (kW)	278	278	278	294	294	294

Figure 192. Fabrication of composite membranes process parameters

Annual Production Rate	1,000	10,000	20,000	50,000	100,000	500,000
Capital Cost (\$/line)	\$1,226,614	\$1,394,249	\$1,394,249	\$2,902,689	\$2,902,689	\$2,921,189
Simultaneous Lines	1	1	1	1	1	1
Laborers per Line	0.67	0.67	0.67	0.67	0.67	0.67
Line Utilization	0.2%	1.4%	2.6%	3.4%	6.8%	32.7%
Casting Line Rate (m/s)	0.17	0.17	0.17	0.17	0.17	0.17
Effective Total Machine Rate (\$/hr)	\$70,912	\$12,740	\$6,580	\$10,460	\$5,353	\$1,155
Backer Cost (\$/m <sup>2</sup> )	\$0.96	\$0.96	\$0.96	\$0.96	\$0.96	\$0.96

Figure 193. Machine rate parameters for fabrication of composite membranes

Annual Production Rate	1,000	10,000	20,000	50,000	100,000	500,000
Materials (\$/stack)	\$36	\$37	\$33	\$28	\$24	\$18
Manufacturings (\$/stack)	\$100	\$57	\$29	\$23	\$12	\$2
Toolings (\$/stack)	\$0	\$0	\$0	\$0	\$0	\$0
Markups (\$/stack)	\$55	\$33	\$22	\$15	\$10	\$5
<b>Total Costs (\$/stack)</b>	<b>\$191</b>	<b>\$127</b>	<b>\$83</b>	<b>\$66</b>	<b>\$46</b>	<b>\$25</b>
<b>Total Costs (\$/kWnet)</b>	<b>\$2.39</b>	<b>\$1.58</b>	<b>\$1.04</b>	<b>\$0.83</b>	<b>\$0.57</b>	<b>\$0.31</b>

Figure 194. Cost breakdown for fabrication of composite membranes

### Fabrication of Etched Stainless Steel Flow Fields

The humidifier flow field plates serve to separate the sides of the cell pouch and open a channel through which the air may pass. The plates are fabricated by electrochemical etching of 0.6mm stainless steel 316L sheet. Etching is selected as it grants the design flexibility and dimensional tolerance critical to achieving low-pressure drop and high membrane water transport performance. To reduce the cost of the etching process, multiple flow fields are etched from a single large panel of SS. The process includes the following stages:

- **Stage 1 (Add Photoresist):** Photoresist is first laminated to both sides of a 0.6mm (24mils) SS316 metal coil and cut to 1m by 2m panel size (holding 180 parts).
- **Stage 2 (Illuminate with light):** Two SS/photoresist panels are manually loaded into a light chamber, covered with stencils (one stencil on each side of each panel), exposed to light simultaneously on each side of panel for 7.5 minutes to activate the photoresist not covered by the stencil, and then the panels are removed from the light chamber. The photoresist has now been selectively removed from the panel in the exact pattern desired for etching.
- **Stage 3 (Stripping):** Ten panels are loaded into a vertical fixture, simultaneously lowered into a stripping tank of alkaline solution (sodium carbonate), the exposed portions of photoresist are stripped/dissolved by the alkaline solution over a 5 minutes submersion, the panels are then lifted from the tank.
- **Stage 4 (Etching):** The ten panels fixture is moved to an electrochemically etching bath, electrodes are connected to each panel, the panels are simultaneously lowered into the etching tank, an electric current is applied to electrochemically etch the exposed SS surface. The electrochemical etching rate is estimated at 6.7  $\mu\text{m}$  per minute, taking a total of 45 minutes to etch 600 microns (300 microns from each side simultaneously). Perforations are stamped into the material to allow for easy flow field separation using a low force stamping machine. The average power consumption estimated is approximately 1.2kW per 100cm<sup>2</sup> part (2.16MW for 10 panels).
- **Stage 5 (Cleaning):** After the etching is complete, the panels are lowered into a wash tank of alkaline solution (sodium hydroxide) for 4 minutes to remove the remaining photoresist.

Additionally, the etched plates are anodized for corrosion resistance, separated by stamping into 10 cm by 10 cm pouch cell sizes, and packaged into magazines for robotic assembly. Anodizing cost is estimated at 1.6 cents per 50 cm<sup>2</sup> of anodizing surface (\$3 for a 100 cell stack) with the parts being anodized while in panel form before separated. Figure 195 and Figure 196 show flow field processing parameters. Cost results for the etching process are shown in Figure 197.



Annual Production Rate	1,000	10,000	20,000	50,000	100,000	500,000
Equipment Lifetime (years)	15	15	15	15	15	15
Interest Rate	10%	10%	10%	10%	10%	10%
Corporate Income Tax Rate	40%	40%	40%	40%	40%	40%
Capital Recovery Factor	0.175	0.175	0.175	0.175	0.175	0.175
Equipment Installation Factor	1.4	1.4	1.4	1.4	1.4	1.4
Maintenance/Spare Parts (% of CC)	13%	13%	13%	13%	13%	13%
Miscellaneous Expenses (% of CC)	2%	2%	2%	2%	2%	2%
Power Consumption (kW)	2,226	2,226	2,226	2,226	2,226	2,226

Figure 195. Fabrication of etched stainless steel flow fields process parameters

Annual Production Rate	1,000	10,000	20,000	50,000	100,000	500,000
Capital Cost (\$/line)	\$1,018,602	\$1,018,602	\$1,018,602	\$1,018,602	\$1,018,602	\$1,868,602
Stage 1 Simultaneous Lines	1	1	1	1	1	1
Stage 2 Simultaneous Lines	1	1	1	1	1	3
Stage 3 Simultaneous Lines	1	1	1	1	1	1
Stage 4 Simultaneous Lines	1	1	1	1	1	3
Stage 5 Simultaneous Lines	1	1	1	1	1	1
Stage 1 Line Utilization	0.0%	0.1%	0.2%	0.6%	1.2%	5.9%
Stage 2 Line Utilization	0.5%	4.7%	9.5%	23.7%	47.4%	79.0%
Stage 3 Line Utilization	0.1%	0.7%	1.3%	3.3%	6.5%	32.6%
Stage 4 Line Utilization	0.5%	5.5%	10.9%	27.3%	54.5%	90.9%
Stage 5 Line Utilization	0.1%	0.6%	1.2%	3.0%	5.9%	29.6%
Stage 1 Laborers per Line	1	1	1	1	1	1
Stage 2 Laborers per Line	2	2	2	2	2	2
Stage 3 Laborers per Line	1	1	1	1	1	1
Stage 4 Laborers per Line	0	0	0	0	0	0
Stage 5 Laborers per Line	1	1	1	1	1	1
Stage 1 Cycle Time (s)	6	6	6	6	6	6
Stage 2 Cycle Time (s)	480	480	480	480	480	480
Stage 3 Cycle Time (s)	330	330	330	330	330	330
Stage 4 Cycle Time (s)	2,761	2,761	2,761	2,761	2,761	2,761
Stage 5 Cycle Time (s)	300	300	300	300	300	300
Effective Total Machine Rate (\$/hr)	\$20,628.77	\$2,285.36	\$1,261.83	\$647.73	\$443.13	\$313.48
Stainless Steel Cost (\$/kg)	\$3.93	\$3.93	\$3.93	\$3.93	\$3.93	\$3.93

Figure 196. Machine rate parameters for fabrication of etched stainless steel flow fields

Annual Production Rate	1,000	10,000	20,000	50,000	100,000	500,000
Materials (\$/stack)	\$8	\$8	\$8	\$8	\$8	\$8
Manufacturings (\$/stack)	\$382	\$42	\$23	\$12	\$8	\$6
Total Costs (\$/stack)	\$390	\$50	\$31	\$20	\$16	\$13
Total Costs (\$/kWnet)	\$4.87	\$0.62	\$0.39	\$0.24	\$0.20	\$0.17

Figure 197. Cost breakdown for fabrication of etched stainless steel flow fields

### Pouch Formation

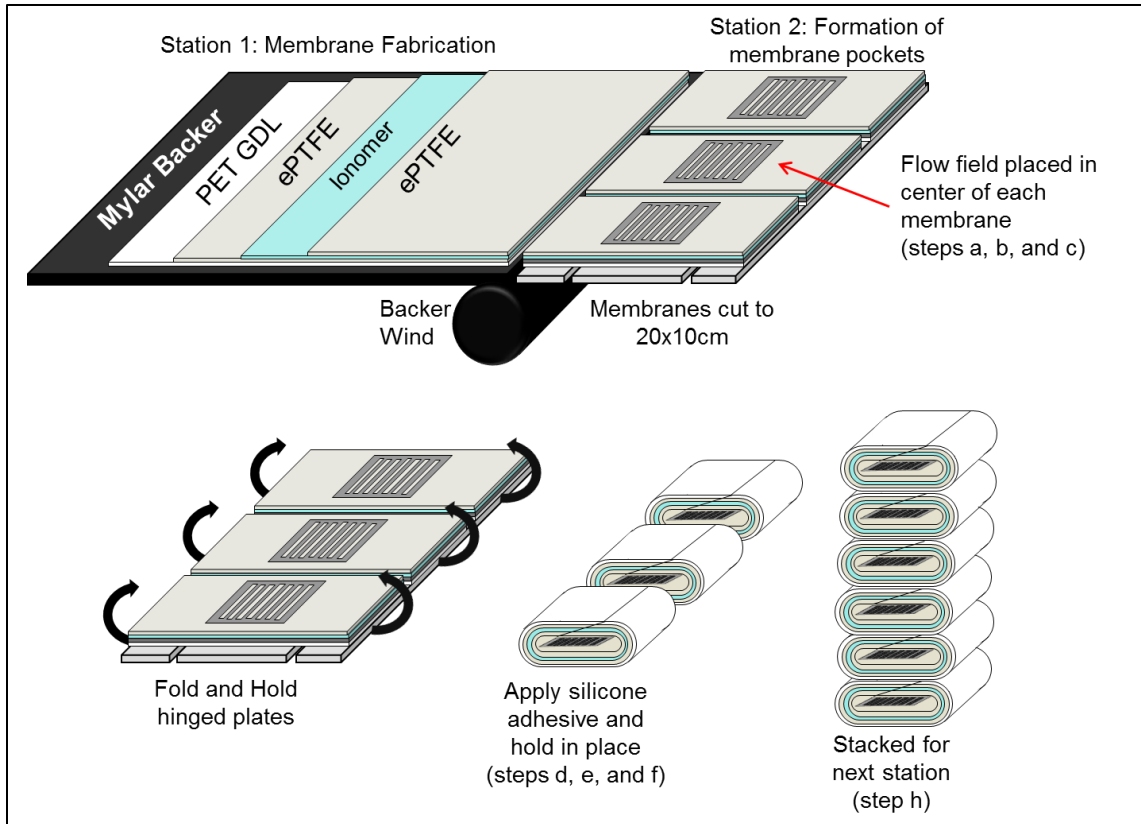
The cell pouches are formed using custom machinery to wrap a flow field with composite membrane and apply adhesive to seal the ends of the membrane and form a membrane loop. An image of a complete single cell pouch is shown in Figure 198. The process order used to fabricate these cell pouches is as follows:

- a. Composite humidifier membrane material is unrolled onto a cutting deck.
- b. The custom machine cuts the composite membrane to a 20 cm length.
- c. A flow field is placed in the center of the membrane.
- d. One end of the membrane is wrapped around the flow field.
- e. A bead of silicone adhesive is applied to the membrane end wrapped around the flow field.
- f. The other end of the membrane is wrapped around the flow field and onto the adhesive bead. The ends are held in place until bonded.
- g. A vision quality control system is used to verify alignment of the cell pouch.
- h. The cell pouch is removed and stacked in a magazine to be used in the next stack assembly process.

A schematic of the process steps is shown in Figure 199. (The schematic does not show the quality control system.) The complete system is estimated at \$413,000 and able to simultaneously prepare 10 pouches with a 9 second cycle time (i.e. 9 seconds per 10 pouches).



**Figure 198. Plate Frame Membrane Humidifier single cell pouch (Source: Johnson, William B. "Materials and Modules for Low-Cost, High-Performance Fuel Cell Humidifiers," W.L. Gore & Associates, Inc., presentation at the 2012 DOE Hydrogen and Fuel Cell Program Annual Merit Review, Washington, DC, 17 May 2012.)**



**Figure 199. Process steps used in DFMA<sup>®</sup> analysis for humidifier cell pouch formation.**

Figure 200 and Figure 201 show cell pouch formation processing parameters. Cost results for the cell pouch formation process are in Figure 202.

<b>Annual Production Rate</b>	<b>1,000</b>	<b>10,000</b>	<b>20,000</b>	<b>50,000</b>	<b>100,000</b>	<b>500,000</b>
<b>Equipment Lifetime (years)</b>	15	15	15	15	15	15
<b>Interest Rate</b>	10%	10%	10%	10%	10%	10%
<b>Corporate Income Tax Rate</b>	40%	40%	40%	40%	40%	40%
<b>Capital Recovery Factor</b>	0.175	0.175	0.175	0.175	0.175	0.175
<b>Equipment Installation Factor</b>	1.4	1.4	1.4	1.4	1.4	1.4
<b>Maintenance/Spare Parts (% of CC)</b>	10%	10%	10%	10%	10%	10%
<b>Miscellaneous Expenses (% of CC)</b>	7%	7%	7%	7%	7%	7%
<b>Power Consumption (kW)</b>	27	27	27	27	27	27

**Figure 200. Pouch formation process parameters**

Annual Production Rate	1,000	10,000	20,000	50,000	100,000	500,000
Capital Cost (\$/line)	\$413,179	\$413,179	\$413,179	\$413,179	\$413,179	\$413,179
Costs per Tooling Set (\$)	\$1,259	\$1,259	\$1,259	\$1,208	\$813	\$324
Costs per Tooling Set 2 (\$)	1,400	1,400	1,400	1,400	1,400	977
Tooling Lifetime (cycles)	2,000,000	2,000,000	2,000,000	2,000,000	2,000,000	2,000,000
Simultaneous Lines	1	1	1	1	1	2
Laborers per Line	0.50	0.50	0.50	0.50	0.50	0.50
Line Utilization	0.3%	3.3%	6.6%	16.0%	32.1%	80.2%
Cycle Time (s)	0.875	0.875	0.875	0.875	0.875	0.875
Effective Total Machine Rate (\$/hr)	\$15,112.54	\$1,572.65	\$799.21	\$342.54	\$183.81	\$88.47
Silicon Adhesive Cost (\$/kg)	\$12.05	\$12.05	\$12.05	\$12.05	\$12.05	\$12.05

Figure 201. Machine rate parameters for pouch formation

Annual Production Rate	1,000	10,000	20,000	50,000	100,000	500,000
Materials (\$/stack)	\$0	\$0	\$0	\$0	\$0	\$0
Manufacturings (\$/stack)	\$161	\$16	\$8	\$3	\$2	\$1
Toolings (\$/stack)	\$0	\$0	\$0	\$0	\$0	\$0
Total Costs (\$/stack)	\$162	\$17	\$9	\$4	\$2	\$1
Total Costs (\$/kWnet)	\$2.02	\$0.21	\$0.11	\$0.05	\$0.03	\$0.01

Figure 202. Cost breakdown for pouch formation

### Stainless Steel Rib Formation

Metal ribs are used to create air passageways between the cell pouches of the plate frame humidifier. The ribs are stamped from 0.6 mm thick stainless steel 316L sheeting and formed into 10 cm by 0.25 cm by 0.6mm ribs. Plate handling robots are used to collect and stack the ribs into magazines to be used during stack assembly. The capital cost of the stamping press is \$160,000 and the cycle time is approximately 0.67 seconds per rib (90 stamps per minute).

Figure 203 and Figure 204 show rib formation processing parameters. Cost results for rib formation are shown in Figure 205.

Annual Production Rate	1,000	10,000	20,000	50,000	100,000	500,000
Equipment Lifetime (years)	15	15	15	15	15	15
Interest Rate	10%	10%	10%	10%	10%	10%
Corporate Income Tax Rate	40%	40%	40%	40%	40%	40%
Capital Recovery Factor	0.175	0.175	0.175	0.175	0.175	0.175
Equipment Installation Factor	1.4	1.4	1.4	1.4	1.4	1.4
Maintenance/Spare Parts (% of CC)	13%	13%	13%	13%	13%	13%
Miscellaneous Expenses (% of CC)	2%	2%	2%	2%	2%	2%
Power Consumption (kW)	18	18	18	18	18	18

Figure 203. Stainless steel rib formation process parameters

Annual Production Rate	1,000	10,000	20,000	50,000	100,000	500,000
Capital Cost (\$/line)	\$158,460	\$158,460	\$158,460	\$158,460	\$158,460	\$158,460
Costs per Tooling Set (\$)	\$6,000	\$6,000	\$6,000	\$6,000	\$6,000	\$6,000
Tooling Lifetime (cycles)	400,000	400,000	400,000	400,000	400,000	400,000
Simultaneous Lines	1	1	1	1	1	4
Laborers per Line	0.5	0.5	0.5	0.5	0.5	0.5
Line Utilization	0.7%	7.1%	14.1%	35.3%	70.5%	88.2%
Cycle Time (s)	0.66	0.66	0.66	0.66	0.66	0.66
Effective Total Machine Rate (\$/hr)	\$2,632.14	\$1,422.02	\$1,422.02	\$1,422.02	\$1,422.02	\$1,422.02
Stainless Steel Rib Material Cost (\$/kg)	\$3.93	\$3.93	\$3.93	\$3.93	\$3.93	\$3.93

Figure 204. Machine rate parameters for stainless steel rib formation

Annual Production Rate	1,000	10,000	20,000	50,000	100,000	500,000
Materials (\$/stack)	\$1	\$1	\$1	\$1	\$1	\$1
Manufacturings (\$/stack)	\$59	\$6	\$3	\$2	\$1	\$1
Toolings (\$/stack)	\$2	\$2	\$2	\$2	\$2	\$2
<b>Total Costs (\$/stack)</b>	<b>\$62</b>	<b>\$9</b>	<b>\$6</b>	<b>\$4</b>	<b>\$4</b>	<b>\$3</b>
<b>Total Costs (\$/kWnet)</b>	<b>\$0.77</b>	<b>\$0.11</b>	<b>\$0.07</b>	<b>\$0.05</b>	<b>\$0.04</b>	<b>\$0.04</b>

Figure 205. Cost breakdown for stainless steel rib formation

### Stack Formation

The plate frame membrane humidifier stack is assembled by “pick and place” robots. The following steps are used for assembly.

1. Repeated robotic steps for the number of pouches required in the stack (58 cell pouches for automotive system).
  - a. Robot acquires and places pouch cell with flow field insert
  - b. Apply silicone gasket/adhesive bead on three sealing lines
  - c. Acquire and place three parallel SS rib spacers onto the sealing lines
  - d. Apply additional silicone gasket/adhesive beads on three sealing lines on rib spacers
2. Compress stack in an assembly jig and hold for 24 hours in a humidified warm enclosure. (72 hours curing time would be required if left at room temperature.)
3. Use optical quality control system to detect membrane misalignment in stack.

The total capital cost of the pick and place robots and other equipment required for the system is \$185,000. The cycle time is 9 seconds for each pouch (~9 min for an 80 cell pouch stack).

Figure 206 and Figure 207 show stack formation processing parameters. Cost results for stack formation process are in Figure 208.

Annual Production Rate	1,000	10,000	20,000	50,000	100,000	500,000
Equipment Lifetime (years)	15	15	15	15	15	15
Interest Rate	10%	10%	10%	10%	10%	10%
Corporate Income Tax Rate	40%	40%	40%	40%	40%	40%
Capital Recovery Factor	0.175	0.175	0.175	0.175	0.175	0.175
Equipment Installation Factor	1.4	1.4	1.4	1.4	1.4	1.4
Maintenance/Spare Parts (% of CC)	10%	10%	10%	10%	10%	10%
Miscellaneous Expenses (% of CC)	7%	7%	7%	7%	7%	7%
Power Consumption (kW)	22	22	22	22	22	22

Figure 206. Stack formation process parameters

Annual Production Rate	1,000	10,000	20,000	50,000	100,000	500,000
Capital Cost (\$/line)	\$185,000	\$185,000	\$185,000	\$185,000	\$185,000	\$185,000
Simultaneous Lines	1	1	1	2	4	16
Laborers per Line	1	1	1	1	1	1
Line Utilization	3%	32%	64%	80%	80%	100%
Cycle Time (s)	9	9	9	9	9	9
Effective Total Machine Rate (\$/hr)	\$737.97	\$95.90	\$60.23	\$53.09	\$53.09	\$47.39
Silicon Adhesive Cost (\$/kg)	\$12.05	\$12.05	\$12.05	\$12.05	\$12.05	\$12.05

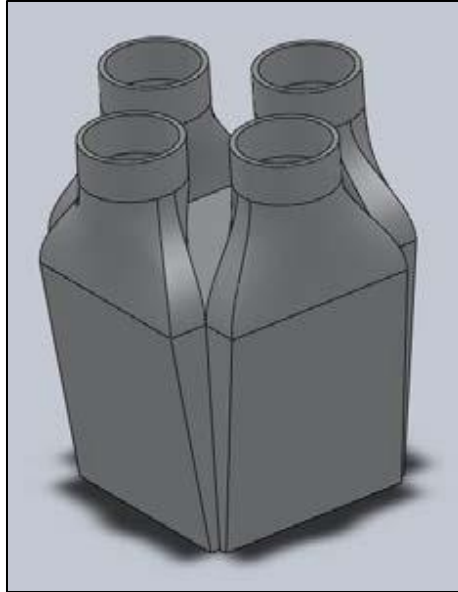
Figure 207. Machine rate parameters for stack formation

Annual Production Rate	1,000	10,000	20,000	50,000	100,000	500,000
Materials (\$/stack)	\$2	\$2	\$2	\$2	\$2	\$2
Manufacturings (\$/stack)	\$75	\$10	\$6	\$5	\$5	\$5
<b>Total Costs (\$/stack)</b>	<b>\$77</b>	<b>\$12</b>	<b>\$8</b>	<b>\$8</b>	<b>\$8</b>	<b>\$7</b>
<b>Total Costs (\$/kWnet)</b>	<b>\$0.96</b>	<b>\$0.15</b>	<b>\$0.10</b>	<b>\$0.09</b>	<b>\$0.09</b>	<b>\$0.09</b>

Figure 208. Cost breakdown for stack formation

### Formation of the Housing

The humidifier aluminum housing is formed using a 900 ton cold chamber die casting machine to form two separate parts (body and upper lid). Boothroyd Dewhurst Inc. (BDI) software was used for the cost estimate. The housing walls are 2.5 mm thick and have approximate dimensions of 11 cm tall by 11 cm length and width. The volume is less than 5 liters and the mass of the housing about 0.65kg. Four bolts/nuts are used to connect the body to the lid with an elastomer O-ring for sealing. A CAD drawing of the complete housing is shown in Figure 209 along with the corresponding cost results are displayed in Figure 210.



**Figure 209. Process steps used in DFMA<sup>®</sup> analysis for humidifier cell pouch formation (Source: Johnson, William B. “Materials and Modules for Low-Cost, High Performance Fuel Cell Humidifiers,” W.L. Gore & Associates, Inc., presentation at the 2012 DOE Hydrogen and Fuel Cell Program Annual Merit Review, Washington, DC, 17 May 2012.)**

Annual Production Rate	1,000	10,000	20,000	50,000	100,000	500,000
Material (\$/stack)	\$4	\$4	\$4	\$4	\$4	\$4
Manufacturing (\$/stack)	\$17	\$4	\$1	\$1	\$1	\$0
Tooling (\$/stack)	\$29	\$3	\$2	\$1	\$1	\$1
<b>Total Cost (\$/stack)</b>	<b>\$49</b>	<b>\$10</b>	<b>\$7</b>	<b>\$6</b>	<b>\$6</b>	<b>\$6</b>
<b>Total Cost (\$/kWnet)</b>	<b>\$0.62</b>	<b>\$0.13</b>	<b>\$0.09</b>	<b>\$0.08</b>	<b>\$0.07</b>	<b>\$0.07</b>

**Figure 210. Cost breakdown for formation of the Housing**

#### **Assembly of the Composite Membrane and Flow Fields into the Housing**

Complete manual assembly of the plate frame humidifier is performed at a custom work stand using the following sequence:

- a. Acquire housing body and insert into fixture.
- b. Acquire pouch stack and load stack into housing.
- c. Acquire and insert gasket into housing body.
- d. Acquire upper lid and place onto gasket/housing-body.
- e. Acquire, insert and fasten 4 bolts/nuts.
- f. Acquire finished housing and move to cart.
- g. Weigh finished unit to detect missing/additional parts. (Quality control step.)

The cycle time is approximately 2 minutes per system. Figure 211 and Figure 212 show assembly process parameters. Cost results for assembly are shown in Figure 213.

Annual Production Rate	1,000	10,000	20,000	50,000	100,000	500,000
Equipment Lifetime (years)	10	10	10	10	10	10
Interest Rate	10%	10%	10%	10%	10%	10%
Corporate Income Tax Rate	40%	40%	40%	40%	40%	40%
Capital Recovery Factor	0.205	0.205	0.205	0.205	0.205	0.205
Equipment Installation Factor	1.4	1.4	1.4	1.4	1.4	1.4
Maintenance/Spare Parts (% of CC)	10%	10%	10%	10%	10%	10%
Miscellaneous Expenses (% of CC)	7%	7%	7%	7%	7%	7%
Power Consumption (kW)	18	18	18	18	18	18

**Figure 211. Assembly of the composite membrane and flow fields into the housing process parameters**

Annual Production Rate	1,000	10,000	20,000	50,000	100,000	500,000
Assembly Method	Manual	Manual	Manual	Manual	Manual	Manual
Capital Cost (\$/line)	\$34,212	\$34,212	\$34,212	\$34,212	\$34,212	\$34,212
Simultaneous Lines	1	1	1	1	1	5
Laborers per Line	1	1	1	1	1	1
Line Utilization	1.0%	9.9%	19.8%	49.6%	99.2%	99.2%
Index Time (min)	2	2	2	2	2	2
Effective Total Machine Rate (\$/hr)	\$429.56	\$85.42	\$66.24	\$54.71	\$50.86	\$50.86

**Figure 212. Machine rate parameters for assembly of the composite membrane and flow fields into the housing**

Annual Production Rate	1,000	10,000	20,000	50,000	100,000	500,000
Manufacturings (\$/stack)	\$13	\$3	\$2	\$2	\$2	\$2
Total Costs (\$/stack)	\$13	\$3	\$2	\$2	\$2	\$2
Total Costs (\$/kWnet)	\$0.17	\$0.03	\$0.03	\$0.02	\$0.02	\$0.02

**Figure 213. Cost breakdown for assembly of the composite membrane and flow fields into the housing**

### Humidifier System Testing

A simple functionality test is completed for each completed humidifier system. It includes testing for air flow pressure drop and air leakage. These tests require an air compressor, gas manifolds, and a diagnostic measurement system. The steps considered in this testing process are:

- a. Acquire unit and insert into fixture.
- b. Connect 4 inlet and outlet air manifolds.
- c. Sequentially flow gas (as appropriate) to test:
  - Pressure drop in primary flow (20 seconds)
  - Pressure drop in secondary flow (20 seconds)
  - Air leakage (primary to secondary) (20 seconds)
- d. Disconnect inlet and outlet air manifolds.
- e. Remove unit from fixture.



The estimated capital cost is:

- \$30,000 for a 1-system test fixture (used at low production levels)
- \$40,000 for a 3-system test fixture (used at high production levels)

The cycle time for testing is about 83 seconds per cycle.

- 83 seconds per system for a 1-system test fixture and 1 worker
- 23 seconds per system for a 3-system test fixture and 1 worker

Figure 214 and Figure 215 show humidifier system testing process parameters. Cost results are displayed in Figure 216.

Annual Production Rate	1,000	10,000	20,000	50,000	100,000	500,000
Equipment Lifetime (years)	15	15	15	15	15	15
Interest Rate	10%	10%	10%	10%	10%	10%
Corporate Income Tax Rate	40%	40%	40%	40%	40%	40%
Capital Recovery Factor	0.175	0.175	0.175	0.175	0.175	0.175
Equipment Installation Factor	1.4	1.4	1.4	1.4	1.4	1.4
Maintenance/Spare Parts (% of CC)	10%	10%	10%	10%	10%	10%
Miscellaneous Expenses (% of CC)	7%	7%	7%	7%	7%	7%
Power Consumption (kW)	2	2	2	5	5	5

Figure 214. Humidifier system testing process parameters

Annual Production Rate	1,000	10,000	20,000	50,000	100,000	500,000
Capital Cost (\$/line)	\$30,000	\$30,000	\$30,000	\$40,000	\$40,000	\$40,000
Simultaneous Lines	1	1	1	1	1	1
Laborers per Line	1	1	1	1	1	1
Line Utilization	0.7%	6.9%	13.7%	9.5%	19.0%	95.1%
Systems partially connected at any one time	1	1	1	3	3	3
Selected Effective Test time per System (min)	1.4	1.4	1.4	0.4	0.4	0.4
Effective Total Machine Rate (\$/hr)	\$503.48	\$102.02	\$79.64	\$100.61	\$79.03	\$61.76

Figure 215. Machine rate parameters for humidifier system testing

Annual Production Rate	1,000	10,000	20,000	50,000	100,000	500,000
Manufacturings (\$/stack)	\$11	\$2	\$2	\$1	\$0	\$0
Total Costs (\$/stack)	\$11	\$2	\$2	\$1	\$0	\$0
Total Costs (\$/kWnet)	\$0.137	\$0.028	\$0.022	\$0.008	\$0.006	\$0.005

Figure 216. Cost breakdown for humidifier system testing

### 9.2.2.3.3 Combined Cost Results for Plate Frame Membrane Humidifier

Cost results for the Gore plate frame membrane humidifier are summarized in Figure 217 at 500,000 systems per year and in Figure 218 for all manufacturing rates, with costs further subdivided into materials, manufacturing, tooling, markup, and total costs. The greatest cost drivers are the material costs, particularly for the membrane materials at \$18.75/humidifier. Costs are strongly impacted by the quantity of membrane material needed for the humidifier. The largest processing cost for the humidifier

is the flow field fabrication due to the innate details of the flow field design which are deemed to require a (relatively) expensive etching process. Membrane and flow fields make up approximately two-thirds of the total cost and materials are about half the total humidifier cost (at 500,000 systems per year), as seen in Figure 219.

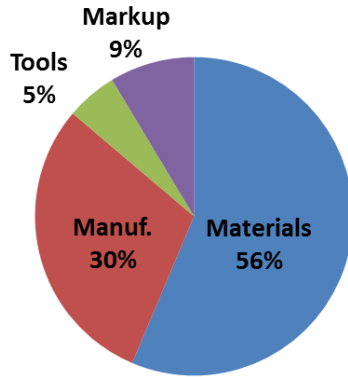
Component Costs per Humidifier System		All at 500k systems per year				
		Materials	Manuf.	Tools	Markup	Total
Station 1: Membrane Fabrication	\$/stack	\$17.62	\$2.43	\$0.08	\$5.03	\$25.16
Station 2: Humidifier Etching (Flow Field Plates)	\$/stack	\$7.62	\$5.78	\$0.00	\$0.00	\$13.40
Station 3: Pouch Forming	\$/stack	\$0.23	\$0.90	\$0.03	\$0.00	\$1.15
Station 4: Stamp SS ribs	\$/stack	\$0.60	\$1.01	\$1.82	\$0.00	\$3.43
Station 5: Stack Forming	\$/stack	\$2.22	\$4.79	\$0.00	\$0.00	\$7.01
Station 6: Stack Housing	\$/stack	\$4.07	\$0.47	\$1.14	\$0.00	\$5.67
Station 7: Assembly of Stack into Housing	\$/stack	\$0.00	\$1.59	\$0.00	\$0.00	\$1.59
Station 8: System Test	\$/stack	\$0.00	\$0.37	\$0.00	\$0.00	\$0.37
<b>Totals =</b>		<b>\$32.35</b>	<b>\$17.34</b>	<b>\$3.06</b>	<b>\$5.03</b>	<b>\$57.79</b>

Figure 217. Membrane humidifier system cost results: ~\$62 at 500k systems/year

Annual Production Rate	1,000	10,000	20,000	50,000	100,000	500,000
Materials (\$/stack)	\$51	\$52	\$48	\$42	\$39	\$32
Manufacturings (\$/stack)	\$818	\$140	\$75	\$49	\$31	\$17
Toolings (\$/stack)	\$31	\$5	\$4	\$3	\$3	\$3
Markups (\$/stack)	\$55	\$33	\$22	\$15	\$10	\$5
<b>Total Costs (\$/stack)</b>	<b>\$955</b>	<b>\$229</b>	<b>\$148</b>	<b>\$110</b>	<b>\$83</b>	<b>\$58</b>
<b>Total Costs (\$/kWnet)</b>	<b>\$11.93</b>	<b>\$2.86</b>	<b>\$1.85</b>	<b>\$1.37</b>	<b>\$1.04</b>	<b>\$0.72</b>

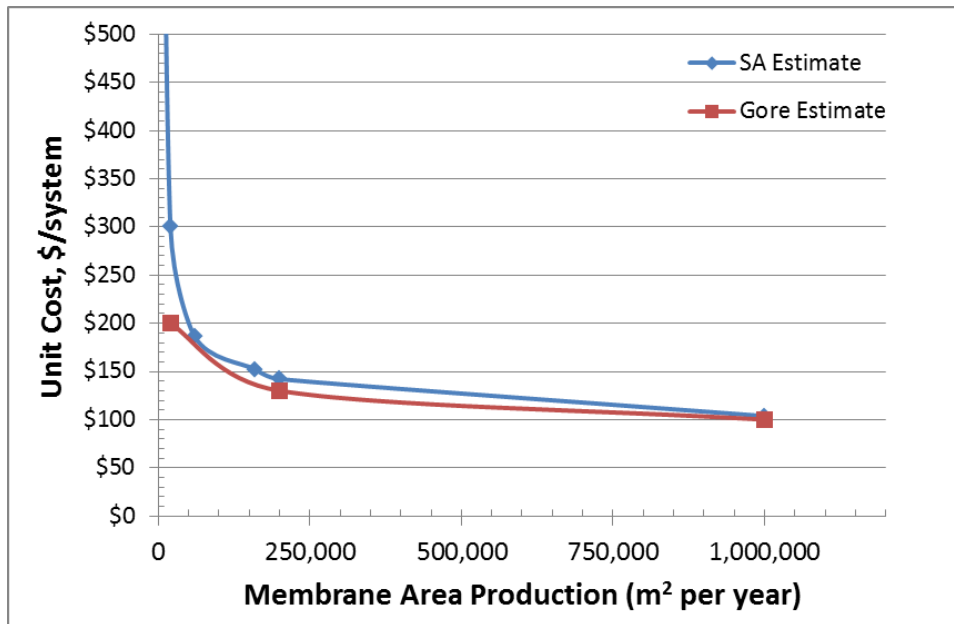
Figure 218. Combined cost results for all plate frame humidifier processes.

Markup is typically applied to the sum of materials, manufacturing, and tooling to capture the real business costs associated with overhead, general administrative (G&A), scrap, R&D, and profit. Per previous DOE directive, markup is only applied to lower-tier suppliers and is NOT applied to the system assembler. A high degree of vertical integration for the overall auto fuel cell power system is assumed. (As discussed in more detail in Section 2.3, a lower level of vertical integration is assumed for the bus fuel cell system, therefore markup is applied to the humidifier.) For the plate frame membrane humidifier, markup is not applied to the auto humidifier assembler. However, markup is included in the costs of the ePTFE, PET, and composite humidifier membrane as those components are assumed to be manufactured by lower-tier suppliers. (Markup on the manufacturing process for the composite membrane appears in the markup column in Figure 217.)



**Figure 219. Humidifier membrane cost dominated by material cost at 500k systems/year**

In cost analysis of fuel cell system components, it is beneficial to benchmark results with currently developed systems. Figure 220 compares SA’s cost estimate to Gore’s cost estimate and shows good agreement at medium and high production rates (for the same 2m<sup>2</sup> of membrane area). SA estimates are much higher than Gore’s at low manufacturing rates due to poor utilization of expensive equipment (i.e. composite membrane fabrication). At low utilization of equipment, a business may decide to “job shop” or outsource the work to a company that has higher utilization of similar equipment. Such “job shopping” is not assumed for the humidifier in the 2018 analysis although as mentioned in Section 9.2.2.3.1, the production of membrane area is assumed to be five times more than what is used for 1,000 systems per year. This multiplier stems from the assumption that the membrane manufacturer would most likely supply to more than one customer and may have multiple industrial applications for this membrane.



**Figure 220. Comparison of Gore and SA cost estimates for the plate frame membrane humidifier (for 2m<sup>2</sup> membrane area).**

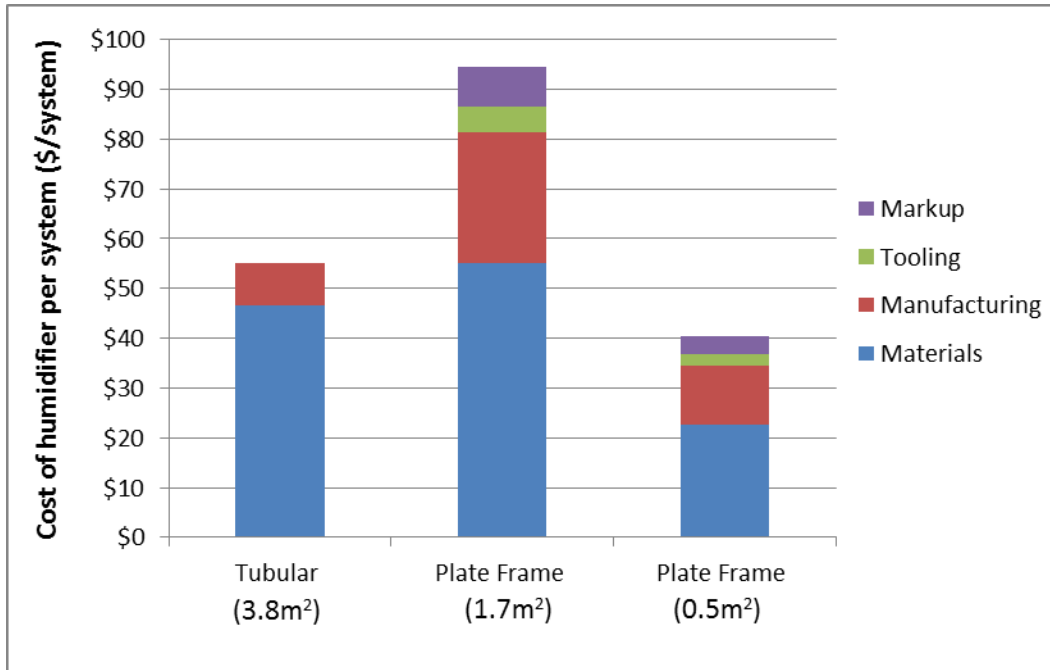
In 2014, SA ran a sensitivity analysis of multiple parameters at 500,000 systems per year (and can be seen in SA's 2014 Update report).<sup>118</sup> The most important cost driver for the humidifier is the quantity of membrane material required. This indicates that between 0.5m<sup>2</sup> and 2.6m<sup>2</sup> of membrane area the plate frame humidifier would cost between \$35/system and \$131/system. The second most important cost driver is the price of the ePTFE material used in the membrane. Both the fuel cell stack MEA and humidifier manufactured costs are quite sensitive to the cost of ePTFE. While plate frame humidifier uncertainty is high (-68%/+19%), the overall humidifier cost is low compared to the total auto fuel cell power system cost.

In comparison to the tubular membrane humidifier previously used in the 2012 analysis, the 2018 plate frame humidifier is projected to be lower cost. However, in retrospect, the 2012 tubular membrane humidifier is now viewed as undersized for the 2012 flow conditions (even at 3.8m<sup>2</sup> of membrane area) and thus a direct comparison of the two systems is not valid. In general, plate frame humidifiers will require less membrane area than tubular designs since their membranes may be thinner, (by virtue of being supported on ePTFE). However, the cost of the ePTFE support is a significant fraction of the total plate frame humidifier cost, and manufacturing (particularly of the etched plates) also can add considerable cost for larger membrane area designs (see Figure 221).

As shown by the sensitivity analysis, membrane area is an extremely important parameter in the determination of humidifier cost. Uncertainty exists related to the required membrane area. Consequently, an optimistic value of 0.5m<sup>2</sup>/system was included in the sensitivity analysis based on ANL modeling projections and a pessimistic value of 2.6m<sup>2</sup> was included to reflect a large allowance for performance degradation. Further testing is required to confidently determine the membrane area requirement.

---

<sup>118</sup> "Mass Production Cost Estimation of Direct H<sub>2</sub> PEM Fuel Cell Systems for Transportation Applications: 2014 Update" Brian D. James, Jennie M. Moton & Whitney G. Colella, Strategic Analysis, Inc., January 2015.



**Figure 221. Graph showing the cost (at 500k sys/yr) comparison between a tubular membrane humidifier and two plate frame membrane humidifiers with different membrane area requirements.**

### 9.2.3 Coolant Loops

The 2018 system has two coolant loops, a high-temperature loop to cool the fuel cell stacks and a low-temperature loop to cool electronic components. The low-temperature loop is also used to cool the CEM motor and in the precooler (to cool the compressed intake air prior to going into the membrane humidifier).

#### 9.2.3.1 High-Temperature Coolant Loop

**Coolant Reservoir:** The cost is based on a molded plastic water tank.

**Coolant Pump:** Small pumps to provide this flow are commercially available in large quantities at approximately \$97 per pump at quantities of 1,000, dropping to \$74 at high quantity.

**Coolant DI Filter:** The cost is based on a resin deionizer bed in a plastic housing.

**Thermostat & Valve:** The cost is based on standard automotive components.

**Radiator:** The heat dissipation requirements of the fuel cell system are similar to those of today's standard passenger cars. Consequently, costs for the high and low-temperature loop radiators are aligned with those of appropriately sized radiators used in contemporary automotive applications.

**Radiator Fan:** The cost is based on a standard automotive radiator fan and sized based on the cooling load.

**Coolant Piping:** Cost is based on 2” diameter rubber pipe from McMaster Carr and a constant \$6.93/ft.

High-temperature coolant loop cost results are shown in Figure 222.

Annual Production Rate	1,000	10,000	20,000	50,000	100,000	500,000
Coolant Reservoir (\$/system)	\$13	\$11	\$10	\$8	\$7	\$6
Coolant Pump (\$/system)	\$59	\$59	\$59	\$59	\$59	\$59
Coolant DI Filter (\$/system)	\$76	\$67	\$61	\$46	\$43	\$37
Thermostat & Valve (\$/system)	\$10	\$9	\$8	\$6	\$6	\$5
Radiator (\$/system)	\$186	\$177	\$168	\$158	\$149	\$140
Radiator Fan (\$/system)	\$83	\$73	\$64	\$49	\$47	\$44
Coolant Piping (\$/system)	\$23	\$23	\$22	\$21	\$20	\$19
<b>Total Cost (\$/system)</b>	<b>\$451</b>	<b>\$419</b>	<b>\$392</b>	<b>\$347</b>	<b>\$331</b>	<b>\$310</b>
<b>Total Cost (\$/kWnet)</b>	<b>\$5.63</b>	<b>\$5.24</b>	<b>\$4.90</b>	<b>\$4.34</b>	<b>\$4.13</b>	<b>\$3.87</b>

**Figure 222. Cost breakdown for high-temperature coolant loop**

### 9.2.3.2 Low-Temperature Coolant Loop

In the 2012 analysis, the low-temperature loop previously cooled components both within the fuel cell system (precooler, CEM motor) and the drive train system (main traction motor inverter (TIM) electronics). Consequently, the cost of the 2012 low-temperature coolant loop was apportioned between these systems and only the cost of the loop associated with the fuel cell system was tabulated in the fuel cell cost summary. Based on the expected duties of the components, 67% of the low-temperature coolant loop cost was attributable to the fuel cell system.

The low-temperature loop for the 2014-2018 analysis is modeled as a dedicated fuel cell system cooling loop and thus only cools components within the fuel cell system (precooler, CEM motor). Drivetrain components have been removed from the cooling loop: thus 100% of the coolant loop cost is charged to the fuel cell system. This change was made in order to simplify the analysis and to be in closer alignment with Argonne National Laboratory modeling methodology.

**Coolant Reservoir:** The cost is based on a molded plastic water tank.

**Coolant Pump:** The low and high-temperature loops require similar flow rates, so the same type of pump is used in each.

**Thermostat & Valve:** The cost is based on standard automotive components.

**Radiator:** As with the radiator for the high-temperature coolant loop, the exhaust loop uses a radiator similar to those used in conventional automotive applications. However, it does not need to be as large as the one for the coolant loop, so it is scaled down in cost.

**Radiator Fan:** It is assumed that the radiators for the high and low-temperature loops are installed together such that the air flow exiting the low-temperature radiator immediately enters the high-temperature radiator, and as such, there is a single fan for both radiators, which is accounted for in the high-temperature coolant loop (Reason why radiator fan cost is \$0 in Figure 223).

**Coolant Piping:** Assumed 2” diameter rubber pipe from McMaster Carr, at \$6.93/ft.

Low-temperature coolant loop cost results are shown in Figure 223.

Annual Production Rate	1,000	10,000	20,000	50,000	100,000	500,000
Coolant Reservoir (\$/system)	\$13	\$11	\$10	\$8	\$7	\$6
Coolant Pump (\$/system)	\$16	\$16	\$16	\$16	\$16	\$16
Thermostat & Valve (\$/system)	\$4	\$4	\$3	\$2	\$2	\$2
Radiator (\$/system)	\$44	\$42	\$40	\$38	\$35	\$33
Coolant Piping (\$/system)	\$6	\$5	\$5	\$5	\$5	\$5
<b>Total Cost (\$/system)</b>	<b>\$82</b>	<b>\$78</b>	<b>\$74</b>	<b>\$68</b>	<b>\$65</b>	<b>\$61</b>
<b>Total Cost (\$/kWnet)</b>	<b>\$1.03</b>	<b>\$0.97</b>	<b>\$0.93</b>	<b>\$0.86</b>	<b>\$0.82</b>	<b>\$0.77</b>

**Figure 223. Cost breakdown for low-temperature coolant loop**

### 9.2.4 Fuel Loop

Per DOE system analysis guidelines, the hydrogen tank, the hydrogen pressure-relief device & regulator, hydrogen fueling receptacle, proportional valve, pressure transducer, and inline filter are not included in the fuel cell power system cost analysis as they are considered part of the hydrogen storage system.

Definition of the H<sub>2</sub> recirculation systems has been altered several times in the last few analysis years as a better understanding of performance and cost has developed. In 2016, a Blower-Ejector H<sub>2</sub> recirculation subsystem was cost analyzed to match ANL’s modeled system and allow a better match of parasitic power estimates between SA and ANL models. The previously used low-flow ejector system was replaced with a hydrogen recirculation blower and system cost was projected to increase by \$3/kWnet. However, when the Ejector-Blower recirculation system was briefed to the FCTT, the Tech Team was not in favor of adopting the new recirculation system for SA’s baseline model before a performance/cost trade-off was conducted to clearly support the change. Consequently, the dual ejector configuration for the H<sub>2</sub> recirculation system was retained for the 2016 baseline analysis.

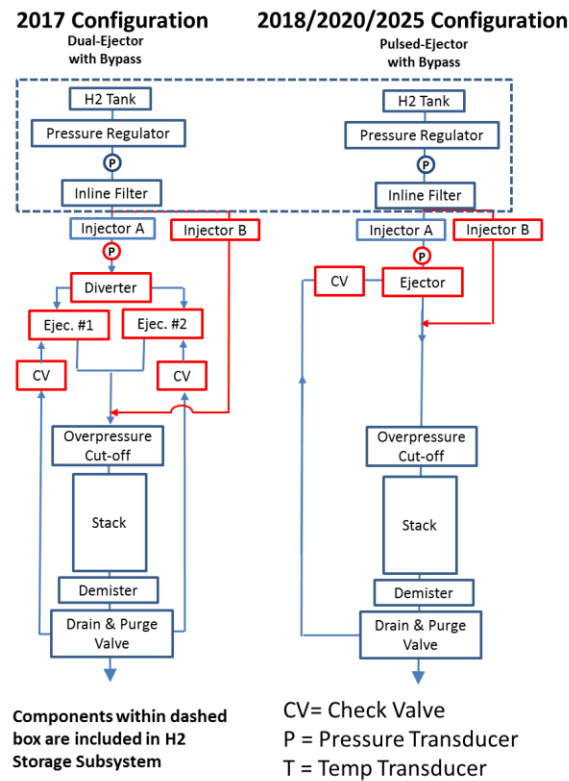
In response to the FCTT recommendation, and in coordination with ANL performance modeling efforts, SA conducted a detailed cost analysis of four H<sub>2</sub> recirculation system configurations in 2017 (Blower-Only, Ejector-Blower, Dual Ejector with Bypass, and Pulsed-Ejector with Bypass) as detailed in SA’s 2017 Annual Report<sup>119</sup>. For the baseline 2017 system, the Dual-Ejector System was selected and updated to include a few more components than contained in the 2016 configuration (extra check valve, pressure transducer, and two injectors) to reflect a fuller understanding of operational requirements.

For the 2018 analysis (as applied to 2018, 2020, and 2025 systems), a Pulsed-Ejector system is selected as having the lowest volume, lowest power requirement, and lowest cost. Comparative diagrams of the Dual-Ejector and Pulsed Ejector systems are shown in Figure 224. A recent Honda patent forms the basis of the Pulsed-Ejector H<sub>2</sub> recirculation system.<sup>120</sup> ANL concluded from their studies that a Pulsed-Ejector system may be able to meet recirculation requirements but only if N<sub>2</sub> buildup is maintained at <=15% (i.e. N<sub>2</sub> gas fractions >15% contain too much mass flow to allow adequate H<sub>2</sub> recirculation flow rates at

<sup>119</sup> “Mass Production Cost Estimation of Direct H<sub>2</sub> PEM Fuel Cell Systems for Transportation Applications: 2017 Update” Brian D. James, Jennie M. Huya-Kouadio, Cassidy Houchins, & Daniel A. DeSantis, Strategic Analysis, Inc., December 2017.

<sup>120</sup> US 2016 Patent 9,373,855 B2

low rated power). This limit is slightly less than the DOE target of  $\leq 20\%$   $N_2$  buildup and results in more frequent purges and thus more wasted  $H_2$ . While this impacts fuel economy and the life cycle cost of the system, it does not impact on-road performance nor capital cost of the fuel cell system.



**Figure 224. Schematics of the 2017 (Dual-Ejector), and 2018, 2020, and 2025 (Pulsed-Ejector) hydrogen recirculation systems.**

Component details of the Pulsed-Ejector system are discussed below.

**Pressure Transducer:** Two pressure transducers are included in the system to ensure the correct hydrogen pressure reading before the inline filter and the diverter for the Dual-Ejector System. The second pressure regulator on the Pulsed-Ejector system is between injector A and the ejector.

**Over-Pressure Cut-Off (OPCO) Valve:** The over-pressure cut-off valve is included as a safety precaution to prevent inadvertent stack pressurization from the high pressure ( $>5000$ psi) in the hydrogen storage tank.

**Injectors:** There are two types of injectors in the  $H_2$  recirculation system. The first type is an injector operating like a solenoid valve, open for however long is needed for the flow to meet specified conditions. The second type operates in continuous open/close operation in pulse width modulation mode (eg. open for 0.5 sec, closed for 1 sec) with the intent of creating rapid flow rate fluctuations. The bypass injectors are the first type of injectors (labeled Injector B in Figure 224) and have the purpose of allowing hydrogen to bypass the ejectors for purge events. In the Dual-Ejector system, both the injectors



are of the first type. In the Pulsed-Ejector system, Injector A is of the second type of injector. Although they have different flow control schemes, both types of injectors are assumed to be similar in cost.

**Ejector (for Pulsed-Ejector System):** A single static ejector is employed to re-circulate hydrogen from the anode exhaust to the anode inlet to achieve target flow rates and hence high stack performance. The ejector operates on the Bernoulli Principle wherein high-pressure hydrogen gas from the fuel tank (>250 psi) flows through a converging-diverging nozzle to entrain lower-pressure anode exhaust gas. The design of the ejector is based on concepts from Graham Manufacturing and the patent literature (US Patent 5,441,821). The fabrication of the ejector consists of stainless steel investment casting of a two-part assembly, followed by machining, welding, and polishing.

**Check Valves:** The check valves ensure that hydrogen does not flow backward from the ejectors.

**Purge Valve:** The purge valve allows for periodic purging of the hydrogen in the fuel loop.

**Hydrogen Piping:** The hydrogen flow lines are modeled as 1/2" SS316 schedule 10 pipe and are priced between \$90 and \$100/system based on estimates provided by Ford.

Fuel loop cost breakdown is shown in Figure 225.

Annual Production Rate	1,000	10,000	20,000	50,000	100,000	500,000
Pressure Transducer (\$/system)	\$54	\$41	\$38	\$34	\$31	\$26
Over-Pressure Cut-Off Valve (\$/system)	\$23	\$21	\$19	\$14	\$13	\$11
Hydrogen Injector (\$/system)	\$113	\$69	\$55	\$51	\$41	\$38
Hydrogen High-Flow Ejector (\$/system)	\$48	\$36	\$33	\$31	\$29	\$29
Check Valves (\$/system)	\$5	\$5	\$5	\$5	\$5	\$5
Purge Valves (\$/system)	\$75	\$66	\$60	\$45	\$42	\$36
Hydrogen Piping (\$/system)	\$85	\$77	\$75	\$71	\$68	\$63
<b>Total Cost (\$/system)</b>	<b>\$403</b>	<b>\$313</b>	<b>\$284</b>	<b>\$249</b>	<b>\$229</b>	<b>\$207</b>
<b>Total Cost (\$/kWnet)</b>	<b>\$5.04</b>	<b>\$3.92</b>	<b>\$3.55</b>	<b>\$3.12</b>	<b>\$2.86</b>	<b>\$2.59</b>

Figure 225. Cost breakdown for fuel loop

### 9.2.5 System Controller

Conventional electronic engine controllers (EEC's) are assumed to control the fuel cell power system. These programmable circuit boards are currently mass-produced for all conventional gasoline engines and are readily adaptable for fuel cell use. Prototype fuel cell vehicles may use four or more controllers out of convenience so that each subsystem is able to have a separate controller. However, even at 1,000 vehicles per year, the system will be refined enough to minimize controller use on the rationale of simplicity of cost and design. A single EEC is judged adequate for control and sensor leads to the power plant.

Controller cost is assessed by a bottom-up analysis of the system controller which breaks the controller into 18 input and output circuits, as listed in Figure 226.

For each input or output circuit, it is estimated that approximately 50 cents in electronic components (referencing catalog prices) would be needed. The costs of input and output connectors, an embedded controller, and the housing are also estimated by catalog pricing. A price quote forms the basis for the assumed dual-layer 6.5" x 4.5" circuit board. Assembly of 50 parts is based on robotic pick-and-place methods. A 10% cost contingency is added to cover any unforeseen cost increases.

Name	Signal
<b>Inputs</b>	
Air Mass Flow Sensor	Analog
H2 pressure Sensor (upstream of ejector)	Analog
H2 Pressure Sensor (stack inlet manifold)	Analog
Air Pressure sensor (after compressor)	Analog
Stack Voltage (DC bus)	Analog
Throttle Request	Analog
Current Sensors (drawn from motor)	Analog
Current Sensors (output from stack)	Analog
Singnal for Coolant Temperature	Analog
H2 Leak Detector 1	Digital
H2 Leak Detector 2	Digital
<b>Outputs</b>	
Singnal to TIM	Analog
Singnal to CEM	Analog
Singnal to Ejector 1	PWM
Singnal to Ejector 2	PWM
High voltage System Relay	Digital
Signal to Coolant Pump	PWM
Signal to H2 Purge Valve	Digital
Total Analog	11
Total Digital	4
Total PWM	3
<b>Total Inputs/Outputs</b>	<b>18</b>

**Figure 226. System controller input & output requirements**

Figure 227 and Figure 228 detail estimated system controller costs.

Component	Description	Cost at 500k systems/year	Cost Basis
Main Circuit Board	2 layer punnchboard	\$7.53	\$5.34 for single layer of 6.5"x4.5" punchboard, Q=500, Assume 25% discount for Q=500k
Input Connector	Wire Connector for inputs	\$0.17	\$0.23 each in Q=10k, reduced ~20% for Q=500k
Output Connector	Wire Connector for outputs	\$0.19	\$0.23 each in Q=10k, reduced ~20% for Q=500k
Embedded Controller	25 MHz, 25 channel microprocessor board	\$30.54	Digi-Key Part no. 336-1489-ND, \$50 @Q=1, assumed 35% reduction for Q=500k
MOSFETs ( total, 1 each per I/O)	P-channel, 2W, 49MOhm @SA, 10V	\$3.69	Digi-Key Part No. 785-1047-2-ND, \$0.2352 @Q=3k, \$0.2184@Q=12k
Misc. Board Elements	Capacitor, resistors, etc.	\$4.23	Estimate based on \$0.25 component for each input/output
Housing	Shielded plastic housing, watertight	\$4.70	Estimate based on comparable shielded, electronic enclosures. Includes fasteners.
Assembly	Assembly of boards/housing	\$5.48	Robotic Assembly of approx. 50 parts at 3.5 sec each, \$2/min assembly cost
Contingency	10% of all components	\$5.65	Standard DFMA additional cost to capture un-enumerated elements/activities.
Markup	25% of all components	\$15.55	Manufacturer's Markup
<b>Total</b>		<b>\$77.74</b>	

Figure 227. System controller component costs

Annual Production Rate	1,000	10,000	20,000	50,000	100,000	500,000
System Controller	\$162	\$143	\$130	\$97	\$91	\$78
<b>Total Cost (\$/system)</b>	<b>\$162</b>	<b>\$143</b>	<b>\$130</b>	<b>\$97</b>	<b>\$91</b>	<b>\$78</b>
<b>Total Cost (\$/kWnet)</b>	<b>\$2.02</b>	<b>\$1.78</b>	<b>\$1.62</b>	<b>\$1.21</b>	<b>\$1.13</b>	<b>\$0.97</b>

Figure 228. Cost breakdown for system controller

### 9.2.6 Sensors

Aside from the air mass flow sensor (which is book-kept as part of the air loop), there are two types of sensors in the fuel cell system: current sensors and voltage sensors. In 2017, hydrogen sensors within the fuel cell system were deemed to not be necessary (although they may still appear on the vehicle as part of the hydrogen storage system or in the passenger cabin). The basic sensor descriptions and their costs are listed in Figure 229 and Figure 230.

Component	Description	Cost at 500k systems/year	Cost Basis
Current Sensor (for stack current)	~400A, Hall Effect transducer	\$9.40	Based on LEM Automotive Current Transducer HAH1BV S/06, 400A
Current Sensor (for CEM motor current)	~400A, Hall Effect transducer	\$9.40	Based on LEM Automotive Current Transducer HAH1BV S/06, 400A
Voltage Sensor	225-335 V	\$7.52	Rough estimate based on a small Hall Effect sensor in series with a resistor
<b>Total</b>		<b>\$26.32</b>	

Figure 229. Sensor details

Annual Production Rate	1,000	10,000	20,000	50,000	100,000	500,000
Current Sensors (\$/system)	\$19	\$19	\$19	\$19	\$19	\$19
Voltage Sensors (\$/system)	\$8	\$8	\$8	\$8	\$8	\$8
Air/H <sub>2</sub> Differential Pressure Sensor (\$/system)	\$172	\$121	\$109	\$95	\$86	\$67
<b>Total Cost (\$/system)</b>	<b>\$199</b>	<b>\$148</b>	<b>\$136</b>	<b>\$121</b>	<b>\$112</b>	<b>\$93</b>
<b>Total Cost (\$/kWnet)</b>	<b>\$2.48</b>	<b>\$1.85</b>	<b>\$1.69</b>	<b>\$1.52</b>	<b>\$1.40</b>	<b>\$1.17</b>

Figure 230. Cost breakdown for sensors

### 9.2.6.1 Current Sensors

The current sensors are located on the stack, and allow the system controller to monitor the current being produced.

### 9.2.6.2 Voltage Sensors

The voltage sensors are located on the stack, and allow the system controller to monitor the voltage being produced.

### 9.2.6.3 Air/H<sub>2</sub> Differential Pressure Sensor

The air/H<sub>2</sub> differential pressure sensor is located between the fuel inlet to the stack anode and the inlet to the air side. This sensor allows the system controller to monitor the pressure differential between anode and cathode within the stack.

## 9.2.7 Miscellaneous BOP

The BOP components which do not fit into any of the other categories are listed here in the miscellaneous section.

Figure 231 shows the cost breakdown for these components.

Annual Production Rate	1,000	10,000	20,000	50,000	100,000	500,000
Belly Pan (\$/system)	\$59	\$10	\$8	\$7	\$5	\$5
Hydrogen/Air Mixer (\$/system)	\$8	\$8	\$8	\$8	\$8	\$8
Mounting Frames (\$/system)	\$94	\$60	\$40	\$31	\$28	\$28
Wiring (\$/system)	\$76	\$69	\$66	\$64	\$63	\$61
Fasteners for Wiring & Piping (\$/system)	\$15	\$14	\$13	\$13	\$13	\$12
<b>Total Cost (\$/system)</b>	<b>\$253</b>	<b>\$161</b>	<b>\$135</b>	<b>\$123</b>	<b>\$118</b>	<b>\$114</b>
<b>Total Cost (\$/kWnet)</b>	<b>\$3.16</b>	<b>\$2.01</b>	<b>\$1.69</b>	<b>\$1.53</b>	<b>\$1.47</b>	<b>\$1.43</b>

Figure 231. Cost breakdown for miscellaneous BOP components

### 9.2.7.1 Belly Pan

The belly pan is modeled as a 1 x 1.5 m shallow rectangular pan, bolted to the underside of the fuel cell system to protect it from weather and stone strikes.

The belly pan manufacturing process is modeled as a vacuum thermoforming process, in which thin polypropylene sheets are softened with heat and vacuum drawn onto the top of a one-sided mold. The capital cost of the vacuum thermoforming machine is approximately \$300,000 and utilizes an optional automatic loading system, which costs another \$200,000. If manual loading is selected, the process requires one laborer per line, instead of the 1/4 laborer facilitated by the automatic loading system. The analysis shows that the automatic system is only cost-effective at the 500,000 systems per year

production rate. Naturally, the loading option also changes the time per part; the vacuum time is 8 seconds per part, on top of which the insertion time adds another 11.2 seconds for the manual loading or 2 seconds for the automatic method. The process parameters are shown in Figure 232, and the machine rate parameters are shown in Figure 233.

Annual Production Rate	1,000	10,000	20,000	50,000	100,000	500,000
Equipment Lifetime (years)	8	8	8	15	15	15
Interest Rate	10%	10%	10%	10%	10%	10%
Corporate Income Tax Rate	40%	40%	40%	40%	40%	40%
Capital Recovery Factor	0.229	0.229	0.229	0.175	0.175	0.175
Equipment Installation Factor	1.4	1.4	1.4	1.4	1.4	1.4
Maintenance/Spare Parts (% of CC)	5%	5%	5%	5%	5%	5%
Miscellaneous Expenses (% of CC)	6%	6%	6%	6%	6%	6%
Power Consumption (kW)	30	30	30	35	35	40

Figure 232. Belly pan thermoforming process parameters

Annual Production Rate	1,000	10,000	20,000	50,000	100,000	500,000
Machine Selection	Vacuum Thermo-former #1	Vacuum Thermo-former #1	Vacuum Thermo-former #1	Vacuum Thermo-former #2	Vacuum Thermo-former #2	Vacuum Thermo-former #2
Assembly Type	Manual	Manual	Manual	Manual	Manual	Auto
Capital Cost (\$/line)	\$50,000	\$50,000	\$50,000	\$250,000	\$250,000	\$655,717
Costs per Tooling Set (\$)	\$96,352	\$96,352	\$96,352	\$96,352	\$96,352	\$96,352
Tooling Lifetime (years)	3	3	3	3	3	3
Cavities per platen	1	1	1	1	1	1
Total Cycle Time (s)	71.20	71.20	71.20	15.20	15.20	7.00
Simultaneous Lines	1	1	1	1	1	1
Laborers per Line	1	1	1	1	1	0.5
Line Utilization	0.6%	5.9%	11.8%	6.3%	12.6%	28.9%
Effective Total Machine Rate (\$/hr)	\$1,136.85	\$156.88	\$102.44	\$468.25	\$258.32	\$265.09
Material Cost (\$/kg)	\$1.48	\$1.48	\$1.48	\$1.48	\$1.48	\$1.48

Figure 233. Machine rate parameters for belly pan thermoforming process

Because of the extremely soft nature of the hot polypropylene and the low impact of the process, each mold (~\$85,056) will easily last the entire lifetime of the thermoforming machine. However, belly pan designs are likely to change well before the forming machine wears out, so the mold's lifetime is set at three years. This means that the tooling costs are sufficiently low to ignore at all but the 1,000 systems per year level, where they account for almost 4% of the part cost. Figure 234 shows the cost breakdown.

Annual Production Rate	1,000	10,000	20,000	50,000	100,000	500,000
Material (\$/system)	\$4	\$4	\$4	\$4	\$4	\$4
Manufacturing (\$/system)	\$21	\$3	\$2	\$2	\$1	\$0
Tooling (\$/system)	\$34	\$3	\$2	\$1	\$0	\$0
<b>Total Cost (\$/system)</b>	<b>\$59</b>	<b>\$10</b>	<b>\$8</b>	<b>\$7</b>	<b>\$5</b>	<b>\$5</b>
<b>Total Cost (\$/kWnet)</b>	<b>\$0.74</b>	<b>\$0.13</b>	<b>\$0.10</b>	<b>\$0.08</b>	<b>\$0.07</b>	<b>\$0.06</b>

Figure 234. Cost breakdown for belly pan

### 9.2.7.2 Hydrogen/Air Mixer

A hydrogen/air mixer component is included in the system for 2018. The mixer essentially dilutes the hydrogen exhaust line gas to below flammable limits to address safety concerns. The DFMA<sup>®</sup> analysis of the H<sub>2</sub>/Air mixer is conceptually based on a combination of GM and Honda patents for an aluminum fuel diluter exhaust system.<sup>121,122</sup> Figure 235 shows the diagram from the Honda patent that was used for the basic concept, estimating sizing components, and assembly method. Baffles were added (as discussed in the GM patent) to allow proper mixing of the exhaust gas flows. Welding is assumed to join the two aluminum chambers. Figure 236 shows the cost breakdown for the hydrogen/air mixer.

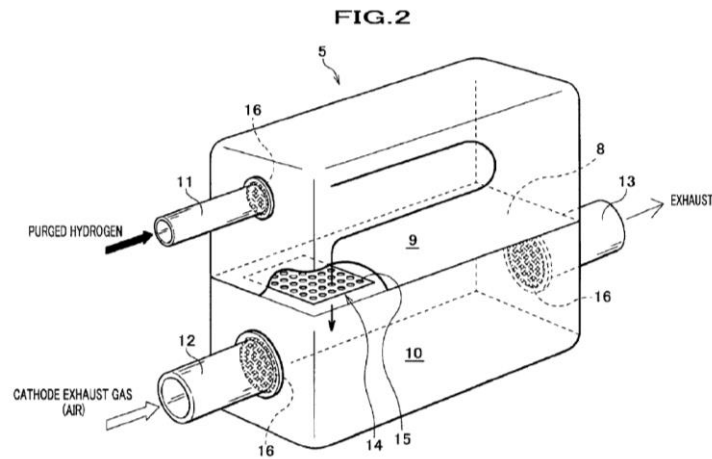


Figure 235. Diagram from Honda Patent US 6,916,563 B2 for fuel diluter (H<sub>2</sub>/Air Mixer)

Annual Production Rate	1,000	10,000	20,000	50,000	100,000	500,000
Material (\$/system)	\$4	\$4	\$4	\$4	\$4	\$4
Manufacturing (\$/system)	\$4	\$4	\$4	\$4	\$4	\$4
<b>Total Cost (\$/system)</b>	<b>\$8</b>	<b>\$8</b>	<b>\$8</b>	<b>\$8</b>	<b>\$8</b>	<b>\$8</b>
<b>Total Cost (\$/kWnet)</b>	<b>\$0.10</b>	<b>\$0.10</b>	<b>\$0.10</b>	<b>\$0.10</b>	<b>\$0.10</b>	<b>\$0.10</b>

Figure 236. Cost breakdown for hydrogen/air mixer

### 9.2.7.3 Mounting Frames

It is assumed that the fuel cell power system would be built as a subsystem, and then hoisted as an assembly into the automotive engine compartment. Consequently, the power system attaches to a mounting frame substructure to allow easy transport. These mounting frames are assumed to be contoured steel beams with various attachment points for power system components, facilitating

<sup>121</sup> US 2011 Patent 7,878,298 B2

<sup>122</sup> US 2005 Patent 6,916,563 B2

attachment to the vehicle chassis. The cost is roughly estimated at \$30 at 500,000 systems per year to \$100 at 1,000 systems per year.

#### **9.2.7.4 Wiring**

Wiring costs include only wiring materials as wiring installation costs are covered under the system assembly calculations.

A conceptual fuel cell system wiring schematic (Figure 237) was created to determine where cables were needed and whether they were for transmission of data, power, or both. Cable types, detailed in Figure 238, are selected based on the maximum current required by each electrical component.

With the exception of the heavy-duty power cables attached to the current collectors, every cable is comprised of multiple wires. Each cable also requires a unique type of connector, of which two are needed for each cable.

It is assumed that the wires and connectors would be purchased rather than manufactured in-house, with high-volume pricing estimates obtained for the cable components from Waytek, Inc. Taking into account the required length of each cable, the number of wires per cable, and selecting the appropriate connectors, the component prices are applied to the wiring bill of materials and the total wiring cost is calculated for each system (see Figure 239).

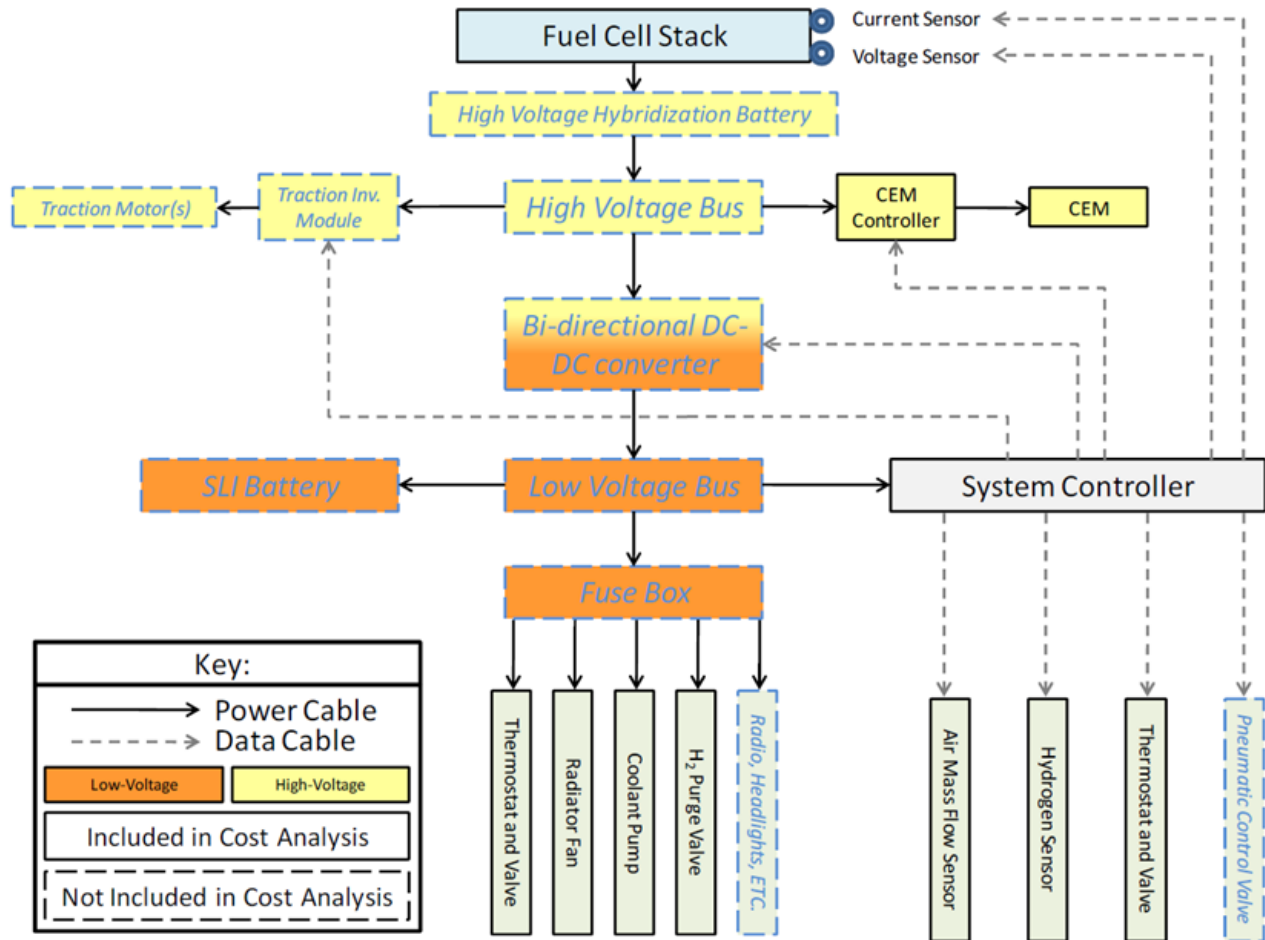


Figure 237. Fuel cell system wiring schematic

	Quantity	Length (m)
<b>Cable Types</b>		
Power Cable, 0000 Gauge	2	0.5
Power Cable, 6 Gauge	1	0.25
Power Cable, 7 Gauge	4	3.5
Power Cable, 12 Gauge	3	3
Power Cable, 16 Gauge	10	9
<b>Totals</b>	<b>20</b>	<b>16.25</b>

Figure 238. Wiring details

	1,000	10,000	20,000	50,000	100,000	500,000
Cables (\$/system)	\$27	\$24	\$23	\$23	\$23	\$22
Connectors (\$/System)	\$49	\$44	\$42	\$41	\$41	\$39
<b>Total Cost (\$/system)</b>	<b>\$76</b>	<b>\$69</b>	<b>\$66</b>	<b>\$64</b>	<b>\$63</b>	<b>\$61</b>
<b>Total Cost (\$/kWnet)</b>	<b>\$0.95</b>	<b>\$0.86</b>	<b>\$0.82</b>	<b>\$0.80</b>	<b>\$0.79</b>	<b>\$0.76</b>

Figure 239. Cost breakdown for wiring



### 9.2.7.5 Fasteners for Wiring & Piping

A detailed DFMA<sup>®</sup> analysis was not conducted for these components since the level of detailed required is well outside the bounds of this project. However, these components are necessary and, in aggregate, are of appreciable cost. Cost is estimated at 20% of the wiring and piping cost.

### 9.2.8 System Assembly

A detailed analysis of system assembly was not conducted since that would require detailed specification of all assembly steps including identification of all screws, clips, brackets, and a definition of specific component placement within the system. Such an analysis is beyond the scope of this project. Instead, an estimate of system assembly time is obtained by breaking the system down into five categories of assembly components (major, minor, piping, hoses, wiring), estimating the number of components within each category, and then postulating a time to assemble each of those components. Specific assumptions and total estimated assembly time for manual assembly are shown in Figure 240.

	Number of Components	Component Placement Time (seconds)	Component Fixation Time (seconds)	Component Totals (minutes)
<b>Major Components (Stack, motors, pumps, vessels, etc.)</b>	<b>19</b>	<b>45</b>	<b>60</b>	<b>33.3</b>
<b>Minor Components (instruments, devices, etc.)</b>	<b>22</b>	<b>30</b>	<b>45</b>	<b>27.5</b>
<b>Piping</b>				
# of pipe segments		<b>5</b>		
bends per segment		<b>2</b>		
time per bend		<b>0</b>		
pipe placement time		<b>30</b>		
# welds per pipe		<b>2</b>		
weld time		<b>90</b>		
# threaded ends per pipe		<b>0</b>		
threading time		<b>0</b>		
				<b>17.5</b>
<b>Hoses</b>	<b>21</b>	<b>30</b>	105	<b>47.3</b>
<b>Wiring (manual)</b>	<b>23</b>	<b>41.8</b>	66.7	<b>41.6</b>
<b>System Basic Functionality Test</b>				<b>10.0</b>
<b>Total System Assembly Time</b>				<b>177.1</b>

Figure 240. Single-station system assembly assumptions

Two types of system assembly methods are examined: single-station and assembly line. In single-station assembly approach, a single workstation is used to conduct assembly of the entire fuel cell power plant. Very little custom machinery is needed to assemble the system and components and subsystems are arrayed around the workstation for easy access. For 1,000 systems per year, only one such workstation is required. Assembly process parameters are listed in Figure 241.

Annual Production Rate	1,000	10,000	20,000	50,000	100,000	500,000
Assembly Method	Assembly Line	Assembly Line	Assembly Line	Assembly Line	Assembly Line	Assembly Line
Index Time (min)	99.06	79.25	79.25	79.25	79.25	79.25
Capital Cost (\$/line)	\$180,000	\$360,000	\$360,000	\$360,000	\$360,000	\$360,000
Simultaneous Lines	1	1	1	1	2	9
Laborers per Line	18	18	18	18	18	18
Line Utilization	2.2%	18.0%	36.0%	90.0%	90.0%	99.9%
Effective Total Machine Rate (\$/hr)	\$1,865.29	\$1,220.02	\$1,112.48	\$1,047.95	\$1,047.95	\$1,028.44
Cost per Stack (\$)	\$189	\$99	\$90	\$85	\$85	\$83

**Figure 241. System assembly process parameters**

The assembly for all other annual production rates uses a ten-workstation assembly line configuration. Each fuel cell system flows through the assembly line sequentially. The line reduces the total cumulative time required for system assembly because workers at each workstation on the line have their tools and components closer at hand than they do under the single workstation approach, and because tool changes are minimized due to the higher repetitive nature of an assembly line. This method is approximately 20% faster than the single-workstation approach, with an assembly line index time<sup>123</sup> of only 14.2 minutes. The system assembly cost is detailed in Figure 242.

Annual Production Rate	1,000	10,000	20,000	50,000	100,000	500,000
System Assembly & Testing (\$/System)	\$189	\$99	\$90	\$85	\$85	\$83
Total Cost (\$/system)	\$189	\$99	\$90	\$85	\$85	\$83
Total Cost (\$/kWnet)	\$2.37	\$1.24	\$1.13	\$1.06	\$1.06	\$1.04

**Figure 242. Cost breakdown for system assembly & testing**

### 9.2.9 System Testing

A ten-minute system functionality and performance test is included in the system assembly process. Each stack has separately undergone multiple hours of testing as part of stack conditioning and thus there is high confidence in the stack performance. System testing is only needed to ensure that the peripheral systems are functioning properly and adequately supporting the stack. Typically, the only testing of gasoline engines contained within automobiles is a simple engine startup as the vehicles are driven off the assembly line. Corresponding, the fuel cell “engines” are only minimally tested for functionality. Cost for this system testing is reported under system assembly.

### 9.2.10 Cost Contingency

It is common practice in the automotive industry to include a 10% cost contingency to cover the cost of procedures or materials not already explicitly included in the analysis. This serves as a guard against an underestimation of cost which can derail a cost estimator’s career within the automotive industry. However, no such cost contingency has been included in this cost analysis upon the request of the DOE.

<sup>123</sup> Assembly line index time is defined as the time interval each system spends at a given workstation.

## 10 Medium Duty Fuel Cell Truck Power System

In addition to the annual automotive fuel cell power system cost update, a full DFMA<sup>®</sup>-style cost analysis of a Class 6 MD truck fuel cell power system is considered for the first time in 2018 and follows-on to the truck FC system scoping study conducted for the 2017 cost report. Additional MDV or HDV fuel cell truck systems will be analyzed in the fourth year of the project's 5-year period. However, the details of that future study are not yet defined and could be an update to the present 2018 MDV system, a different class (or application) MDV system, or an HDV system.

The technology used within many of the current demonstrations of MDV/HDV fuel cell systems is very similar to systems installed in fuel cell buses (Ballard, US Hybrid, Hydrogenics). This is not surprising since transit buses are a type of heavy duty vehicle. However, in general, trucks and busses differ in how they use power: both use FC power to propel the vehicle but transit buses tend to also have high (and generally continuous) electrical loads for cabin heating and cooling, and MDV/HDV trucks tend to utilize more power for hauling heavier loads. However, these differences don't affect basic fuel cell construction or operation and US Hybrid and Hydrogenics agreed that the fuel cell systems installed in buses require only slight modification to be used in fuel cell trucks.

Additionally, the 2018 auto and 2018 MDV power plants are also very similar in construction and operation but possess key differences in:

- power level, operating pressure, operating temperature, and catalyst loading,
- manufacturing rate
- system lifetime, and
- level of vertical integration.

The following section details the key differences between auto and MDV power systems. If no difference is documented in this section, the details of material selection, manufacturing processes, and system design are assumed to be the same as the automotive system.

### 10.1 MDV Truck Power System Overview

#### 10.1.1 Comparison with Automotive Power System

Figure 243 below is a basic comparison summary of the 2018 auto and 2018 MDV systems. As shown, most stack mechanical construction and system design features are identical between the truck and automotive power plants. Primary system differences include:

- Use of two  $\sim 98 \text{ kW}_{\text{gross}}$  fuel cell stacks to achieve a net system power of  $160 \text{ kW}_{\text{net}}$  (instead of one  $\sim 90 \text{ kW}_{\text{net}}$  stack for an  $80 \text{ kW}_{\text{net}}$  power level as used in the automotive system)
- Higher cell platinum loading ( $0.35 \text{ mgPt/cm}^2$  instead of  $0.125 \text{ mgPt/cm}^2$  as used in the automotive system)
- Differences in cell active area and number of active cells per stack
- Higher system voltage (reflecting two stacks electrically in series and the desire to keep current below 400 amps)

- Operation at 2.35 atm (instead of 2.5 atm as used in the automotive system)
- Use of a multi-lobe air compressor (based on an Eaton-style design) without an exhaust gas expander (instead of a centrifugal-compressor/radial-inflow-expander based on a Honeywell-style design as used in the automotive system)
- Reduced stack operating temperature (63°C instead of 95°C as used in the auto system)
- Increased size of balance of plant components to reflect higher system gross power

## 10.2 MDV System Performance Parameters

The MDV and automotive power systems function in nearly identical fashion but have different power levels, flow rates, and pressure levels. The following sections describe the sizing methodology and values for key parameters of the truck power system.

### 10.2.1 Power Level

To provide sufficient power, two 80 kW<sub>net</sub> stacks are used, for a total net electrical power of 160 kW. This power level came out of the scoping study conducted in 2017, which, in turn, was based on a 2016 ANL analysis.<sup>124</sup> The ANL study found that over a range of 12 different MDV/HDV vocations, a majority of the MDV truck systems required an average 168kW of rated power. The average value was rounded down to 160kW since modeling a system which is an even multiple of 80 kW has the additional advantage of allowing a comparison between a dedicated MDV system and a pair of automotive systems.

### 10.2.2 Polarization Performance Basis

Stack performance within the MDV system is based on Argonne National Laboratory recommended values for MDVs and HDVs with deliberate consideration of higher Pt loadings for 25,000 hour durability and relaxed Q/DT constraint for commercial vehicles. ANL considered both Pt catalysts (as representative of near-term fuel cell buses) and Pt alloy cathode catalysts (as extensions of LDV fuel cell systems for heavier vehicle application). The ANL recommended system mimics that used with the Toyota Mirai LDV and also has been demonstrated in nearly 10,000 miles of drayage operation at the Ports of Long Beach with their “Alpha” truck containing two Mirai fuel cell stacks.<sup>125</sup> This demonstrates the ability for two LDV fuel cell stacks to be used in a truck application. While ANL has modeled the PtCo/C cathode catalyst used in the Mirai, their modeling capabilities currently do not allow exact matching of the anticipated MDV operating conditions (reduced temperature and higher Pt loading). Consequently, power density estimates for 2018, 2020, and 2025 are projections based on the team’s best engineering judgment, with consideration of current Mirai performance, the improvements expected in the LDV polarization performance, and the altered truck operating conditions. The 2018 MDV power density is 1,178 mW/cm<sup>2</sup> which is very similar to the 2018 LDV power density of 1,183 mW/cm<sup>2</sup> and the estimated Mirai power density of 1,150 mW/cm<sup>2</sup>.

---

<sup>124</sup> “Driving an Industry: Medium and Heavy Duty Fuel Cell Electric Truck Component Sizing”, J.Marcinkoski, R.Vijayagopal, J.Kast, A.Duran, EVS29 Symposium Montréal, Québec, Canada, June 19-22, 2016. <https://www.evs24.org/wevajournal/volumes/volume.php>

<sup>125</sup> <https://www.autoblog.com/2018/07/31/toyota-next-iteration-fuel-cell-semi-truck/>

	2018 Auto Technology System	2018 MDV Technology System
Power Density (mW/cm <sup>2</sup> )	1,183	1,178
Total Pt loading (mgPt/cm <sup>2</sup> )	0.125	0.35
Net Power (kW <sub>net</sub> )	80	160
Gross Power (kW <sub>gross</sub> )	88.4	196.5
Cell Voltage (V)	0.657	0.68
Operating Pressure (atm)	2.5	2.35
Stack Temp. (Coolant Exit Temp) (°C)	95	63
Air Stoichiometry	1.5	1.5
Q/ΔT (kW/°C)	1.45	7.2
Active Cells	380	736
Membrane Material	14-micron Nafion® (850EW) supported on ePTFE	14-micron Nafion® (850EW) supported on ePTFE
Radiator/ Cooling System	Aluminum Radiator, Water/Glycol Coolant, DI Filter, Air Precooler	Aluminum Radiator, Water/Glycol Coolant, DI Filter, Air Precooler
Bipolar Plates	Stamped SS 316L with TreadStone Litecell™ Coating (Dots-R)	Stamped SS 316L with TreadStone Litecell™ Coating (Dots-A)
Air Compression	Centrifugal Compressor, Radial-Inflow Expander	Eaton-Style Multi-Lobe Compressor, Without Expander
Gas Diffusion Layers	150 microns (105 μm GDL, 45 μm MPL, uncompressed)	150 microns (105 μm GDL, 45 μm MPL, uncompressed)
Catalyst & Application	Slot Die Coating of: Cath.: Dispersed 0.1 mgPt/cm <sup>2</sup> PtCo/HSC Anode: Dispersed 0.025mgPt/cm <sup>2</sup> Pt/C	Slot Die Coating of: Cath.: Dispersed 0.3 mgPt/cm <sup>2</sup> PtCo/HSC Anode: Dispersed 0.05mgPt/cm <sup>2</sup> Pt/C
Air Humidification	Plate Frame Membrane Humidifier	Plate Frame Membrane Humidifier
Hydrogen Humidification	None	None
Exhaust Water Recovery	None	None
MEA Containment	R2R sub-gaskets, GDL hot-pressed to CCM	R2R sub-gaskets, GDL hot-pressed to CCM
Coolant & End Gaskets	Laser Welded(Cooling)/ Screen-Printed Polyolefin Elastomer (End)	Laser Welded(Cooling)/ Screen-Printed Polyolefin Elastomer (End)
Freeze Protection	Drain Water at Shutdown	Drain Water at Shutdown
Hydrogen Sensors	0 for FC System <sup>126</sup>	1 for FC System <sup>127</sup>
End Plates/ Compression System	Composite Molded End Plates with Compression Bands	Composite Molded End Plates with Compression Bands
Stack Conditioning (hours)	2	2

**Figure 243: Comparison table between 2018 auto and 2018 MDV technology systems**

<sup>126</sup> The 2 hydrogen sensors under the hood still remain within the system, however they are not carried under the fuel cell system cost anymore.

<sup>127</sup> In the 2017 and 2018 auto cost analyses, the number of sensors in the fuel cell compartment of the automobile was reduced to zero (from a previous level of 2). Consequently, the MDV sensor estimate is one more than the auto and is thus set at one sensor (for all three technology years).

Beginning-of-life (BOL) stack design conditions at peak power selected for the 2018, 2020, and 2015 MDV truck power systems are shown in Figure 244 compared to the 2016 bus analysis values. Between 2018, 2020, and 2025 truck systems, most parameters are the same except for the power density and Pt loading. The 2020 and 2025 power densities are based on projected improvements in future years.

	2016 Bus Analysis	2018 MDV Analysis	2020 MDV Analysis	2025 MDV Analysis
Cell Voltage (volts/cell)	0.659	0.68	0.68	0.68
Current Density (mA/cm <sup>2</sup> )	1,121	1,732	1,765	1,985
Power Density (mW/cm <sup>2</sup> )	739	1,178	1,200	1,350
Stack Pressure (atm)	1.9	2.35	2.35	2.35
Stack Temperature (outlet coolant temperature)	72°C	63°C	63°C	63°C
Air Stoichiometry	1.8	1.5	1.5	1.5
Total Catalyst Loading (mg/cm <sup>2</sup> )	0.5	0.35	0.35	0.30
Cells per System	758	736	736	736

Figure 244: 2016 bus fuel cell power system stack operating parameters compared to 2018, 2020, and 2025 MDV system operating parameters

As seen in Figure 245, the selected MDV truck power density is noted to be slightly lower than the design point chosen for the automotive systems (1,183 vs. 1,178 mW/cm<sup>2</sup>) and consequently results in a correspondingly (slightly) larger truck fuel cell stack.

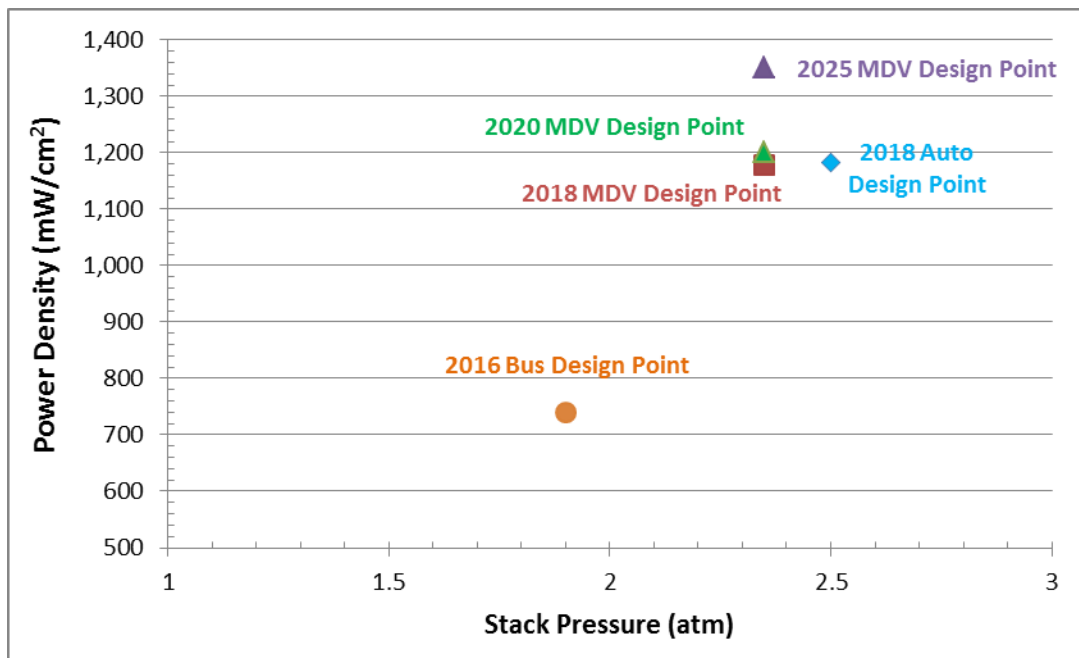


Figure 245: 2018, 2020, & 2025 MDV peak power design points compared to 2016 bus and 2018 auto power design points

### 10.2.3 Catalyst Loading

Catalyst loading is a key driver of system cost and significant effort on the part of fuel cell suppliers has gone towards its reduction. In general, bus and truck applications are less cost-sensitive and have longer lifetime requirements than automotive systems. Consequently, the MDV truck fuel cell stacks are more likely to have high catalyst loading since there is a general correlation between platinum loading and stack durability.<sup>128</sup> Past examination of 3M NSTF cell performance (as represented by ANL modeling results) and discussions with 3M researchers revealed that increases in cathode catalyst loading past  $\sim 0.2\text{mgPt}/\text{cm}^2$  result in declining polarization performance due to a catalyst crowding effect.<sup>129</sup> Such an effect is not expected for dispersed catalyst systems. For the MDV application, catalyst loading is set at  $0.35\text{ mgPt}/\text{cm}^2$  total loading (nominally  $0.3\text{mgPt}/\text{cm}^2$  on the cathode and  $0.05\text{mgPt}/\text{cm}^2$  on the anode) to be approximately consistent with the levels used in Mirai fuel cell stacks and to achieve a balance of performance, durability, and cost.

### 10.2.4 Catalyst Ink

The catalyst layer is formed by applying a catalyst ink to the membrane as described in the Section 9.1.4. The catalyst ink is based on a slurry of powder (d-PtCo/HSC for the cathode, Pt/C for the anode) and Nafion<sup>®</sup> with an aqueous methanol solution for a solvent. Ultrasonic mixing is used to ensure an even dispersion of powder within the slurry.

In 2016, feedback from catalyst suppliers prompted several changes to markups associated with Pt to reflect the unique safety/security aspects of a catalyst manufacturing facility. See Section 9.1.3.3 for a detailed description of markup applied to the auto catalyst: facilities for auto and truck catalyst are assumed to be the same.

### 10.2.5 Parasitic Load Requirements

MDV radiator fan power is based on ANL's fan power of 4.3 kW for an  $83\text{ kW}_{\text{net}}$  bus system and is scaled to the  $160\text{ kW}_{\text{net}}$  MDV system. This significant radiator fan power difference between the  $80\text{ kW}_{\text{net}}$  automotive (400W fan power) and  $160\text{ kW}_{\text{net}}$  bus/truck (8.26kW fan power) systems is due to the lower operating temperature of the bus and truck, the diminished use of ram air for the fuel cell due to possible fuel cell placement away for the hood compartment, and higher pressure drop through the radiator system due to radiator placement and size. The same component efficiencies are used in the MDV as in the automotive application: 45% fan efficiency, 90% fan motor efficiency, and 95% DC-DC converter efficiency. Other parasitic load requirements are listed below in Figure 246. The 2020 and 2025 MDV systems see much lower parasitic loads because of the added expander. The 2025 system

---

<sup>128</sup> Many factors affect stack lifetime and degradation rate. But to the extent that degradation is caused by platinum catalyst poisoning, reduction in surface area, and/or reduced utilization, high catalyst loading tends to correlate with longer lifetime.

<sup>129</sup> The term "catalyst crowding" is meant to represent the situation where the catalyst layer on the substrate whiskers of the NSTF catalyst layer becomes so thick that it blocks gas flow or otherwise adversely affects performance.

also has the benefit of a centrifugal compressor with higher efficiency than the roots compressor used on both the 2018 and 2020 systems.

<b>Parasitic Load (kW)</b>	<b>2016 Bus</b>	<b>2018 MDV</b>	<b>2020 MDV</b>	<b>2025 MDV</b>
Air Compressor Shaft Power	23.74	25.37	18.55	12.40
Air Compressor/Motor Input Required (gross)	24.99	26.71	19.52	15.50
High-Temperature Coolant Loop Pump	1.15	1.15	1.15	1.15
High-Temperature Coolant Loop Radiator Fan	8.26	8.26	8.26	8.26
Low-Temperature Coolant Loop Pump	0.11	0.14	0.14	0.12
Other (Controller, Instruments, etc.)	0.2	0.2	0.2	0.2
<b>Total Parasitic Loads</b>	<b>34.71</b>	<b>36.46</b>	<b>29.27</b>	<b>26.24</b>

**Figure 246. Table of parasitic loads for the 2016 Bus and 2018, 2020, & 2025 MDV systems**

### 10.2.6 Operating Pressure

Bus systems typically operate (eg. Ballard FC buses<sup>130</sup>) at a stack pressure of ~1.8 atm (at rated power) and do not employ an exhaust gas expander. This same design feature (no expander) is also employed for the 2018 MDV system, albeit at a higher operating pressure, 2.35 atm, to match the pressure of the Mirai.

An exhaust gas expander is not used in the 2018 MDV system, in contrast to the optimized automotive system operating conditions of 2.5 atm with expander. However, the 2020 and 2025 systems have expanders to reduce the parasitic loads of the system. A detailed operating pressure trade-off study (i.e. varying stack operating pressure to determine the lowest system cost) was not conducted as polarization performance is not yet available at the higher catalyst loadings expected to be employed to ensure durability. However, a preliminary trade-off was conducted with results confirming the decision (for 2020 and 2025) to shift to an expander system.

### 10.2.7 Stack Operating Temperature

The MDV systems are assumed to operate at lower temperatures than the automotive system. This comes from the idea that bus fuel cell systems tend to operate at cooler temperatures. It is noted that Ballard reports their fuel cell bus stack temperatures at only 60 °C. The reasons for this are several-fold. First, the system may not typically operate at rated power for long enough times for stack temperature to rise to its nominal value. This is particularly true for a bus power plant for which, depending on the bus route, maximum power may be demanded only a low fraction of the time. Second, various stack and membrane failure mode mechanisms are associated with high temperature. Thus it may be desirable to deliberately limit stack peak temperature as a means to achieving the stack lifetime goal of >12,000 hours (this is less of a concern for auto applications with lower lifetime requirements). Thirdly, higher stack temperature reduces the size of the heat rejection temperature since it increases the temperature

<sup>130</sup> Ballard FCvelocity®-HD6 Spec Sheet. <http://www.ballard.com/fuel-cell-products/fc-velocity-hd6.aspx> Accessed 9 October 2012.



difference with the ambient air. For an automobile, volume and frontal area are at a premium under the hood. Minimizing the size of the radiator is important for the auto application but is less important for the bus application where radiators may be placed on the roof. Thus, there are several good reasons—and fewer disadvantages—in selecting a low operating temperature for the bus and MDV systems compared to the auto application.

In consultation with ANL, an operating temperature of 63°C is chosen to match the Toyota Mirai for all three technology years.

### 10.2.8 Q/ΔT Radiator Constraint

A Q/ΔT radiator constraint of <1.45 kW/°C was applied to the automotive system for the first time in 2013. However, such a radiator constraint is not applied to the MDV fuel cell system because 1) trucks are larger vehicles and have generally larger frontal areas to accommodate radiators, and 2) an appropriate numerical Q/ΔT constraint is not obvious.<sup>131</sup> Additional analysis to determine the appropriate Q/ΔT constraint is needed before it can be imposed.

### 10.2.9 Cell Active Area and System Voltage

Because the system consists of two stacks electrically in series, system voltage has been set to 500 V at design conditions.<sup>132</sup> This system voltage represents a doubling relative to the automotive system and is necessary to maintain the total electrical current below 400 amps. These values are broadly consistent with the Ballard fuel cell bus voltage range<sup>133</sup> of 465 to 730 V. Specific cell and system parameters are detailed in Figure 247 for beginning-of-life (BOL) conditions.

Parameter	Value
Cell Voltage (BOL at rated power)	0.68 V/cell
System Voltage (BOL at rated power)	500 V
Number of Stacks	2
Active Cells per Stack	368
Total Cells per System	736
Active Area per Cell	227 cm <sup>2</sup>
Stack Gross Power at Rated Power Conditions (BOL)	196.46 kW

Figure 247: MDV stack parameters

## 10.3 Air Compression Units

The roots compressor-motor unit modeled as part of the 2016 bus DFMA<sup>®</sup> analysis is also used in the 2018 MDV system. Although no mobile fuel cell systems have demonstrated an air compression system

<sup>131</sup> The automotive Q/ΔT constraint of <=1.45 kW/°C was set by DOE per suggestion of the Fuel Cell Technical Team (FCTT). Neither the DOE nor the FCTT has set a comparable constraint for the bus or truck application.

<sup>132</sup> For purposed of the system cost analysis, design conditions correlate to rated maximum power at beginning of life.

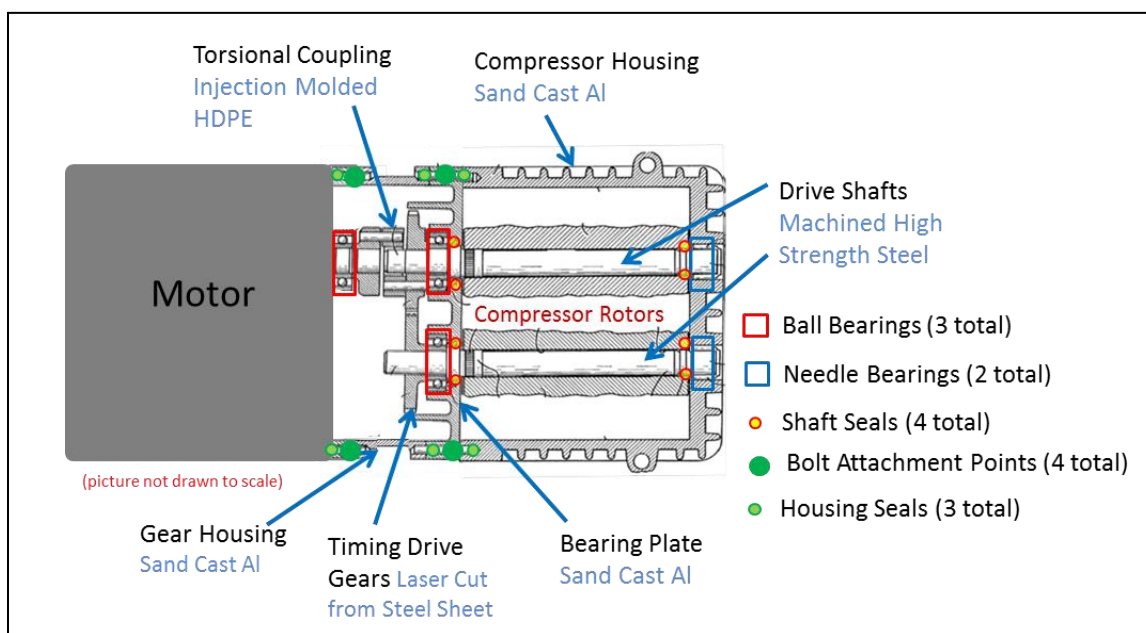
<sup>133</sup> Ballard FCvelocity<sup>®</sup>-HD6 Spec Sheet. <http://www.ballard.com/fuel-cell-products/fc-velocity-hd6.aspx> Accessed 9 October 2012.

with an exhaust gas expander, SA assumes the future 2020 and 2025 systems would have expanders to lower the parasitic load. Each section below describes the system used for each of the technology years.

### 10.3.1 Roots-Type Air Compressor-Motor for 2018 System

An Eaton-style twin vortex, Roots-type air compressor is selected for the 2018 MDV fuel cell system. A complete DFMA<sup>®</sup> analysis of the Eaton-style air compressor was conducted in 2013. Cost is projected at ~\$3,300 for a compressor unit at 100,000 units. The compressor is SA’s interpretation of a unit using Eaton technology and is modeled on Eaton’s R340 supercharger (part of Eaton’s Twin Vortices Series (TVS)) and Eaton’s DOE program.<sup>134</sup> Details of the cost analysis (as was used in the 2016 bus) can be viewed in SA’s 2016 final report.<sup>135</sup> For the MDV system, the cost was projected to much higher volumes (100,000 units per year) compared to the bus system (up to 1,000 units per year).

Figure 248 illustrates a cross-section view of the compressor-motor unit employing the Eaton-style design. The compressor-motor system efficiency values are the same as Eaton’s tested air compression system for the bus and are listed in Figure 250 along with the 2020 and 2025 air compression system efficiencies.



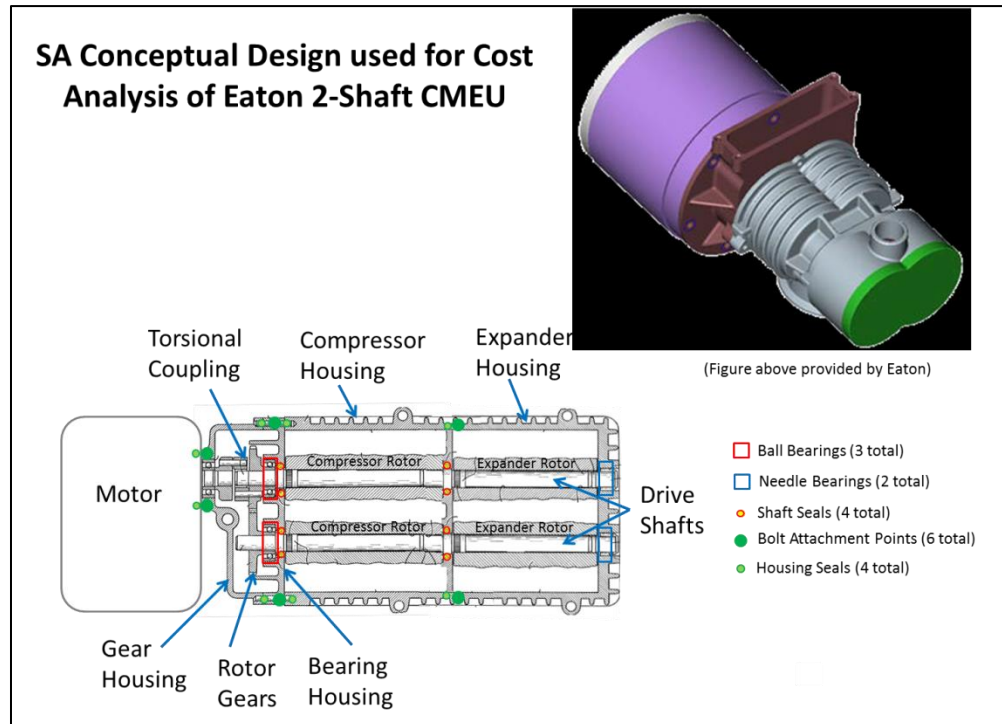
**Figure 248. Schematic of cross-section of compressor-motor unit used in the DFMA<sup>®</sup> cost analysis (Source: Drawing derivation from US patent 4,828,467: Richard J. Brown, Marshall, Mich. “Supercharger and Rotor and Shaft Arrangement Therefor”, Eaton Corporation, Cleveland, Ohio, May 9, 1989)**

<sup>134</sup> Eaton/DOE Contract Number DE-EE0005665.

<sup>135</sup> “Mass Production Cost Estimation of Direct H<sub>2</sub> PEM Fuel Cell Systems for Transportation Applications: 2016 Update” Brian D. James, Jennie M. Huya-Kouadio, & Cassidy Houchins, Strategic Analysis, Inc., December 2016.

### 10.3.2 Roots-Type Air Compressor-Expander-Motor for 2020 System

For the 2020 MDV system, an expander is added to the air compression system. In 2014, SA conducted a cost analysis of a two-shaft roots compressor-expander-motor unit based on an Eaton-style design as seen in Figure 249. The cost is estimated to be ~\$2,700 at 100,000 units per year. Although there are added components for the expander (compared the compressor-motor unit), the 2020 CEM unit is lower cost because of the lower shaft power, equating to a lower cost motor and motor controller.



**Figure 249. Schematic of cross-section of two-shaft compressor-expander-motor unit (CMEU) used in the DFMA<sup>®</sup> cost analysis. (Source: Drawing derivation from US patent 4,828,467: Richard J. Brown, Marshall, Mich. "Supercharger and Rotor and Shaft Arrangement Therefor", Eaton Corporation, Cleveland, Ohio, May 9, 1989)**

### 10.3.3 Centrifugal Air Compressor with Radial In-Flow Expander for 2025 System

The 2025 system is assumed to have a similar air compression system as the automotive fuel cell system, a centrifugal compressor with radial in-flow expander. The cost estimate is based on the Honeywell design as used for the automotive system (described in Section 9.2.1.1), but with air mass flow and compression ratio estimated for the MDV system.

Parameter	2018 Design	2020 Design	2025 Design
Unit Type	Roots Compressor-Motor Unit	Roots (two-shaft) CEM	Centrifugal Compressor/Radial Inflow Expander
Compression Ratio at Design Point	2.52	2.52	2.52
Air Flow Rate at Design Point	559 kg/hr (155 g/s)	538 kg/hr (150 g/s)	527 kg/hr (146 g/s)
Compression Efficiency <sup>136</sup> at Design Point	58%	58%	71%
Expander Efficiency <sup>137</sup> at Design Point	NA	59%	73%
Combined Motor and Motor Controller Efficiency <sup>138</sup>	95%	95%	80%

Figure 250: Details of the 2018, 2020, and 2025 air compression systems.

#### 10.4 MDV System Balance of Plant Components

To accommodate the increased flows and power level of a two-stack 160 kW<sub>net</sub> MDV system, many balance of plant (BOP) components are very similar, if not the same, to the bus system and differ from the automotive system. In some cases, the automotive DFMA<sup>®</sup>-style analysis of balance of plant components were adjusted in response to the larger MDV system design. In other cases, new quotes were obtained, part scaling was included, or individual parts were increased in number (e.g. some parts are used on each of the two stacks). The changes to auto BOP components to reflect an MDV system are summarized in Figure 251.

<sup>136</sup> Compression efficiency is defined as adiabatic efficiency.

<sup>137</sup> Expander efficiency is defined as adiabatic efficiency.

<sup>138</sup> Combined efficiency is defined as the product of motor efficiency and motor controller efficiency.

<b>Balance of Plant Item</b>	<b>MDV System Change from Auto System</b>
CEM & Motor Controller	DFMA <sup>®</sup> analysis scaled to new flow and pressure ratio parameters, but switched to design without Expander (2018 system only)
Air Mass Flow Sensor	New quote obtained for higher mass flow of MDV system
Air Temperature Sensor	No change
Air Filter & Housing	New quote obtained for higher mass flow of MDV system
Air Ducting	Piping and tubing diameters increased by a factor of 1.5 to adjust for higher mass flow of bus system
Stack Bypass Valve (3-way)	No change
Stack Shut-Off Valve (2-way)	Qty 4 instead of 1 (one on each inlet and outlet of each stack)
Air Bleed Orifice	No change
Air Precooler	DFMA <sup>®</sup> analysis scaled to new mass flow and temperature parameters.
Demister	Area size scaled by ratio of MDV to automotive air flows
Membrane Air Humidifier	DFMA <sup>®</sup> analysis scaled to new gas mass flow and temperature parameters
High Temperature Loop (HTL) Coolant Reservoir	New quote obtained for larger expected coolant liquid volume of MDV system
HTL Coolant Pump	New quote obtained for larger expected coolant flow of MDV system
HTL Coolant DI Filter	Size scaled by factor of 2 to correspond to higher expected coolant flow rates of MDV system
HTL Thermostat & Valve	New quote obtained for larger flow rate and pipe diameter of MDV system
HTL Radiator	DFMA <sup>®</sup> analysis scaled to new heat rejection and temperature parameters of DMV system
HTL Radiator Fan	New quote obtained corresponding to larger fan diameter and air flow rate parameters of MDV system
HTL Coolant piping	Piping and tubing diameters increased by a factor of 1.5 to adjust for higher coolant flow of MDV system
Low Temperature Loop (LTL) Coolant Reservoir	New quote obtained for larger expected coolant liquid volume of MDV system
LTL Coolant Pump	New quote obtained for larger expected coolant flow of MDV system
LTL Thermostat & Valve	New quote obtained for larger flow rate and pipe diameter of MDV system
LTL Radiator	DFMA <sup>®</sup> analysis scaled to new heat rejection and temperature parameters of MDV system
LTL Coolant Piping	Piping and tubing diameters increased by a factor of 1.5 to adjust for higher coolant flow of MDV system
Flow Diverter Valve	Quantity doubled to reflect use of two stacks in MDV system
Pressure Transducer	Quantity doubled to reflect use of two stacks in MDV system
Over-Pressure Cut-Off Valve	Quantity doubled to reflect use of two stacks in MDV system
Hydrogen Injector	Quantity doubled to reflect use of two stacks in MDV system
Hydrogen Ejector	Quantity doubled to reflect use of two stacks in MDV system
Check Valves	Three valves to reflect use of two stacks in MDV system and additional valve for H <sub>2</sub> recirculation
Hydrogen Purge Valve	No change

Hydrogen Piping	Piping and tubing diameters increased by a factor of 1.5 to adjust for higher hydrogen flow of MDV system
System Controller	Quantity doubled to reflect increased control/sensors data channels in MDV system
Current Sensors	Quantity doubled to reflect use of two stacks in MDV system
Voltage Sensors	Quantity doubled to reflect use of two stacks in MDV system
Hydrogen Sensors	One sensor added to fuel cell compartment to reflect much larger volume of MDV fuel cell system
Belly Pan	No change
H <sub>2</sub> /Air Mixer	No change
Mounting Frames	Size increased to reflect use of two stacks and larger BOP component in MDV system
Wiring	Cost doubled to reflect use of two stacks in MDV system
Wiring Fasteners	Cost doubled to reflect use of two stacks in MDV system

**Figure 251: Explanation of BOP component scaling for MDV power plant**

## 11 Capital Equipment Cost (LDV Stacks)

Figure 252 and Figure 253 display the tabulation of automotive stack manufacturing/assembly processing steps along with the capital cost of each corresponding process train.<sup>139</sup> Multiple process trains are usually required to achieve very high manufacturing rates. The total capital cost (process train capital cost multiplied by the number of process trains) is also tabulated and shows that bipolar plate coating is the highest capital cost process of the stack. This tabulation is meant to give an approximate cost of the uninstalled capital required for automotive stack and BOP production at 500,000 vehicles per year. Some steps are not included in the tabulation as they modeled as purchased components and thus their equipment cost is not estimated. Furthermore, the capital equipment estimates do not include installation, buildings, or support infrastructure and thus should not be used as an estimate of total capital needed for power plant fabrication. Nonetheless, some insight may be obtained from this partial tabulation.

---

<sup>139</sup> A process train is a grouping of related manufacturing or assembly equipment, typically connected by the continuous flow of parts on a conveyor belt. For instance, the bipolar plate stamping process train consists of a sheet metal uncoiling unit, a tensioner, a 4-stage progressive stamping die, and a re-coil unit.

<b>Stack Manufacturing Machinery Capital Costs at 500,000 sys/yr</b>			
<b>Step</b>	<b>Capital Cost per Process Train</b>	<b>Number of Process Trains</b>	<b>Total Capital Cost</b>
<b>Bipolar Plate Stamping</b>	\$2,611,899	26	\$67,909,377
BPP Coating Step 1	\$2,400,220	17	\$40,803,740.30
BPP Coating Step 2	\$927,161	25	\$23,179,021.98
<b>BPP Coating</b>	\$3,327,381	14	\$63,982,762
<b>Membrane Production</b>	\$15,121,226	1	\$15,121,226
<b>Dispered Slot Die Coating</b>	Proprietary	2	Proprietary
<b>CCM Acid Wash</b>	\$907,000	22	\$19,954,000
<b>GDL</b>	Purchased Comp.		Not Incl.
<b>MEA Gasketing-Subgaskets</b>	\$2,938,600	2	\$5,877,200
<b>MEA Cutting and Slitting</b>	\$449,136	1	\$449,136
<b>MEA Gasketing - Screen Printed Coolant Gaskets</b>	\$1,458,755	17	\$24,798,842
<b>Coolant Gaskets (Laser Welding)</b>	\$1,744,133	40	\$69,765,312
<b>End Gaskets (Screen Printing)</b>	\$392,735	1	\$392,735
<b>End Plates</b>	\$402,589	3	\$1,207,766
<b>Current Collectors</b>	\$162,193	1	\$162,193
<b>Stack Assembly</b>	\$821,339	52	\$42,709,638
<b>Stack Housing</b>	\$655,717	1	\$655,717
<b>Stack Conditioning</b>	\$674,120	22	\$14,830,630
<b>Stack Total</b>			<b>\$307,862,534</b>

\* Bipolar plate coating is based on a vendor-proprietary manufacturing method that consists of multiple sub-process trains. The process train quantity listed is an average of the constituent sub-trains.

**Figure 252. Automotive stack manufacturing machinery capital costs at 500,000 systems per year**



<b>Balance of Plant Manufacturing Machinery Capital Costs at 500,000 sys/yr</b>			
<b>Step</b>	<b>Capital Cost per Process Train</b>	<b>Number of Process Trains</b>	<b>Total Capital Cost</b>
<b>Membrane Air Humidifier</b>	5,620,643	4	\$9,421,050
<b>Belly Pan</b>	655,717	1	\$655,717
<b>Ejectors</b>	<i>[Not Calculated]</i>	<i>N/A</i>	<i>[Not Calculated]</i>
<b>Stack Insulation Housing</b>	655,717	1	\$655,717
<b>Air Precooler</b>	<i>[Not Calculated]</i>	<i>N/A</i>	<i>[Not Calculated]</i>
<b>Demister</b>	318,221	1	\$318,221
<b>CEM</b>	<i>[Not Calculated]</i>	<i>N/A</i>	<i>[Not Calculated]</i>
<b>(Partial) BOP Total</b>	Does not include processes with un-calculated capital costs →		<b>\$11,050,704</b>

\* The membrane air humidifier involves an aluminum casting step which is not included in the capital equipment tabulation.

**Figure 253. Automotive balance of plant manufacturing machinery capital costs at 500,000 systems per year**

## 12 Quality Control Procedures

Although quality control (QC) is listed under individual component sections above, the authors felt it beneficial to the reader to have all QC systems summarized in one section to compare/contrast diagnostic techniques. The QC systems were last updated in 2015 to reflect further review and analysis by QC expert Mike Ulsh of NREL. Overall, a more rigorous definition of the quality control systems was established. The general approach for defining the new QC systems was to:

1. Postulate the required resolution for defect identification.
2. Specify equipment needed to achieve desired resolution at specified line speed.
3. Incorporate automatic adjustment (within the model) for web width processing that varies with production volume.
4. Identify and define QC equipment changes for low volume production processes.

When low volume processing assumptions changed, SA requested the expertise of NREL to identify changes required for the updated process. While under review, NREL suggested additional changes for high volume processes as well. A detailed table of the quality control equipment used for the 2018 baseline system at low volume (1,000 systems per year) and high volume (500k systems per year) is shown in Figure 254.

Part Tested	Baseline Diagnostic System (Low Volume)	Baseline Diagnostic System (High Volume)	Comment	Detection Resolution	Total QC Cost	Fault/Parameters Tested
<b>Membrane</b>	Optical Detection System (ODS)	Optical Detection System (ODS)		20 micron	\$205k (per line 1k and 500k sys/yr)	Visual inspection to locate pinholes in ionomer, discolorations that would indicate thickness variation
<b>Dispersed (slot die coating) Catalyst</b>	IR/DC QC System + XRF QC System	IR/DC QC System + XRF QC System	While IRDC gives full width uniformity, added XRF QC System can detect loading/thickness of electrode layers. XRF is most widely used today.	2,000 microns	1k sys/yr: = \$1.028M 500k sys/yr: = \$1.123M	IRDC gives full width uniformity, XRF loading/thickness restoring across web width.
<b>Gasketed MEA (Subgasket)</b>	Optical Detection System (ODS) (commercial system from Keyence) mounted above single stacked cell or on arm of robot.	Optical Detection System (ODS) (commercial system from Keyence)	At 1k sys/yr, ODS is mounted above the single stacked sub-gasketed cell or on the arm of the robot.	0.6mm	(1k sys/yr) \$50k (no conveyor system required) (500k sys/yr): \$210k	Misalignment of subgasket and membrane. Folds, bends, tears, scratches in subgasket or membrane.
<b>Bipolar Plate</b>	NIST Non-Contact Laser Triangulation Probe (\$70.6k)	NIST Non-Contact Laser Triangulation Probe, Optical Detection System (commercial system from Keyence) (\$100.6k)	At low volume, there is no ODS system. BPP stacking by worker can simultaneously inspect part so no ODS system needed.	~30 micron over 3 scan lines (one side of plate, 3 probes, single pass), 0.6 mm for Optical Camera (entire plate, one side)	(1k sys/yr): \$70.6k (no optical system) (500k sys/yr): \$100k	Triangulation: flow field depth, plate flatness. Optical System: general dimensions, completeness of manifold apertures.
<b>MEA (after cutting/slitting)</b>	NA	Optical Detection System (ODS) (commercial system from Keyence)	ODS can detect cracks and delamination.	0.6mm	(1k sys/yr): NA (500k sys/yr): \$210k	Thickness, cracks, delamination, misalignment of cutting/slitting.
<b>Air Humidifier Membrane Station B (inspection of ePTFE web)</b>	Optical Detection System	Optical Detection System	Set of line cameras to optically detect pinholes or other anomalies of top surface of ePTFE/ionomer membrane. Large anomaly detection size. Accounts for various web widths.	100 micron	(1k sys/yr): \$36.5k (30cm web width - 1 line camera) (500k sys/yr): \$92k (1 m web width - 4 line cameras)	Visual inspection to locate pinholes in ionomer, discolorations that would indicate thickness variation or other problems.

Figure 254. Summary of quality control systems used in stack and membrane humidifier manufacture.

### **13 Automotive Simplified Cost Model Function**

A simplified cost model to estimate the total automotive power system cost at 500,000 systems/year production rate is shown in Figure 255. The simplified model splits the total system cost into five subcategories (stack cost, thermal management cost, humidification management cost, air management cost, fuel management cost, and balance of plant cost) and generates a scaling equation for each one. The scaling equations for individual cost components are based on key system parameters for that component that are likely to be known to analysts conducting a general study. The curves are generated by regression analysis of data generated by successive runs of the full DFMA<sup>®</sup>-style cost model over many variations of the chosen parameters. The simplified model allows a quick and convenient method to estimate system cost at off-baseline conditions.

<b><math>C_{\text{system}} = \text{Total System Cost} = C_{\text{stack}} + C_{\text{thermal}} + C_{\text{Humid}} + C_{\text{air}} + C_{\text{Fuel}} + C_{\text{BOP}}</math></b>	
<p><b><math>C_{\text{stack}}</math> = Total Fuel Cell Stack Cost</b></p> <p>100 Volt, <math>C_{\text{stack}} = 1.97\text{E-}04 \times ((0.16485 \times A + 588.83) \times L \times PC) + (0.00988 \times A) + 167.41</math>  150 Volt, <math>C_{\text{stack}} = 1.97\text{E-}04 \times ((0.16485 \times A + 588.83) \times L \times PC) + (0.00955 \times A) + 200.32</math>  200 Volt, <math>C_{\text{stack}} = 1.97\text{E-}04 \times ((0.16485 \times A + 588.83) \times L \times PC) + (0.00924 \times A) + 245.22</math>  250 Volt, <math>C_{\text{stack}} = 1.97\text{E-}04 \times ((0.16485 \times A + 588.83) \times L \times PC) + (0.00900 \times A) + 295.05</math>  300 Volt, <math>C_{\text{stack}} = 1.97\text{E-}04 \times ((0.16485 \times A + 588.83) \times L \times PC) + (0.00883 \times A) + 342.03</math></p> <p>Where: <math>A</math> = Total active area of the stack (<math>\text{cm}^2</math>)  <math>L</math> = Pt Loading (<math>\text{mg}/\text{cm}^2</math>)  <math>PC</math> = Platinum cost (<math>\\$/\text{troy ounce}</math>)</p>	<p><b>Baseline Stack Cost: \$1,449</b></p>
<p><b><math>C_{\text{thermal}}</math> = Thermal Management System Cost</b></p> <p><math>= [94.0853 \times (Q_{\text{HT}} / \Delta T_{\text{HT}}) + 169.9283]</math></p> <p><math>+ 0.9144 \times (Q_{\text{LT}} / \Delta T_{\text{LT}})^2 + 101.5524 \times (Q_{\text{LT}} / \Delta T_{\text{LT}}) - 2.2211 \times P^2 + 20.8372 \times P - 2.4537 \times P \times (Q_{\text{LT}} / \Delta T_{\text{LT}}) - 10.4304</math></p> <p>Where: <math>Q_{\text{HT}}</math> = Radiator Duty (<math>\text{kW}_{\text{thermal}}</math>) of High Temperature Loop  <math>Q_{\text{LT}}</math> = Radiator Duty (<math>\text{kW}_{\text{thermal}}</math>) of Low Temperature Loop</p> <p><math>\Delta T_{\text{HT}}</math> = Difference between coolant outlet temperature from fuel cell stack and ambient temperature (<math>^{\circ}\text{C}</math>)  <math>\Delta T_{\text{LT}}</math> = Difference between coolant outlet temperature from air precooler and ambient temperature (<math>^{\circ}\text{C}</math>)  <math>P</math> = Stack Operating Pressure (atm)</p>	<p>*High Temperature Loop includes: coolant reservoir, coolant pump, coolant DI filter, coolant piping, thermostat &amp; valve, radiator fan, and radiator.</p> <p>*Low Temperature Loop includes: coolant reservoir, coolant pump, coolant piping, thermostat &amp; valve, and radiator.</p> <p><b>Baseline Thermal Management System Cost: \$371</b></p>
<p><b><math>C_{\text{Humid}}</math> = Humidification Management System Cost</b></p> <p><math>= (-1.48979 \times A^2 + 64.37770 \times A + 14.25859) + (642.03921 \times (Q / \Delta T) - 1.77204)</math></p> <p>Where: <math>A</math> = Humidifier Membrane Area (<math>\text{m}^2</math>)  <math>Q</math> = Heat Duty for Precooler (kW)  <math>\Delta T</math> = Delta Temp. (compr. exit air minus coolant temperature into air precooler)(<math>^{\circ}\text{C}</math>)</p>	<p>*Includes Air Precooler and Membrane Humidifier.</p> <p><b>Baseline Humidification Management System Cost: \$95</b></p>
<p><b><math>C_{\text{air}}</math> = Air Management System Cost</b></p> <p><math>= 284.96480 + (-57.0495 \times P^2) + (267.9631 \times P) + (42.7536 \times \text{PAR}) + (3.9115 \times P \times \text{PAR})</math></p> <p>Where: <math>P</math> = Air Peak Pressure (atm)  <math>\text{PAR}</math> = Parasitic Power (kW)</p>	<p>*Includes demister, compressor, expander, motor, motor controller, air mass flow sensor, air/stack inlet manifold, air temperature sensor, air filter and housing, and air ducting.</p> <p><b>Baseline Air Management System Cost: \$1,039</b></p>
<p><b><math>C_{\text{Fuel}}</math> = Fuel Management System Cost</b></p> <p>Blower Ejector Config. Cost = <math>(4722.05 \times \text{BP}^3 - 3685.92 \times \text{BP}^2 + 1953.79 \times \text{BP} + 109.06) + 262.39</math></p> <p>Where: <math>\text{BP}</math> = blower power (kW)</p> <p>Pulsed Ejector Config. Cost = \$213.09</p>	<p>*Includes valves, ejectors, hydrogen inlet and outlet of stack manifolds, piping, and recirculation blower. Baseline system does not include blower, therefore the Fuel Management System is a constant \$213</p> <p><b>Baseline Fuel Management System Cost: \$213</b></p>
<p><b><math>C_{\text{BOP}}</math> = Additional Balance of Plant Cost</b></p> <p>Where: <math>C_{\text{BOP}} = \\$368.58</math></p>	<p>*Includes system controllers, sensors, and miscellaneous components.</p> <p><b>Baseline Additional BOP Cost: \$369</b></p>

**Figure 255: Simplified automotive cost model at 500,000 systems per year production rate**

Because the simplified cost model equations are based upon regression analysis, there is an input parameter range outside of which the resulting cost estimates are not guaranteed to be accurate. The ranges for each parameter in each sub-equation are given in Figure 256 below.

<b>Validity Range for Stack Cost</b>				
<b>Parameter</b>	<b>Min Value</b>	<b>Baseline Value</b>	<b>Max Value</b>	<b>Units</b>
System Power	60	80	120	kW <sub>net</sub>
Stack Voltage	100	250	300	V
L	0.1	0.125	0.8	mg/cm <sup>2</sup>
A	56,080	74,702	112,147	cm <sup>2</sup>
PC	800	1,500	2,000	\$/troy ounce
<b>Validity Range for Thermal Management System</b>				
<b>Parameter</b>	<b>Min Value</b>	<b>Baseline Value</b>	<b>Max Value</b>	<b>Units</b>
$\Delta T_{HT}$	38	54	70	°C
$\Delta T_{LT}$	25	25	70	°C
$Q_{HT}$	57	80	120	kW
$Q_{LT}$	1.8	9	18	kW
P	1.5	2.5	3.0	atm
<b>Validity Range for Humidification Management System</b>				
<b>Parameter</b>	<b>Min Value</b>	<b>Baseline Value</b>	<b>Max Value</b>	<b>Units</b>
A	0.3	0.657	3	m <sup>2</sup>
Q	1.2	7.4	15	kW
$\Delta T$	40	118	151	°C
<b>Validity Range for Air Management System</b>				
<b>Parameter</b>	<b>Min Value</b>	<b>Baseline Value</b>	<b>Max Value</b>	<b>Units</b>
P	1.57	2.57	3.07	atm
PAR	4.09	8.37	15.29	kW
<b>Validity Range for Fuel Management System</b>				
<b>Parameter</b>	<b>Min Value</b>	<b>Baseline Value</b>	<b>Max Value</b>	<b>Units</b>
BP	0.2	0	0.3	kW

**Figure 256: Range of validity for simplified cost model parameters**

As a check on the accuracy of the simplified regression model, the results of the full DFMA<sup>®</sup> model are compared to the calculations from the simplified model for the parameter of system net power. These results are displayed in Figure 257 indicating very good agreement between the two models within the range of validity.

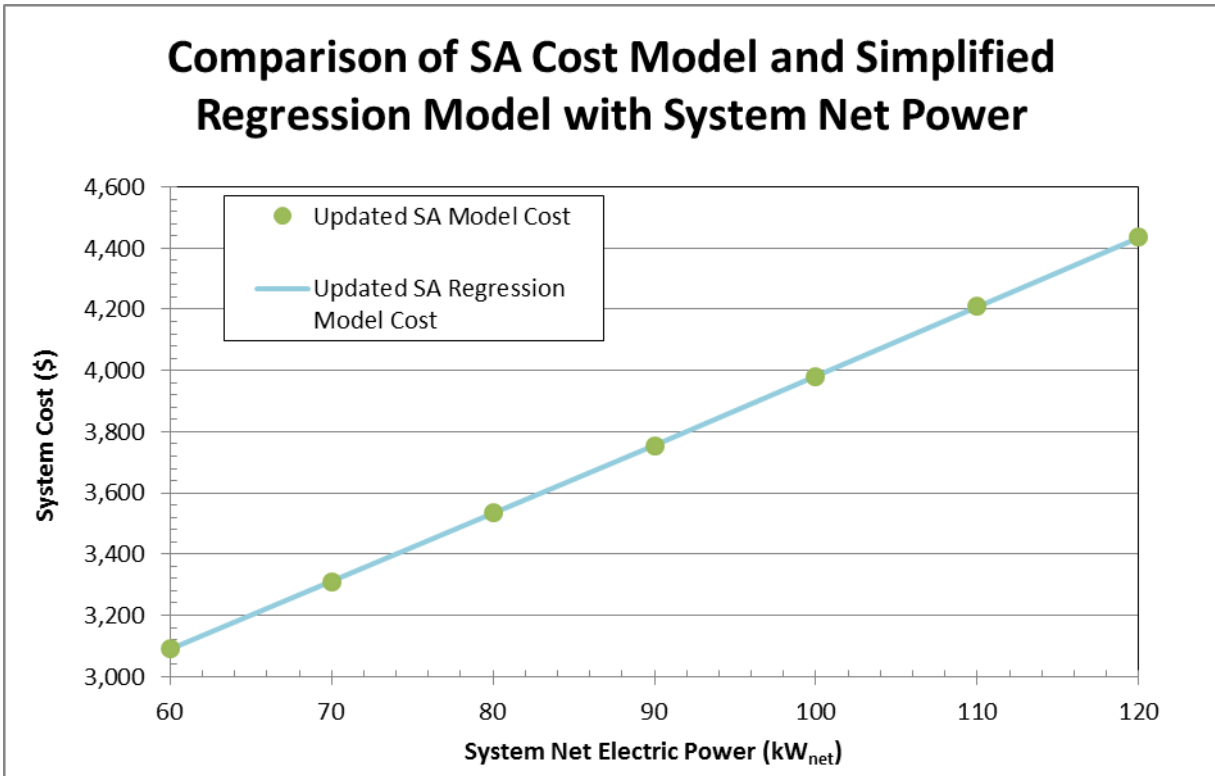


Figure 257: Comparison of SA cost model with simplified cost model at 500,000 systems per year.

## 14 Life Cycle Analysis (LCA)

Up-front cost per kW, while a useful metric and the primary focus of this report, is not the sole determining factor in market worthiness of a power system. Total life cycle cost is an equally important consideration that takes into account the initial purchase price, cost of fuel used over the lifetime of the system, system decommissioning costs and recycle credits, and operating and maintenance expenses, all discounted to the present value using a discounted cash flow methodology. By comparing life cycle costs, it is possible to determine whether an inexpensive but inefficient system (low initial capital cost but high operating and fuel expenses) or an expensive but efficient system (high initial capital cost but low operating and fuel expenses) is a better financial value to the customer over the entire system lifetime.

### 14.1 Platinum Recycling Cost

Since cost of the catalyst platinum within the fuel cell stacks represents a significant fraction of total system cost, particular attention is paid to recovering the Pt at the end of stack life. Two basic approaches are possible for allocating Pt cost:

- An ownership paradigm wherein the consumer buys the Pt contained within the stacks of the fuel cell vehicle, and thus the Pt has a value to the vehicle owner at the end of stack life. (This is the paradigm used in the baseline cost analysis and in the LCA.)
- A renting paradigm, wherein a precious metal dealer (such as Johnson-Matthey or the vehicle manufacturer) owns the Pt in the stacks, the Pt purchase price is not charged to the vehicle owner at the time of purchase, and the value of the Pt at the end of stack life accrues to the precious metal dealer (not to the vehicle owner). (This paradigm is not used in the baseline analysis or LCA but may be considered in future years.)

The ownership paradigm will now be more fully explored.

The life cycle cost analysis under the ownership paradigm is based upon adapting existing vehicular catalytic converter recycling parameters to expectations for a fuel cell system.<sup>140,141</sup> Based on analysis of platinum recycling conducted by Mike Ulsh at the National Renewable Energy Laboratory, total platinum loss during operation and recovery is estimated at:

- a 1% loss during operational life,
- 5% loss during recycling handling, and
- 2%-9% loss during the recycling process itself.<sup>142,143</sup>

---

<sup>140</sup> “The impact of widespread deployment of fuel cell vehicles on platinum demand and price,” Yongling Sun, et. al. *International Journal of Hydrogen Energy* 36 (2011).

<sup>141</sup> “Evaluation of a platinum leasing program for fuel cell vehicles,” Matthew A. Kromer et. al., *International Journal of Hydrogen Energy* 34 (2009).

<sup>142</sup> L. Shore, “Platinum Group Metal Recycling Technology Development,” BASF Catalysts LLC final project report to DOE under subcontract number DE-FC36-03GO13104, 2009.

<sup>143</sup> “The impact of widespread deployment of fuel cell vehicles on platinum demand and price,” Yongling Sun, et. al. *International Journal of Hydrogen Energy* 36 (2011).



Ten percent (10%) is chosen as the Pt loss baseline value while the low (8%) and high (15%) end are represented in the sensitivity analysis below. The cost of recycling<sup>144</sup> is expected to range between \$75 and \$90 per troy ounce of recovered platinum. However, this is only the cost incurred by running the actual recycle process. In addition, there are supply chain costs as the capturer or salvager collecting the unit desires to be paid. Based on current catalyst converter practice, the salvager expects to be paid by the recycler about 70%-75% of the total value of recycled platinum<sup>145</sup> with the remaining Pt value going to the recycle as payment for the recycle process. Whether this comparatively high fraction of Pt value would continue to accrue to the supply chain salvager for fuel cell stack platinum is unclear. If it does, the owner of the fuel cell automobile effectively gets no value from the recycled Pt, just as, in general, a person selling an internal combustion vehicle for scrap does not separately receive payment for the catalytic converter. However, as the value of Pt in the fuel cell may be greater than that of a catalytic converter, the paradigm may be different in the future. Consequently, as a baseline for the LCC analysis, the salvager is estimated to receive 35% (half the value received for catalytic converters) of the value of the recovered Pt less recycling cost. A sensitivity analysis is conducted for cases where the salvager captures only 10% and 75% of the recovered value. Finally, due to platinum market price volatility, it is unlikely that Pt price will be exactly the same at system purchase as it is 10 years later at time of recycle. Consequently, for purposes of the baseline LCC analysis, the price of platinum is held constant at the purchase price used for the catalyst within a new vehicle (\$1,500 / tr. oz.), and sensitivity analysis is conducted for a future<sup>146</sup> higher Pt price (\$2100/tr. oz. at end of life).

To further explore these assumptions, additional conversations were held with precious metal suppliers. The current methodology for recovery of Pt was described as consisting of the following steps:

- 1) Agreement between refiner and supplier of the expected total Pt in the sample
- 2) Assay of contaminants within the sample
- 3) Assessment of a “deleterious elements” charge
- 4) Imposition of a Retention charge (typically 2-3%)
- 5) Imposition of a Refining charge (typically 1-2%)

This would appear to place the recycling charge within the 2-9% range as projected above, thereby broadly confirming the analysis assumptions. However, further clarification of terms and values is needed and will be pursued in future analyses.

---

<sup>144</sup> Ibid.

<sup>145</sup> Ibid.

<sup>146</sup> Platinum price is considered more likely to increase in the future rather than decrease. Consequently, the future price of Pt is based on the current Pt market price (~\$1500/tr. oz) plus a \$60/tr. oz. per year increase, resulting in a \$2100/tr. oz. price after 10 years.

## 14.2 2018 Automotive Life Cycle Analysis Assumptions and Results

The auto life cycle analysis (LCA) of life cycle cost analysis (LCCA<sup>147</sup>) for this report assumes a set of driving conditions and platinum recycling costs to compute the total present value cost of ownership for the lifetime of the vehicle. In previous years, SA only conducted an LCCA for the auto fuel cell system and did not take into account the additional cost for the H<sub>2</sub> storage system or the other components within the vehicle (battery, motor, glider, brakes, HVAC system, etc.). In 2018, SA incorporated these additional components into the LCCA. The assumptions for the LCCA are summarized in the figures below.

Maintenance cost for the FCEV is not included in this analysis in keeping with the methodology of other LCCA (eg. FASTsim). However, FCEV maintenance costs are expected to be substantially lower than for conventional ICEV, once FCEVs reach maturity, due to avoidance of oil changes, head gaskets, spark plugs, etc. Maintenance costs for brakes and tires would still be incurred.<sup>148</sup> Auto insurance is not included in the analysis. It is also assumed that the fuel cell stack is sufficiently durable to last the life of the vehicle and does not need replacement.

Auto Life Cycle Cost Assumption	Value
Production Overhead Markup on Total Vehicle Cost	17% <sup>147</sup>
Marketing/Warranty Markup on Total Vehicle Cost	23.5% <sup>149</sup>
Overhead/Profit Markup on Total Vehicle Cost	9.5% <sup>149</sup>
Discount rate	5% <sup>150</sup>
System lifetime	15 years <sup>150</sup>
Distance driven annually	12,000 miles
System efficiency at rated power	47% (calculated by model)
Fuel economy	62.18 mpgge <sup>151</sup>
Hydrogen to gasoline lower heating value ratio	1.011 kgH <sub>2</sub> /gal gasoline
Fuel cost	\$5 / kg H <sub>2</sub>
Total Pt loss during system lifetime and the Pt recovery process	10%
Market Pt price at end of system lifetime	\$1,500 / tr. oz.
Cost of Pt recovery	\$80 / tr. oz.
% of final salvaged Pt value charged by salvager	35%

**Figure 258. Auto life cycle cost assumptions**

The FCS cost used in the LCCA is the 2018 baseline automotive SA estimate. The H<sub>2</sub> storage system cost is based on a DFMA<sup>®</sup> analysis of a 5.6kgH<sub>2</sub> system with Type-4 700 bar pressure vessels. Details of this H<sub>2</sub>

<sup>147</sup> The abbreviations LCA and LCCA are both used within the analysis community.

<sup>148</sup> FCEV brake pad wear (and thus brake cost) may be lower than for ICEVs due to regenerative braking. However, this benefit would also accrue to hybrid electric ICEV.

<sup>149</sup> Vyas, A., Santini, D., Cuenca, R., "Comparison of Indirect Cost Multipliers for Vehicle Manufacturing", Center for Transportation Research, Energy Systems Division, Argonne National Laboratory, April 2000.

<sup>150</sup> Elgowainy, A. et al. "Cradle-to-Grave Lifecycle Analysis of US Light Duty Vehicle Fuel Pathways: A Greenhouse Gas Emissions and Economic Assessment of Current (2015) and Future (2025-2030) Technologies", Argonne National Laboratory, September 2016.

<sup>151</sup> Calculated from system efficiency at rated power based on formula derived from ANL modeling results: Fuel economy = 0.0028x<sup>3</sup> - 0.3272x<sup>2</sup>+12.993x - 116.45, where x = system efficiency % at rated power.

storage system cost can be viewed in SA's report.<sup>152</sup> The cost of vehicle components, other than the FCS and H<sub>2</sub> storage system, are held constant between 1k and 100k systems per year.<sup>153</sup> At 500k systems per year, there is an assumed slight reduction in these other vehicle costs (from \$17,600/system to \$16,550/system). The effective ratio of retail price to cost due to the cumulative markups of manufacturing overhead, marketing/warranty, and overhead/profit is 1.5. A vehicle system cost and price breakdown is listed in Figure 259. SA estimates a fuel cell vehicle cost of ~\$23,000 and a retail price of ~\$34,000 at 500,000 systems per year.

SA's projected auto FCV retail price of ~\$34,000 is substantially less than the FCV price of \$59,000 projected by David Green of Oak Ridge National Laboratory in a 2013 analysis.<sup>154</sup> This price difference is almost entirely due to differences in the projected cost of the fuel cell and storage systems, with Greene's projections being \$14,000 higher. Both analyses used the same costs for non-FC/non-storage components. Greene used a 1.6 price-to-cost ratio, similar to SA's 1.5 ratio. Greene's projections assumed a 200k systems/year production rate, similar to SA's assumption of 500k systems/year. Greene's projections were for 2016 FCV technology, whereas SA's are for 2018 technology. Additionally, Greene projects the retail price of a similarly sized ICEV to be ~ \$23,000, roughly \$12k less than SA's projected high volume fuel cell vehicle.

Under these assumptions, a basic set of cost results is calculated and displayed in Figure 260. Note that these results are for the automotive system. An LCCA was not conducted for the MDV system this year.

---

<sup>152</sup> Houchins, C., James, B.D., "Hydrogen Storage System Cost Analysis: Summary of FY 2018 Activities", Strategic Analysis annual report for US DOE Fuel Cell Technologies Office, under award DE-EE0007601, September 2018.

<sup>153</sup> Other vehicle components include the battery, electric motor/inverter drive, gearbox, glider, braking system, and climate system. The values come from Table 4 of this reference:

Greene, D., "Status and Prospects of the Global Automotive Fuel Cell Industry and Plans for Deployment of Fuel Cell Vehicles and Hydrogen Refueling Infrastructure", Oak Ridge National Laboratory, Report for the US Department of Energy, July 2013.

<sup>154</sup> Greene, D., "Status and Prospects of the Global Automotive Fuel Cell Industry and Plans for Deployment of Fuel Cell Vehicles and Hydrogen Refueling Infrastructure", Oak Ridge National Laboratory, Report for the US Department of Energy, July 2013.

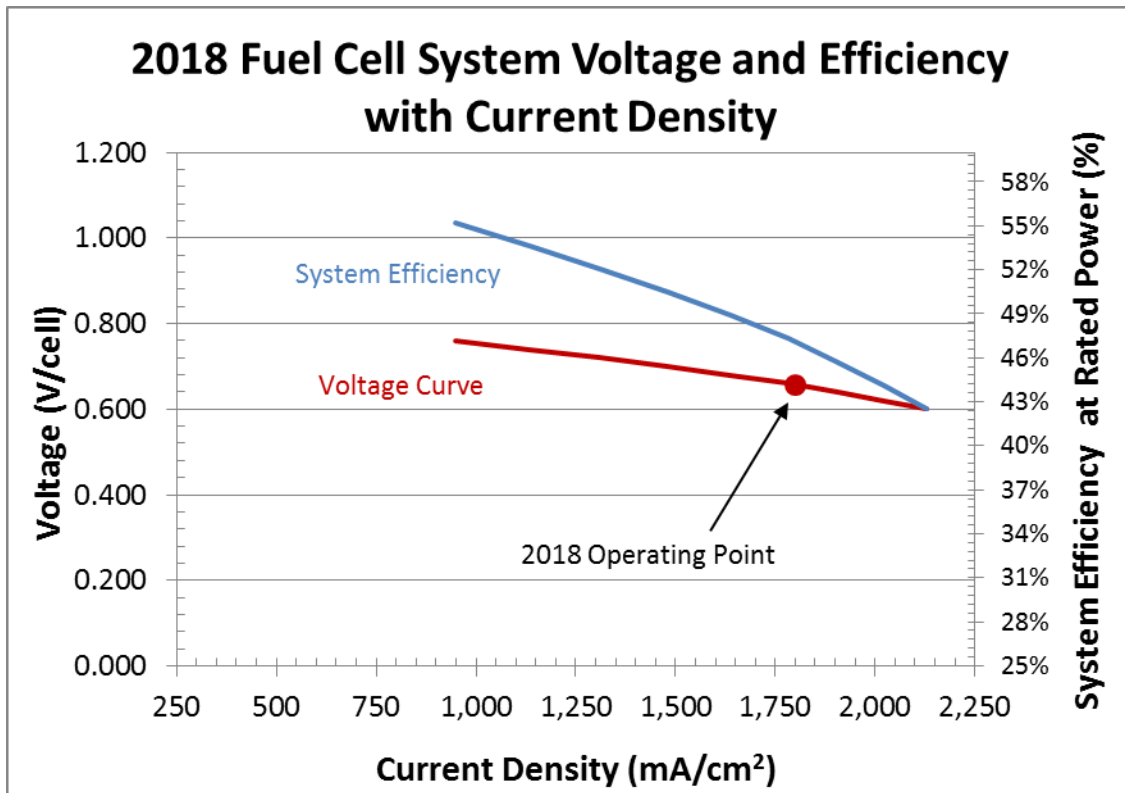
<b>2018 FCEV Price Table</b>						
<b>Annual Production Rate</b>	<b>1,000</b>	<b>10,000</b>	<b>20,000</b>	<b>50,000</b>	<b>100,000</b>	<b>500,000</b>
Fuel Cell System Cost	\$14,485	\$6,775	\$5,174	\$4,342	\$3,974	\$3,567
H <sub>2</sub> Storage System Cost	\$7,518	\$4,417	\$4,041	\$3,477	\$3,007	\$2,631
Battery Cost	\$1,813	\$1,813	\$1,813	\$1,813	\$1,813	\$1,300
Electric Motor/Inverter Drive Cost	\$3,600	\$3,600	\$3,600	\$3,600	\$3,600	\$3,150
Gearbox Cost	\$400	\$400	\$400	\$400	\$400	\$350
Glider Cost	\$11,000	\$11,000	\$11,000	\$11,000	\$11,000	\$11,000
Braking System Cost	\$400	\$400	\$400	\$400	\$400	\$375
Climate/HVAC System Cost	\$400	\$400	\$400	\$400	\$400	\$375
<b>Total Fuel Cell Vehicle System Cost</b>	<b>\$39,617</b>	<b>\$28,805</b>	<b>\$26,828</b>	<b>\$25,433</b>	<b>\$24,594</b>	<b>\$22,748</b>
Production Overhead Markup	\$6,735	\$4,897	\$4,561	\$4,324	\$4,181	\$3,867
Marketing/Warranty Markup	\$9,310	\$6,769	\$6,305	\$5,977	\$5,780	\$5,346
Overhead/Profit Markup	\$3,764	\$2,736	\$2,549	\$2,416	\$2,336	\$2,161
<b>Auto System Price</b>	<b>\$59,425</b>	<b>\$43,208</b>	<b>\$40,242</b>	<b>\$38,149</b>	<b>\$36,891</b>	<b>\$34,122</b>

Figure 259. Breakdown in Fuel Cell Vehicle price

<b>2018 Auto System Life Cycle Costs</b>						
<b>Annual Production Rate</b>	<b>1,000</b>	<b>10,000</b>	<b>20,000</b>	<b>50,000</b>	<b>100,000</b>	<b>500,000</b>
Total Auto System Price (After Markup)	\$59,425	\$43,208	\$40,242	\$38,149	\$36,891	\$34,122
Annual Fuel Cost	\$976	\$976	\$976	\$976	\$976	\$976
Lifecycle Fuel Cost	\$10,127	\$10,127	\$10,127	\$10,127	\$10,127	\$10,127
Net Present Value of Recoverable Pt in System at End of System Lifetime	\$185	\$185	\$185	\$185	\$185	\$185
Final Pt Net Present Value Recovered	\$120	\$120	\$120	\$120	\$120	\$120
Total Lifecycle Cost	\$69,432	\$53,215	\$50,249	\$48,157	\$46,898	\$44,129
<b>Total Lifecycle Cost (\$/mile)</b>	<b>\$0.386</b>	<b>\$0.296</b>	<b>\$0.279</b>	<b>\$0.268</b>	<b>\$0.261</b>	<b>\$0.24516</b>

Figure 260: 2017 Auto LCC results for the baseline assumptions

The variation of life cycle cost with system efficiency was studied in order to examine the trade-offs between low efficiency (higher operating costs but lower initial capital costs) and high efficiency (lower operating costs but higher initial capital costs) systems. Figure 261 shows the projected polarization curve with system efficiency at rated power.



**Figure 261: Auto polarization curves for efficiency sensitivity analysis**

With this relationship, it is possible to calculate the variation in life cycle cost contributors over a range of efficiencies. These results are shown below. Figure 262 displays the results for the total life cycle cost as well as its component costs on an absolute scale. Note that the total life cycle cost (i.e. the present value of the 15 year expenses of the power system) is expressed as a \$/mile value for easy comparison with internal combustion engine vehicle life cycle analyses. Figure 263 shows a zoomed-in look at the total cost, and reveals a minimum total life cycle cost at 54% system efficiency rather than the selected baseline value of 47%. However, the LCC curve is quite flat, indicating that LCC is generally insensitive to system efficiency: the baseline system \$/mile is only 1.3% higher than the optimal case.

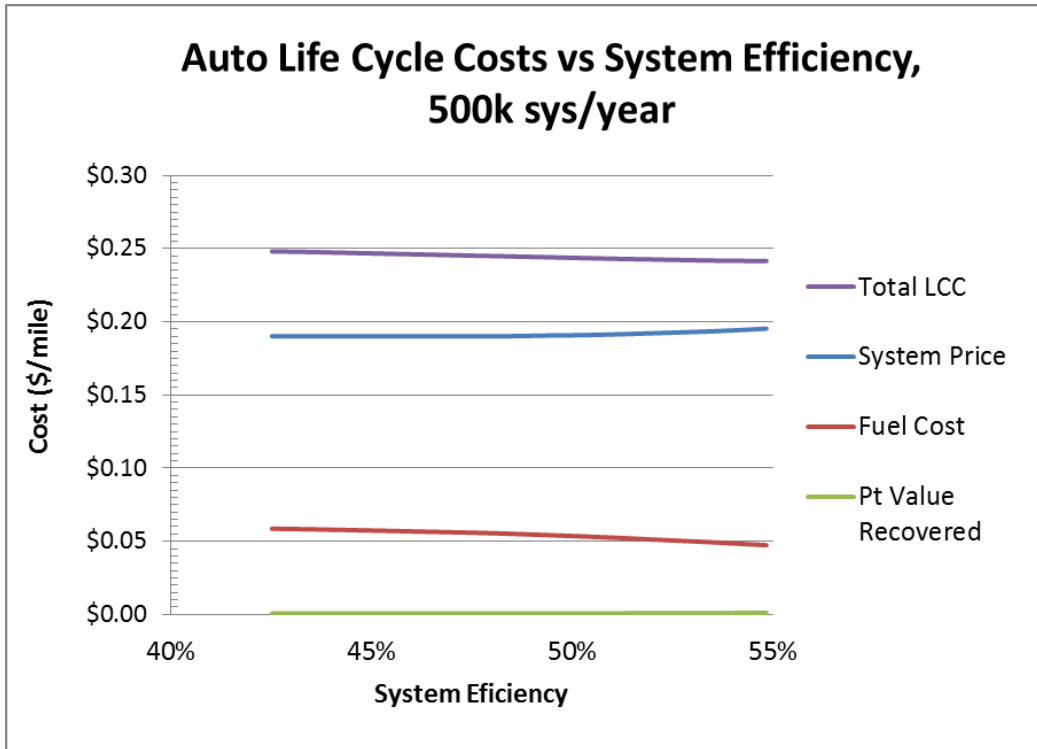


Figure 262: Auto life cycle cost components vs. fuel cell efficiency for 500k automobile systems/year

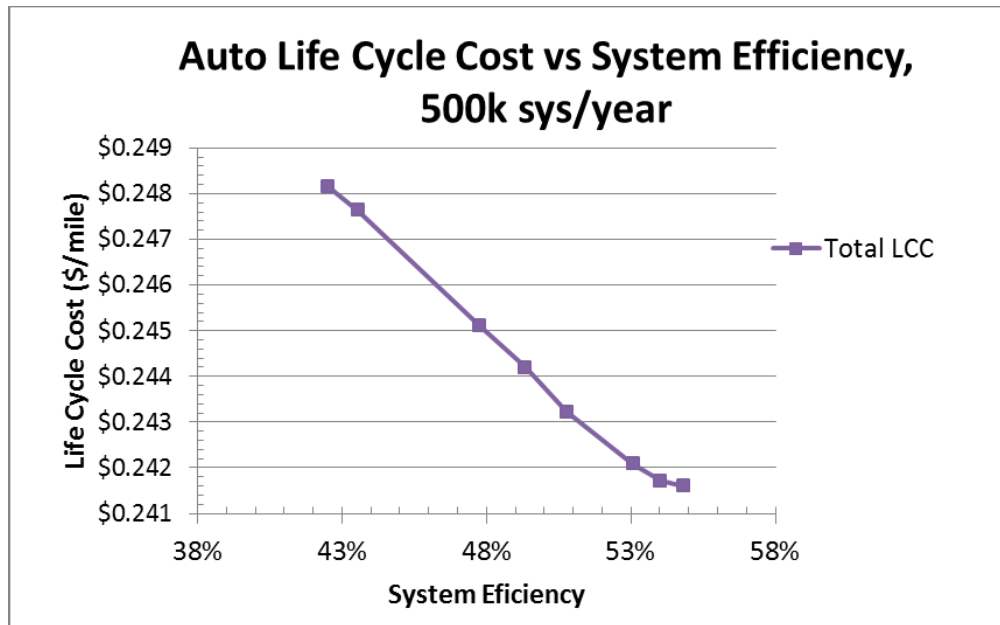


Figure 263: Auto life cycle cost vs. fuel cell efficiency for 500k automobile systems/year

In addition to the efficiency analysis, a simple sensitivity study was conducted on the parameters governing the platinum recycle, to determine the magnitude of the effect platinum recycling has on the life cycle cost. Figure 264 below displays the total life cycle cost in \$ per mile as a function of platinum price during the year of the recycle for three scenarios: the baseline case where the salvager captures

35% of the value of recovered platinum and two sensitivity cases where the salvager captures 10% of the value at the low end and 75% of the value at the high end.

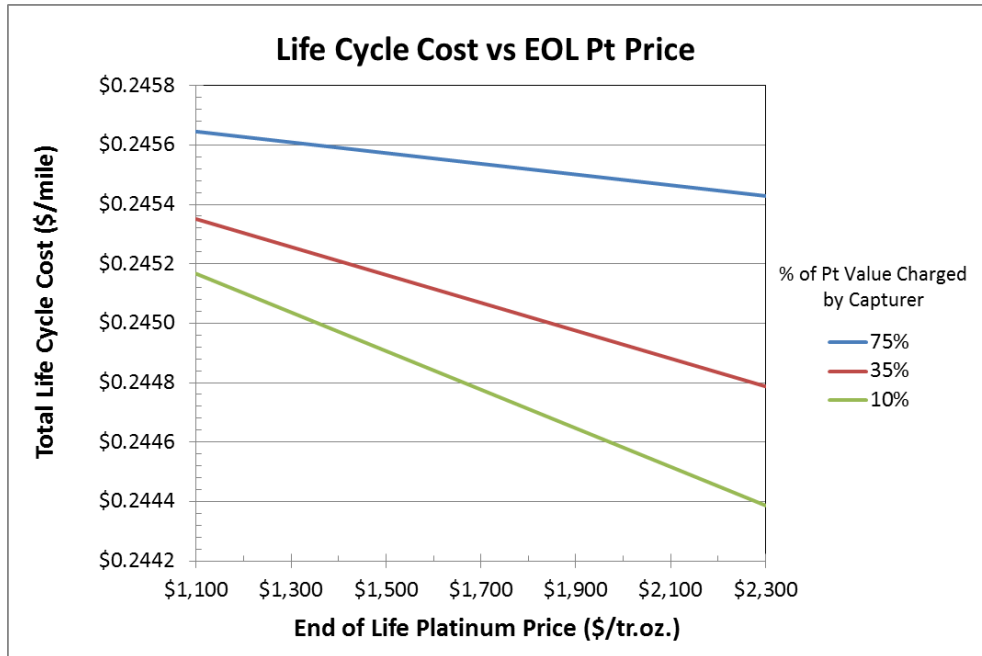


Figure 264: Auto life cycle cost vs. end of life platinum price (at 500k system/year)

Additional parameters were explored and are displayed as a Tornado chart in Figure 265 and Figure 266. These results indicate that platinum recycle parameters do not have a large effect on the overall life cycle cost (~1%).

Life Cycle Cost (\$/mile), 500,000 systems/year				
Parameter	Units	Low Value of Variable	Base Value	High Value of Variable
Hydrogen Fuel Price	\$/kg	\$4.08	\$5	\$6.01
Discount Rate	%	3%	5%	7%
Overhead/Profit Markup	%	7%	9.5%	15%
Marketing/Warranty Markup	%	20%	23.5%	28%
Salvage Value Charged	%	10%	35%	75%
Pt Price at Recovery	\$/tr.oz.	\$1,100	\$1,500	\$2,100
Total Pt Loss	%	8%	10%	15%
Cost of Recovery	\$/tr.oz.	\$70	\$80	\$90
<b>2018 Auto System LLC (\$/mile)</b>			<b>\$0.2452</b>	

Figure 265: Auto life cycle cost Tornado chart parameters

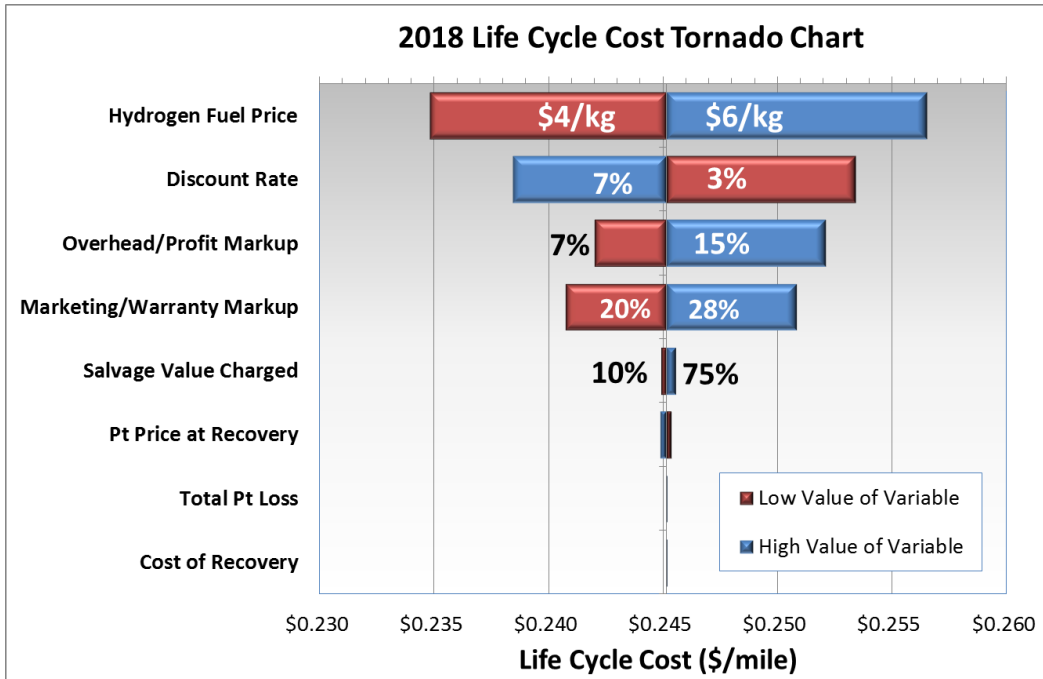


Figure 266: Auto life cycle cost Tornado chart (at 500k systems/year)

### 14.3 2020 & 2025 Automotive Life Cycle Analysis Results

Assuming the same assumptions as specified for the 2018 LCA in Figure 258, the 2020 lifecycle cost (seen in Figure 267) reflects the lower capital cost of system and lower total Pt content due to the higher power density compared to the 2018 life cycle cost.

Annual Production Rate	2020 Auto System Life Cycle Costs					
	1,000	10,000	20,000	50,000	100,000	500,000
Total Auto System Price (After Markup)	\$57,879	\$42,728	\$39,725	\$37,697	\$36,474	\$33,765
Annual Fuel Cost	\$976	\$976	\$976	\$976	\$976	\$976
Lifecycle Fuel Cost	\$10,127	\$10,127	\$10,127	\$10,127	\$10,127	\$10,127
Net Present Value of Recoverable Pt in System at End of System Lifetime	\$173	\$173	\$173	\$173	\$173	\$173
Final Pt Net Present Value Recovered	\$113	\$113	\$113	\$113	\$113	\$113
Total Lifecycle Cost	\$67,894	\$52,742	\$49,740	\$47,712	\$46,489	\$43,779
<b>Total Lifecycle Cost (\$/mile)</b>	<b>\$0.377</b>	<b>\$0.293</b>	<b>\$0.276</b>	<b>\$0.265</b>	<b>\$0.258</b>	<b>\$0.243</b>

Figure 267. 2020 Auto LCC results

The 2025 system, also with the same LCA assumptions, shows further lifecycle cost reduction due to the capital cost and lower Pt content (lower Pt loading and higher power density). The results are shown in Figure 268.



	<b>2025 Auto System Life Cycle Costs</b>					
<b>Annual Production Rate</b>	<b>1,000</b>	<b>10,000</b>	<b>20,000</b>	<b>50,000</b>	<b>100,000</b>	<b>500,000</b>
<b>Total Auto System Price (After Markup)</b>	\$56,701	\$41,808	\$39,104	\$37,159	\$35,939	\$33,237
<b>Annual Fuel Cost</b>	\$976	\$976	\$976	\$976	\$976	\$976
<b>Lifecycle Fuel Cost</b>	\$10,127	\$10,127	\$10,127	\$10,127	\$10,127	\$10,127
<b>Net Present Value of Recoverable Pt in System at End of System Lifetime</b>	\$102	\$102	\$102	\$102	\$102	\$102
<b>Final Pt Net Present Value Recovered</b>	\$67	\$67	\$67	\$67	\$67	\$67
<b>Total Lifecycle Cost</b>	\$66,762	\$51,869	\$49,165	\$47,220	\$46,000	\$43,298
<b>Total Lifecycle Cost (\$/mile)</b>	<b>\$0.371</b>	<b>\$0.288</b>	<b>\$0.273</b>	<b>\$0.262</b>	<b>\$0.256</b>	<b>\$0.241</b>

Figure 268. 2025 Auto LCC results

## 15 Sensitivity Studies

A series of Tornado and Monte Carlo sensitivity analyses were conducted to determine key parameters and assess avenues to further reduce cost.

### 15.1 Single Variable Analysis

#### 15.1.1 Single Variable 2018 Automotive Analysis

A single variable analysis was performed to evaluate which parameters have the largest effect on system cost. Figure 269 shows the parameter ranges used to develop the Tornado chart, while Figure 270 displays the results of the analysis.

2018 Auto Sensitivity Ranges (500,000 sys/year)				
Parameter	Units	Min Param. Value	Base Value	Max Param. Value
Pt Loading (manufacturing variation)	mgPt/cm <sup>2</sup>	0.124	0.125	0.126
Membrane Humidifier Cost	\$/system	\$43.34	\$57.79	\$86.68
Q/ΔT Constraint	kW/°C	1.35	1.45	1.55
ePTFE Cost	\$/m <sup>2</sup>	\$2.90	\$5.81	\$9.87
Bipolar Plate Welding Speed	m/min	2.5	7.5	7.5
Power Density	mW/cm <sup>2</sup>	1128	1183	1238
Active to Total Area Ratio		0.55	0.625	0.80
Ionomer Cost	\$/kg	\$64.21	\$107.02	\$469.89
Bipolar Plate Cost	\$/kW <sub>net</sub>	\$4.11	\$4.89	\$6.01
GDL Cost	\$/m <sup>2</sup>	\$2.82	\$5.65	\$15.04
Hydrogen Recirculation System Cost	\$/system	\$207.22	\$207.22	\$501.46
Air Stoichiometry		1.3	1.5	2.0
Air Loop Cost (including CEM)	\$/system	\$536	\$848	\$1,222
<b>2018 Auto System Cost (\$/kW<sub>net</sub>)</b>			<b>\$44.58</b>	

Figure 269: 2018 automotive results Tornado chart parameter values

As shown in Figure 270, variation air loop cost has the most capacity to affect system cost. Air loop cost range takes into account the air compressor cost range,<sup>155</sup> efficiencies for the air compressor, expander, and motor controller,<sup>156</sup> and balance of air compressor cost range.<sup>157</sup> Air stoichiometry and hydrogen recirculation system cost are the 2<sup>nd</sup> and 3<sup>rd</sup> largest impacts to the fuel cell system cost. Previously, Pt loading and power density dominated the cost impact to the system. Initiated in 2017 and continued for

<sup>155</sup> CEM cost multiplier: Low end is 30% reduction of calculated cost to get a minimum value of \$500/system from DOE targets. High end is 20% increase of calculated cost.

<sup>156</sup> Efficiencies: ANL estimate for centrifugal compressor/expander/motor unit: Compressor Effic.: 64.7% min (71% baseline) to 80% max; Expander Effic.: 71.6% min (73% baseline) to 80% max; combined Motor/Controller Effic.: 75%min (80% baseline) to 90% max

<sup>157</sup> Balance of Air Compressor Cost: 2/3 of value at min, 1.7 factor at max.

2018, SA re-evaluated the ranges of Pt loading and power density because they are often linked. The range in Pt loading is based on a specified design point with variation in manufacturing rather than an alternative design point. The 2018 power density range is smaller compared to past years (+/- 55mW/cm<sup>2</sup> in 2018 compared to +50% and -15% in 2016 or +/-10% in 2017), based on ANL modeling results for range in experimental data of d-PtCo/HSC catalyst. The range in projected cost is based on 2018 reported costs at high volume. Note that while resizing of the compressor and stack to reflect a different air flow rate (range in stoichiometric rates) is included in the system cost impact, the impact on power density is not.

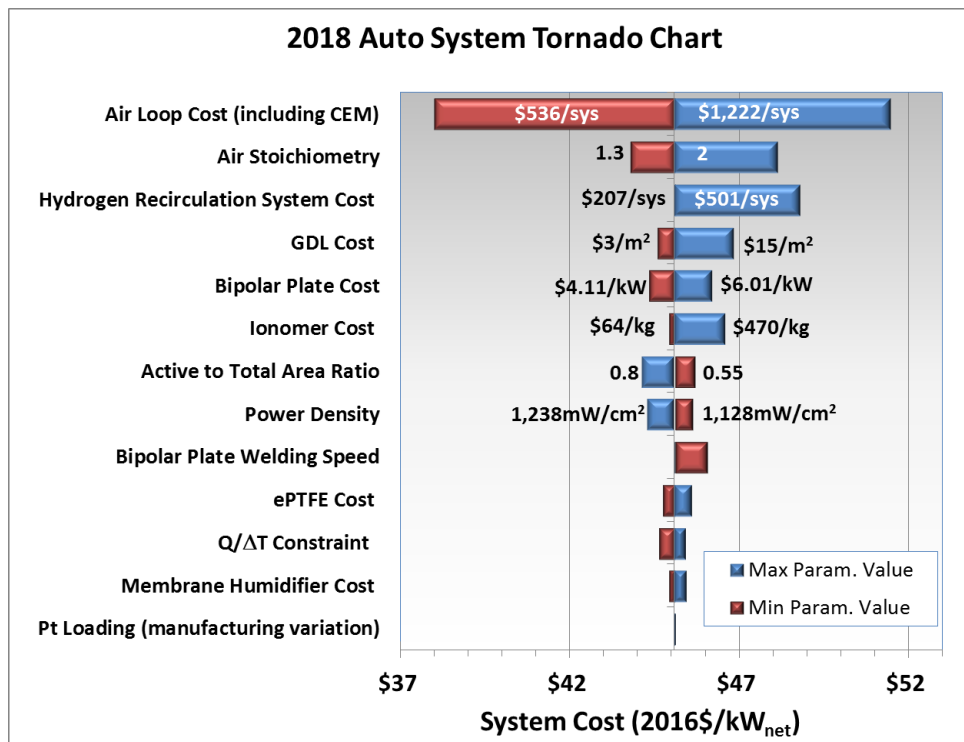


Figure 270: 2018 Auto results Tornado chart

### 15.1.2 Single Variable 2020 Automotive Analysis

A single variable sensitivity analysis was also completed for the 2020 system. Figure 271 shows the parameter ranges used to develop the 2020 automotive Tornado chart, while Figure 272 displays the results of the 2020 automotive analysis. Similarly to the 2018 case, the system cost is most impacted by the air loop cost.

2020 Auto Sensitivity Ranges (500,000 sys/year)				
Parameter	Units	Min Param. Value	Base Value	Max Param. Value
Air Loop Cost (including CEM)	\$/system	\$551	\$1,033	\$1,474
Hydrogen Recirculation System Cost	\$/system	\$207	\$207	\$501
Air Stoichiometry		1.3	1.5	2.0
Power Density	mW/cm <sup>2</sup>	1134	1260	1386
GDL Cost	\$/m <sup>2</sup>	\$2.82	\$5.63	\$15.04
Active to Total Area Ratio		0.55	0.625	0.80
Ionomer Cost	\$/kg	\$71.85	\$119.75	\$469.89
Bipolar Plate Cost	\$/kW <sub>net</sub>	\$3.20	\$3.48	\$4.21
Bipolar Plate Welding Speed	m/min	2.5	7.5	7.5
Membrane Humidifier Cost	\$/system	\$43.43	\$57.91	\$86.86
Membrane Support Cost	\$/m <sup>2</sup>	\$0.26	\$1.44	\$1.44
Q/ΔT Constraint	kW/°C	1.35	1.45	1.55
Pt Loading (manufacturing variation)	mgPt/cm <sup>2</sup>	0.124	0.125	0.126
<b>2020 Auto System Cost (\$/kW<sub>net</sub>)</b>			<b>\$41.60</b>	

Figure 271. 2020 automotive results Tornado chart parameter values

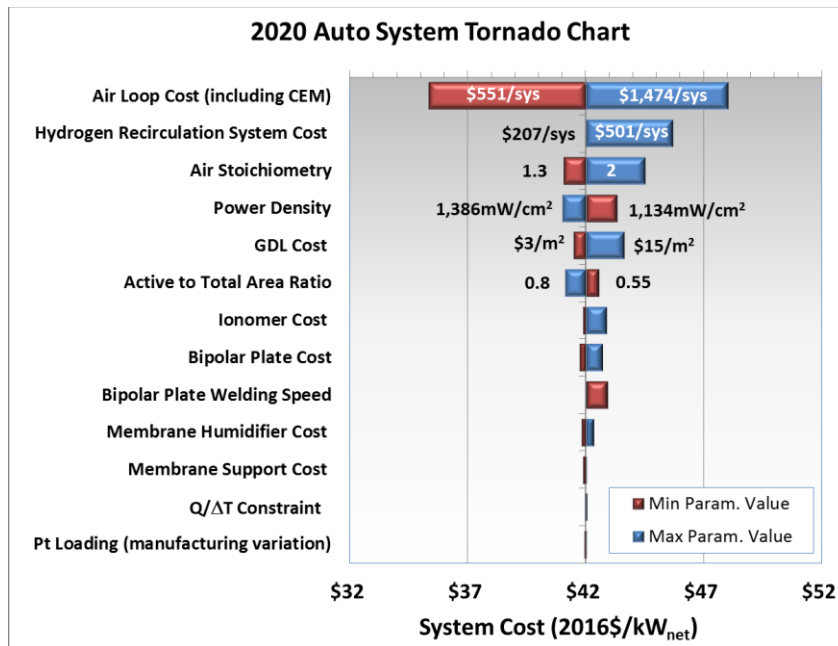


Figure 272. 2020 Auto results Tornado chart

### 15.1.3 Single Variable 2025 Automotive Analysis

Figure 273 shows the parameter ranges used to develop the 2025 automotive Tornado chart, while Figure 274 displays the results of the 2025 automotive analysis.

2025 Auto Sensitivity Ranges (500,000 sys/year)				
Parameter	Units	Min Param. Value	Base Value	Max Param. Value
Air Loop Cost (including CEM)	\$/system	\$546	\$982	\$1,412
Hydrogen Recirculation System Cost	\$/system	\$207	\$207	\$501
Air Stoichiometry		1.3	1.5	2.0
GDL Cost	\$/m <sup>2</sup>	\$2.82	\$5.97	\$15.04
Power Density	mW/cm <sup>2</sup>	1350	1500	1650
Active to Total Area Ratio		0.55	0.650	0.80
Bipolar Plate Cost	\$/kW <sub>net</sub>	\$2.77	\$3.05	\$3.70
Bipolar Plate Welding Speed	m/min	2.5	7.5	7.5
Ionomer Cost	\$/kg	\$81.79	\$136.32	\$469.89
Membrane Humidifier Cost	\$/system	\$43.47	\$57.96	\$86.93
Q/ΔT Constraint	kW/°C	1.35	1.45	1.55
Pt Loading (manufacturing variation)	mgPt/cm <sup>2</sup>	0.087	0.088	0.089
<b>2025 Auto System Cost (\$/kW<sub>net</sub>)</b>			<b>\$37.21</b>	

Figure 273. 2025 automotive results Tornado chart parameter values

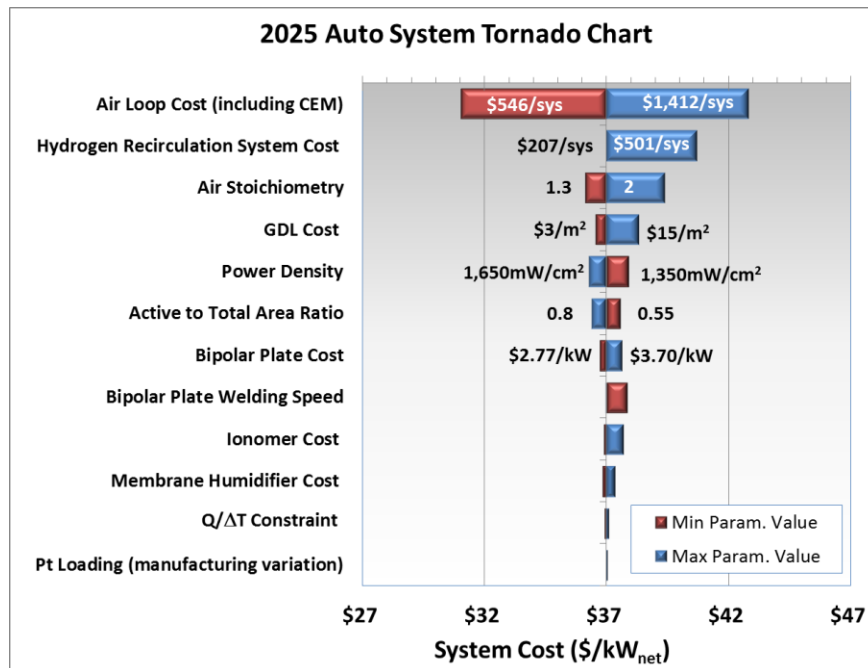


Figure 274. 2025 Auto results Tornado chart

### 15.1.4 Single Variable 2018 Medium Duty Truck Analysis

Figure 275 shows the parameter ranges used to develop the 2018 MDV Tornado chart, while Figure 276 displays the results of the 2018 MDV analysis.

2018 MDV Sensitivity Ranges (100,000 sys/year)				
Parameter	Units	Min Param. Value	Base Value	Max Param. Value
Pt Loading (manufacturing variation)	mgPt/cm <sup>2</sup>	0.347	0.35	0.354
Membrane Thickness	μm	10.00	14.00	20.00
Bipolar Plate Welding Speed	m/min	2.5	7.5	7.5
ePTFE Cost	\$/m <sup>2</sup>	\$2.82	\$5.64	\$9.59
GDL Cost	\$/m <sup>2</sup>	\$2.80	\$6.99	\$15.03
Power Density	mW/cm <sup>2</sup>	1123	1178	1233
Active to Total Area Ratio		0.55	0.625	0.80
Bipolar Plate Cost	\$/kW <sub>net</sub>	\$7.07	\$8.42	\$10.32
Membrane Humidifier Cost	\$/system	\$535	\$714	\$1,071
Ionomer Cost	\$/kg	\$24.02	\$109.19	\$547.02
Hydrogen Recirculation System Cost	\$/system	\$418.43	\$627.33	\$1,254.66
Air Stoichiometry		1.3	1.5	2.0
Air Loop Cost (including CEM)	\$/system	\$2,375	\$3,706	\$4,915
<b>2018 MDV System Cost (\$/kW<sub>net</sub>)</b>			<b>\$92.41</b>	

Figure 275. 2018 MDV results Tornado chart parameter values

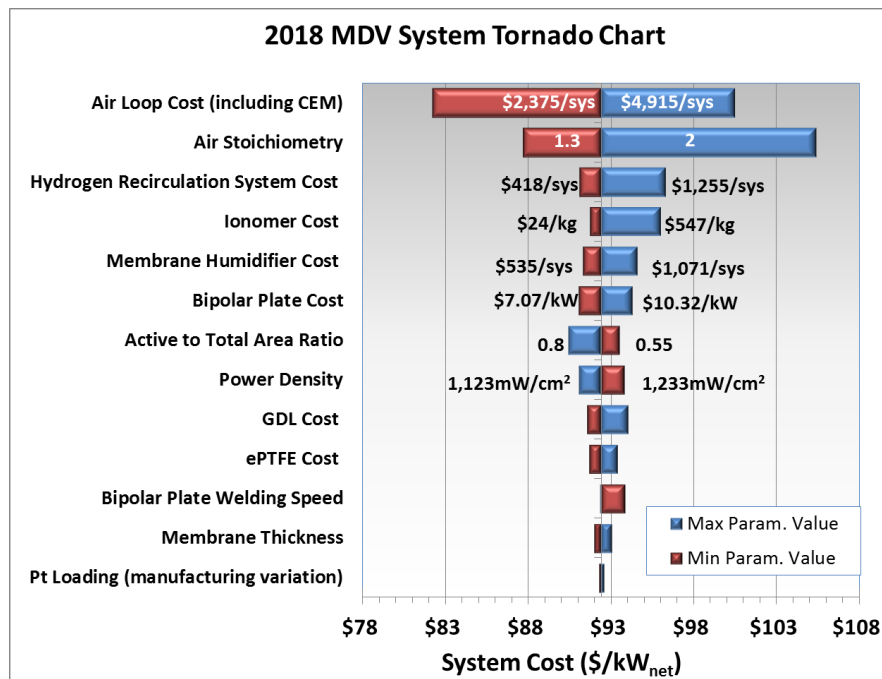


Figure 276. 2018 MDV results Tornado chart

### 15.1.5 Single Variable 2020 Medium Duty Truck Analysis

Figure 277 shows the parameter ranges used to develop the 2020 MDV Tornado chart, while Figure 278 displays the results of the 2020 MDV analysis.

2020 MDV Sensitivity Ranges (100,000 sys/year)				
Parameter	Units	Min Param. Value	Base Value	Max Param. Value
Air Loop Cost (including CEM)	\$/system	\$1,779	\$3,145	\$4,246
Air Stoichiometry		1.3	1.5	2.0
Hydrogen Recirculation System Cost	\$/system	\$419	\$628	\$1,256
Ionomer Cost	\$/kg	\$24	\$110	\$551
Power Density	mW/cm <sup>2</sup>	1145	1200	1255
Membrane Humidifier Cost	\$/system	\$536	\$714	\$1,071
Bipolar Plate Cost	\$/kW <sub>net</sub>	\$5.78	\$6.79	\$8.33
GDL Cost	\$/m <sup>2</sup>	\$2.85	\$7.02	\$15.01
Active to Total Area Ratio		0.55	0.625	0.80
ePTFE Cost	\$/m <sup>2</sup>	\$2.82	\$5.64	\$9.59
Bipolar Plate Welding Speed	m/min	2.5	7.5	7.5
Membrane Thickness	μm	10.00	14.00	20.00
Pt Loading (manufacturing variation)	mgPt/cm <sup>2</sup>	0.347	0.35	0.354
<b>2020 MDV System Cost (\$/kW<sub>net</sub>)</b>			<b>\$85.69</b>	

Figure 277. 2020 MDV results Tornado chart parameter values

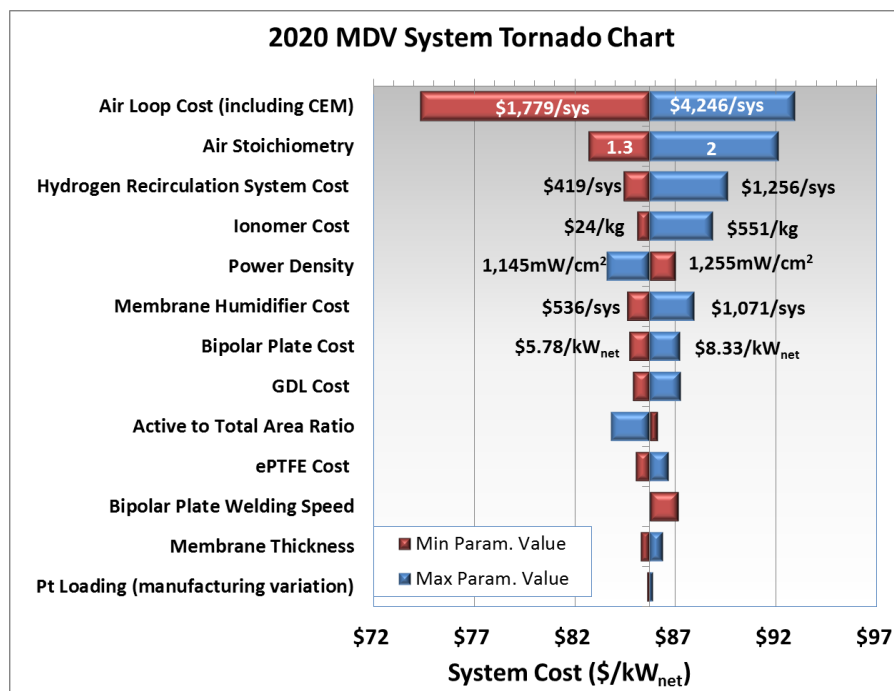


Figure 278. 2020 MDV results Tornado chart

### 15.1.6 Single Variable 2025 Medium Duty Truck Analysis

Figure 279 shows the parameter ranges used to develop the 2025 MDV Tornado chart, while Figure 280 displays the results of the 2025 MDV analysis.

2025 MDV Sensitivity Ranges (100,000 sys/year)				
Parameter	Units	Min Param. Value	Base Value	Max Param. Value
Air Loop Cost (including CEM)	\$/system	\$1,918	\$2,792	\$3,927
Hydrogen Recirculation System Cost	\$/system	\$419	\$628	\$1,256
Air Stoichiometry		1.3	1.5	2.0
Power Density	mW/cm <sup>2</sup>	1215	1350	1485
Ionomer Cost	\$/kg	\$24	\$110	\$550
Membrane Humidifier Cost	\$/system	\$536	\$714	\$1,071
Active to Total Area Ratio		0.55	0.650	0.80
GDL Cost	\$/m <sup>2</sup>	\$2.82	\$7.44	\$15.04
Bipolar Plate Cost	\$/kW <sub>net</sub>	\$4.62	\$5.47	\$6.71
Bipolar Plate Welding Speed	m/min	2.5	7.5	7.5
Membrane Thickness	μm	10	14	20
Pt Loading (manufacturing variation)	mgPt/cm <sup>2</sup>	0.297	0.3	0.303
<b>2025 MDV System Cost (\$/kW<sub>net</sub>)</b>			<b>\$75.46</b>	

Figure 279. 2025 MDV results Tornado chart parameter values

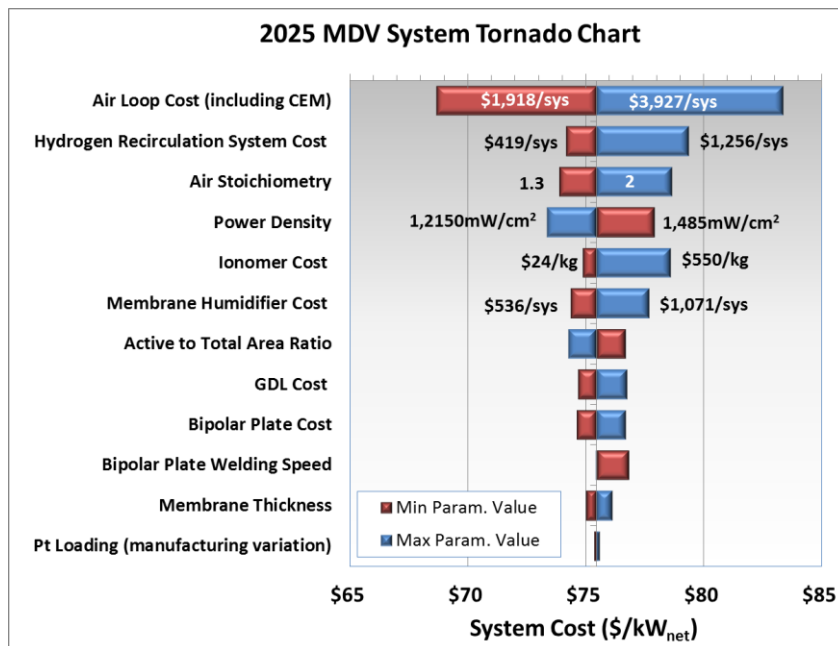


Figure 280. 2025 MDV results Tornado chart



### 15.1.7 Automotive Analysis at a Pt price of \$1100/troy ounce

To aid in comparisons to other previous cost studies, the automotive system was also evaluated with a platinum price of \$1,100/troy ounce (instead of the baseline value of \$1,500/troy ounce). All other parameters remain the same. Results are shown in Figure 281.

		2018 Auto System					
Annual Production Rate	systems/year	1,000	10,000	20,000	50,000	100,000	500,000
System Net Electric Power (Output)	kWnet	80	80	80	80	80	80
System Gross Electric Power (Output)	kWgross	88	88	88	88	88	88
<b>Component Cost/System</b>							
Fuel Cell Stacks	\$/system	\$9,395	\$3,368	\$2,304	\$1,829	\$1,586	\$1,344
Balance of Plant	\$/system	\$4,763	\$3,172	\$2,643	\$2,292	\$2,167	\$2,004
System Assembly & Testing	\$/system	\$189	\$99	\$90	\$85	\$85	\$83
<b>Total System Cost</b>	<b>\$/system</b>	<b>\$14,348</b>	<b>\$6,639</b>	<b>\$5,037</b>	<b>\$4,207</b>	<b>\$3,838</b>	<b>\$3,431</b>
<b>Total System Cost</b>	<b>2016\$/kWnet</b>	<b>\$179.34</b>	<b>\$82.98</b>	<b>\$62.97</b>	<b>\$52.58</b>	<b>\$47.97</b>	<b>\$42.89</b>
<b>Cost/kWgross</b>	<b>\$/kWgross</b>	<b>\$162.35</b>	<b>\$75.12</b>	<b>\$57.00</b>	<b>\$47.60</b>	<b>\$43.43</b>	<b>\$38.83</b>

Figure 281: Detailed system cost for the 2018 automotive technology system with a Pt price of \$1,100/troy ounce

## 15.2 Monte Carlo Analysis

In order to evaluate the bounds for the likely variation in final results, a Monte Carlo analysis was conducted for the automotive system results. With these results, it is possible to examine the probability of various model outcomes based upon assumed probability distribution functions (PDFs) for selected inputs. For all inputs, triangular distributions were chosen with a minimum, maximum, and most likely value. The most likely value is the result used in the baseline cost analysis, while the maximum and minimum were chosen with the input of the Fuel Cell Tech Team to reflect likely real-world bounds for 2018. The 2018 limits are quite similar to those from 2016, except for power density, Pt loading, and CEM efficiencies. Bipolar Plate cost multiplier was broken into three components (material, forming, and coating multipliers). For 2020 and 2025, bounds are similarly applied with cost factors or specific bounds are set based on what is suitable for future systems.

### 15.2.1 Monte Carlo 2018 Current Automotive Analysis

Assumptions and results for the Monte Carlo analysis of the 2018 automotive systems are shown in Figure 282 and Figure 283. In previous years, the Monte Carlo analysis was conducted solely for 500,000 systems per year. In 2014 the Monte Carlo analysis was expanded to all manufacturing rates. The lower and upper limits for the Monte Carlo analysis are presented as multipliers (or percentages) on each parameter's most likely value (eg. lower bound = 50% of the likeliest value, upper bound = 150% of the likeliest value). While these limits were initially conceived solely for application at 500,000 systems per year, upon consideration they were judged to be reasonably applied to all manufacturing rates.

The numerical bounds for the Monte Carlo Results for manufacturing rate of 500,000 systems per year are shown in Figure 283. Results are shown graphically in Figure 284. Further results of automotive stack, BOP, and total system cost are shown in Section 5.1.

Monte Carlo analysis indicates that the middle 90% probability range of cost is between \$43.09/kW<sub>net</sub> and \$50.11/kW<sub>net</sub> for the automotive system at 500,000 systems per year.

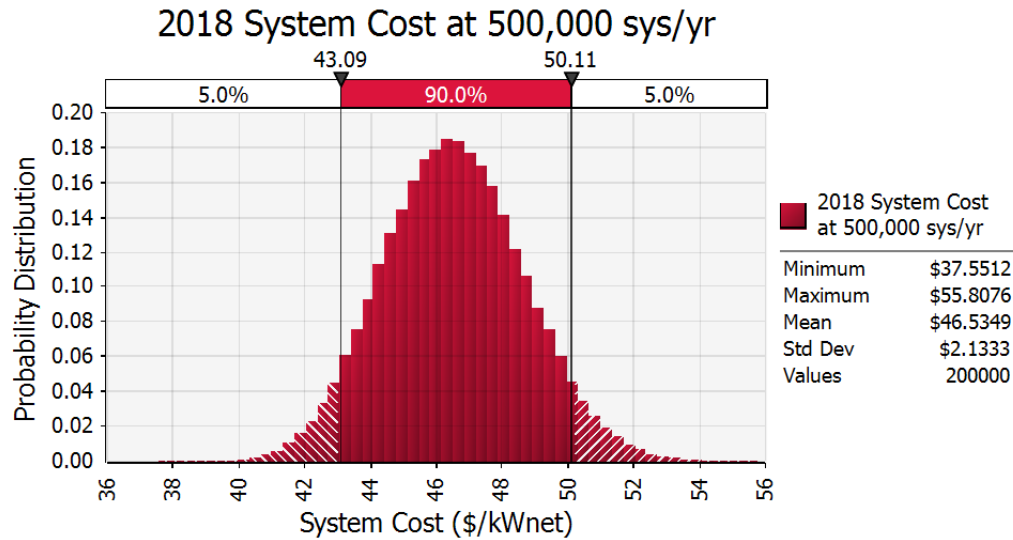
<b>2018 Auto Technology Monte Carlo Analysis</b>				
<b>Parameter</b>	<b>Unit</b>	<b>Minimum Value</b>	<b>Likeliest Value</b>	<b>Maximum Value</b>
Power Density	<b>mW/cm2</b>	1128	<b>1183</b>	1238
Pt Loading	<b>mgPt/cm2</b>	0.124	<b>0.125</b>	0.126
Ionomer Cost Multiplier		0.6	<b>1</b>	4.39
GDL Cost		0.50	<b>1</b>	2.66
Bipolar Plate Welding Speed	<b>m/min</b>	2.5	<b>7.5</b>	7.5
Air Stoichiometry		1.3	<b>1.5</b>	2
Membrane Humidifier Cost Multiplier		0.75	<b>1</b>	1.5
Compressor Effic. Multiplier		0.911	<b>1</b>	1.13
Expander Effic. Multiplier		0.981	<b>1</b>	1.10
Motor/Controller Effic. Multiplier		0.9375	<b>1</b>	1.058
Air Compressor Cost Multiplier		0.587	<b>1</b>	1.2
Balance of Air Compressor Cost Multiplier		0.667	<b>1</b>	1.7
Hydrogen Recirculation System Cost Multiplier		1.000	<b>1</b>	2.42
Membrane Support Cost Multiplier		0.5	<b>1</b>	1.7
Active to Total Area Ratio		0.55	<b>0.625</b>	0.8
Bipolar Plate Material Cost Multiplier		0.93	<b>1</b>	1.200
Bipolar Plate Forming Cost Multiplier		0.7	<b>1</b>	1.3
Bipolar Plate Coating Cost Multiplier		0.80	<b>1</b>	1.20

**Figure 282. 2018 Auto Parameter values used in Monte Carlo analysis for all manufacturing rates.**

<b>2018 Auto Technology Monte Carlo Analysis, 500k sys/year</b>				
<b>Parameter</b>	<b>Unit</b>	<b>Minimum Value</b>	<b>Likeliest Value</b>	<b>Maximum Value</b>
Power Density	mW/cm <sup>2</sup>	1065	<b>1183</b>	1301
Pt Loading	mgPt/cm <sup>2</sup>	0.124	<b>0.125</b>	0.126
Ionomer Cost	\$/kg	\$68.33	<b>\$113.88</b>	\$500.00
GDL Cost	\$/m <sup>2</sup> of GDL	\$3.00	<b>\$6.01</b>	\$16.00
Bipolar Plate Welding Speed	m/min	2.5	<b>7.5</b>	7.5
Air Stoichiometry		1.3	<b>1.5</b>	2
Membrane Humidifier Cost	\$/system	\$46.12	<b>\$61.49</b>	\$92.23
Compressor Effic.	%	64.7%	<b>71%</b>	80%
Expander Effic.	%	71.6%	<b>73%</b>	80%
Motor/Controller Effic.	%	75%	<b>80%</b>	84.6%
Air Compressor Cost		\$500.00	<b>\$852.43</b>	\$1,022.91
Balance of Air Compressor Cost	\$/system	\$164.58	<b>\$246.74</b>	\$419.46
Hydrogen Recirculation System Cost	\$/system	\$220.50	<b>\$220.50</b>	\$534.32
Membrane Support Cost	\$/m <sup>2</sup> of EPTFE	\$3.09	<b>\$6.18</b>	\$10.50
Active to Total Area Ratio		0.55	<b>0.625</b>	0.8
Bipolar Plate Material Cost	\$/kg	\$12.22	<b>\$13.19</b>	\$15.83
Bipolar Plate Forming Cost	\$/kW	\$1.08	<b>\$1.54</b>	\$2.00
Bipolar Plate Coating Cost	\$/kW	\$0.72	<b>\$0.90</b>	\$1.08

<b>2018 Auto Technology Monte Carlo Analysis, 500k sys/year</b>				
<b>Parameter</b>	<b>Unit</b>	<b>Minimum Value</b>	<b>Likeliest Value</b>	<b>Maximum Value</b>
Power Density	mW/cm <sup>2</sup>	1065	<b>1183</b>	1301
Pt Loading	mgPt/cm <sup>2</sup>	0.124	<b>0.125</b>	0.126
Ionomer Cost	\$/kg	\$64.21	<b>\$107.02</b>	\$500.00
GDL Cost	\$/m <sup>2</sup> of GDL	\$3.00	<b>\$5.64</b>	\$16.00
Bipolar Plate Welding Speed	m/min	2.5	<b>7.5</b>	7.5
Air Stoichiometry		1.3	<b>1.5</b>	2
Membrane Humidifier Cost	\$/system	\$43.34	<b>\$57.79</b>	\$86.68
Compressor Effic.	%	64.7%	<b>71%</b>	80%
Expander Effic.	%	71.6%	<b>73%</b>	80%
Motor/Controller Effic.	%	75%	<b>80%</b>	84.6%
Air Compressor Cost		\$500.00	<b>\$801.09</b>	\$961.31
Balance of Air Compressor Cost	\$/system	\$154.66	<b>\$231.88</b>	\$394.20
Hydrogen Recirculation System Cost	\$/system	\$207.22	<b>\$207.22</b>	\$502.14
Membrane Support Cost	\$/m <sup>2</sup> of EPTFE	\$2.90	<b>\$5.81</b>	\$9.87
Active to Total Area Ratio		0.55	<b>0.625</b>	0.8
Bipolar Plate Material Cost	\$/kg	\$12.22	<b>\$13.19</b>	\$15.83
Bipolar Plate Forming Cost	\$/kW	\$1.01	<b>\$1.45</b>	\$1.88
Bipolar Plate Coating Cost	\$/kW	\$0.68	<b>\$0.85</b>	\$1.01

**Figure 283: 2018 Automotive Monte Carlo analysis bounds at 500,000 systems per year**



**Figure 284: 2018 automotive Monte Carlo analysis results at 500k systems per year**

#### 15.2.2 Monte Carlo 2020 Automotive Analysis

Similar to the current 2018 auto sensitivity analysis, Monte Carlo analysis was also conducted for all manufacturing rates of the 2020 auto cost study. The range in cost for the 2020 auto stack, BOP, and total system cost are detailed in Section 5.2. Assumptions and results for the Monte Carlo analysis of the 2020 auto system are shown in Figure 285 and Figure 287 and the graph at a manufacturing rate of 500,000 systems per year appears in Figure 287.

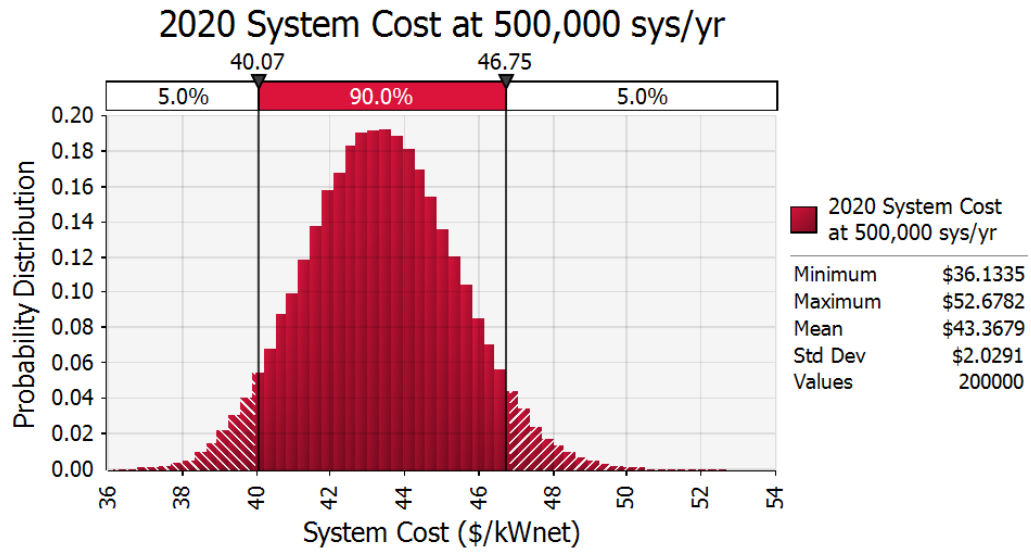
Monte Carlo analysis indicates that the middle 90% probability range of cost is between \$40.07/kW<sub>net</sub> and \$46.75/kW<sub>net</sub> for the 2020 auto system at 500,000 systems per year.

2020 Auto Technology Monte Carlo Analysis				
Parameter	Unit	Minimum Value	Likeliest Value	Maximum Value
Power Density	mW/cm2	1205	<b>1260</b>	1315
Pt Loading	mgPt/cm2	0.124	<b>0.125</b>	0.126
Ionomer Cost Multiplier		0.6	<b>1</b>	3.92
GDL Cost		0.49	<b>1</b>	2.63
Bipolar Plate Welding Speed	m/min	2.5	<b>7.5</b>	7.5
Air Stoichiometry		1.3	<b>1.5</b>	2
Membrane Humidifier Cost Multiplier		0.75	<b>1</b>	1.5
Compressor Effic. Multiplier		0.911	<b>1</b>	1.13
Expander Effic. Multiplier		0.981	<b>1</b>	1.10
Motor/Controller Effic. Multiplier		0.9375	<b>1</b>	1.058
Air Compressor Cost Multiplier		0.5866	<b>1</b>	1.2
Balance of Air Compressor Cost Multiplier		0.667	<b>1</b>	1.7
Hydrogen Recirculation System Cost Multiplier		1.000	<b>1</b>	2.42
Membrane Support Cost Multiplier		0.178	<b>1</b>	1
Active to Total Area Ratio		0.55	<b>0.625</b>	0.8
Bipolar Plate Material Cost Multiplier		1	<b>1</b>	1.200
Bipolar Plate Forming Cost Multiplier		0.7	<b>1</b>	1.3
Bipolar Plate Coating Cost Multiplier		0.80	<b>1</b>	1.20

Figure 285: 2020 Automotive Parameter values used in Monte Carlo analysis for all manufacturing rates.

2020 Auto Technology Monte Carlo Analysis				
Parameter	Unit	Minimum Value	Likeliest Value	Maximum Value
Power Density	mW/cm <sup>2</sup>	1134	<b>1260</b>	1386
Pt Loading	mgPt/cm <sup>2</sup>	0.124	<b>0.125</b>	0.126
Ionomer Cost	\$/kg	\$71.85	<b>\$119.74</b>	\$500.00
GDL Cost	\$/m <sup>2</sup> of GDL	\$3.00	<b>\$5.72</b>	\$16.00
Bipolar Plate Welding Speed	m/min	2.5	<b>7.5</b>	7.5
Air Stoichiometry		1.3	<b>1.5</b>	2
Membrane Humidifier Cost	\$/system	\$43.43	<b>\$57.91</b>	\$86.87
Compressor Effic.	%	65%	<b>71%</b>	80%
Expander Effic.	%	72%	<b>73%</b>	80%
Motor/Controller Effic.	%	75%	<b>80%</b>	85%
Air Compressor Cost		\$500.00	<b>\$801.09</b>	\$961.31
Balance of Air Compressor Cost	\$/system	\$154.66	<b>\$231.88</b>	\$394.20
Hydrogen Recirculation System Cost	\$/system	\$207.22	<b>\$207.22</b>	\$502.14
Membrane Support Cost	\$/m <sup>2</sup>	\$0.24	<b>\$1.35</b>	\$1.35
Active to Total Area Ratio		0.55	<b>0.625</b>	0.8
Bipolar Plate Material Cost	\$/kg	\$12.22	<b>\$12.22</b>	\$14.66
Bipolar Plate Forming Cost	\$/kW	\$0.44	<b>\$0.63</b>	\$0.82
Bipolar Plate Coating Cost	\$/kW	\$0.46	<b>\$0.57</b>	\$0.69

Figure 286: 2020 Automotive Monte Carlo analysis bounds at 500,000 systems per year.



**Figure 287: 2020 auto Monte Carlo analysis results**



### 15.2.3 Monte Carlo 2025 Automotive Analysis

Similar to the current 2018 auto sensitivity analysis, Monte Carlo analysis was also conducted for all manufacturing rates of the 2025 auto cost study. The range in cost for the 2025 auto stack, BOP, and total system cost are detailed in Section 5.2. Assumptions and results for the Monte Carlo analysis of the 2025 auto system are shown in Figure 288 and Figure 289. The graph at a manufacturing rate of 500,000 systems per year appears in Figure 290.

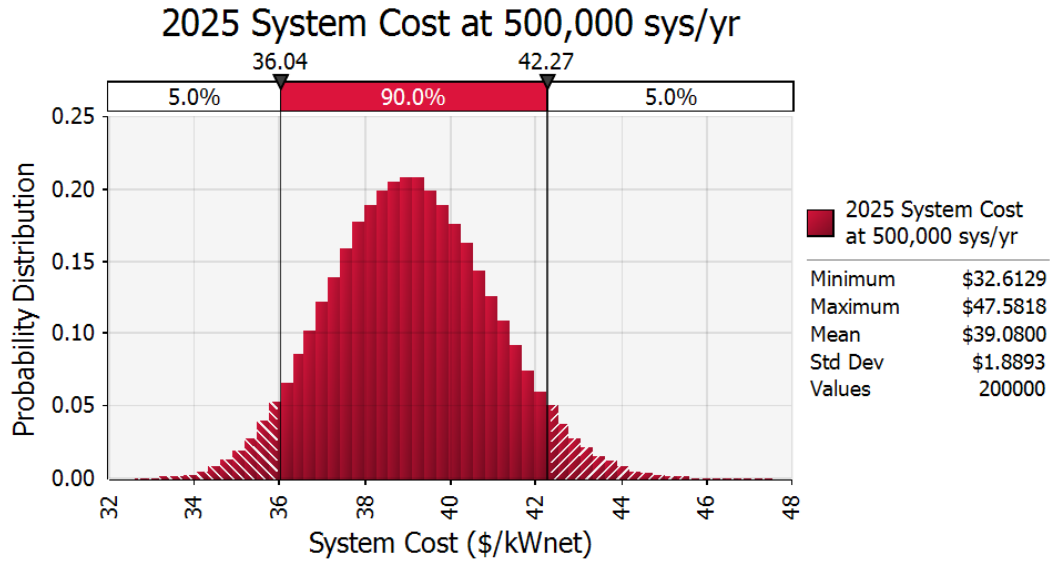
Monte Carlo analysis indicates that the middle 90% probability range of cost is between \$36.04/kW<sub>net</sub> and \$42.27/kW<sub>net</sub> for the 2025 auto system at 500,000 systems per year.

2025 Auto Technology Monte Carlo Analysis				
Parameter	Unit	Minimum Value	Likeliest Value	Maximum Value
Power Density	mW/cm2	1350	1500	1650
Pt Loading	mgPt/cm2	0.087	0.088	0.089
Ionomer Cost Multiplier		0.6	1	3.45
GDL Cost		0.47	1	2.52
Bipolar Plate Welding Speed	m/min	2.5	7.5	7.5
Air Stoichiometry		1.3	1.5	2
Membrane Humidifier Cost Multiplier		0.75	1	1.5
Compressor Effic. Multiplier		0.911	1	1.13
Expander Effic. Multiplier		0.981	1	1.10
Motor/Controller Effic. Multiplier		0.9375	1	1.058
Air Compressor Cost Multiplier		0.6262	1	1.2
Balance of Air Compressor Cost Multiplier		0.667	1	1.7
Hydrogen Recirculation System Cost Multiplier		1.000	1	2.42
Membrane Support Cost Multiplier		0.194	1	1
Active to Total Area Ratio		0.55	0.65	0.8
Bipolar Plate Material Cost Multiplier		1	1	1.200
Bipolar Plate Forming Cost Multiplier		0.7	1	1.3
Bipolar Plate Coating Cost Multiplier		0.80	1	1.20

Figure 288: 2025 Auto Parameter values used in Monte Carlo analysis for all manufacturing rates.

2020 Auto Technology Monte Carlo Analysis				
Parameter	Unit	Minimum Value	Likeliest Value	Maximum Value
Power Density	mW/cm <sup>2</sup>	1350	1500	1650
Pt Loading	mgPt/cm <sup>2</sup>	0.087	0.088	0.089
Ionomer Cost	\$/kg	\$81.80	\$136.33	\$500.00
GDL Cost	\$/m <sup>2</sup> of GDL	\$3.00	\$5.97	\$16.00
Bipolar Plate Welding Speed	m/min	2.5	7.5	7.5
Air Stoichiometry		1.3	1.5	2
Membrane Humidifier Cost	\$/system	\$43.46	\$57.95	\$86.93
Compressor Effic.	%	65%	71%	80%
Expander Effic.	%	72%	73%	80%
Motor/Controller Effic.	%	75%	80%	85%
Air Compressor Cost		\$500.00	\$750.33	\$900.40
Balance of Air Compressor Cost	\$/system	\$154.66	\$231.88	\$394.20
Hydrogen Recirculation System Cost	\$/system	\$207.22	\$207.22	\$502.14
Membrane Support Cost	\$/m <sup>2</sup>	\$0.27	\$1.40	\$1.40
Active to Total Area Ratio		0.55	0.65	0.8
Bipolar Plate Material Cost	\$/kg	\$12.22	\$12.22	\$14.66
Bipolar Plate Forming Cost	\$/kW	\$0.45	\$0.65	\$0.84
Bipolar Plate Coating Cost	\$/kW	\$0.44	\$0.55	\$0.65

Figure 289: 2025 automotive Monte Carlo analysis bounds at 500,000 systems per year



**Figure 290: 2025 Automotive Monte Carlo analysis results**

#### 15.2.4 Monte Carlo 2018 Medium Duty Truck Analysis

Monte Carlo analysis was also conducted for all manufacturing rates of the 2018 MDV cost study. The range in cost for the 2018 MDV stack, BOP, and total system cost are detailed in Section 5.3. Parameter values and analysis bounds for the Monte Carlo analysis of the 2018 MDV system are shown in Figure 291, Figure 288, and Figure 292. The graph at a manufacturing rate of 100,000 systems per year appears in Figure 293.

Monte Carlo analysis indicates that the middle 90% probability range of cost is between \$88.93/kW<sub>net</sub> and \$105.04/kW<sub>net</sub> for the 2018 MDV system at 100,000 systems per year.

2018 MDV Technology Monte Carlo Analysis				
Parameter	Unit	Minimum Value	Likeliest Value	Maximum Value
Power Density	mW/cm <sup>2</sup>	1123	<b>1178</b>	1233
Pt Loading	mgPt/cm <sup>2</sup>	0.347	<b>0.35</b>	0.354
Ionomer Cost Multiplier		0.22	<b>1</b>	5.01
GDL Cost		0.40	<b>1</b>	2.15
Bipolar Plate Welding Speed	m/min	2.5	<b>7.5</b>	7.5
Air Stoichiometry		1.3	<b>1.5</b>	2
Membrane Humidifier Cost Multiplier		0.75	<b>1</b>	1.5
Compressor Effic. Multiplier		0.97	<b>1</b>	1.29
Expander Effic. Multiplier		NA	<b>NA</b>	NA
Motor/Controller Effic. Multiplier		0.97	<b>1</b>	1.00
Air Compressor Cost Multiplier		0.800	<b>1</b>	1.2
Balance of Air Compressor Cost Multiplier		0.667	<b>1</b>	1.7
Hydrogen Recirculation System Cost Multiplier		0.667	<b>1</b>	2.00
Membrane Support Cost Multiplier		0.5	<b>1</b>	1.7
Active to Total Area Ratio		0.55	<b>0.625</b>	0.8
Bipolar Plate Material Cost Multiplier		0.93	<b>1</b>	1.200
Bipolar Plate Forming Cost Multiplier		0.7	<b>1</b>	1.3
Bipolar Plate Coating Cost Multiplier		0.80	<b>1</b>	1.20
Membrane Thickness		0.71	<b>1.00</b>	1.43

Figure 291. 2018 MDV parameter values used in Monte Carlo analysis for all manufacturing rates.

2018 MDV Technology Monte Carlo Analysis				
Parameter	Unit	Minimum Value	Likeliest Value	Maximum Value
Power Density	mW/cm <sup>2</sup>	1123	<b>1178</b>	1233
Pt Loading	mgPt/cm <sup>2</sup>	0.347	<b>0.35</b>	0.354
Ionomer Cost	\$/kg	\$24.02	<b>\$109.18</b>	\$582.00
GDL Cost	\$/m <sup>2</sup> of GDL	\$3.00	<b>\$6.99</b>	\$16.00
Bipolar Plate Welding Speed	m/min	2.5	<b>7.5</b>	7.5
Air Stoichiometry		1.3	<b>1.5</b>	2
Membrane Humidifier Cost	\$/system	\$535	<b>\$714</b>	\$1,071
Compressor Effic.	%	56.0%	<b>58%</b>	75%
Expander Effic.	%	NA	<b>NA</b>	NA
Motor/Controller Effic.	%	92%	<b>95%</b>	95.0%
Air Compressor Cost		\$2,503	<b>\$3,128</b>	\$3,754
Balance of Air Compressor Cost	\$/system	\$386	<b>\$578</b>	\$983
Hydrogen Recirculation System Cost	\$/system	\$418	<b>\$627</b>	\$1,255
Membrane Support Cost	\$/m <sup>2</sup> of EPTFE	\$3.00	<b>\$6.00</b>	\$10.20
Active to Total Area Ratio		0.55	<b>0.625</b>	0.8
Bipolar Plate Material Cost	\$/kg	\$12.22	<b>\$13.19</b>	\$15.83
Bipolar Plate Forming Cost	\$/kW	\$1.03	<b>\$1.48</b>	\$1.92
Bipolar Plate Coating Cost	\$/kW	\$1.18	<b>\$1.48</b>	\$1.77
Membrane Thickness	μm	10	<b>14</b>	20

Figure 292. 2018 MDV Monte Carlo analysis bounds at 100,000 systems per year

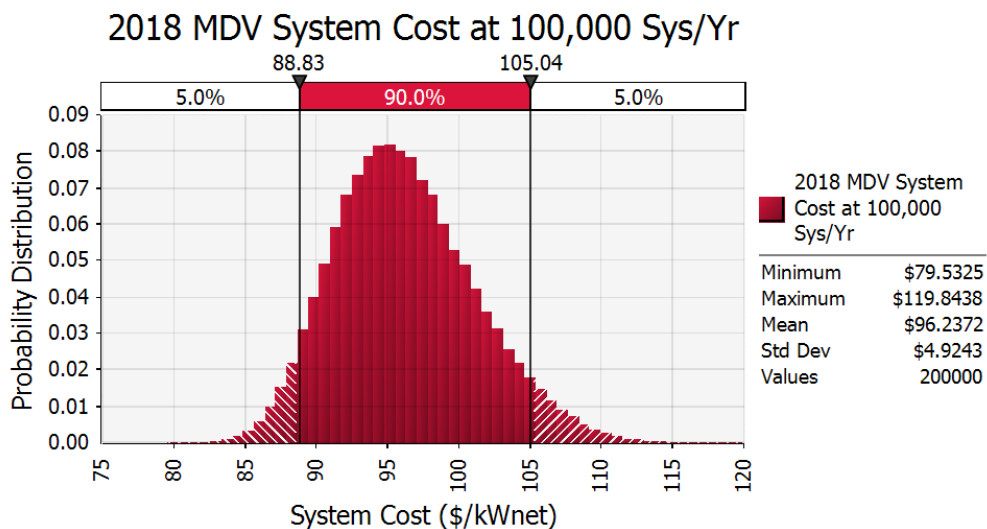


Figure 293. 2018 MDV Monte Carlo analysis results

### 15.2.5 Monte Carlo 2020 Medium Duty Truck Analysis

Monte Carlo analysis was also conducted for all manufacturing rates of the 2020 MDV cost study. The range in cost for the 2020 MDV stack, BOP, and total system cost are detailed in Section 5.3. Parameter values and analysis bounds for the Monte Carlo analysis of the 2020 MDV system are shown in Figure 294, Figure 291, Figure 288, and Figure 295. The graph at a manufacturing rate of 100,000 systems per year appears in Figure 296.

Monte Carlo analysis indicates that the middle 90% probability range of cost is between \$82.15/kW<sub>net</sub> and \$94.53/kW<sub>net</sub> for the 2020 MDV system at 100,000 systems per year.

2020 MDV Technology Monte Carlo Analysis				
Parameter	Unit	Minimum Value	Likeliest Value	Maximum Value
Power Density	mW/cm <sup>2</sup>	1145	1200	1255
Pt Loading	mgPt/cm <sup>2</sup>	0.347	0.35	0.354
Ionomer Cost Multiplier		0.22	1	4.99
GDL Cost		0.40	1	2.11
Bipolar Plate Welding Speed	m/min	2.5	7.5	7.5
Air Stoichiometry		1.3	1.5	2
Membrane Humidifier Cost Multiplier		0.75	1	1.5
Compressor Effic. Multiplier		0.97	1	1.293
Expander Effic. Multiplier		0.981	1	1.36
Motor/Controller Effic. Multiplier		0.97	1	1.00
Air Compressor Cost Multiplier		0.8000	1	1.2
Balance of Air Compressor Cost Multiplier		0.667	1	1.7
Hydrogen Recirculation System Cost Multiplier		0.667	1	2.00
Membrane Support Cost Multiplier		0.5	1	1.7
Active to Total Area Ratio		0.55	0.625	0.8
Bipolar Plate Material Cost Multiplier		0.93	1	1.200
Bipolar Plate Forming Cost Multiplier		0.7	1	1.3
Bipolar Plate Coating Cost Multiplier		0.80	1	1.20
Membrane Thickness		0.71	1.00	1.43

Figure 294. 2020 MDV parameter values used in Monte Carlo analysis for all manufacturing rates.

2020 MDV Technology Monte Carlo Analysis				
Parameter	Unit	Minimum Value	Likeliest Value	Maximum Value
Power Density	mW/cm <sup>2</sup>	1255	1200	1255
Pt Loading	mgPt/cm <sup>2</sup>	0.347	0.35	0.354
Ionomer Cost	\$/kg	\$24.11	\$109.61	\$580.00
GDL Cost	\$/m <sup>2</sup> of GDL	\$3.00	\$7.11	\$16.00
Bipolar Plate Welding Speed	m/min	2.5	7.5	7.5
Air Stoichiometry		1.3	1.5	2
Membrane Humidifier Cost	\$/system	\$535.48	\$713.97	\$1,070.95
Compressor Effic.	%	56%	58%	75%
Expander Effic.	%	58%	59%	80%
Motor/Controller Effic.	%	92%	95%	95%
Air Compressor Cost		\$2,027.50	\$2,534.37	\$3,041.24
Balance of Air Compressor Cost	\$/system	\$385.59	\$578.09	\$982.75
Hydrogen Recirculation System Cost	\$/system	\$418.43	\$627.33	\$1,254.66
Membrane Support Cost	\$/m <sup>2</sup> of EPTFE	\$2.82	\$5.64	\$9.59
Active to Total Area Ratio		0.55	0.625	0.8
Bipolar Plate Material Cost	\$/kg	\$12.22	\$13.19	\$15.83
Bipolar Plate Forming Cost	\$/kW	\$0.91	\$1.30	\$1.69
Bipolar Plate Coating Cost	\$/kW	\$0.56	\$0.70	\$0.85
Membrane Thickness	μm	10.00	14.00	20.00

Figure 295. 2020 MDV Monte Carlo analysis bounds at 100,000 systems per year

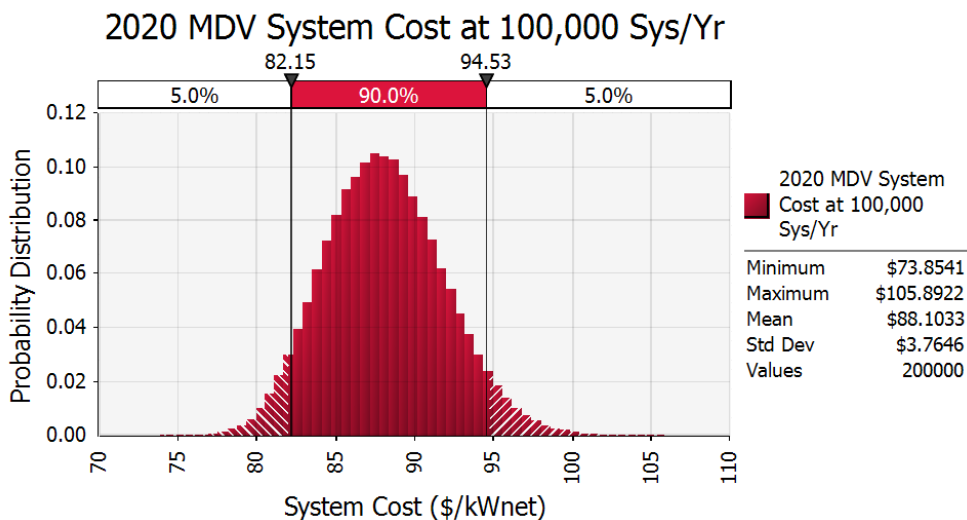


Figure 296. 2020 MDV Monte Carlo analysis results

### 15.2.6 Monte Carlo 2025 Medium Duty Truck Analysis

Monte Carlo analysis was also conducted for all manufacturing rates of the 2025 MDV cost study. The range in cost for the 2025 MDV stack, BOP, and total system cost are detailed in Section 5.3. Parameter values and analysis bounds for the Monte Carlo analysis of the 2025 MDV system are shown in Figure 297 and Figure 298. The graph at a manufacturing rate of 100,000 systems per year appears in Figure 299.

Monte Carlo analysis indicates that the middle 90% probability range of cost is between \$73.77/kW<sub>net</sub> and \$85.65/kW<sub>net</sub> for the 2025 MDV system at 100,000 systems per year.

2025 MDV Technology Monte Carlo Analysis				
Parameter	Unit	Minimum Value	Likeliest Value	Maximum Value
Power Density	mW/cm <sup>2</sup>	1215	1350	1485
Pt Loading	mgPt/cm <sup>2</sup>	0.297	0.3	0.303
Ionomer Cost Multiplier		0.22	1	4.98
GDL Cost		0.38	1	2.02
Bipolar Plate Welding Speed	m/min	2.5	7.5	7.5
Air Stoichiometry		1.3	1.5	2
Membrane Humidifier Cost Multiplier		0.75	1	1.5
Compressor Effic. Multiplier		0.911	1	1.13
Expander Effic. Multiplier		0.981	1	1.10
Motor/Controller Effic. Multiplier		0.9375	1	1.125
Air Compressor Cost Multiplier		0.8000	1	1.2
Balance of Air Compressor Cost Multiplier		0.667	1	1.7
Hydrogen Recirculation System Cost Multiplier		0.667	1	2.00
Membrane Support Cost Multiplier		0.255	1	1
Active to Total Area Ratio		0.55	0.65	0.8
Bipolar Plate Material Cost Multiplier		0.93	1	1.200
Bipolar Plate Forming Cost Multiplier		0.7	1	1.3
Bipolar Plate Coating Cost Multiplier		0.80	1	1.20
Membrane Thickness		0.71	1.00	1.43

Figure 297. 2025 MDV parameter values used in Monte Carlo analysis for all manufacturing rates.



2025 MDV Technology Monte Carlo Analysis			
Parameter	Minimum Value	Likeliest Value	Maximum Value
Power Density	1215	1350	1485
Pt Loading	0.297	0.3	0.303
Ionomer Cost	\$24.14	\$109.74	\$582.00
GDL Cost	\$3.00	\$7.44	\$16.00
Bipolar Plate Welding Speed	2.5	7.5	7.5
Air Stoichiometry	1.3	1.5	2
Membrane Humidifier Cost	\$535.48	\$713.97	\$1,070.95
Compressor Effic.	65%	71%	80%
Expander Effic.	72%	73%	80%
Motor/Controller Effic.	75%	80%	90%
Air Compressor Cost	\$1,744.39	\$2,180.49	\$2,616.59
Balance of Air Compressor Cost	\$407.67	\$611.20	\$1,039.04
Hydrogen Recirculation System Cost	\$418.43	\$627.33	\$1,254.66
Membrane Support Cost	\$0.27	\$1.00	\$1.00
Active to Total Area Ratio	0.55	0.65	0.8
Bipolar Plate Material Cost	\$12.22	\$13.19	\$15.83
Bipolar Plate Forming Cost	\$0.88	\$1.26	\$1.64
Bipolar Plate Coating Cost	\$0.50	\$0.62	\$0.74
Membrane Thickness	10.00	14.00	20.00

Figure 298. 2025 MDV Monte Carlo analysis bounds at 100,000 systems per year

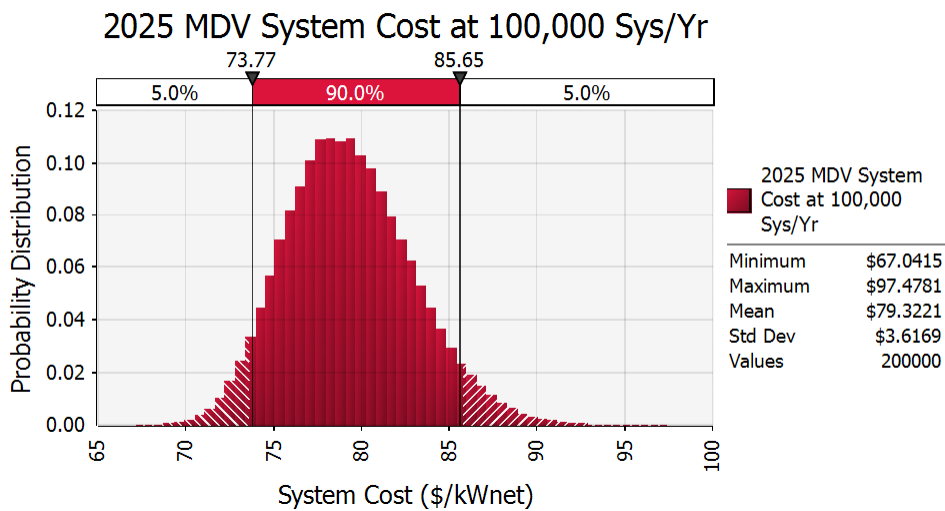


Figure 299. 2025 MDV Monte Carlo analysis results

### 15.2.7 Extension of Monte Carlo Sensitivity

Monte Carlo multi-variable sensitivity analyses are updated each analysis year, however, prior to 2014 the analysis has always focused on highlighting results for the highest manufacturing volumes (500,000 systems per year for the auto system and 1,000 systems per year for the bus system).

The 2014 analysis extended the Monte Carlo sensitivities to all manufacturing rates so that cost results may be shown as both a nominal value and a range of most likely values. Figure 300 graphs the range in cost for the 2018 automotive system at all manufacturing rates based on Monte Carlo analysis. The range in cost for the automotive system generally decreases as manufacturing volume increases. Similar results are seen for the 2020 and 2025 systems (not shown). Additionally, Monte Carlo results are reported for the stack and total BOP cost categories. These results are shown in Section 5.1 for 2018 and Section 5.2 for 2020 and 2025. As in previous years, the range of cost correlates with the middle 90% of results from the Monte Carlo analysis. The summation of the stack and BOP low-value costs do not exactly numerically equal the low value for total system cost. Similarly, the summation of the stack and BOP high-value costs do not equal the high value for total system cost.

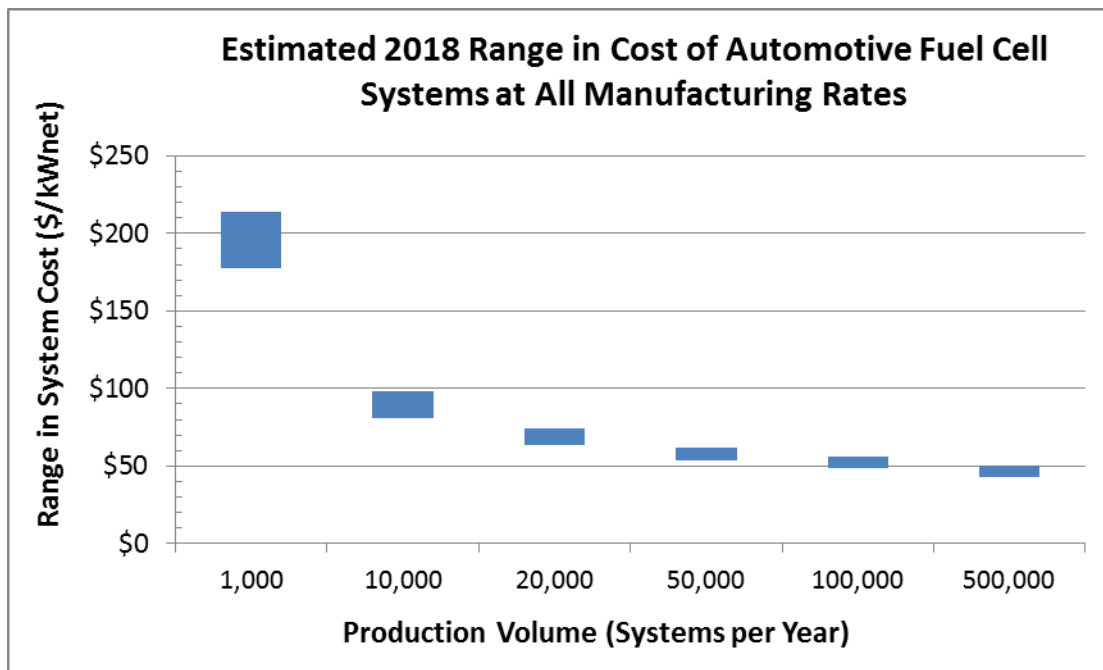
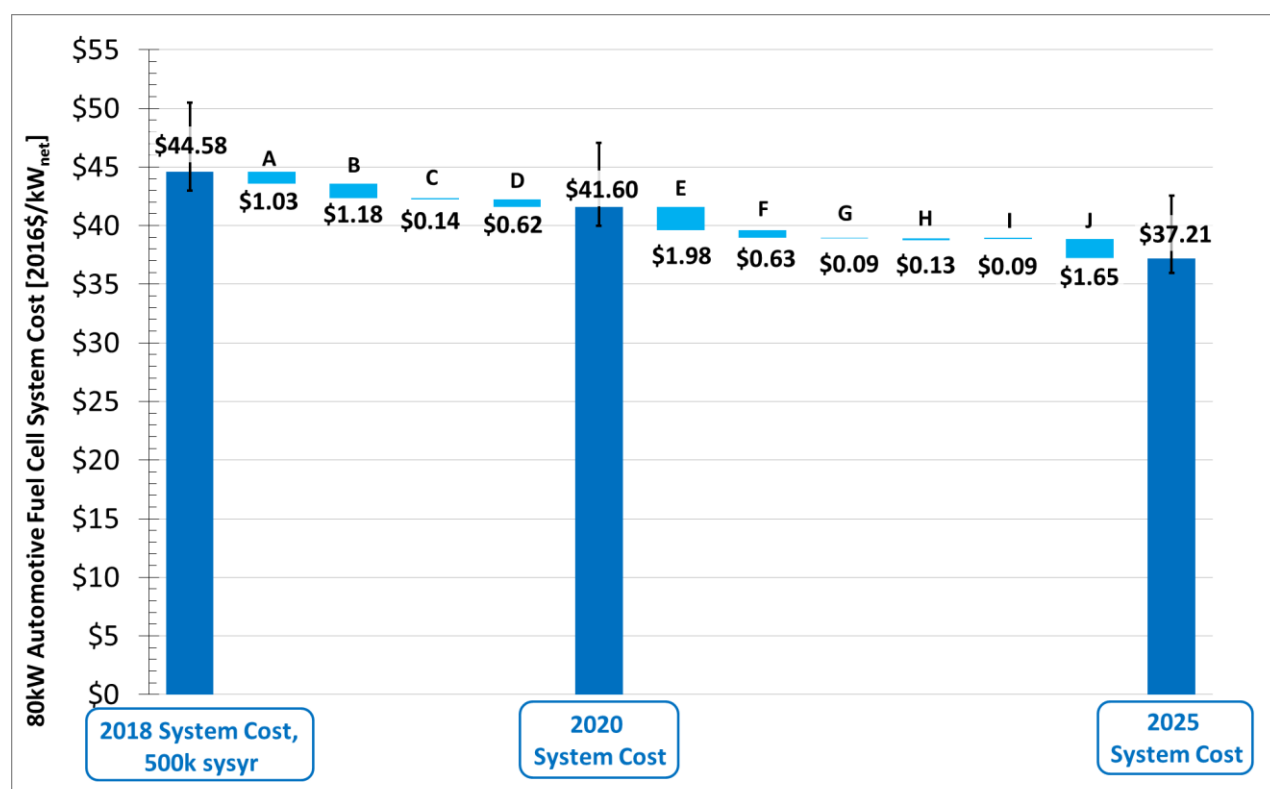


Figure 300. Middle 90% range of 2018 automotive fuel cell cost based on Monte Carlo results at all production rates.

## 16 Future System Cost Projection

In a previous SA study in 2006, automotive fuel cell system costs were projected for 2010 and 2015 technology. In 2017 and 2018, SA analyzed future years 2020 and 2025 systems. The progression of cost reduction based on improved technology through 2020 and 2025 modeled systems is shown in a waterfall chart (Figure 301). Each step in cost is described in the box below the graph. All step changes result in a cost decrease except for step I (the reduction in ionomer EW). This reduction in EW (from 859 to 720) results in an increase in ionomer cost per kg due to an increase in ionomer material cost; however, the increased EW also contributes to an increase in electrochemical performance which is reflected under the power density set change (step E). The largest cost reduction is associated with an increase in power density between 2020 and 2025. The error bars are based on Monte Carlo sensitivity results.



- A: Increase of power density from 1,183 to 1,260mW/cm<sup>2</sup>  
 B: Switched from SS316 to SS304 for BPP base material and switched from TreadStone DOTS -R to TIOX coating.  
 C: Reduction in membrane thickness from 14 to 10 microns thick.  
 D: Membrane support switch from ePTFE to electrospun PPSU.  
 E: Increase of power density from 1,260 to 1,500mW/cm<sup>2</sup>.  
 F: Switched to more advanced CEM design.  
 G: Moved from 2hrs to 1hr of stack conditioning time.  
 H: Increase in active to total area from 0.625 to 0.65  
 I: Reduction in ionomer equivalent weight (859 to 720)  
 J: Reduction in Pt loading from 0.125mg/cm<sup>2</sup> to 0.088mg/cm<sup>2</sup>

**Figure 301. Waterfall chart showing changes in performance operating conditions and designs between analysis years 2018, 2020, and 2025**

To project a potential pathway to lower automotive fuel cell system cost, target values are applied to significant cost-driving components/parameters and the resulting system cost was assessed. An example pathway to \$40/kW<sub>net</sub> (at 500,000 systems per year) is shown in the form of a waterfall chart, with each step corresponding to a system cost parameter improvement. At the left end of the waterfall chart is the 80 kW<sub>net</sub> 2018 baseline system cost (\$45/kW<sub>net</sub>). By varying the input values in the DFMA<sup>®</sup> model for air CEM cost, and bipolar plate (BPP) cost, the combined improvements result in \$39/kW<sub>net</sub>, just below the DOE 2025 cost target. The target values used in this waterfall chart are taken from the Fuel Cell Technical Team U.S. Drive 2013 Roadmap.<sup>158</sup> The most significant step in reducing cost is the air CEM cost (delta \$4/kW<sub>net</sub>, based on a reduction from \$800 to \$500/system). To get to the ultimate DOE target of \$30/kW<sub>net</sub>, more rigorous pathways are used. These include simultaneously increasing power density and decreasing Pt loading, removing the air humidifier, switching to a 2D manufacturing cell assembly, and reduction in catalyst cost by switching from Pt (\$1,500/tr.oz) to a non-precious metal (\$500/tr.oz). The last two steps in the waterfall chart are important steps in order to reach the \$30/kW<sub>net</sub> DOE target. It becomes increasingly difficult to see where costs can be reduced in the system unless a completely different, revolutionary design or manufacturing process was used. There is a need to remove Pt from the stack and consider alternative catalyst materials, particularly for the oxygen reduction reactions at the cathode.

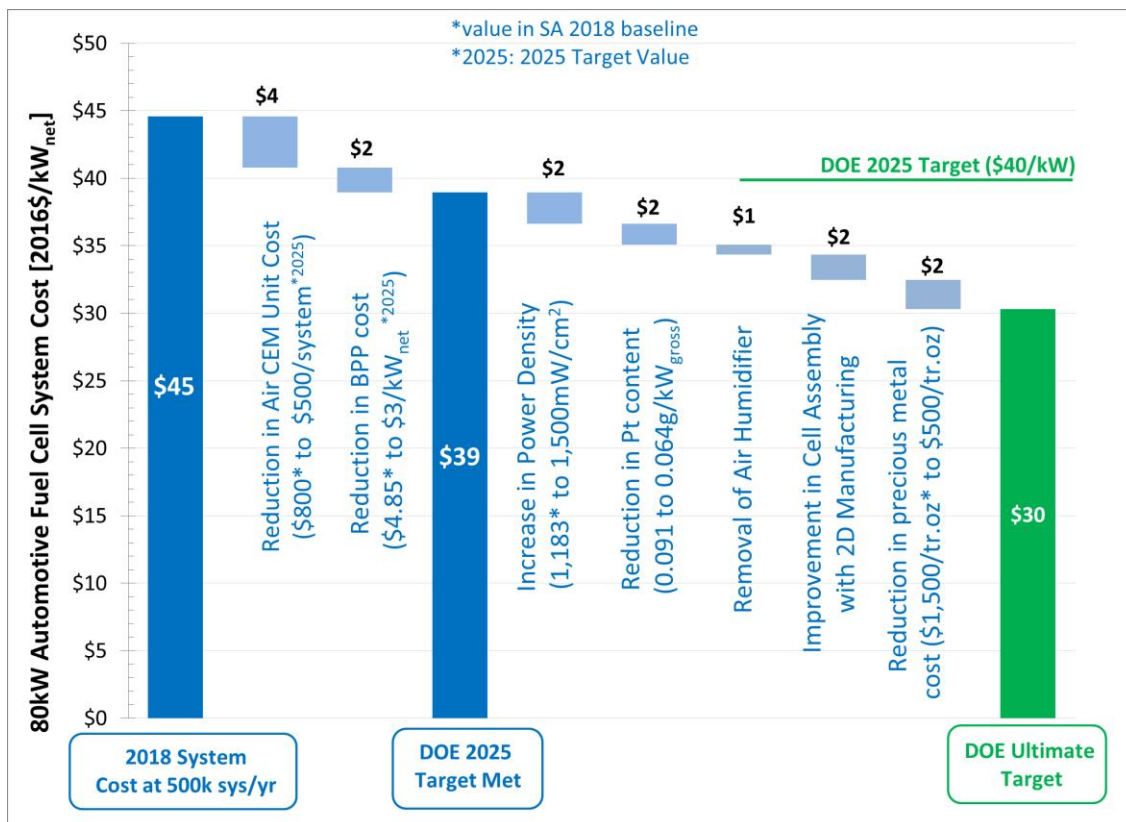


Figure 302. Waterfall chart for projection of automotive fuel cell system cost down to DOE 2025 target \$40/kW<sub>net</sub>, and DOE ultimate target \$30/kW<sub>net</sub>

<sup>158</sup> [http://energy.gov/sites/prod/files/2014/02/f8/fctt\\_roadmap\\_june2013.pdf](http://energy.gov/sites/prod/files/2014/02/f8/fctt_roadmap_june2013.pdf)

## 17 SA Recommendations for Future Study

Analysis of the automotive, bus, and truck fuel cell systems over the past years has shed light on technology and cost shortfalls in achievement of the DOE cost targets. The following is a top-level list of recommendations for further research.

### Bipolar Plates

- Plate Forming: Despite the ability to produce bipolar plates at fast rates in progressive stamping presses (a few seconds per plate), the rates are not fast enough for the millions of plates needed per year. Although the number of lines has reduced since the 2016 analysis, more than 20 forming lines would be required, leading to infeasible factory setups and difficult quality control issues. Faster bipolar plate forming systems are needed or alternative methods for forming/applying gas and coolant flow fields.
- Laser welding: (to seal and create a cooling cell between the plates)
  - Laser welding lengths need to be minimized to achieve low cost. Systems with low effective welding cycle times need to be demonstrated.
  - High rate, low cost, alternates to laser welding should be explored.
  - Clamping of the BPPs to ensure plate contact while welding is identified as a key parameter for welding success. Additional research is needed for optimization.
- Material: Metal plates (as opposed to graphite, Grafoil, or composite materials) appear to be preferred for automotive applications. Alternate alloys with both lower cost and inherent anti-corrosion properties should be explored.

### Membranes

- Increased power density remains the number one pathway to reduced system cost.
- Ionomer costs at high production rates remain uncertain. A more detailed estimate of ionomer cost and the effect of change in EW is needed.
- While ePTFE has proven to be an effective membrane support, its cost is high. Fabrication (at production level) and performance assessment of alternate supports (such as the Giner DSM and electrospun PPSU) should be conducted.

### Catalysts

- Non-Pt based catalysts: Pt-based catalysts have been demonstrated to be most cost-effective. To achieve competitiveness, non-Pt catalysts need to substantially improve their power density.
- Pt Usage: Substantial strides have been achieved in reducing Pt usage (and improving kW/gPt). Nonetheless, Pt cost is one of the largest cost elements within the fuel cell system. Efforts to further reduce Pt while maintaining performance and durability should continue.
- Catalyst Synthesis: Synthesis is complicated but appears to be relatively inexpensive (excluding Pt cost), particularly at high rate production. It appears to be a favorable tradeoff to exchange synthesis complexity (possibly higher cost) for high polarization performance.

- Durability: Catalyst (and membrane) durability has not been explicitly factored in the cost analyses. However, it is clear that durability improvements are needed to meet minimum customer requirements.

### **Gas Diffusion Layers**

- There is a wide distribution in GDL costs seemingly due to a combination of production scale, material wastage, and GDL company markup. More investigation is warranted to better understand these cost drivers.

### **Manufacturing Research**

- Numerous components can be produced in quantities suitable for 1,000 vehicle systems per year but require manufacturing process development to achieve 100k vehicles per year production capability. They require not only a high-confidence market demand (to allow confidence in capital investment) but also substantial R&D dollars to develop the high-speed production systems.

## 18 Key Progress in Automotive Analyses

This section summarizes key progress for the automotive power systems.

2018 Baseline 80 kW<sub>e net</sub> light-duty automotive fuel cell power systems:

- The 2017 DFMA<sup>®</sup>-style cost analysis was updated to reflect changes/improvements achieved in 2018.
- PtCo/HSC cathode catalyst (developed by GM) is selected for the 2018 baseline system. Performance is based on updated 2018 stack polarization projections provided by ANL (based on the latest single cell test data for GM dispersed binary de-alloyed PtCo on high surface area carbon cathode catalyst, with CCM acid washing). SA's cost projections now incorporate specific catalyst powder synthesis methods for d-PtCo/HSC.
- The 2018 system is optimized for low cost, and the resulting design point (at rated power) is shown in Figure 303. These optimized operating conditions differ from the 2016 and 2017 optimization conditions mostly in power density and Pt loading.

	2016 Design Point	2017 Design Point	2018 Design Point
Cell voltage	0.661 volts/cell	0.666 volts/cell	0.657 volts/cell
Power density	749 mW/cm <sup>2</sup>	1,095 mW/cm <sup>2</sup>	1,183 mW/cm <sup>2</sup>
Pressure	2.5 atm	2.5 atm	2.5 atm
Total catalyst loading	0.134 mgPt/cm <sup>2</sup>	0.125 mgPt/cm <sup>2</sup>	0.125 mgPt/cm <sup>2</sup>
Stack Temp. (Coolant Exit Temp)	94°C	94°C	95°C
Cathode Air Stoichiometry	1.4	1.5	1.5

**Figure 303. Design point comparison between 2016, 2017, and 2018.**

- Other significant changes for 2018 include:
  - Re-evaluation of bipolar plate laser welding station design and capital cost assumptions.
  - Switched from a Dual-Ejector to Pulsed-Ejector hydrogen recirculation system.
  - Added three components to the air loop: stack shutoff valve, stack bypass valve, and small flow orifice for air foil bearings.
  - Applied inflation multiplier on air CEM and motor controller to account for the difference in cost between 2009 (the year in which the analysis was completed) and 2018.
- Several analyses were performed to explore alternative manufacturing procedures or types of system components (but were not incorporated into the baseline cost analysis):
  - DFMA<sup>®</sup> analysis of electrospun PPSU as the membrane support (as an alternative to ePTFE).
  - DFMA<sup>®</sup> analysis of co-spun PPSU and ionmer, compaction, and PEO removal for a complete electrospun membrane.
  - DFMA<sup>®</sup> analysis of electrospun electrodes material (as an alternative to ePTFE).

- Capital cost estimation and DFMA<sup>®</sup> analysis of PVD coating to make catalyst powders utilizing Pt and niobium oxide to coat carbon supports.
- DFMA<sup>®</sup> analysis of 2D Manufacturing
- The estimated fuel cell system cost for automobiles is \$44.58/kW<sub>net</sub> at 500,000 systems per year (\$49.67/kW<sub>net</sub> at 100,000 systems per year) and represents the “2018 Update” to previous annual estimates. (This value does not include the cost of hydrogen storage or the electric drivetrain.)
- A Monte Carlo analysis indicates that the automotive fuel cell system cost is likely to be between \$43.09/kW<sub>net</sub> and \$50.11/kW<sub>net</sub>, with 90% probability.
- The 2018 automotive system balance of plant components represent approximately 57% of the overall system cost at a production rate of 500,000 systems per year.

2020 and 2025 80 kW<sub>net</sub> auto fuel cell power systems:

- The primary difference between the 2018 baseline and the 2020/2025 automotive power systems is power density and Pt loading.
- Compared to the 2018 system, the 2020 system has:
  - Higher power density (1,260 mW/cm<sup>2</sup> vs. previous 1,183 mW/cm<sup>2</sup>)
  - Alternative BPP material and coating assumptions (SS304 with TIOX coating vs. previous SS316 with DOTS-R coating)
  - Alternative BPP forming process (hydroforming vs. previous progressive stamping)
  - Alternative low-cost electrospun PPSU membrane support
  - Lower membrane thickness (10 μm vs. previous 14 μm)
- The 2020 system performance is based on GM’s PtCo/HSC cathode catalyst material but with a reasonable increase in power density (at the same catalyst loading) to reflect two additional years of development.
- Compared to the 2020 system, the 2025 system has:
  - Higher power density (1,500 mW/cm<sup>2</sup> vs. previous 1,260 mW/cm<sup>2</sup>)
  - Lower catalyst loading (0.088 mgPt/cm<sup>2</sup> vs. previous 0.125 mgPt/cm<sup>2</sup>)
  - Advanced/lower cost CEM design
  - A reduction in stack conditioning time (1 vs. previous 2 hrs)
  - Larger active-to-total cell area ratio (0.65 vs. previous 0.625)
- The 2025 system performance was suggested by the FCTT and the Pt loading was based on one of GM’s PtCo/HSC variations in Pt loading of 0.088 mg/cm<sup>2</sup>.



	<b>2020 Auto Design Point</b>	<b>2025 Auto Design Point</b>
Cell voltage	0.657 volts/cell	0.657 volts/cell
Power density	1,260 mW/cm <sup>2</sup>	1,500 mW/cm <sup>2</sup>
Pressure	2.5 atm	2.5 atm
Total catalyst loading	0.125 mgPt/cm <sup>2</sup>	0.088 mgPt/cm <sup>2</sup>
Stack Temperature	95°C	95°C
Cathode Air Stoichiometry	1.5	1.5

**Figure 304. Design Point Comparison for 2020 and 2025 auto systems**

- The system schematics and stack construction are identical between the 2018, 2020, and 2025 automobile systems.
- The final 2020 auto cost is projected to be \$41.60/kW<sub>net</sub> at 500,000 systems per year.
- A Monte Carlo analysis indicates that the 2020 auto fuel cell system cost is likely to be between \$40.07/kW<sub>net</sub> and \$46.75/kW<sub>net</sub>, with 90% probability.
- The 2020 auto system balance of plant represents 61% of the overall system cost at a production rate of 500,000 systems per year.
- The final 2025 auto cost is projected to be \$37.21/kW<sub>net</sub> at 500,000 systems per year.
- A Monte Carlo analysis indicates that the 2025 auto fuel cell system cost is likely to be between \$36.04/kW<sub>net</sub> and \$42.27/kW<sub>net</sub>, with 90% probability.
- The 2025 auto system balance of plant represents 66% of the overall system cost at a production rate of 500,000 systems per year.

## 19 Key Progress in Medium Duty Vehicle Analyses

This section summarizes key progress for the MDV power systems.

2018 Baseline 160 kW<sub>e,net</sub> medium-duty truck fuel cell power systems:

- The 2016 DFMA<sup>®</sup>-style cost analysis for the 160kW<sub>e,net</sub> bus system was updated to reflect a medium duty truck type system for 2018.
- PtCo/HSC cathode catalyst is selected for the 2018 baseline MDV system. Performance is based on Toyota Mirai stack performance (utilizes PtCo/C cathode catalyst). The 2018 system design point (at rated power) is shown in Figure 305. These operating conditions differ from the 2016 bus conditions in all parameters except cell voltage.

	2016 Bus Design Point	2018 MDV Design Point
Cell voltage	0.659 volts/cell	0.68 volts/cell
Power density	739 mW/cm <sup>2</sup>	1,178 mW/cm <sup>2</sup>
Pressure	1.9 atm	2.35 atm
Total catalyst loading	0.5 mgPt/cm <sup>2</sup>	0.35 mgPt/cm <sup>2</sup>
Stack Temp. (Coolant Exit Temp)	72°C	63°C
Cathode Air Stoichiometry	1.8	1.5

**Figure 305. Design point comparison between 2016 bus and 2018 MDV.**

- The estimated fuel cell system cost for MDVs is \$92.41/kW<sub>net</sub> at 100,000 systems per year. (This value does not include the cost of hydrogen storage or the electric drivetrain.)
- A Monte Carlo analysis indicates that the MDV fuel cell system cost is likely to be between \$88.83/kW<sub>net</sub> and \$105.04/kW<sub>net</sub>, with 90% probability.
- The 2018 MDV system balance of plant components represent approximately 54% of the overall system cost at a production rate of 500,000 systems per year.

2020 and 2025 160 kW<sub>net</sub> MDV fuel cell power systems:

- The primary difference between the 2018 baseline and the 2020/2025 MDV power systems is power density and air compression system design.
- Compared to the 2018 system, the 2020 system has:
  - Higher power density (1,200 mW/cm<sup>2</sup> vs. previous 1,178 mW/cm<sup>2</sup>)
  - Alternative BPP coating assumptions (TreadStone TIOX coating vs. TreadStone DOTS-R coating)
  - Alternative BPP forming process (hydroforming vs. previous progressive stamping)
  - Addition of an Eaton-style expander on the Eaton-style compressor/motor unit.
- The 2018 system performance is based on Toyota Mirai stack performance (utilizing PtCo/C cathode catalyst) but with a reasonable increase in power density (at the same catalyst loading) to reflect two additional years of development.
- Compared to the 2020 system, the 2025 system has:
  - Higher power density (1,350 mW/cm<sup>2</sup> vs. previous 1,200 mW/cm<sup>2</sup>)
  - Lower Pt loading (0.3 mgPt/cm<sup>2</sup> vs. previous 0.35 mgPt/cm<sup>2</sup>)
  - Alternative low-cost electrospun PPSU membrane support
  - Shift to centrifugal air compressor with radial-inflow expander
  - A reduction in stack conditioning time (1 vs. previous 2 hrs)
  - Higher active-to-total cell area ratio (0.65 vs. previous 0.625)
- The 2025 system performance is based on projected improvements in future years.

	<b>2020 Auto Design Point</b>	<b>2025 Auto Design Point</b>
Cell voltage	0.68 volts/cell	0.68 volts/cell
Power density	1,200 mW/cm <sup>2</sup>	1,350 mW/cm <sup>2</sup>
Pressure	2.35 atm	2.35 atm
Total Pt loading	0.35 mgPt/cm <sup>2</sup>	0.3 mgPt/cm <sup>2</sup>
Stack Temperature	63°C	63°C
Cathode Air Stoichiometry	1.5	1.5

**Figure 306. Design Point Comparison for 2020 and 2025 MDV systems**

- The system schematics and stack construction differ slightly between the 2018, 2020, and 2025 MDV systems. The air compression systems are different for all three year cases: Eaton-style compressor-only system for 2018, Eaton-style compressor-expander system for 2020, and Honeywell-style compressor-expander system for 2025.
- The final 2020 MDV cost is projected to be \$85.69/kW<sub>net</sub> at 100,000 systems per year.
- A Monte Carlo analysis indicates that the 2020 MDV fuel cell system cost is likely to be between \$82.15/kW<sub>net</sub> and \$94.53/kW<sub>net</sub>, with 90% probability.
- The 2020 MDV system balance of plant represents 53% of the overall system cost at a production rate of 100,000 systems per year.
- The final 2025 MDV cost is projected to be \$75.46/kW<sub>net</sub> at 100,000 systems per year.
- A Monte Carlo analysis indicates that the 2025 auto fuel cell system cost is likely to be between \$73.77/kW<sub>net</sub> and \$85.65/kW<sub>net</sub>, with 90% probability.
- The 2025 MDV system balance of plant represents 57% of the overall system cost at a production rate of 100,000 systems per year.

## 20 Appendix A: 2020 & 2025 Auto System Cost Results

### 20.1 Fuel Cell Stack Materials, Manufacturing, and Assembly Cost Results

#### 20.1.1 Bipolar Plates

##### 2020 Analysis

Annual Production Rate	1,000	10,000	20,000	50,000	100,000	500,000
Equipment Lifetime (years)	15	15	15	15	15	15
Interest Rate	10%	10%	10%	10%	10%	10%
Corporate Income Tax Rate	40%	40%	40%	40%	40%	40%
Capital Recovery Factor	0.175	0.175	0.175	0.175	0.175	0.175
Equipment Installation Factor	1.4	1.4	1.4	1.4	1.4	1.4
Maintenance/Spare Parts (% of CC)	13%	13%	13%	13%	13%	13%
Miscellaneous Expenses (% of CC)	2%	2%	2%	2%	2%	2%
Power Consumption (kW)	335	342	342	342	342	342

Annual Production Rate	1,000	10,000	20,000	50,000	100,000	500,000
Capital Cost (\$/line)	\$1,252,525	\$1,379,247	\$1,379,247	\$2,430,916	\$2,430,916	\$2,430,916
Costs per Tooling Set (\$)	\$660,643	\$660,643	\$660,643	\$1,321,286	\$1,321,286	\$1,321,286
Tooling Lifetime (cycles)	10,000,000	10,000,000	10,000,000	10,000,000	10,000,000	10,000,000
Simultaneous Lines	1	1	2	3	5	25
Laborers per Line	1.25	0.5	0.5	0.5	0.5	0.5
Line Utilization	7.8%	78.3%	78.3%	81.8%	98.1%	98.1%
Cycle Time (s)	2.07	2.07	2.07	2.60	2.60	2.60
Effective Total Machine Rate (\$/hr)	\$1,134.40	\$165.52	\$165.54	\$245.18	\$212.62	\$212.64
Stainless Steel Cost (\$/kg)	\$12.22	\$12.22	\$12.22	\$12.22	\$12.22	\$12.22

Annual Production Rate	1,000	10,000	20,000	50,000	100,000	500,000
Materials (\$/stack)	\$181	\$181	\$181	\$178	\$178	\$178
Manufacturing (\$/stack)	\$501	\$73	\$73	\$68	\$59	\$59
Tooling (\$/stack)	\$83	\$54	\$54	\$55	\$54	\$54
Secondary Operations: Coating (\$/stack)	\$663	\$144	\$79	\$61	\$56	\$46
<b>Total Cost (\$/stack)</b>	<b>\$1,428</b>	<b>\$451</b>	<b>\$387</b>	<b>\$361</b>	<b>\$347</b>	<b>\$336</b>
<b>Total Cost (\$/kWnet)</b>	<b>\$17.85</b>	<b>\$5.64</b>	<b>\$4.84</b>	<b>\$4.52</b>	<b>\$4.33</b>	<b>\$4.20</b>

##### 2025 Analysis

Annual Production Rate	1,000	10,000	20,000	50,000	100,000	500,000
Equipment Lifetime (years)	15	15	15	15	15	15
Interest Rate	10%	10%	10%	10%	10%	10%
Corporate Income Tax Rate	40%	40%	40%	40%	40%	40%
Capital Recovery Factor	0.175	0.175	0.175	0.175	0.175	0.175
Equipment Installation Factor	1.4	1.4	1.4	1.4	1.4	1.4
Maintenance/Spare Parts (% of CC)	13%	13%	13%	13%	13%	13%
Miscellaneous Expenses (% of CC)	2%	2%	2%	2%	2%	2%
Power Consumption (kW)	335	342	342	342	342	342

Annual Production Rate	1,000	10,000	20,000	50,000	100,000	500,000
Capital Cost (\$/line)	\$1,084,551	\$1,211,273	\$1,211,273	\$2,094,968	\$2,094,968	\$2,094,968
Costs per Tooling Set (\$)	\$660,382	\$660,382	\$660,382	\$1,320,764	\$1,320,764	\$1,320,764
Tooling Lifetime (cycles)	10,000,000	10,000,000	10,000,000	10,000,000	10,000,000	10,000,000
Simultaneous Lines	1	1	2	3	5	24
Laborers per Line	1.25	0.5	0.5	0.5	0.5	0.5
Line Utilization	7.5%	74.5%	74.5%	77.8%	93.4%	97.3%
Cycle Time (s)	1.96	1.96	1.96	2.45	2.45	2.45
Effective Total Machine Rate (\$/hr)	\$1,039.99	\$156.59	\$156.60	\$226.72	\$197.24	\$191.35
Stainless Steel Cost (\$/kg)	\$12.22	\$12.22	\$12.22	\$12.22	\$12.22	\$12.22

Annual Production Rate	1,000	10,000	20,000	50,000	100,000	500,000
Materials (\$/stack)	\$148	\$148	\$148	\$145	\$145	\$145
Manufacturing (\$/stack)	\$437	\$66	\$66	\$60	\$52	\$50
Tooling (\$/stack)	\$83	\$54	\$54	\$55	\$54	\$52
Secondary Operations: Coating (\$/stack)	\$654	\$65	\$77	\$58	\$55	\$44
<b>Total Cost (\$/stack)</b>	<b>\$1,322</b>	<b>\$333</b>	<b>\$345</b>	<b>\$317</b>	<b>\$306</b>	<b>\$291</b>
<b>Total Cost (\$/kWnet)</b>	<b>\$16.52</b>	<b>\$4.16</b>	<b>\$4.31</b>	<b>\$3.96</b>	<b>\$3.82</b>	<b>\$3.64</b>

### 20.1.1.1 Alloy Selection and Corrosion Concerns

#### 2020 Analysis (TreadStone TIOX)

Annual Production Rate	1,000	10,000	20,000	50,000	100,000	500,000
Station #1 Capital Cost (\$/line)	\$700,000	\$2,400,220	\$2,400,220	\$2,400,220	\$2,400,220	\$2,400,220
Station #1 Simultaneous Lines	1	1	1	2	4	17
Station #2 Capital Cost (\$/line)	\$381,150	\$436,800	\$517,700	\$618,900	\$871,900	\$871,900
Station #2 Simultaneous Lines	1	1	1	1	1	2
Station #3 Capital Cost (\$/line)	\$244,318	\$244,318	\$244,318	\$244,318	\$244,318	\$244,318
Station #3 Simultaneous Lines	1	1	1	2	2	10

Annual Production Rate	1,000	10,000	20,000	50,000	100,000	500,000
Materials (\$/stack)	\$7	\$6	\$5	\$5	\$5	\$4
Manufacturing (\$/stack)	\$625	\$129	\$68	\$52	\$48	\$39
Tooling (\$/stack)	\$31	\$8	\$5	\$4	\$4	\$3
<b>Total Cost (\$/stack)</b>	<b>\$663</b>	<b>\$144</b>	<b>\$79</b>	<b>\$61</b>	<b>\$56</b>	<b>\$46</b>
<b>Total Cost (\$/kWnet)</b>	<b>\$8.29</b>	<b>\$1.80</b>	<b>\$0.99</b>	<b>\$0.76</b>	<b>\$0.70</b>	<b>\$0.57</b>

#### 2025 Analysis (TreadStone TIOX)

Annual Production Rate	1,000	10,000	20,000	50,000	100,000	500,000
Station #1 Capital Cost (\$/line)	\$700,000	\$2,400,220	\$2,400,220	\$2,400,220	\$2,400,220	\$2,400,220
Station #1 Simultaneous Lines	1	1	1	2	4	16
Station #2 Capital Cost (\$/line)	\$381,550	\$438,800	\$522,000	\$626,100	\$886,200	\$886,200
Station #2 Simultaneous Lines	1	1	1	1	1	2
Station #3 Capital Cost (\$/line)	\$243,695	\$243,695	\$243,695	\$243,695	\$243,695	\$243,695
Station #3 Simultaneous Lines	1	1	1	2	2	10

Annual Production Rate	1,000	10,000	20,000	50,000	100,000	500,000
Materials (\$/stack)	\$6	\$5	\$4	\$4	\$4	\$3
Manufacturing (\$/stack)	\$622	\$129	\$68	\$50	\$48	\$38
Tooling (\$/stack)	\$26	\$7	\$4	\$3	\$3	\$3
<b>Total Cost (\$/stack)</b>	<b>\$654</b>	<b>\$141</b>	<b>\$77</b>	<b>\$58</b>	<b>\$55</b>	<b>\$44</b>
<b>Total Cost (\$/kWnet)</b>	<b>\$8.17</b>	<b>\$1.76</b>	<b>\$0.96</b>	<b>\$0.72</b>	<b>\$0.69</b>	<b>\$0.55</b>

## 20.1.2 Membrane

### 2020 Analysis (Gore Direct-Coat Type with Electrospun Membrane Support)

Annual Production Rate	1,000	10,000	20,000	50,000	100,000	500,000
Equipment Lifetime (years)	14	14	14	14	14	14
Interest Rate	10%	10%	10%	10%	10%	10%
Corporate Income Tax Rate	40%	40%	40%	40%	40%	40%
Capital Recovery Factor	0.179	0.179	0.179	0.179	0.179	0.179
Equipment Installation Factor	1.4	1.4	1.4	1.4	1.4	1.4
Maintenance/Spare Parts (% of CC)	10%	10%	10%	10%	10%	10%
Miscellaneous Expenses (% of CC)	7%	7%	7%	7%	7%	7%
Power Consumption (kW)	122	422	481	822	950	1787

Annual Production Rate	1,000	10,000	20,000	50,000	100,000	500,000
Capital Cost (\$/Line)	\$1,142,882	\$2,662,079	\$3,056,303	\$4,868,659	\$5,650,499	\$10,732,461
Simultaneous Lines	1	1	1	1	1	1
Laborers per Line	1.25	1.25	1.25	1.25	1.25	1.25
Line Utilization	11.4%	20.4%	20.7%	25.1%	33.0%	51.1%
Effective Total Machine Rate (\$/hr)	\$585.44	\$767.20	\$860.69	\$1,129.66	\$1,019.96	\$1,288.73
Line Speed (m/s)	0.013	0.033	0.067	0.067	0.100	0.317
Membrane Support Cost (\$/m <sup>2</sup> )	\$2.85	\$2.25	\$1.97	\$2.04	\$1.99	\$1.44
Ionomer Cost (\$/kg)	\$407.20	\$251.38	\$235.27	\$198.64	\$173.90	\$127.42

Annual Production Rate	1,000	10,000	20,000	50,000	100,000	500,000
Material (\$/stack)	\$125	\$90	\$64	\$54	\$49	\$34
Manufacturing (\$/stack)	\$509	\$119	\$68	\$43	\$26	\$10
Tooling (\$/stack)	\$1	\$1	\$1	\$1	\$1	\$1
Markup (\$/stack)	\$374	\$77	\$42	\$24	\$14	\$5
<b>Total Cost (\$/stack)</b>	<b>\$1,009</b>	<b>\$287</b>	<b>\$174</b>	<b>\$122</b>	<b>\$89</b>	<b>\$50</b>
<b>Total Cost (\$/kWnet)</b>	<b>\$12.62</b>	<b>\$3.58</b>	<b>\$2.18</b>	<b>\$1.53</b>	<b>\$1.11</b>	<b>\$0.62</b>

### 2025 Analysis (Gore Direct-Coat Type with Electrospun Membrane Support)

Annual Production Rate	1,000	10,000	20,000	50,000	100,000	500,000
Equipment Lifetime (years)	14	14	14	14	14	14
Interest Rate	10%	10%	10%	10%	10%	10%
Corporate Income Tax Rate	40%	40%	40%	40%	40%	40%
Capital Recovery Factor	0.179	0.180	0.179	0.179	0.179	0.179
Equipment Installation Factor	1.4	1.4	1.4	1.4	1.4	1.4
Maintenance/Spare Parts (% of CC)	10%	10%	10%	10%	10%	10%
Miscellaneous Expenses (% of CC)	7%	7%	7%	7%	7%	7%
Power Consumption (kW)	122	337	376	822	950	1787

Annual Production Rate	1,000	10,000	20,000	50,000	100,000	500,000
Capital Cost (\$/Line)	\$1,142,882	\$2,107,928	\$2,315,591	\$4,868,659	\$5,650,499	\$10,732,461
Simultaneous Lines	1	1	1	1	1	1
Laborers per Line	1.25	1.25	1.25	1.25	1.25	1.25
Line Utilization	10.5%	17.0%	33.4%	21.2%	28.0%	43.2%
Effective Total Machine Rate (\$/hr)	\$630.77	\$728.91	\$446.29	\$1,312.28	\$1,180.87	\$1,486.43
Line Speed (m/s)	0.013	0.033	0.033	0.067	0.100	0.317
Membrane Support Cost (\$/m <sup>2</sup> )	\$2.78	\$2.23	\$1.98	\$2.23	\$1.48	\$1.40
Ionomer Cost (\$/kg)	\$463.61	\$305.35	\$267.86	\$226.15	\$197.99	\$145.07

Annual Production Rate	1,000	10,000	20,000	50,000	100,000	500,000
Material (\$/stack)	\$115	\$68	\$59	\$51	\$40	\$31
Manufacturing (\$/stack)	\$504	\$94	\$57	\$42	\$25	\$10
Tooling (\$/stack)	\$1	\$1	\$1	\$1	\$1	\$0
Markup (\$/stack)	\$371	\$61	\$34	\$24	\$13	\$4
<b>Total Cost (\$/stack)</b>	<b>\$992</b>	<b>\$224</b>	<b>\$151</b>	<b>\$118</b>	<b>\$79</b>	<b>\$46</b>
<b>Total Cost (\$/kWnet)</b>	<b>\$12.40</b>	<b>\$2.80</b>	<b>\$1.88</b>	<b>\$1.48</b>	<b>\$0.99</b>	<b>\$0.57</b>

### 20.1.3 Pt on Carbon Catalyst

#### 20.1.3.1 Catalyst Synthesis Cost

##### 2020 Analysis

##### Cathode

Annual Production Rate	1,000	10,000	20,000	50,000	100,000	500,000
Gross Amount of Catalyst Needed per system (g/system)	38.49	33.61	32.98	31.45	31.06	30.41
Material (\$/gram of catalyst)	\$17.24	\$15.64	\$15.37	\$14.97	\$14.83	\$14.70
Manufacturing (\$/gram of catalyst)	\$12.31	\$1.76	\$1.02	\$0.51	\$0.35	\$0.29
Markup (\$/gram of catalyst)	\$0.00	\$7.01	\$3.79	\$1.94	\$1.29	\$0.75
<b>Total Cost (\$/gram of catalyst)</b>	<b>\$29.55</b>	<b>\$24.41</b>	<b>\$20.18</b>	<b>\$17.42</b>	<b>\$16.47</b>	<b>\$15.74</b>

##### Anode

Annual Production Rate	1,000	10,000	20,000	50,000	100,000	500,000
Gross Amount of Catalyst Needed per system (g/system)	9.37	8.18	8.03	7.65	7.56	7.40
Material (\$/gram of catalyst)	\$12.07	\$10.95	\$10.88	\$10.70	\$10.43	\$10.13
Manufacturing (\$/gram of catalyst)	\$12.04	\$1.77	\$1.01	\$0.48	\$0.32	\$0.20
Markup (\$/gram of catalyst)	\$0.00	\$7.13	\$4.27	\$2.88	\$1.91	\$0.82
<b>Total Cost (\$/gram of catalyst)</b>	<b>\$24.11</b>	<b>\$19.85</b>	<b>\$16.16</b>	<b>\$14.07</b>	<b>\$12.66</b>	<b>\$11.15</b>

##### 2025 Analysis

##### Cathode

Annual Production Rate	1,000	10,000	20,000	50,000	100,000	500,000
Gross Amount of Catalyst Needed per system (g/system)	21.36	18.66	18.31	17.46	17.24	16.88
Material (\$/gram of catalyst)	\$18.57	\$15.85	\$15.71	\$15.19	\$14.94	\$14.72
Manufacturing (\$/gram of catalyst)	\$21.56	\$3.00	\$1.70	\$0.80	\$0.53	\$0.29
Markup (\$/gram of catalyst)	\$0.00	\$10.72	\$6.01	\$3.10	\$1.94	\$0.77
<b>Total Cost (\$/gram of catalyst)</b>	<b>\$40.12</b>	<b>\$29.57</b>	<b>\$23.42</b>	<b>\$19.10</b>	<b>\$17.41</b>	<b>\$15.78</b>

##### Anode

Annual Production Rate	1,000	10,000	20,000	50,000	100,000	500,000
Gross Amount of Catalyst Needed per system (g/system)	7.85	6.85	6.72	6.41	6.33	6.20
Material (\$/gram of catalyst)	\$12.78	\$11.06	\$10.96	\$10.82	\$10.50	\$10.15
Manufacturing (\$/gram of catalyst)	\$14.86	\$2.13	\$1.20	\$0.57	\$0.36	\$0.22
Markup (\$/gram of catalyst)	\$0.00	\$8.32	\$4.84	\$3.34	\$2.18	\$0.89
<b>Total Cost (\$/gram of catalyst)</b>	<b>\$27.64</b>	<b>\$21.51</b>	<b>\$17.00</b>	<b>\$14.74</b>	<b>\$13.04</b>	<b>\$11.26</b>

**20.1.3.2 Catalyst Ink and Application: Slot Die Coating (includes catalyst material cost)**

**2020 Analysis**

Annual Production Rate	1,000	10,000	20,000	50,000	100,000	500,000
Equipment Lifetime (years)	13	14	14	13	13	13
Interest Rate	10%	10%	10%	10%	10%	10%
Corporate Income Tax Rate	40%	40%	40%	40%	40%	40%
Capital Recovery Factor	0.186	0.180	0.180	0.186	0.186	0.186
Equipment Installation Factor	1.40	1.40	1.40	1.40	1.40	1.40
Maintenance/Spare Parts (% of CC)	5%	5%	5%	5%	5%	5%
Miscellaneous Expenses (% of CC)	1%	1%	1%	1%	1%	1%
Power Consumption (kW)	87	121	121	1020	1020	1020

Annual Production Rate	1,000	10,000	20,000	50,000	100,000	500,000
Capital Cost (\$/Line)	<b>Proprietary</b>					
Coating Web Width (cm)	26	50	50	91	91	91
Simultaneous Lines	1	1	1	1	1	1
Laborers per Line	1.25	1.25	1.25	3.25	3.25	3.25
Line Utilization	22.7%	17.7%	34.8%	9.9%	19.5%	95.3%
Effective Total Machine Rate (\$/hr)	\$441.60	\$1,107.71	\$597.90	\$6,015.36	\$3,159.25	\$827.12
Line Speed (m/s)	0.1	0.2	0.2	0.4	0.4	0.4

Annual Production Rate	1,000	10,000	20,000	50,000	100,000	500,000
Material (\$/stack)	\$1,232	\$921	\$742	\$623	\$580	\$544
Manufacturing (\$/stack)	\$321	\$63	\$33	\$39	\$20	\$5
Markup (\$/stack)	\$222	\$37	\$18	\$19	\$9	\$2
<b>Total Cost (\$/stack)</b>	<b>\$1,775</b>	<b>\$1,020</b>	<b>\$793</b>	<b>\$681</b>	<b>\$610</b>	<b>\$551</b>
<b>Total Cost (\$/kWnet)</b>	<b>\$22.18</b>	<b>\$12.75</b>	<b>\$9.91</b>	<b>\$8.52</b>	<b>\$7.62</b>	<b>\$6.89</b>

**2025 Analysis**

Annual Production Rate	1,000	10,000	20,000	50,000	100,000	500,000
Equipment Lifetime (years)	13	14	14	13	13	13
Interest Rate	10%	10%	10%	10%	10%	10%
Corporate Income Tax Rate	40%	40%	40%	40%	40%	40%
Capital Recovery Factor	0.186	0.180	0.180	0.186	0.186	0.186
Equipment Installation Factor	1.40	1.40	1.40	1.40	1.40	1.40
Maintenance/Spare Parts (% of CC)	5%	5%	5%	5%	5%	5%
Miscellaneous Expenses (% of CC)	1%	1%	1%	1%	1%	1%
Power Consumption (kW)	87	121	121	1020	1020	1020

Annual Production Rate	1,000	10,000	20,000	50,000	100,000	500,000
Capital Cost (\$/Line)	<b>Proprietary</b>					
Coating Web Width (cm)	26	50	50	91	91	91
Simultaneous Lines	1	1	1	1	1	1
Laborers per Line	1.25	1.25	1.25	3.25	3.25	3.25
Line Utilization	21.0%	14.8%	29.0%	8.3%	16.5%	80.7%
Effective Total Machine Rate (\$/hr)	\$472.56	\$1,316.70	\$703.60	\$7,065.45	\$3,689.13	\$935.57
Line Speed (m/s)	0.1	0.2	0.2	0.4	0.4	0.4



Annual Production Rate	1,000	10,000	20,000	50,000	100,000	500,000
Material (\$/stack)	\$997	\$664	\$512	\$409	\$367	\$328
Manufacturing (\$/stack)	\$317	\$62	\$33	\$39	\$20	\$5
Markup (\$/stack)	\$219	\$36	\$18	\$19	\$9	\$2
<b>Total Cost (\$/stack)</b>	<b>\$1,533</b>	<b>\$762</b>	<b>\$562</b>	<b>\$467</b>	<b>\$396</b>	<b>\$334</b>
<b>Total Cost (\$/kWnet)</b>	<b>\$19.16</b>	<b>\$9.53</b>	<b>\$7.03</b>	<b>\$5.84</b>	<b>\$4.96</b>	<b>\$4.18</b>

## 20.1.4 Catalyst Coated Membrane Acid Wash

### 2020 Analysis

Annual Production Rate	1,000	10,000	20,000	50,000	100,000	500,000
Equipment Lifetime (years)	15	15	15	15	15	15
Interest Rate	10%	10%	10%	10%	10%	10%
Corporate Income Tax Rate	40%	40%	40%	40%	40%	40%
Capital Recovery Factor	0.175	0.175	0.175	0.175	0.175	0.175
Equipment Installation Factor	1.40	1.40	1.40	1.40	1.40	1.40
Maintenance/Spare Parts (% of CC)	10%	10%	10%	10%	10%	10%
Miscellaneous Expenses (% of CC)	7%	7%	7%	7%	7%	7%
Power Consumption (kW)	20	30	20	30	30	30

Annual Production Rate	1,000	10,000	20,000	50,000	100,000	500,000
Capital Cost (\$/Line)	\$692,000	\$692,000	\$692,000	\$907,000	\$907,000	\$907,000
Simultaneous Lines	1	1	2	2	4	17
Laborers per Line	0.58	0.58	0.58	0.58	0.58	0.58
Line Utilization	16%	72%	70%	92%	90%	100%
Effective Total Machine Rate (\$/hr)	\$569.53	\$147.11	\$149.47	\$150.17	\$153.40	\$141.37
Batch Cycle Time (hrs)	6.0	6.0	6.0	6.0	6.0	6.0
Roll Length (m)	500.0	500.0	500.0	500.0	500.0	500.0
Roll Width (m)	0.3	0.5	0.5	0.9	0.9	0.9
Effective Acid Wash Rate (m <sup>2</sup> /min)	0.4	0.7	0.7	1.3	1.3	1.3

Annual Production Rate	1,000	10,000	20,000	50,000	100,000	500,000
Material (\$/stack)	\$4	\$2	\$2	\$1	\$1	\$1
Manufacturing (\$/stack)	\$284	\$34	\$33	\$18	\$17	\$15
Markup (\$/stack)	\$200	\$20	\$19	\$9	\$9	\$6
<b>Total Cost (\$/stack)</b>	<b>\$488</b>	<b>\$56</b>	<b>\$54</b>	<b>\$28</b>	<b>\$27</b>	<b>\$22</b>
<b>Total Cost (\$/kWnet)</b>	<b>\$6.10</b>	<b>\$0.70</b>	<b>\$0.68</b>	<b>\$0.35</b>	<b>\$0.34</b>	<b>\$0.28</b>

## 2025 Analysis

Annual Production Rate	1,000	10,000	20,000	50,000	100,000	500,000
Equipment Lifetime (years)	15	15	15	15	15	15
Interest Rate	10%	10%	10%	10%	10%	10%
Corporate Income Tax Rate	40%	40%	40%	40%	40%	40%
Capital Recovery Factor	0.175	0.175	0.175	0.175	0.175	0.175
Equipment Installation Factor	1.40	1.40	1.40	1.40	1.40	1.40
Maintenance/Spare Parts (% of CC)	10%	10%	10%	10%	10%	10%
Miscellaneous Expenses (% of CC)	7%	7%	7%	7%	7%	7%
Power Consumption (kW)	20	30	20	30	30	30

Annual Production Rate	1,000	10,000	20,000	50,000	100,000	500,000
Capital Cost (\$/Line)	\$692,000	\$692,000	\$692,000	\$907,000	\$907,000	\$907,000
Simultaneous Lines	1	1	2	2	4	15
Laborers per Line	0.58	0.58	0.58	0.58	0.58	0.58
Line Utilization	15%	60%	59%	78%	76%	96%
Effective Total Machine Rate (\$/hr)	\$616.74	\$170.67	\$173.64	\$172.13	\$175.93	\$146.11
Batch Cycle Time (hrs)	6.0	6.0	6.0	6.0	6.0	6.0
Roll Length (m)	500.0	500.0	500.0	500.0	500.0	500.0
Roll Width (m)	0.3	0.5	0.5	0.9	0.9	0.9
Effective Acid Wash Rate (m <sup>2</sup> /min)	0.4	0.7	0.7	1.3	1.3	1.3

Annual Production Rate	1,000	10,000	20,000	50,000	100,000	500,000
Material (\$/stack)	\$4	\$2	\$2	\$1	\$1	\$1
Manufacturing (\$/stack)	\$283	\$32	\$32	\$17	\$17	\$13
Markup (\$/stack)	\$199	\$20	\$18	\$9	\$8	\$5
<b>Total Cost (\$/stack)</b>	<b>\$485</b>	<b>\$54</b>	<b>\$52</b>	<b>\$27</b>	<b>\$26</b>	<b>\$19</b>
<b>Total Cost (\$/kWnet)</b>	<b>\$6.07</b>	<b>\$0.67</b>	<b>\$0.65</b>	<b>\$0.33</b>	<b>\$0.33</b>	<b>\$0.24</b>

## 20.1.5 Gas Diffusion Layer

### 2020 Analysis

Annual Production Rate	1,000	10,000	20,000	50,000	100,000	500,000
GDL Cost (\$/m <sup>2</sup> )	\$116.53	\$32.58	\$21.54	\$13.17	\$9.59	\$5.72
GDL Cost (\$/stack)	\$1,635	\$457	\$302	\$185	\$135	\$80
<b>Total Cost (\$/stack)</b>	<b>\$1,635</b>	<b>\$457</b>	<b>\$302</b>	<b>\$185</b>	<b>\$135</b>	<b>\$80</b>
<b>Total Cost (\$/kWnet)</b>	<b>\$20.43</b>	<b>\$5.71</b>	<b>\$3.78</b>	<b>\$2.31</b>	<b>\$1.68</b>	<b>\$1.00</b>

### 2025 Analysis

Annual Production Rate	1,000	10,000	20,000	50,000	100,000	500,000
GDL Cost (\$/m <sup>2</sup> )	\$116.53	\$36.31	\$23.83	\$14.38	\$10.34	\$5.97
GDL Cost (\$/stack)	\$1,373	\$428	\$281	\$169	\$122	\$70
<b>Total Cost (\$/stack)</b>	<b>\$1,373</b>	<b>\$428</b>	<b>\$281</b>	<b>\$169</b>	<b>\$122</b>	<b>\$70</b>
<b>Total Cost (\$/kWnet)</b>	<b>\$17.16</b>	<b>\$5.35</b>	<b>\$3.51</b>	<b>\$2.12</b>	<b>\$1.52</b>	<b>\$0.88</b>

## 20.1.6 MEA Sub-Gaskets Total

### 2020 Analysis

Annual Production Rate	1,000	10,000	20,000	50,000	100,000	500,000
Material (\$/stack)	\$50	\$50	\$50	\$50	\$50	\$50
Manufacturing (\$/stack)	\$819	\$176	\$92	\$50	\$38	\$28
Tooling (Kapton Web) (\$/stack)	\$11	\$5	\$5	\$4	\$3	\$3
<b>Total Cost (\$/stack)</b>	<b>\$880</b>	<b>\$231</b>	<b>\$147</b>	<b>\$104</b>	<b>\$91</b>	<b>\$81</b>
<b>Total Cost (\$/kWnet)</b>	<b>\$11.00</b>	<b>\$2.89</b>	<b>\$1.83</b>	<b>\$1.29</b>	<b>\$1.14</b>	<b>\$1.01</b>

## 2025 Analysis

Annual Production Rate	1,000	10,000	20,000	50,000	100,000	500,000
Material (\$/stack)	\$39	\$39	\$39	\$39	\$39	\$39
Manufacturing (\$/stack)	\$819	\$176	\$91	\$50	\$38	\$25
Tooling (Kapton Web) (\$/stack)	\$10	\$3	\$3	\$4	\$4	\$4
<b>Total Cost (\$/stack)</b>	<b>\$868</b>	<b>\$218</b>	<b>\$133</b>	<b>\$92</b>	<b>\$80</b>	<b>\$68</b>
<b>Total Cost (\$/kWnet)</b>	<b>\$10.85</b>	<b>\$2.72</b>	<b>\$1.66</b>	<b>\$1.15</b>	<b>\$1.00</b>	<b>\$0.84</b>

### 20.1.6.1 Sub-Gasket Formation

## 2020 Analysis

Annual Production Rate	1,000	10,000	20,000	50,000	100,000	500,000
Equipment Lifetime (years)	15	13	13	13	13	13
Interest Rate	10%	10%	10%	10%	10%	10%
Corporate Income Tax Rate	40%	40%	40%	40%	40%	40%
Capital Recovery Factor	0.175	0.186	0.186	0.186	0.186	0.186
Equipment Installation Factor	1.4	1.4	1.4	1.4	1.4	1.4
Maintenance/Spare Parts (% of CC)	10%	10%	10%	10%	10%	10%
Miscellaneous Expenses (% of CC)	7%	7%	7%	7%	7%	7%
Power Consumption (kW)	101	101	101	101	101	101

Annual Production Rate	1,000	10,000	20,000	50,000	100,000	500,000
Capital Cost (\$/Line)	\$864,129	\$2,908,600	\$2,908,600	\$2,958,600	\$2,958,600	\$2,958,600
Simultaneous Lines	1	1	1	1	1	2
Laborers per Line	2	5	5	5	5	5
Line Utilization	89.2%	4.9%	9.5%	13.3%	25.9%	61.0%
Effective Total Machine Rate (\$/hr)	\$230.10	\$7,885.61	\$4,167.97	\$3,094.53	\$1,708.83	\$868.81
Line Speed (m/s)	0.3	0.5	0.5	0.5	0.5	0.5
Kapton Tooling Cost (\$/m2)	\$6.47	\$3.56	\$3.40	\$3.30	\$3.27	\$3.24
Subgasket Material Cost (\$/m2)	\$1.67	\$1.67	\$1.67	\$1.67	\$1.67	\$1.67

Annual Production Rate	1,000	10,000	20,000	50,000	100,000	500,000
Material (\$/stack)	\$35	\$35	\$35	\$35	\$35	\$35
Manufacturing (\$/stack)	\$648	\$121	\$63	\$26	\$14	\$7
Tooling (Kapton Web) (\$/stack)	\$11	\$5	\$5	\$4	\$3	\$3
<b>Total Cost (\$/stack)</b>	<b>\$695</b>	<b>\$162</b>	<b>\$103</b>	<b>\$65</b>	<b>\$53</b>	<b>\$45</b>
<b>Total Cost (\$/kWnet)</b>	<b>\$8.68</b>	<b>\$2.02</b>	<b>\$1.29</b>	<b>\$0.81</b>	<b>\$0.66</b>	<b>\$0.57</b>

## 2025 Analysis

Annual Production Rate	1,000	10,000	20,000	50,000	100,000	500,000
Equipment Lifetime (years)	15	13	13	13	13	13
Interest Rate	10%	10%	10%	10%	10%	10%
Corporate Income Tax Rate	40%	40%	40%	40%	40%	40%
Capital Recovery Factor	0.175	0.186	0.186	0.186	0.186	0.186
Equipment Installation Factor	1.4	1.4	1.4	1.4	1.4	1.4
Maintenance/Spare Parts (% of CC)	10%	10%	10%	10%	10%	10%
Miscellaneous Expenses (% of CC)	7%	7%	7%	7%	7%	7%
Power Consumption (kW)	101	101	101	101	101	101

Annual Production Rate	1,000	10,000	20,000	50,000	100,000	500,000
Capital Cost (\$/Line)	\$864,129	\$2,908,600	\$2,908,600	\$2,958,600	\$2,958,600	\$2,958,600
Simultaneous Lines	1	1	1	1	1	1
Laborers per Line	2	5	5	5	5	5
Line Utilization	89.2%	4.2%	8.2%	10.4%	20.2%	94.8%
Effective Total Machine Rate (\$/hr)	\$230.10	\$9,062.80	\$4,772.19	\$3,909.17	\$2,127.72	\$647.30
Line Speed (m/s)	0.3	0.5	0.5	0.5	0.5	0.5
Kapton Tooling Cost (\$/m2)	\$6.47	\$3.56	\$3.40	\$3.30	\$3.27	\$3.24
Subgasket Material Cost (\$/m2)	\$1.67	\$1.67	\$1.67	\$1.67	\$1.67	\$1.67

Annual Production Rate	1,000	10,000	20,000	50,000	100,000	500,000
Material (\$/stack)	\$28	\$28	\$28	\$28	\$28	\$28
Manufacturing (\$/stack)	\$648	\$121	\$62	\$26	\$14	\$4
Tooling (Kapton Web) (\$/stack)	\$10	\$3	\$3	\$4	\$4	\$4
<b>Total Cost (\$/stack)</b>	<b>\$687</b>	<b>\$153</b>	<b>\$94</b>	<b>\$58</b>	<b>\$46</b>	<b>\$36</b>
<b>Total Cost (\$/kWnet)</b>	<b>\$8.58</b>	<b>\$1.91</b>	<b>\$1.17</b>	<b>\$0.72</b>	<b>\$0.57</b>	<b>\$0.45</b>

### 20.1.6.2 Sub-Gasket Adhesive Application (screen-printing)

#### 2020 Analysis

Annual Production Rate	1,000	10,000	20,000	50,000	100,000	500,000
Screen Printing Machine Type	DEK Horizon	DEK PV 1200	DEK PV 1200	DEK PV 1200	DEK PV 1200	DEK PV 1200
Equipment Lifetime (years)	15	15	15	15	15	15
Interest Rate	10%	10%	10%	10%	10%	10%
Corporate Income Tax Rate	40%	40%	40%	40%	40%	40%
Capital Recovery Factor	0.175	0.175	0.175	0.175	0.175	0.175
Equipment Installation Factor	1.4	1.4	1.4	1.4	1.4	1.4
Maintenance/Spare Parts (% of CC)	3%	1%	1%	1%	1%	1%
Miscellaneous Expenses (% of CC)	12%	12%	12%	12%	12%	12%
Power Consumption (kW)	61	166	166	166	166	166

Annual Production Rate	1,000	10,000	20,000	50,000	100,000	500,000
Screen Printing Machine Type	DEK Horizon	DEK PV 1200	DEK PV 1200	DEK PV 1200	DEK PV 1200	DEK PV 1200
Capital Cost (\$/Line)	\$392,735	\$1,458,755	\$1,458,755	\$1,458,755	\$1,458,755	\$1,458,755
Simultaneous Lines	1	1	1	2	4	17
Laborers per Line	0.50	0.50	0.50	0.50	0.50	0.50
Line Utilization	30.6%	32.2%	64.3%	80.4%	80.4%	94.6%
Effective Total Machine Rate (\$/hr)	\$176.66	\$536.83	\$286.55	\$236.43	\$236.43	\$206.34
Line Speed (m/s)	1.00	1.00	1.00	1.00	1.00	1.00
Index Time (s)	\$9.62	\$4.00	\$4.00	\$4.00	\$4.00	\$4.00
Resin Cost (\$/kg)	\$40.00	\$40.00	\$40.00	\$40.00	\$40.00	\$40.00

Annual Production Rate	1,000	10,000	20,000	50,000	100,000	500,000
Material (\$/stack)	\$15	\$15	\$15	\$15	\$15	\$15
Manufacturing (\$/stack)	\$171	\$55	\$29	\$24	\$24	\$21
<b>Total Cost (\$/stack)</b>	<b>\$186</b>	<b>\$69</b>	<b>\$44</b>	<b>\$39</b>	<b>\$39</b>	<b>\$36</b>
<b>Total Cost (\$/kWnet)</b>	<b>\$2.32</b>	<b>\$0.87</b>	<b>\$0.55</b>	<b>\$0.48</b>	<b>\$0.48</b>	<b>\$0.45</b>

## 2025 Analysis

Annual Production Rate	1,000	10,000	20,000	50,000	100,000	500,000
Screen Printing Machine Type	DEK Horizon	DEK PV 1200	DEK PV 1200	DEK PV 1200	DEK PV 1200	DEK PV 1200
Equipment Lifetime (years)	15	15	15	15	15	15
Interest Rate	10%	10%	10%	10%	10%	10%
Corporate Income Tax Rate	40%	40%	40%	40%	40%	40%
Capital Recovery Factor	0.175	0.175	0.175	0.175	0.175	0.175
Equipment Installation Factor	1.4	1.4	1.4	1.4	1.4	1.4
Maintenance/Spare Parts (% of CC)	3%	1%	1%	1%	1%	1%
Miscellaneous Expenses (% of CC)	12%	12%	12%	12%	12%	12%
Power Consumption (kW)	61	166	166	166	166	166

Annual Production Rate	1,000	10,000	20,000	50,000	100,000	500,000
Screen Printing Machine Type	DEK Horizon	DEK PV 1200	DEK PV 1200	DEK PV 1200	DEK PV 1200	DEK PV 1200
Capital Cost (\$/Line)	\$392,735	\$1,458,755	\$1,458,755	\$1,458,755	\$1,458,755	\$1,458,755
Simultaneous Lines	1	1	1	2	4	17
Laborers per Line	0.50	0.50	0.50	0.50	0.50	0.50
Line Utilization	30.8%	32.3%	64.6%	80.7%	80.7%	95.0%
Effective Total Machine Rate (\$/hr)	\$175.70	\$534.56	\$285.42	\$235.52	\$235.52	\$205.56
Line Speed (m/s)	1.00	1.00	1.00	1.00	1.00	1.00
Index Time (s)	\$9.62	\$4.00	\$4.00	\$4.00	\$4.00	\$4.00
Resin Cost (\$/kg)	\$40.00	\$40.00	\$40.00	\$40.00	\$40.00	\$40.00

Annual Production Rate	1,000	10,000	20,000	50,000	100,000	500,000
Material (\$/stack)	\$10	\$10	\$10	\$10	\$10	\$10
Manufacturing (\$/stack)	\$171	\$55	\$29	\$24	\$24	\$21
<b>Total Cost (\$/stack)</b>	<b>\$181</b>	<b>\$65</b>	<b>\$40</b>	<b>\$34</b>	<b>\$34</b>	<b>\$31</b>
<b>Total Cost (\$/kWnet)</b>	<b>\$2.27</b>	<b>\$0.81</b>	<b>\$0.49</b>	<b>\$0.43</b>	<b>\$0.43</b>	<b>\$0.39</b>

## 20.1.7 Hot Pressing GDL to Catalyst Coated Membrane

### 2020 Analysis

Annual Production Rate	1,000	10,000	20,000	50,000	100,000	500,000
Equipment Lifetime (years)	15	15	15	15	15	15
Interest Rate	10%	10%	10%	10%	10%	10%
Corporate Income Tax Rate	40%	40%	40%	40%	40%	40%
Capital Recovery Factor	0.175	0.175	0.175	0.175	0.175	0.175
Equipment Installation Factor	1	1	1	1	1	1
Maintenance/Spare Parts (% of CC)	5%	5%	5%	5%	5%	5%
Miscellaneous Expenses (% of CC)	7%	7%	7%	7%	7%	7%
Power Consumption (kW)	15	16	16	16	16	16

Annual Production Rate	1,000	10,000	20,000	50,000	100,000	500,000
Capital Cost (\$/Line)	\$56,062	\$126,795	\$126,795	\$126,795	\$126,795	\$126,795
Simultaneous Lines	1	1	2	3	6	26
Laborers per Line	1	1	1	1	1	1
Line Utilization	8%	95%	95%	84%	84%	97%
Effective Total Machine Rate (\$/hr)	\$130.48	\$38.53	\$38.55	\$40.36	\$40.36	\$38.19
Total Cycle Time (seconds)	105	95	95	95	95	95

Annual Production Rate						
Manufacturing (\$/stack)	\$35	\$12	\$12	\$6	\$6	\$6
Tooling (\$/stack)	\$1	\$0	\$0	\$0	\$0	\$0
<b>Total Cost (\$/stack)</b>	<b>\$35</b>	<b>\$12</b>	<b>\$12</b>	<b>\$7</b>	<b>\$7</b>	<b>\$6</b>
<b>Total Cost (\$/kWnet)</b>	<b>\$0.44</b>	<b>\$0.15</b>	<b>\$0.15</b>	<b>\$0.08</b>	<b>\$0.08</b>	<b>\$0.08</b>

## 2025 Analysis

Annual Production Rate	1,000	10,000	20,000	50,000	100,000	500,000
Equipment Lifetime (years)	15	15	15	15	15	15
Interest Rate	10%	10%	10%	10%	10%	10%
Corporate Income Tax Rate	40%	40%	40%	40%	40%	40%
Capital Recovery Factor	0.175	0.175	0.175	0.175	0.175	0.175
Equipment Installation Factor	1	1	1	1	1	1
Maintenance/Spare Parts (% of CC)	5%	5%	5%	5%	5%	5%
Miscellaneous Expenses (% of CC)	7%	7%	7%	7%	7%	7%
Power Consumption (kW)	15	16	16	16	16	16

Annual Production Rate	1,000	10,000	20,000	50,000	100,000	500,000
Capital Cost (\$/Line)	\$56,062	\$126,795	\$126,795	\$126,795	\$126,795	\$126,795
Simultaneous Lines	1	1	2	3	5	22
Laborers per Line	1	1	1	1	1	1
Line Utilization	6%	78%	78%	70%	84%	96%
Effective Total Machine Rate (\$/hr)	\$155.67	\$41.69	\$41.71	\$43.61	\$40.35	\$38.39
Total Cycle Time (seconds)	105	95	95	95	95	95

Annual Production Rate						
Manufacturing (\$/stack)	\$31	\$10	\$10	\$6	\$5	\$5
Tooling (\$/stack)	\$1	\$0	\$0	\$0	\$0	\$0
<b>Total Cost (\$/stack)</b>	<b>\$31</b>	<b>\$10</b>	<b>\$10</b>	<b>\$6</b>	<b>\$5</b>	<b>\$5</b>
<b>Total Cost (\$/kWnet)</b>	<b>\$0.39</b>	<b>\$0.13</b>	<b>\$0.13</b>	<b>\$0.07</b>	<b>\$0.07</b>	<b>\$0.06</b>

## 20.1.8 Cutting, and Slitting

### 2020 Analysis

Annual Production Rate	1,000	10,000	20,000	50,000	100,000	500,000
Equipment Lifetime (years)	10	14	14	14	14	14
Interest Rate	10%	10%	10%	10%	10%	10%
Corporate Income Tax Rate	40%	40%	40%	40%	40%	40%
Capital Recovery Factor	0.205	0.180	0.180	0.180	0.180	0.180
Equipment Installation Factor	1.4	1.4	1.4	1.4	1.4	1.4
Maintenance/Spare Parts (% of CC)	10%	10%	10%	10%	10%	10%
Miscellaneous Expenses (% of CC)	7%	7%	7%	7%	7%	7%
Power Consumption (kW)	18	18	18	18	18	18

Annual Production Rate	1,000	10,000	20,000	50,000	100,000	500,000
Capital Cost (\$/line)	\$290,967	\$419,136	\$419,136	\$469,136	\$469,136	\$469,136
Costs per Tooling Set (\$)	\$5,606	\$5,606	\$5,606	\$5,606	\$5,606	\$5,606
Tooling Lifetime (cycles)	200,000	200,000	200,000	200,000	200,000	200,000
Simultaneous Lines	1	1	1	1	1	1
Laborers per Line	0.5	0.5	0.5	0.5	0.5	0.5
Line Utilization	0.6%	2.8%	5.4%	7.2%	14.4%	71.9%
Effective Total Machine Rate (\$/hr)	\$6,798.05	\$1,934.63	\$996.84	\$840.33	\$433.14	\$106.06
Line Speed (m/s)	1.1	1.2	1.3	1.3	1.3	1.3

Annual Production Rate	1,000	10,000	20,000	50,000	100,000	500,000
Manufacturing (\$/stack)	\$125	\$17	\$9	\$4	\$2	\$0
Tooling (\$/stack)	\$8	\$3	\$3	\$2	\$2	\$2
<b>Total Cost (\$/stack)</b>	<b>\$133</b>	<b>\$20</b>	<b>\$11</b>	<b>\$6</b>	<b>\$4</b>	<b>\$3</b>
<b>Total Cost (\$/kWnet)</b>	<b>\$1.66</b>	<b>\$0.24</b>	<b>\$0.14</b>	<b>\$0.08</b>	<b>\$0.05</b>	<b>\$0.03</b>

## 2025 Analysis

Annual Production Rate	1,000	10,000	20,000	50,000	100,000	500,000
Equipment Lifetime (years)	10	14	14	14	14	14
Interest Rate	10%	10%	10%	10%	10%	10%
Corporate Income Tax Rate	40%	40%	40%	40%	40%	40%
Capital Recovery Factor	0.205	0.180	0.180	0.180	0.180	0.180
Equipment Installation Factor	1.4	1.4	1.4	1.4	1.4	1.4
Maintenance/Spare Parts (% of CC)	10%	10%	10%	10%	10%	10%
Miscellaneous Expenses (% of CC)	7%	7%	7%	7%	7%	7%
Power Consumption (kW)	18	18	18	18	18	18

Annual Production Rate	1,000	10,000	20,000	50,000	100,000	500,000
Capital Cost (\$/line)	\$290,967	\$419,136	\$419,136	\$469,136	\$469,136	\$469,136
Costs per Tooling Set (\$)	\$5,606	\$5,606	\$5,606	\$5,606	\$5,606	\$5,606
Tooling Lifetime (cycles)	200,000	200,000	200,000	200,000	200,000	200,000
Simultaneous Lines	1	1	1	1	1	1
Laborers per Line	0.5	0.5	0.5	0.5	0.5	0.5
Line Utilization	0.5%	2.3%	4.5%	6.1%	12.2%	60.9%
Effective Total Machine Rate (\$/hr)	\$7,235.88	\$2,311.30	\$1,189.22	\$988.87	\$507.07	\$120.89
Line Speed (m/s)	1.1	1.2	1.3	1.3	1.3	1.3

Annual Production Rate	1,000	10,000	20,000	50,000	100,000	500,000
Manufacturing (\$/stack)	\$125	\$17	\$8	\$4	\$2	\$0
Tooling (\$/stack)	\$8	\$4	\$4	\$1	\$1	\$1
<b>Total Cost (\$/stack)</b>	<b>\$133</b>	<b>\$20</b>	<b>\$12</b>	<b>\$5</b>	<b>\$3</b>	<b>\$2</b>
<b>Total Cost (\$/kWnet)</b>	<b>\$1.66</b>	<b>\$0.26</b>	<b>\$0.15</b>	<b>\$0.06</b>	<b>\$0.04</b>	<b>\$0.02</b>

## 20.1.9 End Plates

### 2020 Analysis

Annual Production Rate	1,000	10,000	20,000	50,000	100,000	500,000
Equipment Lifetime (years)	15	15	15	15	15	15
Interest Rate	10%	10%	10%	10%	10%	10%
Corporate Income Tax Rate	40%	40%	40%	40%	40%	40%
Capital Recovery Factor	0.175	0.175	0.175	0.175	0.175	0.175
Equipment Installation Factor	1.4	1.4	1.4	1.4	1.4	1.4
Maintenance/Spare Parts (% of CC)	10%	10%	10%	10%	10%	10%
Miscellaneous Expenses (% of CC)	12%	12%	12%	12%	12%	12%
Power Consumption (kW)	25	25	46	49	49	53

Annual Production Rate	1,000	10,000	20,000	50,000	100,000	500,000
Capital Cost (\$/line)	\$204,558	\$204,558	\$333,137	\$351,505	\$351,505	\$388,242
Costs per Tooling Set (\$)	\$25,802	\$25,802	\$73,942	\$79,602	\$79,602	\$90,438
Tooling Lifetime (cycles)	300,000	300,000	300,000	300,000	300,000	300,000
Simultaneous Lines	1	1	1	1	1	3
Laborers per Line	0.75	0.75	0.75	0.75	0.75	0.75
Cycle Time (s)	310.16	310.16	345.72	350.80	350.80	360.96
Cavities/Platen	2	2	9	10	10	12
Effective Total Machine Rate (\$/hr)	\$1,128.11	\$146.35	\$400.42	\$205.62	\$121.84	\$103.18
LYTEX Cost (\$/kg)	\$32.21	\$26.97	\$25.57	\$23.83	\$22.59	\$19.96
Job Shop or Manufactured	Job Shop	Job Shop	Job Shop	Job Shop	Manufactured	Manufactured
Job Shop Line Utilization (%)	39.6%	62.7%	49.7%	66.0%	58.0%	82.9%
Job Shop Machine Rate (\$/min)	\$2.33	\$1.76	\$2.83	\$2.42	\$2.64	\$2.24
Manufactured Line Utilization (%)	2.6%	25.7%	12.7%	29.0%	58.0%	82.9%
Manufactured Machine Rate (\$/min)	\$18.80	\$2.44	\$6.67	\$3.43	\$2.03	\$1.72
Line Utilization Used (%)	39.6%	62.7%	49.7%	66.0%	58.0%	82.9%
Manufacturing Rate Used (\$/min)	\$2.33	\$1.76	\$2.83	\$2.42	\$2.03	\$1.72

Annual Production Rate	1,000	10,000	20,000	50,000	100,000	500,000
Material (\$/stack)	\$49	\$41	\$39	\$37	\$35	\$31
Manufacturing (\$/stack)	\$11	\$9	\$3	\$3	\$2	\$2
Tooling (\$/stack)	\$2	\$0	\$0	\$0	\$0	\$0
Total Cost (\$/stack)	\$62.44	\$50.09	\$42.84	\$39.30	\$36.92	\$32.29
Total Cost (\$/kWnet)	\$0.78	\$0.63	\$0.54	\$0.49	\$0.46	\$0.40

### 2025 Analysis

Annual Production Rate	1,000	10,000	20,000	50,000	100,000	500,000
Equipment Lifetime (years)	15	15	15	15	15	15
Interest Rate	10%	10%	10%	10%	10%	10%
Corporate Income Tax Rate	40%	40%	40%	40%	40%	40%
Capital Recovery Factor	0.175	0.175	0.175	0.175	0.175	0.175
Equipment Installation Factor	1.4	1.4	1.4	1.4	1.4	1.4
Maintenance/Spare Parts (% of CC)	10%	10%	10%	10%	10%	10%
Miscellaneous Expenses (% of CC)	12%	12%	12%	12%	12%	12%
Power Consumption (kW)	23	23	42	44	44	48



Annual Production Rate	1,000	10,000	20,000	50,000	100,000	500,000
Capital Cost (\$/line)	\$197,493	\$197,493	\$301,345	\$316,181	\$316,181	\$345,853
Costs per Tooling Set (\$)	\$25,802	\$25,802	\$73,942	\$79,602	\$79,602	\$90,438
Tooling Lifetime (cycles)	300,000	300,000	300,000	300,000	300,000	300,000
Simultaneous Lines	1	1	1	1	1	3
Laborers per Line	0.75	0.75	0.75	0.75	0.75	0.75
Cycle Time (s)	310.16	310.16	345.72	350.80	350.80	360.96
Cavities/Platen	2	2	9	10	10	12
Effective Total Machine Rate (\$/hr)	\$1,090.29	\$142.43	\$365.45	\$188.39	\$113.03	\$95.68
LYTEX Cost (\$/kg)	\$32.81	\$27.48	\$26.05	\$24.28	\$23.02	\$20.33
Job Shop or Manufactured	Job Shop	Job Shop	Job Shop	Job Shop	Manufactured	Manufactured
Job Shop Line Utilization (%)	39.6%	62.7%	49.7%	66.0%	58.0%	82.9%
Job Shop Machine Rate (\$/min)	\$2.28	\$1.73	\$2.63	\$2.25	\$2.45	\$2.07
Manufactured Line Utilization (%)	2.6%	25.7%	12.7%	29.0%	58.0%	82.9%
Manufactured Machine Rate (\$/min)	\$18.17	\$2.37	\$6.09	\$3.14	\$1.88	\$1.59
Line Utilization Used (%)	39.6%	62.7%	49.7%	66.0%	58.0%	82.9%
Manufacturing Rate Used (\$/min)	\$2.28	\$1.73	\$2.63	\$2.25	\$1.88	\$1.59

Annual Production Rate	1,000	10,000	20,000	50,000	100,000	500,000
Material (\$/stack)	\$40	\$33	\$31	\$29	\$28	\$24
Manufacturing (\$/stack)	\$11	\$8	\$3	\$2	\$2	\$2
Tooling (\$/stack)	\$2	\$0	\$0	\$0	\$0	\$0
Total Cost (\$/stack)	\$52.30	\$41.65	\$34.77	\$31.81	\$29.84	\$26.06
Total Cost (\$/kWnet)	\$0.65	\$0.52	\$0.43	\$0.40	\$0.37	\$0.33

## 20.1.10 Current Collectors

### 2020 Analysis

Annual Production Rate	1,000	10,000	20,000	50,000	100,000	500,000
Equipment Lifetime (years)	10	10	15	15	15	15
Interest Rate	10%	10%	10%	10%	10%	10%
Corporate Income Tax Rate	40%	40%	40%	40%	40%	40%
Capital Recovery Factor	0.205	0.205	0.175	0.175	0.175	0.175
Equipment Installation Factor	1.4	1.4	1.4	1.4	1.4	1.4
Maintenance/Spare Parts (% of CC)	13%	13%	13%	13%	13%	13%
Miscellaneous Expenses (% of CC)	2%	2%	2%	2%	2%	2%
Power Consumption (kW)	16	16	22	22	22	22

Annual Production Rate	1,000	10,000	20,000	50,000	100,000	500,000
Costs per Tooling Set (\$)	\$1,667	\$1,667	\$1,667	\$1,667	\$1,667	\$1,667
Tooling Lifetime (cycles)	400,000	400,000	400,000	400,000	400,000	400,000
Capital Cost (\$/line)	\$31,399	\$65,249	\$161,663	\$161,663	\$161,663	\$161,663
Simultaneous Lines	1	1	1	1	1	1
Laborers per Line	1.00	1.00	0.25	0.25	0.25	0.25
Line Utilization	0.1%	0.5%	0.3%	0.6%	1.2%	6.1%
Effective Total Machine Rate (\$/hr)	\$7,160.49	\$1,612.79	\$7,550.88	\$3,101.53	\$1,557.35	\$322.76
Index Time (s)	3.00	3.00	0.49	0.49	0.49	0.49
Copper Cost (\$/kg)	\$15.78	\$12.92	\$12.02	\$10.84	\$9.94	\$7.86
Job Shop or Manufactured	Job Shop	Job Shop	Job Shop	Job Shop	Job Shop	Job Shop
Job Shop Line Utilization (%)	37.1%	37.5%	37.3%	37.6%	38.2%	43.1%
Job Shop Machine Rate (\$/min)	\$1.25	\$1.51	\$1.39	\$1.38	\$1.36	\$1.24
Manufactured Line Utilization (%)	0.1%	0.5%	0.3%	0.6%	1.2%	6.1%
Manufactured Machine Rate (\$/min)	\$119.34	\$26.88	\$125.85	\$51.69	\$25.96	\$5.38
Line Utilization Used (%)	37.1%	37.5%	37.3%	37.6%	38.2%	43.1%
Manufacturing Rate Used (\$/min)	\$1.25	\$1.51	\$1.39	\$1.38	\$1.36	\$1.24

Annual Production Rate	1,000	10,000	20,000	50,000	100,000	500,000
Material (\$/stack)	\$4.40	\$3.89	\$3.85	\$3.80	\$3.76	\$3.66
Manufacturing (\$/stack)	\$0.14	\$0.15	\$0.03	\$0.03	\$0.03	\$0.03
Tooling (\$/stack)	\$0.10	\$0.01	\$0.01	\$0.01	\$0.01	\$0.01
Secondary Operations (\$/stack)	\$0.49	\$0.49	\$0.49	\$0.49	\$0.49	\$0.49
<b>Total Cost (\$/stack)</b>	<b>\$5</b>	<b>\$5</b>	<b>\$4</b>	<b>\$4</b>	<b>\$4</b>	<b>\$4</b>
<b>Total Cost (\$/kWnet)</b>	<b>\$0.06</b>	<b>\$0.06</b>	<b>\$0.05</b>	<b>\$0.05</b>	<b>\$0.05</b>	<b>\$0.05</b>

## 2025 Analysis

Annual Production Rate	1,000	10,000	20,000	50,000	100,000	500,000
Equipment Lifetime (years)	10	10	15	15	15	15
Interest Rate	10%	10%	10%	10%	10%	10%
Corporate Income Tax Rate	40%	40%	40%	40%	40%	40%
Capital Recovery Factor	0.205	0.205	0.175	0.175	0.175	0.175
Equipment Installation Factor	1.4	1.4	1.4	1.4	1.4	1.4
Maintenance/Spare Parts (% of CC)	13%	13%	13%	13%	13%	13%
Miscellaneous Expenses (% of CC)	2%	2%	2%	2%	2%	2%
Power Consumption (kW)	16	16	22	22	22	22

Annual Production Rate	1,000	10,000	20,000	50,000	100,000	500,000
Costs per Tooling Set (\$)	\$1,616	\$1,616	\$1,616	\$1,616	\$1,616	\$1,616
Tooling Lifetime (cycles)	400,000	400,000	400,000	400,000	400,000	400,000
Capital Cost (\$/line)	\$30,228	\$63,858	\$160,272	\$160,272	\$160,272	\$160,272
Simultaneous Lines	1	1	1	1	1	1
Laborers per Line	1.00	1.00	0.25	0.25	0.25	0.25
Line Utilization	0.1%	0.5%	0.2%	0.6%	1.2%	5.8%
Effective Total Machine Rate (\$/hr)	\$6,895.01	\$1,579.40	\$7,860.08	\$3,211.76	\$1,622.64	\$335.06
Index Time (s)	3.00	3.00	0.48	0.48	0.48	0.48
Copper Cost (\$/kg)	\$15.78	\$12.92	\$12.02	\$10.84	\$9.94	\$7.86
Job Shop or Manufactured	Job Shop	Job Shop	Job Shop	Job Shop	Job Shop	Job Shop
Job Shop Line Utilization (%)	37.1%	37.5%	37.2%	37.6%	38.2%	42.8%
Job Shop Machine Rate (\$/min)	\$1.25	\$1.50	\$1.38	\$1.37	\$1.35	\$1.24
Manufactured Line Utilization (%)	0.1%	0.5%	0.2%	0.6%	1.2%	5.8%
Manufactured Machine Rate (\$/min)	\$114.92	\$26.32	\$131.00	\$53.53	\$27.04	\$5.58
<b>Line Utilization Used (%)</b>	<b>37.1%</b>	<b>37.5%</b>	<b>37.2%</b>	<b>37.6%</b>	<b>38.2%</b>	<b>42.8%</b>
<b>Manufacturing Rate Used (\$/min)</b>	<b>\$1.25</b>	<b>\$1.50</b>	<b>\$1.38</b>	<b>\$1.37</b>	<b>\$1.35</b>	<b>\$1.24</b>

Annual Production Rate	1,000	10,000	20,000	50,000	100,000	500,000
Material (\$/stack)	\$3.82	\$3.36	\$3.32	\$3.27	\$3.23	\$3.13
Manufacturing (\$/stack)	\$0.14	\$0.15	\$0.03	\$0.03	\$0.03	\$0.03
Tooling (\$/stack)	\$0.10	\$0.01	\$0.01	\$0.01	\$0.01	\$0.01
Secondary Operations (\$/stack)	\$0.49	\$0.49	\$0.49	\$0.49	\$0.49	\$0.49
<b>Total Cost (\$/stack)</b>	<b>\$5</b>	<b>\$4</b>	<b>\$4</b>	<b>\$4</b>	<b>\$4</b>	<b>\$4</b>
<b>Total Cost (\$/kWnet)</b>	<b>\$0.06</b>	<b>\$0.05</b>	<b>\$0.05</b>	<b>\$0.05</b>	<b>\$0.05</b>	<b>\$0.05</b>

## 20.1.11 Coolant Gaskets/Laser-welding

### 2020 Analysis

Annual Production Rate	1,000	10,000	20,000	50,000	100,000	500,000
Equipment Lifetime (years)	15	15	15	15	15	15
Interest Rate	10%	10%	10%	10%	10%	10%
Corporate Income Tax Rate	40%	40%	40%	40%	40%	40%
Capital Recovery Factor	0.175	0.175	0.175	0.175	0.175	0.175
Equipment Installation Factor	1.4	1.4	1.4	1.4	1.4	1.4
Maintenance/Spare Parts (% of CC)	10%	10%	10%	10%	10%	10%
Miscellaneous Expenses (% of CC)	12%	12%	12%	12%	12%	12%
Power Consumption (kW)	6	7	7	9	12	12

Annual Production Rate	1,000	10,000	20,000	50,000	100,000	500,000
Capital Cost (\$/line)	\$947,066	\$1,238,066	\$772,133	\$1,126,133	\$1,744,133	\$1,744,133
Parts per station	1	2	2	2	4	4
Effective Cydetime per Welded assembly	15.0	7.5	7.5	4.9	2.4	2.4
Simultaneous Lines	1	3	5	8	8	39
Laborers per Line	0.5	1	1	1	1	1
Line Utilization	47%	79%	94%	96%	96%	98%
Effective Total Machine Rate (\$/hr)	\$300.72	\$263.78	\$159.28	\$208.68	\$298.03	\$291.74
Material Cost (\$/kg)	\$0.00	\$0.00	\$0.00	\$0.00	\$0.00	\$0.00

Annual Production Rate	1,000	10,000	20,000	50,000	100,000	500,000
Material (\$/stack)	\$0	\$0	\$0	\$0	\$0	\$0
Manufacturing (\$/stack)	\$448	\$197	\$119	\$101	\$72	\$71
Tooling (\$/stack)	\$2	\$2	\$2	\$2	\$2	\$2
Secondary Operations: Leak Check (\$/stack)	\$687	\$334	\$16	\$7	\$4	\$3
<b>Total Cost (\$/stack)</b>	<b>\$1,137</b>	<b>\$532</b>	<b>\$136</b>	<b>\$110</b>	<b>\$78</b>	<b>\$76</b>
<b>Total Cost (\$/kWnet)</b>	<b>\$14.21</b>	<b>\$6.65</b>	<b>\$1.70</b>	<b>\$1.38</b>	<b>\$0.97</b>	<b>\$0.95</b>

### 2025 Analysis

Annual Production Rate	1,000	10,000	20,000	50,000	100,000	500,000
Equipment Lifetime (years)	15	15	15	15	15	15
Interest Rate	10%	10%	10%	10%	10%	10%
Corporate Income Tax Rate	40%	40%	40%	40%	40%	40%
Capital Recovery Factor	0.175	0.175	0.175	0.175	0.175	0.175
Equipment Installation Factor	1.4	1.4	1.4	1.4	1.4	1.4
Maintenance/Spare Parts (% of CC)	10%	10%	10%	10%	10%	10%
Miscellaneous Expenses (% of CC)	12%	12%	12%	12%	12%	12%
Power Consumption (kW)	6	7	7	9	12	12

Annual Production Rate	1,000	10,000	20,000	50,000	100,000	500,000
Capital Cost (\$/line)	\$947,066	\$1,238,066	\$772,133	\$1,126,133	\$1,744,133	\$1,744,133
Parts per station	1	2	2	2	4	4
Effective Cydetime per Welded assembly	13.9	7.0	7.0	4.6	2.3	2.3
Simultaneous Lines	1	3	5	8	8	37
Laborers per Line	0.5	1	1	1	1	1
Line Utilization	44%	73%	88%	91%	91%	98%
Effective Total Machine Rate (\$/hr)	\$321.99	\$280.47	\$167.95	\$218.09	\$312.60	\$292.65
Material Cost (\$/kg)	\$0.00	\$0.00	\$0.00	\$0.00	\$0.00	\$0.00

Annual Production Rate	1,000	10,000	20,000	50,000	100,000	500,000
Material (\$/stack)	\$0	\$0	\$0	\$0	\$0	\$0
Manufacturing (\$/stack)	\$446	\$194	\$116	\$100	\$72	\$67
Tooling (\$/stack)	\$2	\$2	\$2	\$2	\$2	\$2
Secondary Operations: Leak Check (\$/stack)	\$687	\$334	\$16	\$7	\$4	\$3
<b>Total Cost (\$/stack)</b>	<b>\$1,134</b>	<b>\$529</b>	<b>\$134</b>	<b>\$109</b>	<b>\$77</b>	<b>\$72</b>
<b>Total Cost (\$/kWnet)</b>	<b>\$14.18</b>	<b>\$6.62</b>	<b>\$1.67</b>	<b>\$1.36</b>	<b>\$0.96</b>	<b>\$0.90</b>

## 20.1.12 End Gaskets

### 2020 Analysis

Annual Production Rate	1,000	10,000	20,000	50,000	100,000	500,000
Equipment Lifetime (years)	15	15	15	15	15	15
Interest Rate	10%	10%	10%	10%	10%	10%
Corporate Income Tax Rate	40%	40%	40%	40%	40%	40%
Capital Recovery Factor	0.175	0.175	0.175	0.175	0.175	0.175
Equipment Installation Factor	1.4	1.4	1.4	1.4	1.4	1.4
Maintenance/Spare Parts (% of CC)	3%	3%	3%	3%	3%	3%
Miscellaneous Expenses (% of CC)	12%	12%	12%	12%	12%	12%
Power Consumption (kW)	61	61	61	61	61	61

Annual Production Rate	1,000	10,000	20,000	50,000	100,000	500,000
Screen Printing Machine Type	DEK Horizon	DEK Horizon	DEK Horizon	DEK Horizon	DEK Horizon	DEK Horizon
Capital Cost (\$/line)	\$392,735	\$392,735	\$392,735	\$392,735	\$392,735	\$392,735
Gaskets Printed Simultaneously	1	1	1	1	1	1
Runtime per Gasket (s)	9.62	9.62	9.62	9.62	9.62	9.62
Simultaneous Lines	1	1	1	1	1	1
Laborers per Line	0.5	0.5	0.5	0.5	0.5	0.5
Line Utilization	0.2%	1.6%	3.2%	8.0%	16.1%	80.5%
Effective Total Machine Rate (\$/hr)	\$28,206	\$2,857	\$1,443	\$594	\$311	\$84
Material Cost (\$/kg)	\$40.00	\$40.00	\$40.00	\$40.00	\$40.00	\$40.00
Job Shop or Manufactured	Job Shop	Job Shop	Job Shop	Job Shop	Job Shop	Manufactured
Job Shop Line Utilization (%)	37.2%	38.6%	40.2%	45.0%	53.1%	80.5%
Job Shop Machine Rate (\$/min)	\$3.26	\$3.16	\$3.05	\$2.79	\$2.46	\$1.83
Manufactured Line Utilization (%)	0.2%	1.6%	3.2%	8.0%	16.1%	80.5%
Manufactured Machine Rate (\$/min)	\$470.09	\$47.61	\$24.06	\$9.90	\$5.18	\$1.40
<b>Line Utilization Used (%)</b>	<b>37.2%</b>	<b>38.6%</b>	<b>40.2%</b>	<b>45.0%</b>	<b>53.1%</b>	<b>80.5%</b>
<b>Manufacturing Rate Used (\$/min)</b>	<b>\$3.26</b>	<b>\$3.16</b>	<b>\$3.05</b>	<b>\$2.79</b>	<b>\$2.46</b>	<b>\$1.40</b>

Annual Production Rate	1,000	10,000	20,000	50,000	100,000	500,000
Material (\$/stack)	\$0.09	\$0.09	\$0.09	\$0.09	\$0.09	\$0.09
Manufacturing (\$/stack)	\$1.00	\$0.96	\$0.93	\$0.85	\$0.75	\$0.43
Tooling (\$/stack)	\$0.00	\$0.00	\$0.00	\$0.00	\$0.00	\$0.00
<b>Total Cost (\$/stack)</b>	<b>\$1.09</b>	<b>\$1.06</b>	<b>\$1.02</b>	<b>\$0.94</b>	<b>\$0.84</b>	<b>\$0.52</b>
<b>Total Cost (\$/kWnet)</b>	<b>\$0.01</b>	<b>\$0.01</b>	<b>\$0.01</b>	<b>\$0.01</b>	<b>\$0.01</b>	<b>\$0.01</b>

## 2025 Analysis

Annual Production Rate	1,000	10,000	20,000	50,000	100,000	500,000
Equipment Lifetime (years)	15	15	15	15	15	15
Interest Rate	10%	10%	10%	10%	10%	10%
Corporate Income Tax Rate	40%	40%	40%	40%	40%	40%
Capital Recovery Factor	0.175	0.175	0.175	0.175	0.175	0.175
Equipment Installation Factor	1.4	1.4	1.4	1.4	1.4	1.4
Maintenance/Spare Parts (% of CC)	3%	3%	3%	3%	3%	3%
Miscellaneous Expenses (% of CC)	12%	12%	12%	12%	12%	12%
Power Consumption (kW)	61	61	61	61	61	61

Annual Production Rate	1,000	10,000	20,000	50,000	100,000	500,000
Screen Printing Machine Type	DEK Horizon	DEK Horizon	DEK Horizon	DEK Horizon	DEK Horizon	DEK Horizon
Capital Cost (\$/line)	\$392,735	\$392,735	\$392,735	\$392,735	\$392,735	\$392,735
Gaskets Printed Simultaneously	1	1	1	1	1	1
Runtime per Gasket (s)	9.62	9.62	9.62	9.62	9.62	9.62
Simultaneous Lines	1	1	1	1	1	1
Laborers per Line	0.5	0.5	0.5	0.5	0.5	0.5
Line Utilization	0.2%	1.6%	3.2%	8.0%	16.1%	80.4%
Effective Total Machine Rate (\$/hr)	\$28,233	\$2,859	\$1,445	\$595	\$311	\$84
Material Cost (\$/kg)	\$40.00	\$40.00	\$40.00	\$40.00	\$40.00	\$40.00
Job Shop or Manufactured	Job Shop	Job Shop	Job Shop	Job Shop	Job Shop	Manufactured
Job Shop Line Utilization (%)	37.2%	38.6%	40.2%	45.0%	53.1%	80.4%
Job Shop Machine Rate (\$/min)	\$3.26	\$3.16	\$3.05	\$2.79	\$2.46	\$1.83
Manufactured Line Utilization (%)	0.2%	1.6%	3.2%	8.0%	16.1%	80.4%
Manufactured Machine Rate (\$/min)	\$470.54	\$47.66	\$24.08	\$9.91	\$5.19	\$1.41
Line Utilization Used (%)	37.2%	38.6%	40.2%	45.0%	53.1%	80.4%
Manufacturing Rate Used (\$/min)	\$3.26	\$3.16	\$3.05	\$2.79	\$2.46	\$1.41

Annual Production Rate	1,000	10,000	20,000	50,000	100,000	500,000
Material (\$/stack)	\$0.06	\$0.06	\$0.06	\$0.06	\$0.06	\$0.06
Manufacturing (\$/stack)	\$1.00	\$0.96	\$0.93	\$0.85	\$0.75	\$0.43
Tooling (\$/stack)	\$0.00	\$0.00	\$0.00	\$0.00	\$0.00	\$0.00
Total Cost (\$/stack)	\$1.06	\$1.03	\$1.00	\$0.92	\$0.81	\$0.49
Total Cost (\$/kWnet)	\$0.01	\$0.01	\$0.01	\$0.01	\$0.01	\$0.01

## 20.1.13 Stack Assembly

### 2020 Analysis

Annual Production Rate	1,000	10,000	20,000	50,000	100,000	500,000
Equipment Lifetime (years)	5	15	15	15	15	15
Interest Rate	10%	10%	10%	10%	10%	10%
Corporate Income Tax Rate	40%	40%	40%	40%	40%	40%
Capital Recovery Factor	0.306	0.175	0.175	0.175	0.175	0.175
Equipment Installation Factor	1.4	1.4	1.4	1.4	1.4	1.4
Maintenance/Spare Parts (% of CC)	10%	10%	10%	10%	10%	10%
Miscellaneous Expenses (% of CC)	7%	7%	7%	7%	7%	7%
Power Consumption (kW)	1	7	7	7	7	7

Annual Production Rate	1,000	10,000	20,000	50,000	100,000	500,000
Assembly Method	Manual	Semi-Auto	Semi-Auto	Semi-Auto	Semi-Auto	Semi-Auto
Capital Cost (\$/line)	\$11,212	\$821,339	\$821,339	\$821,339	\$821,339	\$821,339
Simultaneous Lines	1	2	3	6	11	52
Laborers per Line	1.00	0.50	0.50	0.50	0.50	0.50
Line Utilization	49.1%	51.9%	69.1%	86.4%	94.3%	99.7%
Effective Total Machine Rate (\$/hr)	\$48.96	\$185.67	\$145.22	\$120.85	\$112.72	\$107.85
Index Time (min)	98	21	21	21	21	21

Annual Production Rate	1,000	10,000	20,000	50,000	100,000	500,000
Compression Bands (\$/stack)	\$9	\$8	\$8	\$6	\$5	\$5
Assembly (\$/stack)	\$75	\$61	\$48	\$40	\$37	\$35
<b>Total Cost (\$/stack)</b>	<b>\$85</b>	<b>\$69</b>	<b>\$55</b>	<b>\$45</b>	<b>\$42</b>	<b>\$40</b>
<b>Total Cost (\$/kWnet)</b>	<b>\$1.06</b>	<b>\$0.87</b>	<b>\$0.69</b>	<b>\$0.57</b>	<b>\$0.53</b>	<b>\$0.50</b>

### 2025 Analysis

Annual Production Rate	1,000	10,000	20,000	50,000	100,000	500,000
Equipment Lifetime (years)	5	15	15	15	15	15
Interest Rate	10%	10%	10%	10%	10%	10%
Corporate Income Tax Rate	40%	40%	40%	40%	40%	40%
Capital Recovery Factor	0.306	0.175	0.175	0.175	0.175	0.175
Equipment Installation Factor	1.4	1.4	1.4	1.4	1.4	1.4
Maintenance/Spare Parts (% of CC)	10%	10%	10%	10%	10%	10%
Miscellaneous Expenses (% of CC)	7%	7%	7%	7%	7%	7%
Power Consumption (kW)	1	7	7	7	7	7

Annual Production Rate	1,000	10,000	20,000	50,000	100,000	500,000
Assembly Method	Manual	Semi-Auto	Semi-Auto	Semi-Auto	Semi-Auto	Semi-Auto
Capital Cost (\$/line)	\$11,212	\$821,339	\$821,339	\$821,339	\$821,339	\$821,339
Simultaneous Lines	1	2	3	6	11	52
Laborers per Line	1.00	0.50	0.50	0.50	0.50	0.50
Line Utilization	49.1%	51.9%	69.1%	86.4%	94.3%	99.7%
Effective Total Machine Rate (\$/hr)	\$48.96	\$185.67	\$145.22	\$120.85	\$112.72	\$107.85
Index Time (min)	98	21	21	21	21	21

Annual Production Rate	1,000	10,000	20,000	50,000	100,000	500,000
Compression Bands (\$/stack)	\$9	\$8	\$8	\$6	\$5	\$5
Assembly (\$/stack)	\$75	\$61	\$48	\$40	\$37	\$35
<b>Total Cost (\$/stack)</b>	<b>\$85</b>	<b>\$69</b>	<b>\$55</b>	<b>\$45</b>	<b>\$42</b>	<b>\$40</b>
<b>Total Cost (\$/kWnet)</b>	<b>\$1.06</b>	<b>\$0.87</b>	<b>\$0.69</b>	<b>\$0.57</b>	<b>\$0.53</b>	<b>\$0.50</b>

## 20.1.14 Stack Housing

### 2020 Analysis

Annual Production Rate	1,000	10,000	20,000	50,000	100,000	500,000
Equipment Lifetime (years)	8	8	8	15	15	15
Interest Rate	10%	10%	10%	10%	10%	10%
Corporate Income Tax Rate	40%	40%	40%	40%	40%	40%
Capital Recovery Factor	0.229	0.229	0.229	0.175	0.175	0.175
Equipment Installation Factor	1.4	1.4	1.4	1.4	1.4	1.4
Maintenance/Spare Parts (% of CC)	5%	5%	5%	5%	5%	5%
Miscellaneous Expenses (% of CC)	6%	6%	6%	6%	6%	6%
Power Consumption (kW)	30	30	30	35	35	40

Annual Production Rate	1,000	10,000	20,000	50,000	100,000	500,000
Capital Cost (\$/line)	\$50,000	\$50,000	\$50,000	\$250,000	\$250,000	\$655,717
Costs per Tooling Set (\$)	\$96,352	\$96,352	\$96,352	\$96,352	\$96,352	\$96,352
Tooling Lifetime (years)	3	3	3	3	3	3
Cavities per platen	1	1	1	1	1	1
Total Cycle Times (s)	71	71	71	15	15	7
Simultaneous Lines	1	1	1	1	1	1
Laborers per Line	1.00	1.00	1.00	1.00	1.00	0.50
Line Utilization	0.6%	5.9%	11.8%	6.3%	12.6%	28.9%
Effective Total Machine Rate (\$/hr)	\$1,136.85	\$156.88	\$102.44	\$468.25	\$258.32	\$265.09
Material Cost (\$/kg)	\$1.48	\$1.48	\$1.48	\$1.48	\$1.48	\$1.48

Annual Production Rate	1,000	10,000	20,000	50,000	100,000	500,000
Material (\$/stack)	\$4	\$4	\$4	\$4	\$4	\$4
Manufacturing (\$/stack)	\$21	\$3	\$2	\$2	\$1	\$0
Tooling (\$/stack)	\$34	\$3	\$2	\$1	\$0	\$0
<b>Total Cost (\$/stack)</b>	<b>\$59</b>	<b>\$11</b>	<b>\$8</b>	<b>\$7</b>	<b>\$6</b>	<b>\$5</b>
<b>Total Cost (\$/kWnet)</b>	<b>\$0.74</b>	<b>\$0.13</b>	<b>\$0.10</b>	<b>\$0.08</b>	<b>\$0.07</b>	<b>\$0.06</b>

### 2025 Analysis

Annual Production Rate	1,000	10,000	20,000	50,000	100,000	500,000
Equipment Lifetime (years)	8	8	8	15	15	15
Interest Rate	10%	10%	10%	10%	10%	10%
Corporate Income Tax Rate	40%	40%	40%	40%	40%	40%
Capital Recovery Factor	0.229	0.229	0.229	0.175	0.175	0.175
Equipment Installation Factor	1.4	1.4	1.4	1.4	1.4	1.4
Maintenance/Spare Parts (% of CC)	5%	5%	5%	5%	5%	5%
Miscellaneous Expenses (% of CC)	6%	6%	6%	6%	6%	6%
Power Consumption (kW)	30	30	30	35	35	40

Annual Production Rate	1,000	10,000	20,000	50,000	100,000	500,000
Capital Cost (\$/line)	\$50,000	\$50,000	\$50,000	\$250,000	\$250,000	\$655,717
Costs per Tooling Set (\$)	\$96,352	\$96,352	\$96,352	\$96,352	\$96,352	\$96,352
Tooling Lifetime (years)	3	3	3	3	3	3
Cavities per platen	1	1	1	1	1	1
Total Cycle Times (s)	71	71	71	15	15	7
Simultaneous Lines	1	1	1	1	1	1
Laborers per Line	1.00	1.00	1.00	1.00	1.00	0.50
Line Utilization	0.6%	5.9%	11.8%	6.3%	12.6%	28.9%
Effective Total Machine Rate (\$/hr)	\$1,136.85	\$156.88	\$102.44	\$468.25	\$258.32	\$265.09
Material Cost (\$/kg)	\$1.48	\$1.48	\$1.48	\$1.48	\$1.48	\$1.48

Annual Production Rate	1,000	10,000	20,000	50,000	100,000	500,000
Material (\$/stack)	\$4	\$4	\$4	\$4	\$4	\$4
Manufacturing (\$/stack)	\$21	\$3	\$2	\$2	\$1	\$0
Tooling (\$/stack)	\$34	\$3	\$2	\$1	\$0	\$0
<b>Total Cost (\$/stack)</b>	<b>\$59</b>	<b>\$10</b>	<b>\$7</b>	<b>\$6</b>	<b>\$5</b>	<b>\$4</b>
<b>Total Cost (\$/kWnet)</b>	<b>\$0.74</b>	<b>\$0.13</b>	<b>\$0.09</b>	<b>\$0.08</b>	<b>\$0.06</b>	<b>\$0.05</b>

### 20.1.15 Stack Conditioning and Testing 2020 Analysis

Annual Production Rate	1,000	10,000	20,000	50,000	100,000	500,000
Equipment Lifetime (years)	19	19	19	19	19	19
Interest Rate	10%	10%	10%	10%	10%	10%
Corporate Income Tax Rate	40%	40%	40%	40%	40%	40%
Capital Recovery Factor	0.159	0.159	0.159	0.159	0.159	0.159
Equipment Installation Factor	1.4	1.4	1.4	1.4	1.4	1.4
Maintenance/Spare Parts (% of CC)	10%	10%	10%	10%	10%	10%
Miscellaneous Expenses (% of CC)	7%	7%	7%	7%	7%	7%
Power Consumption (kW)	2	3	3	3	3	9

Annual Production Rate	1,000	10,000	20,000	50,000	100,000	500,000
Capital Cost (\$/line)	<b>Proprietary</b>					
Simultaneous Lines	1	2	4	9	18	22
Laborers per Line	0.4	0.4	0.4	0.4	0.4	0.4
Line Utilization	99.2%	248.0%	248.0%	275.6%	275.6%	281.8%
Effective Total Machine Rate (\$/hr)	\$41.70	\$29.41	\$29.27	\$28.05	\$28.02	\$62.87
Test Duration (hrs)	2	2	2	2	2	2

Annual Production Rate	1,000	10,000	20,000	50,000	100,000	500,000
Conditioning/Testing (\$/stack)	\$78	\$28	\$28	\$26	\$26	\$15
<b>Total Cost (\$/stack)</b>	<b>\$78</b>	<b>\$28</b>	<b>\$28</b>	<b>\$26</b>	<b>\$26</b>	<b>\$15</b>
<b>Total Cost (\$/kWnet)</b>	<b>\$0.98</b>	<b>\$0.35</b>	<b>\$0.34</b>	<b>\$0.33</b>	<b>\$0.33</b>	<b>\$0.18</b>

### 2025 Analysis

Annual Production Rate	1,000	10,000	20,000	50,000	100,000	500,000
Equipment Lifetime (years)	19	19	19	19	19	19
Interest Rate	10%	10%	10%	10%	10%	10%
Corporate Income Tax Rate	40%	40%	40%	40%	40%	40%
Capital Recovery Factor	0.159	0.159	0.159	0.159	0.159	0.159
Equipment Installation Factor	1.4	1.4	1.4	1.4	1.4	1.4
Maintenance/Spare Parts (% of CC)	10%	10%	10%	10%	10%	10%
Miscellaneous Expenses (% of CC)	7%	7%	7%	7%	7%	7%
Power Consumption (kW)	2	3	3	3	3	9

Annual Production Rate	1,000	10,000	20,000	50,000	100,000	500,000
Capital Cost (\$/line)	<b>Proprietary</b>					
Simultaneous Lines	1	1	2	5	9	11
Laborers per Line	0.4	0.4	0.4	0.4	0.4	0.4
Line Utilization	49.6%	248.0%	248.0%	248.0%	275.6%	281.8%
Effective Total Machine Rate (\$/hr)	\$66.37	\$29.41	\$29.27	\$29.17	\$28.02	\$62.87
Test Duration (hrs)	1	1	1	1	1	1



Annual Production Rate	1,000	10,000	20,000	50,000	100,000	500,000
Conditioning/Testing (\$/stack)	\$62	\$14	\$14	\$14	\$13	\$7
<b>Total Cost (\$/stack)</b>	<b>\$62</b>	<b>\$14</b>	<b>\$14</b>	<b>\$14</b>	<b>\$13</b>	<b>\$7</b>
<b>Total Cost (\$/kWnet)</b>	<b>\$0.78</b>	<b>\$0.17</b>	<b>\$0.17</b>	<b>\$0.17</b>	<b>\$0.16</b>	<b>\$0.09</b>

## 20.2 2020 & 2025 Auto Balance of Plant (BOP) Cost Results

### 20.2.1 Air Loop

#### 2020 Analysis

Annual Production Rate	1,000	10,000	20,000	50,000	100,000	500,000
Compressor, Expander & Motor (\$/system)	\$1,766	\$1,318	\$996	\$852	\$825	\$801
Mass Flow Sensor (\$/system)	\$20	\$18	\$16	\$12	\$11	\$10
Air Temperature Sensor (\$/system)	\$9	\$8	\$8	\$6	\$5	\$5
Filter and Housing (\$/system)	\$53	\$53	\$53	\$53	\$53	\$53
Stack Bypass 3-Way Valve (\$/system)	\$50	\$38	\$37	\$35	\$34	\$24
Stack Shut-Off Valve (2-Way)(\$/system)	\$63	\$44	\$42	\$39	\$38	\$27
Air Ducting (\$/system)	\$127	\$124	\$122	\$116	\$111	\$105
Air Bleed Orifice (\$/system)	\$9	\$9	\$9	\$9	\$9	\$9
<b>Total Cost (\$/system)</b>	<b>\$2,097</b>	<b>\$1,612</b>	<b>\$1,282</b>	<b>\$1,122</b>	<b>\$1,086</b>	<b>\$1,033</b>
<b>Total Cost (\$/kWnet)</b>	<b>\$26.22</b>	<b>\$20.15</b>	<b>\$16.03</b>	<b>\$14.03</b>	<b>\$13.58</b>	<b>\$12.91</b>

#### 2025 Analysis

Annual Production Rate	1,000	10,000	20,000	50,000	100,000	500,000
Compressor, Expander & Motor (\$/system)	\$1,593	\$1,189	\$933	\$800	\$773	\$750
Mass Flow Sensor (\$/system)	\$20	\$18	\$16	\$12	\$11	\$10
Air Temperature Sensor (\$/system)	\$9	\$8	\$8	\$6	\$5	\$5
Filter and Housing (\$/system)	\$53	\$53	\$53	\$53	\$53	\$53
Stack Bypass 3-Way Valve (\$/system)	\$50	\$38	\$37	\$35	\$34	\$24
Stack Shut-Off Valve (2-Way)(\$/system)	\$63	\$44	\$42	\$39	\$38	\$27
Air Ducting (\$/system)	\$127	\$124	\$122	\$116	\$111	\$105
Air Bleed Orifice (\$/system)	\$9	\$9	\$9	\$9	\$9	\$9
<b>Total Cost (\$/system)</b>	<b>\$1,925</b>	<b>\$1,483</b>	<b>\$1,220</b>	<b>\$1,069</b>	<b>\$1,034</b>	<b>\$982</b>
<b>Total Cost (\$/kWnet)</b>	<b>\$24.06</b>	<b>\$18.54</b>	<b>\$15.25</b>	<b>\$13.37</b>	<b>\$12.93</b>	<b>\$12.28</b>

### 20.2.2 Humidifier & Water Recovery Loop

#### 2020 Analysis

Annual Production Rate	1,000	10,000	20,000	50,000	100,000	500,000
Air Precooler (\$/system)	\$38	\$38	\$38	\$38	\$38	\$38
Demister (\$/system)	\$124	\$31	\$24	\$16	\$15	\$12
Membrane Air Humidifier (\$/system)	\$955	\$270	\$148	\$110	\$83	\$58
<b>Total Cost (\$/system)</b>	<b>\$1,117</b>	<b>\$339</b>	<b>\$210</b>	<b>\$164</b>	<b>\$136</b>	<b>\$108</b>
<b>Total Cost (\$/kWnet)</b>	<b>\$13.96</b>	<b>\$4.23</b>	<b>\$2.63</b>	<b>\$2.05</b>	<b>\$1.70</b>	<b>\$1.35</b>

**2025 Analysis**

Annual Production Rate	1,000	10,000	20,000	50,000	100,000	500,000
Air Precooler (\$/system)	\$38	\$38	\$38	\$38	\$38	\$38
Demister (\$/system)	\$124	\$31	\$24	\$16	\$15	\$12
Membrane Air Humidifier (\$/system)	\$955	\$270	\$148	\$110	\$83	\$58
<b>Total Cost (\$/system)</b>	<b>\$1,117</b>	<b>\$339</b>	<b>\$210</b>	<b>\$164</b>	<b>\$136</b>	<b>\$108</b>
<b>Total Cost (\$/kWnet)</b>	<b>\$13.96</b>	<b>\$4.24</b>	<b>\$2.63</b>	<b>\$2.05</b>	<b>\$1.70</b>	<b>\$1.35</b>

**20.2.2.1 Air Precooler**

**2020 Analysis**

Annual Production Rate	1,000	10,000	20,000	50,000	100,000	500,000
Material (\$/system)	\$19	\$19	\$19	\$19	\$19	\$19
Manufacturing (\$/system)	\$19	\$19	\$19	\$19	\$19	\$19
<b>Total Cost (\$/system)</b>	<b>\$38</b>	<b>\$38</b>	<b>\$38</b>	<b>\$38</b>	<b>\$38</b>	<b>\$38</b>
<b>Total Cost (\$/kWnet)</b>	<b>\$0.48</b>	<b>\$0.48</b>	<b>\$0.48</b>	<b>\$0.48</b>	<b>\$0.48</b>	<b>\$0.48</b>

**2025 Analysis**

Annual Production Rate	1,000	10,000	20,000	50,000	100,000	500,000
Material (\$/system)	\$19	\$19	\$19	\$19	\$19	\$19
Manufacturing (\$/system)	\$19	\$19	\$19	\$19	\$19	\$19
<b>Total Cost (\$/system)</b>	<b>\$38</b>	<b>\$38</b>	<b>\$38</b>	<b>\$38</b>	<b>\$38</b>	<b>\$38</b>
<b>Total Cost (\$/kWnet)</b>	<b>\$0.48</b>	<b>\$0.48</b>	<b>\$0.48</b>	<b>\$0.48</b>	<b>\$0.48</b>	<b>\$0.48</b>

**20.2.2.2 Demister**

**2020 Analysis**

Annual Production Rate	1,000	10,000	20,000	50,000	100,000	500,000
Equipment Lifetime (years)	15	15	15	15	15	15
Interest Rate	10%	10%	10%	10%	10%	10%
Corporate Income Tax Rate	40%	40%	40%	40%	40%	40%
Capital Recovery Factor	0.175	0.175	0.175	0.175	0.175	0.175
Equipment Installation Factor	1.4	1.4	1.4	1.4	1.4	1.4
Maintenance/Spare Parts (% of CC)	5%	5%	5%	5%	5%	5%
Miscellaneous Expenses (% of CC)	6%	6%	6%	6%	6%	6%
Power Consumption (kW)	21	21	21	21	21	31

Annual Production Rate	1,000	10,000	20,000	50,000	100,000	500,000
Capital Cost (\$/line)	\$288,522	\$288,522	\$288,522	\$288,522	\$288,522	\$318,221
Costs per Tooling Set (\$)	\$16,193	\$16,193	\$16,193	\$16,193	\$16,193	\$26,305
Tooling Lifetime (cycles)	1,000,000	1,000,000	1,000,000	1,000,000	1,000,000	1,000,000
Cavities per platen	1	1	1	1	1	2
Total Cycle Time (s)	7	7	7	7	7	7
Simultaneous Lines	1	1	1	1	1	1
Laborers per Line	0.50	0.50	0.50	0.50	0.50	0.50
Line Utilization	0.3%	2.3%	4.6%	11.3%	22.6%	56.4%
Effective Total Machine Rate (\$/hr)	\$10,740.68	\$1,364.47	\$714.47	\$316.27	\$182.13	\$107.66
Material Cost (\$/kg)	\$1.33	\$1.33	\$1.33	\$1.33	\$1.33	\$1.33

Annual Production Rate	1,000	10,000	20,000	50,000	100,000	500,000
Material (\$/system)	\$23	\$20	\$18	\$14	\$13	\$11
Manufacturing (\$/system)	\$97	\$10	\$5	\$2	\$1	\$0
Tooling (\$/system)	\$4	\$0	\$0	\$0	\$0	\$0
<b>Total Cost (\$/system)</b>	<b>\$124</b>	<b>\$31</b>	<b>\$24</b>	<b>\$16</b>	<b>\$15</b>	<b>\$12</b>
<b>Total Cost (\$/kWnet)</b>	<b>\$1.55</b>	<b>\$0.38</b>	<b>\$0.30</b>	<b>\$0.21</b>	<b>\$0.18</b>	<b>\$0.15</b>

## 2025 Analysis

Annual Production Rate	1,000	10,000	20,000	50,000	100,000	500,000
Equipment Lifetime (years)	15	15	15	15	15	15
Interest Rate	10%	10%	10%	10%	10%	10%
Corporate Income Tax Rate	40%	40%	40%	40%	40%	40%
Capital Recovery Factor	0.175	0.175	0.175	0.175	0.175	0.175
Equipment Installation Factor	1.4	1.4	1.4	1.4	1.4	1.4
Maintenance/Spare Parts (% of CC)	5%	5%	5%	5%	5%	5%
Miscellaneous Expenses (% of CC)	6%	6%	6%	6%	6%	6%
Power Consumption (kW)	21	21	21	21	21	31

Annual Production Rate	1,000	10,000	20,000	50,000	100,000	500,000
Capital Cost (\$/line)	\$288,522	\$288,522	\$288,522	\$288,522	\$288,522	\$318,221
Costs per Tooling Set (\$)	\$16,193	\$16,193	\$16,193	\$16,193	\$16,193	\$26,305
Tooling Lifetime (cycles)	1,000,000	1,000,000	1,000,000	1,000,000	1,000,000	1,000,000
Cavities per platen	1	1	1	1	1	2
Total Cycle Time (s)	7	7	7	7	7	7
Simultaneous Lines	1	1	1	1	1	1
Laborers per Line	0.50	0.50	0.50	0.50	0.50	0.50
Line Utilization	0.3%	2.3%	4.6%	11.3%	22.6%	56.4%
Effective Total Machine Rate (\$/hr)	\$10,740.68	\$1,364.47	\$714.47	\$316.27	\$182.13	\$107.66
Material Cost (\$/kg)	\$1.33	\$1.33	\$1.33	\$1.33	\$1.33	\$1.33

Annual Production Rate	1,000	10,000	20,000	50,000	100,000	500,000
Material (\$/system)	\$23	\$20	\$18	\$14	\$13	\$11
Manufacturing (\$/system)	\$97	\$10	\$5	\$2	\$1	\$0
Tooling (\$/system)	\$4	\$0	\$0	\$0	\$0	\$0
<b>Total Cost (\$/system)</b>	<b>\$124</b>	<b>\$31</b>	<b>\$24</b>	<b>\$16</b>	<b>\$15</b>	<b>\$12</b>
<b>Total Cost (\$/kWnet)</b>	<b>\$1.55</b>	<b>\$0.38</b>	<b>\$0.30</b>	<b>\$0.21</b>	<b>\$0.18</b>	<b>\$0.15</b>

### 20.2.2.3 Membrane Humidifier

#### 20.2.2.3.1 Membrane Humidifier Manufacturing Process

##### Station 1: Fabrication of Composite Humidifier Membranes

##### 2020 Analysis

Annual Production Rate	1,000	10,000	20,000	50,000	100,000	500,000
Equipment Lifetime (years)	15	15	15	15	15	15
Interest Rate	10%	10%	10%	10%	10%	10%
Corporate Income Tax Rate	40%	40%	40%	40%	40%	40%
Capital Recovery Factor	0.175	0.175	0.175	0.175	0.175	0.175
Equipment Installation Factor	1.4	1.4	1.4	1.4	1.4	1.4
Maintenance/Spare Parts (% of CC)	10%	10%	10%	10%	10%	10%
Miscellaneous Expenses (% of CC)	7%	7%	7%	7%	7%	7%
Power Consumption (kW)	294	294	294	294	294	294

Annual Production Rate	1,000	10,000	20,000	50,000	100,000	500,000
Capital Cost (\$/line)	\$1,226,614	\$1,785,112	\$1,394,249	\$2,902,689	\$2,902,689	\$2,921,189
Simultaneous Lines	1	1	1	1	1	1
Laborers per Line	0.67	0.67	0.67	0.67	0.67	0.67
Line Utilization	0.2%	1.4%	2.6%	3.4%	6.8%	32.7%
Casting Line Rate (m/s)	0.17	0.17	0.17	0.17	0.17	0.17
Effective Total Machine Rate (\$/hr)	\$70,913	\$16,299	\$6,581	\$10,460	\$5,353	\$1,155
Backer Cost (\$/m <sup>2</sup> )	\$0.96	\$0.96	\$0.96	\$0.96	\$0.96	\$0.96

Annual Production Rate	1,000	10,000	20,000	50,000	100,000	500,000
Materials (\$/stack)	\$36	\$52	\$33	\$28	\$25	\$18
Manufacturings (\$/stack)	\$100	\$72	\$29	\$23	\$12	\$2
Toolings (\$/stack)	\$0	\$0	\$0	\$0	\$0	\$0
Markups (\$/stack)	\$55	\$43	\$22	\$15	\$10	\$5
<b>Total Costs (\$/stack)</b>	<b>\$191</b>	<b>\$167</b>	<b>\$83</b>	<b>\$66</b>	<b>\$46</b>	<b>\$25</b>
<b>Total Costs (\$/kWnet)</b>	<b>\$2.39</b>	<b>\$2.09</b>	<b>\$1.04</b>	<b>\$0.83</b>	<b>\$0.58</b>	<b>\$0.32</b>

##### 2025 Analysis

Annual Production Rate	1,000	10,000	20,000	50,000	100,000	500,000
Equipment Lifetime (years)	15	15	15	15	15	15
Interest Rate	10%	10%	10%	10%	10%	10%
Corporate Income Tax Rate	40%	40%	40%	40%	40%	40%
Capital Recovery Factor	0.175	0.175	0.175	0.175	0.175	0.175
Equipment Installation Factor	1.4	1.4	1.4	1.4	1.4	1.4
Maintenance/Spare Parts (% of CC)	10%	10%	10%	10%	10%	10%
Miscellaneous Expenses (% of CC)	7%	7%	7%	7%	7%	7%
Power Consumption (kW)	294	294	294	294	294	294

Annual Production Rate	1,000	10,000	20,000	50,000	100,000	500,000
Capital Cost (\$/line)	\$1,226,614	\$1,785,112	\$1,394,249	\$2,902,689	\$2,902,689	\$2,921,189
Simultaneous Lines	1	1	1	1	1	1
Laborers per Line	0.67	0.67	0.67	0.67	0.67	0.67
Line Utilization	0.2%	1.4%	2.6%	3.4%	6.8%	32.7%
Casting Line Rate (m/s)	0.17	0.17	0.17	0.17	0.17	0.17
Effective Total Machine Rate (\$/hr)	\$70,913	\$16,299	\$6,581	\$10,460	\$5,353	\$1,155
Backer Cost (\$/m <sup>2</sup> )	\$0.96	\$0.96	\$0.96	\$0.96	\$0.96	\$0.96

Annual Production Rate	1,000	10,000	20,000	50,000	100,000	500,000
Materials (\$/stack)	\$36	\$52	\$33	\$28	\$25	\$18
Manufacturings (\$/stack)	\$100	\$72	\$29	\$23	\$12	\$2
Toolings (\$/stack)	\$0	\$0	\$0	\$0	\$0	\$0
Markups (\$/stack)	\$55	\$43	\$22	\$15	\$10	\$5
<b>Total Costs (\$/stack)</b>	<b>\$191</b>	<b>\$168</b>	<b>\$83</b>	<b>\$66</b>	<b>\$46</b>	<b>\$25</b>
<b>Total Costs (\$/kWnet)</b>	<b>\$2.39</b>	<b>\$2.09</b>	<b>\$1.04</b>	<b>\$0.83</b>	<b>\$0.58</b>	<b>\$0.32</b>

**Station 2: Fabrication of Etched Stainless Steel Flow Fields**  
**2020 Analysis**

Annual Production Rate	1,000	10,000	20,000	50,000	100,000	500,000
Equipment Lifetime (years)	15	15	15	15	15	15
Interest Rate	10%	10%	10%	10%	10%	10%
Corporate Income Tax Rate	40%	40%	40%	40%	40%	40%
Capital Recovery Factor	0.175	0.175	0.175	0.175	0.175	0.175
Equipment Installation Factor	1.4	1.4	1.4	1.4	1.4	1.4
Maintenance/Spare Parts (% of CC)	13%	13%	13%	13%	13%	13%
Miscellaneous Expenses (% of CC)	2%	2%	2%	2%	2%	2%
Power Consumption (kW)	2,226	2,226	2,226	2,226	2,226	2,226

Annual Production Rate	1,000	10,000	20,000	50,000	100,000	500,000
Capital Cost (\$/line)	\$1,018,602	\$1,018,602	\$1,018,602	\$1,018,602	\$1,018,602	\$1,868,602
Stage 1 Simultaneous Lines	1	1	1	1	1	1
Stage 2 Simultaneous Lines	1	1	1	1	1	3
Stage 3 Simultaneous Lines	1	1	1	1	1	1
Stage 4 Simultaneous Lines	1	1	1	1	1	3
Stage 5 Simultaneous Lines	1	1	1	1	1	1
Stage 1 Line Utilization	0.0%	0.1%	0.2%	0.6%	1.2%	5.9%
Stage 2 Line Utilization	0.5%	4.7%	9.5%	23.7%	47.4%	79.0%
Stage 3 Line Utilization	0.1%	0.7%	1.3%	3.3%	6.5%	32.6%
Stage 4 Line Utilization	0.5%	5.5%	10.9%	27.3%	54.5%	90.9%
Stage 5 Line Utilization	0.1%	0.6%	1.2%	3.0%	5.9%	29.6%
Stage 1 Laborers per Line	1	1	1	1	1	1
Stage 2 Laborers per Line	2	2	2	2	2	2
Stage 3 Laborers per Line	1	1	1	1	1	1
Stage 4 Laborers per Line	0	0	0	0	0	0
Stage 5 Laborers per Line	1	1	1	1	1	1
Stage 1 Cycle Time (s)	6	6	6	6	6	6
Stage 2 Cycle Time (s)	480	480	480	480	480	480
Stage 3 Cycle Time (s)	330	330	330	330	330	330
Stage 4 Cycle Time (s)	2,761	2,761	2,761	2,761	2,761	2,761
Stage 5 Cycle Time (s)	300	300	300	300	300	300
Effective Total Machine Rate (\$/hr)	\$20,628.77	\$2,285.36	\$1,261.83	\$647.73	\$443.13	\$313.48
Stainless Steel Cost (\$/kg)	\$3.93	\$3.93	\$3.93	\$3.93	\$3.93	\$3.93

Annual Production Rate	1,000	10,000	20,000	50,000	100,000	500,000
Materials (\$/stack)	\$8	\$8	\$8	\$8	\$8	\$8
Manufacturings (\$/stack)	\$382	\$42	\$23	\$12	\$8	\$6
<b>Total Costs (\$/stack)</b>	<b>\$390</b>	<b>\$50</b>	<b>\$31</b>	<b>\$20</b>	<b>\$16</b>	<b>\$13</b>
<b>Total Costs (\$/kWnet)</b>	<b>\$4.87</b>	<b>\$0.62</b>	<b>\$0.39</b>	<b>\$0.24</b>	<b>\$0.20</b>	<b>\$0.17</b>

## 2025 Analysis

Annual Production Rate	1,000	10,000	20,000	50,000	100,000	500,000
Equipment Lifetime (years)	15	15	15	15	15	15
Interest Rate	10%	10%	10%	10%	10%	10%
Corporate Income Tax Rate	40%	40%	40%	40%	40%	40%
Capital Recovery Factor	0.175	0.175	0.175	0.175	0.175	0.175
Equipment Installation Factor	1.4	1.4	1.4	1.4	1.4	1.4
Maintenance/Spare Parts (% of CC)	13%	13%	13%	13%	13%	13%
Miscellaneous Expenses (% of CC)	2%	2%	2%	2%	2%	2%
Power Consumption (kW)	2,226	2,226	2,226	2,226	2,226	2,226

Annual Production Rate	1,000	10,000	20,000	50,000	100,000	500,000
Capital Cost (\$/line)	\$1,018,602	\$1,018,602	\$1,018,602	\$1,018,602	\$1,018,602	\$1,868,602
Stage 1 Simultaneous Lines	1	1	1	1	1	1
Stage 2 Simultaneous Lines	1	1	1	1	1	3
Stage 3 Simultaneous Lines	1	1	1	1	1	1
Stage 4 Simultaneous Lines	1	1	1	1	1	3
Stage 5 Simultaneous Lines	1	1	1	1	1	1
Stage 1 Line Utilization	0.0%	0.1%	0.2%	0.6%	1.2%	5.9%
Stage 2 Line Utilization	0.5%	4.7%	9.5%	23.7%	47.4%	79.0%
Stage 3 Line Utilization	0.1%	0.7%	1.3%	3.3%	6.5%	32.6%
Stage 4 Line Utilization	0.5%	5.5%	10.9%	27.3%	54.5%	90.9%
Stage 5 Line Utilization	0.1%	0.6%	1.2%	3.0%	5.9%	29.6%
Stage 1 Laborers per Line	1	1	1	1	1	1
Stage 2 Laborers per Line	2	2	2	2	2	2
Stage 3 Laborers per Line	1	1	1	1	1	1
Stage 4 Laborers per Line	0	0	0	0	0	0
Stage 5 Laborers per Line	1	1	1	1	1	1
Stage 1 Cycle Time (s)	6	6	6	6	6	6
Stage 2 Cycle Time (s)	480	480	480	480	480	480
Stage 3 Cycle Time (s)	330	330	330	330	330	330
Stage 4 Cycle Time (s)	2,761	2,761	2,761	2,761	2,761	2,761
Stage 5 Cycle Time (s)	300	300	300	300	300	300
Effective Total Machine Rate (\$/hr)	\$20,628.77	\$2,285.36	\$1,261.83	\$647.73	\$443.13	\$313.48
Stainless Steel Cost (\$/kg)	\$3.93	\$3.93	\$3.93	\$3.93	\$3.93	\$3.93

Annual Production Rate	1,000	10,000	20,000	50,000	100,000	500,000
Materials (\$/stack)	\$8	\$8	\$8	\$8	\$8	\$8
Manufacturings (\$/stack)	\$382	\$42	\$23	\$12	\$8	\$6
Total Costs (\$/stack)	\$390	\$50	\$31	\$20	\$16	\$13
Total Costs (\$/kWnet)	\$4.87	\$0.62	\$0.39	\$0.24	\$0.20	\$0.17

**Station 3: Pouch Formation**  
**2020 Analysis**

Annual Production Rate	1,000	10,000	20,000	50,000	100,000	500,000
Equipment Lifetime (years)	15	15	15	15	15	15
Interest Rate	10%	10%	10%	10%	10%	10%
Corporate Income Tax Rate	40%	40%	40%	40%	40%	40%
Capital Recovery Factor	0.175	0.175	0.175	0.175	0.175	0.175
Equipment Installation Factor	1.4	1.4	1.4	1.4	1.4	1.4
Maintenance/Spare Parts (% of CC)	10%	10%	10%	10%	10%	10%
Miscellaneous Expenses (% of CC)	7%	7%	7%	7%	7%	7%
Power Consumption (kW)	27	27	27	27	27	27

Annual Production Rate	1,000	10,000	20,000	50,000	100,000	500,000
Capital Cost (\$/line)	\$413,179	\$413,179	\$413,179	\$413,179	\$413,179	\$413,179
Costs per Tooling Set (\$)	\$1,259	\$1,259	\$1,259	\$1,208	\$813	\$324
Costs per Tooling Set 2 (\$)	1,400	1,400	1,400	1,400	1,400	977
Tooling Lifetime (cycles)	2,000,000	2,000,000	2,000,000	2,000,000	2,000,000	2,000,000
Simultaneous Lines	1	1	1	1	1	2
Laborers per Line	0.50	0.50	0.50	0.50	0.50	0.50
Line Utilization	0.3%	3.3%	6.6%	16.0%	32.1%	80.2%
Cycle Time (s)	0.875	0.875	0.875	0.875	0.875	0.875
Effective Total Machine Rate (\$/hr)	\$15,112.54	\$1,572.65	\$799.21	\$342.54	\$183.81	\$88.47
Silicon Adhesive Cost (\$/kg)	\$12.05	\$12.05	\$12.05	\$12.05	\$12.05	\$12.05

Annual Production Rate	1,000	10,000	20,000	50,000	100,000	500,000
Materials (\$/stack)	\$0	\$0	\$0	\$0	\$0	\$0
Manufacturings (\$/stack)	\$161	\$16	\$8	\$3	\$2	\$1
Toolings (\$/stack)	\$0	\$0	\$0	\$0	\$0	\$0
<b>Total Costs (\$/stack)</b>	<b>\$162</b>	<b>\$17</b>	<b>\$9</b>	<b>\$4</b>	<b>\$2</b>	<b>\$1</b>
<b>Total Costs (\$/kWnet)</b>	<b>\$2.02</b>	<b>\$0.21</b>	<b>\$0.11</b>	<b>\$0.05</b>	<b>\$0.03</b>	<b>\$0.01</b>

**2025 Analysis**

Annual Production Rate	1,000	10,000	20,000	50,000	100,000	500,000
Equipment Lifetime (years)	15	15	15	15	15	15
Interest Rate	10%	10%	10%	10%	10%	10%
Corporate Income Tax Rate	40%	40%	40%	40%	40%	40%
Capital Recovery Factor	0.175	0.175	0.175	0.175	0.175	0.175
Equipment Installation Factor	1.4	1.4	1.4	1.4	1.4	1.4
Maintenance/Spare Parts (% of CC)	10%	10%	10%	10%	10%	10%
Miscellaneous Expenses (% of CC)	7%	7%	7%	7%	7%	7%
Power Consumption (kW)	27	27	27	27	27	27

Annual Production Rate	1,000	10,000	20,000	50,000	100,000	500,000
Capital Cost (\$/line)	\$413,179	\$413,179	\$413,179	\$413,179	\$413,179	\$413,179
Costs per Tooling Set (\$)	\$1,259	\$1,259	\$1,259	\$1,208	\$813	\$324
Costs per Tooling Set 2 (\$)	1,400	1,400	1,400	1,400	1,400	977
Tooling Lifetime (cycles)	2,000,000	2,000,000	2,000,000	2,000,000	2,000,000	2,000,000
Simultaneous Lines	1	1	1	1	1	2
Laborers per Line	0.50	0.50	0.50	0.50	0.50	0.50
Line Utilization	0.3%	3.3%	6.6%	16.0%	32.1%	80.2%
Cycle Time (s)	0.875	0.875	0.875	0.875	0.875	0.875
Effective Total Machine Rate (\$/hr)	\$15,112.54	\$1,572.65	\$799.21	\$342.54	\$183.81	\$88.47
Silicon Adhesive Cost (\$/kg)	\$12.05	\$12.05	\$12.05	\$12.05	\$12.05	\$12.05

Annual Production Rate	1,000	10,000	20,000	50,000	100,000	500,000
Materials (\$/stack)	\$0	\$0	\$0	\$0	\$0	\$0
Manufacturings (\$/stack)	\$161	\$16	\$8	\$3	\$2	\$1
Toolings (\$/stack)	\$0	\$0	\$0	\$0	\$0	\$0
<b>Total Costs (\$/stack)</b>	<b>\$162</b>	<b>\$17</b>	<b>\$9</b>	<b>\$4</b>	<b>\$2</b>	<b>\$1</b>
<b>Total Costs (\$/kWnet)</b>	<b>\$2.02</b>	<b>\$0.21</b>	<b>\$0.11</b>	<b>\$0.05</b>	<b>\$0.03</b>	<b>\$0.01</b>

#### Station 4: Stainless Steel Rib Formation 2020 Analysis

Annual Production Rate	1,000	10,000	20,000	50,000	100,000	500,000
Equipment Lifetime (years)	15	15	15	15	15	15
Interest Rate	10%	10%	10%	10%	10%	10%
Corporate Income Tax Rate	40%	40%	40%	40%	40%	40%
Capital Recovery Factor	0.175	0.175	0.175	0.175	0.175	0.175
Equipment Installation Factor	1.4	1.4	1.4	1.4	1.4	1.4
Maintenance/Spare Parts (% of CC)	13%	13%	13%	13%	13%	13%
Miscellaneous Expenses (% of CC)	2%	2%	2%	2%	2%	2%
Power Consumption (kW)	18	18	18	18	18	18

Annual Production Rate	1,000	10,000	20,000	50,000	100,000	500,000
Capital Cost (\$/line)	\$158,460	\$158,460	\$158,460	\$158,460	\$158,460	\$158,460
Costs per Tooling Set (\$)	\$6,000	\$6,000	\$6,000	\$6,000	\$6,000	\$6,000
Tooling Lifetime (cycles)	400,000	400,000	400,000	400,000	400,000	400,000
Simultaneous Lines	1	1	1	1	1	4
Laborers per Line	0.5	0.5	0.5	0.5	0.5	0.5
Line Utilization	0.7%	7.1%	14.1%	35.3%	70.5%	88.2%
Cycle Time (s)	0.66	0.66	0.66	0.66	0.66	0.66
Effective Total Machine Rate (\$/hr)	\$2,632.14	\$1,422.02	\$1,422.02	\$1,422.02	\$1,422.02	\$1,422.02
Stainless Steel Rib Material Cost (\$/kg)	\$3.93	\$3.93	\$3.93	\$3.93	\$3.93	\$3.93

Annual Production Rate	1,000	10,000	20,000	50,000	100,000	500,000
Materials (\$/stack)	\$1	\$1	\$1	\$1	\$1	\$1
Manufacturings (\$/stack)	\$59	\$6	\$3	\$2	\$1	\$1
Toolings (\$/stack)	\$2	\$2	\$2	\$2	\$2	\$2
<b>Total Costs (\$/stack)</b>	<b>\$62</b>	<b>\$9</b>	<b>\$6</b>	<b>\$4</b>	<b>\$4</b>	<b>\$3</b>
<b>Total Costs (\$/kWnet)</b>	<b>\$0.77</b>	<b>\$0.11</b>	<b>\$0.07</b>	<b>\$0.05</b>	<b>\$0.04</b>	<b>\$0.04</b>

#### 2025 Analysis

Annual Production Rate	1,000	10,000	20,000	50,000	100,000	500,000
Equipment Lifetime (years)	15	15	15	15	15	15
Interest Rate	10%	10%	10%	10%	10%	10%
Corporate Income Tax Rate	40%	40%	40%	40%	40%	40%
Capital Recovery Factor	0.175	0.175	0.175	0.175	0.175	0.175
Equipment Installation Factor	1.4	1.4	1.4	1.4	1.4	1.4
Maintenance/Spare Parts (% of CC)	13%	13%	13%	13%	13%	13%
Miscellaneous Expenses (% of CC)	2%	2%	2%	2%	2%	2%
Power Consumption (kW)	18	18	18	18	18	18



Annual Production Rate	1,000	10,000	20,000	50,000	100,000	500,000
Capital Cost (\$/line)	\$158,460	\$158,460	\$158,460	\$158,460	\$158,460	\$158,460
Costs per Tooling Set (\$)	\$6,000	\$6,000	\$6,000	\$6,000	\$6,000	\$6,000
Tooling Lifetime (cycles)	400,000	400,000	400,000	400,000	400,000	400,000
Simultaneous Lines	1	1	1	1	1	4
Laborers per Line	0.5	0.5	0.5	0.5	0.5	0.5
Line Utilization	0.7%	7.1%	14.1%	35.3%	70.5%	88.2%
Cycle Time (s)	0.66	0.66	0.66	0.66	0.66	0.66
Effective Total Machine Rate (\$/hr)	\$2,632.14	\$1,422.02	\$1,422.02	\$1,422.02	\$1,422.02	\$1,422.02
Stainless Steel Rib Material Cost (\$/kg)	\$3.93	\$3.93	\$3.93	\$3.93	\$3.93	\$3.93

Annual Production Rate	1,000	10,000	20,000	50,000	100,000	500,000
Materials (\$/stack)	\$1	\$1	\$1	\$1	\$1	\$1
Manufacturings (\$/stack)	\$59	\$6	\$3	\$2	\$1	\$1
Toolings (\$/stack)	\$2	\$2	\$2	\$2	\$2	\$2
Total Costs (\$/stack)	\$62	\$9	\$6	\$4	\$4	\$3
Total Costs (\$/kWnet)	\$0.77	\$0.11	\$0.07	\$0.05	\$0.04	\$0.04

### Station 5: Stack Formation 2020 Analysis

Annual Production Rate	1,000	10,000	20,000	50,000	100,000	500,000
Equipment Lifetime (years)	15	15	15	15	15	15
Interest Rate	10%	10%	10%	10%	10%	10%
Corporate Income Tax Rate	40%	40%	40%	40%	40%	40%
Capital Recovery Factor	0.175	0.175	0.175	0.175	0.175	0.175
Equipment Installation Factor	1.4	1.4	1.4	1.4	1.4	1.4
Maintenance/Spare Parts (% of CC)	10%	10%	10%	10%	10%	10%
Miscellaneous Expenses (% of CC)	7%	7%	7%	7%	7%	7%
Power Consumption (kW)	22	22	22	22	22	22

Annual Production Rate	1,000	10,000	20,000	50,000	100,000	500,000
Capital Cost (\$/line)	\$185,000	\$185,000	\$185,000	\$185,000	\$185,000	\$185,000
Simultaneous Lines	1	1	1	2	4	16
Laborers per Line	1	1	1	1	1	1
Line Utilization	3%	32%	64%	80%	80%	100%
Cycle Time (s)	9	9	9	9	9	9
Effective Total Machine Rate (\$/hr)	\$737.97	\$95.90	\$60.23	\$53.09	\$53.09	\$47.39
Silicon Adhesive Cost (\$/kg)	\$12.05	\$12.05	\$12.05	\$12.05	\$12.05	\$12.05

Annual Production Rate	1,000	10,000	20,000	50,000	100,000	500,000
Materials (\$/stack)	\$2	\$2	\$2	\$2	\$2	\$2
Manufacturings (\$/stack)	\$75	\$10	\$6	\$5	\$5	\$5
Total Costs (\$/stack)	\$77	\$12	\$8	\$8	\$8	\$7
Total Costs (\$/kWnet)	\$0.96	\$0.15	\$0.10	\$0.09	\$0.09	\$0.09

**2025 Analysis**

Annual Production Rate	1,000	10,000	20,000	50,000	100,000	500,000
Equipment Lifetime (years)	15	15	15	15	15	15
Interest Rate	10%	10%	10%	10%	10%	10%
Corporate Income Tax Rate	40%	40%	40%	40%	40%	40%
Capital Recovery Factor	0.175	0.175	0.175	0.175	0.175	0.175
Equipment Installation Factor	1.4	1.4	1.4	1.4	1.4	1.4
Maintenance/Spare Parts (% of CC)	10%	10%	10%	10%	10%	10%
Miscellaneous Expenses (% of CC)	7%	7%	7%	7%	7%	7%
Power Consumption (kW)	22	22	22	22	22	22

Annual Production Rate	1,000	10,000	20,000	50,000	100,000	500,000
Capital Cost (\$/line)	\$185,000	\$185,000	\$185,000	\$185,000	\$185,000	\$185,000
Simultaneous Lines	1	1	1	2	4	16
Laborers per Line	1	1	1	1	1	1
Line Utilization	3%	32%	64%	80%	80%	100%
Cycle Time (s)	9	9	9	9	9	9
Effective Total Machine Rate (\$/hr)	\$737.97	\$95.90	\$60.23	\$53.09	\$53.09	\$47.39
Silicon Adhesive Cost (\$/kg)	\$12.05	\$12.05	\$12.05	\$12.05	\$12.05	\$12.05

Annual Production Rate	1,000	10,000	20,000	50,000	100,000	500,000
Materials (\$/stack)	\$2	\$2	\$2	\$2	\$2	\$2
Manufacturings (\$/stack)	\$75	\$10	\$6	\$5	\$5	\$5
<b>Total Costs (\$/stack)</b>	<b>\$77</b>	<b>\$12</b>	<b>\$8</b>	<b>\$8</b>	<b>\$8</b>	<b>\$7</b>
<b>Total Costs (\$/kWnet)</b>	<b>\$0.96</b>	<b>\$0.15</b>	<b>\$0.10</b>	<b>\$0.09</b>	<b>\$0.09</b>	<b>\$0.09</b>

**Station 6: Formation of the Housing**  
**2020 Analysis**

Annual Production Rate	1,000	10,000	20,000	50,000	100,000	500,000
Material (\$/stack)	\$4	\$4	\$4	\$4	\$4	\$4
Manufacturing (\$/stack)	\$17	\$4	\$1	\$1	\$1	\$0
Tooling (\$/stack)	\$29	\$3	\$2	\$1	\$1	\$1
<b>Total Cost (\$/stack)</b>	<b>\$49</b>	<b>\$10</b>	<b>\$7</b>	<b>\$6</b>	<b>\$6</b>	<b>\$6</b>
<b>Total Cost (\$/kWnet)</b>	<b>\$0.62</b>	<b>\$0.13</b>	<b>\$0.09</b>	<b>\$0.08</b>	<b>\$0.07</b>	<b>\$0.07</b>

**2025 Analysis**

Annual Production Rate	1,000	10,000	20,000	50,000	100,000	500,000
Material (\$/stack)	\$4	\$4	\$4	\$4	\$4	\$4
Manufacturing (\$/stack)	\$17	\$4	\$1	\$1	\$1	\$0
Tooling (\$/stack)	\$29	\$3	\$2	\$1	\$1	\$1
<b>Total Cost (\$/stack)</b>	<b>\$49</b>	<b>\$10</b>	<b>\$7</b>	<b>\$6</b>	<b>\$6</b>	<b>\$6</b>
<b>Total Cost (\$/kWnet)</b>	<b>\$0.62</b>	<b>\$0.13</b>	<b>\$0.09</b>	<b>\$0.08</b>	<b>\$0.07</b>	<b>\$0.07</b>

**Station 7: Assembly of the Composite Membrane and Flow Fields into the Housing  
2020 Analysis**

Annual Production Rate	1,000	10,000	20,000	50,000	100,000	500,000
Equipment Lifetime (years)	10	10	10	10	10	10
Interest Rate	10%	10%	10%	10%	10%	10%
Corporate Income Tax Rate	40%	40%	40%	40%	40%	40%
Capital Recovery Factor	0.205	0.205	0.205	0.205	0.205	0.205
Equipment Installation Factor	1.4	1.4	1.4	1.4	1.4	1.4
Maintenance/Spare Parts (% of CC)	10%	10%	10%	10%	10%	10%
Miscellaneous Expenses (% of CC)	7%	7%	7%	7%	7%	7%
Power Consumption (kW)	18	18	18	18	18	18

Annual Production Rate	1,000	10,000	20,000	50,000	100,000	500,000
Assembly Method	Manual	Manual	Manual	Manual	Manual	Manual
Capital Cost (\$/line)	\$34,212	\$34,212	\$34,212	\$34,212	\$34,212	\$34,212
Simultaneous Lines	1	1	1	1	1	5
Laborers per Line	1	1	1	1	1	1
Line Utilization	1.0%	9.9%	19.8%	49.6%	99.2%	99.2%
Index Time (min)	2	2	2	2	2	2
Effective Total Machine Rate (\$/hr)	\$429.56	\$85.42	\$66.24	\$54.71	\$50.86	\$50.86

Annual Production Rate	1,000	10,000	20,000	50,000	100,000	500,000
Manufacturings (\$/stack)	\$13	\$3	\$2	\$2	\$2	\$2
Total Costs (\$/stack)	\$13	\$3	\$2	\$2	\$2	\$2
Total Costs (\$/kWnet)	\$0.17	\$0.03	\$0.03	\$0.02	\$0.02	\$0.02

**2025 Analysis**

Annual Production Rate	1,000	10,000	20,000	50,000	100,000	500,000
Equipment Lifetime (years)	10	10	10	10	10	10
Interest Rate	10%	10%	10%	10%	10%	10%
Corporate Income Tax Rate	40%	40%	40%	40%	40%	40%
Capital Recovery Factor	0.205	0.205	0.205	0.205	0.205	0.205
Equipment Installation Factor	1.4	1.4	1.4	1.4	1.4	1.4
Maintenance/Spare Parts (% of CC)	10%	10%	10%	10%	10%	10%
Miscellaneous Expenses (% of CC)	7%	7%	7%	7%	7%	7%
Power Consumption (kW)	18	18	18	18	18	18

Annual Production Rate	1,000	10,000	20,000	50,000	100,000	500,000
Assembly Method	Manual	Manual	Manual	Manual	Manual	Manual
Capital Cost (\$/line)	\$34,212	\$34,212	\$34,212	\$34,212	\$34,212	\$34,212
Simultaneous Lines	1	1	1	1	1	5
Laborers per Line	1	1	1	1	1	1
Line Utilization	1.0%	9.9%	19.8%	49.6%	99.2%	99.2%
Index Time (min)	2	2	2	2	2	2
Effective Total Machine Rate (\$/hr)	\$429.56	\$85.42	\$66.24	\$54.71	\$50.86	\$50.86

Annual Production Rate	1,000	10,000	20,000	50,000	100,000	500,000
Manufacturings (\$/stack)	\$13	\$3	\$2	\$2	\$2	\$2
Total Costs (\$/stack)	\$13	\$3	\$2	\$2	\$2	\$2
Total Costs (\$/kWnet)	\$0.17	\$0.03	\$0.03	\$0.02	\$0.02	\$0.02

**Station 8: Humidifier System Testing  
2020 Analysis**

Annual Production Rate	1,000	10,000	20,000	50,000	100,000	500,000
Equipment Lifetime (years)	15	15	15	15	15	15
Interest Rate	10%	10%	10%	10%	10%	10%
Corporate Income Tax Rate	40%	40%	40%	40%	40%	40%
Capital Recovery Factor	0.175	0.175	0.175	0.175	0.175	0.175
Equipment Installation Factor	1.4	1.4	1.4	1.4	1.4	1.4
Maintenance/Spare Parts (% of CC)	10%	10%	10%	10%	10%	10%
Miscellaneous Expenses (% of CC)	7%	7%	7%	7%	7%	7%
Power Consumption (kW)	2	2	2	5	5	5

Annual Production Rate	1,000	10,000	20,000	50,000	100,000	500,000
Capital Cost (\$/line)	\$30,000	\$30,000	\$30,000	\$40,000	\$40,000	\$40,000
Simultaneous Lines	1	1	1	1	1	1
Laborers per Line	1	1	1	1	1	1
Line Utilization	0.7%	6.9%	13.7%	9.5%	19.0%	95.1%
Systems partially connected at any one time	1	1	1	3	3	3
Selected Effective Test time per System (min)	1.4	1.4	1.4	0.4	0.4	0.4
Effective Total Machine Rate (\$/hr)	\$503.48	\$102.02	\$79.64	\$100.61	\$79.03	\$61.76

Annual Production Rate	1,000	10,000	20,000	50,000	100,000	500,000
Manufacturings (\$/stack)	\$11	\$2	\$2	\$1	\$0	\$0
Total Costs (\$/stack)	\$11	\$2	\$2	\$1	\$0	\$0
Total Costs (\$/kWnet)	\$0.137	\$0.028	\$0.022	\$0.008	\$0.006	\$0.005

**2025 Analysis**

Annual Production Rate	1,000	10,000	20,000	50,000	100,000	500,000
Equipment Lifetime (years)	15	15	15	15	15	15
Interest Rate	10%	10%	10%	10%	10%	10%
Corporate Income Tax Rate	40%	40%	40%	40%	40%	40%
Capital Recovery Factor	0.175	0.175	0.175	0.175	0.175	0.175
Equipment Installation Factor	1.4	1.4	1.4	1.4	1.4	1.4
Maintenance/Spare Parts (% of CC)	10%	10%	10%	10%	10%	10%
Miscellaneous Expenses (% of CC)	7%	7%	7%	7%	7%	7%
Power Consumption (kW)	2	2	2	5	5	5

Annual Production Rate	1,000	10,000	20,000	50,000	100,000	500,000
Capital Cost (\$/line)	\$30,000	\$30,000	\$30,000	\$40,000	\$40,000	\$40,000
Simultaneous Lines	1	1	1	1	1	1
Laborers per Line	1	1	1	1	1	1
Line Utilization	0.7%	6.9%	13.7%	9.5%	19.0%	95.1%
Systems partially connected at any one time	1	1	1	3	3	3
Selected Effective Test time per System (min)	1.4	1.4	1.4	0.4	0.4	0.4
Effective Total Machine Rate (\$/hr)	\$503.48	\$102.02	\$79.64	\$100.61	\$79.03	\$61.76

Annual Production Rate	1,000	10,000	20,000	50,000	100,000	500,000
Manufacturings (\$/stack)	\$11	\$2	\$2	\$1	\$0	\$0
Total Costs (\$/stack)	\$11	\$2	\$2	\$1	\$0	\$0
Total Costs (\$/kWnet)	\$0.137	\$0.028	\$0.022	\$0.008	\$0.006	\$0.005

### 20.2.2.3.2 Combined Cost Results for Plate Frame Membrane Humidifier

#### 2020 Analysis

Annual Production Rate	1,000	10,000	20,000	50,000	100,000	500,000
Materials (\$/stack)	\$51	\$66	\$48	\$43	\$39	\$32
Manufacturings (\$/stack)	\$818	\$155	\$75	\$49	\$31	\$17
Toolings (\$/stack)	\$31	\$5	\$4	\$3	\$3	\$3
Markups (\$/stack)	\$55	\$43	\$22	\$15	\$10	\$5
<b>Total Costs (\$/stack)</b>	<b>\$955</b>	<b>\$270</b>	<b>\$148</b>	<b>\$110</b>	<b>\$83</b>	<b>\$58</b>
<b>Total Costs (\$/kWnet)</b>	<b>\$11.94</b>	<b>\$3.37</b>	<b>\$1.85</b>	<b>\$1.37</b>	<b>\$1.04</b>	<b>\$0.72</b>

#### 2025 Analysis

Annual Production Rate	1,000	10,000	20,000	50,000	100,000	500,000
Materials (\$/stack)	\$51	\$67	\$48	\$43	\$39	\$32
Manufacturings (\$/stack)	\$818	\$155	\$75	\$49	\$31	\$17
Toolings (\$/stack)	\$31	\$5	\$4	\$3	\$3	\$3
Markups (\$/stack)	\$55	\$43	\$22	\$15	\$10	\$5
<b>Total Costs (\$/stack)</b>	<b>\$955</b>	<b>\$270</b>	<b>\$148</b>	<b>\$110</b>	<b>\$83</b>	<b>\$58</b>
<b>Total Costs (\$/kWnet)</b>	<b>\$11.94</b>	<b>\$3.38</b>	<b>\$1.85</b>	<b>\$1.37</b>	<b>\$1.04</b>	<b>\$0.72</b>

## 20.2.3 Coolant Loops

### 20.2.3.1 High-Temperature Coolant Loop

#### 2020 Analysis

Annual Production Rate	1,000	10,000	20,000	50,000	100,000	500,000
Coolant Reservoir (\$/system)	\$13	\$11	\$10	\$8	\$7	\$6
Coolant Pump (\$/system)	\$59	\$59	\$59	\$59	\$59	\$59
Coolant DI Filter (\$/system)	\$76	\$67	\$61	\$46	\$43	\$37
Thermostat & Valve (\$/system)	\$10	\$9	\$8	\$6	\$6	\$5
Radiator (\$/system)	\$186	\$177	\$168	\$158	\$149	\$140
Radiator Fan (\$/system)	\$83	\$73	\$64	\$49	\$47	\$44
Coolant Piping (\$/system)	\$23	\$0	\$22	\$21	\$20	\$19
<b>Total Cost (\$/system)</b>	<b>\$451</b>	<b>\$397</b>	<b>\$392</b>	<b>\$347</b>	<b>\$331</b>	<b>\$310</b>
<b>Total Cost (\$/kWnet)</b>	<b>\$5.63</b>	<b>\$4.96</b>	<b>\$4.90</b>	<b>\$4.34</b>	<b>\$4.13</b>	<b>\$3.87</b>

#### 2025 Analysis

Annual Production Rate	1,000	10,000	20,000	50,000	100,000	500,000
Coolant Reservoir (\$/system)	\$13	\$11	\$10	\$8	\$7	\$6
Coolant Pump (\$/system)	\$59	\$59	\$59	\$59	\$59	\$59
Coolant DI Filter (\$/system)	\$76	\$67	\$61	\$46	\$43	\$37
Thermostat & Valve (\$/system)	\$10	\$9	\$8	\$6	\$6	\$5
Radiator (\$/system)	\$186	\$177	\$168	\$158	\$149	\$140
Radiator Fan (\$/system)	\$83	\$73	\$64	\$49	\$47	\$44
Coolant Piping (\$/system)	\$23	\$0	\$22	\$21	\$20	\$19
<b>Total Cost (\$/system)</b>	<b>\$451</b>	<b>\$397</b>	<b>\$392</b>	<b>\$347</b>	<b>\$331</b>	<b>\$310</b>
<b>Total Cost (\$/kWnet)</b>	<b>\$5.63</b>	<b>\$4.96</b>	<b>\$4.90</b>	<b>\$4.34</b>	<b>\$4.13</b>	<b>\$3.87</b>

### 20.2.3.2 Low-Temperature Coolant Loop

#### 2020 Analysis

Annual Production Rate	1,000	10,000	20,000	50,000	100,000	500,000
Coolant Reservoir (\$/system)	\$13	\$11	\$10	\$8	\$7	\$6
Coolant Pump (\$/system)	\$16	\$16	\$16	\$16	\$16	\$16
Thermostat & Valve (\$/system)	\$4	\$4	\$3	\$2	\$2	\$2
Radiator (\$/system)	\$44	\$42	\$40	\$38	\$35	\$33
Coolant Piping (\$/system)	\$6	\$0	\$5	\$5	\$5	\$5
<b>Total Cost (\$/system)</b>	<b>\$82</b>	<b>\$73</b>	<b>\$74</b>	<b>\$68</b>	<b>\$65</b>	<b>\$61</b>
<b>Total Cost (\$/kWnet)</b>	<b>\$1.03</b>	<b>\$0.91</b>	<b>\$0.93</b>	<b>\$0.86</b>	<b>\$0.82</b>	<b>\$0.77</b>

#### 2025 Analysis

Annual Production Rate	1,000	10,000	20,000	50,000	100,000	500,000
Coolant Reservoir (\$/system)	\$13	\$11	\$10	\$8	\$7	\$6
Coolant Pump (\$/system)	\$16	\$16	\$16	\$16	\$16	\$16
Thermostat & Valve (\$/system)	\$4	\$4	\$3	\$2	\$2	\$2
Radiator (\$/system)	\$44	\$42	\$40	\$38	\$35	\$33
Coolant Piping (\$/system)	\$6	\$0	\$5	\$5	\$5	\$5
<b>Total Cost (\$/system)</b>	<b>\$82</b>	<b>\$73</b>	<b>\$74</b>	<b>\$68</b>	<b>\$65</b>	<b>\$61</b>
<b>Total Cost (\$/kWnet)</b>	<b>\$1.03</b>	<b>\$0.91</b>	<b>\$0.93</b>	<b>\$0.86</b>	<b>\$0.82</b>	<b>\$0.77</b>

### 20.2.4 Fuel Loop

#### 2020 Analysis

Annual Production Rate	1,000	10,000	20,000	50,000	100,000	500,000
Pressure Transducer (\$/system)	\$54	\$41	\$38	\$34	\$31	\$26
Over-Pressure Cut-Off Valve (\$/system)	\$23	\$21	\$19	\$14	\$13	\$11
Hydrogen Injector (\$/system)	\$113	\$69	\$55	\$51	\$41	\$38
Hydrogen High-Flow Ejector (\$/system)	\$48	\$36	\$33	\$31	\$29	\$29
Check Valves (\$/system)	\$5	\$5	\$5	\$5	\$5	\$5
Purge Valves (\$/system)	\$75	\$66	\$60	\$45	\$42	\$36
Hydrogen Piping (\$/system)	\$85	\$75	\$75	\$71	\$68	\$63
<b>Total Cost (\$/system)</b>	<b>\$403</b>	<b>\$312</b>	<b>\$284</b>	<b>\$249</b>	<b>\$229</b>	<b>\$207</b>
<b>Total Cost (\$/kWnet)</b>	<b>\$5.04</b>	<b>\$3.90</b>	<b>\$3.55</b>	<b>\$3.12</b>	<b>\$2.86</b>	<b>\$2.59</b>

#### 2025 Analysis

Annual Production Rate	1,000	10,000	20,000	50,000	100,000	500,000
Pressure Transducer (\$/system)	\$54	\$41	\$38	\$34	\$31	\$26
Over-Pressure Cut-Off Valve (\$/system)	\$23	\$0	\$19	\$14	\$13	\$11
Hydrogen Injector (\$/system)	\$113	\$69	\$55	\$51	\$41	\$38
Hydrogen High-Flow Ejector (\$/system)	\$48	\$0	\$33	\$31	\$29	\$29
Check Valves (\$/system)	\$5	\$5	\$5	\$5	\$5	\$5
Purge Valves (\$/system)	\$75	\$66	\$60	\$45	\$42	\$36
Hydrogen Piping (\$/system)	\$85	\$75	\$75	\$71	\$68	\$63
<b>Total Cost (\$/system)</b>	<b>\$403</b>	<b>\$255</b>	<b>\$284</b>	<b>\$249</b>	<b>\$229</b>	<b>\$207</b>
<b>Total Cost (\$/kWnet)</b>	<b>\$5.04</b>	<b>\$3.19</b>	<b>\$3.55</b>	<b>\$3.12</b>	<b>\$2.86</b>	<b>\$2.59</b>

## 20.2.5 System Controller

### 2020 Analysis

Annual Production Rate	1,000	10,000	20,000	50,000	100,000	500,000
System Controller	\$162	\$143	\$130	\$97	\$91	\$78
<b>Total Cost (\$/system)</b>	<b>\$162</b>	<b>\$143</b>	<b>\$130</b>	<b>\$97</b>	<b>\$91</b>	<b>\$78</b>
<b>Total Cost (\$/kWnet)</b>	<b>\$2.02</b>	<b>\$1.78</b>	<b>\$1.62</b>	<b>\$1.21</b>	<b>\$1.13</b>	<b>\$0.97</b>

### 2025 Analysis

Annual Production Rate	1,000	10,000	20,000	50,000	100,000	500,000
System Controller	\$162	\$143	\$130	\$97	\$91	\$78
<b>Total Cost (\$/system)</b>	<b>\$162</b>	<b>\$143</b>	<b>\$130</b>	<b>\$97</b>	<b>\$91</b>	<b>\$78</b>
<b>Total Cost (\$/kWnet)</b>	<b>\$2.02</b>	<b>\$1.78</b>	<b>\$1.62</b>	<b>\$1.21</b>	<b>\$1.13</b>	<b>\$0.97</b>

## 20.2.6 Sensors

### 2020 Analysis

Annual Production Rate	1,000	10,000	20,000	50,000	100,000	500,000
Current Sensors (\$/system)	\$19	\$19	\$19	\$19	\$19	\$19
Voltage Sensors (\$/system)	\$8	\$8	\$8	\$8	\$8	\$8
Air/H2 Differential Pressure Sensor (\$/system)	\$172	\$121	\$109	\$95	\$86	\$67
<b>Total Cost (\$/system)</b>	<b>\$199</b>	<b>\$148</b>	<b>\$136</b>	<b>\$121</b>	<b>\$112</b>	<b>\$93</b>
<b>Total Cost (\$/kWnet)</b>	<b>\$2.48</b>	<b>\$1.85</b>	<b>\$1.69</b>	<b>\$1.52</b>	<b>\$1.40</b>	<b>\$1.17</b>

### 2025 Analysis

Annual Production Rate	1,000	10,000	20,000	50,000	100,000	500,000
Current Sensors (\$/system)	\$19	\$19	\$19	\$19	\$19	\$19
Voltage Sensors (\$/system)	\$8	\$8	\$8	\$8	\$8	\$8
Air/H2 Differential Pressure Sensor (\$/system)	\$172	\$121	\$109	\$95	\$86	\$67
<b>Total Cost (\$/system)</b>	<b>\$199</b>	<b>\$148</b>	<b>\$136</b>	<b>\$121</b>	<b>\$112</b>	<b>\$93</b>
<b>Total Cost (\$/kWnet)</b>	<b>\$2.48</b>	<b>\$1.85</b>	<b>\$1.69</b>	<b>\$1.52</b>	<b>\$1.40</b>	<b>\$1.17</b>

## 20.2.7 Miscellaneous BOP

### 2020 Analysis

Annual Production Rate	1,000	10,000	20,000	50,000	100,000	500,000
Belly Pan (\$/system)	\$59	\$10	\$8	\$7	\$5	\$5
Hydrogen/Air Mixer (\$/system)	\$8	\$8	\$8	\$8	\$8	\$8
Mounting Frames (\$/system)	\$94	\$60	\$40	\$31	\$28	\$28
Wiring (\$/system)	\$76	\$69	\$66	\$64	\$63	\$61
Fasteners for Wiring & Piping (\$/system)	\$15	\$14	\$13	\$13	\$13	\$12
<b>Total Cost (\$/system)</b>	<b>\$253</b>	<b>\$161</b>	<b>\$135</b>	<b>\$123</b>	<b>\$118</b>	<b>\$114</b>
<b>Total Cost (\$/kWnet)</b>	<b>\$3.16</b>	<b>\$2.01</b>	<b>\$1.69</b>	<b>\$1.53</b>	<b>\$1.47</b>	<b>\$1.43</b>

## 2025 Analysis

Annual Production Rate	1,000	10,000	20,000	50,000	100,000	500,000
Belly Pan (\$/system)	\$59	\$10	\$8	\$7	\$5	\$5
Hydrogen/Air Mixer (\$/system)	\$8	\$8	\$8	\$8	\$8	\$8
Mounting Frames (\$/system)	\$94	\$60	\$40	\$31	\$28	\$28
Wiring (\$/system)	\$76	\$69	\$66	\$64	\$63	\$61
Fasteners for Wiring & Piping (\$/system)	\$15	\$14	\$13	\$13	\$13	\$12
<b>Total Cost (\$/system)</b>	<b>\$253</b>	<b>\$161</b>	<b>\$135</b>	<b>\$123</b>	<b>\$118</b>	<b>\$114</b>
<b>Total Cost (\$/kWnet)</b>	<b>\$3.16</b>	<b>\$2.01</b>	<b>\$1.69</b>	<b>\$1.53</b>	<b>\$1.47</b>	<b>\$1.43</b>

### 20.2.7.1 Belly Pan

## 2020 Analysis

Annual Production Rate	1,000	10,000	20,000	50,000	100,000	500,000
Equipment Lifetime (years)	8	8	8	15	15	15
Interest Rate	10%	10%	10%	10%	10%	10%
Corporate Income Tax Rate	40%	40%	40%	40%	40%	40%
Capital Recovery Factor	0.229	0.229	0.229	0.175	0.175	0.175
Equipment Installation Factor	1.4	1.4	1.4	1.4	1.4	1.4
Maintenance/Spare Parts (% of CC)	5%	5%	5%	5%	5%	5%
Miscellaneous Expenses (% of CC)	6%	6%	6%	6%	6%	6%
Power Consumption (kW)	30	30	30	35	35	40

Annual Production Rate	1,000	10,000	20,000	50,000	100,000	500,000
Machine Selection	Vacuum Thermo-former #1	Vacuum Thermo-former #1	Vacuum Thermo-former #1	Vacuum Thermo-former #2	Vacuum Thermo-former #2	Vacuum Thermo-former #2
Assembly Type	Manual	Manual	Manual	Manual	Manual	Auto
Capital Cost (\$/line)	\$50,000	\$50,000	\$50,000	\$250,000	\$250,000	\$655,717
Costs per Tooling Set (\$)	\$96,352	\$96,352	\$96,352	\$96,352	\$96,352	\$96,352
Tooling Lifetime (years)	3	3	3	3	3	3
Cavities per platen	1	1	1	1	1	1
Total Cycle Time (s)	71.20	71.20	71.20	15.20	15.20	7.00
Simultaneous Lines	1	1	1	1	1	1
Laborers per Line	1	1	1	1	1	0.5
Line Utilization	0.6%	5.9%	11.8%	6.3%	12.6%	28.9%
Effective Total Machine Rate (\$/hr)	\$1,136.85	\$156.88	\$102.44	\$468.25	\$258.32	\$265.09
Material Cost (\$/kg)	\$1.48	\$1.48	\$1.48	\$1.48	\$1.48	\$1.48

Annual Production Rate	1,000	10,000	20,000	50,000	100,000	500,000
Material (\$/system)	\$4	\$4	\$4	\$4	\$4	\$4
Manufacturing (\$/system)	\$21	\$3	\$2	\$2	\$1	\$0
Tooling (\$/system)	\$34	\$3	\$2	\$1	\$0	\$0
<b>Total Cost (\$/system)</b>	<b>\$59</b>	<b>\$10</b>	<b>\$8</b>	<b>\$7</b>	<b>\$5</b>	<b>\$5</b>
<b>Total Cost (\$/kWnet)</b>	<b>\$0.74</b>	<b>\$0.13</b>	<b>\$0.10</b>	<b>\$0.08</b>	<b>\$0.07</b>	<b>\$0.06</b>



## 2025 Analysis

Annual Production Rate	1,000	10,000	20,000	50,000	100,000	500,000
Equipment Lifetime (years)	8	8	8	15	15	15
Interest Rate	10%	10%	10%	10%	10%	10%
Corporate Income Tax Rate	40%	40%	40%	40%	40%	40%
Capital Recovery Factor	0.229	0.229	0.229	0.175	0.175	0.175
Equipment Installation Factor	1.4	1.4	1.4	1.4	1.4	1.4
Maintenance/Spare Parts (% of CC)	5%	5%	5%	5%	5%	5%
Miscellaneous Expenses (% of CC)	6%	6%	6%	6%	6%	6%
Power Consumption (kW)	30	30	30	35	35	40

Annual Production Rate	1,000	10,000	20,000	50,000	100,000	500,000
Machine Selection	Vacuum Thermo-former #1	Vacuum Thermo-former #1	Vacuum Thermo-former #1	Vacuum Thermo-former #2	Vacuum Thermo-former #2	Vacuum Thermo-former #2
Assembly Type	Manual	Manual	Manual	Manual	Manual	Auto
Capital Cost (\$/line)	\$50,000	\$50,000	\$50,000	\$250,000	\$250,000	\$655,717
Costs per Tooling Set (\$)	\$96,352	\$96,352	\$96,352	\$96,352	\$96,352	\$96,352
Tooling Lifetime (years)	3	3	3	3	3	3
Cavities per platen	1	1	1	1	1	1
Total Cycle Time (s)	71.20	71.20	71.20	15.20	15.20	7.00
Simultaneous Lines	1	1	1	1	1	1
Laborers per Line	1	1	1	1	1	0.5
Line Utilization	0.6%	5.9%	11.8%	6.3%	12.6%	28.9%
Effective Total Machine Rate (\$/hr)	\$1,136.85	\$156.88	\$102.44	\$468.25	\$258.32	\$265.09
Material Cost (\$/kg)	\$1.48	\$1.48	\$1.48	\$1.48	\$1.48	\$1.48

Annual Production Rate	1,000	10,000	20,000	50,000	100,000	500,000
Material (\$/system)	\$4	\$4	\$4	\$4	\$4	\$4
Manufacturing (\$/system)	\$21	\$3	\$2	\$2	\$1	\$0
Tooling (\$/system)	\$34	\$3	\$2	\$1	\$0	\$0
<b>Total Cost (\$/system)</b>	<b>\$59</b>	<b>\$10</b>	<b>\$8</b>	<b>\$7</b>	<b>\$5</b>	<b>\$5</b>
<b>Total Cost (\$/kWnet)</b>	<b>\$0.74</b>	<b>\$0.13</b>	<b>\$0.10</b>	<b>\$0.08</b>	<b>\$0.07</b>	<b>\$0.06</b>

### 20.2.7.2 H2/Air Mixer

#### 2020 Analysis

Annual Production Rate	1,000	10,000	20,000	50,000	100,000	500,000
Material (\$/system)	\$4	\$4	\$4	\$4	\$4	\$4
Manufacturing (\$/system)	\$4	\$4	\$4	\$4	\$4	\$4
<b>Total Cost (\$/system)</b>	<b>\$8</b>	<b>\$8</b>	<b>\$8</b>	<b>\$8</b>	<b>\$8</b>	<b>\$8</b>
<b>Total Cost (\$/kWnet)</b>	<b>\$0.10</b>	<b>\$0.10</b>	<b>\$0.10</b>	<b>\$0.10</b>	<b>\$0.10</b>	<b>\$0.10</b>

#### 2025 Analysis

Annual Production Rate	1,000	10,000	20,000	50,000	100,000	500,000
Material (\$/system)	\$4	\$4	\$4	\$4	\$4	\$4
Manufacturing (\$/system)	\$4	\$4	\$4	\$4	\$4	\$4
<b>Total Cost (\$/system)</b>	<b>\$8</b>	<b>\$8</b>	<b>\$8</b>	<b>\$8</b>	<b>\$8</b>	<b>\$8</b>
<b>Total Cost (\$/kWnet)</b>	<b>\$0.10</b>	<b>\$0.10</b>	<b>\$0.10</b>	<b>\$0.10</b>	<b>\$0.10</b>	<b>\$0.10</b>

### 20.2.7.3 Wiring

#### 2020 Analysis

	1,000	10,000	20,000	50,000	100,000	500,000
Cables (\$/system)	\$27	\$24	\$23	\$23	\$23	\$22
Connectors (\$/System)	\$49	\$44	\$42	\$41	\$41	\$39
<b>Total Cost (\$/system)</b>	<b>\$76</b>	<b>\$69</b>	<b>\$66</b>	<b>\$64</b>	<b>\$63</b>	<b>\$61</b>
<b>Total Cost (\$/kWnet)</b>	<b>\$0.95</b>	<b>\$0.86</b>	<b>\$0.82</b>	<b>\$0.80</b>	<b>\$0.79</b>	<b>\$0.76</b>

#### 2025 Analysis

	1,000	10,000	20,000	50,000	100,000	500,000
Cables (\$/system)	\$27	\$24	\$23	\$23	\$23	\$22
Connectors (\$/System)	\$49	\$44	\$42	\$41	\$41	\$39
<b>Total Cost (\$/system)</b>	<b>\$76</b>	<b>\$69</b>	<b>\$66</b>	<b>\$64</b>	<b>\$63</b>	<b>\$61</b>
<b>Total Cost (\$/kWnet)</b>	<b>\$0.95</b>	<b>\$0.86</b>	<b>\$0.82</b>	<b>\$0.80</b>	<b>\$0.79</b>	<b>\$0.76</b>

### 20.2.8 System Assembly

#### 2020 Analysis

Annual Production Rate	1,000	10,000	20,000	50,000	100,000	500,000
Assembly Method	Assembly Line	Assembly Line	Assembly Line	Assembly Line	Assembly Line	Assembly Line
Index Time (min)	99.06	79.25	79.25	79.25	79.25	79.25
Capital Cost (\$/line)	\$180,000	\$360,000	\$360,000	\$360,000	\$360,000	\$360,000
Simultaneous Lines	1	1	1	1	2	9
Laborers per Line	18	18	18	18	18	18
Line Utilization	2.2%	18.0%	36.0%	90.0%	90.0%	99.9%
Effective Total Machine Rate (\$/hr)	\$1,865.29	\$1,220.02	\$1,112.48	\$1,047.95	\$1,047.95	\$1,028.44
Cost per Stack (\$)	\$201	\$105	\$96	\$90	\$90	\$89

Annual Production Rate	1,000	10,000	20,000	50,000	100,000	500,000
System Assembly & Testing (\$/System)	\$189	\$99	\$90	\$85	\$85	\$83
<b>Total Cost (\$/system)</b>	<b>\$189</b>	<b>\$99</b>	<b>\$90</b>	<b>\$85</b>	<b>\$85</b>	<b>\$83</b>
<b>Total Cost (\$/kWnet)</b>	<b>\$2.37</b>	<b>\$1.24</b>	<b>\$1.13</b>	<b>\$1.06</b>	<b>\$1.06</b>	<b>\$1.04</b>

#### 2025 Analysis

Annual Production Rate	1,000	10,000	20,000	50,000	100,000	500,000
Assembly Method	Assembly Line	Assembly Line	Assembly Line	Assembly Line	Assembly Line	Assembly Line
Index Time (min)	99.06	79.25	79.25	79.25	79.25	79.25
Capital Cost (\$/line)	\$180,000	\$360,000	\$360,000	\$360,000	\$360,000	\$360,000
Simultaneous Lines	1	1	1	1	2	9
Laborers per Line	18	18	18	18	18	18
Line Utilization	2.2%	18.0%	36.0%	90.0%	90.0%	99.9%
Effective Total Machine Rate (\$/hr)	\$1,865.29	\$1,220.02	\$1,112.48	\$1,047.95	\$1,047.95	\$1,028.44
Cost per Stack (\$)	\$201	\$105	\$96	\$90	\$90	\$89

Annual Production Rate	1,000	10,000	20,000	50,000	100,000	500,000
System Assembly & Testing (\$/System)	\$189	\$99	\$90	\$85	\$85	\$83
<b>Total Cost (\$/system)</b>	<b>\$189</b>	<b>\$99</b>	<b>\$90</b>	<b>\$85</b>	<b>\$85</b>	<b>\$83</b>
<b>Total Cost (\$/kWnet)</b>	<b>\$2.37</b>	<b>\$1.24</b>	<b>\$1.13</b>	<b>\$1.06</b>	<b>\$1.06</b>	<b>\$1.04</b>

## 21 Appendix B: 2018, 2020 & 2025 MDV System Cost Results

### 21.1 Fuel Cell Stack Materials, Manufacturing, and Assembly Cost Results

#### 21.1.1 Bipolar Plates

##### 2018 Analysis (Progressive Stamping)

Annual Production Rate	200	500	1,000	10,000	50,000	100,000
Equipment Lifetime (years)	15	15	15	15	15	15
Interest Rate	10%	10%	10%	10%	10%	10%
Corporate Income Tax Rate	40%	40%	40%	40%	40%	40%
Capital Recovery Factor	0.175	0.175	0.175	0.175	0.175	0.175
Equipment Installation Factor	1.4	1.4	1.4	1.4	1.4	1.4
Maintenance/Spare Parts (% of CC)	13%	13%	13%	13%	13%	13%
Miscellaneous Expenses (% of CC)	2%	2%	2%	2%	2%	2%
Power Consumption (kW)	342	342	342	342	342	342

Annual Production Rate	200	500	1,000	10,000	50,000	100,000
Capital Cost (\$/line)	\$1,642,700	\$2,957,165	\$2,957,165	\$2,957,165	\$2,957,165	\$2,957,165
Costs per Tooling Set (\$)	\$661,695	\$1,323,740	\$1,323,740	\$1,323,740	\$1,323,740	\$1,323,740
Tooling Lifetime (cycles)	10,000,000	10,000,000	10,000,000	10,000,000	10,000,000	10,000,000
Simultaneous Lines	1	1	1	1	5	10
Laborers per Line	0.5	0.5	0.5	0.5	0.5	0.5
Line Utilization	40.1%	41.8%	46.6%	95.8%	95.7%	95.7%
Cycle Time (s)	2.23	2.79	2.79	2.79	2.79	2.79
Effective Total Machine Rate (\$/min)	\$6.92	\$11.16	\$10.12	\$4.21	\$4.22	\$4.22
Stainless Steel Cost (\$/kg)	\$13.19	\$13.19	\$13.19	\$13.19	\$13.19	\$13.19
Manufacture or Job Shop	Job Shop	Job Shop	Job Shop	Manufactured	Manufactured	Manufactured
Job Shop Line Utilization (%)	40%	42%	47%	96%	96%	96%
Job Shop Total Machine Rate (\$/min)	\$6.92	\$11.16	\$10.12	\$5.48	\$5.48	\$5.48
Manufactured Line Utilization (%)	3%	5%	10%	96%	96%	96%
Manufactured Total Machine Rate (\$/min)	\$59.62	\$68.38	\$34.63	\$4.21	\$4.22	\$4.22
Line Utilization Used (%)	40%	42%	47%	96%	96%	96%
Total Machine Rate Used (\$/min)	\$6.92	\$11.16	\$10.12	\$4.21	\$4.22	\$4.22

Annual Production Rate	200	500	1,000	10,000	50,000	100,000
Material (\$/stack)	\$230	\$230	\$230	\$230	\$230	\$230
Manufacturing (\$/stack)	\$179	\$181	\$164	\$68	\$68	\$68
Tooling (\$/stack)	\$104	\$83	\$83	\$50	\$50	\$50
Secondary Operations: Coating (\$/stack)	\$247	\$236	\$221	\$129	\$119	\$118
Secondary Operations: Leak Check (\$/stack)	\$795	\$733	\$672	\$69	\$14	\$7
Markup (\$/stack)	\$306	\$284	\$264	\$261	\$221	\$208
Total Cost (\$/stack)	\$1,861	\$1,747	\$1,633	\$807	\$701	\$681
Total Cost (\$/kWnet)	\$23.26	\$21.83	\$20.42	\$10.09	\$8.77	\$8.51

## 2020 Analysis (Hydroforming)

Annual Production Rate	200	500	1,000	10,000	50,000	100,000
Equipment Lifetime (years)	15	15	15	15	15	15
Interest Rate	10%	10%	10%	10%	10%	10%
Corporate Income Tax Rate	40%	40%	40%	40%	40%	40%
Capital Recovery Factor	0.175	0.175	0.175	0.175	0.175	0.175
Equipment Installation Factor	1.4	1.4	1.4	1.4	1.4	1.4
Maintenance/Spare Parts (% of CC)	13%	13%	13%	13%	13%	13%
Miscellaneous Expenses (% of CC)	2%	2%	2%	2%	2%	2%
Power Consumption (kW)	61	61	61	61	61	61

Annual Production Rate	200	500	1,000	10,000	50,000	100,000
Capital Cost (\$/line)	\$903,958	\$903,958	\$903,958	\$903,958	\$903,958	\$903,958
Costs per Stamping Tooling Set (\$)	\$95,000	\$95,000	\$95,000	\$95,000	\$95,000	\$95,000
Stamping Tooling Lifetime (cycles)	221,400	553,500	1,107,000	10,000,000	10,000,000	10,000,000
Costs per Hydroforming Tooling Set (\$)	\$57,500	\$57,500	\$57,500	\$57,500	\$57,500	\$57,500
Hydroforming Tooling Lifetime (cycles)	738,000	1,845,000	3,690,000	10,000,000	10,000,000	10,000,000
Simultaneous Lines	1	1	1	3	15	29
Laborers per Line	1.25	1.25	1.25	1.25	1.25	1.25
Line Utilization	5.6%	14.1%	28.1%	93.7%	93.6%	96.8%
Total Cycle Time per Form (s)	7.5	7.5	7.5	7.5	7.5	7.5
Number of plates formed simultaneously	2	2	2	2	2	2
Total Effective Cycle Time per Plate	3.8	3.8	3.8	3.8	3.8	3.8
Effective Total Machine Rate (\$/min)	\$3.75	\$3.25	\$2.71	\$2.09	\$2.09	\$2.05
Stainless Steel Cost (\$/kg)	\$13.19	\$13.19	\$13.19	\$13.19	\$13.19	\$13.19
Manufacture or Job Shop	Job Shop	Job Shop	Job Shop	Manufactured	Manufactured	Manufactured
Job Shop Line Utilization (%)	43%	51%	65%	94%	94%	97%
Job Shop Total Machine Rate (\$/min)	\$3.75	\$3.25	\$2.71	\$2.11	\$2.11	\$2.06
Manufactured Line Utilization (%)	6%	14%	28%	94%	94%	97%
Manufactured Total Machine Rate (\$/min)	\$18.62	\$8.07	\$4.55	\$2.09	\$2.09	\$2.05
Line Utilization Used (%)	43%	51%	65%	94%	94%	97%
Total Machine Rate Used (\$/min)	\$3.75	\$3.25	\$2.71	\$2.09	\$2.09	\$2.05

Annual Production Rate	200	500	1,000	10,000	50,000	100,000
Material (\$/stack)	\$216	\$216	\$216	\$216	\$216	\$216
Manufacturing (\$/stack)	\$179	\$155	\$129	\$99	\$99	\$98
Tooling (\$/stack)	\$191	\$76	\$38	\$7	\$7	\$6
Secondary Operations: Coating (\$/stack)	\$177	\$156	\$144	\$68	\$58	\$57
Secondary Operations: Leak Check (\$/stack)	\$795	\$733	\$672	\$69	\$14	\$7
Markup (\$/stack)	\$307	\$235	\$200	\$214	\$180	\$168
Total Cost (\$/stack)	\$1,864	\$1,571	\$1,398	\$672	\$573	\$551
Total Cost (\$/kWnet)	\$23.31	\$19.63	\$17.47	\$8.41	\$7.16	\$6.88

## 2025 Analysis (Hydroforming)

Annual Production Rate	200	500	1,000	10,000	50,000	100,000
Equipment Lifetime (years)	15	15	15	15	15	15
Interest Rate	10%	10%	10%	10%	10%	10%
Corporate Income Tax Rate	40%	40%	40%	40%	40%	40%
Capital Recovery Factor	0.175	0.175	0.175	0.175	0.175	0.175
Equipment Installation Factor	1.4	1.4	1.4	1.4	1.4	1.4
Maintenance/Spare Parts (% of CC)	13%	13%	13%	13%	13%	13%
Miscellaneous Expenses (% of CC)	2%	2%	2%	2%	2%	2%
Power Consumption (kW)	61	61	61	61	61	61

Annual Production Rate	200	500	1,000	10,000	50,000	100,000
Capital Cost (\$/line)	\$901,387	\$901,387	\$901,387	\$901,387	\$901,387	\$901,387
Costs per Stamping Tooling Set (\$)	\$95,000	\$95,000	\$95,000	\$95,000	\$95,000	\$95,000
Stamping Tooling Lifetime (cycles)	221,400	553,500	1,107,000	10,000,000	10,000,000	10,000,000
Costs per Hydroforming Tooling Set (\$)	\$57,500	\$57,500	\$57,500	\$57,500	\$57,500	\$57,500
Hydroforming Tooling Lifetime (cycles)	738,000	1,845,000	3,690,000	10,000,000	10,000,000	10,000,000
Simultaneous Lines	1	1	1	3	15	29
Laborers per Line	1.25	1.25	1.25	1.25	1.25	1.25
Line Utilization	5.7%	14.2%	28.4%	94.5%	94.4%	97.7%
Total Cycle Time per Form (s)	7.5	7.5	7.5	7.5	7.5	7.5
Number of plates formed simultaneously	2.00	2.00	2.00	2.00	2.00	2.00
Total Effective Cycle Time per Plate	3.8	3.8	3.8	3.8	3.8	3.8
Effective Total Machine Rate (\$/min)	\$3.67	\$3.17	\$2.62	\$2.02	\$2.02	\$1.97
Stainless Steel Cost (\$/kg)	\$13.19	\$13.19	\$13.19	\$13.19	\$13.19	\$13.19
Manufacture or Job Shop	Job Shop	Job Shop	Job Shop	Job Shop	Job Shop	Job Shop
Job Shop Line Utilization (%)	43%	51%	65%	94%	94%	98%
Job Shop Total Machine Rate (\$/min)	\$3.67	\$3.17	\$2.62	\$2.02	\$2.02	\$1.97
Manufactured Line Utilization (%)	6%	14%	28%	94%	94%	98%
Manufactured Total Machine Rate (\$/min)	\$18.43	\$7.99	\$4.51	\$2.08	\$2.08	\$2.04
Line Utilization Used (%)	43%	51%	65%	94%	94%	98%
Total Machine Rate Used (\$/min)	\$3.67	\$3.17	\$2.62	\$2.02	\$2.02	\$1.97

	200	500	1,000	10,000	50,000	100,000
Material (\$/stack)	\$182	\$182	\$182	\$182	\$182	\$182
Manufacturing (\$/stack)	\$176	\$152	\$126	\$97	\$97	\$94
Tooling (\$/stack)	\$206	\$82	\$41	\$7	\$7	\$6
Secondary Operations: Coating (\$/stack)	\$154	\$136	\$126	\$63	\$54	\$50
Secondary Operations: Leak Check (\$/stack)	\$795	\$733	\$672	\$69	\$14	\$7
Markup (\$/stack)	\$290	\$215	\$180	\$121	\$110	\$105
Total Cost (\$/stack)	\$1,804	\$1,500	\$1,326	\$538	\$463	\$445
Total Cost (\$/kWnet)	\$22.54	\$18.75	\$16.58	\$6.73	\$5.79	\$5.56

### 21.1.1.1 Alloy Selection and Corrosion Concerns

#### 2018 Analysis (TreadStone DOTS-A)

Annual Production Rate	200	500	1,000	10,000	50,000	100,000
Material (\$/stack)	\$48	\$48	\$48	\$48	\$48	\$48
Manufacturing (\$/stack)	\$199	\$188	\$173	\$82	\$71	\$71
Total Cost (\$/stack)	\$247	\$236	\$221	\$129	\$119	\$118
Total Cost (\$/kWnet)	\$3.08	\$2.95	\$2.76	\$1.62	\$1.49	\$1.48

#### 2020 Analysis (TreadStone TIOX)

Annual Production Rate	200	500	1,000	10,000	50,000	100,000
Material (\$/stack)	\$16	\$11	\$9	\$6	\$5	\$5
Manufacturing (\$/stack)	\$161	\$145	\$135	\$62	\$53	\$52
Total Cost (\$/stack)	\$177	\$156	\$144	\$68	\$58	\$57
Total Cost (\$/kWnet)	\$2.21	\$1.95	\$1.79	\$0.85	\$0.72	\$0.71

#### 2025 Analysis (TreadStone TIOX)

Annual Production Rate	200	500	1,000	10,000	50,000	100,000
Material (\$/stack)	\$15	\$10	\$8	\$5	\$4	\$4
Manufacturing (\$/stack)	\$140	\$126	\$118	\$58	\$49	\$46
Total Cost (\$/stack)	\$154	\$136	\$126	\$63	\$54	\$50
Total Cost (\$/kWnet)	\$1.93	\$1.69	\$1.57	\$0.79	\$0.67	\$0.62

## 21.1.2 Membrane

### 2018 Analysis (Gore Direct-Coat Type with ePTFE Membrane Support)

Annual Production Rate	200	500	1,000	10,000	50,000	100,000
Equipment Lifetime	14	14	14	14	14	14
Interest Rate	10%	10%	10%	10%	10%	10%
Corporate Income Tax Rate	40%	40%	40%	40%	40%	40%
Capital Recovery Factor	0.179	0.179	0.179	0.179	0.179	0.179
Equipment Installation Factor	1.4	1.4	1.4	1.4	1.4	1.4
Maintenance/Spare Parts (% of CC)	10%	10%	10%	10%	10%	10%
Miscellaneous Expenses (% of CC)	7%	7%	7%	7%	7%	7%
Power Consumption (kW)	111.7	123.9	129.5	888.4	1059.8	2175.5

Annual Production Rate	200	500	1,000	10,000	50,000	100,000
Capital Cost (\$/Line)	\$1,121,589	\$1,207,104	\$1,244,100	\$5,124,789	\$6,051,887	\$12,078,022
Simultaneous Lines	1	1	1	1	2	2
Laborers per Line	1.25	1.25	1.25	1.25	1.25	1.25
Line Utilization	9.1%	10.9%	21.2%	44.6%	78.2%	73.3%
Line Speed (m/s)	0.8	0.8	0.8	4.0	6.0	19.0
Total Machine Rate (\$/min)	\$26.78	\$24.18	\$13.34	\$26.03	\$18.46	\$38.12
ePTFE Substrate Cost (\$/m <sup>2</sup> )	\$17.87	\$16.21	\$14.86	\$10.39	\$7.23	\$6.00
Ionomer Cost (\$/kg)	\$369.11	\$316.72	\$278.40	\$180.81	\$132.79	\$116.18

Annual Production Rate	200	500	1,000	10,000	50,000	100,000
Material (\$/stack)	\$631	\$479	\$418	\$254	\$174	\$143
Manufacturing (\$/stack)	\$2,085	\$880	\$464	\$181	\$86	\$82
Markup (\$/stack)	\$1,097	\$530	\$334	\$151	\$84	\$71
Total Cost (\$/m <sup>2</sup> )	\$278	\$152	\$98	\$47	\$28	\$24
Total Cost (\$/stack)	\$3,813	\$1,889	\$1,216	\$585	\$344	\$295
Total Cost (\$/kWnet)	\$47.66	\$23.62	\$15.21	\$7.31	\$4.30	\$3.69

### 2020 Analysis (Gore Direct-Coat Type with ePTFE Membrane Support)

Annual Production Rate	200	500	1,000	10,000	50,000	100,000
Equipment Lifetime	14	14	14	14	14	14
Interest Rate	10%	10%	10%	10%	10%	10%
Corporate Income Tax Rate	40%	40%	40%	40%	40%	40%
Capital Recovery Factor	0.179	0.179	0.179	0.179	0.179	0.179
Equipment Installation Factor	1.4	1.4	1.4	1.4	1.4	1.4
Maintenance/Spare Parts (% of CC)	10%	10%	10%	10%	10%	10%
Miscellaneous Expenses (% of CC)	7%	7%	7%	7%	7%	7%
Power Consumption (kW)	111.7	123.9	129.5	888.4	1059.8	2175.5

Annual Production Rate	200	500	1,000	10,000	50,000	100,000
Capital Cost (\$/Line)	\$1,121,589	\$1,207,104	\$1,244,100	\$5,124,789	\$6,051,887	\$12,078,022
Simultaneous Lines	1	1	1	1	2	2
Laborers per Line	1.25	1.25	1.25	1.25	1.25	1.25
Line Utilization	8.9%	10.6%	20.6%	43.4%	76.1%	71.3%
Line Speed (m/s)	0.8	0.8	0.8	4.0	6.0	19.0
Total Machine Rate (\$/min)	\$27.47	\$24.84	\$13.68	\$26.71	\$18.91	\$39.09
ePTFE Substrate Cost (\$/m <sup>2</sup> )	\$17.90	\$16.23	\$14.89	\$10.42	\$7.26	\$6.00
Ionomer Cost (\$/kg)	\$370.66	\$318.00	\$279.52	\$181.51	\$133.30	\$116.63

Annual Production Rate	200	500	1,000	10,000	50,000	100,000
Material (\$/stack)	\$615	\$467	\$408	\$247	\$170	\$139
Manufacturing (\$/stack)	\$2,083	\$879	\$463	\$181	\$85	\$81
Markup (\$/stack)	\$1,089	\$525	\$330	\$148	\$83	\$70
<b>Total Cost (\$/m2)</b>	<b>\$284</b>	<b>\$155</b>	<b>\$99</b>	<b>\$48</b>	<b>\$28</b>	<b>\$24</b>
<b>Total Cost (\$/stack)</b>	<b>\$3,788</b>	<b>\$1,871</b>	<b>\$1,201</b>	<b>\$576</b>	<b>\$338</b>	<b>\$290</b>
<b>Total Cost (\$/kWnet)</b>	<b>\$47.35</b>	<b>\$23.39</b>	<b>\$15.01</b>	<b>\$7.20</b>	<b>\$4.23</b>	<b>\$3.63</b>

## 2025 Analysis (Gore Direct-Coat Type with Electrospun Membrane Support)

Annual Production Rate	200	500	1,000	10,000	50,000	100,000
Equipment Lifetime	14	14	14	14	14	14
Interest Rate	10%	10%	10%	10%	10%	10%
Corporate Income Tax Rate	40%	40%	40%	40%	40%	40%
Capital Recovery Factor	0.179	0.179	0.179	0.179	0.179	0.179
Equipment Installation Factor	1.4	1.4	1.4	1.4	1.4	1.4
Maintenance/Spare Parts (% of CC)	10%	10%	10%	10%	10%	10%
Miscellaneous Expenses (% of CC)	7%	7%	7%	7%	7%	7%
Power Consumption (kW)	111.4	123.4	129.0	884.3	1053.7	2156.0

Annual Production Rate	200	500	1,000	10,000	50,000	100,000
Capital Cost (\$/Line)	\$1,119,496	\$1,204,920	\$1,241,370	\$5,102,950	\$6,019,129	\$11,974,288
Simultaneous Lines	1	1	1	1	2	2
Laborers per Line	1.25	1.25	1.25	1.25	1.25	1.25
Line Utilization	8.1%	10.5%	20.5%	43.1%	75.5%	70.7%
Line Speed (m/s)	0.8	0.8	0.8	4.0	6.0	19.0
Total Machine Rate (\$/min)	\$29.80	\$24.98	\$13.76	\$26.80	\$18.95	\$39.05
ePTFE Substrate Cost (\$/m2)	\$8.39	\$6.21	\$4.93	\$2.29	\$1.34	\$1.06
Ionomer Cost (\$/kg)	\$375.47	\$318.38	\$279.85	\$181.72	\$133.45	\$116.77

Annual Production Rate	200	500	1,000	10,000	50,000	100,000
Material (\$/stack)	\$391	\$290	\$237	\$123	\$82	\$68
Manufacturing (\$/stack)	\$2,072	\$877	\$461	\$180	\$85	\$81
Markup (\$/stack)	\$995	\$455	\$265	\$105	\$54	\$47
<b>Total Cost (\$/m2)</b>	<b>\$283</b>	<b>\$135</b>	<b>\$80</b>	<b>\$34</b>	<b>\$18</b>	<b>\$16</b>
<b>Total Cost (\$/stack)</b>	<b>\$3,459</b>	<b>\$1,622</b>	<b>\$963</b>	<b>\$407</b>	<b>\$221</b>	<b>\$196</b>
<b>Total Cost (\$/kWnet)</b>	<b>\$43.23</b>	<b>\$20.28</b>	<b>\$12.04</b>	<b>\$5.09</b>	<b>\$2.77</b>	<b>\$2.45</b>

## 21.1.3 Pt on Carbon Catalyst

### 21.1.3.1 Catalyst Synthesis Cost

#### 2018 Analysis

#### Cathode

Annual Production Rate	200	500	1,000	10,000	50,000	100,000
Cathode Pt cost (\$/system)	\$2,967	\$2,967	\$2,967	\$2,967	\$2,876	\$2,876
d-PtCo/HSC Cathode Catalyst Price (\$/kg)	\$27,225	\$24,525	\$22,661	\$17,430	\$14,559	\$13,453
Mass of cathode catalyst per system (kg/system)	0.2112	0.2112	0.2112	0.2112	0.2047	0.2047
<b>Total Cost (\$/system)</b>	<b>\$5,749</b>	<b>\$5,178</b>	<b>\$4,785</b>	<b>\$3,680</b>	<b>\$2,980</b>	<b>\$2,754</b>
<b>Total Cost (\$/kWnet)</b>	<b>\$35.93</b>	<b>\$32.37</b>	<b>\$29.91</b>	<b>\$23.00</b>	<b>\$18.63</b>	<b>\$17.21</b>

## Anode

Annual Production Rate	200	500	1,000	10,000	50,000	100,000
Anode Pt cost (\$/system)	\$451	\$451	\$451	\$451	\$450	\$450
Material (exluding Pt) (\$/system)	\$271	\$107	\$55	\$13	\$9	\$6
Total Material (\$/system)	\$722	\$559	\$506	\$465	\$458	\$456
Manufacturing (\$/system)	\$44	\$28	\$22	\$14	\$12	\$12
Markup (\$/system)	\$1,215	\$615	\$419	\$227	\$193	\$171
<b>Total Cost (\$/system)</b>	<b>\$1,981</b>	<b>\$1,202</b>	<b>\$947</b>	<b>\$705</b>	<b>\$663</b>	<b>\$639</b>
<b>Total Cost (\$/kWnet)</b>	<b>\$12</b>	<b>\$8</b>	<b>\$6</b>	<b>\$4</b>	<b>\$4</b>	<b>\$4</b>
<b>Total Cost/kgCatalyst(net)</b>	<b>\$43,666</b>	<b>\$26,507</b>	<b>\$20,887</b>	<b>\$15,551</b>	<b>\$14,626</b>	<b>\$14,083</b>

## 2020 Analysis

### Cathode

Annual Production Rate	200	500	1,000	10,000	50,000	100,000
Cathode Pt cost (\$/system)	\$2,812	\$2,812	\$2,812	\$2,812	\$2,726	\$2,726
d-PtCo/HSC Cathode Catalyst Price (\$/kg)	\$27,391	\$24,675	\$22,800	\$17,536	\$14,648	\$13,535
Mass of cathode catalyst per system (kg/system)	0.2002	0.2002	0.2002	0.2002	0.1940	0.1940
<b>Total Cost (\$/system)</b>	<b>\$5,483</b>	<b>\$4,939</b>	<b>\$4,564</b>	<b>\$3,510</b>	<b>\$2,842</b>	<b>\$2,626</b>
<b>Total Cost (\$/kWnet)</b>	<b>\$34.27</b>	<b>\$30.87</b>	<b>\$28.52</b>	<b>\$21.94</b>	<b>\$17.76</b>	<b>\$16.41</b>

## Anode

Annual Production Rate	200	500	1,000	10,000	50,000	100,000
Anode Pt cost (\$/system)	\$428	\$428	\$428	\$428	\$426	\$426
Material (exluding Pt) (\$/system)	\$270	\$107	\$55	\$13	\$8	\$6
Total Material (\$/system)	\$698	\$535	\$483	\$441	\$434	\$432
Manufacturing (\$/system)	\$44	\$28	\$21	\$13	\$11	\$11
Markup (\$/system)	\$1,204	\$603	\$406	\$217	\$184	\$162
<b>Total Cost (\$/system)</b>	<b>\$1,946</b>	<b>\$1,166</b>	<b>\$910</b>	<b>\$672</b>	<b>\$630</b>	<b>\$605</b>
<b>Total Cost (\$/kWnet)</b>	<b>\$12</b>	<b>\$7</b>	<b>\$6</b>	<b>\$4</b>	<b>\$4</b>	<b>\$4</b>
<b>Total Cost/kgCatalyst(net)</b>	<b>\$45,268</b>	<b>\$27,108</b>	<b>\$21,162</b>	<b>\$15,617</b>	<b>\$14,643</b>	<b>\$14,064</b>

## 2025 Analysis

### Cathode

Annual Production Rate	200	500	1,000	10,000	50,000	100,000
Cathode Pt cost (\$/system)	\$2,051	\$2,051	\$2,051	\$2,051	\$1,988	\$1,988
d-PtCo/HSC Cathode Catalyst Price (\$/kg)	\$28,395	\$25,578	\$23,635	\$18,178	\$15,185	\$14,031
Mass of cathode catalyst per system (kg/system)	0.1460	0.1460	0.1460	0.1460	0.1415	0.1415
<b>Total Cost (\$/system)</b>	<b>\$4,146</b>	<b>\$3,734</b>	<b>\$3,451</b>	<b>\$2,654</b>	<b>\$2,149</b>	<b>\$1,986</b>
<b>Total Cost (\$/kWnet)</b>	<b>\$25.91</b>	<b>\$23.34</b>	<b>\$21.57</b>	<b>\$16.59</b>	<b>\$13.43</b>	<b>\$12.41</b>

## Anode

Annual Production Rate	200	500	1,000	10,000	50,000	100,000
Anode Pt cost (\$/system)	\$375	\$375	\$375	\$375	\$373	\$373
Material (exluding Pt) (\$/system)	\$270	\$107	\$54	\$12	\$7	\$5
Total Material (\$/system)	\$644	\$481	\$429	\$387	\$380	\$378
Manufacturing (\$/system)	\$42	\$25	\$19	\$12	\$9	\$9
Markup (\$/system)	\$1,175	\$573	\$378	\$195	\$160	\$142
<b>Total Cost (\$/system)</b>	<b>\$1,861</b>	<b>\$1,080</b>	<b>\$826</b>	<b>\$594</b>	<b>\$549</b>	<b>\$529</b>
<b>Total Cost (\$/kWnet)</b>	<b>\$12</b>	<b>\$7</b>	<b>\$5</b>	<b>\$4</b>	<b>\$3</b>	<b>\$3</b>
<b>Total Cost/kgCatalyst(net)</b>	<b>\$49,449</b>	<b>\$28,697</b>	<b>\$21,939</b>	<b>\$15,795</b>	<b>\$14,591</b>	<b>\$14,059</b>



**21.1.3.2 Catalyst Ink and Application: Slot Die Coating (includes catalyst material cost)**

**2018 Analysis**

Annual Production Rate	200	500	1,000	10,000	50,000	100,000
Manufacture or Job Shop	Job Shop	Job Shop	Job Shop	Job Shop	Job Shop	Job Shop
Job Shop Line Utilization (%)	37%	37%	38%	43%	65%	55%
Job Shop Total Machine Rate (\$/min)	\$9.63	\$27.82	\$27.64	\$24.79	\$17.69	\$20.03
Manufactured Line Utilization (%)	0%	0%	1%	6%	28%	55%
Manufactured Total Machine Rate (\$/min)	\$537.58	\$2,353.39	\$1,178.18	\$123.51	\$27.84	\$15.41
Line Utilization Used (%)	37%	37%	38%	43%	65%	55%
Total Machine Rate Used (\$/min)	\$9.63	\$27.82	\$27.64	\$24.79	\$17.69	\$20.03

Annual Production Rate	200	500	1,000	10,000	50,000	100,000
Materials (\$/stack)	\$2	\$2	\$2	\$1	\$1	\$1
Manufacturing (\$/stack)	\$37	\$27	\$26	\$21	\$14	\$15
Markup (\$/stack)	\$16	\$11	\$11	\$8	\$5	\$5
Total Cost (\$/stack)	\$55	\$40	\$38	\$30	\$20	\$22
Total Cost (\$/kWnet)	\$0.69	\$0.50	\$0.48	\$0.38	\$0.25	\$0.27

**2020 Analysis**

Annual Production Rate	200	500	1,000	10,000	50,000	100,000
Manufacture or Job Shop	Job Shop	Job Shop	Job Shop	Job Shop	Job Shop	Job Shop
Job Shop Line Utilization (%)	37%	37%	38%	43%	64%	54%
Job Shop Total Machine Rate (\$/min)	\$9.63	\$27.82	\$27.64	\$24.86	\$17.84	\$20.47
Manufactured Line Utilization (%)	0%	0%	1%	6%	27%	54%
Manufactured Total Machine Rate (\$/min)	\$537.58	\$2,353.39	\$1,178.18	\$126.68	\$28.50	\$15.74
Line Utilization Used (%)	37%	37%	38%	43%	64%	54%
Total Machine Rate Used (\$/min)	\$9.63	\$27.82	\$27.64	\$24.86	\$17.84	\$20.47

Annual Production Rate	200	500	1,000	10,000	50,000	100,000
Materials (\$/stack)	\$2	\$2	\$2	\$1	\$1	\$1
Manufacturing (\$/stack)	\$37	\$27	\$26	\$21	\$14	\$15
Markup (\$/stack)	\$16	\$11	\$11	\$8	\$5	\$5
Total Cost (\$/stack)	\$55	\$40	\$38	\$30	\$19	\$21
Total Cost (\$/kWnet)	\$0.69	\$0.50	\$0.48	\$0.37	\$0.24	\$0.27

**2025 Analysis**

Annual Production Rate	200	500	1,000	10,000	50,000	100,000
Manufacture or Job Shop	Job Shop	Job Shop	Job Shop	Job Shop	Job Shop	Job Shop
Job Shop Line Utilization (%)	37%	37%	38%	42%	63%	51%
Job Shop Total Machine Rate (\$/min)	\$9.64	\$27.82	\$27.66	\$24.99	\$18.13	\$21.30
Manufactured Line Utilization (%)	0%	0%	1%	5%	26%	51%
Manufactured Total Machine Rate (\$/min)	\$627.04	\$2,353.39	\$1,256.53	\$132.65	\$29.80	\$16.39
Line Utilization Used (%)	37%	37%	38%	42%	63%	51%
Total Machine Rate Used (\$/min)	\$9.64	\$27.82	\$27.66	\$24.99	\$18.13	\$21.30

Annual Production Rate	200	500	1,000	10,000	50,000	100,000
Materials (\$/stack)	\$2	\$2	\$2	\$1	\$1	\$1
Manufacturing (\$/stack)	\$32	\$27	\$24	\$20	\$13	\$15
Markup (\$/stack)	\$14	\$11	\$10	\$7	\$5	\$5
Total Cost (\$/stack)	\$48	\$39	\$36	\$28	\$19	\$21
Total Cost (\$/kWnet)	\$0.59	\$0.49	\$0.45	\$0.35	\$0.23	\$0.26

## 21.1.4 Catalyst Coated Membrane Acid Wash

### 2018 Analysis

Annual Production Rate	200	500	1,000	10,000	50,000	100,000
CCM Acid Washing Cost (\$/m2)	\$71	\$45	\$32	\$10	\$4	\$3
Markup (\$/m2)	\$29	\$17	\$12	\$3	\$1	\$1
<b>Total Cost (\$/m2)</b>	<b>\$100</b>	<b>\$62</b>	<b>\$44</b>	<b>\$13</b>	<b>\$6</b>	<b>\$4</b>
<b>Total Cost (\$/stack)</b>	<b>\$831</b>	<b>\$520</b>	<b>\$364</b>	<b>\$112</b>	<b>\$49</b>	<b>\$34</b>
<b>Total Cost (\$/kWnet)</b>	<b>\$10.39</b>	<b>\$6.49</b>	<b>\$4.55</b>	<b>\$1.40</b>	<b>\$0.61</b>	<b>\$0.43</b>

### 2020 Analysis

Annual Production Rate	200	500	1,000	10,000	50,000	100,000
CCM Acid Washing Cost (\$/m2)	\$73	\$46	\$33	\$10	\$5	\$3
Markup (\$/m2)	\$29	\$18	\$12	\$4	\$1	\$1
<b>Total Cost (\$/m2)</b>	<b>\$103</b>	<b>\$64</b>	<b>\$45</b>	<b>\$14</b>	<b>\$6</b>	<b>\$4</b>
<b>Total Cost (\$/stack)</b>	<b>\$809</b>	<b>\$505</b>	<b>\$354</b>	<b>\$109</b>	<b>\$48</b>	<b>\$34</b>
<b>Total Cost (\$/kWnet)</b>	<b>\$10.11</b>	<b>\$6.32</b>	<b>\$4.43</b>	<b>\$1.36</b>	<b>\$0.60</b>	<b>\$0.42</b>

### 2025 Analysis

Annual Production Rate	200	500	1,000	10,000	50,000	100,000
CCM Acid Washing Cost (\$/m2)	\$78	\$49	\$35	\$11	\$5	\$3
Markup (\$/m2)	\$32	\$19	\$13	\$4	\$2	\$1
<b>Total Cost (\$/m2)</b>	<b>\$110</b>	<b>\$69</b>	<b>\$48</b>	<b>\$15</b>	<b>\$6</b>	<b>\$5</b>
<b>Total Cost (\$/stack)</b>	<b>\$754</b>	<b>\$471</b>	<b>\$330</b>	<b>\$102</b>	<b>\$45</b>	<b>\$31</b>
<b>Total Cost (\$/kWnet)</b>	<b>\$9.43</b>	<b>\$5.89</b>	<b>\$4.13</b>	<b>\$1.27</b>	<b>\$0.56</b>	<b>\$0.39</b>

## 21.1.5 Gas Diffusion Layer

### 2018 Analysis

Annual Production Rate	200	500	1,000	10,000	50,000	100,000
GDL Cost (\$/m2)	\$117	\$117	\$82	\$20	\$9	\$7
GDL Cost (\$/stack)	\$1,943	\$1,943	\$1,374	\$326	\$149	\$117
Markup (\$/stack)	\$1,304	\$778	\$527	\$144	\$58	\$39
<b>Total Cost (\$/stack)</b>	<b>\$3,248</b>	<b>\$2,722</b>	<b>\$1,900</b>	<b>\$469</b>	<b>\$207</b>	<b>\$156</b>
<b>Total Cost (\$/kWnet)</b>	<b>\$40.59</b>	<b>\$34.02</b>	<b>\$23.76</b>	<b>\$5.87</b>	<b>\$2.59</b>	<b>\$1.95</b>

### 2020 Analysis

Annual Production Rate	200	500	1,000	10,000	50,000	100,000
GDL Cost (\$/m2)	\$117	\$117	\$86	\$20	\$9	\$7
GDL Cost (\$/stack)	\$1,838	\$1,838	\$1,349	\$318	\$144	\$112
Markup (\$/stack)	\$1,270	\$758	\$513	\$140	\$57	\$38
<b>Total Cost (\$/stack)</b>	<b>\$3,108</b>	<b>\$2,596</b>	<b>\$1,861</b>	<b>\$458</b>	<b>\$201</b>	<b>\$150</b>
<b>Total Cost (\$/kWnet)</b>	<b>\$38.85</b>	<b>\$32.45</b>	<b>\$23.27</b>	<b>\$5.72</b>	<b>\$2.51</b>	<b>\$1.88</b>

### 2025 Analysis

Annual Production Rate	200	500	1,000	10,000	50,000	100,000
GDL Cost (\$/m2)	\$117	\$117	\$94	\$22	\$10	\$7
GDL Cost (\$/stack)	\$1,599	\$1,599	\$1,288	\$299	\$133	\$102
Markup (\$/stack)	\$1,189	\$709	\$480	\$131	\$53	\$36
<b>Total Cost (\$/stack)</b>	<b>\$2,788</b>	<b>\$2,308</b>	<b>\$1,768</b>	<b>\$430</b>	<b>\$186</b>	<b>\$138</b>
<b>Total Cost (\$/kWnet)</b>	<b>\$34.84</b>	<b>\$28.85</b>	<b>\$22.10</b>	<b>\$5.38</b>	<b>\$2.32</b>	<b>\$1.73</b>

## 21.1.6 MEA Sub-Gaskets Total

### 2018 Analysis

Annual Production Rate	200	500	1,000	10,000	50,000	100,000
Material (\$/stack)	\$60	\$60	\$60	\$60	\$60	\$60
Manufacturing (\$/stack)	\$104	\$80	\$75	\$44	\$35	\$31
Tooling (Kapton Web) (\$/stack)	\$284	\$227	\$151	\$125	\$34	\$22
Cost/Stack	\$181	\$143	\$108	\$89	\$61	\$50
<b>Total Cost (\$/stack)</b>	<b>\$629</b>	<b>\$509</b>	<b>\$394</b>	<b>\$317</b>	<b>\$190</b>	<b>\$163</b>
<b>Total Cost (\$/kWnet)</b>	<b>\$7.86</b>	<b>\$6.36</b>	<b>\$4.93</b>	<b>\$3.96</b>	<b>\$2.37</b>	<b>\$2.04</b>

### 2020 Analysis

Annual Production Rate	200	500	1,000	10,000	50,000	100,000
Material (\$/stack)	\$56	\$56	\$56	\$56	\$56	\$56
Manufacturing (\$/stack)	\$103	\$79	\$74	\$44	\$35	\$31
Tooling (Kapton Web) (\$/stack)	\$276	\$221	\$147	\$118	\$32	\$21
Cost/Stack	\$176	\$139	\$105	\$85	\$46	\$48
<b>Total Cost (\$/stack)</b>	<b>\$611</b>	<b>\$495</b>	<b>\$383</b>	<b>\$303</b>	<b>\$169</b>	<b>\$157</b>
<b>Total Cost (\$/kWnet)</b>	<b>\$7.64</b>	<b>\$6.18</b>	<b>\$4.78</b>	<b>\$3.78</b>	<b>\$2.11</b>	<b>\$1.96</b>

### 2025 Analysis

Annual Production Rate	200	500	1,000	10,000	50,000	100,000
Material (\$/stack)	\$46	\$46	\$46	\$46	\$46	\$46
Manufacturing (\$/stack)	\$99	\$78	\$73	\$43	\$34	\$31
Tooling (Kapton Web) (\$/stack)	\$253	\$135	\$90	\$72	\$19	\$13
Cost/Stack	\$161	\$101	\$79	\$64	\$38	\$40
<b>Total Cost (\$/stack)</b>	<b>\$559</b>	<b>\$360</b>	<b>\$288</b>	<b>\$225</b>	<b>\$137</b>	<b>\$129</b>
<b>Total Cost (\$/kWnet)</b>	<b>\$6.99</b>	<b>\$4.50</b>	<b>\$3.60</b>	<b>\$2.81</b>	<b>\$1.72</b>	<b>\$1.61</b>

### 21.1.6.1 Sub-Gasket Formation

#### 2018 Analysis

Annual Production Rate	200	500	1,000	10,000	50,000	100,000
Manufacture or Job Shop	Job Shop	Job Shop	Job Shop	Job Shop	Manufactured	Manufactured
Job Shop Line Utilization (%)	38%	38%	40%	61%	56%	72%
Job Shop Total Machine Rate (\$/min)	\$8.60	\$9.05	\$8.84	\$6.61	\$6.99	\$5.93
Manufactured Line Utilization (%)	1%	1%	3%	24%	56%	72%
Manufactured Total Machine Rate (\$/min)	\$166.43	\$148.94	\$77.72	\$10.15	\$5.38	\$4.56
<b>Line Utilization Used (%)</b>	<b>38%</b>	<b>38%</b>	<b>40%</b>	<b>61%</b>	<b>56%</b>	<b>72%</b>
<b>Total Machine Rate Used (\$/min)</b>	<b>\$8.60</b>	<b>\$9.05</b>	<b>\$8.84</b>	<b>\$6.61</b>	<b>\$5.38</b>	<b>\$4.56</b>

Annual Production Rate	200	500	1,000	10,000	50,000	100,000
Material (\$/stack)	\$42	\$42	\$42	\$42	\$42	\$42
Manufacturing (\$/stack)	\$45	\$23	\$22	\$15	\$11	\$9
Tooling (Kapton Web) (\$/stack)	\$284	\$227	\$151	\$125	\$34	\$22
Markup (\$/stack)	\$150	\$114	\$81	\$63	\$41	\$33
<b>Total Cost (\$/stack)</b>	<b>\$520</b>	<b>\$405</b>	<b>\$296</b>	<b>\$244</b>	<b>\$128</b>	<b>\$106</b>
<b>Total Cost (\$/kWnet)</b>	<b>\$6.50</b>	<b>\$5.07</b>	<b>\$3.70</b>	<b>\$3.05</b>	<b>\$1.60</b>	<b>\$1.33</b>

## 2020 Analysis

Annual Production Rate	200	500	1,000	10,000	50,000	100,000
Manufacture or Job Shop	Job Shop	Job Shop	Job Shop	Job Shop	Job Shop	Manufactured
Job Shop Line Utilization (%)	38%	38%	40%	60%	91%	107%
Job Shop Total Machine Rate (\$/min)	\$8.61	\$9.06	\$8.86	\$6.65	\$5.20	\$4.78
Manufactured Line Utilization (%)	1%	1%	3%	23%	54%	70%
Manufactured Total Machine Rate (\$/min)	\$170.62	\$154.23	\$80.06	\$10.39	\$5.48	\$4.64
Line Utilization Used (%)	38%	38%	40%	60%	91%	70%
Total Machine Rate Used (\$/min)	\$8.61	\$9.06	\$8.86	\$6.65	\$5.20	\$4.64

Annual Production Rate	200	500	1,000	10,000	50,000	100,000
Material (\$/stack)	\$40	\$40	\$40	\$40	\$40	\$40
Manufacturing (\$/stack)	\$44	\$22	\$21	\$14	\$11	\$9
Tooling (Kapton Web) (\$/stack)	\$276	\$221	\$147	\$118	\$32	\$21
Markup (\$/stack)	\$145	\$110	\$79	\$60	\$27	\$31
Total Cost (\$/stack)	\$505	\$392	\$287	\$232	\$109	\$101
Total Cost (\$/kWnet)	\$6.31	\$4.91	\$3.58	\$2.89	\$1.36	\$1.27

## 2025 Analysis

Annual Production Rate	200	500	1,000	10,000	50,000	100,000
Manufacture or Job Shop	Job Shop	Job Shop	Job Shop	Job Shop	Job Shop	Manufactured
Job Shop Line Utilization (%)	38%	38%	39%	60%	91%	107%
Job Shop Total Machine Rate (\$/min)	\$8.62	\$8.92	\$8.72	\$6.58	\$5.16	\$4.74
Manufactured Line Utilization (%)	1%	1%	2%	23%	54%	70%
Manufactured Total Machine Rate (\$/min)	\$186.65	\$152.16	\$79.00	\$10.28	\$5.43	\$4.61
Line Utilization Used (%)	38%	38%	39%	60%	91%	70%
Total Machine Rate Used (\$/min)	\$8.62	\$8.92	\$8.72	\$6.58	\$5.16	\$4.61

Annual Production Rate	200	500	1,000	10,000	50,000	100,000
Material (\$/stack)	\$33	\$33	\$33	\$33	\$33	\$33
Manufacturing (\$/stack)	\$40	\$22	\$21	\$14	\$10	\$9
Tooling (Kapton Web) (\$/stack)	\$253	\$135	\$90	\$72	\$19	\$13
Markup (\$/stack)	\$132	\$74	\$54	\$41	\$21	\$25
Total Cost (\$/stack)	\$458	\$264	\$198	\$161	\$84	\$80
Total Cost (\$/kWnet)	\$5.73	\$3.30	\$2.48	\$2.01	\$1.04	\$1.00

### 21.1.6.2 Sub-Gasket Adhesive Application (screen-printing)

## 2018 Analysis

Annual Production Rate	200	500	1,000	10,000	50,000	100,000
Manufacture or Job Shop	Job Shop	Job Shop	Job Shop	Manufactured	Manufactured	Manufactured
Job Shop Line Utilization (%)	38%	40%	43%	63%	79%	90%
Job Shop Total Machine Rate (\$/min)	\$9.92	\$9.49	\$8.85	\$6.34	\$5.23	\$4.67
Manufactured Line Utilization (%)	1%	3%	6%	63%	79%	90%
Manufactured Total Machine Rate (\$/min)	\$213.49	\$85.76	\$43.18	\$4.88	\$4.02	\$3.59
Line Utilization Used (%)	38%	40%	43%	63%	79%	90%
Total Machine Rate Used (\$/min)	\$9.92	\$9.49	\$8.85	\$4.88	\$4.02	\$3.59

Annual Production Rate	200	500	1,000	10,000	50,000	100,000
Material (\$/stack)	\$18	\$18	\$18	\$18	\$18	\$18
Manufacturing (\$/stack)	\$59	\$57	\$53	\$29	\$24	\$21
Markup (\$/stack)	\$31	\$29	\$27	\$26	\$20	\$18
<b>Total Cost (\$/stack)</b>	<b>\$108</b>	<b>\$104</b>	<b>\$98</b>	<b>\$73</b>	<b>\$62</b>	<b>\$57</b>
<b>Total Cost (\$/kWnet)</b>	<b>\$1.36</b>	<b>\$1.30</b>	<b>\$1.22</b>	<b>\$0.91</b>	<b>\$0.77</b>	<b>\$0.71</b>

## 2020 Analysis

Annual Production Rate	200	500	1,000	10,000	50,000	100,000
Manufacture or Job Shop	Job Shop	Job Shop	Job Shop	Manufactured	Manufactured	Manufactured
Job Shop Line Utilization (%)	38%	40%	43%	63%	79%	90%
Job Shop Total Machine Rate (\$/min)	\$9.92	\$9.49	\$8.85	\$6.34	\$5.23	\$4.67
Manufactured Line Utilization (%)	1%	3%	6%	63%	79%	90%
Manufactured Total Machine Rate (\$/min)	\$213.67	\$85.83	\$43.21	\$4.88	\$4.02	\$3.60
<b>Line Utilization Used (%)</b>	<b>38%</b>	<b>40%</b>	<b>43%</b>	<b>63%</b>	<b>79%</b>	<b>90%</b>
<b>Total Machine Rate Used (\$/min)</b>	<b>\$9.92</b>	<b>\$9.49</b>	<b>\$8.85</b>	<b>\$4.88</b>	<b>\$4.02</b>	<b>\$3.60</b>

Annual Production Rate	200	500	1,000	10,000	50,000	100,000
Material (\$/stack)	\$17	\$17	\$17	\$17	\$17	\$17
Manufacturing (\$/stack)	\$59	\$57	\$53	\$29	\$24	\$21
Markup (\$/stack)	\$31	\$29	\$26	\$25	\$19	\$17
<b>Total Cost (\$/stack)</b>	<b>\$107</b>	<b>\$102</b>	<b>\$96</b>	<b>\$71</b>	<b>\$60</b>	<b>\$55</b>
<b>Total Cost (\$/kWnet)</b>	<b>\$1.34</b>	<b>\$1.28</b>	<b>\$1.20</b>	<b>\$0.89</b>	<b>\$0.75</b>	<b>\$0.69</b>

## 2025 Analysis

Annual Production Rate	200	500	1,000	10,000	50,000	100,000
Manufacture or Job Shop	Job Shop	Job Shop	Job Shop	Manufactured	Manufactured	Manufactured
Job Shop Line Utilization (%)	38%	40%	43%	37%	37%	37%
Job Shop Total Machine Rate (\$/min)	\$9.92	\$9.49	\$8.86	\$10.23	\$10.23	\$10.23
Manufactured Line Utilization (%)	1%	3%	6%	63%	78%	90%
Manufactured Total Machine Rate (\$/min)	\$214.09	\$85.99	\$43.30	\$4.89	\$4.03	\$3.60
<b>Line Utilization Used (%)</b>	<b>38%</b>	<b>40%</b>	<b>43%</b>	<b>63%</b>	<b>78%</b>	<b>90%</b>
<b>Total Machine Rate Used (\$/min)</b>	<b>\$9.92</b>	<b>\$9.49</b>	<b>\$8.86</b>	<b>\$4.89</b>	<b>\$4.03</b>	<b>\$3.60</b>

Annual Production Rate	200	500	1,000	10,000	50,000	100,000
Material (\$/stack)	\$12	\$12	\$12	\$12	\$12	\$12
Manufacturing (\$/stack)	\$59	\$57	\$53	\$29	\$24	\$21
Markup (\$/stack)	\$29	\$27	\$25	\$23	\$17	\$15
<b>Total Cost (\$/stack)</b>	<b>\$101</b>	<b>\$96</b>	<b>\$90</b>	<b>\$64</b>	<b>\$54</b>	<b>\$49</b>
<b>Total Cost (\$/kWnet)</b>	<b>\$1.26</b>	<b>\$1.20</b>	<b>\$1.13</b>	<b>\$0.80</b>	<b>\$0.67</b>	<b>\$0.61</b>

## 21.1.7 Hot Pressing GDL to Catalyst Coated Membrane

### 2018 Analysis

Annual Production Rate	200	500	1,000	10,000	50,000	100,000
Capital Cost (\$/Line)	\$56,140	\$4,768,177	\$5,261,763	\$5,261,763	\$5,261,763	\$5,261,763
Simultaneous Lines	1	1	1	2	7	14
Laborers per Line	1.25	0.50	0.50	0.50	0.50	0.50
Line Utilization (%)	6%	8%	14%	70%	100%	100%
Total Cycle Time (seconds)	105	105	95	95	95	95
Manufacture or Job Shop	Job Shop	Job Shop	Job Shop	Manufactured	Manufactured	Manufactured
Job Shop Line Utilization (%)	43%	45%	51%	70%	100%	100%
Job Shop Total Machine Rate (\$/min)	\$1.57	\$1.19	\$1.11	\$0.95	\$0.82	\$0.82
Manufactured Line Utilization (%)	6%	8%	14%	70%	100%	100%
Manufactured Total Machine Rate (\$/min)	\$2.61	\$3.38	\$2.04	\$0.73	\$0.63	\$0.63
Line Utilization Used (%)	43%	45%	51%	70%	100%	100%
Total Machine Rate Used (\$/min)	\$1.57	\$1.19	\$1.11	\$0.73	\$0.63	\$0.63

Annual Production Rate	200	500	1,000	10,000	50,000	100,000
Manufacturing (\$/stack)	\$46	\$17	\$15	\$10	\$8	\$8
Tooling (\$/stack)	\$1.76	\$0.70	\$0.35	\$0.14	\$0.10	\$0.10
Markup (\$/stack)	\$38	\$13	\$10	\$5	\$4	\$4
Total Cost (\$/stack)	\$85	\$31	\$25	\$15	\$12	\$12
Total Cost (\$/kWnet)	\$1.07	\$0.39	\$0.32	\$0.19	\$0.16	\$0.15

### 2020 Analysis

Annual Production Rate	200	500	1,000	10,000	50,000	100,000
Capital Cost (\$/Line)	\$56,140	\$126,971	\$5,999,121	\$5,999,121	\$5,999,121	\$5,999,121
Simultaneous Lines	1	1	1	2	7	13
Laborers per Line	1.25	0.50	0.50	0.50	0.50	0.50
Line Utilization (%)	5%	7%	12%	61%	88%	94%
Total Cycle Time (seconds)	105	105	95	95	95	95
Manufacture or Job Shop	Job Shop	Job Shop	Job Shop	Manufactured	Manufactured	Manufactured
Job Shop Line Utilization (%)	42%	44%	49%	61%	88%	94%
Job Shop Total Machine Rate (\$/min)	\$1.57	\$1.20	\$1.13	\$1.01	\$0.86	\$0.84
Manufactured Line Utilization (%)	5%	7%	12%	61%	88%	94%
Manufactured Total Machine Rate (\$/min)	\$2.84	\$3.79	\$2.27	\$0.78	\$0.66	\$0.64
Line Utilization Used (%)	42%	44%	49%	61%	88%	94%
Total Machine Rate Used (\$/min)	\$1.57	\$1.20	\$1.13	\$0.78	\$0.66	\$0.64

Annual Production Rate	200	500	1,000	10,000	50,000	100,000
Manufacturing (\$/stack)	\$40	\$15	\$13	\$9	\$8	\$7
Tooling (\$/stack)	\$1.76	\$0.70	\$0.35	\$0.14	\$0.10	\$0.09
Markup (\$/stack)	\$33	\$12	\$9	\$5	\$4	\$3
Total Cost (\$/stack)	\$76	\$28	\$23	\$14	\$12	\$11
Total Cost (\$/kWnet)	\$0.94	\$0.35	\$0.28	\$0.18	\$0.14	\$0.14

## 2025 Analysis

Annual Production Rate	200	500	1,000	10,000	50,000	100,000
Capital Cost (\$/Line)	\$56,140	\$126,971	\$6,008,939	\$6,008,939	\$6,008,939	\$6,008,939
Simultaneous Lines	1	1	1	2	7	13
Laborers per Line	1.25	0.50	0.50	0.50	0.50	0.50
Line Utilization (%)	5%	7%	12%	61%	87%	94%
Total Cycle Time (seconds)	105	105	95	95	95	95
Manufacture or Job Shop	Job Shop	Job Shop	Job Shop	Manufactured	Manufactured	Manufactured
Job Shop Line Utilization (%)	42%	44%	49%	61%	87%	94%
Job Shop Total Machine Rate (\$/min)	\$1.57	\$1.20	\$1.13	\$1.01	\$0.86	\$0.84
Manufactured Line Utilization (%)	5%	7%	12%	61%	87%	94%
Manufactured Total Machine Rate (\$/min)	\$2.85	\$3.79	\$2.27	\$0.78	\$0.66	\$0.65
Line Utilization Used (%)	42%	44%	49%	61%	87%	94%
Total Machine Rate Used (\$/min)	\$1.57	\$1.20	\$1.13	\$0.78	\$0.66	\$0.65

Annual Production Rate	200	500	1,000	10,000	50,000	100,000
Manufacturing (\$/stack)	\$40	\$15	\$13	\$9	\$8	\$7
Tooling (\$/stack)	\$1.76	\$0.70	\$0.35	\$0.14	\$0.10	\$0.09
Markup (\$/stack)	\$33	\$12	\$9	\$5	\$4	\$3
Total Cost (\$/stack)	\$75	\$28	\$23	\$14	\$11	\$11
Total Cost (\$/kWnet)	\$0.94	\$0.35	\$0.28	\$0.18	\$0.14	\$0.14

## 21.1.8 Cutting, and Slitting

### 2018 Analysis

Annual Production Rate	200	500	1,000	10,000	50,000	100,000
Manufacture or Job Shop	Job Shop	Job Shop	Job Shop	Job Shop	Job Shop	Manufactured
Job Shop Line Utilization (%)	37%	37%	37%	41%	56%	38%
Job Shop Total Machine Rate (\$/min)	\$2.32	\$3.04	\$3.02	\$2.79	\$2.11	\$3.00
Manufactured Line Utilization (%)	0.2%	0.2%	0.4%	3.9%	18.9%	37.8%
Manufactured Total Machine Rate (\$/min)	\$315.63	\$368.22	\$187.89	\$20.39	\$4.39	\$2.30
Line Utilization Used (%)	37%	37%	37%	41%	56%	38%
Total Machine Rate Used (\$/min)	\$2.32	\$3.04	\$3.02	\$2.79	\$2.11	\$2.30

Annual Production Rate	200	500	1,000	10,000	50,000	100,000
Manufacturing (\$/stack)	\$2	\$1	\$1	\$1	\$1	\$1
Tooling (\$/stack)	\$4	\$2	\$2	\$2	\$2	\$2
Markup (\$/stack)	\$3	\$1	\$1	\$1	\$1	\$1
Total Cost (\$/stack)	\$9	\$4	\$4	\$4	\$3	\$4
Total Cost (\$/kWnet)	\$0.11	\$0.05	\$0.05	\$0.05	\$0.04	\$0.05

### 2020 Analysis

Annual Production Rate	200	500	1,000	10,000	50,000	100,000
Manufacture or Job Shop	Job Shop	Job Shop	Job Shop	Job Shop	Job Shop	Job Shop
Job Shop Line Utilization (%)	37%	37%	37%	41%	55%	74%
Job Shop Total Machine Rate (\$/min)	\$2.32	\$3.04	\$3.02	\$2.79	\$2.13	\$1.67
Manufactured Line Utilization (%)	0.2%	0.2%	0.4%	3.8%	18.4%	36.8%
Manufactured Total Machine Rate (\$/min)	\$319.33	\$372.61	\$190.07	\$20.93	\$4.50	\$2.36
Line Utilization Used (%)	37%	37%	37%	41%	55%	74%
Total Machine Rate Used (\$/min)	\$2.32	\$3.04	\$3.02	\$2.79	\$2.13	\$1.67

Annual Production Rate	200	500	1,000	10,000	50,000	100,000
Manufacturing (\$/stack)	\$2	\$1	\$1	\$1	\$1	\$1
Tooling (\$/stack)	\$4	\$2	\$2	\$2	\$2	\$2
Markup (\$/stack)	\$3	\$1	\$1	\$1	\$1	\$1
<b>Total Cost (\$/stack)</b>	<b>\$9</b>	<b>\$4</b>	<b>\$4</b>	<b>\$4</b>	<b>\$3</b>	<b>\$3</b>
<b>Total Cost (\$/kWnet)</b>	<b>\$0.11</b>	<b>\$0.05</b>	<b>\$0.05</b>	<b>\$0.05</b>	<b>\$0.04</b>	<b>\$0.04</b>

## 2025 Analysis

Annual Production Rate	200	500	1,000	10,000	50,000	100,000
Manufacture or Job Shop	Job Shop	Job Shop	Job Shop	Job Shop	Job Shop	Job Shop
Job Shop Line Utilization (%)	37%	37%	37%	41%	55%	72%
Job Shop Total Machine Rate (\$/min)	\$2.32	\$2.89	\$2.88	\$2.67	\$2.06	\$1.63
Manufactured Line Utilization (%)	0.2%	0.2%	0.4%	3.6%	17.5%	35.0%
Manufactured Total Machine Rate (\$/min)	\$358.54	\$360.55	\$190.82	\$20.81	\$4.48	\$2.35
<b>Line Utilization Used (%)</b>	<b>37%</b>	<b>37%</b>	<b>37%</b>	<b>41%</b>	<b>55%</b>	<b>72%</b>
<b>Total Machine Rate Used (\$/min)</b>	<b>\$2.32</b>	<b>\$2.89</b>	<b>\$2.88</b>	<b>\$2.67</b>	<b>\$2.06</b>	<b>\$1.63</b>

Annual Production Rate	200	500	1,000	10,000	50,000	100,000
Manufacturing (\$/stack)	\$2	\$1	\$1	\$1	\$1	\$1
Tooling (\$/stack)	\$4	\$3	\$3	\$3	\$3	\$3
Markup (\$/stack)	\$2	\$1	\$1	\$1	\$1	\$1
<b>Total Cost (\$/stack)</b>	<b>\$9</b>	<b>\$5</b>	<b>\$5</b>	<b>\$5</b>	<b>\$4</b>	<b>\$4</b>
<b>Total Cost (\$/kWnet)</b>	<b>\$0.11</b>	<b>\$0.06</b>	<b>\$0.06</b>	<b>\$0.06</b>	<b>\$0.05</b>	<b>\$0.05</b>

## 21.1.9 End Plates

### 2018 Analysis

Annual Production Rate	200	500	1,000	10,000	50,000	100,000
Manufacture or Job Shop	Job Shop	Job Shop	Job Shop	Job Shop	Manufactured	Manufactured
Job Shop Line Utilization (%)	38%	40%	42%	59%	80%	71%
Job Shop Total Machine Rate (\$/min)	\$2.46	\$2.40	\$2.30	\$2.24	\$2.04	\$2.29
Manufactured Line Utilization (%)	1%	3%	5%	22%	80%	71%
Manufactured Total Machine Rate (\$/min)	\$47.97	\$19.55	\$10.08	\$3.60	\$1.57	\$1.76
<b>Line Utilization Used (%)</b>	<b>38%</b>	<b>40%</b>	<b>42%</b>	<b>59%</b>	<b>80%</b>	<b>71%</b>
<b>Total Machine Rate Used (\$/min)</b>	<b>\$2.46</b>	<b>\$2.40</b>	<b>\$2.30</b>	<b>\$2.24</b>	<b>\$1.57</b>	<b>\$1.76</b>

Annual Production Rate	200	500	1,000	10,000	50,000	100,000
Material (\$/stack)	\$64	\$60	\$57	\$48	\$42	\$40
Manufacturing (\$/stack)	\$12	\$12	\$11	\$5	\$2	\$2
Tooling (\$/stack)	\$4	\$2	\$1	\$0	\$0	\$0
Markup (\$/stack)	\$33	\$29	\$26	\$18	\$21	\$19
<b>Total Cost (\$/stack)</b>	<b>\$113</b>	<b>\$102</b>	<b>\$95</b>	<b>\$71</b>	<b>\$66</b>	<b>\$61</b>
<b>Total Cost (\$/kWnet)</b>	<b>\$1.41</b>	<b>\$1.27</b>	<b>\$1.19</b>	<b>\$0.88</b>	<b>\$0.82</b>	<b>\$0.77</b>

### 2020 Analysis

Annual Production Rate	200	500	1,000	10,000	50,000	100,000
Manufacture or Job Shop	Job Shop	Job Shop	Job Shop	Job Shop	Manufactured	Manufactured
Job Shop Line Utilization (%)	38%	40%	42%	59%	80%	71%
Job Shop Total Machine Rate (\$/min)	\$2.44	\$2.38	\$2.28	\$2.21	\$2.00	\$2.25
Manufactured Line Utilization (%)	1%	3%	5%	22%	80%	71%
Manufactured Total Machine Rate (\$/min)	\$47.43	\$19.33	\$9.97	\$3.53	\$1.54	\$1.73
<b>Line Utilization Used (%)</b>	<b>38%</b>	<b>40%</b>	<b>42%</b>	<b>59%</b>	<b>80%</b>	<b>71%</b>
<b>Total Machine Rate Used (\$/min)</b>	<b>\$2.44</b>	<b>\$2.38</b>	<b>\$2.28</b>	<b>\$2.21</b>	<b>\$1.54</b>	<b>\$1.73</b>



Annual Production Rate	200	500	1,000	10,000	50,000	100,000
Material (\$/stack)	\$61	\$57	\$54	\$45	\$40	\$38
Manufacturing (\$/stack)	\$12	\$12	\$11	\$5	\$2	\$2
Tooling (\$/stack)	\$4	\$2	\$1	\$0	\$0	\$0
Markup (\$/stack)	\$31	\$27	\$25	\$17	\$20	\$18
<b>Total Cost (\$/stack)</b>	<b>\$108</b>	<b>\$97</b>	<b>\$91</b>	<b>\$67</b>	<b>\$62</b>	<b>\$58</b>
<b>Total Cost (\$/kWnet)</b>	<b>\$1.35</b>	<b>\$1.22</b>	<b>\$1.13</b>	<b>\$0.84</b>	<b>\$0.78</b>	<b>\$0.72</b>

## 2025 Analysis

Annual Production Rate	200	500	1,000	10,000	50,000	100,000
Manufacture or Job Shop	Job Shop	Job Shop	Job Shop	Job Shop	Manufactured	Manufactured
Job Shop Line Utilization (%)	38%	40%	42%	59%	80%	71%
Job Shop Total Machine Rate (\$/min)	\$2.39	\$2.32	\$2.23	\$2.11	\$1.91	\$2.12
Manufactured Line Utilization (%)	1%	3%	5%	22%	80%	71%
Manufactured Total Machine Rate (\$/min)	\$45.87	\$18.71	\$9.66	\$3.34	\$1.47	\$1.63
<b>Line Utilization Used (%)</b>	<b>38%</b>	<b>40%</b>	<b>42%</b>	<b>59%</b>	<b>80%</b>	<b>71%</b>
<b>Total Machine Rate Used (\$/min)</b>	<b>\$2.39</b>	<b>\$2.32</b>	<b>\$2.23</b>	<b>\$2.11</b>	<b>\$1.47</b>	<b>\$1.63</b>

Annual Production Rate	200	500	1,000	10,000	50,000	100,000
Material (\$/stack)	\$50	\$46	\$44	\$37	\$32	\$31
Manufacturing (\$/stack)	\$12	\$11	\$11	\$4	\$2	\$2
Tooling (\$/stack)	\$4	\$2	\$1	\$0	\$0	\$0
Markup (\$/stack)	\$26	\$23	\$21	\$14	\$16	\$15
<b>Total Cost (\$/stack)</b>	<b>\$92</b>	<b>\$82</b>	<b>\$77</b>	<b>\$55</b>	<b>\$51</b>	<b>\$48</b>
<b>Total Cost (\$/kWnet)</b>	<b>\$1.15</b>	<b>\$1.03</b>	<b>\$0.96</b>	<b>\$0.69</b>	<b>\$0.64</b>	<b>\$0.60</b>

## 21.1.10 Current Collectors

### 2018 Analysis

Annual Production Rate	200	500	1,000	10,000	50,000	100,000
Manufacture or Job Shop	Job Shop	Job Shop	Job Shop	Job Shop	Job Shop	Job Shop
Job Shop Line Utilization (%)	37%	37%	37%	38%	42%	48%
Job Shop Total Machine Rate (\$/min)	\$2.40	\$2.40	\$2.40	\$2.37	\$2.26	\$2.15
Manufactured Line Utilization (%)	0%	0%	0%	1%	5%	11%
Manufactured Total Machine Rate (\$/min)	\$1,169.10	\$559.65	\$280.31	\$30.25	\$6.86	\$3.92
<b>Line Utilization Used (%)</b>	<b>37%</b>	<b>37%</b>	<b>37%</b>	<b>38%</b>	<b>42%</b>	<b>48%</b>
<b>Total Machine Rate Used (\$/min)</b>	<b>\$2.40</b>	<b>\$2.40</b>	<b>\$2.40</b>	<b>\$2.37</b>	<b>\$2.26</b>	<b>\$2.15</b>

Annual Production Rate	200	500	1,000	10,000	50,000	100,000
Material (\$/stack)	\$5	\$5	\$5	\$5	\$5	\$5
Manufacturing (\$/stack)	\$0.31	\$0.26	\$0.26	\$0.25	\$0.23	\$0.22
Tooling (\$/stack)	\$0.27	\$0.11	\$0.05	\$0.01	\$0.01	\$0.01
Secondary Operation (\$/stack)	\$0	\$0	\$0	\$0	\$0	\$0
Markup (\$/stack)	\$3	\$2	\$2	\$2	\$2	\$2
<b>Total Cost (\$/stack)</b>	<b>\$9</b>	<b>\$8</b>	<b>\$8</b>	<b>\$8</b>	<b>\$8</b>	<b>\$7</b>
<b>Total Cost (\$/kWnet)</b>	<b>\$0.11</b>	<b>\$0.11</b>	<b>\$0.10</b>	<b>\$0.10</b>	<b>\$0.09</b>	<b>\$0.09</b>

## 2020 Analysis

Annual Production Rate	200	500	1,000	10,000	50,000	100,000
Manufacture or Job Shop	Job Shop	Job Shop	Job Shop	Job Shop	Job Shop	Job Shop
Job Shop Line Utilization (%)	37%	37%	37%	38%	42%	48%
Job Shop Total Machine Rate (\$/min)	\$2.40	\$2.40	\$2.39	\$2.37	\$2.25	\$2.14
Manufactured Line Utilization (%)	0%	0%	0%	1%	5%	11%
Manufactured Total Machine Rate (\$/min)	\$1,165.54	\$557.94	\$279.46	\$30.36	\$6.86	\$3.92
Line Utilization Used (%)	37%	37%	37%	38%	42%	48%
Total Machine Rate Used (\$/min)	\$2.40	\$2.40	\$2.39	\$2.37	\$2.25	\$2.14

Annual Production Rate	200	500	1,000	10,000	50,000	100,000
Material (\$/stack)	\$5	\$5	\$5	\$5	\$5	\$5
Manufacturing (\$/stack)	\$0.31	\$0.26	\$0.26	\$0.24	\$0.23	\$0.22
Tooling (\$/stack)	\$0.27	\$0.11	\$0.05	\$0.01	\$0.01	\$0.01
Secondary Operation (\$/stack)	\$0	\$0	\$0	\$0	\$0	\$0
Markup (\$/stack)	\$2	\$2	\$2	\$2	\$2	\$2
Total Cost (\$/stack)	\$9	\$8	\$8	\$7	\$7	\$7
Total Cost (\$/kWnet)	\$0.11	\$0.10	\$0.10	\$0.09	\$0.09	\$0.09

## 2025 Analysis

Annual Production Rate	200	500	1,000	10,000	50,000	100,000
Manufacture or Job Shop	Job Shop	Job Shop	Job Shop	Job Shop	Job Shop	Job Shop
Job Shop Line Utilization (%)	37%	37%	37%	38%	42%	48%
Job Shop Total Machine Rate (\$/min)	\$2.39	\$2.39	\$2.39	\$2.36	\$2.25	\$2.14
Manufactured Line Utilization (%)	0%	0%	0%	1%	5%	11%
Manufactured Total Machine Rate (\$/min)	\$1,156.99	\$553.86	\$277.42	\$30.15	\$6.85	\$3.91
Line Utilization Used (%)	37%	37%	37%	38%	42%	48%
Total Machine Rate Used (\$/min)	\$2.39	\$2.39	\$2.39	\$2.36	\$2.25	\$2.14

Annual Production Rate	200	500	1,000	10,000	50,000	100,000
Material (\$/stack)	\$4	\$4	\$4	\$4	\$4	\$4
Manufacturing (\$/stack)	\$0.31	\$0.26	\$0.26	\$0.24	\$0.23	\$0.22
Tooling (\$/stack)	\$0.26	\$0.10	\$0.05	\$0.01	\$0.01	\$0.01
Secondary Operation (\$/stack)	\$0	\$0	\$0	\$0	\$0	\$0
Markup (\$/stack)	\$2	\$2	\$2	\$2	\$2	\$2
Total Cost (\$/stack)	\$8	\$7	\$7	\$7	\$6	\$6
Total Cost (\$/kWnet)	\$0.10	\$0.09	\$0.09	\$0.08	\$0.08	\$0.08

### 21.1.11 Coolant Gaskets/Laser-welding

#### 2018 Analysis

Annual Production Rate	200	500	1,000	10,000	50,000	100,000
Manufacture or Job Shop	Job Shop	Job Shop	Manufactured	Manufactured	Manufactured	Manufactured
Job Shop Line Utilization (%)	47%	63%	52%	83%	97%	97%
Job Shop Total Machine Rate (\$/min)	\$8.32	\$6.38	\$7.59	\$7.26	\$3.98	\$5.89
Manufactured Line Utilization (%)	10%	26%	52%	83%	97%	97%
Manufactured Total Machine Rate (\$/min)	\$27.61	\$11.28	\$5.83	\$5.58	\$3.06	\$4.53
Line Utilization Used (%)	47%	63%	52%	83%	97%	97%
Total Machine Rate Used (\$/min)	\$8.32	\$6.38	\$5.83	\$5.58	\$3.06	\$4.53

Annual Production Rate	200	500	1,000	10,000	50,000	100,000
Material (\$/stack)	\$0	\$0	\$0	\$0	\$0	\$0
Manufacturing (\$/stack)	\$413	\$316	\$290	\$175	\$96	\$71
Tooling (\$/stack)	\$0	\$0	\$0	\$0	\$0	\$0
Markup (\$/stack)	\$167	\$123	\$196	\$96	\$45	\$32
<b>Total Cost (\$/stack)</b>	<b>\$580</b>	<b>\$440</b>	<b>\$486</b>	<b>\$271</b>	<b>\$141</b>	<b>\$103</b>
<b>Total Cost (\$/kWnet)</b>	<b>\$7.24</b>	<b>\$5.50</b>	<b>\$6.08</b>	<b>\$3.38</b>	<b>\$1.77</b>	<b>\$1.28</b>

## 2020 Analysis

Annual Production Rate	200	500	1,000	10,000	50,000	100,000
Manufacture or Job Shop	Job Shop	Job Shop	Manufactured	Manufactured	Manufactured	Manufactured
Job Shop Line Utilization (%)	47%	63%	51%	81%	96%	96%
Job Shop Total Machine Rate (\$/min)	\$8.35	\$6.42	\$7.72	\$7.36	\$4.03	\$5.97
Manufactured Line Utilization (%)	10%	26%	51%	81%	96%	96%
Manufactured Total Machine Rate (\$/min)	\$28.15	\$11.49	\$5.94	\$5.66	\$3.10	\$4.59
<b>Line Utilization Used (%)</b>	<b>47%</b>	<b>63%</b>	<b>51%</b>	<b>81%</b>	<b>96%</b>	<b>96%</b>
<b>Total Machine Rate Used (\$/min)</b>	<b>\$8.35</b>	<b>\$6.42</b>	<b>\$5.94</b>	<b>\$5.66</b>	<b>\$3.10</b>	<b>\$4.59</b>

Annual Production Rate	200	500	1,000	10,000	50,000	100,000
Material (\$/stack)	\$0	\$0	\$0	\$0	\$0	\$0
Manufacturing (\$/stack)	\$407	\$313	\$289	\$175	\$96	\$71
Tooling (\$/stack)	\$0	\$0	\$0	\$0	\$0	\$0
Markup (\$/stack)	\$164	\$122	\$196	\$96	\$45	\$32
<b>Total Cost (\$/stack)</b>	<b>\$571</b>	<b>\$434</b>	<b>\$485</b>	<b>\$270</b>	<b>\$141</b>	<b>\$102</b>
<b>Total Cost (\$/kWnet)</b>	<b>\$7.13</b>	<b>\$5.43</b>	<b>\$6.07</b>	<b>\$3.38</b>	<b>\$1.76</b>	<b>\$1.28</b>

## 2025 Analysis

Annual Production Rate	200	500	1,000	10,000	50,000	100,000
Manufacture or Job Shop	Job Shop	Job Shop	Manufactured	Manufactured	Manufactured	Manufactured
Job Shop Line Utilization (%)	47%	62%	49%	78%	98%	98%
Job Shop Total Machine Rate (\$/min)	\$8.43	\$6.54	\$8.08	\$7.62	\$3.95	\$5.85
Manufactured Line Utilization (%)	10%	25%	49%	78%	98%	98%
Manufactured Total Machine Rate (\$/min)	\$29.50	\$12.03	\$6.21	\$5.86	\$3.04	\$4.50
<b>Line Utilization Used (%)</b>	<b>47%</b>	<b>62%</b>	<b>49%</b>	<b>78%</b>	<b>98%</b>	<b>98%</b>
<b>Total Machine Rate Used (\$/min)</b>	<b>\$8.43</b>	<b>\$6.54</b>	<b>\$6.21</b>	<b>\$5.86</b>	<b>\$3.04</b>	<b>\$4.50</b>

Annual Production Rate	200	500	1,000	10,000	50,000	100,000
Material (\$/stack)	\$0	\$0	\$0	\$0	\$0	\$0
Manufacturing (\$/stack)	\$391	\$303	\$288	\$174	\$90	\$67
Tooling (\$/stack)	\$0	\$0	\$0	\$0	\$0	\$0
Markup (\$/stack)	\$158	\$118	\$196	\$96	\$43	\$30
<b>Total Cost (\$/stack)</b>	<b>\$549</b>	<b>\$422</b>	<b>\$484</b>	<b>\$270</b>	<b>\$133</b>	<b>\$97</b>
<b>Total Cost (\$/kWnet)</b>	<b>\$6.87</b>	<b>\$5.27</b>	<b>\$6.05</b>	<b>\$3.37</b>	<b>\$1.66</b>	<b>\$1.21</b>

## 21.1.12 End Gaskets

### 2018 Analysis

Annual Production Rate	200	500	1,000	10,000	50,000	100,000
Manufacture or Job Shop	Job Shop	Job Shop	Job Shop	Job Shop	Job Shop	Job Shop
Job Shop Line Utilization (%)	37%	37%	37%	40%	53%	69%
Job Shop Total Machine Rate (\$/min)	\$3.27	\$3.26	\$3.25	\$3.06	\$2.46	\$2.03
Manufactured Line Utilization (%)	0.1%	0.2%	0.3%	3.2%	16.1%	32.2%
Manufactured Total Machine Rate (\$/min)	\$1,174.63	\$470.13	\$235.29	\$24.06	\$5.18	\$2.82
Line Utilization Used (%)	37%	37%	37%	40%	53%	69%
Total Machine Rate Used (\$/min)	\$3.27	\$3.26	\$3.25	\$3.06	\$2.46	\$2.03

Annual Production Rate	200	500	1,000	10,000	50,000	100,000
Material (\$/stack)	\$0.12	\$0.12	\$0.12	\$0.12	\$0.12	\$0.12
Manufacturing (\$/stack)	\$1.00	\$1.00	\$1.00	\$0.93	\$0.75	\$0.62
Markup (\$/stack)	\$0.45	\$0.43	\$0.42	\$0.36	\$0.28	\$0.23
Total Cost (\$/stack)	\$2	\$2	\$2	\$1	\$1	\$1
Total Cost (\$/kWnet)	\$0.02	\$0.02	\$0.02	\$0.02	\$0.01	\$0.01

### 2020 Analysis

Annual Production Rate	200	500	1,000	10,000	50,000	100,000
Manufacture or Job Shop	Job Shop	Job Shop	Job Shop	Job Shop	Job Shop	Job Shop
Job Shop Line Utilization (%)	37%	37%	37%	40%	53%	69%
Job Shop Total Machine Rate (\$/min)	\$3.27	\$3.26	\$3.25	\$3.06	\$2.46	\$2.03
Manufactured Line Utilization (%)	0.1%	0.2%	0.3%	3.2%	16.1%	32.2%
Manufactured Total Machine Rate (\$/min)	\$1,175.03	\$470.29	\$235.38	\$24.07	\$5.18	\$2.82
Line Utilization Used (%)	37%	37%	37%	40%	53%	69%
Total Machine Rate Used (\$/min)	\$3.27	\$3.26	\$3.25	\$3.06	\$2.46	\$2.03

Annual Production Rate	200	500	1,000	10,000	50,000	100,000
Material (\$/stack)	\$0.11	\$0.11	\$0.11	\$0.11	\$0.11	\$0.11
Manufacturing (\$/stack)	\$1.00	\$1.00	\$1.00	\$0.93	\$0.75	\$0.62
Markup (\$/stack)	\$0.45	\$0.43	\$0.42	\$0.36	\$0.28	\$0.23
Total Cost (\$/stack)	\$2	\$2	\$2	\$1	\$1	\$1
Total Cost (\$/kWnet)	\$0.02	\$0.02	\$0.02	\$0.02	\$0.01	\$0.01

### 2025 Analysis

Annual Production Rate	200	500	1,000	10,000	50,000	100,000
Manufacture or Job Shop	Job Shop	Job Shop	Job Shop	Job Shop	Job Shop	Job Shop
Job Shop Line Utilization (%)	37%	37%	37%	40%	53%	69%
Job Shop Total Machine Rate (\$/min)	\$3.27	\$3.26	\$3.25	\$3.06	\$2.46	\$2.03
Manufactured Line Utilization (%)	0.1%	0.2%	0.3%	3.2%	16.1%	32.2%
Manufactured Total Machine Rate (\$/min)	\$1,176.00	\$470.68	\$235.57	\$24.09	\$5.19	\$2.82
Line Utilization Used (%)	37%	37%	37%	40%	53%	69%
Total Machine Rate Used (\$/min)	\$3.27	\$3.26	\$3.25	\$3.06	\$2.46	\$2.03

Annual Production Rate	200	500	1,000	10,000	50,000	100,000
Material (\$/stack)	\$0.08	\$0.08	\$0.08	\$0.08	\$0.08	\$0.08
Manufacturing (\$/stack)	\$1.00	\$1.00	\$1.00	\$0.93	\$0.75	\$0.62
Markup (\$/stack)	\$0.44	\$0.42	\$0.41	\$0.35	\$0.27	\$0.22
Total Cost (\$/stack)	\$2	\$2	\$1	\$1	\$1	\$1
Total Cost (\$/kWnet)	\$0.02	\$0.02	\$0.02	\$0.02	\$0.01	\$0.01

### 21.1.13 Stack Assembly

#### 2018 Analysis

Annual Production Rate	200	500	1,000	10,000	50,000	100,000
Manufacture or Job Shop	Manufactured	Manufactured	Manufactured	Manufactured	Manufactured	Manufactured
Job Shop Line Utilization (%)	56%	48%	95%	68%	92%	96%
Job Shop Total Machine Rate (\$/min)	\$1.05	\$1.06	\$1.03	\$2.97	\$2.25	\$2.16
Manufactured Line Utilization (%)	19%	48%	95%	68%	92%	96%
Manufactured Total Machine Rate (\$/min)	\$0.90	\$0.82	\$0.79	\$2.28	\$1.73	\$1.66
Line Utilization Used (%)	19%	48%	95%	68%	92%	96%
Total Machine Rate Used (\$/min)	\$0.90	\$0.82	\$0.79	\$2.28	\$1.73	\$1.66

Annual Production Rate	200	500	1,000	10,000	50,000	100,000
Compression Bands (\$/stack)	\$16	\$14	\$13	\$11	\$9	\$8
Assembly (\$/stack)	\$81	\$73	\$71	\$44	\$33	\$32
Markup (\$/stack)	\$64	\$53	\$48	\$24	\$16	\$14
Total Cost (\$/stack)	\$160	\$141	\$132	\$78	\$57	\$53
Total Cost (\$/kWnet)	\$2.01	\$1.76	\$1.66	\$0.97	\$0.71	\$0.67

#### 2020 Analysis

Annual Production Rate	200	500	1,000	10,000	50,000	100,000
Manufacture or Job Shop	Manufactured	Manufactured	Manufactured	Manufactured	Manufactured	Manufactured
Job Shop Line Utilization (%)	37%	48%	95%	68%	92%	96%
Job Shop Total Machine Rate (\$/min)	\$1.09	\$1.06	\$1.03	\$2.97	\$2.25	\$2.16
Manufactured Line Utilization (%)	19%	48%	95%	68%	92%	96%
Manufactured Total Machine Rate (\$/min)	\$0.90	\$0.82	\$0.79	\$2.28	\$1.73	\$1.66
Line Utilization Used (%)	19%	48%	95%	68%	92%	96%
Total Machine Rate Used (\$/min)	\$0.90	\$0.82	\$0.79	\$2.28	\$1.73	\$1.66

Annual Production Rate	200	500	1,000	10,000	50,000	100,000
Compression Bands (\$/stack)	\$16	\$14	\$13	\$11	\$9	\$8
Assembly (\$/stack)	\$81	\$73	\$71	\$44	\$33	\$32
Markup (\$/stack)	\$64	\$53	\$48	\$24	\$16	\$14
Total Cost (\$/stack)	\$160	\$141	\$132	\$78	\$57	\$53
Total Cost (\$/kWnet)	\$2.01	\$1.76	\$1.66	\$0.97	\$0.71	\$0.67

#### 2025 Analysis

Annual Production Rate	200	500	1,000	10,000	50,000	100,000
Manufacture or Job Shop	Manufactured	Manufactured	Manufactured	Manufactured	Manufactured	Manufactured
Job Shop Line Utilization (%)	37%	48%	95%	68%	92%	96%
Job Shop Total Machine Rate (\$/min)	\$1.09	\$1.06	\$1.03	\$2.97	\$2.25	\$2.16
Manufactured Line Utilization (%)	19%	48%	95%	68%	92%	96%
Manufactured Total Machine Rate (\$/min)	\$0.90	\$0.82	\$0.79	\$2.28	\$1.73	\$1.66
Line Utilization Used (%)	19%	48%	95%	68%	92%	96%
Total Machine Rate Used (\$/min)	\$0.90	\$0.82	\$0.79	\$2.28	\$1.73	\$1.66

Annual Production Rate	200	500	1,000	10,000	50,000	100,000
Compression Bands (\$/stack)	\$16	\$14	\$13	\$11	\$9	\$8
Assembly (\$/stack)	\$81	\$73	\$71	\$44	\$33	\$32
Markup (\$/stack)	\$64	\$53	\$48	\$24	\$16	\$14
Total Cost (\$/stack)	\$160	\$141	\$132	\$78	\$57	\$53
Total Cost (\$/kWnet)	\$2.01	\$1.76	\$1.66	\$0.97	\$0.71	\$0.67

## 21.1.14 Stack Housing

### 2018 Analysis

Annual Production Rate	200	500	1,000	10,000	50,000	100,000
Manufacture or Job Shop	Job Shop	Job Shop	Job Shop	Job Shop	Manufactured	Manufactured
Job Shop Line Utilization (%)	37%	38%	38%	49%	59%	59%
Job Shop Total Machine Rate (\$/min)	\$1.41	\$1.41	\$1.41	\$1.33	\$1.28	\$1.28
Manufactured Line Utilization (%)	0%	1%	1%	12%	59%	59%
Manufactured Total Machine Rate (\$/min)	\$46.17	\$18.95	\$9.87	\$1.71	\$0.98	\$0.98
Line Utilization Used (%)	37%	38%	38%	49%	59%	59%
Total Machine Rate Used (\$/min)	\$1.41	\$1.41	\$1.41	\$1.33	\$0.98	\$0.98

Annual Production Rate	200	500	1,000	10,000	50,000	100,000
Material (\$/stack)	\$8	\$8	\$8	\$8	\$8	\$8
Manufacturing (\$/stack)	\$3	\$3	\$3	\$3	\$2	\$2
Tooling (\$/stack)	\$170	\$68	\$34	\$3	\$1	\$1
Markup (\$/stack)	\$73	\$31	\$17	\$5	\$5	\$5
Total Cost (\$/stack)	\$255	\$110	\$63	\$20	\$16	\$16
Total Cost (\$/kWnet)	\$3.19	\$1.38	\$0.78	\$0.25	\$0.20	\$0.20

### 2020 Analysis

Annual Production Rate	200	500	1,000	10,000	50,000	100,000
Manufacture or Job Shop	Job Shop	Job Shop	Job Shop	Job Shop	Manufactured	Manufactured
Job Shop Line Utilization (%)	37%	38%	38%	49%	59%	59%
Job Shop Total Machine Rate (\$/min)	\$1.41	\$1.41	\$1.41	\$1.33	\$1.28	\$1.28
Manufactured Line Utilization (%)	0%	1%	1%	12%	59%	59%
Manufactured Total Machine Rate (\$/min)	\$46.17	\$18.95	\$9.87	\$1.71	\$0.98	\$0.98
Line Utilization Used (%)	37%	38%	38%	49%	59%	59%
Total Machine Rate Used (\$/min)	\$1.41	\$1.41	\$1.41	\$1.33	\$0.98	\$0.98

Annual Production Rate	200	500	1,000	10,000	50,000	100,000
Material (\$/stack)	\$8	\$8	\$8	\$8	\$8	\$8
Manufacturing (\$/stack)	\$3	\$3	\$3	\$3	\$2	\$2
Tooling (\$/stack)	\$170	\$68	\$34	\$3	\$1	\$1
Markup (\$/stack)	\$73	\$31	\$17	\$5	\$5	\$5
Total Cost (\$/stack)	\$255	\$110	\$62	\$19	\$16	\$16
Total Cost (\$/kWnet)	\$3.18	\$1.38	\$0.78	\$0.24	\$0.20	\$0.20

### 2025 Analysis

Annual Production Rate	200	500	1,000	10,000	50,000	100,000
Manufacture or Job Shop	Job Shop	Job Shop	Job Shop	Job Shop	Manufactured	Manufactured
Job Shop Line Utilization (%)	37%	38%	38%	49%	59%	59%
Job Shop Total Machine Rate (\$/min)	\$1.41	\$1.41	\$1.41	\$1.33	\$1.28	\$1.28
Manufactured Line Utilization (%)	0%	1%	1%	12%	59%	59%
Manufactured Total Machine Rate (\$/min)	\$46.17	\$18.95	\$9.87	\$1.71	\$0.98	\$0.98
Line Utilization Used (%)	37%	38%	38%	49%	59%	59%
Total Machine Rate Used (\$/min)	\$1.41	\$1.41	\$1.41	\$1.33	\$0.98	\$0.98

Annual Production Rate	200	500	1,000	10,000	50,000	100,000
Material (\$/stack)	\$7	\$7	\$7	\$7	\$7	\$7
Manufacturing (\$/stack)	\$3	\$3	\$3	\$3	\$2	\$2
Tooling (\$/stack)	\$170	\$68	\$34	\$3	\$1	\$1
Markup (\$/stack)	\$73	\$31	\$17	\$5	\$5	\$5
<b>Total Cost (\$/stack)</b>	<b>\$254</b>	<b>\$109</b>	<b>\$61</b>	<b>\$18</b>	<b>\$15</b>	<b>\$15</b>
<b>Total Cost (\$/kWnet)</b>	<b>\$3.17</b>	<b>\$1.37</b>	<b>\$0.77</b>	<b>\$0.23</b>	<b>\$0.19</b>	<b>\$0.18</b>

### 21.1.15 Stack Conditioning and Testing

#### 2018 Analysis

Annual Production Rate	200	500	1,000	10,000	50,000	100,000
Capital Cost (\$/line)	<b>Proprietary</b>					
Simultaneous Lines	1	1	1	10	50	25
Laborers per Line	0.4	0.4	0.4	0.4	0.4	0.4
Test Duration (hrs/stack)	2	2	2	2	2	2
Line Utilization Used (%)	14%	17%	35%	35%	35%	35%
<b>Total Machine Rate Used (\$/min)</b>	<b>\$1.55</b>	<b>\$1.31</b>	<b>\$0.81</b>	<b>\$0.81</b>	<b>\$0.81</b>	<b>\$2.41</b>

Annual Production Rate	200	500	1,000	10,000	50,000	100,000
Conditioning/Testing (\$/stack)	\$175	\$74	\$45	\$45	\$45	\$34
Markup (\$/stack)	\$138	\$54	\$31	\$25	\$22	\$15
<b>Total Cost (\$/stack)</b>	<b>\$313</b>	<b>\$128</b>	<b>\$76</b>	<b>\$70</b>	<b>\$67</b>	<b>\$49</b>
<b>Total Cost (\$/kWnet)</b>	<b>\$3.91</b>	<b>\$1.59</b>	<b>\$0.95</b>	<b>\$0.88</b>	<b>\$0.84</b>	<b>\$0.62</b>

#### 2020 Analysis

Annual Production Rate	200	500	1,000	10,000	50,000	100,000
Capital Cost (\$/line)	<b>Proprietary</b>					
Simultaneous Lines	1	1	1	10	50	25
Laborers per Line	0.4	0.4	0.4	0.4	0.4	0.4
Test Duration (hrs/stack)	2	2	2	2	2	2
Line Utilization Used (%)	14%	17%	35%	35%	35%	35%
<b>Total Machine Rate Used (\$/min)</b>	<b>\$1.50</b>	<b>\$1.27</b>	<b>\$0.79</b>	<b>\$0.79</b>	<b>\$0.79</b>	<b>\$2.34</b>

Annual Production Rate	200	500	1,000	10,000	50,000	100,000
Conditioning/Testing (\$/stack)	\$170	\$72	\$44	\$44	\$44	\$33
Markup (\$/stack)	\$134	\$52	\$30	\$24	\$21	\$15
<b>Total Cost (\$/stack)</b>	<b>\$304</b>	<b>\$124</b>	<b>\$74</b>	<b>\$69</b>	<b>\$65</b>	<b>\$48</b>
<b>Total Cost (\$/kWnet)</b>	<b>\$3.79</b>	<b>\$1.55</b>	<b>\$0.93</b>	<b>\$0.86</b>	<b>\$0.82</b>	<b>\$0.60</b>

#### 2025 Analysis

Annual Production Rate	200	500	1,000	10,000	50,000	100,000
Capital Cost (\$/line)	<b>Proprietary</b>					
Simultaneous Lines	1	1	1	10	50	25
Laborers per Line	0.4	0.4	0.4	0.4	0.4	0.4
Test Duration (hrs/stack)	2	2	2	2	2	2
Line Utilization Used (%)	14%	17%	35%	35%	35%	35%
<b>Total Machine Rate Used (\$/min)</b>	<b>\$1.48</b>	<b>\$1.25</b>	<b>\$0.78</b>	<b>\$0.78</b>	<b>\$0.78</b>	<b>\$2.30</b>

Annual Production Rate	200	500	1,000	10,000	50,000	100,000
Conditioning/Testing (\$/stack)	\$167	\$71	\$44	\$44	\$44	\$32
Markup (\$/stack)	\$132	\$51	\$30	\$24	\$21	\$14
<b>Total Cost (\$/stack)</b>	<b>\$298</b>	<b>\$122</b>	<b>\$73</b>	<b>\$68</b>	<b>\$65</b>	<b>\$47</b>
<b>Total Cost (\$/kWnet)</b>	<b>\$3.73</b>	<b>\$1.52</b>	<b>\$0.92</b>	<b>\$0.85</b>	<b>\$0.81</b>	<b>\$0.59</b>

## 21.2 2020 & 2025 MDV Balance of Plant (BOP) Cost Results

### 21.2.1 Air Loop

#### 2018 Analysis

Annual Production Rate	200	500	1,000	10,000	50,000	100,000
Filter and Housing (\$/system)	\$71	\$70	\$69	\$67	\$65	\$65
Compressor, Expander & Motor (\$/system)	\$8,221	\$7,267	\$6,755	\$4,581	\$3,492	\$3,128
Mass Flow Sensor (\$/system)	\$96	\$94	\$94	\$90	\$88	\$87
Air Ducting (\$/system)	\$168	\$164	\$161	\$151	\$143	\$140
Air Temperature Sensor (\$/system)	\$10	\$10	\$9	\$8	\$7	\$7
Stack Bypass Valve (3-way)(\$/system)	\$50	\$38	\$37	\$35	\$34	\$24
Stack Shut-Off Valve (2-way)(\$/system)	\$253	\$178	\$169	\$157	\$151	\$106
Air Bleed Orifice (\$/system)	\$9	\$9	\$9	\$9	\$9	\$9
Markup on Purchased Components (\$/system)	\$265	\$219	\$208	\$179	\$162	\$139
<b>Total Cost (\$/system)</b>	<b>\$9,142</b>	<b>\$8,050</b>	<b>\$7,512</b>	<b>\$5,277</b>	<b>\$4,153</b>	<b>\$3,706</b>
<b>Total Cost (\$/kWnet)</b>	<b>\$57.14</b>	<b>\$50.31</b>	<b>\$46.95</b>	<b>\$32.98</b>	<b>\$25.96</b>	<b>\$23.17</b>

#### 2020 Analysis

Annual Production Rate	200	500	1,000	10,000	50,000	100,000
Filter and Housing (\$/system)	\$71	\$70	\$69	\$67	\$65	\$65
Compressor, Expander & Motor (\$/system)	\$6,858	\$6,053	\$5,642	\$3,790	\$2,843	\$2,534
Mass Flow Sensor (\$/system)	\$96	\$94	\$94	\$90	\$88	\$87
Air Ducting (\$/system)	\$198	\$193	\$190	\$178	\$169	\$165
Air Temperature Sensor (\$/system)	\$10	\$10	\$9	\$8	\$7	\$7
Stack Bypass Valve (3-way)(\$/system)	\$50	\$38	\$37	\$35	\$34	\$24
Stack Shut-Off Valve (2-way)(\$/system)	\$253	\$178	\$169	\$157	\$151	\$106
Air Bleed Orifice (\$/system)	\$9	\$9	\$9	\$9	\$9	\$9
Markup on Purchased Components (\$/system)	\$277	\$231	\$219	\$188	\$171	\$147
<b>Total Cost (\$/system)</b>	<b>\$7,821</b>	<b>\$6,877</b>	<b>\$6,439</b>	<b>\$4,522</b>	<b>\$3,538</b>	<b>\$3,146</b>
<b>Total Cost (\$/kWnet)</b>	<b>\$48.88</b>	<b>\$42.98</b>	<b>\$40.24</b>	<b>\$28.26</b>	<b>\$22.11</b>	<b>\$19.66</b>

#### 2025 Analysis

Annual Production Rate	200	500	1,000	10,000	50,000	100,000
Filter and Housing (\$/system)	\$71	\$70	\$69	\$67	\$65	\$65
Compressor, Expander & Motor (\$/system)	\$4,236	\$3,553	\$3,519	\$2,767	\$2,322	\$2,180
Mass Flow Sensor (\$/system)	\$96	\$94	\$94	\$90	\$88	\$87
Air Ducting (\$/system)	\$198	\$193	\$190	\$178	\$169	\$165
Air Temperature Sensor (\$/system)	\$10	\$10	\$9	\$8	\$7	\$7
Stack Bypass Valve (3-way)(\$/system)	\$50	\$38	\$37	\$35	\$34	\$24
Stack Shut-Off Valve (2-way)(\$/system)	\$253	\$178	\$169	\$157	\$151	\$106
Air Bleed Orifice (\$/system)	\$9	\$9	\$9	\$9	\$9	\$9
Markup on Purchased Components (\$/system)	\$277	\$231	\$219	\$188	\$171	\$147
<b>Total Cost (\$/system)</b>	<b>\$5,200</b>	<b>\$4,377</b>	<b>\$4,316</b>	<b>\$3,499</b>	<b>\$3,017</b>	<b>\$2,792</b>
<b>Total Cost (\$/kWnet)</b>	<b>\$32.50</b>	<b>\$27.36</b>	<b>\$26.97</b>	<b>\$21.87</b>	<b>\$18.86</b>	<b>\$17.45</b>



## 21.2.2 Humidifier & Water Recovery Loop

### 2018 Analysis

Annual Production Rate	200	500	1,000	10,000	50,000	100,000
Air Precooler (\$/system)	\$130	\$125	\$122	\$112	\$107	\$105
Demister(s) (\$/system)	\$82	\$55	\$45	\$30	\$24	\$22
Membrane Air Humidifier (\$/system)	\$1,934	\$1,593	\$1,431	\$975	\$802	\$714
<b>Total Cost (\$/system)</b>	<b>\$2,146</b>	<b>\$1,773</b>	<b>\$1,598</b>	<b>\$1,118</b>	<b>\$934</b>	<b>\$841</b>
<b>Total Cost (\$/kWnet)</b>	<b>\$13.41</b>	<b>\$11.08</b>	<b>\$9.99</b>	<b>\$6.99</b>	<b>\$5.84</b>	<b>\$5.26</b>

### 2020 Analysis

Annual Production Rate	200	500	1,000	10,000	50,000	100,000
Air Precooler (\$/system)	\$125	\$120	\$117	\$108	\$103	\$101
Demister(s) (\$/system)	\$127	\$97	\$84	\$61	\$49	\$44
Membrane Air Humidifier (\$/system)	\$1,934	\$1,593	\$1,431	\$975	\$802	\$714
<b>Total Cost (\$/system)</b>	<b>\$2,185</b>	<b>\$1,809</b>	<b>\$1,631</b>	<b>\$1,144</b>	<b>\$954</b>	<b>\$859</b>
<b>Total Cost (\$/kWnet)</b>	<b>\$13.66</b>	<b>\$11.31</b>	<b>\$10.20</b>	<b>\$7.15</b>	<b>\$5.97</b>	<b>\$5.37</b>

### 2025 Analysis

Annual Production Rate	200	500	1,000	10,000	50,000	100,000
Air Precooler (\$/system)	\$116	\$112	\$109	\$101	\$96	\$94
Demister(s) (\$/system)	\$127	\$97	\$84	\$61	\$49	\$44
Membrane Air Humidifier (\$/system)	\$1,934	\$1,593	\$1,431	\$975	\$802	\$714
<b>Total Cost (\$/system)</b>	<b>\$2,177</b>	<b>\$1,801</b>	<b>\$1,623</b>	<b>\$1,137</b>	<b>\$947</b>	<b>\$852</b>
<b>Total Cost (\$/kWnet)</b>	<b>\$13.60</b>	<b>\$11.26</b>	<b>\$10.15</b>	<b>\$7.10</b>	<b>\$5.92</b>	<b>\$5.33</b>

#### 21.2.2.1 Air Precooler

### 2018 Analysis

Annual Production Rate	200	500	1,000	10,000	50,000	100,000
Material (\$/system)	\$36	\$36	\$36	\$36	\$36	\$36
Manufacturing (\$/system)	\$36	\$36	\$36	\$36	\$36	\$36
Markup (\$/system)	\$57	\$53	\$49	\$40	\$34	\$32
<b>Total Cost (\$/system)</b>	<b>\$130</b>	<b>\$125</b>	<b>\$122</b>	<b>\$112</b>	<b>\$107</b>	<b>\$105</b>
<b>Total Cost (\$/kWnet)</b>	<b>\$0.81</b>	<b>\$0.78</b>	<b>\$0.76</b>	<b>\$0.70</b>	<b>\$0.67</b>	<b>\$0.66</b>

### 2020 Analysis

Annual Production Rate	200	500	1,000	10,000	50,000	100,000
Material (\$/system)	\$35	\$35	\$35	\$35	\$35	\$35
Manufacturing (\$/system)	\$35	\$35	\$35	\$35	\$35	\$35
Markup (\$/system)	\$55	\$50	\$47	\$38	\$33	\$31
<b>Total Cost (\$/system)</b>	<b>\$125</b>	<b>\$120</b>	<b>\$117</b>	<b>\$108</b>	<b>\$103</b>	<b>\$101</b>
<b>Total Cost (\$/kWnet)</b>	<b>\$0.78</b>	<b>\$0.75</b>	<b>\$0.73</b>	<b>\$0.67</b>	<b>\$0.64</b>	<b>\$0.63</b>

### 2025 Analysis

Annual Production Rate	200	500	1,000	10,000	50,000	100,000
Material (\$/system)	\$32	\$32	\$32	\$32	\$32	\$32
Manufacturing (\$/system)	\$32	\$32	\$32	\$32	\$32	\$32
Markup (\$/system)	\$51	\$47	\$44	\$36	\$31	\$29
<b>Total Cost (\$/system)</b>	<b>\$116</b>	<b>\$112</b>	<b>\$109</b>	<b>\$101</b>	<b>\$96</b>	<b>\$94</b>
<b>Total Cost (\$/kWnet)</b>	<b>\$0.73</b>	<b>\$0.70</b>	<b>\$0.68</b>	<b>\$0.63</b>	<b>\$0.60</b>	<b>\$0.59</b>

### 21.2.2.2 Demister

#### 2018 Analysis

Annual Production Rate	200	500	1,000	10,000	50,000	100,000
Manufacture or Job Shop	Job Shop	Job Shop	Job Shop	Job Shop	Job Shop	Job Shop
Job Shop Line Utilization (%)	37%	37%	37%	38%	40%	43%
Job Shop Total Machine Rate (\$/min)	\$3.01	\$3.01	\$3.01	\$2.98	\$2.87	\$2.75
Manufactured Line Utilization (%)	0.07%	0.09%	0.12%	0.62%	2.88%	5.69%
Manufactured Total Machine Rate (\$/min)	\$792.89	\$640.27	\$484.83	\$90.85	\$20.30	\$10.65
Line Utilization Used (%)	37%	37%	37%	38%	40%	43%
Total Machine Rate Used (\$/min)	\$3.01	\$3.01	\$3.01	\$2.98	\$2.87	\$2.75

Annual Production Rate	200	500	1,000	10,000	50,000	100,000
Material (\$/system)	\$31	\$29	\$27	\$22	\$18	\$16
Manufacturing (\$/system)	\$2	\$1	\$1	\$0	\$0	\$0
Tooling (\$/system)	\$26	\$10	\$5	\$1	\$0	\$0
Markup (\$/system)	\$24	\$16	\$12	\$8	\$6	\$5
Total Cost (\$/system)	\$82	\$55	\$45	\$30	\$24	\$22
Total Cost (\$/kWnet)	\$0.51	\$0.35	\$0.28	\$0.19	\$0.15	\$0.14

#### 2020 Analysis

Annual Production Rate	200	500	1,000	10,000	50,000	100,000
Manufacture or Job Shop	Job Shop	Job Shop	Job Shop	Job Shop	Job Shop	Job Shop
Job Shop Line Utilization (%)	37%	37%	37%	39%	48%	60%
Job Shop Total Machine Rate (\$/min)	\$3.01	\$3.00	\$3.00	\$2.90	\$2.55	\$2.27
Manufactured Line Utilization (%)	0.10%	0.17%	0.28%	2.31%	11.32%	22.58%
Manufactured Total Machine Rate (\$/min)	\$536.96	\$326.50	\$197.69	\$25.05	\$5.75	\$3.29
Line Utilization Used (%)	37%	37%	37%	39%	48%	60%
Total Machine Rate Used (\$/min)	\$3.01	\$3.00	\$3.00	\$2.90	\$2.55	\$2.27

Annual Production Rate	200	500	1,000	10,000	50,000	100,000
Material (\$/system)	\$62	\$57	\$54	\$43	\$36	\$32
Manufacturing (\$/system)	\$3	\$2	\$2	\$1	\$1	\$1
Tooling (\$/system)	\$26	\$10	\$5	\$1	\$0	\$0
Markup (\$/system)	\$36	\$27	\$23	\$16	\$12	\$11
Total Cost (\$/system)	\$127	\$97	\$84	\$61	\$49	\$44
Total Cost (\$/kWnet)	\$0.79	\$0.60	\$0.52	\$0.38	\$0.31	\$0.28

#### 2025 Analysis

Annual Production Rate	200	500	1,000	10,000	50,000	100,000
Manufacture or Job Shop	Job Shop	Job Shop	Job Shop	Job Shop	Job Shop	Job Shop
Job Shop Line Utilization (%)	37%	37%	37%	39%	48%	60%
Job Shop Total Machine Rate (\$/min)	\$3.01	\$3.00	\$3.00	\$2.90	\$2.55	\$2.27
Manufactured Line Utilization (%)	0.10%	0.17%	0.28%	2.31%	11.32%	22.58%
Manufactured Total Machine Rate (\$/min)	\$536.96	\$326.50	\$197.69	\$25.05	\$5.75	\$3.29
Line Utilization Used (%)	37%	37%	37%	39%	48%	60%
Total Machine Rate Used (\$/min)	\$3.01	\$3.00	\$3.00	\$2.90	\$2.55	\$2.27

Annual Production Rate	200	500	1,000	10,000	50,000	100,000
Material (\$/system)	\$62	\$57	\$54	\$43	\$36	\$32
Manufacturing (\$/system)	\$3	\$2	\$2	\$1	\$1	\$1
Tooling (\$/system)	\$26	\$10	\$5	\$1	\$0	\$0
Markup (\$/system)	\$36	\$27	\$23	\$16	\$12	\$11
<b>Total Cost (\$/system)</b>	<b>\$127</b>	<b>\$97</b>	<b>\$84</b>	<b>\$61</b>	<b>\$49</b>	<b>\$44</b>
<b>Total Cost (\$/kWnet)</b>	<b>\$0.79</b>	<b>\$0.60</b>	<b>\$0.52</b>	<b>\$0.38</b>	<b>\$0.31</b>	<b>\$0.28</b>

### 21.2.2.3 Membrane Humidifier

#### 21.2.2.3.1 Membrane Humidifier Manufacturing Process

##### Station 1: Fabrication of Composite Humidifier Membranes

##### 2018 Analysis

Annual Production Rate	200	500	1,000	10,000	50,000	100,000
Manufacture or Job Shop	Job Shop	Job Shop	Job Shop	Job Shop	Manufactured	Manufactured
Job Shop Line Utilization (%)	37%	37%	38%	45%	39%	75%
Job Shop Total Machine Rate (\$/min)	\$12.43	\$14.32	\$14.00	\$18.81	\$21.13	\$11.26
Manufactured Line Utilization (%)	0.2%	0.5%	0.9%	8.2%	38.7%	75.4%
Manufactured Total Machine Rate (\$/min)	\$1,407.68	\$736.15	\$378.27	\$72.38	\$16.11	\$8.70
<b>Line Utilization Used (%)</b>	<b>37.2%</b>	<b>37.5%</b>	<b>37.9%</b>	<b>45.2%</b>	<b>38.7%</b>	<b>75.4%</b>
<b>Total Machine Rate Used (\$/min)</b>	<b>\$12.43</b>	<b>\$14.32</b>	<b>\$14.00</b>	<b>\$18.81</b>	<b>\$16.11</b>	<b>\$8.70</b>

Annual Production Rate	200	500	1,000	10,000	50,000	100,000
Material (\$/stack)	\$601	\$526	\$473	\$314	\$218	\$180
Manufacturing (\$/stack)	\$133	\$69	\$46	\$31	\$24	\$13
Tooling (\$/stack)	\$1	\$1	\$1	\$1	\$1	\$1
Markup (\$/stack)	\$291	\$226	\$190	\$111	\$115	\$87
<b>Total Cost (\$/stack)</b>	<b>\$1,025</b>	<b>\$822</b>	<b>\$710</b>	<b>\$458</b>	<b>\$358</b>	<b>\$282</b>
<b>Total Cost (\$/kWnet)</b>	<b>\$6.41</b>	<b>\$5.14</b>	<b>\$4.43</b>	<b>\$2.86</b>	<b>\$2.24</b>	<b>\$1.76</b>

##### 2020 Analysis

Annual Production Rate	200	500	1,000	10,000	50,000	100,000
Manufacture or Job Shop	Job Shop	Job Shop	Job Shop	Job Shop	Manufactured	Manufactured
Job Shop Line Utilization (%)	\$0	\$0	\$0	\$0	\$0	\$1
Job Shop Total Machine Rate (\$/min)	\$12.43	\$14.32	\$14.00	\$18.81	\$21.13	\$11.26
Manufactured Line Utilization (%)	0.2%	0.5%	0.9%	8.2%	38.7%	75.4%
Manufactured Total Machine Rate (\$/min)	\$1,407.68	\$736.15	\$378.27	\$72.38	\$16.11	\$8.70
<b>Line Utilization Used (%)</b>	<b>37.2%</b>	<b>37.5%</b>	<b>37.9%</b>	<b>45.2%</b>	<b>38.7%</b>	<b>75.4%</b>
<b>Total Machine Rate Used (\$/min)</b>	<b>\$12.43</b>	<b>\$14.32</b>	<b>\$14.00</b>	<b>\$18.81</b>	<b>\$16.11</b>	<b>\$8.70</b>

Annual Production Rate	200	500	1,000	10,000	50,000	100,000
Material (\$/stack)	\$601	\$526	\$473	\$314	\$218	\$180
Manufacturing (\$/stack)	\$133	\$69	\$46	\$31	\$24	\$13
Tooling (\$/stack)	\$1	\$1	\$1	\$1	\$1	\$1
Markup (\$/stack)	\$291	\$226	\$190	\$111	\$115	\$87
<b>Total Cost (\$/stack)</b>	<b>\$1,025</b>	<b>\$822</b>	<b>\$710</b>	<b>\$458</b>	<b>\$358</b>	<b>\$282</b>
<b>Total Cost (\$/kWnet)</b>	<b>\$6.41</b>	<b>\$5.14</b>	<b>\$4.43</b>	<b>\$2.86</b>	<b>\$2.24</b>	<b>\$1.76</b>

## 2025 Analysis

Annual Production Rate	200	500	1,000	10,000	50,000	100,000
Manufacture or Job Shop	Job Shop	Job Shop	Job Shop	Job Shop	Manufactured	Manufactured
Job Shop Line Utilization (%)	\$0	\$0	\$0	\$0	\$0	\$1
Job Shop Total Machine Rate (\$/min)	\$12.43	\$14.32	\$14.00	\$18.81	\$21.13	\$11.26
Manufactured Line Utilization (%)	0.2%	0.5%	0.9%	8.2%	38.7%	75.4%
Manufactured Total Machine Rate (\$/min)	\$1,407.68	\$736.15	\$378.27	\$72.38	\$16.11	\$8.70
Line Utilization Used (%)	37.2%	37.5%	37.9%	45.2%	38.7%	75.4%
Total Machine Rate Used (\$/min)	\$12.43	\$14.32	\$14.00	\$18.81	\$16.11	\$8.70

Annual Production Rate	200	500	1,000	10,000	50,000	100,000
Material (\$/stack)	\$601	\$526	\$473	\$314	\$218	\$180
Manufacturing (\$/stack)	\$133	\$69	\$46	\$31	\$24	\$13
Tooling (\$/stack)	\$1	\$1	\$1	\$1	\$1	\$1
Markup (\$/stack)	\$291	\$226	\$190	\$111	\$115	\$87
Total Cost (\$/stack)	\$1,025	\$822	\$710	\$458	\$358	\$282
Total Cost (\$/kWnet)	\$6.41	\$5.14	\$4.43	\$2.86	\$2.24	\$1.76

## Station 2: Fabrication of Etched Stainless Steel Flow Fields

### 2018 Analysis

Annual Production Rate	200	500	1,000	10,000	50,000	100,000
Manufacture or Job Shop	Job Shop	Job Shop	Job Shop	Manufactured	Manufactured	Manufactured
Job Shop Line Utilization (%)	38%	40%	44%	68%	85%	98%
Job Shop Total Machine Rate (\$/min)	\$11.79	\$11.44	\$10.94	\$8.82	\$11.34	\$13.87
Manufactured Line Utilization (%)	1%	3%	7%	68%	85%	98%
Manufactured Total Machine Rate (\$/min)	\$139.93	\$58.36	\$31.17	\$6.70	\$5.11	\$4.89
Line Utilization Used (%)	38%	40%	44%	68%	85%	98%
Total Machine Rate Used (\$/min)	\$11.79	\$11.44	\$10.94	\$6.70	\$5.11	\$4.89

Annual Production Rate	200	500	1,000	10,000	50,000	100,000
Material (\$/stack)	\$96	\$96	\$96	\$96	\$96	\$96
Manufacturing (\$/stack)	\$164	\$159	\$152	\$93	\$71	\$68
Markup (\$/stack)	\$103	\$96	\$90	\$71	\$56	\$53
Total Cost (\$/stack)	\$362	\$351	\$338	\$259	\$223	\$216
Total Cost (\$/kWnet)	\$2.26	\$2.19	\$2.11	\$1.62	\$1.39	\$1.35

### 2020 Analysis

Annual Production Rate	200	500	1,000	10,000	50,000	100,000
Manufacture or Job Shop	Job Shop	Job Shop	Job Shop	Manufactured	Manufactured	Manufactured
Job Shop Line Utilization (%)	38%	40%	44%	68%	85%	98%
Job Shop Total Machine Rate (\$/min)	\$11.79	\$11.44	\$10.94	\$8.82	\$11.34	\$13.87
Manufactured Line Utilization (%)	1%	3%	7%	68%	85%	98%
Manufactured Total Machine Rate (\$/min)	\$139.93	\$58.36	\$31.17	\$6.70	\$5.11	\$4.89
Line Utilization Used (%)	38%	40%	44%	68%	85%	98%
Total Machine Rate Used (\$/min)	\$11.79	\$11.44	\$10.94	\$6.70	\$5.11	\$4.89

Annual Production Rate	200	500	1,000	10,000	50,000	100,000
Material (\$/stack)	\$96	\$96	\$96	\$96	\$96	\$96
Manufacturing (\$/stack)	\$164	\$159	\$152	\$93	\$71	\$68
Markup (\$/stack)	\$103	\$96	\$90	\$71	\$56	\$53
<b>Total Cost (\$/stack)</b>	<b>\$362</b>	<b>\$351</b>	<b>\$338</b>	<b>\$259</b>	<b>\$223</b>	<b>\$216</b>
<b>Total Cost (\$/kWnet)</b>	<b>\$2.26</b>	<b>\$2.19</b>	<b>\$2.11</b>	<b>\$1.62</b>	<b>\$1.39</b>	<b>\$1.35</b>

### 2025 Analysis

Annual Production Rate	200	500	1,000	10,000	50,000	100,000
Manufacture or Job Shop	Job Shop	Job Shop	Job Shop	Manufactured	Manufactured	Manufactured
Job Shop Line Utilization (%)	38%	40%	44%	68%	85%	98%
Job Shop Total Machine Rate (\$/min)	\$11.79	\$11.44	\$10.94	\$8.82	\$11.34	\$13.87
Manufactured Line Utilization (%)	1%	3%	7%	68%	85%	98%
Manufactured Total Machine Rate (\$/min)	\$139.93	\$58.36	\$31.17	\$6.70	\$5.11	\$4.89
<b>Line Utilization Used (%)</b>	<b>38%</b>	<b>40%</b>	<b>44%</b>	<b>68%</b>	<b>85%</b>	<b>98%</b>
<b>Total Machine Rate Used (\$/min)</b>	<b>\$11.79</b>	<b>\$11.44</b>	<b>\$10.94</b>	<b>\$6.70</b>	<b>\$5.11</b>	<b>\$4.89</b>

Annual Production Rate	200	500	1,000	10,000	50,000	100,000
Material (\$/stack)	\$96	\$96	\$96	\$96	\$96	\$96
Manufacturing (\$/stack)	\$164	\$159	\$152	\$93	\$71	\$68
Markup (\$/stack)	\$103	\$96	\$90	\$71	\$56	\$53
<b>Total Cost (\$/stack)</b>	<b>\$362</b>	<b>\$351</b>	<b>\$338</b>	<b>\$259</b>	<b>\$223</b>	<b>\$216</b>
<b>Total Cost (\$/kWnet)</b>	<b>\$2.26</b>	<b>\$2.19</b>	<b>\$2.11</b>	<b>\$1.62</b>	<b>\$1.39</b>	<b>\$1.35</b>

### Station 3: Pouch Formation

#### 2018 Analysis

Annual Production Rate	200	500	1,000	10,000	50,000	100,000
Manufacture or Job Shop	Job Shop	Job Shop	Job Shop	Manufactured	Manufactured	Manufactured
Job Shop Line Utilization (%)	38%	39%	41%	40%	100%	100%
Job Shop Total Machine Rate (\$/min)	\$3.46	\$3.37	\$3.23	\$3.29	\$1.64	\$1.64
Manufactured Line Utilization (%)	1%	2%	4%	40%	100%	100%
Manufactured Total Machine Rate (\$/min)	\$105.32	\$42.56	\$21.50	\$2.53	\$1.26	\$1.26
<b>Line Utilization Used (%)</b>	<b>38%</b>	<b>39%</b>	<b>41%</b>	<b>40%</b>	<b>100%</b>	<b>100%</b>
<b>Total Machine Rate Used (\$/min)</b>	<b>\$3.46</b>	<b>\$3.37</b>	<b>\$3.23</b>	<b>\$2.53</b>	<b>\$1.26</b>	<b>\$1.26</b>

Annual Production Rate	200	500	1,000	10,000	50,000	100,000
Material (\$/stack)	\$3	\$3	\$3	\$3	\$3	\$3
Manufacturing (\$/stack)	\$27	\$26	\$25	\$19	\$10	\$10
Tooling (\$/stack)	\$1	\$1	\$1	\$1	\$0	\$0
Markup (\$/stack)	\$12	\$11	\$10	\$9	\$4	\$4
<b>Total Cost (\$/stack)</b>	<b>\$42</b>	<b>\$40</b>	<b>\$38</b>	<b>\$31</b>	<b>\$17</b>	<b>\$17</b>
<b>Total Cost (\$/kWnet)</b>	<b>\$0.26</b>	<b>\$0.25</b>	<b>\$0.24</b>	<b>\$0.19</b>	<b>\$0.11</b>	<b>\$0.10</b>

## 2020 Analysis

Annual Production Rate	200	500	1,000	10,000	50,000	100,000
Manufacture or Job Shop	Job Shop	Job Shop	Job Shop	Manufactured	Manufactured	Manufactured
Job Shop Line Utilization (%)	38%	39%	41%	40%	100%	100%
Job Shop Total Machine Rate (\$/min)	\$3.46	\$3.37	\$3.23	\$3.29	\$1.64	\$1.64
Manufactured Line Utilization (%)	1%	2%	4%	40%	100%	100%
Manufactured Total Machine Rate (\$/min)	\$105.32	\$42.56	\$21.50	\$2.53	\$1.26	\$1.26
Line Utilization Used (%)	38%	39%	41%	40%	100%	100%
Total Machine Rate Used (\$/min)	\$3.46	\$3.37	\$3.23	\$2.53	\$1.26	\$1.26

Annual Production Rate	200	500	1,000	10,000	50,000	100,000
Material (\$/stack)	\$3	\$3	\$3	\$3	\$3	\$3
Manufacturing (\$/stack)	\$27	\$26	\$25	\$19	\$10	\$10
Tooling (\$/stack)	\$1	\$1	\$1	\$1	\$0	\$0
Markup (\$/stack)	\$12	\$11	\$10	\$9	\$4	\$4
Total Cost (\$/stack)	\$42	\$40	\$38	\$31	\$17	\$17
Total Cost (\$/kWnet)	\$0.26	\$0.25	\$0.24	\$0.19	\$0.11	\$0.10

## 2025 Analysis

Annual Production Rate	200	500	1,000	10,000	50,000	100,000
Manufacture or Job Shop	Job Shop	Job Shop	Job Shop	Manufactured	Manufactured	Manufactured
Job Shop Line Utilization (%)	38%	39%	41%	40%	100%	100%
Job Shop Total Machine Rate (\$/min)	\$3.46	\$3.37	\$3.23	\$3.29	\$1.64	\$1.64
Manufactured Line Utilization (%)	1%	2%	4%	40%	100%	100%
Manufactured Total Machine Rate (\$/min)	\$105.32	\$42.56	\$21.50	\$2.53	\$1.26	\$1.26
Line Utilization Used (%)	38%	39%	41%	40%	100%	100%
Total Machine Rate Used (\$/min)	\$3.46	\$3.37	\$3.23	\$2.53	\$1.26	\$1.26

Annual Production Rate	200	500	1,000	10,000	50,000	100,000
Material (\$/stack)	\$3	\$3	\$3	\$3	\$3	\$3
Manufacturing (\$/stack)	\$27	\$26	\$25	\$19	\$10	\$10
Tooling (\$/stack)	\$1	\$1	\$1	\$1	\$0	\$0
Markup (\$/stack)	\$12	\$11	\$10	\$9	\$4	\$4
Total Cost (\$/stack)	\$42	\$40	\$38	\$31	\$17	\$17
Total Cost (\$/kWnet)	\$0.26	\$0.25	\$0.24	\$0.19	\$0.11	\$0.10

## Station 4: Stainless Steel Rib Formation

### 2018 Analysis

Annual Production Rate	200	500	1,000	10,000	50,000	100,000
Manufacture or Job Shop	Job Shop	Job Shop	Job Shop	Manufactured	Manufactured	Manufactured
Job Shop Line Utilization (%)	39%	41%	46%	88%	88%	98%
Job Shop Total Machine Rate (\$/min)	\$1.57	\$1.50	\$1.41	\$0.98	\$0.98	\$0.94
Manufactured Line Utilization (%)	2%	4%	9%	88%	88%	98%
Manufactured Total Machine Rate (\$/min)	\$17.86	\$7.41	\$3.91	\$0.76	\$0.76	\$0.72
Line Utilization Used (%)	39%	41%	46%	88%	88%	98%
Total Machine Rate Used (\$/min)	\$1.57	\$1.50	\$1.41	\$0.76	\$0.76	\$0.72

Annual Production Rate	200	500	1,000	10,000	50,000	100,000
Material (\$/stack)	\$8	\$8	\$8	\$8	\$8	\$8
Manufacturing (\$/stack)	\$26	\$25	\$24	\$13	\$13	\$12
Tooling (\$/stack)	\$24	\$23	\$23	\$23	\$23	\$23
Markup (\$/system)	\$23	\$21	\$20	\$16	\$15	\$14
<b>Total Cost (\$/stack)</b>	<b>\$81</b>	<b>\$77</b>	<b>\$74</b>	<b>\$59</b>	<b>\$58</b>	<b>\$56</b>
<b>Total Cost (\$/kWnet)</b>	<b>\$0.51</b>	<b>\$0.48</b>	<b>\$0.46</b>	<b>\$0.37</b>	<b>\$0.36</b>	<b>\$0.35</b>

## 2020 Analysis

Annual Production Rate	200	500	1,000	10,000	50,000	100,000
Manufacture or Job Shop	Job Shop	Job Shop	Job Shop	Manufactured	Manufactured	Manufactured
Job Shop Line Utilization (%)	39%	41%	46%	88%	88%	98%
Job Shop Total Machine Rate (\$/min)	\$1.57	\$1.50	\$1.41	\$0.98	\$0.98	\$0.94
Manufactured Line Utilization (%)	2%	4%	9%	88%	88%	98%
Manufactured Total Machine Rate (\$/min)	\$17.86	\$7.41	\$3.91	\$0.76	\$0.76	\$0.72
<b>Line Utilization Used (%)</b>	<b>39%</b>	<b>41%</b>	<b>46%</b>	<b>88%</b>	<b>88%</b>	<b>98%</b>
<b>Total Machine Rate Used (\$/min)</b>	<b>\$1.57</b>	<b>\$1.50</b>	<b>\$1.41</b>	<b>\$0.76</b>	<b>\$0.76</b>	<b>\$0.72</b>

Annual Production Rate	200	500	1,000	10,000	50,000	100,000
Material (\$/stack)	\$8	\$8	\$8	\$8	\$8	\$8
Manufacturing (\$/stack)	\$26	\$25	\$24	\$13	\$13	\$12
Tooling (\$/stack)	\$24	\$23	\$23	\$23	\$23	\$23
Markup (\$/system)	\$23	\$21	\$20	\$16	\$15	\$14
<b>Total Cost (\$/stack)</b>	<b>\$81</b>	<b>\$77</b>	<b>\$74</b>	<b>\$59</b>	<b>\$58</b>	<b>\$56</b>
<b>Total Cost (\$/kWnet)</b>	<b>\$0.51</b>	<b>\$0.48</b>	<b>\$0.46</b>	<b>\$0.37</b>	<b>\$0.36</b>	<b>\$0.35</b>

## 2025 Analysis

Annual Production Rate	200	500	1,000	10,000	50,000	100,000
Manufacture or Job Shop	Job Shop	Job Shop	Job Shop	Manufactured	Manufactured	Manufactured
Job Shop Line Utilization (%)	39%	41%	46%	88%	88%	98%
Job Shop Total Machine Rate (\$/min)	\$1.57	\$1.50	\$1.41	\$0.98	\$0.98	\$0.94
Manufactured Line Utilization (%)	2%	4%	9%	88%	88%	98%
Manufactured Total Machine Rate (\$/min)	\$17.86	\$7.41	\$3.91	\$0.76	\$0.76	\$0.72
<b>Line Utilization Used (%)</b>	<b>39%</b>	<b>41%</b>	<b>46%</b>	<b>88%</b>	<b>88%</b>	<b>98%</b>
<b>Total Machine Rate Used (\$/min)</b>	<b>\$1.57</b>	<b>\$1.50</b>	<b>\$1.41</b>	<b>\$0.76</b>	<b>\$0.76</b>	<b>\$0.72</b>

Annual Production Rate	200	500	1,000	10,000	50,000	100,000
Material (\$/stack)	\$8	\$8	\$8	\$8	\$8	\$8
Manufacturing (\$/stack)	\$26	\$25	\$24	\$13	\$13	\$12
Tooling (\$/stack)	\$24	\$23	\$23	\$23	\$23	\$23
Markup (\$/system)	\$23	\$21	\$20	\$16	\$15	\$14
<b>Total Cost (\$/stack)</b>	<b>\$81</b>	<b>\$77</b>	<b>\$74</b>	<b>\$59</b>	<b>\$58</b>	<b>\$56</b>
<b>Total Cost (\$/kWnet)</b>	<b>\$0.51</b>	<b>\$0.48</b>	<b>\$0.46</b>	<b>\$0.37</b>	<b>\$0.36</b>	<b>\$0.35</b>

**Station 5: Stack Formation  
2018 Analysis**

Annual Production Rate	200	500	1,000	10,000	50,000	100,000
Manufacture or Job Shop	Job Shop	Job Shop	Manufactured	Manufactured	Manufactured	Manufactured
Job Shop Line Utilization (%)	45%	57%	40%	80%	95%	98%
Job Shop Total Machine Rate (\$/min)	\$1.63	\$1.40	\$1.77	\$1.15	\$1.05	\$1.04
Manufactured Line Utilization (%)	8%	20%	40%	80%	95%	98%
Manufactured Total Machine Rate (\$/min)	\$5.15	\$2.31	\$1.36	\$0.88	\$0.81	\$0.80
Line Utilization Used (%)	45%	57%	40%	80%	95%	98%
Total Machine Rate Used (\$/min)	\$1.63	\$1.40	\$1.36	\$0.88	\$0.81	\$0.80

Annual Production Rate	200	500	1,000	10,000	50,000	100,000
Material (\$/stack)	\$27	\$27	\$27	\$27	\$27	\$27
Manufacturing (\$/stack)	\$124	\$106	\$103	\$67	\$61	\$61
Markup (\$/system)	\$60	\$51	\$57	\$36	\$30	\$28
Total Cost (\$/stack)	\$211	\$184	\$188	\$130	\$119	\$116
Total Cost (\$/kWnet)	\$1.32	\$1.15	\$1.18	\$0.81	\$0.74	\$0.73

**2020 Analysis**

Annual Production Rate	200	500	1,000	10,000	50,000	100,000
Manufacture or Job Shop	Job Shop	Job Shop	Manufactured	Manufactured	Manufactured	Manufactured
Job Shop Line Utilization (%)	45%	57%	40%	80%	95%	98%
Job Shop Total Machine Rate (\$/min)	\$1.63	\$1.40	\$1.77	\$1.15	\$1.05	\$1.04
Manufactured Line Utilization (%)	8%	20%	40%	80%	95%	98%
Manufactured Total Machine Rate (\$/min)	\$5.15	\$2.31	\$1.36	\$0.88	\$0.81	\$0.80
Line Utilization Used (%)	45%	57%	40%	80%	95%	98%
Total Machine Rate Used (\$/min)	\$1.63	\$1.40	\$1.36	\$0.88	\$0.81	\$0.80

Annual Production Rate	200	500	1,000	10,000	50,000	100,000
Material (\$/stack)	\$27	\$27	\$27	\$27	\$27	\$27
Manufacturing (\$/stack)	\$124	\$106	\$103	\$67	\$61	\$61
Markup (\$/system)	\$60	\$51	\$57	\$36	\$30	\$28
Total Cost (\$/stack)	\$211	\$184	\$188	\$130	\$119	\$116
Total Cost (\$/kWnet)	\$1.32	\$1.15	\$1.18	\$0.81	\$0.74	\$0.73

**2025 Analysis**

Annual Production Rate	200	500	1,000	10,000	50,000	100,000
Manufacture or Job Shop	Job Shop	Job Shop	Manufactured	Manufactured	Manufactured	Manufactured
Job Shop Line Utilization (%)	45%	57%	40%	80%	95%	98%
Job Shop Total Machine Rate (\$/min)	\$1.63	\$1.40	\$1.77	\$1.15	\$1.05	\$1.04
Manufactured Line Utilization (%)	8%	20%	40%	80%	95%	98%
Manufactured Total Machine Rate (\$/min)	\$5.15	\$2.31	\$1.36	\$0.88	\$0.81	\$0.80
Line Utilization Used (%)	45%	57%	40%	80%	95%	98%
Total Machine Rate Used (\$/min)	\$1.63	\$1.40	\$1.36	\$0.88	\$0.81	\$0.80

Annual Production Rate	200	500	1,000	10,000	50,000	100,000
Material (\$/stack)	\$27	\$27	\$27	\$27	\$27	\$27
Manufacturing (\$/stack)	\$124	\$106	\$103	\$67	\$61	\$61
Markup (\$/system)	\$60	\$51	\$57	\$36	\$30	\$28
Total Cost (\$/stack)	\$211	\$184	\$188	\$130	\$119	\$116
Total Cost (\$/kWnet)	\$1.32	\$1.15	\$1.18	\$0.81	\$0.74	\$0.73



**Station 6: Formation of the Housing  
2018 Analysis**

Annual Production Rate	200	500	1,000	10,000	50,000	100,000
Material (\$/stack)	\$11	\$11	\$11	\$11	\$11	\$11
Manufacturing (\$/stack)	\$45	\$26	\$20	\$10	\$7	\$7
Tooling (\$/stack)	\$91	\$44	\$26	\$4	\$1	\$1
Markup (\$/system)	\$59	\$31	\$21	\$8	\$6	\$5
<b>Total Cost (\$/stack)</b>	<b>\$206</b>	<b>\$113</b>	<b>\$77</b>	<b>\$34</b>	<b>\$25</b>	<b>\$25</b>
<b>Total Cost (\$/kWnet)</b>	<b>\$1.29</b>	<b>\$0.70</b>	<b>\$0.48</b>	<b>\$0.21</b>	<b>\$0.16</b>	<b>\$0.15</b>

**2020 Analysis**

Annual Production Rate	200	500	1,000	10,000	50,000	100,000
Material (\$/stack)	\$11	\$11	\$11	\$11	\$11	\$11
Manufacturing (\$/stack)	\$45	\$26	\$20	\$10	\$7	\$7
Tooling (\$/stack)	\$91	\$44	\$26	\$4	\$1	\$1
Markup (\$/system)	\$59	\$31	\$21	\$8	\$6	\$5
<b>Total Cost (\$/stack)</b>	<b>\$206</b>	<b>\$113</b>	<b>\$77</b>	<b>\$34</b>	<b>\$25</b>	<b>\$25</b>
<b>Total Cost (\$/kWnet)</b>	<b>\$1.29</b>	<b>\$0.70</b>	<b>\$0.48</b>	<b>\$0.21</b>	<b>\$0.16</b>	<b>\$0.15</b>

**2025 Analysis**

Annual Production Rate	200	500	1,000	10,000	50,000	100,000
Material (\$/stack)	\$11	\$11	\$11	\$11	\$11	\$11
Manufacturing (\$/stack)	\$45	\$26	\$20	\$10	\$7	\$7
Tooling (\$/stack)	\$91	\$44	\$26	\$4	\$1	\$1
Markup (\$/system)	\$59	\$31	\$21	\$8	\$6	\$5
<b>Total Cost (\$/stack)</b>	<b>\$206</b>	<b>\$113</b>	<b>\$77</b>	<b>\$34</b>	<b>\$25</b>	<b>\$25</b>
<b>Total Cost (\$/kWnet)</b>	<b>\$1.29</b>	<b>\$0.70</b>	<b>\$0.48</b>	<b>\$0.21</b>	<b>\$0.16</b>	<b>\$0.15</b>

**Station 7: Assembly of the Composite Membrane and Flow Fields into the Housing  
2018 Analysis**

Annual Production Rate	200	500	1,000	10,000	50,000	100,000
Manufacture or Job Shop	Job Shop	Job Shop	Job Shop	Job Shop	Manufactured	Manufactured
Job Shop Line Utilization (%)	37%	37%	38%	47%	50%	100%
Job Shop Total Machine Rate (\$/min)	\$1.24	\$1.24	\$1.24	\$1.20	\$1.19	\$1.10
Manufactured Line Utilization (%)	0%	0%	1%	10%	50%	100%
Manufactured Total Machine Rate (\$/min)	\$32.68	\$13.54	\$7.16	\$1.42	\$0.91	\$0.85
<b>Line Utilization Used (%)</b>	<b>37%</b>	<b>37%</b>	<b>38%</b>	<b>47%</b>	<b>50%</b>	<b>100%</b>
<b>Total Machine Rate Used (\$/min)</b>	<b>\$1.24</b>	<b>\$1.24</b>	<b>\$1.24</b>	<b>\$1.20</b>	<b>\$0.91</b>	<b>\$0.85</b>

Annual Production Rate	200	500	1,000	10,000	50,000	100,000
Manufacturing (\$/stack)	\$2	\$2	\$2	\$2	\$2	\$2
Markup (\$/system)	\$1	\$1	\$1	\$1	\$1	\$1
<b>Total Cost (\$/stack)</b>	<b>\$3</b>	<b>\$3</b>	<b>\$3</b>	<b>\$3</b>	<b>\$2</b>	<b>\$2</b>
<b>Total Cost (\$/kWnet)</b>	<b>\$0.02</b>	<b>\$0.02</b>	<b>\$0.02</b>	<b>\$0.02</b>	<b>\$0.01</b>	<b>\$0.01</b>

## 2020 Analysis

Annual Production Rate	200	500	1,000	10,000	50,000	100,000
Manufacture or Job Shop	Job Shop	Job Shop	Job Shop	Job Shop	Manufactured	Manufactured
Job Shop Line Utilization (%)	37%	37%	38%	47%	50%	100%
Job Shop Total Machine Rate (\$/min)	\$1.24	\$1.24	\$1.24	\$1.20	\$1.19	\$1.10
Manufactured Line Utilization (%)	0%	0%	1%	10%	50%	100%
Manufactured Total Machine Rate (\$/min)	\$32.68	\$13.54	\$7.16	\$1.42	\$0.91	\$0.85
Line Utilization Used (%)	37%	37%	38%	47%	50%	100%
Total Machine Rate Used (\$/min)	\$1.24	\$1.24	\$1.24	\$1.20	\$0.91	\$0.85

Annual Production Rate	200	500	1,000	10,000	50,000	100,000
Manufacturing (\$/stack)	\$2	\$2	\$2	\$2	\$2	\$2
Markup (\$/system)	\$1	\$1	\$1	\$1	\$1	\$1
Total Cost (\$/stack)	\$3	\$3	\$3	\$3	\$2	\$2
Total Cost (\$/kWnet)	\$0.02	\$0.02	\$0.02	\$0.02	\$0.01	\$0.01

## 2025 Analysis

Annual Production Rate	200	500	1,000	10,000	50,000	100,000
Manufacture or Job Shop	Job Shop	Job Shop	Job Shop	Job Shop	Manufactured	Manufactured
Job Shop Line Utilization (%)	37%	37%	38%	47%	50%	100%
Job Shop Total Machine Rate (\$/min)	\$1.24	\$1.24	\$1.24	\$1.20	\$1.19	\$1.10
Manufactured Line Utilization (%)	0%	0%	1%	10%	50%	100%
Manufactured Total Machine Rate (\$/min)	\$32.68	\$13.54	\$7.16	\$1.42	\$0.91	\$0.85
Line Utilization Used (%)	37%	37%	38%	47%	50%	100%
Total Machine Rate Used (\$/min)	\$1.24	\$1.24	\$1.24	\$1.20	\$0.91	\$0.85

Annual Production Rate	200	500	1,000	10,000	50,000	100,000
Manufacturing (\$/stack)	\$2	\$2	\$2	\$2	\$2	\$2
Markup (\$/system)	\$1	\$1	\$1	\$1	\$1	\$1
Total Cost (\$/stack)	\$3	\$3	\$3	\$3	\$2	\$2
Total Cost (\$/kWnet)	\$0.02	\$0.02	\$0.02	\$0.02	\$0.01	\$0.01

## Station 8: Humidifier System Testing

### 2018 Analysis

Annual Production Rate	200	500	1,000	10,000	50,000	100,000
Manufacture or Job Shop	Job Shop	Job Shop	Job Shop	Job Shop	Manufactured	Manufactured
Job Shop Line Utilization (%)	37%	38%	38%	41%	56%	38%
Job Shop Total Machine Rate (\$/min)	\$1.42	\$1.42	\$1.42	\$1.46	\$1.40	\$1.48
Manufactured Line Utilization (%)	0%	1%	1%	4%	19%	38%
Manufactured Total Machine Rate (\$/min)	\$19.55	\$8.39	\$4.67	\$2.75	\$1.32	\$1.14
Line Utilization Used (%)	37%	38%	38%	41%	19%	38%
Total Machine Rate Used (\$/min)	\$1.42	\$1.42	\$1.42	\$1.46	\$1.32	\$1.14

Annual Production Rate	200	500	1,000	10,000	50,000	100,000
Manufacturing (\$/stack)	\$2	\$2	\$2	\$1	\$0	\$0
Markup (\$/system)	\$1	\$1	\$1	\$0	\$0	\$0
Total Cost (\$/stack)	\$3	\$3	\$3	\$1	\$1	\$1
Total Cost (\$/kWnet)	\$0.03	\$0.03	\$0.03	\$0.01	\$0.01	\$0.01

## 2020 Analysis

Annual Production Rate	200	500	1,000	10,000	50,000	100,000
Manufacture or Job Shop	Job Shop	Job Shop	Job Shop	Job Shop	Manufactured	Manufactured
Job Shop Line Utilization (%)	37%	38%	38%	41%	56%	38%
Job Shop Total Machine Rate (\$/min)	\$1.42	\$1.42	\$1.42	\$1.46	\$1.40	\$1.48
Manufactured Line Utilization (%)	0%	1%	1%	4%	19%	38%
Manufactured Total Machine Rate (\$/min)	\$19.55	\$8.39	\$4.67	\$2.75	\$1.32	\$1.14
Line Utilization Used (%)	37%	38%	38%	41%	19%	38%
Total Machine Rate Used (\$/min)	\$1.42	\$1.42	\$1.42	\$1.46	\$1.32	\$1.14

Annual Production Rate	200	500	1,000	10,000	50,000	100,000
Manufacturing (\$/stack)	\$2	\$2	\$2	\$1	\$0	\$0
Markup (\$/system)	\$1	\$1	\$1	\$0	\$0	\$0
Total Cost (\$/stack)	\$3	\$3	\$3	\$1	\$1	\$1
Total Cost (\$/kWnet)	\$0.03	\$0.03	\$0.03	\$0.01	\$0.01	\$0.01

## 2025 Analysis

Annual Production Rate	200	500	1,000	10,000	50,000	100,000
Manufacture or Job Shop	Job Shop	Job Shop	Job Shop	Job Shop	Manufactured	Manufactured
Job Shop Line Utilization (%)	37%	38%	38%	41%	56%	38%
Job Shop Total Machine Rate (\$/min)	\$1.42	\$1.42	\$1.42	\$1.46	\$1.40	\$1.48
Manufactured Line Utilization (%)	0%	1%	1%	4%	19%	38%
Manufactured Total Machine Rate (\$/min)	\$19.55	\$8.39	\$4.67	\$2.75	\$1.32	\$1.14
Line Utilization Used (%)	37%	38%	38%	41%	19%	38%
Total Machine Rate Used (\$/min)	\$1.42	\$1.42	\$1.42	\$1.46	\$1.32	\$1.14

Annual Production Rate	200	500	1,000	10,000	50,000	100,000
Manufacturing (\$/stack)	\$2	\$2	\$2	\$1	\$0	\$0
Markup (\$/system)	\$1	\$1	\$1	\$0	\$0	\$0
Total Cost (\$/stack)	\$3	\$3	\$3	\$1	\$1	\$1
Total Cost (\$/kWnet)	\$0.03	\$0.03	\$0.03	\$0.01	\$0.01	\$0.01

### 21.2.2.3.2 Combined Cost Results for Plate Frame Membrane Humidifier

#### 2018 Analysis

Annual Production Rate	200	500	1,000	10,000	50,000	100,000
Material (\$/stack)	\$745	\$671	\$617	\$459	\$363	\$325
Manufacturings (\$/stack)	\$523	\$415	\$373	\$237	\$188	\$172
Tooling (\$/stack)	\$118	\$69	\$50	\$29	\$25	\$25
Markup (\$/stack)	\$549	\$437	\$390	\$252	\$226	\$192
Total Cost (\$/stack)	\$1,934	\$1,593	\$1,431	\$975	\$802	\$714
Total Cost (\$/kWnet)	\$24.17	\$19.91	\$17.88	\$12.19	\$10.03	\$8.92

#### 2020 Analysis

Annual Production Rate	200	500	1,000	10,000	50,000	100,000
Material (\$/stack)	\$745	\$671	\$617	\$459	\$363	\$325
Manufacturings (\$/stack)	\$523	\$415	\$373	\$237	\$188	\$172
Tooling (\$/stack)	\$118	\$69	\$50	\$29	\$25	\$25
Markup (\$/stack)	\$549	\$437	\$390	\$252	\$226	\$192
Total Cost (\$/stack)	\$1,934	\$1,593	\$1,431	\$975	\$802	\$714
Total Cost (\$/kWnet)	\$24.17	\$19.91	\$17.88	\$12.19	\$10.03	\$8.92

## 2025 Analysis

Annual Production Rate	200	500	1,000	10,000	50,000	100,000
Material (\$/stack)	\$745	\$671	\$617	\$459	\$363	\$325
Manufacturings (\$/stack)	\$523	\$415	\$373	\$237	\$188	\$172
Tooling (\$/stack)	\$118	\$69	\$50	\$29	\$25	\$25
Markup (\$/stack)	\$549	\$437	\$390	\$252	\$226	\$192
<b>Total Cost (\$/stack)</b>	<b>\$1,934</b>	<b>\$1,593</b>	<b>\$1,431</b>	<b>\$975</b>	<b>\$802</b>	<b>\$714</b>
<b>Total Cost (\$/kWnet)</b>	<b>\$24.17</b>	<b>\$19.91</b>	<b>\$17.88</b>	<b>\$12.19</b>	<b>\$10.03</b>	<b>\$8.92</b>

## 21.2.3 Coolant Loops

### 21.2.3.1 High-Temperature Coolant Loop

#### 2018 Analysis

Annual Production Rate	200	500	1,000	10,000	50,000	100,000
Coolant Reservoir (\$/system)	\$15	\$15	\$15	\$14	\$14	\$14
Coolant Pump (\$/system)	\$132	\$130	\$128	\$121	\$117	\$115
Coolant DI Filter (\$/system)	\$164	\$155	\$149	\$130	\$118	\$114
Thermostat & Valve (\$/system)	\$19	\$19	\$19	\$18	\$18	\$18
Radiator (\$/system)	\$974	\$940	\$915	\$831	\$773	\$747
Radiator Fan (\$/system)	\$126	\$123	\$121	\$115	\$111	\$110
Coolant Piping (\$/system)	\$30	\$29	\$29	\$27	\$26	\$25
Markup (\$/system)	\$589	\$550	\$521	\$436	\$383	\$362
<b>Total Cost (\$/system)</b>	<b>\$2,049</b>	<b>\$1,961</b>	<b>\$1,896</b>	<b>\$1,693</b>	<b>\$1,559</b>	<b>\$1,504</b>
<b>Total Cost (\$/kWnet)</b>	<b>\$12.81</b>	<b>\$12.26</b>	<b>\$11.85</b>	<b>\$10.58</b>	<b>\$9.75</b>	<b>\$9.40</b>

#### 2020 Analysis

Annual Production Rate	200	500	1,000	10,000	50,000	100,000
Coolant Reservoir (\$/system)	\$15	\$15	\$15	\$14	\$14	\$14
Coolant Pump (\$/system)	\$132	\$130	\$128	\$121	\$117	\$115
Coolant DI Filter (\$/system)	\$164	\$155	\$149	\$130	\$118	\$114
Thermostat & Valve (\$/system)	\$19	\$19	\$19	\$18	\$18	\$18
Radiator (\$/system)	\$938	\$906	\$882	\$801	\$744	\$720
Radiator Fan (\$/system)	\$126	\$123	\$121	\$115	\$111	\$110
Coolant Piping (\$/system)	\$30	\$29	\$29	\$27	\$26	\$25
Markup (\$/system)	\$575	\$536	\$509	\$425	\$374	\$353
<b>Total Cost (\$/system)</b>	<b>\$1,999</b>	<b>\$1,913</b>	<b>\$1,850</b>	<b>\$1,652</b>	<b>\$1,522</b>	<b>\$1,468</b>
<b>Total Cost (\$/kWnet)</b>	<b>\$12.49</b>	<b>\$11.96</b>	<b>\$11.56</b>	<b>\$10.32</b>	<b>\$9.51</b>	<b>\$9.18</b>

#### 2025 Analysis

Annual Production Rate	200	500	1,000	10,000	50,000	100,000
Coolant Reservoir (\$/system)	\$15	\$15	\$15	\$14	\$14	\$14
Coolant Pump (\$/system)	\$132	\$130	\$128	\$121	\$117	\$115
Coolant DI Filter (\$/system)	\$164	\$155	\$149	\$130	\$118	\$114
Thermostat & Valve (\$/system)	\$19	\$19	\$19	\$18	\$18	\$18
Radiator (\$/system)	\$918	\$887	\$863	\$784	\$728	\$705
Radiator Fan (\$/system)	\$126	\$123	\$121	\$115	\$111	\$110
Coolant Piping (\$/system)	\$30	\$29	\$29	\$27	\$26	\$25
Markup (\$/system)	\$567	\$529	\$502	\$419	\$369	\$348
<b>Total Cost (\$/system)</b>	<b>\$1,971</b>	<b>\$1,886</b>	<b>\$1,824</b>	<b>\$1,629</b>	<b>\$1,501</b>	<b>\$1,448</b>
<b>Total Cost (\$/kWnet)</b>	<b>\$12.32</b>	<b>\$11.79</b>	<b>\$11.40</b>	<b>\$10.18</b>	<b>\$9.38</b>	<b>\$9.05</b>

### 21.2.3.2 Low-Temperature Coolant Loop

#### 2018 Analysis

Annual Production Rate	200	500	1,000	10,000	50,000	100,000
Coolant Reservoir (\$/system)	\$2	\$2	\$2	\$2	\$2	\$2
Coolant Pump (\$/system)	\$38	\$37	\$36	\$35	\$33	\$33
Thermostat & Valve (\$/system)	\$8	\$8	\$8	\$8	\$8	\$8
Radiator (\$/system)	\$110	\$107	\$104	\$94	\$88	\$85
Coolant Piping (\$/system)	\$3	\$3	\$3	\$3	\$3	\$3
Markup (\$/system)	\$65	\$61	\$58	\$49	\$43	\$41
<b>Total Cost (\$/system)</b>	<b>\$227</b>	<b>\$219</b>	<b>\$212</b>	<b>\$191</b>	<b>\$177</b>	<b>\$171</b>
<b>Total Cost (\$/kWnet)</b>	<b>\$1.42</b>	<b>\$1.37</b>	<b>\$1.32</b>	<b>\$1.19</b>	<b>\$1.11</b>	<b>\$1.07</b>

#### 2020 Analysis

Annual Production Rate	200	500	1,000	10,000	50,000	100,000
Coolant Reservoir (\$/system)	\$2	\$2	\$2	\$2	\$2	\$2
Coolant Pump (\$/system)	\$37	\$37	\$36	\$34	\$33	\$33
Thermostat & Valve (\$/system)	\$8	\$8	\$8	\$8	\$8	\$8
Radiator (\$/system)	\$105	\$101	\$98	\$89	\$83	\$80
Coolant Piping (\$/system)	\$3	\$3	\$3	\$3	\$3	\$3
Markup (\$/system)	\$63	\$59	\$56	\$47	\$42	\$40
<b>Total Cost (\$/system)</b>	<b>\$219</b>	<b>\$210</b>	<b>\$204</b>	<b>\$184</b>	<b>\$171</b>	<b>\$165</b>
<b>Total Cost (\$/kWnet)</b>	<b>\$1.37</b>	<b>\$1.31</b>	<b>\$1.27</b>	<b>\$1.15</b>	<b>\$1.07</b>	<b>\$1.03</b>

#### 2025 Analysis

Annual Production Rate	200	500	1,000	10,000	50,000	100,000
Coolant Reservoir (\$/system)	\$2	\$2	\$2	\$2	\$2	\$2
Coolant Pump (\$/system)	\$35	\$34	\$33	\$32	\$31	\$30
Thermostat & Valve (\$/system)	\$8	\$8	\$8	\$7	\$7	\$7
Radiator (\$/system)	\$91	\$88	\$85	\$77	\$72	\$70
Coolant Piping (\$/system)	\$3	\$3	\$3	\$3	\$3	\$3
Markup (\$/system)	\$56	\$52	\$50	\$42	\$37	\$35
<b>Total Cost (\$/system)</b>	<b>\$194</b>	<b>\$186</b>	<b>\$181</b>	<b>\$163</b>	<b>\$151</b>	<b>\$147</b>
<b>Total Cost (\$/kWnet)</b>	<b>\$1.21</b>	<b>\$1.16</b>	<b>\$1.13</b>	<b>\$1.02</b>	<b>\$0.95</b>	<b>\$0.92</b>

### 21.2.4 Fuel Loop

#### 2018 Analysis

Annual Production Rate	200	500	1,000	10,000	50,000	100,000
Flow Diverter Valve (\$/system)	\$29	\$29	\$29	\$29	\$29	\$29
Pressure Transducer (\$/system)	\$121	\$121	\$121	\$111	\$102	\$99
Over-Pressure Cut-Off Valve (\$/system)	\$50	\$48	\$46	\$40	\$36	\$35
Hydrogen Injector (\$/system)	\$247	\$209	\$184	\$121	\$90	\$79
Hydrogen Ejector (\$/system)	\$111	\$102	\$94	\$72	\$57	\$51
Check Valves (\$/system)	\$14	\$14	\$14	\$14	\$14	\$14
Purge Valves (\$/system)	\$80	\$76	\$73	\$64	\$58	\$56
Hydrogen Piping (\$/system)	\$164	\$153	\$146	\$127	\$116	\$112
Markup (\$/system)	\$330	\$293	\$268	\$200	\$164	\$151
<b>Total Cost (\$/system)</b>	<b>\$1,147</b>	<b>\$1,045</b>	<b>\$977</b>	<b>\$779</b>	<b>\$668</b>	<b>\$627</b>
<b>Total Cost (\$/kWnet)</b>	<b>\$7.17</b>	<b>\$6.53</b>	<b>\$6.10</b>	<b>\$4.87</b>	<b>\$4.17</b>	<b>\$3.92</b>

## 2020 Analysis

Annual Production Rate	200	500	1,000	10,000	50,000	100,000
Flow Diverter Valve (\$/system)	\$29	\$29	\$29	\$29	\$29	\$29
Pressure Transducer (\$/system)	\$121	\$121	\$121	\$111	\$102	\$99
Over-Pressure Cut-Off Valve (\$/system)	\$50	\$48	\$46	\$40	\$36	\$35
Hydrogen Injector (\$/system)	\$247	\$209	\$184	\$121	\$90	\$79
Hydrogen Ejector (\$/system)	\$111	\$102	\$94	\$72	\$57	\$51
Check Valves (\$/system)	\$14	\$14	\$14	\$14	\$14	\$14
Purge Valves (\$/system)	\$80	\$76	\$73	\$64	\$58	\$56
Hydrogen Piping (\$/system)	\$164	\$153	\$146	\$127	\$116	\$112
Markup (\$/system)	\$330	\$293	\$268	\$200	\$164	\$151
<b>Total Cost (\$/system)</b>	<b>\$1,147</b>	<b>\$1,045</b>	<b>\$977</b>	<b>\$779</b>	<b>\$668</b>	<b>\$627</b>
<b>Total Cost (\$/kWnet)</b>	<b>\$7.17</b>	<b>\$6.53</b>	<b>\$6.10</b>	<b>\$4.87</b>	<b>\$4.17</b>	<b>\$3.92</b>

## 2025 Analysis

Annual Production Rate	200	500	1,000	10,000	50,000	100,000
Flow Diverter Valve (\$/system)	\$29	\$29	\$29	\$29	\$29	\$29
Pressure Transducer (\$/system)	\$121	\$121	\$121	\$111	\$102	\$99
Over-Pressure Cut-Off Valve (\$/system)	\$50	\$48	\$46	\$40	\$36	\$35
Hydrogen Injector (\$/system)	\$247	\$209	\$184	\$121	\$90	\$79
Hydrogen Ejector (\$/system)	\$111	\$102	\$94	\$72	\$57	\$51
Check Valves (\$/system)	\$14	\$14	\$14	\$14	\$14	\$14
Purge Valves (\$/system)	\$80	\$76	\$73	\$64	\$58	\$56
Hydrogen Piping (\$/system)	\$164	\$153	\$146	\$127	\$116	\$112
Markup (\$/system)	\$330	\$293	\$268	\$200	\$164	\$151
<b>Total Cost (\$/system)</b>	<b>\$1,147</b>	<b>\$1,045</b>	<b>\$977</b>	<b>\$779</b>	<b>\$668</b>	<b>\$627</b>
<b>Total Cost (\$/kWnet)</b>	<b>\$7.17</b>	<b>\$6.53</b>	<b>\$6.10</b>	<b>\$4.87</b>	<b>\$4.17</b>	<b>\$3.92</b>

## 21.2.5 System Controller

### 2018 Analysis

Annual Production Rate	200	500	1,000	10,000	50,000	100,000
System Controller	\$189	\$184	\$181	\$171	\$164	\$162
Markup (\$/system)	\$76	\$72	\$69	\$59	\$53	\$51
<b>Total Cost (\$/system)</b>	<b>\$266</b>	<b>\$256</b>	<b>\$250</b>	<b>\$230</b>	<b>\$218</b>	<b>\$213</b>
<b>Total Cost (\$/kWnet)</b>	<b>\$1.66</b>	<b>\$1.60</b>	<b>\$1.56</b>	<b>\$1.44</b>	<b>\$1.36</b>	<b>\$1.33</b>

### 2020 Analysis

Annual Production Rate	200	500	1,000	10,000	50,000	100,000
System Controller	\$189	\$184	\$181	\$171	\$164	\$162
Markup (\$/system)	\$76	\$72	\$69	\$59	\$53	\$51
<b>Total Cost (\$/system)</b>	<b>\$266</b>	<b>\$256</b>	<b>\$250</b>	<b>\$230</b>	<b>\$218</b>	<b>\$213</b>
<b>Total Cost (\$/kWnet)</b>	<b>\$1.66</b>	<b>\$1.60</b>	<b>\$1.56</b>	<b>\$1.44</b>	<b>\$1.36</b>	<b>\$1.33</b>

### 2025 Analysis

Annual Production Rate	200	500	1,000	10,000	50,000	100,000
System Controller	\$189	\$184	\$181	\$171	\$164	\$162
Markup (\$/system)	\$76	\$72	\$69	\$59	\$53	\$51
<b>Total Cost (\$/system)</b>	<b>\$266</b>	<b>\$256</b>	<b>\$250</b>	<b>\$230</b>	<b>\$218</b>	<b>\$213</b>
<b>Total Cost (\$/kWnet)</b>	<b>\$1.66</b>	<b>\$1.60</b>	<b>\$1.56</b>	<b>\$1.44</b>	<b>\$1.36</b>	<b>\$1.33</b>

## 21.2.6 Sensors

### 2018 Analysis

Annual Production Rate	200	500	1,000	10,000	50,000	100,000
Current Sensors (\$/system)	\$38	\$38	\$38	\$38	\$38	\$38
Voltage Sensors (\$/system)	\$15	\$15	\$15	\$15	\$15	\$15
Hydrogen Sensors (\$/system)	\$260	\$231	\$210	\$156	\$126	\$116
Air/H2 Differential Pressure Sensors (\$/system)	\$220	\$191	\$172	\$121	\$95	\$86
Markup (\$/system)	\$215	\$185	\$165	\$114	\$89	\$80
<b>Total Cost (\$/system)</b>	<b>\$748</b>	<b>\$659</b>	<b>\$600</b>	<b>\$444</b>	<b>\$363</b>	<b>\$334</b>
<b>Total Cost (\$/kWnet)</b>	<b>\$4.68</b>	<b>\$4.12</b>	<b>\$3.75</b>	<b>\$2.77</b>	<b>\$2.27</b>	<b>\$2.09</b>

### 2020 Analysis

Annual Production Rate	200	500	1,000	10,000	50,000	100,000
Current Sensors (\$/system)	\$38	\$38	\$38	\$38	\$38	\$38
Voltage Sensors (\$/system)	\$15	\$15	\$15	\$15	\$15	\$15
Hydrogen Sensors (\$/system)	\$260	\$231	\$210	\$156	\$126	\$116
Air/H2 Differential Pressure Sensors (\$/system)	\$220	\$191	\$172	\$121	\$95	\$86
Markup (\$/system)	\$215	\$185	\$165	\$114	\$89	\$80
<b>Total Cost (\$/system)</b>	<b>\$748</b>	<b>\$659</b>	<b>\$600</b>	<b>\$444</b>	<b>\$363</b>	<b>\$334</b>
<b>Total Cost (\$/kWnet)</b>	<b>\$4.68</b>	<b>\$4.12</b>	<b>\$3.75</b>	<b>\$2.77</b>	<b>\$2.27</b>	<b>\$2.09</b>

### 2025 Analysis

Annual Production Rate	200	500	1,000	10,000	50,000	100,000
Current Sensors (\$/system)	\$38	\$38	\$38	\$38	\$38	\$38
Voltage Sensors (\$/system)	\$15	\$15	\$15	\$15	\$15	\$15
Hydrogen Sensors (\$/system)	\$260	\$231	\$210	\$156	\$126	\$116
Air/H2 Differential Pressure Sensors (\$/system)	\$220	\$191	\$172	\$121	\$95	\$86
Markup (\$/system)	\$215	\$185	\$165	\$114	\$89	\$80
<b>Total Cost (\$/system)</b>	<b>\$748</b>	<b>\$659</b>	<b>\$600</b>	<b>\$444</b>	<b>\$363</b>	<b>\$334</b>
<b>Total Cost (\$/kWnet)</b>	<b>\$4.68</b>	<b>\$4.12</b>	<b>\$3.75</b>	<b>\$2.77</b>	<b>\$2.27</b>	<b>\$2.09</b>

### 21.2.6.1 Hydrogen Sensors

#### 2018 Analysis

Annual Production Rate	200	500	1,000	10,000	50,000	100,000
Sensors per system	1	1	1	1	1	1
Sensor (\$)	\$260	\$231	\$210	\$156	\$126	\$116
<b>Total Cost (\$/system)</b>	<b>\$260</b>	<b>\$231</b>	<b>\$210</b>	<b>\$156</b>	<b>\$126</b>	<b>\$116</b>
<b>Total Cost (\$/kWnet)</b>	<b>\$1.63</b>	<b>\$1.44</b>	<b>\$1.32</b>	<b>\$0.97</b>	<b>\$0.79</b>	<b>\$0.72</b>

#### 2020 Analysis

Annual Production Rate	200	500	1,000	10,000	50,000	100,000
Sensors per system	1	1	1	1	1	1
Sensor (\$)	\$260	\$231	\$210	\$156	\$126	\$116
<b>Total Cost (\$/system)</b>	<b>\$260</b>	<b>\$231</b>	<b>\$210</b>	<b>\$156</b>	<b>\$126</b>	<b>\$116</b>
<b>Total Cost (\$/kWnet)</b>	<b>\$1.63</b>	<b>\$1.44</b>	<b>\$1.32</b>	<b>\$0.97</b>	<b>\$0.79</b>	<b>\$0.72</b>

#### 2025 Analysis

Annual Production Rate	200	500	1,000	10,000	50,000	100,000
Sensors per system	1	1	1	1	1	1
Sensor (\$)	\$260	\$231	\$210	\$156	\$126	\$116
<b>Total Cost (\$/system)</b>	<b>\$260</b>	<b>\$231</b>	<b>\$210</b>	<b>\$156</b>	<b>\$126</b>	<b>\$116</b>
<b>Total Cost (\$/kWnet)</b>	<b>\$1.63</b>	<b>\$1.44</b>	<b>\$1.32</b>	<b>\$0.97</b>	<b>\$0.79</b>	<b>\$0.72</b>

## 21.2.7 Miscellaneous BOP

### 2018 Analysis

Annual Production Rate	200	500	1,000	10,000	50,000	100,000
Belly Pan (\$/system)	\$247	\$103	\$55	\$12	\$9	\$8
H2/Air Mixer (\$/system)	\$12	\$11	\$11	\$10	\$10	\$10
Mounting Frames (\$/system)	\$234	\$222	\$213	\$186	\$169	\$162
Wiring (\$/system)	\$216	\$210	\$206	\$190	\$180	\$175
Fasteners for Wiring & Piping (\$/system)	\$43	\$42	\$41	\$38	\$36	\$35
Markup (\$/system)	\$199	\$185	\$174	\$144	\$125	\$118
<b>Total Cost (\$/system)</b>	<b>\$952</b>	<b>\$773</b>	<b>\$700</b>	<b>\$581</b>	<b>\$529</b>	<b>\$508</b>
<b>Total Cost (\$/kWnet)</b>	<b>\$5.95</b>	<b>\$4.83</b>	<b>\$4.38</b>	<b>\$3.63</b>	<b>\$3.30</b>	<b>\$3.18</b>

### 2020 Analysis

Annual Production Rate	200	500	1,000	10,000	50,000	100,000
Belly Pan (\$/system)	\$247	\$103	\$55	\$12	\$9	\$8
H2/Air Mixer (\$/system)	\$12	\$11	\$11	\$10	\$10	\$10
Mounting Frames (\$/system)	\$234	\$222	\$213	\$186	\$169	\$162
Wiring (\$/system)	\$216	\$210	\$206	\$190	\$180	\$175
Fasteners for Wiring & Piping (\$/system)	\$43	\$42	\$41	\$38	\$36	\$35
Markup (\$/system)	\$199	\$185	\$174	\$144	\$125	\$118
<b>Total Cost (\$/system)</b>	<b>\$952</b>	<b>\$773</b>	<b>\$700</b>	<b>\$581</b>	<b>\$529</b>	<b>\$508</b>
<b>Total Cost (\$/kWnet)</b>	<b>\$5.95</b>	<b>\$4.83</b>	<b>\$4.38</b>	<b>\$3.63</b>	<b>\$3.30</b>	<b>\$3.18</b>

### 2025 Analysis

Annual Production Rate	200	500	1,000	10,000	50,000	100,000
Belly Pan (\$/system)	\$247	\$103	\$55	\$12	\$9	\$8
H2/Air Mixer (\$/system)	\$12	\$11	\$11	\$10	\$10	\$10
Mounting Frames (\$/system)	\$234	\$222	\$213	\$186	\$169	\$162
Wiring (\$/system)	\$216	\$210	\$206	\$190	\$180	\$175
Fasteners for Wiring & Piping (\$/system)	\$43	\$42	\$41	\$38	\$36	\$35
Markup (\$/system)	\$199	\$185	\$174	\$144	\$125	\$118
<b>Total Cost (\$/system)</b>	<b>\$952</b>	<b>\$773</b>	<b>\$700</b>	<b>\$581</b>	<b>\$529</b>	<b>\$508</b>
<b>Total Cost (\$/kWnet)</b>	<b>\$5.95</b>	<b>\$4.83</b>	<b>\$4.38</b>	<b>\$3.63</b>	<b>\$3.30</b>	<b>\$3.18</b>

### 21.2.7.1 Belly Pan

#### 2018 Analysis

Annual Production Rate	200	500	1,000	10,000	50,000	100,000
Manufacture or Job Shop	Job Shop	Job Shop	Job Shop	Job Shop	Manufactured	Manufactured
Job Shop Line Utilization (%)	37%	37%	38%	43%	66%	59%
Job Shop Total Machine Rate (\$/min)	\$1.42	\$1.41	\$1.41	\$1.37	\$1.25	\$1.28
Manufactured Line Utilization (%)	0.1%	0.3%	0.6%	5.9%	29.4%	58.9%
Manufactured Total Machine Rate (\$/min)	\$91.54	\$37.10	\$18.95	\$2.62	\$1.16	\$0.98
<b>Line Utilization Used (%)</b>	<b>37.1%</b>	<b>37.3%</b>	<b>37.6%</b>	<b>42.9%</b>	<b>29.4%</b>	<b>58.9%</b>
<b>Total Machine Rate Used (\$/min)</b>	<b>\$1.42</b>	<b>\$1.41</b>	<b>\$1.41</b>	<b>\$1.37</b>	<b>\$1.16</b>	<b>\$0.98</b>

Annual Production Rate	30,000	30,000	30,000	80,000	100,000	500,000
Material (\$/system)	\$4	\$4	\$4	\$4	\$4	\$4
Manufacturing (\$/system)	\$2	\$2	\$2	\$2	\$1	\$1
Tooling (\$/system)	\$170	\$68	\$34	\$3	\$1	\$0
Markup (\$/system)	\$71	\$29	\$15	\$3	\$3	\$2
<b>Total Cost (\$/system)</b>	<b>\$247</b>	<b>\$103</b>	<b>\$55</b>	<b>\$12</b>	<b>\$9</b>	<b>\$8</b>
<b>Total Cost (\$/kWnet)</b>	<b>\$1.54</b>	<b>\$0.64</b>	<b>\$0.34</b>	<b>\$0.08</b>	<b>\$0.06</b>	<b>\$0.05</b>



## 2020 Analysis

Annual Production Rate	200	500	1,000	10,000	50,000	100,000
Manufacture or Job Shop	Job Shop	Job Shop	Job Shop	Job Shop	Manufactured	Manufactured
Job Shop Line Utilization (%)	37%	37%	38%	43%	66%	59%
Job Shop Total Machine Rate (\$/min)	\$1.42	\$1.41	\$1.41	\$1.37	\$1.25	\$1.28
Manufactured Line Utilization (%)	0.1%	0.3%	0.6%	5.9%	29.4%	58.9%
Manufactured Total Machine Rate (\$/min)	\$91.54	\$37.10	\$18.95	\$2.62	\$1.16	\$0.98
Line Utilization Used (%)	37.1%	37.3%	37.6%	42.9%	29.4%	58.9%
Total Machine Rate Used (\$/min)	\$1.42	\$1.41	\$1.41	\$1.37	\$1.16	\$0.98

Annual Production Rate	30,000	30,000	30,000	80,000	100,000	500,000
Material (\$/system)	\$4	\$4	\$4	\$4	\$4	\$4
Manufacturing (\$/system)	\$2	\$2	\$2	\$2	\$1	\$1
Tooling (\$/system)	\$170	\$68	\$34	\$3	\$1	\$0
Markup (\$/system)	\$71	\$29	\$15	\$3	\$3	\$2
Total Cost (\$/system)	\$247	\$103	\$55	\$12	\$9	\$8
Total Cost (\$/kWnet)	\$1.54	\$0.64	\$0.34	\$0.08	\$0.06	\$0.05

## 2025 Analysis

Annual Production Rate	200	500	1,000	10,000	50,000	100,000
Manufacture or Job Shop	Job Shop	Job Shop	Job Shop	Job Shop	Manufactured	Manufactured
Job Shop Line Utilization (%)	37%	37%	38%	43%	66%	59%
Job Shop Total Machine Rate (\$/min)	\$1.42	\$1.41	\$1.41	\$1.37	\$1.25	\$1.28
Manufactured Line Utilization (%)	0.1%	0.3%	0.6%	5.9%	29.4%	58.9%
Manufactured Total Machine Rate (\$/min)	\$91.54	\$37.10	\$18.95	\$2.62	\$1.16	\$0.98
Line Utilization Used (%)	37.1%	37.3%	37.6%	42.9%	29.4%	58.9%
Total Machine Rate Used (\$/min)	\$1.42	\$1.41	\$1.41	\$1.37	\$1.16	\$0.98

Annual Production Rate	30,000	30,000	30,000	80,000	100,000	500,000
Material (\$/system)	\$4	\$4	\$4	\$4	\$4	\$4
Manufacturing (\$/system)	\$2	\$2	\$2	\$2	\$1	\$1
Tooling (\$/system)	\$170	\$68	\$34	\$3	\$1	\$0
Markup (\$/system)	\$71	\$29	\$15	\$3	\$3	\$2
Total Cost (\$/system)	\$247	\$103	\$55	\$12	\$9	\$8
Total Cost (\$/kWnet)	\$1.54	\$0.64	\$0.34	\$0.08	\$0.06	\$0.05

### 21.2.7.2 H2/Air Mixer

## 2018 Analysis

Annual Production Rate	200	500	1,000	10,000	50,000	100,000
Materials (\$/system)	\$3	\$3	\$3	\$3	\$3	\$3
Manufacturing (\$/System)	\$3	\$3	\$3	\$3	\$3	\$3
Markup (\$/System)	\$5	\$5	\$4	\$4	\$3	\$3
Total Cost (\$/system)	\$12	\$11	\$11	\$10	\$10	\$10
Total Cost (\$/kWnet)	\$0.07	\$0.07	\$0.07	\$0.06	\$0.06	\$0.06

### 2020 Analysis

Annual Production Rate	200	500	1,000	10,000	50,000	100,000
Materials (\$/system)	\$3	\$3	\$3	\$3	\$3	\$3
Manufacturing (\$/System)	\$3	\$3	\$3	\$3	\$3	\$3
Markup (\$/System)	\$5	\$5	\$4	\$4	\$3	\$3
<b>Total Cost (\$/system)</b>	<b>\$12</b>	<b>\$11</b>	<b>\$11</b>	<b>\$10</b>	<b>\$10</b>	<b>\$10</b>
<b>Total Cost (\$/kWnet)</b>	<b>\$0.07</b>	<b>\$0.07</b>	<b>\$0.07</b>	<b>\$0.06</b>	<b>\$0.06</b>	<b>\$0.06</b>

### 2025 Analysis

Annual Production Rate	200	500	1,000	10,000	50,000	100,000
Materials (\$/system)	\$3	\$3	\$3	\$3	\$3	\$3
Manufacturing (\$/System)	\$3	\$3	\$3	\$3	\$3	\$3
Markup (\$/System)	\$5	\$5	\$4	\$4	\$3	\$3
<b>Total Cost (\$/system)</b>	<b>\$12</b>	<b>\$11</b>	<b>\$11</b>	<b>\$10</b>	<b>\$10</b>	<b>\$10</b>
<b>Total Cost (\$/kWnet)</b>	<b>\$0.07</b>	<b>\$0.07</b>	<b>\$0.07</b>	<b>\$0.06</b>	<b>\$0.06</b>	<b>\$0.06</b>

### 21.2.7.3 Wiring

#### 2018 Analysis

Annual Production Rate	200	500	1,000	10,000	50,000	100,000
Cables (\$/system)	\$72	\$70	\$69	\$64	\$60	\$59
Connectors (\$/System)	\$144	\$140	\$137	\$127	\$119	\$116
<b>Total Cost (\$/system)</b>	<b>\$216</b>	<b>\$210</b>	<b>\$206</b>	<b>\$190</b>	<b>\$180</b>	<b>\$175</b>
<b>Total Cost (\$/kWnet)</b>	<b>\$1.35</b>	<b>\$1.31</b>	<b>\$1.29</b>	<b>\$1.19</b>	<b>\$1.12</b>	<b>\$1.09</b>

#### 2020 Analysis

Annual Production Rate	200	500	1,000	10,000	50,000	100,000
Cables (\$/system)	\$72	\$70	\$69	\$64	\$60	\$59
Connectors (\$/System)	\$144	\$140	\$137	\$127	\$119	\$116
<b>Total Cost (\$/system)</b>	<b>\$216</b>	<b>\$210</b>	<b>\$206</b>	<b>\$190</b>	<b>\$180</b>	<b>\$175</b>
<b>Total Cost (\$/kWnet)</b>	<b>\$1.35</b>	<b>\$1.31</b>	<b>\$1.29</b>	<b>\$1.19</b>	<b>\$1.12</b>	<b>\$1.09</b>

#### 2025 Analysis

Annual Production Rate	200	500	1,000	10,000	50,000	100,000
Cables (\$/system)	\$72	\$70	\$69	\$64	\$60	\$59
Connectors (\$/System)	\$144	\$140	\$137	\$127	\$119	\$116
<b>Total Cost (\$/system)</b>	<b>\$216</b>	<b>\$210</b>	<b>\$206</b>	<b>\$190</b>	<b>\$180</b>	<b>\$175</b>
<b>Total Cost (\$/kWnet)</b>	<b>\$1.35</b>	<b>\$1.31</b>	<b>\$1.29</b>	<b>\$1.19</b>	<b>\$1.12</b>	<b>\$1.09</b>

### 21.2.8 System Assembly

#### 2018 Analysis

Annual Production Rate	200	500	1,000	10,000	50,000	100,000
Assembly Method	Assembly Line	Assembly Line	Assembly Line	Assembly Line	Assembly Line	Assembly Line
Index Time (min)	106	106	106	106	106	106
Capital Cost (\$/line)	\$50,000	\$50,000	\$50,000	\$100,000	\$100,000	\$100,000
Simultaneous Lines	1	1	1	1	4	7
Laborers per Line	12	12	12	12	12	12
Cost per Stack (\$)	\$225.27	\$150.27	\$124.64	\$99.01	\$93.52	\$91.36
<b>Line Utilization Used (%)</b>	<b>1%</b>	<b>3%</b>	<b>7%</b>	<b>67%</b>	<b>83%</b>	<b>95%</b>
<b>Total Machine Rate Used (\$/min)</b>	<b>\$18.77</b>	<b>\$13.00</b>	<b>\$11.08</b>	<b>\$9.54</b>	<b>\$9.46</b>	<b>\$9.42</b>

Annual Production Rate	200	500	1,000	10,000	50,000	100,000
System Assembly & Testing (\$/System)	\$237	\$164	\$140	\$120	\$119	\$119
Markup (\$/system)	\$187	\$119	\$95	\$66	\$57	\$53
<b>Total Cost (\$/system)</b>	<b>\$423</b>	<b>\$282</b>	<b>\$234</b>	<b>\$186</b>	<b>\$176</b>	<b>\$172</b>
<b>Total Cost (\$/kWnet)</b>	<b>\$2.65</b>	<b>\$1.77</b>	<b>\$1.46</b>	<b>\$1.16</b>	<b>\$1.10</b>	<b>\$1.07</b>

## 2020 Analysis

Annual Production Rate	200	500	1,000	10,000	50,000	100,000
Assembly Method	Assembly Line	Assembly Line	Assembly Line	Assembly Line	Assembly Line	Assembly Line
Index Time (min)	108	108	108	108	108	108
Capital Cost (\$/line)	\$45,000	\$45,000	\$45,000	\$90,000	\$90,000	\$90,000
Simultaneous Lines	1	1	1	1	4	7
Laborers per Line	11	11	11	11	11	11
Cost per Stack (\$)	\$204.58	\$137.02	\$113.90	\$90.70	\$85.69	\$82.66
Line Utilization Used (%)	1%	3%	7%	67%	83%	95%
<b>Total Machine Rate Used (\$/min)</b>	<b>\$17.05</b>	<b>\$11.86</b>	<b>\$10.12</b>	<b>\$8.74</b>	<b>\$8.67</b>	<b>\$8.53</b>

Annual Production Rate	200	500	1,000	10,000	50,000	100,000
System Assembly & Testing (\$/System)	\$215	\$149	\$128	\$110	\$109	\$107
Markup (\$/system)	\$170	\$108	\$87	\$60	\$52	\$48
<b>Total Cost (\$/system)</b>	<b>\$385</b>	<b>\$258</b>	<b>\$214</b>	<b>\$170</b>	<b>\$161</b>	<b>\$155</b>
<b>Total Cost (\$/kWnet)</b>	<b>\$2.40</b>	<b>\$1.61</b>	<b>\$1.34</b>	<b>\$1.07</b>	<b>\$1.01</b>	<b>\$0.97</b>

## 2025 Analysis

Annual Production Rate	200	500	1,000	10,000	50,000	100,000
Assembly Method	Assembly Line	Assembly Line	Assembly Line	Assembly Line	Assembly Line	Assembly Line
Index Time (min)	108	108	108	108	108	108
Capital Cost (\$/line)	\$45,000	\$45,000	\$45,000	\$90,000	\$90,000	\$90,000
Simultaneous Lines	1	1	1	1	4	7
Laborers per Line	11	11	11	11	11	11
Cost per Stack (\$)	\$204.58	\$137.02	\$113.90	\$90.70	\$85.69	\$82.66
Line Utilization Used (%)	1%	3%	7%	67%	83%	95%
<b>Total Machine Rate Used (\$/min)</b>	<b>\$17.05</b>	<b>\$11.86</b>	<b>\$10.12</b>	<b>\$8.74</b>	<b>\$8.67</b>	<b>\$8.53</b>

Annual Production Rate	200	500	1,000	10,000	50,000	100,000
System Assembly & Testing (\$/System)	\$215	\$149	\$128	\$110	\$109	\$107
Markup (\$/system)	\$170	\$108	\$87	\$60	\$52	\$48
<b>Total Cost (\$/system)</b>	<b>\$385</b>	<b>\$258</b>	<b>\$214</b>	<b>\$170</b>	<b>\$161</b>	<b>\$155</b>
<b>Total Cost (\$/kWnet)</b>	<b>\$2.40</b>	<b>\$1.61</b>	<b>\$1.34</b>	<b>\$1.07</b>	<b>\$1.01</b>	<b>\$0.97</b>