

A Vehicle Manufacturer's Perspective on Higher-Octane Fuels

Tom Leone, Ford Motor Company



Research and
Advanced Engineering

DOE "Biomass 2014" meeting
Washington, D.C. July 29, 2014

Octane rating of fuel

The octane rating of a fuel is measured on a standardized test engine with variable compression ratio

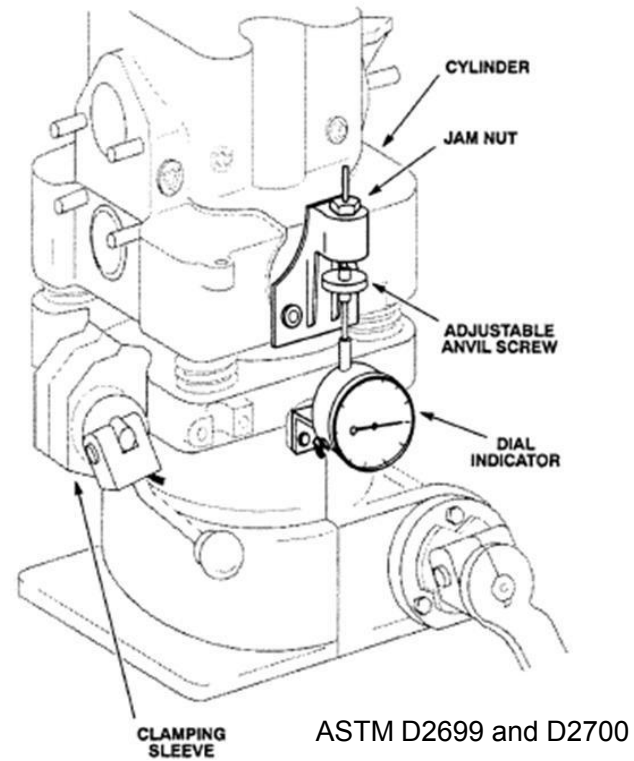

Compression Ratio (CR)

- Higher CR can improve efficiency
- But higher CR causes more knock and spark retard at high torques
 - This degrades torque capability and high-load efficiency
 - Production engines don't have variable CR
- Higher-octane fuel reduces knock, enables higher CR

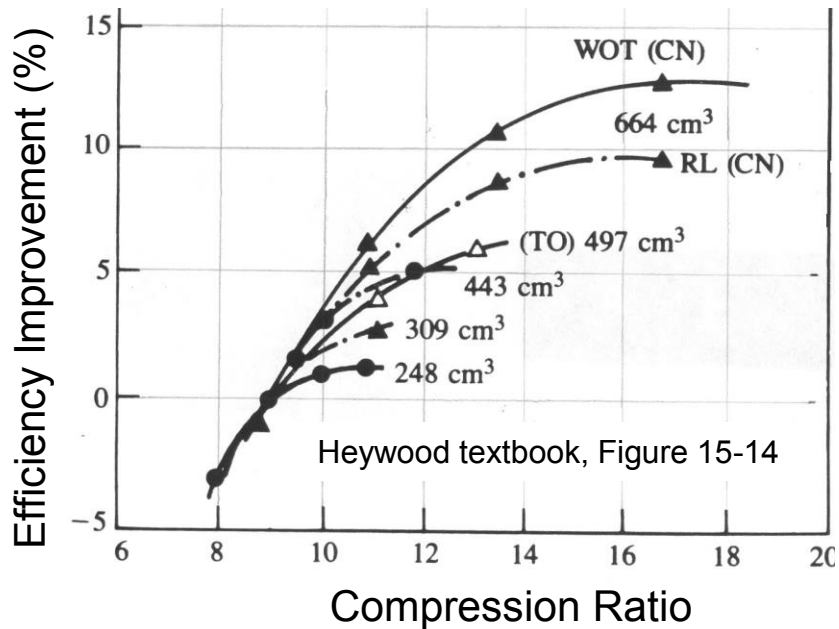

Increasing importance of octane rating

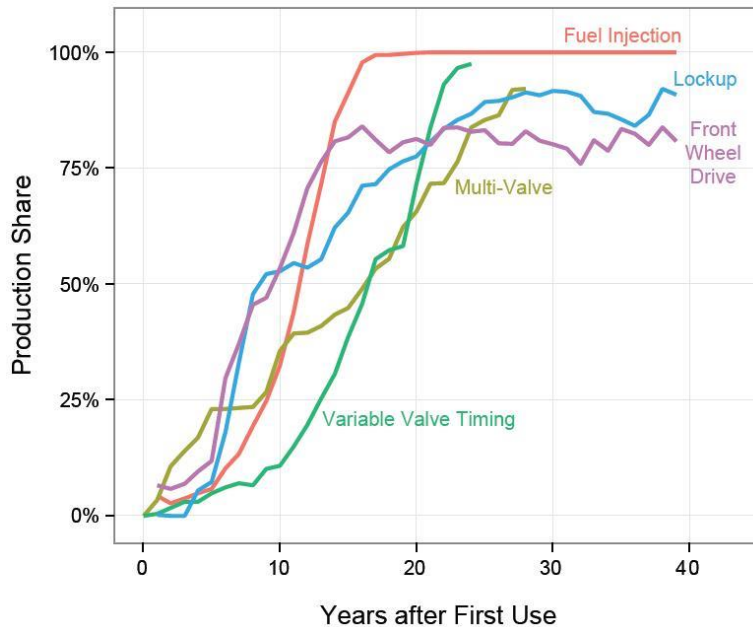

Technology is evolving rapidly to meet MPG and CO₂ goals

Market Share of Gasoline Turbo Vehicles

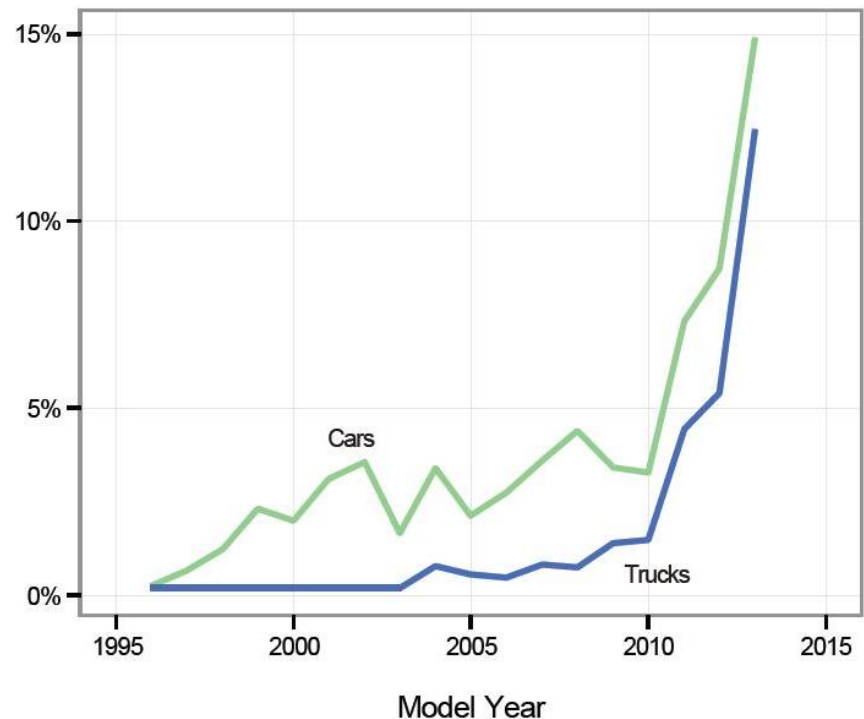

Downsizing, downspeeding, cylinder deactivation, hybridization, higher CR, etc. increase the benefits of higher-octane fuel

EPA report 420-R-13-011 "Light-Duty Automotive Technology, Carbon Dioxide Emissions, and Fuel Economy Trends: 1975 Through 2013"

Efficiency changes with octane rating and CR

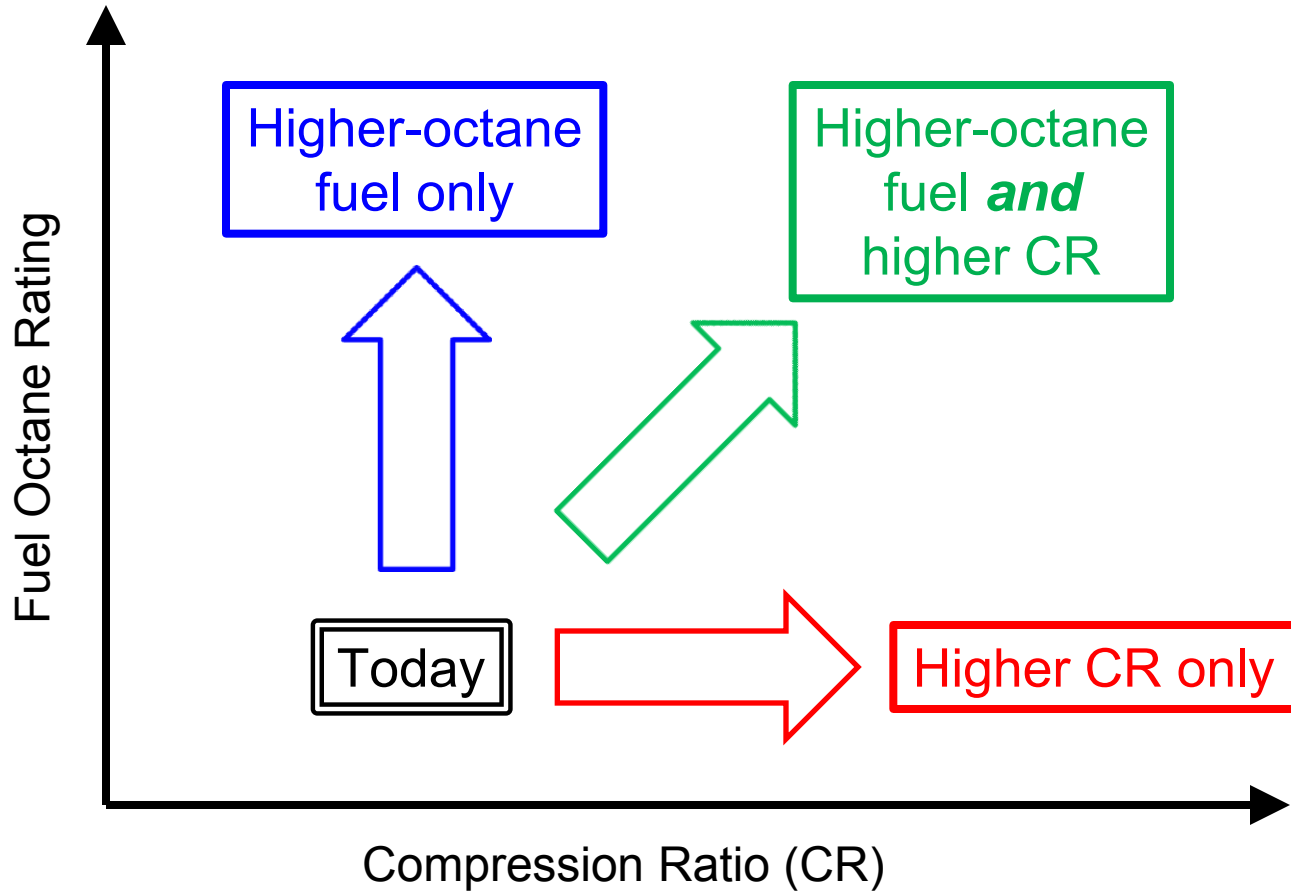

Quantitative examples

- Higher CR only:
 - 2.6% EPA CO₂ benefit
 - 4.9% US06 Highway CO₂ *penalty*
- Higher-octane fuel only:
 - 1.1% EPA CO₂ benefit
 - 2.5% US06 Highway CO₂ benefit
- Higher-octane fuel *and* higher CR:
 - 4.8% EPA CO₂ benefit
 - 4.9% US06 Highway CO₂ benefit

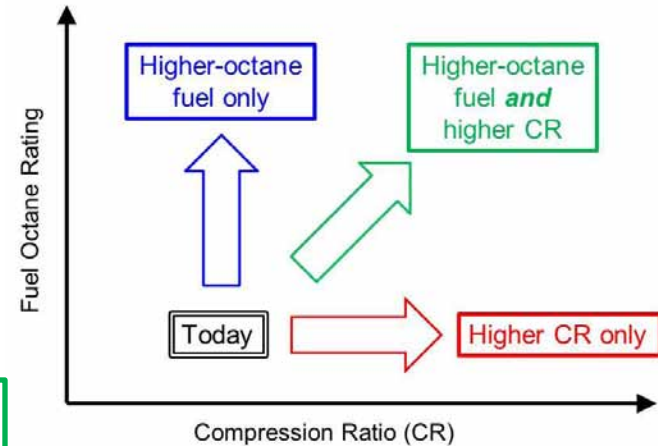

Best results are achieved by the ***combination*** of higher-octane fuel and an engine optimized for that fuel

Jung et al., "Fuel Economy and CO₂ Emissions of Ethanol-Gasoline Blends in a Turbocharged DI Engine", SAE paper 2013-01-1321, doi:10.4271/2013-01-1321.

Octane is important, but so is well-to-wheels CO₂

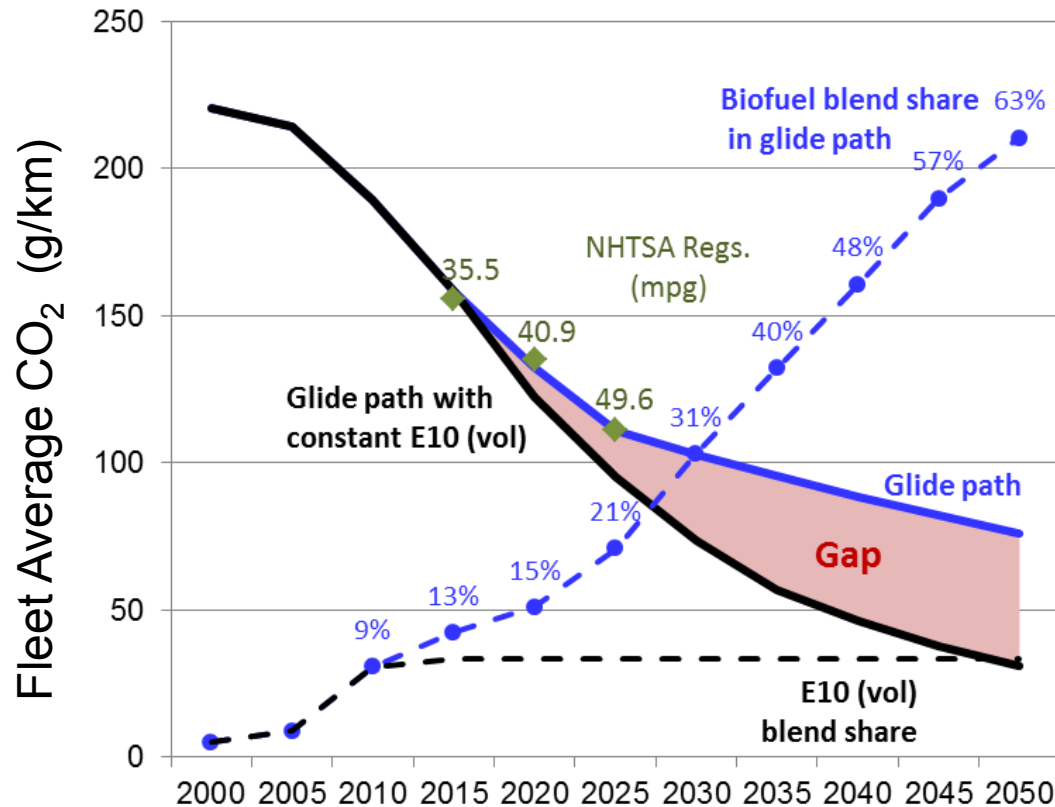

Long-term stabilization of CO₂ at 450 ppm requires contributions from both vehicle technology and biofuels

Winkler, Wallington, Maas, and Haas, "Light-Duty Vehicle CO₂ Targets Consistent with 450 ppm CO₂ Stabilization", Environmental Science & Technology, May 2014, dx.doi.org/10.1021/es405651p

Considerations for a future fuel

- Higher octane rating
- Low well-to-wheels carbon intensity, high renewable content
- Compatibility:
 - Distribution infrastructure
 - Vehicles
 - Lawn mowers, boats, generators, snow blowers, etc.
- Improved criteria pollutants (e.g. particulates)
- Low cost

Compromises may be necessary to achieve a balance of attributes!

Pathway to a higher-octane lower-carbon fuel

1. Agree on a future fuel
2. Introduce **compatible*** vehicles, off-road engines, and fuel distribution system
3. Optimize for the new fuel **after** it becomes “regular fuel”

* Higher-octane fuel could be backwards compatible (like today’s premium fuel) but lower-carbon fuel would probably add compatibility issues

Future Fuels: Shared Responsibility

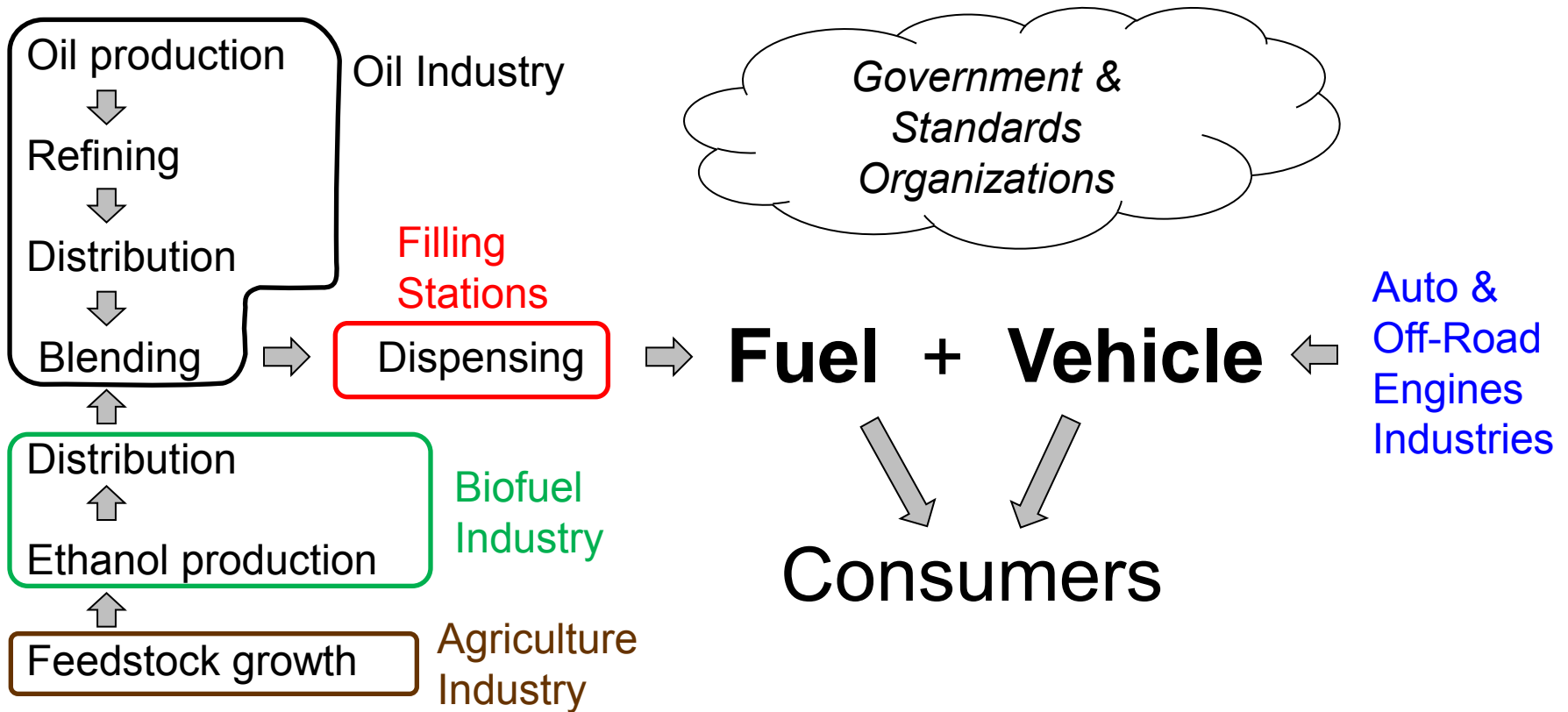

Any future fuel needs to provide value for each stakeholder individually, as well as for the consumer

Summary

- Higher-octane fuel **directly** improves efficiency of today's engines, by reducing spark retard at high torques
- Higher-octane fuel can **enable** even larger efficiency improvements: higher compression ratio, downsizing, downspeeding, cylinder deactivation, hybridization, etc.
 - To achieve the full potential of these trends, the **minimum** market fuel octane must be increased
- Fuels with lower well-to-wheels CO₂ are critical for meeting long-term CO₂ goals
- Coordination is needed between government and multiple industries (automotive, petroleum, fuel distribution, and off-road engines)

Additional reading

- Speth et al. (MIT) "Economic and Environmental Benefits of Higher-Octane Gasoline," *Environmental Science & Technology*, May 2014, doi:10.1021/es405557p.
- Stein et al. (AVL & Ford), "An Overview of the Effects of Ethanol-Gasoline Blends on SI Engine Performance, Fuel Efficiency, and Emissions", SAE Paper 2013-01-1635 (2013), doi:10.4271/2013-01-1635.