

# Resilient Distribution Systems Portfolio Overview

**Juan Torres**

National Renewable Energy Laboratory

DOE GMI Peer Review, September 4-7, 2018

# Resilient Distribution Systems

## Lab Call Overview

- ▶ Seeks to develop and validate innovative approaches to enhance the resilience of **distribution systems**, including **microgrids**, with **high penetration of clean DERs**.

- ▶ Focus on **field validations** including control/coordination strategies, real-time system monitoring, robust communications infrastructure, grid planning and analytical platforms, and integration of multiple DER technologies.

- ▶ Address **cybersecurity** needs in grid technologies from the earliest stages to survive a cyber-incident.

- ▶ Builds on FY16-18 GMLC Lab Call

- ▶ **POP – FY18/19/20**

- ▶ **Total Funding - \$32M**



# 1.5.01 - Grid Resilience and Intelligence Platform (GRIP)

► **Goal:** Develop and validate a new software platform to help operators anticipate, respond to, and recover from extreme events.

► **Labs:** SLAC, LBNL

► **Partners:**

- National Rural Electric Cooperative Association
- Southern California Edison
- Packetized Energy
- Vermont Electric Cooperative
- Presence
- University of California Berkeley
- Stanford University

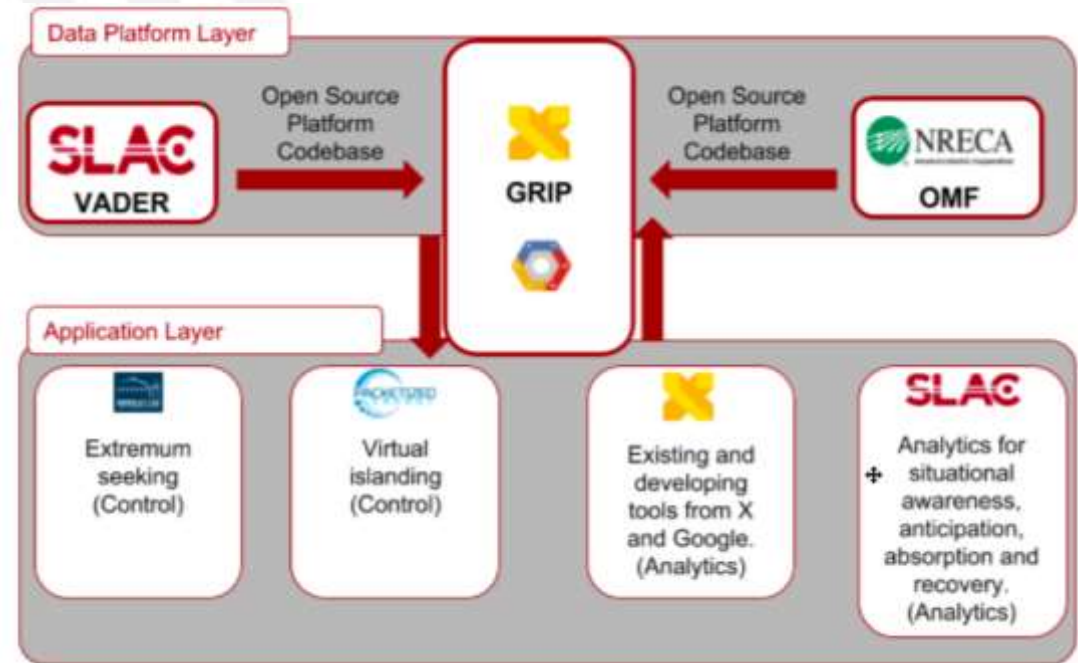

# 1.5.02 - Resilient Alaskan Distribution System Improvements using Automation, Network analysis, Control, and Energy storage (RADIANCE)

- ▶ **Goal:** Increase grid resilience for geographically remote communities using a cyber-secure resilience framework.
- ▶ **Labs:** INL, SNL, PNNL
- ▶ **Partners:**
  - ❑ City of Cordova
  - ❑ Cordova Electric Cooperative
  - ❑ University of Alaska – Alaska Center for Energy and Power
  - ❑ Washington State University
  - ❑ Florida State University
  - ❑ New Mexico State University
  - ❑ Siemens Corporation
  - ❑ Alaska Village Electric Cooperative
  - ❑ National Rural Electric Cooperative Association



# 1.5.03 – Increasing Distribution Resiliency Using Flexible DER and Microgrid Assets Enabled by OpenFMB (Decentralized FLISR)

► **Goal:** Develop and test a flexible architecture that coordinates decentralized and centralized assets within a central distribution management system.

► **Labs:** PNNL, ORNL, NREL

► **Partners:**

- Duke Energy
- GE Grid Solutions
- University of North Carolina Charlotte
- University of Tennessee
- Smart Electric Power Alliance (SEPA)

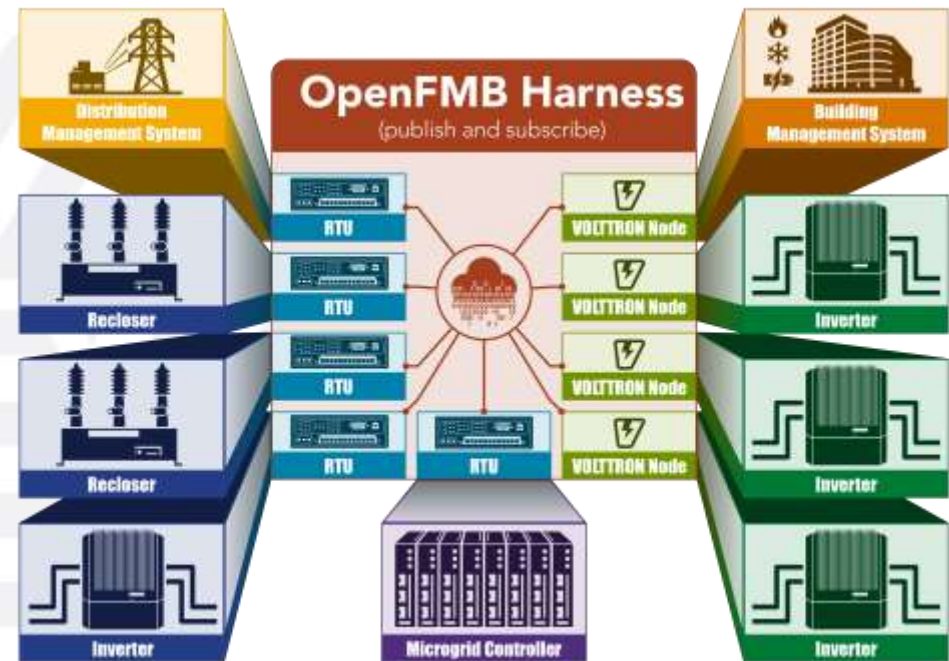

# 1.5.04 - Integration of Responsive Residential Loads into Distribution Management Systems

- ▶ **Goal:** Provide electric utilities with the necessary software and hardware, all based on open standards, to leverage demand-side management of residential DERs.

- ▶ **Labs:** ORNL, PNNL

- ▶ **Partners:**

- Electric Power Research Institute
- National Rural Electric Cooperative Association
- Southern Company
- Tennessee Valley Authority
- Duke Energy
- Con Edison
- Electric Power Board
- Jackson EMC

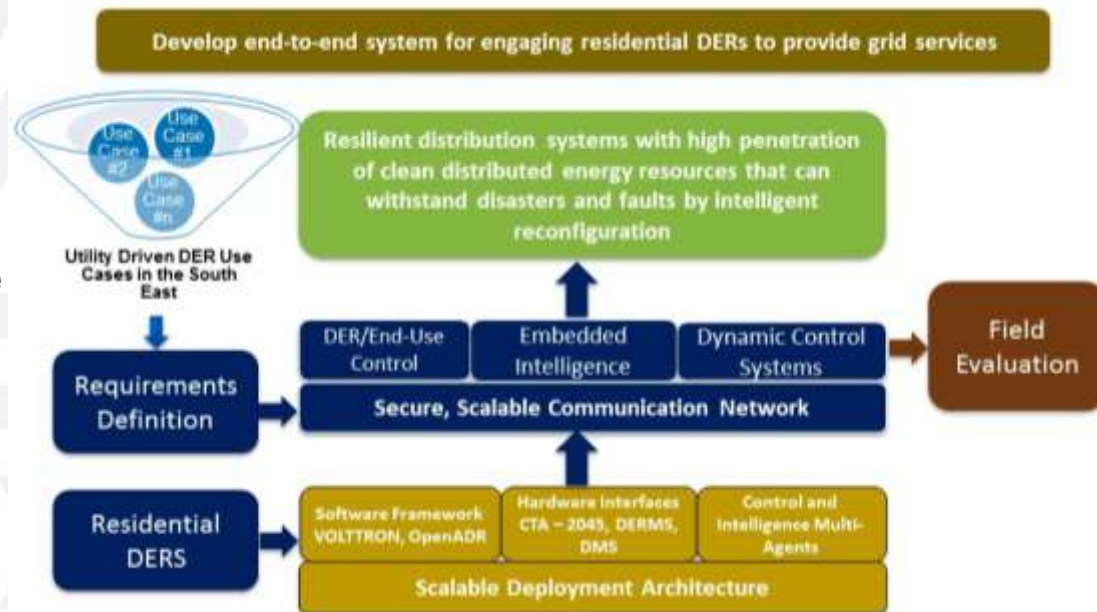

# 1.5.05 - CleanStart Distributed Energy Resource Management System (DERMS)

► **Goal:** Design, implement, and validate a novel blackstart and dynamic microgrid solution from DER feeders.

► **Labs:** LLNL, PNNL, LANL

► **Partners:**

- Smarter Grid Solutions
- SolarEdge
- PingThings
- City of Riverside Public Utility
- Pacific Gas & Electric
- University of California Riverside

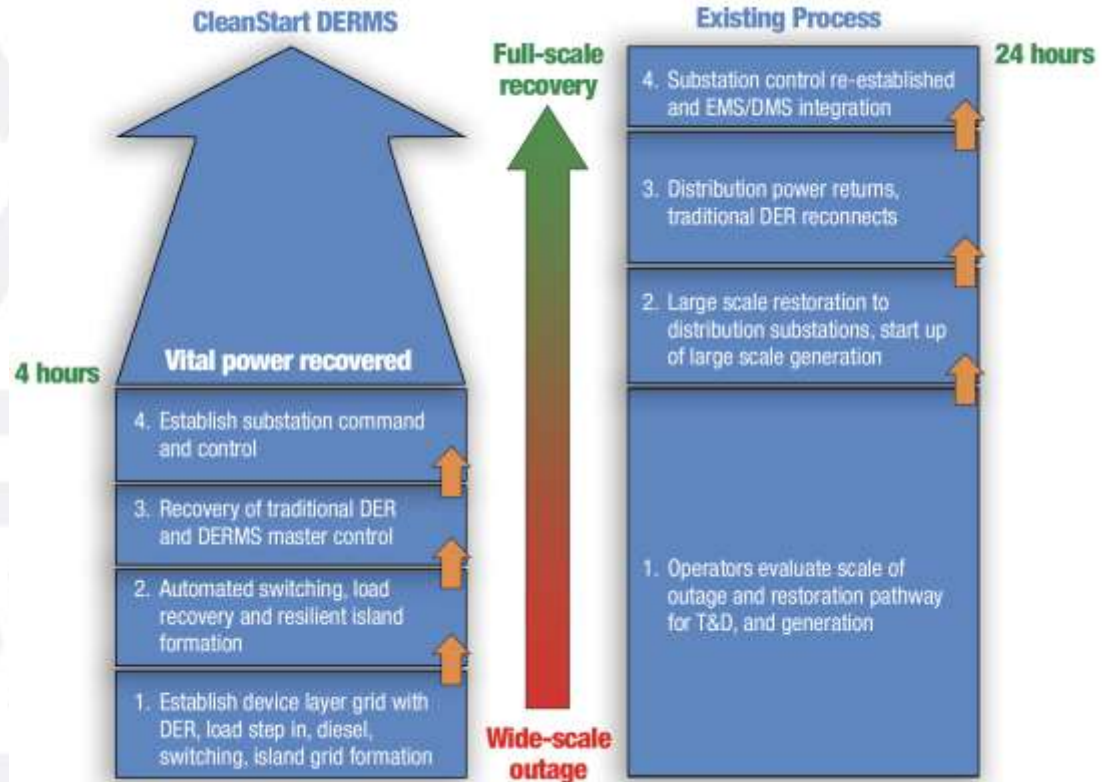

# 1.5.06 - Consequence-Based Approach for Considering Community Grid Resiliency Investments

► **Goal:** Develop and validate a new software platform to help operators anticipate, respond to, and recover from extreme events.

► **Labs:** SNL

► **Partners:**

- CPS Energy, San Antonio
- The City of San Antonio
- University of Texas at San Antonio
- National Grid
- The City of Buffalo, NY
- Synapse Energy
- The 100 Resilient Cities Organization





# Connections to MYPP



MYPP Pillar	RDS Project
<b>Devices and Integrated System Testing</b>	1.5.03 – Increasing Distribution Resiliency Using Flexible DER and Microgrid Assets Enabled by OpenFMB (Decentralized FLISR)  1.5.04 - Integration of Responsive Residential Loads into Distribution Management Systems
<b>Sensing and Measurement</b>	
<b>System Operations, Power Flow, and Control</b>	1.5.02 - Resilient Alaskan Distribution System Improvements using Automation, Network analysis, Control, and Energy storage (RADIANCE)  1.5.05 - CleanStart Distributed Energy Resource Management System (DERMS)
<b>Design and Planning Tools</b>	
<b>Security and Resilience</b>	1.5.01 - Grid Resilience and Intelligence Platform (GRIP)
<b>Institutional Support</b>	1.5.06 - Consequence-Based Approach for Considering Community Grid Resiliency Investments  1.5.07 – Laboratory Value Analysis Team (1.5.07)

# Summary



- ▶ Six of seven RDS projects being reviewed in this session
- ▶ Projects started in ~ Q2-3 FY18
- ▶ An opportunity to provide early recommendations to deliver on DOE expectations:

“The project results are expected to ***deliver credible information on technical and economic viability of integrated solutions*** as well as ***demonstrate viability to key stakeholders*** who are ultimately responsible for making grid modernization investments.”

<https://www.energy.gov/grid-modernization-initiative-0/resilient-distribution-systems-lab-call-awards>

# GRID MODERNIZATION INITIATIVE PEER REVIEW

## Grid Resilience & Intelligence Platform (GRIP) 1.5.01

September 4–7, 2018

Sheraton Pentagon City Hotel – Arlington, VA

**SLAC** NATIONAL  
ACCELERATOR  
LABORATORY



# Grid Resilience & Intelligence Platform (GRIP)



## High-Level Project Summary

### Project Description

For GRIP we will develop and deploy a suite of novel software tools to **anticipate, absorb** and **recover** from extreme events. The innovations in the project include application of artificial intelligence and machine learning for distribution grid resilience (ie. using predictive analytics, image recognition, increased “learning” and “problem solving” capabilities for anticipation of grid events).

### Value Proposition

- ✓ Extreme weather events pose an enormous and increasing threat to the nation’s electric power systems and the associated socio-economic systems that depend on reliable delivery of electric power. While utilities have software tools available to help plan their daily and future operations, these tools do not include capabilities to help them plan for and efficiently recover from extreme events.
- ✓ Field validation directly supports the GMLC objectives of delivery of resilient grid, seamlessly integrated resources and U.S. prosperity, competitiveness, and innovation in a global clean energy economy.

### Project Objectives

- ✓ Demonstrate machine learning and artificial intelligence from different data sources to anticipate grid events
- ✓ Validate controls for distributed energy resources for absorbing grid events
- ✓ Reduce recovery time by managing distributed energy resources in the case of limited communications

**Primary MYPP Goal:** 10% reduction in the economic costs of power outages by 2025

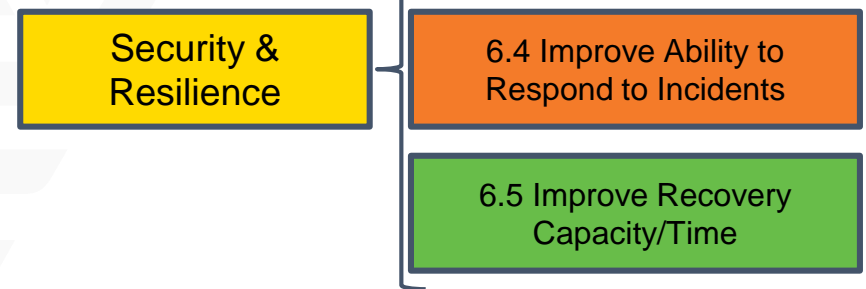

### SLAC National Accelerator Laboratory

Leading the project by organizing the project partners around the project tasks and deliverables; developing and validating predictive analytics for grid events; working with partners to organize and get results from field tests; and disseminate results.

### Lawrence Berkeley National Laboratory

Adapting its extremum seeking controls for DERs and extend the set of controllable assets to include electric storage devices and support hardware demonstrations of the resiliency controller.

**X (formerly Google X)** - Providing secure cloud infrastructure, support, development, and unique datasets in service of demonstrating grid resilience via GRIP.

**Presence** - Developing platform architecture, data integration, application integration and platform UI/UX.

**Packetized Energy** - Validating virtual islanding concept through simulation and field tests to ride through grid events.

PROJECT FUNDING			
Partner	Year 1	Year 2	Year 3
SLAC	641K	642K	642K
LBNL	298K	302K	200K
Presence	1000K	400K	400K
Packetized Energy	194K	96K	135K
SCE	50K	50K	50K
NRECA	133.4K	454.4K	312.2K

**Southern California Edison** - Providing access to data, models, and additional information that will be required for developing and validating predictive analytics and field demonstrations.

**National Rural Electric Cooperative Association** - Supporting the development and field validation of predictive analytics and controls as well as enhancing the NRECA platform to incorporate capabilities developed and validated through this project.

# GRIP

## Approach



- **Approach:**
  - Anticipation analytics will be tested and validated with Southern California Edison (Ex. pole vulnerability)
  - Absorption algorithms will be tested in Vermont with 150+ controllable loads that demonstrate virtual islanding capability (Ex. power balancing water heaters)
  - Extremum seeking controls that support recovery by following an objective function, such as voltage stabilization, broadcasted at the feeder will be tested with one of NRECA members
  - Site specific data ingestion algorithms will be developed by X in conjunction with project team members and will be readily available for each application as part of the data platform layer
- **Key Issues:** Determining what capabilities can be run locally behind firewalls vs remain in the cloud
  - Data Agreements (ownership, access, & use)
- **Distinctive Characteristics:** The project team will demonstrate a different machine learning capability at each site and each respective site will be connected to the GRIP. All the demonstrations will be managed using the GRIP with appropriate connectivity to each demonstration.

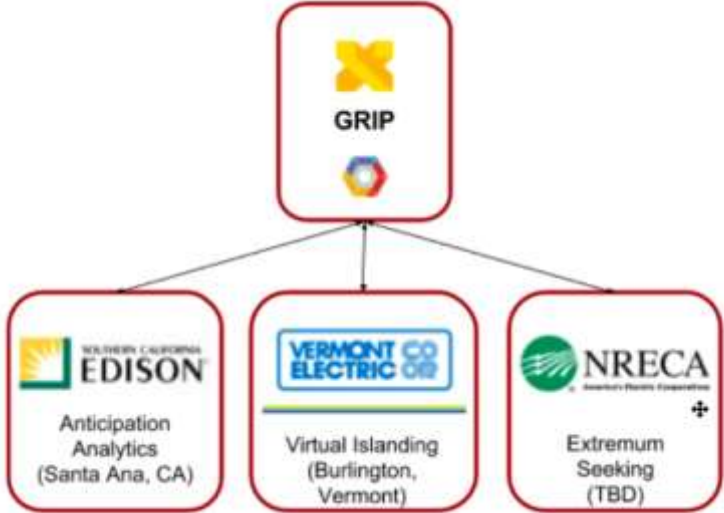

### Year 1 - Platform and Systems Integration focused on anticipation of grid events

Milestone Name/Description	End Date	Type
<p><b>Project Q1 Progress Measure:</b>                      Task 1 - We will deliver final list of TAG members approved by the DOE Program Offices.                      Task 2 - We will develop a strategic plan for the project that includes a description of the workshop including the objectives and plans on how to achieve these objectives.</p>	12/31/2017	Quarterly Progress Measure
<p><b>Project Q2 Progress Measure:</b>                      Task 2 - We will deliver a workshop report that summarizes the regional resilience use cases and prioritizes their development for the project.                      Task 5 - We will deliver a finalized set of prioritized predictive analytics for resilience applications.</p>	3/31/2018	Quarterly Progress Measure
<p><b>Project Q3 Progress Measure:</b>                      Task 3 - We will deliver a platform requirements document                      Task 4 - We will develop a recruitment plan for the field tests                      Task 7 - We will draft a validation plan including feedback from LVAT.</p>	6/30/2018	Quarterly Progress Measure
<p><b>Project Q4 Progress Measure:</b>                      Task 3 - We will deliver a document summarizing the OMF integration along with code, visualization of network data, completion of preliminary data integration.                      Task 4 - We will deliver site agreements from field test sites.                      Task 6 - We will demonstrate at least one predictive analytics capability</p>	9/30/2018	Quarterly Progress Measure

- Project Kick-off Workshop
- Utility Resilience Surveys & Interviews
- Data Management & Platform Architecture Workshop
- Prioritized predictive analytics & apps
- Created a data catalogue
- SCE Stakeholder Engagement Workshop
- TAG Y1 Annual Meeting
- Platform UI/UX Workshop

# Utility Resilience Survey



## GRIP Resilience Questionnaire

The goal of the DOE-funded Grid Resilience & Intelligence Platform (GRIP) project is to respond to grid events by demonstrating machine learning and artificial intelligence from different data sources to anticipate grid events; validating controls for distributed energy resources for absorbing grid events; and reducing recovery time by managing distributed energy resources in the case of limited communications. The purpose of this survey is to develop our use cases via key utility insights.

What is the name of your company & contact email? \*

How do you define grid resilience in your company?

Ability to reduce the magnitude and/or duration of disruptive events; to absorb an event & quickly recover

What are the top 3 causes of grid failure for your region?

Wind, trees, human-induced, equipment failure, ice/snow

We categorize the resilience cycle as "Anticipate, Absorb and Recover" - how does your company categorize the cycle of a grid event?

Prepare, react, recover

What are your company's current strategies and tools for anticipating grid events?

Weather forecasts, OMS, vegetation management system, STORMS

If you had a wish list of tools for anticipating grid events, what would those be?

Active alert system connecting utilities; better location-specific weather forecasts & modelling scenarios

What distributed generation do you have on your system and what are the specifications?

wind, solar, hydro

What sources of weather information do you use in your operations?

Weather Bug, NOAA, wind-lightning radar

What remote or automated control capabilities do you have on your system? (Recloser automation, FLISR, automatic source transfer, etc.)

SCADA, FLISR, remote source transfer

Do you have any of the following?

- Outage Management System (OMS) 100%
- Plans to deploy energy storage for resiliency 50%
- Plans to deploy microgrids for resiliency 0%
- Strategies in place to manage disruptions as they unfold 60%
- Disaster recovery strategies that include distributed energy resources 20%
- Separate processes for human-induced events vs natural events 40%
- The ability to easily capture the state of the grid at any point in time (esp right before a grid event) 60%

What are the metrics your company uses to measure resilience of the grid?

Reliability metrics (SAIDI, SAIFI, CAIDI, CAIFI, MAIFI); consumer outage hours



# Technical Advisory Group



- Recruited 8 utilities and coops from across the US through NRECA
- Members participated in both the utility resilience survey and follow-up team interviews
- Year 1 Annual Meeting was held in August 2018 to review progress and provide feedback on use cases and platform development.



# Anticipation Analytics



- pole location + age
- pole tilt + direction
- magnitude of tilt

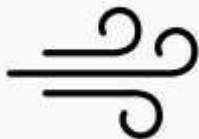

- wind speed
- wind direction  
(*measured + predicted*)



## Test Case: Santa Ana, CA (Camden sub)

Stage 1: 100 poles (*street view + measured*)

Stage 2: all street visible poles on 1 of 7 feeders

Stage 3: all street visible poles on all 7 feeders

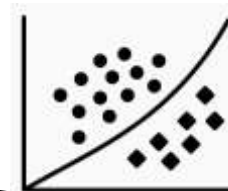
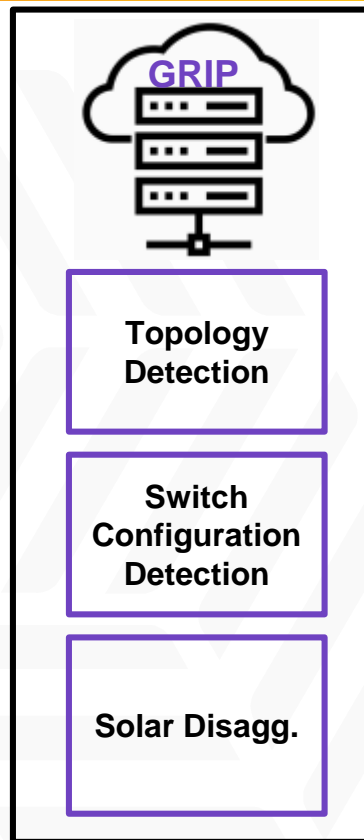

ML-Based  
Powerflow

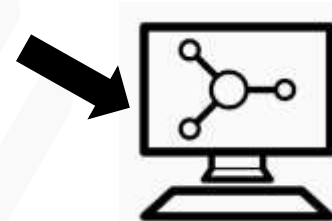
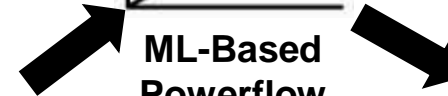

GridLAB-D

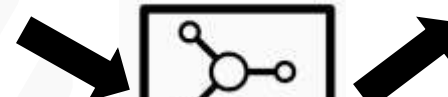

## Outputs

Determine  
voltages

Determine  
impacts &  
minimize

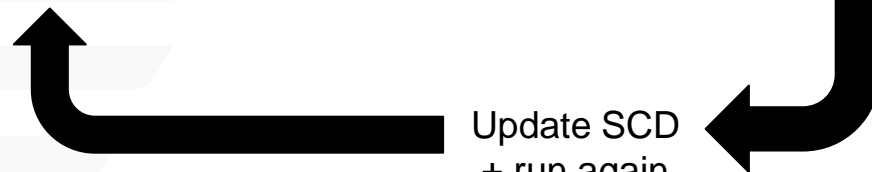

Update SCD  
+ run again

## Technical Goals & Benefits:

- Develop/collect a set of use cases for resilience:
  - asset and protective device location and mapping
  - predicting vulnerabilities to thermal conditions
  - switch re-configuration
  - predict ferroresonance occurrences
  - secondary voltage optimization with DERs
  - vegetation management
  - optimized work plans considering budget and hardening options
- Development of a new platform based on existing Google tools:
  - Google Cloud
  - Data Lab
  - TensorFlow
  - Maps
  - Streetview
- Transfer existing capabilities in terms of situational awareness, user interfaces, libraries, etc., which have been already developed by VADER and NRECA to this new platform.

# Absorption: Virtual Islanding

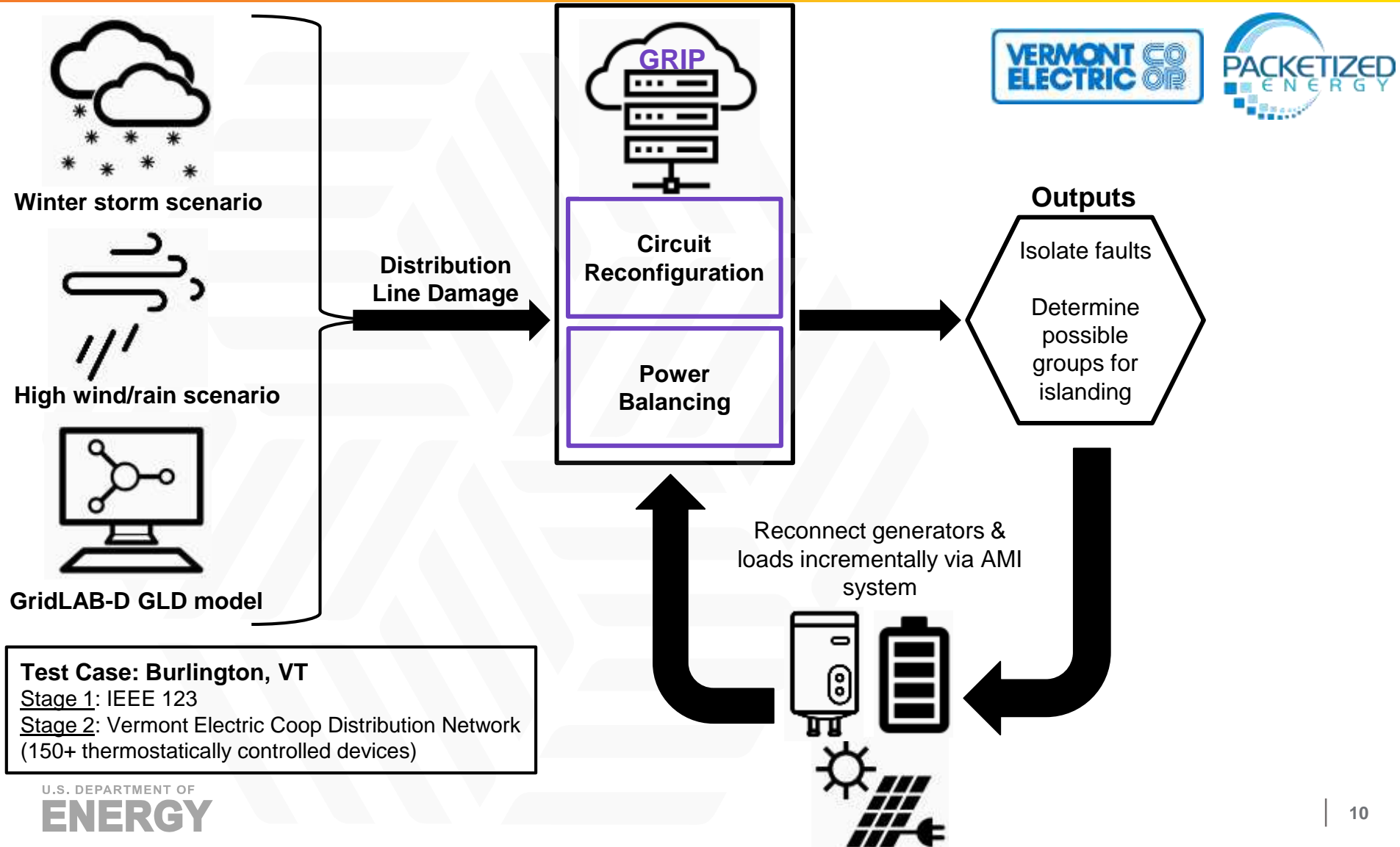

## Technical Goals & Benefits

- Deploy at least three different DERs types and at least 150 distinct devices (water heaters, electric vehicles and PV/battery inverters) within a particular region of a distribution system and then demonstrating how these devices can be used to operate a dynamically formed microgrid after an extreme event.
- Demonstrate the Virtual Islanding concept using a high resolution 3-phase Quasi-Static Time Series (QSTS) distribution network simulation model and integrate Packetized Energy's DER coordination software into the GRIP project's software platform.
- Development of a utility guidebook to virtual islanding

# Recovery: Extremum Seeking

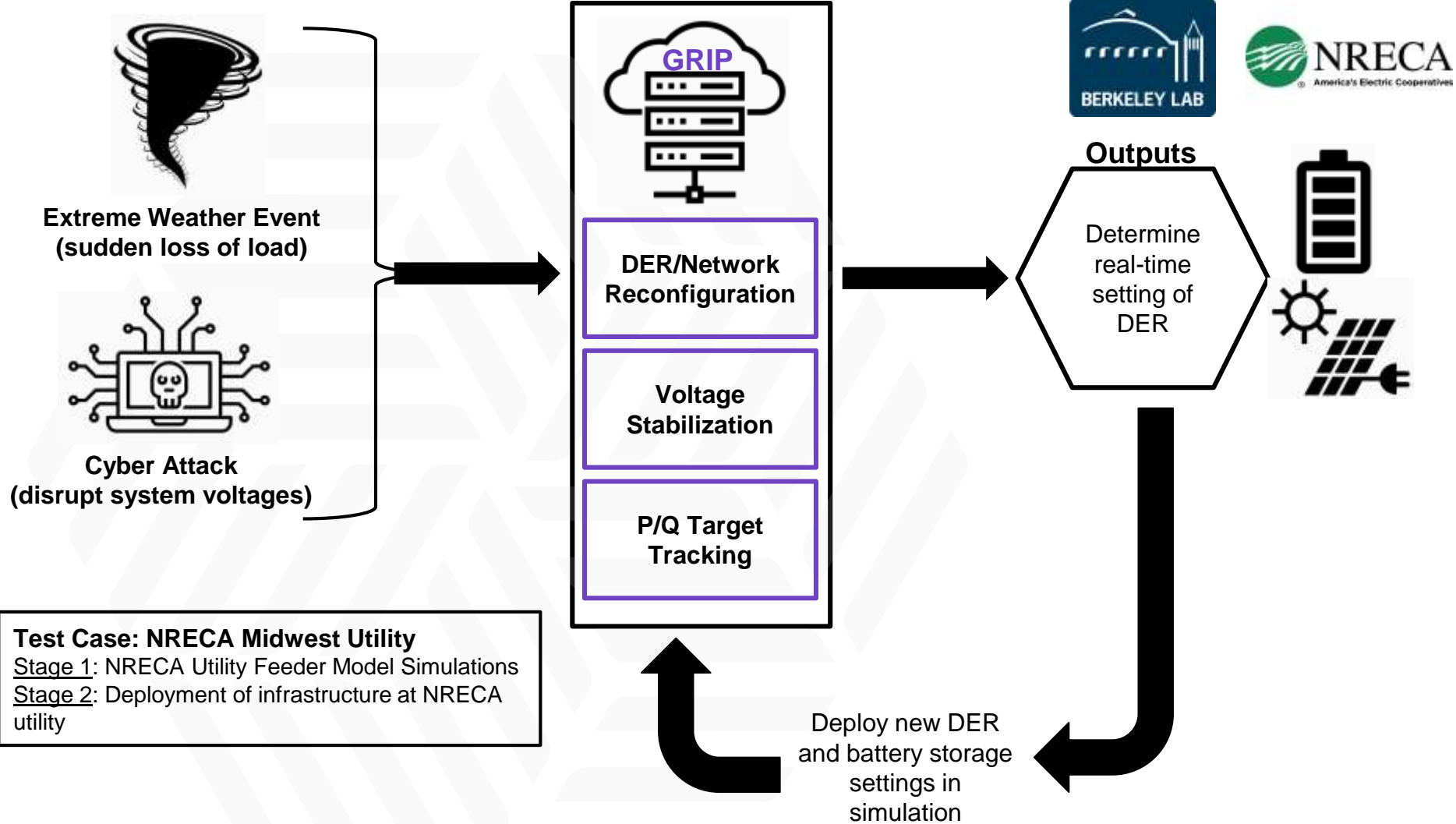

**Test Case: NRECA Midwest Utility**  
Stage 1: NRECA Utility Feeder Model Simulations  
Stage 2: Deployment of infrastructure at NRECA utility

## Technical Goals & Benefits:

- Normal operating conditions:
  - Prevent backflows
  - Provide voltage support
  - Minimize resistive losses
  - Minimize reactive power procured at feeder head (i.e. feeder operates at unity power factor)
  - Feeder can participate in electricity markets as an aggregated unit (sponsored DOE research)
- Resiliency operations:
  - Enable switching via regulating distribution phasor differences without need to deploy a crew
- Utility does not need to provide network models and all feeder real-time loads

# Platform - View 1

GRIP Platform - Grid Topography - Pole Vulnerability

Current View | Late July 2018 (v2) | 7 Day Forecast | Extreme Cond. Model455 | Extreme Cond. Model456 | Import

Data View

Live View
  Forecast
  Historical
  Simulation

Weather Layers:  NOAA  AccuWeather  WeatherCompany

Filter Data

Substation: Camden | Feeders: All | Vulnerability: 80+ | Criticality: All

Pole	Substation	Feeder	Reports	Vulnerability	Criticality
#457293	Camden	Uranium	Outage Confirmed (500 affected)	97	Low
#428343	Camden	Uranium	Outage Reported (30 affected)	96	Medium
#632823	Camden	Bismuth		95	High
#021342	Camden	Cobalt			Low
#238131	Camden	Bismuth			Medium
#293342	Camden	Aluminium			Low
#299873	Camden	Alloy			Low
#039282	Camden	Cobalt			Low
#723423	Camden	Cobalt		83	Low
#238974	Camden	Cobalt		83	Low
#120722	Camden	Aluminium		82	Low
#238237	Camden	Cobalt		81	Low
#234932	Camden	Bismuth		80	Low
#234255	Camden	Alloy		80	Low
#302833	Camden	Cadmium		80	Low

Vulnerability Index Data  
 Pole Tilt: 25° (5.6 Magnitude)  
 Tilt Direction: ENE  
 Pole Age: 15 years  
 Material: Wood  
 Last Inspection: 8 months ago  
 Current Wind: 35mph  
 Wind Direction: E  
 Wind Prediction: 65mph (2 hrs)  
 Predicted Outcome: Hold

Map Layers:  Radar  Clouds  Wind  Ocean

Map Layers | Map View | + | -



# Platform - View 2

GRIP Platform - Grid Topography - Pole Vulnerability

Current View | Late July 2016 (v2) | 7 Day Forecast | Extreme Cond. Model455 | Extreme Cond. Model456 | Import

### Data View

Live View | Forecast | Historical | Simulation | Filter Data

#### Forecast Selection

View: 10 Day

Data Layers:
 

- Cloud Cover
- Dew Point
- Humidity
- Hourly Liquid Precip.
- Chance of Precip.
- Precip. Accum. Total
- Pressure
- Temperature
- Wind Speed

Friday 08/17 0% / 0 in  
Sunny. High 88F. Winds SW at 40 to 55 mph.

Time	Weather	Temp	Humidity	Wind	Pressure
8:00 am	Sunny	78°F	75%	25 mph SW	30.03 in
10:00 am	Sunny	80°F	82%	25 mph SW	30.03 in
11:00 am	Sunny	82°F	86%	25 mph SW	30.03 in
12:00 pm	Sunny	85°F	88%	25 mph SW	30.03 in
1:00 pm	Sunny	87°F	88%	25 mph SW	29.99 in
2:00 pm	Sunny	87°F	88%	25 mph SW	29.97 in
3:00 pm	Sunny	87°F	88%	25 mph WSW	29.98 in
4:00 pm	Sunny	86°F	88%	25 mph SW	29.94 in
5:00 pm	Sunny	84°F	88%	25 mph SW	29.93 in

Pole	Substation	Feeder	Reports	Vulnerability	Criticality
#457293	Camden	Uranium	⚠️ Outage Confirmed (500 affected)	97	Low
#428343	Camden	Uranium	⚠️ Outage Reported (30 affected)	96	Medium
#832623	Camden	Bismuth		95	High
#021342	Camden	Cobalt			Low
#236131	Camden	Bismuth			Medium
#293342	Camden	Aluminum			Low
#299873	Camden	Alloy			Low
#038282	Camden	Cobalt			Low
#723423	Camden	Cobalt		83	Low

**Vulnerability Index Data**

Pole Tilt: 26° (6.6 Magnitude)

Tilt Direction: ENE

Pole Age: 15 years

Material: Wood

Last Inspection: 8 months ago

Current Wind: 35mph

Wind Direction: E

Wind Prediction: 65mph (2 hrs)

Predicted Outcome: Hold

Map Layers | Map View | + | -

# GRIP Data & Application Layers

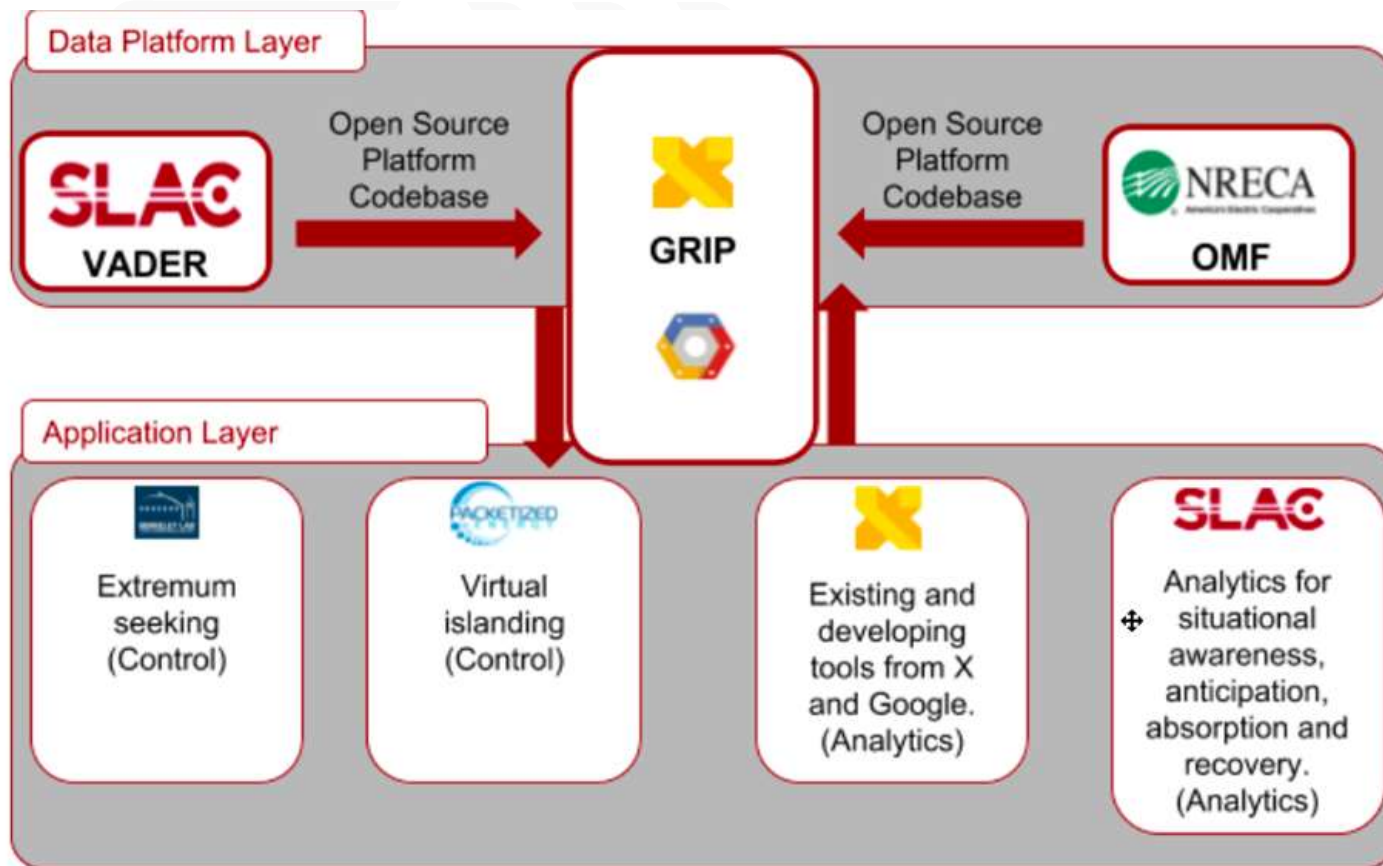

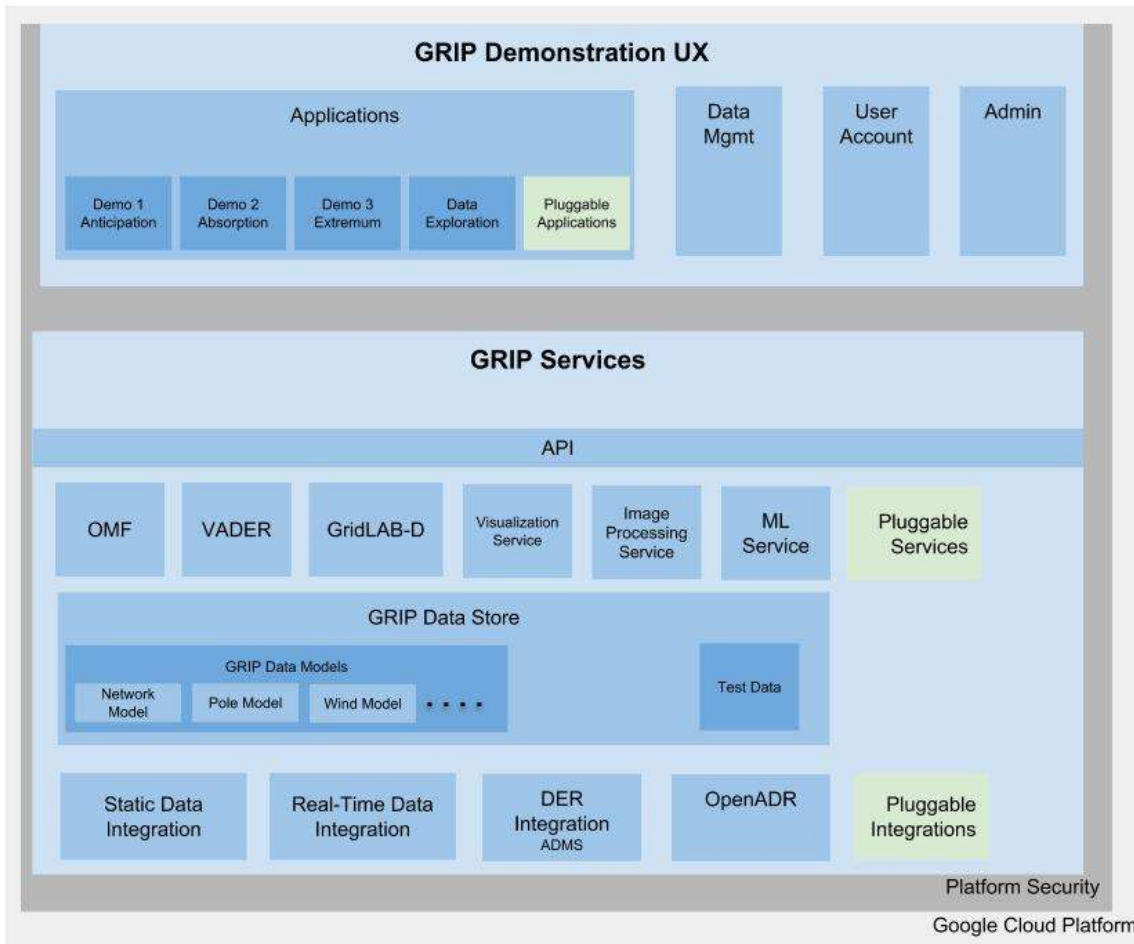

- Potential Input Projects**
- EASE
  - GMLC 1.4.23 Cyber security
  - GMLC 1.4.09 Data Analytics and Machine Learning for the Grid
  - GMLC 1.2.1 Grid Architecture
  - 1.1 Foundational Analysis
  - OSIsoft - OSC Pi Data
  - CIGAR" (LBL Co-Lead): reinforcement learning over controllable devices in the distribution grid to actively mitigate cyber attacks

# GRIP Platform Architecture

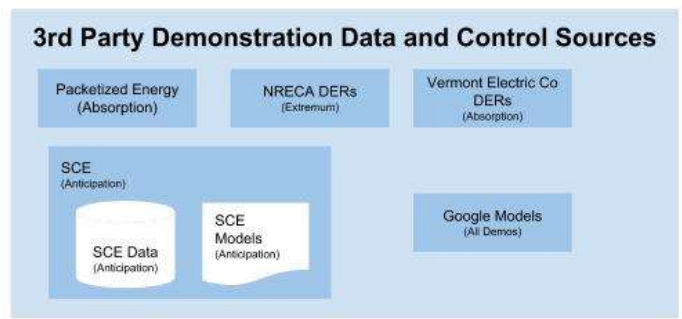
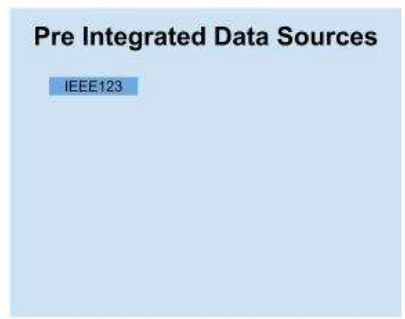

# GRIP Y2: Riding through grid events

## Next Steps and Future Plans



Milestone Name/Description	End Date
<b>Project Q5 Progress Measure:</b> Task 5 - We will finalize and publish predictive analytics requirements document	12/31/2018
<b>Project Q6 Progress Measure:</b> Task 6 - We will demonstrate power balancing with water heaters.	3/31/2019
<b>Project Q7 Progress Measure:</b> Task 4 - Deliver a report on site integration and architecture plan for each site Task 6 - Publish a report on the preliminary results on power balancing with water heaters	6/30/2019
<b>Project Q8 Progress Measure:</b> Task 6 - Demonstrate platform with predictive analytics Task 6 - Report of Virtual Islanding method	9/30/2019

- **Milestone 2:** Validate virtual islanding
- **Deliverable 2:** Demonstrate virtual islanding with Vermont Coop
- **Deliverable 3:** Demonstrate platform with advanced analytics

# Thank you!



**Dan Arnold**



**Paul Hines**



**Dave Pinney**



**Dale Knauss**



**Sila Kiliccote**



**Mark Hartney**



**Ashley Pilipiszyn**



**Ty Jagerson**



**Leo Casey**



**Peter Evans**



# Backup Slides



# Platform - View 3

GRIP Platform
GRIP Platform - Grid Topography - Pole Vulnerability
GRIP

July 2018 (v2)
7 Day Forecast
Extreme Cond. Model455
Extreme Cond. Model456
+ Import

Historical Simulation

Filter Data

WeatherCompany
Update
Save View

Substation
Feeder
Vulnerability
Criticality

Camden

All

80+

All

Feeder	Reports	Vulnerability	Criticality
Uranium	<span style="color: red;">⚠</span> Outage Confirmed (500 affected)	97	Low
Uranium	<span style="color: orange;">⚠</span> Outage Reported (30 affected)	96	Medium
Bismuth		95	High
Cobalt			Low
Bismuth			Medium
Aluminium			Low
Alloy			Low
Cobalt			Low
Cobalt		83	Low
Cobalt		83	Low
Aluminium		82	Low
Cobalt		81	Low
Bismuth		80	Low
Alloy		80	Low
Cadmium		80	Low

**Vulnerability Index Data**

Pole Tilt: 26° (5.6 Magnitude)

Tilt Direction: ENE

Pole Age: 15 years

Material: Wood

Last Inspection: 5 months ago

---

Current Wind: 35mph

Wind Direction: E

Wind Prediction: 65mph (2 hrs)

Predicted Outcome: Hold

**Map Layers**

Radar  Clouds  Wind  Ocean

Map Layers Map View + -

# Platform - View 4

- GRIP Platform
- Dashboard
- Grid Topography
- Pole Vulnerability →
- Saved Views
- Shared Views
- Switch Configuration
- Alerts
- Settings
- Data Mangement

GRIP Platform - Grid Topography - Pole Vulnerability
7 Day Forecast
Extreme Cond. Model455
Extreme Cond. Model456
Import

Historical | Simulation | Filter Data ▼

Day	Tue 8/14	Wed 8/15	Thu 8/16	Fr 8/17	Sat 8/18	Sun 8/19	Mon 8/20	Tue 8/21	Wed 8/22
Weather	Sunny	Sunny	Sunny	Sunny	Sunny	Sunny	Partly Cloudy	Sunny	Sunny
Temp Range	80° - 87° F	80° - 87° F	80° - 88° F	80° - 88° F	80° - 88° F	87° - 87° F	80° - 88° F	85° - 88° F	84° - 87° F
Precip	0 in	0 in	0 in	0 in	0 in	0 in	0 in	0 in	0 in



**Friday 08/17 0% / 0 in**  
Sunny. High 88F. Winds SW at 40 to 55 mph.

[View Predicted Data](#) [Save View](#)

Time	Weather	Temp	Humidity	Wind	Clouds	Precip
9:00 am	Sunny	78°F	78%	25	0%	0%
10:00 am	Sunny	80°F	80%	25	0%	0%
11:00 am	Sunny	83°F	83%	25	0%	0%
12:00 pm	Sunny	85°F	85%	25	0%	0%
1:00 pm	Sunny	87°F	87%	25	0%	0%
2:00 pm	Sunny	87°F	87%	25	0%	0%
3:00 pm	Sunny	87°F	87%	25	0%	0%
4:00 pm	Sunny	86°F	86%	25	0%	0%
5:00 pm	Sunny	84°F	84%	25	0%	0%

Feeder	Reports	Vulnerability ↑	Criticality
Uranium	<span style="color: red;">⚠</span> Outage Confirmed (500 affected)	97	Low
Uranium	<span style="color: orange;">⚠</span> Outage Reported (30 affected)	96	Medium
Bismuth		95	High
Cobalt			Low
Bismuth			Medium
Aluminium			Low
Alloy			Low
Cobalt			Low
Cobalt		83	Low

**Vulnerability Index Data**  
 Pole Tilt: 26° (6.6 Magnitude)  
 Tilt Direction: ENE  
 Pole Age: 15 years  
 Material: Wood  
 Last Inspection: 8 months ago

Current Wind: 35mph  
 Wind Direction: E  
 Wind Prediction: 65mph (2 hrs)  
 Predicted Outcome: Hold





# Platform - View 5

GRIP Platform

GRIP Platform

GRIP

Dashboard →

Grid Topography

Pole Vulnerability

Saved Views

Shared Views

Switch Configuration

Alerts

Settings

Data Mangement

### Pole Vulnerability - Live View

Filter 1 (Critical Poles above 90%)

12

Filter 2 (All Poles above 95%)

3

Filter 3 (reported down poles)

0

+

### Pole Vulnerability - Forecast

3 Days (Critical Poles above 90%)

12

2 days (All Poles above 95%)

3

+

10 days (downed pole estimated)

3

5 days (All Poles above 95%)

7

### Switch Configuration



By Substation failure risk in Re-route plan - VIEW HERE

22  
hours

+

Some Data View Here

# Summary of VADER

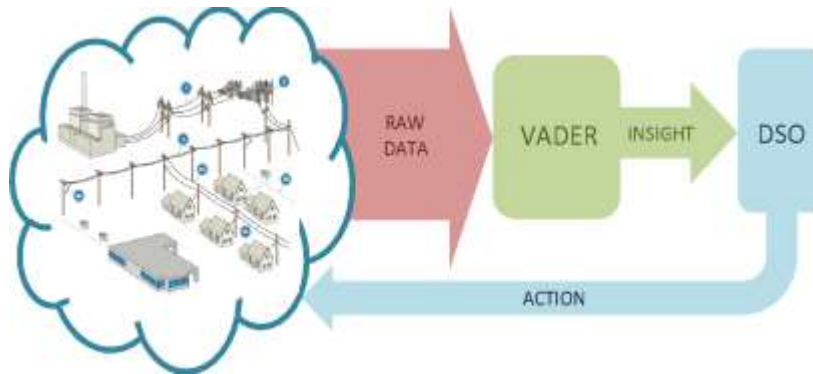

- Integrate** large number of “high-resolution” and heterogeneous data sources
- Define** a broad set of industry, utility and research driven use cases
- Embed** existing tools and QSTS capabilities
- Validate** the platform utilizing a pilot Hardware-in-the-Loop (HIL) testbed
- Demonstrate** tools using data from industry and utility partners

How to plan and monitor distribution systems with high penetration of Distributed Energy Resources?

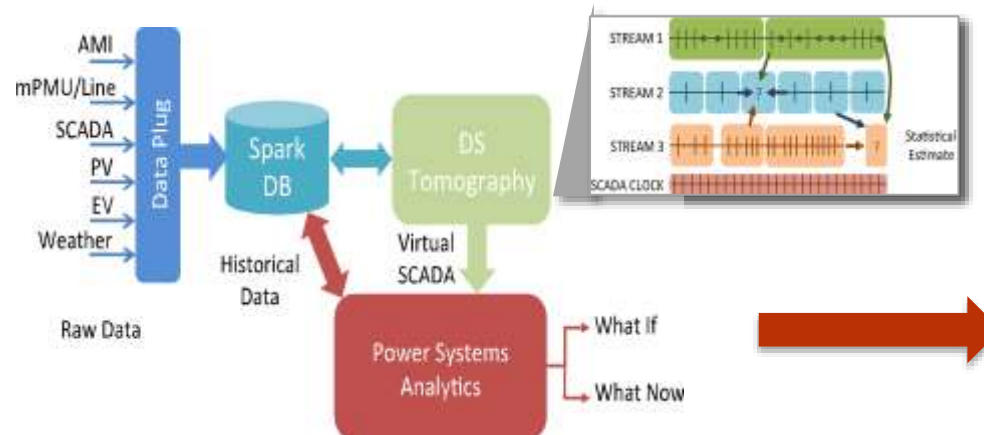

- Resource placement
- PV shortage or over-generation management
- Reverse power flow detection
- Overvoltage detection
- Flexibility planning
- Performance evaluation of distribution systems.

# VADER Accomplishments

- Initial set of analytics developed and tested with IEEE-123 Bus Model (GridLab-D integration)
  - Machine Learning-based Power Flow
  - Switch Detection
  - Solar Disaggregation
  - Forecasting
  - Topology detection
- Platform demonstration with historical data
- Held first VADER Lab in March 2017
- Started applying SCE's data and getting results
  - Solar Disaggregation
  - Switch Detection
- Expanded machine learning- based Power Flow to three-phase systems.
- Developed EV flexibility analytics.

# Example of Basic Analytics: Machine Learning-Based Power Flow

## Availability of topology line parameters

- Traditional state estimation method: require line connectivity and parameters information
- ML method: *no need for line Information*

## Ability to handle missing measurements

- Traditional Method: No. It needs the whole system to be observable.
- ML Method: Yes. It only *builds correlation between available data at available time slots.*

## Ability to conduct voltage forecasting / power flow

- Traditional Method: No. It is static state estimation.
- ML Method: Yes. It only *builds correlation between voltages and power*, forecast power, and recover voltage based on the relationship.

# ML-based Power Flow: How does it work and how does it compare?

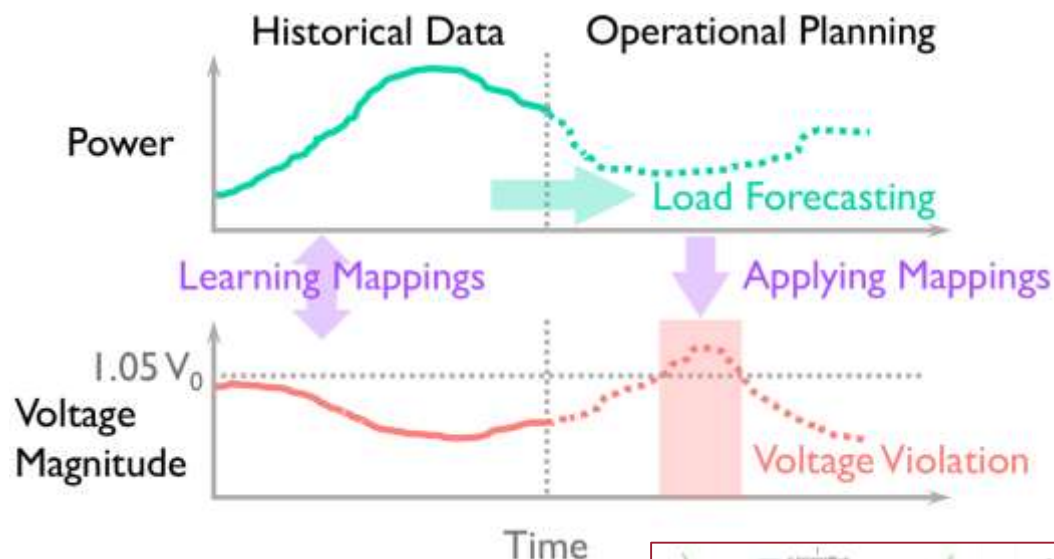

- Practical Advantages of Machine learning based Power Flow
  - Equivalence to physical model
  - Robustness against outliers
  - Capability of modeling 3rd party controllers
  - Flexibility for partially observed systems model construction
  - Capability of inverse mapping: P, Q to voltage mapping

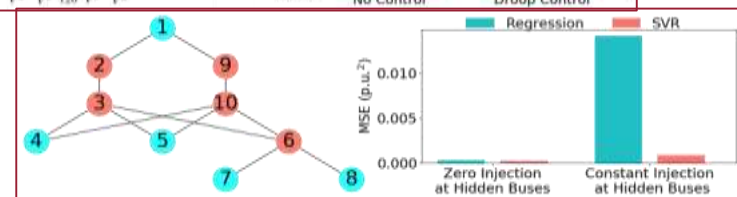
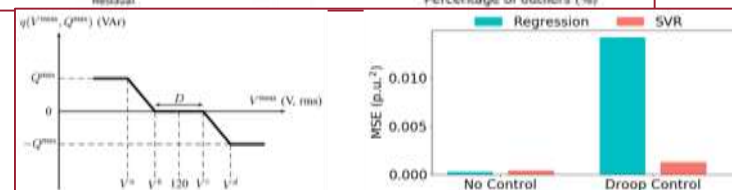
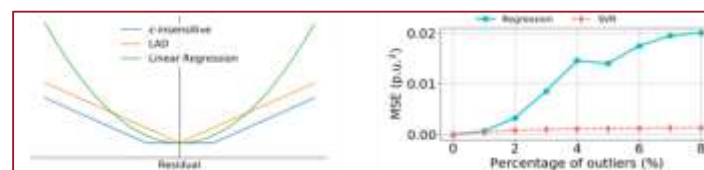

# Solar Disaggregation

- Increasing solar penetration
  - Behind-the-meter
  - Distribution-level
- Switches maintain a radial structure
- Load is masked
- Visibility into behind-the-meter solar generation is limited

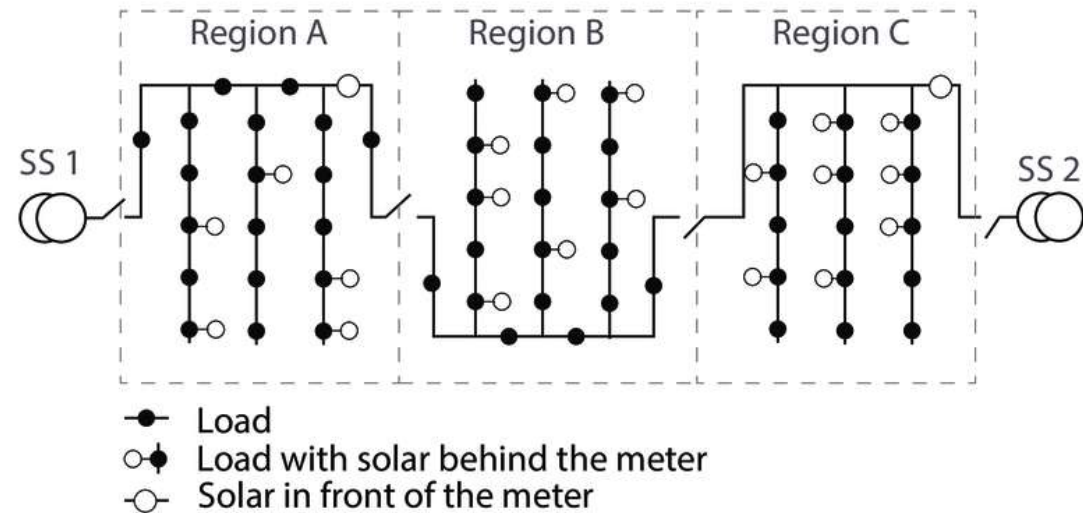

**How do we gain more visibility into the load and solar generation?**

# SCE Radial Configuration Detection

## Overview:

Detect Switch Status

Sensing: AMI, Line Sensing, Substation

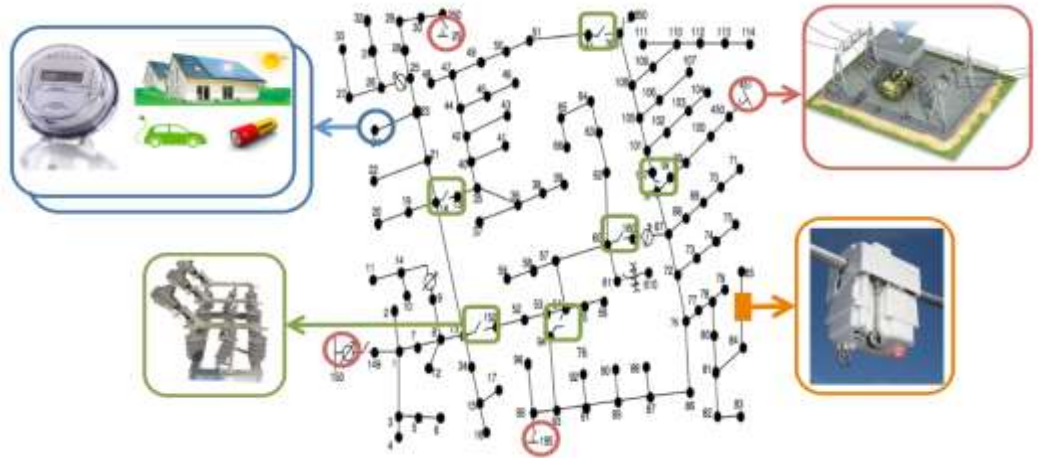

## Traditional Approach:

General State Estimation; Voltage,

Current

## Flow Based Detection

Simple assumptions, detection

guarantees

Robust to noise, unknown impedance

Error in Impedances

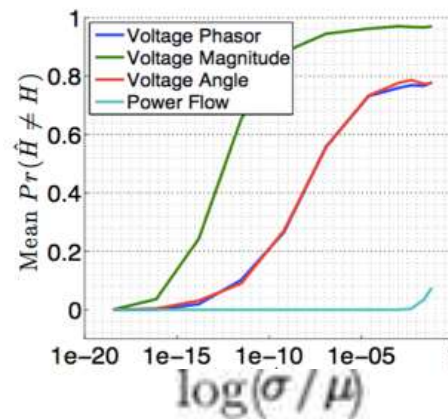

Error in Voltage Meas.

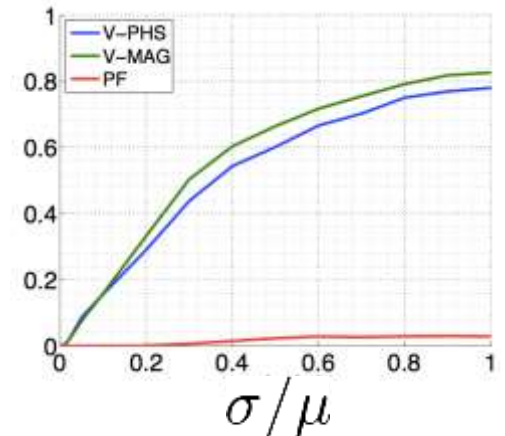

# SCE Radial Configuration Detection

## Camden Substation



### Inter/Intra Feeder:

Underground, Pole Top, Remote Controlled

### Network Summary

112 Aggregated Loads with 1, 2, 3 phase loads.

123 Switches to Monitor

5.76057e+09 Possible Radial Configurations

### Theory Predicts:

AMI + 12 Line Measurements vs. 123 SCADA Sensors

### Current Work:

Extending Algorithms for lossy/3-phase networks.

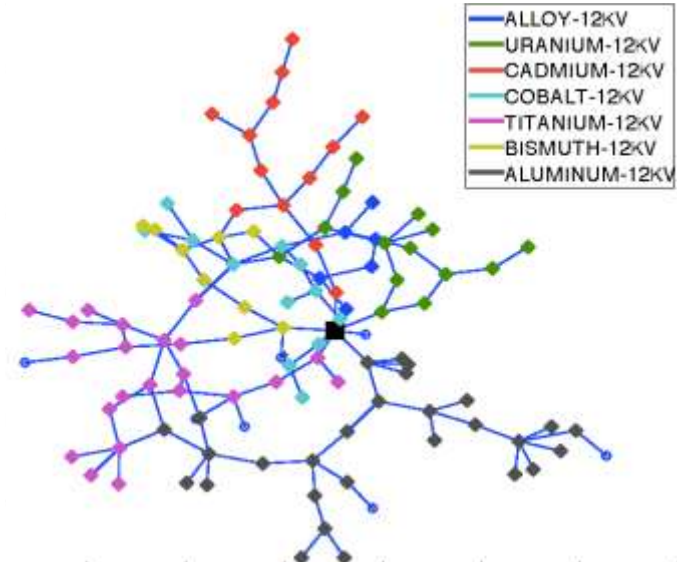



# SCE Radial Configuration Detection

## Camden Substation



### Inter/Intra Feeder:

Underground, Pole Top, Remote Controlled

### Network Summary

112 Aggregated Loads with 1, 2, 3 phase loads.

123 Switches to Monitor

5.76057e+09 Possible Radial Configurations

### Theory Predicts:

AMI + 12 Line Measurements vs. 123 SCADA Sensors

### Current Work:

Extending Algorithms for lossy/3-phase networks.

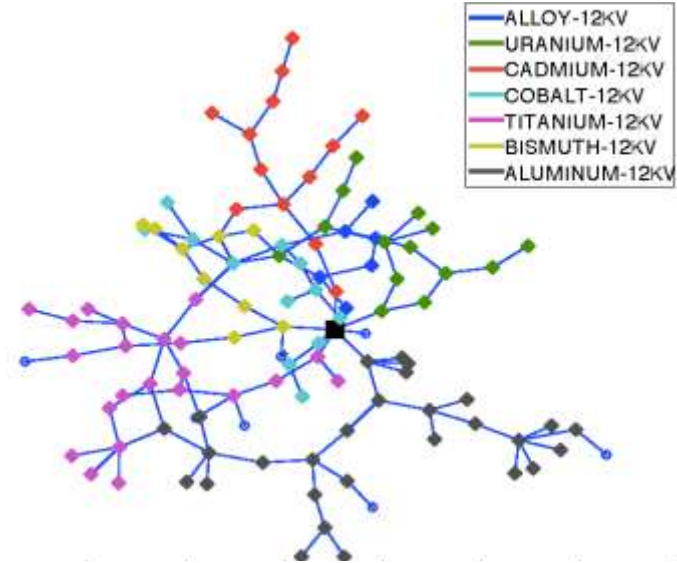

# Absorption: Virtual Islanding

Feedback control system in which active power is balanced through stochastic “packet” access requests.

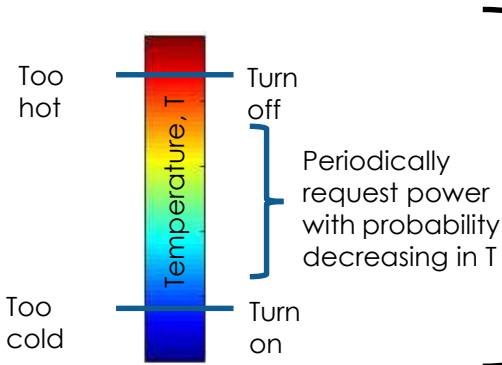
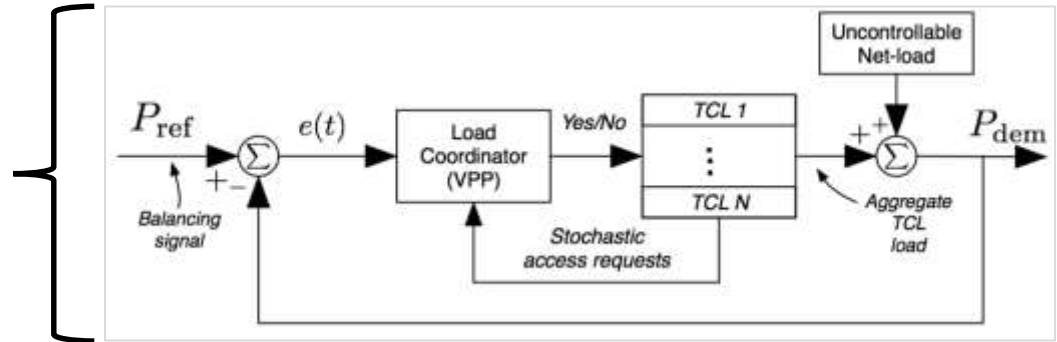

Loads and distributed storage units make stochastic requests (left) for network access to a coordinator, leading to accurate real-time load balancing (right)

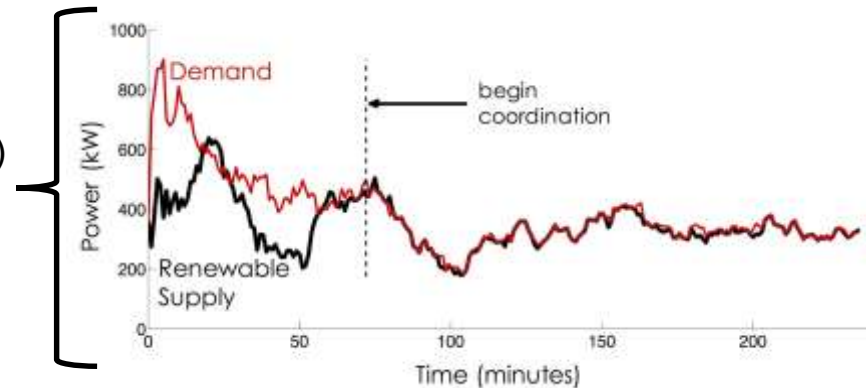

**Event response.** The project will use real data from Vermont Electric Coop’s distribution network and GridLAB-D models for dynamic microgrid formation over both the planning and operations time scales.

**Virtual Islanding.** Packetized Energy’s integrated software and hardware system will be used to demonstrate voltage and primary/secondary frequency control with more than 150 devices, including water heaters, solar PV inverters, and batteries.

**Restoration.** These same devices will be used to demonstrate the process of restoring voltage and frequency so that circuit breakers can safely switch in. GridLAB-D simulations will be used to demonstrate this process for more extreme scenarios in which large amounts of the network have been damaged.

# Dynamically Formed Microgrids for Resilience: Concept

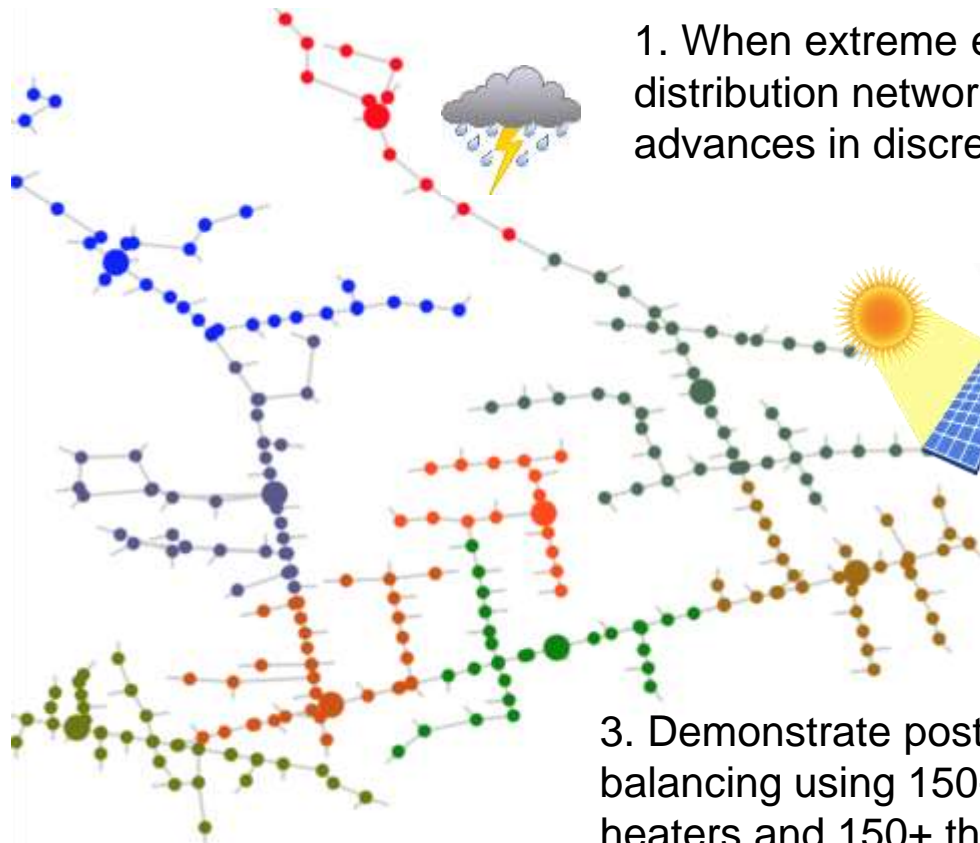

1. When extreme events hit, dynamically re-configure distribution networks into microgrids, leveraging recent advances in discrete optimization and clustering techniques.

2. Leverage distributed energy and demand-side flexible resources to balance power, serving loads in priority order, starting with critical services, such as hospitals, police, fire.

3. Demonstrate post-islanding load balancing using 150+ connected water heaters and 150+ thermostats using distributed artificial intelligence emerging from a DOE/ARPA-E project: Packetized Energy Management.

Packetized Energy's connected thermostat for water heaters



Demonstration partner



# Dynamically Formed Microgrids: Packetized Energy Management

When extreme events hit, T&D networks separate into islands. Disconnect switches open to isolate sections of the network that have the ability to self-supply. Real and virtual storage resources are managed to balance demand with the available supply in real time, building on Packetized Energy Management (existing ARPA-E NODES project).

Feedback control system in which active power is balanced through stochastic "packet" access requests.

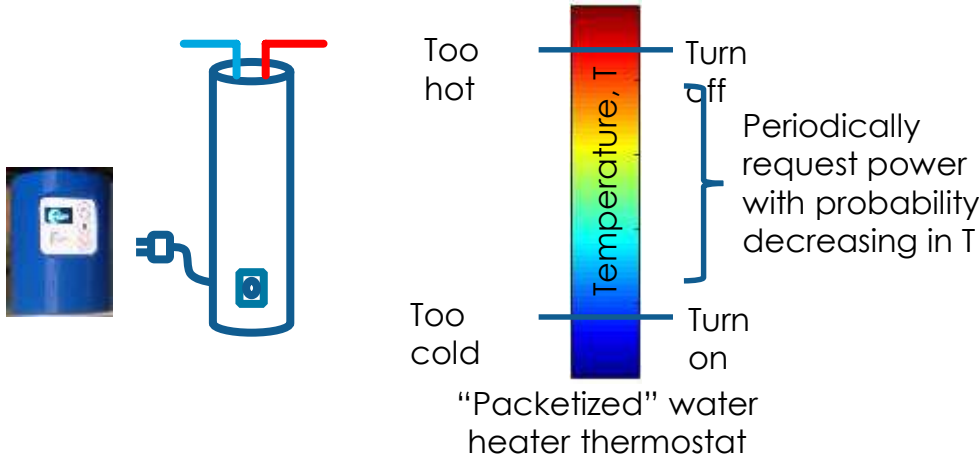
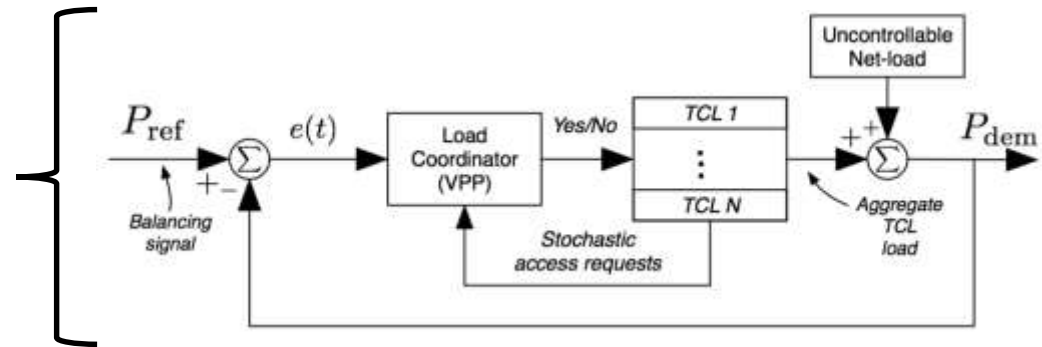

Individual loads and distributed storage units make stochastic requests for network access to a coordinator.

# Communication pathways

1. **Existing architecture.** Real time load balancing will be initially demonstrated using Packetized Energy's Virtual Power Plant software service, which uses customer-owned wifi connections to a cloud-based server network.
2. **Post-disaster microgrid frequency management.** To demonstrate the case in which a disaster has disabled communication pathways, Packetized Devices will use local frequency measurements to provide real-time load balancing, rather than connecting to the cloud. The cloud server will be used for measurements, but not real-time control for this demonstration.
3. **Post-disaster primary voltage and frequency control.** We will use commercially available smart inverters to demonstrate the ability to manage voltage and frequency with a small number of battery and PV systems. Cloud-services will be used for measurements, but not control.

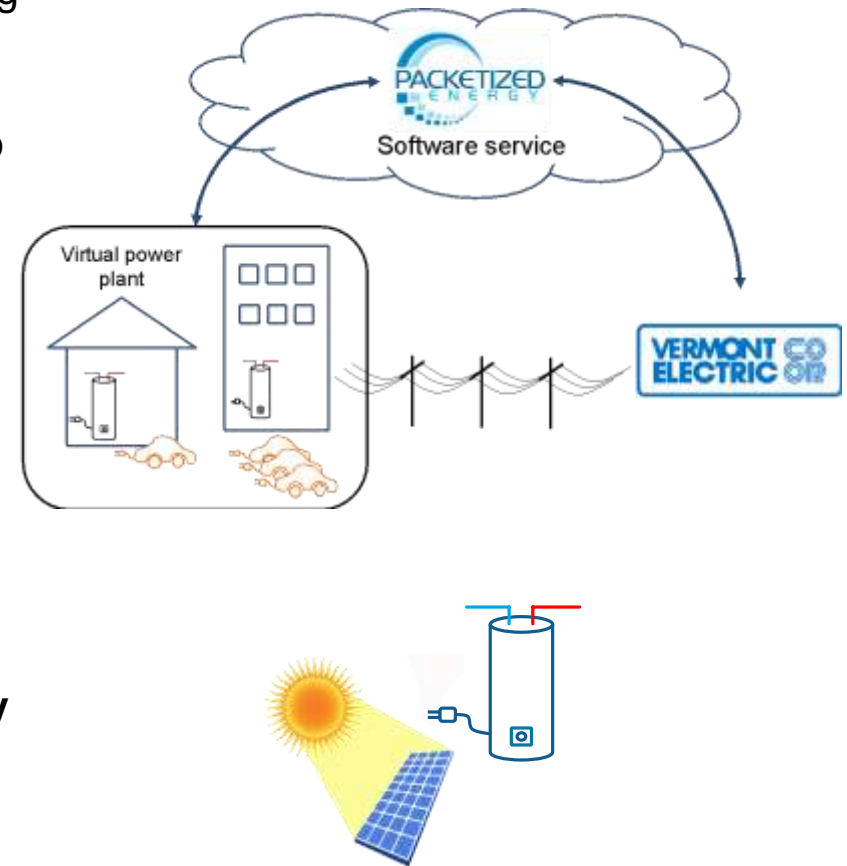

# Recovery: Hierarchical distributed controls for DER controls without communication (extremum seeking)

## Benefits of Hierarchical approach

- ❑ Network level plans operation through time
- ❑ Local level optimizes in real time to absorb forecast and network model errors

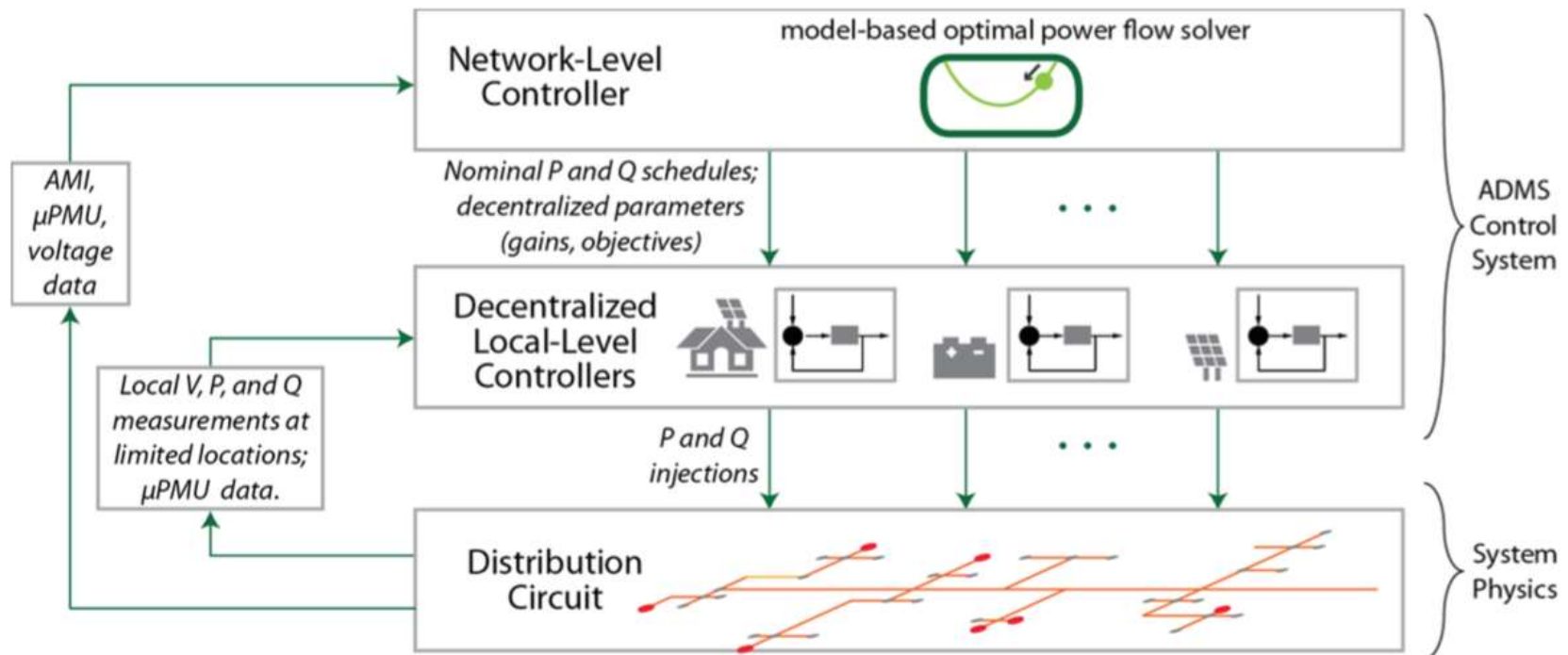

# Open Modeling Framework – <https://omf.coop/>

SLAC

- Open source analytics library
- In use at 176+ organizations (utilities, vendors, universities)
- Available in a web application serving utilities with cost-benefit analysis of emerging grid technologies
- Capabilities leveraged in GRIP:
  - Data conversion from industry-standard IT systems
  - component characterization including DERs and SCADA/AMI-based load models
  - powerflow, visualization and monetization libraries

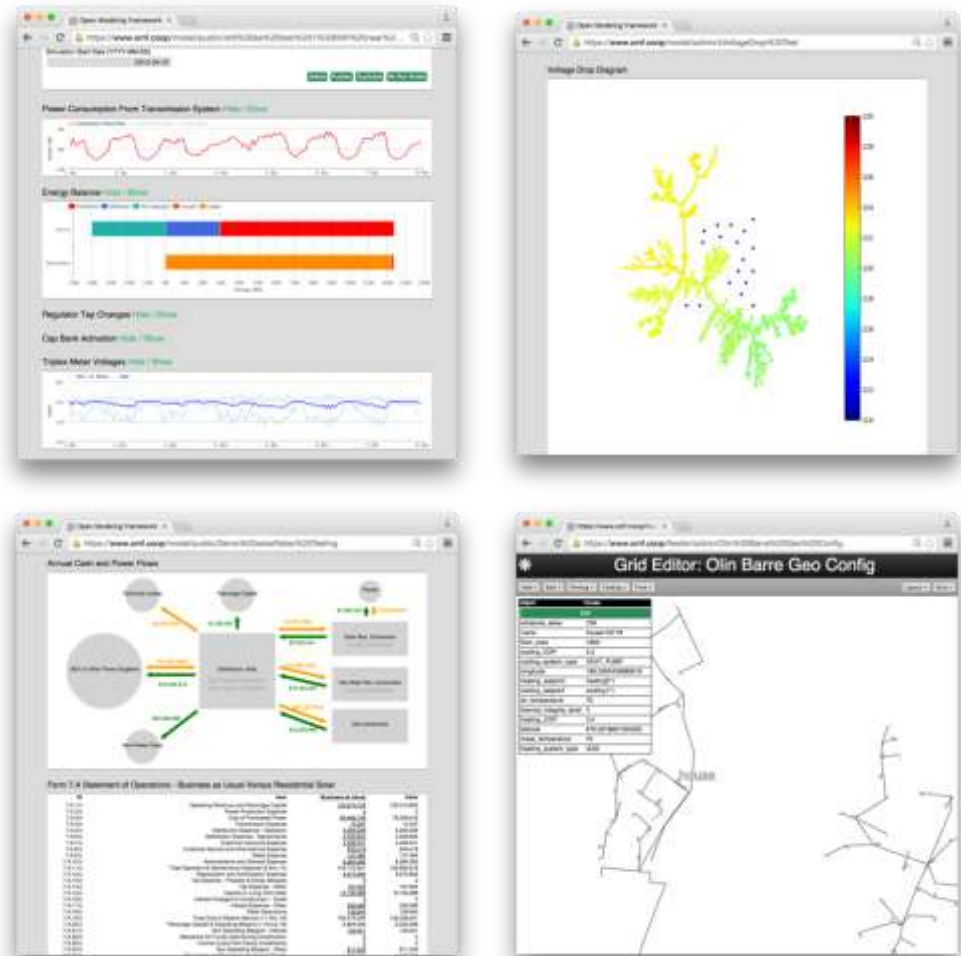

Figure: powerflow, monetization, and circuit editing examples from the OMF

# GRID MODERNIZATION INITIATIVE PEER REVIEW

**GMLC 1.5.02 – Resilient Alaskan Distribution system  
Improvements using Automation, Network analysis,  
Control, and Energy storage (RADIANCE)**

**ROB HOVSAPIAN / ABE ELLIS / MARK KNIGHT**

September 4–7, 2018

Sheraton Pentagon City Hotel – Arlington, VA



# RADIANCE

## High-Level Project Summary



**Project Description**  
To perform a full-scale regional deployment of advanced technologies and methods for **resiliency-enhanced operation** of regional distribution grid in the City of Cordova, AK under harsh weather, cyber-threats, dynamic grid conditions using early-stage technologies such as micro-PMUs, energy storage, loosely- and tightly-networked microgrids, multi-dimensional metrics-based approach for resiliency, zonal reconfiguration, and cyber-vulnerability analysis.

**Value Proposition**

- ✓ Field validation of **resiliency-driven** distribution grid operation through **networked microgrids, zonal reconfiguration**, energy storage, real-time **cyber-secure** communication and control
- ✓ Field demonstration, best practices to utilities to adopt microgrids as a resiliency resource

**Project Objectives**

**Cultivate a better fundamental understanding of resiliency for networked microgrids**

- Application of resilience-by-design
- Develop a systematic framework for quantification, and practical use of multi-dimensional resilience framework

**Regional field validation of resilience enhancement methods for distribution grids/microgrids**

- Coordinated operation of multiple networked microgrids, micro-PMUs for real-time controls
- De-risking field deployment by iterative HIL testing, evaluation of energy storage technologies

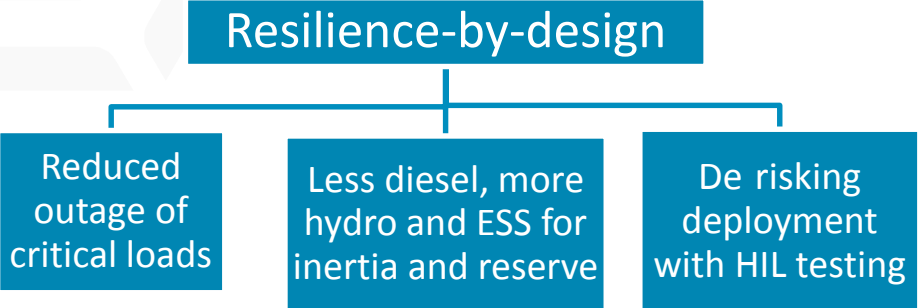

# RADIANCE Project Team



**Humpback Creek Hydroelectric Plant**  
1250kW (2 x 500 kW + 1 x 250 kW)  
17,000 foot UG and submarine transmission line

**Power Creek Hydroelectric**  
6248kW (2 x 3124 kW)  
25 kV transmission ties to Eyak Substation, inflatable dams

**City of Cordova**  
1,566 customers, 18MW  
One Substation  
78mi UG distribution lines

**Orca Power Plant**  
10.8 MW Diesel  
Control Center, CEC

**Crater Lake Dam Storage**  
may offset 25% Diesel consumption



## Lab Valuation Analysis Team

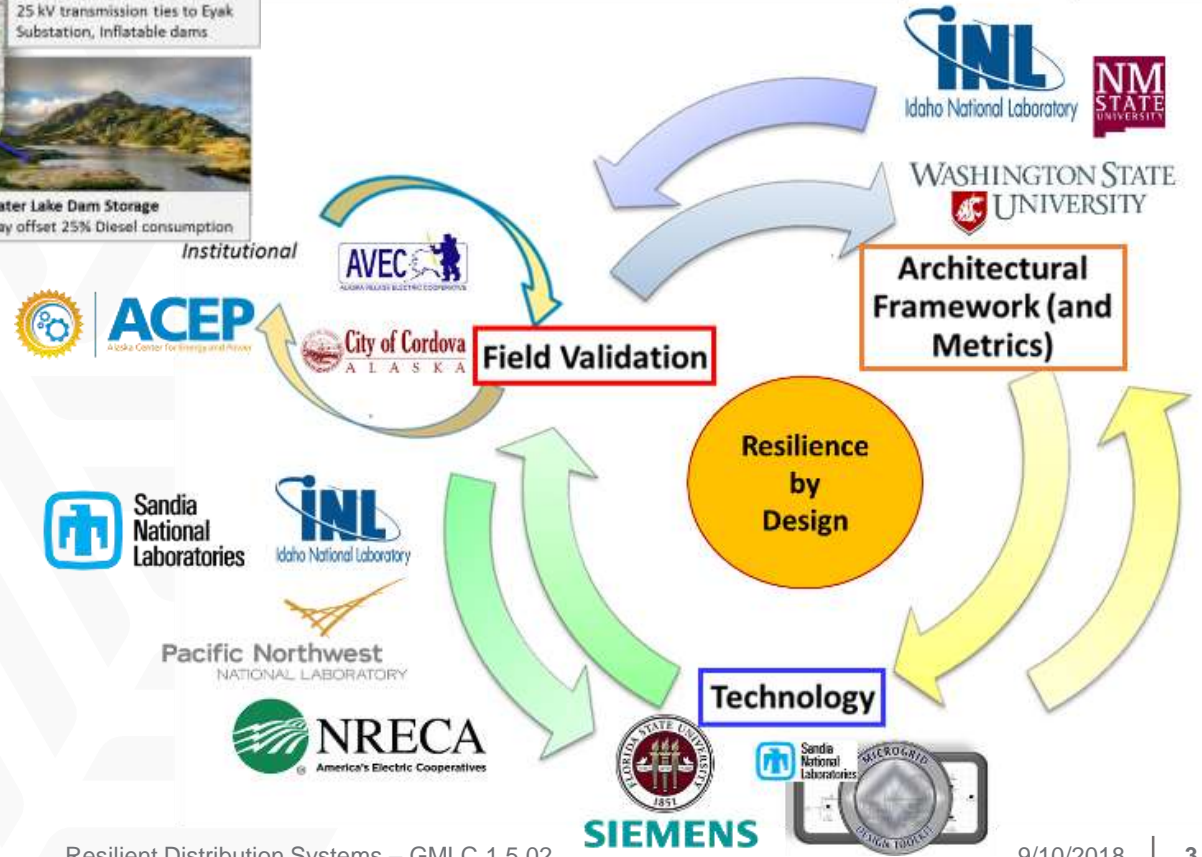

# RADIANCE

## Project Team



**INL** – Real-time modeling, simulation, CHIL, digital blueprint testing, cybersecurity testbed with DRTS, advanced energy storage and PSH controls

**SNL** – Microgrid design (MDT), inverter controls, protection systems, Microgrid controls vendor for networked microgrids, protection relays

**PNNL** – Communication networks testbed and protocols, IEC 61850, sensor and micro-PMU placement, fault propagation, GridLAB-D integration with DRTS

**WSU** – Resilience metrics, analysis, baseline

**FSU** – Micro-PMU testbed

**NMSU** – microgrid design and stability analysis

**Siemens** – Controllers for energy storage

**NRECA** – regulatory structure for generalized learnings dissemination

**City of Cordova** – Demo site, support personnel, regional expertise and engineering

PROJECT FUNDING			
Lab	Year-1	Year-2	Year-3
INL	\$450K	\$500K	\$550K
SNL	\$300K	\$300K	\$350K
PNNL	\$250K	\$200K	\$200K
Cost Share	\$300K	\$1070K	\$200K

**Alaska Village Electric Coop** – 58 dispersed village communities, institutional and site support, local project coordination with engineering and field deployment

**Cordova Electric Coop** – regional electric Coop, institutional support, project integration, engineering and field deployment

**University of Alaska-ACEP** – university support research in regional rural microgrids, microgrid and communication design, field deployment

# RADIANCE Approach



Project will be executed in three main phases of **design, integration testing, partial deployment, and field validation, technology transfer and valuation analysis**

Design of microgrid operation methodologies will be completed in Year-1, followed by partial field deployment in Year-2 and iterative testing, leading to full scale field validation through deployment and technology transfer in Year-3

Data and findings from the deployment in Cordova will be done in coordination with Alaska Village Coop, City of Cordova, Alaska Electric Coop, Alaska Center for Energy & Power

Publications in peer-reviewed journals, IEEE, ASME and other major scientific and industrial society meetings and workshops for rural electrification, grid modernization, cyber-resilience enhancement

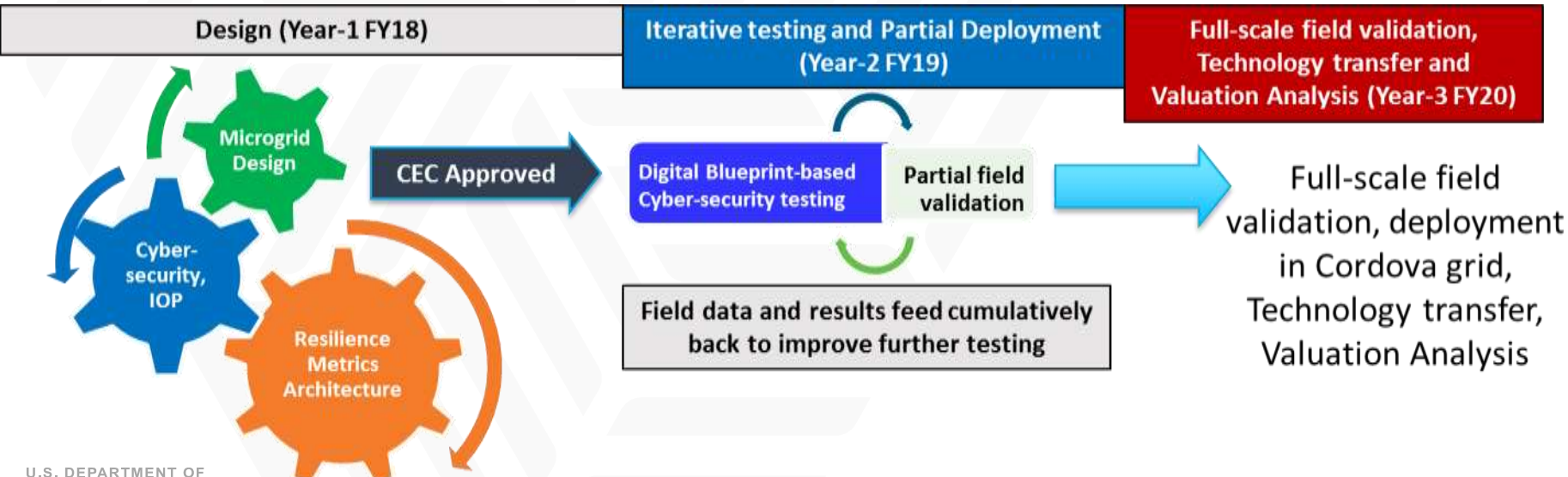

- ▶ In current phase of the project, three Integrated Project Teams (IPT) are focusing on
  - **Cybersecurity Plan IPT**
    - To include cyber and network information before RADIANCE.
    - To develop plans and policies for cyber-secure communication and access of the existing system, and future upgrades/additions of hardware and software.
  - **Microgrid Control Design IPT**
    - Selection of microgrid vendor based on requirements – choice selection matrix.
    - Identification of local critical loads, layout and profiles for developing requirements.
    - Utilize Sandia’s MDT for specifying microgrid control design including physical aspects and cyber-threat scenarios.
  - **Baseline of Cordova Distribution System IPT**
    - To establish a baseline system and quantify the baseline performance using metrics framework in line with LVAT.
    - Utilize system survey and field measurements/data from PMUs, SCADA to develop baseline performance for comparison at the end of the project.

### Key Issues

- ▶ Baseline information about the system, design parameters, communication infrastructure was not readily available from the utility.
  - Database of assets, physical parameters, and network information is being compiled systematically by support from the utility to address this issue.
- ▶ Coordination between multiple stakeholders to successfully achieve project goals
  - A close coordination is maintained by establishing IPTs, quarterly face-to-face Technical Interchange Meetings, conducting bi-weekly team, IPT meetings to identify risks continually, and realize project goals.

### Distinctive Characteristics

- ▶ **Resilience-by-design:** Real-time, resilience-driven operation, control, and planning is adopted.
- ▶ **Hardware-in-the-loop** testing and iterative field deployment provides confidence in the developed solutions before full-scale field deployment; also de-risks the development and integration of new technologies such as micro-PMUs used in this project.
- ▶ **Multi-dimensional Resiliency Metrics framework** will consider aspects such as historical data and prediction of avalanches, tsunamis, cyber-threats, that affect resilience of the distribution grid.
- ▶ Treatment of resilience from a functional perspective – **anticipate, withstand, recover, adapt** – focusing on real-time operations; provisioning use of real-time sensing and historical data.

# RADIANCE Approach

► Operational Resilience Metrics Computation Flowchart

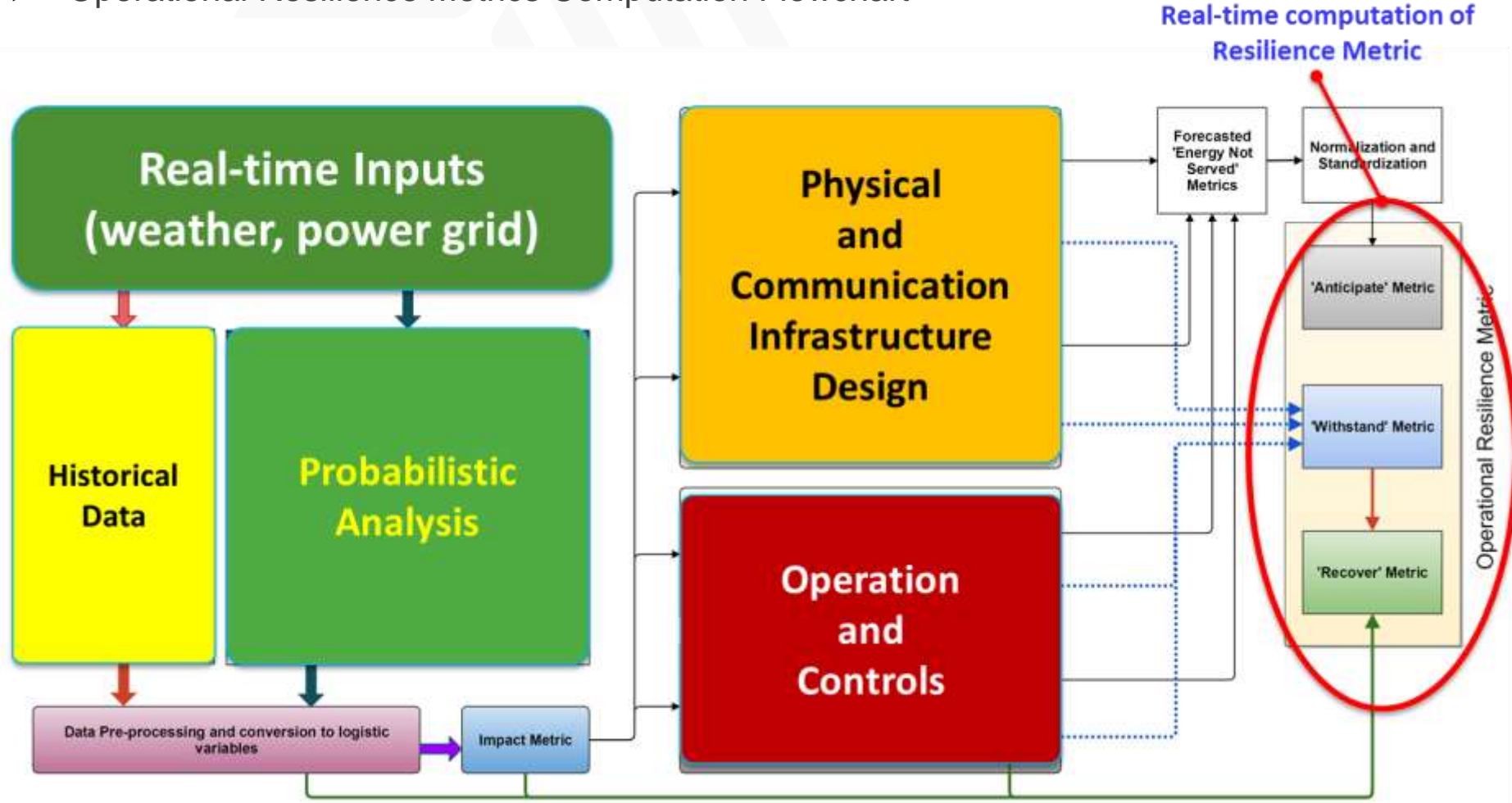

# RADIANCE Approach



► Resiliency enabling process is dynamic

- Storm Hardening
- Installation of backup generator

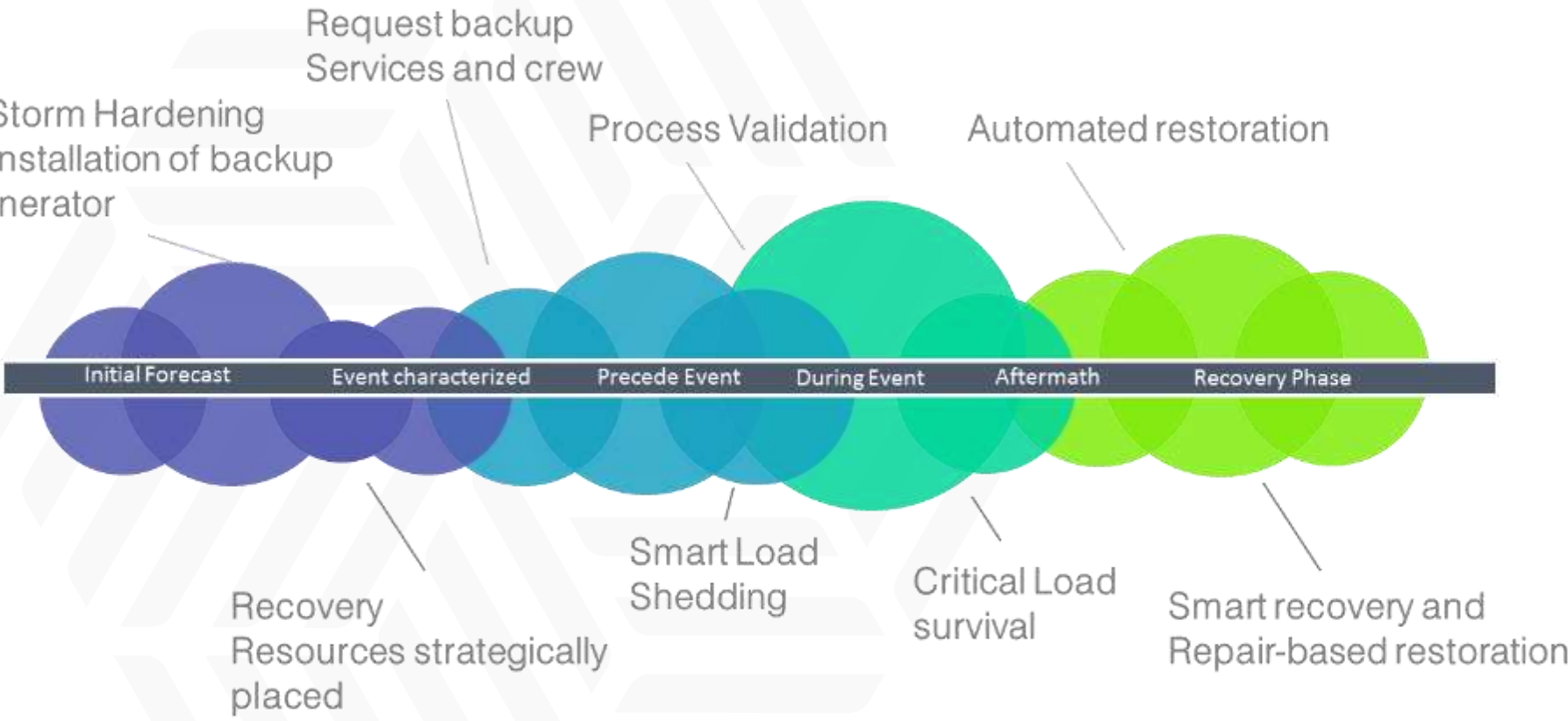



# RADIANCE

## Accomplishments to Date



### Sandia's MDT used for microgrid design [July 2018]

Updating the model based on the latest single line diagram, load data, and conductor database.

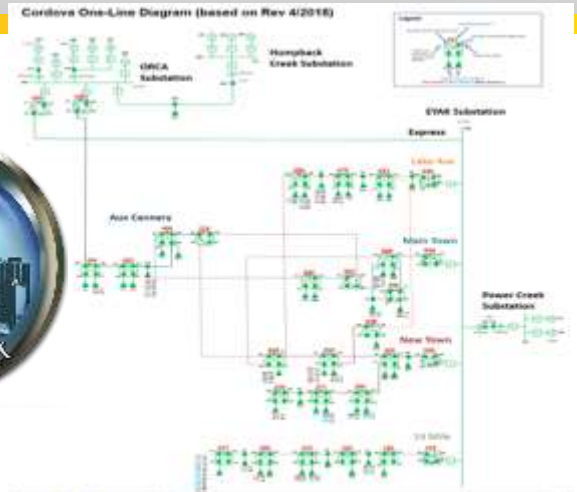

### Digital Blueprint of Cordova Grid [August 2018]

- Updating the model based on the latest single line diagram, load data, and conductor database.
- $\mu$ PMU data to validate dynamic generator models.
  - Both Hydro and Diesel Plants
  - Leveraging models developed as part of St. Mary's project (Technology Transfer to other AK villages)
- Establishing key critical loads and key communication infrastructure
- Load dynamic characteristics and characterization with transient response validation

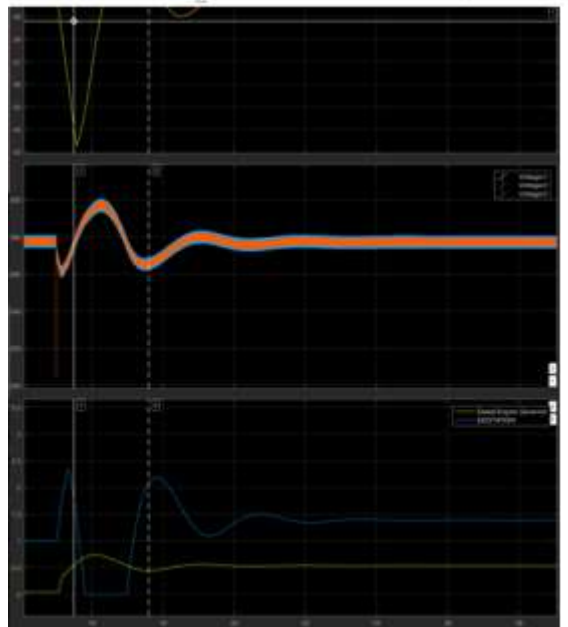

# RADIANCE

## Accomplishments to Date

### Technical insight from the project so far

- ▶ Micro-PMUs and PQ meters for capturing real-time dynamics and transient data for model validation and baseline. [March/July 2018]
- ▶ Threat scenarios – physical and cyber – avalanche, tsunamis, cyber that affect the resilience, considered from the design stage. [April 2018]
- ▶ Critical loads identification by utility – as well as coordinated plan for operations during emergency so that system automation, zonal reconfiguration, control can be designed to maximize resiliency of distribution grids and serve critical loads in during various scenarios. [June 2018]
- ▶ Integration challenges of energy storage with existing SCADA, new microgrid controls and protection were considered early in the project, and helped devise some communication protocol specifications for the energy storage converter controls. [August 2018]

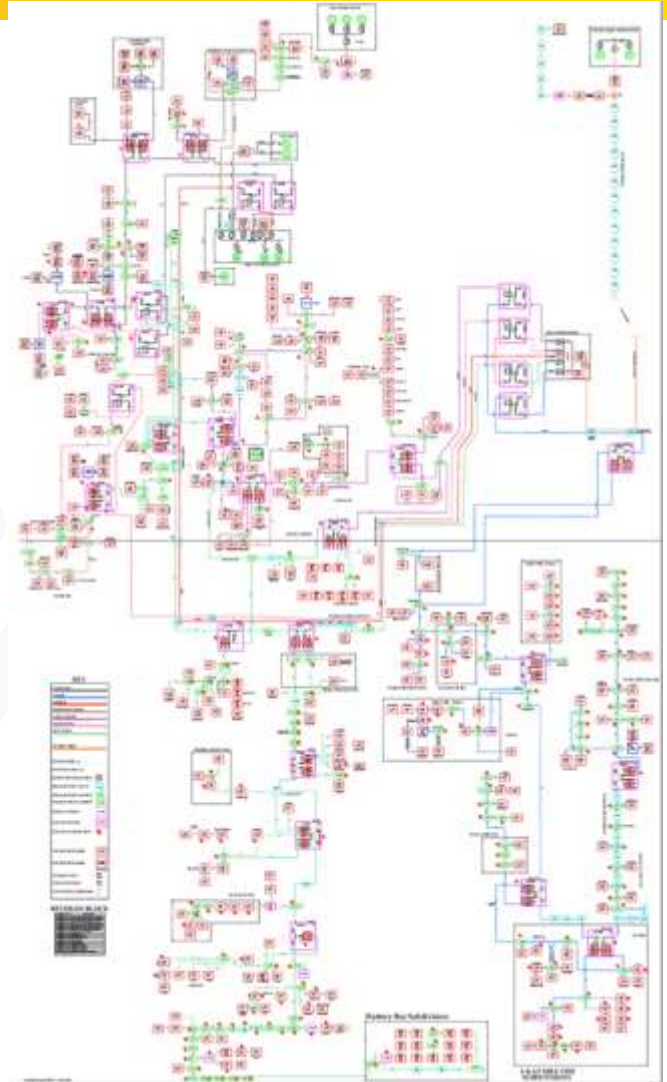

# RADIANCE

## Accomplishments to Date



### Establishing a baseline – capturing dynamic data for validation [March 2018]

Four micro-PMU devices installed, one each at two hydro plants, one at control station, and one in Substation

microPMU Installation at PowerCreek hydro plant



microPMU Installation at Eyak substation – Main Town feeder

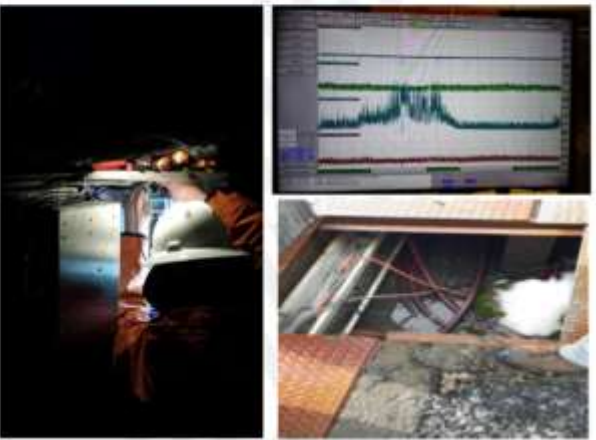

Presently streaming to laptops

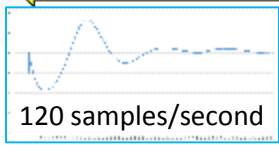

Streaming using OpenPDC

4 PMUs (PowerCreek, HumpBack, Eyak, Orca)

Data available for local use



Stream data for remote site INL



PNNL tool from GMLC 1.3.9

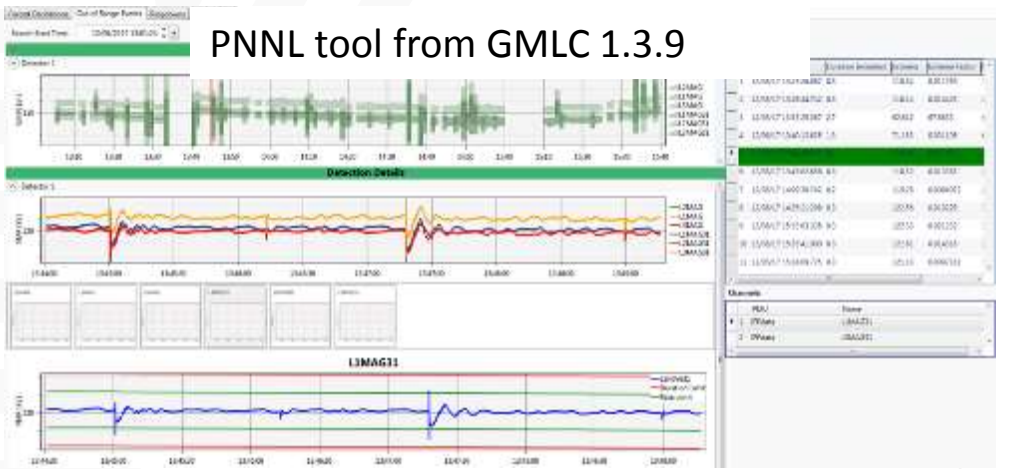

# RADIANCE

## Accomplishments to Date



### Cyber Security Plan [July 2018]

- ▶ A cybersecurity plan based on the format of ARRA SGIG cybersecurity plans is prepared
- ▶ The RADIANCE team is providing an exhaustive review of CEC's cyber security based off INL's cyber informed engineering methodology to document areas lacking in security principles.
- ▶ The original status of the network is as it was on 7/20/2018, all of the information gathered on the network was gathered at the TIM and new additions to the network will be addressed using the new device policy or revisions to the cyber security plan.
- ▶ Cyber IPT included inputs from CEC, NRECA, electrical and communication subcontractors.
- ▶ Cybersecurity Plan will include the (i) baseline cyber system and (ii) additions as part of RADIANCE.

#### Overview

This document describes the cyber security plan, and a description for the technology to be adopted in the project with details. The outcome of this subtask will be a complete cyber plan as per GMLC Call document. A cybersecurity plan based on the format of ARRA SGIG cybersecurity plans will be prepared. The overall approach will be adjusted based on the final approach defined for the micro grid design. The plan identifies vulnerabilities associated with the project's micro grid approach and how will these will be mitigated and tested for risks.

The RADIANCE team is providing an exhaustive review of CEC's cyber security based off INL's cyber informed engineering methodology to document areas lacking in security principles. This document is the result of that review and lists the recommended areas of improvement.

The cyber security plan consists of a survey of the original security status for Cordova Electric Corporation, valid attacks, mitigations to said attacks and procedures for testing mitigations. The original status of the network is as it was on 7/20/2018, all of the information gathered on the network was gathered at the TIM and new additions to the network will be addressed using the new device policy or revisions to the cyber security plan.

#### Impact

Cordova Electric Corporation (CEC) may use the results of the project to validate a consequence-driven cyber-informed engineering (CIE) framework. This document can also be used as a template for CEC to evaluate their own security and implement the remediation herein.

#### Points of Contact

Table 1 Points of Contact

Name	Area of Interest		Email	Phone
Scott Mix	Grid Cyber Security Specialist	PNNL	scott.mix@pnnl.gov	(509) 371-6093
Mark Knight	Research Engineer	PNNL	mark.knight@pnnl.gov	(509) 375-2395
Carl Ladwig	IT Network Security Expert	PCS	carl.ladwig@pcsco.com	
Jeremiah	Cordova ISP Technical	CTC	jeremiah@ctcak.coop	

Page 4 of 17 of  
Cyber Security Plan

Trever Kudma	SCADA Integrator, Power Systems	EPS	tkudma@epsinc.com	
Michael McCarty	Cyber Security Researcher	INL	michael.mccarty@inl.gov	(208) 528-3744
Cynthia L. Hsu	Cybersecurity Program Manager	NRECA	Cynthia.Hsu@nreca.coop	
Venkat Banunayanan	Senior Director, Distributed Energy	NRECA	Venkat.Banunayanan@nreca.coop	

#### Project Background

### **Workshops/meetings/other stakeholder engagement [Dec/Apr/Jul 2018]**

- ▶ Technical Interchange Meetings (December 2017, April 2018, July 2018) were conducted in Cordova each quarter for risk identification and coordination between IPTs, CEC, external stakeholders, and each partner organization.
- ▶ Presentation of the resilience framework being developed in this project at external meetings (NSF Workshop 2018, IEEE PES General Meeting 2018)

### **Impact / Adoption of project products**

- ▶ Alaska Village Electric Cooperative, also a partner in the project has installed micro-PMUs at St. Mary's and St. Michael's in Alaska for monitoring dynamics in standalone/microgrid power systems with renewable energy resources [June 2018] (Technology Transfer to AK villages).

# RADIANCE

## Next Steps and Future Plans



- **Go/No-Go (Dec 11, 2018):** Complete Microgrid Design specifications with approval from Cordova Electric Cooperative.
- Complete Cybersecurity plan for baseline system in Cordova and continue work to include future upgrades as part of RADIANCE. [10/15/2018]
- Establish baseline for CEC as per LVAT and resiliency metrics framework [9/2018]
- Integration of Energy Storage Optimization Toolbox [3/2018]
- Establish hardware integration plan for HIL/CHIL testing [6/2019]

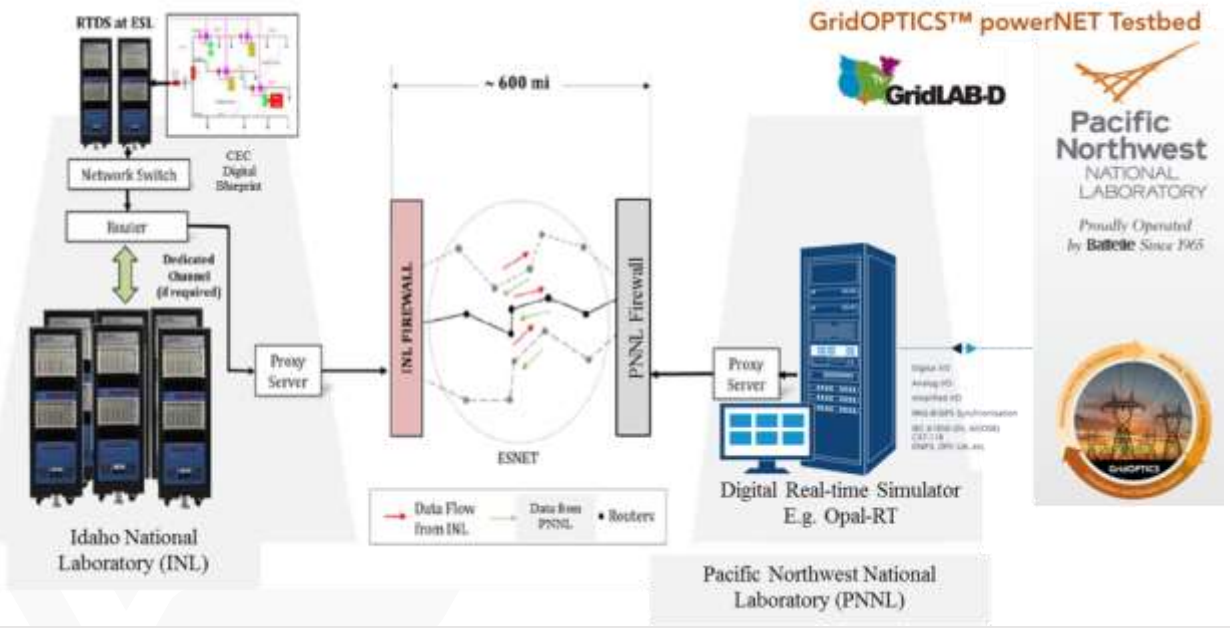

**INL – PNNL Testbed for CyberSecurity**  
Documentation is being prepared for initiating INL-PNNL link

# RADIANCE

## Next Steps and Future Plans



**Establishing a baseline and real-time model validation – Transient capture using Power Quality mode in micro-PMUs for time-synchronized waveform measurement and reference testing with SEL PQ meter [July/October, 2018]**

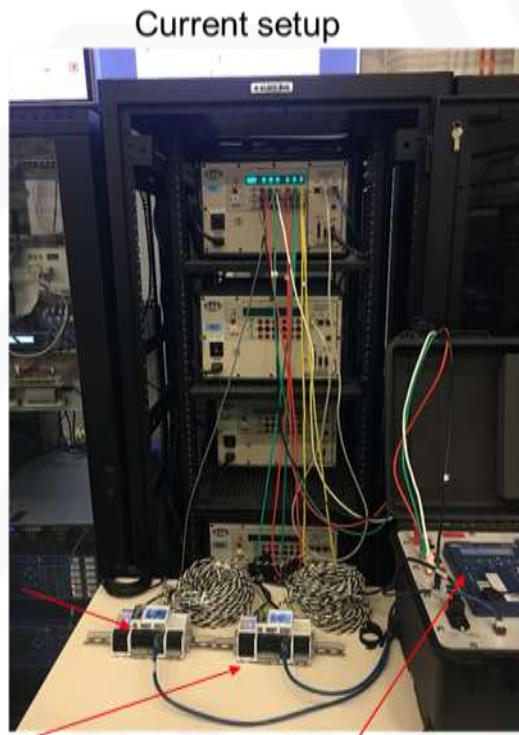

Current setup

50V Three-phase signal from RTDS

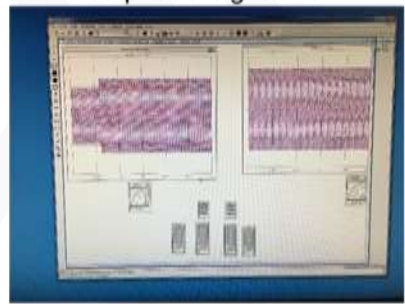

Voltage measurements on SEL

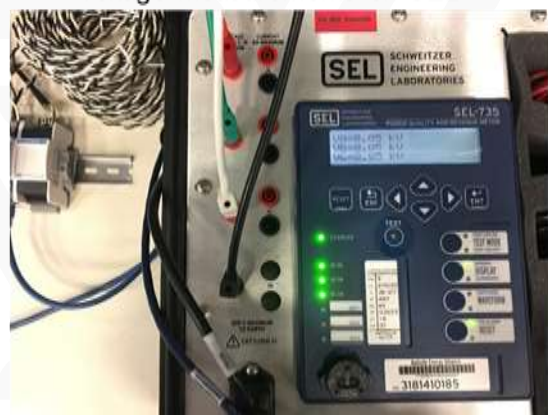

microPMU #2 (PQ)

SEL 735 PQ meter

- GPS time-synchronization (IEEE 1588 PTP) of devices across the grid for coordinated control and protection.
- Address challenges associated with data latency with zonal reconfiguration and islanding.
- Assessment of pumped storage hydro at Crater Lake.

# Thank you

## Questions?

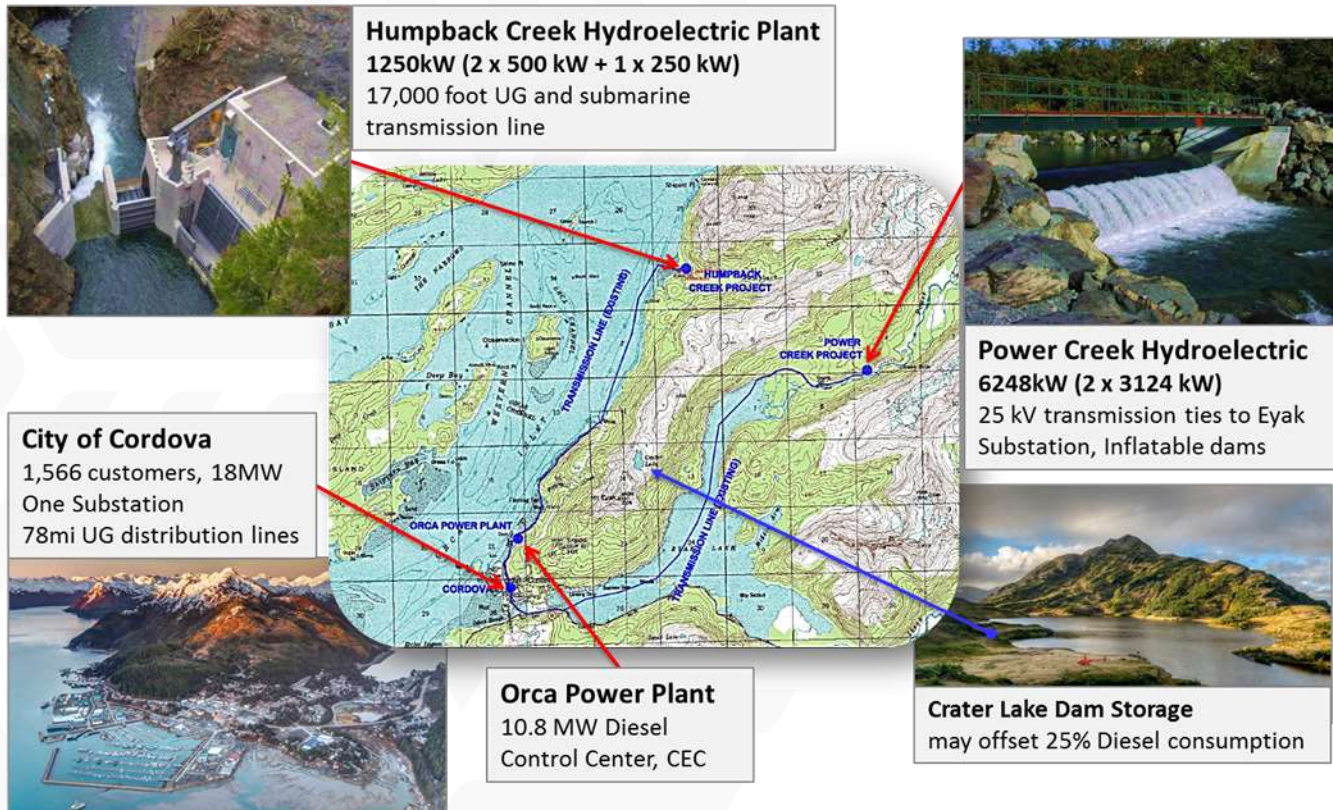



4 Backup Slides

# RADIANCE Approach

## Operational Resilience Metrics Computation Flowchart

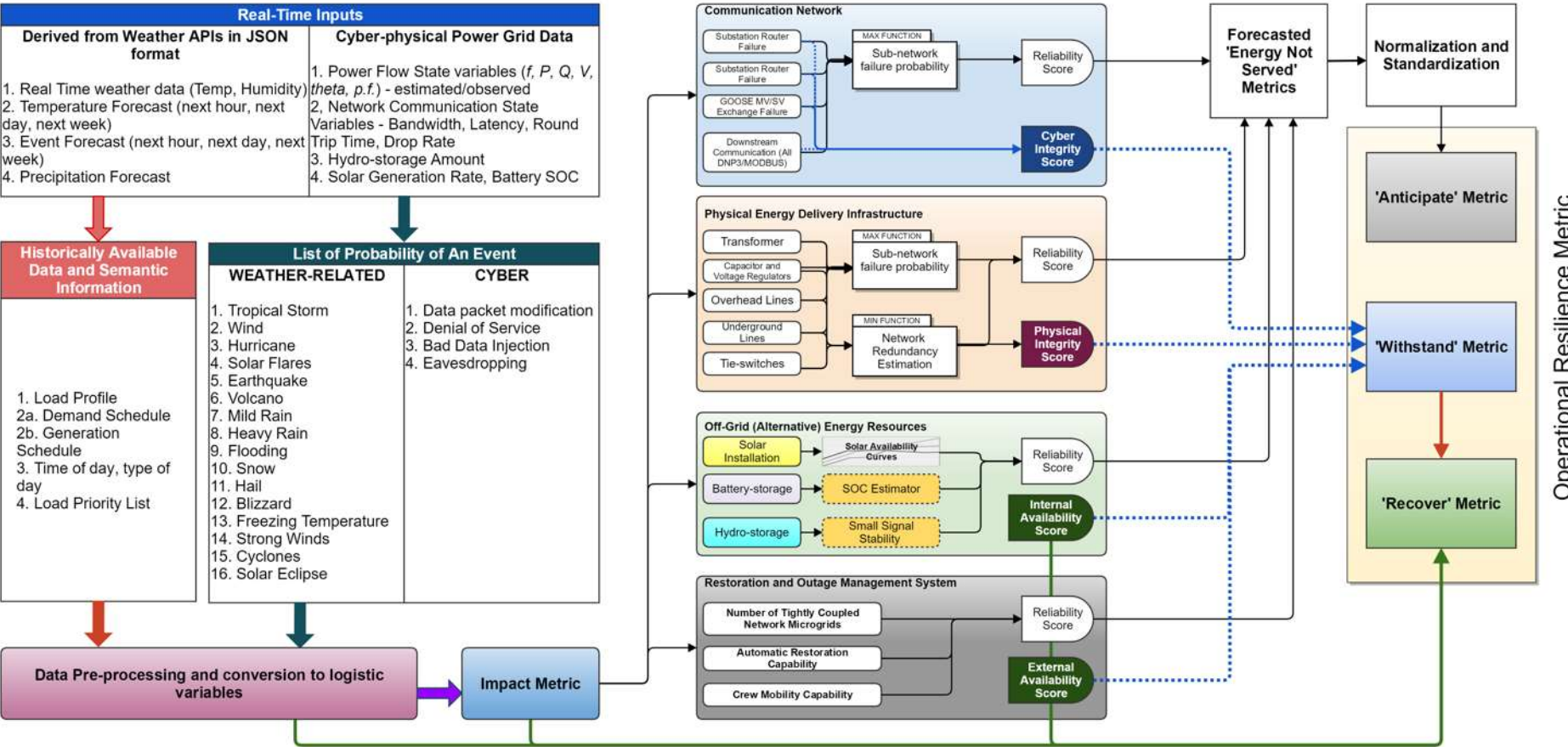

# RADIANCE

## Approach

- ▶ Treatment of resilience from a functional perspective – ***anticipate, withstand, recover, adapt*** – focusing on real-time operations; provisioning use of real-time sensing and historical data.
- ▶ Resilience can be enabled through Data-Driven Distribution Automation technologies

 Spanning-tree & Critical-First Restoration Algorithm

 Proactive Reconfiguration

 Deployment of advanced sensors and micro-PMUs

 Big Data and Machine Learning

 Smart Switch and recloser placement to minimize outages

 Outage management optimization

### Approach - Resilience by Design

1

Identification of key grid vulnerabilities – both physical and cyber

Test and prototyping of data-driven distribution automation technologies to enable resiliency

2

Generalized framework for modeling and simulating high-impact events on power grid critical infrastructure.

3

Validation of resiliency enabling technologies via Control-Hardware in Loop (CHIL) and Power-Hardware in Loop (PHIL) real-time simulations

4

Optimization of recovery and restoration resources using novel resiliency metrics

5

- ▶ Resiliency enabling process is dynamic

## *Calculating Resiliency Metrics*

Building upon software tools developed in GMLC 1.3.9, CANVASS, resiliency metrics will be calculated based on threat at a nodal as well as a network level.



Develop a threat model  
Know the infrastructure  
Anticipate impact of threat on the infrastructure

Ability of an infrastructure component or infrastructure to endure an high-impact event, may be storm hardening, or backup individual generators

Minimum spanning tree and critical-first restoration strategies and resource optimization to enable maximum resilience and minimum downtime

# GRID MODERNIZATION INITIATIVE PEER REVIEW

## GMLC 1.5.03 Increasing Distribution System Resiliency using Flexible DER and Microgrid Assets Enabled by OpenFMB

**KEVIN SCHNEIDER, PACIFIC NORTHWEST NATIONAL LABORATORY**

September 4–7, 2018

Sheraton Pentagon City Hotel – Arlington, VA

# Increasing Distribution System Resiliency using Flexible DER and Microgrid Assets Enabled by OpenFMB (High-Level Project Summary)



The primary goal of this project is to increase distribution resiliency through flexible operating strategies. This will be accomplished by actively engaging utility and non-utility assets as flexible resources.

### Value Proposition

- DER deployments at moderate to high penetration levels prevent a “business as usual” approach
- Duke Energy has halted some self-healing systems deployments due to moderate/high penetration PV concerns
- What is needed is a way to coordinate the operation of distributed PV, to make it a resource, and not an obstacle
- This is extensible to other centralized and decentralized system combinations

### Project Objectives

- Develop flexible operating strategies that integrate centralized and decentralized control systems (e.g., self-healing/PV)
- Engage utility and non-utility assets to increase the resiliency of critical end-use loads to all hazards events
- Develop, and deploy, a layered control architecture using commercial-off-the-shelf (COTS) equipment and open source code

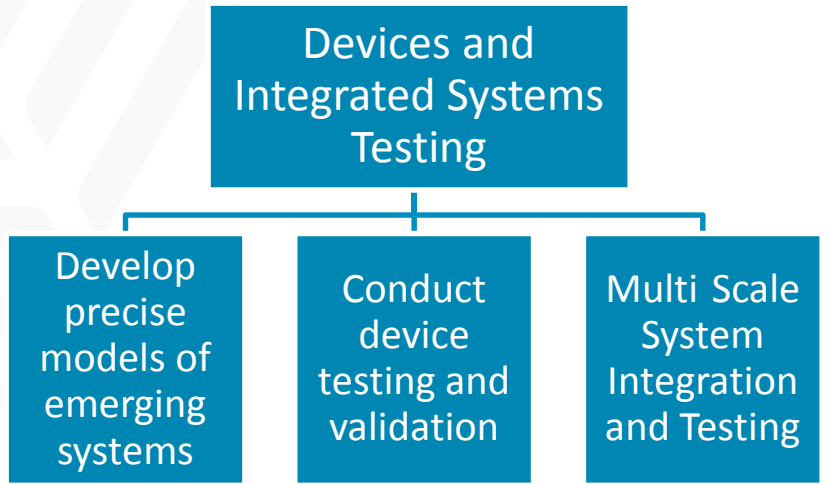

# Increasing Distribution System Resiliency using Flexible DER and Microgrid Assets Enabled by OpenFMB (Project Team)



- **PNNL – Kevin Schneider and Jacob Hansen**
  - Development of architecture, controls, and operations
  - Co-Simulation of distribution and communications
- **ORNL – Josh Hambrick and Mark Buckner**
  - Implementation of the OpenFMB Harness
  - Application of OpenFMB cybersecurity framework and microgrids protection
- **NREL – Murali Baggu and Kumaraguru Prabakar**
  - Sub-system testing of centralized controls, e.g., GE DMS
  - Cost/Benefit Analysis and technical performance analysis
- **Duke Energy – Stuart Laval and Leslie Ponder**
  - Host utility which owns and operates all utility assets
  - Execute final field evaluation and cyber red team activities
- **GE Grid Solutions – Avnaesh Jayantilal**
  - Technical support for production DMS and FLISR
- **UNC-Charlotte – Madhav Manjrekar and Somasundaram Essakiappan**
  - Primary HIL performers, using Typhoon, support of controls validation
- **University of Tennessee – Leon Tolbert and Yilu Liu**
  - Integrate VOLTTRON nodes into OpenFMB Harness
- **Smart Electric Power Alliance (SEPA) – Aaron Small**
  - Outreach agency to ensure that lessons learned are transferred
- **Project Industry Advisory Board (IAB) Members**
  - Entergy – Cat Wong
  - Avista – Curt Kirkeby
  - APS – Jason Delany
  - North America Energy Standards Board (NAESB) – Jonathan Booe & Elizabeth Mallet

PROJECT FUNDING			
Team Member	Year 1 \$	Year 2 \$	Year 3 \$
PNNL	600,000	600,000	600,000
ORNL	483,333	483,333	483,333
NREL	300,000	300,000	300,000
Duke Energy	250,000	250,000	250,000
UNC	183,333	183,333	183,333
UTK	150,000	150,000	150,000
SEPA	30,000	30,000	40,000





# Increasing Distribution System Resiliency using Flexible DER and Microgrid Assets Enabled by OpenFMB (Approach)



## ➤ **Approach:**

- R&D: foundational research in architecture, controls, simulation & emulation, and multi-scale testing
- Market Stimulation: active Industry Advisory Board (IAB), including material developed and distributed by SEPA
- Standards: using OpenFMB, and an open-source standards-based approach

## ➤ **Key Issues:**

- Increasing flexibility as a resiliency resource, to address uncertainty in planning and operations
- Coordinating centralized and decentralized systems, utility and non-utility owned/operated
- Transforming the perspective of DER from being an obstacle to being a resource

## ➤ **Distinctive Characteristics:**

- Industry driven: the project is motivated by utility needs, and supported by IAB members with similar classes of operational challenges
- Standards based: all work is being conducted with open platforms to facilitate broad adoption
- Deployable: the final field validation will use COTS equipment running containerized open-source software, further facilitating broad adoption

# Increasing Distribution System Resiliency using Flexible DER and Microgrid Assets Enabled by OpenFMB (Architecture and Controls)



A layered control structure with elements of a laminar control architecture developed to coordinate self-healing, microgrids, and DERs.

Concept of Operations (CONOPS) draft has been completed, including 12 use-cases

- Protection operates autonomously at the device level, using local set point groups
- OpenFMB maintains protection coordination after system changes (publish & subscribe)
- The central DMS determines “optimal” topology post event, issues commands
- The DMS can engage transactive to incentivize non-utility assets to generate additional switching options
- Operations across layers are coordinated, enabling effective centralized and distributed system operations

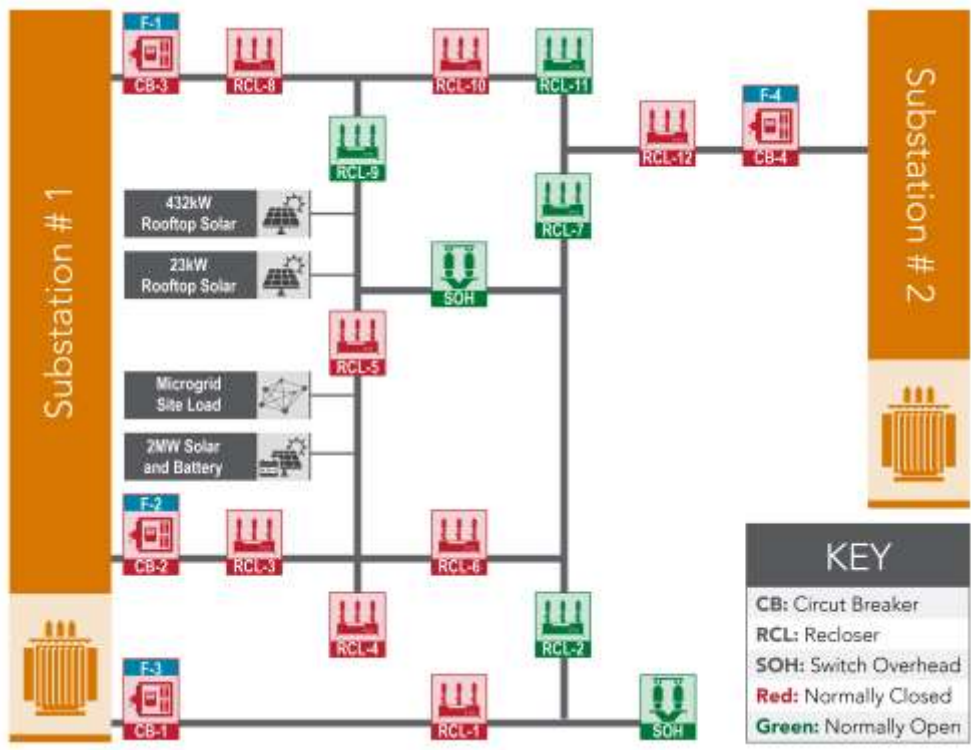

# Increasing Distribution System Resiliency using Flexible DER and Microgrid Assets Enabled by OpenFMB (Simulation/HIL/Emulation)



**Before equipment can be operationally deployed, the architecture, controls, and set points must be developed, simulated and validated. A multi-stage validation approach has been taken.**

- Co-Simulation: HELICS, GridLAB-D, and NS-3
  - Initial electric and communications models complete
  - Results will support HIL simulations
- HIL Simulation: Typhoon HIL & ADMS Testbed
  - Typhoon running at UNCC and Duke Energy
  - NREL is working on setting up GE DMS
- Emulation: ORNL SI-Grid
  - ORNL and UTK are working with Duke RTUs
  - SI-Grid being connected to NREL for DMS tie
- Field Deployment: Anderson, SC
  - Duke is on track for deployment of equipment
  - Siting changes are being tracked
- One significant challenge is the version control and validation of the various model types.

## Co-Simulation



## HIL Simulation & Emulation



## Field Deployment



# Increasing Distribution System Resiliency using Flexible DER and Microgrid Assets Enabled by OpenFMB (OpenFMB Harness)

The OpenFMB “Harness” enables the integration of distributed assets in a common framework.

- Built using the standards-based OpenFMB reference implementation: leveraging past work the data structure and models are almost defined
- The harness is scalable for large numbers of DERs, and does not use proprietary adaptors
- Utility assets connected via COTS Remote Terminal Units (RTUs) with containerized applications: RTUs are being tested with initial harness
- Non-Utility assets connections will use VOLLTTRON on commodity platforms: work has begun on VOLLTTRON integration

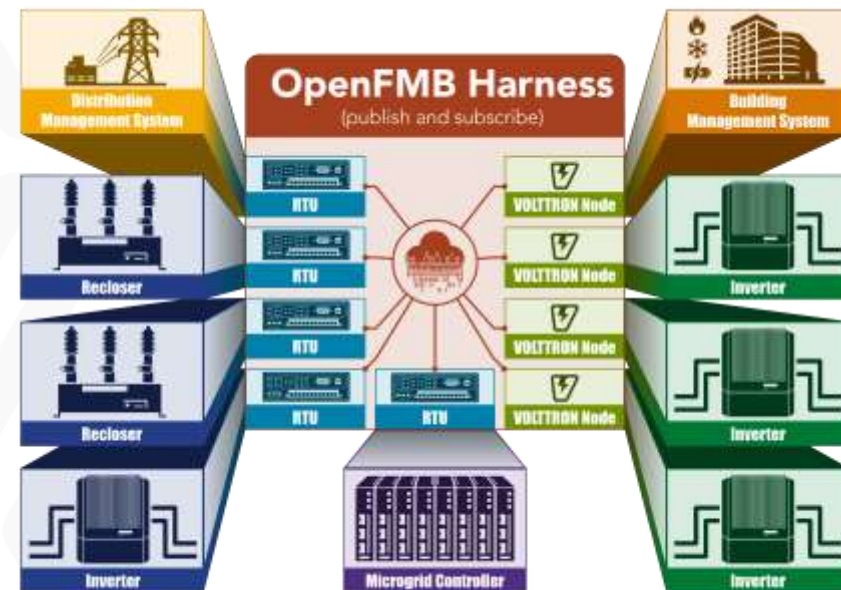

# Increasing Distribution System Resiliency using Flexible DER and Microgrid Assets Enabled by OpenFMB (Hardware Transitions)



**For a resilient control system to be viable, there must be a path to deployment with COTS equipment.**

- Early OpenFMB work used commodity Raspberry Pi™ prototype controllers
- The utility assets for this project will use COTS RTUs and/or 4G LTE gateways, with OpenFMB in a containerized environment
- Using open software containerized applications on COTS equipment enables hardening for industrial applications while ensuring interoperability and portability
- COTS devices integrates TPM2.0 crypto-chips and X.509 certificates with whitelisted containerized OpenFMB applications
- COTS devices are being tested on the initial harness implementation

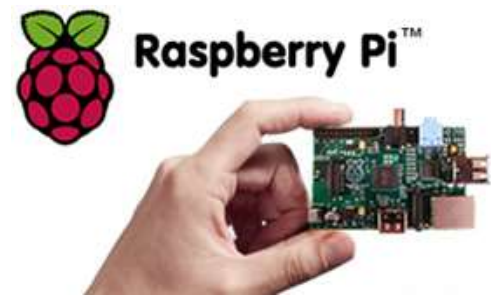

Substation/Microgrid RTU: SEL 3555



Recloser RTU  
SEL 3505



4G LTE Gateway  
Sierra Wireless MP70+

# Increasing Distribution System Resiliency using Flexible DER and Microgrid Assets Enabled by OpenFMB (Industry Advisory Board)



## **This project is driven by an active IAB, providing input that impacts direction.**

- IAB members reviewed proposal concept
- IAB members have provided direct feedback as the work has progressed
- Two in-person IAB meetings in 2018
- IAB feedback has been incorporated to the research direction, including the Concept of Operations (CONOPS) document
- Next step is to produce one-page summary for FY18 work, and have IAB complete questionnaire to evaluate work conducted

## **Example IAB “needs” which have been integrated into project work plan**

- “Faster, more secure, and non-proprietary plug-n-play integration of DERs/microgrids with the existing DA devices being controlled by the ADMS.”
- “A more resilient self-healing system integrated with ADMS that could reduce the duration and frequency of momentary faults and leverage DERs for back-up when a permanent fault occurs.”
- “Faster and more modular development and deployment framework for grid-edge applications. ADMS or DERMS are monolithic and cannot be easily extended for new functionality without breaking it.”
- “Need multiple sources of supply with diverse vendor & technology mix for best in breed solution.”

# Increasing Distribution System Resiliency using Flexible DER and Microgrid Assets Enabled by OpenFMB (Next Steps and Future Plans)

## Year two efforts will begin the transition from foundational work to early stage applied.

- Integrate feedback from IAB on year one efforts (Y2:Q1)
- Begin transition of year one efforts: peer reviewed publications, presentations, and trade journals (Y2:Q1-Q4)
- Begin working with specific information from Duke Energy asset deployments (Y2:Q2)
- Complete architecture and controls work (Y2:Q2)
- Complete co-simulation analysis (Y2:Q3)
- Complete initial HIL work (Y2:Q3)
- Finalization of CONOPS and beginning of field validation plan (Y2:Q4)



# Increasing Distribution System Resiliency using Flexible DER and Microgrid Assets Enabled by OpenFMB





# Grid Modernization Initiative Peer Review

## 1.05.04 - Integration of Responsive Residential Loads into Distribution Management Systems

**TEJA KURUGANTI**

September 4–7, 2018

Sheraton Pentagon City Hotel – Arlington, VA

# Integration of Responsive Residential Loads into Distribution Management Systems



End-to-end system for engaging residential DERs to provide grid resilience services

The goal of the project is to engage residential loads and distributed energy resources (DERs) to increase distribution system resiliency. This will be achieved through interoperable end-to-end system architecture employing hierarchical control and optimization technology to demonstrate coordinated response from large number of assets in time and magnitude.

## Value Proposition

- ✓ Increasing number of smart residential-level assets including controllable loads, rooftop solar, and storage technologies imposing new challenges in distribution operations
- ✓ These assets can be leveraged for enabling resilient rapid reconfiguration of the distribution circuits by managing demand, voltage, and power flows
- ✓ An end-to-end solution establishing interoperability across the meter and coordinated control technology is needed to engage residential loads for grid services
- ✓ The end-to-end system performance and resilience has to be validated in field for adoption

## Project Objectives

- ✓ Develop interoperable home energy management system (HEMS) as an interface to distribution-level integration of Residential loads and DERs to provide distribution resiliency services
- ✓ Develop transactive control system to co-optimize Loads/DER performance to satisfy grid requirements and residential needs
- ✓ Deploy and validate the technology in field with utility partners

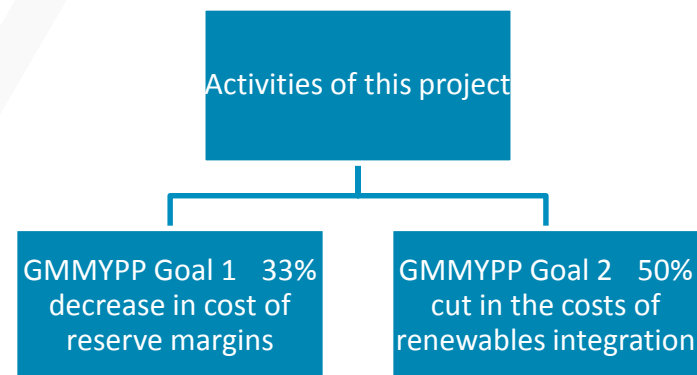

# Integration of Responsive Residential Loads into Distribution Management Systems

## Project Team



**Oak Ridge National Laboratory - Teja Kuruganti**

- Team: Michael Starke, Alex Melin, Mohammed Olama, Helia Zandi, Sonny Xue, Jin Dong
- Development of system architecture, software, hardware
- Development of utility-scale control algorithms
- Modeling and simulation for control development in collaboration with University of Tennessee (Fran Li, Xiao Kou)
- Assist in testing, data collection and analytics
- Coordination of overall project

**Pacific Northwest National Laboratory - George Hernandez**

- Measurement and verification solutions for responsive loads
- Engage in HEMS development and control applications
- Engage in utility-dispatch signal specification

**Electric Power Research Institute - Chuck Thomas**

- Develop use cases and logical architectures
- Develop field evaluation deployment plan and execution
- Develop end-use device controls and establish interoperable architecture between ADMS and HEMS
- Conduct field evaluation at test sites, collect data and perform analytics

**Utilities Partners**

- Develop use cases and define requirements for engaging loads for resilient distribution systems
- Provide deployment sites and deployment assistance
- Technology evaluation and technology transition
- Southern Company – Justin Hill
- Tennessee Valley Authority – Sam Delay
- Duke Energy – George Gurlaskie
- Jackson EMC – Amy Bryan
- Electric Power Board – Hunter Ellis

PROJECT FUNDING			
Team Member	Year 1	Year 2	Year 3
ORNL	700,000	750,000	733,000
PNNL	300,000	377,000	300,000
EPRI	613,000	613,000	614,000
EPRI (Cost Share)	420,000	420,000	420,000

Modeling, Simulation, Controls, Software



M&V, Software, Analytics



Hardware, Analytics, Deployment



Requirement Definition, Deployment



# Project Overview

**Develop end-to-end system for engaging residential DERs to provide grid services**

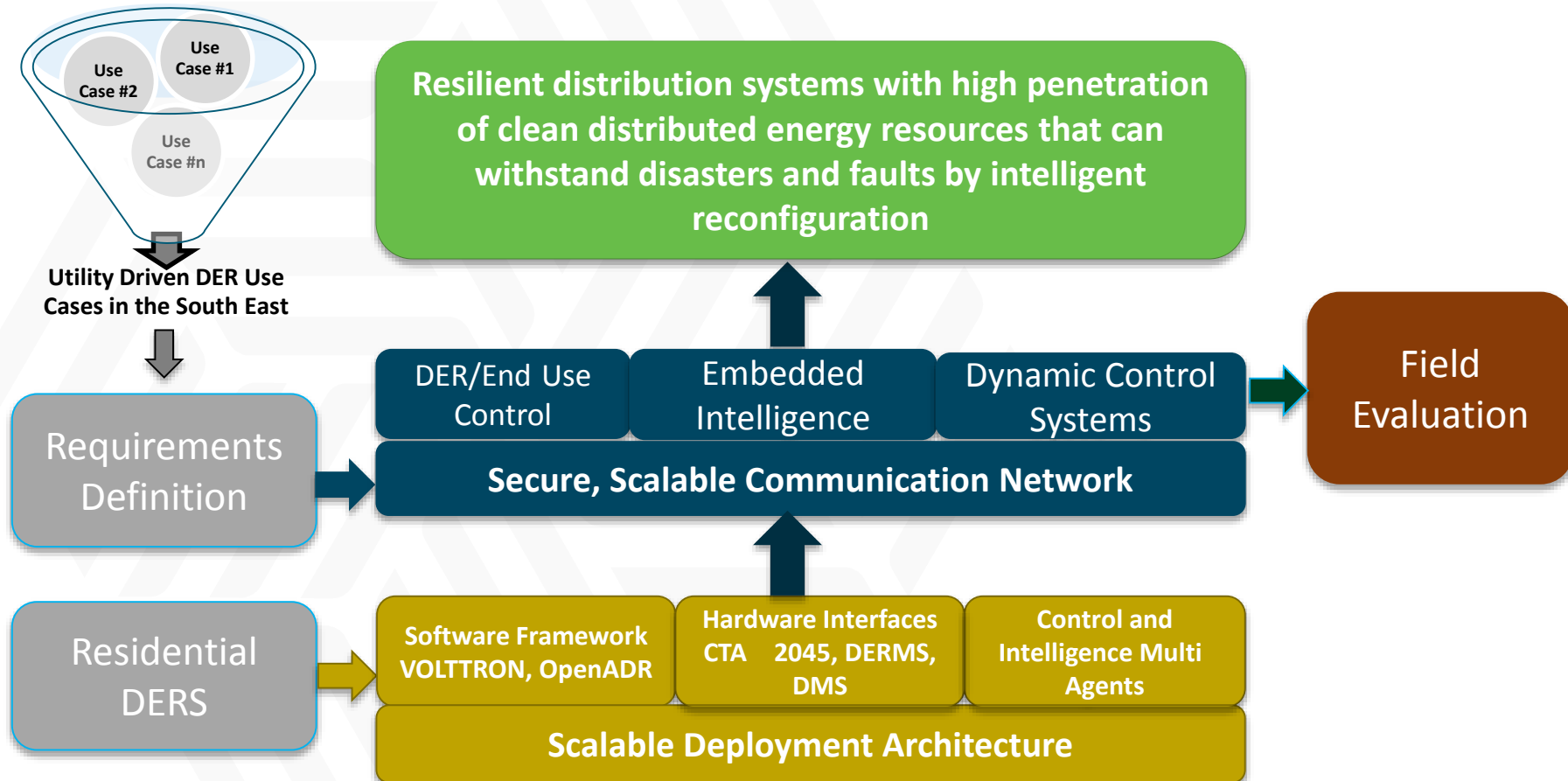

# Addressing the Challenge

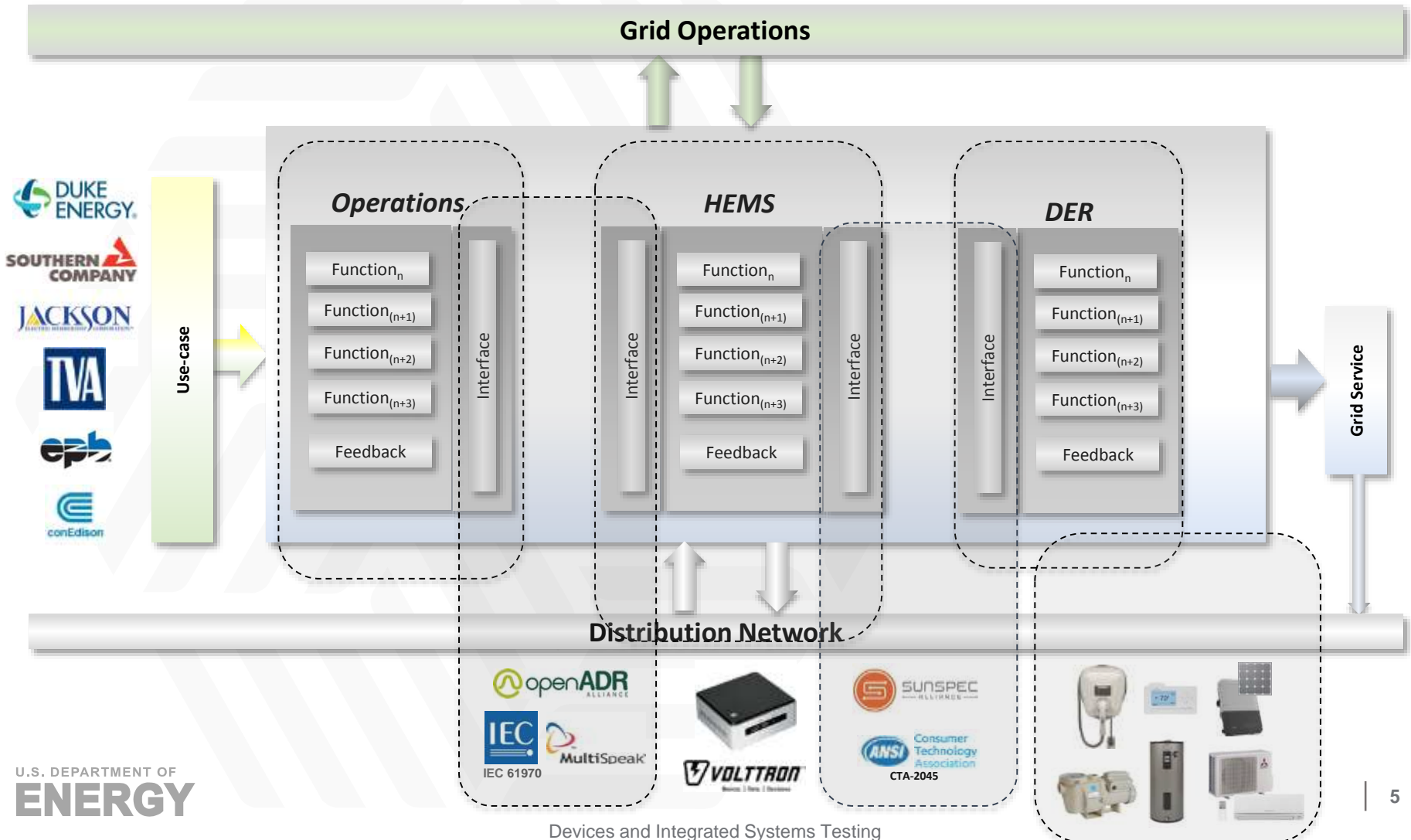

# Method of Design - Systems to Enable Behind-the-Meter Grid Services

## Use case and System Architecture Development



### ► Design Templates

- Stakeholder Questionnaire
- Use-case Narrative – 14 use cases developed
- Actor Specifications
  - Information Exchange and Communication Interfaces

### ► Graphical Representations

- Layered architectural diagrams (information exchange sequence)

### ► Unified Documentation

- System Design Package

### ► System Architecture

- End-to-end system architecture to support hierarchical control of demand side assets to provide unified response
- Demand management system (DeMS) coordinates the communication with HEMS for transactive control using incentives to drive optimization
- Local HEMS coordinates device response to grid service request while maintaining customer constraints
- Interoperability and cybersecurity driven by requirement definition

Layered Architecture Diagrams

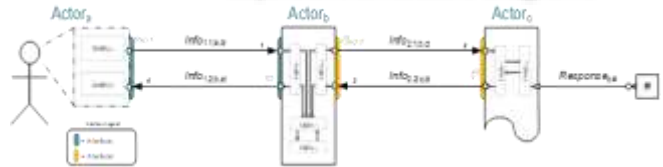

Use case Sequence Diagrams

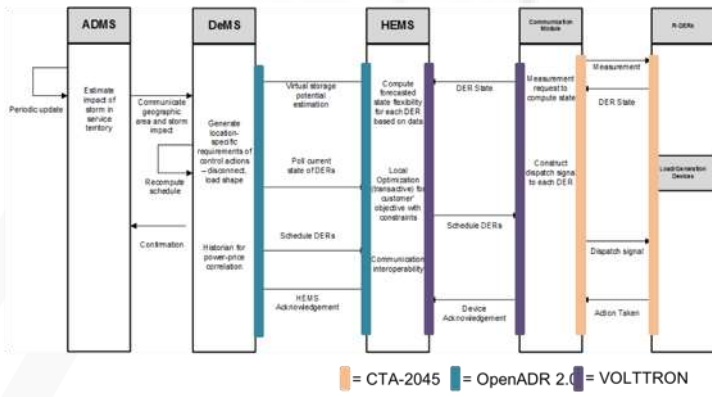

System Design Package

SYSTEM DESIGN DOCUMENTS	
USE-CASE NARRATIVE .....	SECTION 1
ARCHITECTURE .....	SECTION 2
ACTORS .....	SECTION 3
TECHNICAL REQUIREMENTS .....	SECTION 4
Operational (Logic) .....	Section 4.1
Information Exchange (Interfaces) .....	Section 4.2
ACTOR-TO-ACTOR INTERACTIONS (SEQUENCE DIAGRAMS) .....	SECTION 5
DESIGN VERIFICATION .....	SECTION 6
MEASUREMENT AND VERIFICATION .....	SECTION 7

# System Architecture - Overview

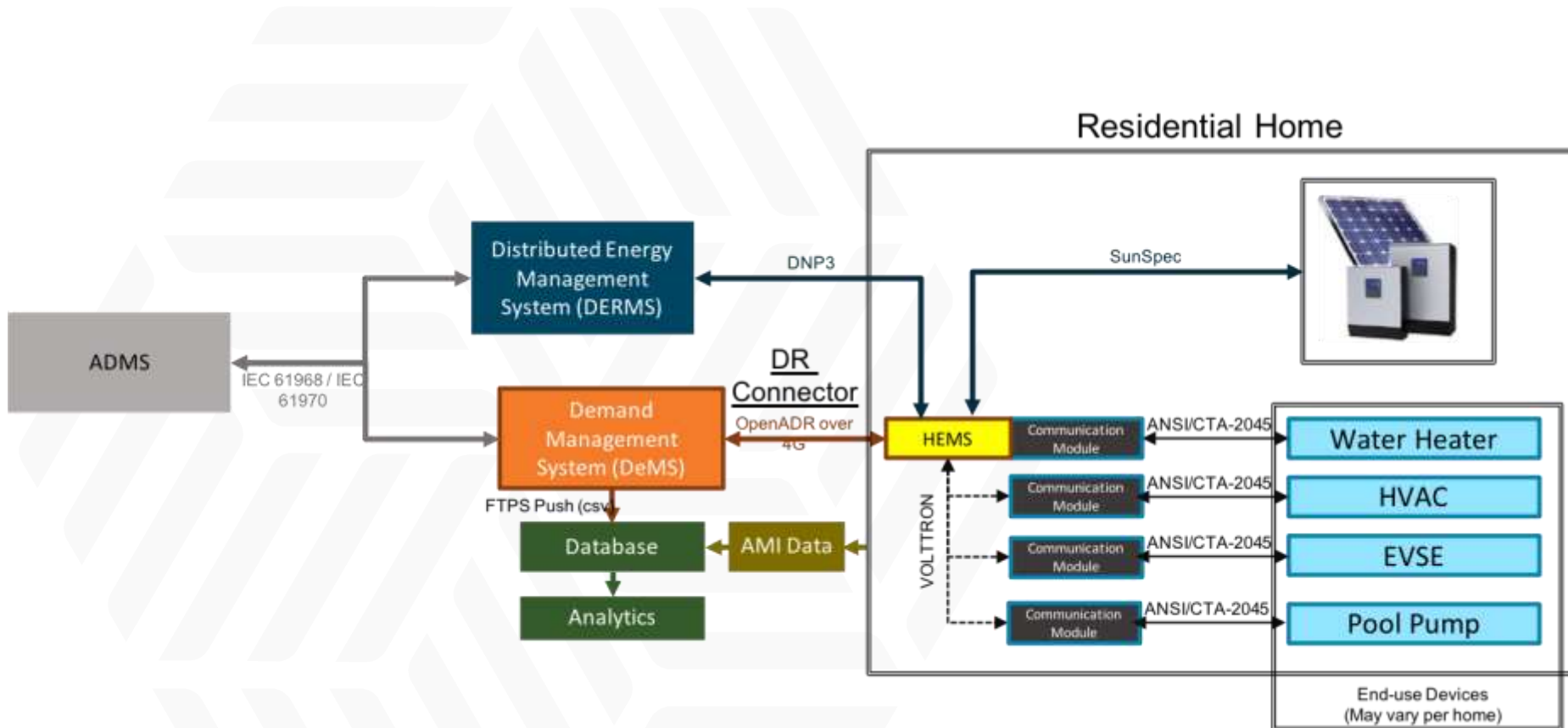

# System Architecture - Detail

Enable wide-area responsive residential loads

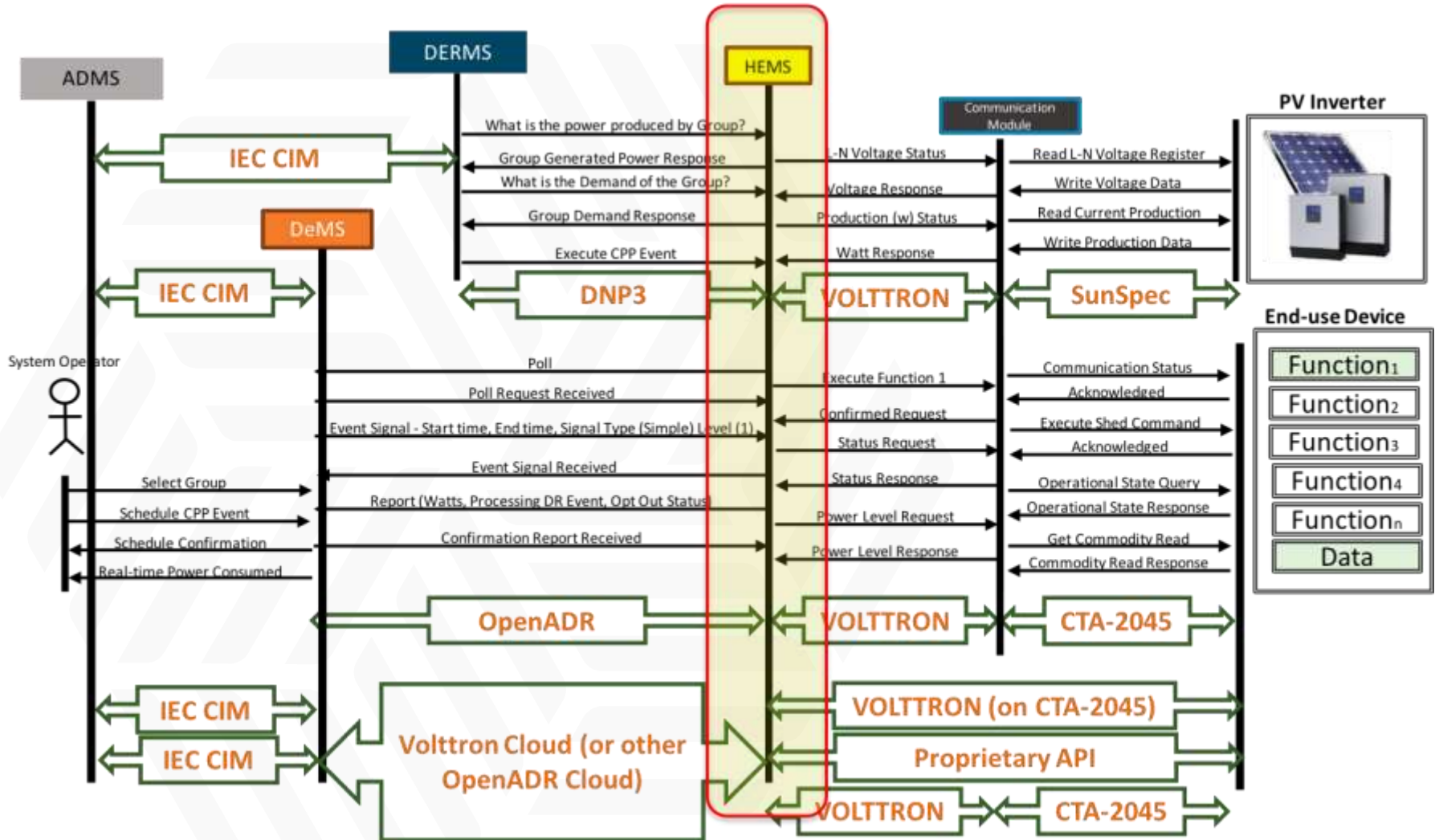



# Model-based Control and Optimization

## ▶ Control and optimization development

- Distribution circuit-level topology driven studies
- Linearized DISTFLOW methods for evaluating use cases and optimization requirements
- Interval analysis for upper and lower bounds of uncertain parameters - best/worst reference points for operators

## ▶ MATLAB-OpenDSS simulation infrastructure

- Detailed simulation and testing – collecting reliability and resiliency metrics for long-duration
- Actual network topology – 12.47kV 2-feeder circuits with one year data

## ▶ Robust control development

- HEMS-level control of the devices – device specific control agents
- Online optimization techniques that can perform negotiation between operators, aggregator, and devices
- Validate individual communication at Yarnell Test Home before deployment
- Validation at scale using simulation testbed

## ▶ Architecture that supports distributed control over communication networks

- Handling latency, jitter, communication QoS
- Validation of asynchronous event-driven application

## ▶ Key issues solved

- Computationally efficient optimization techniques for transactive control of devices while constantly updating the device status
- Ability to manage number of devices providing grid services for a reliable response

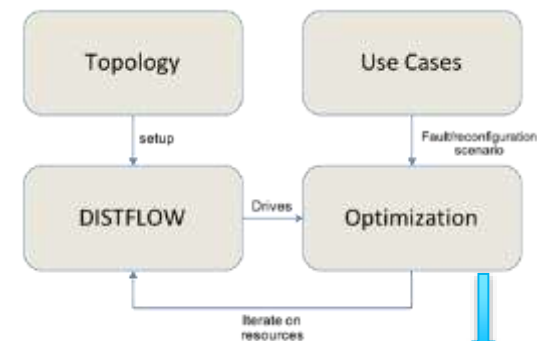

- Upper/lower bounds of uncertainty-based *demand side management*
- Drive requirements for SW and HW response (not DER, that is a constraint)
- Network bounds – latency and jitter tolerance
- Use only to drive requirements and analyze arbitrarily large scale network

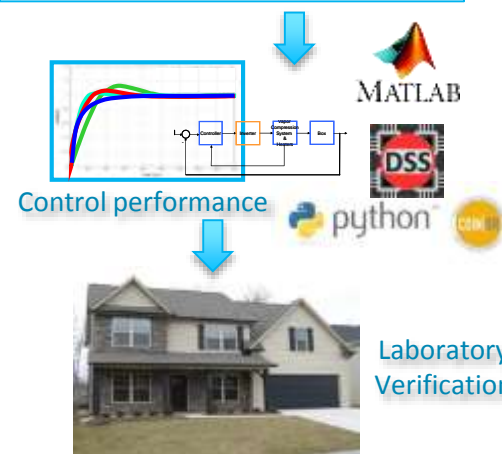

# Software and Hardware Development

## ► System Specification

- Designed architecture, subcomponents and functions of the system required to implement and test use-cases
- Reviewed OpenADR and CTA-2045 and performed a cross-walk with each use case requirements
- Prototypic definitions of the schema to enable information exchange with focus on deployment readiness needs.

## ► Hardware

- Approved design of CTA-2045 Cellular/Wi-Fi Raspberry Pi Zero Communication Module
- Added frequency and voltage monitoring capabilities to the HEMS system
- Utilizing open-source VOLTTRON on single-board computers for HEMS with focus on interoperability and portability

## ► Software

- VOLTTRON-based HEMS software prototyped to meet requirements
- Developed CTA-2045 and OpenADR agents to manage DER(Loads)
- Evaluated and formulated online optimization schemes required for accessing DERs to provide grid services targeted at distribution resilience – Open-source solvers
- HEMS-level peak demand reduction control agent developed
- Developing signal dispatch structure and schema requirements

## HEMS Architecture

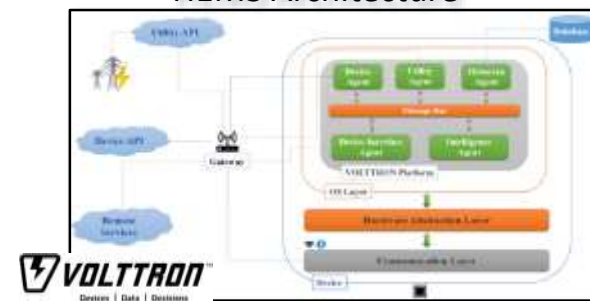

## CTA-2045 Cellular/Wi-Fi Raspberry Pi Zero

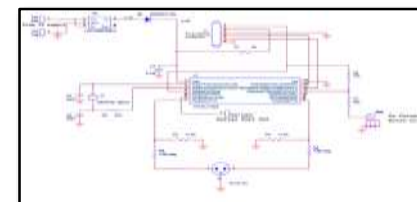

## Frequency and Voltage Sensing

# Testing, Measurement, and Verification

## ► Test setup at Yarnell Research home

- ❑ Equipment donated by EPRI
- ❑ Setup VOLTRON-based HEMS with device agents
- ❑ Instrumentation for evaluating controller performance (device-level submetering)
- ❑ Accessing device-level API for enabling advanced control functionality



## ► Measurement and Verification (M&V)

- ❑ Traditional M&V is for efficiency not load management
  - Calculates kWh not kW – Often uses proxy measurements and statistical analytics
- ❑ Developing a methodology that will use near real time power measurements
  - Leverage existing VOLTRON agents that measure and calculate time relative kW impacts at the device level
  - Determining appropriate ‘baseline’ that is statistically acceptable given inconsistent consumption patterns that are both weather and non-weather dependent - Use both existing load data from ORNL test home and data collected from small experiments at PNNL test homes
  - If appropriate and reasonable to execute, will incorporate utility developed Demand Response M&V methodologies

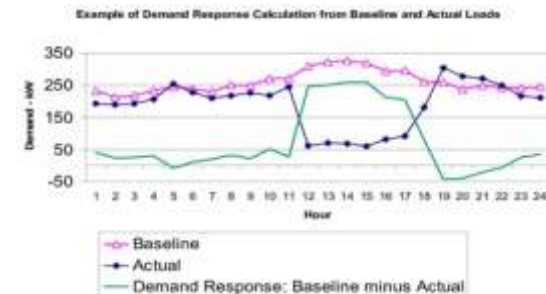

## ► Publications

- Helia Zandi, Michael Starke, Teja Kuruganti, “A General Framework to Transform any Home Energy Management System to a Multi-agent System”, 7th International Building Physics Conference Syracuse, NY, September 23-26, 2018 (Accepted)
- J. Dong, Y. Xue, T. Kuruganti, M. Olama, J. Nutaro, “Distribution Voltage Control: Current Status and Future Trends,” 9th International Conference on Power Electronics for Distributed Generation Systems (PEDG2018), Charlotte, NC, June 2018
- Yaosuo Xue, Michael Starke, Jin Dong, Mohammed Olama, Teja Kuruganti, Jeffrey Taft, Mallikarjun Shankar, “On a Future for Smart Inverters with Integrated System Functions” Power Electronics for Distributed Generation Systems (PEDG2018), Charlotte, NC, June 2018
- M. M. Olama, T. Kuruganti, J. Nutaro, J. Dong, “Coordination and Control of Building HVAC Systems to Provide Frequency Regulation to the Electric Grid,” *Energies*, 11, 1852, pp. 1-15, July 2018.
- Teja Kuruganti, Chuck Thomas, George Hernandez et. al., “Use Case Development and Logical Architecture Specification”, Technical Report
- Mohammed Olama, Helia Zandi et al., “State-of-the-art of Demand Response Management Applications” Technical Report

## ► Meetings

- Use case definition – webinar/work session – December 5<sup>th</sup> 2017 – provided project overview
- Face-to-Face Requirement Definition Meeting with Utilities – San Diego, CA – February 7<sup>th</sup> 2018 – workshop for use case
- Transmission Control Center – Generation Operator Interview – FL – July 19<sup>th</sup> 2018 – understanding operational processes
- Monthly phone calls with Utility partners – Providing direct feedback
- Obtain Year 1 feedback and summarize in Q4 report

## ► LVAT, Cybersecurity, and Interoperability

- Completed Metrics selection for Resiliency, Reliability, Security, Flexibility, Security, Sustainability, and Affordability
- Establishing procedures for metrics collection
- Selected Cybersecurity technology for implementation – Beholder (malware detection for appliances), and Reviewing secure multi-speak protocol for ADMS and DeMS communication
- Performing review for interoperability crosswalk across protocols of interest to support use cases - OpenADR (Complete), OpenFMB (partial), Multispeak (partial), SEP (complete), CTA2045 (complete)

# Next Steps and Future Plans

- ▶ Year two work will focus on developing deployable HEMS software and hardware prototypes based on R&D performed in Year 1
- ▶ Implement cybersecurity and interoperability plan developed in year 1 (9/30/18)
- ▶ Complete development of networked optimization/control algorithms to demonstrate grid service – simulation-based testing on actual circuit topologies for scalability (3/31/19)
- ▶ Device interface hardware development and prototype fabrication in collaboration with partners (6/30/19)
- ▶ End-to-end prototypic software development and testing (9/30/19)
- ▶ Demonstration at test facility driven by selected use-cases (Year 3)
- ▶ Perform M&V on testing data (Year 3)

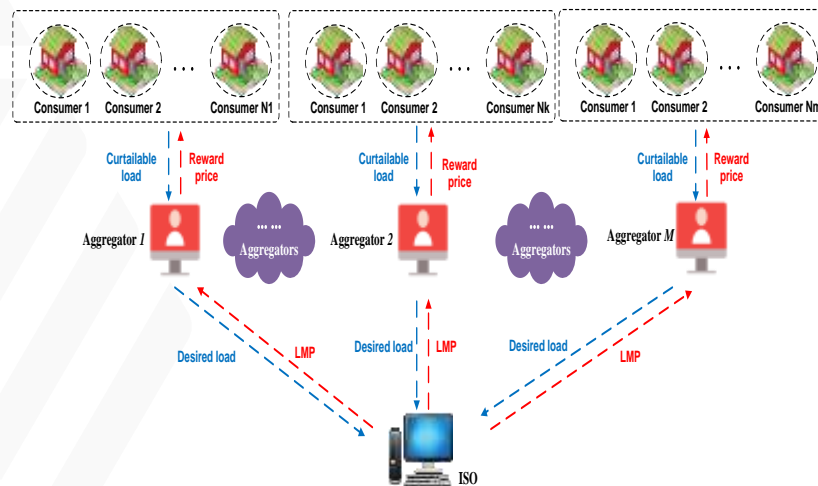

# Key Outcomes

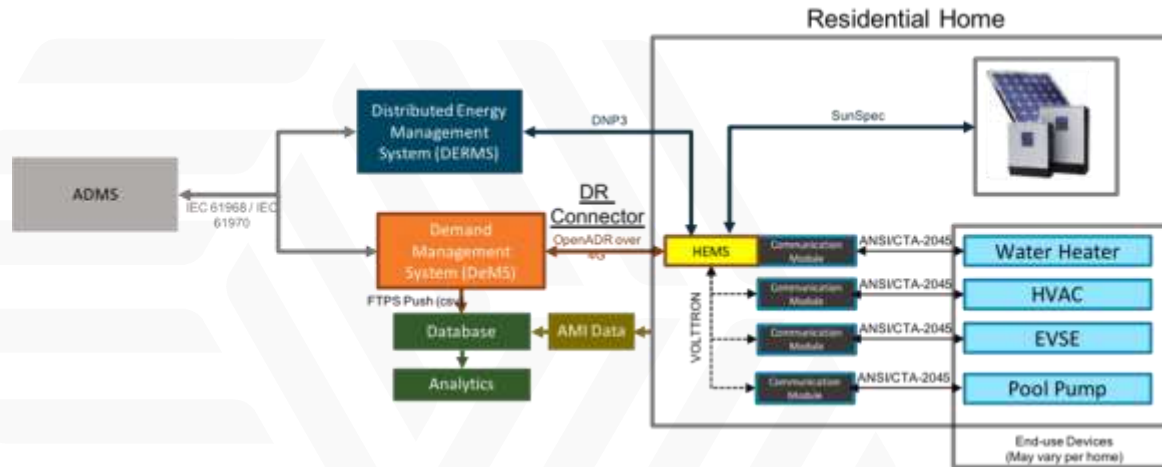

## ► Establish HEMS as an interface for demand/DER management

- ❑ Interoperable interface with DeMS – reliably support data exchange
- ❑ Engage residential loads – control execution and feedback to operations

## ► Transactive control system to co-optimize Loads/DER performance to satisfy grid requirements and residential needs

- ❑ Scalable formulation with minimal communication overhead
- ❑ Embed fault-tolerance and fail-safe mechanisms

## ► Improve distribution-level grid resilience

- ❑ Field validation to demonstrate the SW, HW, and Algorithms demonstrate response in time and magnitude
- ❑ Demonstrate this capability to be expandable to multiple deployment architectures

# Project Timeline

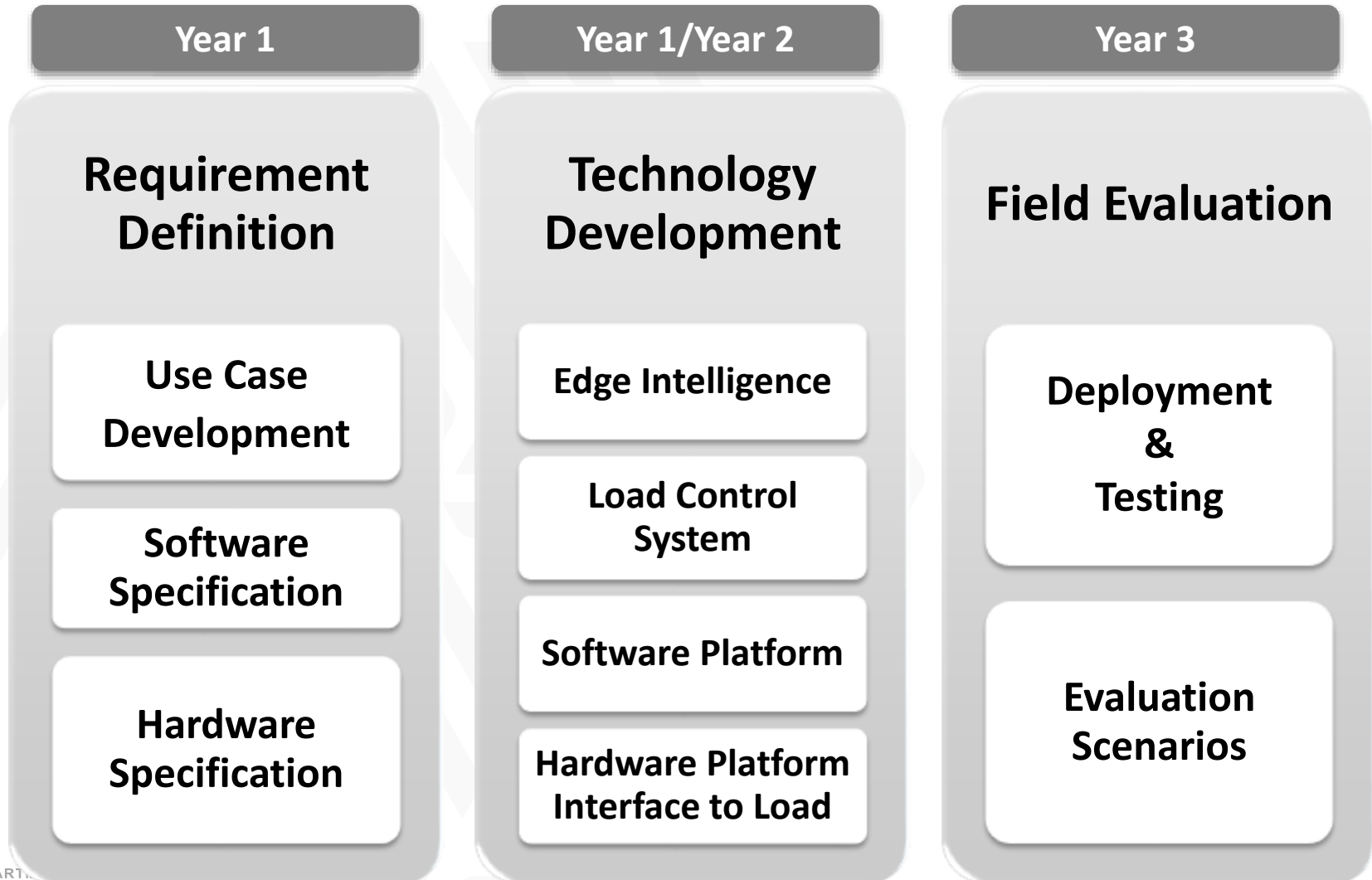

# Year 1 Milestones



No.	Milestone/Deliverable	Due Date	
1.1	Report detailing the project overview and feedback from utility meeting along with the presentation material utilized for the utility meeting	12/31/17	✓
1.2	Report detailing the utility use cases identified by the utility partners	1/30/18	✓
1.3	Document detailing the logical architecture for utility-driven use cases with data exchange requirements identified. The document demonstrates the use of open-standards based architectures for end-to-end demand-side management solution	3/31/18	✓
1.4	A survey report detailing the state-of-the-art assessment of utility demand side management solutions including open-standards-based architectures and proprietary solutions	12/31/17	✓
1.5	Report detailing the software and hardware architecture for end-use load control using VOLTTRON and CTA2045 to demonstrate the ability of load control in response to a grid incentive signal with response times between 0-10 minutes. Demonstrate 100% accuracy in generating a desired load shape of price responsiveness	6/30/18	✓
1.6	Draft Report detailing the dispatch signal structure and software implementation of the dispatch top node in conjunction with the specific utility architectures identified in Task 2.2	9/30/18	
1.7	Draft report detailing the cybersecurity and interoperability plan for the system developed for deployment in collaboration with utility	9/30/18	



# Improve Resilience – Leveraging Residential DERs

**Capacity Management:** Reduce electricity consumption and usually reduce peak demand.

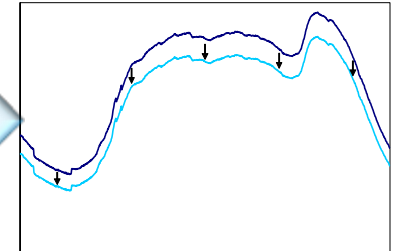

**Adaptive Load Shape** – Intelligently move consumption to enable voltage regulation, **renewable penetration**, peak demand management – Fast Demand Response

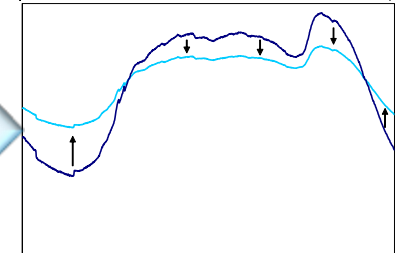

**Reliability response:** Manage outages, reduce effect of weather related “events”, and reduce restoration time through wide-area control of loads

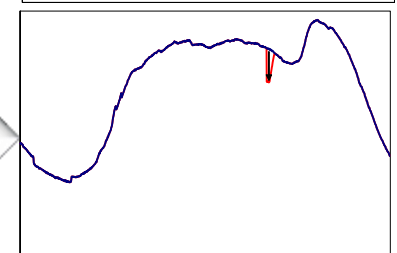

**Regulation response:** Continuously follows the power system’s minute-to-minute commands to balance the aggregate system for frequency and inertia

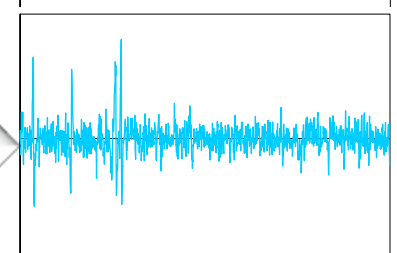

To arrive at such responsive loads, integrated end use control is needed

# Use Cases Developed

- UC #1** • Reduce Critical Peak Load
- UC #2** • Improve Disaster Preparedness through Real-time Situational Awareness and Distribution Operations Planning
- UC #3** • High Penetration of Renewable Energy in Distribution Systems
- UC #4** • Virtual networked microgrids in distribution circuits to enable resilience
- UC #5** • Improves Asset Utilization through Locational Pricing
- UC #6** • Reduce Outage and Recovery times through intelligent Cold Load Pickup
- UC #7** • Residential-level islanding with Assets Sensing a Grid Event
- UC #8** • Distribution Feeder-level Battery for Transmission Level Grid Service and Enabling Distribution Resilience
- UC #9** • Inverter Control to Prevent Power Generation Curtailment due to Control of Distribution-level Voltage Control Assets (e.g. capacitor banks)
- UC #10** • Adaptive control of DERs on a Distribution Radial Line to Stabilize Voltage Sag across a Line
- UC #11** • Power flow and Congestion Management
- UC #12** • Load Control to Support Frequency Regulation

# Use Case detail

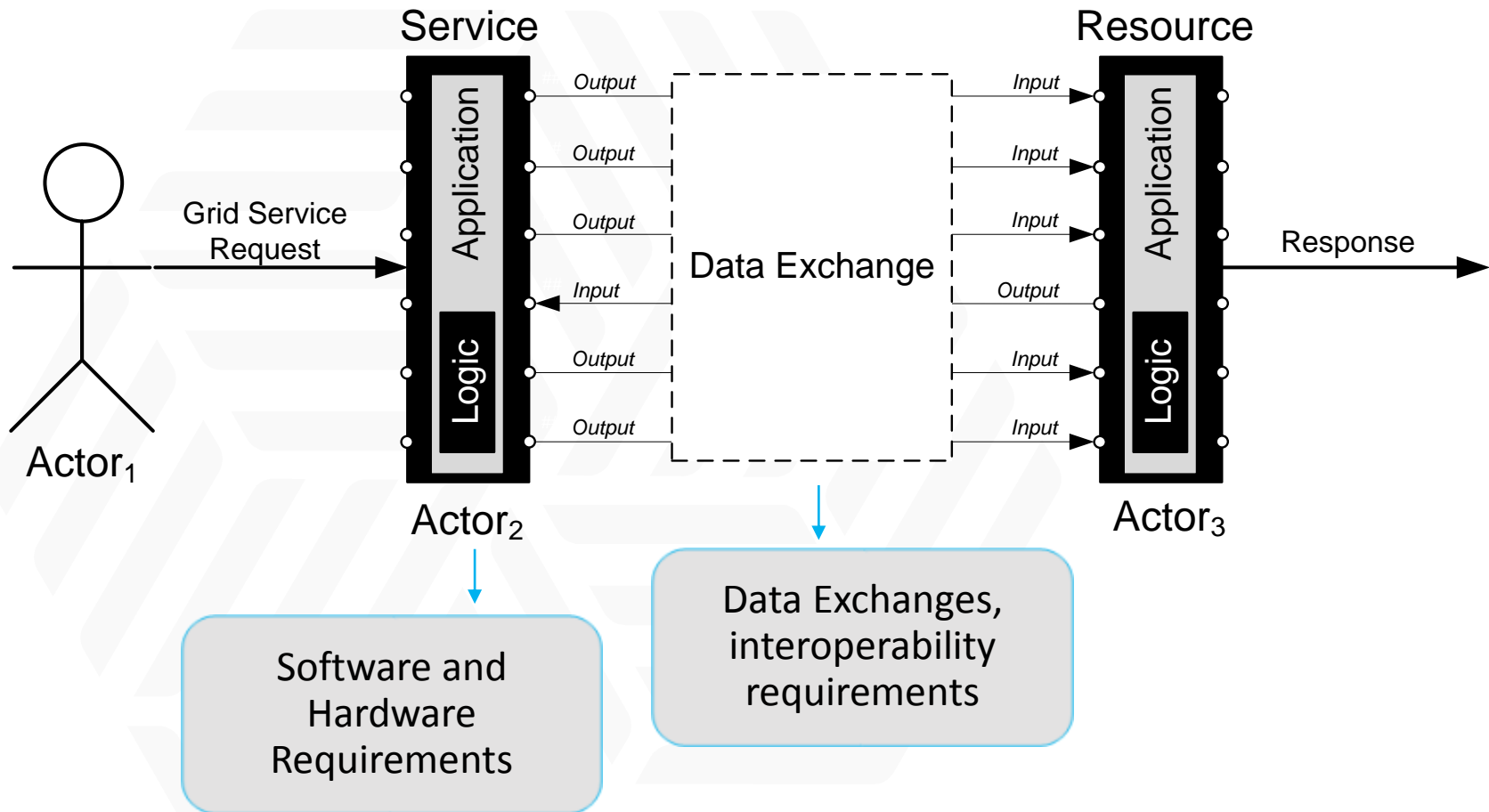

# Reviewing Interoperability

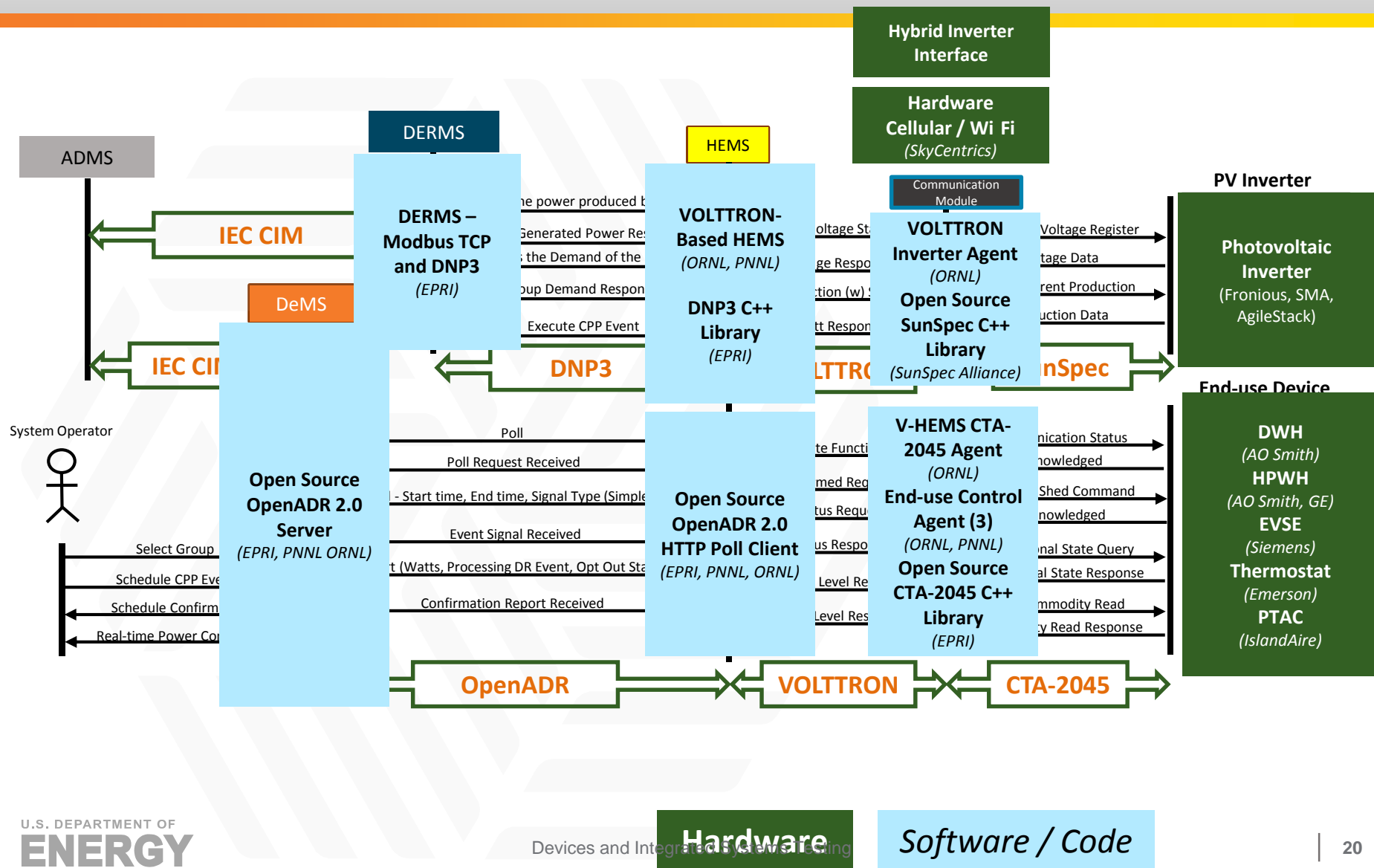

# Control Application Development

## System Characterization

Disturbances



Virtual System



Control parameters

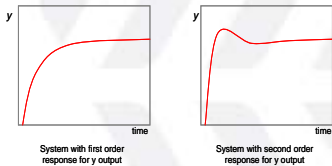

System Dynamics



## Control Design

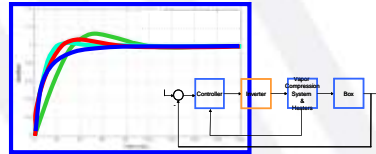

Objective and constraint handling

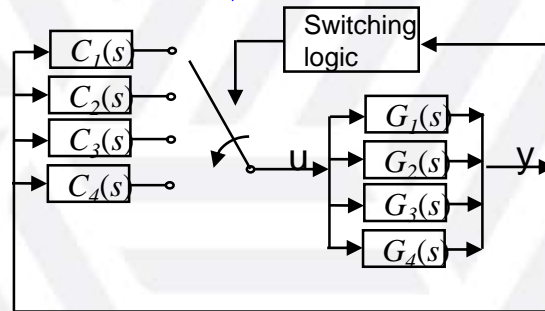

Hybrid control analysis

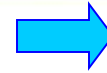

## Control over Network

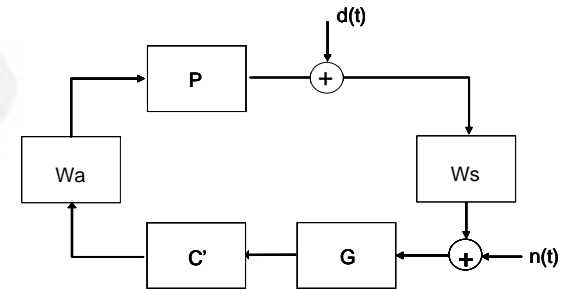
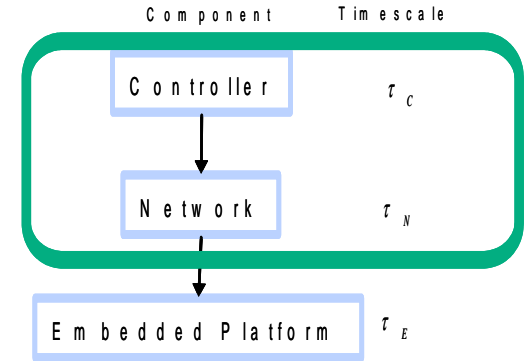

### Networked Controls

- No time-scale separation
- Network and controller design have system-level effects
- Co-design Communication, Controls – Deterministic Devices and Integrated Systems Testing

# GRID MODERNIZATION INITIATIVE PEER REVIEW CleanStart DERMS 1.5.05

**EMMA M. STEWART (LLNL)  
PLUS ONE: JASON FULLER (PNNL)**

September 4–7, 2018

Sheraton Pentagon City Hotel – Arlington, VA

# CleanStart DERMS 1.5.5

## High-Level Project Summary

### *Project Description*

Develop and implement a DER Management System integrated application, which provides a separate communications, analytics and control layer, purely for a black-start and restoration application

Solution will demonstrate the start of a microgrid following an outage (cyber or physical)

### *Value Proposition*

- Black start and restoration at present is a centralized bulk system driven solution whereas DER is by nature decentralized
- Key innovations
  - DER controls as a mechanism for black start and restoration
  - Cross utility coordination and effective useful information/resource transfer
- Product will be transformational to utilities experiencing a rapid DER influx, considering both controlled and uncontrolled resources as part of the resilient resources to be utilized in widescale events

### *Project Objectives*

- ✓ Minimize the outage time for the maximum number of customers using the greatest contribution from distributed and clean energy resources
- ✓ Implement methods for coupling and validation of predictive analytics and advanced controls for resilience
- ✓ Provide support services from DER back to the transmission system during critical outages
- ✓ Demonstrate a CEDS funded cybersecurity technology showing integration with the resilient DER architecture (CES-21/SSP-21)

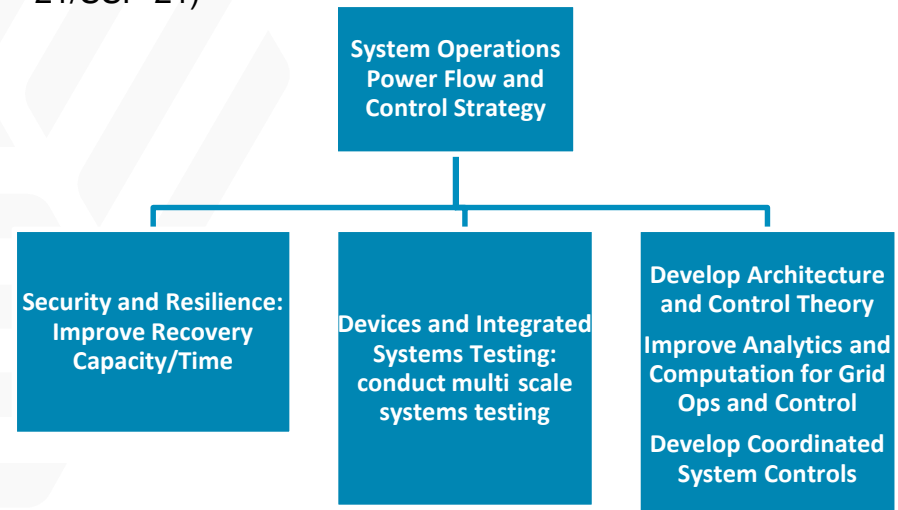

# CleanStart DERMS

## Project Team



Lead Demonstration  
Utility + Cost Share

Lead lab – device control  
and analytics integration

Simulation and  
implementation

Control algorithm  
development

Data integration

Microgrid Design

DERMS technology provider  
+ Cost Share Provider

### PROJECT FUNDING

Lab	Year 1	Year 2	Year 3
LLNL	\$1009k	\$1209k	\$1064k
PNNL	\$460k	\$210k	\$190k
LANL	\$285k	\$290k	\$285k
Subs (through LLNL budget)	\$492k	\$683k	\$547k
Cost Share (through Subs)	\$1592k		
<b>Total</b>	<b>\$1754k</b>	<b>\$1709k</b>	<b>\$1539k</b>





# CleanStart DERMS Approach



- Approach: Achieve black start and restoration objectives through combination and application of advanced co-simulation and architecture design, measurement and analytics, controls and optimization, communications and cyber security
- TD&C co-simulation planning tools will be used to design, validate and evaluate CSDERMS

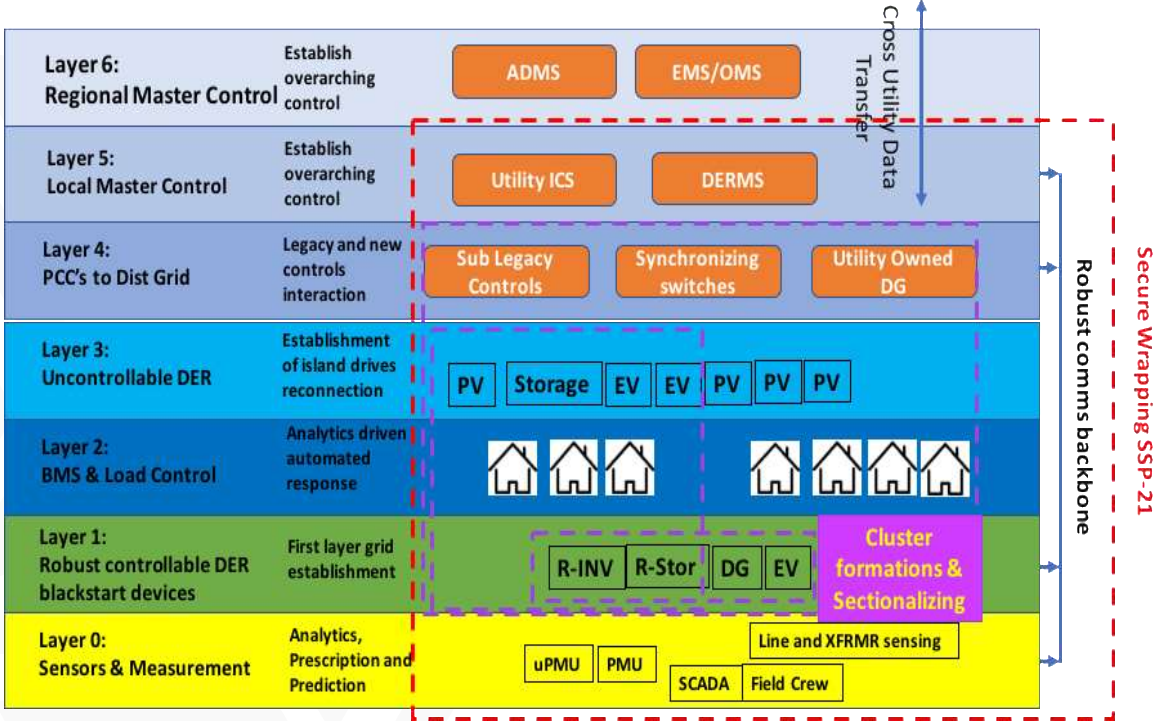

- ▶ Key Issues
  - Complex demonstration at new microgrid location with critical and non critical load
- ▶ Distinctive characteristics
  - Development of dynamic ad-hoc microgrids, which form around resilience objectives integrating both traditional and non traditional DER
  - Solves critical problems for partner utilities yet applicable throughout the nation at similar facilities

# CleanStart DERMS

## Accomplishments: Demonstration Site, Data Collection & Model Validation (casa + freeman)



- ▶ Selected site is a 2 feeder location, with Emergency and Utility Operations Center, Car dealerships and commercial load (Critical and non critical load)
- ▶ Collected models, measured, and meta data
- ▶ Converted SynerGi models provided by RPU into GridLAB-D (and OpenDSS) models
- ▶ Working with RPU, classified load types (residential, commercial, street lighting, etc.)
- ▶ Identified critical loads and locations of existing DG (diesels and PVs)

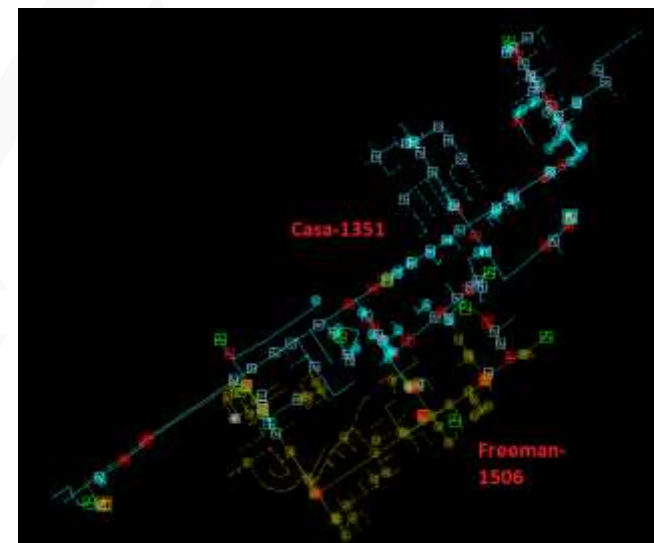

# Clean Start DERMS

## Accomplishments: Design and Technology Selection

Defined and preliminary selection of the new and existing technology required to meet the load needs for critical and non critical

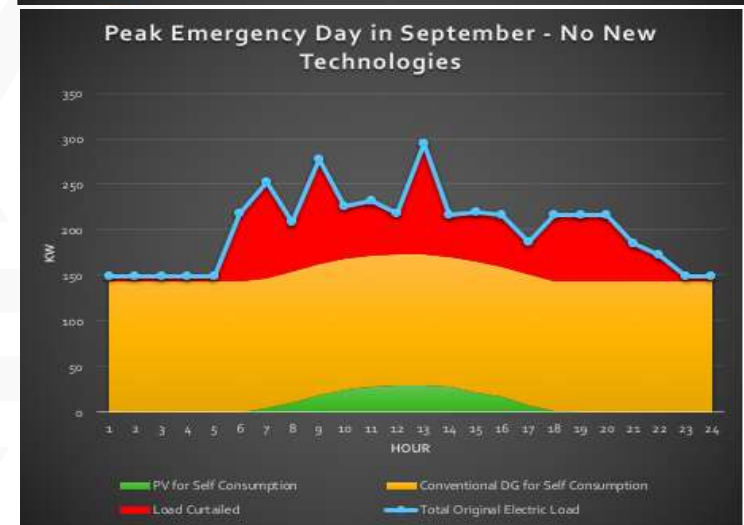
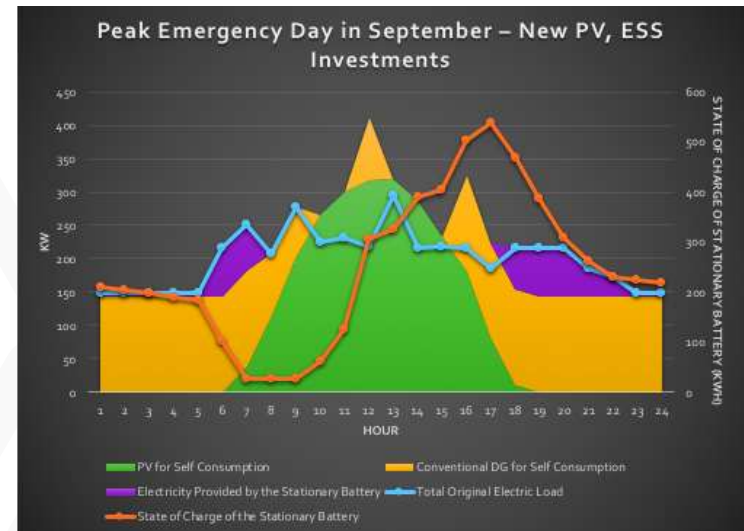
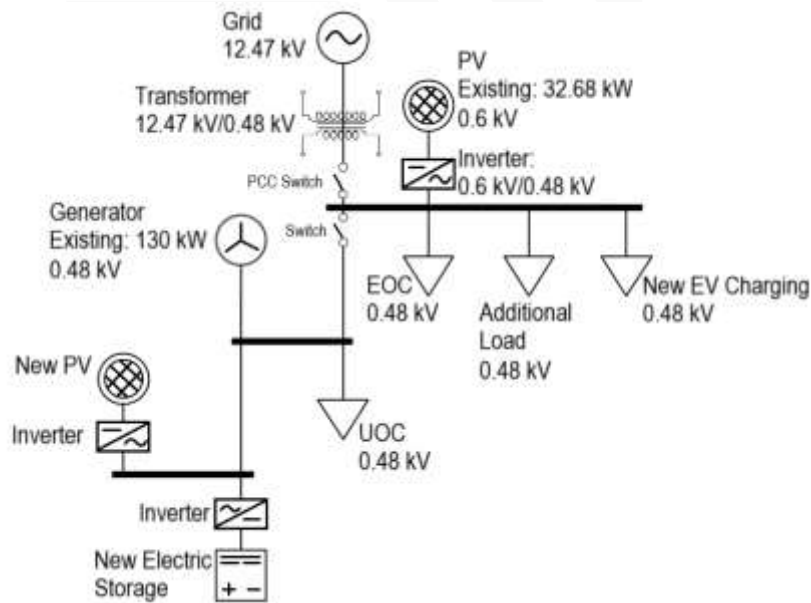

# CleanStart DERMS

## Accomplishments: Use Cases Definition



- ▶ UC1: Initial restoration of an islanded segment. Variations include available of DER assets and state of charge of any Energy Storage System.
- ▶ UC2: Enlargement of the islanded segment through network switching, determining whether black start optimization application needs to be re-run.
- ▶ UC3: Synchronization of two islanded microgrids or synchronization with the transmission substation
- ▶ UC4: Cybersecurity UC 1: Variations on use case 1 through 3 under a denial of service attack on one or more automated reclosers.
- ▶ UC5: Cybersecurity UC2: Variations on use cases 1 through 3 under a denial of service attack on one or more of the grid-forming DER assets.

# CleanStart DERMS

## Accomplishments: Use Case Example

- Example: UC1
- Assumption: At least one generator with Clean Start capability, either has
  - sufficient capacity to reenergize the local load
  - reenergized load can be dispatched
- Assumption: DERMS has control over the state of network assets within the microgrid, namely Microgrid Tie Points
- Assumption: Devices have sufficient back-up power (e.g. battery) that they can be operated during microgrid black-start.
- This use case includes interaction with Optimization Algorithm calculates the best assets to facilitate the black start process and the closing sequence of the utility switches to rebuilt the islanded system.

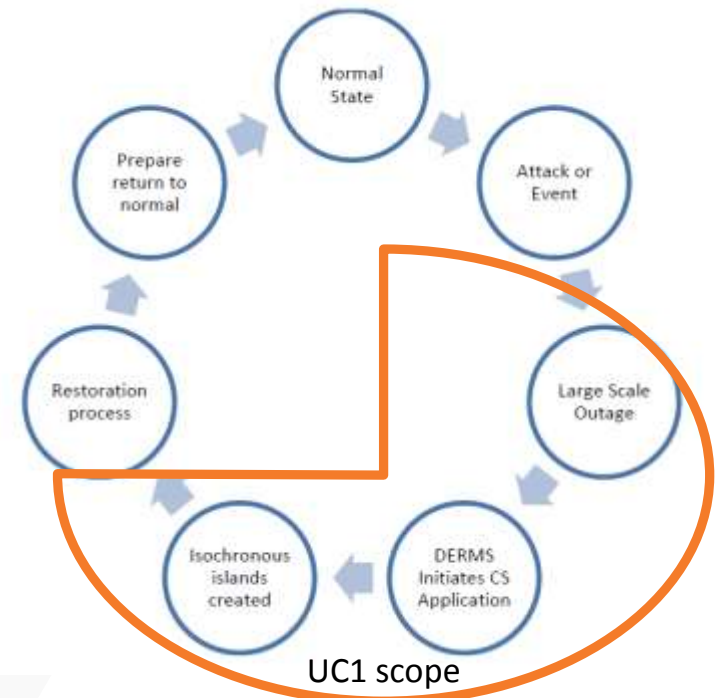

# CleanStart DERMS

## Accomplishments: Co-Simulation with HELICS



- Validate control/optimization algorithms in highly detailed simulations
- Identify the best locations for assets, controllers, and sensors
- Evaluate alternative network designs to ensure robust communications

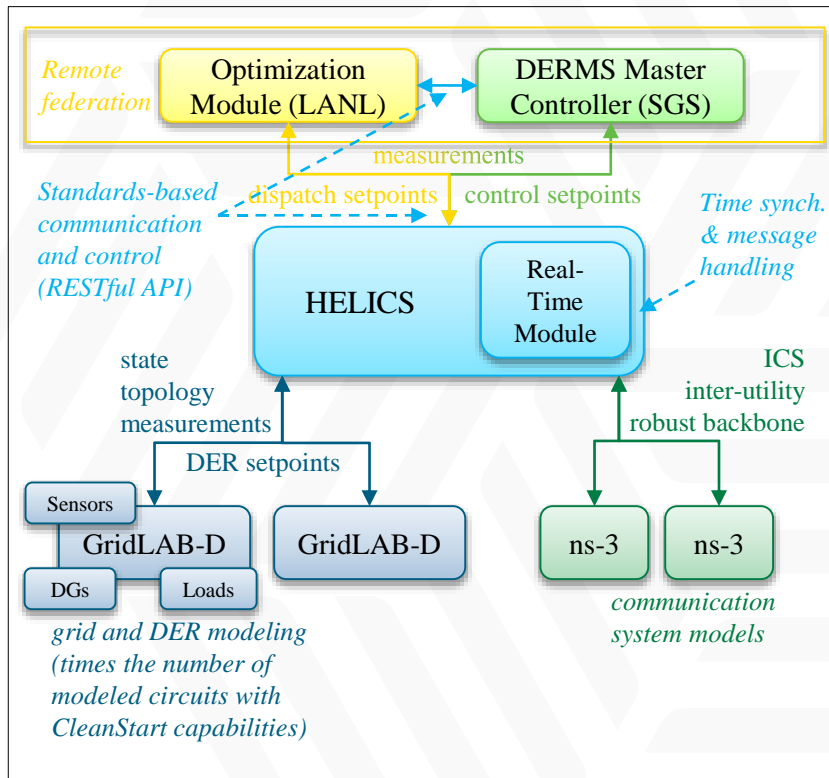

Added a remote federation layer between LANL's optimization tools, SGS's DERMS controller, and PNNL's simulations using a RESTful API

HELICS project has enabled a Real-Time Module, allowing us to test the scalability and speed of algorithm

GridAPPS-D has been eliminated to simplify interfaces

Next stage is dynamic model integration and assessment

# CleanStart DERMS

## Accomplishments: Control Integration

- Joint generation, topology, and power flow control of distribution networks.
- Optimize restoration that accounts for cyber compromised devices (generation, storage, etc.)
- Capturing the (stochastic) uncertainties in DER flexibility
- The LANLYTICS API is a generic distributed compute engine that allows arbitrary services to be executed via a HTTP interface.
- Completed proof-of-concept Groovy script for interfacing with the LANLYTICS Public API, script has been successfully deployed on a test system using ANM Pre-processor.
- Currently, the JSON object supplied has an echo service. This can be replaced to support more advanced algorithms hosted on the site.

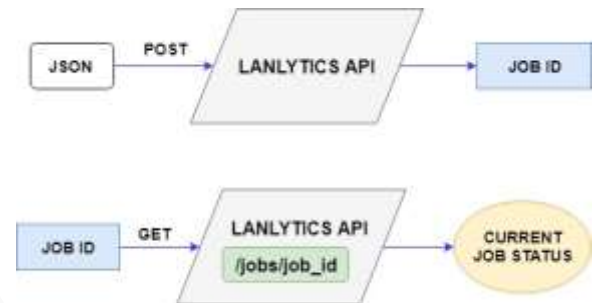

In progress:

Determine a set of sequential operational steps that **minimizes the total energy not served**

A “step” =

Switching operations + Redispatch of one or more generators

Time scale for 1 “step” ~ one minute

Entire restoration sequence can be solved for then executed, with appropriate mid-sequence recourse

### Cyber

- ▶ DER Control, analytics integration and utility legacy systems create new attack vectors
- ▶ New communication scheme must be robust to attack in degraded scenarios
- ▶ TD&C tool will be utilized to evaluate the risk in tandem with the benefits of the new controls
- ▶ Cyber plan is delivered with true vendor interaction to address identifying and isolating risk, along with interaction with 1.4.23 project
- ▶ Cybersecurity plan
  - SSP-21 secure protocol used to protect communications.
  - TD&C analysis will provide basis for risk assessment, model the critical network nodes, and robust communication.
- ▶ SSP-21 is a next-generation secure SCADA communications protocol that can enhance the security of legacy equipment/protocols.
  - Provides protection against
    - Alteration of messages
    - Replay attacks
    - Man-in-the-middle attacks
    - Eavesdropping (optional)
  - Developed as part of the CES-21 program, now funded as a new CEDS project
  - Reference architecture available, licensing work complete, details shared with SGS



# CleanStart DERMS

## Next Steps and Future Plans



- ▶ Next Large Steps in Year 1/2:
  - Strategy Review and Approval (Oct 2018)
  - Technology Procurement and permitting (Dec 2018)
  - HIL testing and functional acceptance (June 2019)
  
- ▶ Possible expansions:
  - Integration of dynamic var compensation device, approach by technology vendors with solution and possible linkage with defense microgrid solutions
  - Design tool integration with HELIC
  - Cyber security based use case and control implementation

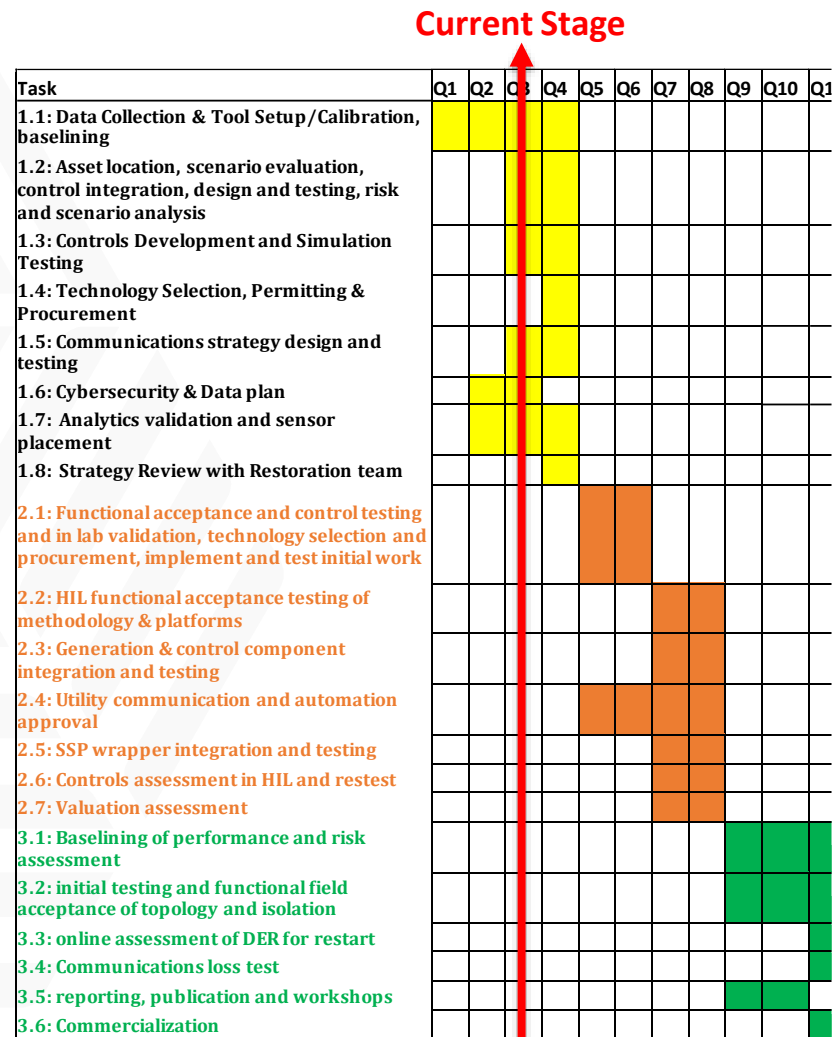

# Extra Slides



# Key Outcomes



- ▶ Reduced cost, increased availability and redundancy of blackstart generation, improved customer reconnection time
- ▶ Repeatable, published set of requirements & tool for utilities to utilize DER in critical supply scenarios
- ▶ Real time DER control tools which maximize resilience and account for degraded scenarios
- ▶ Interoperable and secure platform demonstration
- ▶ Demonstration of an advanced CEDS-funded cybersecurity technology, with an energy sector industry partner, to show that an advanced cybersecurity technology is an integral part of the advanced resilient DER architecture being developed in this project

# Optimization Algorithm Integration



- ▶ SGS will communicate to the web-hosted optimization algorithm through a toolchain which will send and request JSON payloads to the algorithm, that allow the user to generate a functioning control application for deployment on the ANM platform.
- ▶ The purpose of the toolchain is to provide the flexibility required to allow LANL to modify and update algorithms which use a specific third-party modelling or optimization tool-set.

# UC1: Clean Start Process



1. ANM Strata receives real-time state measurements from ANM Element, MTP, and MIID. ANM Strata validates the configuration of the network and the anticipated Clean Start load (cold-load pickup factor is taken into consideration, if relevant, i.e. depends on the duration of the outage) and compares with the Clean Start capability of the largest Clean Start DER. The local dynamic reactive power load is also considered and the total Clean Start MVA is calculated and compared with the DER capacity. This information is communicated to CSO.
2. CSO calculates the optimal devices to use in the black start process and provides set points to ANM Strata.
3. Based on the CSO set points, ANM Strata issues disconnect signals to the low priority load ANM Element's and MTPs to adjust the Clean Start load to below the total Clean Start MVA capability.
4. ANM Strata confirms the state and indicates intention to Clean Start Microgrid.
5. ANM Strata issues Clean Start control signals to relevant ANM Element(s). ANM Element initiates black-start procedure (Clean Start DER is initially in isochronous mode) and re-energizes sectionalized load.
6. ANM Element confirms successful Clean Start to ANM Strata and measurements.
7. The CSO calculates setpoints based on the new system state and issues to ANM Strata.
8. ANM Strata sequentially issues dispatch commands to additional generators to synchronize to the local grid. For non-actively managed generators (e.g. small PV), they typically will connect automatically 5 minutes following the initial black-start.
9. ANM Strata issues signals to the load ANM Elements and MTP to add additional load as sufficient capacity becomes available. This may be interleaved with step 6 particularly once the available generation greatly exceeds the initial Clean Start Load. When picking up load blocks through closing of the MTP, stability margins are factored in to avoid loss of the existing island due to step changes in loads.
10. ANM Element communicates status to ANM Strata and waits for further instructions, such as a request to resynchronize the islanded microgrid.

# Validating models (steady-state)

- ▶ Validated converted models to ensure that conversion was successful
- ▶ Added DG to models at the specified locations

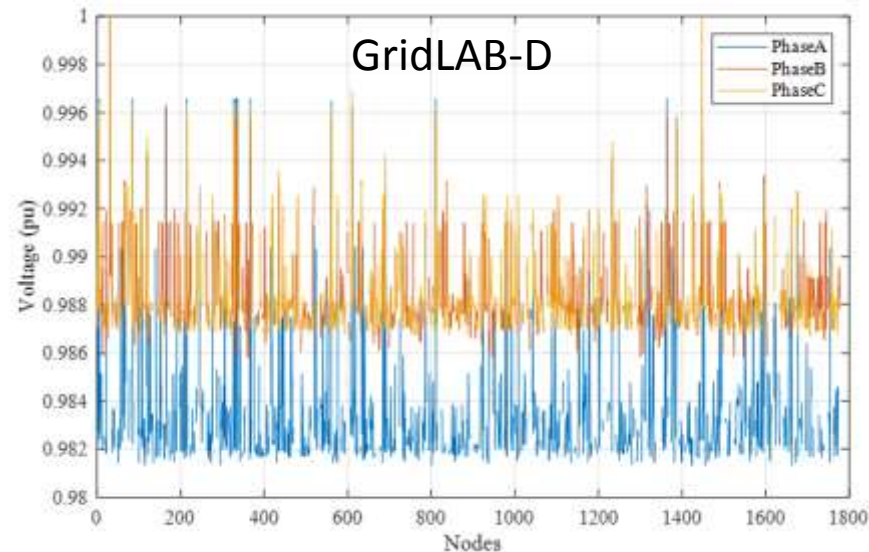
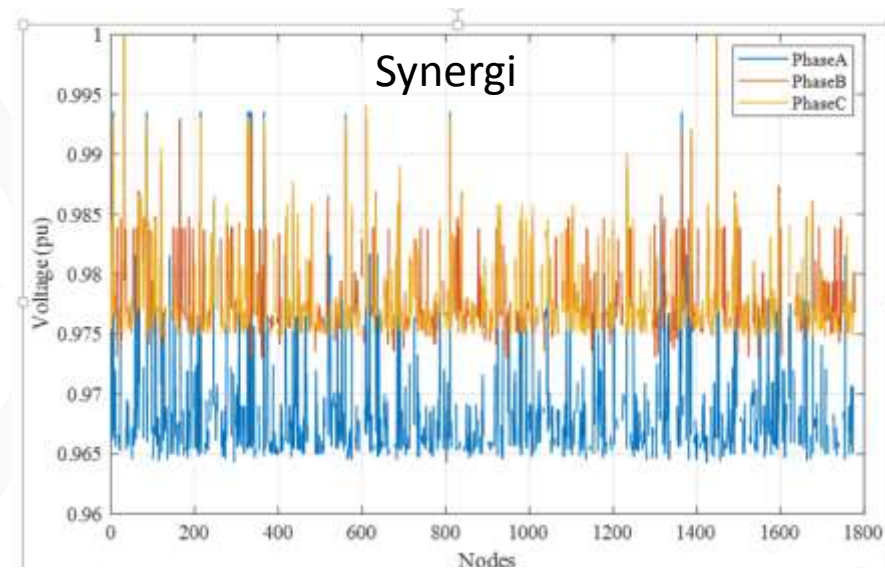
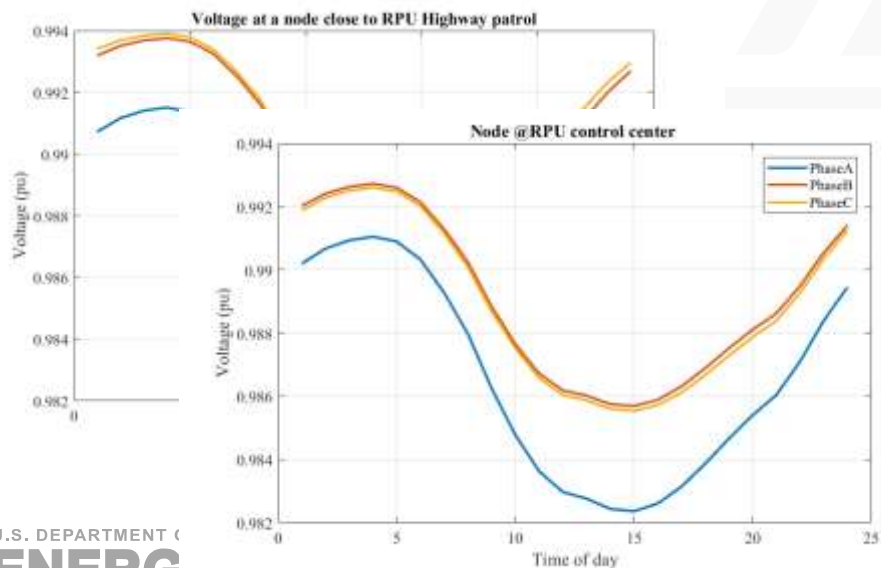

# Key Definitions



- ▶ **Cyber attacks** – A number of cyber and security attacks could cause outages on the network. Examples of these include:
  - Denial of Service, Phishing Attacks, SQL Injection Attacks (SQLi), Cross-Site Scripting (XSS), Man-in-the-Middle (MITM) Attacks, Malware Attacks, Denial-of-Service Attacks, Spear Phishing Attacks.
- ▶ Physical Outage – transmission scale with long term impact
- ▶ **Distributed Energy Resource (DER)** – is a generic umbrella term that refers to any distributed generator, energy storage system or demand response resource that is part of the microgrid or the wider power system. Not all generators have CS capabilities. Types of DER include:
  - Fossil Fuel generators – They have fuel sources available to generator as and when required, and typically operate in either iso-synchronous or droop control and can therefore initiate a black start sequence.
  - Iso-synchronous generators – any generator which can provide a steady state frequency when required in order to initiate black start
  - ESS with and without grid forming capability – The capability of ESS to support black start will depend on the battery chemistry.
  - Converter connected renewable generation – depending on available resource (such as sun, wind, water) and the inverter control will dictate the ability of the device to sustain frequency needed for black start.
- ▶ All recloser in the RPU area are automated and equipped with smart functionality:
  - **Microgrid Intelligent Interconnection Device (MIID)** – the intelligent electronic device (IED) and associated Sectionalizing Switch (SS) at the point of common coupling between the microgrid and the bulk power system. It is assumed this device has active or passive synchronization capability, meaning the necessary logic, and that it has sufficient potential transformers (PT) on either side of the switch.

# CleanStart DERMS

## Approach and Problem Definition

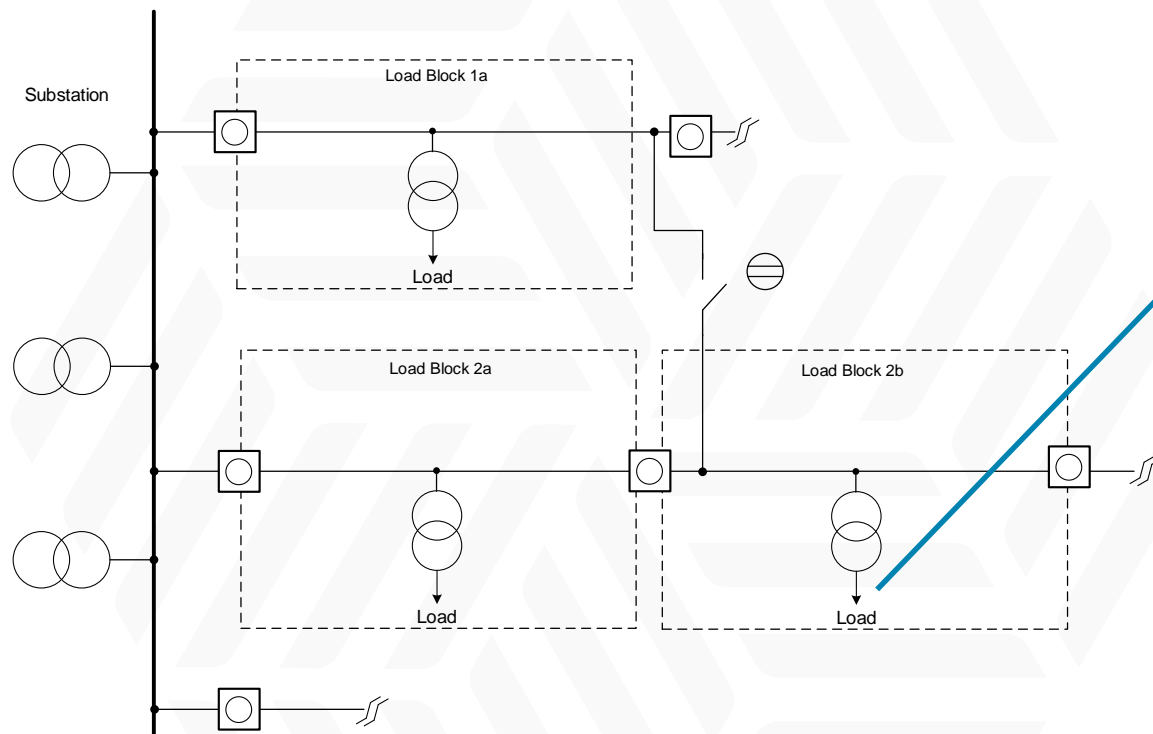

Each CleanStart block may contain one or more of the following:

- Non-grid forming DER (PV, wind, biogas)
- Grid-forming DER (diesel, natural gas, small hydro, energy storage system)
- Load (with cold-load pick-up factors)
- Controllable Load
- Connection via smart recloser to one or more blocks or adjacent substations



# General DERMS and Active Network Management Requirements



- ▶ Fail to safe in the event of communications failure between DERs and the central controller
- ▶ Fail to safe in the event of communications failures
- ▶ Management of DER for non-compliance
- ▶ Operational Data Store
- ▶ SSP-21 wrapper

# Publications, Presentations and Workshops



- ▶ Distributech 2018 (planning for 2019)
- ▶ SETO Peer Review
- ▶ Presented to PG&E, SCE & HECO
- ▶ RPU Board Meeting
- ▶ Workshop Planned: Oct 2018
  - LLNL workshop on CleanStart DERMS and related projects
  - Oct 18 2018
  - Will review restoration etc
  - Details to follow

# GRID MODERNIZATION INITIATIVE PEER REVIEW

## GMLC 1.5.06 - Designing Resilient Communities: A consequence-based approach for grid investment

**ROBERT JEFFERS, ROBERT BRODERICK**  
**SANDIA NATIONAL LABS**

September 4–7, 2018

Sheraton Pentagon City Hotel – Arlington, VA

# Designing Resilient Communities

## High-Level Project Summary



### *Project Description*

The high-level goal of this project is to demonstrate an actionable path toward designing resilient communities through consequence-based approaches to grid planning and investment and through field validation of technologies with utility partners to enable distributed and clean resources to improve community resilience.

### *Project Objectives*

- ✓ Form and hold national outreach meetings with a Stakeholder Advisory Group (SAG) that will inform the technical and policy solution space
- ✓ Design and implement (with two city/utility pairs) a widely-applicable framework that aligns grid investment planning with community resilience planning
- ✓ Design, implement, and field validate at a utility scale resilience nodes implemented predominately using clean distributed energy technologies

### *Value Proposition*

- ✓ Incorporating community resilience within electric utility investment planning
- ✓ Examining the impact of alternative regulatory frameworks and utility business models to incentivize resilience
- ✓ Demonstrating that a community resilience node can be implemented through clean, renewable technologies via inverter-dominated island protection and control

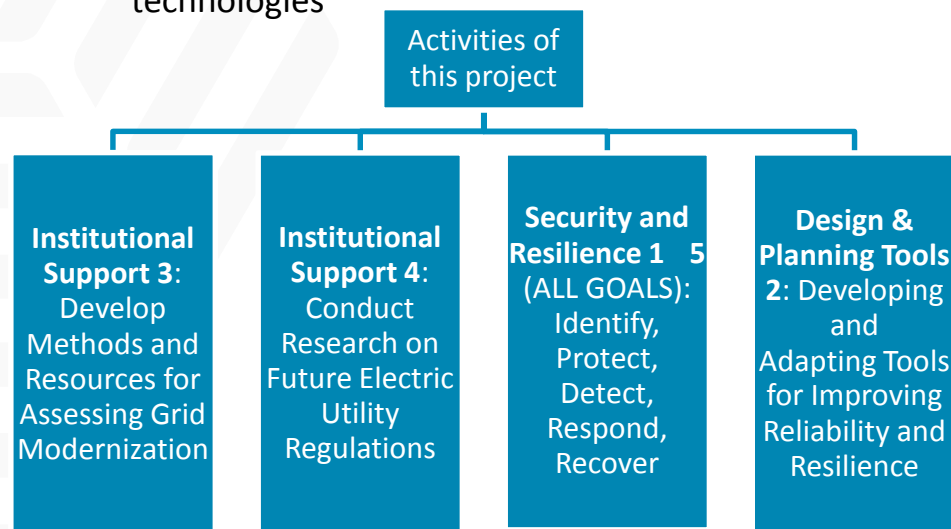

# Designing Resilient Communities

## Project Team



**Federally Funded Partners:**

- Sandia National Labs – Principal and lead executor, all tasks
- Clemson University – Adaptive protection
- New Mexico State University – Islanding control
- Synapse Energy – Regulatory and economic analysis
- SUNY Buffalo – Societal resilience metrics

**Cost Share Providing Partners:**

- CPS Energy – demonstration partner, resilience as a service
- National Grid – demonstration partner, microgrids for community services
- 100 Resilient Cities – dissemination, convening, and outreach

**Other Core Partners:**

- City of San Antonio
- City of San Juan, PR
- UT San Antonio
- City of Buffalo, NY
- Village of Potsdam, NY



PROJECT FUNDING			
Lab	YR1 \$	YR2\$	YR3\$
Sandia	1,500	1,500	1,500
100RC*	50	50	50
CPS Energy*	200	200	260
National Grid*	50	125	125
* = all cost share			

**SAG Members:**

- New York City
- Con Edison
- City of Honolulu
- HECO
- HI PUC
- City of Los Angeles
- LADWP
- Siemens
- City of Norfolk
- Dominion Energy
- City of Atlanta
- GA PUC
- City of Boston
- GE

# Designing Resilient Communities Approach



Task 1: Development of a national framework for integrated, consequence-focused resilience planning

## Resilient Community Design Framework

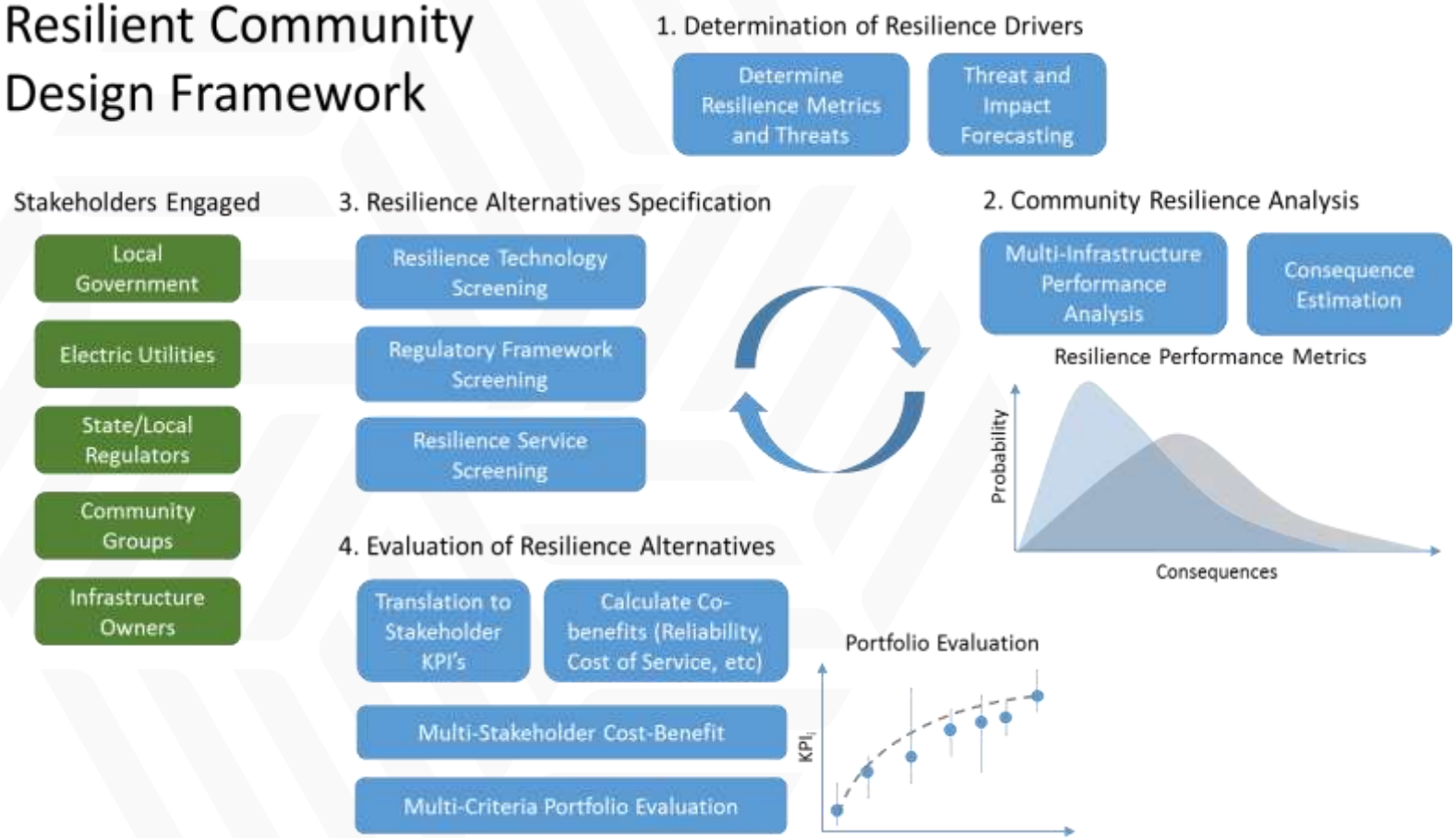

# Designing Resilient Communities Approach



Task 2: Analysis to demonstrate key aspects of the framework developed in task 1 with National Grid and CPS energy

Task 3: Analysis of alternative regulatory frameworks and alternative business models

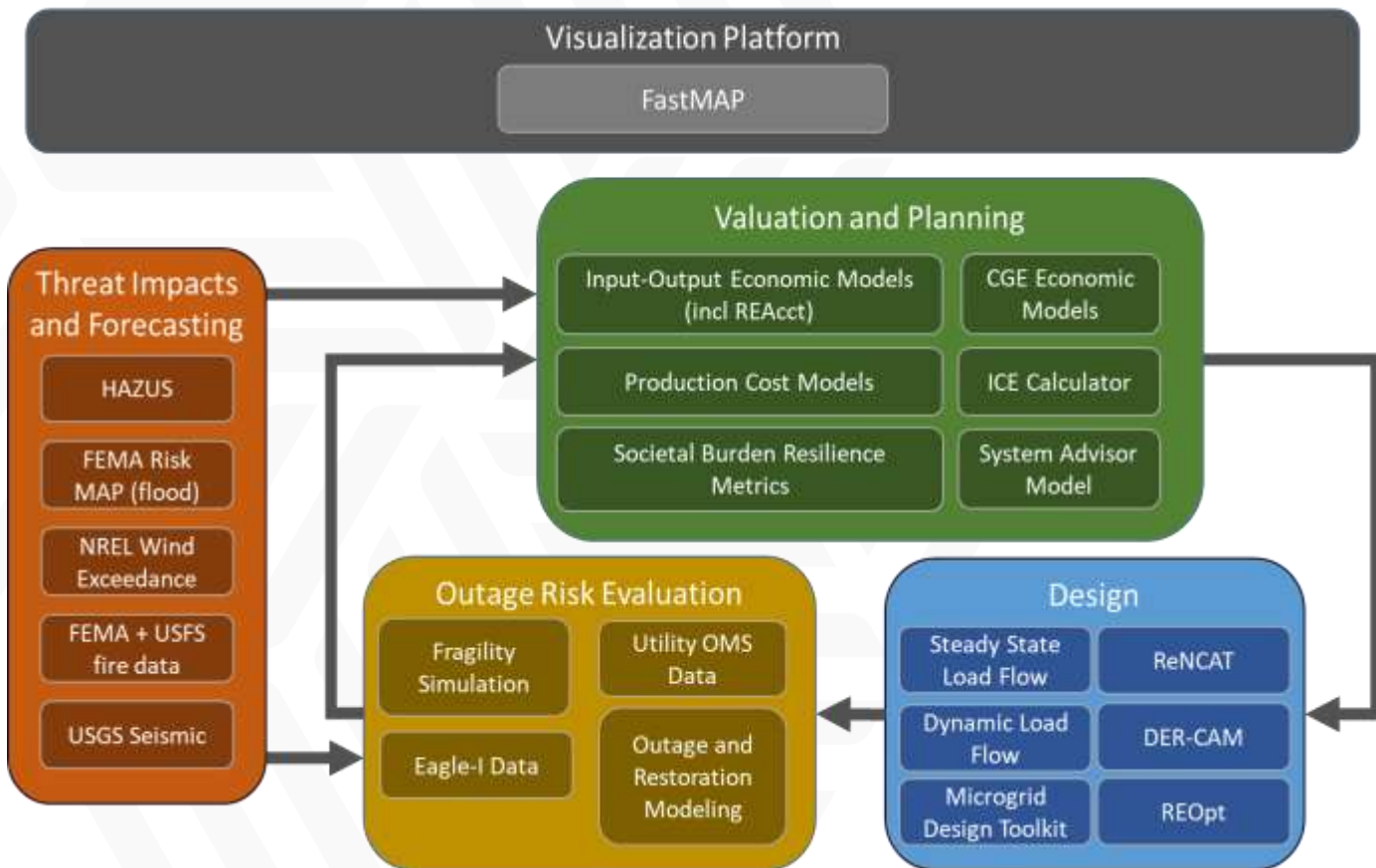

# Designing Resilient Communities Approach

Task 4: Demonstration and validation at scale of resilience nodes supported by clean DER technologies.

- ▶ Dynamic model for PV+ storage system + load in islanded, grid-tied, and transition
- ▶ Design and test at lab scale adaptive protection systems for inverter-based resilience nodes
- ▶ Design and implement at utility scale novel non-protection aspects of resilience nodes
- ▶ Design and implement at utility scale adaptive protection for inverter-dominated resilience node

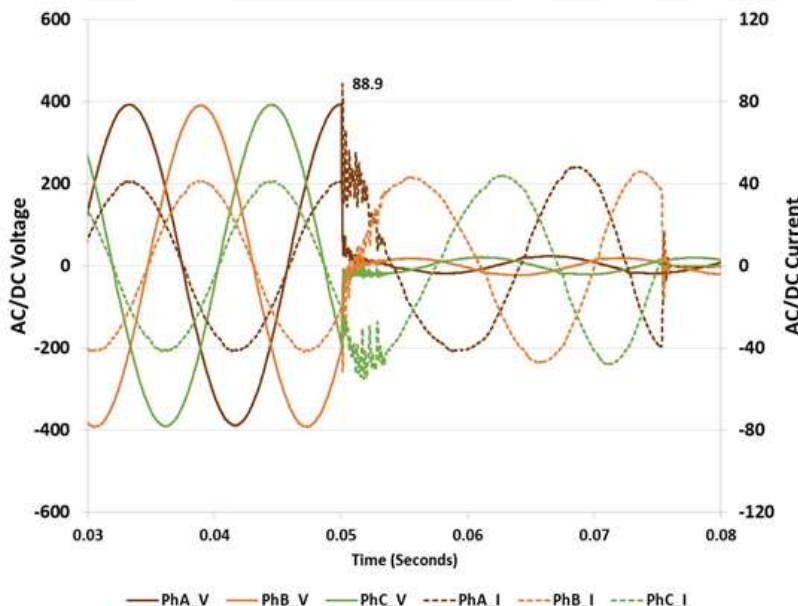



# Designing Resilient Communities Approach



Awarded plus-up to full project status on Aug 16, 2018

GMLC Designing Resilient Communities	Yr0				Yr1				Yr2				Yr3				
	Q1	Q2	Q3	Q4	Q5	Q6	Q7	Q8	Q9	Q10	Q11	Q12	Q13	Q14	Q15	Q16	
1 Outreach, Verification, Gap Analysis	Active																
1.1 SAG Formation and Hosting	Active																
1.2 Verification and Gap Analysis			Active														
1.3 Tech Outreach and Framework			Active														
2 Framework Demonstration	Active																
2.1 Threat ident and metric spec	Active																
2.2 Baseline resilience analysis		Active															
2.3 Portfolio specification			Active														
2.4 Additional benefits				Active													
2.5 Resilience cost/benefit analysis					Active												
3 Reg Frameworks and Service Design			Active														
3.1 Alternative policy collection			Active														
3.2 Alternative policy evaluation				Active													
4 Field Validation of Resil Nodes				Active													
4.1 Dyn models under faults				Active													
4.2 Resilient protection lab scale				Active													
4.3 Cyber resil protection test				Active													
4.4 Utility scale demo non-protection						Active											
Utility scale demo with							Active										
4.5 protection							Active										

# Designing Resilient Communities

## Accomplishments to Date



**First SAG meeting – July 24-25, 2018**  
**Washington, D.C.**

- Attendance:
- DOE OE and EERE
  - City of Boston
  - City of New York
  - Con Edison
  - City of Atlanta
  - City of Norfolk
  - Dominion Energy
  - City of Honolulu
  - HECO
  - HI PUC
  - City of Los Angeles
  - LADWP
  - Siemens
  - GE
  - UPitt

- SUNY Buffalo
- CPS Energy
- National Grid
- Synapse Energy
- 100 RC

**HAWAII TACKLING REGULATION FOR RESILIENCE**



**BOSTON SMART UTILITIES VISION**

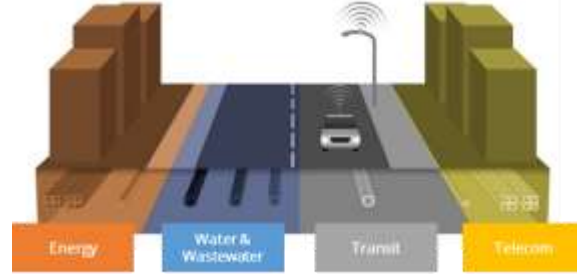

**NEW YORK INCREASING COORDINATION WITH CON EDISON**

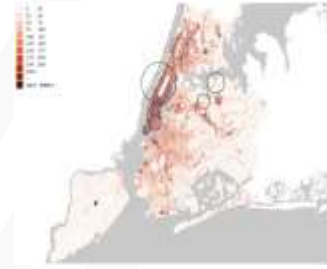

**NORFOLK ST PAUL'S REDEVELOPMENT**



**Themes and Takeaways**

- Defining and measuring resilience a clear need
- Engaging stakeholders – the SAG has inherent value
- Implementation - who does what in the process?
- Rethinking regulatory frameworks and business models
- Developing technical capabilities, especially to value a resilient grid's community benefits

# Designing Resilient Communities

## Accomplishments to Date

### Further refinement of a community-focused resilience metric

► Societal Burden  $B_{n,m} = \frac{E_{n,m}}{A_n}$

- Calculated over dimensions of discrete space (n) and infrastructure services (m)
- $E_{n,m}$  = Attainment effort; how hard people have to work to attain their infrastructure service needs
- $A_n$  = Attainment ability; the resources people have at their disposal for attaining their infrastructure service needs

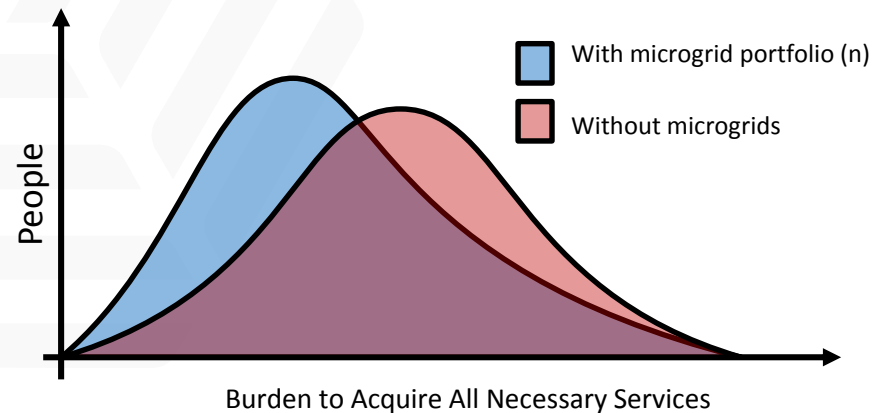
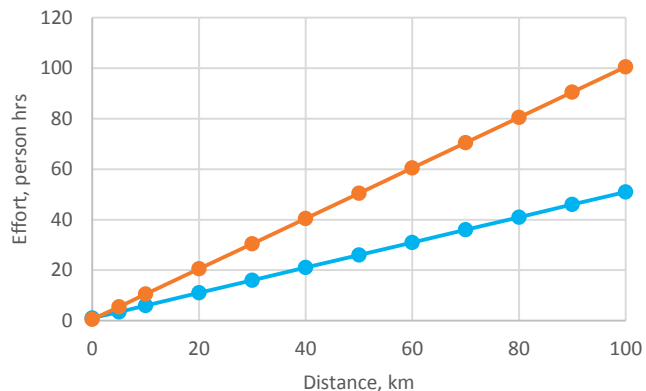

# Designing Resilient Communities

## Next Steps and Future Plans

- Heavier engagement with CPS Energy – directly integrating community resilience metrics into integrated resource planning process
  - Yr2: Applying the resilient node system design methodology with improved ReNCAT 2.0, siting and sizing of PV+storage to optimize consequence-based resilience metrics
  - Yr3: Evaluating alternative CPS investments based on community resilience impacts
- Beginning Task 4 (Clean DER-based Resilience Nodes) this quarter
  - Yr1: Characterize inverter-based PV+Storage system under various scenarios
  - Yr2: Determine appropriate protection scheme for resilient microgrid in San Antonio
  - Yr3: Utility-scale demo of resilience node with adaptive protection during islanding
- Increasing engagement with Puerto Rico and the City of San Juan
  - Yr3: Including option to design and assist in implementation of resilience nodes
- Regulatory focus – increasing confidence in consequence-based resilience metrics
  - Yr2: SUNY Buffalo and Sandia validating the societal burden metrics using data and survey mechanisms