

# Design and Planning Tools

**John Grosh**

Lawrence Livermore National Laboratory  
Grid Modernization Initiative Peer Review

September 6, 2018

# Design and Planning Tools Summary

## Objective

- Drive development of next- generation tools that address evolving grid needs

## Expected Outcomes

- Software framework to couple grid transmission, distribution, and communications models to understand cross-domain effects
- Incorporate uncertainty and system dynamics into planning tools to accurately model renewables, extreme events, etc.
- Computational tools, methods and libraries that enable 1000x improvements in performance

## Federal Role

- Attack strategic gaps in tools capabilities
- Partner with industry to demonstrate value
- Work with vendors to transition to practice



Simulating Interactions  
Across Domains



Computational Speedup

# Activities and Technical Achievements

## MYPP Activity Description



<b>Activity</b>	<b>Technical Achievements by 2020</b>
1. Scaling Tools for Comprehensive <b><u>Economic Assessment</u></b>	<ul style="list-style-type: none"> <li>Enhance performance of stochastic production cost modeling from 100 to 10,000 transmission nodes; expand to include distribution system.</li> </ul>
2. Developing and Adapting Tools for Improving <b><u>Reliability and Resilience</u></b>	<ul style="list-style-type: none"> <li>Scalable simulation framework that couples transmission, distribution, and communications systems for integrated modeling at regional scale.</li> </ul>
3. Building <b><u>Computational Technologies</u></b> and High Performance Computing ( <b><u>HPC</u></b> ) Capabilities to Speed up Analyses	<ul style="list-style-type: none"> <li>Scalable math libraries and tools for enhanced analysis; co-simulation frameworks to support coupling of tools and models, uncertainty quantification, and systems optimization.</li> </ul>

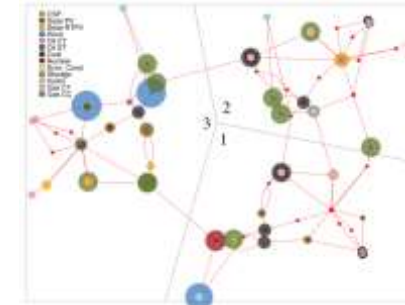

**Datasets**

**Software**

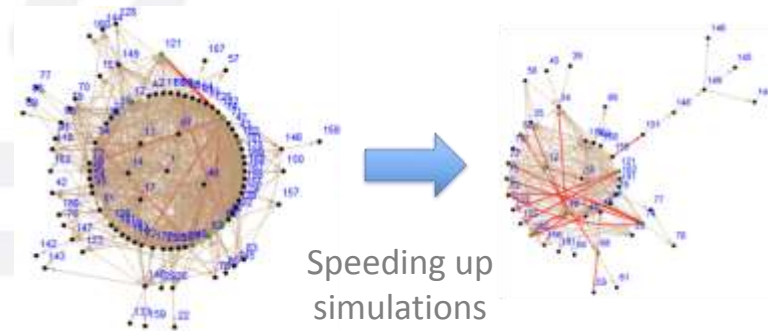

**Algorithms**

# 1.4.15 - Development of Integrated Transmission, Distribution and Communication Models (Lead: PNNL)

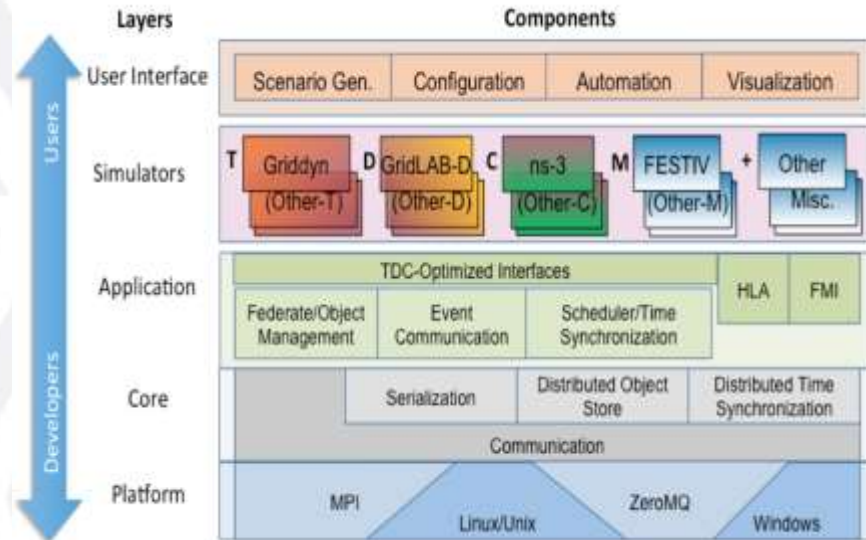
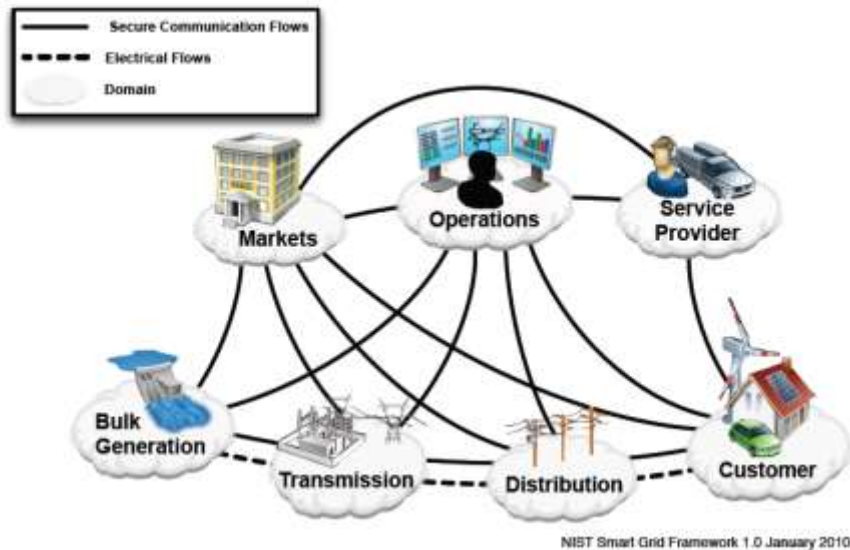

**Goal:** Create HELICS™, an **open-source co-simulation platform**, enabling interactions between leading commercial & lab developed simulators on a wide range of computing environments (HPC to laptop).



## 1.4.26 – Development of Multi-scale Production Cost Simulation (Lead: NREL)

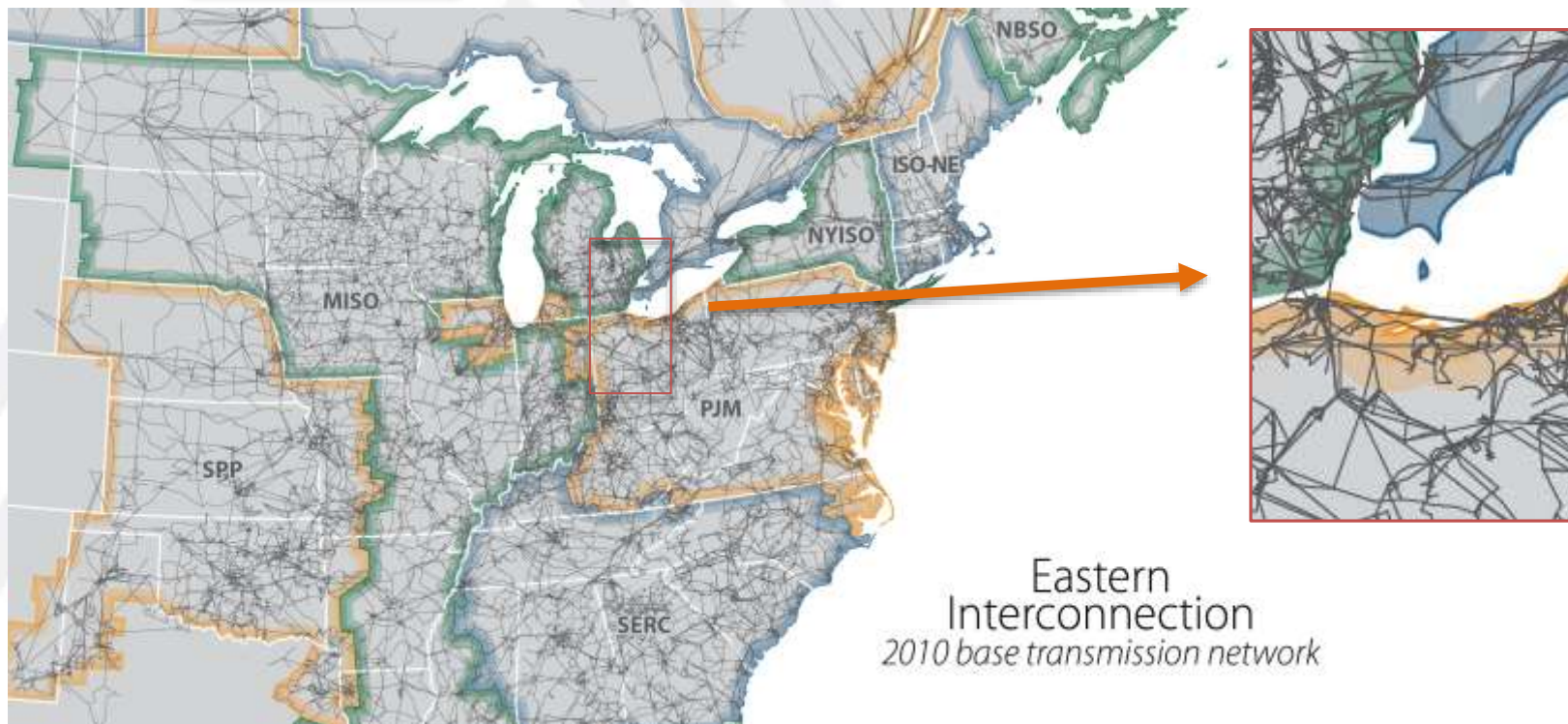

**Goal:** Develop scalable algorithms used for deterministic and stochastic production cost models

# 1.4.17 - Extreme Event Modeling (Lead: LANL)

Light Spring Base Case Trip Path 66 (COI)

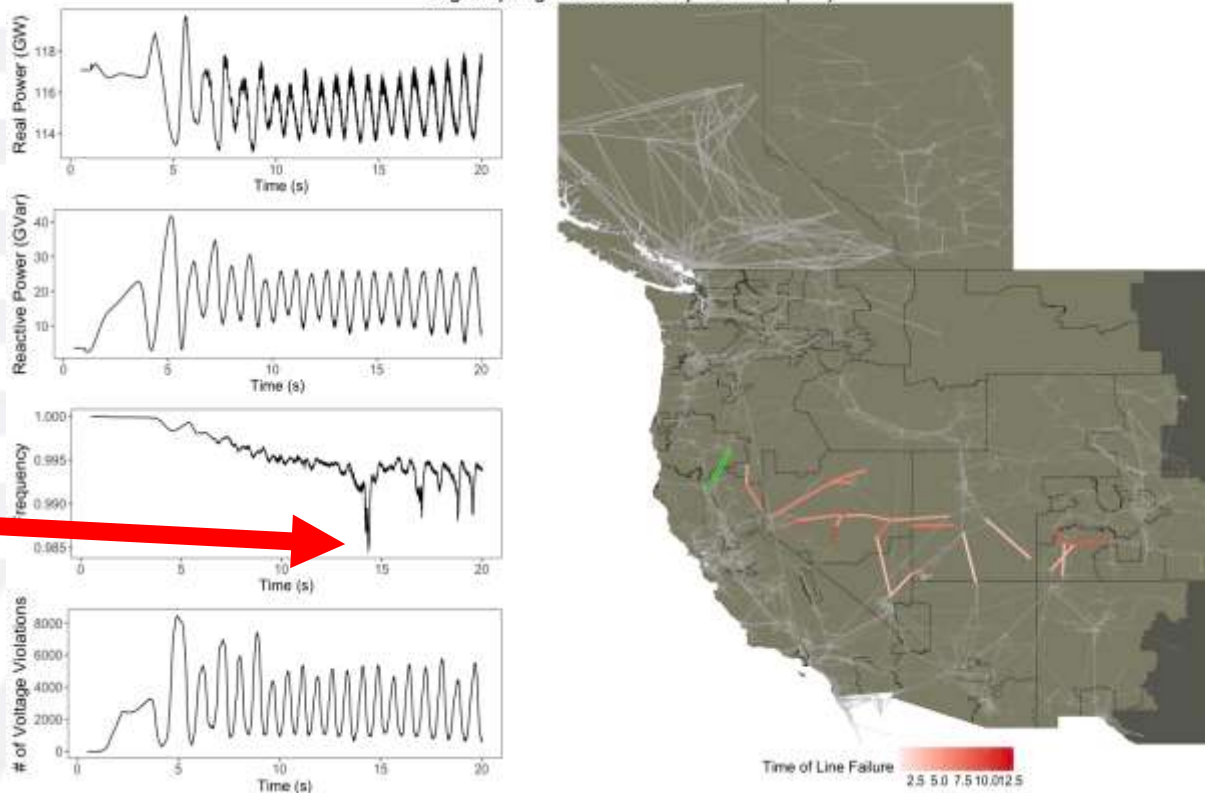

Frequency  
Event

**Goal:** Improve performance of tools for modeling cascading outages and develop new approaches for contingency analysis

# 1.4.18 - Computational Science for Grid Management (Lead: ANL)

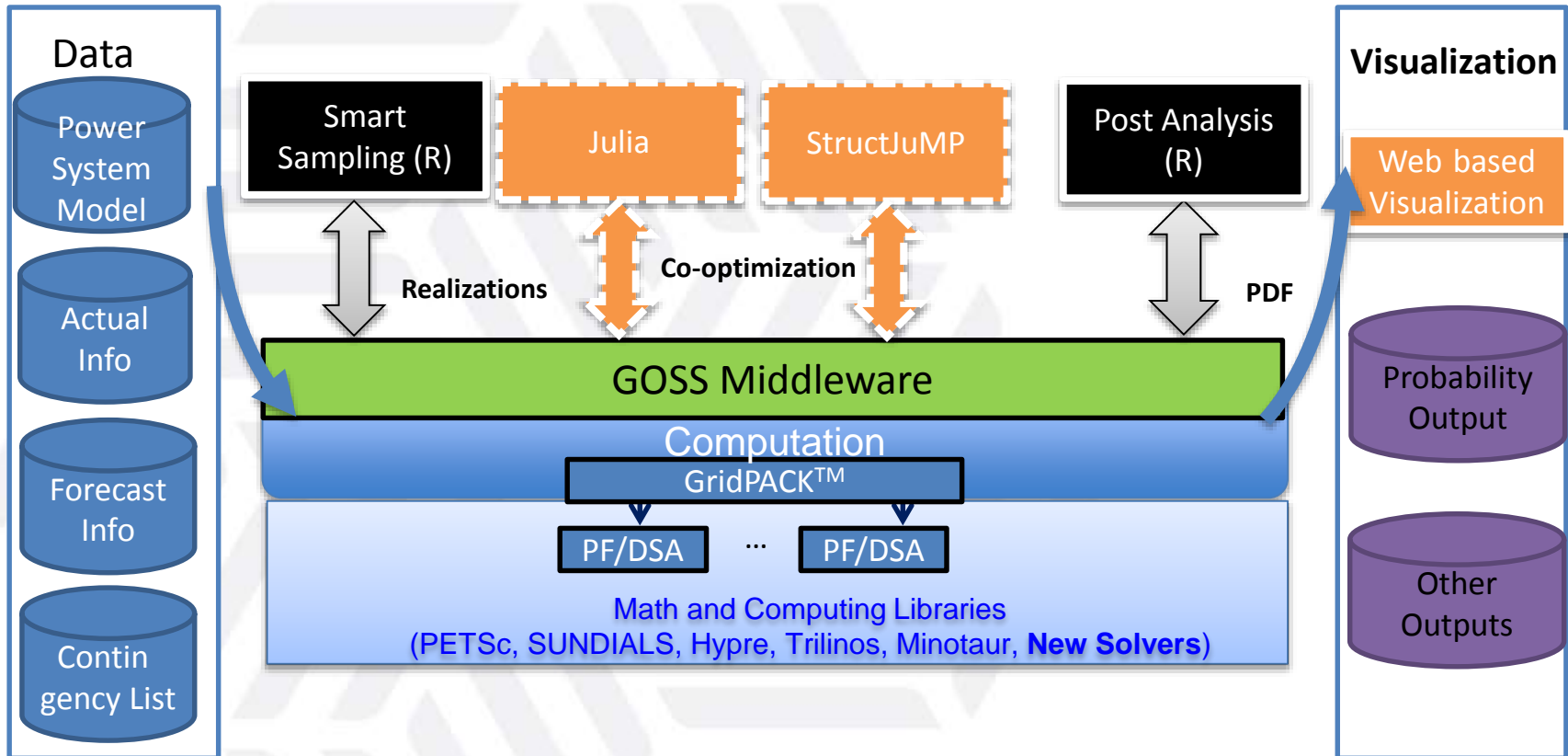

**Goal:** Apply DOE innovations in computational science to develop unified grid math library optimization, dynamics, and uncertainty

# Accomplishments and Emerging Opportunities

## Accomplishments

- **1.4.15: Co-Simulation**
  - Multiple releases of HELICS™, latest at V1.3
  - Hosted webinars and built/presented tutorials
- **1.4.17: Extreme Events**
  - Developed Zone 3 protection models for commercial power flow solvers
  - Demonstrated >6000X for dynamic contingency analysis & 10X for prob. N-k
- **1.4.26: Production Cost Modeling**
  - Developed new algorithms for speeding up PCM, such geographic domain decomposition
  - Implemented and released algorithms in python-based Prescient framework
- **1.4.18: Computational Science**
  - Refocused projects on resiliency and restoration problems
  - Demonstrated scalability for security constrained ACOPF to O(1000) processors

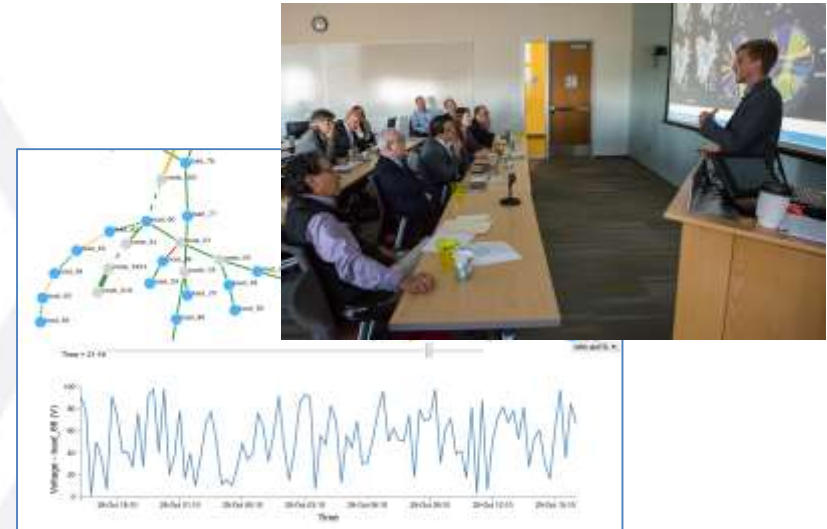

## Next Year

- Increase industry and vendor engagement
- Continued release of software tools on GitHub
- Expand use case development



# Program-Specific Projects

## Transmission

- GM0111 - Protection and Dynamic Modeling, Simulation, Analysis, and Visualization of **Cascading Failures** (Lead: ANL)
- GM0074 - Models and methods for assessing the value of **HVDC and MVDC technologies** in modern power grids (Lead: PNNL)
- WGRID-38: North American Renewable **Integration Study** (NARIS) (Lead: NREL)
- SI-1631: Assessing the Value and Impact of **Dispatchable Concentrating Solar** Power in a SunShot Future (Lead: NREL)

## Distribution

- GM0057 - LPNORM: A LANL, PNNL, and NRECA Optimal **Resiliency Model** (Lead: LANL)
- SI-1545 - **Rapid QSTS** Simulations for High-Resolution Comprehensive Assessment of Distributed **PV Impacts** (Lead: SNL)
- SI-1756 - **Visualization and Analytics** of Distribution Systems with Deep Penetration of **Distributed Energy Resources** (VADER) (Lead: SLAC)
- SI-1639: System Advisor Model (Lead: NREL)

## Multiple Domains

- SI-1625 - CyDER: A Cyber Physical **Co-simulation** Platform for **Distributed Energy Resources** in Smart Grids (Lead: LBNL)
- GM0229 - Integrated Systems Modeling of the Interactions between **Stationary Hydrogen, Vehicle and Grid Resources** (Lead: LBNL)

## Load Modeling

- GM0094 - Measurement-Based Hierarchical Framework for Time-Varying **Stochastic Load Modeling** (Lead: ANL)
- GM0064 - Open-Source High-Fidelity Aggregate Composite Load Models of **Emerging Load Behaviors** for large-Sale Analysis (Lead: PNNL)

# GRID MODERNIZATION INITIATIVE PEER REVIEW

## 1.4.15 - Development of Integrated Transmission, Distribution and Communication (TDC) Models



**HENRY HUANG (PI), LIANG MIN (+1)**

September 4–7, 2018

Sheraton Pentagon City Hotel – Arlington, VA



### Project Description

This project aims to **enable large-scale TDC interdependency studies** through a flexible and scalable, open-source co-simulation platform for the following industry drivers

### Project Objectives

- ✓ Provide foundational capabilities for grid planning, operation, and control
- ✓ Engage and educate grid developers on the value of multi-domain planning

### Value Proposition

- ✓ There is currently a gap in simulation and modeling technology that inhibits integrated planning across multiple domains
- ✓ Left to it's own devices, the grid community is unlikely to develop capabilities to overcome planning stovepipes (in near term)
- ✓ The DOE plays a unique role in initiating this effort and creating foundational tools that support both research and industry

5.0: Design and Planning Tools

Activity 2: Tools for Improving Reliability & Resilience

5.2.1: Dynamic modeling across TD&C

3.0: Sensing and Measurements

Activity 5: Demo Unified Grid Comms. Network

3.5.1: Incorporate comm. models into grid simulations

### National Lab Participants



### Technical Review Committee

20+ members: academia, vendors, and industry experts

PROJECT FUNDING			
Lab	FY16	FY17	FY18
PNNL	\$430K	\$430K	\$430K
LLNL	\$325K	\$325K	\$325K
NREL	\$195K	\$195K	\$195K
ANL	\$165K	\$165K	\$165K
ORNL	\$95K	\$95K	\$95K
SNL	\$60K	\$60K	\$60K
INL	\$60K	\$60K	\$60K

Name	Organization	Name	Organization
Aidan Tuohy	EPRI	Ernie Page	MITRE
Jens Boemer		Hung-Ming Chou	Dominion
Anjan Bose	WSU	Jianzhong Tong	PJM
Dave Anderson		John Gibson	Avista
Anuja Ratnayake	Duke Energy	Jun Wen, Raul Perez	SCE
Avi Gopstein	NIST	Mike Zhou	InterPSS
Babak Enayati	National Grid	Shruti Rao	GE
Bernie Zeigler	U. Arizona	Slaven Kincic	Peak RC
Craig Miller	NRECA	Vijay Vital	ASU
Cynthia Hsu			
David Pinney			



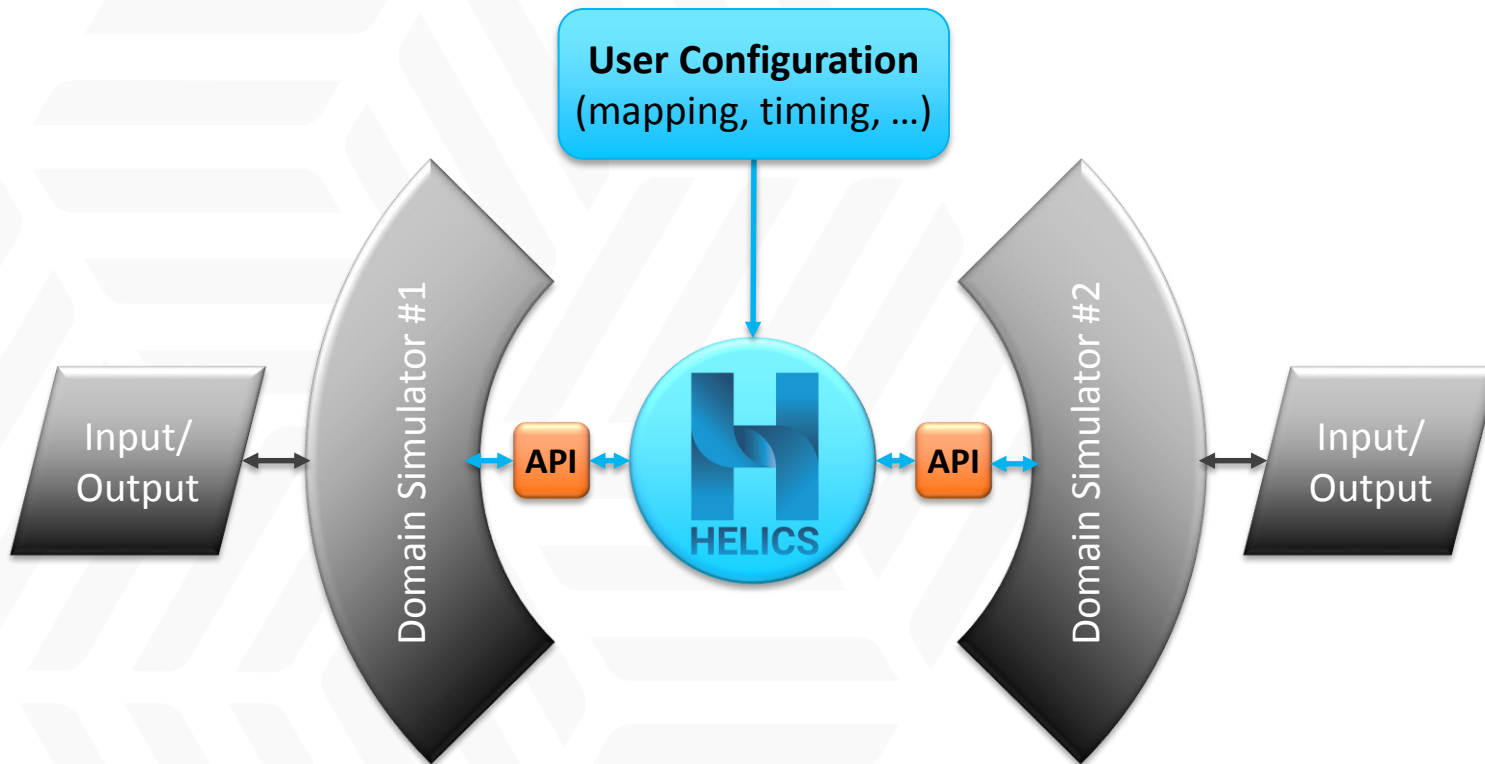

Three tracks (test case driven):

### TEST CASES, PLATFORM DESIGN AND DEVELOPMENT, OUTREACH

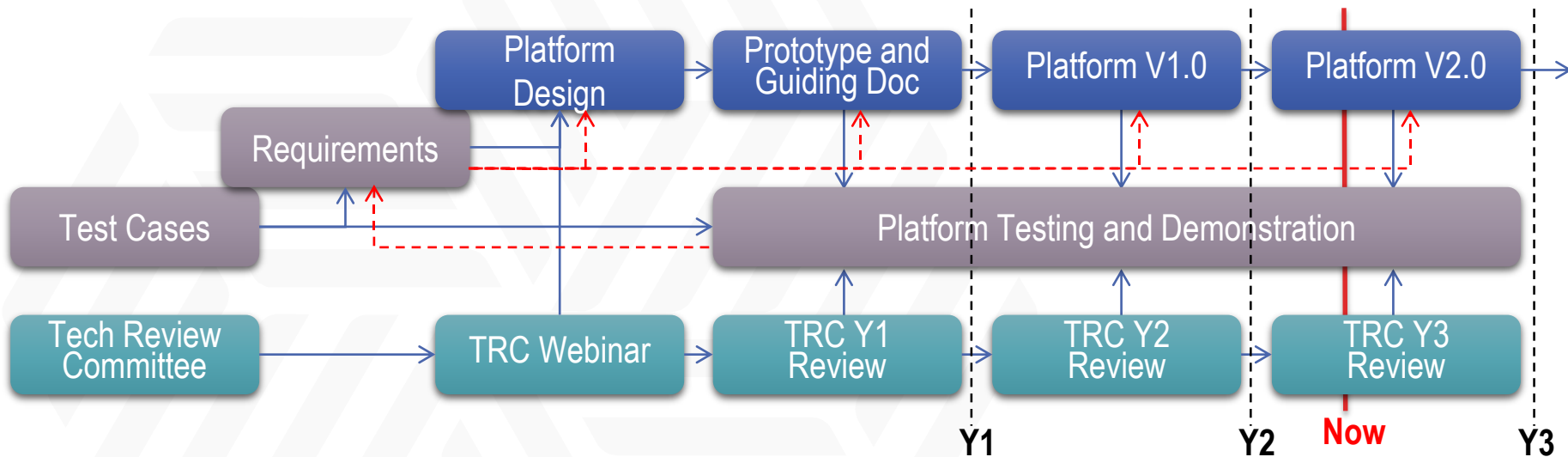

Development plan targets open-source release of the co-simulation platform

**HELICS – Hierarchical Engine for Large-scale Infrastructure Co-Simulation**

Support a variety of simulation types:

- Discrete Event
- Time Series
- Quasi Steady Time Series
- Dynamics
- Transients

Evaluate systems of unprecedented scale:

- 2-100,000+ Simulators
- High Performance Computing (HPC), including cloud
- But also workstations and laptops

No	Title	Description
1	<b>Impacts of DER's on Bulk Systems Reliability</b>	The test case will analyze a combined T&D test system with and without advanced distributed systems with high penetrations of distributed solar PV. Studying the impact on reliability metrics such as the NERC Control Performance Standards 1 and 2 as well as other main metrics can quantify the impacts of advanced distribution systems.

	Domain				Simulation			Comm	
	Transmission	Distribution	Communication	Market	Steady State	Dynamic	Transient	Latency	Packets
DER's on Bulk Systems Reliability	X	X			X				
Load Modeling under high penetration of DERs	X	X				X			
Wide Area Voltage Stability Support Using DERs	X	X	X		X			X	
Voltage and Frequency Ride-Through Settings for Smart Inverters	X	X	X			X			
Real-time Co-simulation of Power Systems and Communication Networks for Transient Assessment	X	X	X				X	X	
Communications Architecture Evaluation for High-Pen Solar	X	X	X		X				X
New Control Paradigm – Centralized vs Distributed to Prevent Voltage Stability Collapse	X	X	X			X		X	
Wide Area Monitoring, Protection, and Control (WAMPAC)	X		X			X		X	X
Impacts of Distributed Energy Resources on Wholesale Prices	X	X		X	X				
Mitigating T/D Interface Congestion Through Demand Side Management	X	X		X	X			X	
Regional Coordinated Electric Vehicles Charging	X	X		X	X			X	
Real-time Coordination of Large Scale Solar PV and Energy Storage	X	X			X			X	

Layered and modular architecture to support:

- Laboratory, open-source, and commercial tools
- Interchangeable time synchronization algorithms (depending on use case)
- Reiteration, when necessary

Support standardized interfaces:

- HLA (High Level Architecture), FMI (Functional Mockup Interface), etc.
- Tuned Application Program Interfaces (APIs) for highly used tools (e.g., GridLAB-D, ns-3)

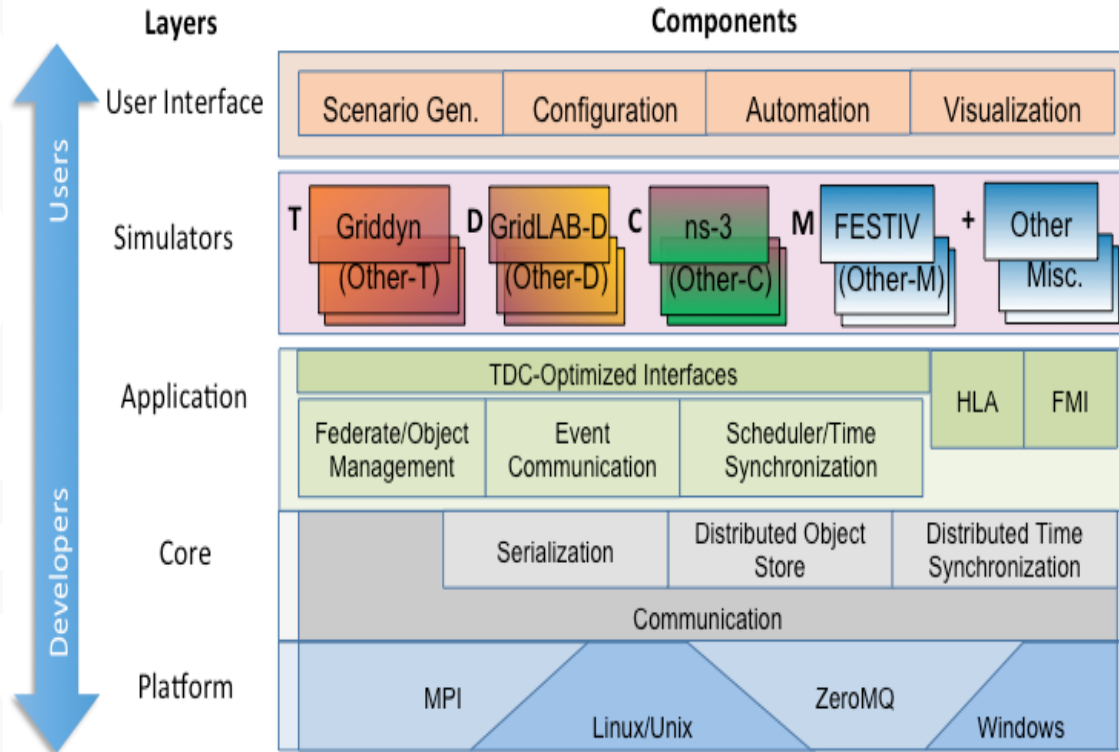



### Use Case Requirements

	Domain		Simulation				Comm
	Transmission	Distribution	Market	Steady State	Dynamic	Transient	
DER's on Bulk Systems Reliability	X	X		X			
Load Modeling under high penetration of DERs	X	X			X		
Wide Area Voltage Stability Support Using DERs	X	X	X	X			X
Voltage and Frequency Ride-Through Settings for Smart Inverters	X	X	X		X		X
Real-time Co-simulation of Power Systems and Communication Networks for Transient Assessment	X	X	X			X	X
Communications Architecture Evaluation for High-Pen Solar	X	X	X	X			X
New Control Paradigm – Centralized vs Distributed to Prevent Voltage Stability Collapse	X	X	X		X		X
Wide Area Monitoring, Protection, and Control (WAMPAC)	X	X		X	X		X
Impacts of Distributed Energy Resources on Wholesale Prices	X	X	X	X			
Mitigating T/D Interface Congestion Through Demand Side Management	X	X	X	X			X
Regional Coordinated Electric Vehicles Charging	X	X	X	X			X
Real-time Coordination of Large Scale Solar PV and Energy Storage	X	X	X		X		X

### New Platform Design

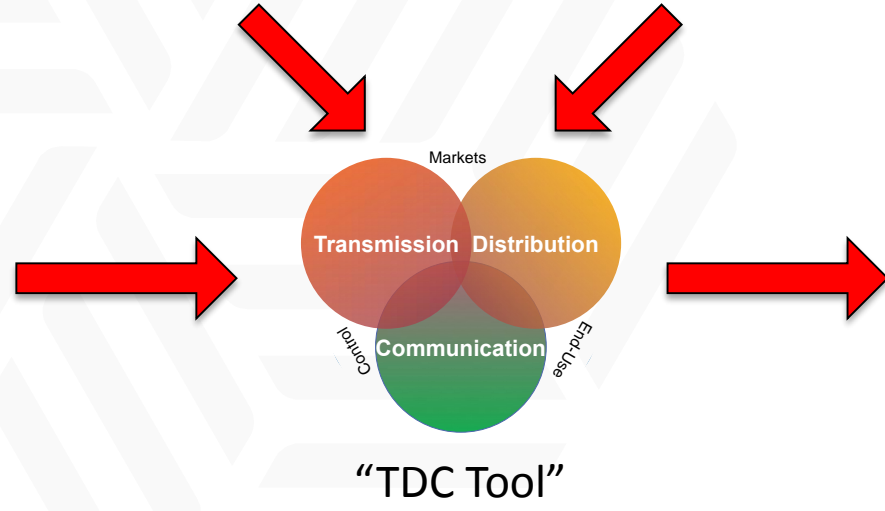
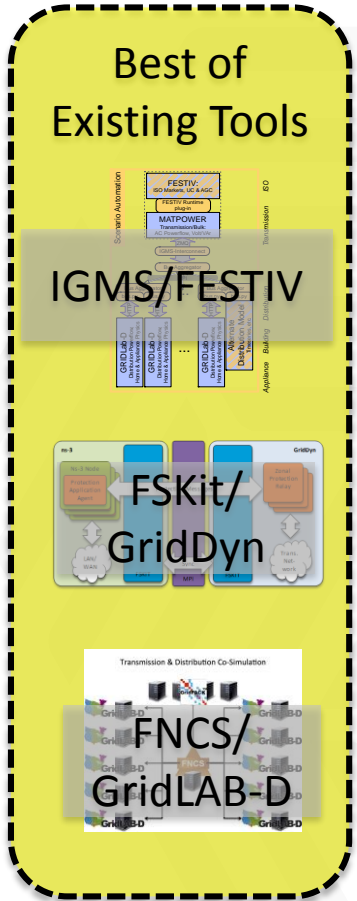
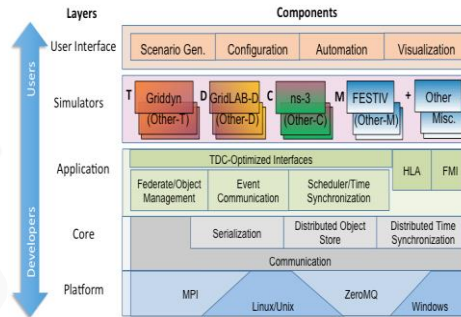

IGMS: Integrated Grid Modeling System  
 FSKit: Federated Simulation Toolkit  
 FNCS: Framework for Network Co-Simulation

- ▶ HELICS v1.3 released, <https://www.github.com/GMLC-TDC/HELICS-src>, with HELICS documentation on website, <https://www.helics.org>. *350+ downloads last two weeks of July 2018.*
  - Distributed time synchronization; Boundary information exchange.
  - Continuous + discrete, steady-state and dynamic simulation.
  - Co-simulation configuration and control; Compatible with FMI and HLA.
  - APIs to key domain simulators, e.g. GridDyn (T), MATLAB (T/D), GridLAB-D (D), NS3 (C), FESTIV (M); Supports C/C++, MATLAB, Python, Java.
  - Demonstrated validity and value by multiple use cases. Public use-case repository <https://github.com/GMLC-TDC/HELICS-Use-Cases>.
- ▶ HELICS mini-tutorials developed, <https://www.youtube.com/channel/UCPa81c4BVXEYXt2EShTzbcg>
- ▶ HELICS [tutorial](#) at IEEE PES T&D Conference in April 2018; Plan again for IEEE PES General Meeting in August 2019.
- ▶ HELICS 8-session webinar series (August 2018).

- Assess impact of very high DER penetration on bulk system stability – fulfill a very important industry need as a result of increasing DER penetration (PVs, EVs, etc.)
- **Very large (0.5 million buses) T+D dynamics co-simulation** provides a practical way to achieve this objective.

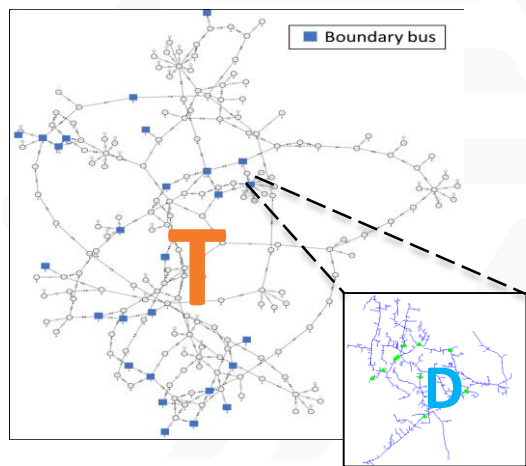

**1 T + 135 D's:**  
540,000 T+D buses

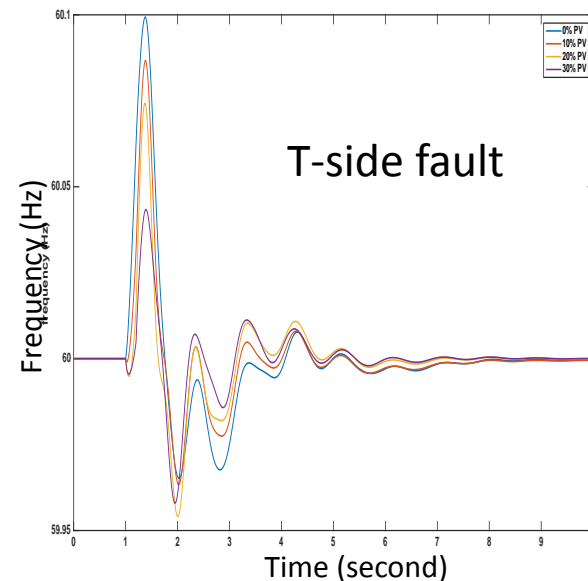
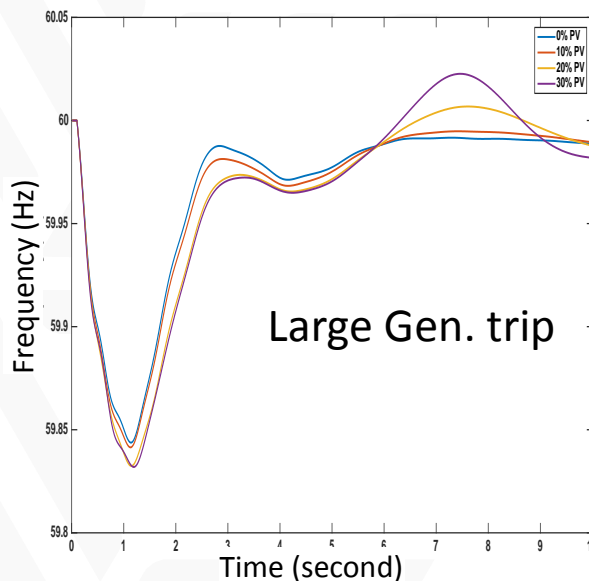

**Impact of % PV penetration on system frequency**

- Assess the ability of smart inverters in regulating transmission system voltage: Unity Power Control, Fixed Volt/Var Control, and Adaptive Volt/Var Control.
- Adaptive Volt/Var control demonstrates the best voltage performance.
- T+D co-simulation (e.g. HELICS + PFLOW + GridLAB-D) enables the design and evaluation of such an adaptive control across transmission and distribution.

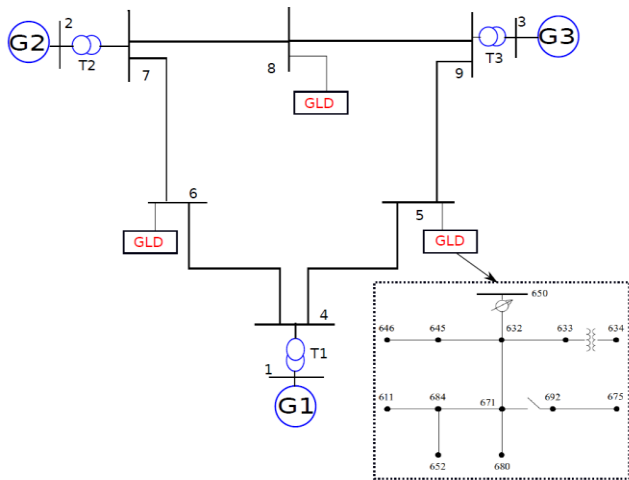

1 T + 3 D's with smart inverters

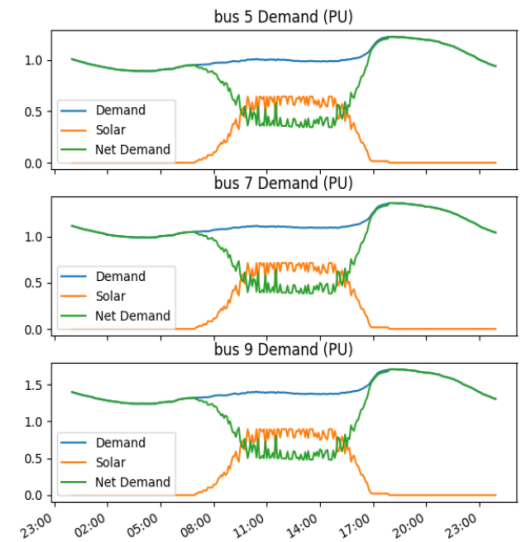
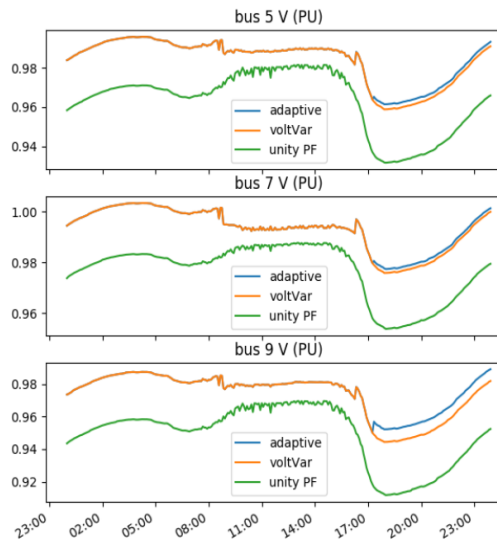

Comparison of 3 smart inverter control strategies  
Adaptive Volt-VAR - no voltage violation.



- Correctly modeling motor behaviors in loads for system stability analysis: Evaluate and calibrate composite load model (CMPLDWG) in response to faults.
- T+D dynamics co-simulation (e.g. HELICS + InterPSS + GridLAB-D) reveals motors stalling at different levels instead of all at once – accurately representing load recovery in system stability analysis.

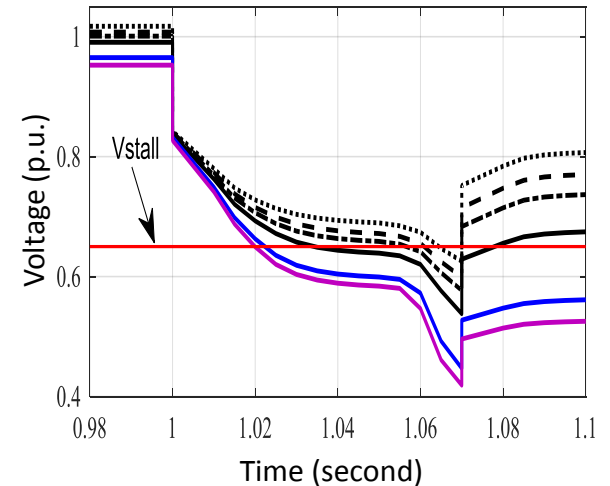
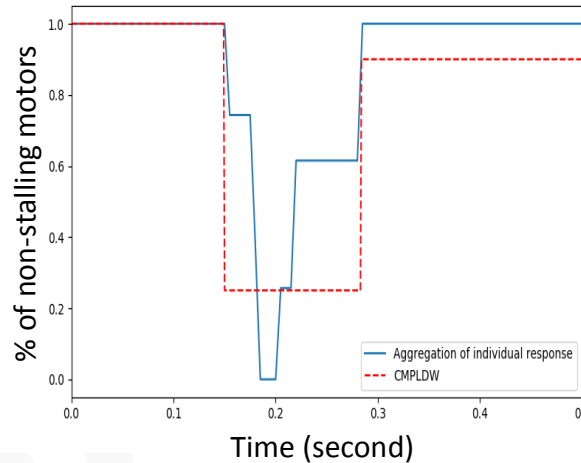
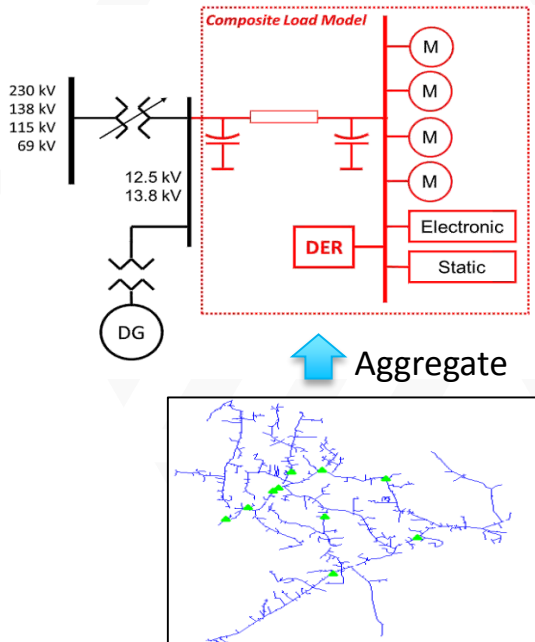

**Transmission-side fault causes slow voltage recovery due to motor stalling behaviors**

- Wide-area control critically depends on the performance of communication networks for stabilizing power systems.
- T+C co-simulation (e.g. HELICS + GridPACK + NS3) enables the design and evaluation of wide-area control with realistic communication characteristics instead of assumed arbitrary properties.

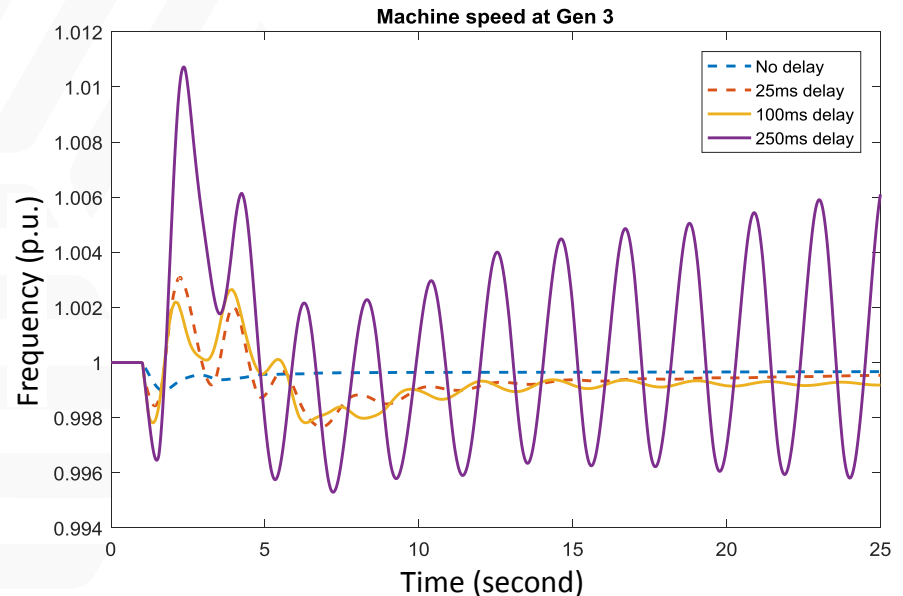
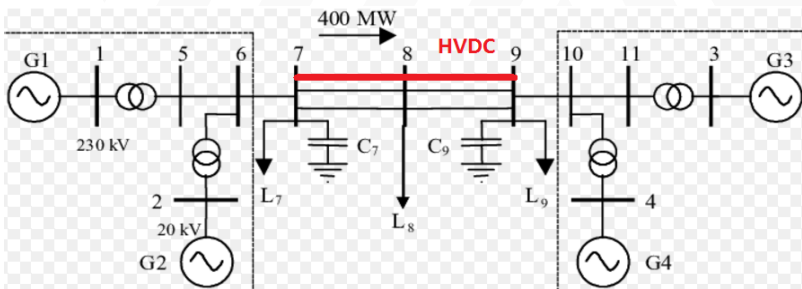
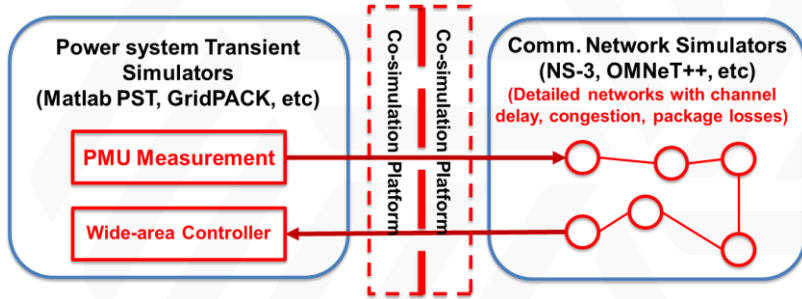

Name	Responsible Lab	Simulation type	Static / Transient	Use-case supporting GMLC or other projects?	Power system tools used.	HELICS software needs: OS, programming languages(s), HELICS features (see software prioritization doc),
Real-time coordination of Large Scale Solar PV and Energy Storage	ANL	TCM	Static	GMLC	MATPOWER, NS-3	MATLAB, Python
Combined Transmission-Distribution Stability Analysis	ANL	TD	Transient	GMLC	Dyn, GridLAB-D/OpenDSS	C
Adaptive Volt-VAR control at high PV penetration: Impacts on transmission system voltages	ANL (& NREL?)	TD	Static	GMLC	PFLOW, GridLAB-D	Python
Evaluate Modeling Adequacy of Composite Load Model Under High Penetration of DERs	PNNL	TD	Transient	GMLC	InterPSS, GridLAB-D	Validated Java bindings
Impacts of Distributed Energy Resources on Wholesale Prices	NREL	TDC	Static	GMLC	FESTIV, Matpower, GridLAB-D	MATLAB, Python
Communication Architecture Evaluation for High-Pen Solar	NREL	DC then TDC	Static	SuNLaMP	GridLAB-D, ns-3	Later: MATLAB/Python
GO-Solar (Advanced Controls & Monitoring using subset of points)	NREL	TDC	Static	ENERGISE: GO-Solar	FESTIV, Matpower, GridLAB-D, ns-3	MATLAB, Python
Reactive Power Analytics for T-D interfaces	NREL (& ANL)	TD	Static	SuNLaMP	FESTIV, PFLOW, GridLAB-D	MATLAB, Python
Wide Area Control and Protection	PNNL	TC	Transient	GMLC	MATLAB, NS-3	MATLAB
Wide Area Voltage Stability Support using DERs	SNL	TDC	Static	GMLC	MATLAB, GridLAB-D, NS-3	MATLAB
ORNL use case	ORNL	TDC	Transient	GMLC	T and D in detail, C in abstract	Linux; multi-core/multi-node
Real-time cosimulation of power systems and communication networks for transient assessment	INL	TDC	Transient	GMLC	1) DRTS: Real time power simulation for T & D. 2) NS3: Communication network 3)	HELICS with NS3 integration
DER Siting and Optimization	LLNL	TD	Static	GMLC-1.3.5	GridDyn+GridLab-D	

Not exhaustive lists.

- ▶ Enable large-scale interdependency all-hazards studies: scale to 100,000 domain simulators
- ▶ Diverse simulation types:
  - Continuous & discrete
  - Steady-state & dynamic
  - Time series
  - Other energy systems
- ▶ Support multiple platforms: HPC, cloud, workstations, laptops (Win, Linux, Mac)
- ▶ Support standards: HLA, FMI, ...

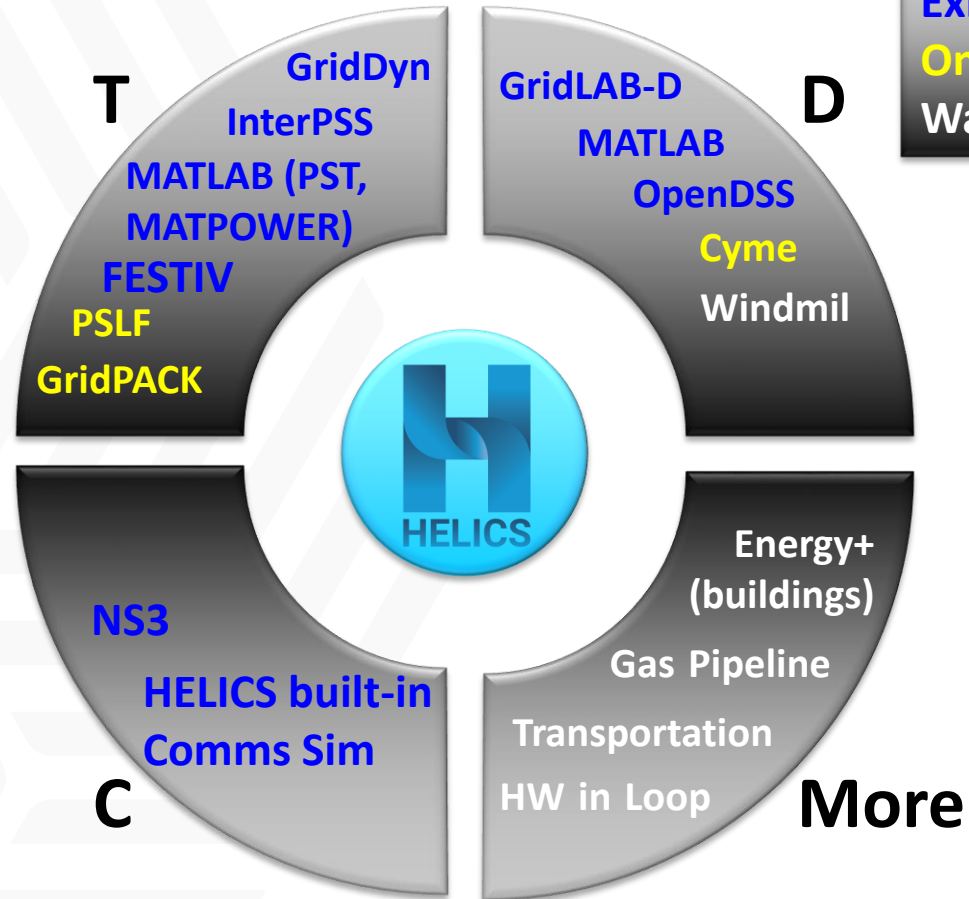

**Existing**  
**Ongoing**  
**Waiting**

	Milestone	End Date
Year 1	✓ M1: Document initial test cases	9/2016
	✓ M2: Organize an industry stakeholder webinar	12/2016
	✓ M3: Report documenting test case studies	3/2017
	✓ M4: Deliver a HELICS guiding document	6/2017
	✓ M5: Organize a TRC workshop	6/2017
Year 2	✓ M6: Deliver an initial HELICS framework to open source	6/2017
	✓ M7.1: Deliver HELICS v0.3 framework to open source	10/2017
	✓ M7.2: Deliver use case implementation examples	12/2017
	✓ M7: Deliver HELICS v1.0 framework to open source	12/2017
	✓ M8: Host a TRC meeting	6/2018
	✓ M9.1: Host a TRC webinar series (8 sessions)	8/2018
Year 3	M9: Deliver ver2.0 framework to open source	12/2018
	M10: Demonstrate ver2.0 framework with selected use cases	4/2019

◉ Usability

◉ Scalability

- ▶ ◉ Standardized scripts for setup and configuration
- ▶ ◉ APIs to more simulators
- ▶ ◉ API development guide
- ▶ ◉ Hands-on tutorials
- ▶ ◉ Dynamic federation
- ▶ ◉ Roll-back capability
- ▶ ◉ Improvements of communication patterns and memory layout
- ▶ ◉ Scale to 100,000 simulators
- ▶ ◉ Real-time simulation

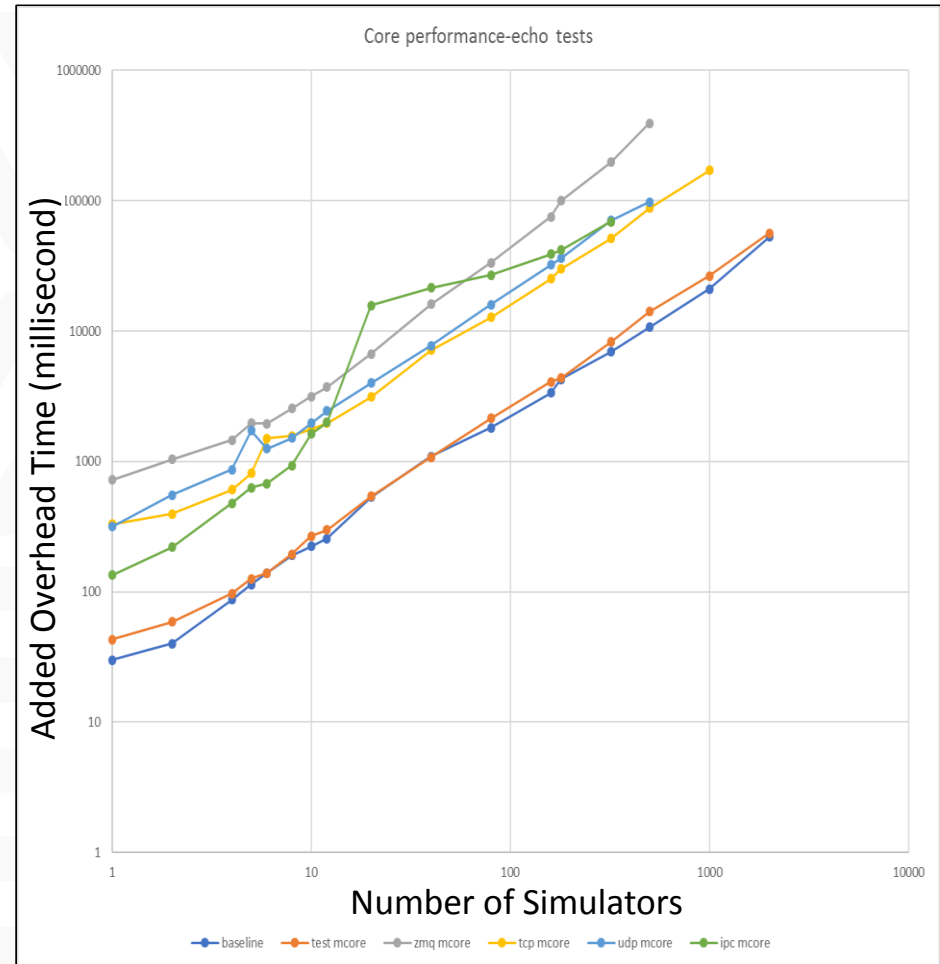





# GMLC 1.4.15 TDC Models

Outreach: position HELICS to be the co-simulation platform of choice



## ▶ TRC (\*active development):

- \*EPRI
- \*WSU
- Duke Energy
- \*NIST
- National Grid
- U. Arizona
- \*NRECA
- MITRE
- Dominion
- PJM
- \*Avista
- \*SCE
- \*InterPSS
- \*GE
- Peak RC
- ASU

## ▶ HELICS Users

- CleanStart DERMS
- Integrated D&C (CenterPoint)

## ▶ Other Interested Parties

- Transactive Energy Systems Platform
- GridAPPS-D
- TU-Delft
- Colorado School of Mines
- SDSU
- Opsim
- Office of Science

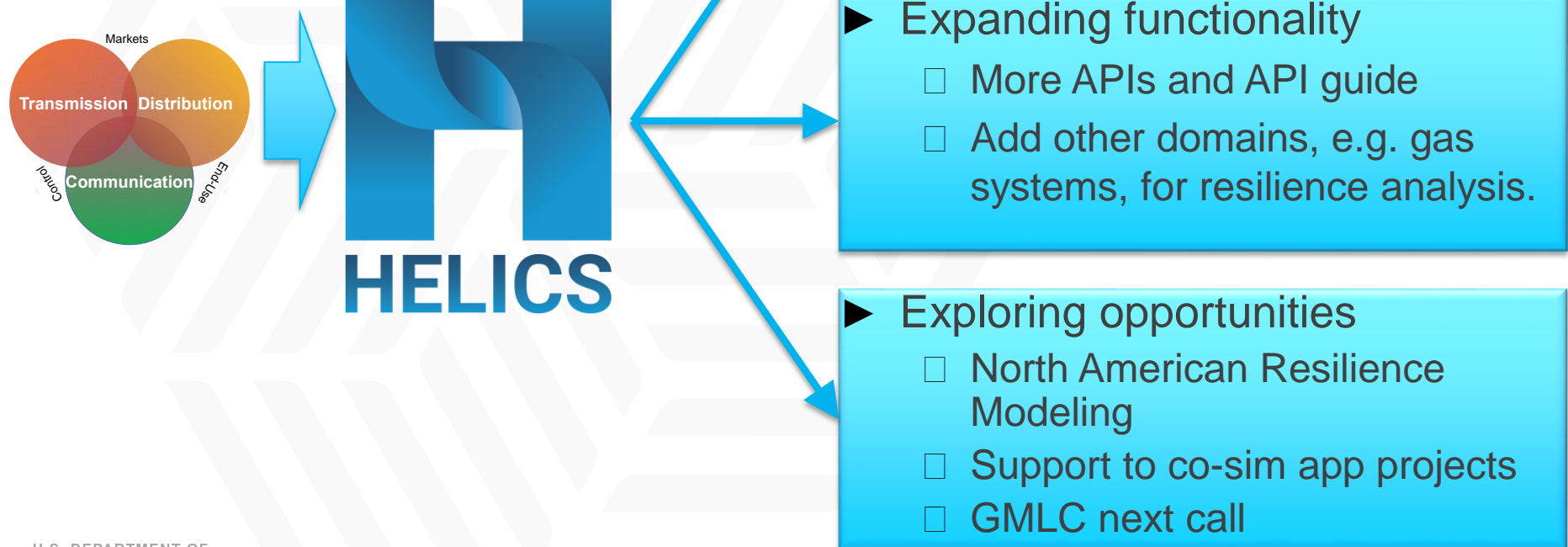

- ▶ HELICS v1.3 was successfully released as a result of multi-lab effort.
- ▶ HELICS is designed to be the most comprehensive co-simulation platform for the grid by converging prior lab efforts.
- ▶ HELICS current capabilities support key co-simulation applications in the grid, demonstrated with select use cases.
- ▶ Expand HELICS core capabilities to federate with more domain simulators, with improved usability and validated scalability. (potential for co-simulation beyond T, D, and C)
- ▶ Continue user engagement through workshops, tutorials, webinars, web forums, etc.
- ▶ Build open-source community support of HELICS development.

# Questions?

Henry Huang: [zhenyu.huang@pnnl.gov](mailto:zhenyu.huang@pnnl.gov)

Liang Min: [min2@inl.gov](mailto:min2@inl.gov)



- ▶ 1 Use case of T+D dynamics (8-16)
  - ▶ 2 Use case of impact of communications on the grid (8-15)
  - ▶ 3 Latest progress on HELICS TDC use cases (8-24)
  - ▶ 4 HELICS Usability (8-27)
  - ▶ 5 HELICS Scalability (8-17)
  - ▶ 6 Future HELICS Software Development (8-14)
  - ▶ 7 Future HELICS application development (8-13)
  - ▶ 8 HELICS Transition Plan (8-20)
- 
- ▶ GMLC Peer Review, September 4-7, 2018
  - ▶ TRC in-person meeting, October 2018?

### TDC Modeling and Simulation is Foundational

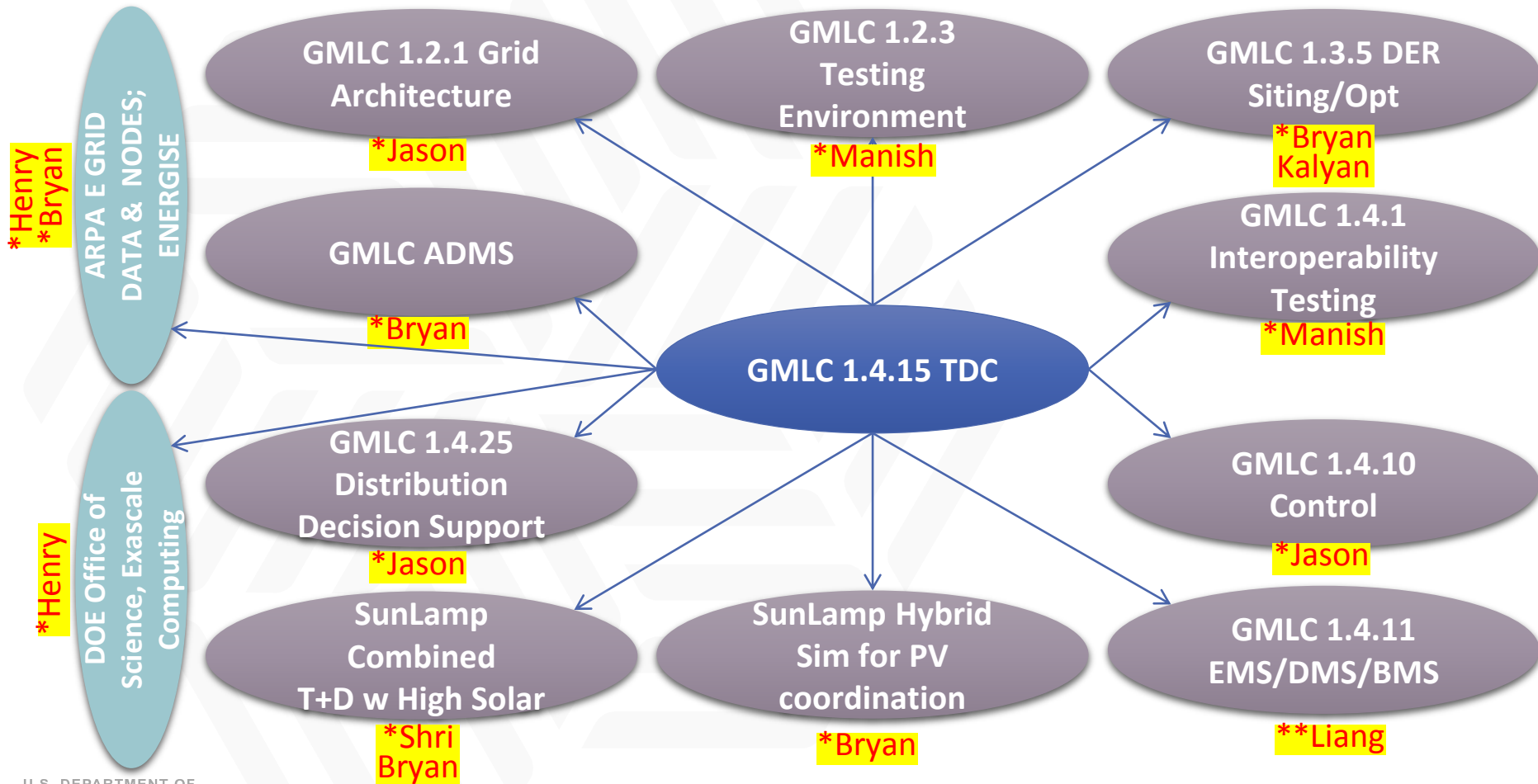



# GRID MODERNIZATION INITIATIVE PEER REVIEW Extreme Event Modeling 1.4.17

**RUSSELL BENT**

September 4–7, 2018

Sheraton Pentagon City Hotel – Arlington, VA

# Extreme Event Modeling 1.4.17

## Natural and man-made extreme events pose threats

### Project Description

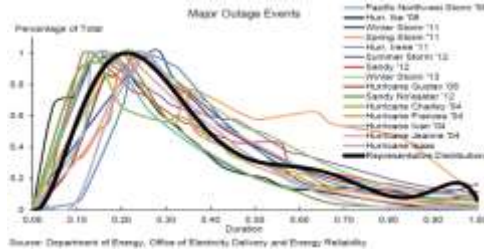

- Cascading and N-k modeling have large gaps
  - Inadequate modeling
    - Reliability standards (NERC Standard TPL-001-4) challenging to meet with existing methods
  - Computational efficiency
    - Considerable speed up required for near term operations planning
- N-k contingency analysis
  - Existing k=3 analysis misses large-scale adversary attacks
  - Neglects high likelihood failures

### Value Proposition

- ✓ Identify extreme event risk prior to event occurrence

### Project Objectives

- ✓ Cascading tools that are 500x faster than existing packages
- ✓ Identify the worst k contingencies twice as fast
- ✓ Demonstration on a large-scale system

Planning and Design

5.3: Modeling for Extreme Events

5.3.3: Simulating Cascades and N k

5.3.4: Interconnection Level Analysis

### Multi-year Program Plan (MYPP)

- Project addresses computational scalability issues outlined in 5.3.3

# Extreme Event Modeling 1.4.17

## Project Team

### Project Participants and Roles

- **Russell Bent** (LANL): PI, Task Lead for 3.4: *Most probable N-k identification*
- **Yuri Makarov** (PNNL): +1, Task Lead for 1.1: *Integrating multiple temporal scales, 1.2: Inadequate Modeling—Integrating Protection System models*
- **Liang Min** (LLNL): Task Lead for 1.3: *Integrating renewables, 2.3: Parallel computing for massive dynamic contingency*
- **Feng Qiu** (ANL): Task Lead for 2.1: *Predicting critical cascading path*
- **Yaosuo Xue**(ORNL): Task Lead for 2.2: *Model Reduction Techniques*
- **Meng Yue** (BNL): Task Lead for 3.1: *Component Failure Probabilities*
- **Anthony Florita** (NREL): Task Lead for 3.2: *Mitigation Plan Modeling*
- **Jean-Paul Watson** (SNL): Task Lead for 3.3: *Worst Case N-k identification*

PROJECT FUNDING			
Lab	FY16 \$	FY17 \$	FY18 \$
LANL	155K	130K	145K
PNNL	210K	235K	180K
LLNL	160K	260K	210K
ANL	125K	95K	125K
ORNL	125K	95K	125K
BNL	50K	45K	45K
NREL	50K	45K	45K
SNL	125K	95K	125K

- Industry and Academic Partners: GMLC, **NERC**, FERC, IEEE Cascading Failure Working Group, Dominion Virginia Power, PJM, ERCOT, UTK
- Webinar participation
  - Power system data

# Extreme Event Modeling 1.4.17

## Approach

### ► Cascade Modeling: Inadequate Modeling

- Integrating multiple temporal scales
  - Description: Develop new methods for modeling phenomena at different time multiple time scales
  - Key Issues: Fundamentally different methods used at different time scales, difficult to integrate
  - Novelty: Unique hybrid approach for combining phenomena and mathematics at different time scales
- Integrating protection system models
  - Description: Develop models of Zone 3 protection
  - Key Issues: The extent and ordering of protection execution is often unknown
  - Novelty: New methods for estimating the behavior of protection during cascades.
- Integrating Renewables
  - Description: Develop mathematical models and implementations of long-term wind dynamics
  - Key Issues: No stability simulation platform that combines computational capabilities with models needed for assessing the implications of wind energy resources dynamics
  - Novelty: new mathematical models of wind dynamics suitable for cascades

### ► Cascade Modeling: Computational Efficiency

- Predicting critical cascading paths
  - Description: Develop statistical methods for identifying cascading paths
  - Key Issues: The number of possible cascade evolutions can be to large to enumerate
  - Novelty: Models and software tools that statistically characterize component interactions that significantly limit the number cascade evolutions that need to be simulation
- Model Reduction techniques
  - Description: Methods and software for reducing the size of networks
  - Key Issues: Network models can be too large for exhaustive cascade modeling
  - Novelty: New approaches for model reduction based on measurement data

### □ Parallel computing for massive dynamic contingency analysis

- Description: Leverage HPC to improve efficiency of cascade modeling
- Key Issues: The number of cascades are too many to enumerate serially
- Novelty: Extensive leveraging of DOE and lab investments in HPC to improve computation by 500x

### ► Probabilistic N-k

#### □ Component failure probabilities

- Description: Develop probabilistic models of component failure based on data
- Key Issues: Utilities currently do not have rigorous approaches for build probabilistic models of failure
- Novelty: Formal probabilities for N-k

#### □ System failure probabilities

- Description: Develop probabilistic models of system failures based during extreme events
- Key Issues: Data is sparse for examples of extreme event system failures
- Novelty: Formal probabilistic of extreme event system failures

#### □ Worst-Case N-k Identification

- Description: Tools for identifying sets of k component failures with the biggest impact
- Key Issues: It is computationally intractable to find  $k > 3$  worst failures
- Novelty: New approaches for doubling the size of k

#### □ Most probable N-k Identification

- Description: Tools for identifying sets of k component failures whose probabilistic outcome is worst.
- Key Issues: Computationally very difficult to find sets of large k
- Novelty: Tools that combine probabilistic models with N-k optimization

# Extreme Event Modeling 1.4.17

## Approach



- ▶ Cascade Modeling: Inadequate Modeling
  - Integr: **Summary**
    - Core Question: What extreme events pose a risk and should be planned for?
    - **Cascade Modeling**
  - Integr:
    - Goal: Realistic simulation of the outcomes of an extreme event
    - Focus: Develop the realism, computation and tools to make this goal practical
  - Integr: **N-k**
    - Goal: Identify extreme events of concern
    - Focus: Develop the scale, computation, and tools to make this goal practical
    - Historically: Goals pursued independently. Synergies at their intersection
- ▶ Cascade Modeling: Inadequate Modeling
  - Predict:
    - Example: Use N-k to identify extreme events that require cascade modeling
    - Example: Incorporate elements of cascade modeling into N-k
    - Approach: Push the science in these areas and make them practical for planning AND make the intersection between cascade modeling and N-k a viable opportunity.
  - Model:
    - Outcome: Open source software, demonstration on large-scale real systems, demonstrate the need for science at the intersection
    - Novelty: New approaches for model reduction based on measurement data

# Extreme Event Modeling 1.4.17

## Accomplishments to Date

### Cascade Modeling: Inadequate Modeling Highlights

- Enhancement of Software: Dynamic Contingency Analysis Tools (DCAT) for cascading outage analysis (Year 2)
  - Added integration with GE PSLF (Fall 2017)
  - Developed new zone 3 protection models (Spring 2018)
  - Incorporated corrective action models (Spring 2018)
  - Discussed tech transfer
    - GE PSLF
- Demonstration of analysis capabilities (Year 2)
  - WECC planning model
- Stakeholder outreach (Year 2)
  - Presentations to NERC, EPRI workshop, GE PSLF users group meeting and IEEE PES General Meeting
  - Several WECC members are interested in testing DCAT

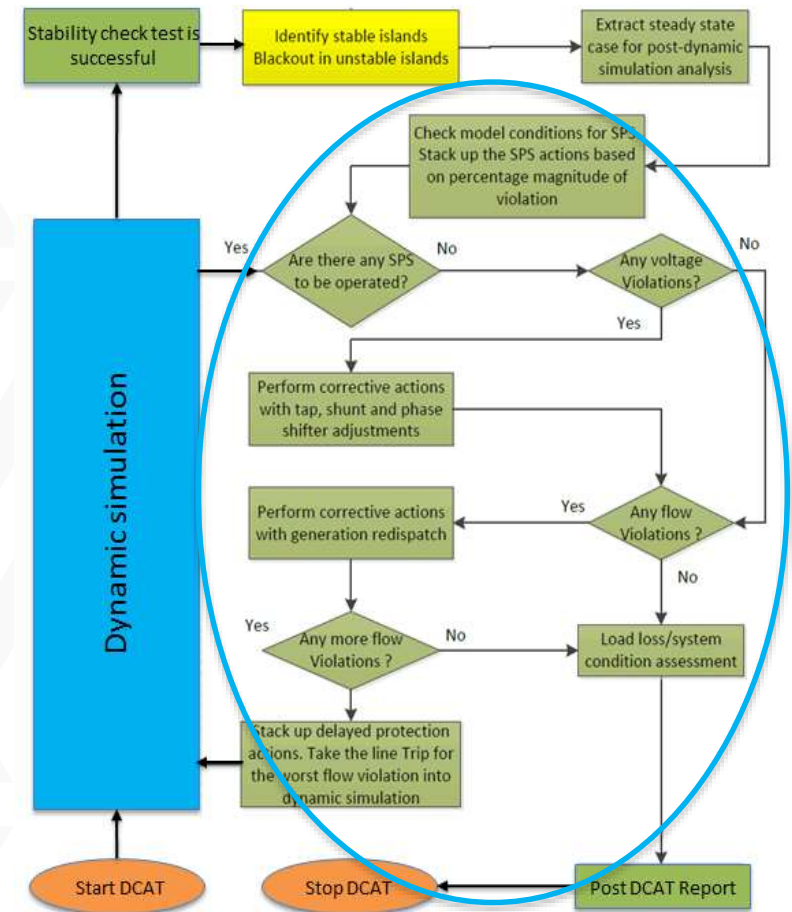



# Extreme Event Modeling 1.4.17

## Accomplishments to date



### Cascade Modeling: Computation Highlights

- Leveraged parallelism of contingency event simulation (Year 2)
- Software Development: Contingency analysis that runs GE's Positive Sequence Load Flow (PSLF) in parallel on the Message Passing Interface (MPI) architecture (Year 2).
- Software Testing: 18.6k+ **single-element (N-1)** contingencies were tested on WECC planning model (Spring 2018)

### Lessons learned:

- Software compatibility—Porting PSLF from 32-bit Windows to 64-bit Linux environment and run on LLNL's Quartz HPC systems is a challenge.
- Parallelization efficiency measured with the *longest-running* contingency.

### Market impact:

- HPC-enabled contingency analysis with PSLF paves the way for analysis of extreme events in a **(near-) real-time** environment.



	Subtask	Runtime (s)
Parallel Runs	Create *.tar archive	9.76
	Create run file	~0.00
	Run all contingencies	842.85
	Postprocessing	22.54
	Post-cleanup	0.01
	<b>Total (<math>T_p</math>)</b>	<b>875.47</b>

	Statistics	Runtime (s)
Sequential Runs	Average	308.63
	Standard Deviation	65.51
	Minimum	6.63
	Maximum	783.99
	<b>Total (<math>T_s</math>)</b>	<b>5,752,155.67</b>

≈14 mins

6,570x speedup

≈66 days

# Extreme Event Modeling 1.4.17

## Accomplishments to Date

### N-k: Highlights

- Scaled N-k methods from systems with 100's of nodes to 1000's of nodes
- Tested on AEP data sets
  - > 10,000 nodes (Winter 2018)
- Developed N-k models based on models of the AC physics
  - Higher fidelity than DC based modeling
- Developed novel N-k approach based on probabilistic failure models (Fall 2018)

### **Lessons learned:**

- Probabilistic models identify different bad contingencies than deterministic models
  - Deterministic = worst case
  - Probabilistic  $\approx$  expected worst case
  - Complimentary contingency lists

### **Market impact:**

- Scalable N-k for near real time planning

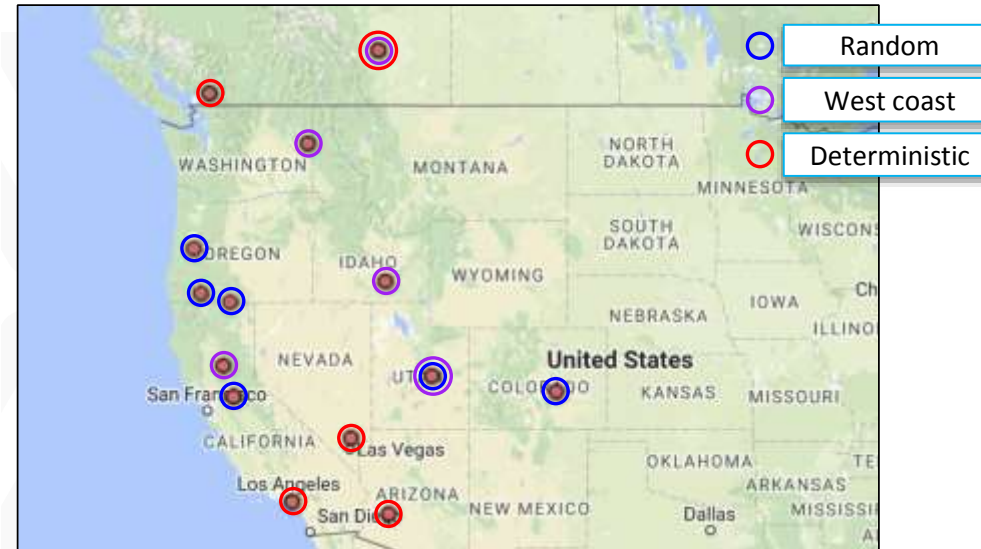

### Open model based on the WECC system

- Plot shows N-5 contingency analysis
- Deterministic = worst case
- Random = Randomized failure rates
- West Coast = High failure rates on the west coast (Earthquake Extreme Event)

### Conclusion: Probabilistic and deterministic

- N-k produces very different results
- Motivates a need for both

# Extreme Event Modeling 1.4.17

## Accomplishments to Date

### Preliminary Cascade Modeling + N-k: Highlights

- N-k identification is based on steady state power flow equations
- Cascading analysis requires detailed transient studies to estimate impact
- Can N-k be used to select contingencies that require cascading analysis?
  - A key open question and outcome of mid project meeting with NERC in Nov. 2017

### Approach

- Rank N-k events using the N-k identification algorithm
- Perform cascading simulations on most severe N-k contingencies

The 20 most severe N-2 contingencies identify high impact cascades

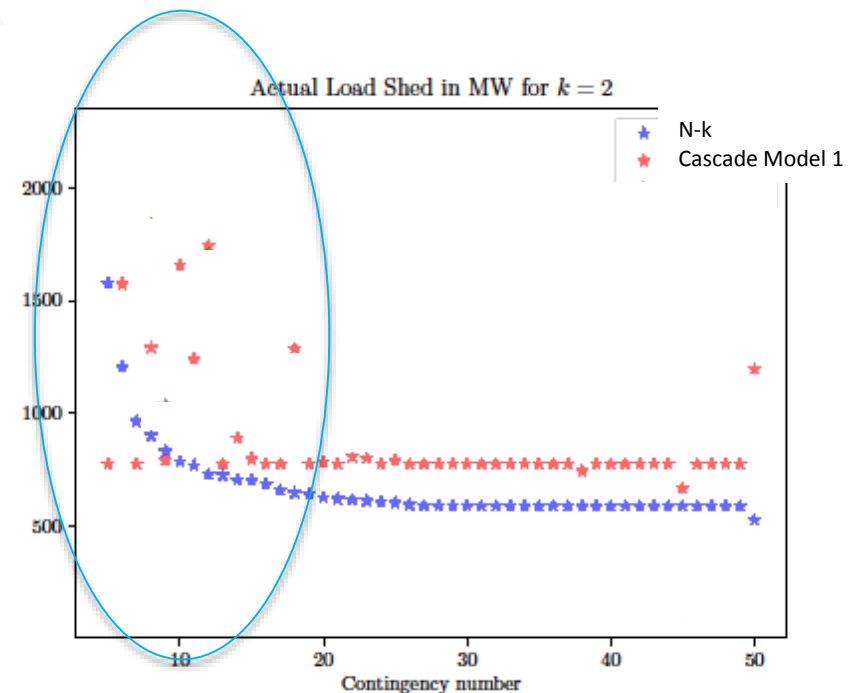

**Blue stars:** 50 most severe “N-2” contingencies from the N-k analysis  
**Red:** cascading simulation

# Extreme Event Modeling 1.4.17

## Accomplishments to Date

### Peer Reviewed Articles

- E. Ciapessoni, D. Cirio, E. Cotilla-Sanchez, R. Diao, I. Dobson, A. Gaikwad, P. Henneaux, S. Miller, M. Papic, A. Pitto, J. Qi, N. Samaan, G. Sansavini, S. Uppalapati, and R. Yao, *Benchmarking quasi-steady state cascading outage analysis methodologies*, IEEE International Conference on Probabilistic Methods Applied to Power Systems (PMAPS), Boise, ID, USA, Jun. 2018. <https://ieeexplore.ieee.org/abstract/document/8440212/>
- X. Zhang, Y. Xue, S. You, and Y. Liu, *U.S. Eastern Interconnection (EI) model reductions using a measurement-based approach*, 2018 IEEE Pes T&D Conference & Exposition, Denver, CO, USA, April 17-19, 2018.
- X. Zhang, Y. Xue, Y. Liu, J. Chai, L. Zhu, and Y. Liu, *Measurement-based System Dynamic*, 2017 North American Power Symposium (NAPS), Morgantown, WV, Sept. 17-19, 2017. <https://ieeexplore.ieee.org/document/8107178/>
- Q. Huang, B. Vyakaranam, R. Diao, Y. Makarov, N. Samaan, M. Vallem, and E. Pajuelo, *Modeling Zone-3 Protection with Generic Relay Models for Dynamic Contingency Analysis*, PES General Meeting, 2017 <https://ieeexplore.ieee.org/document/8274534/>
- J. Qi, J. Wang, and K. Sun, *Efficient Estimation of Component Interactions for Cascading Failure Analysis by EM Algorithm*, IEEE Transactions on Power Systems, 33 (3): 3153-3161, 2018. <https://ieeexplore.ieee.org/document/8070359/>
- A. Florita, M. Folgueras, E. Wenger, V. Gevorgian, and K. Clark. *Grid Frequency Extreme Event Analysis and Modeling in the Western Interconnections*. Solar and Wind Integration Workshop, 2017. <https://www.osti.gov/biblio/1407845>
- Mallikarjuna Vallem, Bharat Vyakaranam, Jesse Holzer, Nader Samaan, Yuri V. Makarov, Ruisheng Diao, Qihua Huang, and Xinda Ke, *Hybrid Cascading Outage Analysis of Extreme Events with Optimized Corrective Actions*, 2017 Intelligent Systems Application to Power Systems (ISAP) Conference, San Antonio, September 2017. <https://ieeexplore.ieee.org/document/8071375/>
- K. Sundar, C. Coffrin, H. Nagarajan, R. Bent. *Probabilistic N-k Failure-Identification for Power Systems*, Networks, accepted for publication. <https://onlinelibrary.wiley.com/doi/abs/10.1002/net.21806>
- Mallikarjuna Vallem, Bharat Vyakaranam, Jesse Holzer, Nader Samaan, Yuri V. Makarov, Ruisheng Diao, Qihua Huang, and Xinda Ke, *Hybrid Cascading Outage Analysis of Extreme Events with Optimized Corrective Actions*, 2017 Intelligent Systems Application to Power Systems (ISAP) Conference, San Antonio, September 2017. <https://ieeexplore.ieee.org/document/8071375/>
- Bharat Vyakaranam, Nader Samaan, Mallikarjuna Vallem, Renke Huang, Ruisheng Diao, and Yuri Makarov, Brian Thomas, and William W Price. *Modeling of Protection Relays using Generic Models in System Wide Power System Dynamic Simulation Studies*. IEEE/PES General Meeting, Denver, August 2017.
- M. Korkali. *Revealing the Role of Renewable Generation Models in Multiscale Power Grid Dynamic Simulation*, Intelligent Power Grid of Tomorrow: Modeling, Planning, Control, and Operation, Reliable and Sustainable Electric Power and Energy Systems Management (Springer), under review.

# Extreme Event Modeling 1.4.17

## Next Steps and Future Plans

### Project Next Steps (April 2019)

- Open source software releases
- Demonstrations on a large scale system (WECC 2020 Planning Model)
- Preliminary results of value-added of N-k + cascading models
- Project continuation document

### Future Plans and Follow on Activities (FY20++)

- Integrate extreme event analysis with mitigation
  - Adjust operating points to reduce risk from extreme events
- Transition software to North American Resilience Model (NARM) Initiative efforts
- Automated recovery of non-converging cascade simulations
- Develop models of sources of extreme events and their impacts
  - GMD, adversarial, natural gas stress
- Research on new risk analysis techniques

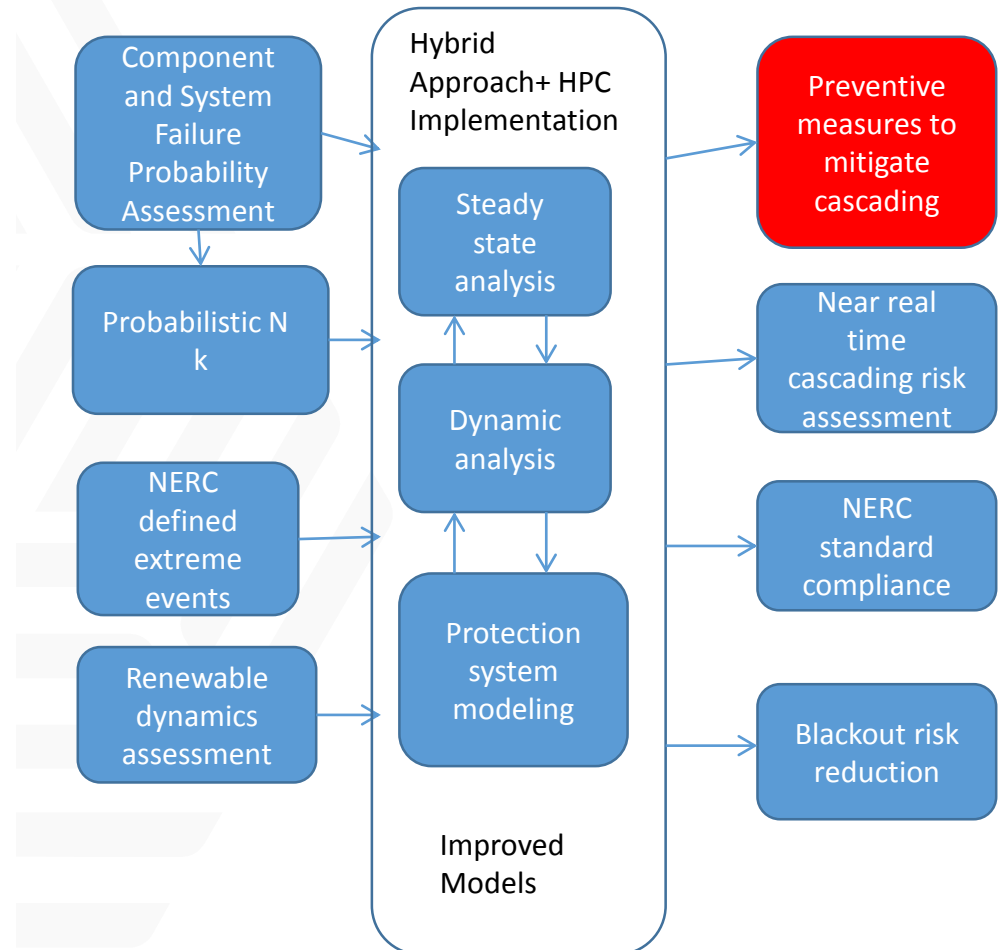



# Probabilistic N-k System Failures

## Accomplishments to date

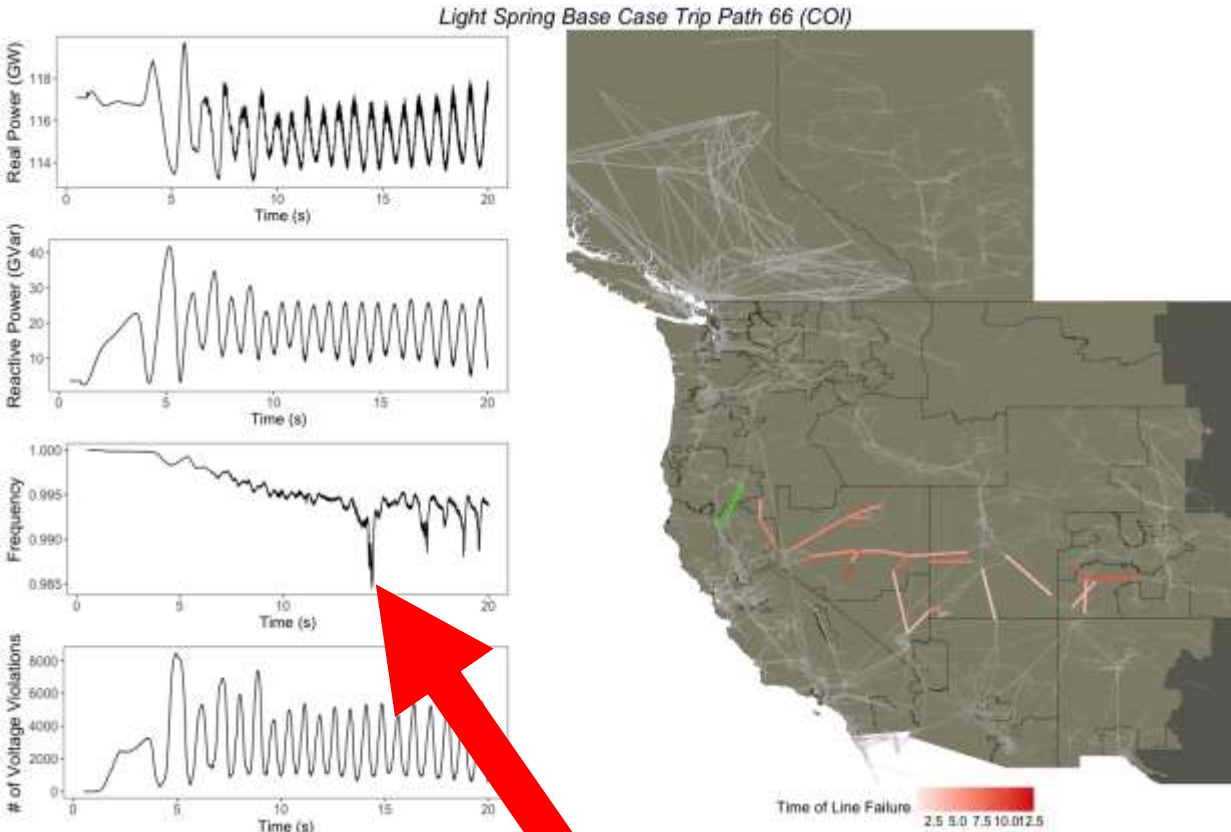

Frequency  
Event

### ► Overall Approach

- Simulate faults (Generators, lines, and transformers) to develop of N-k probabilities

### ► WWSIS3 is used to model contingencies on scenarios:

- Scenario example: WECC model
  - Transmission paths with  $\leq 3$  lines—Trip all lines simultaneously
  - Transmission paths with  $>3$  lines—Trips subsets of 3 lines simultaneously

### ► Lessons Learned

- Studies of generator time series during contingency caused frequency events yield new understanding of coherency groups



# Predicting Critical Cascading Paths

## Accomplishments to date

- ▶ Challenge: Lack of information about exact causes of outages
- ▶ Solution: Extract critical cascading path and failure propagation patterns
  - EM algorithm solves an outage parameter estimation problem
- ▶ Outcomes: Leverage failure propagation patterns
  - Learn failure propagation patterns from a small number of cascading simulations
  - Approximate detailed cascading failure simulation with probabilistic interaction models simulation---more computationally efficient

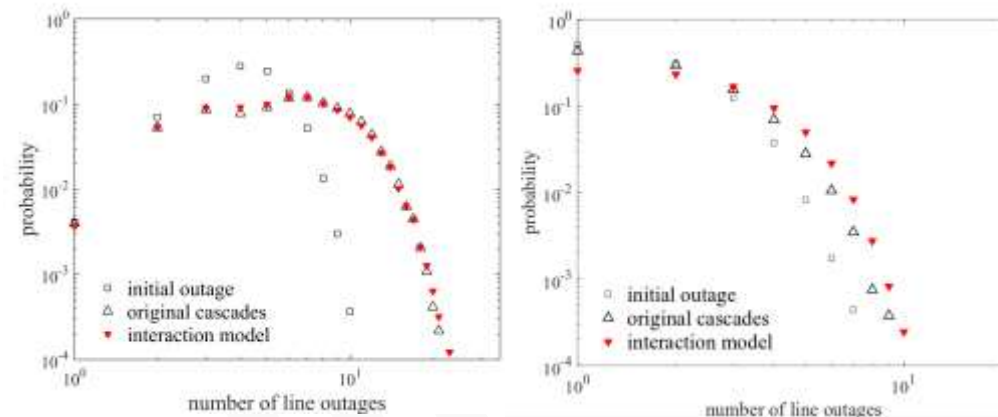

IEEE 118-bus system

RTS-96 system

	IEEE 118 Bus System	RTS 96 System
# of cascades needed	41000	45000
# of cascades used for estimation	400	450
Speed-up by interaction model	<b>100.61</b>	<b>93.64</b>

J. Qi, J. Wang, and K. Sun, Efficient estimation of component interactions for cascading failure analysis by EM algorithm," *IEEE Trans. Power Syst.*, vol. 33, no. 3, pp. 3153-3161, May 2018. <https://ieeexplore.ieee.org/document/8070359/>

F. Qiu and J. Qi,, *Technical Report*, Aug. 2018. Improving efficiency of cascading failure simulation for reliability test system by predicting critical cascading path

# Model Reduction

## Accomplishments to Date

Goal: Develop measurement-based dynamic model reductions

Approach: Adapt model reductions to changing system states.

- Auto-regressive models with exogenous inputs (ARX)
- Transfer Functions
- Artificial Neural Networks (ANN)
  - Best performer

Training Method: Simulate generation trips and line losses

Implementation: PSS/E and MATLAB/ANN co-simulation

Lessons Learned: Significantly reduced simulation time and good accuracy.

- Applied to the Eastern Interconnection network.

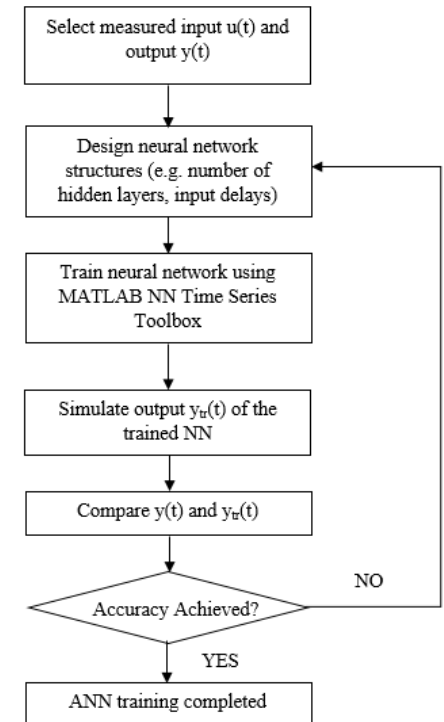
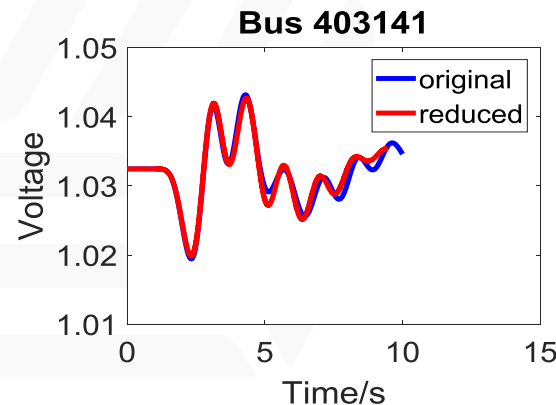
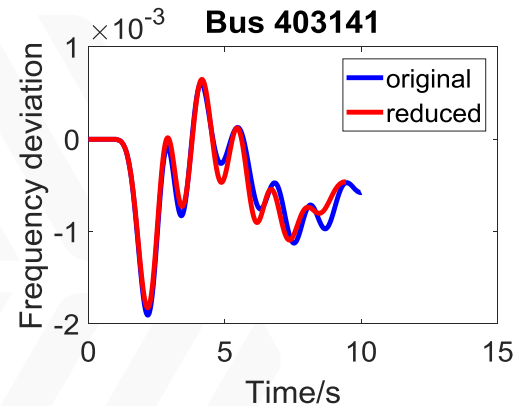

Algorithm Process Flow

Reduced model a good predictor

# Component Failure Probabilities

## Accomplishments to Date

**Accomplishment:** Developed an enhanced reliability data repository

- Includes grid component outage data
- Includes renewable energy induced outages

**Usage:** Develop models of cascading failure based on a Markovian approach and an analytical quantification of system states

- Represents common modes and dependent outages as single outage events in a Markovian framework
- Model multiple outage modes of individual grid components
- Enables probabilistic risk assessment of cascading failures.

**Presentation:** IEEE Working Group on Probability Applications for Common Mode and dependent Events (PACME) during the PES General Meeting, August 7, 2018

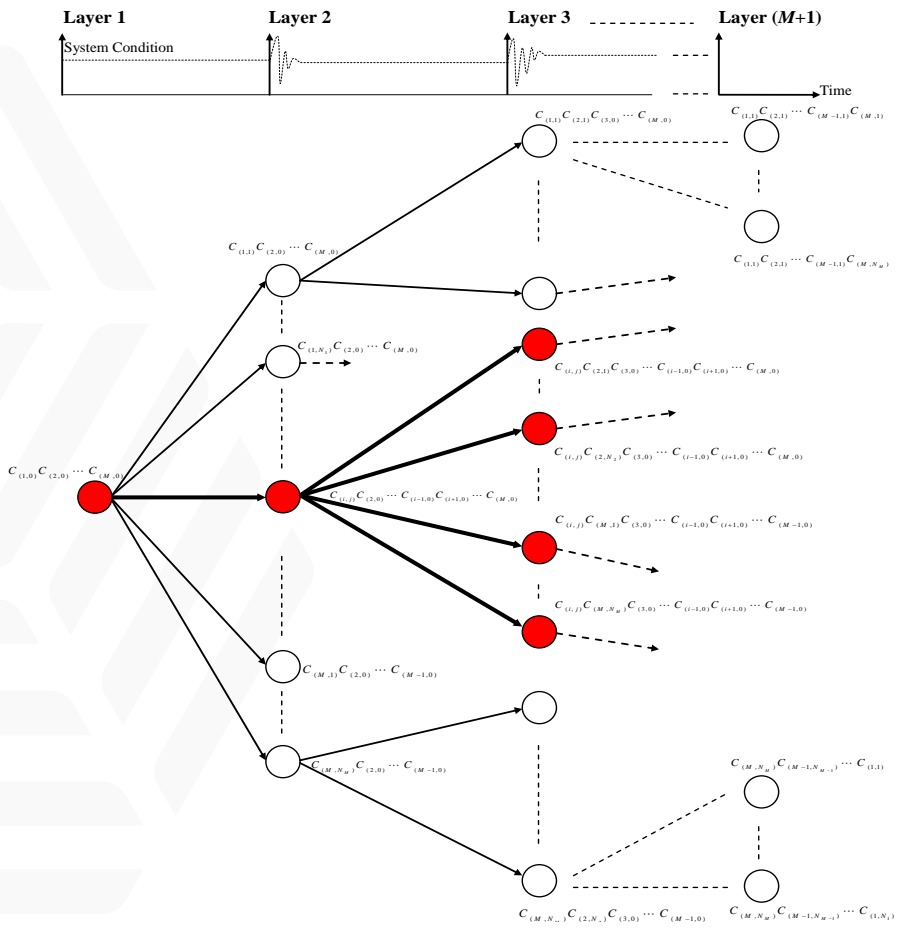

A Fully Expanded Markov Tree for cascading process

# GRID MODERNIZATION INITIATIVE PEER REVIEW

## Project 1.4.18: Computational Science for Grid Management

**MIHAI ANITESCU**

September 4–7, 2018

Sheraton Pentagon City Hotel – Arlington, VA

# GMLC 1.4.18

## Computational Science for Grid Management

### *Project Description*

- (a) In this project, we aim to improve by >100x the performance of optimization under uncertainty (OUU) grid solvers by using parallelism and novel math and algorithms.
- (b) Statement of work was revised at DOE's direction to focus on multiperiod OUD for HPC resilience computation

### *Value Proposition*

- ✓ Improve time-to solution for multiperiod optimization + uncertainty (MP-OUU) in a resilience context by a factor of 10-100.
- ✓ Characterize in a timely fashion the post-contingency optimal recovery and subsequently, OMPC-NR resilience index.

### *Project Objectives*

- ✓ Leverage ACSR-sponsored multiperiod OUU solvers to compute 100x faster by harnessing parallelism.
- ✓ Design and Instantiate an advanced framework (AMICF) that allows 10x faster prototyping of multiperiod OUU analyses.
- ✓ Compute optimal post-contingency recovery in minutes/contingency.
- ✓ Characterize OMPC-NR resilience metric class nominal and under uncertainty.

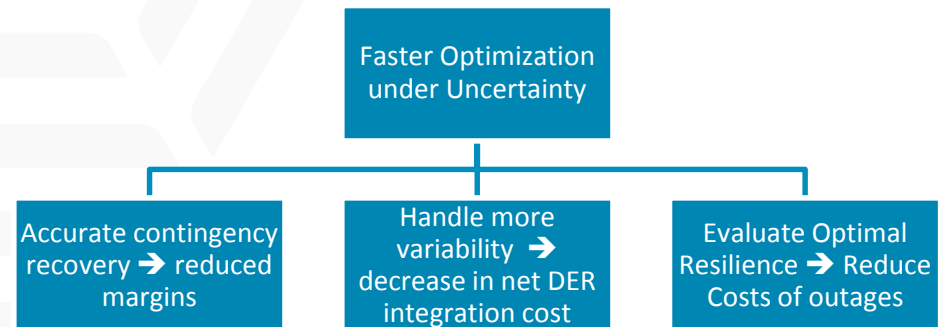

# Computational Science for Grid Management

## Project Team



### *Project Participants and Roles*

- Mihai Anitescu (ANL): PI. Task Lead 1.1 (O) Optimization and Integration.
- Cosmin Petra(LLNL): Task 1.1 Parallel optimization, automatic differentiation.
- Zhenyu (Henry) Huang (PNNL): +1. Task Lead 2.1 (A) Computation and Visualization Functions.
- Wesley Jones (NREL), Task Lead 2.2 (W): Workflow and data generation and access.

PROJECT FUNDING			
Lab	FY16 \$	FY17\$	FY18 \$
ANL	290K	150K	165K
PNNL	263K	150K	165K
NREL	157K	105K	165K
LLNL	220K	150K	165K
SNL	85K		
LANL	85K		

### *Industry Partners:*

- PJM -- Jianzhong Tong
- NEISO -- Eugene Litvinov



- ▶ **Task 1 – Computational Core** Creation of an advanced computational infrastructure for OUD. (ANL, with LANL, LLNL, and SNL). *Achieve a factor of 100 speed up in key computational patterns by enabling and tuning massive parallelism.* Subtasks:
  - 1.1 Optimization and integration. Open, fast, scalable environments and solvers for scenario-based optimization. Fast, automatic differentiation for nonlinear optimization.
  - ~~1.2 Dynamics. Novel dynamics algorithms and interfaces, improve performance and accuracy of design outcomes by online use of transient simulations in optimization with adjoint-based derivatives.~~
  - 1.3 Interfaces and Support for Optimization under Uncertainty: Novel scenario generation and robust formulations. Chance-constrained stochastic multi-period optimal power flow.
- ▶ **Task 2 – Advanced Modeling and Integration Framework (AMICF)** Definition and reference implementation of a framework for scalable integration of data, computation, and visualization functions. (PNNL, with NREL). *Achieve a factor of 10 increase in productivity of problem formulation/instantiation.* Subtasks:
  - 2.1 Computation and Visualization Functions. Design and implement a novel, compact, flexible, open framework for maximum performance. Engage stakeholders design and adoption.
  - 2.2 Data Functions. Create renewable energy forecasts and scenarios.
- ▶ **New Focus: We originally were concerned only with scenario-driven OUD, After guidance from DOE, we decided to refocus on multiperiod optimization and its interaction with resilience, and reduce dynamics. SOW revised for new direction.**

# Computational Science for GM

## Technical Details: Optimization; FY 17 accomplishments



### ► Real-time large scale SCACOPF

- OUU: Scenario-Based Nonlinear Optimization is a prevalent computational pattern (SCACOPF, Stochastic OPF), our Use Case 1.
- In FY17, accelerated the PIPS-NLP solver and deployed on massively parallel architecture.
- Created OUU SCOPF instantiation from PEGASE 2869 buses (MATPOWER); created 512 contingency data, in **StructJuMP**
- **Speedup: 63=11000/173** (s, 10 iter) on 256 cores.
- Takes about 10 minutes (35 iters) to solve at industry standard (1e-3).
- Possibly largest number of SCACOPF contingencies ever solved simultaneously (512; seen 75 on 16 cores,30).

### ► Advances in single period OUU will be reused to accelerate the new multiperiod, nonlinear multiperiod OUU computations

- The advanced differentiation algorithms
- The Gridpack-PSSE-Julia framework for fast instantiation.

Time to Solution

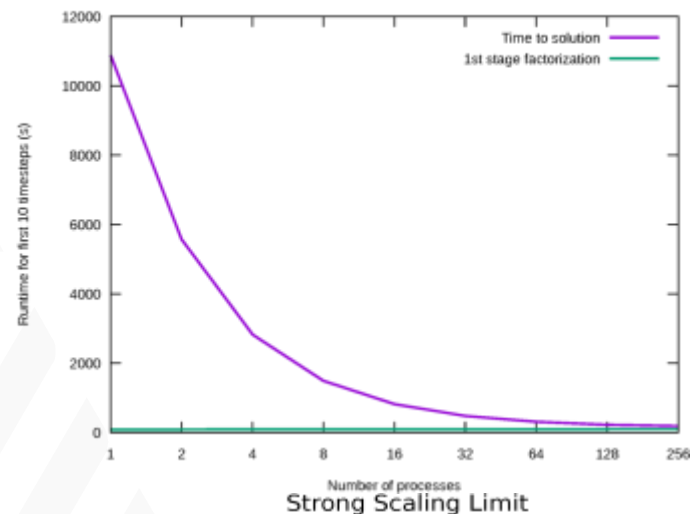

Strong Scaling Limit

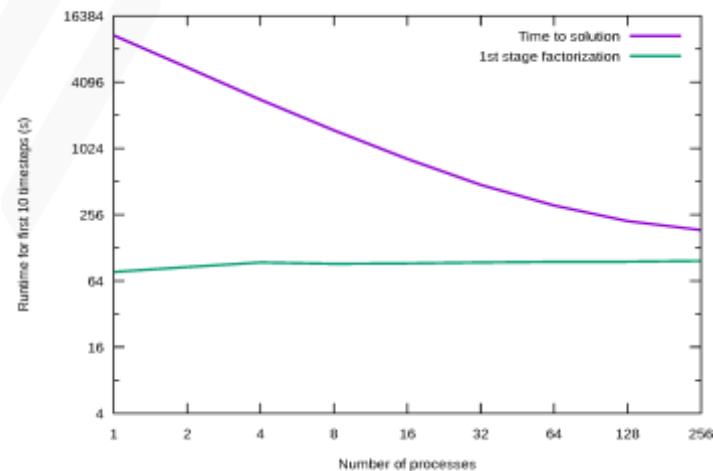

- ▶ A new emphasis: scalable multiperiod optimization under uncertainty (i.e. dynamic programming)

$$\min_{\mathbf{x}, \mathbf{u}} \sum_{k=0}^{N-1} g_k(\mathbf{x}_k, \mathbf{u}_k, \mathbf{d}_k) + g_N(\mathbf{x}_N),$$

$$\text{s.t. } \mathbf{x}_{k+1} = f_k(\mathbf{x}_k, \mathbf{u}_k, \mathbf{d}_k), \quad k = 0, 1, \dots, N-1, \\ \mathbf{x}_0 = \bar{\mathbf{x}}_0.$$

- ▶ **Key element in resilience evaluation.**
- ▶ Respond/Recover model: (**Multi-Period**), **Optimal AC Dispatch from Reserve with emergency limits -- ODREL**
- ▶ The novel **OMPC-NR metric**: difference between ODREL and optimal dispatch with normal limits (basically, OPF)

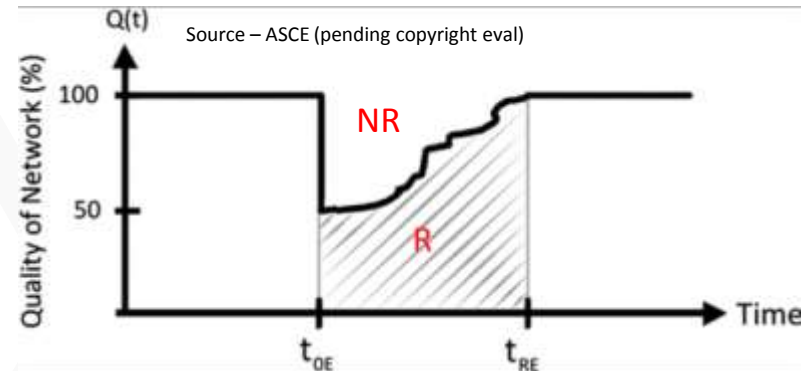

- ▶ A defining element separating resilience from robustness is the *temporal characteristic* of the response.

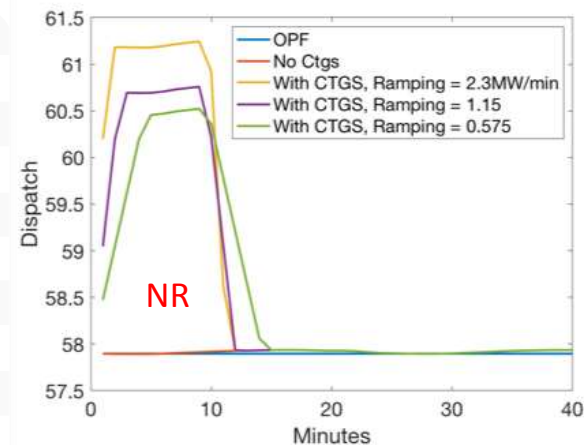

OMPC-NR for 9 bus example, Line loss for 10 periods

- ▶ Can we compute resilience metrics in real time?
- ▶ Accomplishments: Exploited block sparsity for 10K nodes.
  - The linear system 1.3x1.3M for 168 periods
  - Before: too big to store on one node (approx. 12 TB memory needed)
  - Now: 1 IP iteration *245 seconds* on 72 MPI processes (8 nodes)
  - Intra-node speedup obtained with MKL BLAS and LAPACK (4 threads per process)
- ▶ *One iteration can be done in real time.*
- ▶ We aim to push the calculation of these metrics to minutes overall.
- ▶ OMPC-NR dependence on Ramping Capacity (118 and aggregated 1354)

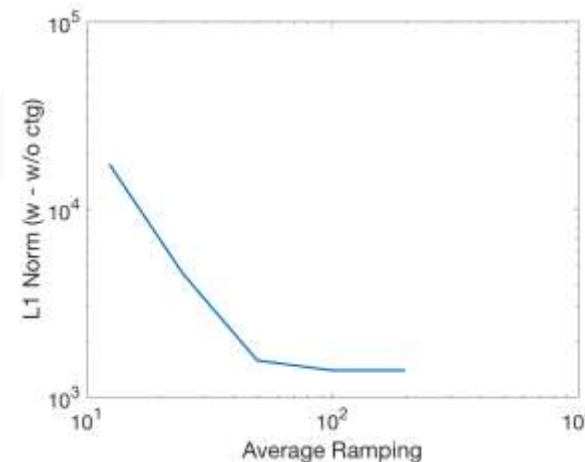
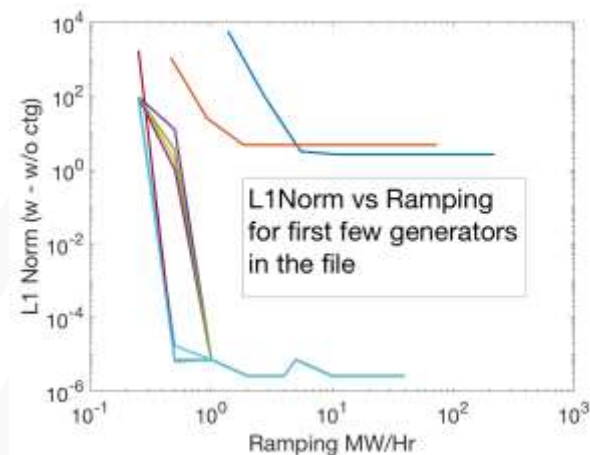

# GMLC 1.4.18 Computational Science

## Technical Details: Wind Scenario Generation

### FY 18 Results



- ▶ ***We produce realistic wind ramping scenarios at scale.***
- ▶ Multiperiod scenarios composed of aggregated WIND Toolkit data for wind plants on the RTS-GMLC network.
- ▶ Scenarios drawn using importance sampling algorithm which vastly reduces computation times ( $O(100)$ )
- ▶ Analogue forecasting ensures realistic forecasts at any level.
- ▶ Scenarios include positive and negative wind ramping events; essential for resilience assessment

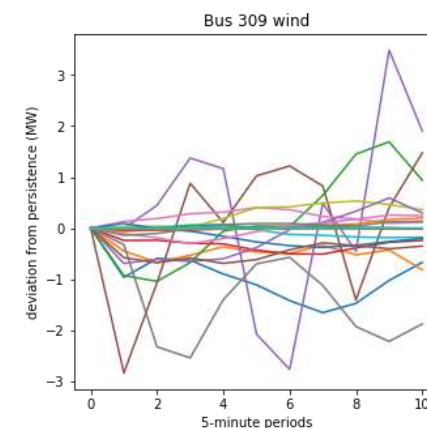
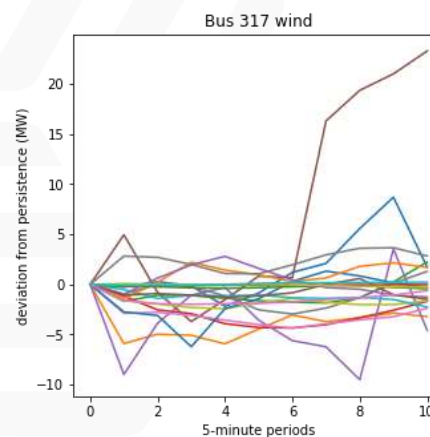
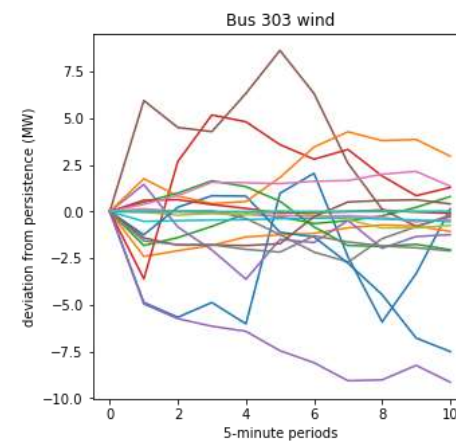
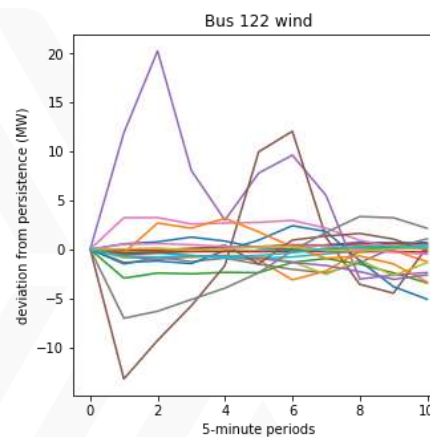

# GMLC 1.4.18 Computational Science Computational Framework. FY18 Results.

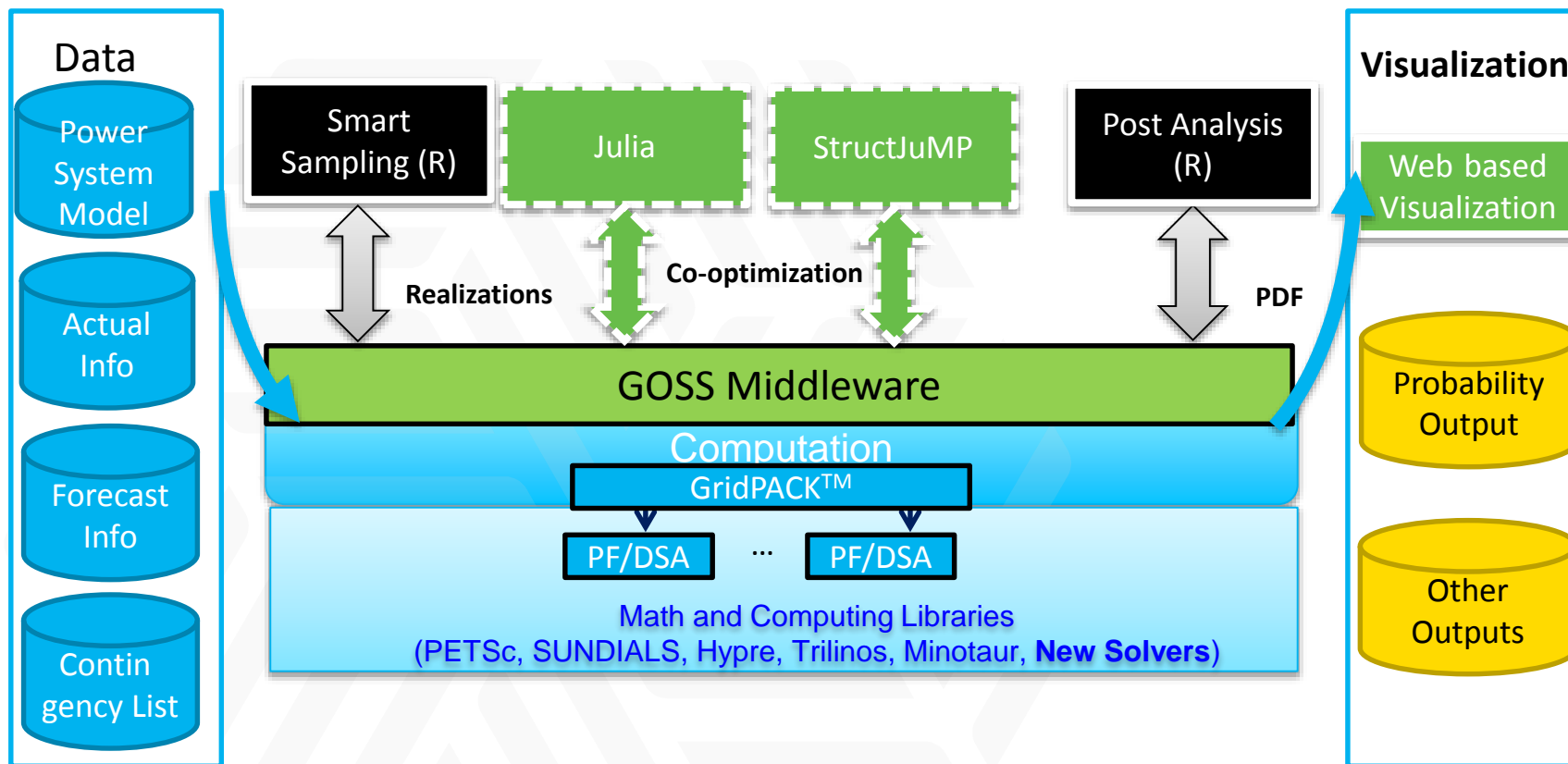

- *We enable HPC performance for multiperiod optimization from existing models (e.g PSSE. In light green, add-ons from this project)*
- A “scalable, portable, extensible, fast, compact” computational framework that enables linking data to computation and software compatibility



# GMLC 1.4.18 Computational Science

## Next Steps and Future Plans



### ► **Immediate steps**

- Integrate new linear algebra with the rest of the framework. Q2 FY19
- Aim for real time (1 minute) calculation for a contingency at "scale". Q4 FY19
- Understand effects of various metrics in defining OMPC-NR (L1 or Lp distance, other MPC objectives ). Q2 FY19+
- Produce uncertainty calculations and/or bounds. Q4 FY19
- Report to PES. Q3 FY19

### ► **Progress and funding-dependent steps**

- Resilience-constrained optimization (both local and global versions, planning and operations). Q2 FY20
- Full uncertainty calculations during contingency resolution. Q4FY20
- Security-Constrained Recovery*. Q3FY20
- Dynamic effects in contingency resolution. Q4FY20

# GMLC 1.4.18 Computational Science for GM

## Papers and Conference Presentations



- Y Chen, B Palmer, P Sharma, Y Yuan, B Raju and Z Huang. "A High Performance Computational Framework for Dynamic Security Assessment under Uncertainty". Submitted to IEEE eGrid 2018
- C. G. Petra, F. Qiang, M. Lubin, J. Huchette, *On efficient Hessian computation using the edge pushing algorithm in Julia*, accepted, Optimization Methods and Software, 2018.
- C. G. Petra, N. Chiang, M. Anitescu, *A structured quasi-Newton algorithm for optimizing with incomplete Hessian information*, in review, 2018.
- M. Schanen, F. Gilbert, C. G. Petra, M. Anitescu, *Towards multiperiod AC-based contingency constrained optimal power flow at large scale*, in print, "Proceedings to the 20th Power Systems Computation Conference", 2018.
- King, Ryan N., Matthew Reynolds, Devon Sigler, and Wesley Jones. "Advanced Scenario Creation Strategies for Stochastic Economic Dispatch with Renewables." *arXiv preprint arXiv:1806.10530* (2018).
- Sampling Techniques for Stochastic Economic Dispatch of Large Electrical Grids, M. Reynolds, R. King, W. Jones, and D. Sigler. SIAM Conference on UQ, April 18, 2018.
- Techniques for Scenario Creation in Two-stage Stochastic Programming Applied to Economic Dispatch under Uncertainty, M. Reynolds, R. King, W. Jones, and D. Sigler, 2018 INFORMS Optimization Society Conference, March 24<sup>th</sup>, 2018.
- Temporal Decomposition Strategies for Long-horizon Dynamic Optimization, V. Rao, W. Xu and M. Anitescu, 2018 World Congress on Computational Mechanics.

# GMLC 1.4.18 Computational Science for GM

## Example Capabilities Enabled



- Optimal Recovery.
  - Current State: Recovery from a contingency is based on off-line calculations, and optimal cost/reserve margin is not emphasized.
  - Future State: On-line, real time computation of lowest cost, *security constrained recovery*.
  - Consequences: Reduce Operational Margins. Safely operate with a wider penetration of DER and bulk renewables.
- Resilience Computations
  - Current State: When a system operates in a degraded (emergency state) we do not have metrics to assess the degradation in resilience.
  - Future State: The OMPC-NR class of metrics we propose can sharply quantify degradation of resilience; our multi-period optimization advances aim to compute them in real time.
  - Consequences: Allow planning for more DER on the grid for prescribed resilience levels. Leverage the increased flexibility in real time.

# GMLC 1.4.18 Computational Science for GM

## StructJuMP encapsulation

- Approach: Distribute the SC-ACOPF multiperiod model across multiple computational nodes and parallelize its evaluations (function, derivatives) needed by the optimization

$$\begin{aligned} \min \quad & f_0(x) + \sum_{i=1}^N f_i(x, y_i) \\ \text{s.t.} \quad & g_0(x) = b_0 \\ & g_i(x, y_i) = b_i, \quad i = 1, \dots, N \\ & x \geq 0, y_i \geq 0, \quad i = 1, \dots, N \end{aligned}$$

- Key Issues:
  - exploit data parallelism (given by the presence of contingencies) to “break” the model into contingency models and enable parallel model evaluation
  - perform parallel automatic differentiation
  - parallelization bottlenecks: evaluations of the first-stage submodel are serial, communication costs
- Distinctive Characteristics:
  - ***A framework that is fast, compact, free, open, scalable***
  - New syntax added on top of JuMP: indentation of contingency submodels to allow
    - breaking down the model
    - reusing JuMP’s automatic differentiation (huge savings in development time!)
  - In-house MPI parallelization with focus on reducing the parallelization bottlenecks

# GMLC 1.4.18 Computational Science for GM

## StructJuMP scalability FY18



### Time for evaluations

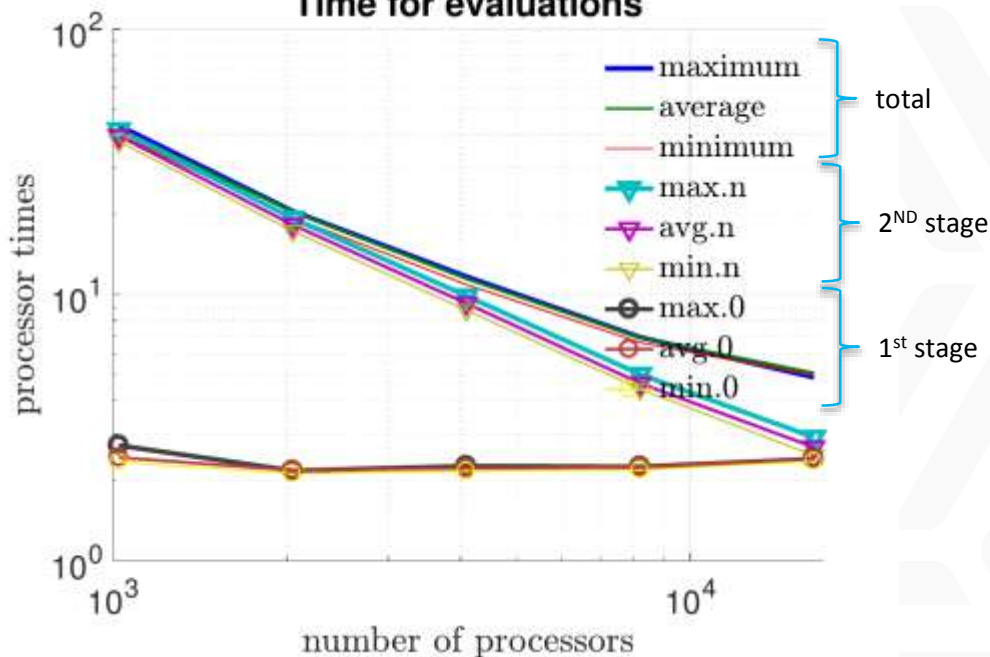

### Time for constructing structures

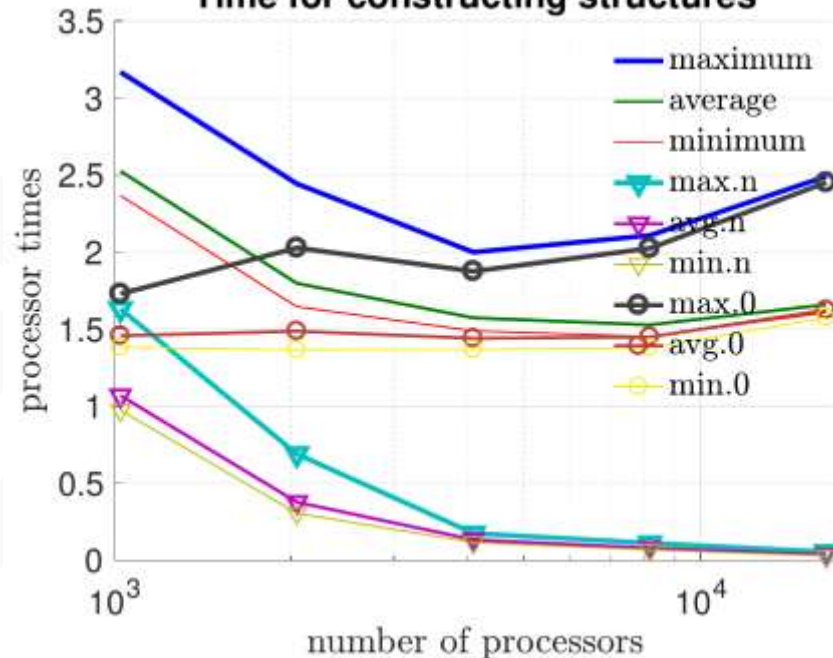

- StructJuMP performance in parallel 8096 MPI processes at on Quartz @LLNL
- Good strong scaling in evaluating the model
  - Low-cost bottlenecks, low load imbalance, streamlined inter-process communication
- Problem setup does not parallelize as well, but it has fixed (and low!) cost that is quickly amortized over the optimization iterations/evaluations.
- Paper in progress.

# GMLC 1.4.18 Computational Science for GM

## Scalable multiperiod SC-ACOPF. FY18

- Approach: Parallel memory distributed sparse solvers for the first-stage linear algebra of multiperiod SC-ACOPF problems

$$\left( K_0 - \sum_{i=1}^N B_i^T K_i^{-1} B_i \right) \Delta z_0 = r_0$$

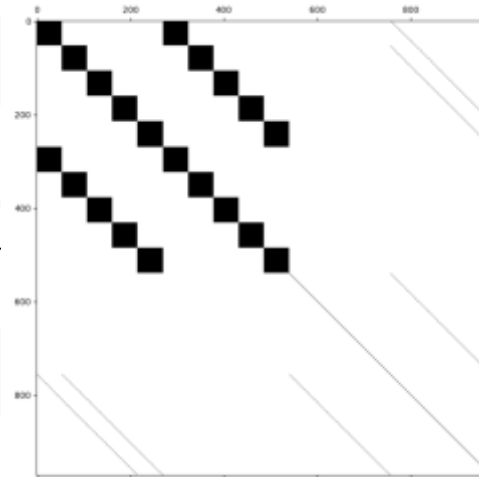

- Key Issues: The first-stage optimization linear systems grow with the number of periods and causes a serial bottleneck in the parallel optimization solver.
  - Current state-of-the-art approaches treat this linear system as a dense linear system
- Distinctive Characteristics: Perform a reformulation of the problem that result in a highly structured first-stage linear systems (see spy plot) that is amenable for the use of memory distributed sparse linear solvers.



# GMLC 1.4.18 Computational Science for GM Analog Sampling: Single Period FY18

- By using real wind data for the creation of scenarios we obtain realistic scenarios with all the desired features.
- NREL The Wind Integration National Dataset (WIND) Toolkit includes meteorological conditions and turbine power for more than 126,000 sites in the continental United States for the years 2007–2013. The data can be accessed using the free, open pywtk python interface.
- The challenging sampling problem is solved with importance sampling (IS). The figures show the importance distribution, the series of sampling points that by 3 IS methods. The second figure shows the impact for two-stage stochastic optimization.

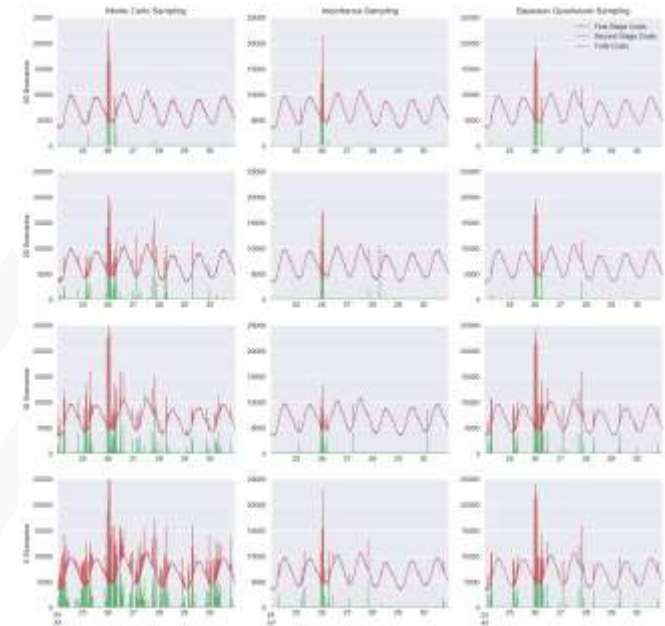
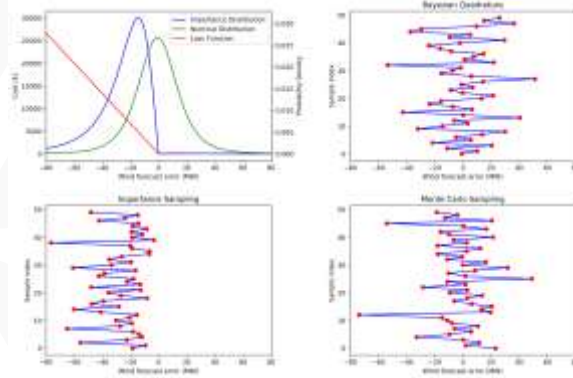

# GMLC 1.4.18 Computational Science for GM Extending Multi-site, multi-period sampling FY18

- ▶ In [1] we explored using importance sampling (IS) to solve the economic dispatch problem.
- ▶ We are currently searching for methods that extend the work of [1] in three ways:
  - Output scenarios built from WIND Toolkit (WTK) data.
  - Scenarios that are multiperiod.
  - Network constraints, e.g. DCOPF, can be used to inform scenario selection.
- ▶ To build scenarios, one possible approach is to first bin WTK data by sums of deviations from wind-power forecasts across the network.
- ▶ Then, distributions computed from WTK data (e.g. Fig. 1) could be used select bins from which to draw analog scenarios.
- ▶ Exploratory tests drawing multiperiod scenarios have been run with RTS-GMLC network (Fig. 2) and show encouraging results.

[1] King et al. *Submitted to IEEE Trans. on Power System*

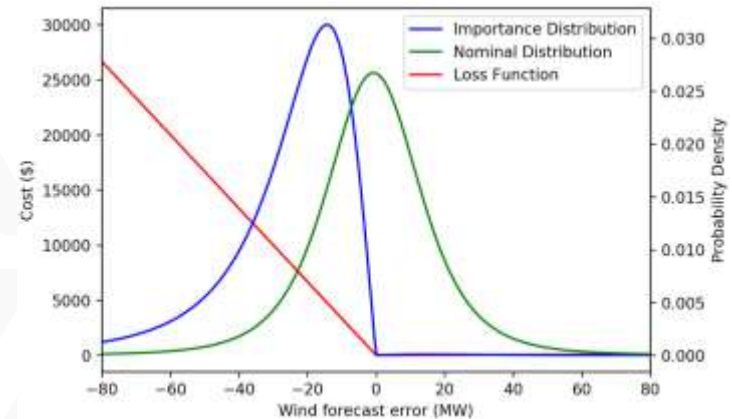

Fig 1. Distributions for economic dispatch

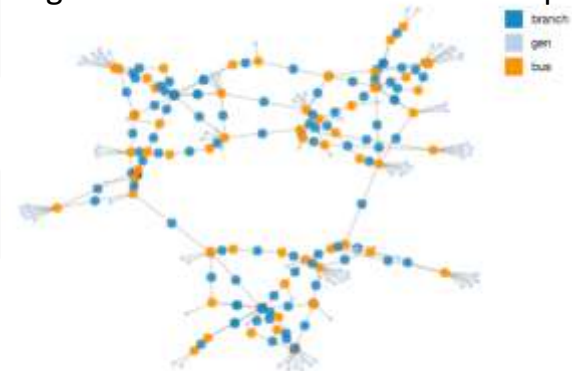
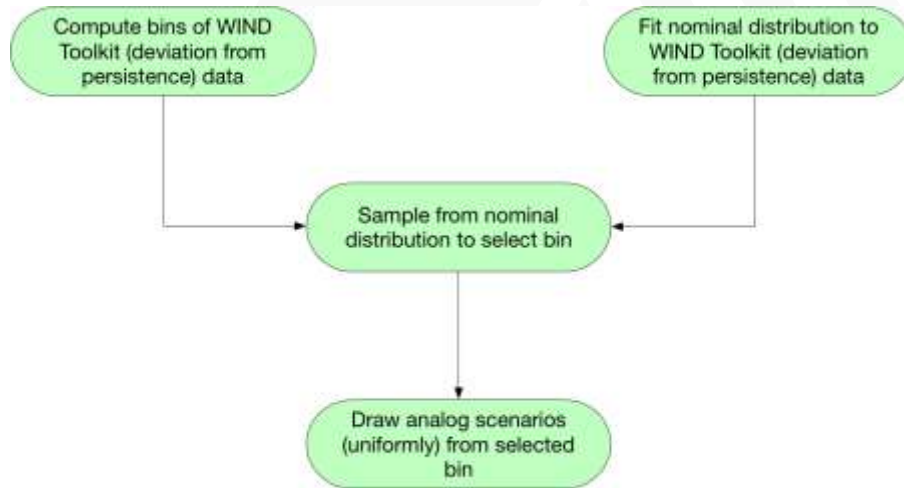

Fig 2. RTS-GMLC network used for experiments

# GMLC 1.4.18 Computational Science for GM Preliminary Scenario Creation Algorithms FY18

## Simple Monte Carlo (MC) Scenario Creation



## Importance Sampling (IS) Scenario Creation

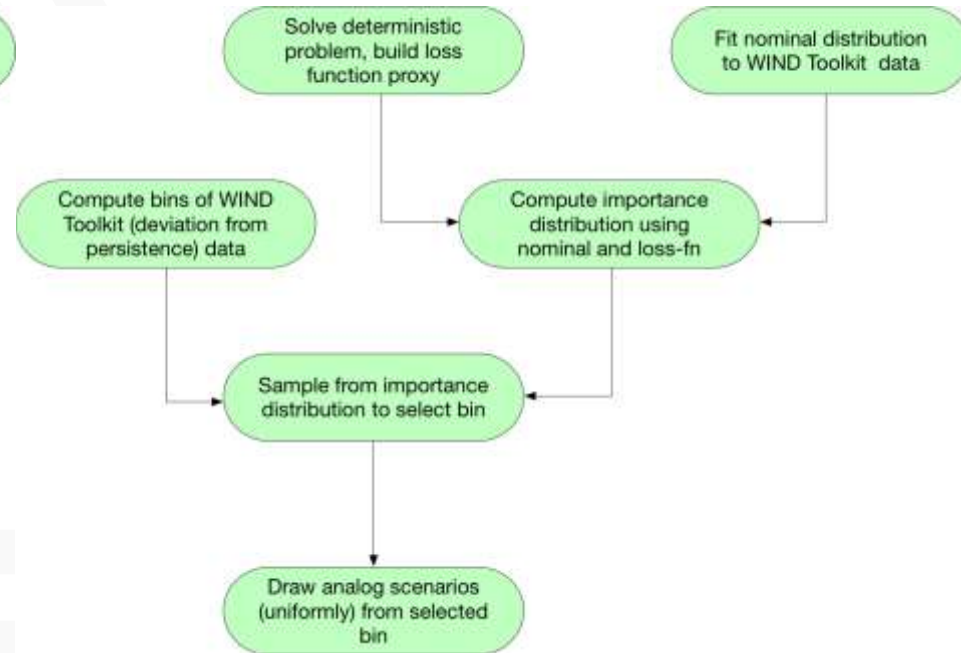

Algorithms sample from bins of WTK data. IS leverages cost information to select from bins with higher average costs.

# GMLC 1.4.18 Computational Framework Optimization Workflow

- Optimization framework has been developed for the problem of Optimal Power Flow constrained by contingencies
  - GridPACK creates Julia input files for StructJuMP optimizer
  - StructJuMP generates the optimization solution for GridPACK
  - GridPACK concatenates results for future analysis
- Test cases
  - RTS system
    - 73 buses
    - 22155 N-1 and N-2 contingencies
  - Texas AM 2000 bus system
    - 2889 N-1 contingencies

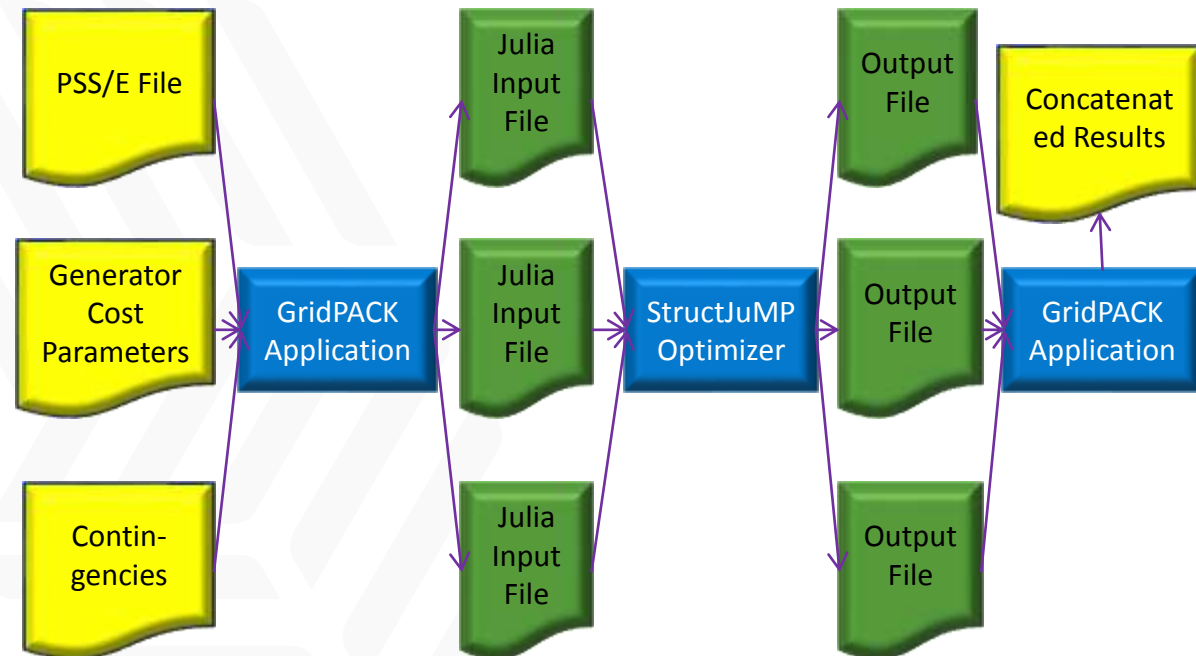

# GMLC 1.4.18 Computational Framework

## GridPACK Optimization Module

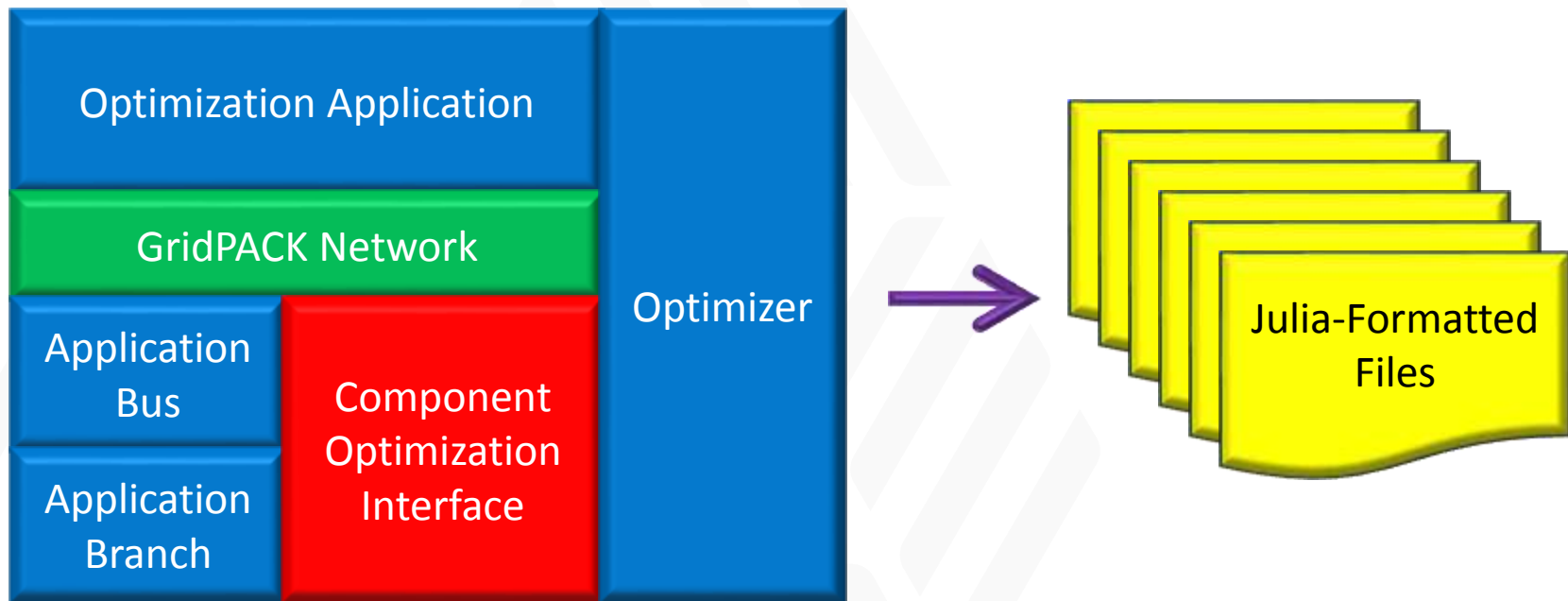

- Set up large scale optimization problems using standard power grid data sources
- Couple directly to solvers such as Cplex and Gurobi
- Create Julia-formatted code for parallel solvers such as StructJuMP

# GMLC 1.4.18 Computational Framework

## Julia formatted input generated by GridPACK



```
using JuMP
using Ipoptgpm = Model(solver=IpoptSolver())
@variable(gpm, LLNs_101_1_1, lowerbound = 0, upperbound = 1)
@variable(gpm, LLNs_102_1_1, lowerbound = 0, upperbound = 1)
:
setvalue(LLNs_101_1_1, 0)
setvalue(LLNs_102_1_1, 0)
setvalue(LLNs_103_1_1, 0)
:
NLconstraint(gpm, VrNs_101_1^2 + ViNs_101_1^2 >= 0.81)
@NLconstraint(gpm, VrNs_101_1^2 + ViNs_101_1^2 <= 1.21)
@NLconstraint(gpm, 1 * dPrNsPlus_101_1 >= 0)
@NLconstraint(gpm, 1 * dPrNsMinus_101_1 >= 0)
@NLconstraint(gpm, 1 * dPiNsPlus_101_1 >= 0)
@NLconstraint(gpm, 1 * dPiNsMinus_101_1 >= 0)
@NLconstraint(gpm, 8 * (1 - WLNns_101_1_1) + 8 * (1 - WLNns_101_2_1) + 76 * (1 - WLNns_101_3_1)
+ 76 * (1 - WLNns_101_4_1) - (VrNs_101_1 * (0.2305 * VrNs_101_1
+ 14.6341 * (VrNs_101_1 - VrNs_102_1) - -68.2927 * (ViNs_101_1 - ViNs_102_1))
+ ViNs_101_1 * (0.2305 * ViNs_101_1 + -68.2927 * (VrNs_101_1 - VrNs_102_1)
+ 14.6341 * (ViNs_101_1 - ViNs_102_1))) - (VrNs_101_1 * (0.0285 * VrNs_101_1...
:
@objective(gpm, :Min, ViolCost * dPrNsPlus_101_1 + ViolCost * dPrNsMinus_101_1
+ ViolCost * dPiNsPlus_101_1 + ViolCost * dPiNsMinus_101_1 + ViolCost * dPrNsPlus_102_1
+ ViolCost * dPrNsMinus_102_1 + ViolCost * dPiNsPlus_102_1 + ViolCost * dPiNsMinus_102_1...
:
print(gpm) status = solve(gpm)
println("Objective value: ", getobjectivevalue(gpm))
println("LLNs_101_1_1 value: ", getvalue(LLNs_101_1_1))
println("LLNs_102_1_1 value: ", getvalue(LLNs_102_1_1))
:
```



# GMLC 1.4.18 Computational Framework

## Proposed Application Architecture

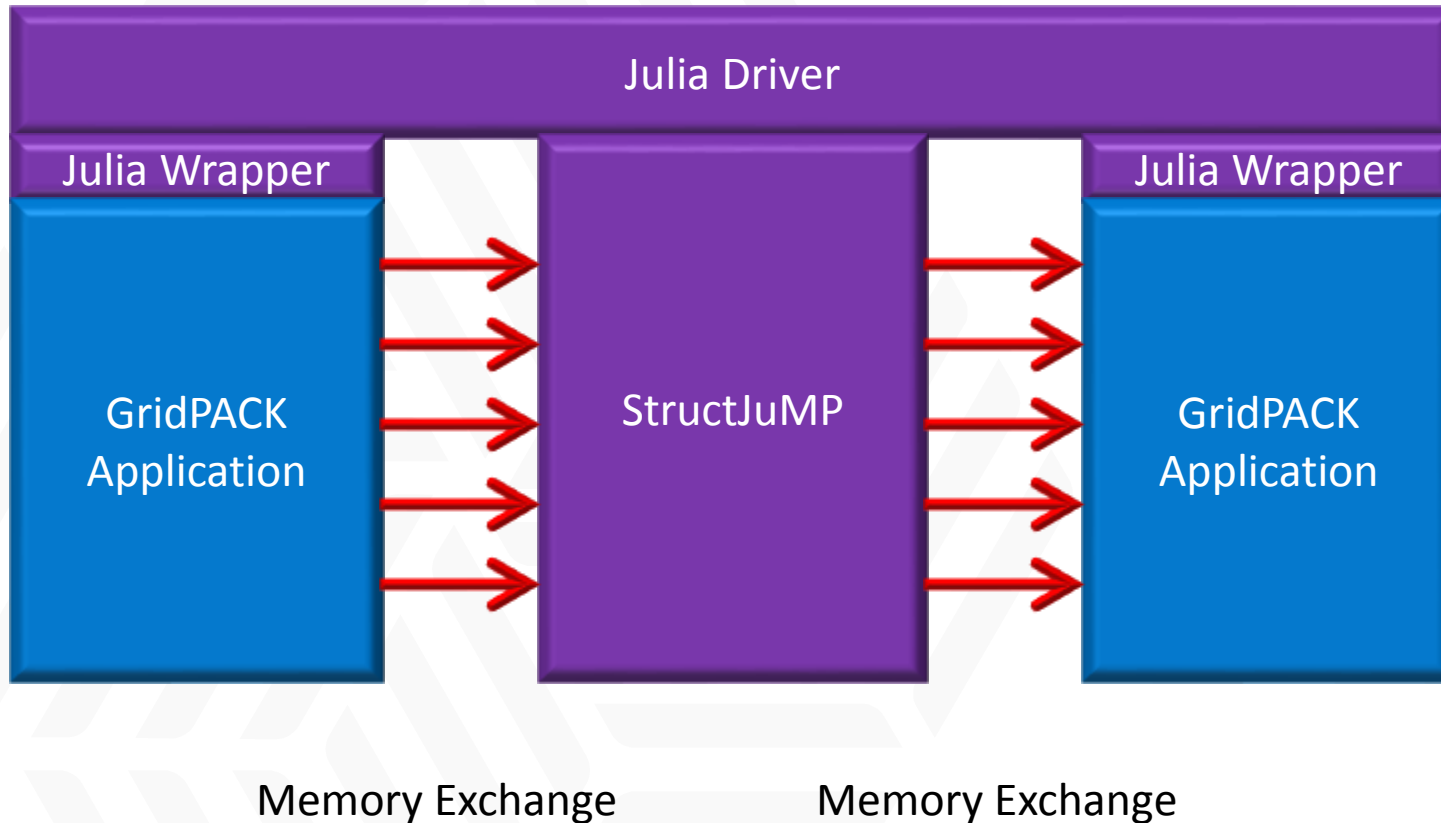

# GRID MODERNIZATION INITIATIVE PEER REVIEW

## Project 1.4.26: Development and Deployment of Multi-Scale Production Cost Models

**JESSICA LAU (NREL)**  
**JEAN-PAUL WATSON (+1 SNL)**

September 4–7, 2018

Sheraton Pentagon City Hotel – Arlington, VA

# Development and Deployment of Multi-Scale Production Cost Models

## High-Level Project Summary

### *Project Description*

**Dramatically reduce the time** required by industry to analyze **high-fidelity** power system scenarios through production cost modeling (PCM)

### *Value Proposition*

- ✓ Improve commercial tools through development and industry coordination
- ✓ Improve fidelity of system representations
- ✓ Enable deeper insights into how systems should be modernized
- ✓ Introduce additional deterministic and stochastic methods
- ✓ Leverage HPC for computational performance
- ✓ Enable broader economic competitiveness

### *Project Objectives*

- ✓ Develop **new models and algorithms**
- ✓ **Expand PCM capabilities** through high-performance computing (HPC)
- ✓ Deploy capabilities and data to **industry**
- ✓ Provide reference implementations for **vendors**

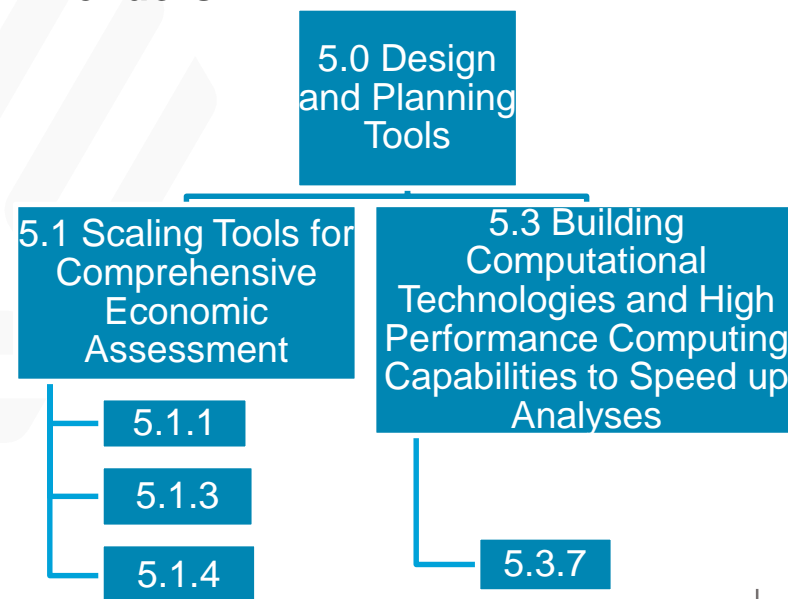

# Development and Deployment of Multi-Scale Production Cost Models

## Project Team



### PROJECT PARTICIPANTS & ROLES

#### Project Management

- NREL, SNL

#### Deterministic PCM

- NREL, ANL

#### Stochastic PCM:

- LLNL, SNL

#### Optimization Formulations:

- SNL

#### Systems:

- NREL, SNL

#### Advisory

- PNNL

### TECHNICAL REVIEW COMMITTEE

#### System Planners

- FERC, SPP, MISO, PJM, ERCOT

#### Commercial Tools

- Energy Exemplar, PSO, ABB, GE

#### Utilities

- NextEra, Xcel, Great River Energy, National Grid

#### Academia & Research

- OSU, UC Berkley, U Chicago, EPRI, PNM

PROJECT FUNDING			
Lab	FY16 \$	FY17\$	FY18 \$
NREL	300K	360K	360K
SNL	269K	235K	235K
ANL	270K	235K	235K
LLNL	130K	139K	139K
PNNL	31K	31K	31K

# Development and Deployment of Multi-Scale Production Cost Models

## Project Approach

Significantly reduced PCM **solve time** by creating **methods** scalable across different **high-fidelity systems** and implemented in common **software**

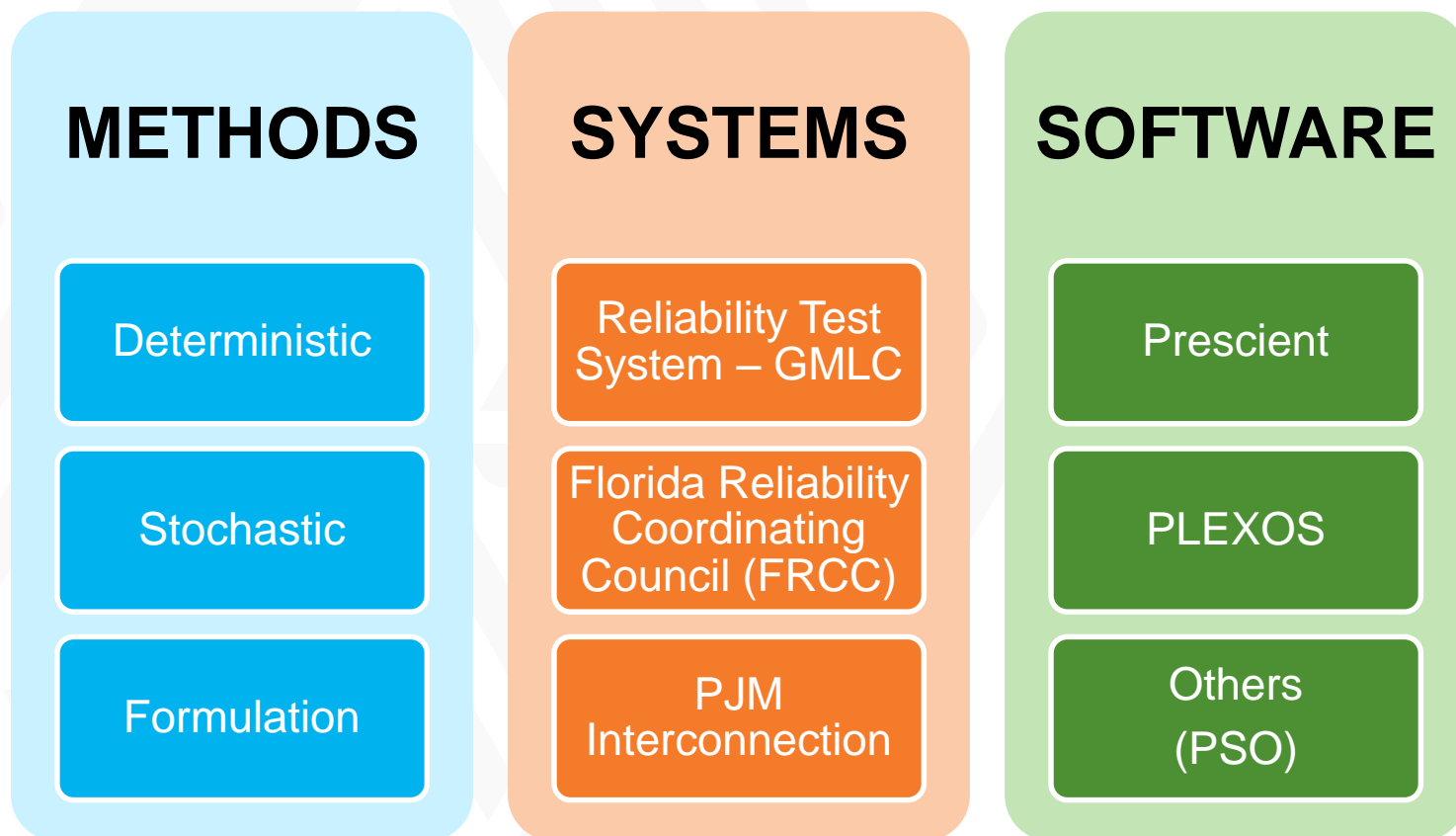

# Development and Deployment of Multi-Scale Production Cost Models

## Methods Approach



### METHODS

Deterministic

Stochastic

Formulation

### IMPROVING SOLUTION TIME AND MODEL FIDELITY

#### Accelerating deterministic PCM

1. Geographic decomposition (NREL)
  - Decomposes large planning models into market regions and iteratively solves
2. Sequential warm-starting (ANL)
  - Provides a near-optimal starting solution by leveraging similarity between unit commitment and inputs and solutions
3. Temporal decomposition (ANL)
  - Decomposes 48-hour unit commitment models and iteratively solves sequential models

#### Accelerating and evaluating stochastic PCM

1. Scenario-based Decomposition (SNL)
  - Decomposition and parallel solution with progressive hedging algorithm
2. Scenario Clustering (LLNL)
  - Enables reduced scenario representations of scenarios by clustering to narrow uncertainty
3. Probabilistic Scenario Construction (SNL)
  - Creates scenarios to reflect desired forecast uncertainty

#### Accelerating and improving optimization formulation in PCM

1. MIP Formulation Enhancements (SNL)
  - Improves unit commitment formulations to solve previously intractable instances and substantially reduce solve time for typical instances



# Development and Deployment of Multi-Scale Production Cost Models

## Methods Accomplishments – Run Time Improvements



### Computation time improvements tackles PCM bottleneck

#### Geographic Decomposition

7-10x run time reduction

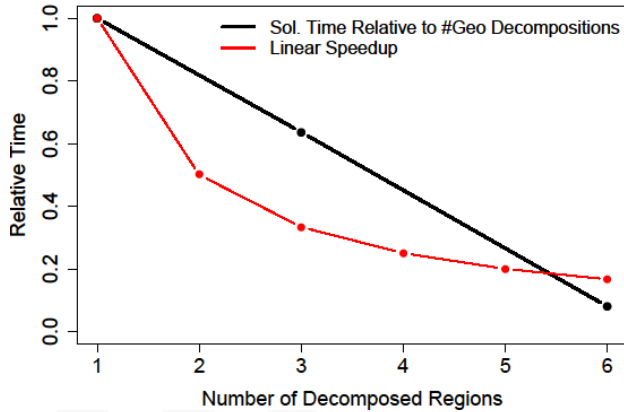

#### Warm Start

~50% run time reduction

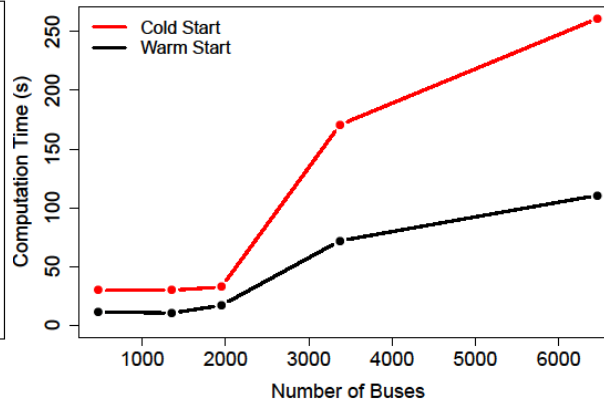

#### Temporal Decomposition

12x run time reduction

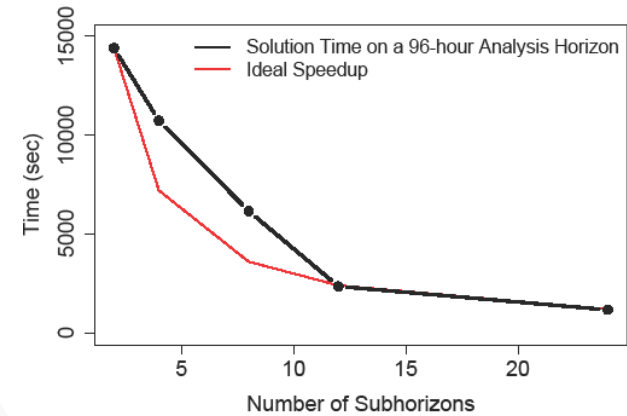

#### Cross-Scenario Cuts

60-77% run time reduction

Idea: Ensure commitment schedule has sufficient generation online to meet the “worst case” net load across *all* scenarios in stochastic formulation, for all time periods

- **60% reduction** in progressive hedging run time for RTS-GMLC
- **77% reduction** in progressive hedging run time for WECC-240++

#### Scenario Grouping

20-40% reduction for more groupings

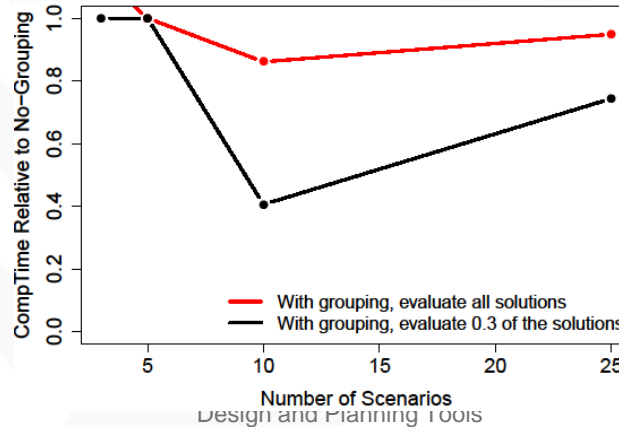

#### MIP Formulation Enhancements

Unit Commitment improvements

(a) 2% Wind Penetration

Formulation	EF	Match	STI	3-bin	1-bin*	1-bin
Time (s)	702	154	218	267	712	739
# of times best	0	6	4	2	0	0
# of times 2nd	0	6	5	1	0	0
Max. time (s)	900	411	491	841	900	900
# of time outs	4	0	0	0	7	7
# of B&C nodes	1.00	1.38	5.91	9.03	67.5	50.8

(b) 30% Wind Penetration

Formulation	EF	Match	STI	3-bin	1-bin*	1-bin
Time (s)	808	215	391	401	799	804
# of times best	0	8	2	2	0	0
# of times 2nd	2	1	6	3	0	0
Max. time (s)	900	648	900	900	900	900
# of time outs	6	0	2	3	10	10
# of B&C nodes	1.00	4.66	51.7	78.2	142	130

# Development and Deployment of Multi-Scale Production Cost Models

Methods Accomplishments – Model Fidelity Improvements

## Improving reflection of real-world systems enables high-fidelity simulations

### Geographic Decomposition

Reflects intra-ISO markets

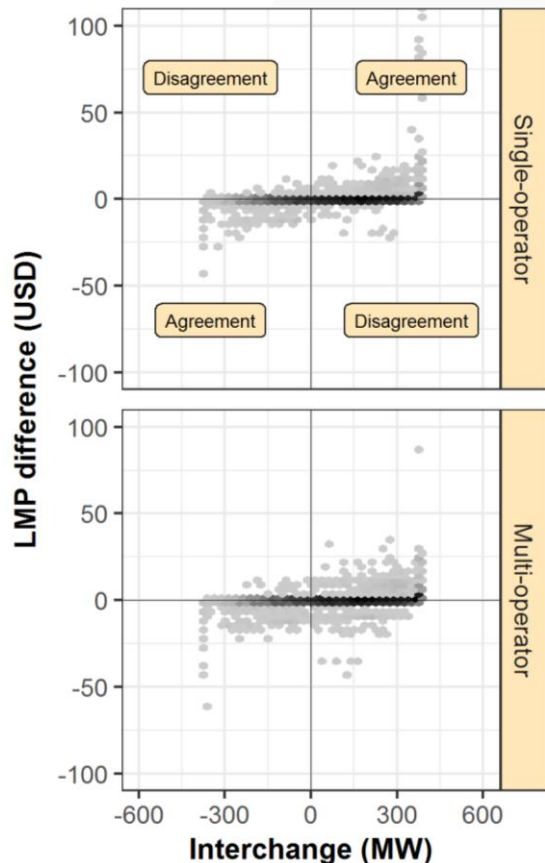

### Non-Parametric Probabilistic Scenarios

Quantile regression

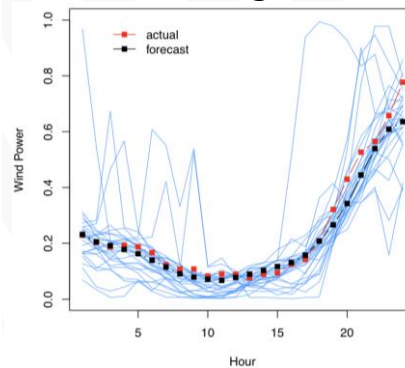

Eliminates artifacts resulting from random sampling

New state-of-the-art

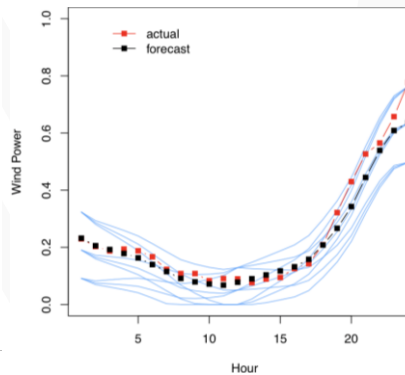

### Probabilistic Scenario Construction

Targeted sampling improves results

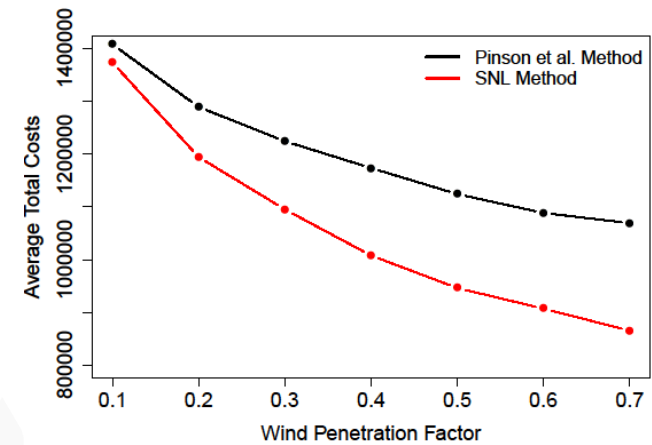

### Scenario Grouping

Optimality gap decreases significantly

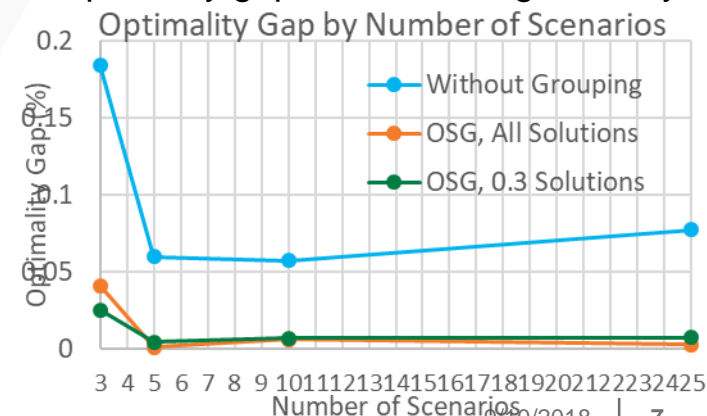

# Development and Deployment of Multi-Scale Production Cost Models System Representations

## REFERENCE SYSTEMS

RTS (Reliability Test System) – GMLC

FRCC (Florida Reliability Coordinating Council)

PJM Interconnection

**Development of open and "lab-open" reference PCM systems enables rigorous benchmarking and ensures relevance due to fleet modernization**

*IEEE requested team to help update RTS-96, including natural gas CC, time synchronized load and renewable resources*

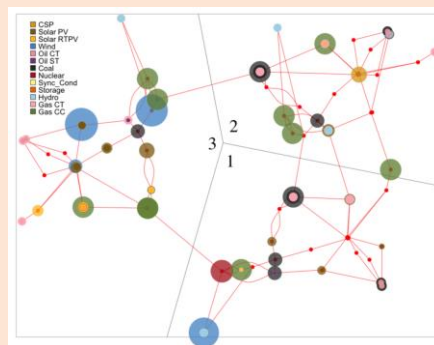

*FRCC and PJM system representations derived from Eastern Renewable Generation Integration Study (ERGIS)*



	Nodes	Lines	Transformers	Generators
<b>RTS-GMLC</b>	73	106	15	158
<b>ERGIS-FRCC</b>	2,681	3,277	803	1,193
<b>ERGIS-PJM</b>	10,579	12,768	4,744	2,980

**Range of reference system sizes, to drive scalability**

# Development and Deployment of Multi-Scale Production Cost Models System Representation Accomplishments

Open-sourced RTS-GMLC has had collaboration from **industry**, **software**, and **academia**, including IEEE, GE, LANL, UT, ISU, NAU, PSO, and Energy Exemplar

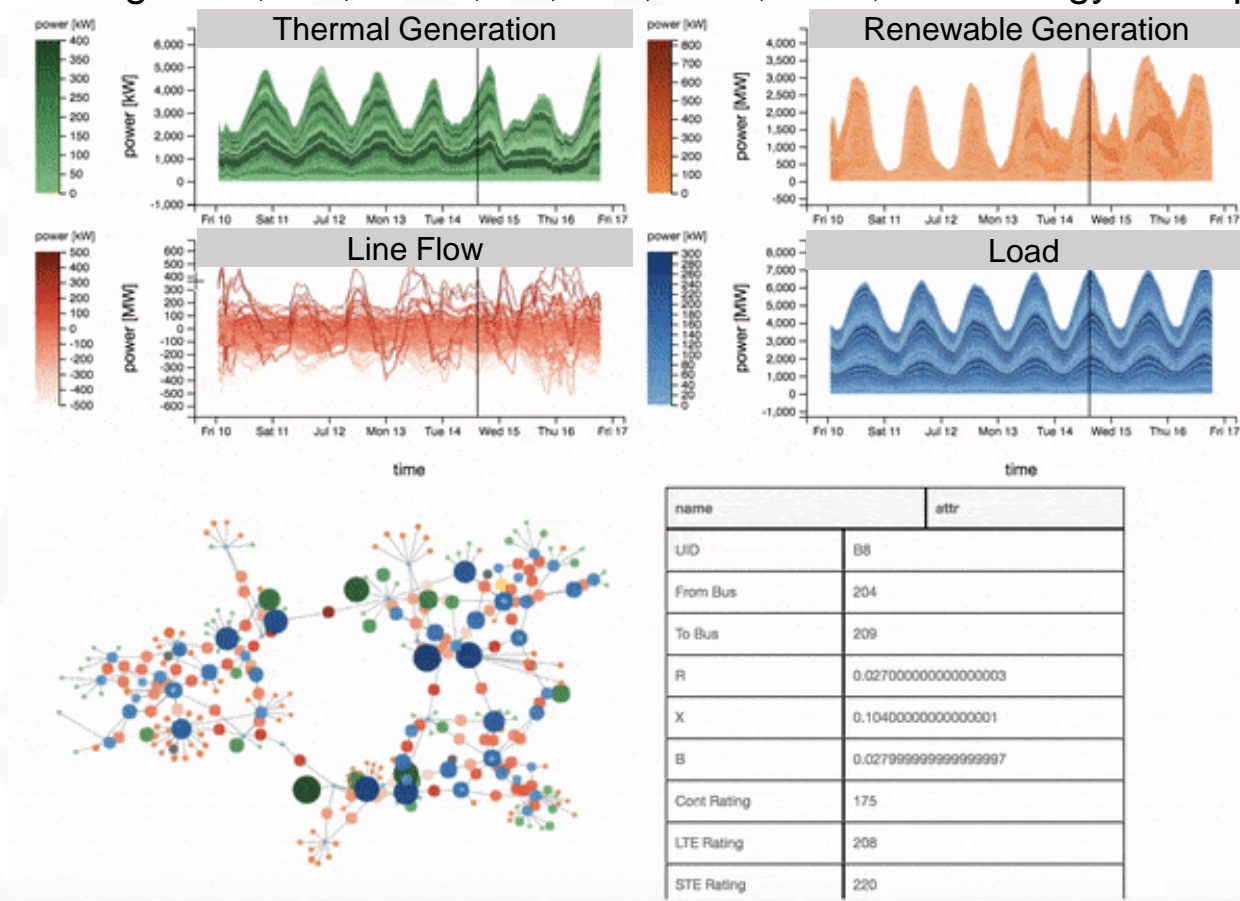

# Development and Deployment of Multi-Scale Production Cost Models Software

## SOFTWARE

Prescient

PLEXOS

Others  
(PSO)

### All developed capabilities integrated into Sandia's *Prescient* Python-based PCM

- Provides **open source** reference implementations
- Transparency to facilitate **industry adoption**

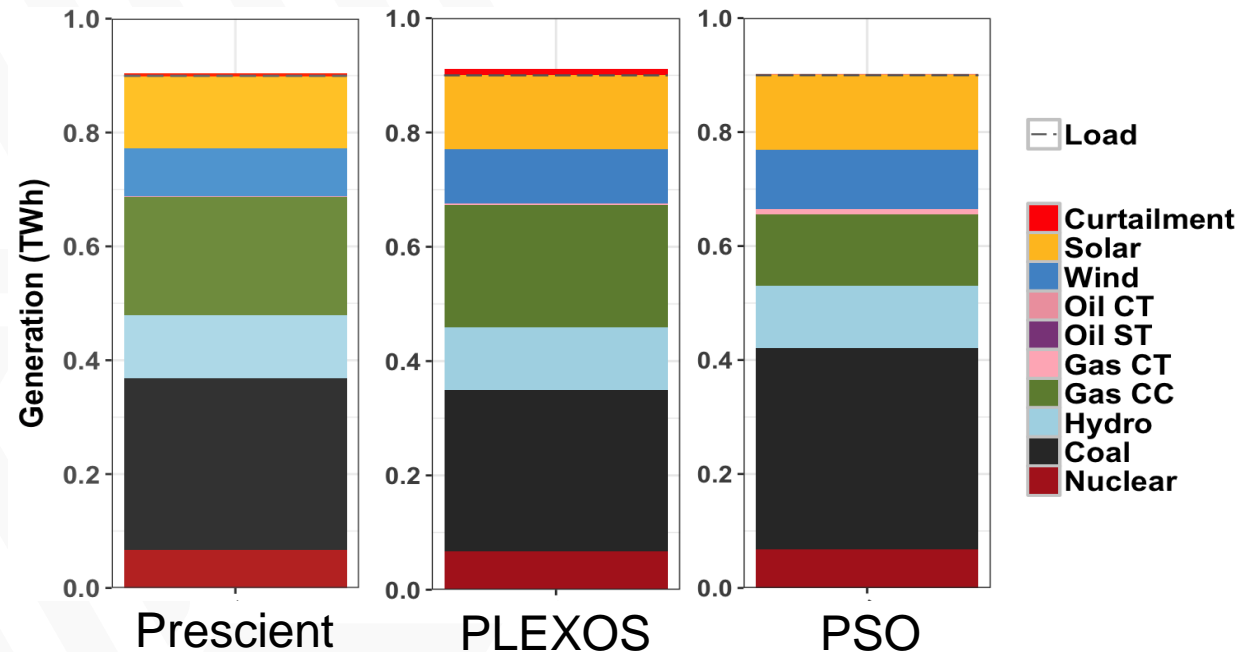

*Prescient has been rigorously benchmarked against the commercial PLEXOS and PSO PCM software packages*



# Development and Deployment of Multi-Scale Production Cost Models

## Project Integration and Collaboration

### Advanced PCM capabilities directly enable other GMLC and related “study” projects

- ▶ Reduced simulation times required for at-scale deterministic PCM studies
- ▶ Facilitates more extensive sensitivity analyses

### Example:

Geographic Decomposition (GD) method enabled **Seams** and **NARIS**.

Seams without GD: **>30 days**

Seams with GD: **20-30 hours**

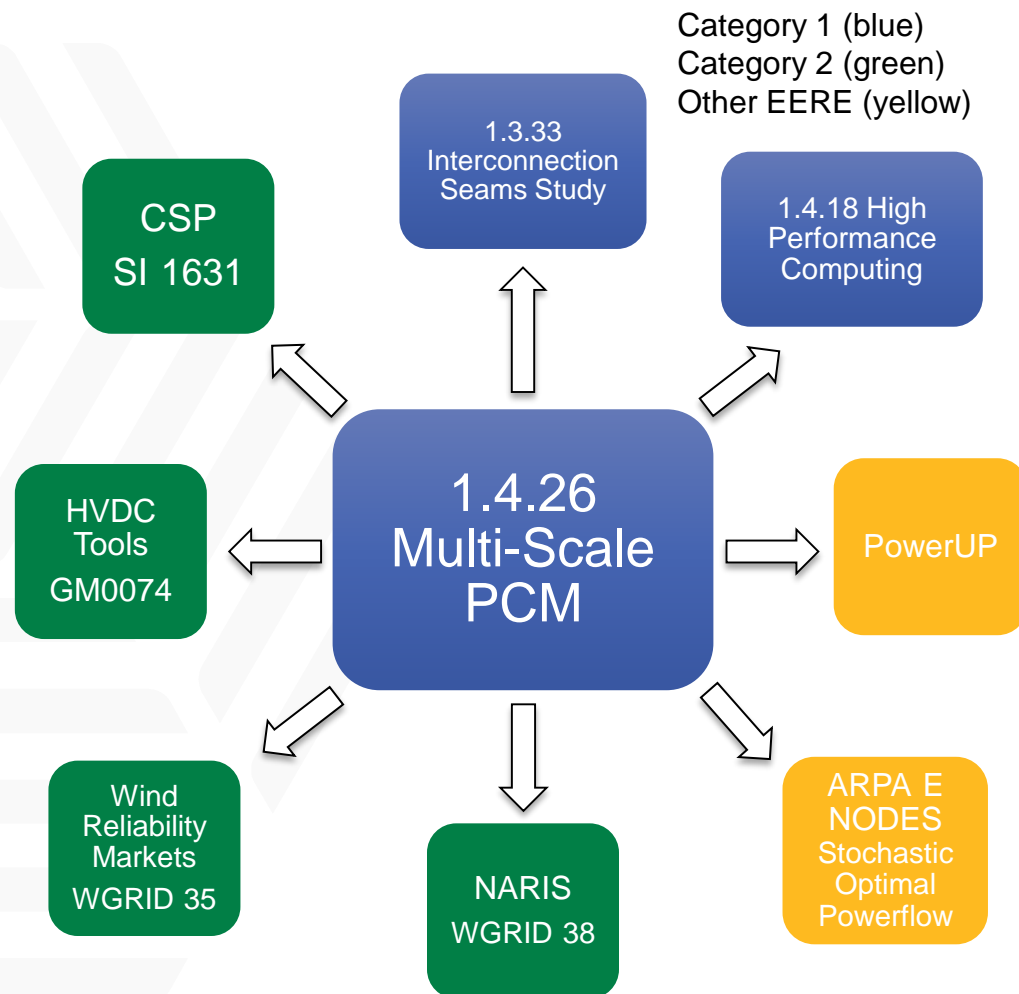



# Development and Deployment of Multi-Scale Production Cost Models

## Accomplishments – Publications



### Deployment of PCM improvements through peer-reviewed publications

- ▶ A. Staid, J. Watson, R. Wets, and D. Woodruff. "Generating short-term probabilistic wind power scenarios via nonparametric forecast error density estimators." *Wind Energy* 20, no. 12 (2017): 1911-1925.  
<https://onlinelibrary.wiley.com/doi/abs/10.1002/we.2129>
- ▶ B. Knueven, J. Ostrowski and J. Watson, "Exploiting Identical Generators in Unit Commitment," in *IEEE Transactions on Power Systems*, vol. 33, no. 4, pp. 4496-4507, July 2018. doi: 10.1109/TPWRS.2017.2783850  
<http://ieeexplore.ieee.org/stamp/stamp.jsp?tp=&arnumber=8207780&isnumber=8387923>
- ▶ B. Knueven, J. Ostrowski, and J. Watson. "A Novel Matching Formulation for Startup Costs in Unit Commitment." Forthcoming
- ▶ C. Barrows, B. McBennett, J. Novacheck, D. Sigler, J. Lau, and A. Bloom. "A Multi-Operator Approach to Production Cost Modeling at Scale." *IEEE Transactions* (Forthcoming)
- ▶ C. Barrows, A. Bloom, A. Ehlen, J. Jorgenson, D. Krishnamurthy, J. Lau, B. McBennett, M. O'Connell, E. Preston, A. Staid, and J. Watson. "The IEEE Reliability Test System: A Proposed 2018 Update." *IEEE Transactions* (Forthcoming)
- ▶ F. Qiu et al. "Transmission Constraint Filtering in Large-Scale Security-Constrained Unit Commitment." (Forthcoming)
- ▶ F. Qiu et al. "Expediting Routinely-Solved Unit Commitment with Integer Warm-Starting." (Forthcoming)
- ▶ K. Kim, A. Botterud and F. Qiu, "Temporal Decomposition for Improved Unit Commitment in Power System Production Cost Modeling," in *IEEE Transactions on Power Systems*, vol. 33, no. 5, pp. 5276-5287, Sept. 2018. doi: 10.1109/TPWRS.2018.2816463  
<http://ieeexplore.ieee.org/stamp/stamp.jsp?tp=&arnumber=8316946&isnumber=8444484>
- ▶ B. Rachunok, D. Woodruff, D. Yang, A. Staid, and J. Watson. "Stochastic Unit Commitment Performance Considering Monte Carlo Wind Power Scenarios." 2018 PMAPS Conference Proceedings (2018).
- ▶ D. Woodruff, J. Deride, A. Staid, J. Watson, G. Slevogt, and C. Silva-Monroy. "Constructing probabilistic scenarios for wide-area solar power generation." *Solar Energy* 160 (2018): 153-167.  
<https://www.sciencedirect.com/science/article/pii/S0038092X17310605>

# Development and Deployment of Multi-Scale Production Cost Models

## Accomplishments – Industry Impact

### TRC/WORKSHOPS

- Attended by commercial vendors, ISOs, and academia.
- Industry feedback and sharing of open-sourced code

### DIRECT IMPACT

- MISO – implemented geo decomp (PLEXOS), kaleidoscope (visualization right), MIP formulation improvements (Day-Ahead Market), and transmission constraint & warm-start (R&D)
  - Accelerated solve time and improves optimality gaps
- PSO – implemented geo decomp
- PLEXOS & PSO – ongoing validation effort

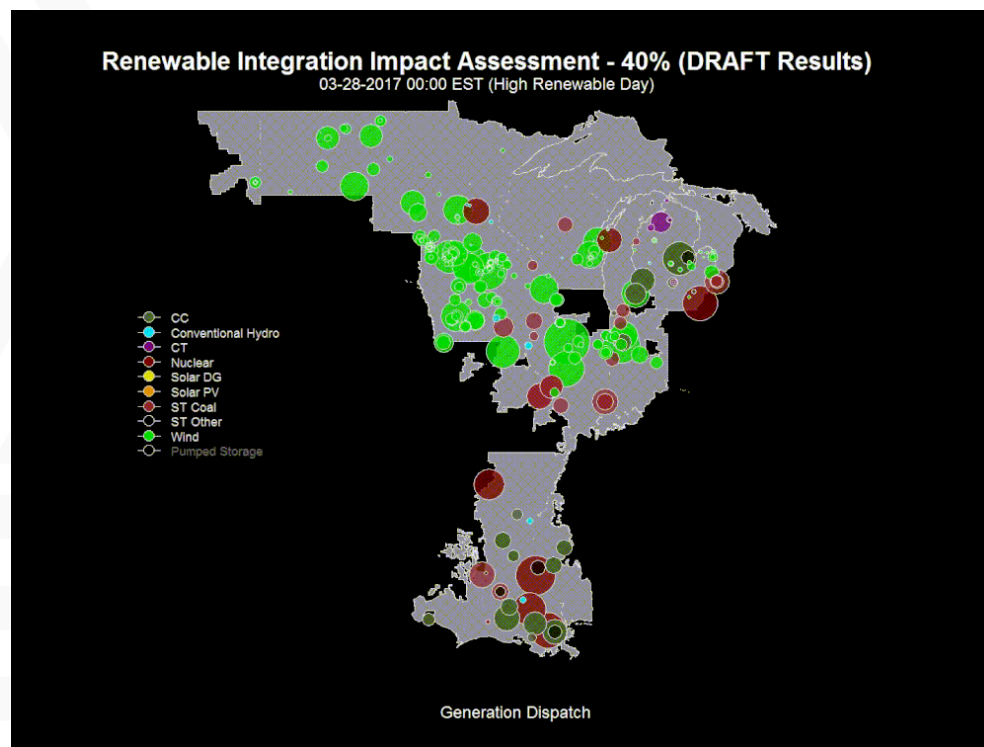

*MISO Renewable Integration Impact Assessment utilizing GMLC 1.4.26 open-source visualization tool (Presented 6/5/18)*

# Development and Deployment of Multi-Scale Production Cost Models

## Next Steps and Future Plans



**Project team remaining milestones are to test methods on large system and complete documentation (by 11/30/18)**

## Future Development

- ▶ **Modular PCM**
  - How can we develop the ability to simulate multiple real systems and their operations?
  - How can we enable different users to easily customize to their footprint?
- ▶ **Markets**
  - How can we examine different price formations?
  - How can we increase the flexibility of modeling different products?
- ▶ **Model Fidelity**
  - How can we continue to reduce run time and other bottlenecks?
  - What about AC optimal power flow?
- ▶ **Resiliency**
  - How can we characterize extreme events in modeling?
  - How can we test operations response and mitigation strategies through events?
- ▶ **Distributed Energy Resources (DERs)**
  - How can bulk system models improve on examining the impact of DERs?
- ▶ **Academic and Industry Outreach**
  - How can we reach out to academia and industry to improve PCM?
  - How can we develop and enable talent through tools and data sets?

# Development and Deployment of Multi-Scale Production Cost Models

## Project Summary



### ► Project Accomplishments

- Successfully developed deterministic, stochastic, and formulation **methods**
- Implemented on multiple **system representations**
  - Developed and open-sourced RTS-GMLC by request of IEEE
- Using Prescient as common PCM **software** to test methods

### ► Industry Impact

- Enabled other DOE and non-DOE projects
- Extensive industry, software vendor, and academic support and collaboration
  - Deployed 4 methods and 1 visualization tool across MISO day-ahead markets, planning studies, and research
  - Collaboration with PSO to implement RTS-GMLC and baseline against other models



**Thank you!**