

Project Description

- The electric power system is becoming more integrated and complex with the wide spread of distributed energy resources and abundant communication systems.
- The interdependency and interaction across transmission, distribution and communication systems can no longer be ignored, demanding integrated analysis of the end-to-end power grid.
- This project developed a scalable co-simulation platform, enabling such integrated analysis to maximize flexibility and resilience of the grid.

Expected Outcomes

- Fill current gaps in simulation and modeling technology that inhibits integrated planning across multiple domains.
- Bring together best-in-class simulation efforts from multiple national labs.
- Create HELICS™, an **open-source co-simulation platform**, enabling interactions between leading commercial & lab-developed simulators on a wide range of computing environments.

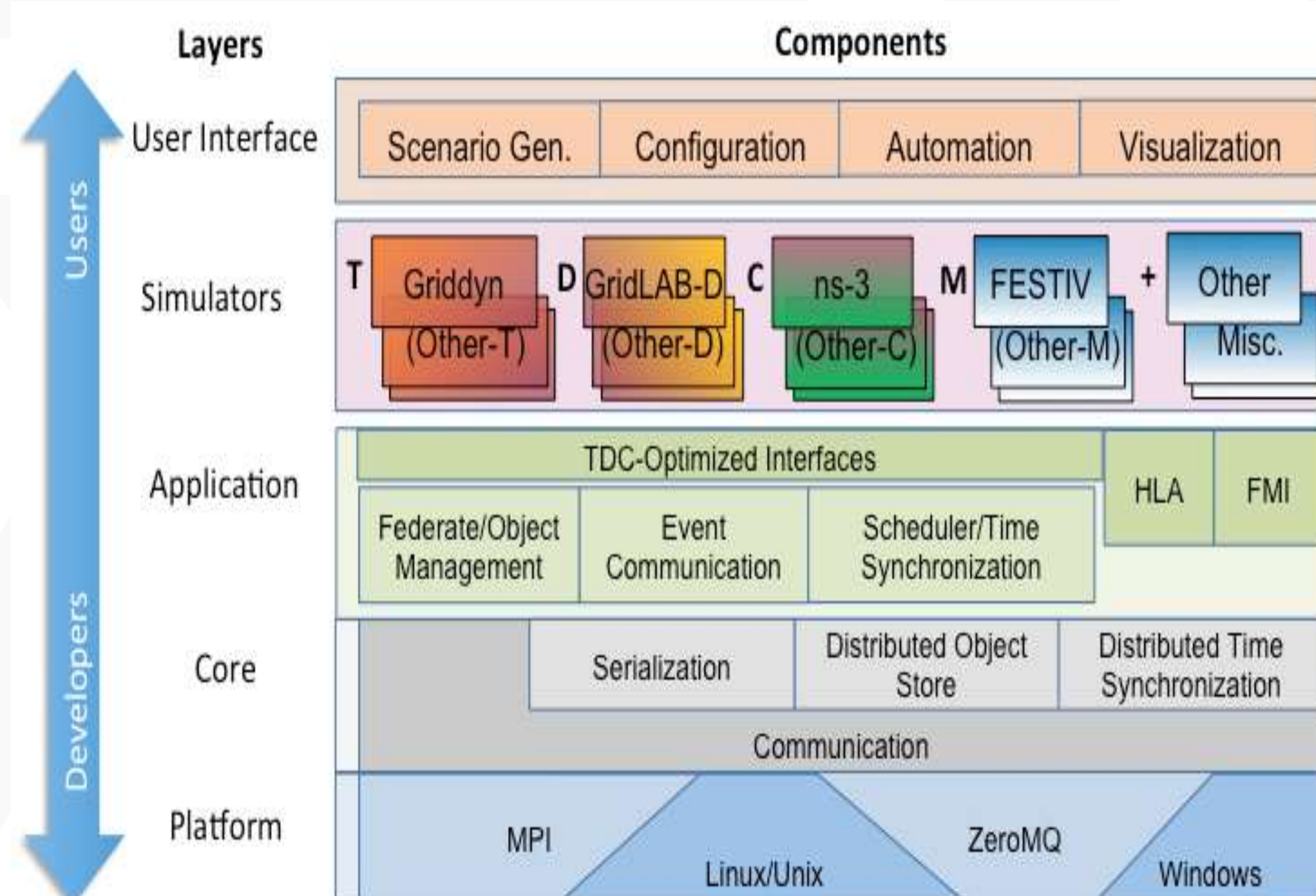

	Milestone	End Date
Year 1	✓ M1: Document initial test cases	9/2016
	✓ M2: Organize an industry stakeholder webinar	12/2016
	✓ M3: Report documenting test case studies	3/2017
	✓ M4: Deliver a HELICS guiding document	6/2017
Year 2	✓ M5: Organize a TRC workshop	6/2017
	✓ M6: Deliver an initial HELICS framework to open source	6/2017
	✓ M7.1: Deliver HELICS v0.3 framework to open source	10/2017
	✓ M7.2: Deliver use case implementation examples	12/2017
	✓ M7: Deliver HELICS v1.0 framework to open source	12/2017
Year 3	✓ M8: Host a TRC meeting	6/2018
	✓ M9.1: Host a TRC webinar series (8 sessions)	8/2018
	✓ M9: Deliver ver2.0 framework to open source	12/2018
	✓ M10: Demonstrate ver2.0 framework with selected use cases	4/2019

HELICS (Hierarchical Engine for Large-scale Infrastructure Co-Simulation)

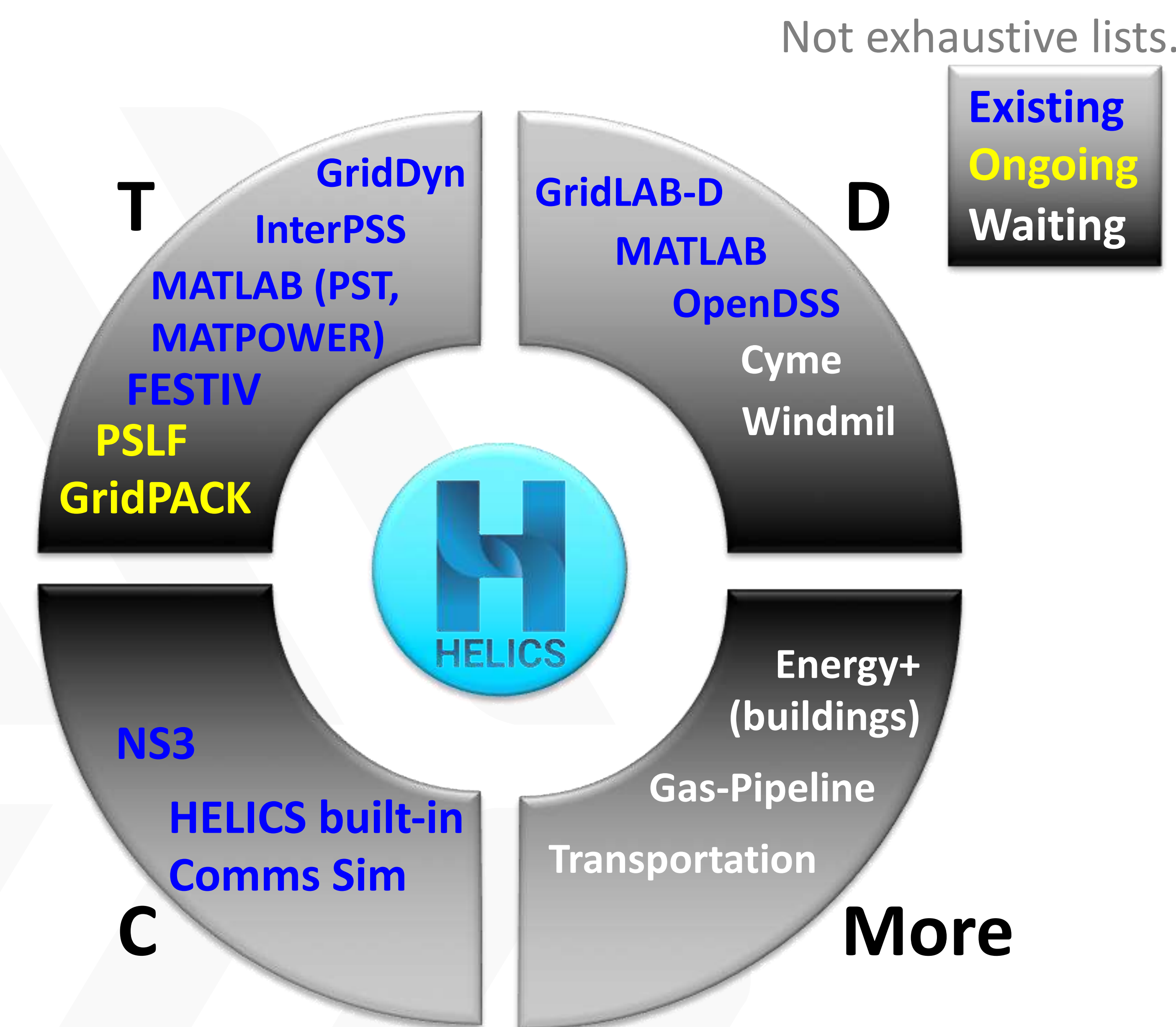

Progress to Date

- Developed and documented 12 use cases to guide HELICS development and benefit the broad community.
- HELICS v1.3 released, <https://www.github.com/GMLC-TDC/HELICS-src>, with HELICS documentation on website, <https://www.helics.org>
- HELICS mini-tutorials developed, <https://www.youtube.com/channel/UCPa81c4BVXEYXt2EShTzbcg>
- HELICS tutorial at IEEE PES T&D Conference in April 2018. (Again for IEEE PES General Meeting 2019).
- Demonstrated validity and value by multiple use cases. Public use-case repository <https://github.com/GMLC-TDC/HELICS-Use-Cases>.
- HELICS TRC webinar series (8 sessions).

Technical Review Committee (TRC): EPRI, WSU, Duke Energy, NIST, National Grid, U. Arizona, NRECA, MITRE, Dominion, PJM, Avista, SCE, InterPSS, GE, Peak RC, ASU.

Extreme Event Modeling 1.4.17

Russell Bent (PI, LANL), Yuri Makarov (+1, PNNL), Liang Min (LLNL), Feng Qiu (ANL), Yaosuo Xue (ORNL), Meng Yue (BNL), Anthony Florita (NREL), Jean-Paul Watson (SNL)



Project Description

Extreme events pose an enormous threat to the nation's electric grid and the socio-economic systems that depend on reliable delivery of power.

- ▶ Superstorm Sandy, Hurricane Katrina, the 2003 Northeast blackout
- ▶ Component Failure (N-k) and Sequential Component Failure (Cascade) modeling has large gaps
 - Cascade models having missing details
 - Low fidelity
 - Reliability regulations are difficult to satisfy
 - ◆ Example: NERC TPL-001-4
 - Simulations of cascades are slow
 - Impractical for near-term, operations planning exercises
 - Component failures (N-k contingency analysis)
 - Existing approaches address a small number of failures ($k < 4$)
 - Existing approaches assume all failures are equally likely

Expected Outcomes

- Cascading tools that are 500x faster than existing packages
- Identify the worst k contingencies twice as fast
- Demonstration on a large-scale system
- Stakeholder Impact: High fidelity cascading analysis for operations planning
- Stakeholder Impact: High fidelity, scalable deterministic contingency analysis for operations planning
- Value Proposition: Identify extreme event risk prior to event occurrence

Significant Milestones	Date
Scale N-k approaches to networks that are 10x larger than what existing tools can handle	10/1/17
Cascade modeling tools demonstrate 100x speed up of cascading simulations, as compared to existing tools	10/1/18
Open source prototype tools release that 1) Integrates multiple temporal scales, protection system modeling, and renewables into cascade models, 2) demonstrates 500x speedup of cascade simulations as compared to existing tools, and 3) improves computation of N-k by increasing k by twice as much over existing practices.	4/1/19
Project continuation document—outlines next steps and open challenges	4/1/19

Example of N-5 contingency analysis

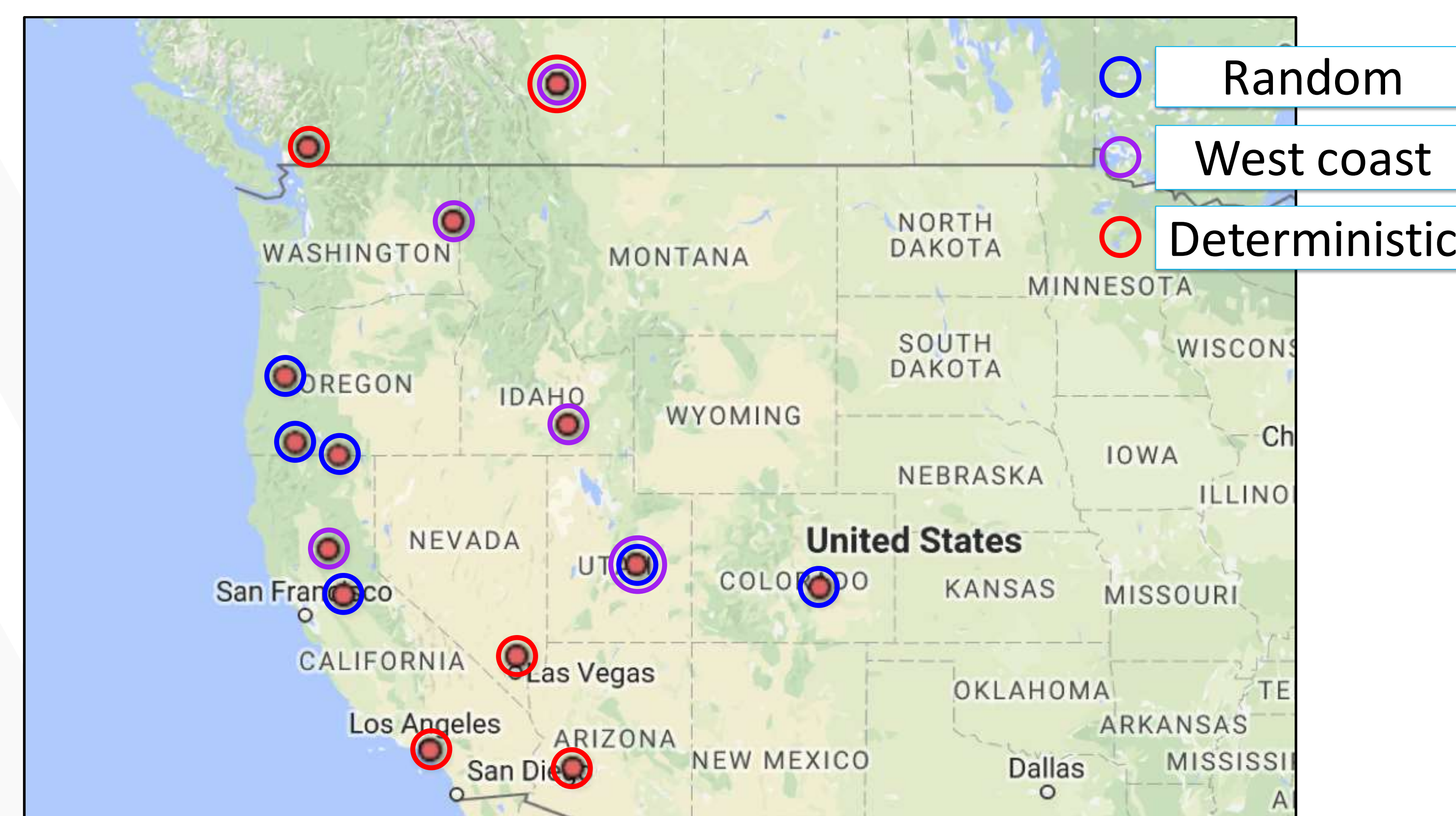

Open model based on the WECC system

- Deterministic = worst case
- Random = Randomized failure rates
- West Coast = High failure rates on the west coast (earthquake extreme event)

Conclusion: Probabilistic and deterministic N-k produces very different results

- Motivates a need for both

Progress to Date

- Implementation and demonstration of zone 3 protections models on WECC planning model
- > 6500x speedup of cascading simulations using HPC (WECC planning model)
- Scaled N-k methods from systems 100's of nodes to 1000's nodes
- Mid project review meeting with NERC (Fall 2017)
- Representative Publications
 - K. Sundar, C. Coffrin, H. Nagarajan, R. Bent. *Probabilistic N-k Failure-Identification for Power Systems, Networks*, accepted for publication.
 - J. Qi, J. Wang, and K. Sun. *Efficient Estimation of Component Interactions for Cascading Failure Analysis by EM Algorithm*, IEEE Transactions on Power Systems, 33 (3): 3153-3161, 2018.
 - E. Ciapessoni, D. Cirio, E. Cotilla-Sanchez, R. Diao, I. Dobson, A. Gaikwad, P. Henneaux, S. Miller, M. Papic, A. Pitto, J. Qi, N. Samaan, G. Sansavini, S. Uppalapati, and R. Yao, *Benchmarking quasi-steady state cascading outage analysis methodologies*, IEEE International Conference on Probabilistic Methods Applied to Power Systems (PMAPS), Boise, ID, USA, Jun. 2018.

GMLC 1.4.18 Computational Science for Grid Management)

Scalable Single and Multiperiod Optimization Under Uncertainty



Project Description

- ▶ In this project, we aim to improve *by >100x* the performance of optimization under uncertainty (OUU) grid solvers by using parallelism and novel math and algorithms.
- ▶ The project, originally focused on single-period OUU, has now been expanded to multiperiod OUU and applications to resilience.
- ▶ We aim to characterize the temporal aspect of resilience/vulnerability.

Expected Outcomes

- Leverage ACSR-sponsored multiperiod OUU solvers to compute 100x faster by harnessing parallelism.
- Design and Instantiate an advanced framework (AMICF) that allows 10x faster prototyping of multiperiod OUU analyses.
- Compute optimal post-contingency recovery in minutes/contingency. *Real-time security-constrained contingency recovery. Optimal cascade prevention.*
- Define and characterize the Optimal Model Predictive Control (OMPC)-NR resilience metric. *Leverage the increased flexibility of DER to improve resilience and allow for increased renewable penetration.*
- Find the optimal ramping required for a given resilience requirement.

Significant Milestones	Date
Julia Scalable Framework StructJUMP released. SCACOPF derivatives can now be scalably computed.	12/16
Tuning of PIPS-NLP for massive parallelism. SCACOPF 3K buses 512 contingencies solvable in 10 minutes.	03/17
At DOE guidance focus chance on multiperiod optimization targeting resilience	03/18
Defined and computed the OMPC-NR resilience metric. One iteration for 9k buses– 30 seconds.	08/18

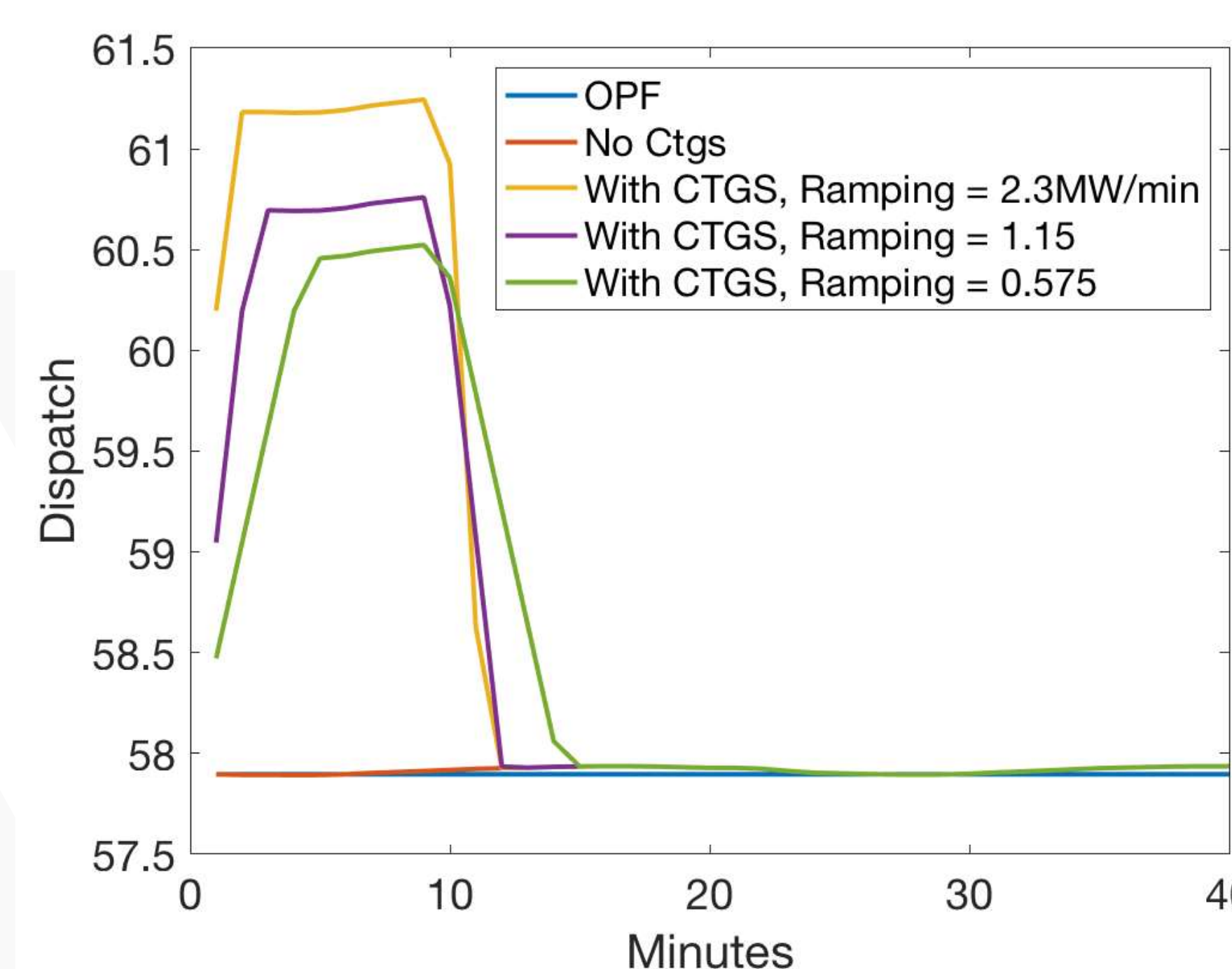

MPC recovery model. More ramping == faster contingency recovery (9 bus) Time to Solution

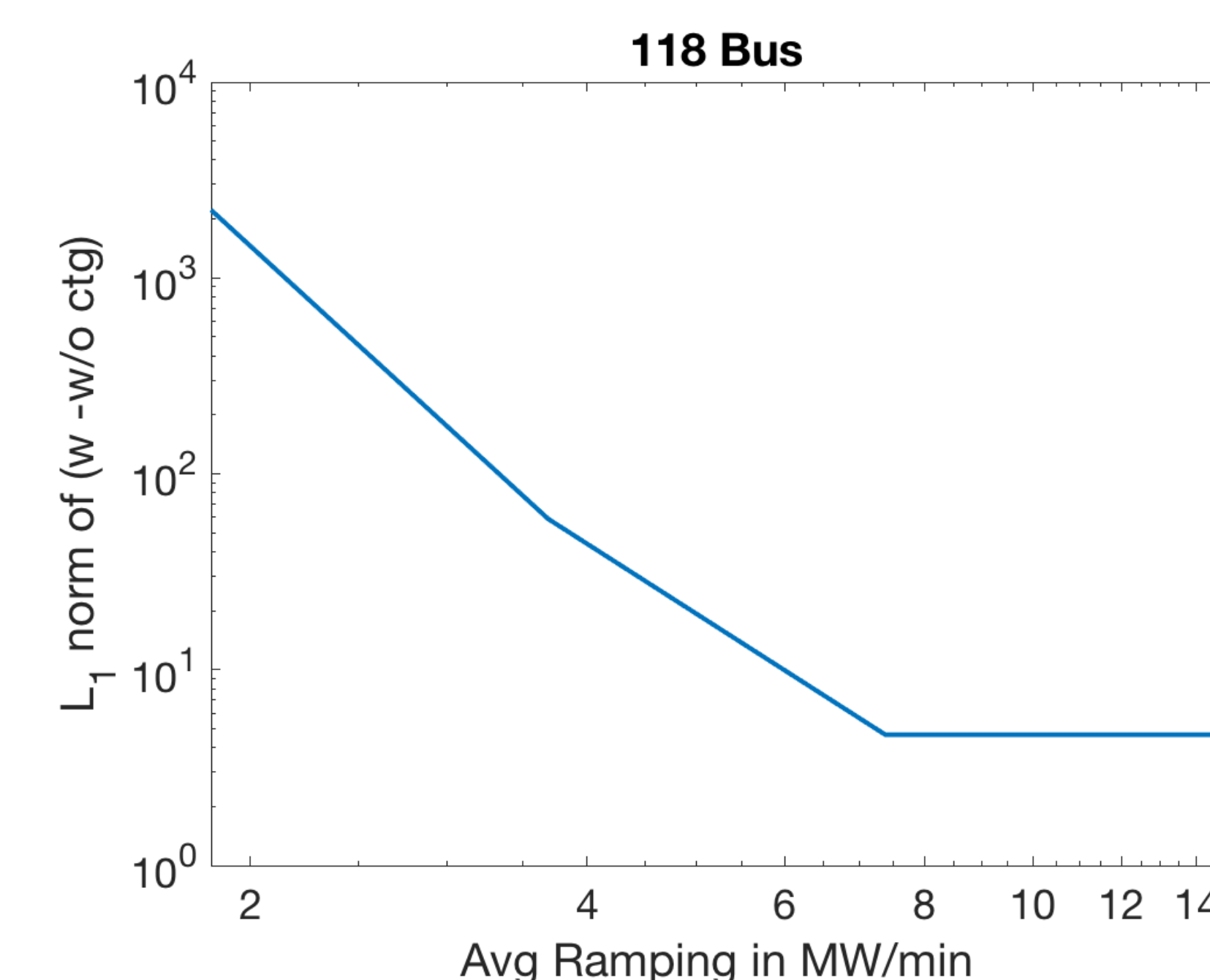

OMPC-NR (negative) resilience metric. More ramping == more resilience

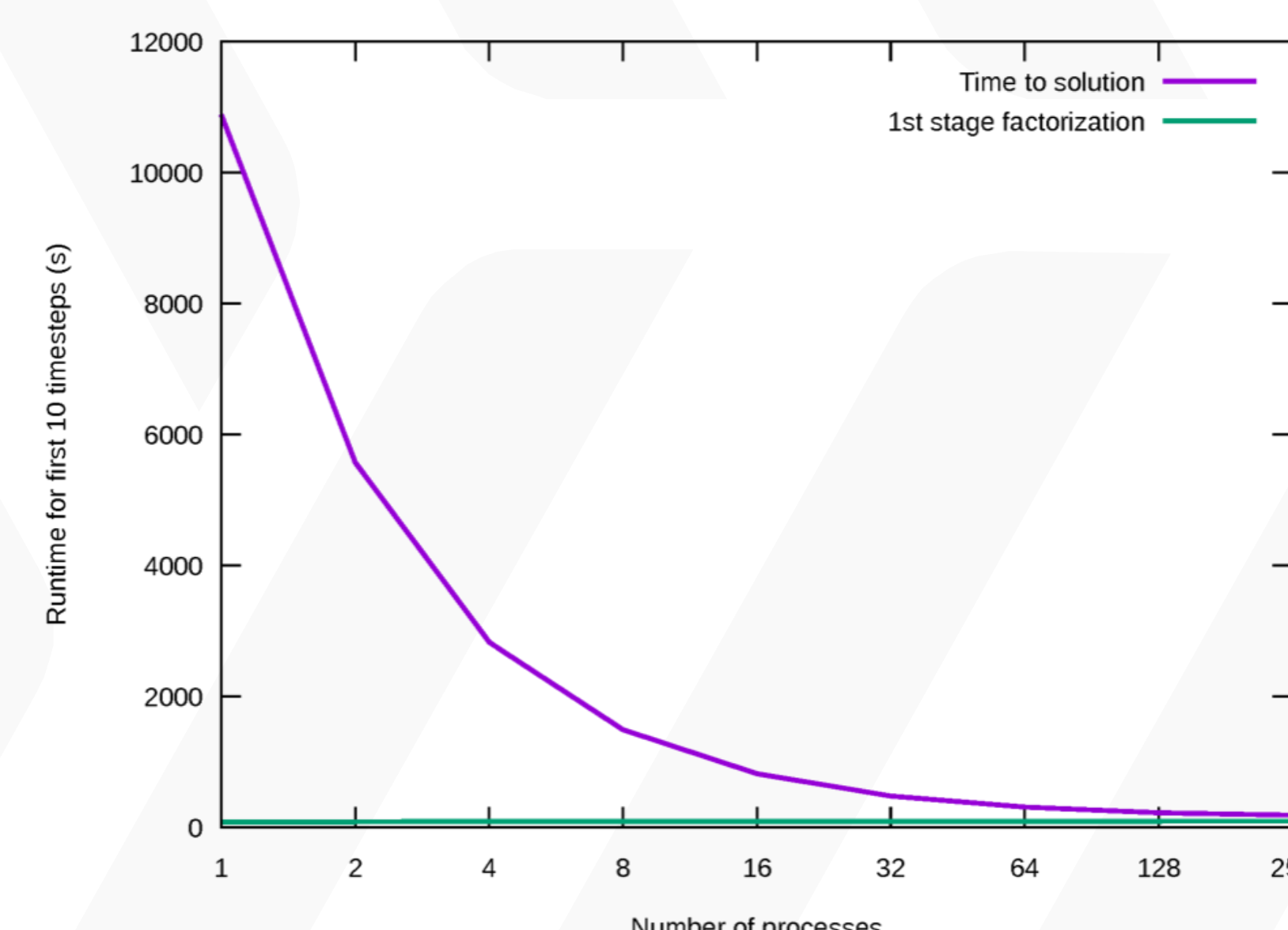

Struct-JUMP+PIPS NLP scalability for SCACOPF PEGASE 3K with 512 scenarios.

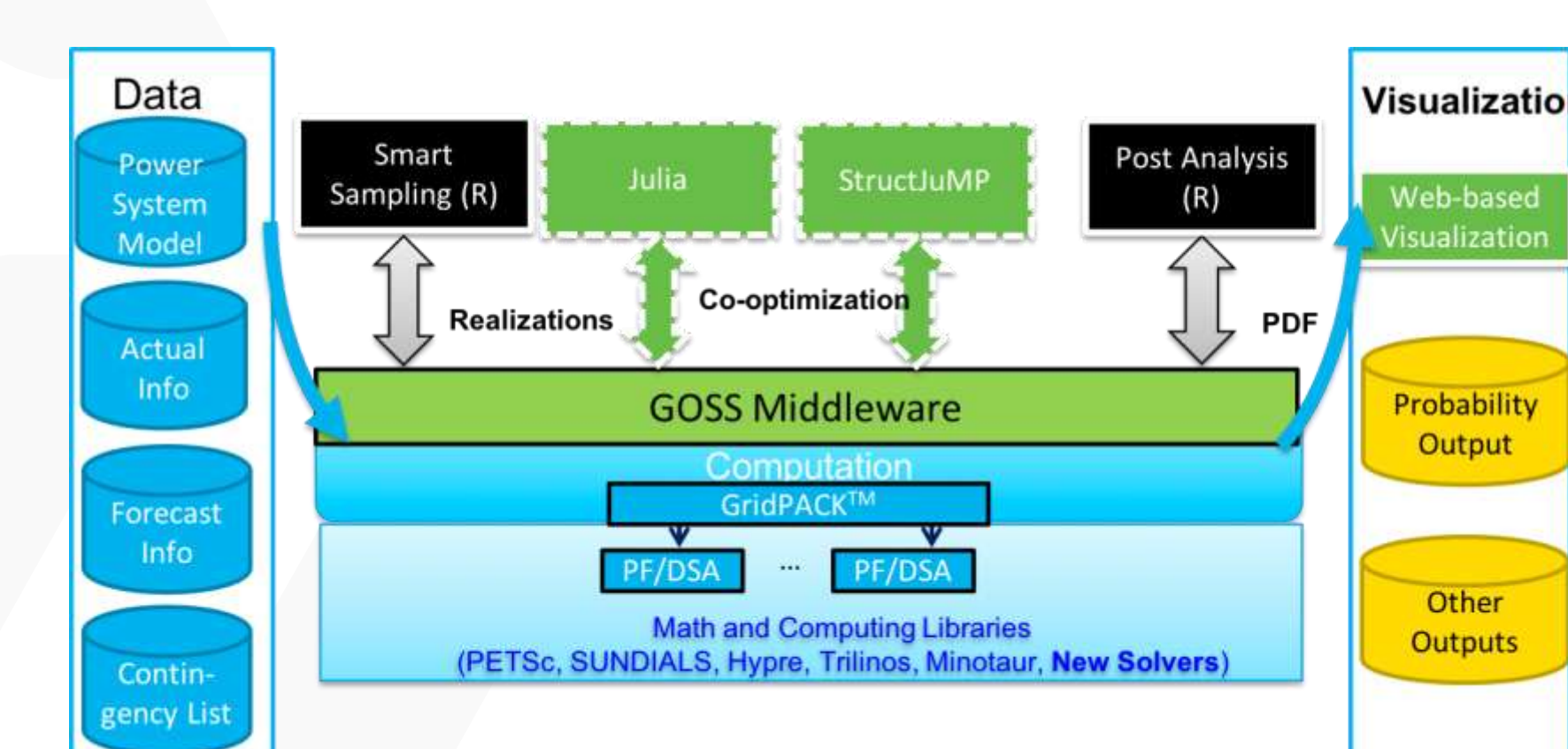

Software architecture. PSSE input, C-like speed, 1000 fold scenario scalability.

Progress to Date

- Two software packages enhanced and released: StructJuMP (Julia for problem definition/derivative computation) and PIPS-NLP for nonlinear nonconvex optimization as used by SCACOPF.
- Both software items in Github, free and open.
- Two journal papers, three conference proceedings papers and three abstract presentations.
- Highlighted publication: C. G. Petra, F. Qiang, M. Lubin, J. Huchette, *On efficient Hessian computation using the edge pushing algorithm in Julia*, accepted, Optimization Methods and Software, 2018.
- Major contribution to new PES task force: "High performance computing for planning problems" Anitescu, co-chair.

Development and Deployment of Multi-Scale Production Cost Models

Project Partners: NREL, SNL, ANL, LLNL, PNNL



GMLC 1.4.26

Project Description

The Multi-scale Production Cost Modeling project aims to improve tools that are used to simulate power system the operations of future power systems. This project is improving the state-of-the-art in production cost modeling to enable industry to conduct more accurate analysis, faster, and in more detail.

Expected Outcomes

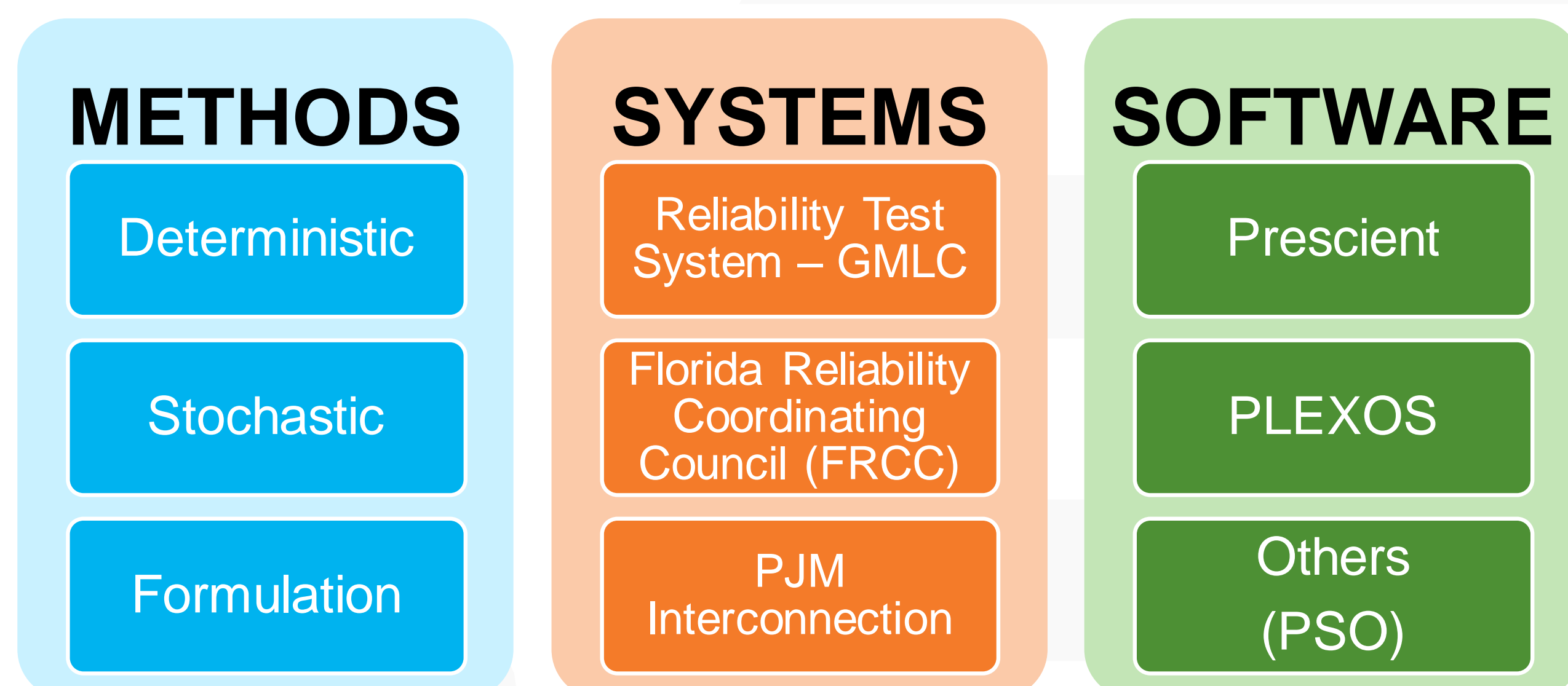

- Methods:** Developing new algorithms, including different decompositions methods, to reduce solve time and increases model accuracy. The computational advances will benefit both deterministic and stochastic analysis of the power grid.
- Systems:** Multiple reference PCM systems to enable rigorous benchmarking and ensures relevance due to fleet modernization.
- Software:** All methods integrated on a common Platform (Prescient) and engaging/benchmarking with commercial production cost model software and user communities, we are pursuing algorithmic and analytical advancements that can be deployed quickly and accelerate grid modernization. We are using tools such as GitHub to give a new dimension to stakeholder engagement.
- Engagement:** Multiple TRCs held with industry vendors, users, and academia to deploy the developed methods, systems, and software. Continuous open-source release to enable collaboration.

FY18 Significant Milestones	Date
Combine NREL temporal decomposition methods with geographic decomposition methods.	11/31/17
Test combination of four decomposition methods	5/31/18
Integrate methods in Prescient	5/31/18
Host TRC and workshop to launch methods with non-lab participants	8/31/18
Demonstrate computational improvements on real-world systems	11/30/18
Publish all methods and release as open-source code	11/30/18



Progress to Date

Improved **solve time** through creating **methods** scalable across different **high-fidelity systems** and implemented in common **software**.

METHODS: Improving solution time and model fidelity Accelerating deterministic PCM

- Geographic decomposition (NREL)**
 - Decomposes large planning models into market regions and iteratively solves
 - Geographic decomposition parallelizes the unit commitment problem according to market footprints. Initial results are seeing a 50% reduction in solve time.
- Sequential warm-starting (ANL)**
 - Provides a near-optimal starting solution by leveraging similarity between unit commitment and inputs and solutions
- Temporal decomposition (ANL)**
 - Decomposes 48-hour unit commitment models and iteratively solves sequential models
- Accelerating and evaluating stochastic PCM**
- Scenario-based Decomposition (SNL)**
 - Decomposition and parallel solution with progressive hedging algorithm
 - 60% reduction** in progressive hedging run time for RTS-GMLC
 - 77% reduction** in progressive hedging run time for WECC-240++
- Scenario Grouping (LLNL)**
 - Enables reduced scenario representations of scenarios by clustering to narrow uncertainty
- Probabilistic Scenario Construction**
 - Creates scenarios to reflect desired forecast uncertainty and eliminates artifacts resulting from random sampling

Accelerating and improving optimization formulation in PCM

- MIP Formulation Enhancements (SNL)**
 - Improves unit commitment formulations to solve previously intractable instances and substantially reduce solve time for typical instances

SYSTEMS: Creating and open-source for planning

- Reliability Test System – GMLC:**
 - An IEEE Task Force recently reached out to NREL requesting help in modernizing the RTS-96 test power system which was last updated in 1996. We modernized the test system (RTS-GMLC) by adding modern generation resources and by adding spatial and temporal variability and uncertainty
- PJM Interconnection and Florida Reliability Coordinating Council (FRCC) system representations derived from Eastern Renewable Generation Integration Study (ERGIS)**

SOFTWARE: Enabling industry and academia through open-source code

All developed capabilities integrated into Sandia's Prescient Python-based PCM

- Provides open source reference implementations
- Transparency to facilitate industry adoption



Design and Planning Tools

September 5, 2018

1. Geographic Decomposition

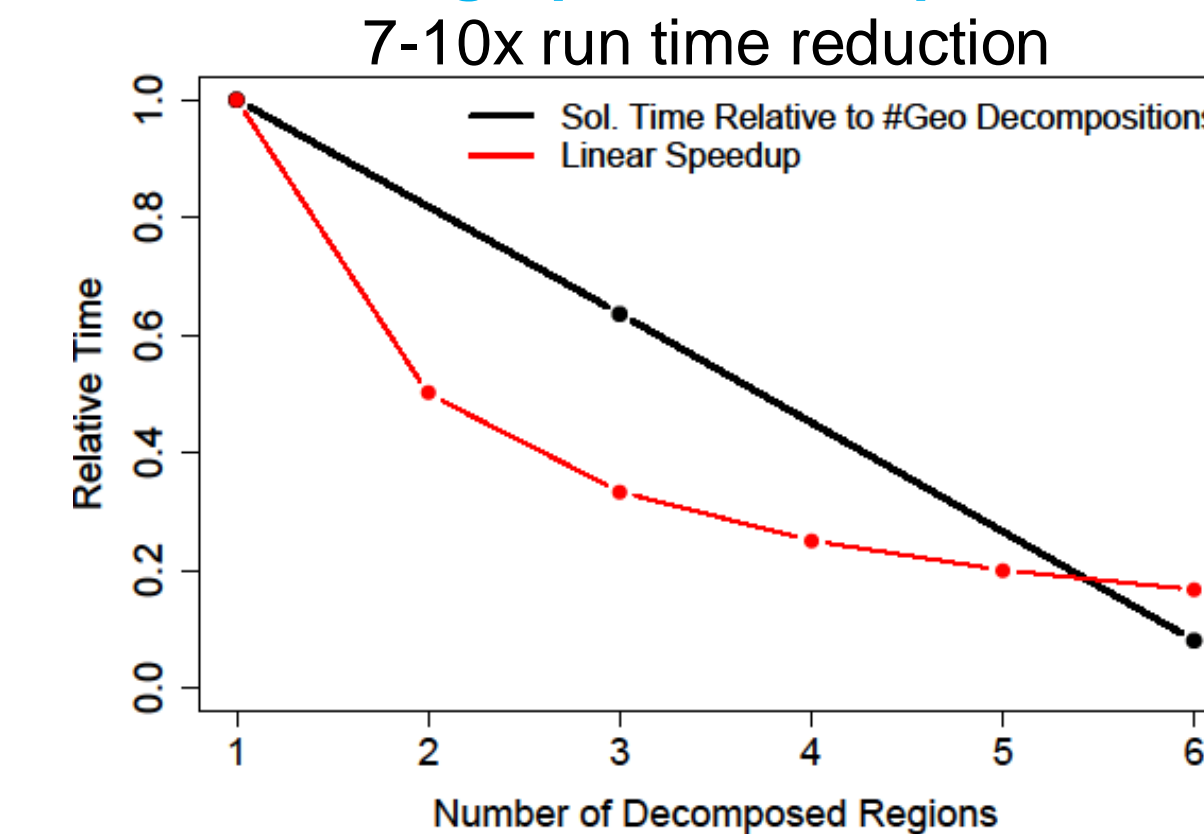

2. Sequential Warm-Starting

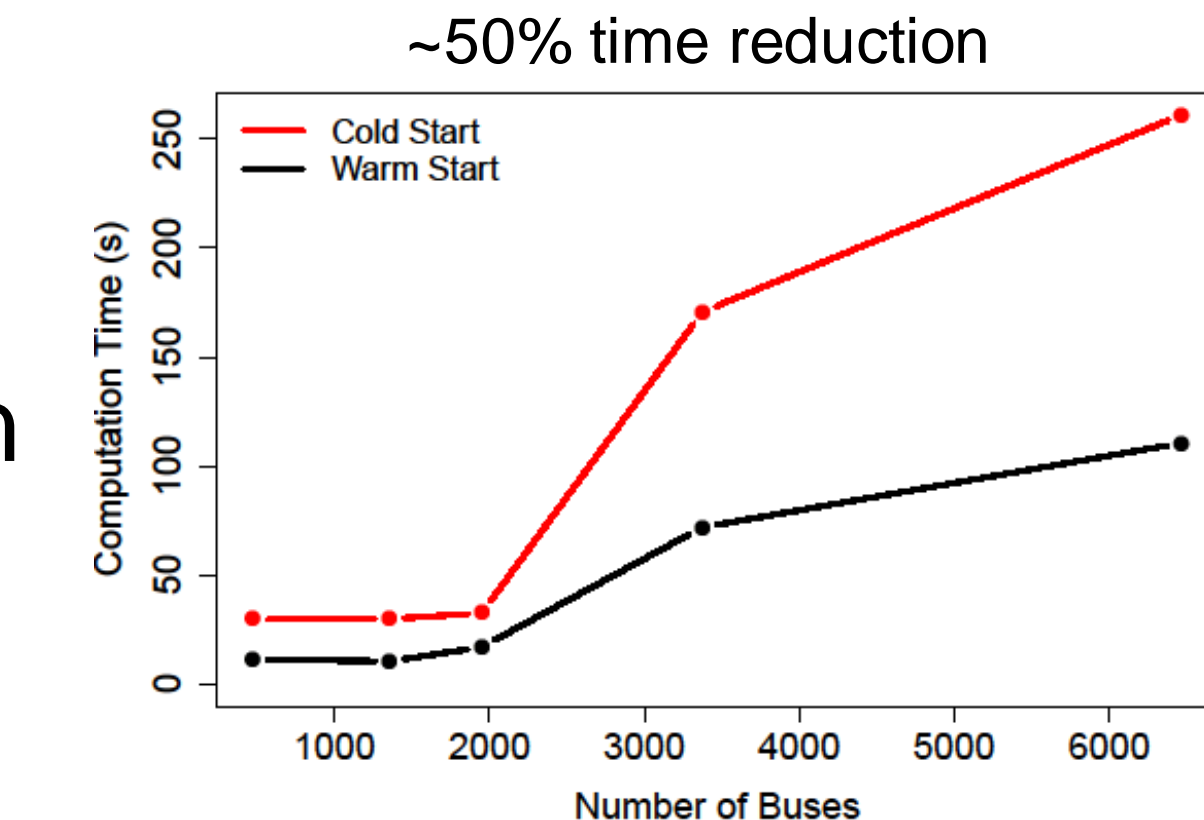

3. Temporal Decomposition

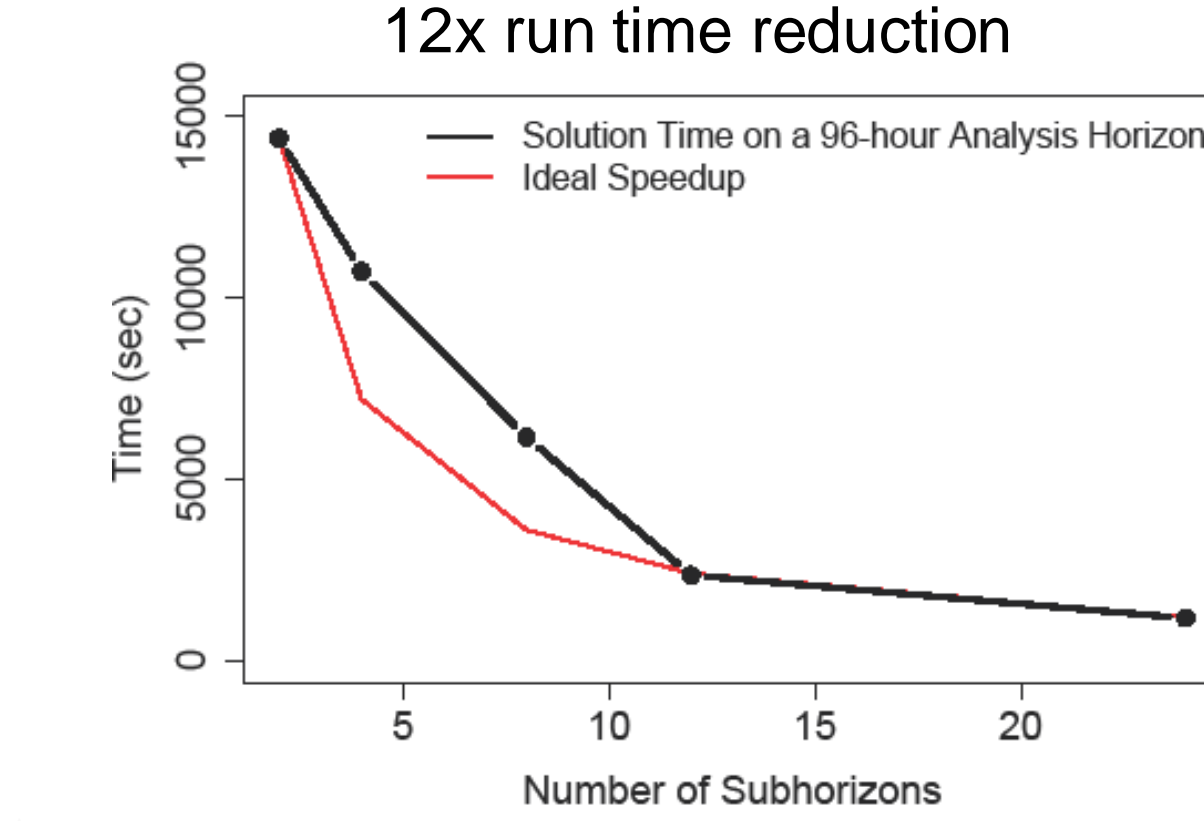

5. Scenario Grouping

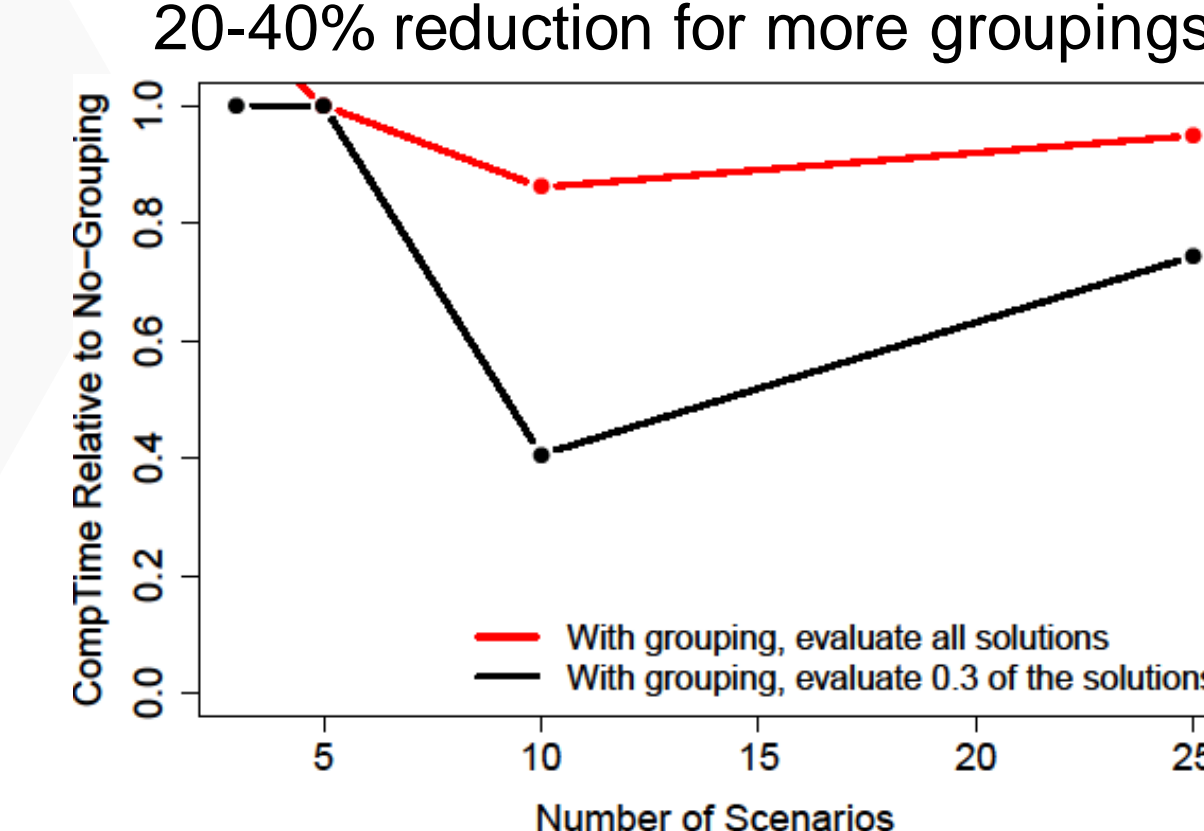

7. MIP Formulation Improvements

Unit commitment improvements

(a) 2% Wind Penetration						
Formulation	EF	Match	STI	3-bin	1-bin*	1-bin
Time (s)	702	154	218	267	712	739
# of times best	0	6	4	2	0	0
# of times 2nd	0	6	5	1	0	0
Max. time (s)	900	411	491	841	900	900
# of time outs	4	0	0	0	7	7
# of B&C nodes	1.00	1.38	5.91	9.03	67.5	50.8

(b) 30% Wind Penetration

Formulation	EF	Match	STI	3-bin	1-bin*	1-bin
Time (s)	808	215	391	401	799	804
# of times best	0	6	2	2	0	0
# of times 2nd	2	1	6	3	0	0
Max. time (s)	900	648	900	900	900	900
# of time outs	6	0	2	3	10	10
# of B&C nodes	1.00	4.66	51.7	78.2	142	130

A visualization of RTS-GMLC to digest PCM simulation results

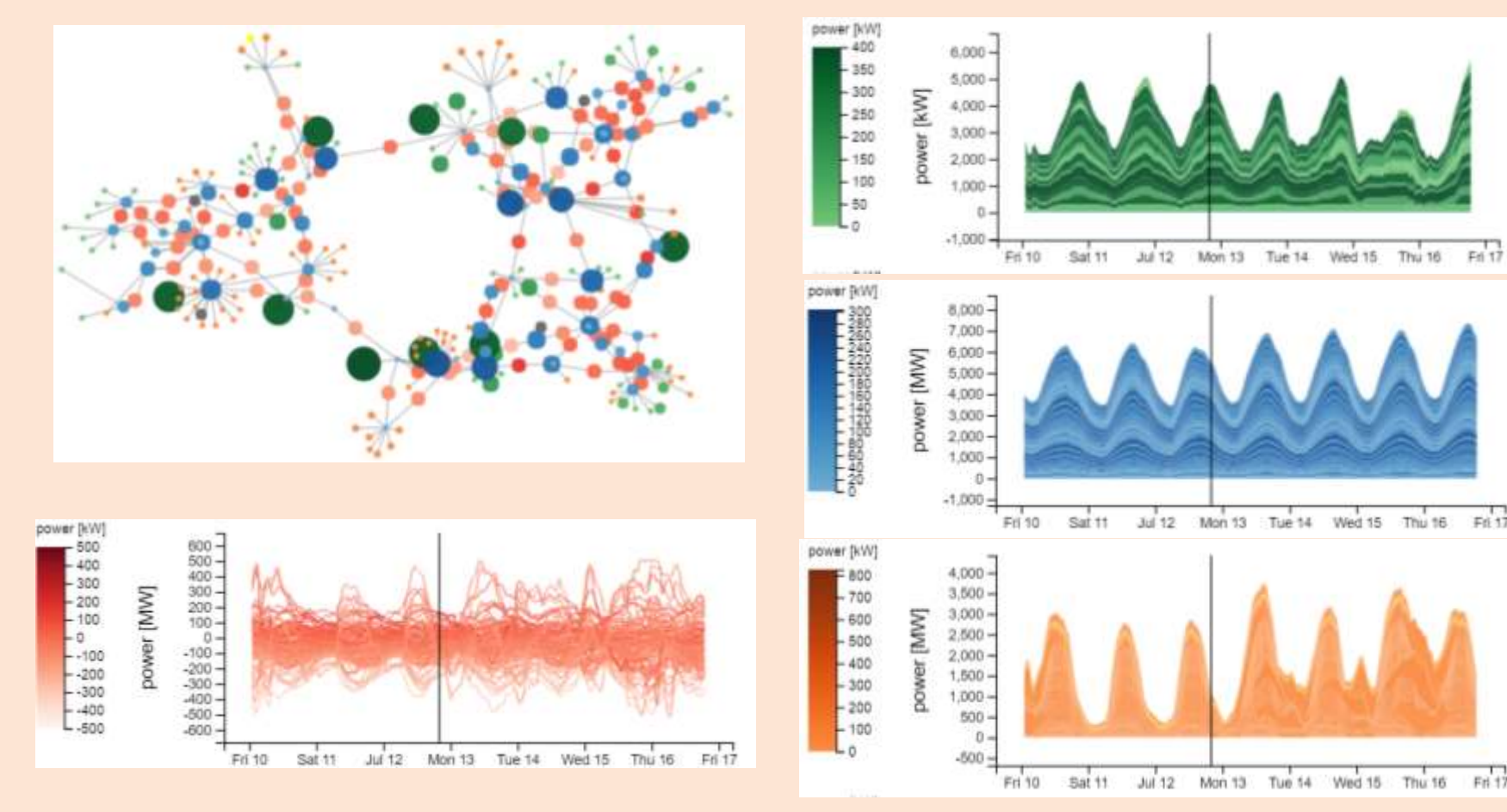

GM0064: Open-Source High-Fidelity Aggregate Composite Load Models of Emerging Load Behaviors for Large-Scale Analysis

PNNL(lead), LBNL, SLAC, WECC MVWG/LMTF, NERC LMTF, SCE



GRID
MODERNIZATION INITIATIVE
U.S. Department of Energy

Project Description

The goal of this research is to develop a set of regional-level, scalable, open source load models and tools for power system planning and operation.

Expected Outcomes

- Models for large-scale aggregate load protection and price-responsive demand
- Next-generation load composition model
- Next-generation load model data tool
- Enable better decisions in power grid planning and operation as well as help avert power outages and contingencies, thus providing cost savings to U.S. power providers and consumers.

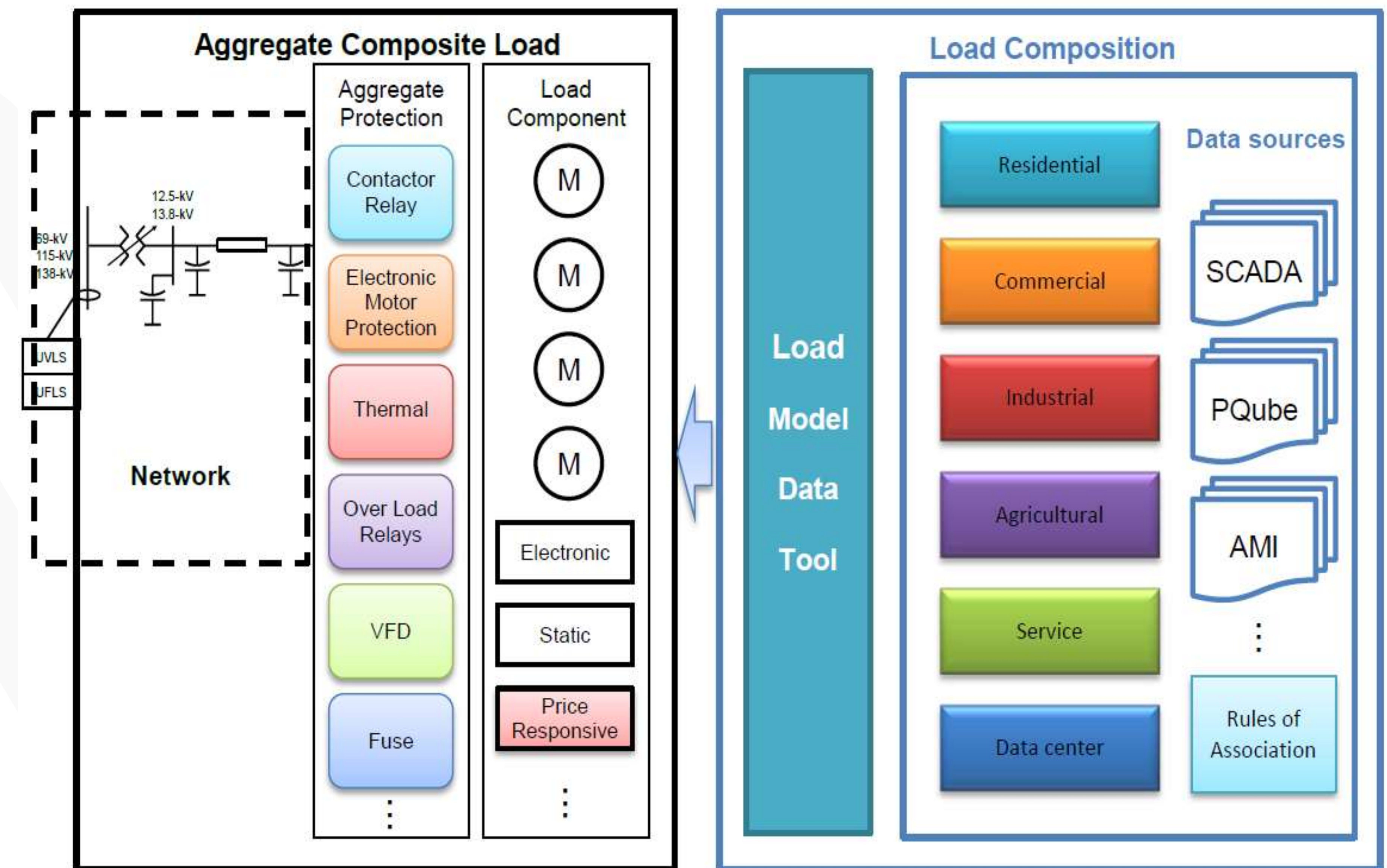

Aggregate Composite Load Modeling

Progress to Date

- Completed framework development for the aggregate load protection model.
- Developed the simulation platform to benchmark the protection parameters generated from the aggregate load protection model.
- Released a technical report on short-term elasticities for time-based electricity rates and published three conference papers.
- Completed the requirements and specifications of the next-generation load model data tool.
- Presented results at multiple events, including IEEE conferences, WECC MVWG, and NERC LMTF.
- Released a new version of the Load Model Data Tool

Significant Milestones	Date
Release of the LMDT 2.2	4/1/18
Release of technical report on short-term elasticities for time-based electricity rates	7/1/18
Release prototype of the next generation regional level load composition model	10/1/18
Generate regional composite load model data for Western, Eastern interconnections and ERCOT	4/1/19

Models and Methods for Assessing the Value of HVDC and MVDC Technologies in Modern Power Grids

Lead: Oak Ridge National Laboratory

Partners: Pacific Northwest National Laboratory, National Renewable Energy Laboratory



Project Description

This work aims to develop the models and methods for assessing and amplifying the value of dc technologies. The multi-objective control and dc system models developed in this project target solutions to current and future RTOs/ISOs/Utilities' issues in HVdc systems.

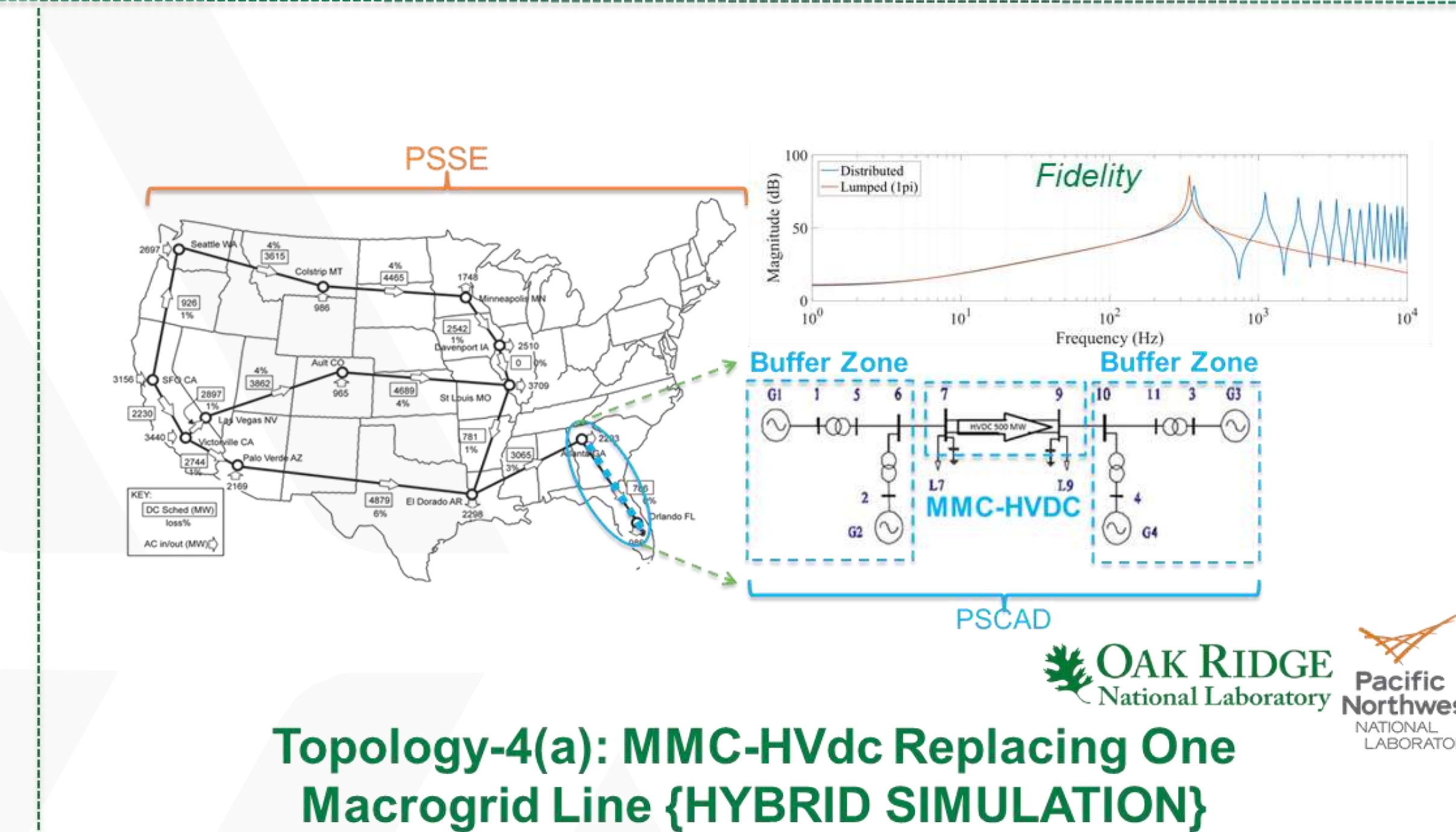
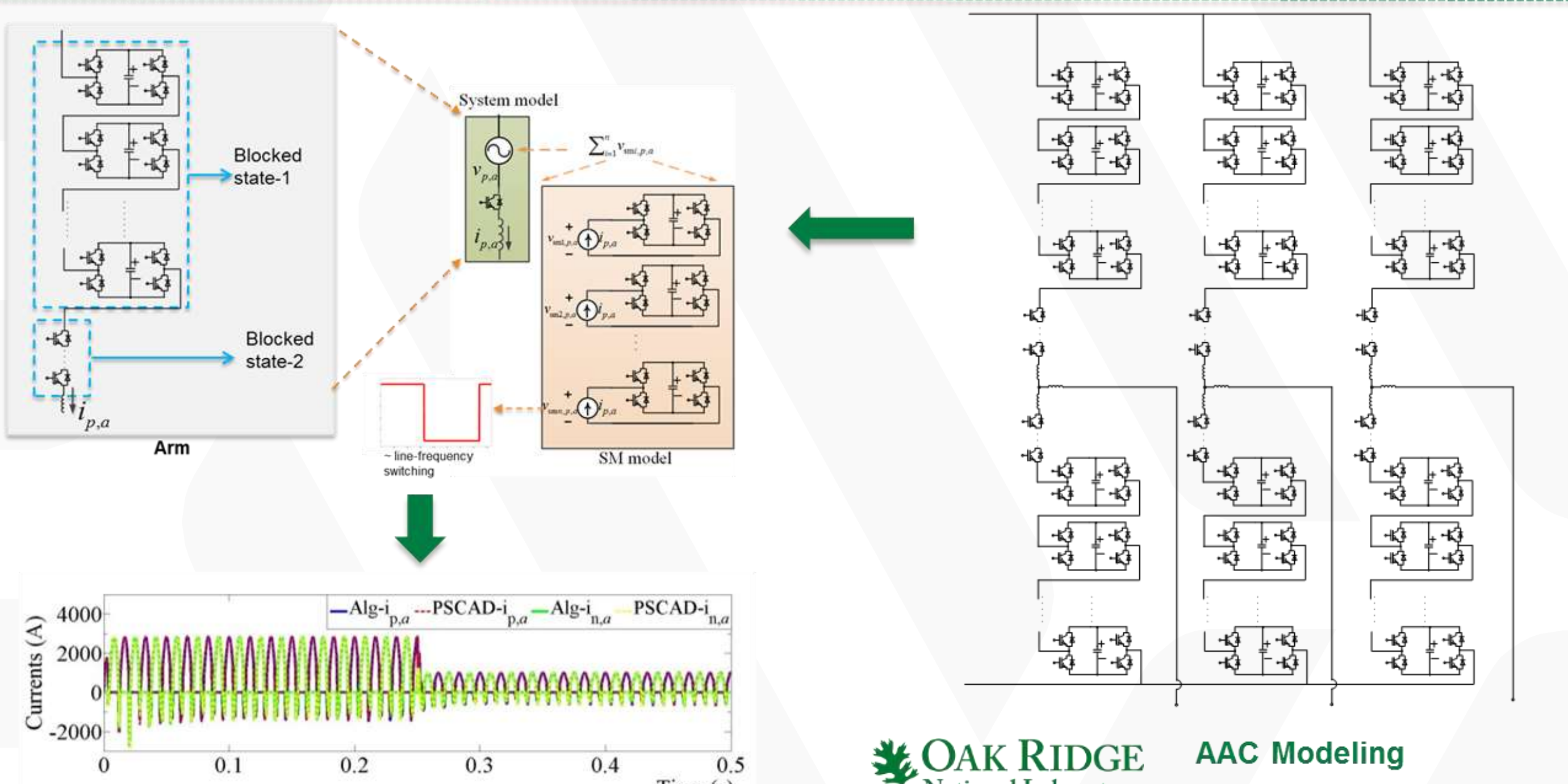
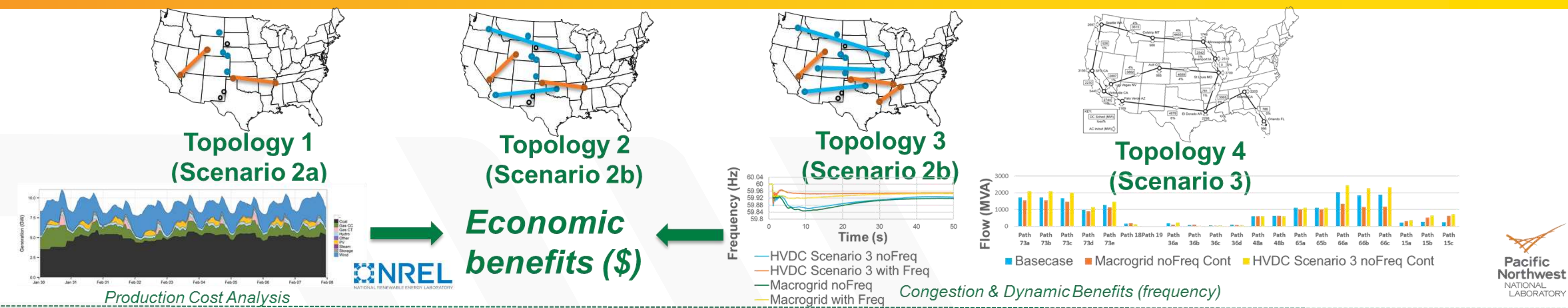

Expected Outcomes

- Economic assessment of different dc penetrations
- Suite of converter models and fast simulation methods
- Multi-terminal dc (MTdc) models
- Hybrid simulation (PSCAD-PSSE) platform
- Quantifying benefits from dynamic simulation (PSSE-PLEXOS)

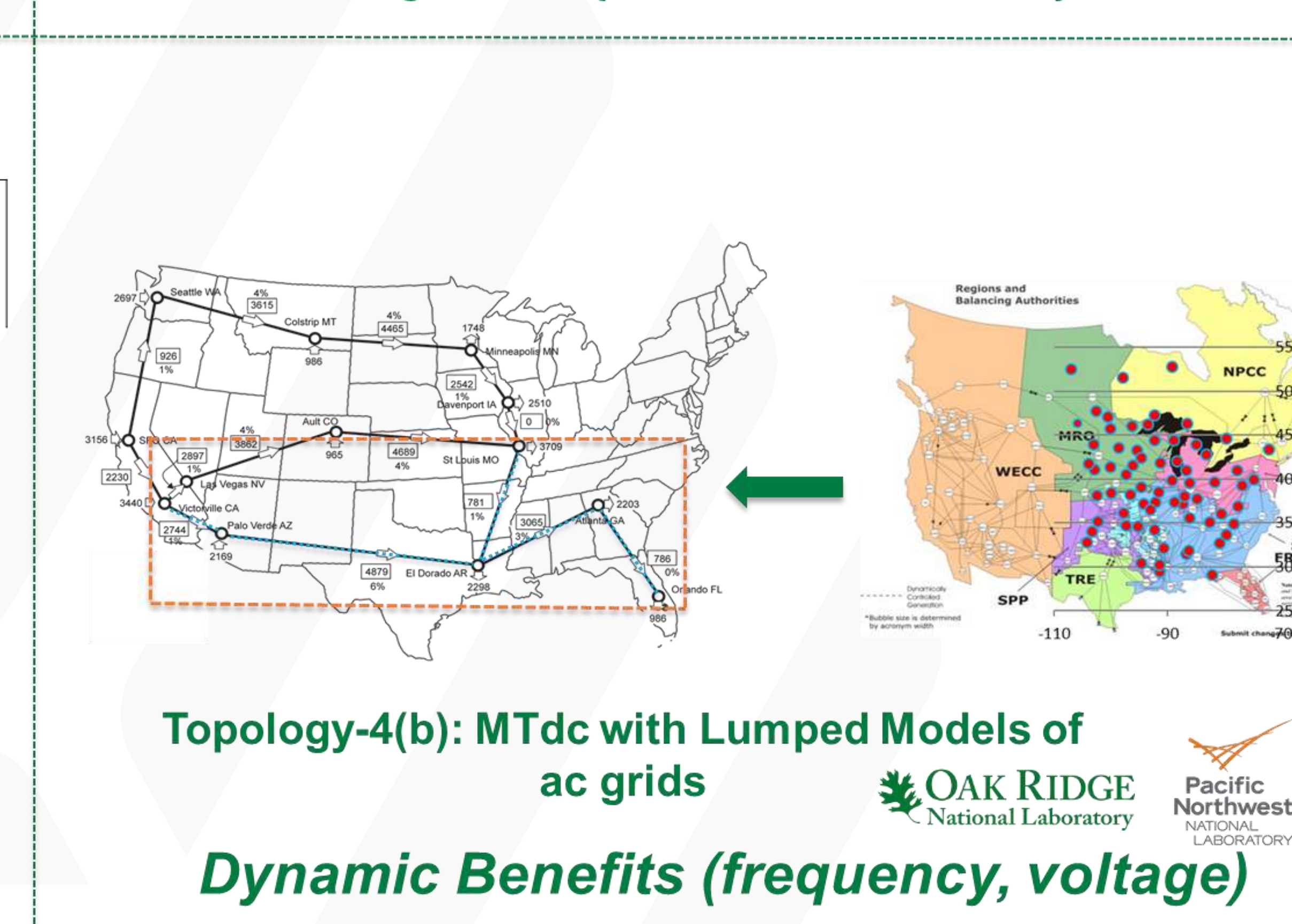
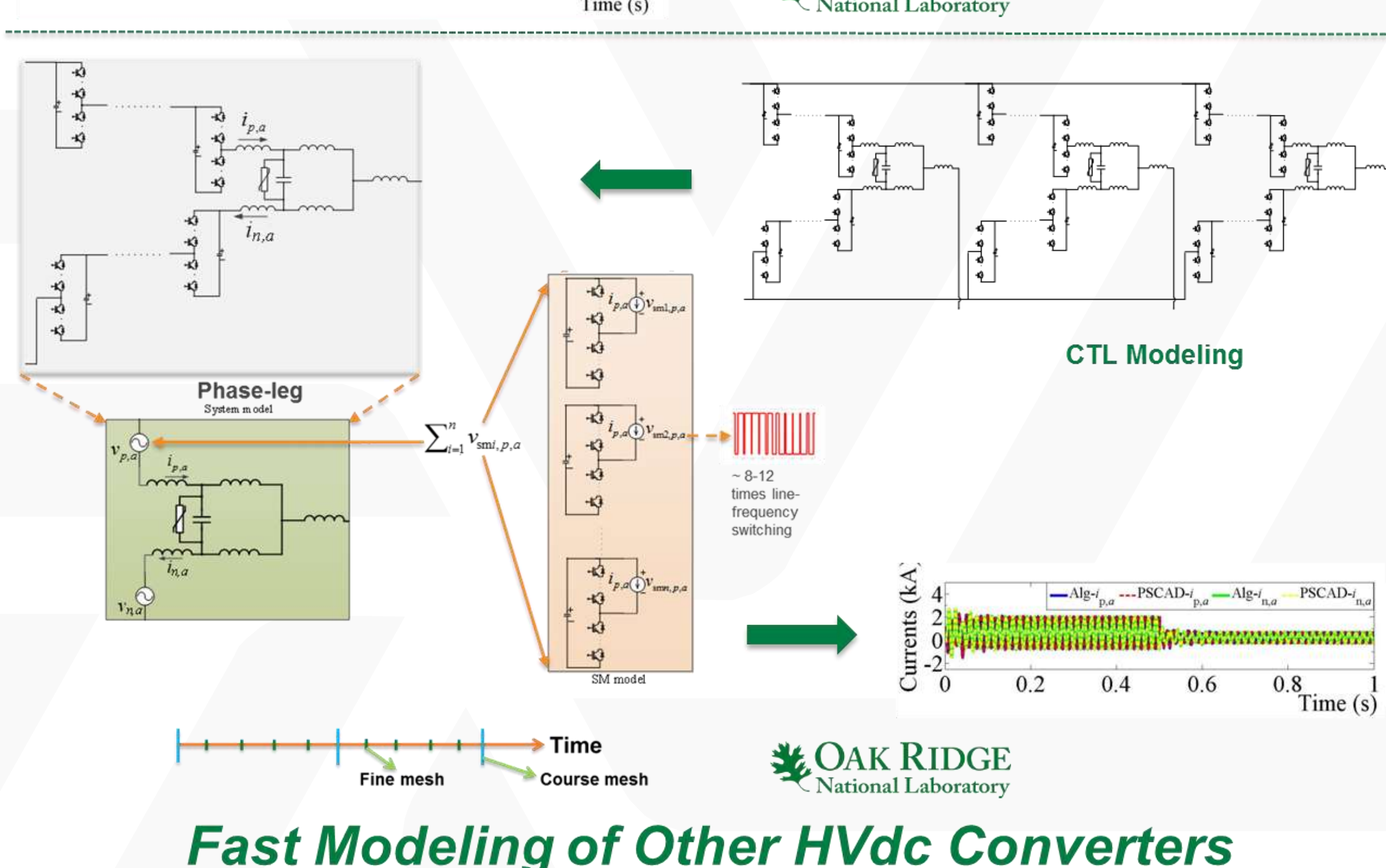

Significant Milestones	Date
Complete dynamic models of AAC and CTL VSCs	03/31/2018
Complete modeling and quantifying benefits from different scenarios of dc systems' penetrations	06/30/2018
Quantify benefits from MTdc systems that connect EI, WECC, and ERCOT	09/30/2018
Complete dynamic simulations to quantify multi-objective control benefits (hybrid simulation)	09/30/2018
Complete economic assessments of dc scenarios	09/30/2018

Progress to Date

- Preliminary results of up to 12x faster voltage-source converter (VSC) models
- Up to 7-terminal multi-terminal dc (MTdc) system models with multi-functional/objective controls
- Multi-area EI & WECC lumped models
- Preliminary hybrid simulation of Kundur 2-area system with separation and model fidelities identified
- PIDG 2.0 speed-up by 10x
- One conference and two journal papers accepted in IEEE IECON, IEEE Transactions on Industrial Electronics, CSEE Journal of Power and Energy Systems

Measurement-Based Hierarchical Framework for Time-Varying Stochastic Load Modeling

Presenter: Dongbo Zhao, Ph.D.

Project team: Argonne National Laboratory, NREL, Iowa State University, SIEMENS PTI



Project Description

This project, led by ANL, is to develop a hierarchical load modeling structure to build time-varying, stochastic, customer behavior-driven and DR-enabled load models by leveraging practical utility data and laboratory experiments. The load modeling techniques leverage practical AMI, SCADA and PMU data at component, customer, feeder and substation levels.

Expected Outcomes

- Static and dynamic load models at component, customer, feeder and substation levels, which are generic and applicable to various practical systems.
- Customer behavior-driven and demand response-enabled load models at component, customer, feeder and substation levels, which are generic and applicable to various practical systems.
- Load model identification techniques which are robust to measurement noises and bad data and suitable for on-line identification of model parameters.
- Recommendations on typical load model parameter values, ranges and probabilistic distributions.
- A set of commercially available software tools with developed load models, which include PSS/E at transmission level, CYME at distribution level, and RTDS/OPAL-RT at customer and component levels
- Technical reports and journal papers with detailed descriptions of load models, assumptions/limitations, laboratory/utility data tests, demonstrations with commercially-available software tools.

Impacts and Benefits

- Be able to account uncertainties (temporal, spatial, human behavior, inter-correlation, etc.) for loads at different levels.
- Support WECC and NERC Composite Load Model (DER_A)
- Apply explicit models developed and machine learning approaches in grid analysis for reliability, stability, resiliency, and control.

Milestones

#	Milestone Name/Description	End Date
1	Overview of power system load modeling/industry practice, and Data Collection.	Month 6
2	Development and testing of load model identification algorithms with trained and validated data-driven models for load composition identification.	Month 12
3	Development and validation of load models at Component, Customer, and Feeder levels.	Month 18
4	Development and validation of load models at substation level.	Month 21
5	Typical ranges and time-varying probabilistic distributions of load models provided.	Month 24
6	Integration of developed load models to existing power system analysis tools with quantification of the operational benefits using the developed load/DG models	Month 30
7	Final reports documenting all models developed with examples of practical operation.	Month 36

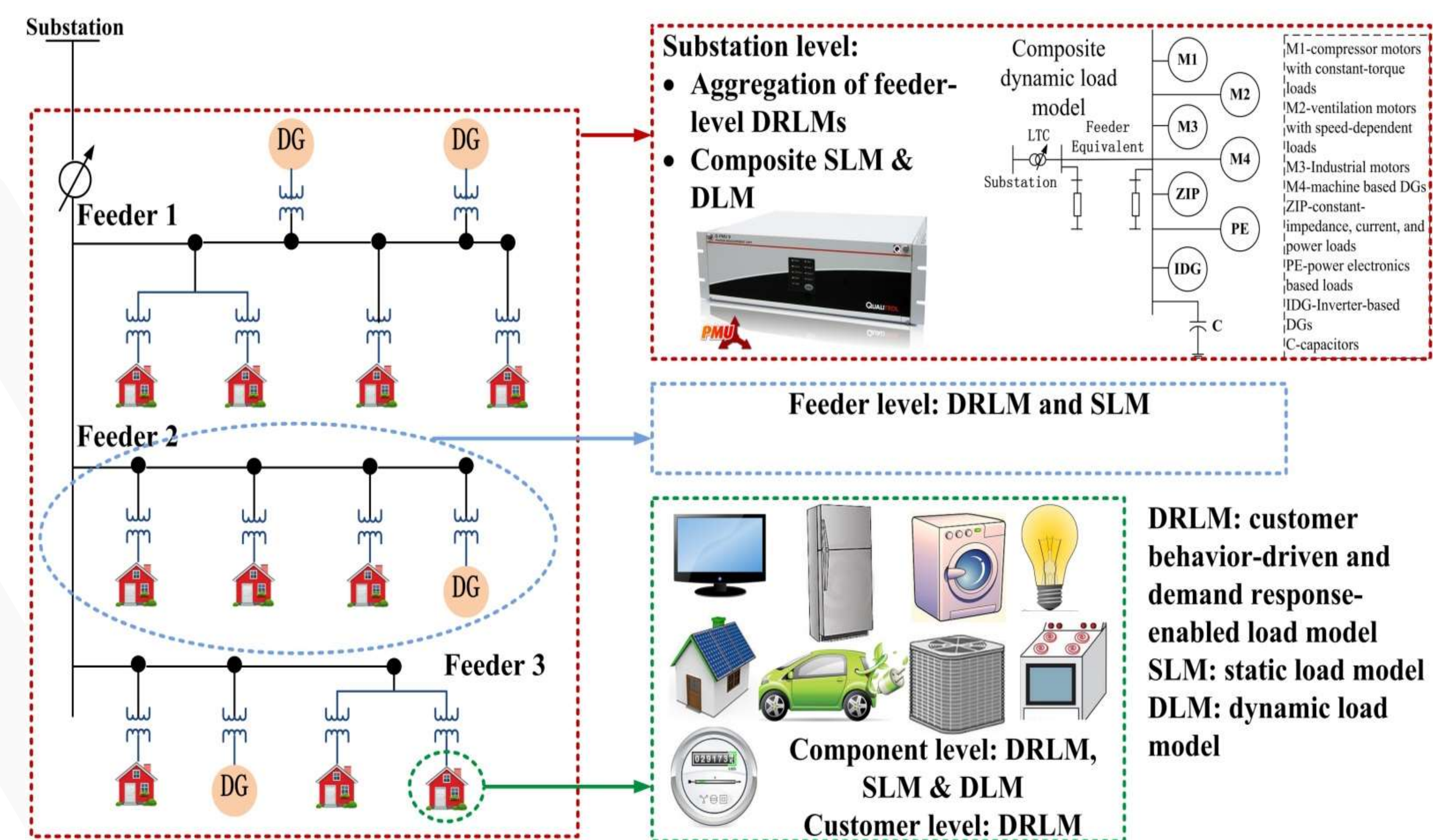

Hierarchical load modeling framework

Progress to Date

- **Peer-reviewed journal articles:**
- Anmar Arif, Zhaoyu Wang, Jianhui Wang, Barry Mather, Hugo Bashualdo, Dongbo Zhao, "Load Modeling – A Review," IEEE Transactions on Smart Grid, Accepted 2017- in press
- Zhaoyuan Fang, Chen Chen, Dongbo Zhao, Jianhui Wang, "Neural Network Ensemble-Based Appliance Identification for Non-Intrusive Load Monitoring," IEEE Transactions on Industrial Informatics, under 1st round review, 2018
- Bo Zeng, Xuan Wei, Dongbo Zhao, Chanan Singh, Jianhua Zhang, "Hybrid Probabilistic-Possibilistic Approach for Capacity Credit Evaluation of Demand Response Considering both Exogenous and Endogenous Uncertainties," Applied Energy, Accepted 2018 - in press
- Chong Wang, Zhaoyu Wang, Jianhui Wang, Dongbo Zhao, "Robust Time-Varying Parameter Identification for Composite Load Modeling," IEEE Transactions on Smart Grid, Accepted 2017 - in press
- Chong Wang, Zhaoyu Wang, Jianhui Wang, Dongbo Zhao, "SVM-Based Parameter Identification for Composite ZIP and Electronic Load Modeling," IEEE Transactions on Power Systems, Accepted 2018 - in press
- Dongbo Zhao, Qian Ge, Jianhui Wang, "Dynamic Aggregated Load Modeling using Recurrent Neural Networks and Rich Features," to be submitted to IEEE Transactions on Smart Grid
- **Workshop and conference presentations:**
- IEEE Smart Grid Webinar – 08/02/2018
- WECC Load Modeling Work Group and NERC Load Modeling Task Force
- Panel Presentation – IEEE PES T&D, ISGT, PMAPS

Protection and Dynamic Modeling, Simulation, and Analysis of Cascading Failures



GRID
MODERNIZATION INITIATIVE
U.S. Department of Energy

Shrirang Abhyankar (Argonne National Laboratory)

Ian Dobson (Iowa State University)

Junjian Qi (University of Central Florida)

Alexander Flueck (Illinois Institute of Technology)

Sandro Aquiles-Perez (Electrocon International Inc.)

Project Description

Lack of high-resolution dynamic and protection models is an important technology gap in predicting blackouts. Goal of this project is to develop state of the art dynamic and protection systems modeling, simulation, and analysis tools to predict root causes and support development of mitigation strategies bolstering resilience against cascading failures for transmission systems.

- Three-phase network model
- Unbalanced faults
- Single-phase induction motor

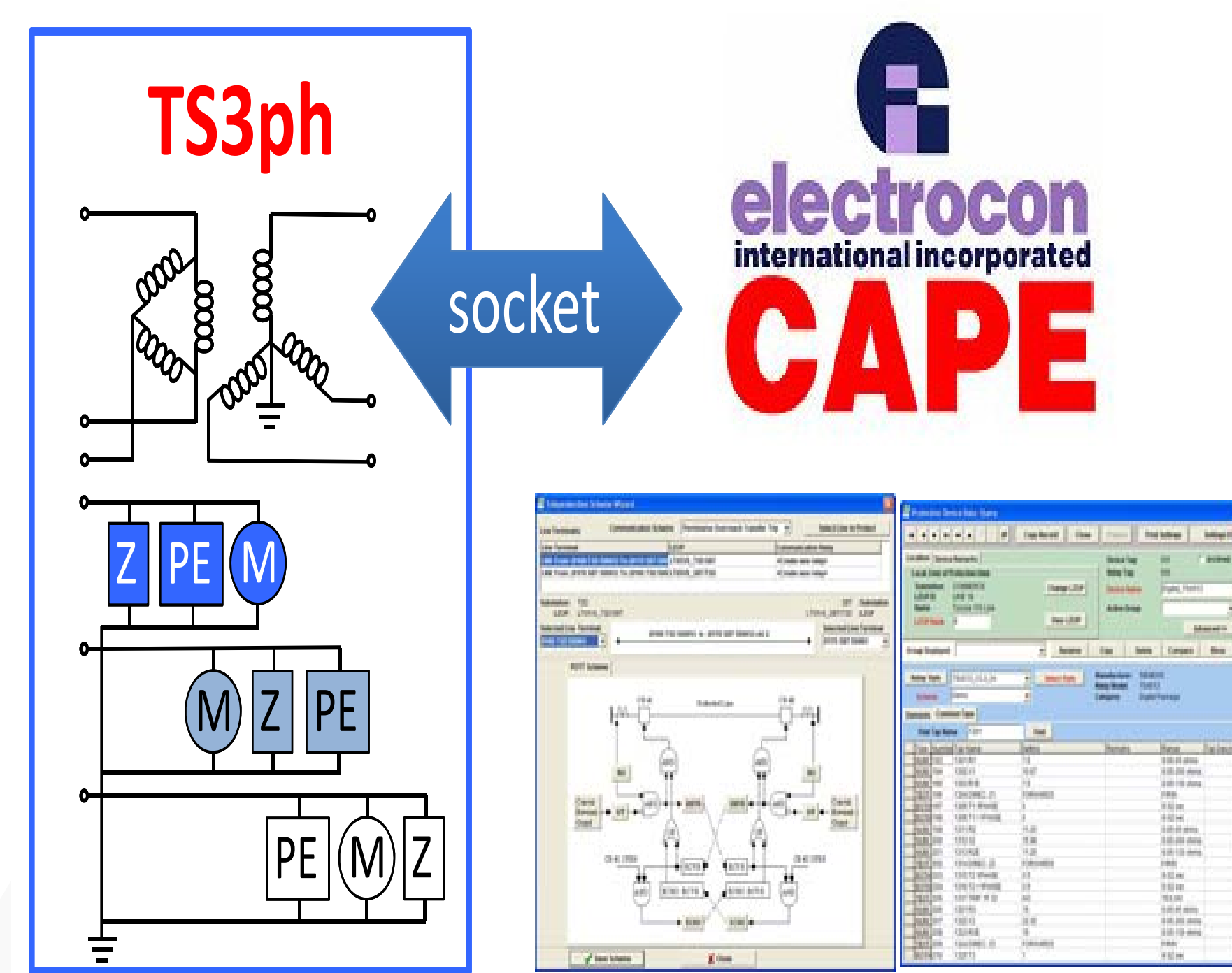

- PETSc**
- Scalable linear solvers
 - Variable time-stepping
 - Limits handling

- Industry-grade protection system models
- Relay database

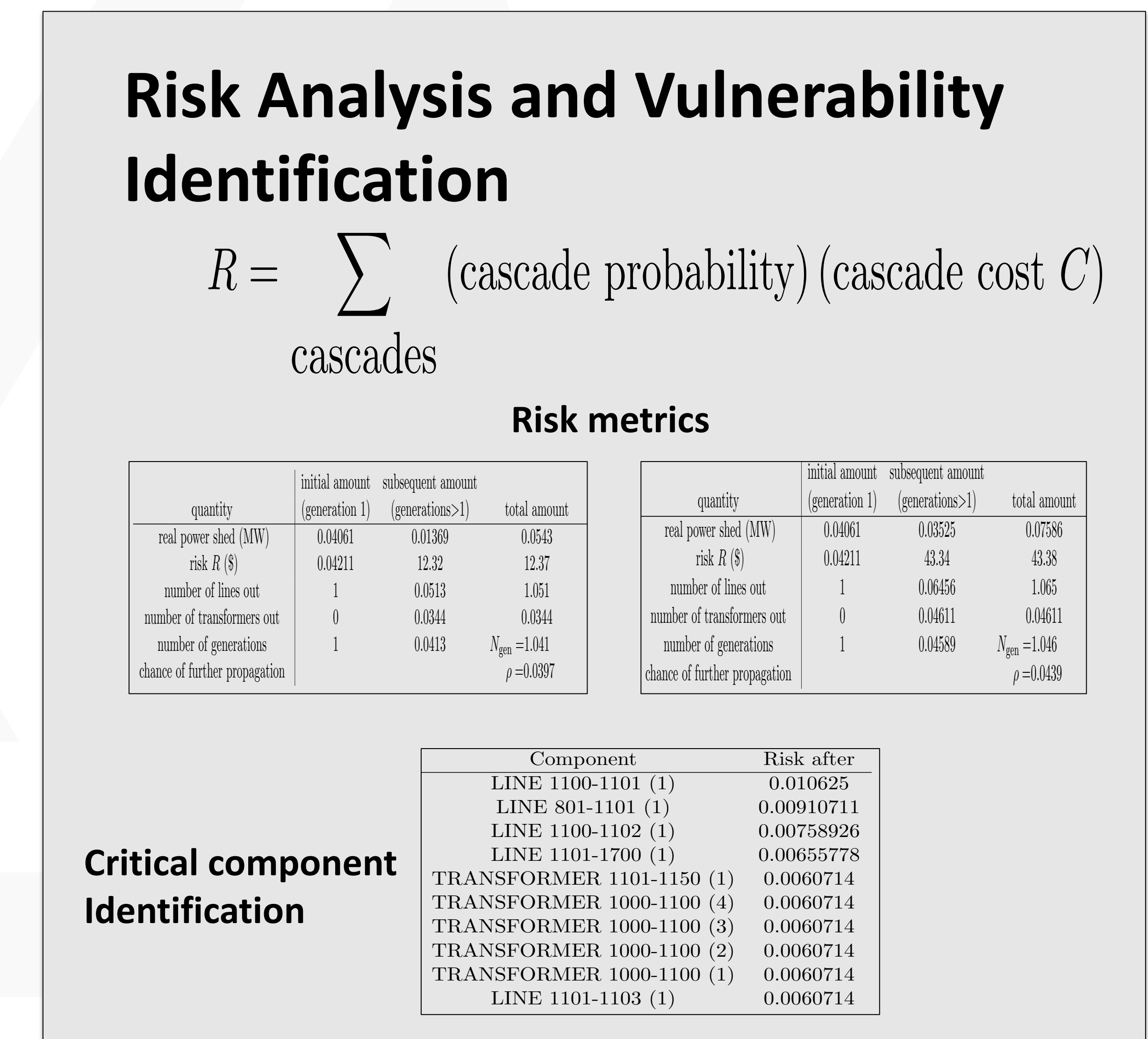
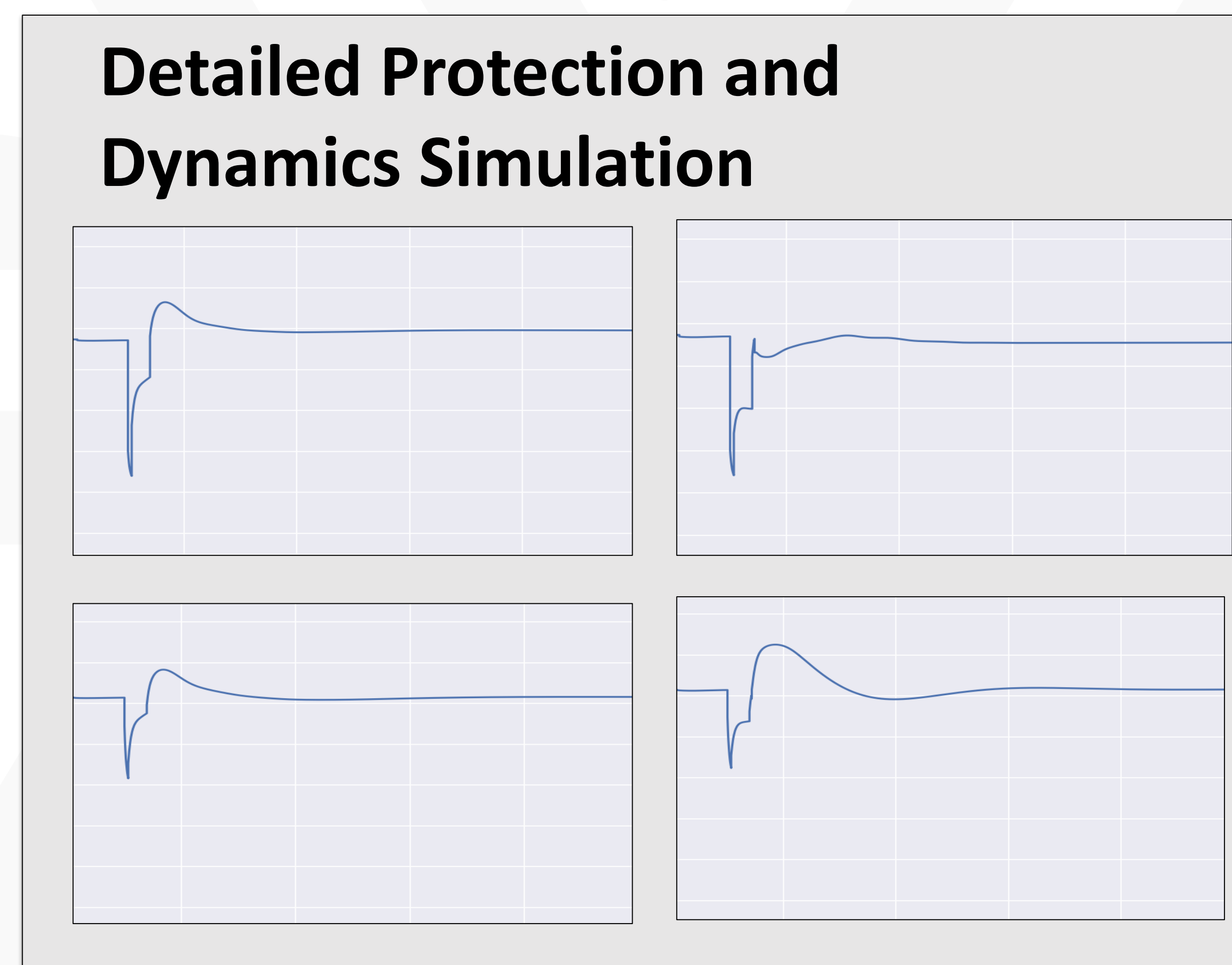
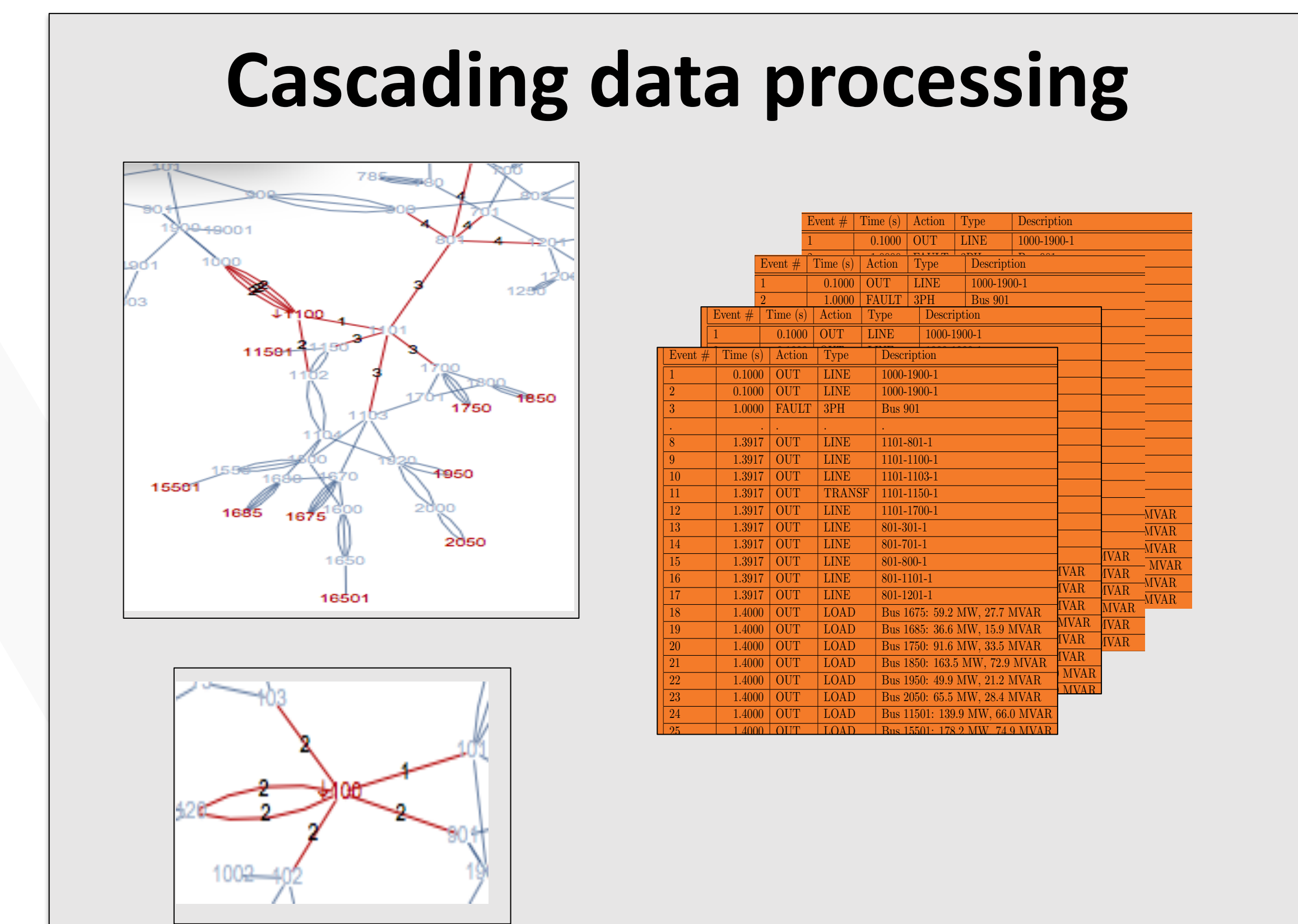
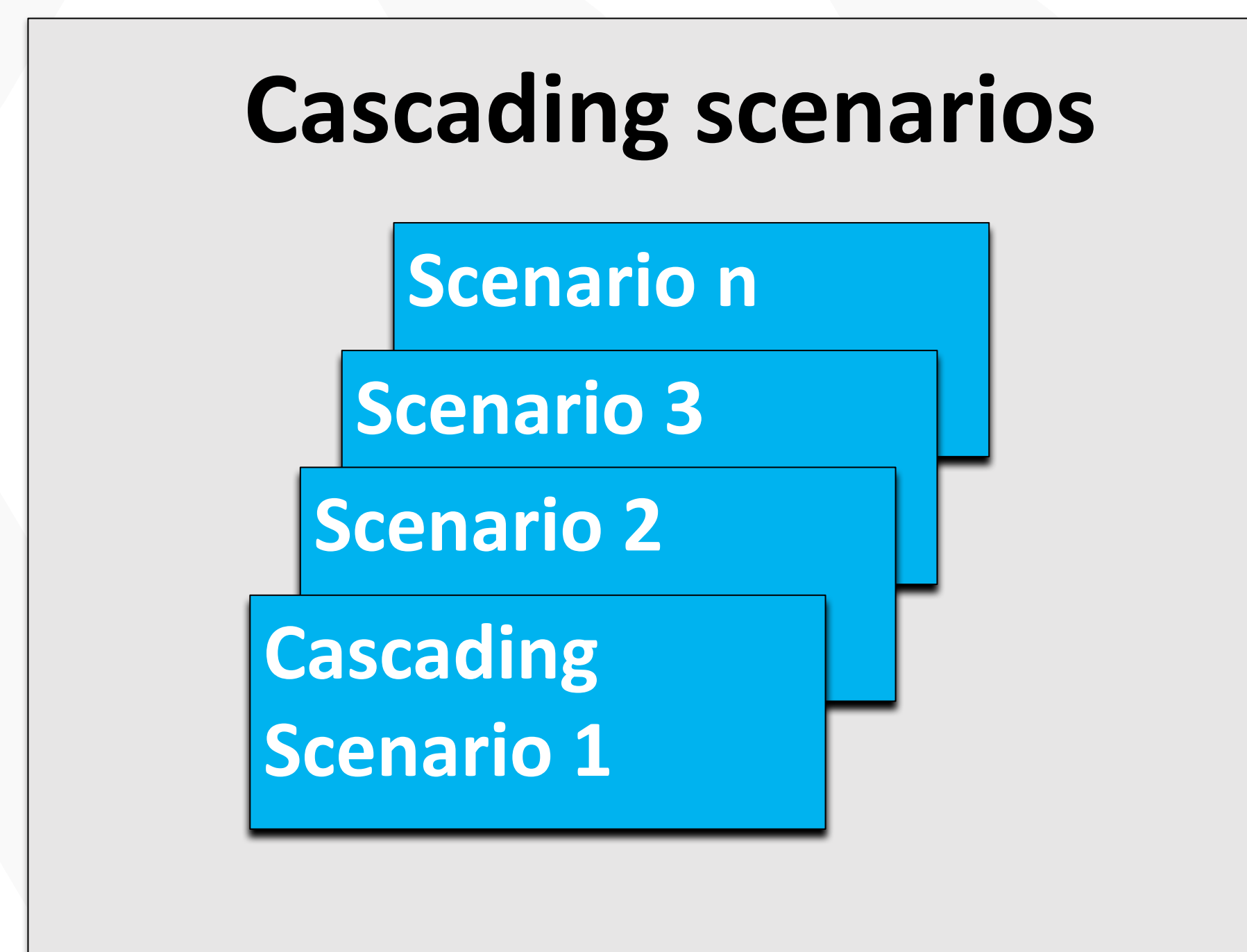

Outcomes

- Cascading failure simulation and analysis with
 - Detailed unbalanced three-phase network
 - High-fidelity protection models
 - Cascading risk analysis
- Comprehensive cascading simulations, including rarer events, to obtain meaningful cascading metrics
- Cascading risk and metrics in terms of dollar contributions
- Identification of critical components starting or continuing the cascades.

Significant Milestones	Date
Handling of discontinuous events in simulator	Sep 2016
Node-breaker model and zero-sequence network model	Dec 2016
Report on practical processing methods for simulator output	Dec 2016
Cascading simulation on 100-bus system	Jun 2017

Accomplishments

- Simulation of cascading failure with industry standard models and detailed protection system
- Data processing and metrics quantifying the impact and risk of cascading failures from simulated cascades
- Identification of critical components contributing to cascading failures
- Proof of principle for practical risk-based cascading simulation, data processing, and analysis for low-probability high-impact events
- Publications:
- *"Towards Incorporating Protection and Uncertainty into Cascading Failure Simulation and Analysis"* – Proceedings of Conference on Probabilistic Methods Applied to Power Systems (PMAPS), 2018.

- ▶ Poster presentations will be presented during our Poster Session towards the end of the first day of the Peer Review. Assume that the attendees may have a mix of policy and technical expertise. Therefore, the posters should be both non-technical enough that a policy professional should be able to understand the general concept of the project, and yet, should infuse some technical aspects of the project that would compel a technical professional to ask questions about your project.
- ▶ Due to the number of posters, there will be two posters per presentation board on each side. Therefore, posters should each be approximately 3.75 feet (or 45 inches) vertical by 3.50 feet (or 42 inches) wide. This slide deck is already sized for this dimension. Push pins will be provided for hanging posters on the boards.
- ▶ General guidance for font size:
 - Title: >90pt
 - Body: >44pt
 - Table: >36pt
- ▶ Posters in the GMI Poster Session are intended to draw attendees to engage with the PI to learn more about the project. Please be mindful information overload – too much data that is included in the poster. A few blank spaces on the poster are okay.
- ▶ Posters should be produced at the labs; work with your communications and production departments as necessary. Plan to bring your poster to the event.
- ▶ Cat 1s – Your poster should reflect content from your peer review presentation as submitted on April 4. Ensure your program manager has had the opportunity to review your poster no later than April 4..
- ▶ Cat 2s – Ensure your program office has the opportunity to review your poster no later than April 4, to allow time for any revisions needed. Please provide a courtesy copy of the final to your Tech Area Lead for overall portfolio awareness.
- ▶ Reminder:
 - This is a public event – all info should be cleared for public release.

Integrated Systems Modeling of the Interactions between Stationary Hydrogen, Vehicle, and Grid Resources

Project Description

Establish the available capacity, value, and impacts of interconnecting hydrogen infrastructure, and fuel cell electric vehicles to the grid.

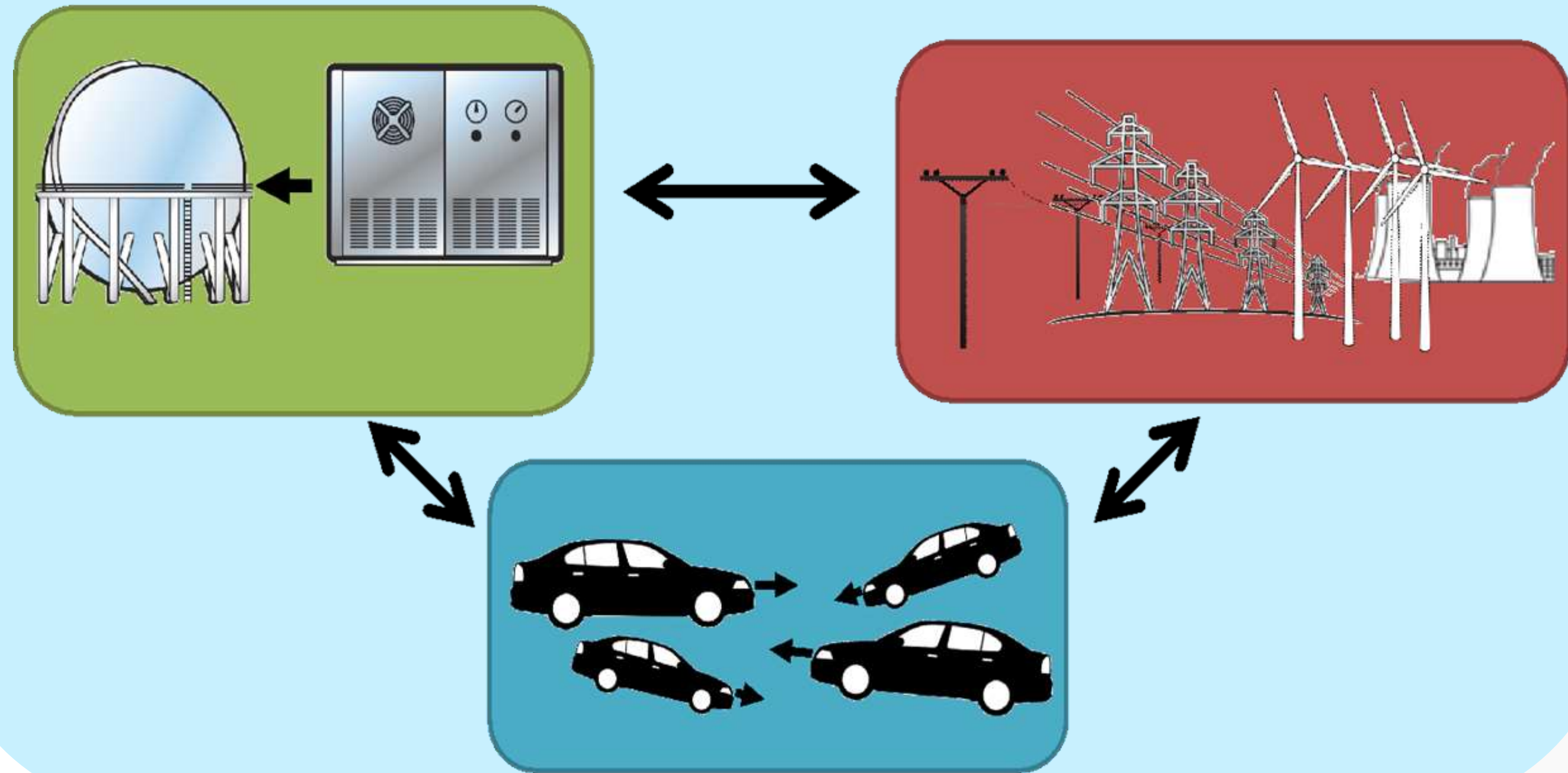

Motivation and Relevance

- Support greater utilization of grid assets for grid reliability, and integration of renewable generation (e.g. mitigating the California net load curve).
- Quantify the co-benefits and value streams for hydrogen resources to provide grid support.

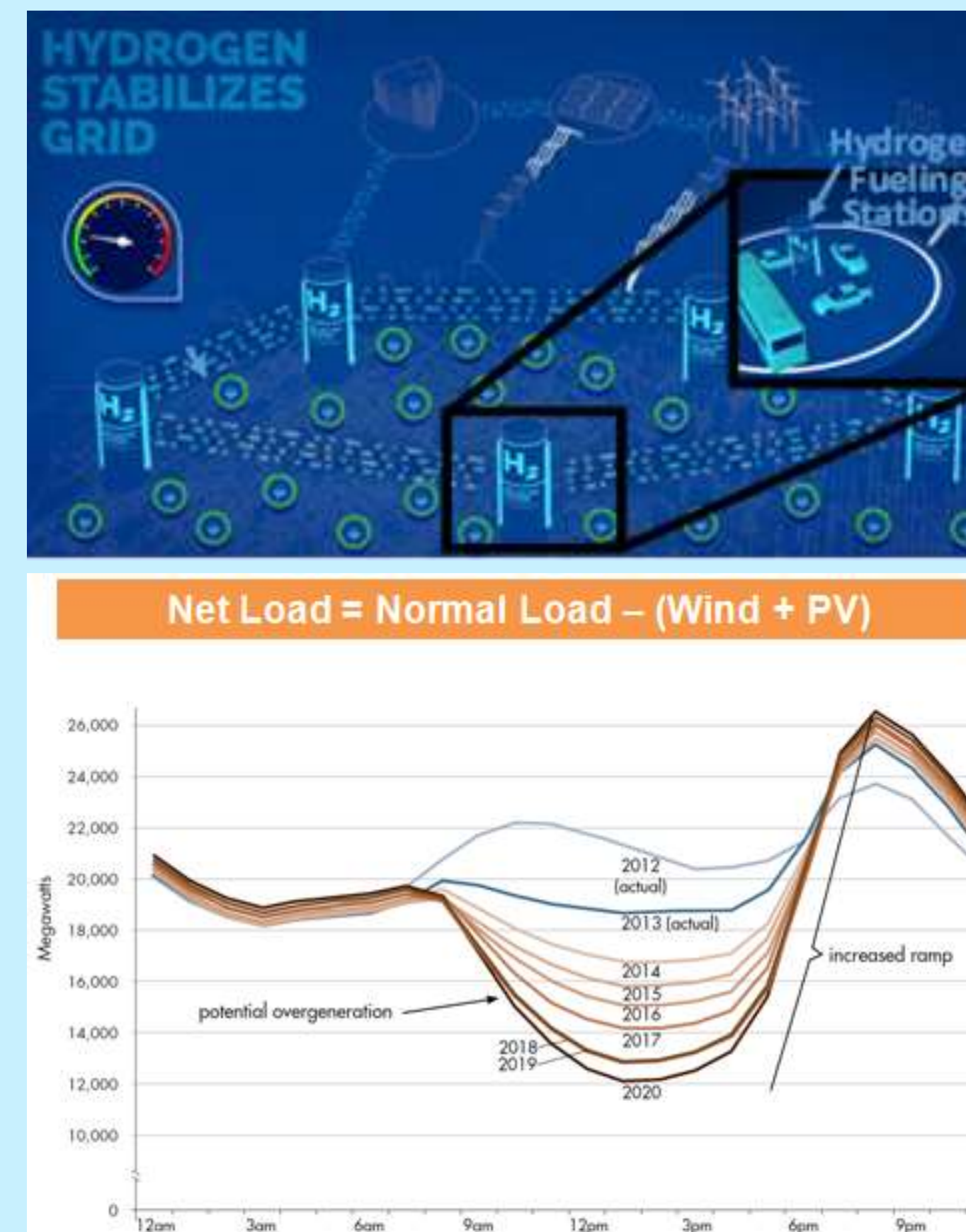

Acknowledgement: This work is supported by the U.S. Department of Energy, Fuel Cells Technologies Office (FCTO)

Significant Milestones	Date
Integrate H ₂ resources into grid models to explore potential benefits and impacts for H ₂ technologies	FY 2018 Q1
Refine input values into economic models for H ₂ resources from available data and literature; Garner industry feedback for project modeling strategy and results.	FY 2018 Q2
Economic case study to quantify the scale of the opportunity from hydrogen-vehicle-grid integration and synthesize findings	FY 2018 Q3 (Go-No Go)

2025 CAISO Ramp-up rates sharply reduced with high FCEV deployment

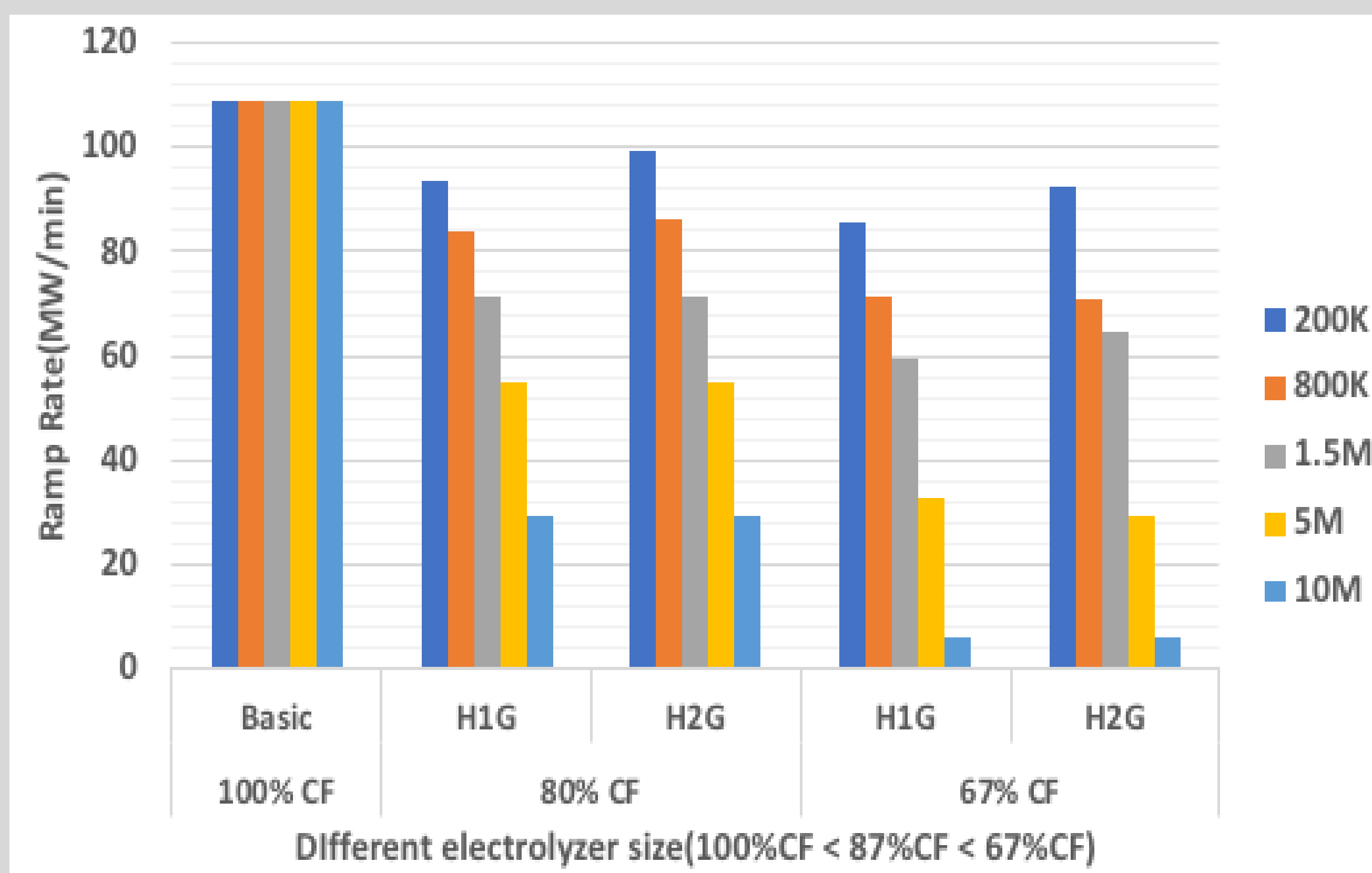

- With an increased number of FCEV s, the ramp-up rate can be reduced sharply.
- The larger the electrolyzer size is, the more ramp-up reduction can be realized.
- Considering the cost and energy loss, H1G is more appropriate for application than H2G.

Central versus distributed hydrogen production

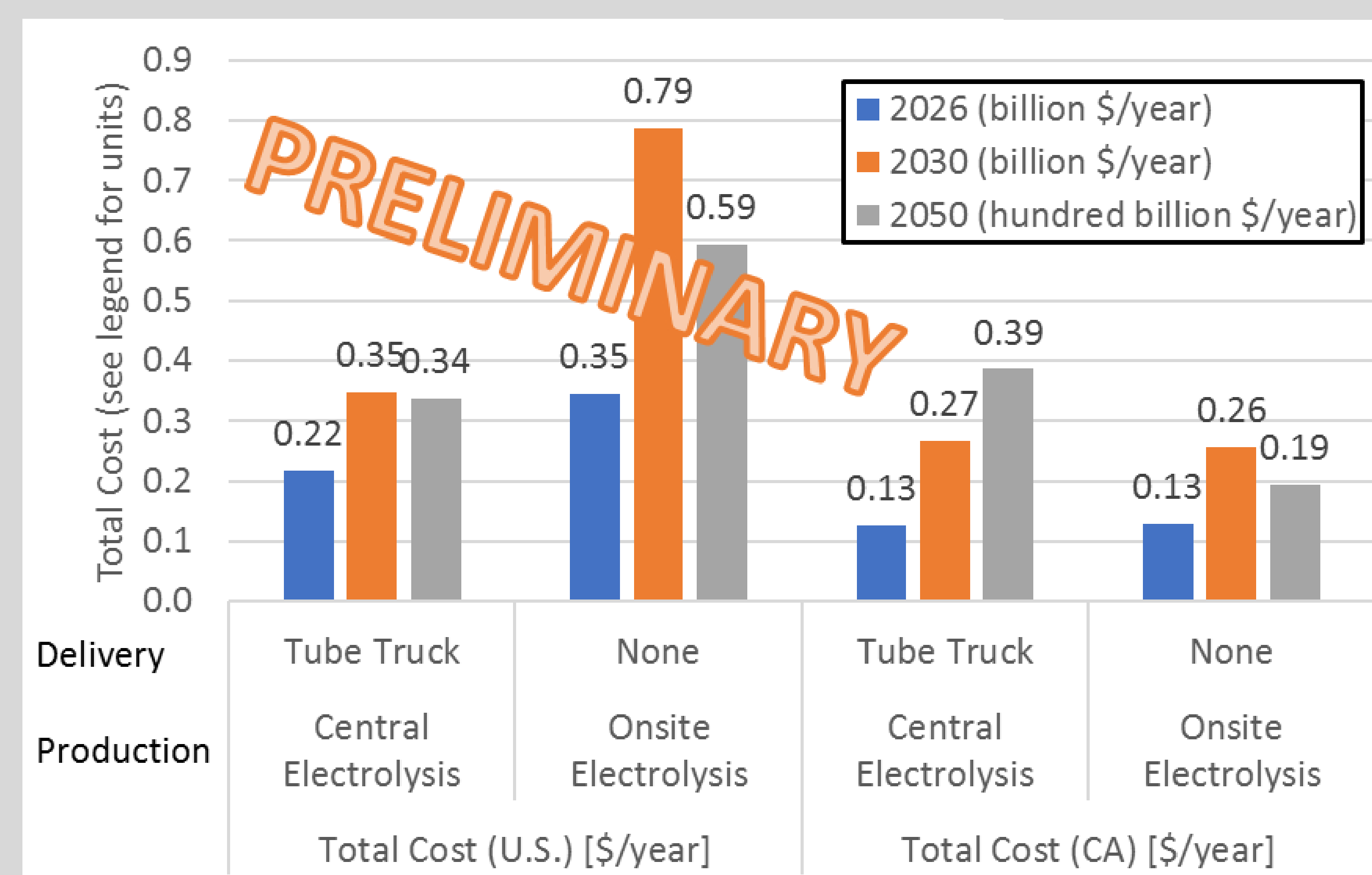

- Local infrastructure decisions can have a significant impact on the overall cost of the system.
- Understanding the implications of investment in different hydrogen production technologies is essential to achieving the lowest system cost.
- Preliminary results show that the optimal selection of production technologies strongly depends on region and timeframe considered

2024 WECC economic opportunity comparison in different scenarios using PLEXOS

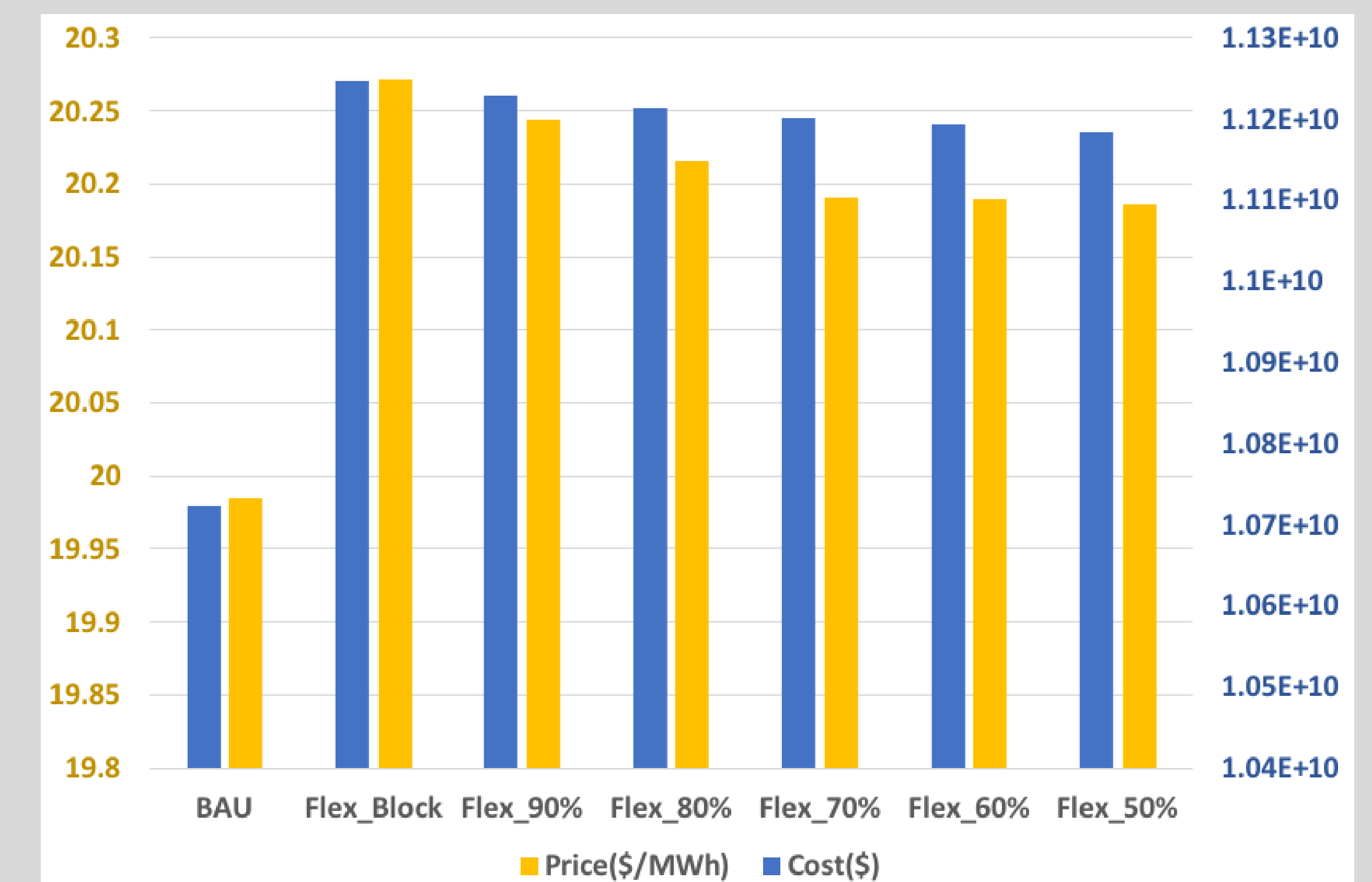

- The flexible hydrogen generation scenarios can optimize the hydrogen production process, which is helpful to reduce the total generation cost.
- The total generation cost can be reduced as the electrolyzer size becomes larger in flexible scenarios.
- The average price has the similar trend as the total generation cost.

Expected Outcomes

- Develop and quantify the influence of flexible hydrogen generation on future grid support.
- Quantify economic opportunity from flexible hydrogen system across the whole WECC area in PLEXOS.
- Develop methods to evaluate the economic value in both centralized and distributed station scenarios.

Progress to Date

- Quantified potential net load shaping in CAISO from H₂ electrolyzer resources; and simulating grid economic costs in PLEXOS with flexible hydrogen production load across the WECC region (**LBNL**).
- Integrated vehicle deployment scenarios, implemented the centralized vs distributed hydrogen stations (**NREL**).
- Journal paper: Quantifying the flexibility of hydrogen production systems to support large-scale renewable energy integration. Journal of Power Sources, 2018.

Next Steps

- Implement scenarios in PLEXOS to quantify the economic opportunity for FCEVs (light, medium, and heavy duty) to provide grid services within the larger AFV opportunity space.
- Generate results from H2VGI+Plexos for each of the chosen scenarios. Compare the relative economic benefits and renewables integration opportunities across the different scenarios of light, medium, and heavy duty FCEV adoption.

Quasi-Static Time Series (QSTS) Simulations for High-Resolution Comprehensive Assessment of Distributed PV



Cat 2- SI_30691 PI: Robert Broderick (SANDIA); Plus 1: Barry Mather (NREL)

Project Team



Problem Statement

The rapid increase in the penetration of distributed energy resources on the electric power distribution system has created a need for more comprehensive interconnection modelling and impact analysis.

Unlike conventional scenario-based studies, quasi-static time-series (QSTS) simulations can realistically model time-dependent voltage controllers and the myriad of potential impacts that can occur at different times of year.

However, to accurately model a distribution system with all its controllable devices, a yearlong simulation at 1-second resolution is often required, which could take conventional computers a computational time of 10 to 120 hours when actual unbalanced distribution feeder is modeled.

Project Overview and Objective

QSTS analysis captures time-dependent aspects of power flow, including the interaction between the daily changes in load and PV output and control actions by feeder devices and advanced inverters.

This project is accelerating QSTS simulation capabilities through use of new and innovative methods for advanced time-series analysis. This project will seamlessly integrate equivalent reduced-order feeder models to precisely simulate grid impacts while dramatically reducing the computational time required to solve the power flow time-series – making QSTS analysis the industry preferred PV impact assessment method.

	Simulation Duration		
	1 Day	1 Month	1 Year
Existing Methods	1.6 – 20 minutes	0.8 - 10 hours	10 - 120 hours
Proposed Algorithm Target	3 minutes	4 minutes	5 minutes

Technical Approach

Computational burden is a clear limitation to the widespread adoption of QSTS simulations in interconnection studies and for determining optimal control solutions for utility operations. Our ongoing research to improve the speed of QSTS simulation has revealed many unique aspects of distribution system modelling and sequential power flow analysis that make fast QSTS a very difficult problem to solve. In this project, the most relevant challenges in reducing the computational time of QSTS simulations are: number of power flows to solve, circuit complexity, time dependence between time steps, multiple valid power flow solutions, controllable element interactions, and extensive accurate simulation analysis.

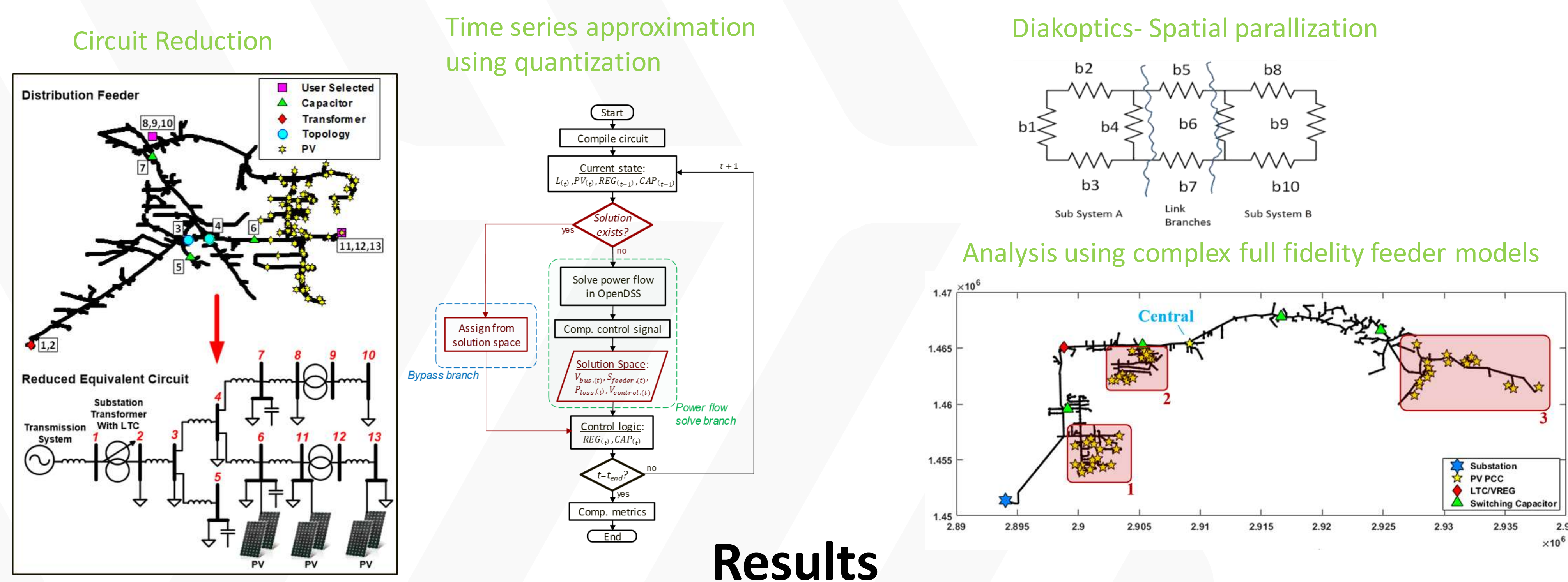

Results

Desired Outcome	Project Output to Date
Develop QSTS algorithms that show speed improvements of 90% or more.	5 rapid time series approximation algorithms have been successfully developed and show speed improvements of 90% or more
Develop Power Flow solution algorithms that speed improvements	Both CYME and EPRI have shown speed improvements of 50% or more
Implement accelerated QSTS analysis into CYME & Open DSS software packages	Combination of the best methods ongoing to verify scalability and accuracy for very complex feeders.
Share data and results	3 journal articles, 13 published papers, 8+ presentations, 1 SAND report and 2 conference panel sessions

Article/Report Title	Journal Name	Significance
Fast Quasi-Static Time-Series (QSTS) for Yearlong PV Impact Studies using Vector Quantization	Solar Energy	Demonstrates time reductions of the vector quantization method to achieve 99+% reductions in QSTS analysis time.
Challenges in reducing the computational time of QSTS simulations for distribution system analysis	Sandia National Laboratories	Provides a detailed review of the key challenges and potential solutions for speeding up QSTS simulations based on the first 1.5 years of the project
An Iterative method for detecting and localizing islands within sparse matrixes using DSSim-RT	IEEE Transactions on Industry Applications	Describes an innovative method to use Diakoptics- a spatial tearing method to assign parts of a feeder to different processors in a parallelization scheme.
A Fast-Scalable Quasi-Static Time Series Analysis Method for PV Impact Studies using Linear Sensitivity Model	IEEE Transactions on Sustainable Energy	Demonstrates time reductions of the event based method to achieve 99+% reductions in QSTS analysis time.



CyDER: A Cyber Physical Co-Simulation Platform for Distributed Energy Resources in Smart Grids



Project Description

- An **open-source, modular, and scalable** tool for power system planning and operation.
- Seamless integration with existing tools and **interoperable** with future utility software, data streams, and controls.
- Quasi-static time series (QSTS) **co-simulation** and optimization, real-time data acquisition, and hardware-in-the-loop (**HIL**) applications.
- Combined **transmission and distribution** system simulation, data collection and analysis, power generation and load **forecasting**, flexibility from electric vehicle (**EV**) charging - and **real-time control of photovoltaics (PV)**.

Expected Outcomes

- Power system co-simulation tool for planning and operation based on the well-established Functional Mock-up Interface (**FMI**) standard.
- CyDER for **short-term planning** for operations: 4-12 hour-ahead QSTS analysis and schedule of inverter set-points for utilities.
- CyDER for **long-term planning**: estimation of PV penetration potential with traditional and novel controls.
- CyDER for **HIL applications**: co-simulation of hardware devices (such as PV inverters, batteries and real-time digital simulators) with software components.

Significant Milestones	Date
Development and integration of individual modules for CyDER (T&D tools, PV and EV models, inverter controllers, etc.).	May 2017
Predictive analytics module for PV & EVs (relative RMSE below 30% for PV and EV forecasts).	May 2017
Interoperability between CyDER modules, sensor data streams and controllers. Development of HIL setup and initial testing.	May 2019
Investigation of PV penetration potential on a selected substation with and without smart inverter controls and battery storage.	May 2019
Full capability for HIL co-simulation with software modules and hardware components including an Opal-RT real time simulator.	May 2019
Delivering CyDER as an open-source bundle including power system FMUs, tools to create new FMUs, co-simulation examples and documentation. Integration effort between CyDER & HELICS.	May 2019

Team: LBNL (lead), LLNL, PG&E, ChargePoint, SolarCity

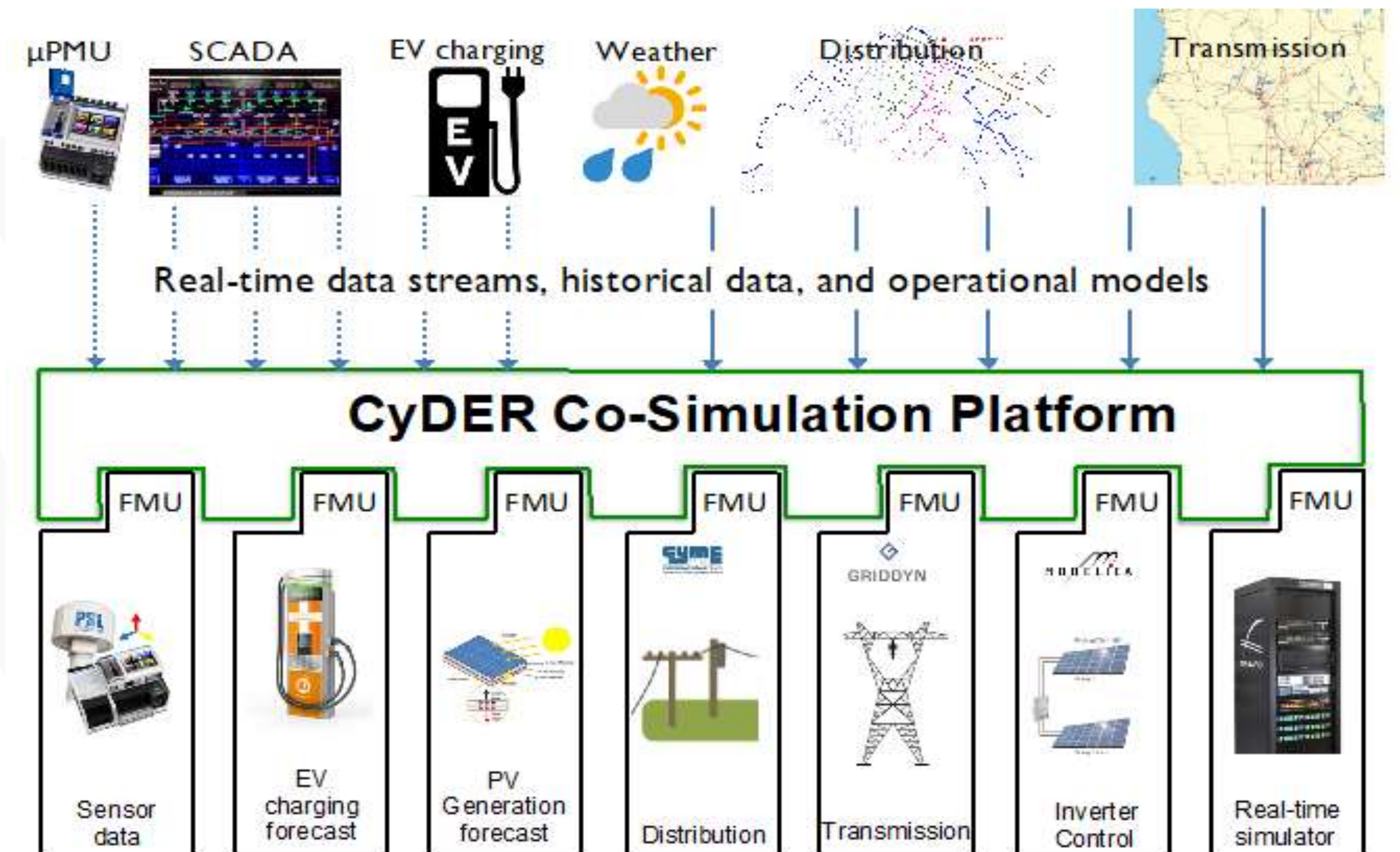

CyDER co-Simulation platform showing integration of simulators, models, controllers and data streams using the FMI standard.

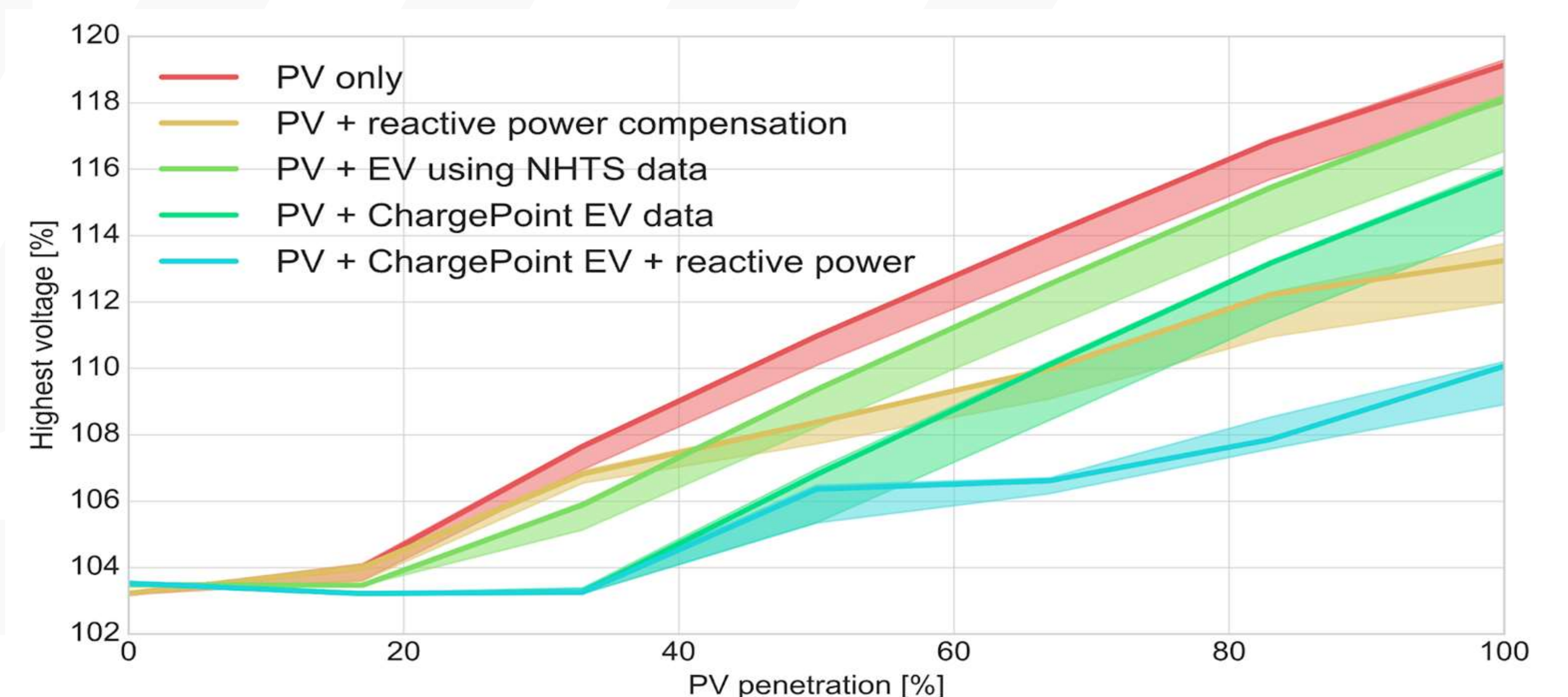

Highest voltage within a distribution feeder as a function of PV penetration (% of annual load energy demand): with and without smart inverter controls and EV charging.

Progress to Date

- Integration of CYMDIST (distribution simulation tool) and GridDyn (transmission simulation tool by LLNL) in CyDER and co-simulation using the PyFMI Master Algorithm.
- SimulatorToFMU: a software package to export a Python-driven simulation or a Python script as a Functional Mock-up Unit (FMU).
- Investigation of PV hosting capacity in real utility feeders with and without smart inverter controls (e.g., Volt/Var) and EV charging.
- Initial HIL testing using CyDER at LBNL's experimental facility FLEXGRID (includes 3 PV inverters + batteries).
- GitHub Repository at <https://github.com/LBNL-ETA/CyDER>

Assessing the Value and Impact of Dispatchable Concentrating Solar Power in a SunShot Future



GRID
MODERNIZATION INITIATIVE
U.S. Department of Energy

Project Description

This project will evaluate the role of CSP in providing grid services including system stability, capacity, energy, and ancillary services

Expected Outcomes

- Provide utilities and system planners a better understanding of the capacity credit of CSP, (ability to provide reliable on-peak generation).
- Provide improved implementation of CSP in commercial production cost models, a class of tools universally applied by system planners.
- Analyze value of CSP in providing system stability. This includes the ability of CSP to respond to contingency events.
- Analysis used extensively by U.S. developers including SolarReserve, BrightSource, and Abengoa in communications to utilities and commissioners
- Highly cited analysis internationally – sets the standard for methods to model and simulate CSP in planning tools.
- Provides utilities, grid planners and other stakeholders improved tools and ability to evaluate the potential role of CSP in providing reliable, low cost energy.

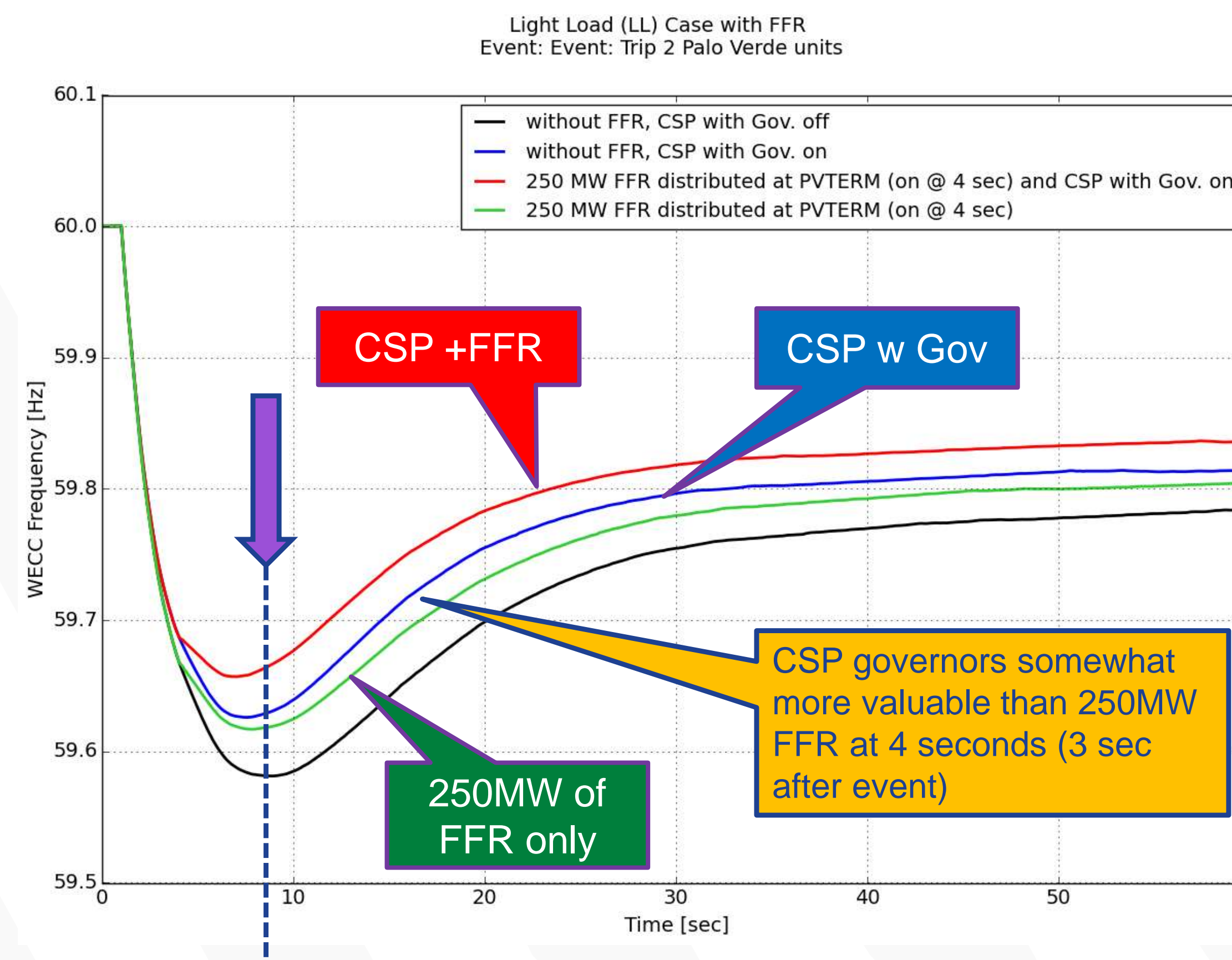

Impact of CSP governor controls on frequency nadir and rate of change of frequency

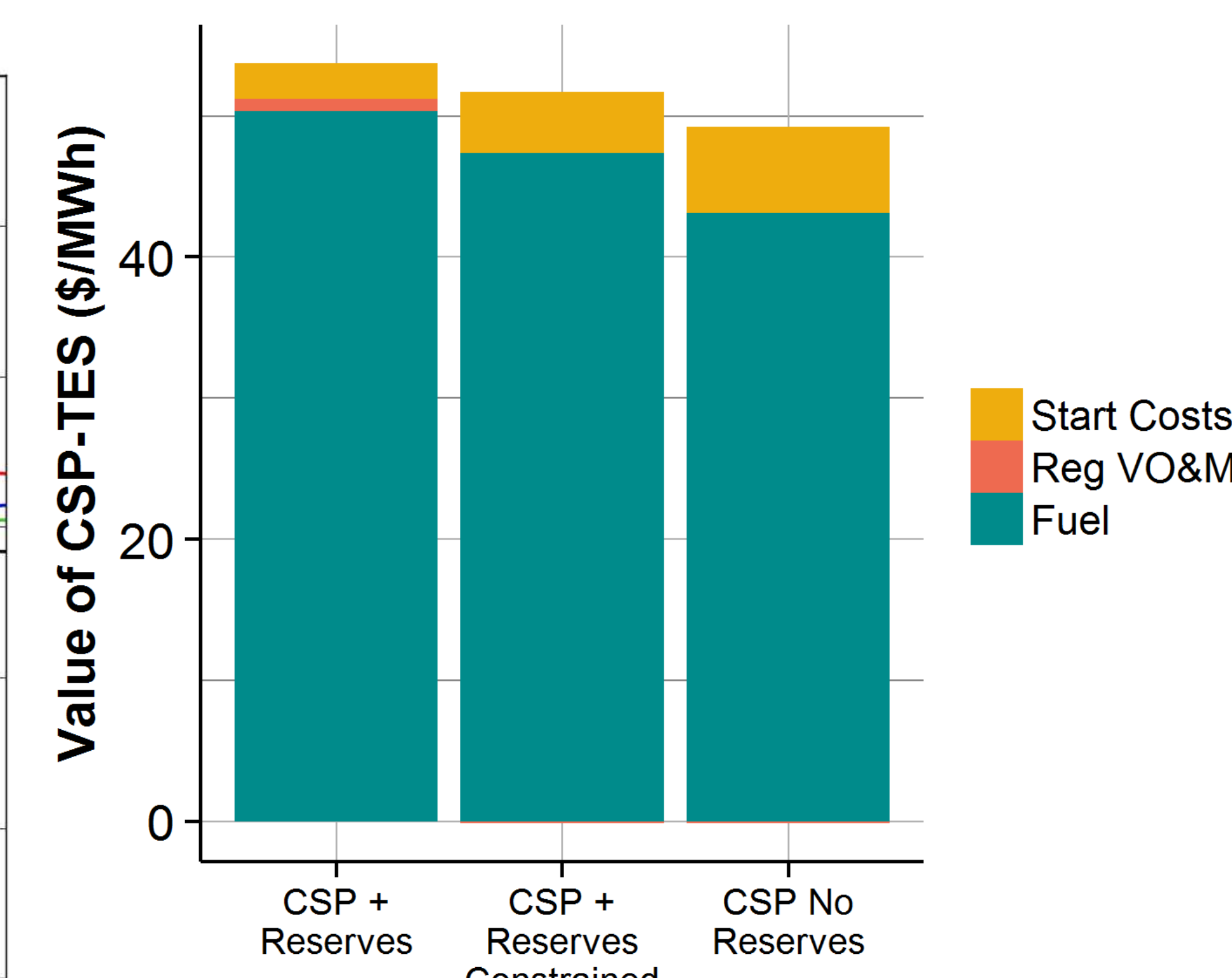

Value of providing operating reserves in the RTS-2016

Progress to Date

- Multiple technical review committee meetings.
- Presentations to: Energy Information Administration Annual Conference, Utility Variable Generation Integration Group, World Bank, IEEE Power and Energy Society Generation Meeting, ARPA-E, Western Energy Institute, Energy Storage Association, EPRI, NERC
- Publications Include:
- Jorgenson, J.; M. O'Connell; P. Denholm; J. Martinek; M. Mehos "A Method to Incorporate Concentrating Solar Power with Thermal Energy Storage in Utility Planning Models" submitted to Journal of Energy Storage
- Martinek, J. ; J. Jorgenson; M. Mehos; P. Denholm "A Comparison of Price-Taker and Production Cost Models for Determining System Value, Revenue, and Scheduling of Concentrating Solar Power Plants" submitted to Applied Energy
- Denholm, P.; J. Eichman, R. Margolis. (2017) Evaluating the Technical and Economic Performance of PV Plus Storage Power Plants. NREL/TP-6A20-68737
- Feldman, D.; R. Margolis; P. Denholm; J. Stekli (2016) Exploring the Potential Competitiveness of Utility-Scale Photovoltaics plus Batteries with Concentrating Solar Power, 2015-2030 NREL/TP-6A20-66592
- N. Miller, S. Pajicm , K. Clark 2018 Concentrating Solar Power Impact on Grid Reliability NREL/TP-5D00-70781
- M. McPherson, M. Mehos, and P. Denholm Leveraging concentrating solar power plant dispatchability: A review of the impacts of global market structures and policy. To be submitted to Renewable and Sustainable Energy Reviews FY18 Q4
- K. Yagi1, R. Sioshansi & P. Denholm. The Ability of CSP to Provide Peaking Capacity Over Extended Time Periods. To be submitted to Solar Energy FY18 Q4.

Significant Milestones	Date
Survey model representation of CSP in existing utility planning tools. Identify areas of deficiencies in these representations potentially including lack of operational value or improper accounting of lifecycle costs	FY16
Demonstrate that grid reliability can be maintained and/or enhanced by CSP with frequency responsive controls	FY17
Simulate CSP plant behavior in commercial dynamic performance software	FY17
Analyze value of CSP peaking plants compared to other configuration and peaking resources including electricity storage.	FY17
Implement improved representation of CSP providing multiple operating modes. Evaluate benefits of CSP when providing multiple ancillary services.	FY18
Capacity credit of low solar multiple CSP using multiple years of resource data and considering use of grid electricity storage	FY18

Improvement and Validation of the System Advisor Model



GRID

MODERNIZATION INITIATIVE
U.S. Department of Energy



NREL: Janine Freeman, Nicholas DiOrio, Nate Blair

Project Description

SAM & PVWatts provide foundational solar profiles and financial analysis for grid integration studies, production cost modeling, technical potential studies, and consumer adoption studies, as well as providing end-user tools that enable a wide variety of stakeholders to perform accurate technoeconomic analysis combining detailed, state-of-the-art solar technology models with sophisticated financial models, powerful scripting, and advanced analysis features not available in any other tool.

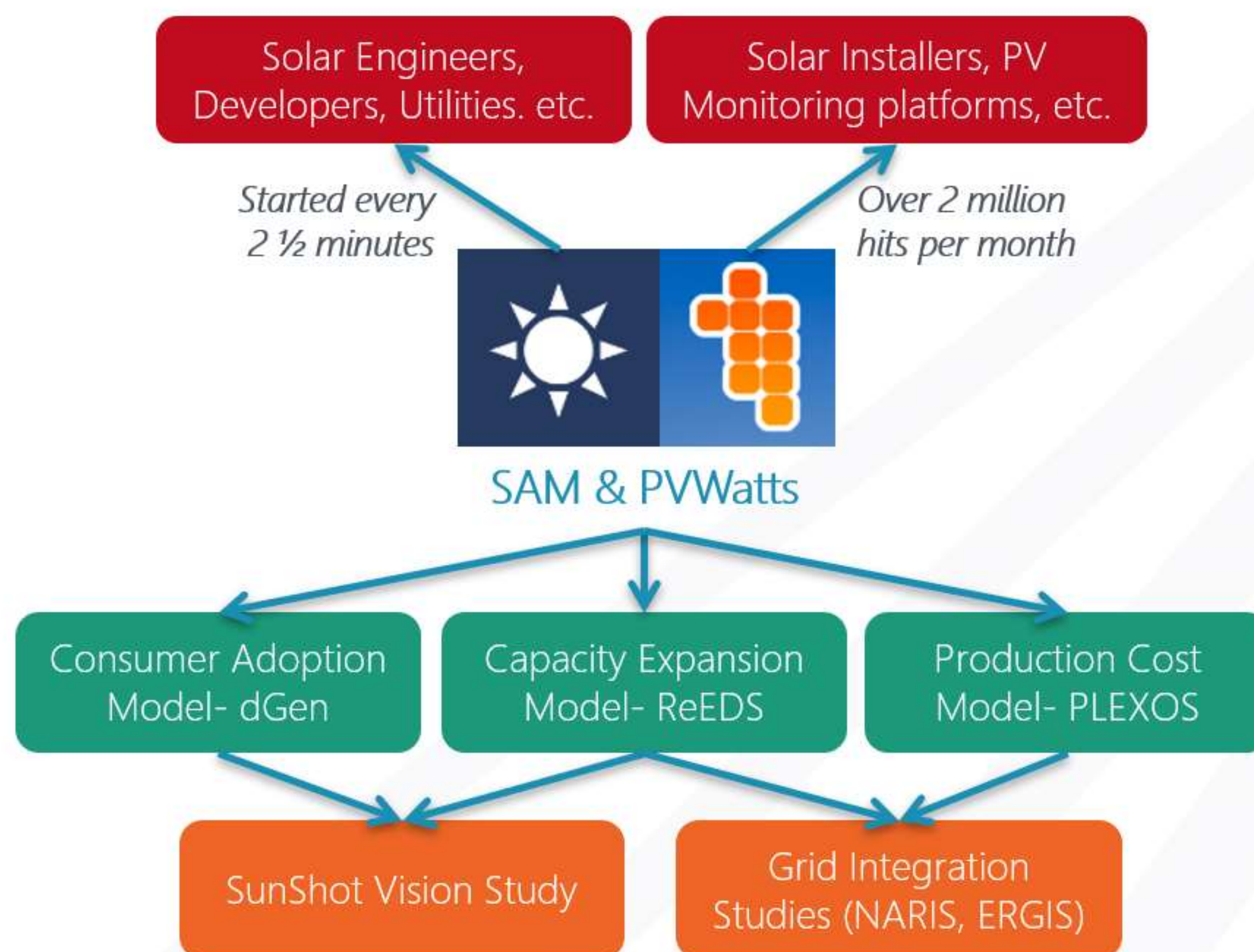

Expected Outcomes

Impact: Provides solar production profiles that are foundational to grid integration, capacity expansion, and production cost models. Reduces risk to financiers, evaluates cost reduction potential, and reduces the cost of capital to lower LCOE.

Innovation: SAM is the only tool that provides the combination of detailed technology and financial models in a fully transparent open-source platform. SAM is the only publicly available platform for:

- PV + Storage: Integrated PV + battery modeling for both behind-the-meter and utility-scale systems, empowering the industry to better predict the potential applications of energy storage for integrating renewables.
- Bifacial PV modeling: Detailed rear-side irradiance model for row installations of bifacial modules, providing the industry and other researchers a model to evaluate the value of installing these novel devices.
- Open code: Enables users to understand and contribute to the underlying algorithms of SAM in a fully transparent, collaborative environment.

Progress to Date

- SAM is launched ~every 2 minutes
- PVWatts gets >2 million hits per month
- 2000+ citations in papers and presentations
- 2000+ unique visitors to SAM open-source repository

Significant Milestones	Date
Open-sourcing SAM & new release	Sep 30, 2017
DC-connected battery model	Sep 30, 2017
Inverter Thermal Model	Sep 30, 2018
Multiple MPPT Inverters in SAM	Sep 30, 2018

Visualization and Analytics of Distribution Systems with Deep Penetration of Distributed Energy Resources (VADER)



(DOE SETO Award DE-EE00031003)

Project Description

This project leverages open-source and open-access big data analytics platforms with state-of-the-art *machine learning* techniques to develop and deploy data-driven techniques for monitoring and planning of distribution systems to accommodate increasing penetrations of Distributed Energy Resources (DERs), especially solar power, and to understand the impact of technologies on the distribution system.

Large number of *heterogeneous* historical and real-time data are ingested, cleansed and organized to enable comprehensive situational awareness, including system state estimation, scenario analysis, and forecasting.

Expected Outcomes

- Develop a **flexible, scalable & easy-to-integrate** data analytics platform, allowing data ingestion, efficient management of data streams with various sampling rates and errors
- Extract information embedded in data: more accurate forecast of load and distribution generation, and **prediction** of complex system dynamics
- Apply modern **machine learning** and statistical inference techniques to develop **analytic tools** for power system operation planning to understand impact of renewable penetration, especially PV; promote **industry adoption** of technologies (e.g., at utilities, such as Southern California Edison)
- Demonstrate real-time visualization, monitoring and control

Significant Milestones	Date
First VADER Technical Workshop and TAG meeting	2016/03/30
DOE On-site Visit, Discussion with VADER Team	2016/07/15
Second Technical Advisory Group (TAG) Meeting	2016/09/15
Budget Year 1 Project Review (in D.C.)	2016/11/09
VADER Hands-On Lab and Second VADER Technical Workshop	2017/03/22-23
Completed VADER System Architecture Design	2017/08/31
Completed VADER System Implementation (Alpha Version)	2017/11/15
Budget Year 2 Project Review (in D.C.)	2017/12/01
Integration of Data-Driven Analytics Tools with VADER	2017/12 - now
DOE Solar Energy Technologies Office Portfolio Review	2018/02/12-14

Publications (Partial list; full list has ~20 journal & conference papers)

- Yang Weng, Yizheng Liao, and Ram Rajagopal, "Distributed Energy Resources Topology Identification via Graphical Modeling", *IEEE Transactions on Power Systems*, July 2017.
- Jiafan Yu, Yang Weng, and Ram Rajagopal, "PaToPa: A Data-Driven Parameter and Topology Joint Estimation Framework in Distribution Grids", *IEEE Transactions on Power Systems*, July 2018.
- Emre Kara, Michaelangelo Tabone, Ciaran Roberts, Sila Kiliccote, and Emma Stewart. "Estimating behind-the-meter solar generation with existing measurement infrastructure", *Proc. of 3rd ACM Int'l Conf. on Systems for Energy-Efficient Built Environments*, (BuildSys'16), Nov. 2016.

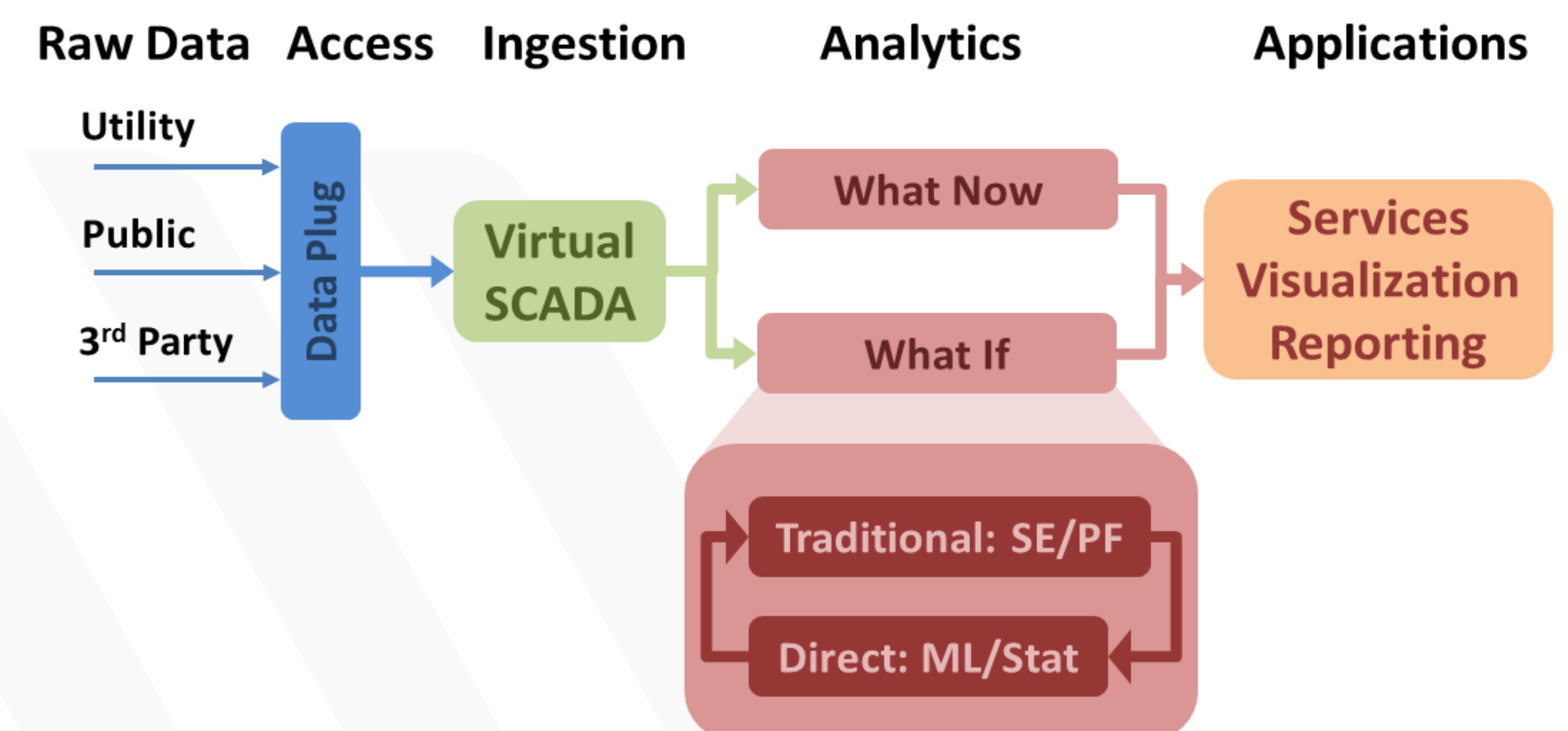

Figure 1. VADER ingestion pipeline: Raw data accessed via various API's are cleansed and then used in data-driven power systems analytics tools

What-now Analytics:

- Grid & resource state estimation
- Estimates of RT load & generation
- Situation awareness – outage detection, topology change

What-if Analytics:

- Day ahead planning; scenario analysis of PV integration, time-space analysis, location benefits

Project Progress (Partial List of Analytics Tools)

Network Topology Reconstruction

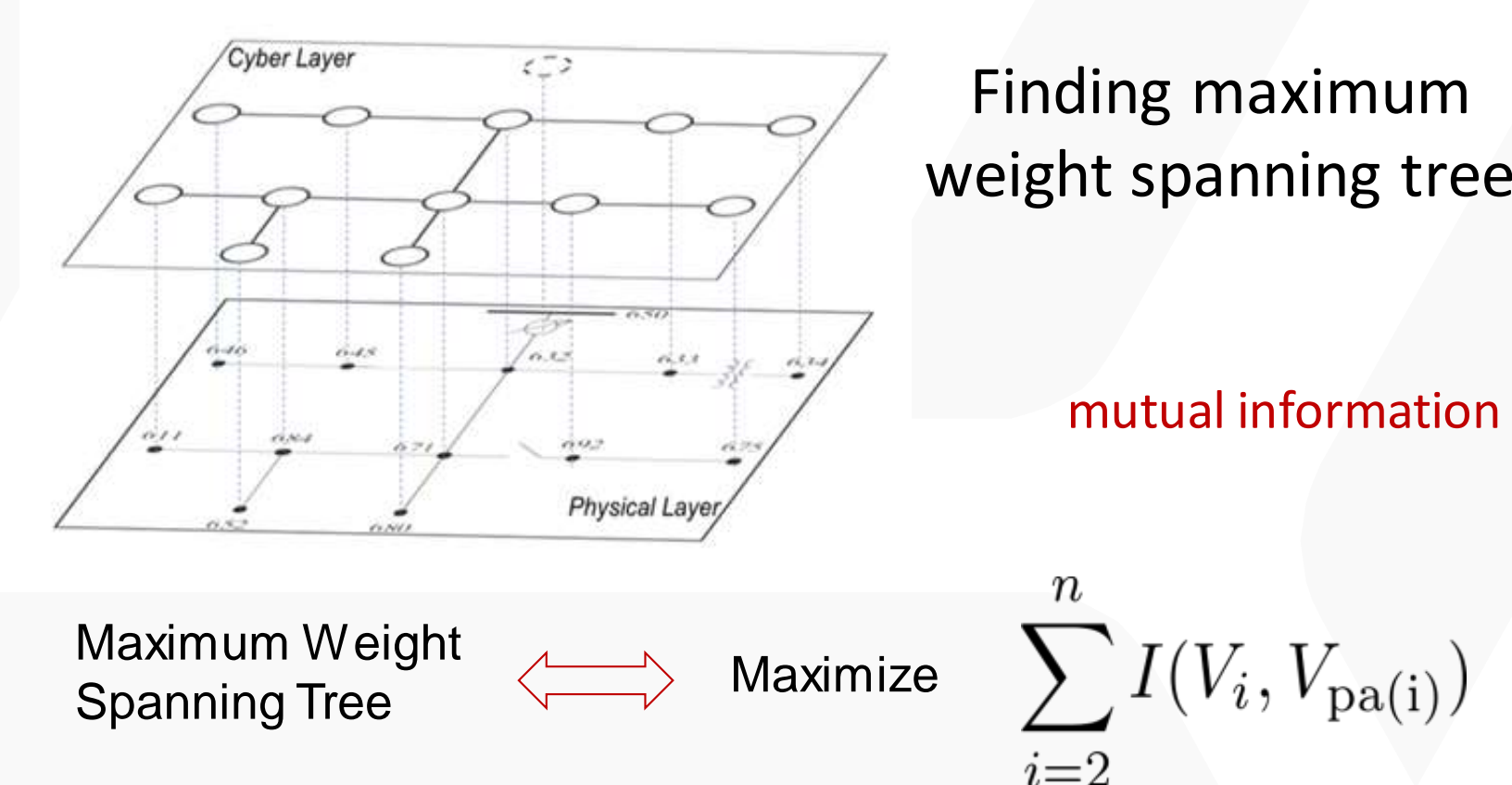

Real-time Outage Detection

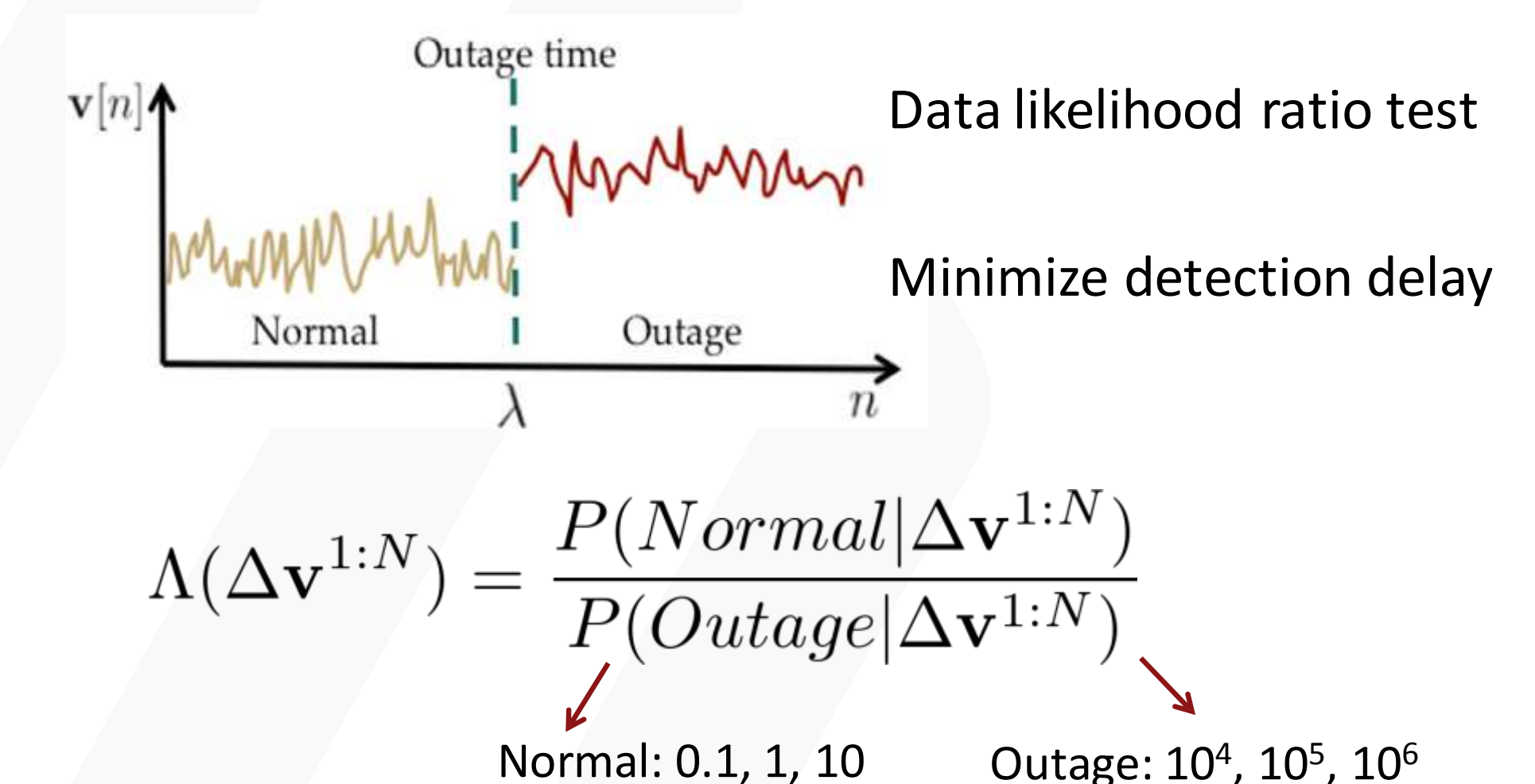

Solar Disaggregation

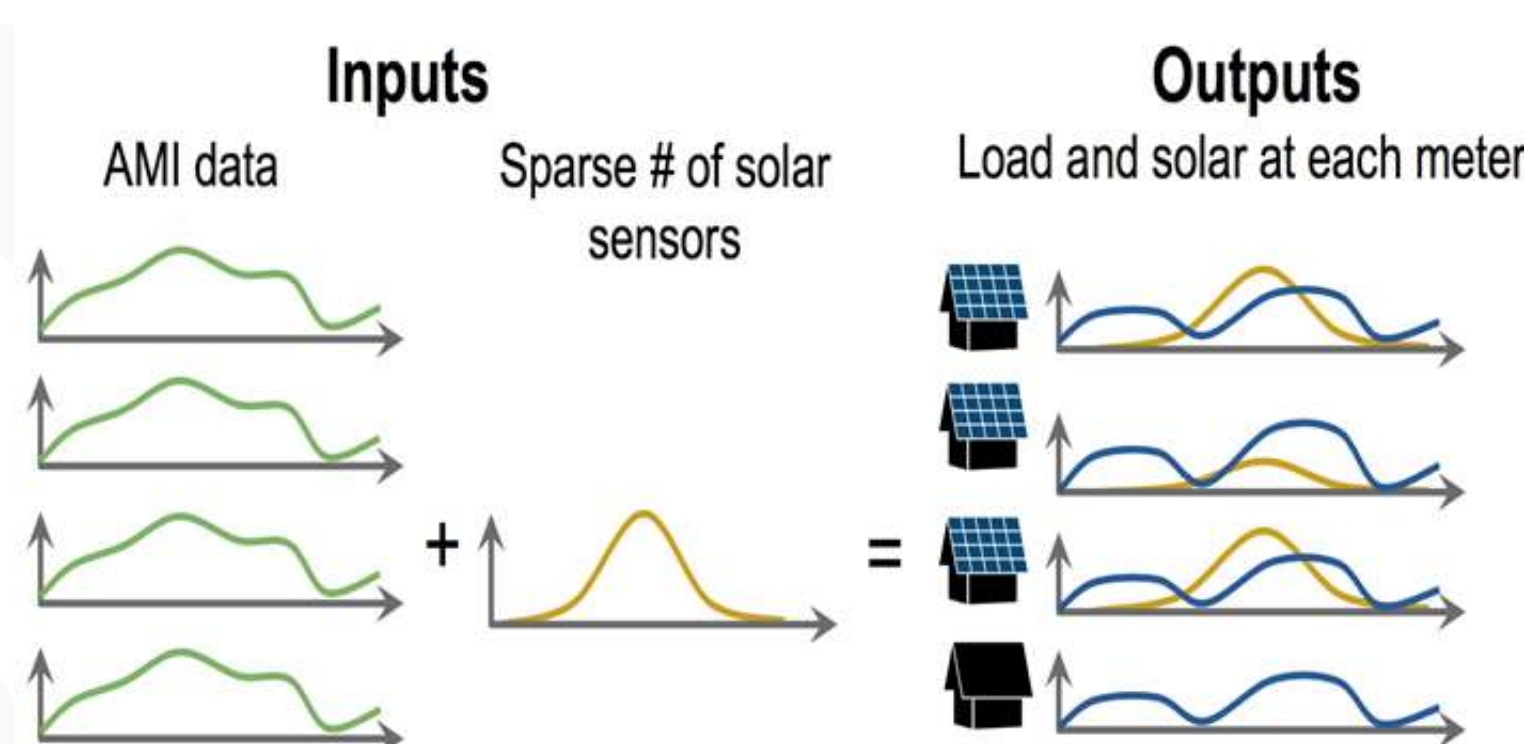

Joint Topology and Admittance Matrix Estimation

$$\min_{\hat{X}, \hat{Y}} \left\| [X^T, y] - [\hat{X}^T, \hat{y}] \right\|_{\Sigma}^2,$$

subject to $\text{Rank}([\hat{X}^T, \hat{y}]) < 2m + 1.$

Locating Renewables on Secondary Feeders

Support	Topology	Result
0.335832	Sun2 ↔ Node0	Incorrect
0.310845	Sun0 ↔ Node0	Correct
0.310345	Sun1 ↔ Node0	Incorrect
0.286357	Sun2 ↔ Node4	Incorrect
0.28086	Sun1 ↔ Node4	Incorrect
0.269365	Sun0 ↔ Node4	Incorrect

Voltagess from SunPower and SCE. Sun0 and Node0 are in close proximity.

EV Charging and Transformer Aging

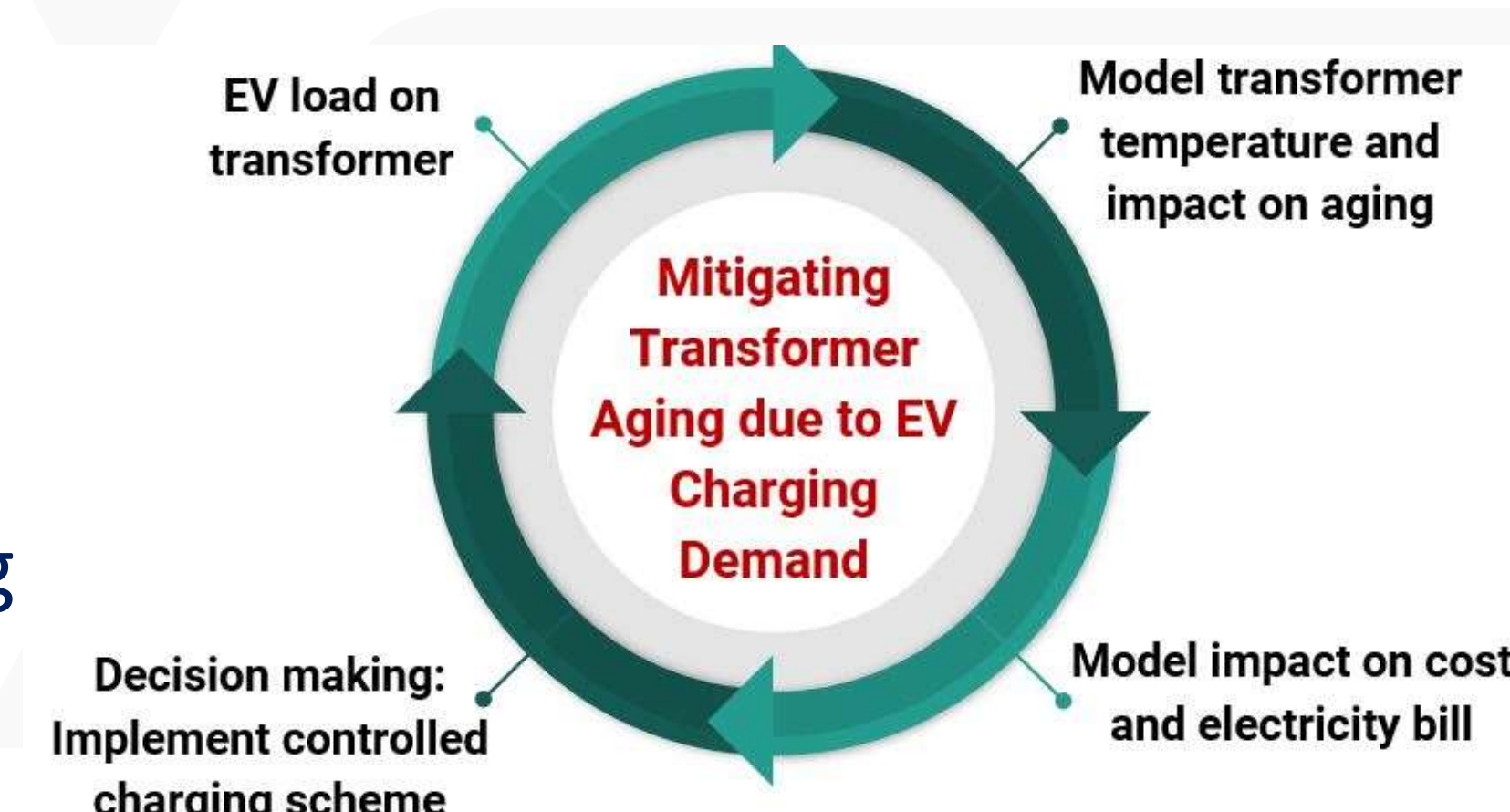

North American Renewable Integration Study

Project Description

The North American Renewable Integration Study (NARIS) is a collaboration between the U.S., Canada, and Mexico to study the system evolution to a modern power system in North America. The goal of the study is to help inform and assist power system stakeholders to better understand the implications of integrating large amounts of renewable resources into the power system. One of the key outcomes of the study will be to understand the value of cooperation between nations and between grid operators.

Expected Outcomes



INFORMING

grid planners, operators, market participants, and regulators of challenges and opportunities for the grid

- Is it **reliable** and **affordable**?
- What operating **practices** and **technologies** help the most?
- Are the “solutions” **robust**?
- What is the benefit of **inter-regional** and **cross-border** cooperation?



ENABLING

stakeholders to deepen and extend their understanding of renewables and modern power systems

- Creating and disseminating new **data**
- Pioneering and deploying new **methods** and computational **tools**



CREATING

a framework for future analysis

- **Stability** (i.e., frequency, transient, voltage)
- **Resilience** to extreme events (e.g., weather)

- Success in this project will mean that stakeholders (grid operators, industry, regulators, and others) will have the information, tools, and methods to help provide affordable and reliable electricity in the coming decades.

Significant Milestones	Date
Set of comprehensive scenarios modeled using ReEDS and dGen capacity expansion tools	12/31/2017
Draft operational modeling results of a NARIS scenario	3/31/2018
Capacity expansion scenarios refined and presented to the TRC	6/30/2018
Operational modeling results of a final (subject to TRC approval) NARIS scenario	9/30/2018

SCENARIO CREATION MODELS

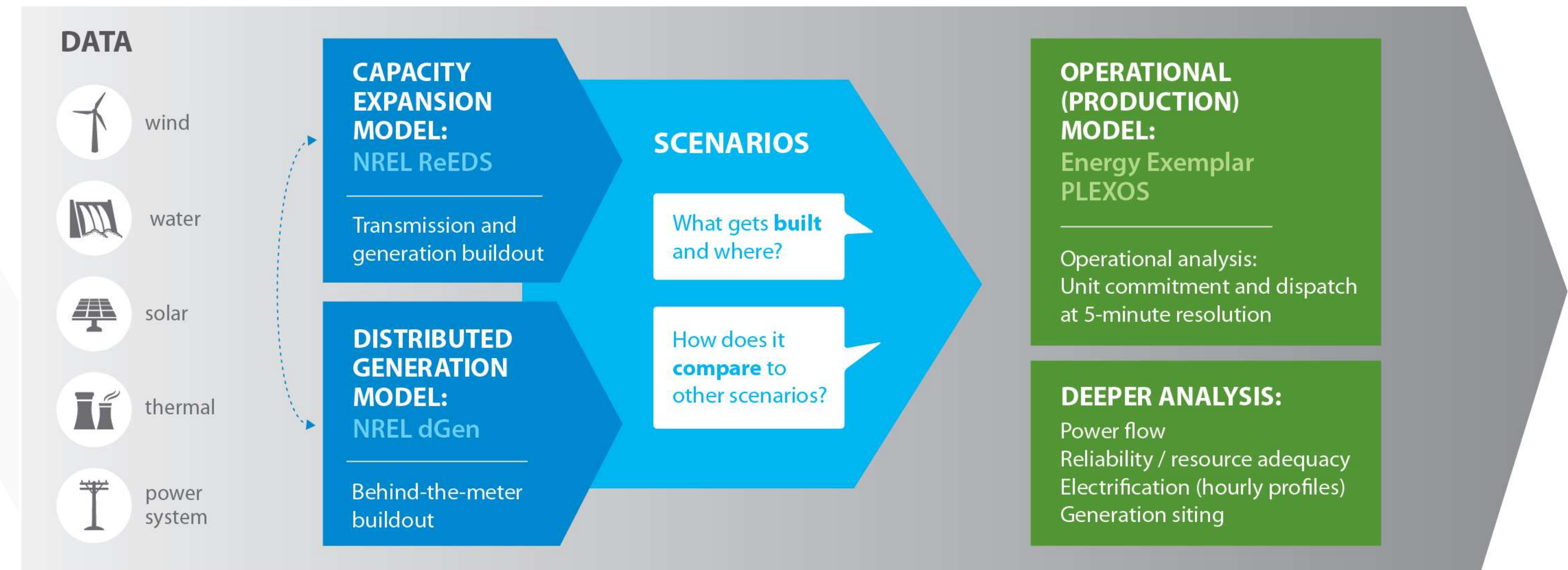

Data and modeling flow for creating scenarios and performing detailed operational and reliability analysis

North America is very diverse in resource and load. This is one of the key motivations behind this project

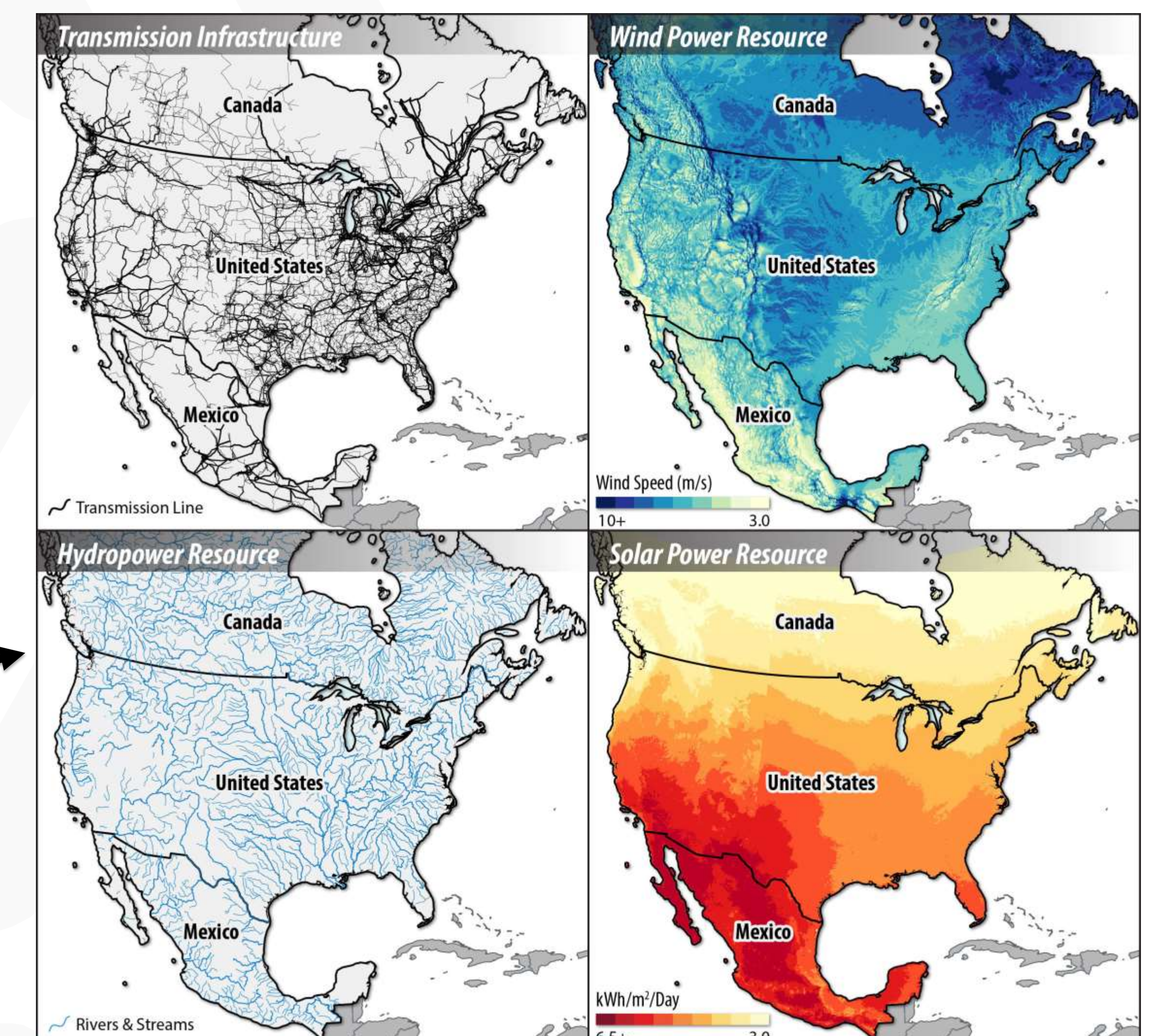

Progress to Date (in addition to milestones)

- Assembled a Technical Review Committee (TRC) and have hosted four in-person meetings of this group of system operators and planners
- Created most detailed North American power system multi-model dataset available (planning through power flow)
- Presentations at IEEE, EPRI, IEA, and other conferences
- Meteorological modeling for Mexico and Canada to be time-synchronous with the US (5 years at 5-minute resolution).
- reV tool created to process petabytes of meteorological data into digestible datasets (will be delivered to public in FY19)
- Probabilistic Resource Adequacy Suite (PRAS) developed and tested to understand reliability and contributions from both transmission and variable generation resources